

# BYTE

THE SMALL SYSTEMS JOURNAL

AUGUST 1985 VOL. 10, NO. 8

\$3.50 IN UNITED STATES  
\$4.25 IN CANADA / £2.10 IN U.K.  
A MCGRAW-HILL PUBLICATION  
0360-5280



**THE AMIGA** from Commodore

**DECLARATIVE  
LANGUAGES:**  
Prolog, Hope, FP



# No matter what business you're in

## Candidate Search Update

**FILE:** Resumes  
**SEARCH DATE:** 5/20/85  
**CLIENT:** Splendora Gourmet Baby Foods

### FIND

**EXPERIENCE:** Marketing Manager  
**FIELD:** Food/Beverage  
**SIZE:** 300+ Employees  
**SALARY REQ.:** \$40-\$50,000 Per Annum  
**LOCATION REQ.:** - Domestic  
 or  
**RELOCATABLE:** - 7 mi

Name	Experience	Salary	Education	Age
Antosz, Hank	1978—Present Pinz-Pinz Baby Food 1976—1978 Health Baby Products	\$45,000	Harvard MBA/Mktg.	33
Brown, Bob	1984—Present Liz for Kids 1982—1984 Bonnie Babe, Inc.	\$48,000	CSUN/Marketing BA	26
Hayden, Steve	1979—Present Health Baby Products 1975—1979 Nummy Tummys	\$43,000	UCLA/Sociology BA Harvard MBA	35
Morrison, John	1977—Present Camille Grocers, Ltd. 1974—1977 Georgie Porgie of London	\$40,000	Oxford/Marketing	32
West Nick	1961—Present Bonnie Babe, Inc.	\$47,000	UCLA MBA/Mktg.	42



**Recruit-A-Sell**  
 180 Adams Avenue  
 Suite 71  
 Detroit, Michigan

May 20, 1985

Dear Mr. Helm:

As a busy executive you know that accomplishing your many professional objectives is a full-time job.

And the last thing you need is to take time out of your hectic schedule to search for a new team player. That's where **Recruit-A-Sell** can help. We're a full-service recruitment firm with our finger on more than 5,000 meticulously selected, aggressive, ambitious, highly-qualified professionals not unlike yourself.

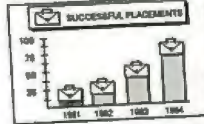

Our selective screening processes help us locate candidates who not only meet your specified work experience and salary requirements, but who are well suited to the corporate culture of your company.

One more reason we enjoy the highest success rate in the industry! Though our fees remain among the most competitive in the industry. Enclosed, please find more information on our client references, case histories and terms of business for your reading pleasure.

And next time you find yourself faced with an empty swivel chair, don't hesitate to call **Recruit-A-Sell**.

Sincerely,

*Cynthia Shem*

Cynthia Shem  
 Senior Associate

CS:dh

enc.



Using database management programs you can store, retrieve and sort information in an almost unlimited number of combinations. As opposed to the way you're probably doing it now. Above, we've located eligible candidates by salary and work experience. But database management is also handy for things like generating master mailing lists. Creating invoices. Sorting by zip code. Checking inventory. No files to lose. No cross-referencing your Rolodex. No paperclips.

In business, people often meet your letterhead before they meet you. Ever wondered what a typewritten page stiff with white-out says about your business? With The Macintosh Office you can even design and print your own letterhead, plus combine publication quality text and graphics for a lasting first impression. More important, you can send personalized letters to as many prospects as you have paper.

\* Manufacturer's suggested retail price. © 1985 Apple Computer, Inc. Apple, the Apple logo, LaserWriter, AppleTalk and MacDraw are trademarks of Apple Computer, Inc. Macintosh is a trademark of McIntosh Laboratory, Inc. and is being used with its express permission. Nabisco is a registered trademark of Nabisco, Inc. Rolodex is a registered trademark of Zephyr American Corporation, a subsidiary of Husco. \*\* Multiplan is a registered trademark of Microsoft Corporation.

# Business you're in, business.

## Candidate Profile Analysis



Each graph represents seven to ten pages of test information per candidate.

Individual tests are available for your review at your request.

As these comparative charts indicate, all candidates tested competitively in the four areas.

However, based on further in-depth study, including extensive personal interviews, we highly recommend you interview candidates 4 and 5 as soon as possible.

Our office will be contacting you immediately to set up these interviews at your earliest convenience.

## Recruit-A-Suit Income Statement Fiscal Year Ending 9/30/84

	Q1	Q2	Q3	Q4	Year-end
<b>SALES</b>					
Ann Arbor					
Fees	20,000	19,000	22,000	17,000	78,000
Commissions	53,000	45,000	48,000	42,000	188,000
Total Ann Arbor	72,000	64,000	70,000	59,000	285,000
Detroit					
Fees	44,000	46,000	42,000	39,000	171,000
Commissions	68,000	72,000	64,000	62,000	266,000
Total Detroit	112,000	118,000	106,000	101,000	437,000
<b>TOTAL SALES</b>	<b>184,000</b>	<b>182,000</b>	<b>176,000</b>	<b>160,000</b>	<b>702,000</b>
<b>OPERATING EXPENSES</b>					
Ann Arbor					
Payroll	35,000	30,000	33,000	30,000	128,000
Taxes	2,800	2,500	2,600	2,500	10,400
Auto	1,200	1,200	1,200	1,200	4,800
Telephone	800	800	800	800	3,200
Rent	8,000	8,000	8,000	8,000	32,000
Utilities	500	500	500	500	2,000
Office/Supplies	100	100	100	100	400
Advertising	3,000	3,000	4,000	4,000	14,000
Travel	1,000	1,000	1,000	1,000	4,000
Entertainment	1,500	1,500	1,350	1,500	5,850
Office Supplies	300	300	300	300	1,200
<b>Ann Arbor Total</b>	<b>48,200</b>	<b>46,100</b>	<b>53,100</b>	<b>48,700</b>	<b>196,100</b>
Detroit					
Payroll	80,000	82,000	80,000	80,000	322,000
Taxes	4,200	4,400	4,300	4,200	17,100
Auto	2,400	2,400	2,400	2,400	9,600
Telephone	1,200	1,500	1,500	1,200	5,400
Rent	9,100	9,100	9,100	9,400	36,700
Utilities	800	800	800	800	3,200
Office/Supplies	200	250	200	200	950
Advertising	3,000	3,600	3,500	3,000	13,600
Travel	1,200	1,800	1,200	1,400	5,600
Entertainment	1,600	1,800	1,600	1,400	6,400
Office Supplies	400	400	400	400	1,600
<b>Detroit Total</b>	<b>94,100</b>	<b>97,800</b>	<b>94,800</b>	<b>94,800</b>	<b>381,500</b>
<b>EXPENSES TOTAL</b>	<b>142,300</b>	<b>143,900</b>	<b>147,900</b>	<b>143,500</b>	<b>588,600</b>
<b>NET PRE-TAX PROFIT</b>	<b>41,700</b>	<b>38,100</b>	<b>28,100</b>	<b>16,500</b>	<b>113,400</b>

Whether you're Nabisco® or Ms. Priss' Cookie Company you worry about the bottom line. Write letters. Keep track of inventory. Keep your overhead under control. Pay taxes. Retrieve files. Schedule projects.

Which is why you can dramatically increase your business' productivity with The Macintosh™ Office.

The cornerstone of The Macintosh Office is our Macintosh 512K computer. All you need to know about its powerful, 32-bit, mouse-driven technology is that it reduces the time it takes to become productive with a computer from well over a work week to just under a lunch hour.

But more important, Macintosh runs more than 500 software programs that can solve a multitude of business problems.



When you team up Macintosh with the second hardest worker in The Macintosh Office, our LaserWriter™ printer, you can bring a new level of professionalism to your paperwork.

It produces publication-quality text and graphics in letters, internal documents, presentations, even business forms. There's no telling what it can save you in outside printing costs alone. And the LaserWriter can be shared with as many as 31 Macintosh computers. So it becomes more cost efficient with every Macintosh you connect to it.

Butcher, baker, candlestick-maker... or Nabisco, for more information about The Macintosh Office call 800-446-3000.

No job too big.  
Or too small.

## The Macintosh Office.



*If a picture is worth a thousand words, business graphics like these could cut meetings and presentations in half. We've taken information on five candidates stored in one software program, copied it into another program, where it was used to create these comparative bar graphs. Once your data is entered, this particular software program gives you your choice of 42 different graph configurations. You can preview your material (whether it's candidate dates, costs or rankings) in each configuration to decide which chart or graph most persuasively makes your point.*



*As you well know, business involves innumerable number related tasks, not the least of which is generating income and expense statements like this one. Should you want to change any of the entered items — to take a look at the effects of opening a new office or decreasing your staff — a spreadsheet program like Multiplan™ will automatically recalculate the entire document. (Here, we've copied it into MacDraw™ and enhanced it for presentation purposes.) It not only saves hours of entering, double checking and erasing, but when teamed up with our LaserWriter printer, it produces a printout impressive enough to show a bank president. Fast enough for this afternoon's meeting.*

# CONTENTS

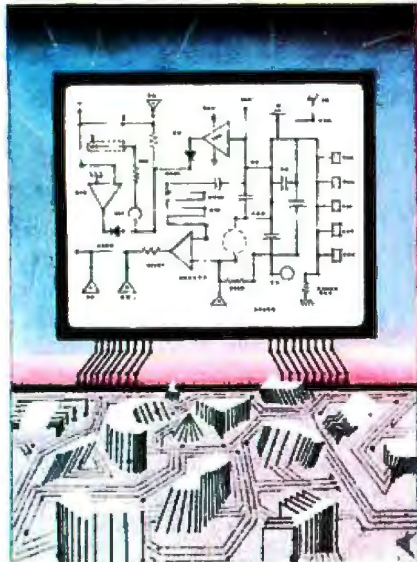

80

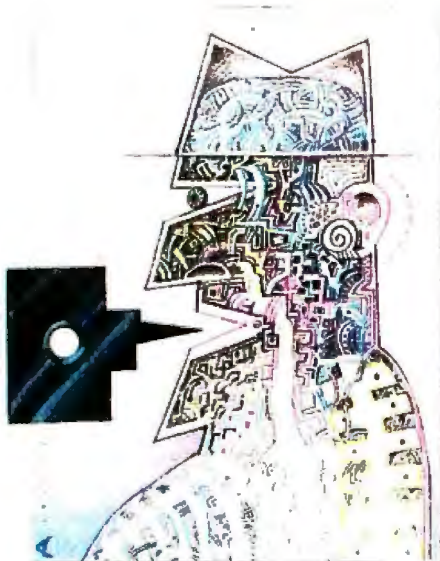

148

## FEATURES

- INTRODUCTION** ..... 80
- THE AMIGA PERSONAL COMPUTER**  
by Gregg Williams, Jon Edwards, and Phillip Robinson ..... 83  
It has plenty of computing power and impressive color graphics.
- CIARCIA'S CIRCUIT CELLAR:**  
**BUILD THE BASIC-52 COMPUTER/CONTROLLER** by Steve Ciarcia ..... 104  
Steve designs a cost-effective performance booster that can be used in serious applications.
- THE DSI-32 COPROCESSOR BOARD, PART I: THE HARDWARE**  
by Trevor G. Marshall, George Scolaro, David L. Rand, Tom King, and Vincent P. Williams ..... 120  
When plugged into an IBM PC, the DSI-32 is a complete National Semiconductor 32032 microcomputer with 256K bytes of memory.
- PROGRAMMING PROJECT:**  
**CONTEXT-FREE PARSING OF ARITHMETIC EXPRESSIONS**  
by Jonathan Amsterdam ..... 138  
This program lets you parse integer arithmetic expressions into executable form.

## THEMES

- INTRODUCTION** ..... 148
- PROLOG GOES TO WORK** by Clara Y. Cuadrado and John L. Cuadrado ..... 151  
What Prolog is, who's using it, and why.
- LOGIC PROGRAMMING** by Robert Kowalski ..... 161  
It can be implemented as either a declarative programming language or a procedural programming language.
- DECLARATIVE LANGUAGES: AN OVERVIEW**  
by Susan Eisenbach and Chris Sadler ..... 181  
Why we need another type of programming language.
- PROGRAM TRANSFORMATION** by John Darlington ..... 201  
A researcher in functional languages explains a program-development methodology.
- FUNCTIONAL PROGRAMMING USING FP**  
by Peter G. Harrison and Hessam Khoshnevisan ..... 219  
This language lets you program without objects by facilitating the manipulation of functions.
- A HOPE TUTORIAL** by Roger Bailey ..... 235  
Learn how to use one of the new generation of functional languages.

BYTE (ISSN 0360-5280) is published monthly with one extra issue per year by McGraw-Hill Inc. Founder: James H. McGraw (1860-1948). Executive, editorial, circulation and advertising offices: 70 Main St., Peterborough, NH 03458, phone (603) 924-9281. Office hours: Mon-Thur 8:30 AM - 4:30 PM, Friday 8:30 AM - 1:00 PM Eastern Time. Address subscriptions to BYTE Subscriptions, POB 190, Martinsville, NJ 08836. Postmaster: send address changes USPS Form 3579, undeliverable copies, and fulfillment questions to BYTE Subscriptions, POB 190, Martinsville, NJ 08836. Second-class postage paid at Peterborough, NH 03458 and additional mailing offices. Postage paid at Winnipeg, Manitoba. Registration number 9321. Subscriptions are \$21 for one year, \$38 for two years, and \$55 for three years in the USA and its possessions. In Canada and Mexico: \$23 for one year, \$42 for two years, \$61 for three years. \$69 for one year air delivery to Europe, 17,000 yen for one year surface delivery to Japan, \$37 surface delivery elsewhere. Air delivery to selected areas at additional rates upon request. Single copy price is \$1.90 in the USA and its possessions, \$1.95 in Canada and Mexico, \$4.90 in Europe, and \$5 elsewhere. Foreign subscriptions and sales should be remitted in United States funds drawn on a US bank. Please allow six to eight weeks for delivery of first issue. Printed in the United States of America.

## REVIEWS

<b>INTRODUCTION</b> .....	262
<b>REVIEWER'S NOTEBOOK</b> <i>by Glenn Hartwig</i> .....	265
<b>THE TANDY 1000</b> <i>by Rich Malloy</i> .....	266
An inexpensive IBM PC-compatible system.	
<b>IBM PASCAL 2.00</b> <i>by Patrick J. Finan</i> .....	275
Improvements include better documentation and support of an 8087 coprocessor.	
<b>REVIEW FEEDBACK</b> .....	283
Readers respond to previous reviews.	

## KERNEL

<b>INTRODUCTION</b> .....	290
<b>COMPUTING AT CHAOS MANOR: THE WEST COAST COMPUTER FAIRE</b> <i>by Jerry Pournelle</i> .....	293
A drive to San Francisco lets Jerry see a multitude of new products.	
<b>BYTE JAPAN: COMDEX IN JAPAN</b> <i>by William M. Raike</i> .....	331
Bill describes many of the new products that were featured at the first-ever COMDEX show in Japan.	
<b>BYTE U.K.: DECLARATIVE UPDATE</b> <i>by Dick Pountain</i> .....	341
Dick rounds out this month's "Declarative Languages" theme with reviews of two books and a look at two new language systems.	
<b>ACCORDING TO WEBSTER: GREETINGS AND AGITATIONS</b> <i>by Bruce Webster</i> ....	355
More Macintosh products are discussed this month.	
<b>BYTE WEST COAST: NEW MICROPROCESSOR CHIPS</b> <i>by Phillip Robinson</i> ....	369
Phil looks at Intel's iAPX 386, the 80C86, and Atron's "hardware-assisted" debugger for the 86 family.	
<b>CIRCUIT CELLAR FEEDBACK</b> <i>conducted by Steve Ciarcia</i> .....	376
Steve answers project-related queries from readers.	
<b>BYTELINES</b> <i>conducted by Sol Libes</i> .....	378
News and speculation about personal computers.	

<b>EDITORIAL:</b>	
A VERY SPECIAL ISSUE .....	6
MICROBYTES .....	9
LETTERS .....	14
FIXES AND UPDATES .....	33
WHAT'S NEW .....	39, 380

BOOK REVIEWS .....	49
ASK BYTE .....	70
UNCLASSIFIED ADS .....	429
BYTE'S ONGOING MONITOR BOX. BOMB RESULTS .....	430
READER SERVICE .....	431

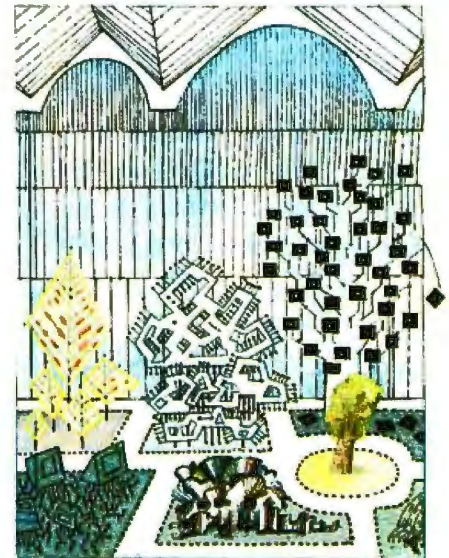

262



290

Address all editorial correspondence to the Editor BYTE, POB 372, Hancock, NH 03449. Unacceptable manuscripts will be returned if accompanied by sufficient first-class postage. Not responsible for lost manuscripts or photos. Opinions expressed by the authors are not necessarily those of BYTE.  
 Copyright © 1985 by McGraw-Hill Inc. All rights reserved. Trademark registered in the United States Patent and Trademark Office. Where necessary permission is granted by the copyright owner for libraries and others registered with the Copyright Clearance Center (CCC) to photocopy any article herein for the flat fee of \$1.00 per copy of the article or any part thereof. Correspondence and payment should be sent directly to the CCC, 29 Congress St., Salem, MA 01970. Specify ISSN 0360-9280 B3 \$1.00. Copying done for other than personal or internal reference use without the permission of McGraw-Hill Inc. is prohibited. Requests for special permission or bulk orders should be addressed to the publisher. BYTE is available in microform from University Microfilms International, 300 North Zeeb Rd., Dept. PR, Ann Arbor, MI 48106 or 18 Bedford Row, Dept. PR, London WC1R 4EJ England.  
 Subscription questions or problems should be addressed to: BYTE Subscriber Service, POB 328, Hancock, NH 03449.





## Can You Name a Dual-Drive Color PC That Runs Lotus 1,2,3 and Costs Under \$1500?

### Hints

- It comes with a 14" RGB monitor much like the 14" monitor that comes with the \$2495 Leading Edge PC.
- It has dual 800K disk drives much like the \$2495 Tandy 2000, but it also has the ability to read and write to popular 160K, 320K, and 360K IBM-PC formats.
- It's an 8088, MS-DOS system with 256K of RAM, but it comes with a better free software bundle than the 8-bit Kaypro including MS-DOS 2.11, HAGEN-DOS, DOS-TUTOR, WordStar 3.3, EasyWriter, Spell, Mail Track, PC File III, FILE-BASE, CalcStar, games, graphics, utilities, and two BASIC languages.
- Although it's not PC-DOS compatible it will run hundreds of the same programs as the IBM including dBASE II, Multiplan, the PFS series, Lotus 1,2,3 and even Flight Simulator.
- During the dog days of summer computer sales, we've lowered the prices of both our color and monochrome systems. You can receive a free booklet on these systems by calling our machine at 1-800-FOR A FOX, and leaving your name and address at the beep.

Your time is up the answer is:

ColorFox ..... \$1497

also

Fox Jr. ... \$899 Silver Fox .. \$1297



**Scottsdale Systems, Ltd**

617 N Scottsdale Rd #B, Scottsdale, Az 85257

(602) 941-5856

The Silver Fox is sold exclusively by Scottsdale Systems Ltd., 617 N. Scottsdale Road #B, Scottsdale, AZ 85257. Trademarks: Silver Fox, HAGEN-DOS, and Datemate. Scottsdale Systems Ltd.: WordStar and CalcStar. Micropro International: MS-DOS, and Multiplan. Microsoft Corporation: FILEBASE, EWWP Software, Inc., dBASE II, Ashton-Tate, IBM-PC, and IBM-PC DOS. International Business Machines Corporation. Ordering: Telemarketing only, Silver Fox price is for cash, F.O.B. Scottsdale, prices subject to change, product subject to limited supply. We accept purchase orders from Fortune 1000 companies and major universities with good credit - add 2% Visa, Mastercard add 3%, AZ residents add 6%. Returned merchandise subject to a 20% restocking fee. Personal or company checks take up to 3 weeks to clear. No COD's or APO's.

# BYTE

## EDITOR IN CHIEF

PHILIP LEMMONS  
MANAGING EDITOR  
GENE SMARTÉ

## CONSULTING EDITORS

STEVE CIARCIA  
JERRY POURNELLE  
BRUCE WEBSTER

## SENIOR TECHNICAL EDITORS

G. MICHAEL VOSE *Thermis*  
GREGG WILLIAMS

## TECHNICAL EDITORS

THOMAS R. CLUNE  
JON R. EDWARDS  
RICHARD GREHAN  
GLENN HARTWIG *Reviews*  
KEN SHELDON  
RICHARD S. SHUFORD  
JANE MORRILL TAZELAAR  
EVA WHITE  
STANLEY WSZOLA

MARGARET COOK GURNEY *Associate*

ALAN EASTON *Drafting*

## WEST COAST EDITORS

EXRA SHAPIRO *Bureau Chief, San Francisco*  
PHILLIP ROBINSON *Senior Technical Editor, Palo Alto*  
DONNA OSGOOD *Associate Editor, San Francisco*  
BRENDA McLAUGHLIN *Editorial Assistant, San Francisco*

## NEW YORK EDITOR

RICHARD MALLOY *Senior Technical Editor*

## MANAGING EDITOR

## ELECTRONIC PUBLISHING AND COMMUNICATIONS

GEORGE BOND

## USER NEWS EDITOR, EAST COAST

ANTHONY I. LOCKWOOD *What's New*

## USER NEWS EDITOR, WEST COAST

MARK WELCH *Microbytes*

## CONTRIBUTING EDITORS

JONATHAN AMSTERDAM *programming projects*  
MARK DAHMKE *video operating systems*  
MARK HAAS *at large*  
RIK JADRNIČEK *CAD graphics spreadsheets*  
MARK KLEIN *communications*  
ALASTAIR J. W. MAYER *software*  
ALAN MILLER *languages and engineering*  
JOHN C. NASH *scientific computing*  
DICK POUNTAIN *U.K.*  
WILLIAM M. RAIKE *Japan*  
PERRY SAIDMAN *computers and law*  
ROBERT STERNE *computers and law*

## COPY EDITORS

BUD SADLER *Chief*  
DENNIS BARKER  
ELIZABETH COOPER  
ANNE L. FISCHER  
NANCY HAYES  
LYNNE M. NADEAU  
PAULA NOONAN  
JOAN VIGNEAU ROY  
WARREN WILLIAMSON

## ASSISTANTS

PEGGY DUNHAM *Office Manager*  
MARTHA HICKS  
LISA JO STEINER

## ART

ROSSLYN A. FRICK *Art Director*  
NANCY RICE *Assistant Art Director*

## PRODUCTION

DAVID R. ANDERSON *Production Director*  
DENISE CHARTRAND  
MICHAEL J. LONSKY  
JAN MULLER

## SENIOR VICE PRESIDENT/PUBLISHER

HARRY L. BROWN  
PUBLISHER'S ASSISTANT  
BEVERLY JACKSON

## PERSONNEL

CHERYL HURD *Office Manager*  
PATRICIA BURKE *Personnel Coordinator*

## ADVERTISING SALES (603-924-6137)

I. PETER HUESTIS *Sales Manager*  
SANDRA FOSTER *Administrative Assistant*  
ADVERTISING/PRODUCTION (603-924-6448)  
LISA WOZMAK *Supervisor*  
ROBERT D. HANNINGS *Senior Account Coordinator*  
MARION CARLSON  
KAREN CILLEY  
LYDA CLARK  
MICHELE GILMORE  
DENISE PROCTOR  
WAI CHIU LI *Quality Control Manager*  
JULIE NELSON *Advertising Production Coordinator*

## CIRCULATION (800-258-5485)

GREGORY SPITZFADEN *Director*  
ANDREW JACKSON *Subscriptions Manager*  
CATHY A. RUTHERFORD *Assistant Manager*  
LAURIE SEAMANS *Assistant Manager*  
SUSAN BOYD  
PHIL DECHERT  
MARY EMERSON  
LOUISE MENEZES  
AGNES E. PERRY  
JENNIFER PRICE  
JAMES BINGHAM *Single-Copy Sales Manager*  
LINDA RUTH *Assistant Manager*  
CAROL AND  
CLAUDETTE CARSWELL  
KAREN DESROCHES

## MARKETING COMMUNICATIONS

HORACE T. HOWLAND *Director (603-924-3424)*  
VICKI REYNOLDS *Marketing Production Manager*  
PRISCILLA ARNOLD *Marketing Assistant*  
STEPHANIE WARNECKY *Marketing Art Director*  
SHARON PRICE *Assistant Art Director*  
DOUG WEBSTER *Director of Public Relations (603-924-9027)*  
WILBUR S. WATSON *Operations Manager, Exhibits*

## PLANNING AND DEVELOPMENT

MICHELE P. VERRILLE *Manager*  
PATRICIA AKERLEY *Research Manager*  
CYNTHIA DAMATO SANDS *Reader Service Coordinator*  
FAITH KUUNTZ *Copyrights Coordinator*

## MANUFACTURING/FINANCE/SERVICES

DANIEL RODRIGUES *Director*

## ACCOUNTING

KENNETH A. KING *Assistant Controller*  
VICKI WESTON *Accounting Manager*  
LINDA SHORT *DTP Manager*  
EDSON WARE *Credit*  
MARIE CAGGIANI  
MARILYN HAIGH  
DIANE HENRY  
VERN ROCKWELL  
JOANN WALTER

## TYPOGRAPHY

SHERBY MCCARTHY *Chief Typographer*

NAN FORNAL

LEN LORETTE

KATHY QUIST

DONNA SWEENEY

## BUILDING SERVICES/TRAFFIC

ANTHONY BENNETT *Building Services Manager*

BRIAN HIGGINS

MARK MONKTON

## RECEPTIONISTS

L. RYAN MCCOMBS

CHERYL CASTRO *Assistant*

**Editorial and Business Office:** 70 Main Street Peterborough New Hampshire 03458 (603) 924-9281

**West Coast Offices:** McGraw-Hill 423 Battery St. San Francisco CA 94111 (415) 362-6600

McGraw-Hill 1000 Ewell Court Palo Alto CA 94303 (415) 964-0624

**New York Office:** 1221 Avenue of the Americas New York NY 10020 (212) 512-2000

Officers of McGraw-Hill Information Systems Company: President Richard B. Miller, Executive Vice Presidents Frederick P. Lamott, Construction Information Group, Russell C. White, Computers and Communications Information Group, I. Thomas Ryan, Marketing and International, Senior Vice Presidents Francis A. Shmal, Controller Robert C. Violette, Manufacturing and Technology, Senior Vice Presidents and Publishers Laurence Altman, Electronics Week, Harry L. Brown, BYTE and Popular Computing, David J. McGrath, Construction Publications Group, Vice President Peter B. McCuen, Communications Information, Vice President Fred O. Jensen, Planning and Development. Officers of McGraw-Hill Inc.: Harold W. McGraw, Jr., Chairman, Joseph L. Dionne, President and Chief Executive Officer, Robert N. Landes, Executive Vice President and Secretary, Ralph J. Webb, Vice President and Treasurer, Shel F. Asen, Vice President, Manufacturing, George R. Elsing, Vice President, Circulation, Ralph R. Schulz, Senior Vice President, Editorial/Publishing Operations.

# Give yourself a Giff.™



Now you can network IBM PCs with a powerful, multitasking, multiuser system.

Run popular MS-DOS™ programs like Lotus™ 1-2-3, SuperCalc® 3 and WordStar™ Plus all the thousands of CP/M® programs. Plus true multiuser accounting, database management, and electronic mail.

Gifford's MC-NET™, running on our MC-186™ and IBM compatible PCs, gives you all this capability and more. It lets you grow a network that shares information and resources among hundreds of people. With full security. Advanced telecommunications. And the ease of use of a standalone PC.

Get the whole story on Gifford hardware, software and service. Just call 415/895-0798 and ask for a Giff Pack.™ Or write to us at 2446 Verna Court, San Leandro, CA 94577.

Give yourself the Giff that keeps on giving.

**G** **GIFFORD**  
**COMPUTER SYSTEMS**  
A subsidiary of Zitel Corporation  
**THE MULTIUSER COMPANY™**

2446 Verna Court, San Leandro, CA 94577 415/895-0798 Telex 704521 2050 North Loop West, Suite 116 Houston, TX 77018 713/680-1944  
In Europe: London (01) 337-2372 Telex 28106 (UK)

MC-NET and MC-186 are trademarks of Gifford Computer Systems. MS-DOS, CP/M, Lotus 1-2-3, SuperCalc 3 and WordStar are trademarks of MicroSoft, Digital Research, Lotus Development Corporation, Sorcim/IUS Micro Software, and MicroPro International respectively.

## A VERY SPECIAL ISSUE

BYTE's readers like to stay on the leading edge of technology and to try things for themselves. We think this issue offers extraordinary opportunities for you to discover some of the most exciting developments at the forefront of personal computing. The new Amiga personal computer from Commodore International is a machine to rekindle the enthusiasm that drives personal computing.

Gregg Williams, Jon Edwards, and Phil Robinson have explained the Amiga's architecture in fascinating detail. The Amiga's custom coprocessors for the 68000 bring high performance. Dazzling graphics and audio and an open expansion bus make the Amiga the intellectual and technical heir to the Apple II. The Amiga's operating system is a full-color, icon-based windowing system with true concurrency. All the dazzle does nothing to inhibit the Amiga's performance in any serious application.

The Amiga's price seems fair, too. With the 68000, three custom chips that control graphics, audio, and peripherals, voice synthesis hardware with software to drive it, 256K bytes of RAM, 192K bytes of ROM, and input/output that includes an 800K-byte microfloppy, RGB analog, RGB digital, NTSC composite, two stereo jacks, a mouse, a parallel port, a high-speed serial port, and a disk port, plus the expansion bus, BASIC, a word processor, a paint program, and four other pieces of bundled software, the Amiga retails for \$1295. Add Tecmar's \$995 hard disk and an RGB monitor, and you have a phenomenal computer system.

This issue also offers readers an opportunity to build a true 32-bit computer system. Based on National Semiconductor's 32032, the Definion DSI-32 coprocessor board for the IBM PC also uses the NS32081 floating-point chip and has the NS32082 memory-management chip as an option. FORTRAN, Pascal, C, and other languages are available. If you have an IBM PC with 15 watts of power to spare, the DSI-32 can move you a generation ahead in computing power. Phil Robinson was instrumental in bringing this exciting project to the pages of BYTE.

Steve Ciarcia, preparing the blockbuster Circuit Cellar SB180 computer for September's 10th Anniversary issue, gives us the versatile and powerful BASIC-52 computer/controller (BCC-52) this month. Programmable in a ROM-based BASIC, the BASIC-52 and its on-board language are ideal for process control and are bus-compatible with Steve's earlier Z8 controllers. The BCC-52 board utilizes the Intel 8052AH-BASIC microcontroller chip and includes 48K bytes of RAM/EPROM, an EPROM programmer, three parallel ports, a serial terminal port, and a serial printer port.

Jonathan Amsterdam's Programming Project shows how to parse integer arithmetic expressions into executable form. This software project is written in Pascal for the Apple II, but Jonathan has taken care to write portable code. He has also explained the roots of the project in linguists' work on context-free grammars. The article goes from theory of context-free grammars to a working Pascal version of a Texas Instruments-style four-function integer calculator. We'll be having at least one Programming Project in the feature section each month.

### LEADING-EDGE SOFTWARE

The feature section emphasizes hardware in part because the theme section is devoted to declarative programming languages. Declarative languages are gaining popularity because they are ideal for parallel processing and because their proponents claim they will increase the productivity of programmers.

Thanks to contributions from a variety of authors, including several at the Imperial College of Science and Technology in London, England, this language issue gives readers insights into relational languages such as Prolog and functional languages such as Hope and FP. (There is little on LISP because of a previous theme issue on LISP and additional LISP articles in the April 1985 issue.) Special thanks go to Susan Eisenbach of Imperial College and Tom Clune of the BYTE staff for putting this theme section together.

Susan Eisenbach and Chris Sadler give an overview of declarative languages. Robert Kowalski, one of the pioneers of

Prolog, explains logic programming as a form of processing that is congenial to human thinking and also easy to implement on a computer. Clara and John Cuadrado tell who is using Prolog where and for what. John Darlington gives an excellent account of the power that declarative languages gain from their "referential transparency"—the fact that the meaning of a program fragment depends only on the meanings of its components, not on the history of any computation done before the evaluation of the fragment. Darlington provides examples written in Hope. Peter Harrison and Hessam Khoshnevisan give us a look at John Backus's functional programming language, FP, which builds variable-free programs from a set of primitive programs by use of program-forming operations and recursive definitions.

Finally, Roger Bailey gives a lucid tutorial in the use of Hope that should bring you into the world of declarative languages. Although he didn't write an article, Victor Wu of Imperial College ported a version of Hope from an Apricot machine to the IBM PC. Victor's version of Hope together with Roger's fine tutorial mean that you can download Hope from BYTenet Listings and try a declarative language for yourself. BYTenet Listings also offers a public-domain version of Prolog.

### SACRIFICES MADE

To get in the long articles on the Amiga, the DSI-32, and the declarative languages, we had to cut from this issue some articles and advisories that we badly wanted to run. We had less editorial space at our disposal than at any time since April 1981. The sacrifices included Books Received, Event Queue, Clubs and Newsletters, Chaos Manor Mail, all reviews except those of the Tandy 1000 and IBM Pascal 2.00, several strong feature articles, and additional strong articles on declarative languages. Our apologies to all editors and authors concerned. We will publish as many of the postponed articles as we can as soon as we can. We are considering electronic publication of some of the postponed material.

—Phil Lemmons, Editor in Chief





# Maxell Gold.

The floppy disk  
that keeps IBM® PC™  
letter perfect,  
helps Xerox 860®  
write great copy,  
and puts more bang  
in Wang®.

Whether you're banging out a letter to Australia, creating a contract, or doing a case study on centipedes, dot every i with Maxell. The Gold Standard in floppy disks. Maxell is an industry leader in durability and error-free performance. There's a Maxell for virtually every computer made, and each comes with a lifetime warranty. That's why, when every word counts, you can count on Maxell.

**maxell**®  
IT'S WORTH IT.



**YOUR DAYS OF BUYING GRAPHICS TERMINALS ARE OVER!**

Now there are two ways to use your PC to access popular mainframe graphics products like SAS/GRAPH\*, TELLAGRAPH\*, RS/1\*, DISSPLA\*, and PLOT-10\*. Joining our popular SmarTerm 125 DEC\* VT125 ReGIS graphics emulator, our new SmarTerm 4014 product gives you full Tektronix\* 4010/4014 plus DEC VT102 emulation. View the entire graphics image on the PC screen, or use the powerful instant ZOOM feature to magnify a selected portion of the

screen image to full Tektronix 1024 x 768 resolution.

Using Picture Replay, pictures drawn by the host can be saved, sent to other users, examined in detail using ZOOM mode, and printed or plotted offline. Like all SmarTerm emulators, SmarTerm 4014 includes powerful text and binary file transfer facilities, PDIP\* and XMODEM protocol support, and TTY mode to link you to popular time sharing services.

By the way, if you only need text terminal emulation, be sure to ask about our SmarTerm 220, SmarTerm 100, and SmarTerm 400 products.

Join the more than 25,000 "FIRST CLASS" people who use SmarTerm. Try it for 30 days with full refund privileges.



Available from Computerland, your local software dealer, or Persoft, Inc. - 2740 Ski Lane Madison, WI 53713 (608) 273-6000 - TELEX 759491

# AFTER SMARTERM®, WHAT DO YOU DO WITH YOUR OBSOLETE TERMINAL?



**IDEA CREDIT:** Jill Roth of Chino, California. Send us your ideas for uses of obsolete terminals replaced by SmarTerm. The best ideas will be used in future ads. Write Persoft, Dept. MAILBOX, 2740 Ski Lane, Madison, WI 53713.

\*SMARTERM is a registered trademark of Persoft, Inc. \*PDIP is a trademark of Persoft, Inc. \*DEC, VT and ReGIS are trademarks of Digital Equipment Corp. \*Tektronix and PLOT-10 are registered trademarks of Tektronix, Inc. \*SAS/GRAPH is a trademark of SAS Institute, Inc. \*RS/1 is a trademark of Bolt Beranek and Newman, Inc. \*TELLAGRAPH is a trademark of ISSCO Graphics Corp. \*DISSPLA is a trademark of Control Data Corp.



Inquiry 246

# M·I·C·R·O·B·Y·T·E·S

---

Staff-written highlights of late developments in the microcomputer industry.

## **Sinclair Rescued from Bankruptcy; Sir Clive Loses Clout**

---

In a marathon weekend session, Sinclair Research and Hollis Brothers & ESA Plc, a major distributor of office and educational equipment in the U.K., reached a buy-out agreement that saved the British computer maker from defaulting on more than £14 million of back bills. In the buy-out, Sir Clive Sinclair surrendered his controlling interest in the company and parted with his chairmanship. He will now serve as Sinclair Research's Lifetime President and as a research consultant.

Trouble had been brewing at Sinclair for some time: Christmas sales were disappointing, the QL computer failed to capture a market, the post-Christmas lull was deafeningly silent (industry wags claim that not a single Sinclair was sold during the first 60 days of 1985), and corporate cash was tied up in unsold inventory and research.

The squeeze came when Thorn/EMI, producer of Sinclair's products, demanded that Sinclair clear its tab. Sinclair, unable to meet its obligations, then began moving toward liquidation. But it stepped Hollis Brothers, amid rumors that 10 Downing Street would be pleased to see Sinclair rescued.

Hollis Brothers arranged to pick up £12 million worth of Sinclair stock. To finance the remaining debt, Sinclair will offer current shareholders a 3-for-1 deal. Depending upon how investors exercise their entitlements, Sir Clive Sinclair will end up holding from 8 to 23 percent. He once owned more than 80 percent.

More than 70 percent of Hollis Brothers & ESA Plc is held by Robert Maxwell, who is viewed in England with the same mixture of awe and annoyance as T. Boone Pickens in the United States. Maxwell will serve as Sinclair's board chairman, a position he already holds at London's *Daily Mirror* and the Pergom Press.

## **Developments Bring Optical Discs Closer to Market**

---

Several developments in June suggested that low-cost optical discs and drives might arrive on the market fairly soon.

Atari showed a compact-disc ROM (read-only memory) player at its booth at the Consumer Electronics Show in Chicago. The company also demonstrated software, developed by Activenture, that accesses the information in an encyclopedia stored in one-third of a 550-megabyte disc. Atari said it will sell CD ROM drives for less than \$600 by the end of this year. CD ROM drives use the same 12-cm (4.7-inch) read-only compact discs used in stereo CD players but require additional error-checking and -correcting circuitry. Activenture said the encyclopedia disc might sell for about \$200. Neither Activenture nor Grolier would confirm reports that Grolier's encyclopedia is on the optical disc.

Just as 12-cm CD ROM drives seemed likely to hit the market, however, CD developer Sony announced it would be focusing its data-storage efforts on a 13-cm (5¼-inch) disc size to increase disc capacity and perhaps provide an upgrade path to write-once and erasable magneto-optic discs. The Sony "DataROM" 13-cm format was reportedly supported by several other Japanese companies at a standards meeting.

National Memory Systems, Livermore, CA, announced two optical-disc products that include interfaces and software for the IBM PC. The \$19,900 NMS-007 uses Optimem's 1-gigabyte 12-inch optical drive and cartridges; NMS says that drive is available now. NMS also plans to offer the \$5000 01-OL drive; it uses Optotech's 400-megabyte 5¼-inch drive and cartridges.

## **New Products Use 65816 Processor**

---

A 4-megahertz version of the 65816 microprocessor, designed to provide more processor horsepower while maintaining compatibility with the 8-bit 6502, is now available to end users. Micro Magic, Millersville, MD, has unveiled MAX-816, an Apple II expansion card that adds a 4-MHz 65816 and 256K bytes of RAM. Micro Magic is developing an operating

(continued)

system, MAX-OS, loosely based on UNIX, to take full advantage of the 65816. The firm also plans to add a 1024 by 1024 graphics card and a cache disk controller to accompany the MAX-816 board. While the basic MAX-816 card will be priced at less than \$500 with 256K bytes, up to 1 megabyte can be added to the card, and the 65816 can directly address up to 16 megabytes of RAM.

An earlier 65816 card (\$395, 1 MHz) is available from Com Log, Scottsdale, AZ. Manx Software Systems, Freehold, NJ, said it expects to finish a 65816 version of its Aztec C compiler late this year; the compiler will run on the Apple II under ProDOS and DOS 3.3.

---

## C Compilers Expand to New Systems

Manx Software Systems reportedly expected to add native versions of its C compiler for the Commodore 64 and 128 and Apple's Macintosh, as well as an Apple II ProDOS version. The product line, including the \$49.95 Apprentice C, was previously sold for the IBM PC and Apple II, with a cross-compiler offered for the Commodore 64. Manx will also provide native compilers for the Commodore Amiga and Atari ST later this year.

Lattice also expected to provide versions of its C compiler for 68000-based systems, including the Commodore Amiga, Atari ST, Sinclair QL, and Apple Macintosh. Both Lattice and Manx are porting cross-compilers to IBM's PC AT.

---

## Two MS-DOS Portable Computers Enhanced

Hewlett-Packard unwrapped the Portable Plus, a 25-line, unbundled version of its Portable. While the Portable included a 300-bps modem, 256K bytes of RAM, and applications software in ROM, the standard Portable Plus provides only 128K bytes of RAM, plus MS-DOS 2.11 and utility software in ROM. A 300/1200-bps modem, ROM applications software, and expansion memory up to 896K bytes will be optional.

Meanwhile, Australian computer maker Time Office Corp. will enter the U.S. market with the Kookaburra laptop computer. Previously available as the Dulmont Magnum, the Kookaburra includes a 25-line LCD, 256K bytes of RAM, an 80186 processor, a video-output port, MS-DOS 2.11, and several applications programs for less than \$2000. Time Office also plans to introduce a line of Z80/80186-based office workstations in the fall.

---

## NANOBYTES

**Actrix Computer Corp.**, Milpitas, CA, which emerged from Chapter 11 bankruptcy protection in May, planned to announce new versions of its Actrix computer that are compatible with IBM's PC, XT, and AT models. . . . **Altos Computer Systems**, San Jose, CA, has developed two multiuser systems. The 2086 is a \$19,900 20-user system based on Intel's 80286 processor using the XENIX operating system; it cannot run PC-DOS programs. The 3068, a 30-user system using Motorola's 68020 32-bit processor, is available only to other manufacturers. . . . At the Consumer Electronics Show, **Melodian** planned to unwrap a music system for the Commodore Amiga computer that it claimed will give the Amiga the capabilities of a \$75,000 music synthesizer. . . . **Tomy's** new \$500 Omnibot 2000 robot can be interfaced to an Apple II or Commodore and has two moving arms as well as the features of its predecessor, Omnibot. . . . Also at CES, **Commodore** announced a \$600 10-megabyte hard-disk drive for its 64. . . . **Fujitsu** announced at NCC an 8086-based multiuser computer that uses both the Pick and the MS-DOS operating systems. . . . **Hannes Keller**, Zurich, Switzerland, has developed WitchPen, a programmable word processor with spelling checker; WitchPad, a drawing program using standard IBM character graphics; WitchCraft, a BASIC database-management program generator; and HK, a text-oriented programming language. The programs, currently available in Switzerland, are slated for U.S. release next month. . . . Printer manufacturer **Axlom Corp.**, San Fernando, CA, said that its newest daisy-wheel printers will use a "wedge-back" daisy-wheel technology. A wedge shape on the back of each letter on the print wheel is struck by an indented hammer, which reportedly improves print accuracy and speed. . . . **STM** introduced an IBM PC AT-compatible computer. Configured like IBM's basic AT but with 640K bytes standard, the STM AT will cost \$3495. . . . **Faraday** has reduced its IBM-compatible single-board computer to fit onto a single 5-inch IBM PC-style expansion card. While Faraday sells the cards primarily to OEMs, it will sell single Micro PC cards for \$695. . . . **AST**, **Quadram**, **Ashton-Tate**, and **Borland** have announced their support of a superset of the Intel/Lotus expanded memory specification.



## If you buy a TI 855 printer now, you won't have to upgrade to one later.

Don't tack just any printer on your new PC for now, thinking that you'll get what you really need later. Start with the best, a TI 855 or TI 865 printer. That way you can put the money you'd have spent on a needless upgrade on some other smart investment.

You see, our OMNI 800™ Model 855 is actually three printers in one. For word processing, it delivers letter-quality printing that rivals the best daisy wheel printers around. For data processing, it prints at 150 characters per second. And for your graphics, it reproduces screen or

OMNI 800 is a trademark of Texas Instruments, Incorporated.

monitor images in the finest detail.

Of course, these advantages are all true of our TI 865 wide-carriage printer, too.

What's more, since our printers are among the easiest to use, you can utilize all the capabilities built into your PC and software right from the start. Instead of sometime later. You even have a choice of over 30 different plug-in type fonts, any three of which can be printed on the same page without ever stopping the printer! Just touch the control panel and it happens. Simple. So every document looks just the way you want it to. Professional.

As for reliability, TI printers are legendary. Just ask any major airline.

So don't downgrade your PC's performance with a printer you'll outgrow in a month. Get yourself a TI 855 or TI 865 printer now. It's easy. Just call 1-800-527-3500, ext. 801, for the TI Dealer near you.

  
**TEXAS  
INSTRUMENTS**

Creating useful products  
and services for you.

# If you believe these simple facts about hard disks, you'd be willing to pay more for ours.... fortunately, you won't have to

**A**voiding hard disk failures and loss of data is just one of the reasons to buy our hard disks.

Hard disks can fail—there's really no other nice way to say it. Even IBM has problems delivering ATs with hard disks that work. We're not talking about nice, clean, clear-cut failures where the drive seizes up, coughs, and rolls over and dies. We're talking about the insidious little creeping failures that sneak up over time—like a missing sector here or a lost sub-directory there.

There are precautions you can take to protect against failure and ultimate loss of data. Here is what we contribute toward minimizing the potential loss of your data.

## Best Drives Available

First, we buy the best drives available. Sounds trite, doesn't it? I mean, a drive's a drive—right? Hardly. You should see some of the junk we get in our labs. Some have such high failure rates that we even questioned our own \$10,000 hard disk tester. But when we tested other manufacturers' drives we were assured that our equipment was fine, which just confirmed that the bad hard disks were not only bad—they were real bad.

But that's just the weeding out process. We then take each drive that we've put through our tester and test it again with the controller you've requested. We call this a "tested pair."

## DOS Doesn't Do It

In case you're thinking that all

this is an unnecessary duplication of what DOS does for you, let me explain the disk facts of life.

If DOS did what you may think it is supposed to do when you format the disk, DOS would map around these bad areas. Unfortunately, DOS doesn't do this.

DOS 2.0 and 2.1 can't enter the bad tracks. DOS 3.0 can, but only on the IBM AT. Unfortunately, as the press has so well documented, the AT's hard disk develops bad tracks later on.

## We do what DOS can't

We believe the problem is so bad, we use a software program that performs a powerful test of your disk drive on all of the IBM or IBM compatible computers—PCs, XTs, and ATs. Our format takes hours to analyze the disk. But when we finish, you know that the bad tracks are really mapped out so you won't write good data that will disappear into a black hole. We even send you a printed statement of our test results.

Our software allows you to type in the bad track locations from the list supplied by the manufacturers, so you'll never write good data to them—even if DOS didn't identify them as bad. The software even lets you save the location of these bad sections to a file, so that you can reformat your disk without spending hours retesting.

We even include a program that will give you continuous comments on the status of your hard disk. No more waiting for that catastrophic failure.

## Average Access Time

As you might suspect, some hard disks are faster than others in their ability to move from one track of data to another. The time it takes the hard disk to move one-half way between the beginning of the disk to the end is called the "average access time."

The first generation of 10 megabyte hard disks had average access times of 80-85 milliseconds (msec). But computer users love speed, and guess what—the average access time for the new 20 megabyte hard disk in the IBM AT is only 40 msec. (We sell an AT equivalent with only 30 msec access time!)

There are some legitimate reasons for the shorter access time. It's particularly helpful when there are multiple users on the same hard disk. It's also important when running a compiler. But remember, before you get too wrapped up in the access speed, there's always that ST 506 interface which won't let data transfer from the hard disk to the computer any faster than 5 megabits/second. We've bypassed that choke hole, too. If you want the functional equivalent of a Ferrari with a turbocharger, order our 10 Mbit per second 108

megabyte hard disk with 18 msec of average access speed.

## Compatibility

To be sure that your hard disk is 100 percent compatible with the IBM XT you don't need to buy the same hard disk that's in the XT. You can't even be sure what brand hard disk it is because IBM, like Express Systems, goes into the marketplace and buys hard disks from several vendors. However, they buy their XT hard disk controller from only one vendor—the same one we do.

You can buy the IBM XT controller from IBM for \$495 or you can buy from us, the functional equivalent, manufactured by the same company that makes it for IBM for only \$195. Is it the exactly identical IBM XT controller? No, it's better. First, it takes less power, and secondly, it can control from 5 to 32 megabytes—the IBM controller can work with only 10 megabytes. It is 100 percent IBM XT compatible, and 100 percent is 100 percent. If you want to save a slot, we carry a version that lets you operate two hard disks and two floppy disk drives.

## More than 32 Megabytes

You can operate with more than 32 megabytes (the limit of DOS) through the use of "device drivers." Express Systems can supply you with device drivers for our hard disks for over 32 megabytes formatted. But, if you don't have individual files, or databases that are large, you might want to consider one of our controllers that can divide our 65 megabyte (formatted) hard disk into two equal volumes of 32 megabytes each.

## Reliability

We offer you a choice between iron oxide and plated media—the stuff that covers the hard disk and gives it its magnetic properties. Iron oxide is, well, it's rust. If you inadvertently joust your disk, you may cause the low flying head to dig out some iron oxide. A little rust flake can ruin your whole day. Plated media is more resistant to damage, and if it happens, less data is lost.

We offer both types of hard disks. The iron oxide is older



technology, and quite frankly, manufacturers understand it better. Their better understanding, combined with some of the special head locking mechanisms, gives us peace of mind when we sell you one.

### Power

Hard disks consume power. Our small, half-high hard disks consume so little power that you can use them with your existing IBM PC power supply. If you plan to use lots of slots, you'll want to increase your power supply to be safe. We offer the same amount of power for your PC that comes in the XT.

### Our Customers

Some folks just never feel comfortable buying mail order. They forget that Sears began as a mail order house or that IBM is now into mail order. But, if it helps, here is a *partial* list of customers who have felt comfortable to buy from us.

IBM	Sears
American Express	Honeywell
U.S. Army	MIT
AT&T (Bell Labs)	RCA
Bausch & Lomb	Lockheed
Xerox	Sperry

### Easy to Install

If you're like most of us, raised on the boob tube rather than the Great Books, you'd rather see the movie than read the book. Well, now you can choose to read our installation manual or for only \$9.95 more, you can get a VHS or Beta video cassette showing the simple steps for installation.



Our VHS or Beta Cassettes make installation easy.

### Warranty

We offer you a one year warranty on our hard disks—the same as IBM on the AT and 90 days on the tape drives. (It's all the manufacturer gives us.) If



### Complete Hard Disk Kits

Formatted Storage Capacity in Mbytes	Height	Plated Media	Average Access	Transfer Rate	PC or PC/XT	AT
10	1/2	yes	85 msec	5 Mbits/s	\$ 625	\$ 430
10	Full	yes	85 msec	5 Mbits/s	\$ 625	\$ 430
21	1/2	yes	85 msec	5 Mbits/s	\$ 825	\$ 630
21	Full	no	30 msec	5 Mbits/s	\$ 1,535	\$ 1,340
32	1/2	yes	85 msec	5 Mbits/s	\$ 1,095	\$ 895
32	Full	no	30 msec	5 Mbits/s	\$ 1,775	\$ 1,575
65	Full	no	30 msec	5 Mbits/s	\$ 2,295	\$ 2,070
108	Full	yes	18 msec	10 Mbits/s	\$ 4,995	\$ 4,995



### Removable Hard Disk

10	1/2	no	90 msec	5 Mbits/s	\$ 1,095	N/A
----	-----	----	---------	-----------	----------	-----



### Tape Systems and Subsystems

Formatted Storage Capacity	Height	Data Transfer Rate (k/sec)	PC or PC/XT	AT
60 Mbytes	1/2	88	\$ 995	\$ 995
60 Mbytes Subsystem		88	\$ 1,295	\$ 1,295
17.6 Mbytes Start/stop Subsystem		24	\$ 795	\$ 795



### Controllers

All of our hard disk and tape controllers are available separately. Please call for prices.

### Subsystem Chassis

Any of our disk or tape units are available in an external subsystem for an additional \$250.00. You can mix & match any of our 1/2 high hard disks or tape drives together or add any single full height hard disk.



### Tape Cartridges

Express Certified 555 foot 310 Hci 1/4-inch Data Cartridge \$ 35.00

### Power Supply

130 Watt Power supply \$ 99.50\*

\*with the purchase of any drive

### More questions?

Because we spend so much attention on the front end with ensuring that our disks will arrive in working order, we have a customer service department that, unlike many of our competitors, has little to do. When you need us, you won't get a constant busy signal.

Call our friendly, knowledgeable customer service staff to get answers to your questions—before or after the sale. Our people, who know the PC, can talk you through the sticky parts, and they'll respond to you quickly. Just call us.

### How to order

Pick up the telephone and call 1-800-341-7549, to order. We accept Master Card, VISA, American Express and Diners Club. Or send a cashier's check or

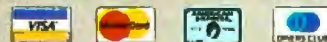

money order (We'll take a check, but you'll have to wait for it to clear) and tell us if you want one of our recommended configurations or you want to mix and match yourself. Corporations with a DUNS number may send purchase orders for quantities over five.

### Comes complete

All Express Systems products come complete with the appropriate software, tape and/or hard disk controllers, and cables where required. Hard disks are formatted and tested with the PC DOS of your choice. All drive sizes are formatted capacities.

If your application requires a stacking kit, power splitter cables, daisy chain cable, or some other variation, we'll supply these items at a nominal charge. We even ship our hard disks with Command Assist™ an on-line DOS-like manual to give you help with your DOS commands.

# EXPRESS SYSTEMS

Call Toll Free 1-800-341-7549 Ext. 500  
In Illinois call (312) 882-7733 Ext. 500

Express Systems, Inc., 1254 Remington, Schaumburg, IL 60195



## QUALITY, NOT JUST QUANTITY

In arguing that "the Macintosh is in harmony with the broad lines of evolution in human communication" toward the visual, Jim Hoekema's letter on page 22 of the May BYTE ("The Macintosh Debate Goes On") offers as evidence that, as of 1981, there were 1,055,000 artists in the US, whereas a seventeenth-century burgher in Amsterdam probably saw some three or four hundred pictures in a lifetime.

The particular example he chose is interesting. The pictures seen by our visually impoverished Amsterdamer probably included a few by fellow citizen Rembrandt van Rijn (1606-1669). Poor old Rembrandt, forced to muddle along with the primitive technology of the paint brush. But will even a single painting of his, taken all by itself, ever fail to stand up against all the visual images ever produced with "creativity" enhancers like the mouse, MacPaint, or whatever? The answer need not be based on abstract aesthetic principles. Putting it more mundanely, how likely is it that any art produced on a computer in 1985 will have the staying power to grace a cigar box three and a half centuries from now?

In deciding how visually oriented we are, *how* we see should be as important as *how much* we see. When it comes to shaping the way we look at the world, no graphics program—not even if it bears a name like Rembrandt—will make as lasting a contribution as a graphic artist of the same name.

WILLIAM LOCKERETZ  
Brookline, MA

## MAC MEMORY

Don Slaughter should spend less time writing to BYTE and more time reading it! First he griped about a lack of RAM-disk software for his 512K Mac ("Take Back Your Mac," February, page 22). Daniel Smith responded that not only is such software already available, but that it costs much less than Slaughter was willing to pay ("A RAM Disk for the Mac," May, page 24)!

Now Slaughter is complaining that he needs a 1-megabyte Mac, and that he won't be able to get a reasonably priced

one (under \$3500) until next year (May, page 26).

Wrong again! The April BYTE has a "What's New" item on the MegaMac on page 441. The company is MicroGraphic Images. Its telephone number is (818) 368-3482. It offers a complete Macintosh with 1 megabyte of memory for \$3495. If you choose to upgrade a 128K Mac, the total cost could be less than \$3000.

DENNIS GRIESSER  
Long Beach, CA

## DON'T BLAME THE COMPUTER

Phil Lemmons's January editorial ("Autonomous Weapons and Human Responsibility," page 6) was very amusing. Being a high school student I can easily picture what would happen if some of the students at Jonesville High were scheduled for lunch at 9 in the morning or at 3:10 in the afternoon.

I'm sure the school mentioned in your editorial had things straightened out within a few days, and people were finding out how beneficial the computer would really be to them. As soon as everybody got over the lunch-period screw-up, they would realize how much easier things were going.

People in today's society are scared of what they think they can't control. If they have to come in contact with a computer, perhaps an automatic bank teller, they're scared to death they will "punch the wrong button" and totally wipe out their life savings. People need to be told of the benefits of computers rather than something to the effect that all computers are good for is screwing up your phone bill or sending junk mail. Humans are responsible for these mistakes and bothers. Magazines like BYTE do a fine job of clearing this up, but if people don't want to believe humans are responsible for these mistakes and not the computer, no number of articles, reports, or editorials will convince them: the only way I can see for them to realize this is to have to use a computer and understand what makes it work. Explain why the computer printed out a phone bill for \$6539.97. Again there is the problem of people not wanting to come in contact with the computer, even to learn about it. In come the schools. Our

school has increased the number of computers by 300 percent in the past year alone, with more on the way. Already students have taken an interest. Granted, not all of them, but enough to justify the purchase of the machines. The ones who scoff at the computers in the classrooms are simply destined to get a phone bill for \$6539.97 and hear the person at the phone company tell them "the computer has made a mistake." If children can learn the basics of computer programming and hardware, then maybe when our generation is older we can use the computer even more efficiently than we do now to simplify our lives and produce programs for school offices that tell the computer *not* to schedule lunch at 9:00 a.m.

MICHAEL A. RUSSELL  
Jonesville, VA

## SANYO SATISFACTION

I read Robert M. Keith's letter ("Sanyo Support," March, page 304) advising against buying a Sanyo just as I was about to order a Sanyo package by telephone from Computer Creations in Dayton, Ohio. The letter made me think twice, but I went ahead anyway. To my consternation the computer unit, which came as packaged at the factory, refused to format any disk, and I was stymied. But when I called Mr. Jack Kaiser of Computer Creations and told him of my problem, he had the computer picked up from my house, sent to Ohio, and returned in good time all fixed, all at the company's expense.

Although I had had no previous hands-on experience with a computer, I was able to write a letter the first day with Easy-Writer, and in the first two weeks have

(continued)

LETTERS POLICY: To be considered for publication, a letter must be typed double-spaced on one side of the paper and must include your name and address. Comments and ideas should be expressed as clearly and concisely as possible. Listings and tables may be printed along with a letter if they are short and legible.

Because BYTE receives hundreds of letters each month, not all of them can be published. Letters will not be returned to authors. Generally, it takes four months from the time BYTE receives a letter until it is published.



**THE ACCENT™ IS ON EXPANDED MEMORY...  
WITH MAYNARD'S NEW LOTUS-COMPATIBLE CARD!**

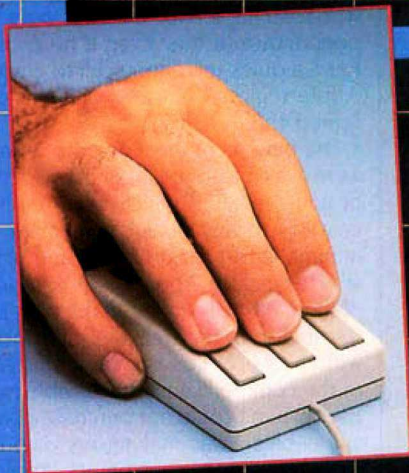

Now, Maynard gives you 2MB of Lotus-compatible Expanded Memory with Accent™. Designed expressly for your personal computer, Accent™ adds memory power to Lotus 1-2-3\*, Symphony\*, and all other Expanded Memory programs so you can create larger spreadsheets than ever! An optional mouse places speed, access, and customized commands at your fingertips, saving time and eliminating inconvenient, multi-key cursor controls. Accent™ is available at the finest computer retail stores everywhere. Contact your local dealer or write to us today for product information.

\*Lotus 1-2-3 and Symphony are trademarks of Lotus Development Corporation.



**Maynard Electronics**  
Shaping tomorrow's technology.

430 E. SEMORAN BLVD., CASSELBERRY, FL 32707 305/331-6402  
Inquiry 195

# Why you should ignore 95% of the news

**Because NewsNet automatically finds the 5% you need.** From our database of authoritative, up-to-date business news, you get just the stories you want, delivered instantly to your microcomputer. You choose your own, unique keywords, and NewsNet saves—just for you—every new article containing those words. Or, you can find that critical 5% on your own, with NewsNet's powerful keyword searching and text scanning.

Just what's in NewsNet's database? The full text of over 300 valuable business newsletters. In-depth news, written by experts, filled with analysis and interpretation. News from 34 different industries and professions—everything from Computers to Investments, from Management to Telecommunications. Plus extras such as wire services, online stock quotes, air fares, and business credit reports.

**Computer News: Your Specialty is our Specialty.** Here are just a few of the 25 Electronics and Computers newsletters on NewsNet:

The Artificial Intelligence Report  
The Business Computer  
The Computer Cookbook  
Consumer Electronics  
Data Base Informer  
Electronic Mail News  
Outlook on IBM  
Japan High Tech Review  
Micro Moonlighter

Mini/Micro Bulletin  
Personal Computers Today  
Robotronics Age  
Newsletter  
Semiconductor Industry & Business Survey  
The Seybold Report on Professional Computing  
Stanley Klein Newsletter on Computer Graphics

**ONLINE  
BUSINESS  
NEWS**

# NewsNet

**Call Today!  
We'll send all you  
need to subscribe.**

**(800)  
345-1301**

(in PA 215-527-8030)

NewsNet Inc. 914 Haverford Road, Bryn Mawr, PA 19010  
Inquiry 230

established a spreadsheet and succeeded in drawing a few curves from data. Most of the instructions are clear, especially when read the second time, although I confess I had to spend an hour in the library to come up to the starting level in BASIC. I have no regrets about having taken a chance with a telephone order for a Sanyo.

H. G. MACPHERSON  
Oak Ridge, TN

## AN APPLE DEALER REPLIES

The letters in your April issue regarding Apple service and Apple manuals ("Apple II Blues," page 23, and "Where Are Apple's Manuals When You Need Them?" page 32) really hit me where I live: you see, I am an Apple dealer. As such, I find the treatment given to Mr. Lamar, Mr. Hine, and Mr. Raines unforgivable. Any product sold, no matter who makes it, is only as good as the dealer who sells it. The dealers in question certainly did a very poor job of serving their customers, to the point of not even knowing anything about the software being sold with the system in Mr. Hine's case.

The 1200-bps problem was made known to all Apple dealers, as was the no-charge board-replacement policy for those customers experiencing difficulty. Any dealer who read his service bulletins would have been aware of this. Even if he could not read, a quick telephone call to any of the Apple regional offices would have confirmed this.

The pinouts of the Apple IIc serial port were available for the asking from a variety of sources, all of which were readily accessible to any dealer who made even minimal effort to find out. Some of these sources include Apple's own *Technical Notes* (issued in July of 1984), the Epson distributor for the area, the sheet included with the Apple IIc serial cable, and several of the commercial interface-cable makers. Even when I could not purchase commercial cables I was making my own in the store to sell to my customers. Apple also issued technical information for the second disk port on the IIc that allowed us to modify our existing Apple IIe drives for use on the Apple IIc before we got steady delivery on regular IIc drives.

Ah yes, manuals. Years ago, Apple did supply most manuals with the systems purchased. Starting with the introduction of the IIe, technical manuals became optional, with only an owner's manual being included with the computer. In general, I agree with this policy because, as the type

(continued)

Hook up different types of computers. Servers can exchange information and transfer files. Share expensive resources like disks and printers. Let several people use a PC at the same time.

Keep your favorite DOS applications. With The CONNECTOR™ you can run DOS and UNIX™ applications at the same time.

For a standalone PC UNIX solution, try VENIX engine offers clean, clear UNIX engine offers the best cost/performance system available for personal computers. Including IBM's Compatibles, AT&T 6300's, and DEC PC's.

Bogged down scheduling appointments? The Skeduler™ will find a common available time and notify anyone. It also tracks and reminds you of personal appointments. In-house typesetting can save you time and money. With LaserLink™ it's a breeze. There's no programming to learn or long, complicated codes to in.

Choose from a quality selection of Multi-user business applications—like UNIFY™—which give you powerful productivity software even a non-programmer can use. And we provide total support with an 800-user hotline. All this from a single source—Unisource—your complete Unix software solution company.

Call 617-491-1264



Getting UNIX Software Down To Business  
 Unisource Software Corp.,  
 71 Bent Street  
 Cambridge, MA 02141  
 Inquiry 327

Our software ties don't bind your personal computer.

...they're knot just for networking, multi-tasking, sharing and typesetting...



UNIX is a trademark of AT&T Bell Laboratories. LaserLink and The Skeduler are trademarks of Unisource Software Corp. VENIX/86 is a trademark and an implementation of VenturCom, Inc. UNIFY is a trademark of Unify Corporation. The Connector is a trademark of Uniforum Software Systems, Inc.

ACT NOW!  
\$9.95 VALUE

# FREE OPUS DISKETTE HEAD CLEANER

With Purchase of OPUS "Unfloppable" Floppies

OPUS has a money saving offer to get you to try our floppies, the most reliable on the market today. Purchase 20 OPUS 5-1/4" diskettes and you can receive a Free UNIVERSAL HEAD CLEANER (\$9.95 value), for use on single or dual-side drives.

Purchase OPUS diskettes at your local computer store, send two box tops, a dated sales receipt, and coupon and we will send your Free Head Cleaner.

Or - order by mail and receive Head Cleaner with your shipment.

Or - Call, Toll Free:  
1-800-692-6905, Dept. "M,"  
to charge on your VISA or  
MasterCard.

Now you have a  
money saving reason  
to try OPUS diskettes.  
You will have "NO  
BAD MEMORIES!"



**OPUS**<sup>®</sup>  
NO BAD MEMORIES

SEND TO: OPUS Computer Products  
'85 HEAD CLEANER OFFER  
Dept. BYT 585, 150 Chicago Street  
Cary, IL 60013

Name \_\_\_\_\_

Address \_\_\_\_\_

City \_\_\_\_\_ State \_\_\_\_\_ Zip \_\_\_\_\_

Phone ( ) \_\_\_\_\_

Proof of Purchase Enclosed OR SHIP ME \_\_\_\_\_ Boxes of OPUS 5-1/4" Diskettes:

CHECK ONE:  \$19.95 Single-Side 10-pack  \$29.95 Dual-Side 10-pack

Add \$1.50 for shipping & handling (Illinois residents add 6% sales tax.)

TOTAL ENCLOSED: \$ \_\_\_\_\_ (Check or Money Order Only)

Charge to my:  VISA  MasterCard

Account Number:

Expiration Date:

Signature: \_\_\_\_\_

OFFER EXPIRES AUGUST 31, 1985

## LETTERS

of purchaser shifted from the "hacker" to the novice, the material was more confusing than informative. It was not unusual to be asked, "Why do I have to pay for these manuals when I don't know what they are and don't need them to run my VisiCalc?" Now that the manuals are optional, the opposite situation arises when the purchaser is competent and needs the material. Any dealer worth his salt will stock such reference material in order to meet the needs of all his customers. It is unfair to condemn Apple for the failure of its dealers to act intelligently. Even though Apple has set rather high standards for its dealer network, there are more than enough retailers who are more concerned with shoveling boxes out the door than adequately serving their customers.

The common thread that ran through all three of these letters is that the dealers failed in the most elementary of tasks, that being to support the products that they sold (or sell). In this day when the pressure is on to move more product and to hell with the support, there are some of us out here who really do try. We are the ones who end up holding the hands of those buyers who have been left high and dry by the fast-buck artists and price-only retailers. If there are any other Apple users who need manuals or technical help, call me. My people are competent and can do more than read the numbers on their commission checks.

VERN L. MASTEL  
Bismarck, ND

### BYTENET RESPONSE

It is 11:57 p.m.; I've been dialing BYTEnet since 7:00 p.m. and getting busy signals or that obnoxious recording telling me that all the circuits are busy and I should try calling back later.

I think I understand the rationale and impetus behind BYTEnet. Typos are eliminated and money saved. It sounds like a great idea. However, the current implementation leaves much to be desired.

Oh, how aggravating it is to read an interesting article that makes references to a missing listing! It defeats the tutorial value of the article. And I subscribe to BYTE to learn.

I think that I'm being shortchanged and that there must be an alternative! At the very least, restore the listings until the load on BYTEnet is reduced.

I'm not staying up past midnight, and I'm not thrilled about paying those long-distance rates just to see if a listing is

(continued)

# 4 Out Of 5 PC-AT™ Expansion Board Buyers Own Advantage!™

The overwhelming choice of IBM® PC-AT users, Advantage! from AST sets the standard in high-powered multifunction enhancement. Advantage! was the first multifunction board for the PC-AT. And it remains the leader by providing millions of characters of memory capacity, two serial ports, a parallel port and a game port. All in a single expansion slot.

**First In Memory.** All it takes is Advantage! There's no need to add other cards or hard-to-find chips on your system board. Whether you have an 256K, 512K or 640K AT, our unique memory addressing technique lets you add up to 3 Megabytes of parity checked user memory efficiently and economically. For flexibility, Advantage! can use either 64K or 256K memory chips. And of course, it supports your AT's high performance 16-bit bus and faster program processing speed.

Now you can have the extra memory to run integrated business software such as Symphony™ and

Framework™ To make full use of new concept windowing software such as DESQ™ To utilize multitasking programs such as IBM's TopView™ or multiuser operating systems such as XENIX™ To handle larger amounts of data, faster. Or for RAM disks.

**First In I/O.** Here's all the I/O capability you need now, even if you're starting with a base model AT. Every Advantage! card includes an AT compatible serial port and a parallel port so you can connect printers, plotters, mice and modems. Or with the appropriate software, you can connect other terminals to create multiuser environments.

With our optional second serial port you can attach even more peripherals, while our optional game port lets you plug in joysticks and other cursor-control devices for business or just for fun.

**First In Quality.** AST's reputation is built on quality products, quality support and quality service. Our complete documentation means Advantage! is exceptionally easy

to install and use, but if it's not enough we're always here to help.

Four out of five buyers agree, the choice is Advantage!—only from AST. Ask your dealer, or call our Customer Information Center (714) 863-1333 for more information. AST Research, Inc., 2121 Alton Avenue, Irvine, CA 92714 TWX: 753699ASTR UR

## FEATURES

### Memory Expansion

- 128Kb to 3.0Mb in a single slot
- User Upgradeable with either 64K or 256K memory chips
- Split Memory Addressing rounds out AT's system memory to 640K and continues memory expansion at 1Mb

### I/O Expansion

- Up to 2 Serial Ports (1 optional)
- Parallel Printer Port
- Optional Game Port

**Advantage! Supports AT's Full Program Processing Speed**

Advantage! trademark of AST Research, Inc. IBM PC-AT and TopView trademarks of International Business Machines Corp. Framework trademark of Ashton-Tate. Symphony trademark of Lotus Development Corp. DESQ trademark of Quarterdeck Office Systems. XENIX trademark of Microsoft Corp.

**AST**  
**RESEARCH INC.**



Inquiry 3 for End-Users.  
Inquiry 4 for DEALERS ONLY.



**INTRODUCING 5**

**WE INTERRUPT  
PRODUCT  
BRING**



# THIS MAJOR INTRODUCTION TO YOU SOMETHING REALLY IMPORTANT.

## THE BIG NEWS IN DISK/TAPE IS PC/T, A SENSIBLE NEW APPROACH TO ARCHIVAL STORAGE.

We've tamed tape. And made it docile. By making it DOS-like.

So, while this started as an ad for our five new HardFile™ subsystems, which deliver 25 to 80 megabytes of hard disk storage and 60 megabytes of tape backup, instead we want to introduce you to PC/T.™

PC/T is a new format that makes tape a more sensible storage solution for personal computers. It puts tape on line, in real time, for instant access. And frees your hard disk for your most current data.

You already know how to use PC/T. Because it responds to standard DOS commands.

Here's the big news: just like any DOS-controlled hard or floppy disk, PC/T enables you to create directories and files on tape. Then you can call up the exact file you need, and change a portion of the tape without having to erase and overwrite the entire cartridge.



*Without PC/T, you have to rewrite the entire 60 MB cartridge each time you make a single change.*



*With PC/T, you create and directly access files on tape, just like with floppy or hard disk.*

PC/T formats each new tape cartridge, just like you format any hard or floppy disk, locking out bad blocks to assure that every bit of data you write to tape is recorded with utter accuracy.

What's more, PC/T gives tape true error correction capability. 50% redundancy during write operations ensures 100% reconstruction of data lost because of operator error, dust and dirt, or everyday wear and tear.

There is a catch. You can get your hands on PC/T just one way: Buy one of our powerful new HardFile subsystems. With disk plus tape. Or tape alone. Which brings us back to where we started. And gives you a place to start. Just call 1-800-228-DISK for the Tallgrass dealer nearest you.

**TALLGRASS SELLS MORE HARD DISK  
STORAGE WITH CARTRIDGE TAPE  
BACKUP THAN ANYONE IN THE  
WORLD.**



**TALLGRASS®  
TECHNOLOGIES**

COMMITTED TO MEMORY

Inquiry 315

HardFile™ and Tallgrass™ are trademarks  
of Tallgrass Technologies Corporation  
© 1985 Tallgrass Technologies

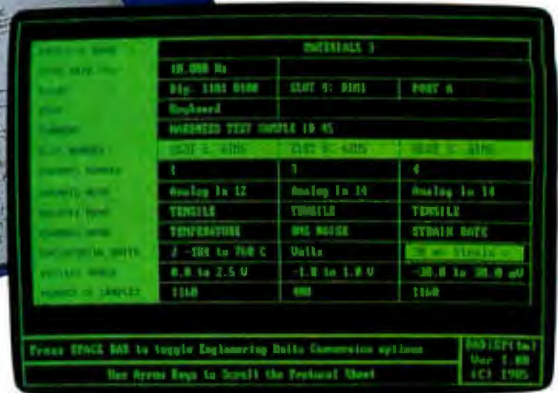
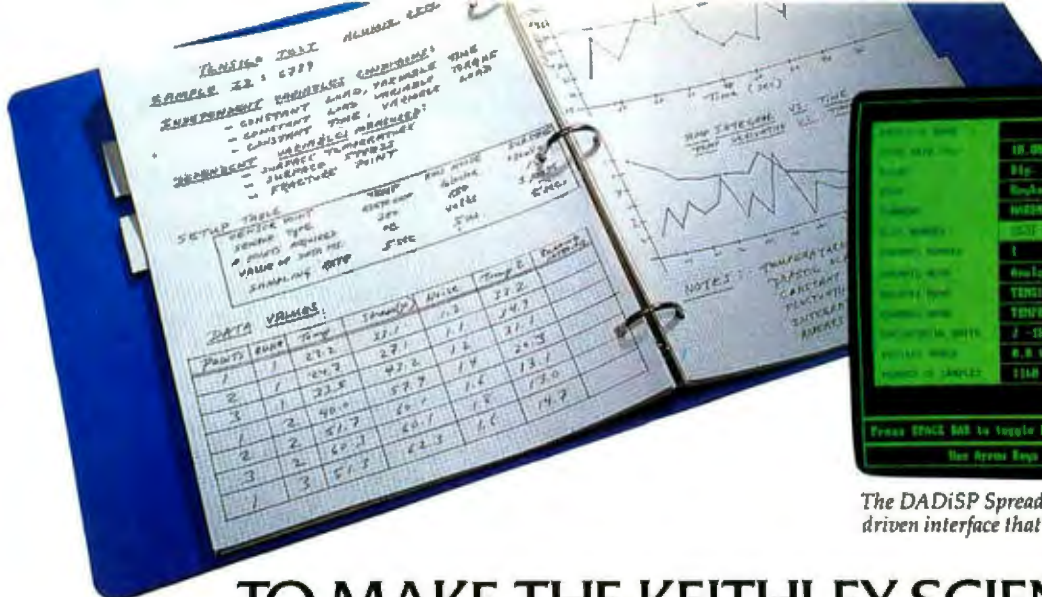

The DADiSP Spreadsheet makes setup easy with a cursor-driven interface that lets you change parameters quickly.

# TO MAKE THE KEITHLEY SCIENTIFIC WORKSTATION EVEN EASIER TO USE, WE TOOK A PAGE OUT OF YOUR BOOK.

Your scientific lab book. Introducing DADiSP (Data Acquisition and Digital Signal Processing), a new graphics-driven software package for data acquisition and analysis with Keithley's Series 500 IBM PC-based Scientific Workstation.

DADiSP parallels the way any scientist or researcher normally records and analyzes data in a scientific lab book.

Using a spreadsheet for setup, windows for analysis and zoom graphics

**■ DADiSP IS EASY TO UNDERSTAND AND EASIER TO USE.**

Simply insert the DADiSP diskette into your IBM PC. To set up a test, begin by moving the cursor to the parameters you want to change, such as engineering units. Next, toggle the space bar to select the test conditions, e.g., volts, °C. If you make a mistake, such as calling for a test condition the system does not support, DADiSP identifies your error. It's that easy.

**\$1975 BUYS THE SERIES 500.**

Turn your PC into a powerful realtime data acquisition and control system for only \$1975. The System 501 is a complete system consisting of Soft500 software and a mainframe with 8 analog inputs, 12-bit A/D conversion, 32 digital I/O channels and 8 additional slots for expansion. To expand your system, choose from our library of over 20 modules for input, output and signal conditioning. The result: a flexible system at board-level prices.

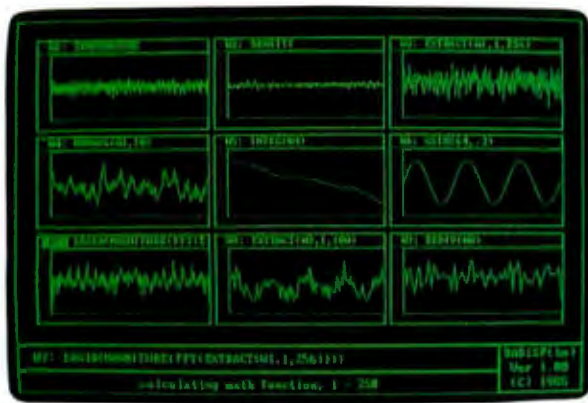

DADiSP graphic analysis makes it easy to define each window as raw data or a function of another window. Results are quickly generated for easy interpretation.

for display, DADiSP takes you through the steps to acquire, record and analyze data from your Series 500.

And you don't have to be a programming professional to do it.

**■ DADiSP IS FRIENDLY AND FLEXIBLE.**

DADiSP consists of two software modules: the DADiSP I Spreadsheet Module is used for test setups, data acquisition and graphic presentation, including dynamic zoom/cursor capability to let you examine the data more closely. For example, use this module for data monitoring, open loop control and to verify Series 500 operation.

The DADiSP II Worksheet Module uses multiple graphic windows, for analysis, display and manipulation of data. With a single keystroke, DADiSP lets you do extensive data analysis, including FFTs (Fast Fourier Transforms), max/min, integration and differentiation. You can analyze data obtained from Soft500, our standard realtime measurement and control software, or from any ASCII or Lotus 1-2-3 compatible file.



**■ IT'S AN EASY CHOICE BECAUSE IT'S KEITHLEY QUALITY.**

Behind the Series 500 is Keithley's 40-year reputation for engineering excellence and low-level measurement expertise. Your Series 500 comes with a one-year full warranty and 90-day free software support. We even provide a toll-free applications hot line. What could be easier?

For more information on the Series 500 and DADiSP software, ask for our new brochure. Call us, toll-free: 1-800-552-1115. (In Massachusetts, call 617-423-7780.) Or write, Keithley Data Acquisition and Control, Inc., 210 Lincoln Street, Boston, MA 02111.





worthwhile. I just dropped you a check for \$21, and now you want me to "buy" the listings from Ma Bell?

PATRICK CONROY  
Vernon Hills, IL

*Phil Lemmons replies:*

*This letter is representative of several we have received concerning BYTEnet. We're sorry about the trouble you had getting into BYTEnet Listings. We're taking several steps to make program listings more accessible.*

1. We're launching the BYTE Information Exchange (BIX), which will handle many simultaneous users.
2. We've increased the free BYTEnet Listings bulletin board to three lines.
3. We're buying a laser printer to permit us to print listings clearly in less space than now required.

*We're trying to make arrangements to make listings available in several disk formats but have nothing to announce yet. Any disk copy services who are interested in copying disks for BYTE should contact me.*

*We're also seeking people who will make BYTE listings available on electronic bulletin boards in foreign countries.*

**WHAT ABOUT MAGIC/L?**

After reading all about various languages in BYTE, I want to bring attention to a language that I have never seen mentioned or advertised. The language, called MAGIC/L, is made by Loki Engineering Inc. of Cambridge, Massachusetts. MAGIC/L is an extensible threaded interactive compiler. It is an exceptionally good development language and includes an assembler that is integrated into the high-level environment and allows access to high-level code and data. This makes a lot of sense. MAGIC/L has a full range of error reporting: when an undeclared routine or variable is encountered during compile, instead of aborting, a word is compiled that generates a run-time error, and the system remains intact. MAGIC/L includes a logging facility that allows all input and/or output to be recorded on a disk file. MAGIC/L also supports modules, pre-compiled versions of your routines; this eliminates compile time for tested and debugged routines. This only touches on some of the advantages that MAGIC/L gives to programmers. MAGIC/L is available for MS-DOS, CP/M-80, RT-11, and UNIX-68000 in various formats. I have

*(continued)*

# Data communication problem?



## Solve it with a BayTech multiport controller

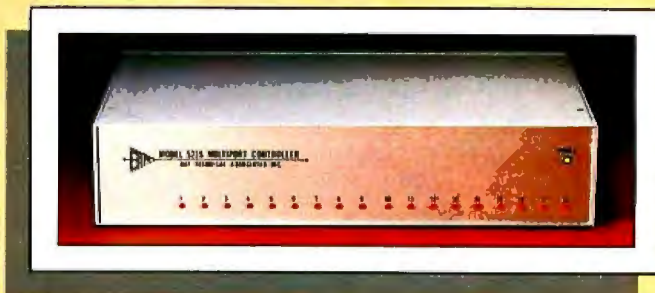

Fifty easy-to-use models for cost-effective, RS-232C serial port expansion.

- Adapt your micro to industrial control and data acquisition applications.
- Add more terminals to your existing computer system.
- Allow your computer to share or select printers.
- Enable your computers to use the same data communication lines by multiplexing.
- Simplify your network with any-device-to-any-device communication.



These intelligent multiports feature many user-programmable functions and are available in 5, 9, 12 and 18-port sizes, \$279 to \$1,795. Call or write for complete details.



**BAY TECHNICAL ASSOCIATES, INC.**  
DATA COMMUNICATIONS PRODUCTS

800/523-2702 or 601/467-8231

Highway 603, P.O. Box 387, Bay Saint Louis, Mississippi 39520  
Telex: 910-333-1618 EasyLink: 6277-1271

been using a version of MAGIC/L on Digital Techniques' "Touchcom" equipment for a year now and find it indispensable. Perhaps a review of this product is in order.

STAN COPLAN  
Philadelphia, PA

Glenn Hartwig replies:  
Thank you for your interest. As it hap-

pens, we recently received a review of MAGIC/L and hope to be able to run it in the near future.

#### ASCII TRANSFER

To honor the country where I discovered it, let me present what I will call the Morocco Principle: "To transfer an ASCII file from one computer to another, communications software is needed only in

the receiving computer."

Testing was done using an IBM PC with the IBM Asynchronous Communications Package and an HP 150 with DSN/LINK. A Smart Cable joined the Quadboard serial port of the IBM to the standard serial port of the HP. Separately, Dick Roberts established the link between Compaq and Apple computers.

First, use the communications software to put the receiving computer in a waiting state. Then use the operating system of the sending computer to route the desired file through the serial port. For example:

```
A>TYPE MYFILE.TXT>COM1:
```

Of course, the Morocco Principle saves time and money only if unidirectional transfer is sufficient. If not, communications software is needed at both ends.

PAUL-ANDRE DESJARDINS  
Rabat, Morocco

#### 8-BIT ASCII DRAFT STANDARD

During 1984, three draft 8-bit character-set standards were developed for the Latin languages of western Europe and the western hemisphere with identical 8-bit code tables. The ANSI draft is called 8-bit ASCII; the ECMA approved standard (ECMA-94) and the ISO draft standard (ISO DIS 8859/1) are called Latin Alphabet Nr 1.

This standard code table is the first 8-bit one intended to facilitate processing by computers (the old 1968 and 1977 ASCII standards are 7-bit standards). Each of the 189 printing characters, including *space*, are one byte. All accented letters are included as single bytes to facilitate processing by software. Eleven U.S. word-processing characters are also included.

Because there is sufficient room in the 8-bit code table for the characters most commonly used in these countries, there are no national or user options in the code table, unlike the old 7-bit ISO 646 standard. Happily for the U.S., the left-hand side is 7-bit ASCII, so the 8-bit standard is upward-compatible with the 7-bit ASCII standard.

Software-application writers and terminal vendors should make plans for support of this standard. They should avoid using the eighth bit in ASCII data for other purposes, such as processing flags, parity, etc. Rather than inventing their own character sets, users should study this new standard to see if it will suffice.

Table 1 is the ANSI/ECMA/ISO 8-bit code table. The ANSI draft is out for public comment until July 14, 1985. Copies of

(continued)



## Sweet deals on memory and logic programmers

Stand-alone, intelligent RS-232 units compatible with most computers or terminals; minimal or no interfacing

**PROMPRO-8™**...Programs virtually all +5V EPROMs, single-chip micros, and emulates EPROMs. ONLY \$689.00 (128K RAM version)

**GANGPRO-8™**...Programs 8 EE/EPROMs at once (supports most EPROMs.) ONLY \$995.00

**UV ERASERS** ...Start at \$49.95, and \$97.50 for timer versions. Production model \$149.95

**AND MORE!** ...Call for more info on PALPRO, SHOOTER, PP7, XP, and required options. Detailed literature and spec sheets available. IBM PC, Apple and other popular PCs support.

PAL is a registered trademark of MMI.

**TOLL-FREE 1-800-EE1-PROM**

**It's only Logical.**

**LOGICAL DEVICES, INC.**

1321 N.W. 65th Place • Fort Lauderdale, FL 33309 • (305) 974-0967 • TELEX: 383142



# Dac Easy Accounting

# \$49.95\*

Special Introductory Price  
Ends July 31, 1985.\*

## Dac Easy Gives You Seven Full Feature Accounting Modules In A Single Integrated Package.

Accounting software doesn't have to be expensive to be the best. Dac Easy gives you a fully integrated accounting system with instant access to General Ledger, Accounts Receivable, Accounts Payable, Inventory, Purchase Order, Billing and Forecasting. Imagine, you can generate over 300 reports from 80 different routines... all in a non copy-protected package. And, with Dac Easy you'll get a handsome slipcase binder with easy-to-follow documentation. Best of all, Dac Easy Accounting can be used to manage either service or product oriented businesses.

Find out for yourself why Dac Easy is the fastest selling accounting package on the market. Compare Dac Easy's features against other packages costing thousands more. Then, order your Dac Easy Accounting by calling our toll free number or returning the coupon below.

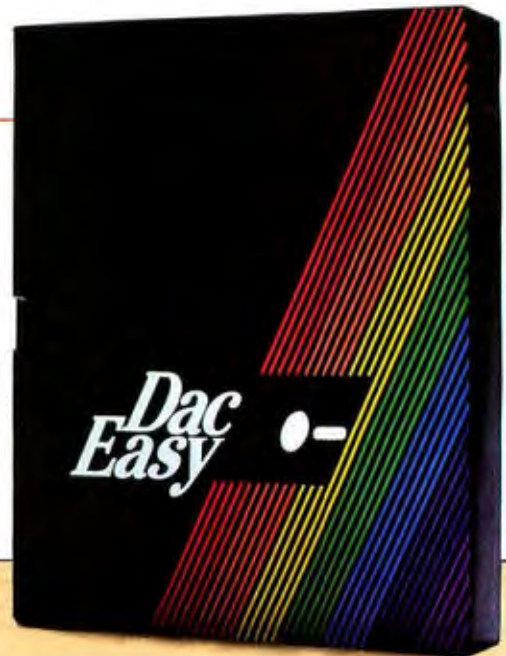

### General Information

- Menu driven
- Password protection
- File capacity limited only by disk space
- Support contract available

### General Ledger

- Unlimited # of accounts with multi-level accounting, unlimited departments
- 3 Year account history for CRT inquiry
- Pencil & pen feature to correct mistakes without reverse entries
- Unique budgeting routine (see Forecasting)
- CRT transaction inquiry, unlimited journals
- Activity report, trial balance, financial statements, etc.

### Accounts Receivable

- Open invoice or balance forward
- 7 Customized columns for aging report
- Unlimited # of customers
- Mailing labels and directories with 4 different sorts
- Automatic finance charges
- Supports partial payments
- 3 Year customer history for # of invoices, sales, costs, and profits
- Customized text on statements
- Cash flow analysis
- Sales analysis
- Automatic sales forecasting by customer, salesperson or customer type

### Accounts Payable

- Check printing and up to 10 invoices paid per check
- Automatic allocation of available cash to payables
- Vendor directories with sorting by vendor code, name, or territory
- Aging reports with 7 customized columns
- Unlimited # of vendors
- Mailing labels with 4 different sorts
- 3 Year vendor history for CRT inquiry and printing
- Flexible payment calendar
- Automatic forecasting of purchases
- Unlimited allocations per invoice

### Inventory

- Supports average, last purchase, and standard costing methods
- Powerful physical inventory routines
- Accepts any unit of measure like fractions/dozens/gross/hours/minutes, etc.
- Automatic changing of costing methods
- Time and product inventory
- 3 Year product history in units, dollars, cost, and profits
- Automatic forecast of product sales
- Automatic pricing assignments
- Alert and activity reports with 11 sorts
- CRT shows on-hand/on-order/committed/sales/cost/profit/turns/GROI

### Purchase Order

- Usable for inventory and non-inventory items
- Allows up to 99 lines per purchase order
- Per line discount in %
- Purchase Order accepts generic discounts/freight/taxes/insurance
- Purchase Order accepts back orders & returns
- Purchase journal
- Automatic interfacing with General Ledger, Payables, and Inventory

### Billing

- Invoicing on plain or pre-printed forms
- Prints sales journal
- Automatic updating of committed products in inventory
- Ability to customize invoice for remarks
- Allows return credit memo
- Interfaces with Inventory, Accounts Receivable and General Ledger

### Forecasting

Unique program that automatically forecasts using your 3 year history

- Forecast revenue and expense accounts
- Forecast vendor purchases
- Forecast customer sales, cost, and profit by customer or salesperson
- Forecast inventory item usage by 4 automatic methods
- Forecast by same as last year, or % base from last year, or trend, or least square trend line analysis method

Minimum Hardware Requirements:  
IBM (PCjr, PC, XT or AT)<sup>1</sup> or other compatibles, 128K memory, one 5 1/4 DSDD floppy disk, 132 column printer in compressed mode, 80X24 CRT, MS-DOS<sup>2</sup>, PC DOS<sup>2</sup> 2.0 or later.

<sup>1</sup> Trademarks of International Business Machines. <sup>2</sup> Trademark of Microsoft Corporation.

## Dac Easy Accounting

To Order Call Toll Free

# 1-800-431-0800

ASK FOR OPERATOR 18

For More Info Call:  
(214) 458-0038

dac software, inc. 5580 Peterson, Suite 130 Dallas, TX 75240

Take advantage of our special introductory offer by ordering Dac Easy Accounting before July 31, 1985. Simply send in this coupon with your credit card number, money order or check for \$49.95 plus \$7.50 for postage and handling. In Texas, add 6 1/2% sales tax (\$3.06). Outside U.S., add \$17.50 for postage and handling. No C.O.D.

\*After July 31, 1985, send \$69.95 plus \$7.50 for postage and handling (in Texas, add \$4.28 sales tax).

CHECK     MONEY ORDER     VISA     MASTERCARD     AMEX  
 Account No. \_\_\_\_\_ Expires \_\_\_\_\_  
 Name \_\_\_\_\_  
 Address \_\_\_\_\_  
 City \_\_\_\_\_ State \_\_\_\_\_ Zip \_\_\_\_\_  
 Phone \_\_\_\_\_ Signature \_\_\_\_\_

30-Day Money Back Guarantee: dac software, incorporated provides a 30-day money back guarantee that all claims and features listed in this ad are true.

Table 1: 8-bit ASCII Level 1. Note: Columns 0-7, 8-9, and 10-15 are specified in dprANS X3.4-198x, ANSI X3.64-1979, and dpANS X3.134.2-198x, respectively; they are shown for information only. Blank code positions (double asterisks) are reserved for future standardization. Readers are advised against directly implementing this chart.

b <sub>7</sub>	b <sub>6</sub>	b <sub>5</sub>	b <sub>4</sub>	b <sub>3</sub>	b <sub>2</sub>	b <sub>1</sub>	b <sub>0</sub>	00	01	02	03	04	05	06	07	08	09	10	11	12	13	14	15
0	0	0	0	0	0	0	0	NUL	DLE	SP	0	␣	P	^	␣	**	DC5	NBTP	"	À	Ø	à	ð
0	0	0	1	0	0	0	0	SOH	DC1	!	1	A	Q	o	q	**	PU1	!	2	Á	Ñ	ó	ñ
0	0	1	0	0	0	0	0	STX	DC2	"	2	B	R	b	r	**	PU2	!	3	Â	Ò	ô	õ
0	0	1	0	1	0	0	0	ETX	DC3	#	3	C	S	c	s	**	STS	!	4	Ã	Ó	õ	ö
0	1	0	0	0	0	0	0	EOT	DC4	\$	4	D	T	d	t	**	IND	CCM	!	5	Ä	Ü	ü
0	1	0	1	0	0	0	0	ENQ	NAK	%	5	E	U	e	u	**	NEL	MW	!	6	Å	Ù	ú
0	1	1	0	0	0	0	0	ACK	SYN	&	6	F	V	f	v	**	SSA	SPA	!	7	Æ	Ú	û
0	1	1	1	0	0	0	0	BEL	ETB	'	7	G	W	g	w	**	ESA	EPA	!	8	Ç	Û	ü
1	0	0	0	0	0	0	0	BS	CAN	(	8	H	X	h	x	**	HTS	**	!	9	È	Ü	ü
1	0	0	1	0	0	0	0	HT	EM	)	9	I	Y	i	y	**	HTJ	**	!	10	É	Ù	ú
1	0	1	0	0	0	0	0	LF	SUB	*	10	J	Z	j	z	**	VTS	**	!	11	Ê	Ú	û
1	0	1	1	0	0	0	0	VT	ESC	+	11	K	[	k	{	**	PLD	CSI	!	12	Ë	Û	ü
1	1	0	0	0	0	0	0	FF	FS	,	12	L	\	l		**	PLU	ST	!	13	Ì	Ü	ü
1	1	0	1	0	0	0	0	CR	GS	-	13	M	]	m	}	**	RI	OSC	!	14	Í	Ý	ÿ
1	1	1	0	0	0	0	0	LSI	RS	.	14	N	^	n	~	**	SSE	PM	!	15	Î	Þ	ÿ
1	1	1	1	0	0	0	0	LSO	US	/	15	O	_	o	~	**	SS3	APC	!	16	Ï	ß	ÿ

BSR X3.134.1 (8-bit ASCII Structure and Rules) and BSR X3.134.2 (8-bit ASCII Supplemental Multilingual Graphic Character Set) are available for \$15 each, along with a self-addressed mailing label, from X3 Secretariat/CBEMA, 311 First St. NW, Washington, DC 20001.

THOMAS N. HASTINGS  
Maynard, MA

**DON'T SELL SOFTWARE,  
SELL AD SPACE**

I was recently talking to a few friends about software piracy. As a result of this discussion, I began to see a possible method to realize profits from this particular situation. First off, computer piracy occurs because software is copyable and almost any protection scheme is breakable. The second reason is that many people are not willing to buy a piece of software but, through various rationalizations, justify themselves in obtaining copies of it. Finally, some software is actually overpriced and of low quality, so the customer

(continued)

For a FREE computer care product, more Floppiclene information, and the name of your nearest dealer, call 1-800-543-2233. Inside California 1-805-687-7040.

# It's a Dirty Job, But Everybody's Got To Do It.

At this very moment, magnetic oxides, dust and airborne pollutants are collecting on the surface of your drive's head. Sooner or later, that dirty head is going to ignore or even ruin valuable information on your floppy disks.

**Fight Back with Floppiclene™**

Floppiclene's disposable wet/dry cleaning system can gently and safely remove all contaminants from your drive's head. Used as recommended, Floppiclene can help win the war against costly down time and drive repairs.

Floppiclene comes packaged in an airtight, vacuum-formed binder and contains a six month's supply of disposable cleaning disks, anti-static screenwipes and polishing cloths. Refills are available.

Available in 3.5, 5.25 and 8 inch formats.



## Floppiclene™

Automation Facilities Corporation

Financial Plaza, 3916 State Street,  
Santa Barbara, CA 93105, Tel. 805/687-7040 TLX 6971013  
Inquiry 26 for End-Users. Inquiry 27 for DEALERS ONLY.

# Ven-Tel's Half Card™ modem is in all the best computers. Here's why...

Ven-Tel gives you lots of reasons to buy our Half Card™ modem for your IBM PC or compatible. The Half Card™ is a complete system that lets you communicate with other PCs, mainframes, and databases effortlessly. It includes Crosstalk-XVI® software. It's reliable. It's got all of the features you want. And it's a good value.

## Do You Own One of These Computers?

Chances are you do. And if you're thinking of buying a modem, consider the Half Card™. Because of its small size, the Half Card™ fits in more computers, including all of the models we've listed here. The Half Card™ is small, so it fits in short slots or long. That means you can save your long slots for other expansion uses.

## Effortless Communication

Each Half Card™ comes with Crosstalk-XVI® communications software, by Microstuf. It's the easiest to use, whether you're a beginner or an old hand, and the most powerful. A full on-line help menu makes using Crosstalk® for the first time a snap. It can turn your PC into a terminal on a mainframe computer with its powerful terminal emulation feature. It will even operate your PC when you're not there. You can call into an information service such as The Source or Dow Jones News Retrieval, or transfer files and electronic mail, all at the touch of a button. The Half Card™ connects your computer to the world. Effortlessly.

## More Modem for Your Money

When you buy the Half Card™, you don't need anything else. The Half Card™ is a complete communications package that includes a full-featured modem and the best known software on the market. Complete easy-to-understand instructions with full technical support on installation and use. And a very competitive price. The Half Card™ with Crosstalk-XVI® software, retails for only \$549.

## Features

- 1200/300 baud auto-dial, auto-answer.
- Uses the industry standard "AT" command set.
- Runs with virtually all communications software, including Smartcom II and PC Talk III and integrated packages such as Symphony and Framework.
- Includes Crosstalk-XVI® software.
- On-board speaker and extra phone jack for easy switching from voice to data mode.
- Selective tone or pulse dialing; full or half duplex.
- Automatic answer on any ring.
- True ring or busy signal detection.

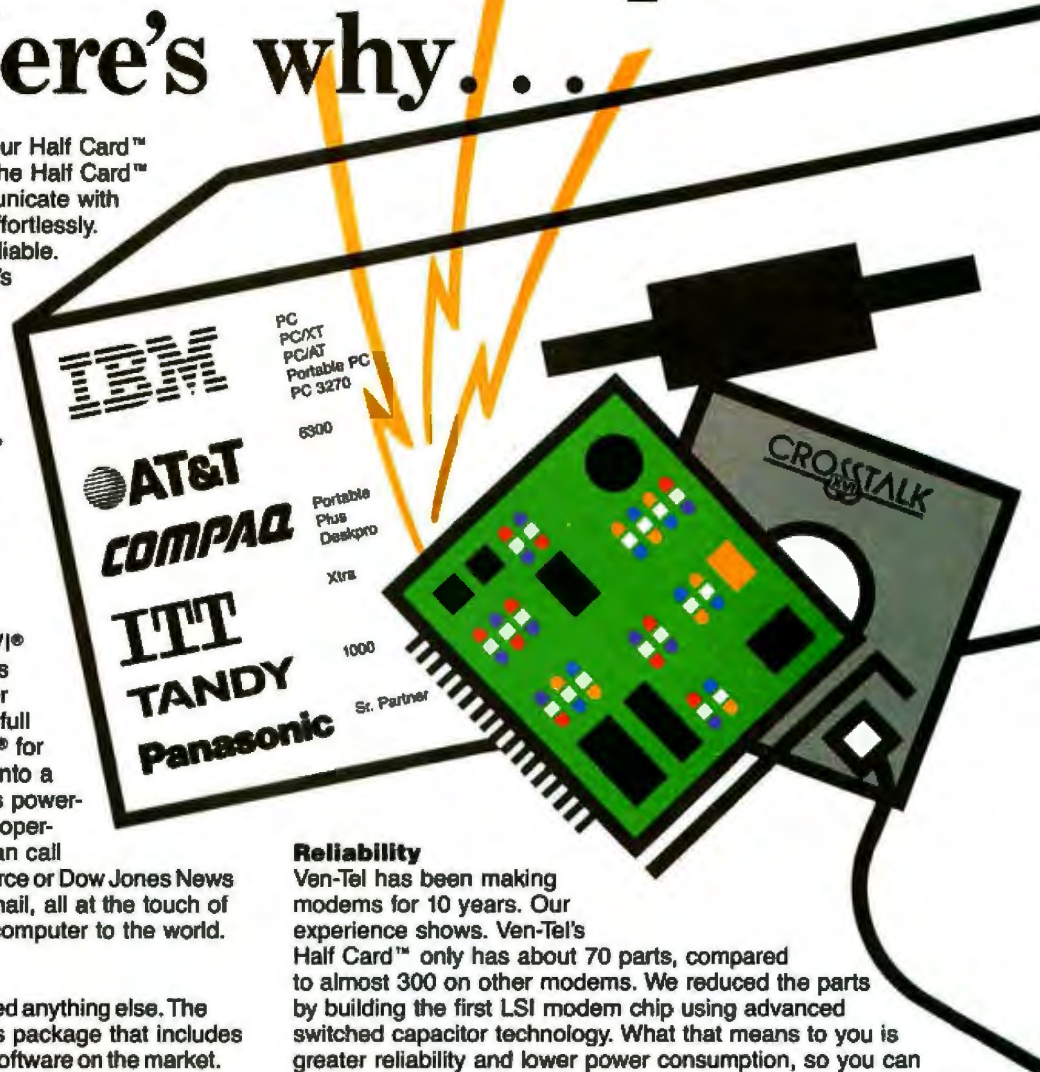

## Reliability

Ven-Tel has been making modems for 10 years. Our experience shows. Ven-Tel's Half Card™ only has about 70 parts, compared to almost 300 on other modems. We reduced the parts by building the first LSI modem chip using advanced switched capacitor technology. What that means to you is greater reliability and lower power consumption, so you can load up your PC with expansion boards and not worry about heat or power problems. And we back the Half Card™ with a full two-year warranty on parts and labor.

## You Can Buy the Half Card™ Anywhere

You can get the Half Card™ at ComputerLand, Businessland, the Genra Group, Entré Computer Centers, Macy's Computer Stores and other fine dealers nationwide. Also from Ven-Tel: the 1200 Plus™, an external modem and the PC Modem 1200™, an IBM internal with V.22 international capability.



Effortless Communication  
 **Ven-Tel Inc.**

2342 Walsh Avenue  
 Santa Clara, CA 95051  
 (408) 727-5721

# THE ADVENTURE CONTINUES . . .



## \$49<sup>95</sup>

## SOMETHING BRAND NEW

**INSTANT DATABASES . . . BECAUSE THAT'S HOW MOST OF US NEED INFORMATION . . . INSTANTLY!**

Homebase provides you instant access to a whole realm of databases. Just hit the hotkey to freeze whatever software you're working in, and you're ready to find, insert or manipulate data.

This is much more than a simple cardfile or mini-database. You'll be able to set up your own templates, define parameters such as the length of a field, and do rapid key searches. You can have thousands of records in a database. And numerous databases on your menu.

### THE TOOLS YOU NEED.

We've included a powerful set of tools that will save you time and help you organize information, schedule, calculate and a whole lot more. All within a quick keystroke . . . regardless of the software you're running! You may find a few of these in some "desktop" products . . . but nothing else approaches the power of Homebase!

- |   |  |
|---|--|
| <ul style="list-style-type: none"><li>• Instant Databases</li><li>• Phone Message Pad</li><li>• Rolodex™</li><li>• Appointment Calendar</li><li>• Calculator</li><li>• Notepad</li><li>• Time and Expense Diary</li><li>• Programmable Hotkey (You choose the key that gets you to your Homebase)</li><li>• Electronic Mail (as an automatic multi-task)</li><li>• Tables and Pages (for those things you always need to look up)</li><li>• Alarm Clock (including Musical Snooze Alarm)</li><li>• To-Do List</li></ul> | <ul style="list-style-type: none"><li>• Quickterm Terminal (available even when you're working in another program)</li><li>• Autodialer</li><li>• Template Maker (for designing your own databases)</li><li>• DOS Services</li><li>• Rolodex Card Printer</li><li>• Mailing Label Printer</li><li>• Data Transfer (between databases or your other software)</li><li>• Cut and Paste (great for putting together an Electronic Mail letter that combines a chunk of spreadsheet, some text from a document, and a few notes)</li></ul> |
|---|--|

# THE EXCITEMENT IS BACK

With the Electronic Mailbag of Your Dreams

ELECTRONIC MAIL THAT TAKES CARE OF ITSELF . . . IN THE BACKGROUND

(While you're running WordStar, Lotus, dBase, a compiler or whatever)

We wanted electronic mail that could take care of itself while we were busy on the computer doing something else.

We always felt that there was something strange about having to play postman every time a piece of electronic mail was due. It was always a case of loading up a communications package and either waiting for the mail or going out to fetch it.

Now, we've got it! And you can have it, too. With HOMEBASE, Electronic Mail can arrive while you're working in another piece of software. Up in the corner of your screen, a signal lets you know that there's incoming mail. You can read it as it comes in, if you want. Or you can ignore it, and your mail will automatically file itself . . . to be read at your leisure.

When you're sending Electronic Mail, it's just as easy. Once you've written and addressed your letter, the rest is done for you, automatically, while you're back working in another piece of software.

## CHECK THE DIFFERENCE IN VALUE!

### WHY ARE YOU GETTING SO MUCH SOFTWARE FOR SUCH A SMALL PRICE?

Amber Systems makes tools for programmers including VSI—The Window Machine. We make mouse drivers, asynchronous drivers and electronic mail packages for a number of companies. Now, we've decided to use these tools, plus some new ones that aren't yet on the market, to produce new concepts in software. Because we make the tools ourselves, our costs, and consequently yours, are the lowest possible . . . with never a compromise in quality.

**YES! Site licenses are available** for companies . . . large and small. If you would like to order a single copy, now, to examine and show around your company, its cost can be deducted, later on, from your site license.

For further information on site licenses call 408-996-1883.

HOMEBASE	SIDEKICK	POLY WINDOWS	SPOTLIGHT
Notepad Autodialer Appointment Calendar DOS Services Calculator Rolodex Rolodex Card Printer Tables and Pages Alarm Clock Template Maker Instant Databases Data Transfer Cut and Paste Programmable HotKey Phone Message Pad Time and Expense Diary To-do List Electronic Mail Quickterm Terminal Mailing Label Printer	Notepad Autodialer Calendar Calculator ASCII Table Rolodex	Notepad Keyboard Macros Calendar Calculator Game Alarm File Cards	Notepad Calendar DOS Services Calculator Rolodex File Cards
\$49.95 !	\$49.95	\$49.95	\$149.95

Sidekick is a trademark of Borland International, Inc. Poly Windows is a trademark of Polytron Corp. Spotlight is a trademark of Software Arts.

ORDER YOUR COPY OF HOMEBASE TODAY!

For VISA and MasterCard Orders Call Toll Free : 800-538-8157 Ext. 824

In CA 800-672-3470 Ext. 824

Call Mon. - Fri. 6 A.M. to 12 P.M., Sat. & Sun. 6 A.M. to 8 P.M. (P.S.T.)

or fill in this ORDER FORM and enclose a check, money order or your VISA or MasterCard number.

**HOMEBASE** is available for the IBM PC, XT and true compatibles  
\$49.95 + \$5 for shipping and handling\*

NAME \_\_\_\_\_  
 TITLE \_\_\_\_\_  
 COMPANY NAME \_\_\_\_\_  
 ADDRESS \_\_\_\_\_  
 CITY \_\_\_\_\_ STATE \_\_\_\_\_ ZIP \_\_\_\_\_  
 HOME PHONE ( ) \_\_\_\_\_ WORK PHONE ( ) \_\_\_\_\_  
 CHECK  MONEY ORDER  VISA  MASTERCARD Card # \_\_\_\_\_ Exp. date \_\_\_\_\_

**30-day money-back guarantee!**

\*California residents add 6% sales tax. Outside U.S. please add \$15. Checks must be on a U.S. bank and in U.S. dollars. Sorry, no C.O.D. or purchase orders.  
 For dealer and site license information, call 408 996-1883. BY FE

SEND TO:

**AMBER**  
 AMBER SYSTEMS, INC.  
 1171 S. Saratoga-Sunnyvale Road  
 San Jose, CA 95129

**NOW SHIPPING!**

# To get a lot out of your printer, you need a lot of programs, right?

**Wrong.** Sure, you could buy one package to change type sizes, another to create fonts, and still another to print sideways. Or you could get one simple program to do it all!

**Printworks.™**  
It's loaded.



**SoftStyle™**

SoftStyle, Inc. 7192 Kalanianaʻole Hwy Suite 205  
Honolulu, Hawaii 96825 Phone (800) 367-5600  
\$69.95 Enhances over 30 dot matrix printers, including  
Epson and Okidata IBM PC or compatible

may not feel that in buying a piece of software he is getting his money's worth. This is our problem. If we assume that software piracy will always exist, that friends will pass along software to friends, then how can money be made in the software market where piracy steals away profits?

Most software can be either considered entertainment or tools. For the purposes of my proposition, I'm only going to consider entertainment software (games). A certain game has a rather specific audience: The user has a specific machine (possibly specific hardware) and can reasonably be assumed to be of a certain age and socioeconomic class—a very specific market of users. Here is the proposal: Since a piece of software can be assumed to attract these users of a specific group, there is a natural grouping to which advertising could be aimed. I am suggesting that instead of selling the entertainment to the user, sell the exposure of the program to advertisers and distribute the programs freely.

What I am saying is, model the entertainment software distribution after other forms of entertainment, i.e., television. Television does not sell the entertainment to its viewers (except examples like movie channels), it sells a captive audience to the advertisers and thus turns a profit. I believe that the same principle could be applied to game software, though in a more discreet manner. So develop the program, make it basically self-explanatory, and sell advertising within the program. Also, since software is notoriously hard to modify, the ads would easily be carried throughout the entire distribution of the game. Methods of implementing this would be to include things like billboards on some game screens, maybe a full-screen ad that appears when the game is paused, ads at the beginning and end of a game, and other visible but nonintrusive advertising. In this manner, the game would still retain all of its lure and glitter, but other elements conveying the advertising message would be included.

So, I am suggesting that there is a way to make a profit and utilize a problem that is currently plaguing the software industry.

EDWARD DEAN TATE, JR.  
Seaford, VA

## WHY THE RESTRICTIONS?

I would like to ask the software manufacturers why unprotected software has more severe restrictions put on its use than does copy-protected software. A typical copy-protected software license says something

(continued)

## Powerful in circuit emulation, priced well within your grasp. That's NICE.™

NICE may be only 3" square and 1/2" thick, but it hands you full speed, real-time emulation—over 50 emulation functions, software breakpoints, all memory addresses and all I/O ports.

Just plug NICE directly into the target MP socket and any RS232 terminal for system development, troubleshooting, debugging or testing . . . at home, in the lab or in the field.

And NICE hands you all this performance, portability and versatility for only \$498\* . . . the best emulator price/performance ratio on the market, hands down.

Call in your order today using

your VISA or Mastercard number: (800) NICOLET outside CA, or (415) 490-8300 in CA.

Or send your check or money order to NICE, Nicolet Paratronics Corporation, 201 Fourier Avenue, Fremont, CA 94539.

\*Payment by check, money order, VISA or MasterCard.  
NICE is a trademark of Nicolet Paratronics Corporation.  
\*Z80 is a trademark of Zilog, Inc.

**Nicolet**







## We make it simple.

An Interface disk or tape subsystem is simple to install and simple to use for IBM PC, XT, AT, and most PC-compatibles

### For the PC and compatibles we give you:

- External DiskSystems<sup>®</sup> from 10 to 119MB.
- Internal with 10 to 55MB.
- 10MB removable cartridge Winchester.
- 10MB TapeSystem<sup>®</sup>.
- DualStor<sup>®</sup> with 10, 22, or 33MB of fixed storage plus 10MB tape or 10MB removable Winchester.



### For the PC-XT, we give you:



10-megabyte TapeSystem

- Internal 10 to 55MB.
- DoubleBarrel<sup>®</sup> is an internal combination with 10, 22, or 33MB fixed storage combined with 10MB of tape back-up.
- External 10MB tape cartridge drive.
- External ExtraDrive<sup>®</sup> is a 10MB removable cartridge Winchester.
- External DiskSystem with 10 to 55MB of additional storage.

### For the PC-AT, we give you:

- Internally mounted hard disk drives with 21 to 117MB.
- Internal 10MB removable cartridge Winchester.



AT up-grade kit

Since 1978, Interface has been providing quality storage subsystems at affordable prices for the personal computer market.

DiskSystems, TapeSystems, DualStor, DoubleBarrel and ExtraDrive are copyrights of Interface, Inc. IBM is a registered trademark of IBM Corporation.



## Interface, Inc.

Inquiry 156 for End-Users.  
Inquiry 157 for DEALERS ONLY.

21101 Osborne Street,  
Canoga Park, CA 91304  
Or call (818) 341-7914

Canada: Santronic Sales, Ltd.  
(604) 522-1658

like "You may physically transfer the program from one computer to another, provided the program is used on only one computer at a time," while the license for an unprotected program says something like "This program may be used by only one user on one machine and may not be transferred."

The difference between these two attitudes can be seen in the following exam-

ple. Suppose I buy an unprotected copy of ClicheWriter, and I spend about two hours a day writing with it. When I'm finished, the program must go back into the box. If I want to work at home, I have to buy another license. If my secretary wants to use the program, she has to buy a copy. If the guy down the hall wants to use it, ditto. Let's say all these things happen so that together we pay for four

ClicheWriter licenses. Meanwhile, my competitor down the street buys a protected copy of WordyPlatitude. He uses it for two hours, lends it to his secretary for a few more hours, then to the guy down the hall, then takes it home to teach his kid. Both programs have been used the same total amount, by several users on several machines (though only one at a time). Yet, to avoid being branded pirates and criminals, the users of the unprotected program have spent four times as much.

The question is, Why do the makers of unprotected software trust users not to copy and distribute the program, yet not trust or allow them to use it by one person on one machine *at a time*? Some programs are used many hours a day, but others are used only for an hour or two once a week. Why can the protected ones be freely passed around while the unprotected ones can't? Why must someone who uses a program for an hour a day pay the same license fee as someone who uses it eight hours a day? Why can't the program be licensed for use eight hours a day, regardless of whether that means eight people at an hour each or one person at eight hours?

Let's say you want to buy a copy of AlphaBetsy, that new program that alphabetizes the Christmas card list you typed at random into your word processor. Now this program takes only five minutes to do its stuff. If it's copy-protected, chances are you will be allowed to lend it to all your friends to alphabetize their Christmas card lists, too, and as a result they may help you pay the \$100 it costs. Yet, if the program is unprotected, you will no doubt be threatened with immediate violent death if you lend it to anyone. But then, will you want to pay \$100 for five minutes' use every few months?

Perhaps software manufacturers should think about just what it is they are licensing. Does the license permit, say, eight hours' use a day without regard to who does the using on what equipment, or does it permit only the use one person can make of it? And if eight hours' a day usage is permitted, what about four people using it *simultaneously* for two hours? Isn't that the very same net use as one user on one machine for eight hours? Or is the manufacturers' attitude one of "Hey, if you can use it all day, great. If not, that's your tough luck"?

I would appreciate some answers to these questions from some software manufacturers.

ROBERT HARRIS  
Corona, CA ■

## Data worth keeping deserves a Data Defender.



**Data Defenders by Ring King.** They're the finest quality protection you can buy for the information you have stored on 5¼" mini-diskettes and printout.

The Ring King 070 Tray holds 70 mini-diskettes in a tough copolymer shell with security lock. The Ring King Flip File II binder holds 20 mini-diskettes and converts to a desktop Index. Ring King Looseleaf Files are punched to fit standard 3-

ring binders. Ring King Data Binders hold up to 8" of 9½" x 11" or 14⅞" x 11" unburst printout.

Ask for Ring King Data Defenders at your computer supply dealer. Or send for our free, full-color catalog of computer support products. Write Ring King Visibles, Inc., 2210 Second Avenue, P.O. Box 599, Muscatine, Iowa 52761. For customer service, phone (800) 553-9647, in Iowa (319) 263-8144.

## DATA DEFENDER™



# READ ONLY



*A review of the IBM Personal Computer Family, Vol. 2 No. 2*



## WHAT'S THE PROGRAM?

**Meaningful dialogue.** There are two programs from IBM that can greatly improve the quality of our running dialogue with computers. They are the IBM EZ-VU Runtime Facility and the IBM EZ-VU Development Facility.

Think of the EZ-VU Runtime Facility as a mediator in your IBM PC conversations. It handles the exchange of commands and information between you and your application programs through predefined screens. It can give you a single consistent interface with applications written in a variety of languages.

In short, the EZ-VU Runtime Facility lets you concentrate on the essentials of the job you're doing.

If your job is program development, the IBM EZ-VU Development Facility can help you write menu-driven applications—or revise existing ones—that are both sophisticated and easy to use. It incorporates a screen design tool that works through the function keys on your IBM Personal Computer, so there are no special codes and commands to slow down your design work. EZ-VU also helps

make fast work of testing and revising your screen designs.

Two additional points. Both of these EZ-VU programs benefit from years of success by similar dialogue management programs in IBM host MVS, VM, and VSE operating environments. And both run under the IBM TopView program, which allows you to run a number of software applications concurrently.

**A quantum leap.** Speaking of technological advances, IBM Personal Computer Professional FORTRAN represents a quantum leap forward in FORTRAN for microcomputers.

It's a full ANSI 77 implementation with enhancements that offers an un-

*Application management, program development, and communications software from IBM. See next page for IBM PC Network SNA 3270 Emulation Program story.*



usual combination of speed and accuracy. Optimization techniques and features such as a full symbolic interactive debug facility are similar to those usually found only in IBM VS FORTRAN and other mainframe FORTRAN compilers.

You can use IBM PC Professional FORTRAN to work on large or small host programs and to recompile existing FORTRAN programs—or sections of those programs—to run on your IBM Personal Computer. It's ability to handle arrays larger than 64KB gives you the equivalent of mainframe capability on a personal computer.

And IBM PC Professional FORTRAN was designed for IBM by Ryan-McFarland Corporation to help you take full advantage of other IBM Personal Computer software, such as the IBM Personal Computer Engineering/Scientific Series graphics development tools.

Make that "quantum leaps."

The IBM *Directory* of personally developed software gives you direct access to some of that hidden talent. It's a catalog of unique programs developed by individuals for the IBM Personal Computer Family.

Programs listed in the *Directory* sell for as little as \$14.95. They cover a wide range of interests, from entertainment and education to personal productivity and business applications.

Each program in the *Directory* has a full description that includes system requirements and illustrations or color photos of representative screens. Programs may be ordered by mail or through a toll-free telephone number.

To subscribe to the *Directory*, call 800-IBM-PCSW.

**The last word.** Or perhaps we should say the last word to date. The new IBM DOS Technical Reference manual contains just about everything you'd want to know about the IBM Disk Operating System Version 3.1 and previous versions 2.1 and 3.0.

That's not to say that new improvements and information won't appear in the future. They will, and you'll be kept abreast of such developments. An update information service is included in the manual's purchase price.

So you'll always have the last word.



Updated versions of the DOS Technical Reference manual and the *Directory of Personally Developed Software* from IBM.



## HARDCOPY

**Hidden talent.** Think of the many entertaining and useful programming ideas that must exist out there but never find their way to market.

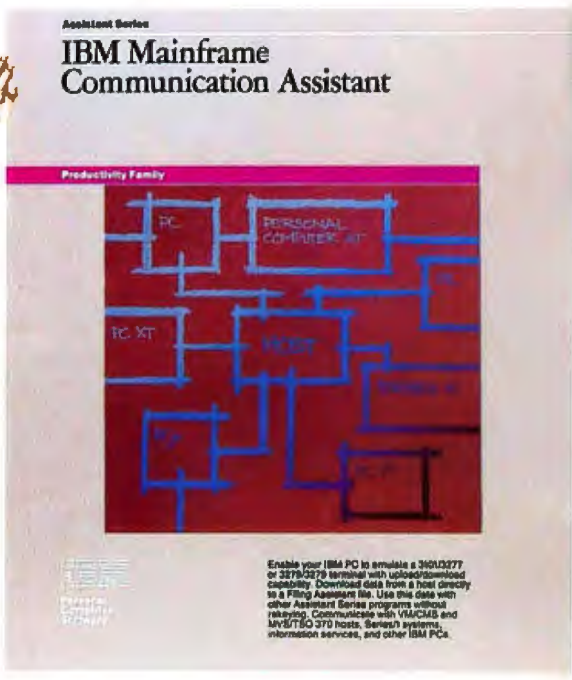

## FAMILY TIES

**Close connections.** The IBM PC Family has always included hardware and software to help you keep in close touch with important contacts.

Last year's announcement of the IBM PC Network, for instance, was an important milestone in communications among the immediate family. It gives you an easy way to share information and hardware resources like printers and disk storage devices.

There are two recent IBM communications software products that extend those IBM PC Family connections even further. They make it possible for you to work directly with data stored on an IBM host computer, to communicate from one network to another, and to do an even wider range of your daily business over the IBM PC Network.

**Host communications.** The IBM PC Network SNA 3270 Emulation Program, for example, allows your IBM Personal Computer to communicate with an IBM host system through telecommunications lines.

Broaden your IBM PC connections with communications software from IBM.

You then have direct access to the data and programs on the host computer. So if you're working on a branch-office quarterly report, you no longer have to wait while essential data from a headquarter's computer is sent to you and copied for your use. There's also a redirector function that allows you to place the data on a file server for distribution to other stations on your IBM PC Network.

In addition, when the program is installed on an IBM Personal Computer in an IBM PC Network, that PC can act as a communications gateway for other members of the same network. If members of a network need to communicate with more than one IBM host computer—or with different applications on the same host—multiple gateways can be attached to a single IBM PC Network.

And an IBM PC with the IBM PC Network SNA 3270 Emulation Program installed can still be used as a network station doing standard PC work.

You could, for instance, use your IBM PC to create a data set on a host system. You could also create a word processing project on your IBM PC using DisplayWrite 3\* switching easily back and forth between them without terminating either session. The IBM PC Network SNA 3270 Emulation Program also allows you to transfer graphics printing jobs from the host to an IBM PC with a graphics printer attached.

**Stand-alone assistance.** There's a new addition to the IBM Assistant Series to help handle stand-alone communications between your IBM Personal Computer and a host machine or another IBM Personal Computer. IBM Mainframe Communication Assistant software includes a 3101 and 3270/78/79 terminal emulator for your IBM PC, plus a set of host computer support programs for VM/CMS and MVS/TSO systems.

Mainframe Communication Assistant has the same easy menu structure as other members of the Assistant Series, such as Writing Assistant and Planning Assistant. And it offers a number of unusual features to simplify your communications work.

It can, of course, speedily transfer files between host and PC (or PC

Quiet, please. printer technology. is as advanced as the computer. versatile, compact, remarkably quiet work that might make people think printing press in a dark room. In this case, the revolution is a new method of resistive printing developed by IBM. The "Quietwriter" Printer replaces print elements or hammers that strike the page with a unique multi-layer ribbon and print mechanism that virtually "paints" characters on the paper.



*IBM Quietwriter® Printer offers advanced printer technology and unusually low operating noise level. Shown with sample of letter-quality printing.*

and PC). After you've worked with the host file, Mainframe Communication Assistant lets you transfer only the changes you've made—rather than the entire file—back to the host computer.

And, as a member of the Assistant Series, Mainframe Communication Assistant allows you to integrate mainframe database information into Filing Assistant files. You're then able to transfer that information to other members of the Assistant Series, saving the time and effort of reentering data that has been stored on a mainframe computer:

\*Follow the proper installation instructions in the IBM PC Network 3270 Emulation Program documentation for DisplayWrite 3.



#### HARDWARE NEWS

**Quiet, please.** There's been a quiet revolution in printer technology. The IBM Quietwriter® Printer is as ad-

vanced as the computers it serves. It's versatile, compact, remarkably quiet, and produces work that might make people think you've got a printing press in the back room.

In this case, the spark behind the revolution is a new method of resistive ribbon, non-impact printing developed by IBM. The "Quietwriter" Printer replaces print elements or hammers that strike the page with a unique multi-layer ribbon and print mechanism that virtually "paints" characters on the paper.

As a result, the "Quietwriter" Printer produces superb, letter-quality printing on a variety of papers and in a wide range of type styles. To change type styles you just unplug one font module and plug in another. And because the "Quietwriter" Printer can accommodate two font modules, you can have two type styles online at once.

The "Quietwriter" Printer also allows you to produce a wide array of character graphics either separately or to highlight reports and correspondence.

And it does all of this very, very quietly. At 50 dB, the IBM "Quietwriter" Printer\* makes less noise while printing than many printers make while idling. That means you can put the "Quietwriter" Printer wherever it's most convenient: it won't disturb either your telephone conversations or your train of thought.

**Unconventional ability.** IBM also makes conventional printer technology seem anything but conventional.

Consider the IBM Wheelprinter,\* for example. Its printwheel is designed to provide sharp, clear letter-quality printing even after millions of impressions. And the printwheel is easy to change, which is important because there's a selection of over 500 printwheels to choose from. The Wheelprinter's standard features also include both automatic sheet feed and continuous forms feed—optional on many other printers.

The Wheelprinter is reliable enough to take on high-volume office work. It even works with two types of ribbons to suit the requirements of different types of jobs. There's a single-strike ribbon for finished reports or correspondence. For more routine jobs like purchase orders or internal memos, you can use a longer lasting, lower cost multi-strike ribbon.

The Wheelprinter has equally impressive qualifications as a home printer: To begin with, it's remarkably easy to use. The Wheelprinter's integrated paper path provides reliable cut-sheet printing and allows it to do much faster work than you might expect from a 25cps printer. And its acoustically engineered cover makes the Wheelprinter an exceptionally quiet impact printer.

Maybe "conventional" isn't the right word at all.

\*These are just two of the various printers available from IBM for the IBM Personal Computer Family.

## ON THE STOREFRONT

**Extra attention.** Even the best equipment sometimes needs a little extra attention. An IBM Dealer Service Option can provide it. It gives you extended service coverage for IBM Personal Computer products, and is

available from participating Authorized IBM Personal Computer Dealers either before or after your original warranty expires.

## We've got you covered

The Dealer Service Option protects your IBM Personal Computer investment



In addition to sparing you the complications of arranging for the job to be done after something has gone wrong, a Dealer Service Option assures you of first-rate work. IBM Personal Computer Dealers have full-time, IBM-trained and authorized technicians on staff as well as direct access to IBM technical experts who can help with unusual or complex questions.

An IBM Dealer Service Option also covers a couple of important additional contingencies. If you move, your service coverage can be honored by a participating Authorized IBM Personal Computer Dealer in your new location. And if you should decide to sell your IBM Personal Computer product, your Dealer Service Option may be transferred to the new owner.

IBM



## TIPS AND TECHNIQUES

**Stop action.** If you occasionally sit frozen while screen after screen of information rolls by too fast to read, take heart. There's more than one way to stop that cascade of data and view one screenful at a time.

When listing the directory of a diskette or fixed disk, the command DIR/P will do the trick. After finishing with one screen, press any key to bring up the next.

To slow down the listing of a text file, you could use the CTL/NUM LOCK keys, but that involves keeping both hands on the keyboard and an eye on the screen.

Instead, check your DOS directory listing to make sure the DOS utility program MORE.COM is available. Then, at the DOS prompt A>, type the command line MORE<filename and press enter:

**NOTE:** be careful to use "<" and not ">"; if you enter the wrong one, you'll destroy your text file.

To view a file called PCWRITE.DOC, for example, enter MORE<PCWRITE.DOC. That will list a single page of text on your screen and display the message —MORE—. Again, press any key to view next screen.

Voilà, perfect control.

Thanks for this tip to Chuck Harrington of the Athens, Ohio, area IBM PC Users Club.

Thanks also—and apologies for omitting a note of credit in the last issue of *Read Only*—to Ed Smuckler of the Redondo Beach, California, Greater South Bay User Group for his tip about setting screen colors.

For more information about IBM Personal Computer products discussed in this issue of *Read Only*, see your Authorized IBM Personal Computer Dealer or IBM Product Center. To learn where, call 800-447-4700. In Alaska and Hawaii 800-447-0890.

© 1985 International Business Machines Corporation  
Little Tramp character licensed by Hubbles Inc., S.A.

## FEEDBACK

### Leaks Like a Sieve

We've often called benchmarks a "can of worms," and the little critters slithered out of the humus to terrorize us again in the wake of our review of True BASIC ("True BASIC" by G. Michael Vose, May BYTE, page 279). One reader wrote to say the algorithm is wrong (it isn't, as explained below), while a couple of others wrote to ask why we persist in using GOTOs in benchmarks of a language that has constructs that allow you to avoid them. All this reexamination of our infamous Sieve helped us discover some problems, including a false impression created by the review's benchmark table and accompanying graph, that need explanation.

The BASIC Sieve benchmark is a single iteration of the algorithm to find prime numbers between 3 and 14003. The Pascal Sieve benchmark, however, executes 10 iterations of the same algorithm. Our review implies that True BASIC is nearly as fast as Turbo Pascal at executing the Sieve when it is in fact substantially slower. Turbo Pascal's sluggish performance in the Calculations benchmark is an indication that its compiler may optimize the code it generates for the Sieve.

BYTE began using single-iteration versions of the Sieve for system benchmarks (which were all written in BASIC) in conjunction with our review of the IBM PC ("A Closer Look at the IBM Personal Computer" by Gregg Williams, January 1982, page 36.) At the same time, we modified the original Sieve ("A High-Level Language Benchmark" by Jim Gilbreath, September 1981, page 180) from 8190 passes to 7000 to accommodate the small memory available on many of the 8-bit machines to which the PC was compared. We've been consistent with this BASIC benchmarking scheme for system reviews since then.

The queries about unstructured versus structured versions of the Sieve in BASIC raise a valid and interesting point—namely, does structure affect the performance of the algorithm? The answer, in the case of True BASIC, is no—the difference in execution time of the structured version of the benchmark (see listing 1) was a 0.4 second, or 1.8 percent, decrease. We pur-

Listing 1: A structured version of the Sieve benchmark, without GOTOs, written in True BASIC.

```

LET starttime = time
LET size = 7000
DIM flags(7000)
PRINT "Start One Iteration"
LET count = 0
FOR i = 1 to size
    LET flags(i) = 1
NEXT i
FOR i = 1 to size
    IF flags(i) < > 0 then
        LET prime = i + i + 3
        LET k = i + prime
        DO while k <= size
            LET flags(k) = 0
            LET k = k + prime
        LOOP
        LET count = count + 1
    END IF
NEXT i
PRINT "Done: ";count;" Primes Found"
LET finishtime = time
PRINT finishtime - starttime;" seconds"
END
    
```

Listing 2: The accuracy benchmarks in two slightly different versions. Using  $Y = Y^2$  yields different results than computing  $Y = Y * Y$ . (In Microsoft BASIC, X and Y must be declared double precision.)

<pre> (a) LET x = 1.0000001 LET y = x FOR i = 1 to 27     LET y = y * y NEXT i PRINT y PRINT x^(2^27) END         </pre>	<pre> (b) LET x = 1.0000001 LET y = x FOR i = 1 to 27     LET y = y^y NEXT i PRINT y PRINT x^(2^27) END         </pre>
--	--

posely ran the benchmark with GOTOs to maintain consistency among BASIC versions of the test (so that we'd be comparing apples to apples), but the readers who took us to task for not asking if there might be a better way have a legitimate gripe.

Digressing a moment from the Sieve, another reader suggests we adopt an accuracy benchmark. Adapted from a dis-

cussion of numeric precision in the April 1984 issue of *Scientific American* ("Computer Recreations" by Fred Gruenberger, page 19), his suggested benchmark appears in listing 2 and its results in table 1. We like its brevity and simplicity and invite your comments as to its usefulness.

Back to the Sieve, the most recent  
(continued)

# MidWest Micro-Peripherals

Gigantic Sale!

Star - Brother - Epson - Sanyo - Zenith

### PRICE GUARANTEE

We at MidWest Micro guarantee that we can save you up to 49% or more on your purchase of new fully warranted equipment and supplies. And we will still give you friendly, courteous service. Call today and Save With Confidence!

Get great hard copy and near letter quality with . . .



**star** ONLY  
**SG-10 \$199**

(Replaces the Gemini 10X) (Limited Time Only)

The SG-10 gives you enough versatility for home or office use. It operates bi-directionally at 120 cps and includes many special features such as near letter quality printing, easy access format switches for a wide range of character modes, friction feed for single sheets and tractor feed for fanfold paper, and even hex dump. Another special feature is the IBM character sets available at the flip of a switch. You get all of this plus a 2k memory buffer and Star's full 1 year warranty at a price you can afford!

Complete STAR Line . . . . . \$CALLS



**brother**

printer's give you all the features of a letter quality

**NEW!** and more with . . . **HR-15XL**  
Special Printer Package SAVE **\$275**

The HR-15XL gives you Daisywheel printing and added attractions such as text reprinting, red printing, attachable cut sheet feeder and the exclusive Brother keyboard attachment.

Complete BROTHER Line . . .	List	Your Price
HR-10 (12CPS)	\$399	\$CALLS
HR-15XL (17 cps, 13.5" carriage, 3k Buffer)	599	\$CALLS
HR-15 & HR-15XL Keyboard Attachment	200	\$CALLS
HR-25 (23 cps, 18.5" carriage, 3k Buffer)	895	\$CALLS
HR-35 (32 cps, 16.5" carriage, 7k Buffer)	1245	\$CALLS
Brother 2024 (160 cps, 24 pin head, NLQ Mode)	1495	\$CALLS

Don't spend a fortune to own the world's most popular printer . . .

**NEW!**  
**EPSON** ONLY  
**LX-80 \$279**



**LX-80 Unbelievable Savings**

The new EPSON LX-80 prints smoothly and quietly at a speed of 100 cps. With the superb near letter quality mode and full graphic capabilities as standard, your correspondence will be letter perfect. The LX-80 comes complete with a parallel interface to quickly connect it to virtually all computers. There are 160 typesets that are switch selectable and the LX-80 comes with EPSON'S full 1 year warranty. Friction feed is standard and an optional tractor feed is available. Let the EPSON LX-80 print your next business letter or report.

Complete EPSON Line . . .	List	Your Price
LX-80 (100 cps, NLQ Mode, 60 Col.)	349	\$CALLS
RX-100 (100 cps, 136 Col.)	895	\$CALLS
FX-80+(160 cps, 80 Col, 2k Buffer)	699	\$CALLS
FX-100+(160 cps, 136 Col, 2k Buffer)	999	\$CALLS
LQ-1500 (200 cps, NLQ Mode, 136 Col.)	1395	\$CALLS

Complete Systems  
**SANYO**



**ZENITH**  
SAVE up to 49% off!  
Computer Systems

Get IBM compatibility, improved keyboard, faster processing speed, more memory capacity, free software, more expansion capability and unbelievable savings! Call today!

Prices subject to change and type errors

**FREE CARD USE**  
**Call Today!**  
Information - Ordering  
**1-800-423-8215**  
In Ohio **1-800-321-7731**  
**CUSTOMER SERVICE (513) 663-4992**

CASH PRICES: Cert. Check, Money Orders, VISA or MC  
CODs (Add \$3) AMEX (Add 4%) P.O.s (Add 5%)

**MidWest Micro-Peripherals**  
(Division of Infotel, Inc.)  
135 South Springfield St  
St. Paris, Ohio 43072

## FIXES & UPDATES

Table 1: The results of runs of the accuracy benchmark of listing 2. The correct value (with 10-digit precision) is 674530.4707.

	a = Y=Y <sup>2</sup>	b = Y=Y*Y	
	y		x
Microsoft(a)	8850273		65536
True BASIC(a)	674530.431654		674530.570667
BetterBASIC(a)	674023.631		674530.4704
Microsoft(b)	674530.470612035		65536
True BASIC(b)	674530.431654		674530.570667
BetterBASIC(b)	674492.751149		674530.470738

Listing 3: The Sieve algorithm with comments.

```

800 SIZE = 7000 ;set number of odd numbers to examine
820 DIM FLAGS(7001) ;dimension the primes-flag array
830 PRINT "start one iteration"
840 COUNT = 0 ;set prime number counter to 0
850 FOR I = 0 TO SIZE ;initialize FLAGS array
860 FLAGS(I) = 1
870 NEXT I
880 FOR I = 0 TO SIZE ;start loop to strike all odd multiples of primes
    from the primes list
890 IF FLAGS(I) = 0 THEN 970
900 PRIME = I + 1 + 3 ;compute prime from FLAGS array index value
910 K = I + PRIME ;find the index to the first odd multiple of PRIME
920 IF K > SIZE THEN 960 ;test for upper bound
930 FLAGS(K) = 0 ;set flag for non-prime
940 K = K + PRIME ;find the index to next odd multiple of PRIME
950 GOTO 920
960 COUNT = COUNT + 1 ;increment prime number counter
970 NEXT I
980 PRINT "done";COUNT;" primes found"
990 END
    
```

reader who claims the Sieve algorithm is incorrect misunderstands how the algorithm uses array indexes. The FLAGS array index is used to calculate the prime numbers in a rather unusual way. Essentially, the algorithm starts by assuming that the first number in the array is prime. Then it eliminates the multiples of the prime, since these numbers are obviously non-prime. The contents of FLAGS (INDEX) = 1 stays unchanged when the number 2 \* INDEX + 3 is computed, as this number is always prime; otherwise, it is changed

to 0 to indicate that a multiple of PRIME has been calculated. The only numbers tested for primeness are the odd numbers beginning with 3. The prime number 2 is thus not captured in the Sieve and is therefore not reported in a run of the algorithm: The message "1651 primes found" is correct although there are 1652 primes less than 14003 because the Sieve doesn't start looking for primes before the number 3. Our solution to the problem of the Sieve's obtuseness is listing 3, a more fully documented version of the algorithm.

### BYTE's BUGS

#### A Power Plant Chip?

Dozens of readers have taken us to task for the following sentence on page 458 of the June BYTE: "Each [Sunol Systems] chip consumes just 100 megawatts when operated from a 5-volt power supply." (See

"A GEM Seminar" by John Markoff and Phillip Robinson, page 455.) Obviously, the sentence should have said "100 milliwatts." We apologize for the error. ■



# Introducing In·a·Vision

## Complex Drawing Made Easy

We created In·a·Vision just for you. The engineer who needs more productive drafting support. The designer who needs versatility for alternate ideas or quick revisions. The architect who needs to manage a variety of working drawings. And the businessman who needs first-class presentation materials as well as detailed flow charts and organization charts.

### Point. Click. Draw.

Now all you do to create complex technical drawings, systems designs, blueprints, diagrams, illustrations, and proposals is point,

click and draw. With In·a·Vision's mouse support, windowing, icons, and pull-down menus, you produce drawings more quickly, accurately and efficiently than ever before.

In·a·Vision's advanced technology includes many features not found on comparable systems costing thousands more. For example,

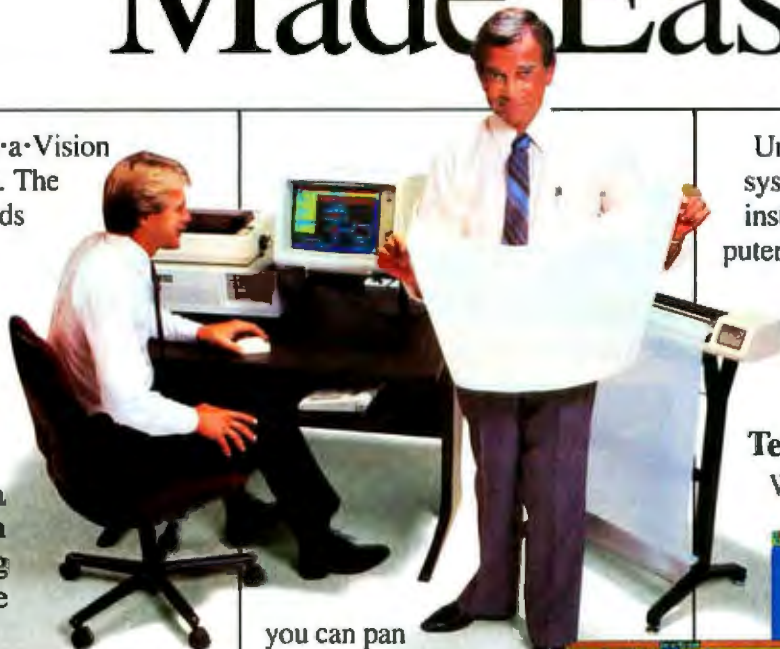

Unlike more expensive CAD systems, In·a·Vision is easy to install and use. Even the computer novice can be productive in less than a day. And In·a·Vision is not copy-protected.

### Ten Day Trial Period.

We're so sure In·a·Vision will

you can pan around in a user-definable drawing space up to 68" x 68" and zoom in on specific areas for greater detail. Scale, rotate and dimension symbols, fill an area with your choices of predefined colors and patterns, as well as draw lines with multiple styles and widths. Other features include overlays, predefined and user-definable page sizes, rulers, grids, and symbol libraries.



make you more productive, we'll give you ten days to prove it to yourself. If In·a·Vision doesn't improve your productivity, return it within ten days for a full refund.

In·a·Vision will make your complex drawing tasks simple and make you more productive. Satisfaction guaranteed. Dial 800-272-3729 to order or for a free brochure. In Texas

### Multi-tasking in a PC-based CAD system.

In·a·Vision uses multi-tasking to enable you to continue drawing while printing hard copies as well as edit multiple drawings simultaneously.



or for customer support, call (214) 234-1769. MICROGRAFX, Inc., 1820 North Greenville Avenue, Richardson, Texas 75081.

## MICROGRAFX™

The Picture of Success.

Inquiry 206

(Most popular graphics cards, plotters and printers supported.)  
Microsoft Windows compatible. Call for specific operating environment requirements.

In·a·Vision and MICROGRAFX are trademarks of MICROGRAFX, Inc.  
Windows and Microsoft are trademarks of Microsoft, Inc.

# What's a database system doing with a



1. Relational capabilities.

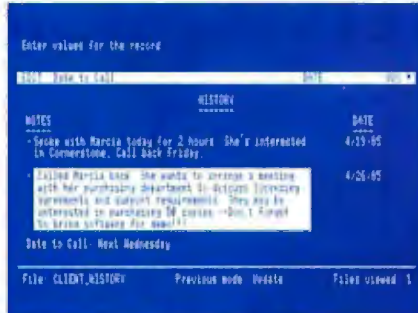

2. Variable-length fields.



3. Multi-valued fields.



4. Subrecords.



5. Interactive report writer.



6. Calculations.

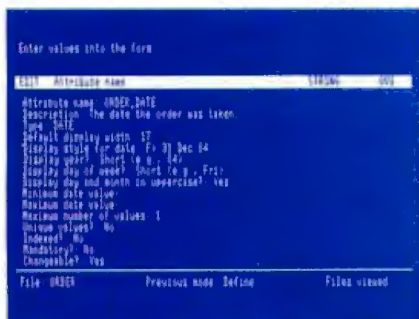

7. Sophisticated data features.



8. Options key.

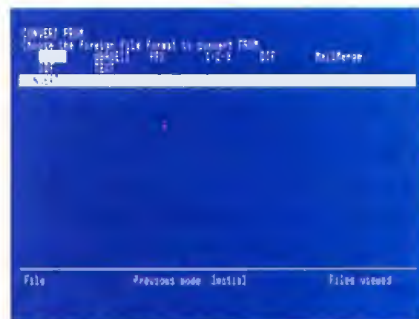

9. File conversion.



Cornerstone is a trademark of Infocom, Inc. IBM is a registered trademark of International Business Machines Corporation. 1-2-3 is a registered trademark of Lotus Development Corporation. Tandy is a registered trademark of Tandy Corporation. dBASE II is a registered trademark of Ashton-Tate. Micro/Answer is a trademark of Informatics General Corporation. PFS is a registered trademark of Software Publishing Company.

# m for non-programmers All this power?

## Cornerstone makes it easy to build sophisticated applications.

Whether you program or not, you expect your personal computer to handle a wide variety of complex jobs. Simply and easily. That's why we designed Cornerstone™ to deliver all the power of a high-end relational (1) database system into the hands of professionals who don't want to spend needless time programming.

## The key is flexibility.

To begin with, Cornerstone will grow with you as your needs change. Which means you don't have to plan every last detail of your database in advance. Instead, you can quickly and easily make changes anywhere and at any time—even with data already in the database. You can add a file, field or index, change a report or relationship, or do countless other things.

And Cornerstone's remarkable flexibility also applies to data handling. For instance, variable-length fields (2) let you add notes of any length anywhere in the database—without determining the length of the field in advance. Cornerstone just makes room as you need it. Which means efficient storage, too.

In addition, any Cornerstone field can be multi-valued (3). So you can type in distinct, multiple entries in the same field. Whether five different phone numbers or 200 different notes. You can even have repeating groups of information, like line items in an order form (4).

The flexibility extends to reporting, too. There's no limit to the number or kind of reports you can create with Cornerstone's interactive report

writer (5). You can design complex reports with titles, headers, sub-totals and totals, and instantly see what your report will look like. Hundreds of reports can be saved for every file and modified at any time.

And Cornerstone has no artificial constraints. You can sort on any field, search on any field.



## The calculating power is built in.

Cornerstone has impressive calculating power (6). Mathematical, scientific, statistical, financial, date, time and string functions are built right in. And because it's a full-featured relational database system, new data can be calculated and reported from multiple files. Cornerstone can also perform sophisticated data validation—checking for minimum, maximum, mandatory, unique or restricted values (7).

## Easy access for all.

Cornerstone's power is designed to be easily accessible. On-line support, including menus and a Help key, allow even unsophisticated users to handle complex jobs. Experienced users can hide the menus entirely.

What's more, Cornerstone's exclusive Options key (8) always shows you what can be entered next—even if it's a restricted data value from a related field.

You can also use Cornerstone with other software and hardware (9). For example, you can easily convert files

from 1-2-3,\* PFS,\* dBASE\* II and word processors (ASCII) directly into Cornerstone. And you can convert Cornerstone files to a wide variety of file formats, including Mailmerge,\* DIF, 1-2-3, SDF and ASCII. You can even download data from most IBM\* mainframe databases, using Micro/Answer™ for Cornerstone.

Cornerstone is a different kind of database system. Created by a company committed to eliminating the barriers between computers and people. It's now available for the IBM PC, PC XT,™ PC AT™ and compatibles, and soon for the Tandy\* 1000, 1200 HD and 2000. Suggested retail price \$495.

## Send for your free demo disk.

To fully appreciate how different Cornerstone really is, you have to try it yourself. For a free demo disk and brochure, call 617-574-0644, or write to Infocom, Inc., Dept. D., 125 CambridgePark Drive, Cambridge, MA 02140. Or see your local Infocom **INFOCOM™** dealer.



# Cornerstone.

## The sophisticated database system for the non-programmer.



THE PETER NORTON  
PROGRAMMER'S GUIDE  
TO THE IBM PC

The ultimate reference  
guide to the *entire*  
family of IBM®  
personal computers.

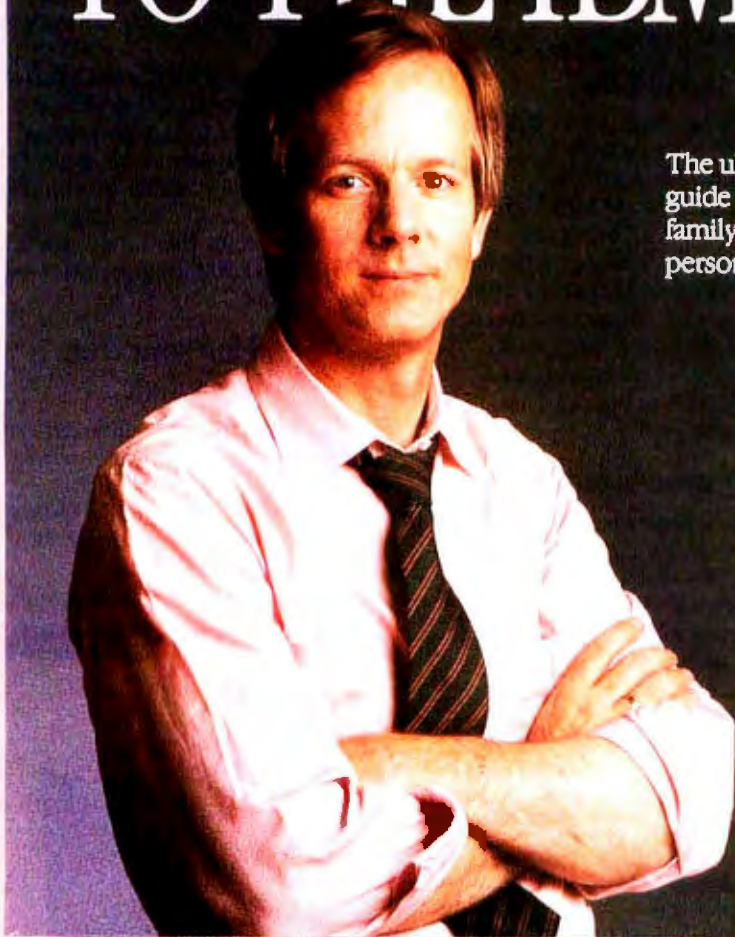

Finally... a comprehensive reference guide rich with resource information on the *entire* IBM family of personal computers: the PC, AT, XT, PCjr, and Portable PC.

*The Peter Norton Programmer's Guide to the IBM PC* is your ultimate guide to programming for the IBM PC environment. It's a gold mine of insights, techniques, technical data, and quick reference charts, all emphasizing the architectural similarities and differences among IBM's five personal computers. Whether you're an experienced or a novice programmer working in assembly language, Pascal, BASIC, or C, you'll find invaluable information for developing portable, effective professional applications.

By Peter Norton, recognized authority on IBM technology, creator of the acclaimed *Norton Utilities*, and noted architect of the now-famous philosophy of simple, clean programming.

\$19.95 Available now wherever books and software are sold.

# W·H·A·T'S N·E·W

## Zoomracks

**Z**oomracks from QuickView Systems is an organizational framework for creating database, text, and appointment applications. It uses a series of files that is similar to a time-card rack. Typical racks can contain cards with appointments, notes, names and addresses, or sales orders. The format of individual cards is user-specifiable; 25 starter formats are supplied.

Both data cards and racks are displayed with Zoomracks' Smart Zooms. This feature differs from windows in that it compresses the information within a card, thereby providing both the essential information and the overall picture associated with the data card. You can tailor Smart Zooms' display to provide an overview of several data racks, a close-up of an isolated data rack, or a view of a single card from a particular data rack.

With Zoomracks, you can copy and move fields, cards, and text into different fields, cards, and racks. You can define, alter, and store card-rack templates, and you can browse through or jump among data racks. Other features include macro instructions, utilities to convert dBASE II files, a simple WordStar-like text editor, and data storage in an ASCII/MS-DOS-file format for conversion to other data formats.



A working overview of Zoomracks with three data racks. Displayed are quotes, memos, and help information in compressed data mode.



A view of a Zoomracks data card, removed from the rack and expanded into full text.



A name, appointment, and tickler file produced with Zoomracks.

Zoomracks can display up to eight racks on screen. It can accommodate 31 fields/cards with 80 characters per line, 250 lines per field, and 20,000 cards per rack. Zoomracks supports display sizes ranging from 25 characters by 6 lines to up to 80 characters by 25 lines. It runs on 256K-byte IBM Personal Computers.

A prerelease, copy-protected version of Zoomracks is \$59.95; an unprotected version is \$79.95. Purchase of the prerelease package entitles you to a free upgrade to the final version, which is due to ship in November; your name in the users manual if you are the first to suggest an improvement; and a six-month, money-back guarantee. Contact QuickView Systems, Suite 404, 146 Main St., Los Altos, CA 94022, (800) 443-0100, ext. 341.

## Modem with Voice Detection

**X**ecom's MOSART is a 300/1200-bps modem with voice detection. MOSART, which is housed in a 40-pin package, comes with all necessary support circuitry. It requires only the appropriate telephone jack, software, and 2 square inches of the IBM PC's motherboard. Speech-synthesis capabilities are optional.

The basic system, the model XE1201, provides full

(continued)

Bell 103/212A (i.e., 300- and 1200-bps) compatibility. It automatically detects normal speech and drops its carrier signal during voice conversation. MOSART can also decode telephone touch-tone signals.

The model XE1203 extends these features with circuitry to generate speech.

To familiarize designers with the features of MOSART, Xecom offers evaluation kits for use with an IBM PC. Each evaluation kit includes a half-size IBM PC expansion card with telephone and headphone jacks, a headset, and a floppy disk with evaluation software and Xecom's XENIAL communications software.

The XE1251 evaluation kit, with the XE1201 MOSART, is available for \$399; the XE1253 kit includes the XE1203 MOSART for \$449. In 100-piece quantities, the XE1201 alone will cost \$199, while the XE1203 will be \$249. Contact Xecom Inc., 374 Turquoise St., Milpitas, CA 95035, (408) 943-0313. Inquiry 600.

### Tektronix AI Systems

The Tektronix Information Display Group has introduced two artificial-intelligence systems that run Smalltalk-80: the models 4405 and 4406. In a related development, Tektronix announced a price reduction for its 4404 artificial-intelligence system. The new price for the 4404 is \$11,950, a \$3000 cut.

In addition to Smalltalk-80, both the 4405 and 4406 come with a UNIX-like operating system and a C compiler. Each machine is equipped with an RS-232C interface, a Centronics-type



The Tektronix 4406.

parallel printer port, a keyboard, a mouse, and ANSI X3.64 terminal-emulation mode.

The 4406 is based on Motorola's 68020 microprocessor, which, in turn, is augmented by a 68881 floating-point coprocessor. Its standard 19-inch, 60-Hz display screen offers a 1280-by-1024-pixel resolution. The 4406 also gives you 2 megabytes of dynamic RAM (expandable to 4 megabytes) with which to work. Other features include a 32-megabyte virtual-memory address space, a 5¼-inch floppy-disk drive, and a 90-megabyte hard-disk drive.

The 4405 has a 13-inch, 60-Hz display screen. The monitor's 640-by-480-pixel display area serves as a window onto the system's 1024-by-1024-pixel addressable bit map. Smooth panning across the bit map is provided by the three-button mouse. Additional equipment includes 1 megabyte of dynamic RAM (expandable to 4 megabytes), 8 megabytes of virtual-memory address space, a floppy-disk drive, and a 45-megabyte hard-disk drive.

Tek Common LISP, Franz LISP, MProlog, a UNIX library, and an EMACS editor are optional. Tek Common LISP is reported to

be a full implementation of Guy Steele's Common LISP standard. It is licensed for \$6000. Such hardware options as increased hard-disk storage, streaming-tape backup, and Ethernet capabilities are offered.

Prices for the Tek 4406 begin at \$23,950. The 4405 starts at \$14,950. Write on company letterhead to Tektronix Inc., POB 1700, Beaverton, OR 97075. Inquiry 601.

### MIDI Magic, Music Disks

Q-R-S Music Rolls, a company that has been producing piano rolls for more than 80 years, has introduced a line of musical hardware and software for Commodore computers.

MIDI Magic is a one-way MIDI interface that lets you connect Commodore's 64 or 128 computer to MIDI-based musical synthesizers, including the Casio CZ-101. It plugs directly into the Commodore's user port and into the MIDI input socket. A

demonstration disk with six songs is supplied.

Q-R-S Music Rolls also offers a collection of music on floppy disks. Many performances feature contemporary musicians and sound quality reminiscent of that achieved by player pianos. The collection includes selections from such artists as Gershwin, Joplin, and Liberace. These compositions can be played back on the synthesizer in any combination of electronic voices. Each floppy disk features six songs.

MIDI Magic costs \$49.95. Q-R-S Music Disks are \$19.95 each. Contact Q-R-S Music Rolls Inc., 1026 Niagara St., Buffalo, NY 14213, (716) 885-4600. Inquiry 602.

### Color Display Adapter

SubLogic recently introduced a high-resolution color-display adapter card for the IBM Personal Computer. The card has a resolution of 640 by 400 pixels by 16 colors. You can select from a palette of 4096 colors.

An on-board custom microprocessor can draw an average of 70,000 line vectors per second. Software support includes an alphanumeric device driver, a primitives library with source code, high-level language interfaces, diagnostic utilities, and demonstration programs. The board will cost approximately \$2500 to \$3000.

Contact SubLogic Corp., 713 Edgebrook Dr., POB 4019, Champaign, IL 61820, (217) 359-8482. Inquiry 603.

(continued)

# Borland's SideKick™ Will Clear Your Desk In 30 Minutes And Increase Your Productivity By 50%

SideKick is a combination of seven desktop accessories, which makes SideKick the single most effective business tool. Just a keystroke suspends your application program, giving you a window into SideKick. Another keystroke brings you back to where you were. Instantly. It's that easy.

**A FULL-SCREEN WORDSTAR™-LIKE EDITOR**

You may jot down notes and edit files up to 25 pages long.

**AN ASCII TABLE** for easy reference.

**AN AUTODIALER** for all your phone calls. It will look up and dial telephone numbers for you. (A modem is required to use this function.)

**A PHONE DIRECTORY** for your names, addresses and telephone numbers. Finding a name or a number becomes a snap.

**A MONTHLY CALENDAR** functional from year 1901 through year 2099.

**A DATEBOOK** to remind you of important meetings and appointments.

**A FULL-FEATURED CALCULATOR** ideal for business use. It also performs decimal to hexadecimal to binary conversions.

COPY-PROTECTED  
**\$54.95**

NOT COPY-PROTECTED  
**\$84.95**

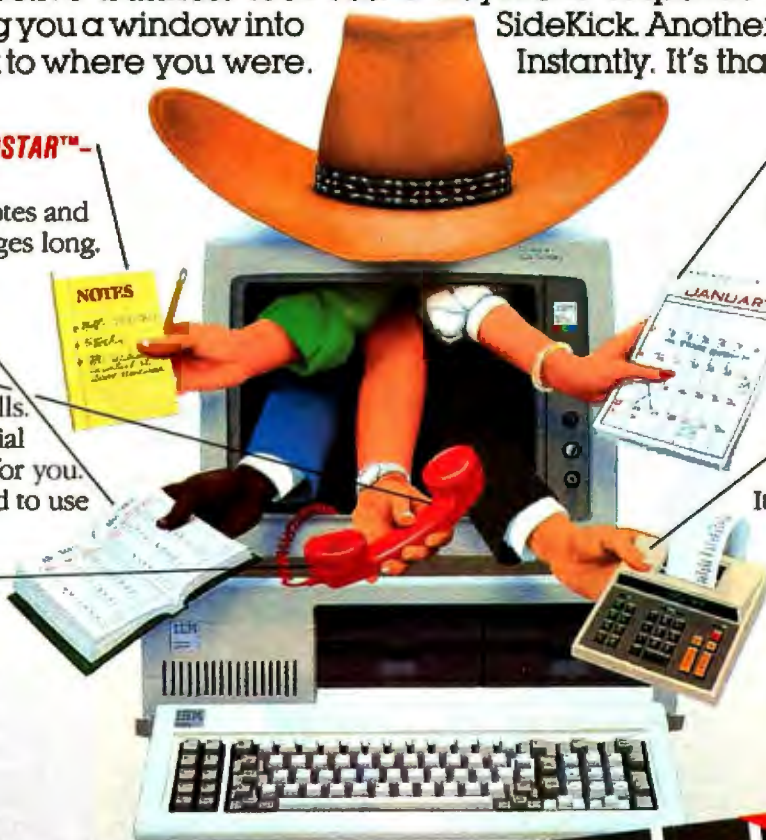

**THE CRITICS' CHOICE**

"SIDEKICK deserves a place in every PC."  
Garry Ray, PC WEEK

"If you use a PC, get SIDEKICK. You'll soon become dependent on it." Jerry Puornelle, BYTE

"SIDEKICK is by far the best we've seen. It is also the least expensive." Ron Mansfield, ENTREPRENEUR

"In a simple, beautiful implementation of WordStar's™ block copy commands, SIDEKICK can transport all or any part of the display screen (even an area overlaid by the notepad display) to the notepad."  
Charles Pezold, PC MAGAZINE



4585 Scotts Valley Drive, Scotts Valley CA 95066  
Phone (408) 438-8400 Telex 172373

Copyright 1985 Borland International BI-1008A  
SideKick is a trademark of Borland International, Inc.  
IBM and PC-DOS are registered trademarks of International Business Machines Corp.  
Infoworld is a trademark of Popular Computing, Inc. a subsidiary of CW Communications, Inc.  
WordStar is a registered trademark of Micropro International Corp.

Inquiry 38 for End-Users. Inquiry 39 for DEALERS ONLY.

## SIDEKICK

**NOT COPY-PROTECTED**

Available at better dealers nationwide. Call (800) 556-2283 for the dealer nearest you. To order by Credit Card call (800) 255-8008, CA (800) 742-1133

Yes, I want the Best.  
Please send me SideKick!

Copy-Protected **\$54.95**  
(CA res. add \$3.30 tax per copy)  
Quantity: \_\_\_\_\_ at \$54.95

Not Copy-Protected **\$84.95**  
(CA res. add \$5.10 tax per copy)  
Quantity: \_\_\_\_\_ at \$84.95



Software for your  
IBM®PC, XT, AT, jr.  
and true compatibles.

PCjr requires  
not copy-protected version

These prices include shipping to  
all US cities. All foreign orders  
add \$10 per product ordered

Amount (CA 6% tax) \_\_\_\_\_  
Payment VISA MC Bank Draft Check  
Credit Card Expir Date \_\_\_\_\_  
Card # \_\_\_\_\_

Name: \_\_\_\_\_  
Shipping Address \_\_\_\_\_  
City \_\_\_\_\_  
State \_\_\_\_\_ Zip: \_\_\_\_\_  
Telephone \_\_\_\_\_

COD's and Purchase Orders WILL NOT be accepted by Borland. California residents: add 6% sales tax  
Outside USA add \$10 and make payment by bank draft, payable in US dollars drawn on a US bank

\$15

## SAM 3001 AT

The SAM 3001 AT is compatible with IBM's PC AT microcomputer. This machine, built around the 80286 microprocessor, comes with 640K bytes of on-board RAM, a graphics card, a parallel port, two RS-232C serial ports, and a socket for the 80287 mathematics coprocessor. The graphics card is compatible with Hercules-type graphics applications, and user memory is expandable to up to 16 megabytes. A 1.2-megabyte floppy disk and a 20-megabyte hard disk store your data.

PC-DOS 3.0, GW-BASIC, MS-DOS 3.1, and XENIX are supported. Available options include fixed-disk storage of up to 80 megabytes and 14-inch color or amber monitors. Multiuser capabilities and multifunction boards are planned for future release.

The SAM 3001 AT is manufactured by Samsung Semiconductor Telecommunications Co. Ltd. of Korea and distributed in the United States by HiTech International. System pricing begins at \$4395. The color monitor is \$375, and the amber display is \$170. The MS-DOS operating system is \$50 per copy, and each copy of GW-BASIC is \$150. Contact HiTech International Inc., 1180-M Miraloma Way, Sunnyvale, CA 94086. (408) 738-0601.

## Robotic Kit

Robotic Computing Kit for the Apple II series and Commodore's VIC-20 and 64 computers is available from fischertechnik.



The SAM 3001 AT.

With this kit, you can build small, stationary robots that perform a variety of tasks, such as plotting computations, sorting objects of different lengths, and solving the Towers of Hanoi puzzle.

The Robotic Computing Kit comes with two motors, two gears, an electromagnet, two potentiometers, lamps, and push buttons. Its computer interface module includes output connections, digital input, analog inputs, and software.

The Robotic Computing Kit system sells for \$199, including the computer interface. Contact Fischer America Inc., 175 Route 46 W, Fairfield, NJ 07006. (201) 227-9283.

Inquiry 604.

## Biometal

Toki Corporation's Biometal is a metallic alloy that changes its shape when a small electrical current is run through it. This titanium-nickel alloy can be shaped as a coil that will contract when current is applied, just like animal muscle tissue.

Toki will begin selling coils of Biometal in September for \$8.99 per 8-inch length. A small robot arm that uses the alloy as an actuator is also available for about \$150, including controller box. Contact Toki Corp., 850 South West Temple, Salt Lake City, UT 84101. (801) 532-5430. In Japan, Toki Corp., Number 11-11, Ebisu-nishi 2-chome, Shibuya-ku, Tokyo 150; tel: 03-461-1961; Telex: 02425204 TOKION J. Inquiry 605.

## The System/36 PC

IBM has announced a desktop version of its System/36 minicomputer with a list price of less than \$6000.

The System/36 PC, which is about the same size as the IBM PC system unit, requires an IBM PC, PC XT, or PC AT as its console and communications server.

You can connect three workstations to the System/36 PC in addition to the IBM PC. Optionally, you can link a pair of workstations and a system printer to the System/36 PC. The console PC can function as a workstation. Each workstation can execute System/36- and IBM PC-based applications concurrently.

The System/36 PC hardware comprises 256K bytes of memory, a 40-megabyte hard-disk drive, and a 1.2-megabyte 5¼-inch floppy-disk drive. A second 40-megabyte hard disk can be added, and memory can be increased to 512K bytes.

IBM says that the System/36 PC is object-code-compatible with its two 8-inch-disk-based versions of the System/36. IBM plans to transfer software for these machines to the smaller format for the System/36 PC.

The System/36 has a list price of \$5995. Its operating system is \$995. It will be sold through selected retail stores. The IBM PC requires a special adapter card and software. For the name of your nearest dealer, call (800) 447-4700; in Alaska and Hawaii, call (800) 447-0890.

Inquiry 606.

(continued)



ATTENTION SIDEKICK USERS: SUPERKEY IS  
SIDEKICK'S BEST COMPANION. GET SUPERKEY TODAY!

# Borland's SuperKey™

## lets one powerful keystroke do the work of hundreds and helps keep your confidential files . . . confidential!

**SUPERKEY TURNS 1,000 INTO 1!** Yes, SuperKey can record lengthy keystroke sequences and play them back at the touch of a single key. Instantly. Like Magic. Say, for example, you want to add a column of figures in 1-2-3. Without SuperKey you'd have to type seven keystrokes just to get started. ["shift-@-s-u-m-shift-(")]. With SuperKey you can turn those 7 keystrokes into 1.

**SUPERKEY HELPS PROTECT YOUR CAPITAL INVESTMENT.** SuperKey, at your convenience, will make your screen go blank after a predetermined time of screen/keyboard inactivity. You've paid hard-earned money for your PC. SuperKey will protect your monitor's precious phosphor . . . and your investment. This feature alone justifies your SuperKey purchase!



**SUPERKEY KEEPS YOUR 'CONFIDENTIAL' FILES . . . CONFIDENTIAL!** Time after time you've experienced it: anyone can walk up to your PC, and read your confidential files (tax returns, business plans, customer lists, personal letters . . .). With SuperKey you can encrypt any file, even while running another program. As long as you keep the password secret, only YOU can decode your file. SuperKey implements the U.S. government Data Encryption Standard (DES).

**SUPERKEY PROTECTS YOUR WORK FROM INTRUDERS WHILE YOU TAKE A BREAK.**

Now you can lock your keyboard at any time. Prevent anyone from changing hours of work. Type in your secret password and everything comes back to life . . . just as you left it.

### THE CRITICS' CHOICE

"While most people only talk about low-cost personal computer software, Borland has been doing something about it. And Borland provides good technical support as part of the price."  
**John Markell & Paul Freiburger, syndicated columnists**

"What I think the computer industry is headed for: well-documented, standard, plenty of good features, and a reasonable price."  
**Jerry Pournelle, BYTE**

**BORLAND**  
INTERNATIONAL

4585 Scotts Valley Drive, Scotts Valley CA 95066  
Phone (408) 438-8400 Telex 172373

Copyright 1985 Borland International BI-1009A

SuperKey is a trademark of Borland International, Inc.  
1-2-3 is a trademark of Lotus Development Corp.  
IBM is a registered trademark of International Business Machines Corp.

Inquiry 40 for End-Users. Inquiry 41 for DEALERS ONLY.

**NOT COPY-PROTECTED**

# SuperKey

Get your IBM PC or compatible a SuperKey today.

Available at better dealers nationwide. Call (800) 556-2283 for the dealer nearest you. To order by Credit Card call (800) 255-8008, CA (800) 742-1133

**\$69<sup>95</sup>**

This price includes shipping to all U.S. Cities. All foreign orders add \$10 per product ordered.

**60 DAY MONEY-BACK GUARANTEE**

YES! Please rush SuperKey to me. Send me \_\_\_\_\_ copies.

Subtotal \_\_\_\_\_  
(CA res. add 4.20 tax per copy)

Amount Enclosed: \_\_\_\_\_  
Payment VISA MC BankDraft Check  
Credit Card Exp. Date \_\_\_\_\_  
Card # \_\_\_\_\_

Name \_\_\_\_\_  
Shipping Address \_\_\_\_\_  
City \_\_\_\_\_  
State \_\_\_\_\_ Zip \_\_\_\_\_  
Telephone: \_\_\_\_\_

COD's and Purchase Orders WILL NOT be accepted by Borland. California residents: add 6% sales tax  
Outside USA: add \$10 and make payment by bank draft, payable in US dollars drawn on a US bank.

K15

### Conquest PC Turbo

The Conquest PC Turbo is a single-board computer that's compatible with the IBM PC.

It comes with a switch-selectable 4.77-/8-MHz system clock, 256K bytes of memory, a keyboard, single serial and parallel ports, and five expansion slots. RAM memory is expandable to 1 megabyte without using an expansion slot. It also has a floppy-disk controller and video-adaptor card built in.

Twin slim-line 360K-byte floppy-disk drives serve as your mass-storage devices. Optionally, the Conquest PC Turbo can be outfitted with half-height 10-, 20-, or 40-megabyte hard-disk subsystems. Half-height streaming-tape backups are also available.

The Conquest PC Turbo supports PC-DOS, MS-DOS, CP/M-86, Concurrent CP/M, and such applications programs as Lotus 1-2-3, VisiCalc, dBASE III, and Multiplan.

With the dual floppy disks and power supply, the Conquest PC Turbo begins at \$1695. Contact Microshop Computer Products, Unit K, 2640 Walnut Ave., Tustin, CA 92680, (714) 838-7530. Inquiry 607.

### Video Digitizer and BASIC Enhancement for Commodore

Cardco has introduced a pair of products for the Commodore 64: Digi-Cam, a video digitizer, and S'more BASIC, an enhancement to Commodore BASIC.

The Digi-Cam system includes a Panasonic mono-



The Conquest PC Turbo.



The Executive Partner has a 640- by 400-pixel gas-plasma display.

chrome video camera, a digitizer, software, and necessary cabling. It takes 3 seconds to produce a 320-by 200-pixel screen image in five shades of gray. Images

can be stored on disk, transmitted over a modem, and printed. The software lets

you manipulate the digitized image.

Digi-Cam is \$249.

S'more (Super Memory Optimized RAM/ROM Expansion) BASIC gives you more than 60 new or enhanced BASIC commands and functions, including automatic line numbering, a program renumbering facility, and an undo command. This \$69.95 cartridge lets you use more than 60K bytes of RAM for BASIC programming, as opposed to the Commodore's usual 38K-byte limitation. A companion BASIC compiler will be available next month for \$39.95.

Contact Cardco Inc., 300 South Topeka, Wichita, KS 67202, (316) 267-3807. Inquiry 608.

### Executive Partner

Panasonic's Executive Partner is an IBM PC-compatible portable computer equipped with a 640-by 400-pixel gas-plasma display. It uses the 8086-2 microprocessor, which features selectable clock speeds, 256K bytes of RAM (expandable to 640K bytes), two 5¼-inch floppy-disk drives, an internal clock/calendar, and a built-in thermal-transfer printer.

The Executive Partner's keyboard is attached. A single 5¼-inch (i.e., IBM PC XT-length) expansion slot and an external bus port are standard. The Executive Partner measures 5 by 16 by 21 inches, weighs 28 pounds, and is AC-powered.

The Executive Partner is \$2595, which includes MS-DOS and BASIC. Contact Panasonic Industrial Co., One Panasonic Way, Secaucus, NJ 07094, (201) 348-7183. Inquiry 609.

(continued on page 380)

# Borland Introduces the Laws of *TURBO DYNAMICS*™

**Laws That Work Like Magic.** Whether considering technological excellence, or innovation in areas such as pricing, not copy-protection, licensing agreements, site licenses, 60 day money-back guarantee —Borland is clearly recognized as the software industry leader. The following three laws of "Turbo Dynamics"™ exemplify our pledge for excellence.



**Turbo Dynamics Applies to Turbo Pascal.** Borland's Pascal family of products is growing by leaps and bounds. You can now join hundreds of thousands of users and enter the world of Turbo Pascal programming. And remember, all three laws of Turbo Dynamics apply to all Borland products.

## TURBO PASCAL™ \$69.95

**The industry standard.** With more than 350,000 users worldwide Turbo Pascal is the industry's de facto standard. Turbo Pascal is praised by more engineers, hobbyists, students and professional programmers than any other development environment in the history of microcomputing. And yet, Turbo Pascal is simple and fun to use. **Free spreadsheet** included on every Turbo disk with ready-to-compile source code. **Options:** We offer the exciting Binary Coded Decimal (BCD) option for your business applications as well as an 8087 option for your number-crunching applications at a very low charge. Please refer to the coupon. **Portability.** Turbo Pascal is available today for most computers running PC-DOS, MS-DOS, CP/M-80 or CP/M-86. **Jeff Dunham, PC Magazine:** "In its simplicity it achieves an elegance that no other language compiler has ever displayed."



## TURBO GRAPHIX TOOLBOX™ \$54.95

**High resolution monochrome graphics for the IBM PC.** The Turbo Graphix Toolbox will give even a beginning programmer the expert's edge. It's a complete library of Pascal procedures and functions. Tools that will allow you to draw and hatch pie charts, bar charts, circles, rectangles and a full range of geometric shapes. Procedures that will save and restore graphic images to and from disk. And much, much, more. You may incorporate part or all of these tools in your programs and yet we won't charge you any royalties. Best of all, these functions and procedures come complete with commented source code on disk ready to compile.



## TURBO TUTOR™ \$34.95

**From start to finish in 300 pages.** Turbo Tutor is for everyone from novice to expert. Even if you've never programmed before Turbo Tutor will get you started right away. **A must.** You'll find the source code for all the examples in the book on the accompanying disk ready to compile. Turbo Tutor might be the only reference on Pascal and programming you'll ever need.



## TURBO DATABASE TOOLBOX™ \$54.95

**The Turbo Database Toolbox is the perfect complement to Turbo Pascal.** It contains a complete library of Pascal procedures that allows you to sort and search your data and build powerful applications. It's another Borland set of tools that will give the beginning programmer the expert's edge. **Get started right away: free database!** Included on every Toolbox disk is the source code to a working data base which demonstrates how powerful and easy to use our search system, Turbo-Access, really is. Modify it to suit your individual needs or just compile it and run. **Remember, no royalties!**



**TURBO PASCAL FAMILY**

NOT COPY-PROTECTED

Available at better dealers nationwide. Call (800) 556-2283 for the dealer nearest you. To order by Credit Card call (800) 255-8008, CA (800) 742-1133

Carefully Describe your Computer System? Mine is _____ bit _____ bit I use _____ PC-DOS _____ MS-DOS _____ CP/M 80 _____ CP/M 86 My computer's name/model is _____  The disk size I use is <input type="checkbox"/> 3 1/2" <input type="checkbox"/> 5 1/4" <input type="checkbox"/> 8"	<div style="border: 2px solid black; border-radius: 50%; padding: 10px; width: 60px; margin: 0 auto;"> <b>60 DAY MONEY-BACK GUARANTEE</b> </div>
---	--

Name _____ Shipping Address _____ City _____ State _____ Zip _____ Telephone _____	Pascal 3.0 \$ 69.95 _____ Pascal w/8087 \$109.90 _____ Pascal w/BCD \$109.90 _____ Pascal w/8087 & BCD \$124.95 _____ Turbo Database Toolbox \$ 54.95 _____ Turbo Graphix \$ 54.95 _____ Turbo Tutor \$ 34.95 _____ *These prices include shipping to all U.S. cities. All foreign orders add \$10 per product ordered.
--	--

Amount: (CA 8% tax) \_\_\_\_\_

Payment:  VISA  MC  Bank Draft  Check

Credit Card Expr Date \_\_\_\_\_

Card # \_\_\_\_\_

F15

COD's and Purchase Orders WILL NOT be accepted by Borland. California residents add 6% sales tax. Outside USA add \$10 and make payment by bank draft, payable in US dollars drawn on a US bank.



4585 Scotts Valley Drive, Scotts Valley CA 95066  
Phone (408) 438-8400 Telex 172373

Copyright 1985 Borland International BI-1011

Turbo Pascal, Turbo Database Toolbox, Turbo Graphix Toolbox, Turbo Tutor and Turbo Dynamics are trademarks of Borland International, Inc.

Inquiry 42 for End-Users. Inquiry 43 for DEALERS ONLY.

# IBM's best efforts are now going into Macintosh.

Macintosh and IBM PC software. Compatible at last, thanks to MacCharlie, a rather innovative coprocessing system.

And imagine the consequences.

Nearly 10,000 IBM PC software programs designed for general business and specific applications in real estate, insurance, law, medicine, banking, etcetera, can now join forces with Macintosh's own popular programs.

And, the myriad of IBM PC-compatible software adopts Macintosh's many beloved features, including desktop utilities such as the clipboard and the calculator.

In addition, MacCharlie allows

IBM PC and Macintosh data files to be exchanged. Talk about flexibility.

But the good news gets better.

You see, MacCharlie delivers hardware compatibility, as well. For example, IBM letter-quality printers can be easily used with Macintosh.

Furthermore, MacCharlie

now allows Macintosh to perform virtually any networking an IBM PC can perform. Even to the extent of tying in with IBM mainframes.

In other words, your networking capability goes beyond the Apple family.

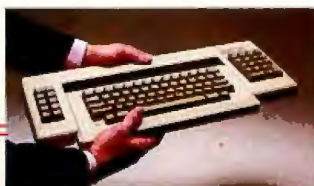

The Macintosh keyboard slides right into MacCharlie's keyboard. About as easy as slipping a letter in an envelope.



Macintosh sets snugly beside MacCharlie, on a custom-fit pedestal.



Once you plug in MacCharlie's power and keyboard cords, you're ready to enjoy a very happy marriage.

How does it happen? As easily as slipping on penny loafers.

In mere moments, MacCharlie combines the best features of the world's premier personal computers.

And despite the fact that it turns one computer into two,

MacCharlie adds but a handful of square inches to Macintosh's physique.

In short, one of life's most perplexing decisions—whether to buy a Macintosh or an IBM PC—can now be made with the greatest of ease.

Ask for MacCharlie at your local computer store. Suggested retail price for the 256K single disk drive model is only \$1195, and just \$1895 for the 640K dual disk drive version.

For more information, call Operator 14 toll-free, 1-800-531-0600. (In Utah, call 801-531-0600.)

MacCharlie offers 256K RAM, with optional upgrade to 640K RAM, 360KB disk drive, and optional second disk drive.



# MacCharlie™

THE BEST OF BOTH WORLDS.

MacCharlie is a product of Dayna Communications,  
50 S. Main, Salt Lake City, Utah 84144  
Inquiry 95

Apple is a trademark of Apple Computer, Inc. Macintosh is a trademark licensed to Apple Computer, Inc. IBM is a registered trademark of International Business Machines Corporation.

# EVEREX EVER FOR EXCELLENCE



## The Everex Hard Disk/Backup Systems Are Your Expansion Systems too... with little additional cost.

### More Room To Expand, Not More Money

Think about Off-loading expansion boards from your PC or XT to an External Hard Disk/Backup System. Everex provides a complete line to choose from...

- Full-size system with eight expansion slots and room to add up to four hard disk/backup systems.
- Half-size system with four expansion slots and space for two hard disk/backup systems.
- Slimline system, only 2½ inches high with three full-size, one half-size expansion slots and room for two hard disk/backup systems.
- All Expansion systems are available with any combination of Everex hard disk drives and backup systems.

### Unique Features

- One shielded round cable (as IBM) instead of flat ribbon cables.

Replace the clumsy flat ribbon cable with Everex's shielded, round cable.



- Advanced design eliminates "wait states" for faster data transmission.
- Compatible with more controllers than other systems.

Visit your local Everex dealer today and ask to see Everex Hard Disk/Backup Systems in action. For the name of your nearest Everex dealer, please call (415) 498-1111, 47777 Warm Springs Blvd., Fremont, CA 94539. Dealer Hotline (800) 821-0806. In CA (800) 821-0807

Imagineering Ultimo, Australia TLX: 74349 IMAGIN AA  
Microage Distribution Ltd. London, England TLX: 881 3241  
WONGS G

Feeder Paris, France TLX: 4413241 FEEDER  
Automated Office Systems Hout Bay, South Africa 2721-70-8091  
Survex, 1027 Speers Road, Oakville, Ontario Canada L6L-2X5,  
416-842-6093

Pride Computers, 102-8167 Main Street, Vancouver,  
British Columbia, V5X 3L2, 604-321-5690

IBM, PC, XT and AT are registered trademarks of International Business Machines Corporation.

**EVEREX**  
EVER FOR EXCELLENCE

# B·O·O·K R·E·V·I·E·W·S

BEGINNING  
MICRO-PROLOG  
J. R. Ennals  
Harper & Row  
New York: 1984  
196 pages, \$15.95

MICRO-PROLOG:  
PROGRAMMING  
IN LOGIC  
K. L. Clark  
and F. G. McCabe  
Prentice-Hall  
Englewood Cliffs, NJ: 1984  
416 pages, \$18.95

A SOFTWARE LAW  
PRIMER  
Frederic W. Neitzke  
Van Nostrand Reinhold  
New York: 1984  
157 pages, \$24.95

EXTRATERRESTRIALS—  
SCIENCE AND ALIEN  
INTELLIGENCE  
Edward Regis, editor  
Cambridge University  
Press  
New York: 1985  
286 pages, \$39.50



as a Computer Language for Children, in progress at London's Imperial College of Science and Technology. The rest of the book is a tutorial introduction to the micro-PROLOG version of Prolog used in that project.

Ennals begins with a quick introduction to logic programming and what makes Prolog, the first widely used language based on the concept of logic programming, different from "classical" languages. He explains that in conventional programming languages the focus is on designing a step-by-step procedure that consists of commands that match the step-by-step operation of the hardware operations. This is why these languages are sometimes referred to as procedural or imperative languages. But the concept of programming in logic emphasizes declarations or assertions of the relationships between, and the rules applicable to, the

various objects or entities involved in the problem. The task of deriving the necessary results is left to the computer.

Because of this fundamentally different approach to what constitutes a program, Prolog makes a programmer be concerned with specifying logical relationships rather than designing procedures. In other words, a Prolog program is a description or declaration of the problem, and the Prolog interpreter undertakes the task of developing the solution procedure. Ennals provides simple examples to illustrate these ideas. Using these concepts as a starting point, he argues that a language like Prolog is more suitable than procedural languages for human beings since it emphasizes specification as the human's share of

(continued)

## BEGINNING MICRO-PROLOG

Reviewed by Ramachandran Bharath

If you're seeking a lucid introduction to the Prolog language and its growing importance, or if you're interested in the role of computers in education, I recommend you read *Beginning Micro-Prolog* by J. R. Ennals. For people interested in extensive programming, this book could serve as a good lead-in to Clark and McCabe's text *micro-PROLOG* [reviewed next] or Clocksin and Mellish's *Programming in Prolog* (New York: Springer-Verlag, 1982), although the latter uses a different version of the language. Ennals also covers Prolog's background in relation to fifth-generation knowledge information processing systems.

This book is partly a report from a project entitled Logic

# maxell Savings



## 5¼" DISKETTES

MD-1 Sngl. Sided Dbl. Density	\$12.50 cellophal of ten (min. qty. 15 pkgs.) \$14.50 box of ten.
MD-2 Dbl. Sided Dbl. Density	\$17.50 cellophal of ten (min. qty. 15 pkgs.) \$19.50 box of ten.
MD-2HD High Density	\$38.50 box of ten
MD-1 (96 TPI) 5S Quad	\$22.50 box of ten
MD-2 (96 TPI) DS Quad	\$28.50 box of ten

## 3½" MICRO FLOPPY DISKS

MF-1 5S Quad	\$26.50 box of ten
MF-2 DS Quad	\$39.50 box of ten

## 8" DISKETTES

Single Sided	\$28.95 box of ten
Double Sided	\$28.95 box of ten

### TERMS:

Visa/Mastercard  
—C.O.D.— Prepaid.  
Allow 10 days for  
personal/ Company  
check to clear. Add  
\$3.00 Shipping.  
C.O.D. add \$2.00.  
Texas residents add  
5.125% sales tax.



Call for other  
Maxell Products



1-800-527-1814  
(in Texas 1-512-682-7774)  
P.O. Box 3424—Edinburg, Texas 78540-3424

the labor, with procedural details being the computer's share.

Ennals mentions that the project at Imperial College shares the educational philosophy Seymour Papert discusses in *Mindstorms: Children, Computers, and Powerful Ideas* (New York: Basic Books, 1980), although the project uses Prolog and not Logo. Indeed, even as I read *Beginning Micro-Prolog I* found it almost as enchanting as Papert's classic because the same concerns come through—for instance, finding ways to use computers as instruments to promote human worth and development rather than making them tools that limit people.

The core of the book is in the third chapter, a description of teaching materials used for educating children between the ages of 8 and 13. Guidance notes for teachers are also included. This part of the book is valuable to anyone interested in learning the general principles of Prolog. Even if you have no access to the micro-PROLOG interpreter that runs on MS-DOS and CP/M systems, reading this chapter and trying the examples (for which solutions are provided at the back of the book) should help you get a working knowledge of how to program in this language. Even though the syntax of micro-PROLOG is slightly different from the version in Clocksin and Mellish's book, which is more or less the standard, the differences are not great. A person who has learned the basics of the language from micro-PROLOG could adjust easily.

Particularly interesting is Ennals's presentation of the principles of list processing. He provides specific examples of how writing programs and querying databases are made easier by having data in the form of lists rather than in individual items. A representative example is a set of geographical data in the form of a list:

( (city country) location (latitude longitude) )

Ennals shows how list-processing functions for extracting parts of a list or sublists make it convenient to formulate simple Prolog programs for answering questions like Which cities are east of London? Is there any city east of Moscow? and so on.

Next, Ennals covers the wide range of subjects for which Prolog would be appropriate as a teaching medium, such as languages, science, historical simulation, and information retrieval.

In a chapter entitled "Prolog for Greater Things," Ennals discusses a variety of issues. In particular, he emphasizes the suitability of a Prolog-type language for designing expert systems. He quotes the view of the Japanese Fifth Generation Project that "Prolog seems to be the best suited as the starting point for knowledge information processing." You can see the rationale behind this view when you look at what underlies successful expert systems, such as those for medical diagnosis or geological prospecting. Essentially, the expert system mirrors the working of the human expert by embodying "if...then" rules that deduce actions to be taken or diagnoses to be made.

(continued)

# ZENITH data systems

THE QUALITY GOES IN BEFORE THE NAME GOES ON

PROFIT FROM ZENITH DATA SYSTEMS Z-150 PC DESKTOP OR Z-160 PC PORTABLE IBM COMPATIBLES!

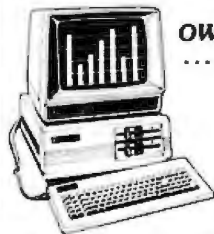

OWN TOTAL PERFORMANCE .....  
..... BETTER THAN AN XT!

- 4 Open Expansion Slots ■ Full Color\*, Green\*, or Amber Video ■ Clearly Labeled, Easy-to-Use Keyboard ■ Excellent Price/Performance Ratio ■ Zenith Total Service & Support!

\*Z-160 PC ONLY - MONITOR NOT INCLUDED

## ZENITH DATA SYSTEMS Z-150 PC DESKTOP SYSTEM

- 2 DRIVES, 320K RAM, GAME, SERIAL & 2 PARALLEL PORTS, CLOCK-CALENDAR WITH BATTERY BACK-UP, FREE SOFTWARE TO INCLUDE MS-DOS, RAM-DISK, PRINT SPOOLER, MS-WORD, MS-MULTIPLAN \$1,749
- 640K RAM OPTION \$99
- 2 FLOPPY & 10Mb DRIVES \$2,325
- 2 FLOPPY & 20Mb DRIVES \$2,559
- ½ HT 10Mb TAPE \$675



## ZENITH DATA SYSTEMS Z-160 PC PORTABLE SYSTEM

- SAME AS Z150PC W/ 2 DRVS. 640K RAM, S, P, MS-DOS, WORD AND MULTI-PLAN SOFTWARE \$2,195
- W/ 2 FLOPPY & 10Mb DRIVES \$2,795

**S=100™**  
(800) 528-3138

\*SEE PAGE 407 FOR MONITORS



# RIP US OFF FOR A FREE C COMPILER.

Tear off our entry form and get in on the  
Mark Williams \$75,000 Let's C™ Giveaway today!

Of course, we'd never suggest ripping off anything other than our entry form. But we are giving you a chance to get something for nothing. And that something is Let's C.™ At last, for MS-DOS users, there's a full-function C compiler that's fully affordable.

How affordable? Well, it's actually free if you're one of 1,000 names drawn in the Let's C Giveaway. And it's only \$75 if you're not. Either way, that's extremely affordable.

How good is it? Good enough that we think Let's C will soon be the most popular personal-size C compiler around. And why not? Let's C has all the essential ingredients of the Mark Williams C designed for commercial software developers. The one chosen by Intel, DEC, Wang, thousands of professional programmers and plenty of very critical software reviewers.

Why a giveaway? Because we know nothing will spread the word about Let's C faster than you, the user. And nothing will get it into more hands faster than giving it away.

So how about it? Rip us off for a free Let's C. Or, if you're torn between winning and waiting, don't wait. Call Mark Williams at this special order taking number: **1-800-692-1700.**

Let's C features:  
Runs under MS-DOS 2.0 or greater • Full Kernighan & Ritchie C • Complete libraries • Recent extensions to C • Linker, assembler • Small memory model • Floating point • *csd*, C Source Debugger option • Full screen editor • Upgradable to C Programming System.



1430 West Wrightwood  
Chicago, Illinois 60614

**Mark  
Williams  
Let's C  
Giveaway  
Entry Form.**

Send us 25 words  
or more on how  
you'd use our low cost  
C compiler and your  
name could be drawn to  
win a free Let's C:

NAME

ADDRESS

CITY

STATE

ZIP

#### CONTEST RULES

1. How to enter: No purchase necessary. Send your name and address along with 25 words or more describing how you would use Let's C with the entry form or on plain paper. Mail to: C OFFER, 1430 W. Wrightwood, Chicago, IL 60614. Entries must be received by August 31, 1985. 2. Winners will be determined by a random drawing. All winners will be notified by mail. The decision of the judges will be final. For a list of winners, write: WINNERS, 1430 W. Wrightwood, Chicago, IL 60614. 3. The odds of winning will be determined by number of entries. One entry per person. No mechanical reproductions. All taxes are the sole responsibility of winners. 4. This sweepstakes is open to all residents of U.S. except where void, taxed or prohibited. 5. All entries become the property of Mark Williams.

**What a performance!**  
Seven new data acquisition  
and control boards for  
your IBM PC.™

Encore!  
Encore!

Data Translation  
has done it again. Our  
first two analog and  
digital I/O boards for  
IBM personal com-  
puters received rave  
reviews.

So we extended  
our product line to seven  
... starting at \$295 for quan-  
tity purchasers.

While most of the  
personal computer world  
focused on home and office applications,  
we lifted the curtain on two other key  
areas. Laboratory data acquisition and  
industrial control.

Now, no matter what you need for  
your IBM PC, we have it. Each board  
is a complete data acquisition and  
control system. With A/D, D/A,  
digital I/O, and a programmable  
clock. You simply choose the  
board offering the speed and  
resolution you need most. Just  
plug it into your PC's backplane  
and it's showtime.

With on-board intelligence,  
all seven are software compati-  
ble and supported by Data

Translation's PCLAB software package.

Data Translation is playing the lead-  
ing role in personal computer data ac-  
quisition and control. Find out how we can  
help your performance today.

VISA and MasterCard accepted.  
Call (617)  
481-3700



Price (U.S. \$)	Class	Model	A/D			D/A			Programmable Clock	
			Resolution (bits)	No. of Channels	Speed (kHz)	Resolution (bits)	No. of Channels	Speed (kHz)		
295 (OEM) 495	Low Cost	DT2808	10	16SE	3.3	8	2	10	16	yes
895	General Purpose	DT2801	12	16SE or 8DI	13.7	12		16		
1095	High Speed	DT2801-A			27.5			33		
1970	High Resolution	DT2801/5716	16	8DI	2.5			16		
1095	Low Level	DT2805	12		13.7					
2070	Low Level, High Resolution	DT2805/5716	16		2.5					
1695	Simultaneous S/H	DT2818	12	4	27.5			33		

NOTES: 1. PCLAB software supports all models.  
2. Programmable gain is standard for all DT2801 and DT2805 models.  
3. Screw terminal and signal conditioning panels available for connection of all I/O signals

# DATA TRANSLATION

World Headquarters: Data Translation, Inc., 100 Locke Dr., Marlboro, MA 01752 (617) 481-3700 Tlx 951 646  
European Headquarters: Data Translation, Ltd., 13 The Business Centre, Mally Millars Lane, Wokingham  
Berk., RG11 2DZ, England Tlx: 851849862 (#D)  
In Canada: (416) 625-1907

IBM PC is a registered trademark of IBM

## BOOK REVIEWS

These are usually referred to as "production rules." Since a Prolog program consists of logical specifications or rules, the translation of rules developed for expert systems into the form of a Prolog program is straightforward. While it is true that an expert-system program could be written in a conventional procedural/imperative language, its modification to embody new knowledge and rules would be an involved process. In Prolog or LISP, however, such modifications are natural. Prolog would help free users from worrying about the procedures for solving problems and allow them to concentrate on analyzing and specifying problems.

Ennals's concluding claim is that teaching Prolog would have multiple advantages and a significance much beyond that of teaching computer programming. Ennals's statement that by learning Prolog "children are being prepared for the world of the 1990s" seems to me a persuasive argument.

The subjects dealt with in this book are important and interesting for general readers as well as for those who specifically want to learn more about Prolog. I did not notice any misprints or errors in the body of the book. On checking a fair sample of the solutions to problems, I noticed only one minor error (the solution to problem 12 on page 45), but this would not mislead you.

Ramachandran Bharath is a professor in the Department of Management, Marketing, and Computer Information Systems at Northern Michigan University (Marquette, MI 49855). His book *Introduction to Programming in Prolog* is scheduled for publication this year.

### MICRO-PROLOG: PROGRAMMING IN LOGIC

Reviewed by Margaret M. Sklar

Prolog is a relatively new language, both chronologically and conceptually. K. L. Clark and F. G. McCabe, authors of *micro-PROLOG: Programming in Logic*, and B. D. Steele designed micro-PROLOG for microcomputers. The authors' claim that micro-PROLOG contains all of the significant features of mainframe Prolog seems well founded. It's a very sophisticated system, allowing the user to perform functions as simple as presenting queries about an existent (user-created) database and other functions as complex as creating expert systems that can answer queries about the database and provide explanations as to why or why not a particular answer (or query) is appropriate.

The book *micro-PROLOG* is essential for people who use the micro-PROLOG interpreter. The reference manual accompanying the micro-PROLOG 3.1 disk includes an excellent description of the system, utility modules, and other considerations for programmers (including how to add assembly-language subroutines to Prolog programs), but the manual recommends that the user work through

(continued)

**IMPORTANT P.C. BREAKTHROUGH!**

Now you can buy a full power mainframe Artificial Intelligence language for your IBM-compatible personal computer



**T**hrough a major breakthrough in the development of Artificial Intelligence applications, a unique version of Prolog is now available for your personal computer. It is called MPROLOG P-500. MPROLOG P-500 is an extended, programmer-friendly edition of Prolog — the computer language selected as the basis for the Japanese Fifth Generation Computer Systems Project.

MPROLOG has been specially designed for:

- Software developers
- AI innovators
- Expert systems researchers and developers
- Corporations seeking a competitive edge

**How MPROLOG Programming Works**

An MPROLOG program consists of **FACTS** and **RULES** expressed in a natural way. The inference mechanism for answering questions or arriving at conclusions based on **FACTS** and **RULES** is built into the language. This language allows you to write powerful software faster and easier than with traditional algorithmic languages. MPROLOG extends your computer's ability from its current tasks of processing and manipulating data to reasoning tasks that are based on the knowledge you provide it.

"... if programmed with the statements 'Boston is the capital of Massachusetts' and 'All capitals are cities', the system could deduce that 'Boston is a city'. As witnessed by the actual notation for the first statement — (capital of/Boston Massachusetts) — the language is declarative and easy to learn."  
 — High Technology, December 1984

**MPROLOG P-500 Offers Seven Key Features**

- Easy to learn.
- Flexible enough to let you tailor your expert systems.
- Supported by Logic Lab, a powerful, interactive programming development environment to maximize convenience and productivity.
- Designed for the modular development of AI applications to reduce their complexity and to enable a programming team to concurrently develop applications.
- Machine independent. Any application written in MPROLOG on one machine can be transferred to or run on any other machine with a run-time implementation of MPROLOG.
- A full-featured implementation of PROLOG. It contains over 200 built-in predicates including DEC-10 compatibilities

- Built to offer performance, productivity and portability
- MPROLOG P-500 on your IBM® PC or compatible system lets you take the identical, unaltered MPROLOG application code running under PC DOS and run it under: IBM® VM/CMS; IBM® MVS/TSO; DEC VAX/VMS™; DEC VAX™/UNIX™; M68000 UNIX; and TEKTRONIX 4404 UNIFLEX and other AI work stations.

For further details call the numbers below, or complete and mail this coupon today.

**LOGICWARE**

Los Angeles • Toronto • Atlanta • Boston  
 Call our Micro Division at

**1-617-547-2393** or  
**1-416-665-0022 (In Canada)**

UNIX is a registered trademark of Bell Laboratories. VAX is a trademark of Digital Equipment Corp. IBM, PC, DOS, MVS, VM/CMS, TSO are registered trademarks of International Business Machines Corporation. Tektronix 4404 is a trademark of Tektronix Corporation.

**Find Out More about MPROLOG P-500**

For free information, complete and mail this coupon to: Logicware Inc., Suite 3000  
 5000 Birch Street The West Tower  
 Newport Beach, CA 92660

Yes, Please send me more information on MPROLOG P-500.

Name: \_\_\_\_\_

Title: \_\_\_\_\_ Company: \_\_\_\_\_

Address: \_\_\_\_\_

State/Prov.: \_\_\_\_\_ Zip/Postal Code \_\_\_\_\_

Computer Operating System: \_\_\_\_\_ Version #: \_\_\_\_\_

Manufacturer's Make & Model: \_\_\_\_\_ Memory: \_\_\_\_\_



DYNAMIC RAMS				STATIC RAMS			
41256	256K x 1	120 ns \$ 3.95		6264LP	8K x 8	120 ns \$ 5.95	
		150 ns \$ 3.15				150 ns \$ 4.95	
4164	64K x 1	120 ns \$ 0.75		6116P	2K x 8	120 ns \$ 2.15	
		150 ns \$ 0.65				150 ns \$ 1.95	
		200 ns \$ 0.65		5514	1K x 4	200 ns \$ 3.95	
						300 ns \$ 3.25	
E. PROMS				8000's			
27256	32K x 8	250 ns \$ 8.00		7201	\$ 7.25	8253-5	\$ 3.75
27128	16K x 8	250 ns \$ 3.95		765A	\$ 7.25	8255A-5	\$ 3.75
27C64	8K x 8	200 ns \$ 7.75		8085A	\$ 3.95	8748	\$ 9.00
		200 ns \$ 3.10		8088	\$ 8.75	8749HD	\$12.00
2764	8K x 6	250 ns \$ 2.25		8155	\$ 3.25	8755A	\$16.75
		450 ns \$ 2.25					
2732A	4K x 8	200 ns \$ 2.95		8251A	\$ 3.50	*For more parts not listed here, please call.	
		250 ns \$ 2.50		●SPECIAL ITEMS			
2732	4K x 8	450 ns \$ 3.25		8087-2		\$105.00	
2532	4K x 8	450 ns \$ 4.95		8087-3		\$105.00	
2716	2K x 8	450 ns \$ 2.65		80287-3		\$195.00	
PRINTERS AND KEYBOARDS							
*Made in Japan, high quality product with one year warrantee.							
SX-100 cps	PRINTER					\$189.00	
SX-130 cps	PRINTER (IBM Compatible)					\$199.00	
SFK-201B	KEYBOARD (IBM Compatible-Capacity Type)					\$119.00	
I.C. EXPRESS							
15358 Valley Boulevard, City of Industry, CA 91746 Phone: 818-369-2688 (Mon-Fri 8-5)							
ORDER TOLL FREE 800-892-8889 • 800-882-8181							
EXCEPT FROM CALIFORNIA CALIFORNIA RESIDENTS ONLY							
Call for current prices & volume discounts. Prices are subject to change. TERMS: Minimum order \$10.00. California residents must add 6.5% sales tax. Shipping & Handling: UPS Ground \$3.00, UPS Air \$5.00 (under 1 lb). ALL MERCHANDISE IS 100% GUARANTEED.							

## BOOK REVIEWS

Clark and McCabe's book to learn the language.

The book claims to be a "self-instruction tutorial on logic programming using micro-PROLOG (version 3.1 or later) for someone unfamiliar with Prolog logic programming." The overall style and method of presentation are conducive to learning on your own, but the authors assume a certain degree of sophistication on the part of the reader. This book is indeed suitable for a reader unfamiliar with Prolog, but it is doubtful that a reader with little programming, mathematics, or linguistics background could easily follow much beyond the basic concepts presented in part I. Nonetheless, it is a fast-paced introduction to what computing can and should be like.

"Basic Concepts" introduces the foundations of Prolog: setting up a database of facts, formulating queries in the database, formulating rules (or conditional facts), arithmetic, and the key concepts of recursion and lists. Prolog is based on the concept of relations. A relation, mathematically speaking, is a set of "tuples," the individual elements of which come from different domains but are connected via some property.

The reader is led stepwise through key concepts by examples and exercises. The authors develop a "family" database with the relations father-of, mother-of, male, and female. They then discuss retrieving information from the database. Arithmetic operations (SUM, TIMES, LESS, and INT) are also considered relations by micro-PROLOG. Rules can be derived from relations to build still other relations. For example, parent-of can be derived from the relations father-of and mother-of, grandparent-of from parent-of, difference from SUM, etc. Clark and McCabe present these concepts thoroughly. They offer numerous examples and exercises to help solidify the learning process. Exercise sets are related to the text material, but each set of exercises leads the reader to discover more than just what was presented in the text. A reader seriously interested in mastering micro-PROLOG should work through all of the exercises in the book.

### LISTS

The concept of list processing, which is central in artificial-intelligence research, is the main topic of "Logic Programming Using micro-PROLOG" in the second part. An interactive approach, where the user can input data to the program, is discussed along with functions, sorts, and more complex forms of conditions. The authors also discuss concatenation of lists and parsing.

The material just mentioned covers Prolog for the casual reader; the rest of part II is for the reader with some degree of sophistication. This is where the thrill of Prolog begins. Metaconditions, metaprograms, tail-recursive definitions, and user-created modules let you experience the full power of Prolog and, indeed, add to the built-in power of the micro-PROLOG supervisor. Again, the concepts are presented via numerous examples and exercises, but now they are of a more theoretical nature.

(continued)

## From the leaders in logic...



### Unbeatable Tools for Artificial Intelligence and Expert Systems

**NEW** LPA micro-PROLOG Professional for the IBM PC & AT. Fully integrated with the MS DOS 2 environment and using all the memory available. It has its own window handling primitives and Wordstar-like screen editor.

Launch Price - US \$395.00

**NEW** LPA MacPROLOG for the Apple 512k Macintosh. It is an incremental compiler system completely integrated with the Macintosh environment.

Launch Price - US \$450.00

A seminar led by Professor Robert Kowalski is planned for December 1985. Please enquire for full details.

For information contact—  
NORTH AMERICA  
**PS** Programming Logic Systems Inc.  
31 Crescent Drive, Millford,  
CT 06460, U.S.A.  
Tel: (203) 877 7988

REST OF THE WORLD  
Logic Programming Associates Ltd., Dept BY/3  
Studio 4, The Royal Victoria Patriotic Building,  
Trinity Road, London SW18 3SX, England  
Tel: 01-874 0350

Dealer enquiries welcome.



# The C for Microcomputers

PC-DOS/MS-DOS, CP/M-86, Macintosh, Amiga, Apple II, CP/M-80, Radio Shack, Commodore, XENEX, ROM, and Cross Development systems

## MS-DOS, PC-DOS, CP/M-86, XENIX, 8086/80x86 ROM

### Manx Aztec C86

*"A compiler that has many strengths... quite valuable for serious work"*

Computer Language review, February 1985

**Great Code:** Manx Aztec C86 generates fast executing compact code. The benchmark results below are from a study conducted by Manx. The Dhrystone benchmark (CACM 10/84 27:10 p1018) measures performance for a systems software instruction mix. The results are without register variables. With register variables, Manx, Microsoft, and Mark Williams run proportionately faster. Lattice and Computer Innovations show no improvement.

	Execution Time	Code Size	Compile/Link Time
<b>Dhrystone Benchmark</b>			
Manx Aztec C86 3.3	34 secs	5,760	93 secs
Microsoft C 3.0	34 secs	7,146	119 secs
Optimized C86 2.20j	53 secs	11,009	172 secs
Mark Williams 2.0	56 secs	12,980	113 secs
Lattice 2.14	89 secs	20,404	117 secs

**Great Features:** Manx Aztec C86 is bundled with a powerful array of well documented productivity tools, library routines and features.

Optimized C compiler	Symbolic Debugger
AS86 Macro Assembler	LN86 Overlay Linker
80186/80286 Support	Librarian
8087/80287 Sensing Lib	Profiler
Extensive UNIX Library	DOS, Screen, & Graphics Lib
Large Memory Model	Intel Object Option
Z (M) Source Editor -c	CP/M-86 Library -c
ROM Support Package -c	INTEL HEX Utility -c
Library Source Code -c	Mixed memory models -c
MAKE, DIFF, and GREP -c	Source Debugger -c
One year of updates -c	CP/M-86 Library -c

Manx offers two commercial development systems, Aztec C86-c and Aztec C86-d. Items marked -c are special features of the Aztec C86-c system.

<b>Aztec C86-c Commercial System</b>	<b>\$499</b>
<b>Aztec C86-d Developer's System</b>	<b>\$299</b>
<b>Aztec C86-p Personal System</b>	<b>\$199</b>
<b>Aztec C86-a Apprentice System</b>	<b>\$49</b>

All systems are upgradable by paying the difference in price plus \$10.

**Third Party Software:** There are a number of high quality support packages for Manx Aztec C86 for screen management, graphics, database management, and software development.

<b>C-tree \$395</b>	<b>Greenleaf \$185</b>
<b>PHACT \$250</b>	<b>PC-lint \$98</b>
<b>HALO \$250</b>	<b>Amber Windows \$59</b>
<b>PRE-C \$395</b>	<b>Windows for C \$195</b>
<b>C-terp \$300</b>	<b>FirstTime \$295</b>
<b>WindScreen \$149</b>	<b>C Util Lib \$185</b>
<b>SunScreen \$99</b>	<b>Plink-86 \$395</b>
<b>PANEL \$295</b>	

## MACINTOSH, AMIGA, XENIX, CP/M-68K, 68k ROM

### Manx Aztec C68k

*"Library handling is very flexible... documentation is excellent... the shell a pleasure to work in... blows away the competition for pure compile speed... an excellent effort."*

Computer Language review, April 1985

Aztec C68k is the most widely used commercial C compiler for the Macintosh. Its quality, performance, and completeness place Manx Aztec C68k in a position beyond comparison. It is available in several upgradable versions.

Optimized C Macro Assembler	Creates Clickable Applications
Overlay Linker	Mouse Enhanced SHELL
Resource Compiler	Easy Access to Mac Toolbox
Debuggers	UNIX Library Functions
Librarian	Terminal Emulator (Source)
Source Editor	Clear Detailed Documentation
MacRam Disk -c	C-Stuff Library
Library Source -c	UnTools (vi, make, diff, grep) -c
	One Year of Updates -c

Items marked -c are available only in the Manx Aztec C86-c system. Other features are in both the Aztec C86-d and Aztec C86-c systems.

<b>Aztec C68k-c Commercial System</b>	<b>\$499</b>
<b>Aztec C68d-d Developer's System</b>	<b>\$299</b>
<b>Aztec C68k-p Personal System</b>	<b>\$199</b>
<b>C-tree database (source)</b>	<b>\$399</b>
<b>AMIGA, CP/M-68k, 68k UNIX</b>	<b>call</b>

## Apple II, Commodore, 65xx, 65C02 ROM

### Manx Aztec C65

*"The AZTEC C system is one of the finest software packages I have seen"*

NIBBLE review, July 1984

A vast amount of business, consumer, and educational software is implemented in Manx Aztec C65. The quality and comprehensiveness of this system is competitive with 16 bit C systems. The system includes a full optimized C compiler, 6502 assembler, linkage editor, UNIX library, screen and graphics libraries, shell, and much more. The Apple II version runs under DOS 3.3, and ProDOS, Cross versions are available.

The Aztec C65-c/128 Commodore system runs under the C128 CP/M environment and generates programs for the C64, C128, and CP/M environments. Call for prices and availability of Apprentice, Personal and Developer versions for the Commodore 64 and 128 machines.

<b>Aztec C65-c ProDOS &amp; DOS 3.3</b>	<b>\$399</b>
<b>Aztec C65-d Apple DOS 3.3</b>	<b>\$199</b>
<b>Aztec C65-p Apple Personal system</b>	<b>\$99</b>
<b>Aztec C65-a for learning C</b>	<b>\$49</b>
<b>Aztec C65-c/128 C64, C128, CP/M</b>	<b>\$399</b>

### Distribution of Manx Aztec C

In the USA, Manx Software Systems is the sole and exclusive distributor of Aztec C. Any telephone or mail order sales other than through Manx are unauthorized.

## Cross Compilers

Cross Development programs are edited, compiled, and linked on one machine (the HOST) and transferred to another machine (the TARGET) for execution. This method is useful where the target machine is slower or more limited than the HOST. Manx cross compilers are used heavily in consumer software development (games), scientific, industrial, research, and educational environments.

**HOSTS:** VAX UNIX (\$3000), PDP-11 UNIX (\$2000), MS-DOS (\$750), CP/M (\$750), MACINTOSH (\$750), CP/M-68k (\$750), XENIX (\$750).

**TARGETS:** MS-DOS, CP/M-86, Macintosh, CP/M-68k, CP/M-80, TRS-80 3 & 4, Apple II, Commodore C64, 8086/80x86 ROM, 68xxx ROM, 8080/8085/280 ROM, 65xx ROM.

The first TARGET is included in the price the HOST system. Additional TARGETS are \$300 to \$500 (non VAX) or \$1000 (VAX).

Call Manx for information on cross development to the 68000, 65816, Amiga, C128, CP/M-68K, VRTX, and others.

## CP/M, Radio Shack, 8080/8085/280 ROM

### Manx Aztec CII

*"I've had a lot of experience with different C compilers, but the Aztec C80 Compiler and Professional Development System is the best I've seen"* 80-Micro, December, 1984, John B. Harrell III

<b>Aztec C II-c (CP/M &amp; ROM)</b>	<b>\$349</b>
<b>Aztec C II-d (CP/M)</b>	<b>\$199</b>
<b>C-tree database (source)</b>	<b>\$399</b>
<b>Aztec C80-c (TRS-80 3 &amp; 4)</b>	<b>\$299</b>
<b>Aztec C80-d (TRS-80 3 &amp; 4)</b>	<b>\$199</b>

### How To Become an Aztec C User

To become an Aztec C user call 1-800-221-0440 or call 1-800-832-9273 (800-TEC WARE). In NJ or outside the USA call 201-530-7997. Orders can also be telexed to 4995812.

Payment can be by check, COD, American Express, VISA, Master Card, or Net 30 to qualified customers.

Orders can also be mailed to Manx Software Systems, Box 55, Shrewsbury, NJ 07701.

### How To Get More Information

To get more information on Manx Aztec C and related products, call 1-800-221-0440, or 201-530-7997, or write to Manx Software Systems,

### 30 Day Guarantee

Any Manx Aztec C-c or Manx Aztec C-d development system can be returned within 30 days for a refund if it fails to meet your needs. The only restrictions are that the original purchase must be directly from Manx, shipped within the USA, and the package must be in resalable condition. Returned items must be received by Manx within 30 days. A small restocking fee may be required.

### Discounts

There are special discounts available to professors, students, and consultants. A discount is also available on a "trade in" basis for users of Lattice C, C1-C86, Mark Williams C, Wizard C, Digital Research C, and Microsoft C. Call for information.

# MANX

# 1-800-241-8149. TWO NUMBERS YO

Locally or across the nation, you're only a phone call away from the best advice, information, sales and service for all your computer needs.

At Micro Mart. A name you can trust.

We're proud to offer the widest range of computer products anywhere. At very competitive prices. With innovative financing options like the Micro Mart Blue Chip Credit Card.

When we say a product is available today, we mean today. Our Micro-to-Mainframe inventory system keeps our products current. And our customers satisfied. We deliver quickly because we're geared to ship hundreds of products daily to customers all over the world.

But we don't stop there. Micro Mart offers a comprehensive range of Technical Support and Customer Service after-the-sale. We're on-site with hundreds of service locations nationwide. And our National Service Center is one of the fastest depot services in the USA.

Call Micro Mart today. You'll meet people who back up price, availability and service with performance. You can count on it.

## COMPUTERS

AT&T Color and Mono Systems in stock \_\_\_\_\_ Start at \$2195

COMPUTER SPECIAL OF THE MONTH Call for details! \_\_\_\_\_

## NETWORKING/ PROTOCOL CONVERSION

SNA & BISYNC 3780, 5251.

Mod 11 & 12, 3274, 3278 \_\_\_\_\_

PC TURBO 186 by ORCHID,

80186 coprocessor board \$599

IRMA Complete line From \$829

## PRINTERS & PLOTTERS

We have thousands in stock.

PRINTER SPECIAL OF THE

MONTH Call for details! \_\_\_\_\_

HOUSTON INSTRUMENTS

Plotters and Digitizers in stock \_\_\_\_\_

### DOT MATRIX

EPSON RX80/100, FX80

Plus/100 Plus \_\_\_\_\_

EPSON LX80/100, LQ1500

EPSON JX80 Color printer \_\_\_\_\_

COMREX 420, Epson

compatible, 400cps \$1695

OKIDATA 192 & 193, ML84,

Pacemark 2410 \_\_\_\_\_

OKIDATA Color printers,

complete line \_\_\_\_\_

TOSHIBA P-351 & 1340 \_\_\_\_\_

\_\_\_\_\_ New Low Prices!

TEXAS INSTRUMENTS 855 \_\_\_\_\_

\_\_\_\_\_ From \$729

### LETTER QUALITY

NEC Spinwriters 2050, 3550,

8850 \_\_\_\_\_ New Low Prices!

COMREX CR II E, CR III & CR

IV \_\_\_\_\_ Start at \$369

We carry a full range of form handling options.

## FLOPPY DISK DRIVES

TANDON TM 100-2, DD/DS,

360K \_\_\_\_\_ \$119

1/2 HEIGHT Disk Drives from

Shugart, Mitsubishi & TEAC.

PC, XT & AT Compatible \_\_\_\_\_ \$115

SPECIAL! Two 1/2 Height

Drives, "Y" cables &

brackets. \_\_\_\_\_ \$219

## HARD DISCS

Micro Mart carries many of the major brands. If you don't see it—ask for it.

PEACHTREE TECHNOLOGIES P-10, 20, 30 & 50, int. &

ext. for your PC, XT, AT, AT&T,

COMPAQ & others From \$695

PEACHTREE TECHNOLOGIES New 1/2 Height Tape

and Winchester back-up

system \_\_\_\_\_ \$1395

SYSGEN 10 & 20 Meg.

w/streamer tape \_\_\_\_\_

\_\_\_\_\_ New Models—Call!

SYSGEN Image & Quickfile,

Streamer tape for XT/AT \_\_\_\_\_

\_\_\_\_\_ New Price!

BERNOULLI TECHNOLOGY

Hard Disc Subsystems \_\_\_\_\_ \$2595

## CHIPS

We guarantee the lowest prices

in chips. Call us!

INTEL 8087, 80287, high speed

coproc. \_\_\_\_\_ \$125

64K—256K RAMCHIPS \_\_\_\_\_

\_\_\_\_\_ Call for Market Price.

128K Piggy-back chips for your

AT \_\_\_\_\_ Call for Market Price.

## MULTIFUNCTION BOARDS

We have a complete line of

Multifunction Boards compatible

with the Portable, XT/AT & Jr.

THE BOARD SPECIAL OF THE

MONTH \_\_\_\_\_ Call for details!

SIX PAK 64-384K, multifunc. \_\_\_\_\_

MPII RAMboards for PC's &

compatibles \_\_\_\_\_

I/O MINNIE I/O shortboard for

Portable & AT \_\_\_\_\_

ADVANTAGE 128K-3Mb, expansion

for AT \_\_\_\_\_

QUADRAM QUADBOARD,

64-384K, multifunc. \_\_\_\_\_ \$249

TECMAR CAPTAIN, 0-384K,

multifunc. \_\_\_\_\_ \$185

TALLTREE J-RAM II \_\_\_\_\_

\_\_\_\_\_ New Low Price!

STB RIO GRANDE & GRANDE

BYTE, 128K AT expansion \_\_\_\_\_

\_\_\_\_\_ From \$259

## GRAPHIC CARDS

PREVIEW Mono Graphics/Hercules

look-alike \_\_\_\_\_ Call

HERCULES Mono & Color

Graphics cards \_\_\_\_\_

\_\_\_\_\_ New Low Prices!

TECMAR Graphics Master, HiRes

Color & Mono supports Lotus \_\_\_\_\_

\_\_\_\_\_ \$449

QUADRAM Quadcolor I & II color

cards \_\_\_\_\_

PARADISE Multi-display or

modular graphics cards \_\_\_\_\_

\_\_\_\_\_ From \$199

STB Chauffeur & Colorific \_\_\_\_\_

\_\_\_\_\_ \$189 & \$289

SIGMA Color 400 for PGS

SR-12 \_\_\_\_\_ New Low Price!



# (404) 449-8089. YOU CAN COUNT ON.

## SOFTWARE

**SOFTWARE SPECIAL OF THE MONTH.** Call for details!  
**ACCOUNTING**  
SORCIM/IUS Complete line including Windows \_\_\_\_\_  
From **\$289/each**

**SPREADSHEETS & INTEGRATED PACKAGES**  
Call for unadvertised spreadsheet packages.  
MICROSOFT MultiPlan, w/templates \_\_\_\_\_  
SORCIM SuperCalc 3, vers. 2.0 \_\_\_\_\_ **New Low Price!**  
**ENHANCEMENTS & UTILITIES**

FOX & GELLER Complete line for dBase II/III, Rbase 4000 \_\_\_\_\_  
NORTON Utilities 3.0 \_\_\_\_\_ **\$69**  
ROSESOFT ProKey 3.0 \_\_\_\_\_ **\$89**  
CENTRAL POINT SOFTWARE Copy II PC \_\_\_\_\_ **\$35**  
SOFTSTYLE Set FX + and Printworks, printer control \_\_\_\_\_  
SIDEWAYS Inverts printout \_\_\_\_\_  
BORLAND SideKick and SuperKey \_\_\_\_\_ From **\$35**  
LIVING VIDEO TEXT Think Tank \_\_\_\_\_ **\$125**

**COMPILERS & LANGUAGE TOOLS**  
LATTICE C-Compilers \_\_\_\_\_ **\$299**  
MICROSOFT Complete line \_\_\_\_\_  
BORLAND Turbo Pascal, Turbo Toolbox & more From **\$35/each**  
**GRAPHICS & CAD**

Micro Mart carries many of the major CAD packages. Call if you don't see it listed.

Z-SOFT PC Paintbrush, mouse graphics \_\_\_\_\_ **\$75**  
**DECISION RESOURCES**  
ChartMaster Latest version **\$239**  
MICROPRO ChartStar \_\_\_\_\_  
MICROSOFT Chart \_\_\_\_\_ **\$169**  
**COMMUNICATIONS**  
MICROSTUF Crosstalk XVI, Latest version \_\_\_\_\_ **\$99**  
HAYES Smartcom II \_\_\_\_\_

**WORD PROCESSORS**  
MULTIMATE w/spelling checker & tutorial \_\_\_\_\_ **New Low Price!**

SAMNA + MICROSOFT Word, New version \_\_\_\_\_  
LIFETREE Volkswriter Deluxe \_\_\_\_\_ **\$169**  
SSI WordPerfect, version 4.0 \_\_\_\_\_ **\$269**

MICROPRO WordStar Professional series \_\_\_\_\_ **New Low Price!**  
**OFFICE & PROJECT PLANNING**

HARVARD Total Project Manager \_\_\_\_\_ **\$299**  
SORCIM/IUS Super Project \_\_\_\_\_  
MICROSOFT Project \_\_\_\_\_ **\$175**  
**DATA BASE MANAGERS**  
Call for unadvertised Data

Base Managers.  
MICRORIM 4000 or 5000, Report Writer & Clout \_\_\_\_\_ **New Low Price!**  
**WARNER SOFTWARE** The Desk Organizer \_\_\_\_\_ **\$145**  
MICROSTUF Infoscope \_\_\_\_\_ **\$149**  
**MODEMS**

HAYES Smartmodem 300, 1200, 1200B & 2400. We have the best stock in the USA \_\_\_\_\_ **Call!**  
VEN-TEL 1200 Baud Half Card w/Crosstalk \_\_\_\_\_ **\$419**  
POPCOM Int. & ext. w/voice & data \_\_\_\_\_  
AST Reach Modems \_\_\_\_\_ **Special Introductory Price!**  
**MISCELLANEOUS**

DYSAN Diskettes at the lowest price in the USA \_\_\_\_\_ **Call!**  
MOUSE SYSTEMS PC Mouse, optical w/software \_\_\_\_\_ **\$139**  
MICROSOFT Mouse, bus or serial mechanical \_\_\_\_\_  
KEYTRONICS 5151 & 5152 keyboards \_\_\_\_\_ From **\$149**  
KENSINGTON MICROWARE MasterPiece \_\_\_\_\_ **\$199**  
CURTIS Accessories, Pedestals, cables, etc. \_\_\_\_\_

HAYES Mach II & Mach III Joysticks \_\_\_\_\_ **\$39/\$45**  
QUADRAM Microfazer print buffer 8-128K \_\_\_\_\_ From **\$129**  
TRIPPELITE ISOBAR surge protectors, 4 & 8 plug From **\$49**  
POLAROID Palette \_\_\_\_\_ **\$1345**  
PTI Back-up power supplies \_\_\_\_\_ **New Low Prices!**

**MONITORS AND CRT'S**  
PGS Max12 (E), amber & mono \_\_\_\_\_ **New Low Prices!**  
PGS HX-12 & SR-12, color RGB's \_\_\_\_\_ **New Low Prices!**  
QUADRAM Quadchrome, 690 dot RGB \_\_\_\_\_ **\$429**  
AMDEK Color 300, 500, 600, 700, 710, 725 \_\_\_\_\_  
AMDEK 300A/300G/310A \_\_\_\_\_ **\$129/\$119/\$165**

© 1985 Micro Mart, Inc. Technology Corporate Campus 3159 Campus Drive Norcross, Georgia 30071



# THE COMPUTER TELEMARKET MICRO MART™

Inquiry 202



# New 64K SBC

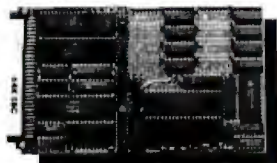

Only  
**\$375.**  
4" x 6"

- Requires no terminal. Includes Video Controller and CP/M® 2.2
- Runs any size floppy drive
- Substantial OEM Discounts Available

Other models include Hard Disk Controller, CP/M® 3.0, 128K or 256K RAM, Time of Day Clock, E<sup>2</sup>PROM, Peripheral Expansion & RGB Color Video Display

#### 64K SBC Includes:

- 6 MHz Z80B®
- Video Controller
- 2 Serial Ports
- 4 Parallel Ports

- I/O Expansion
- Source Code and Drivers included
- CP/M® 2.2

CP/M is a registered trademark of Digital Research Inc.  
Z80B is a registered trademark of Zilog Inc.

Megatel Computer Technologies  
Head Office and Technical Support Center  
150 Turbine Drive, Weston, Ontario M9L 2S2  
Telephone: (416) 745-7214 Telex: 065-27453 MEGATEL TOR.  
U.S. Sales and Service Office  
2311 South Anthony, Fort Wayne IN 46805  
Telephone: (219) 745-0310

## **megatel**

# IBM COPY PROTECTION

MultiGuard provides maximum protection for your PC software at a reasonable price. Ten disks or thousands—formatted or fully duplicated. Call today for complete information.

## DISK COPYING

Whether you need 50 disks or thousands, we have years of experience in creating the highest quality copies. Reasonable prices—fast turnaround. Call today for our free booklet on software duplication and packaging.

Call ALF first  
**1-800-321-4668**  
in Colorado (303) 234-0871

### **ALF**

ALF Products • Denver, CO

## BOOK REVIEWS

Part III is short (26 pages) and technical, showing mainly how to translate the SIMPLE sentence syntax (SIMPLE is a special syntax of micro-PROLOG that allows for a more English-like expression of sentences) used throughout the book into standard Prolog syntax. Little is new here aside from terminology and notation. A few features of micro-PROLOG that need standard syntax are included. This standard syntax, incidentally, is more like other versions of microcomputer Prolog, such as PROLOG-86. Someone familiar with SIMPLE Prolog would be able to use other versions of Prolog after mastering the concepts in this section.

The last part, "Applications of micro-PROLOG," is composed of four chapters written by guest authors to illustrate applications of micro-PROLOG. One chapter, by F. Kriwaczek, demonstrates an application of graph searching for project management. Kriwaczek develops a critical-path analysis program with explanations as to how Prolog is especially suited for this type of analysis.

The next chapter, entitled "micro-PROLOG of Expert Systems," was written by P. Hammond. It scans the development of a minicomputer expert system based on the medical system MYCIN, with particular emphasis on how Prolog lends itself to this type of system. The most interesting concept in this chapter is found in the explanations of how the system, if asked to explain its conclusions, can trace its own logic and provide the how and why of a particular conclusion.

"The Logic of Two-Person Games" by M. H. Van Emden and K. L. Clark is just good pure fun for anyone with a bias toward game theory. The authors provide an analysis of game trees and min-max principle, using Prolog relations (user-defined) such as good-move-for-white and value-of-white-to-move to develop winning strategy. Their discussion of chess-playing programs is very informative.

In the final chapter, "micro-PROLOG for Problem Solving," R. A. Kowalski and M. J. Sergot tackle all-purpose problem solving. Alternative search strategies and loop-detection techniques are incorporated as well. The only disappointment in this chapter was that it ended.

#### REQUIRED READING

This book should be considered required reading for anyone interested in artificial intelligence, computer science, programming, or applied mathematics. Though learning the Prolog language is the main emphasis of the book, it is not really simplified.

In addition to examples and exercises mentioned earlier, "system notes" scattered throughout the text explain non-logic programming activities (such as starting up, interrupting a program run, executing a trace, and so on) that are not part of syntax but are certainly necessary if you are following along on a computer. Without a computer, you can still get a feel for programming in Prolog. The four applications chapters are excellently written and can help provide a feel for the full impact of this type of program-

(continued)



# WHO SAYS WORDSTAR 2000 IS SO GREAT?

“Move over MultiMate, MicroPro’s back on top.”  
— *Business Software*

“The new package is packed with virtually dozens of features everybody wants... Even in a dedicated machine, word processing has never been more plushly self contained and comprehensive.”  
— *Personal Computing*

“Three early users of WordStar 2000 gave the program high marks for its overall design, mnemonic command set and intelligent use of function keys.”  
— *ComputerWorld*

“I’ve become addicted to some of the features such as undo, windows, and automatic reformatting.”  
— *Popular Computing*

“Include WordStar 2000 on your shopping list—it’s competitive with anything now on the market.”  
— *Computers and Electronics*

**WORDSTAR**  
**2000**  
*Now there are no limits.*

**MicroPro.**

**"Switch boxes are sold by many suppliers, but by far the two best values are from MFJ Enterprises."**



**"The MFJ RS-232 Transfer Switch. Buy it before the manufacturer comes to his senses!"**

Joe Campbell, *The RS-232 Solution*  
Sybex Computer Books

Now you can have *reliable and affordable* and unplugging cables. You can easily switch letter-quality printer, modem, terminal - any Transfer Switches includes one to fit. Look at these choices, then look at any price! Then ask them for show you, call MFJ...

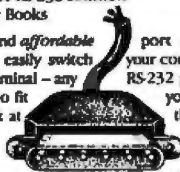

**When you need to switch between two peripherals... or you need to have two computers sharing the same peripheral... Model 1240/\$79.95**

Never unplug a cable again. Now, with the push of a button you can go from dot matrix to letter-quality printing, or go from your printer to your modem. MFJ's Model 1240

Transfer Switch features a built-in transmit/receive switch allowing you two-way information flow. LEDs monitor important data lines while a built-in surge protector guards them. The 1240 also acts as a null modem. All this for just \$79.95. No wonder it's MFJ's No. 1 seller!

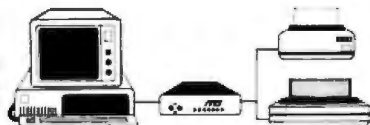

**When you need 1-to-4 computers to share one peripheral or 1-to-4 peripherals to share a common computer... Model 1243/\$119.95**

The perfect office Transfer Switch. Don't buy multiple printers or modems. Just buy MFJ's Model 1243. Then you can connect one or all your computers to a single printer or modem. Or let your one computer share up to four peripherals. Think of the money you'll save. LEDs monitor important data lines while a built-in surge protector guards them. Two-way communication is allowed with no complicated software to learn: just push a button!

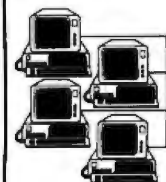

Seven additional models to choose from. Each unit's casing is constructed from high-quality aluminum. Printed circuit boards assure maximum reliability by eliminating crosstalk, line interference and any need for wiring. All MFJ switches have LEDs to monitor data lines and MOV surge protectors. Enhance the investment you've already made in your computer by choosing from the finest line of Transfer Switches on the market, including MFJ's IBM & Centronics Parallel Switches.

**You've got a lot of money tied up in your computer. Don't blow it!**

Your valuable computer and peripheral equipment can be damaged by electrical surges much smaller than you've been led to believe. Far more likely to happen is having your important data wiped out. These disasters, and others, can be prevented with MFJ's Power Centers. Relay latches power off during power dropouts (Model 1108). Multi-filters isolate equipment, eliminate interaction, noise and hash. MOVs suppress spikes and surges. MFJ's Power Centers also have 3 isolated, switched socketpairs, with at least one unswitched socket (so you can add a clock, etc.), lighted power switch, fast-acting fuse, 3-wire, 6-foot cords; 15A, 125V, and 1875 watts. Although each model is attractively housed in a protective aluminum casing, these are heavy-duty, commercial-quality power centers.

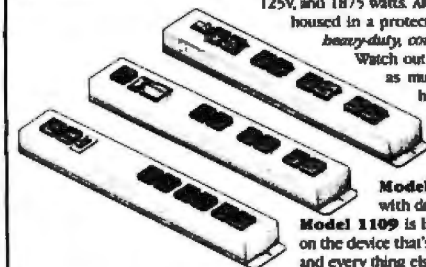

Watch out for fancy names that cost twice as much, last half as long, and have half the features of MFJ's Power Centers

**Model 1107** 8 sockets, 2 unswitched; \$79.95

**Model 1108** 7 sockets, 1 unswitched, with dropout relay; \$99.95

**Model 1109** is like 1107 but intelligent (switch on the device that's plugged into the control socket and every thing else comes on). \$129.95

There are other RS-232 Switches, Power Centers, and Computer Peripheral Products available from MFJ. Call and talk with us about all your computing needs, and when you do, ask for our latest catalog. Both the call and the catalog are free.

**1-800-647-1800**

For technical/repair information, or in Mississippi, or outside the Continental United States, please telephone...

**1-(601)323-5869** or telex **53-4590 MFJSTKV**

All MFJ products come with a *double* guarantee we think is unmatched. Order from MFJ and try any product for 30 days. If it doesn't satisfy your needs, just return it for a *full refund*, less shipping. If you keep it you can be assured of continued service with our *One Year Unconditional Guarantee*.

Call toll-free 1-800-647-1800 and charge the products you need to your VISA or MasterCard, or send a check or money order, plus \$5.00 shipping, and our shipping department will promptly have your computer peripheral on its way to you.

**MFJ** MFJ Enterprises Inc.  
921 Louisville Road  
Starkville, MS 39759

## BOOK REVIEWS

ming. While perhaps not a book for self-teaching, *MICROPROLOG* is a standard model for textbooks on programming.

Margaret M. Sklar is an instructor in computer information systems at Northern Michigan University (Marquette, MI 49855). Her specialty is computer languages.

### A SOFTWARE LAW PRIMER

Reviewed by Mark J. Welch

Many programmers know that a variety of legal questions need to be addressed before they can sell a program. Foremost is protection of the software itself since the programmer's goal is usually profit. Other issues, including potential liability to customers, obligations to previous employers, and contract law are less apparent but require consideration.

A *Software Law Primer* packs much useful information into a short, readable volume. I expected to find the usual analysis of methods of protecting software from being copied: copyrights, patents, trademarks, trade secrets, and licenses. Frederic W. Neitzke addresses each of these in brief detail and also deals with contracts, torts, and potential problems between employees and employers.

As explained in legal books and articles, protection for software is a fuzzy issue because laws covering patents, trademarks, copyrights, and trade secrets can all potentially protect software but not all at the same time. Neitzke suggests that while patents provide the strongest protection if upheld, they are too costly and uncertain for most programs. He explains how copyright, trade-secret, and trademark laws may be applied. Another chapter covers what must be done to be certain that specific protection will apply. The problems of contract and tort law, each of which could create unexpected liabilities for a company selling software, are also addressed.

In an industry with such a high turnover rate, employee/employer concerns need clarification. Neitzke identifies problems that could arise when an employee leaves a company, including concerns over trade secrets, ownership of general programming methods and tools, and the legality of some contract restrictions.

Throughout the book, Neitzke summarizes relevant cases and cautions that because the laws pertaining to software are still evolving, unexpected twists could occur. He suggests that a programmer consult a lawyer before considering selling software.

The only problem with this book is that only weeks need pass before it is out of date. The *Betamax case (Sony v. Universal City Studios)*, which could have an effect on software publishing, was reversed by the Supreme Court shortly after this book was published. Despite the changes in software law, Neitzke's book provides an excellent summary of the issues confronting software entrepreneurs.

(continued)

# YOU DON'T NEED A COMPUTER TO FIGURE OUT WHICH IS THE BEST WORD PROCESSOR.

	MultiMate™ v.3.30	Microsoft® Word v.2.0	Word Perfect v.4.0	WORDSTAR® 2000 PLUS v.1.01
Easy-to-remember Mnemonic Commands		✓		✓
Onscreen Tutor For Easy Learning	✓	✓		✓
Format Sheets For Fast, Easy Documents		✓		✓
"Undo" To Easily Restore Text		✓	✓	✓
Built-in Telecommunications				✓
Spelling Corrector*	✓	✓	✓	✓
Mail List Manager				✓
Windows Onscreen		✓		✓
Math Built-in			✓	✓
Alphabetic And Numeric Sorting Within Document				✓
"Macros" For Recalling Often Used Command Sequences	✓		✓	✓
Supports Over 100 Printers				✓
Experience With Over 1.3 Million Owners				✓

**WORDSTAR®**  
**2000**  
*Now there are no limits.™*

**MicroPro.**

\*Only with WordStar 2000 can correction be done while in editing mode; other programs cited require exiting the program. For a complete comparison chart, write: MicroPro, Dept. 2000, 33 San Pablo Ave., San Rafael, CA 94903. Specifications are for the latest released versions of all products effective April 1985. MultiMate is a trademark of MultiMate Corp.; Microsoft is a registered trademark of Microsoft Corp.; WordStar and MicroPro are trademarks of MicroPro International.

# TOTAL CONTROL with LMI FORTH™



## For Programming Professionals: an expanding family of compatible, high-performance, Forth-83 Standard compilers for microcomputers

### For Development:

#### Interactive Forth-83 Interpreter/Compilers

- 16-bit and 32-bit implementations
- Full screen editor and assembler
- Uses standard operating system files
- 400 page manual written in plain English
- Options include software floating point, arithmetic coprocessor support, symbolic debugger, native code compilers, and graphics support

### For Applications: Forth-83 Metacompiler

- Unique table-driven multi-pass Forth compiler
- Compiles compact ROMable or disk-based applications
- Excellent error handling
- Produces headerless code, compiles from intermediate states, and performs conditional compilation
- Cross-compiles to 8080, Z-80, 8086, 68000, and 6502
- No license fee or royalty for compiled applications

### Support Services for registered users:

- Technical Assistance Hotline
- Periodic newsletters and low-cost updates
- Bulletin Board System

**Call or write for detailed product information  
and prices. Consulting and Educational Services  
available by special arrangement.**



**Laboratory Microsystems Incorporated**  
Post Office Box 10430, Marina del Rey, CA 90295  
Phone credit card orders to: (213) 306-7412

#### Overseas Distributors.

Germany: Forth-Systeme Angelika Fiesch, D-7820 Titisee-Neustadt  
UK: System Science Ltd., London EC1A 9JX  
France: Micro-Sigma S.A.R.L., 75008 Paris  
Japan: Southern Pacific Ltd., Yokohama 220  
Australia: Wave-onic Associates, 6107 Wilson, W.A.

## BOOK REVIEWS

Anyone hoping to make money from software should read *A Software Law Primer*.

Mark J. Welch is a staff writer for BYTE. He can be contacted at 425 Battery St., San Francisco, CA 94111.

### EXTRATERRESTRIALS—SCIENCE AND ALIEN INTELLIGENCE

Reviewed by Jack D. Kirwan

A collection of 16 essays written by "some of the most distinguished philosophers and scientists of our generation," *Extraterrestrials—Science and Alien Intelligence* is a stunning summation of scholarly arguments, pro and con, on the question of other intelligences in the universe. Given that none of the contributors has ever seen an extraterrestrial, much of the book is based on speculation and extrapolation. The essays range from logical and ingenious exercises in reasoning to rather subjective anthropomorphism.

The academic contributors to *Extraterrestrials* include philosophers, biologists, mathematicians, and physicists. Personalities range from the relatively unknown to Carl Sagan and Marvin Minsky. The book is divided into five categories that cover "Existence and Nature of Extraterrestrial Intelligence," "Extraterrestrial Epistemology," "Where Are They?" "Detectability and Decipherability," and "Meaning and Consequences of Contact." The question of alien intelligence and existence is looked at from several vantage points.

In terms of dazzling ideas per square inch, almost every page has something worth quoting. Some of the concepts function like delayed-action mines: They go off hours or even days later. While each contributor deserves in-depth discussion, space permits mentioning only a few.

### COMPUTER THEORY

Computer theory recurs sporadically throughout the book. However, sections in "Extraterrestrial Epistemology" and "Detectability and Decipherability" specifically address computers and the search for aliens. A philosophy professor, Nicholas Rescher, and artificial-intelligence pioneer Marvin Minsky discuss whether we can even communicate with aliens (assuming there are any). Rescher thinks not. He argues that in adapting to an environment completely distinct from our own, an alien may develop science, intelligence, or senses so different that communication is impossible.

Minsky, on the other hand, reasons that "all intelligent problem solvers are subject to the same ultimate constraints: limitations on space, time, and materials." To handle these constraints, they will perforce develop both arithmetic and language skills. Because arithmetic is based on universal truths, alien mathematics will be congruent to our own, Minsky says. And because life's realities are,

(continued)

*The future... a little sooner than you expected.™*



**ACHIEVE THE POWER  
AND SPEED OF TOMORROW'S  
TECHNOLOGY. TODAY.**

**INTRODUCING  
THE EXEC. PARTNER™ FROM  
PANASONIC®**

The Panasonic Exec. Partner. What makes it an executive? The 7.16 Mhz 8086-2 microprocessor for high-speed processing. So you can do more in less time.

What makes it your partner? Like all ambitious achievers the Panasonic Exec. Partner gets along with others. Namely, IBM hardware and software.

You'll also accomplish more with the new high-resolution plasma display. It lasts four times longer, offers clearer definition and is easier to read than an ordinary screen.

The Exec. Partner's built-in dual mode printer will help

you make a good impression. From silent, draft-quality mode to correspondence quality.

The 256K internal memory has built-in expandability to 640K. So the Exec. Partner will run the most sophisticated data base management programs. And its expansion slot allows you to fulfill the needs of specific applications like telecommunications and Local Area Networks.

Tomorrow's technology for today's executives. The new Panasonic Exec. Partner.

**Panasonic  
Industrial Company**

## INTRODUCING THE **Western AT**

Newest Compatible in the Personal Computer Market!!! By the OEM Manufacturer of the Most Advanced IBM PC Compatible — The "Western PC Turbo."



### Some Outstanding Features of the "Western AT":

- 6MHz or Optional 8MHz CPU
- Up to 1MB RAM on the Mother Board
- 16MB in System Protected Virtual Address Mode.
- 8 I/O Expansion Slots
- On Board Battery Backed Clock-Calendar
- Socket for 80287 Math Co-Processor
- 20/40MB Winchester Disk Memory
- 2 Serial, 1 Parallel
- Optional 4 Serial, 1 Game Port
- 20-60MB Tape Streamer Back-Up



### Some Outstanding Features of the "Western PC Turbo":™

- Dual Clock Speed of 8MHz-4.77MHz Giving 65% Faster Operation.
- Up to 1MB RAM on the Mother Board. Optional RAM Disk Software to Address above 640K.
- 1 Serial, 1 Parallel Port on the Mother Board.
- Optional Clock Calendar and 1 Serial Port, 1 Parallel Port on Floppy Disk Controller.
- 10, 20, 40MB Internal Winchester Disk Capability.

IBM PC is a registered trademark of IBM Corp.  
Distributors, Dealers & OEM Welcome

**Western Computer**

1381 Warner Ave., Warner Corporate Park, Suite B  
Tustin, CA 92680  
(714) 544-4740, 544-4743, 544-4748  
TELEX 756731  
AnswerBack Western Comp

## BOOK REVIEWS

in general, the same everywhere, our languages will match to a "degree that will enable us to communicate with them."

Interestingly, the astronomers, especially those of SETI (the Search for Extraterrestrial Intelligence), are generally optimists on the subject of extraterrestrials, while evolutionary biologists tend to be pretty dubious. Ernst Mayer, for example, considers SETI "a deplorable waste of the taxpayers' money."

Jill Tarter's essay "Searching for Extraterrestrials" applies the old analogy of searching for a needle in a haystack: How many haystacks are there? How long do they last? How should one look for a needle? (A magnet might miss a platinum one.) Tarter exemplifies that scientific reasoning need not be dull.

Cipher A. Deavours (one of the editors and founders of *Cryptologia*, a quarterly cryptology journal published in Lawrence, Kansas) has contributed a fascinating essay on using cryptology to solve the problem of communication with aliens. After all, many a top-drawer cryptographer can break a foreign code without knowing a word in the encoded language.

One essay that stands out is Hans Freudenthal's "Excerpts from *LINCOS: Design of a Language for Cosmic Inter-course*" (Amsterdam: North-Holland, 1960). This excerpt from the out-of-print classic covers the reasoning behind the development of the binary language LINCOS, which stands for *lingua cosmica*. LINCOS uses >, <, +, =, and - as vocabulary words and variables.

### THE DEBATE

The heart of the book is part IV, "Where Are They?" The title originates from Enrico Fermi's well-known query: "If extraterrestrials really exist, where are they?" This section is a veritable scientific debate. Carl Sagan and William J. Newman clash ideas with Frank Tipler, a University of Texas physicist whose unequivocal piece is entitled "Extraterrestrial Beings Do Not Exist." Newman and Sagan (the father of SETI) call their reply "A Solipsist Approach to External Intelligence."

This debate could have been the most dramatic and interesting part of the book, but it is not. There is no contest. Tipler makes a very strong case for the anti-ET premise, while the Sagan/Newman response is disappointing in contrast.

Tipler's piece (originally published in 1980 in the *Quarterly Journal of the Royal Astronomical Society*) begins with the premise that "an intelligent species with the technology for interstellar communication would necessarily develop the technology for interstellar travel, and this would automatically lead to the exploration and/or colonization of the Galaxy in less than 300 million years."

Put briefly, Tipler argues that any species with the technology to send or receive communications would have made comparable advances in other fields, particularly rocketry. He reminds us that "it is a deficiency in com-

(continued)

# THE PROFESSIONAL'S CHOICE

Lotus  
1-2-3  
**Call**

Lotus  
Symphony  
**Call**

dBase III  
**\$349**

FrameWork  
**\$349**

MultiMate  
**\$249**

Word  
Perfect  
**\$209**

## Software

<b>Database Systems</b>	<b>Graphics/Statistics</b>	<b>Display Boards</b>	<b>Input Devices</b>
ALPHA DATA BASE MANAGER II \$179	ABSTAT \$279	EVEREX GRAPHICS \$329	KEYTRONIC 5151 \$179
CLIPPER \$Call	AUTOCAD \$1475	EDGE \$299	KOALA \$Call
CLOUT V 2.0 \$139	BPS BUSINESS \$229	HERCULES GRAPHICS CARD \$299	MICROSOFT MOUSE \$139
CONDOR III \$299	GRAPHICS \$229	HERCULES COLOR CARD \$169	PC MOUSE W PAINT \$159
CORNERSTONE \$329	CHARTMASTER \$239	PARADISE MODULAR GRAPHICS \$275	<b>Emulation Boards</b>
DBASE II \$299	CHARTSTAR \$209	PARADISE \$295	AST \$Call
DBASE III \$349	DR DRAW \$199	MULTIDISPLAY CARD \$295	CXI 3278/9 \$950
INFOSTAR+ \$319	ENERGRAPHICS W/ PLOTTER \$279	PERSYST BOB \$449	IRMA \$799
KNOWLEDGEMAN \$269	EXECUVISION \$259	PRINCETON SCAN DOUBLER \$Call	IRMALINE \$999
PFS: FILE/PFS: REPORT \$169	GRAPHWRITER COMBO \$359	SIGMA COLOR 400 \$559	QUAD 3278 \$949
POWERBASE \$319	MS CHART \$159	STB GRAPHICS \$309	<b>Modems</b>
QUICKCODE III \$169	OVERHEAD EXPRESS \$139	TECMAR GRAPHICS PLUS II \$479	AST REACH 1200 \$Call
QUICKREPORT \$169	PC DRAW \$259	MASTER \$399	HAYES 1200 \$389
R BASE 4000 \$249	PC PAINTBRUSH \$ 89	TSENG ULTRA PAK \$399	HAYES 2400 \$609
<b>Project Management</b>	PFS: GRAPH SIGNMASTER \$179	TSENG ULTRA PAK-S \$349	<b>Moderns</b>
HARVARD PROJECT MANAGER \$209	STATPAC-NWA \$329		AST REACH 1200 \$Call
HARVARD TOTAL PROJECT MANAGER \$269	WALONICK \$349		HAYES 1200B \$385
MICROSOFT PROJECT \$159	SYSTAT \$419		HAYES 2400 \$609
PERTMASTER \$549	<b>Professional Development</b>		VENTEL 1200 HALF CARD \$379
SCITOR PROJECT 5000 W/GRAPHICS \$259	EXPERTASE \$Call		<b>Multifunction Boards</b>
SUPERPROJECT \$199	MANAGEMENT EDGE \$159		AST ADVANTAGE \$375
TIME LINE \$259	SALES EDGE \$159		AST 6 PAK PLUS (64K) \$259
	THINK TANK \$119		AST 6 PAK PLUS (384K) \$339
<b>Desktop Environments</b>	<b>Communications/ Productivity Tools</b>		ORCHID BLOSSOM (64K) \$289
DESK ORGANIZER \$129	CROSSTALK \$105		ORCHID PC TURBO (64K) \$739
DESK ORGANIZER SIDEKICK \$ 45	PROKEY \$ 89		PERSYST TIME SPECTRUM (64K) \$259
SPOTLIGHT \$109	RELAY \$ 99		QUADBOARD (0K) \$229
	SMARTCOM II \$109		QUADBOARD (384K) \$329
<b>Accounting</b>		<b>Mass Storage/Backup</b>	TECMAR CAPTAIN (64K) \$Call
BPI \$329		IOMEGA BERNOULLI BOX \$2695	TECMAR JR CAPTAIN (128K) \$329
GREAT PLAINS \$479		MT25 TAPE BACKUP \$885	TECMAR JR WAVE (64K) \$329
IUS EASYBUSINESS \$279		TALLGARSS TG5025 \$2945	TECMAR MAESTRO \$429
ONE WRITE PLUS \$199		SYSGEN IMAGE \$850	TECMAR WAVE (64K) \$209
OPEN SYSTEMS \$379		SYSGEN QICFILE \$Call	
PEACHTREE \$299		<b>Printers/Plotters</b>	
REAL WORLD \$469		C. ITOH \$Call	<b>Accessories</b>
STATE OF THE ART STAR ACCOUNTING PARTNER \$249		DIABLO 620/630 \$Call	CURTIS SURGE \$Call
STAR ACCOUNTING PARTNER II \$549		EPSON FX-80+ \$349	PROTECTORS \$Call
<b>Personal Finance</b>		EPSON FX-100+ \$499	DATASHIELD BACKUP POWER \$Call
DOLLARS AND SENSE \$119		EPSON LQ-1500 \$999	GILTRONIX A/B SWITCH MICROBUFFER INLINE (64K) \$264
HOWARD TAX PREPARER 85 \$195		HP 7475A PLOTTER \$Call	MICROFAZZER INLINE (64K) \$219
MANAGING YOUR MONEY \$129		JUKI 6100 \$419	64K RAM SET \$25
		NEC P3 COLOR \$1099	256K RAM SET \$ 79
		NEC P3 \$799	8087 MATH CHIP \$150
		NEC 2050 \$769	
		NEC 3550 \$1139	
		OKIDATA 84P/93P \$729/619	
		PANASONIC \$Call	
		QUME SPRINT 1155 \$1569	
		STAR SG/SR/SD \$Call	
		TOSHIBA P1340 \$779	
		TOSHIBA P351 \$1279	

## Hardware\*

Samna  
Word III  
**\$279**

Chart-Master  
**\$239**

Quadboard  
384K  
**\$329**

Tseng  
Ultra Pak  
**\$399**

Smartmodem  
1200B  
**\$365**

Smartmodem  
2400  
**\$609**



## LOWEST PRICE GUARANTEE!!

We will match current nationally advertised prices on most products. Call and compare.

*free!*

Diskette Library Case with your order



**1-800-221-1260**

In New York State call (718) 438-6057

TERMS: Checks—allow 14 days to clear. Credit processing—add 3%. COD orders—cash, M.O or certified check—add \$3.00. Shipping and handling UPS surface—add \$3.00 per item (UPS Blue \$6.00 per item). NY State Residents—add applicable sales tax. All prices subject to change.



MON.-THURS. 9:00AM-8:00 PM  
SUN. & FRI. 9:00AM-4:00 PM

**Softline**  
Softline Corporation  
P.O. Box 729, Brooklyn, N.Y. 11230  
TELEX: 421047 ATLN UI

# BANC \$AFE

LOWEST PRICES ANYWHERE! ANYTIME! ANYPLACE!

THOUSANDS OF AVAILABLE ITEMS. CALL FOR COMPLETE PRICING.

<b>IBM PC AT</b> \$4895 20MB Hard Drive 512K Ram 1.2 MB floppy Monitor PAA/SEA	<b>IBM PC</b> Monitor/2 dr CALL US Monitor/2 dr <b>IBM PC ROMB</b>	<b>IBM PC Compatible</b> <b>I II XTAA</b> \$1599 2 dr. 256K Monitor, SER/PAA FREE Software
---	--	---

<b>HARD DISK DRIVES</b>	<b>10 meg</b> 539/529	<b>20 meg</b> 689/669	<b>Quantity</b> 1/10	<b>HARD DISK DRIVES</b>
-------------------------	--------------------------	--------------------------	-------------------------	-------------------------

<b>IBM SOFTWARE</b>				
SOACIM SUPERCALC III	235.00	NEC 1201 Hi Res Green	99.00	
LOTUS 123	CALL	1260 Green	72.00	
SYMPHONY	CALL	JC 1215 Composite Color w/audio	200.00	
ENABLE	399.00	PRINCETON GRAPHICS HX-12	469.00	
ASHTON TATE Framework	289.00	SA-12	625.00	
dBASE II	399.00	MAX-12	189.00	
dBASE III	399.00	TAXAN 121/122	149.00	
MULTIMATE	249.00	420 (RGB)	439.00	
MICROSOFT Multiplan	125.00	415 (RGB)	489.00	
Word	229.00	PANASONIC DT-5101 Color	379.00	
Project	139.00	DT-H102 10" High Res RGB	499.00	
FOX & GELLER Quickcode	139.00	DT = D13000 13" RGB Color	279.00	
ASCI PRO Comm Software	99.00	DT-M140 14" RGB Color	439.00	
In-House Accountant	99.00			
Word Perfect	285.00			
MICROPRO WordStar	249.00			
WordStar 2000	285.00			
SRANNA WORD III	279.00			
ALSO HAYDEN, MONOGRAM, BPI, MICROCRIM, NORTON AND MANY MANY MORE				

<b>IBM HARDWARE</b>		<b>PRINTERS</b>	
AST Six Pack Plus 64K	259.00	BROTHER HA-10	CALL
MegaPlus II	269.00	HA-15	353.00
HERCULES Mono Graphics	319.00	HA-25	504.00
Color Card	159.00	HA-35	749.00
ORCHID Turbo 186	459.00	2024 LQ	679.00
Pc Net Starter Kit	CALL	Tulnwriter	985.00
Blossom ok-384k 5 Function	189.00	EPSON LX-80 F/T	CALL
QUADRAM Quadboard O-K	219.00	FX-80 +	359.00
Quadcolor 1 or Mikrofozer 64K	205.00	FX-100 +	CALL
STB Rio plus 64K	245.00	LQ1500	CALL
Super Flo	255.00	OHIDATA ML 182P	227.00
Graphix + II	245.00	ML192P	373.00
High Res 400 NEW for Taxan 440	379.00	ML193P	535.00
Chaffeur monographs NEW	269.00	PANASONIC 1091	229.00
TALORASS W/Tape	CALL	TOSHIBA 1340	375.00
MICROSCIENCE 10MB DRIVE	599.00	STAR MICRONICS SG-10	219.00
MINISCRIBE 10MB Drive	519.99	CITIZEN	CALL
IRWIN TAPE DRIVE	499.00	NEC 2050	CALL
FRANLIN TELECOM 10MB DRIVE	659.00		
RODME 20MB DRIVE	CALL		
TANDON TM 100-2	169.00		
TEAC 55B	99.00		
IBM 1.2MB FLOPPY	CALL		
MOUSE SYSTEMS Mouse	169.00		
ALSO — PERYSY, PARADISE, TECHMAR, TITAN AND OTHERS			

<b>MODEMS</b>		<b>APPLE PRODUCTS</b>	
ANCHOR Mark X	109.00	AST Multi I/O	CALL
Mark XII	239.00	APPLIED ENGR Mega Ram	CALL
Volkmodem 1200 (5 yr wrnty)	189.00	MICRO SCI R2 Drive Ite	169.00
HAYES 1200	395.00	Ite drive	179.00
1200B	349.00	APPLE Compatible Drive	145.00
2400	CALL	TEAC Ite Drive	169.00
Micromodem //e	219.00	ASCI II Express Professional	89.00
PROMETHUS Promodem 1200	308.00	REMINGTON RAND MAC DRIVE	289.00
Promodem 1200A	329.00	HABA MAC drive	CALL
Promodem Mac Pac Kit	CALL	MACINTOSH Harddrive	CALL
NOVATION SmartCat w/softwar	329.00	MACINTOSH Software Jazz	CALL
		MICROSOFT Macenhancer	189.00
		Softcard II	239.00
		Multi-plan //e & Mac	129.00
		Basic (Mac)	109.00
		ASCII XPRSS (communications)	69.00
		THE DESK ORGANIZER (Mac)	133.00
		APPLE MOUSE II	129.00
		HAYES Moch III Joustick	39.00
		SYSTEM Saver Fan	69.00
		VIDEO 7 V-color 7	CALL
		V-color Ite	CALL
		Mousestick (Mac)	CALL
		Tran Accelerator	229.00
		VIDEX Ultraterm	179.00
		Videoterm	159.00
		APRICOHN (Lifetime Warranty)	
		Super Serial Imager	99.00
		Graphics Interface	79.00
		80 Column/64K	89.00
		Extend to 64K	89.00
		WE SUPPORT THESE FINE SYSTEMS:	
		APPLE, IBM, COMPAQ, ITT, AND MANY MORE	

<b>MONITORS</b>			
AMD6X 300	189.00		
300A	145.00		
310A Hi-Res Amber	169.00		

TELEX #550757/ANSWER BACK—COMPUTERBANC UD

**Orders Only**  
**800/332-BANC**  
OUTSIDE CALIFORNIA

**COMPUTERBANC**  
16783 Beach Blvd., Huntington Beach, CA 92647  
714/841-6160

Cash prices indicated. All products are in factory sealed packages. We guarantee all items for 30 days. Within this period, defective merchandise returns must be accompanied by RMA number. All other returns will be subject to a 10% restocking fee. For prepaid orders, there will be a 5% shipping charge. 5% for UPS Blue Label. \$5.00 minimum, all orders outside U.S.A. or 15% shipping. California residents add 6% sales tax. Prices subject to change without notice.

© Copyright 1985 COMPUTERBANC. All Rights Reserved.

## BOOK REVIEWS

puter technology, not rocket technology, which prevents us from beginning the exploration of the Galaxy tomorrow." Tipler then assumes that "a species will eventually develop a self-replicating universal constructor with intelligence comparable to our present-day technology, but which is comparable to the human level—such a machine should be developed within a century." This theoretical unit is known as a von Neumann machine. Tipler suggests that the sole problem of interstellar travel boils down to "transporting a von Neumann machine to another solar system." He figures that for a technologically advanced culture, "the exploration of the Galaxy would cost about 3 billion dollars, about one-tenth the cost of the Apollo program." This telescoped version of Tipler's argument contains only some key links in a long chain of reasoning.

I found the response to Tipler by Sagan and Newman (published in 1982) disappointing on several counts. For one thing, they figure "these implacable replicators will not stop until the entire Universe has been converted into ~10<sup>47</sup> von Neumann machines, which will then presumably cannibalize each other." (Tipler previously addressed this argument.) But the weakness of Sagan and Newman is that they weave their own prejudices into the argument. For example: "It seems to us quite unlikely that an advanced technological civilization, undergoing continued biological and psychological as well as scientific development, will persevere in such imperialist designs for a billion years" and "Civilizations devoted to territoriality and aggression and violent settlement of disputes do not long survive after the development of apocalyptic weapons. Long before they are able to make any colonization of the Milky Way, they are gone from the galactic stage."

I question how Sagan and Newman know all this. Though Sagan and Newman make valid points, much of their article is anthropomorphizing.

This is definitely not the case with Edward Regis, the editor of this book. His essay "SETI Debunked" examines a fairly common mindset, typified by those people who (consciously or not) favor SETI as a means of attracting Higher Beings who will beam down and save mankind from human follies. Regis's pro-human contribution is a highlight of the book.

All in all, the anti-ET people argue a more compelling case. This is not to say that they advocate playing ostrich and letting the rest of the galaxy go by, but they do point out that the odds are against SETI's success.

While I consider this book must reading for anyone interested in aliens in general or SETI in particular, *Extraterrestrials* deserves a wide audience. This collection of essays, even the comparatively weaker ones, is a tribute to the level of terrestrial reasoning possible with such sparse information. ■

Jack D. Kirwan is assistant editor of *The Energy Journal*, produced by the Department of Economics at the University of Arizona in Tucson (85721).





## Feel right at home with the stock market.

Now you can use your personal computer and modem to help make investment decisions with confidence. Right in your own home.

Dow Jones News/Retrieval® is the surprisingly affordable, online financial news resource with exclusive electronic access to *The Wall Street Journal*. The combination of News/Retrieval and Dow Jones™ Software makes personal investment decisions easier by giving you a clear, organized picture of the facts.

Use News/Retrieval to check on your stocks or read up on companies and industries that interest you. Get tomorrow's business news today—90 seconds after it appears on the Dow Jones News Service® (the broadtape). See what impact government or world news is having on the marketplace.

Measure stock performance—past and present—with Dow Jones Quotes. And to round out the picture, review economic and earnings forecasts or SEC, Merrill Lynch and Standard & Poor's reports. It's all here in one place.

Then use Dow Jones Software to display trends, organize your portfolio and give you the entire picture in clear graphics.

After you've checked your investments, the whole family can use News/Retrieval to get hot sports news, shop at home, look up articles in the encyclopedia and much, much more.

For more information on how Dow Jones News/Retrieval can help *you* feel at home with the stock market, call **800-345-8500 Ext. 144\***.

## Dow Jones News/Retrieval & Software

*Keeping you a step ahead.*

\*Alaska, Hawaii and foreign, call 1-215-789-7008 Ext. 144.

© 1985 Dow Jones & Company, Inc. All rights reserved. Dow Jones News/Retrieval and Dow Jones News Service are registered service marks of Dow Jones & Company, Inc. Dow Jones is a trademark of Dow Jones & Company, Inc.



Commodore Accessories



RS232 Adapter for VIC-20 and Commodore 64

The JE232CM allows connection of standard serial RS232 printers, modems, etc. to your VIC-20 and C-64. A 4-pole switch allows the inversion of the 4 control lines. Complete installation and operation instructions included.

- Plugs into User Port • Provides Standard RS232 signal levels • Uses 6 signals (Transmit, Receive, Clear to Send, Request to Send, Data Terminal Ready, Data Set Ready)
JE232CM ..... \$39.95

VOICE SYNTHESIZER FOR COMMODORE VIC-20 AND C-64 Plug-In - Talking in Minutes! JE520CM ..... \$99.95

TRS-80 Accessories

MPI 5 1/4" DISK DRIVE

Use as a second disk drive • Single-sided • Single/double density • Full-height drive • AS 179 • Documentation included • Weight: 3.7 lbs
MPI51S ..... \$89.95 or 2 for \$159.95

EXPAND TRS-80 MEMORY TRS-80 MODEL III, IIII

Each kit comes complete with 1 MB (128K) EPROM (641118) 16K Dynamic RAMs and documentation for conversion. Model I 16K equipped with Expansion Interface can be expanded to 48K with 2 kits. Model III can be expanded from 16K to 48K using 2 kits. Each kit will expand computer by 16K increments.

- TRS-16K3 200ns (Model III) ..... \$6.29
TRS-16K4 250ns (Model I) ..... \$5.49

TRS-80 COLOR AND COLOR II

Easy to install kit comes complete with 8 each 4164N-20 (200ns) 64K Dynamic RAMs and documentation for conversion. Converts TRS-80 Model IV computers with D, E, F and G circuit boards to 32K. Also converts TRS-80 Color Computer II to 64K. The DOS or OS-9 required to utilize full 64K RAM on all computers.

- TRS-64K-2 ..... \$17.95

TRS-80 MODEL IV & 4P

Easy to install kit comes complete with 8 each 4164N-20 (200ns) 64K Dynamic RAMs and documentation for conversion. Converts TRS-80 Model IV computers from 16K to 64K. Also expands Model 4P from 64K to 128K.

- TRS-64K-2 ..... \$17.95

(Converts the Model IV from 16K to 64K or will expand the Model 4P from 64K to 128K)

- TRS-64K2PAL (Model IV only) ..... \$38.95

(• 4164's with PAL Chip to expand from 64K to 128K)

TRS-80 Model 100\* • NEC • Olivetti

\*ALSO COMPATIBLE WITH NEC PC-8201A AND OLIVETTI M10

Easy to install module plugs right into the socket increasing memory in 8K increments. Complete with module and documentation for conversion.

- M1008K (TRS-80 Model 100 Expansion) ..... \$49.95
NEC8KR (NEC PC-8201A & Olivetti M10) Please Specify \$49.95

PROMETHEUS MODEMS

Intelligent 300/1200 Baud Modem with Real Time Clock/Calendar

The ProModem™ is a Bell 212A (300/1200 baud) intelligent stand-alone modem • Full featured expandable modem • Standard features include Auto Answer and Auto Dial, Help Commands, Programmable Intelligent Dialing, Touch Tone™ & Pulse Dialing and More • Hayes command set compatible plus an additional extended command set • Shown w/alphanumeric display option

- PM1200 RS-232 Stand-Alone Unit ..... \$299.95

OPTIONS FOR ProModem 1200

- PM-COM (ProCom Communication Software) ..... \$79.95
Please specify Operating System
PM-OP (Options Processor) ..... \$79.95
PMO-16K (Options Processor Memory - 16K) ..... \$ 4.50
PMO-32K (Options Processor Memory - 32K) ..... \$ 9.00
PMO-64K (Options Processor Memory - 64K) ..... \$18.00
PM-ALP (Alphanumeric Display) ..... \$79.95

Incl. Options Processor: 64K Memory and Alphanumeric Display ..... \$149.95

DATA BOOKS

- 30009 Internet Data Book (1984) ..... \$9.95
Complete Line 7445 pages
30013 Zigzag Data Book (1984) ..... \$9.95
Microprocessors and Success Chips 849 pages
210830 Intel Memory Components Handbook (1983/84) ..... \$14.95
Contains all Appointments, Notes, Article Reprints, Data Sheets & other design information on Intel's RAMs, ROMs, EPROMs, PROMs, and Bubble Memories 180 pages
230843 Intel Microsystem Components Handbook (1983/84) \$19.95
Contains Data Sheets on all of Intel's microprocessors & peripherals - 2 volumes 275 & 268 pages
30022 National Logic Data Book Set (1984) ..... \$24.95
Volumes 1 & 2 (2485 pages)
Contains information on National's TTL product line and CMOS family. This includes 7400, 74LS, 6 AS, 1S and ALS Series devices, and MM54HC, 74HC, 74HCT, 74HCCT, 74HCCT High Speed Micro CMOS family, MM54HC, 74C family and CMOS 1.8V, 1.5V

Sprite-Style and Muffin-Style Fans

- MUF60 (SPNS-15-2462) Howard Industries 14 5/8" sq. 60ct/min. .... \$9.95
SU27C Reverse Flow EG&G Ronson (3.125" sq. 32ct/min.) ..... \$9.95

310 Minimum Order - U.S. Funds Only CA Residents: Add 6 1/2% Sales Tax Shipping: Add 5% plus \$1.50 Insurance Send \$1.00 for FREE 1983 Jameco Catalog Send stamped, self-addressed envelope to receive a Monthly Sales Flyer - FREE!

APPLE Accessories

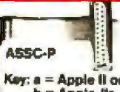

APPLE\* Compatible CARDS Key: a = Apple II or II+ b = Apple Ite

16K RAM Card (Language Card)

The ARC-16K RAM Card allows the Apple II and II+ computers to expand from 48K to 64K. Complete with instructions. Key: (a)

- ARC-16K ..... \$39.95

Z-80 CP/M Card

The AZ80-1 is soft-card computer. Used with CP/M related programs. Software not included. Key: (a,b)

- AZ80-1 ..... \$49.95

EPROM Burner Card

The AEB-2 allows user to program and work with standard EPROMs (2718, 2732 & 2764). Easy to use, on-board firmware. Menu contains the following options: Write, Read, Copy, Compare, Blank-Check and Monitor. Complete with instructions. Key: (a,b)

- AEB-2 ..... \$69.95

80-Column Card w/Soft Switch

The A80-C is an 80-column card designed for the Apple II and II+ computers. The card is equipped with a soft switch which allows easy hookup for any monitor. The A80-C also features inverse video capabilities. This card is similar to the Videx™ 80 column card. Complete with instructions. Key: (a)

- A80-C ..... \$74.95

Super Serial Card

The ASSC-P is a serial card with a printer mode. It generates standard RS-232C signals and is similar to the Apple™ Super Serial Card. Complete with instructions. Key: (a,b)

- ASSC-P ..... \$99.95

Parallel Graphics Printer Card w/64K Buffer

The APC-64K is a parallel graphics printer card with a 64K buffer and graphic dump capabilities. Complete with instructions. Key: (a,b)

- APC-64K ..... \$129.95

80-Column/64K RAM Card

Extended 80-Column/64K RAM Card expands memory by 64K to give 128K when used with programs like VisiCalc™. Complete with instructions. Key: (b)

- JE864 ..... \$79.95

\*APPLE, APPLE II, II+, III, IIII and Macintosh are registered trademarks of APPLE Computers. \*\*VisiCalc is a registered trademark of Visi Corp Inc. \*\*\*Videx is a registered trademark of Videx Inc.

APPLE™ Compatible 5 1/4" Half-Height Disk Drive



• Uses Chung Pinch-type mechanics • 143K formatted storage • 35 tracks • Soft dust • Works with Apple Controller or other Apple-compatible controllers (ACC-1) • Complete with controller - just plug into your disk controller card • 35 tracks • Size 5 1/4" x 3 1/4" x 8-9/16" H • Wt. 4 1/2 lbs Key: (a,b)

- ADD-514 (Disk Drive) ..... \$149.95

APPLE™ Compatible 5 1/4" Disk Drive & Controller Card



• Uses Shugart SA390 mechanics • 143K formatted storage • Color matches Apple Computer • Works with Apple Controller or other Apple-compatible controllers (ACC-1) • Complete with controller - just plug into your disk controller card • 35 tracks • Size 5 1/4" x 3 1/4" x 8-9/16" H • Wt. 4 1/2 lbs Key: (a,b)

- ADD-514 (Controller Card) ..... \$ 49.95

APPLE™ IIc Compatible 5 1/4" Half-Height Disk Drive

• Same specs as ADD-514 (a) except no controller necessary

- ADD-IIc ..... \$129.95

Additional Apple\* Compatible Products

- APF-1 Cooling Fan with surge protection • Key: (a,b) ..... \$ 39.95
JE614 Numeric/Aux. Keypad - 23 accessible functions • Key: (b) ..... \$ 49.85
EAEC-1 Expanded Apple Enclosure Case only • Key: (a) ..... \$ 59.95
KHP4007 Switching Power Supply • Key: (a) ..... \$ 59.85
KB-A68 68-Key Apple Keyboard only • Key: (a) ..... \$ 79.95
12" Green Monitor with swivel stand • Key: (a, b & c) ..... \$ 79.95
JES20AP Voice Synthesizer - Plug-In, User Ready • Key: (a,b) ..... \$119.95
KB-EA1 Apple Keyboard and Case • Key: (a) ..... \$134.95
PM1200A Prometheus Internal Modem - 2 cards • Key: (a,b) ..... \$299.95
PM1200M Prometheus Macintosh Ext. Modem • Key: (Macintosh) ..... \$369.95

General Application Power Supplies

Power/Mate Corp. REGULATED POWER SUPPLY

• Input: 105-125/210-250VAC @ 47-63Hz • Line regulation: -0.05% • Three mounting surfaces • Overvoltage protection • UL recognized - CSA certified

Table with 5 columns: Part No., Output, Size, Weight, Price. Rows: EMAS/68 5V@3A/6V@2.5A 4 1/4" L x 4 1/2" W x 2 1/2" H 2lbs \$29.95; EMAS/6C 5V@6A/6V@5A 5 1/4" L x 4 1/2" W x 2 1/2" H 4lbs \$39.95

KEPCO/TDK 4-OUTPUT SWITCHING POWER SUPPLY

Ideal for disk drive needs of CRT terminals, microcomputers and video games • Input: 115/230VAC, 50/60Hz • Output: +5V @ 5A, +12V @ 1.8A, +12V @ 2A, -12V @ 0.5A • UL recognized • CSA certified • Size: 7 1/2" L x 6-3/16" W x 1 1/4" H • Weight: 2 lbs

- MRM 174KF ..... \$49.95

4-CHANNEL SWITCHING POWER SUPPLY

Microprocessor, mini-computer, terminal, medical equipment and process control applications • Input: 90-130VAC, 47-440Hz • Output: +5VDC @ 5A, -5VDC @ 1A, +12VDC @ 1A, -12VDC @ 1A • Line regulation: -0.25% • Ripple: 30mV p-p • Load regulation: ±1% • Overcurrent protection • Adj: 5V main output ±10% • Size: 6 3/4" L x 1 1/2" W x 4-15/16" H • Weight: 1 1/2 lbs

- FCS-604A ..... \$69.95

7-110 Minimum Order - U.S. Funds Only CA Residents: Add 6 1/2% Sales Tax Shipping: Add 5% plus \$1.50 Insurance Send \$1.00 for FREE 1983 Jameco Catalog Send stamped, self-addressed envelope to receive a Monthly Sales Flyer - FREE!

MasterCard, Jameco ELECTRONICS, VISA logos

1355 SHOREWAY ROAD, BELMONT, CA 94002 8/85 PHONE ORDERS WELCOME - (415) 592-8097 - Telex: 178043

IBM Accessories



8-Foot Parallel Printer Cable

IBM-8PC (DB25 Male to Centronics 26-pin Male) ..... \$19.95

6-Foot Serial Printer/Modem Cable

MMS-2206 (DB25 Male to DB25 Male) ..... \$14.95

MFS-2206 (DB25 Male to DB25 Female) ..... \$15.25

5-Foot Keyboard Extension Cable for IBM-PC and XT Computers

IBM-KEC ..... \$9.95

MEMORY EXPANSION KITS

IBM PC, PC XT and Compatibles

The IBM64K kit will increase memory in 64K byte increments. The kit is simple to install - just insert the 9 - 64K RAM chips in the provided sockets and set the 2 groups of switches. Conversion documentation included

IBM64K (Nine 200ns 64K RAMs) ..... \$12.95

IBM PC AT

Each kit comes complete with nine 128K dynamic RAMs and documentation for conversion

IBM128K (Nine 250ns 128K RAMs) ..... \$133.95



IBM PCXT Equivalent 130 Watt Power Supply

UPGRADE YOUR PC • Input: 110V @ 60Hz • Output: +5VDC @ 15A, -5VDC @ 0.5A, +12VDC @ 4.2A, -12VDC @ 0.5A • Plug compatible connectors • Fits into IBM PC • Weight: 6 lbs

IBM-PS ..... \$159.95

Prometheus Modems

The ProModem 1200B/BS is a 1200/300 baud modem card which plugs into IBM PC and XT. Provides a third serial port. Two versions available: 1200B (without software) and 1200BS (with software). The PM1200BS is supplied with powerful MITE communications software from Microbit Labs.

PM1200B (without Software) ..... \$239.95

PM1200BS (with MITE Software) ..... \$274.95

IBM Compatible! DISK DRIVES



Documentation Included

• Includes Chung Pinch-type mechanics • 143K formatted storage • 35 tracks • Soft dust • Works with Apple Controller or other Apple-compatible controllers (ACC-1) • Complete with controller - just plug into your disk controller card • 35 tracks • Size 5 1/4" x 3 1/4" x 8-9/16" H • Wt. 4 1/2 lbs Key: (a,b)

• Uses Shugart SA390 mechanics • 143K formatted storage • Color matches Apple Computer • Works with Apple Controller or other Apple-compatible controllers (ACC-1) • Complete with controller - just plug into your controller • Size 5 1/4" x 3 1/4" x 8-9/16" H • Wt. 4 1/2 lbs Key: (a,b)

• Same specs as ADD-514 (a) except no controller necessary

• Includes Chung Pinch-type mechanics • 143K formatted storage • 35 tracks • Soft dust • Works with Apple Controller or other Apple-compatible controllers (ACC-1) • Complete with controller - just plug into your controller • Size 5 1/4" x 3 1/4" x 8-9/16" H • Wt. 4 1/2 lbs Key: (a,b)

• Same specs as ADD-514 (a) except no controller necessary

• Uses Chung Pinch-type mechanics • 143K formatted storage • 35 tracks • Soft dust • Works with Apple Controller or other Apple-compatible controllers (ACC-1) • Complete with controller - just plug into your controller • Size 5 1/4" x 3 1/4" x 8-9/16" H • Wt. 4 1/2 lbs Key: (a,b)

• Same specs as ADD-514 (a) except no controller necessary

• Uses Chung Pinch-type mechanics • 143K formatted storage • 35 tracks • Soft dust • Works with Apple Controller or other Apple-compatible controllers (ACC-1) • Complete with controller - just plug into your controller • Size 5 1/4" x 3 1/4" x 8-9/16" H • Wt. 4 1/2 lbs Key: (a,b)

• Same specs as ADD-514 (a) except no controller necessary

• Uses Chung Pinch-type mechanics • 143K formatted storage • 35 tracks • Soft dust • Works with Apple Controller or other Apple-compatible controllers (ACC-1) • Complete with controller - just plug into your controller • Size 5 1/4" x 3 1/4" x 8-9/16" H • Wt. 4 1/2 lbs Key: (a,b)

• Same specs as ADD-514 (a) except no controller necessary

• Uses Chung Pinch-type mechanics • 143K formatted storage • 35 tracks • Soft dust • Works with Apple Controller or other Apple-compatible controllers (ACC-1) • Complete with controller - just plug into your controller • Size 5 1/4" x 3 1/4" x 8-9/16" H • Wt. 4 1/2 lbs Key: (a,b)

• Same specs as ADD-514 (a) except no controller necessary

5 1/4" DISK DRIVE ENCLOSURES

Complete with power supply, switch, power cord, fuseholder and connectors

DDE-1FH (Houses 1 full-height 5 1/4" drive) ..... \$69.95

DDE-2HH (Houses 2 1/2-height 5 1/4" drives) ..... \$79.95

General Application Keyboards

Mitsumi 54-Key Unencoded All-Purpose Keyboard

• SPST keyswitches • 20 pin ribbon cable connection • Low profile keys • Features: cursor controls, control, caps (lock), function, enter and shift keys • Color (key-caps): grey • Weight: 1 lb • Pinout incl. • Size: 13 1/2" L x 4 1/4" W x 3 1/4" H

KB54 ..... \$14.95

74-Key ASCII Cherry Keyboard

• 7-bit parallel ASCII • Full Upper Case, Full Lower Case except l, m, n, o and p • Cursor keypad • SPST mechanical keyswitches • 26-pin header connector • Color: white • Size: 18 1/2" L x 6 1/4" W x 1 1/4" H • Spec included

KB8201 ..... (1700 available) ..... \$29.95

UV-EPROM ERASER

8 Chips - 21 Minutes

• Erases all EPROMs. Erases up to 8 chips within 21 minutes (1 chip in 15 minutes). Maintains constant exposure distance of one inch. Special conductive foam liner eliminates static build-up. Built-in safety lock to prevent UV exposure. Compact - only 9.00" L x 3.70" W x 2.60" H. Complete with holding tray for 8 chips

DE-4 UV-EPROM Eraser ..... \$74.95

UVS-11EL Replacement Bulb ..... \$16.95

1 Chip - 15 Minutes

Erases all EPROMs. Erases up to 8 chips within 21 minutes (1 chip in 15 minutes). Maintains constant exposure distance of one inch. Special conductive foam liner eliminates static build-up. Built-in safety lock to prevent UV exposure. Compact - only 9.00" L x 3.70" W x 2.60" H. Complete with holding tray for 8 chips

DE-4 UV-EPROM Eraser ..... \$74.95

UVS-11EL Replacement Bulb ..... \$16.95

## Conducted by Steve Ciarcia

### 80186 C MACHINE

Dear Steve,

I'm interested in building a 16-bit C machine based on one of the Intel 80186 chips. Does anyone offer instructions or a kit? Is a suitable C available in ROM?

JOHN A. ZOOK  
Tempe, AZ

*I haven't seen any kits for 80186-based computers, but I did locate an S-100 board. It is the Thunder 186 from Lomas Data Products (66 Hopkinton Rd., Westborough, MA 01581, (617) 366-6434).*

*There are also a couple of S-100 boards available using the 80286:*

*MI-286 S-100 board from  
Macrotech International Corp.  
9551 Irondale Ave.  
Chatsworth, CA 91311  
(818) 700-1501*

*CompuPro CPU 286/287 board from  
Viasyn  
3506 Breakwater Court  
Hayward, CA 95455  
(415) 768-0909*

*The CompuPro board is also available as part of the System 816/F computer, which runs CP/M. There are C compilers that run under CP/M-86 available from Digital Research, Microsoft, Mark Williams, and c-systems. Addresses of these companies can be found in ads in BYTE.*

*The Macrotech board runs MP/M 8/16 and other operating systems. It reportedly replaces the CompuPro 8085/88 board, so C compilers should be available from the above suppliers.—Steve*

### S-100 BOARDS FOR HORIZON

Dear Steve,

I am writing for myself and for North Star Horizon users in general. Every day I notice ads for S-100/IEEE-696 boards. Many whet my appetite, but I become discouraged when I remember that my Horizon does not follow the IEEE-696 standard.

Selling my system to buy another computer that does conform to the IEEE-696 standard seems like a waste of good money.

How different is the Horizon's bus from

the IEEE-696 standard? Is it possible to alter the bus lines to conform? Where can I get technical information for altering the bus, if it is feasible?

JEFF CHADIMA  
Austin, TX

*The Horizon remains a popular S-100 machine. North Star thought that demand would decline when the Advantage was introduced a few years ago, but such was not the case.*

*It is true that the Horizon does not completely follow the IEEE-696 standard. However, it is very close, and most S-100 boards should work in it without modification. I have used boards (some claiming IEEE-696 compatibility) from six manufacturers in the Horizon with no changes. The pin-outs used in the Horizon are detailed in the Horizon manual.*

*INSUA (International North Star User's Association, POB 2910, Fairfield, CA 94533) publishes The Compass quarterly (\$20 per year) for its members. Vol. IV.1 contains an article about various "alien" boards being used in the Horizon and notes incompatibilities, if any. They also have a former North Star technician who writes a regular column, answering questions about specific problems.*

*Although now defunct, Microsystems magazine (from Ziff-Davis) had a regular column on North Star topics. You might check your local library or computer club for back issues.—Steve*

### AN 8087 ON THE SANYO MBC 555

Dear Steve,

I recently purchased a Sanyo MBC 555 microcomputer and find it to be everything I want in a computer. The review in the August 1984 BYTE (page 270) stated that the Sanyo had a slot for (and was configured for) the 8087 mathematics coprocessor. What does the 8087 do for the computer, and is it a wise investment for a small accounting practice?

WILLIAM CORNELISON  
Ogdensburg, NY

*The 8087 coprocessor is a special-purpose computer chip designed to per-*

*form certain arithmetic operations at high speed, under the control of an 8088 or 8086 processor. Its functions, which include floating-point addition, subtraction, multiplication, and division; square root, tangent, and arctangent; and log and exponential in base 2, are coded into the chip hardware to make for very fast execution. It has no effect on the speed of disk data transfer or other I/O operations.*

*The usefulness of the 8087 for your accounting applications depends on whether you need faster computational speed from your computer and on whether the 8087 will be used by your software. Most commercial business software is not written to look for an 8087 and will ignore it if present. The computer does not automatically use the 8087; special instructions are required at the machine-language level.*

*If you have software that will use the 8087, you can gain considerable speed in computation-intensive operations. Speed gains of up to 10 times have been reported in some cases, with 2 to 3 times being more typical.—Steve*

### UNINTERRUPTIBLE POWER SUPPLY

Dear Steve,

I live on a houseboat, and it seems to me that I already have half of an uninterruptible power supply in the boat. The boat has two engines and a generator, with a battery for each. One of the batteries is oversized and powers the toilet, running lights, and so on. The other batteries are used only for starting the engine.

The boat spends almost all its time at the dock, where the marina power is none too steady. I have a Raritan Crown automatic marine converter (20 amperes) that keeps the batteries constantly charged. The converter also works at anchor with the generator running.

It seems that if I got an inverter large enough to handle my IBM PC, I'd have an uninterruptible power supply. Is this true?

STEVE BESTE  
Washington, DC

*Two types of uninterruptible or back-*  
(continued)

**NEW!**  
**Zorro AT™**



**Power, Performance, and Price  
Zorro is where it's AT**

Our new Zorro AT systems give you an 80286 CPU operating at a quick 6 Mhz., eight expansion slots, a clock/calendar with battery backup, a 1.2 Megabyte 5 1/4" floppy disk drive and IBM-AT compatibility.

Zorro AT's also come with a 360K drive for PC/XT media compatibility and 512K of RAM, features that would cost you hundreds of dollars from big blue.

Zorro AT-20's feature a 20 Mb. Winchester drive from NEC, and you still have room to add a fourth drive or tape backup.

To be quite frank, we believe our Zorro AT's are built better, and we back each system with a limited warranty for a full year. Our quality and features invite comparison, our prices speak for themselves.

Zorro AT	\$2995
Zorro AT-20	\$3995



**The Silver Fox Trots  
Through Lotus Like 1,2,3**

The Silver Fox is not IBM-PC compatible yet it runs hundreds of MS-DOS programs including Lotus 1, 2, 3, dBASE II, Multiplan, and even Flight Simulator.

The Silver Fox does not have IBM compatible expansion slots but you can economically add printers, serial ports, modems, 10-40 Mb. hard disks, clock/calendar cards, RAM, joysticks, an 8087 co-processor, and more.

What makes the Silver Fox unique, however, isn't what you can add to it, but what comes with it. Each Silver Fox comes with an 8088 CPU, 256K of RAM, four video ports, and a printer port. Plus you get more than twice the storage of a standard PC, 1.6 Megabytes on dual 5 1/4" floppies, and the Fax will read and write to standard 160K, 320K, and 360K IBM-PC formats.

Standard equipment also includes a better keyboard, a 12" high resolution monitor with a full 25x80 display, and we back each Silver Fox with a one year limited warranty.

Were this not enough each Silver Fox comes with the best free software bundle in the business including: MS-DOS 2.11/HAGEN-DOS 2.11, DOS Tutor, Wordstar 3.3, Easy Writer, Spell Mail Track, PC File III, FILEBASE, CalcStar, games, graphics, utilities, and two BASIC languages.

Because computer sales usually slow down during the summer we've given you an extra incentive to buy a Fox by lowering our prices. If you want to get the most for your computer dollar, call our machine at 1-800-FORAFox, leave your name and address or the beep, and we'll send you a Silver Fox booklet that will tell you how it can.

Silver Fox	\$1297
Color Fox	\$1497

**Altos**



High-performance, Xenix-based, multi-user systems from Altos-world leaders in multi-user systems and applications software.

As part of TRW's marketing support group we can have your Altos system installed on your site (additional charge).

Altos systems are easy to expand, and with shared printers and hard disks are cost competitive with multiple single user systems. Call for additional pricing and availability.

486-20	\$4539
586-40	\$7249
986-40	\$8829
Altos Acc't	\$2779

**The Bernoulli Box™**

- Hard disk capacity and performance
  - Removable cartridge economy
  - Cartridge convenience
  - Flexible disk economy
  - Winchester capacity
  - Unparalleled reliability
- |           |        |
|-----------|--------|
| 10 Mb     | \$1839 |
| 20 Mb     | \$2489 |
| 5 Mb./Mac | \$1379 |

**Fox Jr.**

8088•Dual 360K Drives  
128K•Keyboard•Software  
**\$899**

**PRINTERS**

**Columbia 4220 or 2220 \$1698**

**OLYMPIA**



Star 5G-10	\$234
Star 5R-15	\$599
EpsonFX-80+	<del>\$299</del> \$141 off
LX-80	<del>\$399</del> \$60 off
Okidata 182	<del>\$299</del> \$74 off
Okidata 192	<del>\$399</del> \$125 off
Olympia NP	\$329
Panasonic 1091	\$269
Citizen MSP-10	\$295
Toshiba 1340	\$579
Toshiba 351	\$1198

**LETTER QUALITY**

Juki 6100	\$399
Juki 6300	\$719
Silver Reed 500	\$299
Silver Reed 550	\$409
Silver Reed 770	\$724
Diablo	Call
NEC	Call
Daisywriter 2000	\$824

**HOUSTON INSTRUMENTS**

DMP-29	\$1795
DMP-40	\$745
DMP-41	\$2340
other models	Call

**Scottsdale Systems Ltd.**  
617 N. Scottsdale Road, Suite B, Scottsdale, Arizona 85257

(602) 941-5856

Call 8-5 Mon.-Fri.

We participate in arbitration for business and customers through the Better Business Bureau of Maricopa County.

**SINCE 1980**

**TELEMARKETING ONLY:** If you plan to stop by please phone ahead. Prices listed are for cash. P.O.'s from Fortune 1200 companies and universities with good credit add 2% / Mastercard and Visa add 3% / Arizona residents add 6% sales tax / Shipping extra / All items are new with manufacturers warranty / Returned merchandise subject to 20% restocking fee / Personal or company checks take up to 3 weeks to clear / No COD's or APO's. Prices and specifications subject to change / Product subject to availability. Trademarks: Silver Fox, HAGEN-DOS, and Zorro AT, Scottsdale Systems, Ltd.; Wordstar and CalcStar, Micropro International; MS-DOS, and Multiplan, Microsoft Corporation; FILEBASE EWDP Software, Inc.; dBASE II, Ashton-Tate; IBM-PC, IBM-PC DOS, and IBM-AT, International Business Machines.

**TERMINALS**

Qume		
VT101	\$298	
Wyse 50	\$449	

**1200 BPS Modems**

Volkmodem 12	\$199
Password	Call
Prometheus	\$315
Hoyes 300/1200	\$369



**IS IT SICK TO  
LOVE A PRINTER?**

If you love your Okidata 92 or Epson FX80 don't read any further because the new Olympia NP is rated as faster, is noticeably quieter and has a near letter quality mode that is much superior to anything in its price class.

Plus, unlike the Okidata or the Epson the Olympia comes with adjustable tractor feed (as well as friction feed) as standard equipment. The tractor feed is the "punch-type" and the NP has a rear bar so that it works great with continuous forms.

The NP uses standard Epson type ribbons, comes with the quality that has made Olympia world leader in type-writers and is backed by nationwide service.

To quote PC magazine: "The (NP) printer is a sure thing if it falls into your price range and even if it doesn't it may be worth considering..."

If you're considering the purchase of an Okidata, an Epson, or even a Toshiba, give us a call and let us send you an actual print sample from the Olympia NP and additional information.

Because if you were to buy an Epson FX-80 or an Okidata 92 with tractor and a cable for the lowest advertised prices you would pay about \$50 more for an inferior printer. Scottsdale Systems sells the Olympia NP with a 10' shielded cable for a mere:

**\$344**

# GOLDEN

COMPUTERS • VIDEO • ELECTRONICS • PHOTOGRAPHY  
FOR INFO CALL  
**(212) 725-1234 (800) 221-3160**

### IBM PC & COMPAT.

IBM PC w/256K (2) 360 drives, keyboard, monitor & monitor card.....1949

IBM PC w/1 (1) 360k floppy & 20Mb disc drive.....2495

IBM PC as above w/RGB color monitor.....Call

IBM PC XT w/256K.....Call

IBM AT Enhanced.....Call

COMPAQ PORTABLE w/256K (2) 360 disc drives, DOS & basic.....1975

COMPAQ PLUS.....3295

COMPAQ Desk Pro II.....2599

COMPAQ Desk Pro III.....3795

COMPAQ Desk Pro IV.....4895

LEADING EDGE PC w/128k (2) 360 disc drives, monitor & adapter, basic DOS 2.11.....1499

LEADING EDGE PC w/256k as above but RGB color.....1899

LEADING EDGE 10Mb hard disc system.....2395

SANYO MBC 550 2.....879

SANYO MBC 555 2.....879

SANYO 7150 w/2 (2) 360k disc drives, 128k RAM, IBM compatible, w/free Microsoft Word & free Microsoft Multiplan & Color graphics card.....1999

ZENITH ZV 151 52 as above but w/color monitor & 10Mb hard disc system.....3495

ZENITH 3 COM Local Area Network.....From 1749

### LAP COMPUTERS

MORROW w/2 (2) 360k disc drives, 130k 256k IBM compatible.....1995

### PRINTERS & PLOTTERS

EPSON: RX 80.....229 LO 1500.....1069

JUNI: 132.....349 6000.....218

6100.....374 6300.....179

HP: Laser Printer.....2795

Sweet Print Plotter.....Call

NEC 3550.....1099

OKIDATA: 862.....879

193.....569 2410.....249

OLYMPIA: RO.....319

SILVER REED: 400.....249 500.....289

450.....449 770.....769

TOSHIBA: 1340.....575 351.....1195

### MONITORS

AMDEK 310A.....179

LEADING EDGE RGB Color.....399

FTL Green 130 TTL Amber 149

PRINCETON GRAPHICS: HX 12.....469 Max 12 E.....174

SR 12 w/Scan Double.....899

TAXAN 410 IBM RGB.....299

TAXAN 420 14 Res RGB IBM414

XTRON 1000 Lines Hi Res Amber IBM TTL.....149

ZENITH: ZVM 124 IBM Compatible.....139

### MODEMS

HAYES: 300.....199 1200.....389

1200B w/Smartcom II.....359

SMARTCOM II.....99

2400.....Call

Micro Modem II.....249

US ROBOTICS: Password 1200.....299

### DISKETTES

Verbatim Data Life 10021 05:00.....27

FLUJ (10).....13 17

MAXELLI (10).....18 20

BASF (10).....17 23

IBM (10).....22 27

FAMOUS MAKE.....13 18

SPECIALS TDK

Quantities of 100ea 1.35 ea 1.55

### TYPEWRITERS

CANDID Typewriter 5.....148

CANDID Typewriter 6.....196

BROTHER CE 58.....454

EMETH GORDON A 350M.....311

See Manufacturer's Dealer

### CANON COPIERS

PC 17.....449 PC 20.....645

PC 25.....884 Stand.....99

### BOARDS FOR IBM

AST & Pak Plus w/64k.....244

MERCURUS color card.....189

MERCURUS graphic card for TTL mono monitor.....289

PARADISE MODULAR Graphics Card.....269

ORCHID Turbo 105.....645

### HARD DISKS

Tall Green Call Ampex.....Call

Barnesull Box 20Mb.....249

Mini Scribe Internal 10Mb.....349

### SOFTWARE

Nutshell.....89 dBase III.....349

PFS FIG.....84 RBase 4000.....258

Wordstar Professional.....249

Wordstar 2000.....249

X Y Write Plus II.....229

Word Perfect 4.0.....229

Writers Deluxe w/AT.....189

Samra Plus.....349

Samra II.....299

Multimate.....244

Leading Edge Word w/Spell.....189

Smart System.....Call

Framework 348 Enable.....63

Sedwick.....29 Norton 3.0.....63

Managing Your Money.....99

Dollar & Sense.....189

Think Tank.....99

Pro Key ver 2.0.....99

Flight Simulator.....99

Sargon III.....34 PFS Write.....89

Multiplan.....124 Run "C".....79

Microsoft "C".....79

### IBM PC

w/64k (1) 360 Disc Drive & Keyboard.....1499

IBM PC w/256k (2) 360 Disc Drives, Graphics Monitor Card, Mon, Keyboard & Software Kit.....Call

IBM PC AT.....Call

### LEADING EDGE PC

w/128k, Leading Edge Monitor, Keyboard, Monitor & Printer Adapter.....1399

### ZENITH Z 150

w/2 (2) 360k Drives, Microsoft Word, Multiplan, Keyboard, 15 above 68000, w/10Mb Hard Disk and (1) 360k Floppy.....2395

### SANYO 650-2

New Runs Lotus 123 IBM PC Compatible, 360k Disc Drive, 128k RAM, Home Star Calc Star & Easy Writer RGB VIDEO CARD.....699

### OLYMPIA RO

Daisy Wheel Letter Quality, 14 Cps w/Parallel & Serial Ports w/Built in Tractor Feed, 3 Pitch ONLY.....299

### COMPAQ

Portable w/2 (2) 360k Disc Drives, DOS & Basic Keyboard.....1975

COMPAQ Plus With Hard Disc.....3295

1265 Broadway at 32nd Street New York 10001

up power supplies are commonly available. One type is inactive until a power failure occurs. It senses the power loss and switches in to power your system. The switch takes a few milliseconds and usually doesn't appear as an interruption to the computer.

The other type supplies power to the computer at all times and might be more suitable for your situation. This type effectively runs your computer off its internal batteries at all times and provides excellent isolation from power-line transients. Both types maintain fully charged batteries by taking power from the line as needed. Some make provisions for external batteries, as you require for extended operation.

Some vendors of on-line uninterruptible power supplies are

**Electronic Protection Devices**  
41 Montvale  
Stoneham, MA 02180  
(617) 890-2518

**General Power Systems**  
1400 North Baxter St.  
Anaheim, CA 92806  
(714) 956-9521

**Jefferson Electric**  
840 25th Ave.  
Bellewood, IL 60104  
(312) 544-2200

**RTE Deltec**  
2727 Kurtz St.  
San Diego, CA 92110  
(619) 291-4211

—Steve

### IBM PC RS-232C

Dear Steve,

Before I purchased my IBM PC, I owned a Qume Sprint 5 printer. By trial and error, I created a usable but not fully satisfactory cable to connect this serial printer to the IBM serial board. Apart from identifying pin usage and furnishing general suggestions, neither IBM nor Qume can help me. I am using an intelligent interface, but I would prefer to have a real cable. Is there a source that specifies proper computer-to-printer interfaces?

FREDERICK ORKIN  
Philadelphia, PA

Your problem is not uncommon. Despite the reputation that RS-232C has as a standard, it really hasn't helped end the confusion about printer interfacing.

There are a few solutions, however. IQ Technologies (11811 Northeast First St.,

Bellevue, WA 98005, (206) 451-0232) sells a smart cable that lets you hook up RS-232C devices to your machine without worrying about what signal is on what pin. LEDs on the device indicate which direction two switches on the cable must be set to ensure proper handshaking. The price is \$89.

Another possibility is to use a breakout box (available from many manufacturers, priced from about \$40 to \$80). This device slips between your computer and printer. It has LEDs that monitor the status of the various RS-232C lines so that you can actually "see" which lines are active. Some models provide jumpers so you can experiment with different connections until you determine the correct configuration.

For a complete description of the operation of breakout boxes and a circuit for the construction of one, see my article on page 28 of the April 1983 BYTE, "Build an RS-232C Breakout Box."—Steve

### CHAINING BASIC PROGRAMS

Dear Steve,

Frequently, I use the CHAIN command in BASIC to chain two smaller programs together. How can I chain two already-compiled BASIC programs?

If I write two BASIC programs, what statements do I need to include, before compiling, to make one of the programs act as a subroutine of the other?

Is it possible to call a compiled BASIC program as a subroutine from a noncompiled BASIC program?

SEN CAN  
St. Louis, MO

Two previously compiled BASIC programs cannot be chained without recompiling the source code and including the appropriate statements. An accomplished assembly-language programmer with a good debugging program could probably identify the "return to operating system" call in the first program. The programmer could then patch in a machine-language routine to chain to the second program, but it would be impossible to pass variables between the two programs.

Microsoft BASIC does not allow you to make a compiled BASIC program act as a subroutine to another program. However, a new product called BetterBASIC (Summit Software Technology, Box 99, Babson Park, Wellesley, MA 02157, (617) 235-0729) allows something similar. Read "IBM Images" in the December 1984

(continued)

# Circuit-Board-Artwork Software for the Design Engineer in a Hurry

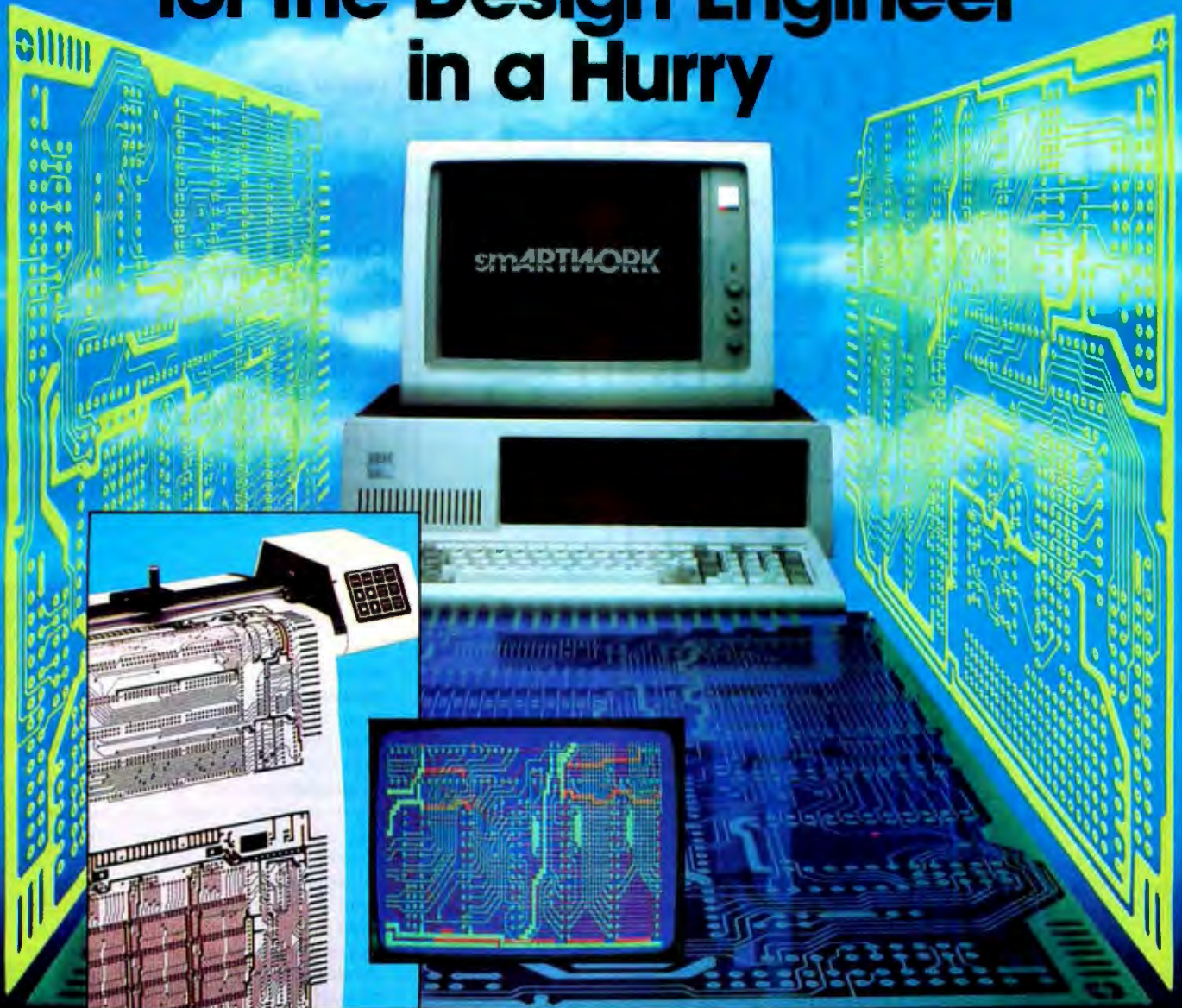

For only \$895, smARTWORK® lets the design engineer create and revise printed-circuit-board artwork on the IBM Personal Computer. You keep complete control over your circuit-board artwork — from start to finish.

Forget the tedium of taping it yourself or waiting for a technician, draftsman, or the CAD department to get to your project.

smARTWORK® is the only low-cost printed-circuit-board artwork editor with all these advantages:

- Complete interactive control over placement and routing
- Quick correction and revision
- Production-quality 2X artwork from a pen-and-ink plotter
- Prototype-quality 2X artwork from a dot-matrix printer

- Easy to learn and operate, yet capable of sophisticated layouts
- Single-sided and double-sided printed circuit boards up to 10 x 16 inches
- Multicolor or black-and-white display

#### System Requirements:

- IBM Personal Computer, XT, or AT with 256K RAM, 2 disk drives, and DOS Version 2.0 or later
- IBM Color/Graphics Adapter with RGB color or black-and-white monitor
- IBM Graphics Printer or Epson FX/MX/RX series dot-matrix printer
- Houston Instrument DMP-41 pen-and-ink plotter
- Optional Microsoft Mouse

#### The Smart Buy

At \$895, smARTWORK® is proven, convenient, fast, and a sound value. Call us today. And put it to work for yourself next week.

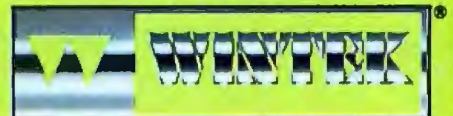

Wintek Corporation  
1801 South Street  
Lafayette, IN 47904-2993  
Telephone: (317) 742-8428  
Telex: 70-9079 WINTEK CORP UD

Inquiry 339

In Europe contact: RIVA Terminals Limited,  
Woking, Surrey GU21 5JY ENGLAND,  
Telephone: 04862-71001, Telex: 859502

"smARTWORK," "Wintek" and the Wintek logo are registered trademarks of Wintek Corporation.

# How to go from UNIX to DOS without compromising your standards.

It's easy. Just get an industry standard file access method that works on both.

C-ISAM™ from RDS.

It's been the UNIX™ standard for years (used in more UNIX languages and programs than any other access method), and it's fast becoming the standard for DOS. Why?

Because of the way it works. Its B+ Tree indexing structure offers unlimited indexes. There's also automatic or manual record locking and optional transaction audit trails. Plus index compression to save disk space and cut access times.

How can we be so sure C-ISAM works so well?

We use it ourselves. It's a part of INFORMIX®, INFORMIX-SQL and File-it!™, our best selling database management programs.

For an information packet, call (415) 424-1300. Or write RDS, 2471 East Bayshore Road, Palo Alto, CA 94303.

You'll see why anything less than C-ISAM is just a compromise.



**RELATIONAL DATABASE SYSTEMS, INC.**

© 1985, Relational Database Systems, Inc. UNIX is a trademark of AT&T Bell Laboratories. INFORMIX is a registered trademark and RDS, C-ISAM and File-it! are trademarks of Relational Database Systems, Inc.

## ASK BYTE

*issue of Creative Computing for more details.*

*It is not possible to call a compiled BASIC program as a subroutine from a noncompiled BASIC program.—Steve*

### CHAMELEON PLUS POWER SUPPLY

Dear Steve,

In his review of the Chameleon Plus (June 1984, page 327), Rich Krajewski stated that the Chameleon has a switching power supply and that it could be switched only by a dealer. Is there any way to switch it myself?

Also, do the Chameleon Plus, Compaq, and the Panasonic Sr. Partner run Microsoft's Flight Simulator?

DAVID TAY  
McLean, VA

*When you speak of "switching" the power supply in the Chameleon Plus, I assume you are referring to the review article's mention of being able to switch between 110 V and 220 V. Although I have not seen the power supply in the Chameleon myself, most power supplies of this type do have a simple switch, appropriately marked, for changing between the two voltages. I am assuming that this switch is located within the power-supply box in the Chameleon. If you are the experimenting type, you can remove the power supply from the Chameleon, take the cover off of the supply, and look for a switch marked something like "110-120 V, 50-60 cycle" on one side and "220-240 V, 50-60 cycle" on the other. If you do not find such a switch, do take it to your dealer.*

*I have personally tested Flight Simulator on the Chameleon and it does not work. Published reports state that it does work on both the Compaq and the Sr. Partner.—Steve*

### ATARI NUMBER CRUNCHING

Dear Steve,

I have been doing a certain amount of scientific computing on the 6502-based Atari 400 and 800XL computers. The main advantage of these machines is that interactive graphics is easy and nice, but there is a problem with speed as the BASIC and the floating-point hardware are pretty slow. Accessing the floating-point routines with machine language seems to speed things up by only about 40 percent.

*(continued)*



# FORTRAN, C, and BASIC Programmers...

## Programming just got easier with Scientific Subroutine Libraries from Wiley Professional Software.

You need to quickly generate dependable, accurate and error-free code. Whatever language you use, Wiley Professional Software has a powerful Scientific Subroutine Library that can save you considerable programming time and development money.

Each library consists of more than 100 pretested and precompiled mathematical and statistical subroutines, supplied on disk as a linkable library and as source code. Each package includes 400-plus pages of documentation, providing you with extensive reference material, a listing of the subroutine's source code, complete test programs and the results of running each test. The Subroutines cover formulas for:

- ◆ General statistics
- ◆ Probability
- ◆ Analysis of variance
- ◆ Regressions
- ◆ Matrices
- ◆ Interpolations
- ◆ Fourier analysis
- ◆ Cross tabulations
- ◆ Differential equations
- ◆ Roots of biquadratic equations
- ◆ Function evaluations
- ◆ Systems of equations
- ◆ Solution of equations
- ◆ Times series analysis
- ◆ and more

### Just out, Professional FORTRAN! Coming Soon, MORE FORTRAN!

And now all the subroutines are available to those of you programming in Professional FORTRAN. All that's required is IBM Professional FORTRAN or Ryan McFarland FORTRAN.

On the way is MORE FORTRAN, which includes subroutines covering such areas as:

Analytical Geometry ◆ Vector Algebra ◆ Utility (including complex matrix manipulation) ◆ Numerical Analysis (including fast Fourier transforms, and solution to systems of non-linear equations) ◆ Assembler Service Routines—FORTRAN CALLS

LIBRARY	PRICE	REQUIREMENTS
FORTRAN Library	\$175	Microsoft FORTRAN ver. 3.13 or later, or IBM 2.0
C Language Library	\$175	Lattice C Compiler ver. 2.12 or later
BASICA Library	\$125	BASICA
Professional FORTRAN Library	\$175	IBM Professional FORTRAN: Ryan McFarland FORTRAN
MORE FORTRAN Library	Call for Price	Microsoft FORTRAN ver. 3.2 or later: IBM Professional FORTRAN: PC DOS 2.0 or better

Developed by Peerless Engineering Service

To order, or for free literature, call: 212-850-6788

Or write: Wiley Professional Software  
John Wiley & Sons, Inc.  
Leslie Bixel, Dept. B8  
605 Third Avenue, New York, NY 10158



Dealer Inquiries Invited.  
Educational site licenses available.

**wiley**<sup>TM</sup>  
PROFESSIONAL  
SOFTWARE  
THE TECHNICAL SOFTWARE SOURCE

# \$29<sup>95</sup> SOFTWARE!

## POWERFUL NEVADA™ SOFTWARE FOR CPM™-80

### NEVADA COBOL™

**NEW** Rev. 3.0. Based on ANSI-74 standards with powerful level 2 features, including compound conditionals & full CALL CANCEL. A classroom favorite. Requires 32K RAM. Package includes diskette, 165-page manual, many examples & 16 complete COBOL source code programs. ~~\$29.95~~.  
COBOL Application Package, Book 1: \$9.95.

### NEVADA FORTRAN™

Based on ANSI-66 standards (FORTRAN IV) with some 1977 level features. Advanced features include: IF..THEN...ELSE statement; COPY (Include); CHAINing with COMMON; TRACE debugging. Requires 48K RAM. Package includes diskette, 214-page manual, 5 sample programs & an 8080 assembler. ~~\$29.95~~.

### NEVADA EDIT™

A full-screen, video-display text editor designed specifically for computer program text preparation. Completely user-changable, it can be configured to almost any terminal & takes only 12K disk space. Requires 32K RAM. Package includes diskette & 59-page manual. ~~\$29.95~~.

NEVADA PASCAL™ ~~\$29.95~~ NOW \$19.95!  
Diskette & 184-page manual. Requires 64K RAM & 2 disk drives with at least 90K storage.

NEVADA BASIC™ \$29.95  
Diskette & 220-page manual. Requires 48K RAM.

NEVADA PILOT™ \$29.95  
Diskette & 131-page manual with 10 sample programs. Requires 32K RAM.

BIGPRINT™ DISKETTE \$19.95  
Great for making signs. Requires 132-print position printer.

## POWERFUL UTAH™ SOFTWARE FOR PC-DOS/MS™-DOS

### UTAH PASCAL™

Has many advanced features including: 14 digit precision, BCD math (no round-off errors), floating point + 63 - 64, TRACE debugging, Arrays up to 8 dimensions, 64 strings, External procedures & Dynamic Module loading. Requires 128K RAM. Package includes diskette & 134-page manual. ~~\$29.95~~.  
NOW \$19.95!

### UTAH BASIC™

Has advanced BASIC features such as full matrix operations, Single- & Multi-Line functions, BCD math (no round-off errors). And Utah BASIC has a built-in, full-screen text editor that makes programming a real pleasure. Requires 128K RAM. Package includes diskette & 220-page manual. ~~\$29.95~~.

### UTAH PILOT™

Written by Prof. J. Starkweather, the language's creator, Utah PILOT exceeds all PILOT-73 standards. And it has an integrated full-screen text editor for easy program development. Ideal for classroom instruction, business training & home study. Requires 128K RAM. Package includes diskette, 125-page manual & 10 sample programs. ~~\$29.95~~.

UTAH EDIT™ \$29.95  
Diskette & 55-page manual. Requires 128K RAM.

BIGPRINT™ DISKETTE \$19.95  
Great for making signs. Requires 132-print position printer.

UTAH software requires 128K RAM (i.e., 90K user RAM) an IBM-PC, XT, AT, PCjr, or compatible (16-bit) micro with MS-DOS or PC-DOS Operating System, Rev. 2.0 or higher.

NEVADA Software requires 32K RAM (unless otherwise indicated above), a CPM Operating System & an 8080, 8085, or Z-80 (8-bit) processor.

**SATISFACTION GUARANTEED!** If for any reason you're not completely satisfied, just return the Nevada or Utah package within 15 days—in good condition, with the sealed diskette unopened—and we'll refund your money! There's absolutely no risk to you, so why wait?—order today! We welcome C.O.D.s and (PLEASE NOTE: In-store prices are \$39.95. Prices shown here are valid only by mail order with this coupon; offer expires Aug. 31, 1984.)



**NEVADA** Please send me these NEVADA Software packages:

COBOL  FORTRAN  EDIT  PASCAL  BASIC  PILOT  BIGPRINT  
(Extra manuals—\$14.95 each; diskettes alone—\$19.95 each. Specify number & formats of manuals and/or diskettes required.)

Please specify the diskette format you want:

8" SSSD (Standard CP/M IBM 3740)  
 5 1/4" Diskette for:  Access/Actrix;  Apple CPM;  DEC VT 180, or  
 Rainbow;  Epson QX-10;  Heath Hard Sector (Z-89), or  Soft Sector (Z-90, Z-100);  IBM-PC (requires Z-80, Baby Blue II Card);  Kaypro DD (NCR);  
 Micropolis Mod II;  NEC PC 8001;  North Star DD;  Osborne SD;  
 Sanyo 1000, 1050;  Superbrain DD 3.X;  Televideo;  Xerox 820 SD.)

**UTAH** Please send me these UTAH Software packages (IBM-PC diskette):

PASCAL  BASIC  PILOT  EDIT  BIGPRINT  
(Extra manuals—\$14.95 each; diskettes alone—\$19.95 each. Specify number & formats of manuals and/or diskettes required.)

Send me \_\_\_\_\_ software packages: TOTAL \_\_\_\_\_

Other: extra manuals, extra diskettes,  
Nevada COBOL application Book 1, BIGPRINT: TOTAL \_\_\_\_\_

California residents add sales tax (6% or 6 1/2%) \_\_\_\_\_

Handling/shipping: add \$5 for first package or manual, \$2 each additional. OVERSEAS: add \$15 for first package or manual, \$5 each additional. \_\_\_\_\_

Check  MasterCard  VISA \_\_\_\_\_

Checks must be in U.S. Dollars, drawn on a U.S. bank  
 C.O.D. (add \$4) \_\_\_\_\_

Enclosed: TOTAL \_\_\_\_\_

CARD # \_\_\_\_\_ Exp. \_\_\_\_\_

SIGNATURE \_\_\_\_\_

SHIP TO NAME \_\_\_\_\_

STREET \_\_\_\_\_

CITY/STATE/ZIP \_\_\_\_\_



Send your order to:

**ELLIS COMPUTING, INC.**  
3917 Noriega Street, San Francisco, CA 94122

Phone (415) 753-0186

SINCE 1977

CP/M is a Digital Research TM. MS is a Microsoft Corp TM. Apple II is an Apple Computer, Inc TM. Osborne is an Osborne Computer Corp TM. Xerox 820 is a Xerox Corp TM. Kaypro is a Non-linear Sys TM. Heath/Zenith is a Heath Corp TM. IBM is an International Business Machines, Corp TM. Nevada BASIC, Nevada COBOL, Nevada FORTRAN, Nevada PILOT, Nevada PASCAL, Nevada EDIT, Utah BASIC, Utah PASCAL, Utah PILOT, Utah EDIT, BIGPRINT & Ellis Computing, Inc are Ellis Computing TMs. © 1985 Ellis Computing, Inc.



Se habla Español

Call for programs not listed

Technical & Other Information (602) 246-2222  
TOLL FREE ORDER LINE 1-(800)-421-3135

at most, and is clumsy.

Is it possible to speed things up by replacing the 6502 chip with the new 65816 in the Ataris, or would something much more extensive be necessary?

Also, I remember seeing an ad for the Fastchip, a faster replacement of the floating-point hardware chip for the Atari. That was a year or so ago. Are they still available, and do you know where I might get a couple?

JOHN COCKE  
Tucson, AZ

*Replacing your 6502 with a faster chip is possible, but several hardware and firmware changes are required that make it uneconomical.*

*A less expensive approach is to use the Fastchip. This chip will speed up applications involving floating-point calculations by as much as four times, according to the manufacturer. A review of the Fastchip appeared in the September 1982 issue of Compute! magazine. The Fastchip is available from Newell Industries, 3340 Nottingham Lane, Plano, TX 75074.*  
—Steve ■

*Between Circuit Cellar Feedback, personal questions, and Ask BYTE, I receive hundreds of letters each month. As you might have noticed, at the end of Ask BYTE I have listed my own paid staff. We answer many more letters than you see published, and it often takes a lot of research.*

*If you would like to share the knowledge you have on microcomputer hardware with other BYTE readers, joining the Circuit Cellar/Ask BYTE staff would give you the opportunity. We're looking for additional researchers to answer letters and gather Circuit Cellar project material.*

*If you're interested, let us hear from you. Send a short letter describing your areas of interest and qualifications to Steve Ciarcia, POB 582, Glastonbury, CT 06033.*

IN ASK BYTE, Steve Ciarcia answers questions on any area of microcomputing. The most representative questions received each month will be answered and published. Do you have a nagging problem? Send your inquiry to

Ask BYTE  
c/o Steve Ciarcia  
POB 582  
Glastonbury, CT 06033

*Due to the high volume of inquiries, personal replies cannot be given. All letters and photographs become the property of Steve Ciarcia and cannot be returned. Be sure to include "Ask BYTE" in the address.*

*The Ask BYTE staff includes manager Harv Weiner and researchers Bill Curlew, Larry Bregoli, Dick Sawyer, Robert Stek, and Jeannette Dojan.*

**SOFTWARE SPECIALS**

Authorized Sperry Dealer

Word Perfect .....	\$199	Supercalc III Ver. 2 ...	\$159	Crosstalk .....	\$95
Multimate .....	\$225	Nutshell .....	\$55	We stock over 300 IBM software programs—call for pricing	
Knowledgeman .....	\$225	R Base 5000 .....	\$369		

**FREE! PRINTER SET SOFTWARE**

Purchase an Okidata, Epson, Gemini or Toshiba printer and receive at no charge a menu driven program to set print characteristics or to make your computer function as a correcting typewriter. Retail value \$35. Available for most disk formats.

--- PRINTERS ---

<b>CITIZEN</b>	
MSP-10 .....	\$299
MSP-15 .....	Call
MSP-20 .....	425
<b>C-ITOH</b>	
F-10-55 .....	1030
8510 Parallel (Pro-writer) .....	295
8510SEP .....	399
<b>DAISYWRITER 2000</b> .....	795
<b>EPSON</b> - Call on all models	

<b>JUKI</b>	
Juki 6100 .....	385
Juki 6300 .....	685
Juki Tractors .....	129

<b>NEC</b>	
3550 .....	1009
8850 .....	1349
P2 Parallel .....	525
P3 Parallel .....	725
<b>OKIDATA</b> - Call on all models	

<b>PANASONIC</b>	
1091 .....	258
1092 .....	Call
1093 .....	515
KXP3151 .....	455

<b>SILVER REED</b>	
EXP 400P .....	235
EXP 500P .....	289
EXP 550P .....	399
EXP 770P .....	699

<b>STAR MICRONICS</b>	
SG-10 .....	235
SG-15 .....	369

Call for prices on other models	
<b>TOSHIBA</b>	
1340 .....	549
P351 .....	1164

<b>AB PRINT SWITCH</b> .....	75
------------------------------	----

--- COMPUTERS ---

<b>IBM PC</b> .....	Call
Sperry PC Mono .....	1650

--- MOUSE SYSTEMS ---

PC Mouse w/Paintbrush .....	135
-----------------------------	-----

--- TERMINALS ---

Qume QVT-102 Green .....	\$448
WYSE 50 .....	450

--- MICROSOFT ---

Bus. Mouse .....	120
Serial Mouse .....	129

--- MODEMS ---

Hayes 1200 .....	389
Hayes 1200B .....	359
Hayes 2400 .....	595
Anchor Mark XII .....	239
Anchor Express .....	274
Promodem 1200B .....	265
Promodem 1200 .....	305

--- RAM ---

64K 150NS Chips (set of 9) .....	9.50
256K Ram Chips (set of 9) .....	35

--- BOARDS ---

AST Six Pack Plus W/384K .....	295
AST Advantage .....	395
Hercules Color Card .....	149
Hercules Graphics Board .....	295
Paradise Graphics Board .....	259
Paradise Five Pak w/64K .....	175
Quadram Board .....	199
Quadcolor I .....	179
Sigma Maximizer W/64K .....	189
512K Expansion Board W/128K .....	145
STB Graphics Chauffeur Board .....	255
STB Mono Board .....	155
TEC Mar Graphics Master .....	465

--- DISK DRIVES ---

Iomega Bernoulli 20 mg .....	2450
Iomega Bernoulli Plus 20 mg .....	2625
10 mg External Hard Drive .....	825
33 mg External Hard Drive .....	1625
Teac 1/2 Ht. Drives .....	99
Turbo 10 Internal Drive .....	625
Turbo 20 Internal Drive .....	1010

--- MONITORS ---

<b>AMDEK</b> .....	Call for price
Princeton HX-12 .....	449
Princeton Max 12E .....	179
Taxan 425 .....	399
Taxan 121 Green .....	125
Taxan 122 Amber .....	134

--- CP/M SOFTWARE ---

Call us for pricing on CP/M Software! Programs like Multiplan, Wordstar Propack, Fortran, Move-It, Crosstalk and more!

**TERMS:** Prices include 3% cash discount. Add 3% for charge orders. Shipping on most items \$5.00. AZ orders +6% Sales Tax. Personal check, allow ten (10) days to clear. Prices subject to change.

TOLL-FREE ORDER LINE 1-800-421-3135

**WAREHOUSE DATA PRODUCTS**

2701 West Glendale Ave., Suite 6  
Phoenix, AZ 85021



# My, how printers

**MOST EPSON PRINTERS HAVE BEEN RUNNING LONGER THAN MOST PRINTER COMPANIES.**



In this age of rampant office automation, Epson® printers seem to be one of the few things that never break down. This reliable, worry-free performance has been

characteristic of Epson ever since we developed the first low-cost printer 20 years ago. No other printer or printer company comes close to such proven, long-term reliability.

Which is why most of our printers have been operating longer than most printer companies. And will probably continue working after many of them have stopped.

The most forgettable printer you ever bought.

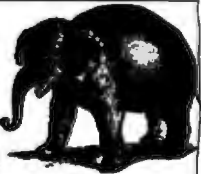

The main reason corporate MIS departments think so much of Epson printers is that once they're bought, they rarely have to give them another thought. With an estimated 5 million lines between failures. And 100 million characters between new print heads.

They're easy to use, many with simple push-button typestyle controls, so you won't be hearing those complaints or frantic calls for help.

The ribbon cartridge is very easy to put in and take out. No muss. No engineering degree required.

And Epson printers are famous for being able to take those odd little bumps and crashing falls that render other equipment useless.

As for our full year warranty, well it's reassuring to have. But nobody seems to need it.

## FULL COMPATIBILITY WITH MANAGEMENT INTERESTS.

Not all printers work with all computers. Or all software.

This incompatibility can be avoided if you're just matching one printer to one computer. But it can cause real problems if you ever want the flexibility to hook that printer up to a different computer.



Since Epson is the world standard for printers, virtually all major hardware and software is designed to work with our printers. From IBM® to the newest name on the market—which means you can be sure you'll be able to put your Epson printer to use where you need it, when you need it.

## NO MORE MANUAL LABOR

For most people, reading a printer manual is like hard labor. But it's important if you want to get the most out of your printer. We've been working to make our manuals as user friendly as our printers.

# Epson do go on...

**&**  
for  
**SPEED**  
readers



If it's characters per second you're looking for, one of these five Epson printers is probably just your speed.

The FX series dot matrix printers. 160 cps draft. 32 cps Near Letter Quality.

The LQ-1500 dot matrix printer. 200 cps draft. 67 cps Letter Quality.

The SQ-2000 ink jet printer. 176 cps draft. 106 cps Letter Quality.

The JX-80 color printer. 160 cps draft. 32 cps Near Letter Quality (optional).

The HS-80 portable ink jet printer. 160 cps unidirectional draft. 32 cps Near Letter Quality.

Just  
A  
Sample  
Of The  
Variety Of  
Type  
Available  
From our  
**LQ-1500**  
Printer

## HARD COPY DECISIONS MADE EASY

Epson's on-going line of dot matrix, daisywheel, ink jet, and thermal transfer printers and plotters sets the standard for the entire industry. The more you know about them, the easier your printer decision will be.

**The New Standard.** The Epson FX series have set new standards as the workhorses of the industry. With print speeds of 160 characters per second in draft

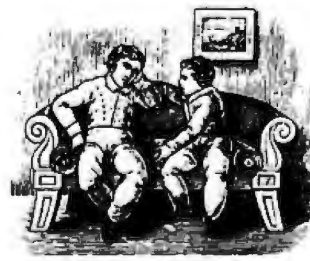

"So the question is:  
Which Epson?"

mode, easy access to Near Letter Quality, a 20% increase in throughput, and excellent graphics, they're the number one selling printers from the number one printer company. For spreadsheets and financial reports, there's a wide carriage model.

**The Complete Printer.** For speed, versatility and quality, there's nothing like the LQ-1500. Featuring a 24 pin printhead, its type rivals an office typewriter, at four times the speed of

the average daisywheel. In draft mode, the LQ-1500 flies at 200 cps. And its graphics are among the highest resolution of all dot matrix printers.

**The Strong Silent Type.** The Epson performance alternative for sound-sensitive work environments is the quiet new SQ-2000 ink jet printer. This state-of-the-art printer uses 24 ink jet nozzles to produce letter quality print on virtually any paper. It combines both high speed and high quality. It speeds through wide carriage spreadsheets at 176 cps, in draft mode. And produces beautiful letter quality originals at a remarkable 106 cps. As with all Epson printers, it offers a full year warranty.

Epson printers  
are used  
by more major  
companies  
than any other  
printer  
in the world.

Corporate  
Opportunities



Epson  
FX-185



Epson  
LQ-1500

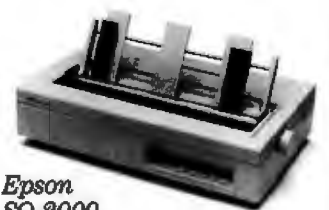

Epson  
SQ-2000

## EPSON

Number One.  
And built like it.

Epson is a registered trademark of Epson Corporation.  
IBM is a registered trademark of International Business  
Machines Corporation. FX-185 is a trademark of  
Epson America, Inc.

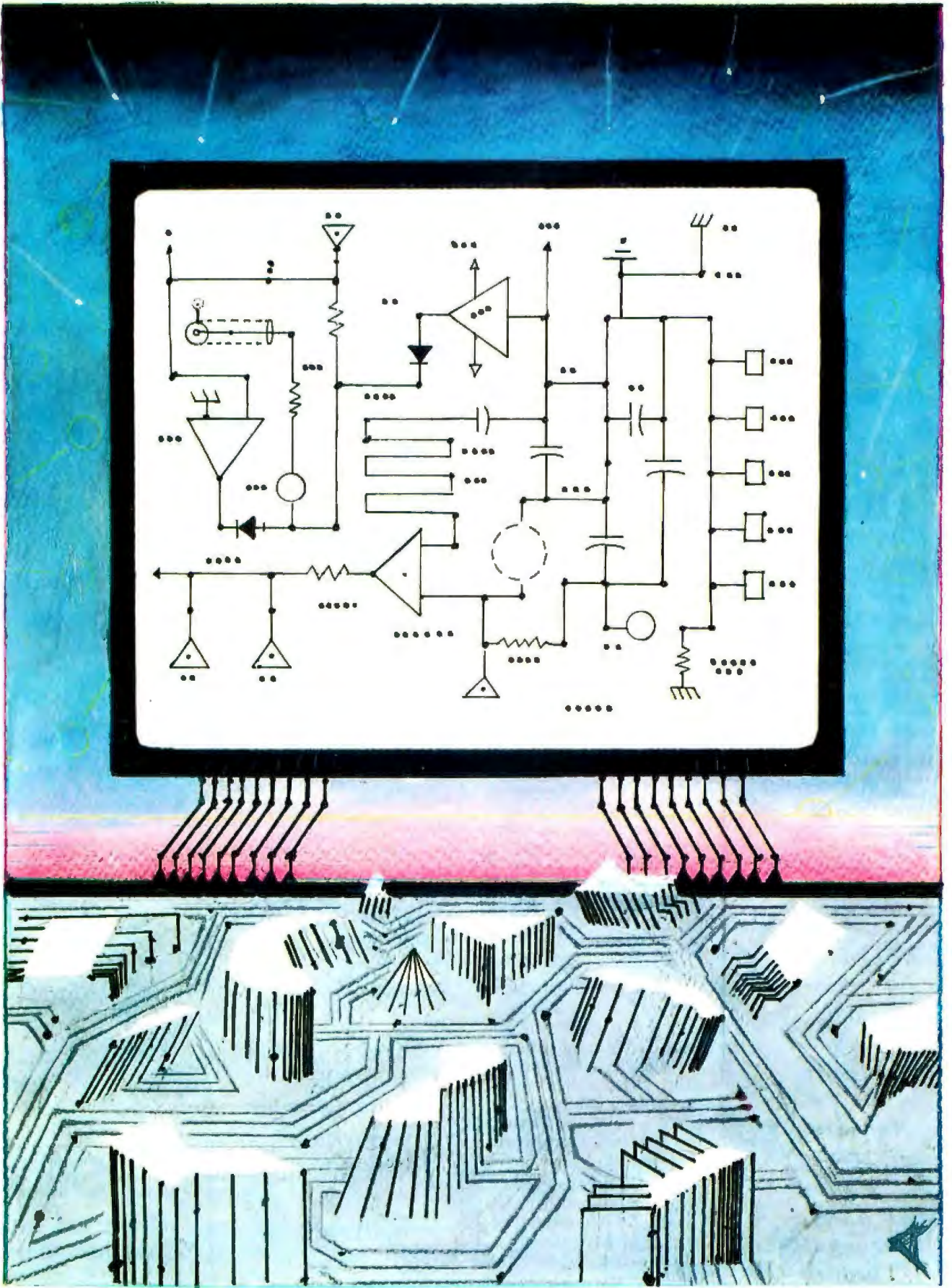

# Features

---

**THE AMIGA PERSONAL COMPUTER**  
*by Gregg Williams, Jon Edwards, and Phillip Robinson* . . . . . **83**

**CIARCIA'S CIRCUIT CELLAR: BUILD THE BASIC-52 COMPUTER/CONTROLLER**  
*by Steve Ciarcia* . . . . . **104**

**THE DSI-32 COPROCESSOR BOARD, PART I: THE HARDWARE**  
*by Trevor G. Marshall, George Scolaro, David L. Rand, Tom King, and Vincent P. Williams* . . . **120**

**PROGRAMMING PROJECT: CONTEXT-FREE PARSING OF ARITHMETIC EXPRESSIONS**  
*by Jonathan Amsterdam* . . . . . **138**

---

IN EARLY 1984, officials from a start-up company called Amiga showed journalists prototypes of a new personal computer. The prototypes used a Sage 68000-based machine as a CPU. Big steel boxes performed the special graphics and sound functions that Amiga planned to implement in silicon. The graphics were spectacular—fast enough to support animation. The audio output not only produced music but used stereo to enhance animation. Sound shifted from the right speaker to the left as a ball bounced across the screen. Everyone wondered if Amiga could really reduce all the power in the prototypes to silicon chips.

Late in 1984 and early in 1985, venture capital firms became wary of new entries in the crowded personal computer market increasingly dominated by IBM. Serious doubt arose about whether Amiga would be able to get capital to manufacture its machine. Many of us feared that the exciting machine we had seen in prototype would never become a product. We were delighted when Commodore acquired Amiga and saved this technically outstanding machine from oblivion. Gregg Williams, Jon Edwards, and Phillip Robinson give an in-depth look at the technology that makes the Amiga the most advanced and innovative personal computer today.

Steve Ciarcia's Z8 controllers are running all sorts of devices throughout the world. This month, Steve introduces a new controller that is bus-compatible with his Z8 products. The BASIC-52 computer/controller has an 8K BASIC in ROM and so is easy to program. Steve will be developing applications for the BASIC-52 in the months ahead.

BYTE's readers appreciate the 32032 microprocessor from National Semiconductor because of its outstanding architecture and its raw power. Those who want to buy a complete 32032 system can now get systems such as the Elite Computer Systems Expert 32 (see What's New, May, page 464). Those readers who want to move a 32032 into an existing box can complete the DSI-32 32032 coprocessor board for the IBM PC described in this issue. Five authors from Definicon Systems tell about the hardware and software that will give many of us our first taste of 32-bit microcomputing.

The August Programming Project lists Pascal code that can do context-free parsing of arithmetic instructions, which converts them to executable form. The code generates what amounts to a TI-style calculator. In the process of building the calculator in software, you learn a lot about the roots of the parser in linguistic theory of context-free grammars. Jonathan Amsterdam wrote the parser in highly portable Pascal code.

# WordPerfect 4.0. Our highest marks yet.

InfoWorld	
REPORT CARD	
WORD PERFECT	
	Poor Fair Good Excellent
Performance	<input type="checkbox"/> <input type="checkbox"/> <input type="checkbox"/> <input checked="" type="checkbox"/>
Documentation	<input type="checkbox"/> <input type="checkbox"/> <input type="checkbox"/> <input checked="" type="checkbox"/>
Ease of Use	<input type="checkbox"/> <input type="checkbox"/> <input type="checkbox"/> <input checked="" type="checkbox"/>
Error Handling	<input type="checkbox"/> <input type="checkbox"/> <input type="checkbox"/> <input checked="" type="checkbox"/>
Support	<input type="checkbox"/> <input type="checkbox"/> <input type="checkbox"/> <input checked="" type="checkbox"/>

Versions now available for  
**Novell Netware**  
and selected other  
Networks

**A** perfect report card. It wasn't necessarily our goal when we added the most recent enhancements to WordPerfect. We were more interested in responding to the suggestions of our users and dealers.

But a perfect report card is like icing on the cake. And it makes us more confident than ever that WordPerfect 4.0 is the most perfect WordPerfect, yet.

### Easier.

Most WordPerfect 4.0 functions require only one keystroke, a simple press of a finger. And new comprehensive documentation makes learning a breeze.

### Faster.

Document orientation means WordPerfect 4.0 never makes you

wait between pages. No matter how fast you type, WordPerfect won't slow you down.

### Better.

WordPerfect 4.0 includes several features not found on many word processors. Like a 100,000-word phonetic dictionary; multi-page footnoting capability; table of contents and index generation; automatic outlining and para-

graph numbering; and a 4.0 network version.

Get the word processor that lives up to its name (and its report card): WordPerfect 4.0. For more

information, see your dealer. Or call or write:

*new version lives up to its perfect billing*

InfoWorld

*WordPerfect 4.0 represents a new standard of excellence*

InfoWorld

WordPerfect 4.0. For more

SSI Software  
288 West Center Street  
Orem, Utah 84057  
Information: (801) 227-4020  
Order Desk 1-800-321-4566,  
Toll-free



**SSI Software**  
Reaching for perfection.



# The AMIGA

## PERSONAL COMPUTER



*Its speed and colorful graphics come from a 68000 and sophisticated custom chips*

*Editor's note: The following is a BYTE product preview. It is not a review. We provide an advanced look at this new product because we feel it is significant. A complete review will follow in a subsequent issue.*

THERE ARE TWO ways to get work done inside a computer: do it in software or do it in hardware. The first way gives you unlimited flexibility; the other, speed. The Apple Macintosh does almost everything in software—and,

*(continued)*

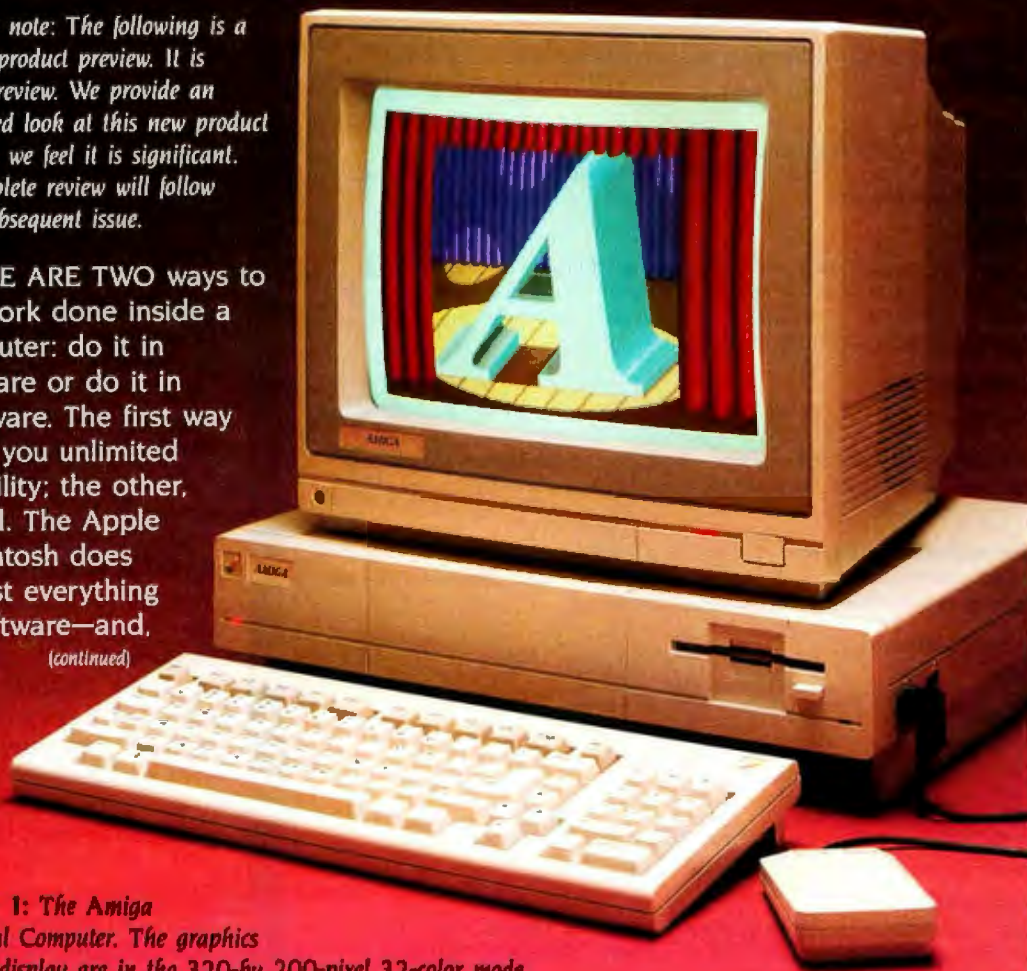

**Photo 1:** *The Amiga Personal Computer. The graphics on the display are in the 320-by 200-pixel 32-color mode.*

BY GREGG WILLIAMS, JON EDWARDS, AND PHILLIP ROBINSON

**IN BRIEF****Name**

Amiga Personal Computer

**Manufacturer**Commodore International  
1200 Wilson Dr.  
West Chester, PA 19380  
(215) 431-9100**Price**

\$1295

**Microprocessor**

Motorola 68000, a 32-/16-bit microprocessor (32-bit internal data path and registers, 16-bit external data bus) running at 7.15909 MHz

**Main Memory**

256K bytes dynamic RAM, user-expandable to 512K bytes; machine's design allows for maximum of 8.5 megabytes

**ROM**

192K bytes of ROM containing multitasking, graphics, sound, and animation support routines

**Graphics**

Five modes (320 by 200 pixels, 32 colors; 320 by 400, 32 colors; 640 by 200, 16 colors; 640 by 400, 16 colors; sample-and-hold mode); independent horizontal and vertical scrolling of dual playfields; eight hardware sprites; colors chosen from a palette of 4096 colors

**Sound**

Four independent audio channels; sound produced without supervision of 68000

**Floppy Disk**

Built-in 3½-inch double-sided disk drive. Disks hold 880K bytes in 160 tracks, each with eleven 512-byte sectors; drive hardware can read an entire track at a time

**Keyboard**

Detached 89-key keyboard with calculator pad, function and cursor keys; keyboard returns row/column keycodes for each key, sends both key-up and key-down signals; can sense up to two keys simultaneously; 8-key type-ahead buffer

**Expansion Ports**

Disk port onto which three additional disk drives can connect via daisy chain; serial port with maximum transfer rate of 500,000 bps; programmable parallel port normally configured as Centronics-compatible; expansion bus includes full set of signals for optional peripherals and memory expansion

**User Interface (Intuition)**

Supports multitasking through the use of virtual terminals; allows simultaneous display of different resolutions and graphics modes

**Bundled Software**AmigaDOS  
Voice Synthesis Library  
ABasiC  
Tutorial (Mindscape)  
Kaleidoscope (Electronic Arts)**Audio and Video Ports**

Two stereo audio jacks; RGB analog, RGB digital, and NTSC composite output

**Miscellaneous**

Three custom chips to control graphics, audio, and peripheral I/O; chips connected by 19-bit register-address bus; two-button mechanical mouse

**Optional Peripherals**

3½-inch 880K-byte disk drive; RGB analog color monitor; 256K-byte memory expansion module; 300/1200-bps modem; MIDI interface; frame grabber

not coincidentally, people want Apple to increase the Mac's speed, add color, and lower its price.

Commodore has just introduced a computer that promises these improvements, and it does so by doing many things in hardware. At \$1295, the Amiga Personal Computer (see photo 1) promises lightning-fast desktop-metaphor graphics in color and twice as much memory and disk storage as the Macintosh for several hundred dollars less than the Macintosh (about \$900, but you'll have to buy a monitor or television set for the Amiga). It also has an expansion bus and a whopping 192K bytes of sophisticated 68000 code in ROM (read-only memory) that extends the multitasking, graphics, sound, and animation capabilities of the Amiga hardware.

**SYSTEM DESCRIPTION**

The Amiga is summarized in the In Brief section on this page. It has no slots for expansion cards, but Commodore later intends to offer a box that connects to the expansion connector to add several expansion slots. (It is theoretically possible to add 8 megabytes of memory in this way.) The Amiga's disk operating system will also be able to look at the expansion box, determine what peripherals are present, and configure itself accordingly, regardless of the box's contents.

**SYSTEM ARCHITECTURE**

The Amiga has a unique architecture that is only partially described by a functional block diagram (see figure 1). Three custom chips relieve the 68000 processor of many tasks that tie it down in other computers. However, the diagram does not show the finely tuned sharing of the system's data and address buses, the 25 DMA

*Gregg Williams is a senior technical editor at BYTE, and Jon Edwards is a technical editor. They can be reached at BYTE, POB 372, Hancock, NH 03449. Phillip Robinson is a West Coast senior technical editor at BYTE. He can be reached at BYTE Magazine, 425 Battery St., San Francisco, CA 94111.*

(direct memory access) channels that do many data-movement-intensive operations without tying up the 68000, or the multiprocessing routines in ROM that allow the Amiga to orchestrate a variety of tasks. In the following sections we will look at the key elements of the Amiga's system architecture.

**THE CUSTOM CHIPS**

The three custom chips that control DMA, graphics, sound, and I/O (input/output) (see photo 2) were designed by Jay Miner, who is best known for his design of the custom chips in the Atari 800 series computers. Although we will discuss them in depth by function, here is a simple breakdown:

- The "animation custom chip" actually contains several miscellaneous functions. It is the "traffic cop" that controls DMA. It contains the Copper, a coprocessor that can directly control the other chips in relation to the video beam, and the Blitter, a device that quickly draws lines, fills areas with a given color, and manipulates rectangular blocks of pixels.

- The graphics custom chip, which manipulates the visible display, permits up to two independent bit-mapped images and eight sprites (which are images that can be moved easily around the screen, "under" or "on top of" the bit-mapped images).
- The peripherals/sound custom chip contains four channels of sound, the disk controller, an interrupt controller, and the interfaces for the serial port and the mouse/joystick port.

**INTERRUPTS AND DMA**

In the Amiga, all the peripherals are interrupt-driven—that is, the 68000 is not tied up constantly *polling* them to see if they have new data; instead, the 68000 gets data from the peripheral only when the peripheral sends an interrupt signal. The peripherals/sound chip receives interrupt-request signals from one of 15 sources (e.g., the disk drive or a sound channel), translates the request to one of six interrupt levels supported by the 68000 (the seventh is reserved for future use), and sends the interrupt signal to the 68000.

The 68000 shares the address and

data buses with 25 channels of DMA, the registers and logic of which reside in the custom chips. Amiga's DMA is fast for two reasons: first, the fact that each device has its own DMA channel decreases the overhead associated with a DMA operation; second, many DMA operations are interleaved with 68000 bus access in a way that makes the DMA transparent to the 68000 (see below for details).

When DMA occurs between memory- and custom-chip registers, the use of the 19-bit register-address bus (see figure 1) makes the transfer twice as fast. By putting the memory address on the address bus and the register address on the register-address bus, the DMA circuitry causes the data value to move directly from the memory address to the register. This occurs twice as fast as DMA would via the 68000, which would first read the data into itself and then write the result to the register.

**LIBRARIES AND DEVICES**

System software (much of it in the 192K bytes of ROM) contains *libraries*.

(continued)

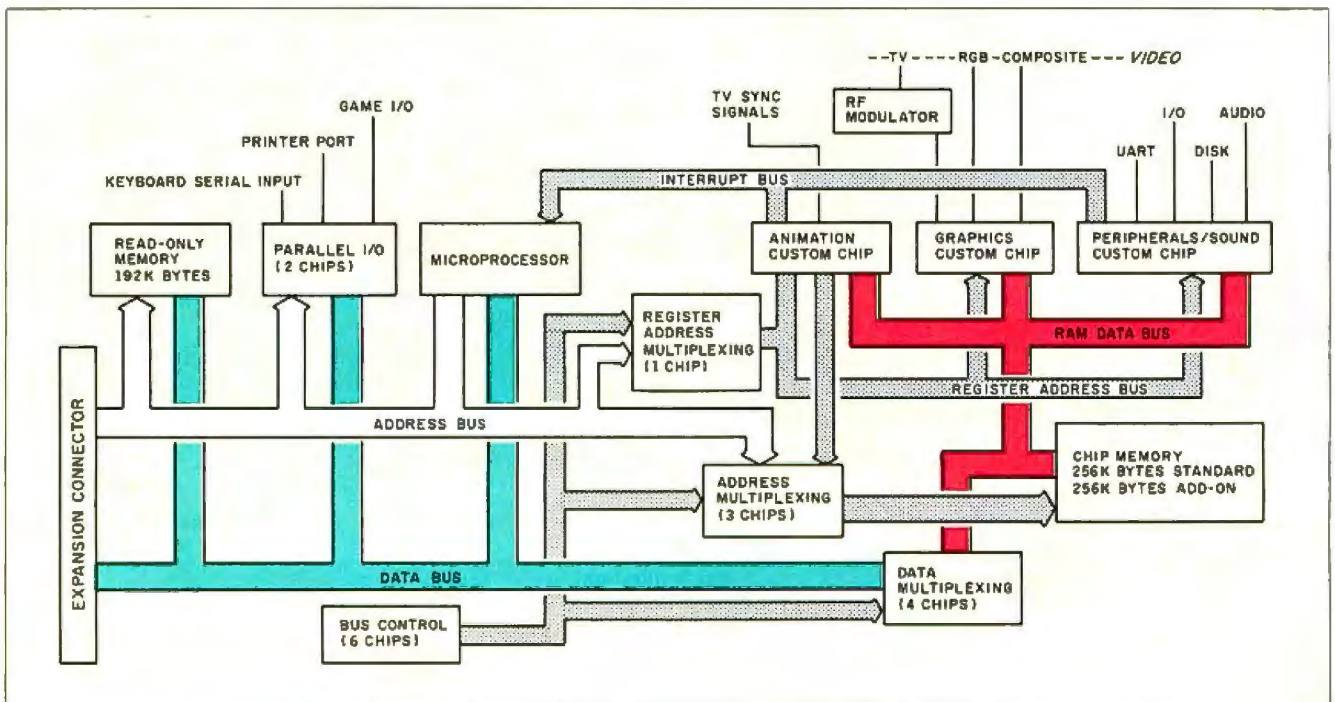

Figure 1: A block diagram of the Amiga Personal Computer.

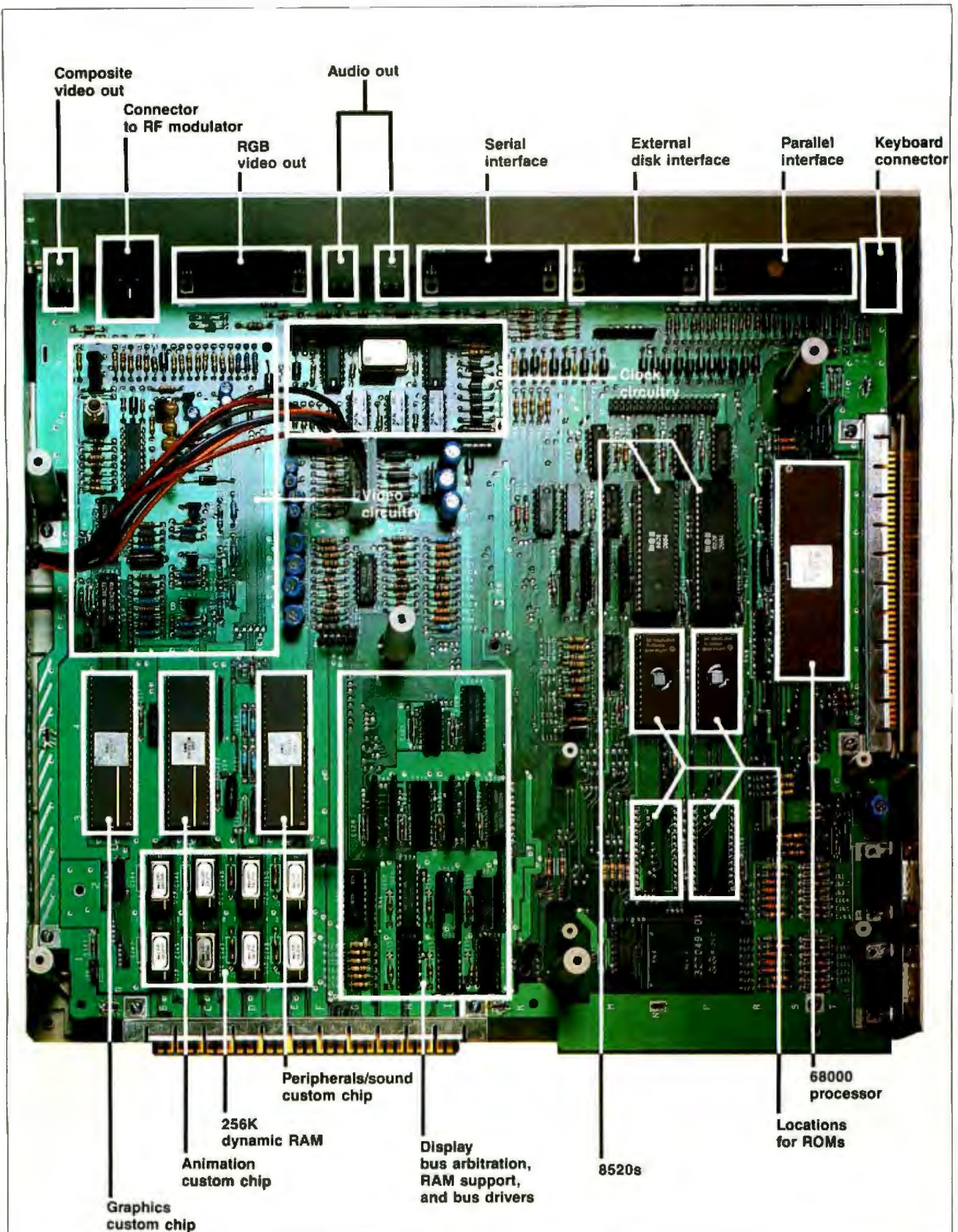

Photo 2: The Amiga motherboard. The internal disk drive, which has been removed, would normally obscure the lower right corner of the motherboard. The power supply (not shown) is to the left of the motherboard.

a predefined way of organizing useful routines so that they can be accessed with maximum flexibility. Libraries can be resident or transient and can be used at any memory address (when they're in RAM [random-access read/write memory]). Both routines and data can always be called via a 68000 indirect reference with offset; this allows you to write code using a library routine without knowing that library's address at compile time. (In fact, all the code in the system can be referenced knowing only one fixed address in the machine, and even that address is supplied to any machine that needs it.) A *device* is an extension of the library concept that allows software to access I/O devices (both present and future) in a uniform way.

### THE EXEC ROUTINES

The Exec system is a collection of reentrant optimized 68000 ROM routines that perform many functions vital to the operation of the Amiga. It includes routines that create and manipulate lists and queues, schedule tasks by priority, handle interrupts, organize device I/O, control memory use, and perform other functions.

An important data structure in the Amiga is the *list node*. The list node is a block of data with pointers to the predecessor and successor nodes in the list it's in, two 8-bit type and priority fields, and an associated block of data. A *list* is a doubly linked chain of list nodes and items, started by a header that points to the first and last nodes. Exec contains several routines that let you do things like create a new list, insert a list item into its proper place in a queue, and remove a node from a list.

Another important set of routines allows you to manipulate *tasks*. A task is a unit of work that shares the Amiga with other tasks in a way that varies with both the type and priority of the task. (All the current tasks are held in a queue and are executed by decreasing priority.) Most programs and operations reside in the Amiga as tasks.

The task priority field, which contains a number between -128 and 127, determines the order in which

## The Exec routines perform many functions vital to the operation of the Amiga.

tasks will execute. Tasks with identical numbers share the Amiga in time slices of preselected duration. A task with higher priority preempts the current task and begins executing. Because the system saves a task's states, registers, and stack area, a task can resume at any time. More important, programmers do not have to make allowances for other tasks that may be running concurrently—while a task is active, it "thinks" that it has full unrestricted access to the 68000.

### SHARING THE SYSTEM BUS

Consider that the Amiga can simultaneously read the disk, play four channels of audio, and show 16-color low-resolution bit-plane graphics and eight sprites with virtually no slowdown of the 68000 processor. This is possible largely because of the way various subsystems share the bus.

The Amiga's 68000 runs at 7.15909 MHz, while its memory runs at twice that speed. Most of the instructions in the 68000 alternate between using the bus and doing internal calculation. In this situation, the memory can run at its top speed and still leave every other bus cycle free.

The bus sharing takes place in subdivisions of the time the electron gun takes to draw one line of pixels and do a horizontal retrace, approximately 63 microseconds ( $\mu$ s). This divides into approximately 226 memory-access cycles of 280 nanoseconds (ns) each. The Copper, Blitter, and 68000 access memory on the even cycles (0, 2, 4, . . .); the odd cycles (1, 3, 5, . . .) are reserved for four cycles of memory-refresh DMA, three cycles of disk DMA, four cycles of audio DMA (enough for four channels), 16 cycles of sprite DMA (enough for eight sprites), and 80 cycles of bit-plane

DMA (enough to show a 16-color low-resolution image). The DMA circuits on each chip "know" when their slots occur on each horizontal line and automatically initiate the DMA transfer without involving the 68000.

In many cases, the Copper and the Blitter aren't active, leaving the 68000 running at full speed. (Actually, some instructions need the bus at odd times; if the bus isn't available, the 68000 will insert wait states until the bus-arbitration PAL [programmed-array logic chip] signals that the bus is free by asserting the 68000's  $\overline{DTACK}$  line. This happens more frequently as the custom chips demand more of the bus's cycles.)

Several things modify this bus sharing. If you use more than four bit planes of low-resolution display, or more than two high-resolution bit planes, the bit-plane DMA will steal some memory cycles from the 68000. Both the Copper and the Blitter have higher priority than the 68000 and will get the cycles they need first. If the Blitter senses a memory-bus request by the 68000, it will halt within a few cycles to let the 68000 use the bus; then it will again take over the bus and continue. This gives the 68000 some cycles even when the Blitter is running. If you set an internal "Blitter priority" bit, however, the Blitter steals *all* the cycles it needs from the 68000. Even this is not as bad as it sounds; whenever any of the above items steals cycles, it still performs its function faster and more efficiently than the 68000 could have.

### MULTITASKING

The Amiga is multitasking—that is, it can work on more than one thing at a time. At a low level, for example, this means that the Amiga can move sprites, read from the disk, and play music at the same time. At higher levels, several programs can run simultaneously in overlapping windows.

The Amiga's multitasking ability comes from several features we've already discussed: the interrupt structure and the Exec multitasking routines in ROM. Interrupts, which are

(continued)

routed through and prioritized by the peripherals/sound chip, initiate task switching. For example, when a peripheral signals its need to do I/O, the interrupt goes through the peripherals/sound chip and causes the peripheral's interrupt routine to execute (assuming that no interrupt of higher priority is running). The interrupt routine either handles the peripheral's need immediately or notifies a task to do so, then the routine ends. In both cases, the Amiga then calls the task rescheduler, which ensures that the

appropriate task has the chance to use the system.

### THE COPPER

The Copper is a coprocessor inside the animation chip that runs its own program. The execution of this program is tied to the progress of the electron beam as it draws the video display. Because of this capability, the Copper is most often used to control the graphics and sound parts of the custom chips, thus relieving the 68000 of the same task. The Copper reads

its instructions from memory and uses DMA to write from its program (in memory) to the registers in itself and the other two custom chips. (According to Jay Miner, this is not so strange if you look at the three chips as "one big custom chip.")

The Copper's instruction set has only three instruction types: *move* immediate data to a register, *wait* until the electron beam passes a given position, and *skip* past the next instruction if the electron beam is past a given location. The beam-position values are accurate to the exact line vertically and to 4 low-resolution pixels (or 8 high-resolution pixels) horizontally.

The Copper's versatility can be extended by clever use of its registers. For example, you can get the Copper to jump to a given instruction by causing the new address to be placed in the Copper's internal "program counter." By setting bit 15 of the INTREQ (interrupt request) register, the Copper can cause a level-6 interrupt, which should lead to a more complex 68000 routine that will service the situation that caused the interrupt.

One important aspect of the Copper is that, while it is waiting for the electron beam, it is off the system bus and does not tie up any resources. This is in contrast to many systems that tie up their processors while waiting for a given beam position. Because of the Copper, the 68000 is never tied up for several milliseconds waiting for a display-related event.

The Copper can handle many basic system functions without the intervention of the 68000. For example, it can refresh certain bit-plane and sprite values that must be restored at the beginning of each frame. It can also change the color palette in mid-screen (giving you more than 32 colors on the screen), change the graphics mode (saving memory), and update the display memory without glitches by changing an image *after* the electron beam has drawn it for the current frame.

The Copper programs give the maximum amount of control over the video display and events of that

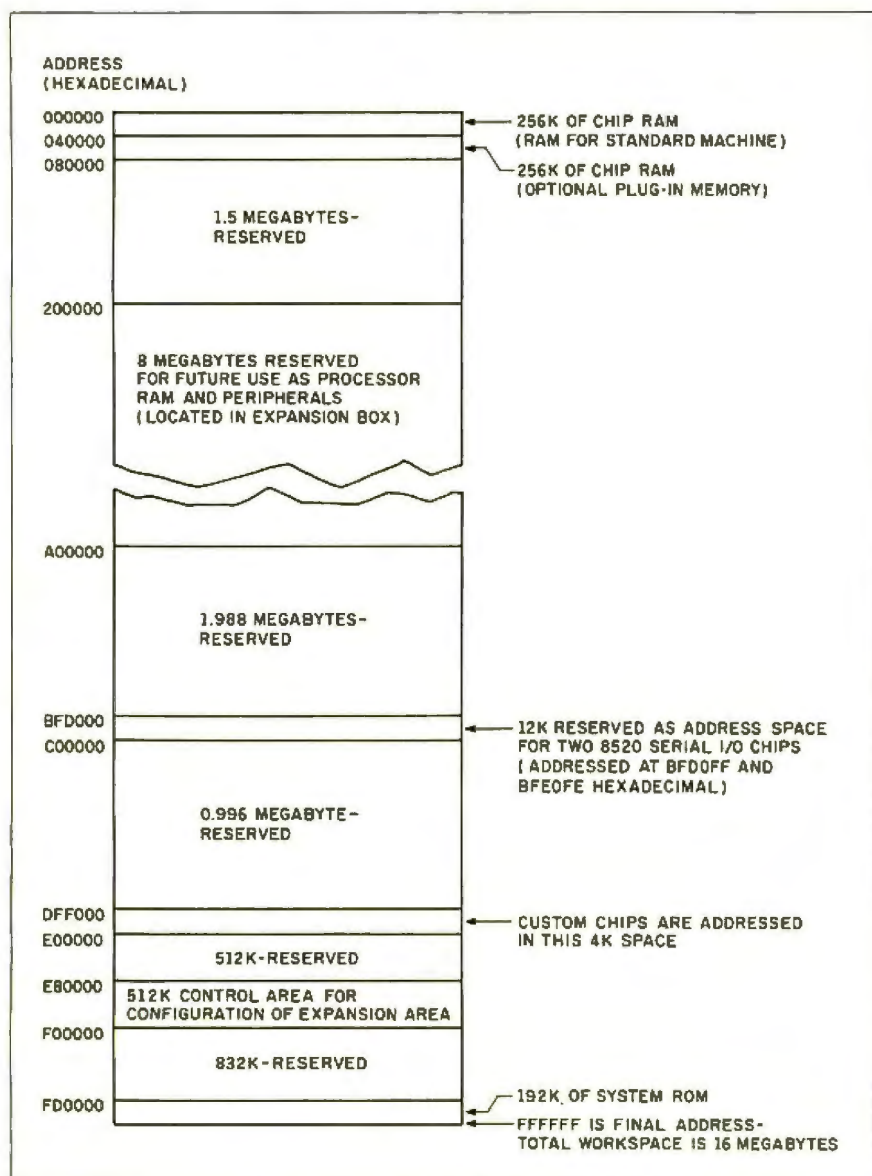

Figure 2: The Amiga memory map.

periodicity, but most programmers will not create them directly. Many of the ROM routines that accomplish high-level tasks manipulate Copper programs to get their work done.

**MEMORY SPACE**

The first 512K bytes of memory is called the *chip memory* (see figure 2 for a memory map). Any function performed by the custom chips—bit-plane and sprite images, Copper programs, and other data (covered below)—must be in this memory area.

Of course, in the standard 256K-byte Amiga (or the expanded 512K-byte version), the chip memory is also used for everything else a computer needs RAM for. Commodore/Amiga may announce an expansion box at a later date that can accommodate various peripheral cards and up to 8 continuous megabytes of memory. Normal programs and data should be placed there, leaving the display memory free for its specialized uses.

**GRAPHICS**

The Amiga's graphics are, in a word, breathtaking—in both their quality and their speed. The machine's major graphic components are the playfield, the sprites, the Blitter, and the animation and text routines.

**THE PLAYFIELD**

A *bit map* is an area of memory that the computer interprets as a rectangular array of pixels (dots); most computers have some bit-mapped graphics capability. Many machines form different colored pixels by grouping two or more adjacent bits in the bit map. The Amiga, however, uses only one bit per pixel in its bit map (this is called a *bit plane*) and "stacks" separate bit planes together to get different colors (see figure 3). (The colors available are not "hard-wired" into the machine but are specified in a *color-register table*, also known as a *color palette*.) An image created by multiple bit planes is called a *raster*. The *playfield* is the bit-mapped graphics display that comprises most of the Amiga's video display.

The Amiga can stack up to five bit

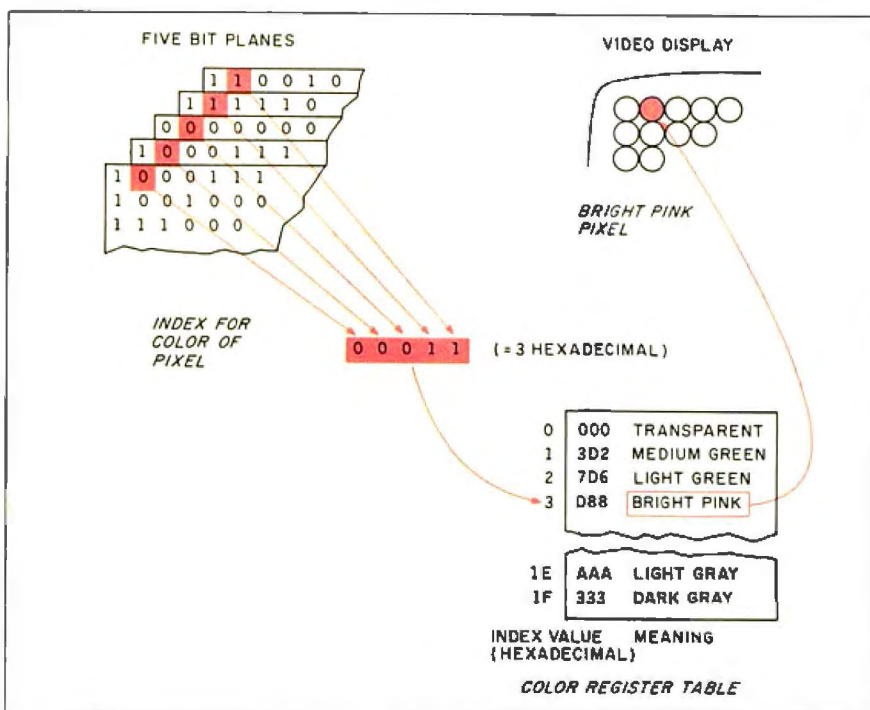

Figure 3: Amiga playfield graphics. The bits from a given position in each bit plane combine to create an index into the color-register table. The selected entry in the color-register table determines the color of the pixel.

planes to get a maximum of 32 colors. The color-register table contains 12-bit values that can specify any of 4096 different colors. Therefore, the Amiga can draw images that use any 32 of these 4096 colors.

The Amiga has five bit-mapped resolutions. Four of them come from two horizontal resolutions (320 pixels per line, low resolution, and 640 pixels per line, high resolution) times two vertical resolutions (200 visible lines per screen, *noninterlaced* frame, displayed every 1/60 second, and 400 visible lines per screen, *interlaced* frame, displayed in two passes every 1/30 second). These can take anywhere from a minimum of 4000 bytes (for a 320- by 200-pixel image) to 32,000 bytes (for a 640- by 400-pixel image). Photo 3 shows an example of the 320 by 200 mode.

The fifth mode, called *hold-and-modify*, uses six bit planes in a way that can simultaneously display all 4096 colors on screen. In this mode, the top 2 bits of a pixel control the interpretation of the bottom 4 bits, which may repre-

sent either a color-register table value for that pixel or a modification to one component of the previous pixel's color. Using hold-and-modify, you can display all 4096 colors on an analog RGB (red-green-blue) color monitor.

A playfield image can be much larger, both horizontally and vertically, than the screen area used to display it. By manipulating several register values, you can scroll an image horizontally, vertically, or both, with very little effort. (When the total image is wider than its displayed part, the last pixel on one line and the first pixel on the next are not adjacent and are separated by a fixed number of bytes. The Amiga makes use of *modulo registers* to make the manipulation of two such bytes as fast and as simple as if they were contiguous.)

Another display option is called the *dual-playfield mode*. When you use this mode, up to six bit planes are divided into two separate images of up to three bit planes each, with one image having priority over the other.

(continued)

often simplifies complex graphic displays. For example, to simulate the effect of looking at a landscape through binoculars, you can scroll a wide landscape playfield "underneath" a stationary playfield that is all black ex-

cept for a transparent area that lets the lower playfield show through.

## SPRITES

A *sprite* is a small bit-mapped image that can be repositioned simply by re-

defining the horizontal and vertical values for its upper left corner; sprites are independent of the playfield and appear to be over or under each other and the playfield(s) according to a specified priority.

The Amiga has eight hardware sprites, each of which can have three colors (sprites are two bit planes deep, and each 2-bit pixel translates to three colors plus transparency). Amiga sprites are 16 low-resolution pixels wide by any height. Each pair of sprites shares a different three-color color-register table (for example, sprites 0 and 1 share color registers 17, 18, and 19, sprites 2 and 3 share 21, 22, and 23), allowing the eight sprites to use up to 12 colors. Adjacent sprites (0 and 1, for example) can be *attached*, meaning that their four bit planes are combined; an attached sprite pair can then use color registers 17 through 31 to display up to 15 colors.

As happens often in the Amiga, complexity underlies apparent simplicity. A sprite is actually a 16-bit value with a specified horizontal displacement for the current line of the video display. In *manual mode*, you are responsible for creating the sprite's image on a line-by-line basis (few people will use this mode directly). In *automatic mode*, however, you activate the sprite's DMA circuitry, which looks to a data structure that contains the line-by-line position and shape of the sprite and draws it automatically. In addition, you can redefine the sprite indefinitely while the electron beam creates the video display. The sprite DMA circuitry accepts a list of sprite position and shape-definition words and draws them as long as the bottom line of one occurrence and the top line of the next are separated by at least one video line (note that this is *without* intervention of the Copper).

## THE BLITTER

The Blitter is an area of the animation chip that controls a DMA channel dedicated to drawing lines and manipulating rectangular areas of the playfield. Its name comes from an earlier

(continued)



Photo 3: *Robocity*, an example of Amiga graphics in the 320- by 200-pixel 32-color mode.

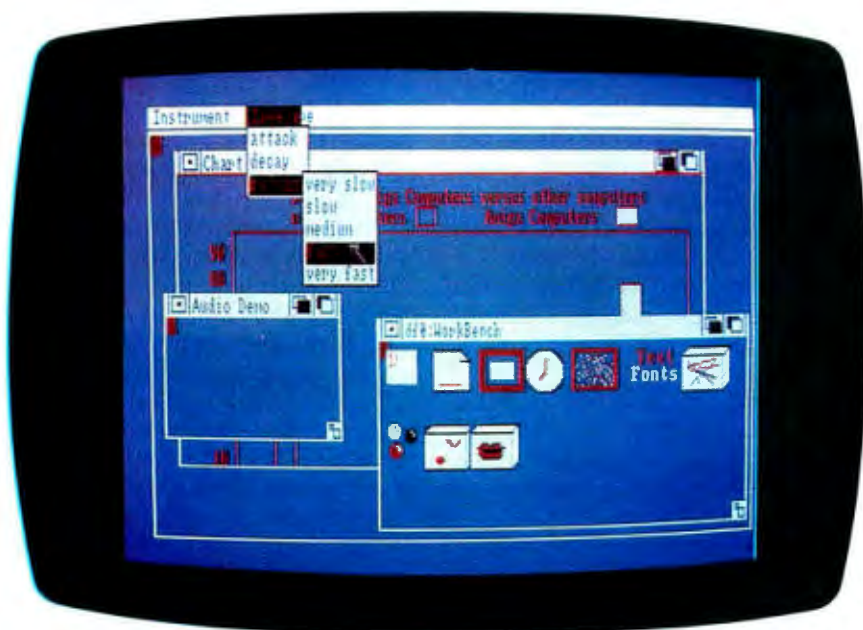

Photo 4: *The Workbench display*. This is an example of the 640 by 200 mode.



# The most BASIC.

Microsoft® BASIC is the language spoken by nine out of ten microcomputers worldwide. It's the language with the most programs written for it.

So if you want to access the power of your Macintosh™, only one language makes the most sense. Mac's first language, Microsoft BASIC.

Not only is it the industry standard, it's the most advanced BASIC for Macintosh. It lets you add mouse commands. Graphics. Windows. Change type fonts and styles. Customize menus. Incorporate music and sound effects. Write your own dialog boxes. Basically, it lets you take advantage of everything that makes Mac 'Mac.'

It makes editing programs as easy as cutting and pasting and pointing and clicking. Debugging is easier

than ever with the advanced trace command.

It's no wonder Microsoft is the most logical choice for the Macintosh.

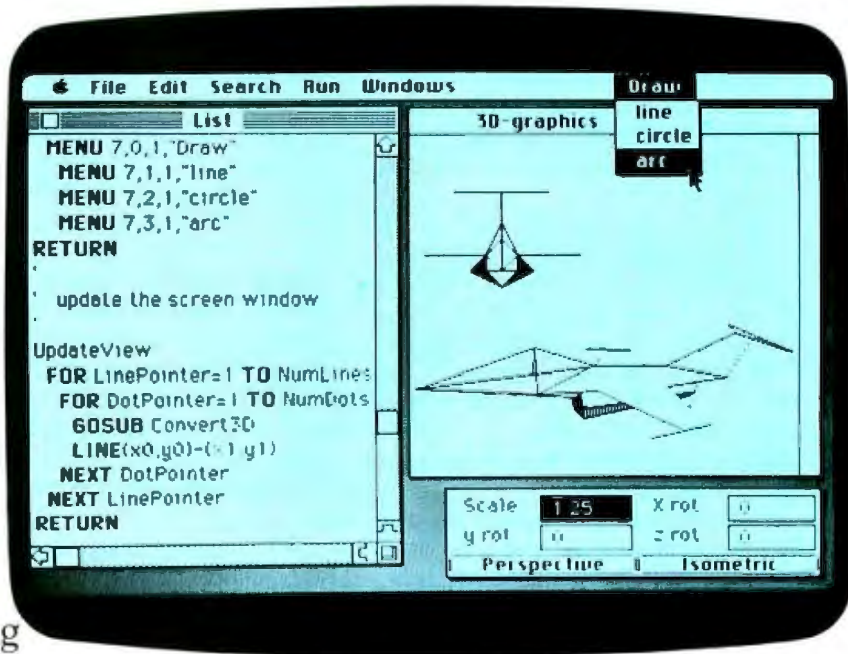

**MICROSOFT** We've The High Performance Software written more Macintosh programs than any other software company. Including Mac's spreadsheet, Multiplan®.

So if you want to get the most out of your Macintosh, call (800) 426-9400 for the name of your nearest Microsoft dealer. In Washington State, Alaska, Hawaii and Canada, call (206) 828-8088.

Microsoft and Multiplan are registered trademarks of Microsoft Corporation. Macintosh is a trademark licensed to Apple Computer, Inc.

# MICROSOFT



**T**he basic element in the animation subroutine is the GEL, a graphics element.

term, *bit-blt*, which means "bit-mapped block transfer." Miner calls it a *Bimmer*, for "bit-mapped image manipulator," because of its extended capabilities, but "Blitter" is used exclusively in the Amiga's documentation.

When manipulating blocks of an image, the Blitter (when properly set up) takes care of a number of "house-keeping" tasks that, in other computers, tie up a lot of the processor's time. These include: masking out the bits just outside the image that belong to the same memory word as the desired bits; shifting the image several bits horizontally to match the word alignment of the destination; and filling an area bounded on the left and right by two nonhorizontal single-pixel lines (this is the basis of its area-fill capability).

The Blitter distinguishes itself from other bit-blt devices by its ability to combine up to three source areas in one of 256 ways to become the destination area. (If we call the sources A, B, and C and their inverses  $\bar{A}$ ,  $\bar{B}$ , and  $\bar{C}$ , these combine in eight ways: ABC,  $A\bar{B}\bar{C}$ ,  $\bar{A}BC$ , . . . ,  $\bar{A}\bar{B}\bar{C}$ . There are 256 possible combinations of these eight terms.)

When being used to draw lines, the Blitter can draw lines as 1s, 0s, or a specified pattern; it can also draw single-bit-wide lines, which are needed to bound an area to be filled.

In both its line-drawing and area-manipulating operations, the Blitter must have a moderate amount of "housekeeping" calculations done first. Given the speed and simplicity of the resulting operation, the setup calculations are not an unreasonable overhead; however, you can deal with the Blitter on a higher level using some graphics routines in ROM.

#### ANIMATION ROUTINES

The animation routines that are part of the Amiga's ROM form the basis for the most sophisticated color animation the personal computer market has ever seen. One of the demonstrations we saw, *Robocity*, showed five cartoon characters roaming across the screen. The resolution was very good—only when you looked closely

could you see the "jaggies" that proved you weren't looking at a hand-drawn cartoon.

Animation is accomplished through a few subroutine calls that draw a linked list of things needing to be animated. The basic element in the animation subsystem is the *GEL*, or graphics element. There are four types of GELs: VSprites, BOBs, AnimComps, and AnimObjs.

*VSprite* stands for "virtual sprite." A *VSprite* is a data structure in memory, closely tied to a hardware sprite, that is managed by the animation routines. By letting the routines manage the mapping of VSprites to hardware sprites, you can (with some limitations) define more than eight VSprites and let the routines keep track of the details automatically. VSprites can also be clipped to display themselves only within a certain horizontal slice of the display.

*BOB* stands for "Blitter object." A BOB is an image that acts like a sprite, but the animation routines use the Blitter to "paste" the image onto the playfield and (optionally) restore the image that was "underneath" the BOB. A BOB is defined by the combination of a BOB data structure and a *VSprite* data structure, both of which point to each other. One advantage of a BOB over a *VSprite* is that a BOB is drawn into a playfield—this means it can be of any width and it can have as many colors as the playfield (up to 32). BOBs can also be clipped to appear only in a certain rectangular window.

An *AnimComp* is an animation component, one part of an *AnimObj*, an animation object. If your *AnimObj* is a figure of a man walking, its *Anim-*

*Comps* will probably include BOBs for a torso, a head, two arms, and two legs. Each *AnimComp* includes several views of the same object (e.g., arm bent, arm straight) with an associated time that must elapse before progressing from one view to the next. Once all this is assembled, repeated calls to the *Animate* routine substitute new views (as determined by their timer constants) into the linked list of GELs before drawing the items in the list.

You can do *sequenced drawing animation* by specifying a series of views that describe a repeated motion and by specifying an offset to add to the object's position each time the routines cycle from the last view to the first. For example, take the example of a cat walking two steps to the right in six views so that view 1 appears natural when it is shown after view 6. By specifying the correct horizontal offset to the right (which gets added every time the image cycles back to view 1), the *Animate* routine will automatically draw the six views in the correct order and position to make the cat appear to walk across the entire width of the screen.

Alternatively, you can have the *Animate* routine do *motion-control animation*, in which the next position of a BOB is automatically calculated from its current position and four *x*- and *y*-axis velocity and acceleration values. (You can also do this with a "ring" of BOB views that cycle as in sequenced drawing animation.)

Another routine, *DoCollision*, detects two types of collisions, GEL-to-GEL collisions and boundary collisions (collisions of GELs with rectangular boundary windows); the routine then executes a given collision-handling routine from a table of 16 possible routines. GELs can be coded so that only certain types of collisions register (useful in a game, for example, to detect missile-target collisions but not missile-missile collisions).

#### TEXT

The Amiga treats text as a special kind of graphics. Fonts are described

(continued)

**New Version**

# Classic COBOL.

True mainframe COBOL for your microcomputer. Validated by the GSA at the highest possible level of compliance with the ANSI '74 standard. With Microsoft COBOL, mainframe programmers can be productive on MS-DOS™ and Microsoft XENIX® micro-computers immediately.

## Speed and Beauty.

High performance in a COBOL program comes mostly from the speed of the ISAM. And Microsoft COBOL 2.0 has the fastest ISAM on the market.

And our advanced screen handling capability lets you create the highly interactive programs that end users prefer.

## We wrote the book.

It's no surprise that IBM®, DEC®, AT&T, H-P and Wang® all chose Microsoft COBOL for their MS-DOS machines. We know how to get the most out of their micro-computers. After all, we designed the operating system.

So call (800) 426-9400. In Washington State, Alaska, Hawaii and Canada, call **MICROSOFT** (206) 828-8080. The High Performance Software®  
We'll give you the name of your nearest Microsoft dealer or help you update to Microsoft COBOL 2.0.

### Certified High Level Compiler:

- GSA validation at the Federal High Level of compliance with the ANSI '74 standard.
- Built in sort-merge, chaining, dynamic calling, and overlays.

### Fast multi-key ISAM:

- Split-keys and duplicate keys.
- Benchmark results of 5000 reads and writes to an ISAM file:

	Microsoft COBOL 2.0	Realia COBOL	MicroFocus* Native Code	Ryan-McFarland* COBOL 2.0
hours:				
minutes	1:32	1:56	2:58	3:30

### Interactive extended screen section:

- Cursor positioning, auto skip, automatic data field formatting.

- ACCEPT and DISPLAY data by the screen full.

### Productivity utilities:

- Interactive Symbolic Debugger.
- Rebuild file recovery utility restores corrupted ISAM files.

### Price:

- \$700 for compiler and utilities.
- No runtime royalty fees.

### Minimum System requirements:

- MS-DOS 2.0 or later, 192K RAM, and one disk drive.
- Xenix 286, 512K RAM, and one disk drive.



Microsoft and Xenix are registered trademarks and The High Performance Software is a trademark of Microsoft Corporation IBM is a registered trademark of International Business Machines DEC is a registered trademark of Digital Equipment Corp Wang is a registered trademark of Wang Laboratories, Inc. MicroFocus is a registered trademark of MicroFocus Ryan-McFarland is a registered trademark of Ryan-McFarland

by a Text Font (TF) data structure that allows the creation of either mono-spaced or proportional characters of any height. To save room with larger fonts, a font may define anywhere between 1 and 255 characters. Two fonts, Topaz 8 and Topaz 9, are in the Amiga ROM. The first gives 40 characters per line in normal resolution, 80 in high resolution; the second gives 30 and 60 characters per line, respectively. Additional fonts may be loaded into and removed from RAM as needed.

The Amiga uses the ROM routine TxWrite to draw a given message to a given location. The text can be drawn in one of two user-definable "pen" colors and in one of three drawing modes: JAM1, an overstrike mode; JAM2, a mode that draws both the character in one color and the "white space" behind it in another; and Complement, which inverts every pixel that corresponds to a pixel of the character being drawn.

As in the Apple Macintosh, fonts may be modified by combining any of several styles: underline, italic, boldface, and extended. However, unlike the Macintosh, the Amiga text-drawing routine looks for a separately defined font that contains the needed style(s). If this fails, a future revision of the text-drawing routine may try to modify the existing "normal" version of the font (this is the only way of achieving font styles in the Macintosh).

#### AUDIO HARDWARE

The Amiga includes four hardware channels of sound that are largely controlled by DMA circuitry, independent of the 68000. Audio-controlling routines in part of the Amiga's ROM extend these capabilities, allowing you to work with the Amiga's sound capabilities at a higher conceptual level and to manipulate the sound channels "on the fly" without "glitching" the output.

The four channels of sound, numbered 0 through 3, are converted to analog signals, filtered through a low-pass filter, and mixed into two separate output signals, one combin-

**F**onts may be modified by any combination of several styles: underline, italic, boldface, and extended.

ing channels 0 and 3, the other, channels 1 and 2. The filter begins to attenuate frequencies between 5.5 kHz and 7.5 kHz and effectively eliminates any higher frequencies. This eliminates much *aliasing*, which is distortion that occurs when a signal that was sampled too infrequently is played back.

The sound channels can be controlled directly by the 68000, which gives you complete control over the sound but keeps the 68000 from doing other work. In most cases, you can get the sound you need by letting the DMA channels produce the sound from a table of values (called a *sound table*) that describe one or more cycles of the needed waveform.

In the Amiga, each audio DMA channel includes registers that give the channel's loudness, point to a 16-bit-wide table of sound-table bytes (the values are fetched a word at a time and must be stored on even byte boundaries), and establish the time that must elapse before the next sound byte is sent out. This last is a *period register*, which contains a value that is decremented every 279 ns; the next value from the sound table is sent out when the counter reaches zero, and the register is reset to its original value. When the pointer to the sound table reaches its last value, the pointer is reset to the start of the table. In this way, the audio channel continues to produce the given waveform without supervision until it is explicitly turned off.

Sound channels 0 through 2 can be *attached* to the channels directly above them to modulate the output of the higher channel. When a channel is attached, the 16-bit words that make up

its sound table are not interpreted as two 8-bit sound values. Instead, the data words are interpreted as volume or period values for the current value in the channel being modulated (i.e., the volume value will determine the current loudness of the channel, and the period value determines how much time passes before the channel sends out the next value in *its* sound table). You can manipulate these values to cause either amplitude modulation, frequency modulation, or both.

#### AUDIO SOFTWARE

The ROM contains three kinds of routines. The first, channel-allocation routines, allow you to allocate, use, and discard a channel without keeping track of which channel it is. If you have more than four "virtual" channels open, the four with the highest priorities are mapped to actual hardware audio channels.

Second, the DMA-control routines control the way the audio DMA channel manipulates the hardware audio channel via the various registers and the sound table. In addition, you can cause the channel to send a user-specified signal bit to an existing task (which may then trigger some event) when the sound channel has played a given number of repetitions of the sound table; this allows tasks to manipulate the Amiga based on the sound channel's activity.

Third, the envelope-generator routines automate the task of varying the amplitude envelope that determines how slow or fast a note changes volume when it is played. To use these routines, you must create a table of four slope/destination values that describe an ADSR (attack, decay, sustain, release) envelope. (The ADSR envelope tells you how fast the note gains volume as soon as it starts, what its maximum value is, how fast it decays once it reaches that value, on what level it remains as long as the note is sustained, and how fast it returns to zero once the note is released. You can draw such an envelope with four line segments: the

(continued)

# Ferocious FORTRAN.

Microsoft® FORTRAN crunches numbers with a vengeance!

It combines fast and efficient native code compilation with built-in 8087 coprocessor support. The result? Mini and mainframe performance from your MS™ DOS micro.

Based on the '77 standard, Microsoft FORTRAN supports extensive statements and data types—including complex numbers and IEEE single and double-precision floating point accuracy.

Support for large arrays (greater than 64K bytes), separate module **MICROSOFT** compilation, The High Performance Software and overlays, allow you to create very large programs—up to one megabyte, with access to more than 65 thousand records in a file as large as four gigabytes.

How do programmers feel about Microsoft FORTRAN?

“The first FORTRAN compiler

that takes advantage of the full addressing capability of the 8088 and the power of the 8087.”

—Jack Wilschke, *Softalk*

“We decided to use the Microsoft FORTRAN Compiler for its INTEGER 4 capability and the flexibility of its 8087 implementation.”

—Charlie Huizena & Chip Barnaky, *PC World*

Call 800-426-9400 to order the ferocious FORTRAN.  
\$350\*

In Washington State, call 206-828-8088. Ask for operator A4, who will rush you your order, send you more information, or give you the name of your nearest dealer to see Microsoft FORTRAN in action.



\*Price exclusive of handling and Washington State sales tax.  
Microsoft is a registered trademark and MS is a trademark of Microsoft Corporation.

Amiga defines the ADSR envelope by giving the slope and destination *y*-axis values for each line segment.) As with the audio DMA, the software involved can be told to send a signal bit to a given task when the envelope is completed.

One potentially significant piece of code is a library of text-to-speech routines that is included with the standard Amiga computer. These are transient routines that are loaded from disk to memory when needed; they are capable of "speaking" normal English text in a variety of pitches and rates via one of the sound channels. We heard the routines and found their output to be heavily inflected but understandable even with our eyes closed (a test that many text-to-speech algorithms fail).

### INTUITION

Intuition, the user interface of the Amiga, sits on top of the disk operating system and provides the icon-oriented, mouse-based, desktop-metaphor interface popularized by the Apple Macintosh. Intuition complements the architectural philosophy and the graphics capabilities of the computer by managing a complex windowing system and providing access to multitasking capabilities.

Intuition allows programs to execute, each in its own window, simultaneously. Each program opens a *virtual terminal* that has access to all the system resources. Even though multiple programs can execute simultaneously, only one can accept input and display its menu bar. You can select which program does this by clicking on its window; this window will also display special command messages from the system. Different programs can share the video display, or a single program can create several virtual terminals.

To support the simultaneous display of different resolutions and graphics modes, Intuition uses *screens*, which are rectangular areas that occupy the full width of the video display. Screens have predefined resolutions, color palettes, and height and contain one or more windows. A bar at the top of

each screen identifies the screen.

All screens have pull-down menus. Pressing the right mouse button, which generally summons a menu, transforms the screen bar into a menu bar (a strip containing the names of the menus that apply to the currently active window). The screen bar also contains two boxes that, when clicked with the left mouse button (generally responsible for selecting things), move the screen to the top or bottom of the stack of screens. You can select menu items in the conventional way, although there are several new features. Pull-down menus, for example, can have up to two levels (see photo 4). Menus can contain options that, when selected, persist until other, mutually exclusive choices are made. Programs may allow you to use command-key/letter combinations to select commonly used menu items.

Programmers have considerable flexibility in designing the menus. For example, menus can appear in multi-column format and contain graphics. Menu items can, when selected, be marked with checks, and they can automatically display command-key/letter alternatives.

Windows, which appear within screens, can support all of the Amiga's graphics, text, and animation features. Since Intuition opens application programs in windows, applications must specify their graphics, text, and color requirements by selecting or creating an appropriate screen. Intuition will support as many screens and windows as can fit in memory, but only one window and, by extension, one screen can receive input at a time. As a virtual terminal, programs need not know if they are active; they can continue to process data as long as they don't need any external input.

You can activate a window either by moving the on-screen pointer inside it and clicking the mouse button or by moving an icon into it. Closing a window causes the last activated window to be reactivated. Windows can include any of several features, including vertical and horizontal scroll bars, title bars, window-dragging areas

(used to drag the window to a new position), depth arrangers (which move the window to the top or bottom of a stack of windows), sizing boxes (which allow you to change the window's size), and close boxes (which close a window).

Intuition supports *backdrop windows*, which open behind all other windows and cannot be moved, sized, or depth-arranged. The application program is entirely responsible for maintaining its contents, and normal windows appear on top of it. A graphics program, for example, may use a backdrop window as the primary drawing area and call a normal window to show you a palette of colors from which to choose.

Programmers can specify whether an application will refresh its window when partially covered and uncovered, or whether memory must be allocated to save the concealed portions of the window. A third choice, *super bit map*, reserves enough memory to store an image larger than the windowing system will display. Intuition automatically adjusts and displays as much of the super bit map as it can. Programmers can use this technique to create windows whose contents scroll. They can also determine where windows will appear, what color to use when drawing the border and text, whether the window will have a border, and whether to include a window title.

### REQUESTERS, ALERTS, AND GADGETS

*Requesters* are pop-up information boxes that wait for either keyboard or mouse input from you. Normally, you will have to click the left mouse button over an "OK" area before continuing, although you may be able to switch to a different window (the requester will still be there when you return to the first window). With a single call, programmers can attach requesters to a window or to the double click of the mouse button.

Programmers have access to predefined system requesters, like the "Please Insert Disk XXXX" requester.

(continued)

# Plotter graphics prevent boardroom boredom

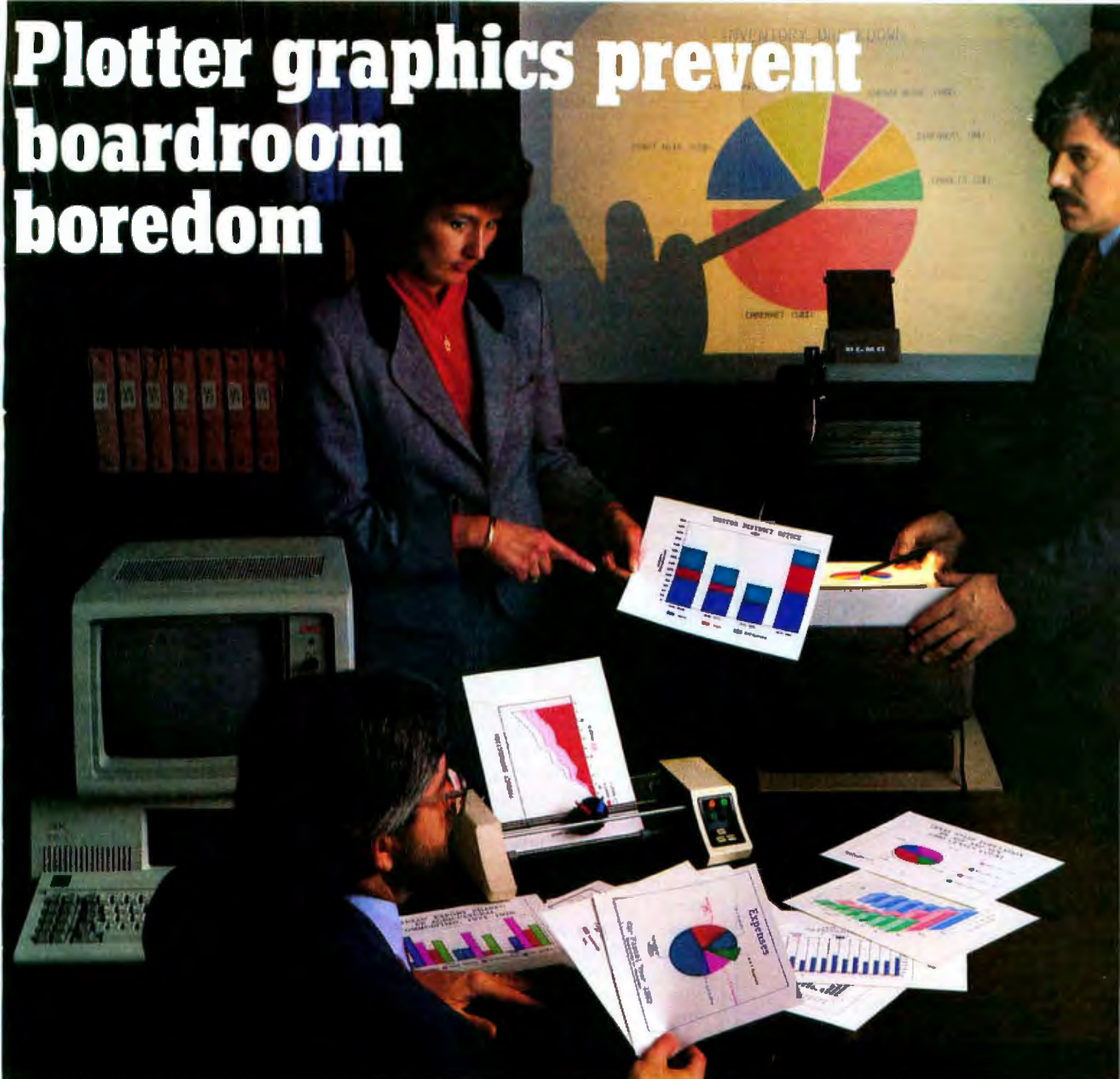

Crisp, clean, hardcopy graphics make dramatic impressions. Now, with Houston Instrument's PC Plotter, you have an affordable way to link the power of graphics to your personal computer. The PC Plotter produces quality graphics at a price you won't mind paying. It allows you to produce vibrant line, bar, and pie charts using eight different colors on either paper or overhead transparencies. And you can create either 8½" x 11" or 11" x 17" graphics.

Whether you're a computer wizard or novice, the PC Plotter is simple to operate and can be used with virtually any computer on the market today. Plus, your graphics software choices are unlimited. Houston Instrument products are supported by a versatile collection of more than 250 graphics software packages.

For example, just take a look at the above photo and you'll see plots created by PFS:® Graph, Lotus® 1-2-3,™ Peachtree Business Graphics System,™ Design Intelligence,™ Energraphics,™ and Smart Spreadsheet with Graphics.®

Make the most out of owning an IBM,® Apple® or other personal computer. Give it a PC Plotter. . . and give your presentations the visual advantage you need to win in business.

Visit your authorized Houston Instrument dealer or local computer store today and ask for a demonstration of the PC Plotter. For more information, call us at 800-531-5205. Texas residents may phone (512) 835-0900. Houston Instrument products are designed, marketed, and manufactured in Austin, Texas.

**houston  
instrument**

Inquiry 147

4P019



2

# GPIB

IEEE-488 Interfaces and  
Bus Extenders For:

IBM PC, PCjr  
& COMPATIBLES

DEC UNIBUS, Q-BUS  
& RAINBOW 100

MULTIBUS, VMEbus  
STD & S-100

Full IEEE-488 functionality, with the most comprehensive language and operating system coverage in the industry. It takes experience to make IEEE-488 systems work with nearly 4000 devices available from more than 500 different manufacturers, and experience is what enables National Instruments to take the GPIB to the second power and beyond.



2

Your personal guarantee of unsurpassed customer support and satisfaction. CALL 1-800-531-GPIB for instant access to 100+ man-years of GPIB experience.

**NATIONAL  
INSTRUMENTS**  
12109 Technology Blvd.  
Austin, TX 78727  
1-800-531-5086 512/250-9119  
Telex: 756737 NAT INST AUS

IBM and PCjr are trademarks of International Business Machines, MULTIBUS is a trademark of Intel, DEC, UNIBUS, Q-BUS, and Rainbow 100 are trademarks of Digital Equipment Corporation.

To use a custom requester, however, the programmer must specify things like gadgets (discussed below), borders, requester text, and, if desired, hand-designed bit-mapped images.

**Alerts** are special screens that carry absolutely crucial information. They differ from requesters in that no screen or window can obscure them, and users must act immediately on the information before proceeding. **Recovery alerts** require immediate responses; **dead-end alerts** tell users that the system has crashed.

Screens, windows, requesters, and alerts all use **gadgets**, which are input devices that attach to windows, requesters, and alerts. **System gadgets** include window-sizing gadgets, window/screen-dragging areas, depth arrangers, and close boxes.

Programmers can design their own gadgets by specifying border shapes and colors, describing the select box of the gadget, providing gadget text, supplying a memory buffer for the gadget response, and defining how the gadget will behave.

In addition to system gadgets, programmers can select among Boolean, string, integer, and proportional gadgets. **Boolean gadgets** are true/false devices that return a value only when selected. **String gadgets** return a string from the keyboard. **Integer gadgets** return integer values. **Proportional gadgets**, which return a value proportional to their positions on either the horizontal or vertical axis (or both), are similar to scroll bars on the Macintosh. A programmer can customize the appearance of the **knob** (the element that slides along the axis of movement) to something different from the default rectangular shape.

## THE WORKBENCH

Intuition includes Workbench, an iconic, window-based command interface. The Workbench area is a four-color screen with 640- by 200-pixel resolution. It is both a **screen** on which disks will open and application programs will run and an **application** that keeps track of Workbench objects and displays information using Intuition

windows. The Workbench automatically opens when you enter a disk containing it. By opening the Workbench library, programmers can access Workbench functions to create and manipulate the Workbench and Workbench objects.

In the Workbench, users can open and close disks, tools, projects, drawers, the clipboard, and the trash can. Opening a **tool** (Amiga's term for an application program) creates a window on the current screen. Tools create **projects**—files associated with the tool. (A document file, for example, is the project of a word-processing application.) Opening a tool automatically opens a window that lists the names of available projects. Opening a project icon automatically opens the tool associated with it.

Workbench also supports **extended selection**, a method of selecting multiple items that will be operated on in the order they were selected. For example, you can select a word processor and three projects (documents); the word processor will then work on the projects in the order in which they were selected.

**Drawers** are Workbench icons that contain tools, projects, and other drawers; when opened, they display their contents as icons in a window. To add an item to the drawer, either drag the item's icon into the window of an opened drawer or drop it over a closed drawer's icon. You can delete an item by moving its icon over the trash can, a special drawer in each disk drawer that contains deleted objects.

The **clipboard** is a special object that lets you transfer data between tools (programs). The clipboard stores the last text, graphics, or data cut from a project as a RAM-based file (disk-based if the clipping is too large for memory). By using the clipboard, you can quickly transfer information between tools or projects.

Programmers can also design custom screens, in which they can specify things like the screen size and position, the number of colors available, the screen titles, and the default font.

(continued)



# Avocet puts you in the chips!

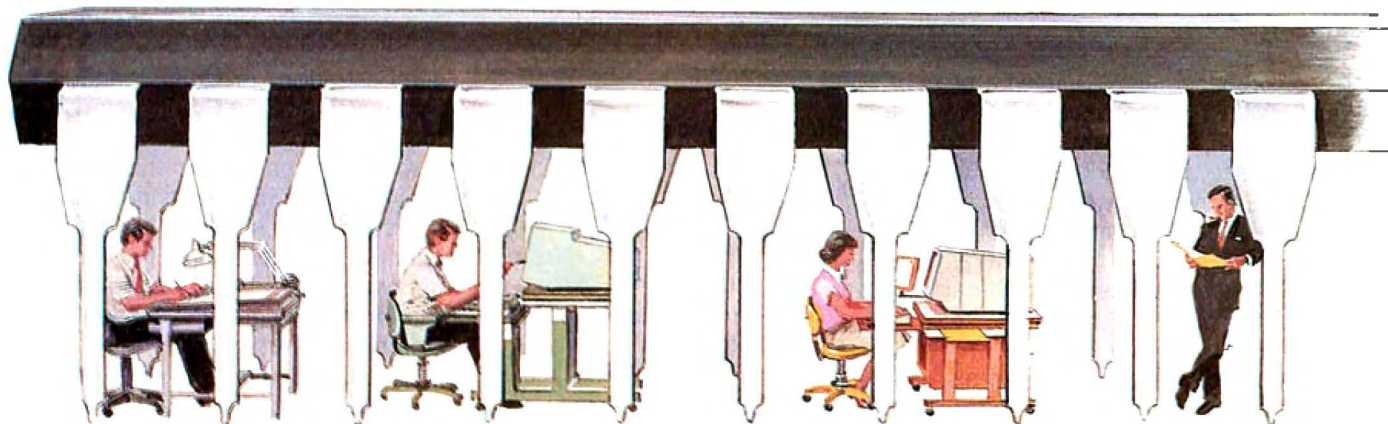

**Now you can use your PC to develop software for virtually any microprocessor. Quickly. Easily. Inexpensively.**

#### THE AVOCET CROSS-ASSEMBLER FAMILY.

Avocet Cross-assembler	Target Micro-processor	CP/M*-80	CP/M-86 IBM PC, MSDOS**
XASMO4	6804	\$250.00	\$250.00
XASMO5	6805	200.00	250.00
XASMO9	6809	200.00	250.00
XASM18	1802/1805	200.00	250.00
XASM48	8048/8041	200.00	250.00
XASM51	8051	200.00	250.00
XASM65	6502/65C02	200.00	250.00
XASM68	6800/01,6301	200.00	250.00
XASM75	NEC 7500	500.00	500.00
XASMB5	8085	250.00	250.00
XASM400	COP400	300.00	300.00
XASMF8	FB/3870	300.00	300.00
XASMZ8	Z8	200.00	250.00
XASMZ80	Z80	250.00	250.00
<b>NEW!</b>			
XASM6811	68HC11	250.00	250.00
<b>NEW!</b>			
XASM180	HD64180	250.00	250.00
XMAC682	68200	595.00	595.00
XMAC68K	68000/68010	595.00	595.00

\* Trademark of Digital Research

\*\* Trademark of Microsoft

Avocet cross-assemblers, simulators, emulators and EPROM programmers will help put your design ideas into more chips than any other software development system on the market. You don't need a mainframe, or even a dedicated system. All you need is a PC, a good idea...and Avocet. It's as simple as that.

Avocet has been creating tools for software development since 1979 to help design engineers find easier and more productive ways to develop software for virtually any microprocessor—without

switching development systems.

Our customers turn ideas into real products. From data entry through assembly, debugging and final EPROMs, Avocet has everything you need to transform your personal computer into a fully integrated development system.

#### Cross-assembler capabilities.

No matter what the application, our family of cross-assemblers runs on any computer with CP/M\* or DOS and processes assembly language for most microprocessors.

#### Taking the bugs out.



Avocet's new debugging tools will eliminate "crash and burn" from your vocabulary in two ways.

First, AVSIM software simulator/debuggers allow you to test program modules on your PC. No special hardware is required for executing your target code interpretively in a crash-proof, interactive environment. AVSIM's full screen display lets you see at a glance what your program is doing.

When you're ready to test your program in a working model, Avocet's TRICE in-circuit emulators allow you to examine target memory and register, set breakpoints, single-step, trace and more. A standard serial interface lets you control emulation and download code from your PC.

And best of all, TRICE costs less than \$500.

#### Progressive EPROM programming.

Avocet AVPROM programmers work with over 37 different devices including EPROMs through 27512, CMOS and E<sup>2</sup> PROMs, and MPU/EPROM combos using fast "adaptive" algorithms. These intelligent, self-contained units work with any personal computer using Avocet's GDX driver software.

#### Made to order.

You don't have to come to Maine to get Avocet products (unless, of course, you want a really great lobster dinner).

Just call, toll-free,

## 1-800-448-8500

(in the U.S. except Alaska and Hawaii)

and we'll rush out your order, send out more information, or, if you want, talk about some of your great ideas. Avocet Systems Inc., P.O. Box 490-B8, Rockport, Maine 04856. (207) 236-9055. Telex: 467210 AVOCET CI

**AVOCET SYSTEMS INC.** 

The Workbench also contains a program called Preferences that lets you set things like the maximum time for two clicks to be considered a double click, the monitor type, the speed with which keyboard keys repeat, the interval before they begin to repeat, and the presence of optional peripherals, including printers, modems, and touchpads.

The Preferences program can also give you access to a command-line interface (CLI), which allows you to get work done via typed-in commands. The CLI, which opens as a window under Workbench, will not be heavily documented in the standard manuals, and you will normally not see the icon associated with it. The CLI uses commands that are similar to those of Microsoft's MS-DOS. It can, for example, examine directories, run programs, and redirect input and output; in essence, it gives programmers access to the operating system that is "underneath" Workbench.

### CAVEATS

This product preview is unusual in that we looked at the Amiga in an earlier state than we usually do for other product previews. We feel justified in doing this for two reasons: First, the hardware *was* in its final state (the custom chips were working on the production-version motherboard, although the PROM [programmable read-only memory] chips did not contain the final version of the ROM code); second, the Amiga should be announced by the time you read this, and we feel that the technology used here is noteworthy. BYTE will print a formal review of the Amiga as soon as we can get our hands on a finished machine.

We wrote this product preview after two days with the Amiga engineering staff, much study of four volumes of technical documentation and several user manuals, and subsequent telephone conversations. At the time we saw the machine, neither the ROM code nor the operating system had been "frozen," which limited the amount of software we could see to the Workbench user interface, several

**Table 1:** *This is a list of the announced hardware and software for the Amiga.*

#### Hardware

- 20-megabyte hard disk,
- 20-megabyte tape backup, multifunction card,
- 2400-bps modem (Tecmar)
- Laser disk,
- Color digitizer,
- Genlock peripheral—allows computer's display to overlay an external video signal (Commodore)

#### Software

- Pascal,
- Linkage Editor,
- Overlay Loader,
- Macro Assembler (Metacomco)
- Turbo Pascal (Borland International)
- Logo (The LISP Company)
- Propaint,
- Business Graphics,
- Graphicraft,
- Animation (Island Graphics)
- Enable/Write (The Software Group)
- Textcraft (Arktronics)
- Musicraft (Commodore)
- Harmony and four-octave music keyboard,
- Pitchrider (Cherry Lane Technologies)
- C Compiler (Lattice)
- General Ledger,
- Accounts Receivable,
- Accounts Payable (Chang Laboratories)
- 7 Cities of Gold,
- One on One,
- Archon,
- Adventure Construction Set,
- Pinball Construction Set,
- Skyfox,
- Financial Cookbook,
- Deluxe Music Construction Set,
- Black Knight,
- Video Construction Set,
- Return to Atlantis (Electronic Arts)
- Communications package (Software 66)
- Welcome Aboard,
- Print Shop,
- SynCalc,
- Mindwheel (Broderbund)
- Keyboard Cadet,
- The Halley Project (Mindscape)
- All Infocom Interactive fiction products

demonstration programs, and an early version of the Graphicraft drawing program.

All the screen shots in this product preview came from working (though still unfinished) software, but most of what we've written about the Amiga's software came from the documentation or the engineers. According to Commodore/Amiga, the BASIC that will be bundled with the system will have extended graphics and sound capabilities driven by calls to the ROM routines. Table 1 gives a list of products for the Amiga that we learned of from their respective manufacturers.

### CONCLUSIONS

We were impressed by the Amiga's detail and speed of the color graphics and by the quality of its sound system. The interlocking features of the Amiga—its custom chips, multitasking support, multiple DMA channels, shared system bus, display-driven coprocessor, system routines in ROM, etc.—point to a complexity of hardware design that we have not seen before in personal computers. (It's interesting to note that the Macintosh's complexity is in its software and that, according to several third-party developers who have used both computers, the Macintosh is harder to program.) The synergistic effect of these features accounts for the speed, quality, and low cost of the Amiga.

We are also very excited about the inclusion of the text-to-speech library in the Amiga. This means that *any* Amiga program can potentially create voice output, something that has never been common in personal computers because it was never, until now, a standard feature.

The hardware looks good—we have seen it work—but we saw very little software actually working (a painting program, the Workbench "desktop," and a few demonstration programs). However, we think this machine will be a great success; if that happens, the Amiga will probably have a great effect on other personal computer companies and the industry in general. ■



# NUMBER SMASHER

**Speeds Up Everything...Especially 1-2-3™!**

The MicroWay NUMBER SMASHER triples the speed of all cpu bound software while doubling the speed of 8087 bound software. When combined with MicroWay's FASTBREAK™ it results in an increase in the speed of 1-2-3™ of up to 80 to 1! If you're tired of WAITing, the SMASHER is the card for you!

The heart of the NUMBER SMASHER is a 9.54 mhz 8086 working with a matched high speed 8087. The card comes standard with 512K of 16 bit RAM and can be expanded to 640K. It triples the throughput of your original 8088 by doubling the system clock speed and quadrupling the data bus bandwidth.

Software compatibility is guaranteed by the nature of our card. It does not augment the 8088, but replaces it with a special 8086 that runs as a true 16-bit processor in the first 640K of ram and as an 8-bit processor everywhere else.

Examples of software which show dramatic speed-ups include AUTOCAD, 1-2-3™ worksheets which depend heavily on financial or transcendental functions, and multi-user operating systems. Any program written with an MS-DOS compiler that supports the 8087, such as MS-FORTRAN or 87BASIC, will run on the NUMBER SMASHER at least a factor of 2.5 times faster! Software that comes with the card also increases the throughput of I/O bound programs and includes a disk cache routine, ram disk and print spooler.

The NUMBER SMASHER is an upgrade product for 8088 based PCs and compatibles. It works on the IBM-PC and XT, the COMPAQ and compatibles manufactured to the IBM-PC hardware standard. Contact MicroWay or your local MicroWay Installation Center for technical specifications and supporting benchmarks.

**Micro  
Way**

**The World Leader in 8087 Support**

P.O. Box 79, Kingston, Mass. 02364 USA (617) 746-7341

NUMBER SMASHER and FASTBREAK are trademarks of MicroWay, Inc. LOTUS and 1-2-3 are trademarks of Lotus Development Corp.



## For everyone who ever tried doing five things at once

**The perfect computer program  
for someone as busy as you.  
It lets you keep several other  
programs working at once.**

Do you ever go in so many directions  
so fast not even a computer can keep up  
with you?

Well, now an IBM Personal Comput-  
er can—thanks to IBM TopView.

TopView is a new kind of software  
that lets you switch between other pro-  
grams as quickly as you can change your  
mind, even run several programs at the  
same time.

Once you load TopView into your  
computer, you load the other programs  
you use most—as many as your com-  
puter's memory will permit.

After that, the greatest distance  
between two programs is just a couple of

keystrokes, or (optional) mouse moves.

There's no waiting and a lot less  
diskette swapping.

But when you're *really* busy is when  
TopView really shines, letting you do  
many jobs simultaneously.

For example, you can print a letter,  
while you search a file, while you analyze  
a spreadsheet, while your clock/calen-  
dar reminds you that your automatic  
dialer is about to place a call for you.



## ...IBM presents TopView.

And you can see everything through on-screen "windows" and control it all with easy-to-use pop-up menus.

You can even make unrelated programs work together: say a "Brand Y" spreadsheet with a "Brand Z" word processor:

But simplest of all is a certain "Brand IBM", namely the IBM Assistant Series—for filing, writing, planning, reporting and graphing.

Many other popular programs also work with TopView, and the number is growing.

Naturally, the more computer memory you have, the more TopView can help you. At least 512K is recommended.

And the price is only \$149\*.

Beyond that, all you need is to be the kind of person who never does a single thing all day, but who wants to do everything, at once.

To learn more, call an IBM marketing representative, or visit an IBM Product Center or Authorized IBM PC or Software Dealer.

For the store nearest you, and a free brochure, call 800-447-4700. (In Alaska and Hawaii, 800-447-0890.)

Personal Computer Software

\*IBM Product Center price.

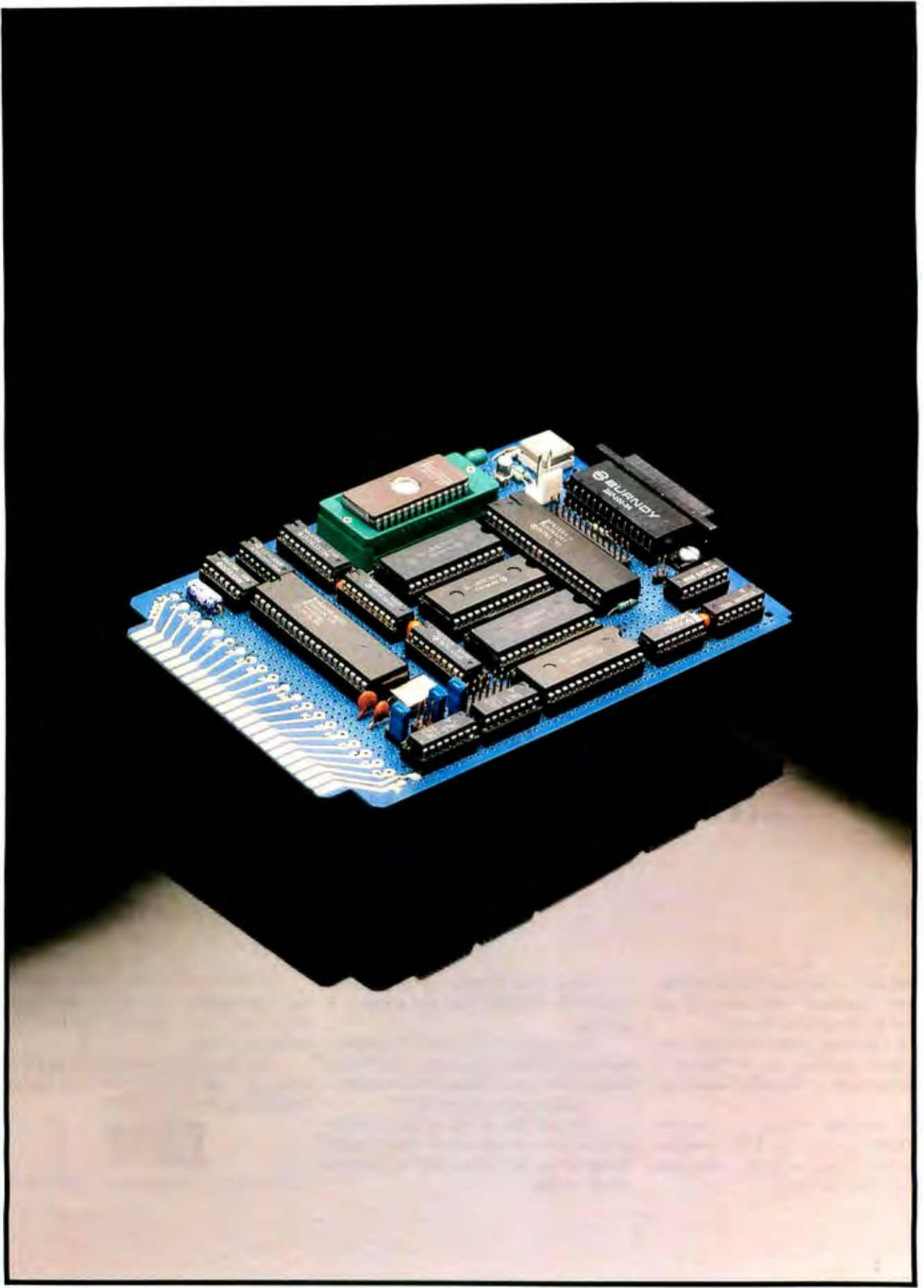

## BUILD THE BASIC-52 COMPUTER/ CONTROLLER

BY STEVE CIARCIA

*A single-board problem solver  
with great potential*



One of the most popular Circuit Cellar projects was the Z8 BASIC computer/controller presented in July and August of 1981. Since then, thousands of Z8 controller boards have found their way into end-user and OEM applications.

I specifically designed the original Z8 controller because I hate programming. Generally speaking, if the program has fewer than 100 lines I'll grin and bear it. Any longer than that, however, and I lose interest and call in a programmer. To ease the pain, I generally use high-level languages like BASIC. Most people understand BASIC, and it excuses me from wasting time on tedious bit manipulations merely to demonstrate a hardware peripheral device. (My favorite programming language is solder.)

I don't try to justify using BASIC. I just get results. While others are arguing the merits of Pascal and C, I've plugged in my single-board computer/controller and am plinking away in BASIC to solve the problem. I've learned enough about other programming languages so that I know when to nod appreciatively at a programmer's description of a random-number seed generator written in some obscure programming dialect.

This "plug and program" approach has been adequately satisfied by the Z8, but I

find that I purposely avoid applications involving floating-point calculations or trigonometric functions that would otherwise force me to resort to assembly-language programming (ugh!). In an effort to forestall my inevitable defection from BASIC, I am continually on the lookout for cost-effective performance boosters that I can package as single-board problem solvers (that execute in BASIC, naturally). And I just found another one!

What I have found is the Circuit Cellar BASIC-52 computer/controller (BCC-52) board. It uses the new Intel 8052AH-BASIC microcontroller chip that contains a ROM (read-only memory)-resident 8K-byte BASIC interpreter. The BCC-52 board includes the 8052AH, 48K bytes of RAM/EPROM (random-access read/write memory/erasable programmable ROM), a 2764/128 EPROM programmer, three parallel ports, a serial terminal port with automatic data-transmission-rate selection, a serial printer port, and is bus-compatible with the BCC-11 Z8 system/controller and all the BCC-series expansion boards I've already designed. Figure 1

*(continued)*

Steve Ciarcia (pronounced "see-ARE-see-af") is an electronics engineer and computer consultant with experience in process control, digital design, nuclear instrumentation, and product development. He is the author of several books about electronics. You can write to him at POB 582, Glastonbury, CT 06033.

is a block diagram of the hardware.

BASIC-52 is particularly suited for process control, providing IF... THEN, FOR...NEXT, DO... WHILE/UNTIL, ONTIME, and CALL statements among its broad repertoire of instructions (figure 2 lists the software features). Calculations are handled in integer or floating-point math and are fully supported with trigonometric and logical operators. Because of its low system overhead it is extremely fast and efficient.

I'll get into the system configuration and the design details momentarily, but I first have to mention an interesting aspect of BASIC-52. While I considered using EEPROMS (electrically erasable programmable ROMs) and other nonvolatile storage techniques, the sophisticated EPROM programming capabilities of BASIC-52 justified eliminating them simply on the basis of cost and board real estate. Unlike most one-shot EPROM programmers that fill the entire contents of an EPROM regardless of the application program's size, BASIC-52 treats the EPROM as write-once mass storage.

When a BASIC application program is saved to EPROM, it is tagged with an identifying ROM number and stored only in the amount of EPROM required to fit the program (plus header and EOF [end of file]). Additional application programs can be

stored to the same EPROM and recalled for execution by requesting a particular ROM number. A 27128 EPROM provides 16K bytes of mass-storage space. When it is full (a non-destructive EPROM FULL error will tell you), simply erase the present EPROM or insert another. Finally, since this pseudo-mass storage exists in directly addressable memory space rather than cassettes or disks, it runs at full processor speed and stored application programs are instantly accessible.

BASIC-52 bridges the gap between expensive, intelligent control capabilities and hard-to-justify, price-sensitive control applications. BASIC-52's full floating-point BASIC is fast and efficient enough for the most complicated tasks, while its cost-effective design lets it be considered for many new areas of implementation.

I'm bullish on the BCC-52 board, and you can expect to see it in future Circuit Cellar projects. With so much power and convenience, I can accomplish quite a bit in a few lines of code—especially since that's all I may ever write.

**THE BCC-52 BOARD**

The BCC-52 is a single-board controller/development system. Shown as a prototype in photo 1 and as a schematic in figure 3, this 17-chip circuit

fits in a compact 4½ by 6½ inches (the same size as the Term-Mite smart terminal [see photo 2], if you want a two-board complete system—see my columns in the January and February 1984 issues of BYTE). It contains RAM/EPROM, an EPROM programmer, three parallel ports, and two serial ports.

The BCC-52 board has five main sections: processor, address decoding and memory, parallel I/O (input/output), serial I/O, and EPROM programmer.

The BCC-52 board is based on the 8052AH-BASIC chip, a preprogrammed version of Intel's 8052AH microcontroller (see figure 4). The 8052AH is the newest of Intel's 8-bit microcontroller-chip series, also known as the MCS-51 family.

The 8052AH contains 8K bytes of on-chip ROM, 256 bytes of RAM, three 16-bit counter/timers, six interrupts, and 32 I/O lines. In the 8052AH-BASIC chip, the ROM is a masked BASIC interpreter, and the I/O lines are redefined to address, data, and control lines. Figure 5a illustrates the 8052AH-BASIC chip pinout.

The 8052AH-BASIC chip has a 16-bit address and an 8-bit data bus (the 8 least significant address bits [AD0-AD7] and the data bus [D0-D7] are multiplexed together, similar to

*(continued)*

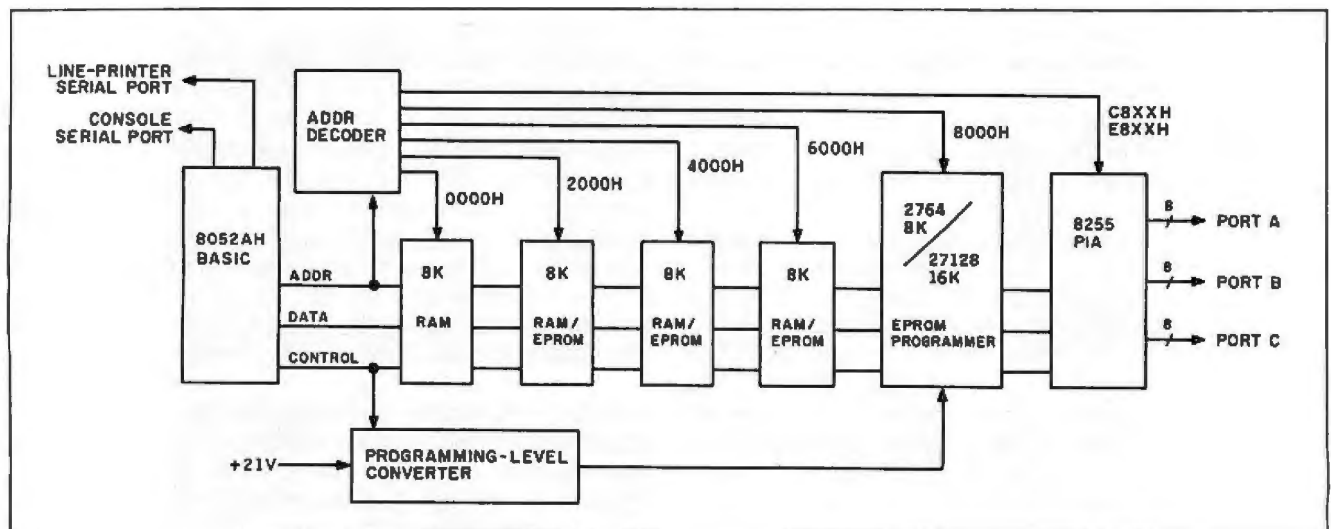

Figure 1: Block diagram of the Circuit Cellar BASIC-52 computer/controller board.



# CIRCUIT CELLAR

Command	Function	Statement	Function
RUN	Execute a program	POP	Pop argument stack to variables
CONT	Continue after a stop or Control-C	PWM	Pulse-width modulation
LIST	List program to the console device	REM	Remark
LIST#	List program to serial printer	RETI	Return from interrupt
NEW	Erase the program stored in RAM	STOP	Break program execution
NULL	Set null count after carriage return/line feed	STRING	Allocate memory for strings
RAM	Evoke RAM mode, current program in read/write memory	UI1	Evoke user console input routine
ROM	Evoke ROM mode, current program in ROM/EPROM	UI0	Evoke BASIC console input routine
XFER	Transfer a program from ROM/EPROM to RAM	UO1	Evoke user console output routine
PROG	Save the current program in EPROM	UO0	Evoke BASIC console output routine
PROG1	Save data-transmission-rate information in EPROM		
PROG2	Save data-transmission-rate information in EPROM and execute program after reset		
FPROG	Save the current program in EPROM using the intelligent algorithm		
FPROG1	Save data-transmission-rate information in EPROM using the intelligent algorithm		
FPROG2	Save data-transmission-rate information in EPROM and execute program after reset, use intelligent algorithm		
		<b>Operator</b>	<b>Function</b>
<b>Statement</b>	<b>Function</b>	CBY()	Read program memory
BAUD	Set data-transmission rate for line-printer port	DBY()	Read/assign internal data memory
CALL	Call assembly-language program	XBY()	Read/assign external data memory
CLEAR	Clear variables, interrupts, and strings	GET	Read console
CLEARs	Clear stacks	IE	Read/assign IE register
CLEAR1	Clear interrupts	IP	Read/assign IP register
CLOCK1	Enable real-time clock	PORT1	Read/assign I/O port 1 (P1)
CLOCK0	Disable real-time clock	PCON	Read/assign PCON register
DATA	Data to be read by READ statement	RCAP2	Read/assign RCAP2 (RCAP2H:RCAP2L)
READ	Read data in DATA statement	T2CON	Read/assign T2CON register
RESTORE	Restore read pointer	TCON	Read/assign TCON register
DIM	Allocate memory for arrayed variables	TMOD	Read/assign TMOD register
DO	Set up loop for WHILE or UNTIL	TIME	Read/assign real-time clock
UNTIL	Test DO loop condition (loop if false)	TIMER0	Read/assign TIMER0 (TH0:TL0)
WHILE	Test DO loop condition (loop if true)	TIMER1	Read/assign TIMER1 (TH1:TL1)
END	Terminate program execution	TIMER2	Read/assign TIMER2 (TH2:TL2)
FOR-TO-{STEP}	Set up FOR...NEXT loop	+	Addition
NEXT	Test FOR...NEXT loop condition	/	Division
GOSUB	Execute subroutine	**	Exponentiation
RETURN	Return from subroutine	*	Multiplication
GOTO	GOTO program line number	-	Subtraction
ON GOTO	Conditional GOTO	.AND.	Logical AND
ON GOSUB	Conditional GOSUB	.OR.	Logical OR
IF-THEN-{ELSE}	Conditional test	.XOR.	Logical exclusive OR
INPUT	Input a string or variable		
LET	Assign a variable or string a value (LET is optional)	<b>Stored Constant</b>	
ONERR	ONERR or GOTO line number	PI	PI - 3.1415926
ONTIME	Generate an interrupt when time is equal to or greater than ONTIME argument; line number is after comma		
ONEX1	GOSUB to line number following ONEX1 when INT1 pin is pulled low		
PRINT	Print variables, strings, or literals, P. is shorthand for print	<b>Operators—Single Operand</b>	
PRINT#	Print to software serial port	ABS()	Absolute value
PH0.	Print hexadecimal mode with zero suppression	NOT()	One's complement
PH1.	Print hexadecimal mode with no zero suppression	INT()	Integer
PH0.#	PH0.# to line printer	SGN()	Sign
PH1.#	PH1.# to line printer	SQR()	Square root
PUSH	Push expressions on argument stack	RND	Random number
		LOG()	Natural log
		EXP()	"e" (2.7182818) to the X
		SIN()	Returns the sine of argument
		COS()	Returns the cosine of argument
		TAN()	Returns the tangent of argument
		ATN()	Returns the arctangent of argument

Figure 2: Detailed description of the Intel 8052AH BASIC-52 programming language.

# CIRCUIT CELLAR

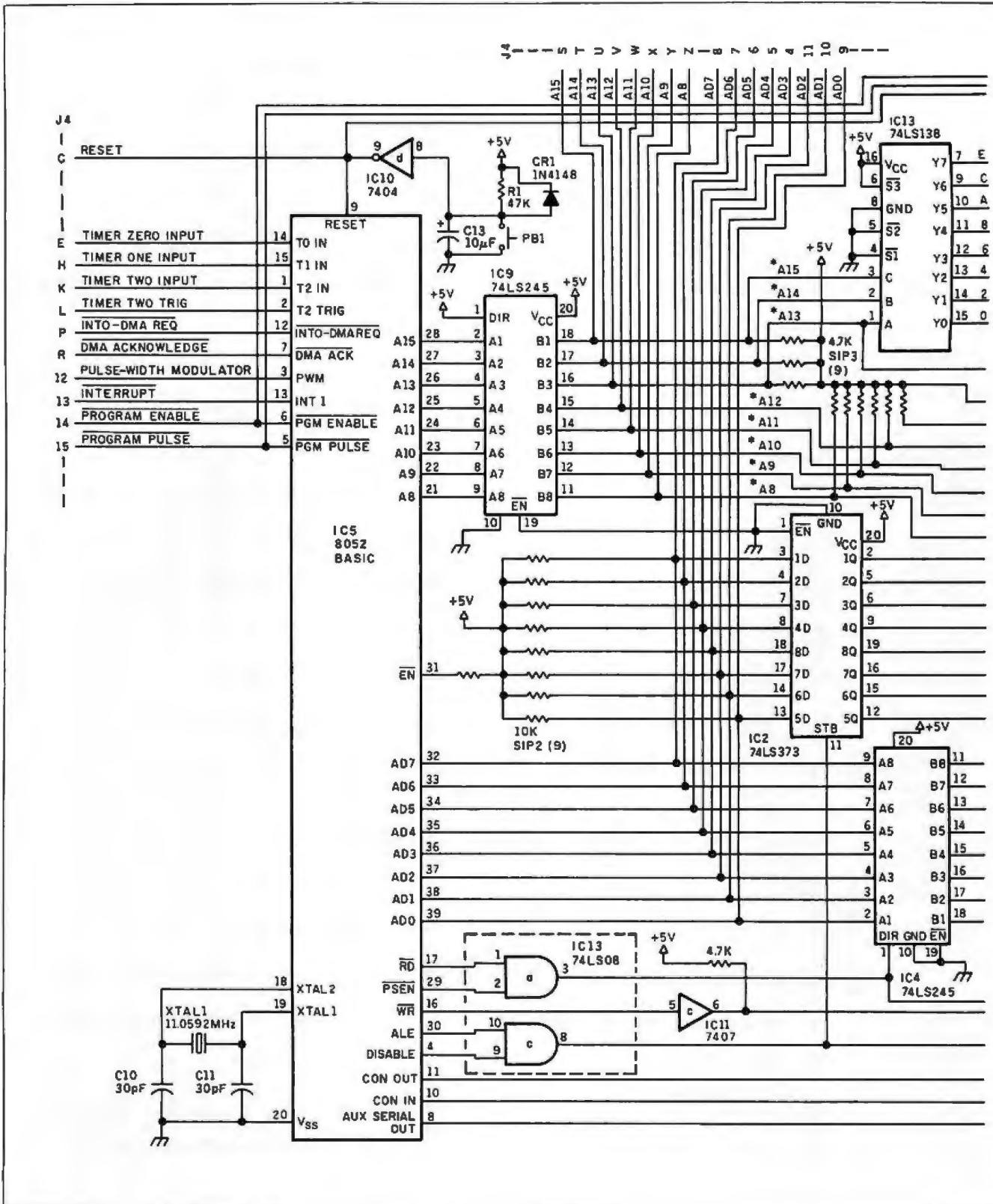
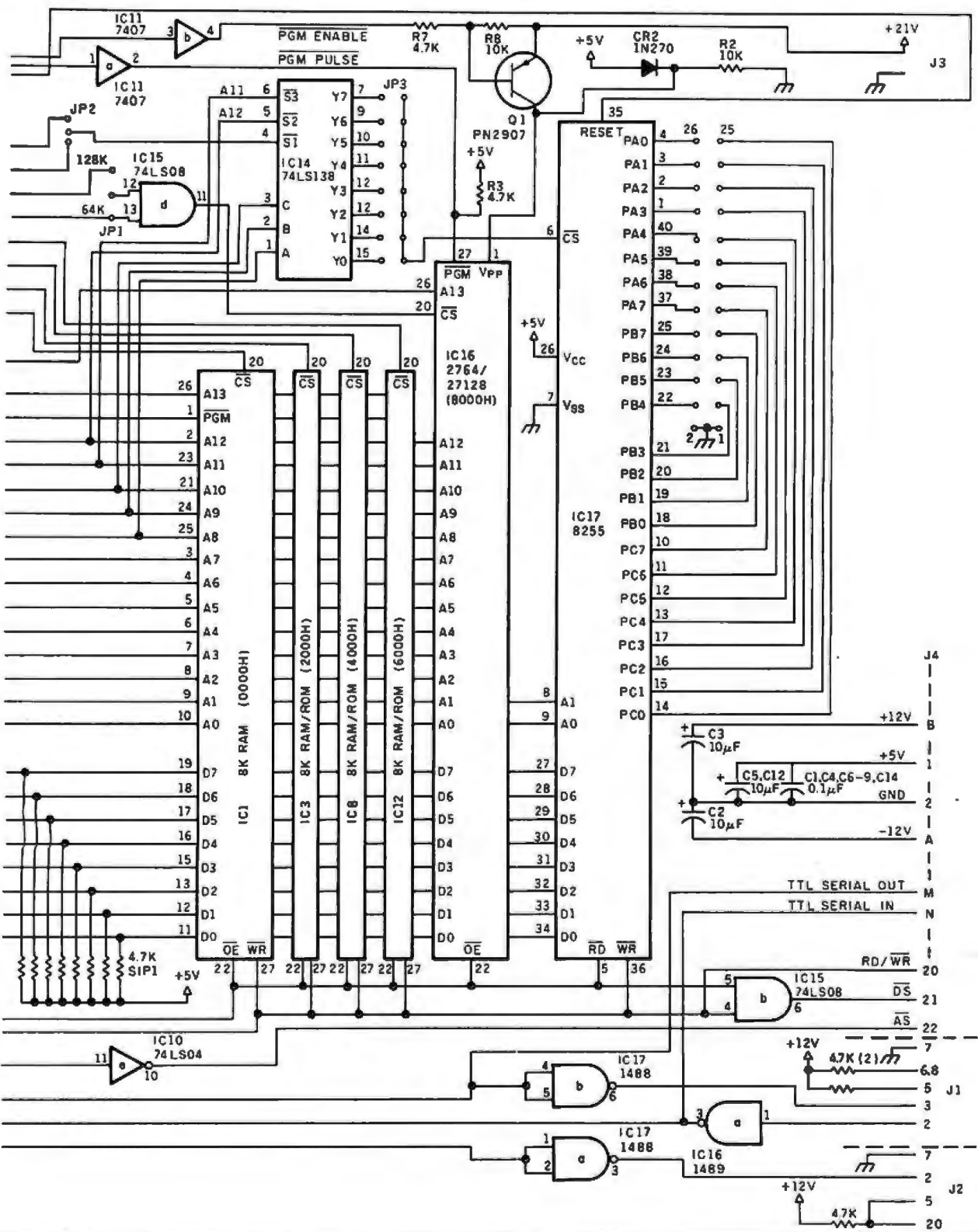

Figure 3: Schematic diagram of the BCC-52 board.

# CIRCUIT CELLAR



the 8085 and Z8). When the chip is powered up, it sizes consecutive external memory from 0000 to the end of memory (or memory failure) by alternately writing 55 hexadecimal and 00 to each location. A minimum of 1K bytes of RAM is required for BASIC-52 to function, and any RAM

must be located starting at 0000. [Editor's note: For the remainder of the article, all addresses and data values will be hexadecimal unless otherwise specified.]

Three control lines,  $\overline{RD}$  (pin 17),  $\overline{WR}$  (pin 16), and  $\overline{PSEN}$  (pin 29), partition the address space as 64K bytes each of program and data memory. How-

ever, user-called assembly-language routines and EPROM programming are unsupported in data memory. For that reason, the BCC-52 board as I've designed it is addressed completely as program memory (RAM/EPROM mode), both for RAM and I/O. The addressing logic is as follows:

1. The  $\overline{RD}$  and  $\overline{WR}$  pins on the 8052AH chip enable RAM from 0000 to 7FFF. Addresses are used to decode the chip select ( $\overline{CS}$ ) for the RAM devices, and  $\overline{RD}$  and  $\overline{WR}$  are used to enable the  $\overline{OE}$  and  $\overline{WE}$  (or  $\overline{WR}$ ) pins, respectively.
2.  $\overline{PSEN}$  is used to enable EPROM from 2000 to 7FFF. Addresses are used to decode the  $\overline{CS}$  for the EPROM devices, and  $\overline{PSEN}$  is used to enable the  $\overline{OE}$  pin.
3. Between 8000 and 0FFFF, both  $\overline{RD}$  and  $\overline{PSEN}$  are used to enable either EPROM or RAM.  $\overline{RD}$  and  $\overline{PSEN}$  are applied as inputs to AND gate IC15, a 74LS08. The  $\overline{WR}$  pin on the chip is used to write to RAM in this same address space.

BASIC-52 reserves the first 512 bytes of external data memory to implement two software stacks: the control stack and the arithmetic or argument stack. Understanding how the stacks work is necessary only if you want to link BASIC-52 and 8052 assembly-language routines. The details of how to do this are covered in the assembly-language linkage section of the *MCS BASIC-52 User's Manual*.

The control stack occupies locations 60 (96 decimal) through 0FE (254 decimal) in external RAM. This memory is used to store all information associated with loop control (i.e., DO...WHILE, DO...UNTIL, and FOR...NEXT) and BASIC subroutines (GOSUB). The stack is initialized to 0FE and "grows down."

The argument stack occupies locations 12D (301 decimal) through 1FE (510 decimal) in external RAM. This stack stores all the constants that BASIC is currently using. Operations like add, subtract, multiply, and divide always operate on the first two numbers on the argument stack and return the result to the argument

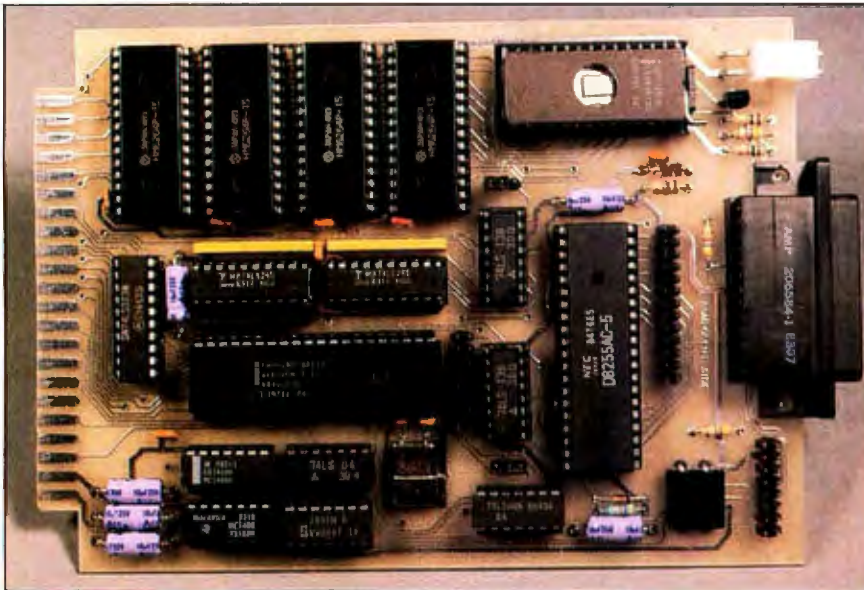

Photo 1: The Circuit Cellar BASIC-52 computer/controller prototype.

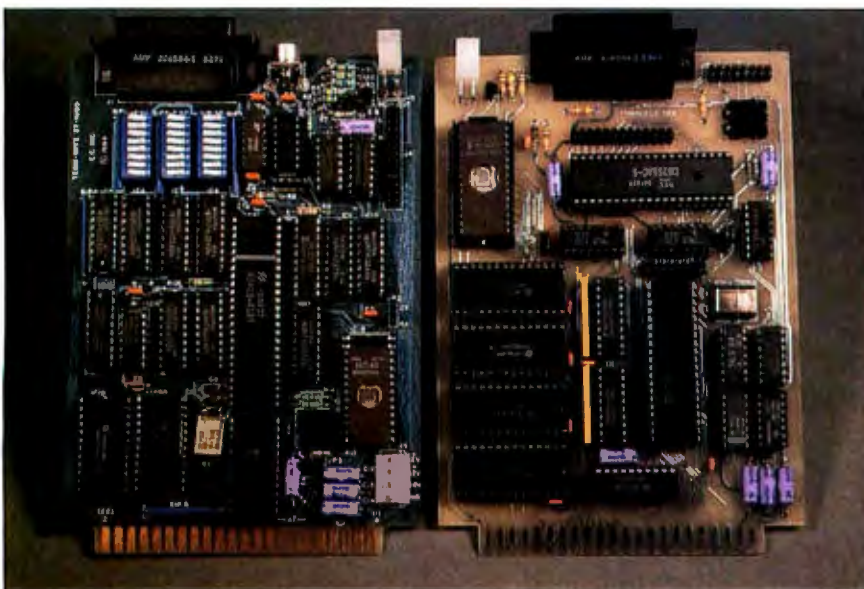

Photo 2: On the right is the BCC-52 prototype; on the left is the Circuit Cellar BCC Term-Mite smart-terminal board (see the January 1984 Circuit Cellar). With the addition of a video monitor and keyboard, the two boards constitute a complete computer system suitable for software development or installed use.

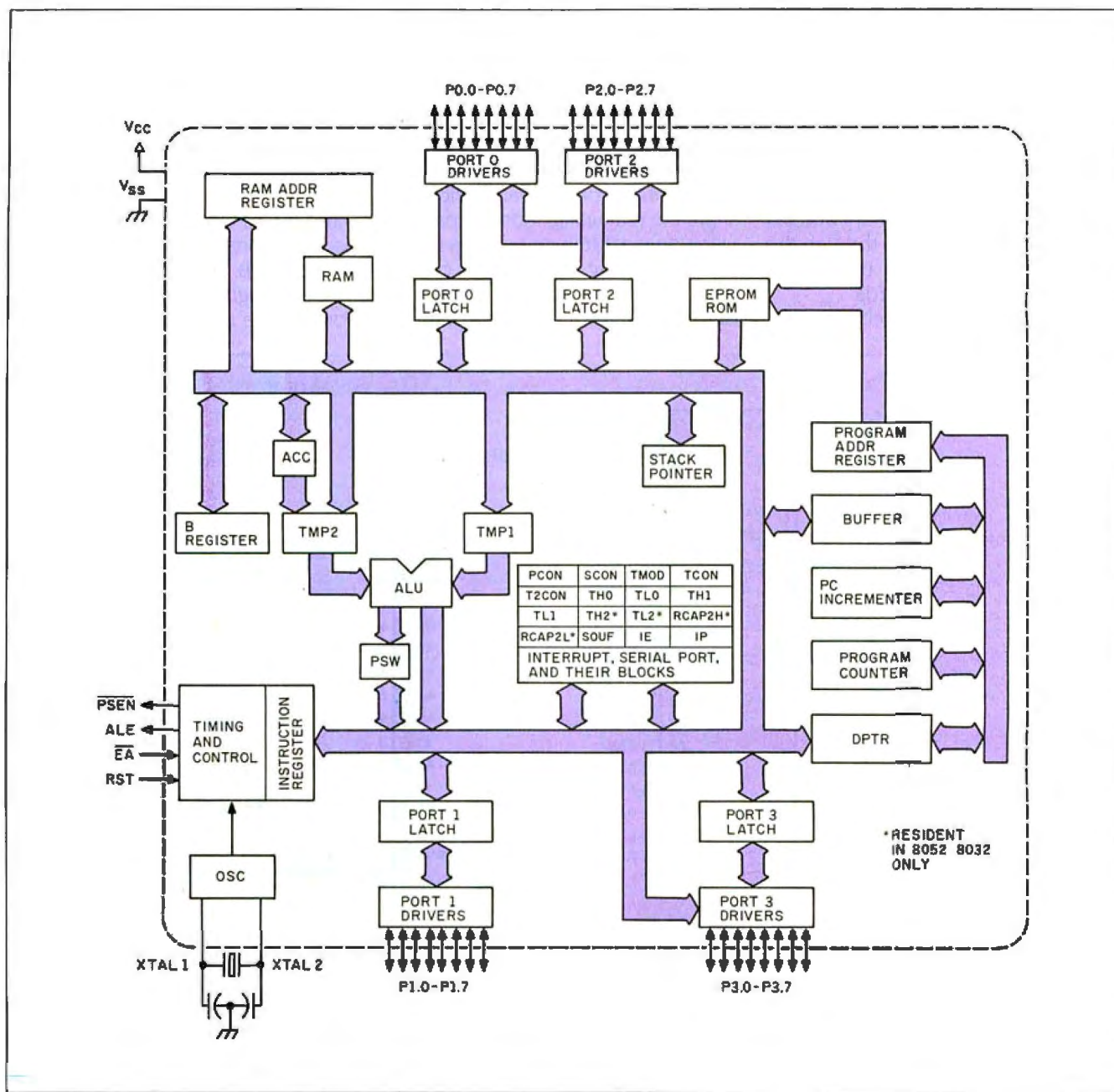

Figure 4: Block diagram of the Intel 8052AH-BASIC chip.

stack. The argument stack is initialized to IFE and "grows down" as more values are placed on it. Each floating-point number placed on the argument stack requires 6 bytes of storage.

The stack pointer on the 8052AH (special-function register, SP) is initialized to 4D (77 decimal). The 8052AH's stack pointer "grows up" as

additional values are placed on the stack.

#### ADDRESS DECODING

The three most significant address lines (A13-A15) are connected to a 74LS138 decoder chip, IC13, which separates the addressable range into eight 8K-byte memory segments, each with its own chip select (Y0-Y7). The

four least significant chip selects are connected to 28-pin, 64K-bit (8K by 8) memory devices, either 2764 EPROMs or 6264 static RAMs. IC1, addressed at 0000, must be RAM in order for BASIC-52 to function. IC locations 3 (2000-3FFF), 11 (4000-5FFF), and 12 (6000-7FFF) can use either RAM or EPROM. IC16 (8000-

(continued)

9FFF or BFFF) is an EPROM programming socket intended for 2764 or 27128 EPROMs (see figures 5b and 5c).

Altogether, you have 48K bytes of memory on the BCC-52 board if you use four 6264 RAMs (as ICs 1, 3, 8, and 12) (see figure 5d) and a 27128 EPROM in IC16. The memory and I/O can be further expanded through the expansion bus using BCC-series Z8-system expansion cards.

A second 74LS138 decoder, IC14,

partitions either C800-CFFF or E800-EFFF as eight 256-byte I/O blocks. Rather than simply using the available C000 or E000 strobes from IC13 alone, which would occupy a 2000 address space for a single PIA (peripheral interface adapter) chip, IC14 allows many peripheral devices to share the remaining address space by using only a 256-byte address range. This addressing convention is consistent with other expansion boards I've designed, and it is easy to configure

a 64-channel A/D (analog-to-digital) or 128-channel power I/O system using this board with a number of peripheral cards.

**PARALLEL I/O**

The BCC-52 board contains an 8255A-5 PIA (IC17) that provides three 8-bit I/O software-configurable parallel ports. The three I/O ports, labeled A, B, and C, and a write-only mode-configuration port occupy four consecutive addresses in one of the

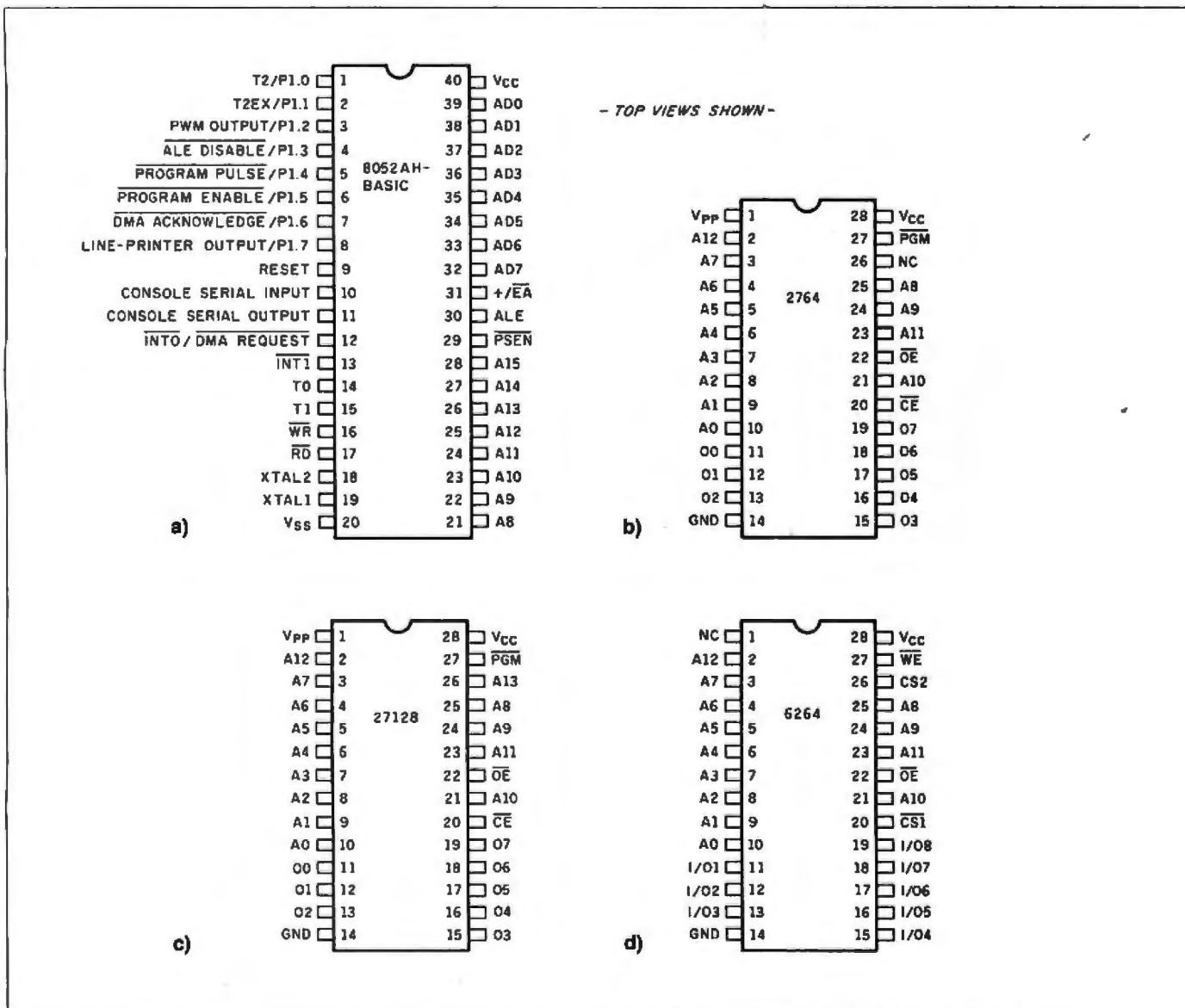

Figure 5: Pinouts for (a) the 8052AH-BASIC chip, (b) the 2764 8K-byte EPROM, (c) the 27128 16K-byte EPROM, and (d) the 6264 8K-byte RAM.

TEAR AND COMPARE! TEAR AND COMPARE! TEAR AND COMPARE! TEAR AND COMPARE!

**LOGICSOFT INCREDIBLE  
NEW SERVICE BREAKTHROUGH**

**FREE  
OVERNIGHT  
DELIVERY!**

On Orders Totalling  
Over \$100...Shipped  
UPS FREE if  
Under \$100

VIA... **Purolator  
courier**



MEMBER  
Direct Marketing  
Association Inc.



**PLUS... For a Limited Time...  
Any Price \$10  
By.....**

**THAT'S RIGHT! OUR LOWEST PRICE GUARANTEE IS STILL EFFECTIVE!**  
Tell us the advertiser and price of any software or hardware item on these pages currently advertised in any popular computer publication and we'll beat that price by \$10. This offer does not apply to items under \$100 or where the price is not lower than Logicsoft's.

**SOFTWARE for IBM PC**

**DATA BASE MANAGEMENT**

KNOWLEDGEMAN	\$259
Clout 2	145
Trm IV	189
R:Base 4000	265
R:Base 5000	399
DB Master	475
d BASE III	365
Quickcode III	159
d Base II (New Release)	269
Condor III	349
Data Base Mgr. II (alpha)	175
Extended Report Writer	119
Friday	169
pfs: file & pfs: report	165
REVELATION	745
Powerbase	255
Easyfiler	99

**FINANCIAL**

DOLLARS AND SENSE	\$115
Market Mgr. Plus (Dow Jones)	179
MANAGING YOUR MONEY	119

**GRAPHICS**

CHARTMASTER	\$275
-------------	-------

**GRAPHICS (cont.)**

BPS Graphics	\$289
SIGNMASTER	195
pfs: graph	85
Graphwriter	319
Graphwriter Extension	319
Graphwriter Combo Pak	485
Microsoft Chart	175
ENERGRAPHICS	259
Energraphics (w/plotter opt.)	325
PC Draw	295

**LANGUAGES/UTILITIES**

CONCURRENT PC DOS (cont.)	\$175
Pascal MT + (PC DOS)	349
PL/1 (DR)	489
Display Manager (DR)	359
Access Manager (DR)	269
LATTICE C COMPILER	305
C-Food Smorgasbord	119
CIS Cobol 86 (DR)	479
Pascal Compiler (MS)	245
C Compiler (MS) (New Release)	305
Microsoft Sort	159
Cobol Compiler (MS)	479

**LANGUAGES/UTILITIES (cont.)**

Business Basic (MS)	\$299
FORTRAM COMPILER (MS)	229
C86 C Compiler (Computer innovations)	329
INTEGRATED/SPREADSHEETS	
LOTUS 1-2-3 (While They Last)	\$329
Enable	305
Smart Series	579
FRAMEWORK	355
Open Access	395
Electric Desk	229
SYMPHONY (Limited Quantity)	459
Supercalc 3	175
Multiplan	129
TK! Solver	279
pfs: plan	85

**PROJECT SCHEDULERS**

MICROSOFT PROJECT	\$165
SuperProject (IUS)	245
HARVARD TOTAL PROJECT MGR.	285

**WORD PROCESSING**

Wordstar 2000	\$259
WORDSTAR 2000 PLUS	309

**WORD PROCESSING (cont.)**

Wordstar Pro Pac	\$265
Wordstar Pro Plus	345
WORD PERFECT (New Release)	245
Microsoft Word	245
MULTIMATE	249
Volkswriter Deluxe	165
Peachtree 5000	199
Easywriter II/Speller/Mailer	199
Edix & Wordix	255
Finalword	225
Samna III	325
Xy Write II Plus	255
Think Tank	125
pfs: write	85
MISCELLANEOUS UTILITIES	
PROKEY 3.0	\$89
Norton Utilities (New Release)	65
SIDEKICK (unprotected)	65
Crosstalk XVI (New Release)	115
Sideways	45
Copy II PC	39
DESK ORGANIZER	129

**HARDWARE for IBM PC**

**GRAPHICS BOARDS**

AST	
Preview	\$279
EVEREX	
Graphics Edge	\$375
HERCULES	
Graphics Card	\$325
Color Card	169
PLANTRONICS/FREDERICK	
Colorplus	\$385
STB	
Graphics Plus II	\$315
TECMAR	
Graphics Master	\$459
TSENS LABORATORIES	
Ultra Pak	\$545

**GRAPHICS BOARDS (cont.)**

PARADISE SYSTEMS	
Multi-Display Card	\$279
Modular Graphics Card	289
Options A&B	Lowest Price
MODEMS (INTERNAL)	
PROMETHEUS	
Pro-modem 1200B	\$319
QUADRAM	
Asher	\$395
HAYES	
Smartmodem 1200B (cont.)	\$385
NOVATION	
Smart-Cat Plus	\$355
RACAL-VADOC	
Maxwell 1200PC	\$395

**MODEMS (INTERNAL) (cont.)**

VEN-TEL	
PC Modem Half Card	\$439
COMMUNICATIONS BOARDS	
AST	
AST-5251-11	\$699
AST-3780	749
DCA	
IRMA Board	\$949
QUADRAM	
Quadlink	\$449
MULTI-FUNCTION BOARDS	
AST RESEARCH	
Six Pak Plus (64k)	\$259
Mega Plus II (64k)	275
VO Plus II	135

**MULTI-FUNCTION BOARDS (cont.)**

AST RESEARCH (cont.)	
Advantage (128k)	\$429
QUADRAM	
Quadboard (64k)	\$259
STB	
Rio-Plus II (64k)	\$259
Rio Grande	375
Grande Byte	275
TECMAR	
Captain	\$235
KEYBOARDS	
KEYTRONIC	
5150	\$159
5151 (Deluxe)	179
5152 B	645

Prices subject to change without notice.

Immediate Replacement on any Defective Product.

NO SURCHARGE for VISA or MasterCard • No Sales Tax on Orders Outside N.Y. State • Purchase Orders  
Welcome from Qualified Institutions • NO SURCHARGE (Please call for price verification) • Please add 2%  
for handling and insurance (Int'l orders add 1) • Payment: MasterCard VISA American Exp. C.O.D. Money Order or Check



National Sales  
Hot Line

**1-800-645-3491**

Customer Service 1-800-431-9037

New York State...516-249-8440

Canada...416-283-2354

Domestic/International Telex...286905 Soft UR

**LOGICSOFT®**

THE LOGICAL CHOICE  
A Member of The Logic Group

110 Bi-County Blvd., Farmingdale, N.Y. 11735

SEE OTHER SIDE  
FOR MORE SAVINGS!

**WE WILL BEAT ANY PRICE BY \$10**  
See Other Side for Details

**NEW! Expanded Special Order Dept.**  
We know there are many products that simply cannot be found through mail order. We've solved that problem...just ask for our **SPECIAL ORDER** department...We've got the suppliers...still at low mail order prices!

**FREE**  
Overnight Delivery  
See Other Side for Details

**TEAR AND COMPARE! TEAR AND COMPARE! TEAR AND COMPARE! TEAR AND COMPARE!**

**SOFTWARE for Macintosh**

**DATABASE**

DB Master	\$125
Filevision	105
1st Base	105
Habladex	29
Helix	249
Mainstreet Filer	195
Megatier	135
Microsoft File	140
Omnis 2	155
Omnis 3	Lowest Price
Overview	179
pis: File & Report	105
MacLion	245
Factfinder	85

**GRAPHICS**

Animation Tool Kit	\$39
DaVinci Series (Buildings, Interiors, Landscapes)	180

**GRAPHICS**

DaVinci Commercial Int	\$149
DaVinci Building Blocks	49
MacPic	35
MicroSoft Chart	85
Click Art Series (Graphics, Pub's, Letters, Effects)	125

**LANGUAGES/UTILITIES**

Basic Interpreter (MS)	\$95
MacForth (Level 1)	85
MacForth (Level 2)	135
Smoothtalker	115
Softmaker II	119
Softworks "C"	275
PC to Mac & Back	85
Hippo-C (Level 1)	115

**MANAGEMENT/FINANCE**

Dollars & Sense	\$89
Front Desk	85

**MANAGEMENT/FINANCE (cont.)**

Home Accountant Plus	\$89
MacManager	35
MacProject	Lowest Price
Management Edge	125
Market Analyzer	Lowest Price
Market Manager Plus (Dow Jones)	129
Peachtree G/L	89
Sales Edge	165
Straight Talk	49
Financial Planning (Apropos)	89
Investment Planning (Apropos)	69
Communications Edge	119
Negotiation Edge	175
Tax Manager (MicroLab)	119
Forecast	45
Electronic Checkbook	59
MacCalendar	59

**MANAGEMENT/FINANCE (cont.)**

General Financial Analysis	\$70
Real Estate Dev. (Comm. or Res.)	70

**SPREADSHEETS/INTEGRATED**

Jazz	Lowest Price
Multiplan	\$125
Microplanner	Lowest Price
TK Solver	169
Ensemble	185

**WORD PROCESSING**

Microsoft Word	\$149
Think Tank (128k)	85
MacSpell+Right	55
MacSpell +	50
Hayden Speller	45
Think Tank (512k)	135
TECH (Lingust)	70
Megaform	185

**HARDWARE for Macintosh**

**ASSIMILATION PROCESS**

Mac Daisywheel Connection	\$85
Mac Turbo Touch	85

**CURTIS SURGE PROTECTOR**

Diamond	\$39
Emerald	49
Sapphire	59
Ruby	89

**HAYES**

Smartmodem 300	\$205
Smartmodem 1200	\$445

**INTERMATRIX**

Macphone	\$159
----------	-------

**KENSINGTON**

300 Baud Modem	\$95
Surge Suppressor	39

**MICROCOM**

MacModem	\$450
----------	-------

**MICRON TECHNOLOGY**

Micron Eye	\$325
------------	-------

**MICROSOFT**

MacEnhancer	\$179
-------------	-------

**NOVATION**

Cat	\$375
-----	-------

**OPTIMUM**

MacTote	\$65
---------	------

**PROMETHEUS**

Promodem 1200	\$375
Mac Pak	105

**DISKS**

Maxell 3 1/2" (Box of 10)	\$35
Memorex 3 1/2" (Box of 10)	39
3M 3 1/2" (Box of 10)	39

**GENERAL HARDWARE**

**PRINTERS\***

**DIABLO**

36**	\$1229
D25**	619
630 API	1699
630 ECS**	1799

**EPSON**

LQ1500	\$1199
Parallel Interface	79
JX-80	599
LX-80**	265
RX-100	399
FX-80**	379
FX-100**	599

**C. ITOH**

Prowriter 8510 BPI	\$375
Starwriter A10P	529
Starwriter F10-40P	989
Printmaster F10-55P	1249

**JUKI**

6100	\$439
6300	799

**MANNESMANN TALLY**

Sprint	\$279
160	579
180	649

**NEC**

2030**	\$719
2050**	995
3530	1329
3550	1395
8950**	1949
Printwriter P2**	675
Printwriter P3**	895

**OKidata**

182 IBM	\$239
84-IBM	799
192 IBM	489
83-IBM	639
2410P	2295

**QUADRAM**

Quadjet	\$789
---------	-------

**QUME**

Sprint 11/40**	\$1299
Sprint 11/55**	1595
Sprint 11/90**	2199

**SILVER REED**

400	\$279
500	349
550	449
770	795

**PRINTERS\* (cont.)**

**TOSHIBA**

P351	\$1375
P351 Tractor	165
1340	779

**CITIZEN**

MSP10	\$409
MSP15	619
MSP20	579
MSP25	789

**PRINTER/PLOTTERS\***

**HOUSTON INSTRUMENT**

PC Plotter	\$475
------------	-------

**MONITORS\***

**AMDEK**

Color 300	\$255
Color 500	389
Color 600	479
Color 710	579
12" Green 300G	135
12" Amber 300A	145
12" Amber 310A	169

**NEC**

JB 1201	\$159
JB 1205	149
JC 1215	239
JC 1216	399

**PRINCETON GRAPHICS**

RGB MX 12	\$489
RGB SR 12	599
Scan Doubler Board (for SR 12)	186
Amber Max 12E	185

**QUADRAM**

Quadchrome 12"	\$465
Quadchrome 17"	1695
Quadchrome II 14"	465
Amberchrome 12"	165

**TAXAN**

100G	\$125
105A	135
121	149
122	149
210	259
420	489
440	699

**VIDEO TERMINALS\***

**ADDS**

A-2 Green	\$465
A-3	\$465

**VIDEO TERMINALS\* (cont.)**

**ALTOS**

Smart II	\$695
----------	-------

**QUME**

OVT 102-Green	\$395
OVT 102-Amber	415
OVT 103-Green	810
OVT 103-Amber	845
OVT 108-Green	445
OVT 108-Amber	515

**TELEVIDEO**

600	\$1220
800A	975
910	420
910 +	555
921	445
922	750
924	635
925	695
925E	595
WYSE	\$485
50	560
75	560

**ZENITH**

Z-22	\$445
Z-29	595
Z-49	Lowest Price

**MULTI-FUNCTION BOARDS**

**AST RESEARCH**

Six Pak Plus (64k)	\$259
--------------------	-------

**IDEA**

IDE Amax 384 (64k)	\$259
--------------------	-------

**ORCHID**

Blossom (0 k)	\$235
STB	
Super Rio (64k)	\$329

**COMMUNICATIONS BOARDS**

**AST**

AST SNA	\$699
AST BSC	699

**GRAPHICS BOARDS**

**AST**

Monochrome plus	\$425
-----------------	-------

**MA SYSTEMS**

Peacock Color Board	\$245
---------------------	-------

**PERSYST**

Monochrome Card	\$199
-----------------	-------

**QUADRAM**

Quadcolor I	\$195
Quadcolor II	485

**MODEMS (External)**

**PROMETHEUS**

Pro-modem 1200	\$375
----------------	-------

**QUADRAM**

Quadmodem 1100	\$555
----------------	-------

**HAYES**

Smartmodem 300	\$205
Smartmodem 1200	445
Smartmodem 2400	719

**NOVATION**

Access 1-2-3	\$475
Professional 2400	635

**PRENTICE**

Popcom X100	\$379
Popcom C100	355

**BACAL-VADIC**

Maxwell 1200 V	\$439
2400 PC	635

**VEN-TEL**

PC Modem 1200	\$399
1200 Plus	399

**BACK-UP DEVICES**

**ALLOY**

PC Quick Tape	\$1719
---------------	--------

**SYSGEN**

Image	\$635
-------	-------

**MOUSE INPUT DEVICES**

**MOUSE SYSTEMS**

PC Mouse w/paint brush	\$139
------------------------	-------

**MICROSOFT**

Microsoft Mouse (Serial)	149
Microsoft Mouse (Bus)	139

**SURGE PROTECTORS**

**KENSINGTON MICROWARE**

Masterpiece	\$119
-------------	-------

**CURTIS**

Diamond	\$39
Emerald	49
Sapphire	59
Ruby	69

**MEMORY CHIPS**

(200ns) 64k	\$35
(150ns) 256k	69

**DISKETTES**

LOGICTRAK 5 1/4" 100% Guaranteed, Double side, double density	
10 per box	
20 + boxes	per disk \$2.35
10-19 boxes	per disk \$2.50
2-9 boxes	per disk \$2.95
1 box	per disk \$3.99

\*Due to weight restrictions, Printers and Monitors are shipped UPS...FREE! \*\*Parallel interface req...Ask sales agent



**National Sales Hot Line**  
**1-800-645-3491**  
**Customer Service 1-800-431-9037**

**LOGICSOFT**  
THE LOGICAL CHOICE  
A Member of The Logic Group  
110 Bi-County Blvd., Farmingdale, N.Y. 11735

New York State..516-249-8440 Canada....416-283-2354 Domestic/International Telex...286905 Soft UR



eight jumper-selectable I/O blocks. With C000 selected and pin 17 of IC14 (Y0) jumpered to pin 6 of IC17 (at JP3), the range would be C800-C803. Using the XBY() operator in BASIC, data can be written to and read from this PIA. (You are probably more familiar with PEEK and POKE. PEEK (C802H) is accomplished with XBY (C802H), and POKE C902H,A is XBY(C802H) = A.) I won't belabor the discussion on the 8255. I have used it many times in Circuit Cellar projects

and refer you to the manufacturer's data sheets.

The three parallel ports and ground are connected to a 26-pin flat ribbon-cable connector. The outputs are TTL (transistor-transistor logic)-compatible.

**SERIAL I/O**

Two serial ports are found on the BCC-52 board. One is for the console I/O terminal (IC5 pins 10 and 11); the other is an auxiliary serial output (IC5 pin 8) frequently referred to as the

line-printer port. When using an 11.0592-megahertz (MHz) crystal, the console port does automatic data-transmission-rate determination on power-up (a preset data-transmission rate can alternatively be stored in EPROM as well). I've used it at 19,200 bits per second (bps) with no degradation in operation.

The BAUD[expr] statement is used to set the data-transmission rate for the line-printer port. In order for this statement to properly calculate the data-transmission rate, the crystal (special-function operator—XTAL) must be correctly assigned (e.g., XTAL = 9000000). BASIC-52 assumes a crystal value of 11.0592 MHz if no XTAL value is assigned.

The main purpose of the software line-printer port is to let you make a hard copy of program listings and/or data. The command LIST# and the statement PRINT# direct outputs to the software line-printer port. If the BAUD[expr] statement is not executed before a LIST# or PRINT# command/statement is entered, the output to the software line-printer port will be at about 1 bps, and it will take a long time to output something. It is necessary to assign a data-transmission rate to the software line-printer port before using LIST# or PRINT#. The maximum data-transmission rate that can be assigned by the BAUD[expr] statement depends on the crystal, but 4800 bps is a reasonable maximum rate.

MCI488 and 1489 level shifters (ICs 6 and 7) convert the TTL levels from the console and line-printer ports to RS-232C. (The TTL serial lines are also connected to the bus to allow use of the Term-Mite smart-terminal board without RS-232C voltages.) The BCC-52 board requires only about 200 milliamperes (mA) at +5 volts (V) to function. The voltage required for external RS-232C communication is ±12 V; that required for EPROM programming is +21 V.

**EPROM PROGRAMMER**

One of the more unique and powerful features of the BCC-52 board is its

(continued)

■ Mode Selection (goes with figure 5b)

Mode	Pins	$\overline{CE}$ (20)	$\overline{OE}$ (22)	$\overline{PGM}$ (27)	$V_{PP}$ (1)	$V_{CC}$ (28)	Outputs (11-13, 15-19)
Read		$V_{IL}$	$V_{IL}$	$V_{IN}$	$V_{CC}$	$V_{CC}$	Dout
Standby		$V_{IN}$	x	x	$V_{CC}$	$V_{CC}$	High Z
Program		$V_{IL}$	x	$V_{IL}$	$V_{PP}$	$V_{CC}$	Din
Program Verify		$V_{IL}$	$V_{IL}$	$V_{IN}$	$V_{PP}$	$V_{CC}$	Dout
Program Inhibit		$V_{IN}$	x	x	$V_{PP}$	$V_{CC}$	High Z

■ Mode Selection (goes with figure 5c)

Mode	Pins	$\overline{CE}$ (20)	$\overline{OE}$ (22)	$\overline{PGM}$ (27)	$V_{PP}$ (1)	$V_{CC}$ (28)	Outputs (11-13, 15-19)
Read		$V_{IL}$	$V_{IL}$	$V_{IN}$	$V_{CC}$	$V_{CC}$	Dout
Standby		$V_{IN}$	x	x	$V_{CC}$	$V_{CC}$	High Z
Program		$V_{IL}$	x	$V_{IL}$	$V_{PP}$	$V_{CC}$	Din
Program Verify		$V_{IL}$	$V_{IL}$	$V_{IN}$	$V_{PP}$	$V_{CC}$	Dout
Program Inhibit		$V_{IN}$	x	x	$V_{PP}$	$V_{CC}$	High Z

■ Mode Selection (goes with figure 5d)

$\overline{WE}$	$\overline{CS}_1$	$\overline{CS}_2$	$\overline{OE}$	Mode	I/O Pin
x	H	x	x	Not Selected (Power Down)	High Z
x	x	L	x		High Z
H	L	H	H	Output Disabled	High Z
H	L	H	L	Read	Dout
L	L	H	H	Write	Din
L	L	H	L		Din

x: don't care

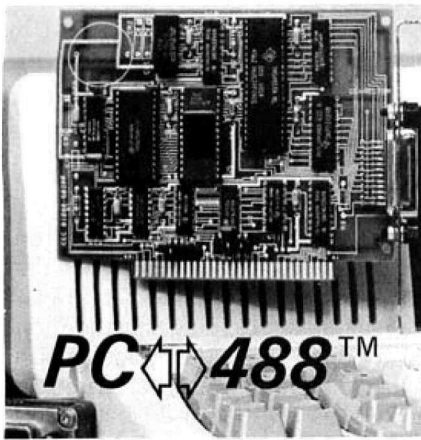

## An IEEE-488 interface for all IBM-PC's and COMPATIBLES

### VERSATILE

Easy-to-use commands for all IEEE-488 (GP-IB, HP-IB) functions.

Resident firmware supports **BASIC, Pascal, C, and FORTRAN.**

Emulates Hewlett-Packard controller functions and graphics language statements.

Supports Tektronix® Standard Codes and Formats.

Print listings, plot graphs, and use **Lotus 123™** with IEEE-488 peripherals.

### FAST

Direct memory transfer rates to 800K bytes/second.

### PROFESSIONAL

Clear and concise documentation includes a complete tutorial, programming examples, and application programs.

**\$395.00 complete.** There are no additional software charges.

Find out why **PC 488** is the first choice of over 500 companies.



**CAPITAL EQUIPMENT CORP.**

10 Evergreen Avenue  
Burlington, MA. 01803  
(617) 273-1818

IBM is a trademark of International Business Machines Corp.  
Lotus 123 is a trademark of Lotus Development.  
Tektronix is a trademark of Tektronix, Inc.

## CIRCUIT CELLAR

ability to execute and save programs in an EPROM. The 8052AH chip actually generates all the timing signals needed to program 2764/128 EPROMs. Saving programs in EPROMs is a much more attractive and reliable alternative to cassette tape, especially in control and/or noisy environments.

The entire EPROM programming circuitry consists of two 7407 open-collector drivers and a single transistor circuit that switches between +5 V and 21 V (CR2, connected to the collector of the transistor should be a germanium diode like a 1N270).

Port 1, bit 4 (IC5 pin 5) is used to provide a 1- or 50-millisecond (ms) programming pulse. The length of the pulse is determined by whether we are programming Intel fast-program EPROMs or generic 2764s and 27128s. BASIC-52 calculates the length of the pulse from the assigned crystal value. The accuracy of this pulse is within 10 processor clock cycles. This pin is normally in a logical high (1) state. It is asserted low (0) to program the EPROMs.

Port 1, bit 5 (IC5 pin 6) is used to enable the EPROM programming voltage. This pin is normally in a logical high (1) state. Prior to the EPROM programming operation, this pin is brought to a logical low (0) state, and it is used to turn on the high voltage (21 V) required to program the EPROMs on or off.

BASIC-52 saves several programs on a single EPROM. In fact, it can save as many programs as the size of the EPROM permits. The programs are stored sequentially in the EPROM, and any program can be retrieved and executed. This sequential storage of programs is referred to as the EPROM file. The following commands permit you to generate and manipulate the EPROM file.

RAM and ROM[integer] tell the BASIC-52 interpreter whether to select the current program (the one that will be displayed during a LIST# command and executed when RUN is typed) out of RAM or EPROM. The RAM address is assumed to be 200 (512 decimal), and the EPROM address begins at 8010 (32,784 decimal).

When RAM is entered, BASIC-52 selects the current program from RAM. This is usually considered the normal mode of operation and is the mode that most users employ to interact with the command interpreter.

When ROM[integer] is entered, BASIC-52 selects the current program out of EPROM. If no integer is typed after the ROM command (i.e., ROM(cr)), BASIC-52 defaults to ROM 1. Since the programs are stored sequentially in EPROM, the integer following the ROM command selects which program you want to run or list. If you attempt to select a program that does not exist (i.e., you type in ROM 8 and only six programs are stored in the EPROM), the message Error: Prom Mode will be displayed. The error is nondestructive, and you can retype the correct command.

BASIC-52 does not transfer the program from EPROM to RAM when the ROM mode is selected, and you cannot edit a program in ROM. Attempting to do so will result in an error message.

Since the ROM command does not transfer a program to RAM, it is possible to have different programs in ROM and RAM simultaneously. You can flip back and forth between the two modes at any time. Another benefit of not transferring a program to RAM is that all the RAM can be used for variable storage if the program is stored in EPROM. The system-control values, MTOP and FREE, always refer to RAM.

The XFER (transfer) command transfers the currently selected program in EPROM to RAM and then selects the RAM mode. After the XFER command is executed, you can edit the program in the same manner any RAM program can be edited.

The PROG command programs the resident EPROM with the current program (this is the only time that the +21-V programming voltage needs to be applied). The current program can reside in either RAM or EPROM. After PROG is typed, BASIC-52 displays the number in the EPROM file the program will occupy.

Normally, after power is applied to

the BASIC-52 device, you must type a space character to initialize the 8052AH's console port. As a convenience, BASIC-52 contains a PROG1 command. This command programs the resident EPROM with the data-transmission-rate information. The next time the MCS BASIC-52 device is powered up, i.e., reset, the chip will read this information and initialize the serial port with the stored data-transmission rate. The sign-on message will be sent to the console immediately after the BASIC-52 device completes its reset sequence. The space character no longer needs to be typed.

The PROG2 command does everything the PROG1 command does, but instead of signing on and entering the command mode, the BCC-52 board immediately begins executing the first program stored in the resident EPROM.

By using the PROG2 command, it is possible to run a program from a reset condition and never connect the BCC-52 board to a console. In essence, saving PROG2 information is equivalent to typing ROM 1 and RUN in sequence. This is ideal for control applications, where it is not always possible to have a terminal present. In addition, this feature lets you write a special initialization sequence in BASIC or assembly language and generate a custom sign-on message for specific applications.

#### POWERING UP THE BOARD

The best way to check out the BCC-52 board is to run it with the minimum hardware first. With only ICs 1, 2, 4-7, 9-11, 13, and 15 installed, we have an 8K-byte RAM-only system. After applying power, BASIC-52 clears the internal 8052AH memory; initializes the internal registers and pointers; and tests, clears, and sizes the external memory.

BASIC-52 then assigns the top of external RAM to the system-control value (MTOP) and uses this number as the random-number seed. BASIC-52 assigns the default-crystal value, 11.0592 MHz, to the system-control value (XTAL) and uses this default value to calculate all time-dependent functions, like the EPROM program-

ming timer and the interrupt-driven real-time clock. Finally, BASIC-52 checks external memory location 8000 to see if the data-transmission-rate information is stored. If the data-transmission rate is stored, BASIC-52 initializes the data-transmission-rate generator (the 8052AH's special-function register, T2CON) with this information and signs on. If not, BASIC-52 interrogates the serial-port input and waits for a space character to be typed (automatic data-transmission-rate detection).

If you have entered nothing on the console device, BASIC-52 will appear inoperative to the uninitiated. Simply type a space, and the console device should display the following:

```
*MCS-52(tm) BASIC Vx.x"
READY
>
```

To see if the processor is operating correctly, we type the following:

```
>PRINT XTAL, TMOD, TCON,
T2CON
```

BASIC-52 should respond with the control and special-function values:

```
11059200 16 244 52
>
```

#### A WORD ABOUT THE BASIC

As I mentioned earlier, BASIC-52 is oriented toward process control and is significantly more powerful than a tiny BASIC. Since most of you are familiar with BASIC, I will not describe individual instructions like DO... WHILE and FOR... NEXT. Instead, I'd like to point out the pertinent features that demonstrate the exceptional small-package performance of the BCC-52 board.

MCS BASIC-52 contains a minimum-level line editor. Once a line is entered, you cannot change the line without retyping it. However, it is possible to delete characters while a line is in the process of being entered. This is done by inserting a rubout or delete character (7F). The rubout character will cause the last character entered to be erased from the text input buffer. Additionally, pressing

Control-D will cause the entire line to be erased.

#### VARIABLES AND EXPRESSIONS

The range of numbers that can be represented in BASIC-52 (in decimal) is +1E-127 to +0.99999999E+127.

It has eight digits of significance. Numbers are internally rounded to fit this precision. Numbers can be entered and displayed in four formats: integer, decimal, hexadecimal, and exponential, for example, 129, 34.98, OA6EH, 1.23456E+3.

Integers are numbers that range from -32,768 to +32,767 decimal. All integers can be entered in either decimal or hexadecimal format. A hexadecimal number is indicated by placing the letter "H" after the number. When an operator like AND requires an integer, BASIC-52 will truncate the fraction portion of the number so that it will fit the integer format. All line numbers are integers.

A variable can be either a letter (e.g. A, X, I), a letter followed by a number (e.g., Q1, T7, L3), a letter followed by a one-dimensioned expression (e.g., J(4), G(A+6), I(10\*SIN(X))), or a letter followed by a number followed by a one-dimensioned expression (e.g., A1(8), P7(DBY(9)), W8(A+B)). Variables with a one-dimensioned expression are called dimensioned or arrayed variables. Variables that involve only a letter or a letter and a number are called scalar variables.

BASIC-52 allocates variables in a static manner. Each time a variable is used, BASIC-52 allocates 8 bytes specifically for that variable. This memory cannot be deallocated on a variable-by-variable basis. If you execute a statement like Q=3, later on you cannot tell BASIC-52 that the variable Q no longer exists and free up the 8 bytes of memory that belong to Q. You can clear the memory allocated to variables with a CLEAR statement.

Relative to a dimensioned variable, it takes BASIC-52 much less time to find a scalar variable. That's because a scalar variable has no expression to

(continued)

evaluate. If you want to make a program run as fast as possible, use dimensioned variables only when you have to. Use scalar variables for intermediate variables, then assign the final result to a dimensioned variable.

An expression is a logical mathematical term that involves operators (both unary and dyadic), constants, and variables. Expressions can be simple or quite complex, e.g.,  $12 * EXP(A)/100$ ,  $H(1)+55$ , or  $(SIN(A) * SIN(A) + COS(A) * COS(A))/2$ . A stand-alone variable [var] or constant [const] is also considered an expression.

### REAL-TIME OPERATION

After RUN is typed, all variables are set equal to zero, all BASIC-evoked interrupts are cleared, and program execution begins with the first line number of the selected program. The RUN command and the GOTO statement are the only ways you can execute a program in the command mode. Program execution can be terminated at any time by typing a Control-C on the console device.

Unlike some BASIC interpreters that allow a line number to follow the RUN

command (e.g., RUN 100), BASIC-52 does not permit such a variation on the RUN command. Execution always begins with the first line number. To obtain the same functionality as the RUN[in num], use GOTO[in num] in the direct mode.

The CLOCK1 statement enables the software real-time clock in BASIC-52. The special-function operator time is incremented once every 5 ms after the CLOCK1 statement has been executed. The CLOCK1 statement uses timer/counter 0 in the 13-bit mode to generate an interrupt once every 5 ms. Because of this, the special-function operator time has a resolution of 5 ms.

BASIC-52 automatically calculates the proper reload value for timer/counter 0 after the crystal value has been assigned (i.e., XTAL = value. If no crystal value is assigned, MCS BASIC-52 assumes a value of 11.0592 MHz). The special-function operator time counts from 0 to 65,535.995 seconds. After reaching a count of 65,535.995 seconds, time overflows back to a count of 0.

The interrupts associated with the

CLOCK1 statement cause BASIC programs to run at about 99.6 percent of normal speed. That means that the interrupt handling for the real-time-clock feature consumes only about 0.4 percent of the total processor time. This is small interrupt overhead. The CLOCK0 statement disables or turns off the real-time-clock feature.

The TIME statement is used to retrieve and/or assign a value to the real-time clock after the CLOCK1 statement enables it. TIME = 5 presets the real-time clock to 5 seconds, while ONTIME 30,100 causes the program to jump to line 100 when the real-time clock reaches 30 seconds.

Finally, PWM might be useful to literally add bells and whistles to your next control application. PWM stands for pulse-width modulation. It generates a user-defined pulse sequence on IC5 pin 3.

The statement appears as PWM 50,50,100. The first expression following PWM is the number of clock cycles the pulse will remain high. A clock cycle is equal to 1.085 microseconds (11.0592-MHz crystal). The second expression is the number of clock cycles the pulse will remain low; the third expression is the total number of cycles you want to output. All expressions in the PWM statement must be valid integers, and the minimum value for the first two expressions is decimal 20.

These are only a few of the 103 commands, statements, and operators in BASIC-52. The *User's Manual* describes them in detail.

### IN CONCLUSION

This was a hard article for me to write, but not for any of the reasons you might think. So much is built into this compact board that I am impatient to use it, and it was hard to sit down and write. Unfortunately, documentation is the drudge work side of engineering.

It won't take long to put the BCC-52 board into some serious applications. It might be a single-board computer, but its configuration does not stop with a single board. The BCC-52 is BCC-series Z8-bus-compatible and can be expanded using many of the

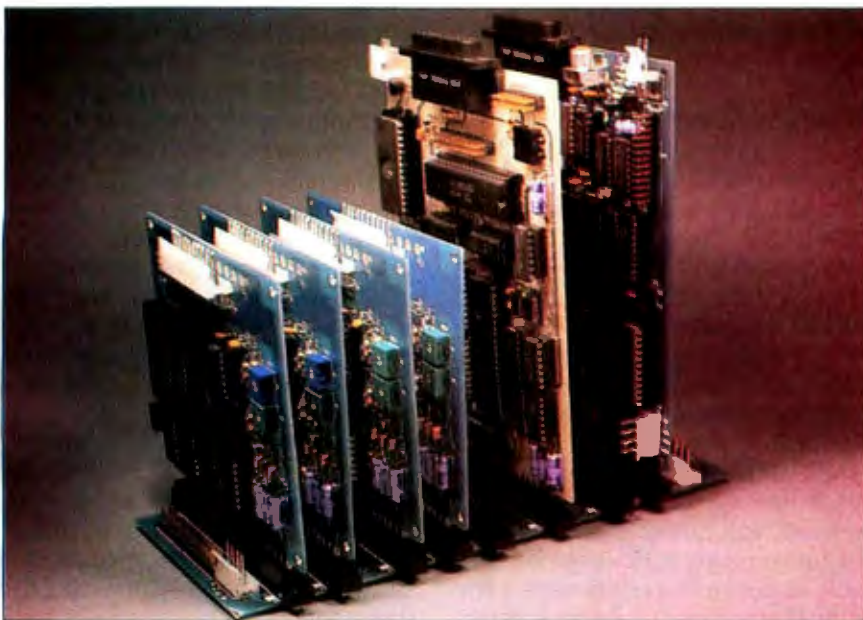

Photo 3: The BCC-52 and Term-Mite boards can be combined with other BCC-series peripheral devices to create control and data-acquisition systems. Here, they are combined with four BCC-13 8-channel, 8-bit A/D converter boards to make a 32-channel data-acquisition system.

## CIRCUIT CELLAR

projects and boards I've already designed. For example, monitoring temperatures, controlling motors and heaters, and reporting events are adequately handled by existing power I/O, serial and parallel expansion, and A/D converter boards (see photo 3).

This BASIC-52 project has just started. Because of its power, I am inspired to further develop applications and peripheral support devices. While a specific time has not been chosen, I'll be back in a few months with the next chapter on the BCC-52.

### CIRCUIT CELLAR FEEDBACK

This month's feedback is on page 376.

### NEXT MONTH

Go beyond the Z80 with the Circuit Cellar SB180 computer. ■

Diagrams and data pertinent to the 8052AH-BASIC chip are reprinted courtesy of the Intel Corporation.

**Editor's Note:** Steve often refers to previous Circuit Cellar articles. Most of these past articles are available in book form from BYTE Books, McGraw-Hill Book Company, POB 400, Hightstown, NJ 08520.

*Ciarcia's Circuit Cellar, Volume I* covers articles in BYTE from September 1977 through November 1978. *Volume II* covers December 1978 through June 1980. *Volume III* covers July 1980 through December 1981. *Volume IV* covers January 1982 through June 1983.

The following items are available from

The Micromint Inc.  
561 Willow Ave.  
Cedarhurst, NY 11516  
(800) 645-3479 for orders  
(203) 871-6170 for information

- 1 BCC-52 board with 8K bytes of RAM. Assembled and tested with operator's manual and MCS BASIC-52 User's Manual. . . . \$239
- 2 Same as item 1 in kit form. . . . \$209
- 3 8052AH-BASIC chip with MCS BASIC-52 User's Manual. . . . \$80

Please include \$4 for shipping and handling in the continental United States. \$8 elsewhere. New York residents please include 8 percent sales tax. Connecticut residents please include 7.5 percent sales tax.

To receive a complete list of Ciarcia's Circuit Cellar project kits, circle 100 on the reader-service inquiry card at the back of the magazine

Many Hard to Find Formats Available

No Lower Prices Anywhere!

No Hidden Charges

# EXPRESS

## BUSINESS SOFTWARE

<b>WORDSTAR PROPAG</b>	<b>SYMPHONY</b>	<b>SIDEKICK (C.P.)</b>	<b>SUPERCALC 3</b>	<b>WORD PERFECT</b>	<b>LOTUS 1-2-3</b>
<b>\$238</b>	<b>\$419</b>	<b>\$29</b>	<b>\$164</b>	<b>\$235</b>	<b>\$299</b>

<b>AID</b> Typequick 85 69	<b>ALPHA SOFTWARE</b> Data Base Manager 2 295 169	<b>ANDERSON-BELL</b> Abstat 395 267	<b>ASHTON-TATE</b> D Base II 495 CALL D Base III 695 CALL Framework 695 CALL Friday 295 CALL	<b>ATI</b> Training Word Star 75 45 Training dBase III 75 45	<b>BPI</b> General Accounting 585 348	<b>BORLAND INTERNATIONAL</b> Superkey 54 42 Turbo Graph 54 42 Toolbox 54 35 Turbo Pascal 70 52	<b>COLEX</b> Advanced Lotus 1-2-3 70 45	<b>CHANG LABS</b> Rags to Riches Ledger 99 79	<b>CONDOR</b> Condor 3 650 259	<b>CONTINENTAL SOFTWARE</b> Home Accountant Plus 150 89	<b>DIGITAL MARKETING</b> Writers Pak 250 165 Milestone (PC) 250 165 Datebook II 150 98 Proofreader 50 38	<b>DIGITAL RESEARCH</b> Concurrent PC DOS 295 209	<b>ENERTRONICS</b> Energraphics 350 239 Plotter Option 100 55	<b>FOX &amp; GELLER</b> DGraph 295 145 dUbi 99 58 Quickcode II or III 295 139	<b>FUNK</b> Sideways 60 39	<b>HARVARD SOFTWARE</b> Harvard Project Mgr 395 219 Harvard Total Project Mgr 495 275	<b>HUMAN EDGE</b> Mind Probe 50 35	<b>KOALA</b> Touch Tablet (PC) 150 95 MacVision 400 249	<b>LEXISOFT</b> Spellbinder 495 239	<b>LIFETREE</b> Volkswriter Deluxe 295 158	<b>LIVING VIDEO TEXT INC.</b> Think Tank (IBM) 195 99 Think Tank (Mac) 245 149	<b>MOBS</b> Knowledgeman 500 234 K Paint 100 65 K Graph 225 145	<b>MECA</b> Managing Your Money 199 119	<b>MICROGRAFX</b> PC Draw 395 289	<b>MICROPRO</b> WordStar 350 178 SpellStar 99 55 CorrectStar 145 99 MailMerge 99 55 InfoStar 250 199 WordStar 2000 495 235 WordStar 2000 Plus 595 295	<b>MICROIM</b> R Base 4000 495 239 R Base 5000 700 385 Extended Report Writer 150 109 Clout 250 128	<b>MICROSOFT</b> Multiplan 195 138 Chart (MAC) 125 99 Project 250 179	<b>MICROSTUFF</b> Crosstalk 195 98	<b>MONOGRAM</b> Dollars and Sense (IBM) 179 109 Dollars and Sense (Mac) 149 99	<b>MULTIMATE INTERNATIONAL</b> Multimate 495 231	<b>OASIS</b> Word Plus 150 105 Punctuation and Style 150 95	<b>PEACHTREE</b> Peachtext 5000 425 185 Business Graphics System 295 219 Peachpak 4 395 199	<b>PETER NORTON</b> Norton Utilities (Vers 3.0) 100 58	<b>PRENTICE-HALL</b> Execuvision 395 289	<b>PRO TEM SOFTWARE</b> Notebook II 189 123 Footnote 99 84	<b>ROSESOFT</b> ProKey 130 69	<b>SAMRA</b> Word III 550 279	<b>SORCIM</b> SuperCalc 2 295 149 Super Project 395 209 Easy System II 395 184 General Ledger 595 289 Accounts Payable 595 289	<b>SOFTWARE PRODUCTS INT'L</b> Open Access 695 349	<b>SOFTWARE PUBLISHING</b> PFS File or Write 140 85	<b>SSI</b> Word Perfect 495 249	<b>TELOS</b> Filevision (Mac) 195 119	<b>TYLOG</b> dBase Window 249 149	<b>WARNER SOFTWARE INC.</b> The Desk Organizer 195 129	<b>WOLFF SYSTEMS</b> Move It 150 85
-------------------------------	--	--	--	--	--	--	--	--	-----------------------------------	--	--	--	---	--	-------------------------------	---	---------------------------------------	---	--	---	--	--	--	--------------------------------------	--	---	--	---------------------------------------	--	---	---	--	---	---	--	----------------------------------	----------------------------------	---	---	--	------------------------------------	--	--------------------------------------	---	--

### HARDWARE SECTION

<b>AMDEK MONITORS</b> (Amber) 230 138 (Color) 349 243	<b>AST</b> Megaplus 64K 395 258 Six Pac Plus 64K 395 238	<b>HAYES</b> Smartmodem 1200 599 423 Smartmodem 1200B 549 375 Smartmodem 2400 899 695	<b>HERCULES</b> Graphic Card 499 318 Color Card 245 189	<b>PARADISE</b> Multidisplay 459 290 Modular Graphics 398 289	<b>STB</b> Graph Plus 2 395 229 Rio Plus 2 395 229
---	--	--	---	---	--

TO ORDER CALL TOLL-FREE:

(800) 235-3020 (USA)

(800) 235-3021 (CA)

(415) 382-9085

#### TERMS:

- Call for shipping charges and support policies
- Full guarantee against manufacturers defects
- Allow 3 weeks for checks to clear
- Prices may change
- Call for availability
- No cash refunds!
- Due to our low prices, all sales final.

**EXPRESS**  
BUSINESS SOFTWARE

448 IGNACIO BLVD., STE: 332  
NOVATO, CA 94947

- CALL FOR OUR FREE CATALOG
- SAME DAY SHIPMENT ON MOST ORDERS
- Prompt UPS service
- Authorized purchase orders accepted
- Dealer, institutional and quantity discounts available
- No surcharge for credit card purchases
- VISA & Mastercard accepted
- COD

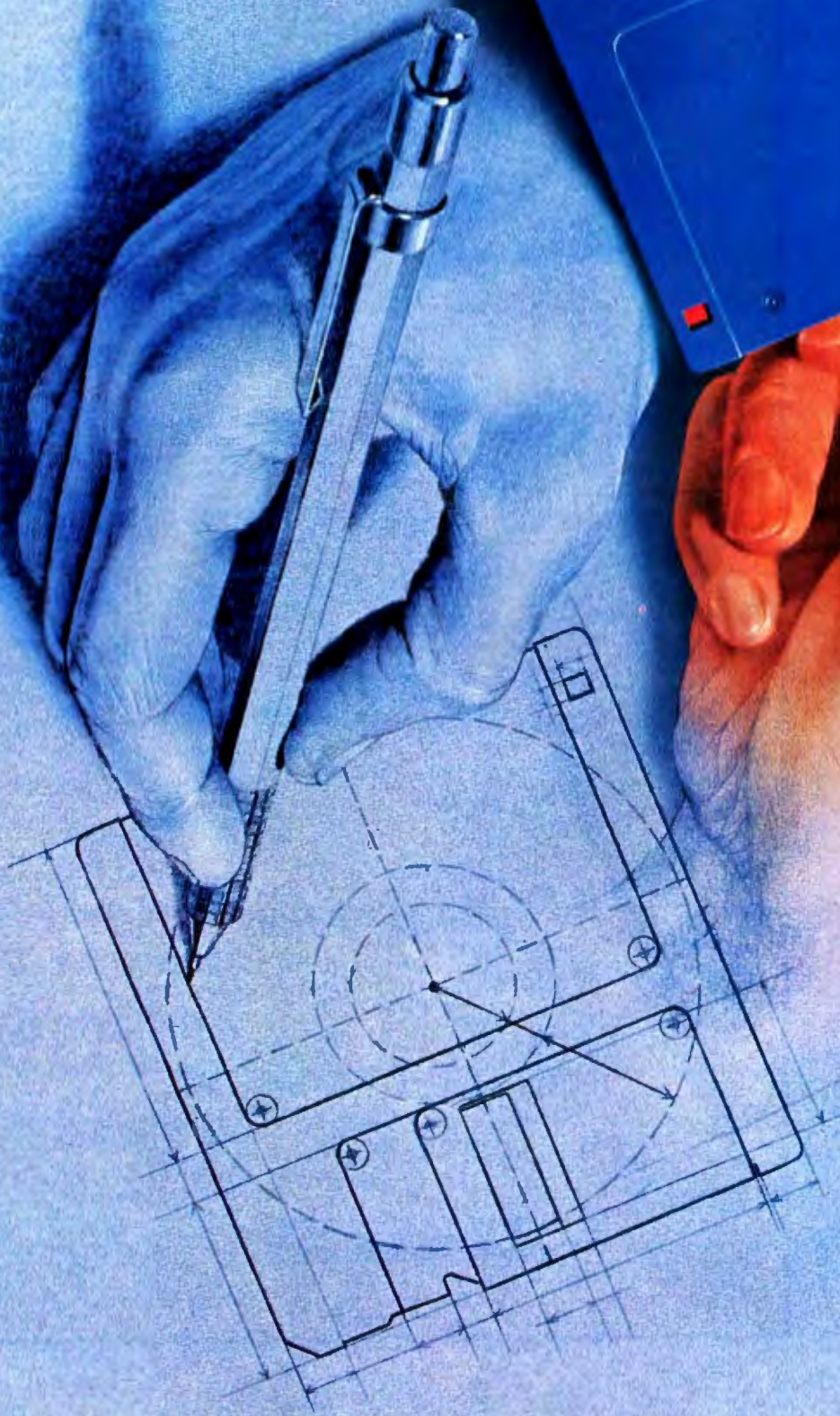

# WHO MAKES THE HIGHEST QUALITY 3.5" DISK? ASK SONY. WE INVENTED IT.

Long before there was a market for 3.5" disks, in fact, four years before, there was Sony.

And while every single 3.5" disk manufacturer has duplicated the Sony design, there's one thing they haven't been able to duplicate. Sony quality.

Such error-suppressing materials as VIVAX™ magnetic particles (the very core of the disk itself) have been developed by Sony. As is the case for our manufacturing process. It includes a burnishing technique that eliminates projections as small as 1/1,000,000 of a millimeter from the disk's surface.

The result? Every time you use a Sony 3.5" disk you're assured you're using the best magnetic medium you can buy.

With somebody else's, you can only guess.

**SONY**

# THE DSI-32 COPROCESSOR BOARD

### *Plug a 32-bit microcomputer into your IBM PC*

**D**o you have scientific number-crunching problems that leave your IBM Personal Computer (PC) gasping? Do you want to learn about the 32032, one of the first commercially available 32-bit microprocessors? Or do you just want the fastest IBM PC on the block? If you answered "yes" to any of these questions, then you may be looking for the DSI-32 coprocessor board from Definicon Systems Inc.

The DSI-32 coprocessor board uses the National Semiconductor NS32032 full 32-bit CPU (central processing unit), the NS32081 high-speed FPU (floating-point processing unit), and optionally the NS32082 MMU (memory-management unit).

There are two kits. The starter kit has a 6-MHz CPU and 256K bytes of RAM (random-access read/write memory). The advanced kit has a 10-MHz CPU and 1 megabyte of RAM. The only difference between the two kits is the jumper configuration; both use the same board. If you get the starter kit, you can upgrade later to the more advanced system. Both kits have a socket for the MMU chip.

The board also has two high-speed (up to 38.4k bits per second) RS-232C

serial ports and a 16-bit programmable timer. In addition, all MS/PC-DOS facilities—such as communication ports and video and printer controllers—are available to the NS32032 via the Definicon MS/PC-DOS interface software. The interface has special support for bit-mapped graphics-display access, including support for multiple-screen images in memory.

Did we call the DSI-32 a coprocessor? Well, that's only one way to look at it. You can also think of the IBM PC as a convenient standard chassis—supplying disk drives, power supply, display, keyboard, and expansion-board connectors—into which you can plug a powerful 32-bit microcomputer. Since Definicon's interface software runs in MS-DOS, you don't have to learn a different operating system to use the DSI-32.

#### **A WALK AROUND THE CIRCUIT BOARD**

The DSI-32 consists of a number of relatively independent functional units (see photo 1 and figures 1 through 4). The 32032 CPU (IC44) is near the center of the board. Above it is the 32201 TCU (timing control unit, IC43), which contains the clock oscillator and much of the bus-interface timing circuitry. To its right is the 32081 FPU (IC49) and to its immediate left is the MMU (IC40). Further left is the DP8409 dynamic RAM controller (IC37) and the RAM array (IC1-32). To the right of the FPU is the 2681 DUART (dual universal asynchronous receiver/transmitter, IC55), the RS-232C drivers (IC58,59,61,63,

64), and serial port connectors.

Above the DUART is a socket for user-defined peripheral devices. This socket simplifies the task of designing additional special-function daughterboards. At the far lower left are the dual bidirectional latches (74LS646, IC33-36) that buffer the data between the asynchronous 8-bit PC bus and the 32-bit internal data bus of the DSI-32. The remaining circuits perform address decoding, buffering, and control-signal generation.

There are four jumper blocks (JB1, JB2, JB3, and JB4) for selecting the operational configuration of the board. When shipped, the jumpers are in the correct position for a 32032 (full 32-bit bus) with no MMU chip in the MMU socket. Other possible configurations include the 32032 with the 32082 MMU, or just the 32016 CPU (16-bit bus). Jumpers for these configurations are shown in figure 5. The JB1 jumpers determine whether 64K-byte RAM chips or 256K-byte RAM

*(continued)*

*Trevor G. Marshall, George Scolaro, David L. Rand, and Tom King are engineers with Definicon Systems Inc. Vincent P. Williams is president of Definicon. They can be contacted at 21042 Vintage St., Chatsworth, CA 91311.*



BY TREVOR G. MARSHALL, GEORGE SCOLARO,  
DAVID L. RAND, TOM KING, AND VINCENT P. WILLIAMS

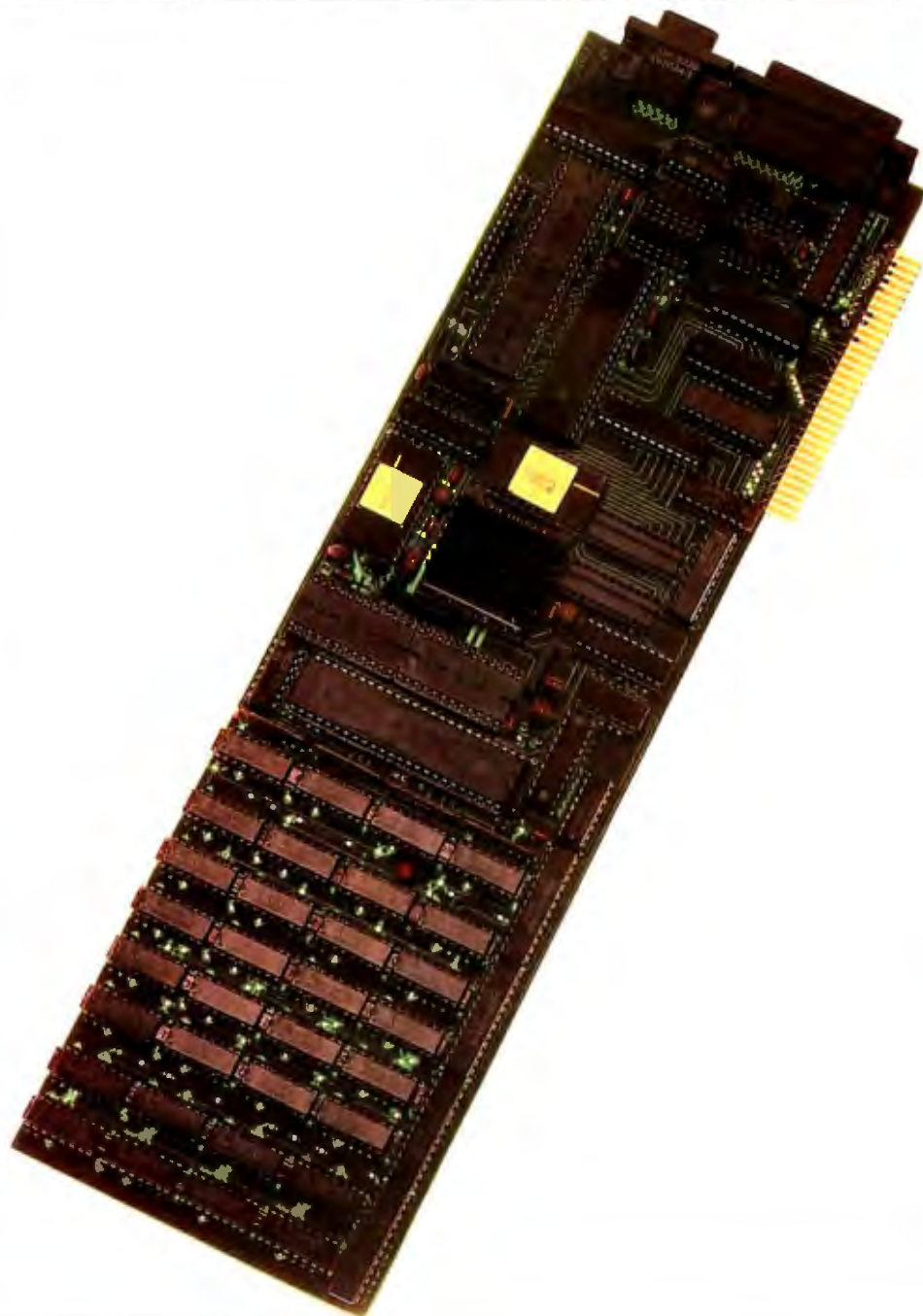

PHOTOGRAPHED BY PAUL AVIS

Photo 1:  
*The DSI-32  
coprocessor board.*

# ARCHITECTURE

BY PHILLIP ROBINSON

National Semiconductor's absence from the 8-bit and 16-bit microprocessor markets turned out to be an advantage in one way. The 32000 series could be designed from scratch. Other microprocessor makers often felt it was important to keep some compat-

ibility between their earlier chips and any new designs. Free of such constraints, National Semiconductor took what it calls a "radical departure from popular trends in architectural design." The main aim was to make software development easy: to design a chip that

compiler writers would love.

Figure A is a block diagram of the 32032. It has a 16-megabyte uniform (nonsegmented) linear-addressing space and is available in 6-, 8-, and 10-MHz versions.

The 32032 has eight 32-bit-wide, general-purpose registers that can handle byte, word, or double-word data. It also has eight dedicated registers including a 32-bit program counter, a processor status register, two stack pointer registers for user and interrupt stacks, the frame-pointer register that points to a procedure's dynamically allocated local storage, the static base register (which points to relocatable global variables), the interrupt base register (which locates the dispatch table for interrupts and traps), and the module register (which holds the descriptor's address of the currently executing module).

The 32032's design was heavily influenced by the VAX, particularly its addressing modes. Besides the standard immediate, absolute, register, and register-relative modes, there are five other modes that help support high-level languages. These are the memory-space, memory-relative, external, scaled-index, and top-of-stack modes.

As with many advanced microprocessors, the 32032 has both supervisor and user operating modes. To protect operating systems, a user mode program cannot execute some instructions or access certain registers. A supervisor mode program doesn't have such restrictions.

The 32032 has customary move, integer-arithmetic, BCD (binary-coded decimal), integer-comparison, logical, Boolean, shift, bit, jump, stack, and control instructions. To that stew it adds new instructions such as MODi (modulus arithmetic) as well as new instruction groups including bit-field, array, and string operations. Finally, the 32032 has a list of floating-point, memory-management, and custom slave instructions that allow it to cooperate with other processors.

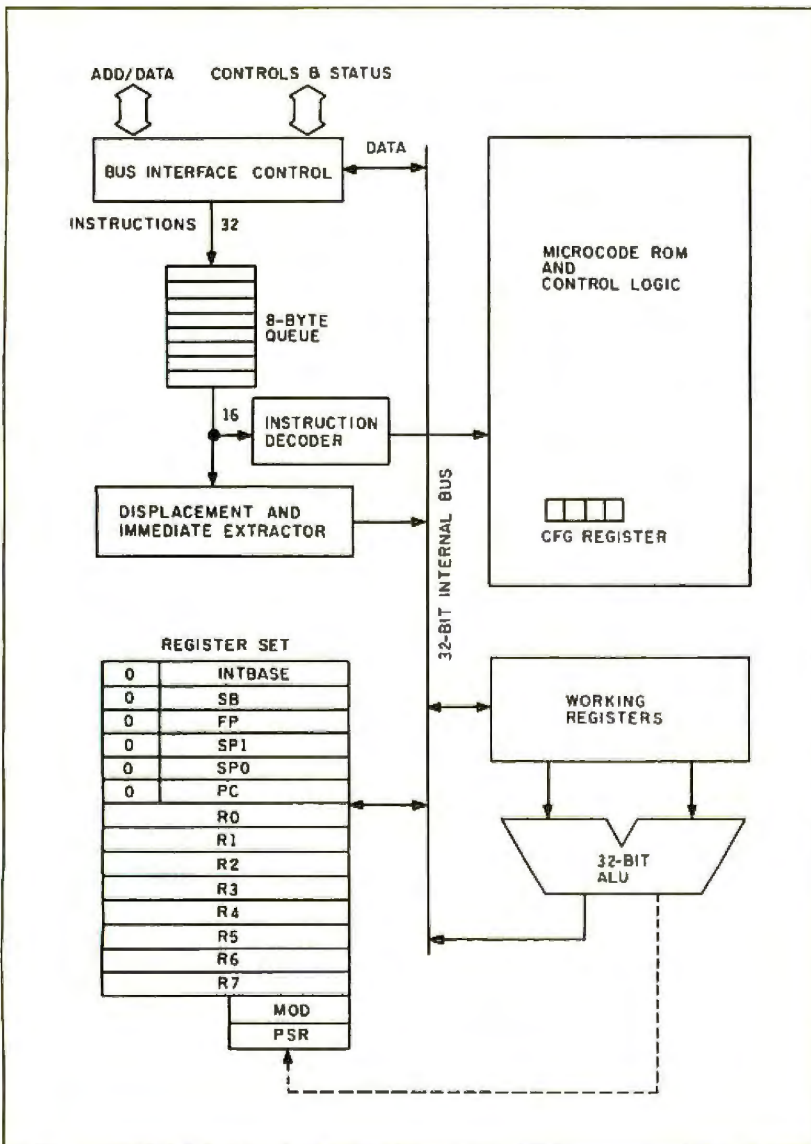
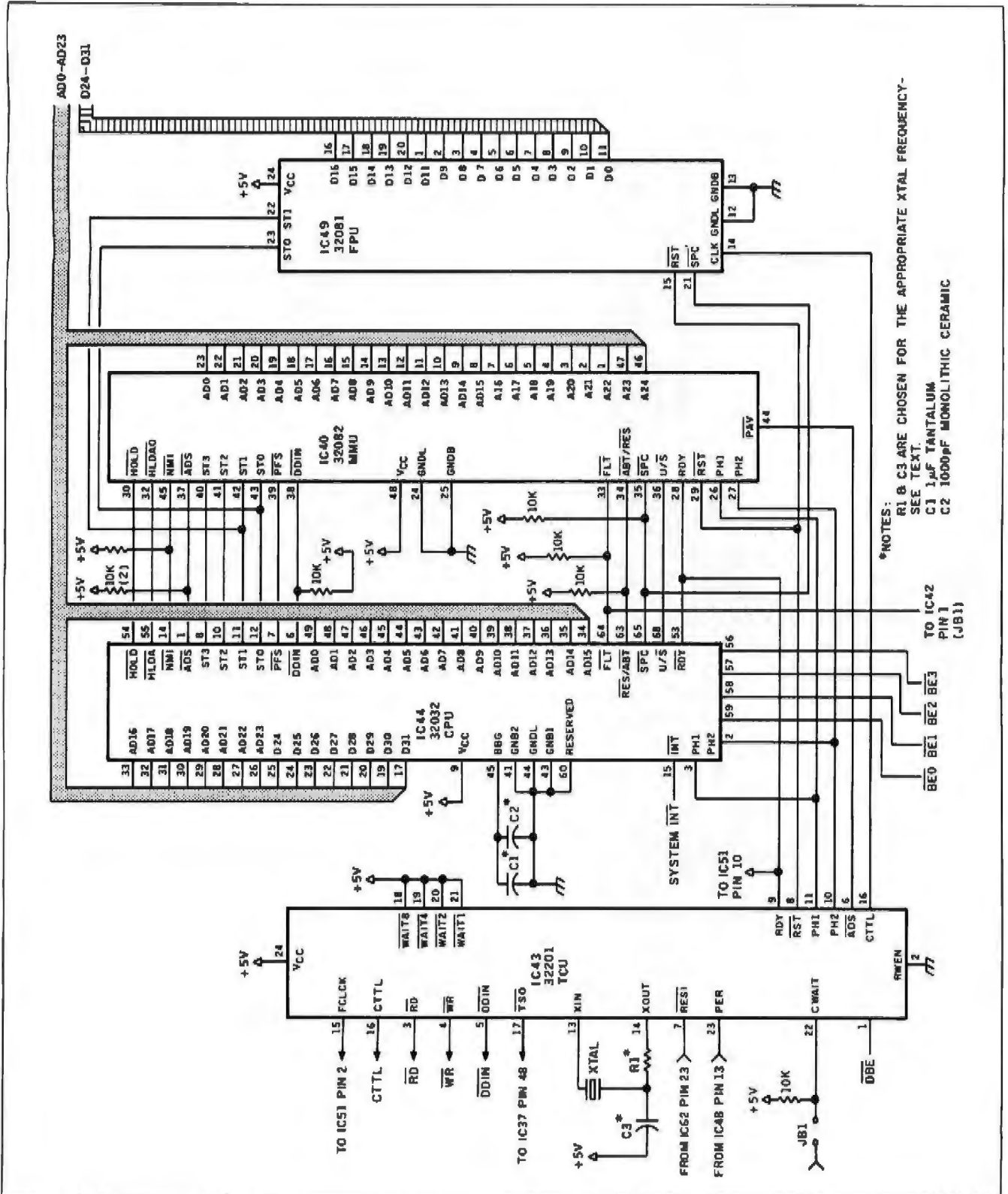

Figure A: A block diagram of the 32032 CPU.

# DSI COPROCESSOR



\*NOTES:  
 R1 & C3 ARE CHOSEN FOR THE APPROPRIATE XTAL FREQUENCY -  
 SEE TEXT.  
 C1 1µF TANTALUM  
 C2 1000pF MONOLITHIC CERAMIC

Figure 1: Schematic of the DSI-32 board's CPU and CPU support circuitry, including the optional memory-management unit and floating-point unit.

# DSI COPROCESSOR

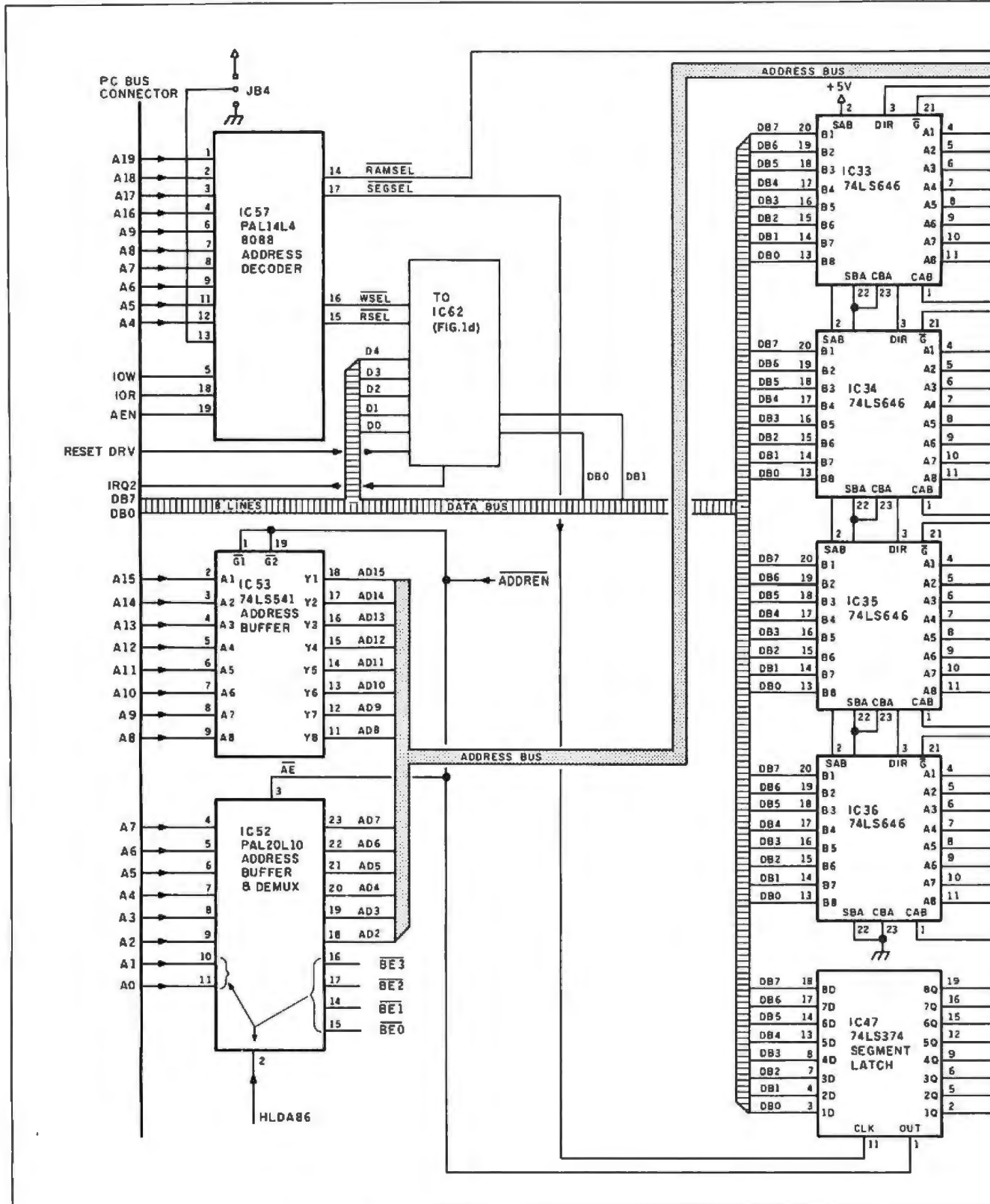
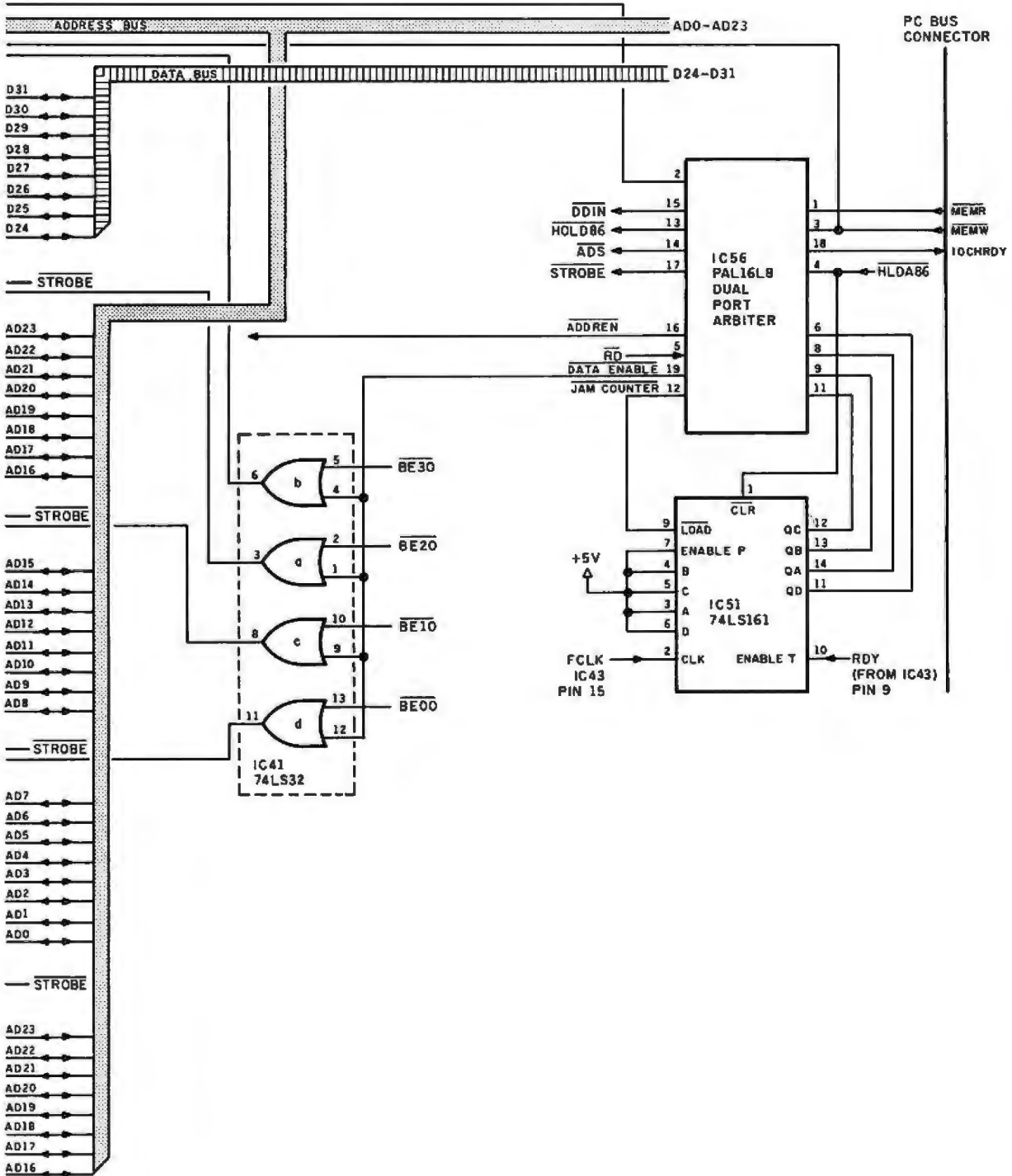

Figure 2: Schematic of the DSI-32's IBM PC bus interface circuitry.

# DSI COPROCESSOR



## DSI COPROCESSOR

chips are installed and the memory-refresh rate.

### THE PC BUS INTERFACE

When power is first applied to the IBM PC, a bus signal RESET DRV is

generated. This is a power-on reset for any slave boards on the bus. The RESET DRV signal is latched in IC60, the DIAG vector PAL (programmable array logic). Pin 22 of this PAL, /POWERON, initializes the board and

then remains latched until the loader software resets it by pulsing the RFSH INHIBIT line.

Since there is no room for a ROM (read-only memory) on this board, we

*(continued)*

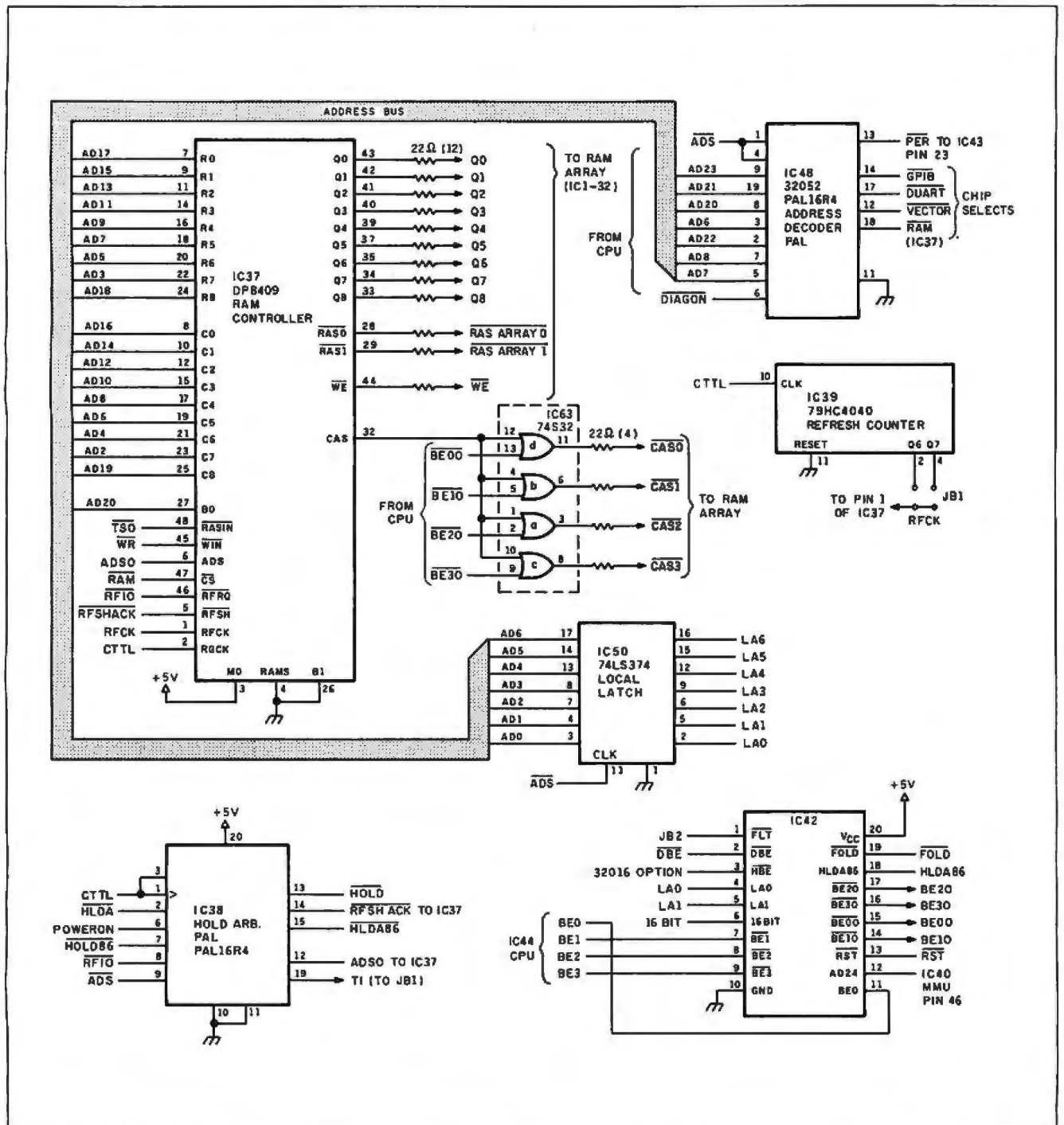

Figure 3: Schematic of the DSI-32's RAM controller circuitry, including the address decoding and HOLD arbiter PALs.

# THE BYTEK SYSTEM 125



## PROGRAMS A WORLD OF TECHNOLOGIES

BYTEK Corporation, Instrument Systems Division, introduces the finest Universal Software-Controlled Programmer on the market, at a price nobody can beat. The S125 MultiProgrammer is a high technology masterpiece that's been two years in the making. This state of the art instrument is packed with features like these:

- Supports all current technologies: EPROMs including CMOS, and Three Voltage devices, EEPROMs, Bipolar PROMs, Micro computer chips, PALS, HPLs, and IFLs.
- Internal RAM starts at 8K bytes and is expandable to 2 megabyte (16 megabits).
- Integrated EPROM Programming. No modules or personality adapters are required to program most popular EPROMs and EEPROMs.
- Integrated Gang Programming capable of programming 8 EPROMs simultaneously; 8, 16, 32 and 64 bit words. Up to four masters may be copied in a single operation. Eight sets of EPROMs, each set with different data, may be programmed from RAM.
- Optional Gang Expansion Module doubles the gang programming capacity, allowing for sixteen duplicates in a single operation, or a word width from 8 to 128 bits.
- 25 key full-travel integrated keyboard.
- 16 Character X 2 Line LCD Display. Integrated alphanumeric display provides a truly operator friendly environment.
- Intelligent Algorithms automatically identify the type of EPROM in the socket.
- Two Serial RS232 Ports and a Parallel Printer Port provide maximum communication flexibility.
- Advanced Technology Module Port supports present and future programming technologies.
- 16 Bit in Circuit Emulation Option.
- Completely software-controlled programming plus hardware expandability insures that your S125 will not become obsolete.
- Prices start at \$995.
- Delivery in one to two weeks.

inquiry 43

**BYTEK**

CORPORATION  
INSTRUMENT SYSTEMS DIVISION

1021 South Rogers Circle  
Boca Raton, Florida 33431

(306) 994-3520  
Telex 4310073 MEVBTC

# DSI COPROCESSOR

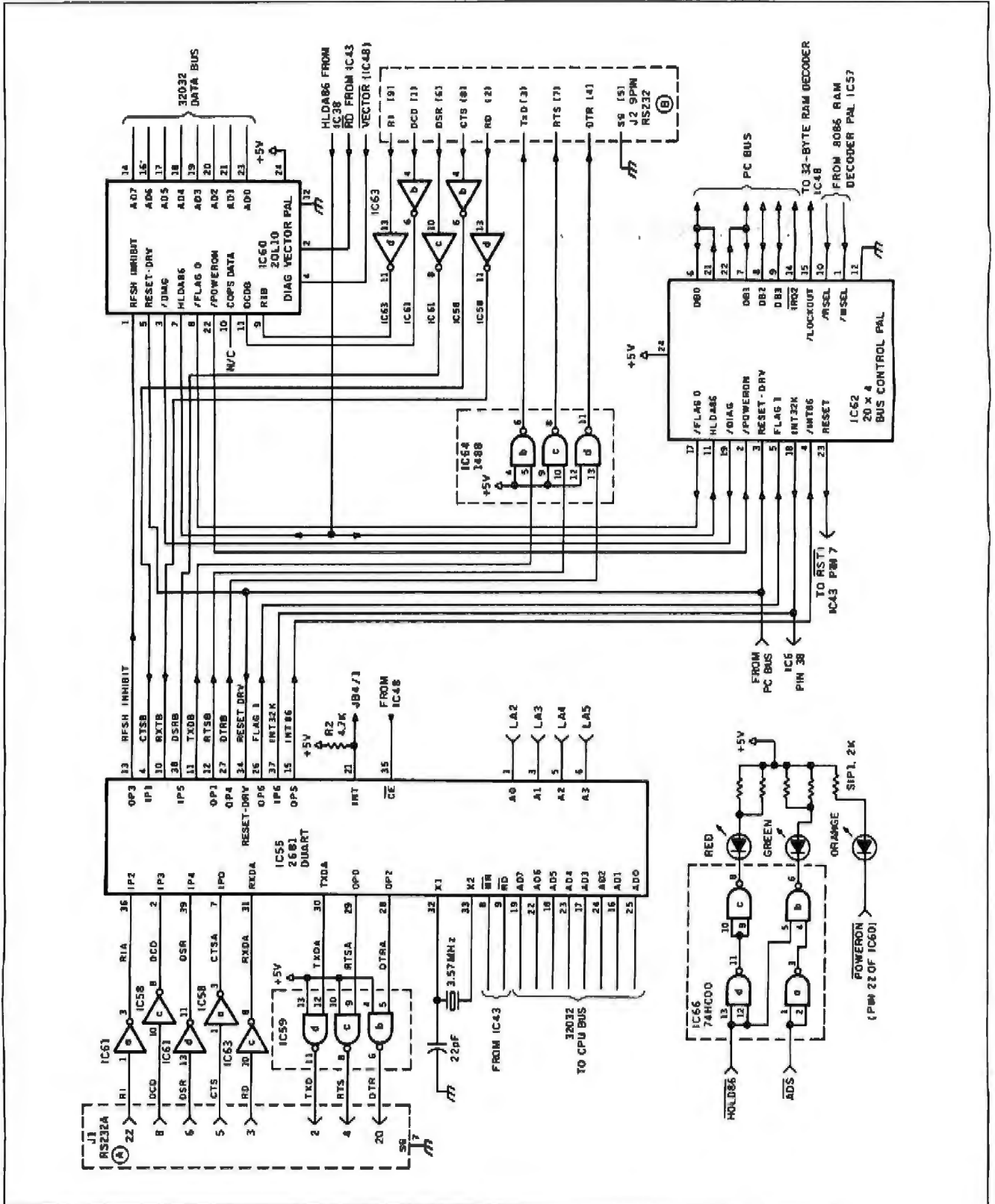

Figure 4: The DSI-32's DUART serial-port circuitry, DIAG vector PAL, and IBM PC bus control PAL.



# Compare the Hercules™ Color Card to IBM's.

Five reasons why the Hercules Color Card is better.



**IBM Color Adapter \$244**

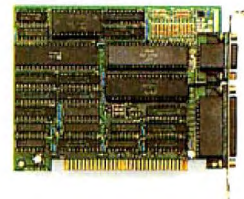

**Hercules Color Card \$245**

- |                  |  |   |
|------------------|--|---|
| 1. Compatibility | Runs hundreds of graphics programs.              | Runs the same hundreds of graphics programs. "The Hercules Color Card is so nearly identical to the IBM Color/ Graphics Card that it's almost uncanny." PC Mag. |
| 2. Printer port. | None.  | Standard. Our parallel port allows you to hook up to any IBM compatible printer.  |
| 3. Size.         | 13.25 inches. Limited to long slots.             | 5.25 inches. Fits in a long or short slot in a PC, XT, AT or <i>Portable</i> .  |
| 4. Flexibility.  | Can't always work with a Hercules Graphics Card. | Always works with a Hercules Graphics Card by means of a software switch.   |
| 5. Warranty.     | 90 days.   | Two years.  |

Any one of these five features is enough reason to buy a Hercules Color Card. But perhaps the most convincing reason of all is just how easy the Hercules Color Card is to use: "Right out of the box, the Hercules Color Card goes into an empty expansion slot, ready for you to plug in. . . and go to work—no jumpers, no software. For most applications, it's just that easy." PC Magazine.

Call 1-800-532-0600 Ext. 421 for the name of the Hercules dealer nearest you and we'll rush you our free info kit.

**Hercules.**

**We're strong on graphics.**

Inquiry 139

# DSI COPROCESSOR

needed some mechanism for the CPU to execute defined instructions during the power-on cycle. The DIAG vector PAL performs this function. The PAL forces a DIA instruction on the data bus whenever the CPU is uninitialized. This makes the CPU fetch a DIA as its

first instruction (at address 0). [Editor's note: All addresses to follow are in hexadecimal.] The DIA instruction causes the CPU to flush its queue and execute a "branch to self." In this way, the 32032 is put into a very tight loop and won't lock up by executing some

undefined instruction from its uninitialized main RAM memory space. The remaining function of the DIAG vector PAL is to act as a 4-bit read-only port so the CPU can read the RS-232C status lines of J2.

(continued)

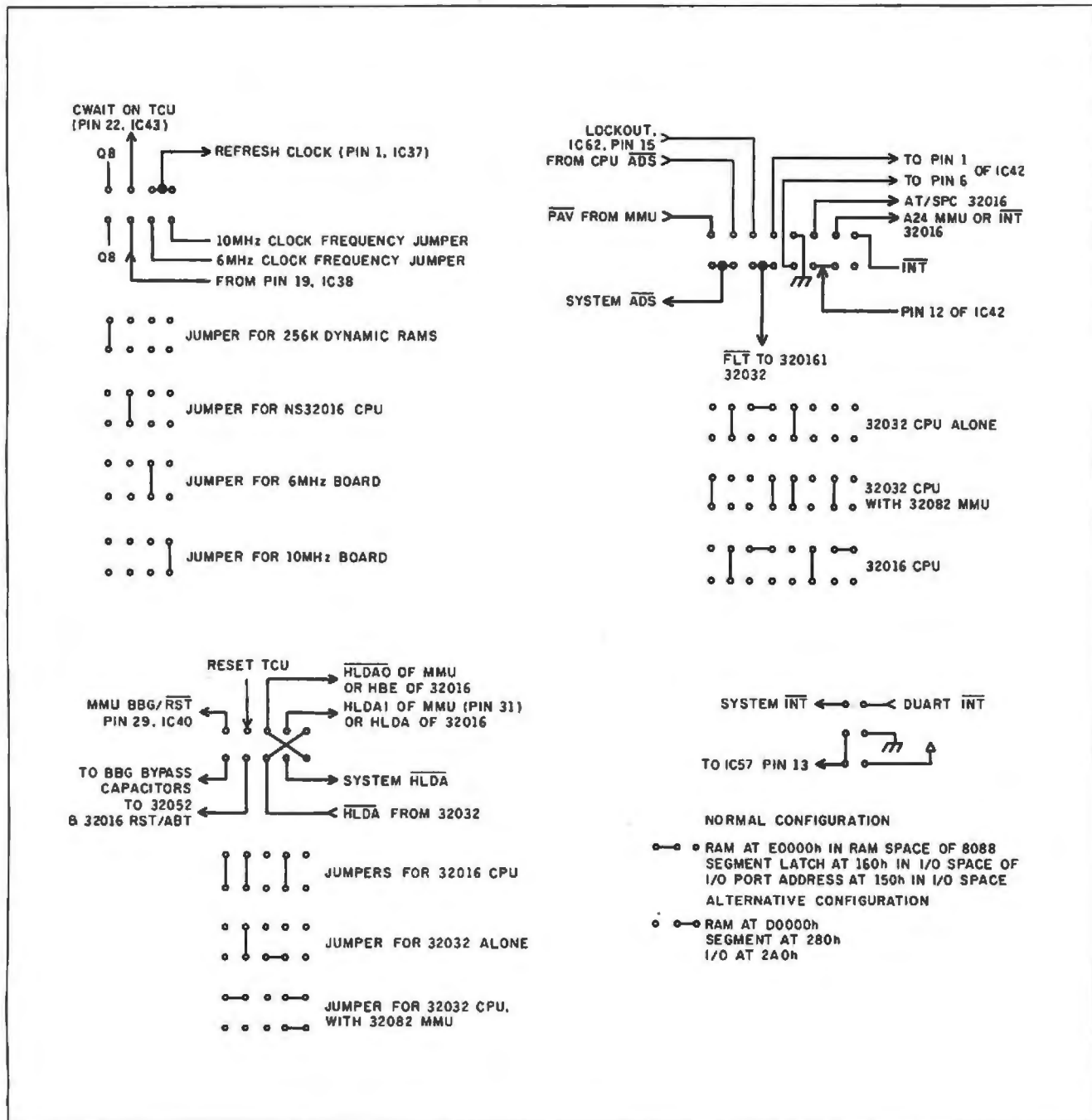
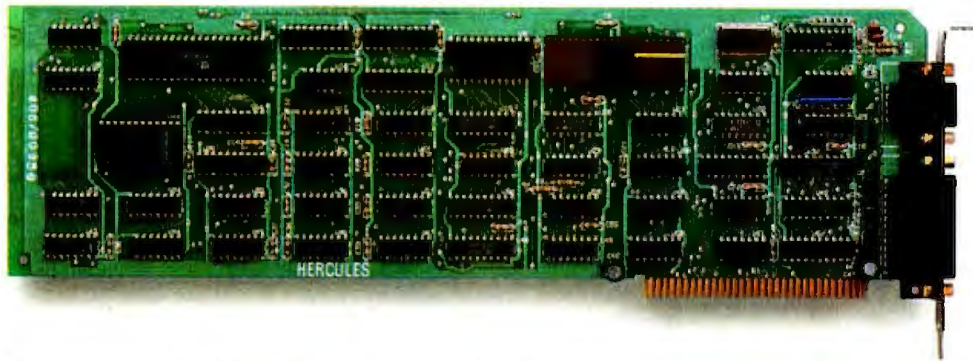

Figure 5: Various jumper configurations for the DSI-32. All diagrams are shown looking at the top of the board, with the edge connector to the bottom right.



## The world's best selling monochrome graphics card for the IBM PC.

There are more Hercules™ Graphics Cards in more IBM® PCs, XT's and AT's than any other monochrome graphics card in the world.

Over a quarter of a million demanding users around the world use a Hercules Graphics Card to improve the performance of their software.

### The Lotus® 1-2-3® Booster.

Consider Lotus 1-2-3. Hercules gives an off-the-shelf copy of 1-2-3 the highest resolution possible on an IBM PC, XT or AT. More 1-2-3 users choose the Hercules Graphics Card to get crisper text and sharper graphics than any other monochrome graphics card.

And we bring the same performance to other integrated programs like Symphony™, Framework™, and SuperCalc®3.

But we don't stop there. The Hercules Graphics Card

improves all kinds of software.

Like Microsoft® Word, a word processor that enables you to display text with subscripts, superscripts and italics.

Or pfs:Graph, an easy-to-use business graphics program that converts your data into presentation quality graphs.

Or Microsoft® Flight Simulator, the high flying game for the overworked executive.

Or our own Graph X™, a library of graphics sub-routines that eases graphics programming.

Or AutoCAD™, a computer aided design program that offers features normally associated with expensive CAD systems.

And we supply free software with each card to do hi-res graphics using the PC's BASIC interpreter. **State-Of-The-Art Hardware.**

The Hercules Graphics Card gives you graphics resolution of 720h x 348v and a

parallel printer port. Our unique static RAM buffer provides sharp 9 x 14 characters and flicker-free scrolling. Our exclusive safety features help



prevent damage to your monitor.

State-of-the-art custom IC technology delivers unsurpassed reliability. Ordinary graphics cards use up to 30 ICs to do what one Hercules IC does. By using fewer parts, we reduce the possibility of component failure.

Which is one reason we warranty the Hercules Graphics Card for two years.

Unbeatable reliability. Advanced technology. Proven by over a quarter of a million users. Why settle for anything less than Hercules?

Call 1-800-532-0600 Ext 408 for the name of a Hercules dealer nearest you and we'll rush you our free info kit.

**Hercules.**  
**We're strong on graphics.**

Inquiry 140

The PC bus interface PAL, IC62, performs many functions. It provides the IBM PC with a 2-bit status (read) port and also a 4-bit control (write) port. Also, this PAL supplies two polled flags for interprocessor communication, in addition to the one level of interrupt in each direction.

When the IBM PC's CPU accesses the DSI-32's RAM, it performs a memory (read or write) cycle in a 64K-byte segment of its address space. For the PC XT this is from E000 to EFFF. For the PC AT the board can be mapped from D000 to DFFF. IC47 determines which 64K-byte segment of the DSI-32 address space the PC is referencing.

When a memory read/write request from the 8088 is detected by the dual port RAM controller (IC56), it asserts a HOLD (DMA) request to the 32032 CPU. When it is able to service the HOLD request, the 32032 responds with a HLDA (hold acknowledge) signal and IC56 completes the DMA cycle. Due to the 8-byte instruction prefetch queue on the 32032, the internal CPU state machine continues to run even after it has relinquished its bus to the DMA cycle. This is fortunate because, although the much slower 8088 may take almost a microsecond to complete its portion of the DMA cycle, the usual loss of execution time to the 32032 is only 100 nanoseconds.

The default I/O (input/output) memory-address allocation for the DSI-32's control register can be changed if another board in your IBM PC has an address clash with the DSI-32. A program that comes with the kit guides your choice of memory and I/O port address configuration.

### THE DYNAMIC RAM ARRAY

Either 256K bytes or 1 megabyte of dynamic RAM can be installed on the DSI-32. The first 14 megabytes of address space are uniquely decoded, allowing for future memory expansion on a separate board.

No parity checking or obvious-error correction was designed into the DSI-32. Parity checking on an IBM PC slave board is of little use. The only action you could take if an error were

## BENCHMARKS

These three benchmarks in table A represent numerically intensive algorithms that require both integer and floating-point arithmetic.

The Sieve of Eratosthenes tests the performance of a high-level language implementing Boolean algebra and integer arithmetic (see listing A). The Float benchmark examines the processor's ability to execute floating-point array arithmetic (see listing B). The FLT benchmark tests the speed of the floating-point coprocessor (see listing C).

Array handling is primarily exercised by the Float and Sieve benchmarks, since the FLT benchmark uses only scalar calculations.

It should be noted, however, that the Sieve benchmark uses only a Boolean array, and this negates much of the throughput advantage of the NS32032's 32-bit bus (and indeed the VAX's 64-bit bus), tending to favor the 8- and 16-bit processors.

### NOTES ON BENCHMARKS

The Sieve benchmarks that were run on the IBM PC XT and PC AT were written in Digital Research C. The FLT benchmark used Microsoft FORTRAN

for the XT and DR F77 for the AT.

The variable  $n$  represents the maximum control number on the major loop of the benchmark test. In the Sieve benchmark, the major loop was run 10 times.

N/D indicates No Data, a test not run.

N/A indicates Not Available. No compiler could be found that could use arrays with more than 64,000 elements.

The five target machines being compared are the IBM PC XT (8088 CPU), the IBM PC AT (80286 CPU), the VAX-11/750, the VAX-11/780, and Definicon System's DSI-32 coprocessor (10-MHz 32032 CPU). All five machines have additional numeric-processing hardware:

1. IBM PC XT has Intel's 8087 floating-point chip (4.77 MHz).
2. IBM PC AT has Intel's 80287 floating-point chip (4.0 MHz).
3. VAX-11/750 has Digital Equipment's Floating-Point Accelerator.
4. VAX-11/780 has Digital Equipment's Floating-Point Accelerator.
5. DSI-32 coprocessor has National Semiconductor's 32081 FPU (floating-point unit).

The compilers used for the PC XT and PC AT were chosen on their pub-

Table A: Execution time (in seconds) for 10 iterations of the Sieve. All machines have floating-point accelerators.

Sieve Benchmark					
$n$	IBM PC XT	IBM PC AT	VAX-11/750	VAX-11/780	DSI-32
8191	11.6	3.71	2.41	1.90	1.85
20000	35.3	8.13	6.11	3.04	4.52
30000	44.9	12.40	N/D	N/D	6.78
40000	351.5	99.71	13.13	6.38	9.04
80000	N/A	N/A	29.65	13.34	18.12
Float Benchmark					
$n$	IBM PC XT	IBM PC AT	VAX-11/750	VAX-11/780	DSI-32
40000	11.46	17.71	0.83	0.50	0.84
FLT Benchmark					
$n$	IBM PC XT	IBM PC AT	VAX-11/750	VAX-11/780	DSI-32
256000	119.3	134.0	9.48	6.18	16.48

lished reputation for generating high-speed code. Microsoft FORTRAN version 3.1 was used for the FLT and Float benchmarks on the PC XT. As it did not execute on the PC AT, Digital Research F77 was used for the FLT and Float benchmarks on that machine. Digital Research C was used for the Sieve

benchmark on both the PC XT and the PC AT. The FORTRAN compiler for the VAX was written by Digital Equipment running under the VMS operating system.

The compilers for the DSI-32 coprocessor were written by Green Hills Software and ported to the Definion MS-PC-DOS environment.

detected would be to shut down the host 8088 CPU. Although the 8088 then reports the address currently on its bus, this usually bears no relation to the true cause of the problem. Conventional external error correction is slow and requires adding wait states to the memory cycles, reducing the 32032's performance.

There is a level of protection provided by the DSI-32 interface software. Should the 32032 execute an instruction that it cannot decode (such as would occur on a faulty program read), it executes an ILLEGAL INSTRUCTION trap. This trap is caught by the Definion MS-PC-DOS interface software, and the full status is reported to the operator.

To further increase the board's reliability, a REFRESH INHIBIT control signal has been made available to the 8088/8086 CPU. This lets the diagnostic software determine the exact safety margin of each dynamic RAM chip in the memory array. This signal is also used to start the CPU after a cold boot.

Nevertheless, true error correction is available as an option on the 1-megabyte advanced kit. The DSI-32 is designed to accommodate the new INMOS (a British semiconductor company) 256K by 1-bit RAM chip that internally detects and corrects errors, such as those occurring from irregular refresh or alpha-particle activity.

The RAM array is driven and controlled by a National Semiconductor DP8409. This device (IC37) contains high-current outputs that can drive the highly capacitive RAM array, as well as circuitry to insert "hidden" refresh cycles whenever the RAM is inactive. These cycles allow the CPU to avoid the otherwise mandatory HOLD request (every 12 microseconds or so) to allow the DP8409 to refresh the array. Nevertheless, when a forced refresh is required, it is completed in two T (timing) states, leaving the processor's execution essentially unaffected.

Since both the RAM array and the 8088/8086 are asynchronously placing HOLD requests on the CPU, a

(continued)

Listing A: The Sieve benchmark.

```
#define LIMIT 8191
#define ITS 10
#define FALSE 0
#define TRUE 1
main ()
{
char flags[LIMIT + 1];
register long i,prime,k;
int count,iter;
for (iter = 1;iter <= ITS;iter++) {
count = 0;
for (i = 0;i <= LIMIT;i++) flags[i] = TRUE;
for (i = 0;i <= LIMIT;i++) {
if (flags[i]) {
prime = i + i + 3;
for (k = i + prime;k <= LIMIT;k += prime) flags[k] = FALSE;
count++;
}
}
}
printf("Found %d primes",count);
}
```

Listing B: The Float benchmark.

```
PROGRAM FLOAT
DIMENSION RARRAY (40000)
COMMON /FAST/ RARRAY
INTERGER*4 I
DO 10 I = 1,40000
10 RARRAY(I) = 1.0
DO 91 I = 1,40000
RARRAY(I) = RARRAY(I) *
C RARRAY(40000 - I)
91 CONTINUE
STOP
END
```

Listing C: The FLT benchmark.

```
C
PROGRAM FLT
INTEGER*4 I,J
REAL*8 X,Y,Z
DO 10 I = 1,256000
J = 256000 - I
X = FLOAT(I)
Y = FLOAT(J)
Z = Y/X
X = Y - Z
Y = Z * X
Z = Y + X
10 CONTINUE
C Force the loop optimizer to retain
C all four lines by:
X = Z + Y
STOP
END
```

## DSI-32 HARDWARE, SOFTWARE, AND SUPPORT

The following hardware kits and software are available from Definicon Systems Inc., 21042 Vintage St., Chatsworth, CA 91311, (818) 341-5654.

### HARDWARE

1. Starter kit — 32032 CPU and 32081 FPU, 6-MHz clock rate, 256K bytes of RAM (32 64K by 1-bit chips) wave-soldered, partially tested, fully socketed printed-circuit board. Full set of integrated circuits and assembly instructions. Diagnostic software disk. Simplified NSX-compatible assembler/linker/loader. MS-DOS interface software, advanced debug monitor. Public-domain software disk (supplied upon request). Price: \$995.

2. Advanced kit — Same as above, except CPU and FPU are 10-MHz and 1 megabyte of memory (32 256K by 1-bit chips) is supplied. Price: \$1495.

The DSI-32 is suitable for use with the IBM PC or any identical "clone" microcomputer. However, a money-back guarantee is the only guarantee of compatibility offered by Definicon. The DSI-32 draws up to 15 watts from the PC's power supply. Make sure you have that much spare power before ordering.

A fixed disk is almost essential if you are to run the Green Hills compilers (which range to 250K bytes of code).

### SOFTWARE

Public-domain compilers/interpreters are available for FORTH, Small-C, Pascal, and Tiny BASIC. A disk containing them will be included with your kit provided that you specifically ask for it.

The following advanced software is available. (Note that the C and Pascal compilers will run in 256K bytes of RAM, but their capabilities will be considerably limited. The FORTRAN compiler will not run in 256K bytes of RAM.

If you want to run these compilers, Definicon suggests you use the Advanced kit with its 1-megabyte of RAM.)

1. Green Hills C Compiler: Kernighan and Ritchie C plus full Berkeley 4.2 UNIX extensions.

2. Green Hills Pascal Compiler: Full Berkeley 4.2 UNIX-compatible plus many extensions.

3. Green Hills FORTRAN Compiler: ANSI (American National Standards Institute) FORTRAN 77 plus full Berkeley 4.2 UNIX extensions.

4. Definicon/Computer Systems Design NS32000 Assembler/Linker: Advanced National Semiconductor NSX syntax assembler with the GENIX extensions required by Green Hills compilers. Supports fully relocatable code and "Pascal-like" high-level constructs. Linker supports assembler output syntax and fully relocatable code, including named COMMON blocks and initialized statics.

5. Definicon/Computer Systems Design NS32000 Library Manager and Programmer's Utilities: LIB32 program to form and examine libraries of object modules, assembly and high-level language examples for direct (OEM) interface to the Definicon MS-PC-DOS interface.

### Prices:

Library manager/programmer's utilities:	\$49
Assembler/linker (purchased separately):	\$149
One compiler (your choice), including assembler/linker:	\$299
Two compilers, including assembler/linker (one purchase):	\$499
Three compilers, including assembler/linker (one purchase):	\$649
Any compiler, purchased alone	

(needs assembler above); \$249

Note: Green Hills Software has helped make these compilers available to BYTE readers using the Definicon MS-PC-DOS software environment at prices well below those of the identical compilers for their original UNIX environment.

A 32-bit FORTH interpreter is available for \$299 from Symbolic Processing Systems, 501 West Maple, Orange, CA 92668, (714) 637-4298. This FORTH includes a screen editor, string and file handling, and full floating-point support. Debugging aids—including TRACE and VIEW—are provided. The metacompiler and source-code screens are provided to ease system customization.

### SUPPORT

The prices Definicon is charging for the software are special discounts for BYTE readers. The only support that Definicon can offer to purchasers of this software is a guarantee to respond promptly to written bug reports. Definicon assumes that BYTE readers will be proficient in the basic programming syntax of a language before they order these products, and the documentation provided reflects this assumption.

Trevor Marshall's Thousand Oaks Technical Database (RCP/M) will act as a focal point for public-domain software for the DSI-32. The database may be reached on the public access number (24 hours a day, 1200 bits per second) at (805) 492-5472, or, for uploads, at the restricted (sysop's) number, (805) 493-1495.

Micro Cornucopia (POB 223, Bend, OR 97709, (503) 382-8048) has agreed to form a users group to support the DSI-32. Contact them directly for details.

# A FEW NEAT THINGS YOU CAN DO WITH KODAK'S CAT-QUICK INSTANT SLIDE-MAKERS...



*"Make your slides one by one, save on film and have some fun!"*

*"Correct mistakes, add new facts, give a show the punch it lacks."*

*"Take CRT data off the screen, edit freely in between."*

*"Mount your slides fast and clean—project bright hues on the screen."*

*"Meet tight deadlines, do a whole show, win new clients, hear 'bravo.'"*

*"Waste no money, waste no time, get results that are sublime."*



**"If you can't do without these cat-quick instant slide-makers another minute, contact your dealer in Kodak audiovisual products, listed in the Yellow Pages under 'AV Equipment and Supplies.' Or, phone 1 800 44KODAK, Ext 293 (1 800 445-6325, Ext 293). Tell 'em Slide Cat sent you!"**



The system includes KODAK INSTAGRAPHIC Copy Stand, KODAK INSTAGRAPHIC CRT Slide Imager and CRT Adapters, KODAK INSTAGRAPHIC Color Slide Film, and KODAK INSTAGRAPHIC Slide Mounter and Mounts.

© Eastman Kodak Company, 1985

# Subscription Problems?



## We want to help!

*If you have a problem with your **BYTE** subscription, write us with the details. We'll do our best to set it right. But we must have the name, address, and zip of the subscription (new and old address, if it's a change of address). If the problem involves a payment, be sure to include copies of the credit card statement, or front and back of cancelled checks. Include a "business hours" phone number if possible. We'll respond A.S.A.P.*

**BYTE**  
Subscriber Service  
P.O. Box 328  
Hancock, NH 03449

*In conjunction with  
the interrupt-driven  
16-bit timer and the  
two serial ports, an  
MMU will let the  
DSI-32 run UNIX.*

HOLD arbiter PAL (IC38) allots each a priority and ensures that no access contention can occur.

### UNUSUAL COMPONENTS IN THIS DESIGN

Murata ceramic resonators are used instead of quartz crystals. Although not quite as stable as the crystals, they are perfectly adequate. The typical frequency tolerance is  $\pm 0.5$  percent maximum. They are easier to mount than crystals and are also cheaper. Note that the RS-232C data-transfer rate can be up to 3 percent slower due to the use of a standard 3.58-MHz resonator rather than the 3.686-MHz resonator originally specified for the 2681 DUART.

Rogers Q-PAC bypass capacitors are used in several critical areas of the board. They provide near-perfect bypassing of high-frequency transients and help reduce noise that otherwise might reduce reliability.

### OPTIONAL 32082 MEMORY-MANAGEMENT UNIT

The DSI-32 can accommodate the NS32082 MMU. This, in conjunction with the interrupt-driven 16-bit timer and the two serial ports, gives it the capability of running UNIX (when it becomes available). The MMU also adds some debugging capability to the current monitor, such as a breakpoint-on-address reference.

### A BRIEF LOOK AT SOFTWARE

In addition to a number of public-domain compilers and interpreters,

three high-performance, UNIX-compatible, optimizing compilers for the DSI-32 are currently available from Definicon. The Green Hills Software C, FORTRAN, and Pascal implement the full Berkeley 4.2 extensions in addition to the commonly accepted language definitions. These compilers produce NS32032 source code, which is assembled with the Computer Systems Design/Definicon assembler, linker, and loader. In addition, a 32-bit FORTH interpreter, a Tiny BASIC, and a dBASE II compiler were scheduled for release last month.

The disk operating system is MS/PC-DOS. No special partitions or file conversions are required. The 32032 data files can be identical to their MS/PC-DOS counterparts, and 32032 executable code files exist on disk as standard MS/PC-DOS files. Software development is done entirely within the MS/PC-DOS command shell, with no need for special editors or other file managers.

A resident (RAM-based) monitor allows easy debugging. Its command syntax is similar to DEBUG and DDT (dynamic debugging tool). It allows single-step execution, running with multiple breakpoints, and, with the optional MMU, breakpoint-on-address reference. Also, the monitor includes standard memory and register display and substitute features. A powerful disassembler with full floating-point support is part of the monitor.

### NEXT MONTH

We have taken a glimpse inside the hardware of the DSI-32, and we hope that this gives you some idea of this coprocessor board's speed and flexibility. Although we have discussed software only briefly, next month we will look in greater detail at the languages and programming tools available. ■

### ACKNOWLEDGMENT

The authors are indebted to Martin A. Lewis of Cambrian Consultants Inc. of Calabasas, California, for his help and guidance during the project and to applications engineer Les Wilson of National Semiconductor for his untiring assistance.



# "Thanks for the memory."



## INTRODUCING THE COMMODORE 128.™

It's here. And it's going to make a lot of Commodore 64™ owners very happy. A personal computer with a 128K memory and 80-column capability that's still compatible with all the peripherals and over 3,000 programs designed for the Commodore 64.

In fact, the new 128 is almost like getting three computers in one. That's because it can run as a 64, a 128 and in a CP/M® mode. Or it can even be expanded to a full 512K memory. And that's about as "personalized" as a personal computer can get. It's intelligence that can match your

own versatility. And then, even take it to a higher level.

### There's more than a bigger memory.

There are a lot of extra features we didn't forget. Like a handy numeric keypad for data-entry efficiency and accuracy.

An expanded keyboard that puts more commands at your fingertips for easier programming. So you can be a whiz at using more varied graphics and text. Or a musical genius playing full three-part melody in any tempo you set. And there's even a "help" key

that comes to your rescue, listing programming errors on-screen with the error in reverse field.

There's also a new faster disk drive. With a separate "Burst" mode that can transfer up to 3,000 characters per second. Just in case you're a speed demon.

"Thanks for the memory!" You're welcome. And for the expandability. And compatibility. And versatility. And for making it all very affordable. After all, one of the other things that should go into a more intelligent computer is a price that makes sense.

**COMMODORE 128 PERSONAL COMPUTER**

A Higher Intelligence



# CONTEXT-FREE PARSING OF ARITHMETIC EXPRESSIONS

BY JONATHAN AMSTERDAM

*Parse integer arithmetic  
expressions into executable form*



I think I was in the fifth grade when I first heard about My Dear Aunt Sally. The teacher had no sooner written "3 + 4 × 5" on the blackboard than I, impetuous young fool that I was, shouted out "35!" After pointing out that the correct answer was 23, the teacher introduced me to my new-found relative—My Dear Aunt Sally: multiplication, division, addition, subtraction. That's the order in which we calculate arithmetic expressions. Once we learn it, it's an easy rule to master.

But computers are not so clever. They find these so-called operator precedence rules a bit of a nuisance. Some programmers, like the folks at Hewlett-Packard and FORTH inventor Charles Moore, have taken an easy way out by using Polish-postfix (or reverse-Polish) notation, in which 3 + 4 × 5 becomes 3 4 5 \* +.

This notation is easy for computers to understand and, FORTH addicts will swear, for people too. But those of us who prefer to keep our eyes uncrossed would like some way to teach the machine our way of doing business.

What we want, more precisely, is a way to *parse* ordinary integer arithmetic expressions—that is, to translate the string of symbols that make up such an expres-

sion into something with more structure, something that captures the fact that 4 × 5 is a meaningful component of 3 + 4 × 5, while 3 + 4 is not. We can break the problem into two parts: writing a set of rules that correctly describes the structure of the expressions, and implementing those rules in a computer program. The result will be a parsing algorithm that, when combined with a simple evaluation function, gives a four-function integer calculator of the "algebraic," or more commonly, Texas Instruments variety. I'll discuss more general applications of parsing at the end of this article.

## CONTEXT-FREE GRAMMARS

First, though, I need to describe the structure of arithmetic expressions. Here I'll use an idea originally developed by linguists. At one time, they thought that the syntax of English and other natural languages could be described by a series of rules like the following:

S → NP VP  
NP → ADJ N  
VP → V ADV

*(continued)*

Jonathan Amsterdam is a graduate student at the Massachusetts Institute of Technology Artificial Intelligence Laboratory. He can be reached at 1643 Cambridge St. #34, Cambridge, MA 02138.

These rules say that a sentence consists of a noun part and a verb part, a noun part consists of an adjective followed by a noun, and a verb part consists of a verb followed by an adverb. We can use these rules to generate a subset of English by starting with the "S" rule and replacing symbols on the right-hand side with the corresponding rule. The rules I've given don't allow much freedom. You can replace the NP of the first rule with ADJ N and the VP with V ADV, giving you sentences of the form adjective-noun-verb-adverb: sentences like "Loose lips sink fast" (but *not* "Loose lips sink ships"). If you use more rules, you can capture more of English, but Noam Chomsky (considered the founder of transformational or generative grammar) showed in the late 1950s that these *context-free* grammars—so called because the symbols on the left-hand sides of the right arrows don't have to appear in any special context in order to be substituted into right-hand sides—aren't powerful enough to describe any natural languages.

They're just the ticket, though, for computer languages. Most of the syntax of modern programming languages is describable by context-free grammars, including that small part of syntax we're interested in here. In table 1, I present the context-free grammar for arithmetic expressions in Backus-Naur form.

I've switched syntax from the linguists' to the computer scientists'. The ::= is just like the right arrow, and the | means "or." These rules say that an expression is a term, a term plus an expression, or a term minus an expression; a term is a factor, a factor times a term, or a factor divided by a term; and a factor is either a number, a minus sign followed by a factor, or an expression enclosed in parentheses. These rules capture the correct precedence rules for the four common arithmetic operations, as well as unary minus and parentheses (both of which have higher precedence than any other operator).

If you look carefully at the rules, you may find yourself getting dizzy. It

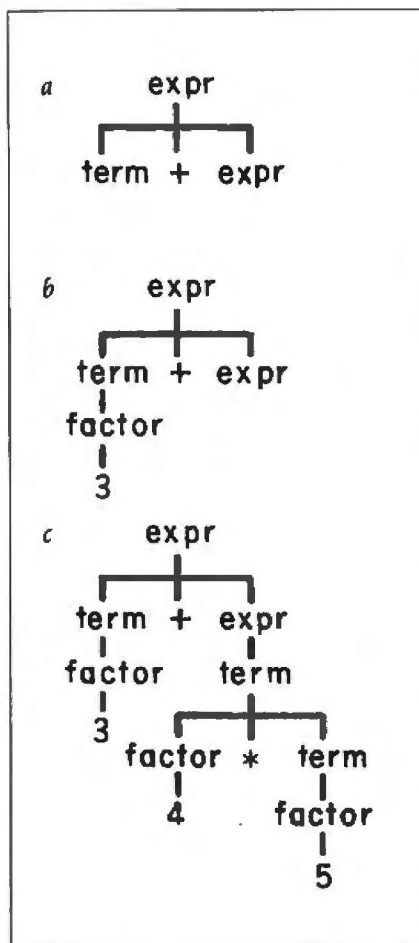

Figure 1: The steps in creating the parse tree for 3 + 4 \* 5.

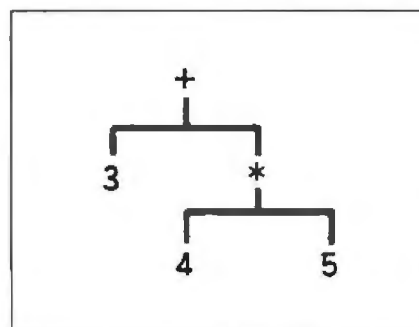

Figure 2: An abbreviated parse tree of 3 + 4 \* 5.

seems that each rule is defined in terms of itself and another rule. Where does it all end? It ends in the characters that make up the four operations and parentheses and in the numbers. Let's use the rules to parse

3 + 4 \* 5. The description of what we're doing is called a "parse tree."

**PARSING AN EXPRESSION**

To begin with, the whole thing is an expression (we always start parsing with expr). Now, there are three kinds of expressions: one is just a term, another is two things separated by a plus sign, and the third is two things separated by a minus sign. With 3 + 4 \* 5, we obviously have two things that are separated by a plus sign. So far, the parse tree looks like figure 1a. Let's concentrate next on the first component, which is the number 3. We know it's a term, but which of the three term rules apply? Again, the only choice is the first one, which says a term is a factor. And now we have reached dry land because a factor is, among other things, a number. Our parse tree now looks like figure 1b.

Now we can concentrate on the other half of our expression, 4 \* 5. Here, the only appropriate expression rule is the first one, since there are no plus or minus signs in our subexpression. And the only fitting term rule is the second one, because of the multiplication sign. The complete parse tree is shown in figure 1c.

Do you see how the parse tree captures the precedence rules? Notice that the 4 \* 5 is together on a single subtree, joined to the 3 by the plus sign. If you eliminate all the occurrences of expr, term, and factor, which were useful in the parsing process but now serve no purpose, you have the much simpler tree shown in figure 2.

It is just these latter trees that my parsing program will construct. Once you've got the tree, it's easy to actually calculate the expression: just start at the root (top) of the tree, evaluate (recursively) the left and right subtrees, and then perform the operation at the root on the two results.

**FROM GRAMMAR TO PARSER**

But how do you go from the three grammar rules I described earlier to a working program? The choice of which rule to apply at any step seems to require looking ahead. When con-

fronted with  $3 + 4 * 5$ . I chose the second *expr* rule because of the plus sign. This required only slight look-ahead, but consider the expression  $3 * 4 * 5 * 6 + 7$ . This is also correctly described by the second *expr* rule, but now the look-ahead is considerably larger, and I could make it as large as I want by putting more multiplications before the addition. Now, an arithmetic expression 20 pages long may be absurd, but a program 20 pages long is not, so if you want to be able to generalize this technique to parsing programs, you have to confine the look-ahead. And even if you decide to take the easy way out by reading the whole input in at once and looking ahead, it would be inefficient to rescan the entire string over and over again.

In fact, there is a better way—the grammar rules require *no more than one character look-ahead*. How is this possible, after what I just said about choosing the right rule? If you examine the rules again, you'll notice that *an expression always starts with a term*. Sometimes the term is followed by a plus sign, sometimes a minus sign, sometimes nothing—but you can worry about that *after* parsing the term. Then you can peek at the next character to see if it's what you want, and if it's not, you can put it back. The "put-back" operation is easy to implement because you'll never have to put back more than one character. If you look at the rules for term and factor, you'll see that there, too, the correct rule can be chosen on the basis of only one character.

The construction of the actual program will be quite straightforward if you implement the parser by associating a procedure with each group of rules—one for the *expr* rules, one for the term, and one for the factor. The procedures just mirror the rules. Each procedure is responsible for parsing its own category of subexpression, consuming just enough of the input to do so, and returning the proper parse tree. For example, the *expr* procedure first calls the term procedure to take care of the parsing of the term; then it looks ahead to see if the next

(continued)

**Table 1: The grammar of arithmetic in Backus-Naur form.**

```

expr ::= term | term + expr | term - expr
term ::= factor | factor * term | factor / term
factor ::= number | -factor | (expr)
    
```

**Listing 1: A program to parse and evaluate ordinary integer arithmetic expressions.**

```

(* This is a Texas Instruments-style calculator. It parses arithmetic
   expressions using the usual precedence rules.
   Written by Jonathan Amsterdam, December 1984.
*)

PROGRAM TICalc;

CONST
  endOfFile = 0; (* special character signifying end of file *)
  empty = 127; (* character used to indicate that savedChar is empty *)
  endOfLine = 13; (* special character signifying end of line *)

TYPE
  nodetype = (binop, unop, number);
  node = ^noderec;
  noderec = RECORD
    CASE tag:nodetype OF
      binop: (operator: CHAR;
              leftOperand, rightOperand:node);
      unop: (uOperator:CHAR;
             operand:node);
      number:(num:INTEGER);
    END;

VAR
  savedChar: CHAR;
  digits: SET OF CHAR;

(* input functions *)

FUNCTION getChar:CHAR;
(* Useful low-level character input. Returns special characters at
   end of file and end of line. *)
VAR c:CHAR;
BEGIN
  IF savedCHAR <> chr(empty) THEN BEGIN
    getChar := savedChar;
    savedChar := chr(empty);
  END ELSE IF EOF THEN
    getChar := chr(endOfFile)
  ELSE IF EOLN THEN BEGIN
    getChar := chr(endOfLine);
    readln;
  END ELSE BEGIN
    read(c);
    getChar := c;
  END;
END;
    
```

(continued)

# C Programmers: Program three times faster with *Instant-C*<sup>TM</sup>

*Instant-C*<sup>TM</sup> is an optimizing interpreter for the C language that can make programming in C three or more times faster than using old-fashioned compilers and loaders. The interpreter environment makes C as easy to use as Basic. Yet *Instant-C*<sup>TM</sup> is 20 to 50 times faster than interpreted Basic. This new interactive development environment gives you:

**Instant Editing.** The full-screen editor is built into *Instant-C*<sup>TM</sup> for immediate use. You don't wait for a separate editor program to start up.

**Instant Error Correction.** You can check syntax in the editor. Each error message is displayed on the screen with the cursor set to the trouble spot, ready for your correction. Errors are reported clearly, by the editor, and only one at a time.

**Instant Execution.** *Instant-C*<sup>TM</sup> uses no assembler or loader. You can execute your program as soon as you finish editing.

**Instant Testing.** You can immediately execute any C statement or function, set variables, or evaluate expressions. Your results are displayed automatically.

**Instant Symbolic Debugging.** Watch execution by single statement stepping. Debugging features are built-in; you don't need to recompile or reload using special options.

**Instant Loading.** Directly generates .EXE or .CMD files at your request to create stand-alone versions of your programs.

**Instant Floating Point.** Uses 8087\* co-processor if present.

**Instant Compatibility.** Follows K & R standards. Comprehensive standard library provided, with source code.

**Instant Satisfaction.** Guaranteed, or your money back. *Instant-C*<sup>TM</sup> is available now, and works under PC-DOS, MS-DOS\*, and CP/M-86\*.

Find out how *Instant-C*<sup>TM</sup> is changing the way that programming is done.

*Instant-C*<sup>TM</sup> is \$495. Call or write for more information.

## Rational Systems, Inc.

(617) 653-6194

P.O. Box 480

Natick, Mass. 01760

Trademarks: MS-DOS (Microsoft Corp.), IBM\* (Intel Corp.), CP/M-86 (Digital Research, Inc.), *Instant-C* (Rational Systems, Inc.)

## PROGRAMMING PROJECT

```
PROCEDURE ungetChar(c:CHAR);
(* Allows one character at a time to be pushed back on the input. *)
BEGIN
  IF savedChar = chr(empty) THEN
    savedChar := c
  ELSE
    writeln('ungetChar' can't unget more than one character at a time);
END;
```

```
FUNCTION nextChar:CHAR;
(* Skips over blanks. *)
VAR c:CHAR;
BEGIN
  REPEAT
    c := getChar
  UNTIL c <> ' '
  nextChar := c;
END;
```

```
FUNCTION charToInt(c:CHAR):INTEGER;
(* Converts a numeric character to an integer. *)
BEGIN
  IF NOT (c IN digits) THEN BEGIN
    writeln('charToInt: ', c, 'is not a digit');
    charToInt := 0;
  END ELSE
    charToInt := ord(c) - ord('0');
END;
```

```
FUNCTION getNum(c:CHAR):INTEGER;
(* Reads a number from the input. The first digit of the number has
   already been read and is passed as an argument. *)
VAR n:INTEGER;
BEGIN
  n := 0;
  REPEAT
    n := 10*n + charToInt(c);
    C := getChar;
  UNTIL NOT (c IN digits);
  ungetChar(c);
  getNum := n;
END;
```

(\* node creation functions \*)  
 (\* The following three functions create nodes for the parse tree. The first two each return NIL if their node arguments are NIL. \*)

```
FUNCTION binopNode(opor:CHAR; lopand, ropand:node):node;
VAR n: node;
BEGIN
  IF (lopand = NIL) OR (ropand = NIL) THEN
    binopNode := NIL
  ELSE BEGIN
    New(n, binop);
    WITH n* DO BEGIN
      lag := binop;
      operator := opor;
      leftOperand := lopand;
      rightOperand := ropand;
    END;
    binopNode := n;
  END;
END;
```

```

FUNCTION unopNode(opor:CHAR; opand:node):node;
VAR n:node;
BEGIN
  IF opand = NIL THEN
    unopNode := NIL
  ELSE BEGIN
    new(n, unop);
    WITH n DO BEGIN
      tag := unop;
      uOperator := opor;
      operand := opand;
    end;
    unopNode := n;
  END;
END;

FUNCTION numberNode(i:INTEGER):node;
VAR n:node;
BEGIN
  new(n, number);
  WITH n DO BEGIN
    tag := number;
    num := i;
  END;
  numberNode := n;
END;

(* tree-printing procedures *)

PROCEDURE ptree(n:node; depth:INTEGER);
BEGIN
  WITH n DO
    CASE tag OF
      binop: BEGIN
        ptree(leftOperand, depth + 2);
        writeln(' ',depth,operator);
        ptree(rightOperand, depth + 2);
      END;
      unop: Begin
        writeln(' ',depth,uoperator);
        ptree(operand, depth + 2);
      END;
      number: writeln(' ',depth,num);
    END;
END;

PROCEDURE PrintTree(n:node);
BEGIN
  ptree(n, 0);
END;

(* parser *)
(* Each of the three parsing functions returns NIL if an error occurs in the parse. *)

```

(continued)

*One of the variants is for binary operations, another for unary operations, and a third for numbers.*

nonblank character is a plus or minus and, if so, calls itself—recursively—to parse the rest of the expression. Finally, it combines the parse tree produced by term and the one produced by the recursive call on itself into a larger tree with the operator—plus or minus—at its root and returns this tree. The implementations of term and factor are similar.

#### IMPLEMENTATION

At this point, the actual programming is trivial; its outcome can be found in listing 1 and may be downloaded from BYTEnet Listings. (The phone number is (617) 861-9774.) I wrote it in UCSD Pascal on an Apple II, but I didn't use any features peculiar to that implementation, so it should be portable. The nodes of the parse tree are represented by variant records. One of the variants is for binary operations like addition and multiplication, another for unary operations like negation, and a third for numbers (I used integers to keep it simple).

Because I have to put back a character on the input sometimes, I built an input procedure on top of Pascal's; this is a good idea anyway, because Pascal has such hideous I/O (input/output). My routine, called getChar, always returns a character, even at end of line or end of file; two special characters are chosen for these cases. The getChar routine interacts with ungetChar through the variable savedChar to allow one character to be put back on the input. The next-Char function ignores blanks, which is usually the right thing to do. The getNum function translates a string of

(continued)

# DeSmet C

8086/8088  
Development  
Package

**\$109**

## FULL DEVELOPMENT PACKAGE

- Full K&R C Compiler
- Assembler, Linker & Librarian
- Full-Screen Editor
- Execution Profiler
- Complete **STDIO** Library (>120 Func)

## Automatic DOS 1.X/2.X SUPPORT

## BOTH 8087 AND S/W FLOATING POINT OVERLAYS

## OUTSTANDING PERFORMANCE

- First and Second in AUG '83 BYTE benchmarks

## SYMBOLIC DEBUGGER

**\$50**

- Examine & change variables by name using C expressions
- Flip between debug and display screen
- Display C source during execution
- Set multiple breakpoints by function or line number

## DOS LINK SUPPORT

**\$35**

- Uses DOS .OBJ Format
- LINKs with DOS ASM
- Uses Lattice® naming conventions

Check:  Dev. Pkg (109)  
 Debugger (50)  
 DOS Link Supt. (35)

SHIP TO: \_\_\_\_\_

\_\_\_\_\_

ZIP \_\_\_\_\_

**CW A R E**  
CORPORATION

P.O. BOX C  
Sunnyvale, CA 94087  
(408) 720-9696

All orders shipped UPS surface on IBM format disks. Shipping included in price. California residents add sales tax. Canada shipping add \$5, elsewhere add \$15. Checks must be on US Bank and in US Dollars. Call 9 a.m. - 1 p.m. to CHARGE by VISA/MC/AMEX.

Street Address: 505 W. Olive, #767, (94086)

## PROGRAMMING PROJECT

```
FUNCTION term:node; FORWARD;
```

```
FUNCTION factor:node; FORWARD;
```

```
FUNCTION expr:node;
```

```
(* An expression is either a term, or a term +, - an expression. *)
```

```
VAR c:CHAR;
```

```
n:node;
```

```
BEGIN
```

```
n := term;
```

```
expr := n;
```

```
IF n <> NIL THEN BEGIN
```

```
c := nextChar;
```

```
IF (c = '+') OR (c = '-') THEN
```

```
expr := binopNode(c, n, expr)
```

```
ELSE IF c <> chr(endOfLine) THEN
```

```
ungetChar(c);
```

```
END;
```

```
END;
```

```
FUNCTION term(*:node*);
```

```
(* A term is either a factor, or a factor */ a term. *)
```

```
VAR c:CHAR;
```

```
n:node;
```

```
BEGIN
```

```
n := factor;
```

```
term := n;
```

```
IF n <> NIL THEN BEGIN
```

```
c := nextChar;
```

```
IF (c = '*') OR (c = '/') THEN
```

```
term := binopNode(c, n, term)
```

```
ELSE
```

```
ungetChar(c);
```

```
END;
```

```
END;
```

```
FUNCTION factor(*:node*);
```

```
(* A factor is either a number, or a - followed by a factor, or a parenthesized expression. *)
```

```
VAR c:CHAR;
```

```
BEGIN
```

```
c := nextChar;
```

```
IF c IN digits THEN
```

```
factor := numberNode(getNum(c))
```

```
ELSE IF c = '-' THEN
```

```
factor := unopNode(c, factor)
```

```
ELSE IF c = '(' THEN BEGIN
```

```
factor := expr;
```

```
IF nextChar <> ')' THEN
```

```
writeln('close parenthesis expected');
```

```
END ELSE BEGIN
```

```
writeln('illegal expression');
```

```
factor := NIL;
```

```
END;
```

```
END;
```



```

FUNCTION eval(n:node):REAL;
(* Evaluates a parse tree. Assumes that the only binary operations are +, -, *,
and / and that the only unary operation is -. *)
VAR op1, op2:REAL;
BEGIN
  WITH n DO
    CASE tag OF
      binop:
        BEGIN
          op1 := eval(leftOperand);
          op2 := eval(rightOperand);
          CASE operator OF
            '+': eval := op1 + op2;
            '-': eval := op1 - op2;
            '*': eval := op1 * op2;
            '/': eval := op1 / op2;
          END;
        END;
      unop: eval := -eval(operand);
      number: eval := num;
    END;
  END;

PROCEDURE run;
VAR n:node;
    c:CHAR;
BEGIN
  REPEAT
    write('> ');
    n := expr;
    IF n <> NIL THEN BEGIN
      writeln;
      printTree(n);
      writeln;
      writeln(eval(n):0:2);
    END;
  UNTIL FALSE;
END;

BEGIN (** MAIN PROGRAM **)
  write('TI-style calculator');
  writeln('Enter an arithmetic expression and hit <RETURN> .');
  writeln('I will print a parse tree and evaluate the expression. ');
  digits := ['0'..'9'];
  run;
END.

```

digits into an integer; I couldn't use Pascal's read procedure because I don't know I have a number until I've read the first digit.

The three parsing functions, `expr`, `term`, and `factor`, each return the parse tree they construct or NIL if an error occurred during the parse. If the parse is successful, the completed parse tree is fed to the evaluation

function `eval`, and the answer appears. Just for fun, I wrote a simple procedure (`printTree` in listing 1) to print out the parse tree. The tree comes out sideways, but what do you expect for 10 lines of code?

#### WHERE TO GO FROM HERE

As I said at the beginning of this article, this little calculator's just the tip

of the iceberg. You might begin with some simple modifications, like disposing of the storage used by the parse tree when it is no longer needed, improving the error checking in both the parsing and evaluation phases, and making it simpler to exit the program. The calculator could easily be extended to handle floating-point numbers and other operations (such as exponentiation and square root).

It would be somewhat more challenging to make the operators left associative. That is, now the expression `"3 + 4 + 5"` is parsed as if it were `"3 + (4 + 5)"`, but it really ought to be parsed as `"(3 + 4) + 5."` Simply rewriting the grammar rules won't work; you have to modify the parser directly.

The calculator could be made much more powerful by adding a "memory" in the form of 26 one-letter variables, *a* through *z*, and a new grammar rule:

`assignment ::= letter := expr`

(Note that the `::=` is part of the description of the rule, while the `:=` is actually part of the rule's right-hand side.) The meaning of this rule is "assign the value of the expression to the variable." To make this work, variables have to be able to appear in expressions, so a rule should be added that says that a single letter can be a factor.

Is it starting to look like a programming language? Here are two more useful rules:

`if_stmt ::= if bool_expr then stmt else stmt`  
`while_stmt ::= while bool_expr do stmt`

I leave the rules for Boolean expressions and statements to you. Once you've built up the parse tree for a program in this simple programming language, you have two choices: You can *interpret* the parse tree right then and there, as I did above, or you can *compile* it by outputting instructions (in machine language or in another high-level language) for carrying out the statements of the program. ■



# CONROY

TELEX 910 380 3980

**ALL MAIL: 12060 SW Garden Place, Portland, OR 97223**

## FOR YOUR APPLE



### MACINTOSH

	LIST PRICE	CONROY PRICE
AEIGIS, Challenger or Pyramid, ea.	\$ 50	\$ 33
ASSIMILATION, Turbo Touch	\$ 129	\$ 89
BLUECHIP, Millionaire, Barron, Tycoon, ea.	\$ 60	\$ 38
CENTRAL POINT, Copy II Mac or Mac Tools, ea.	\$ 40	\$ 24
CONROY-LA POINTE, Diskettes	SEE BELOW	
CONTINENTAL, Home Accountant	\$ 100	\$ 65
CREATIVE SOLUTIONS, MacForth Level I	\$ 149	\$ 95
CREIGHTON, Home Pak or Mac Office, ea.	\$ 39	\$ 26
Mac Spell +	\$ 99	\$ 60
CSD, MacIcon	\$ 379	\$ 239
DOW JONES, Market Manager Plus	\$ 249	\$ 159
EXPERTELIGENCE, ExperLogo	\$ 150	\$ 95
FIRST BYTE, Smooth Teller	\$ 150	\$ 95
FORETHOUGHT, Fact Finder	\$ 150	\$ 95
HABA, DS/DD, Ext. Disk Drive, BOOK	\$ 795	\$ 479
HAYDEN, Sargon III	\$ 50	\$ 31
HIPPOBOTAMUS, Hippo C, Level I	\$ 150	\$ 99
HUMAN EDGE, Mind Prober	\$ 50	\$ 29
INFOCOM, Hitchhiker's Guide	\$ 40	\$ 25
KOALA, Mac Vision	\$ 400	\$ 229
LIVING VIDEOTEXT, Think Tank	\$ 145	\$ 83
LOTUS, Jazz	\$ 695	\$ 395
MEGAHAUS, Megalorm	\$ 295	\$ 189
MICROSOFT, Business Pak	\$ 585	\$ 395
Excel	\$ 395	\$ 259
Multiple, Word, or File, each	\$ 195	\$ 125
NILES, Mac the Knife, v. 1	\$ 39	\$ 25
MONOGRAM, Dollars & Sense	\$ 150	\$ 89
NOVATION, Smartcal Plus Modem w/Software	\$ 499	\$ 349
OBESTA, Helix	\$ 395	\$ 259
PROVUE, Omnivue	\$ 295	\$ 185
SIMON & SCHUSTER, Typing Tutor III	\$ 60	\$ 37
SOFTV. PUBL., PFS: Fat & Report Combo	\$ 175	\$ 105
SOFTWARE ARTS, T/K Solver	\$ 249	\$ 159
STATE OF THE ART, Electronic Checkbook	\$ 80	\$ 50
STONEWARE, DB Master	\$ 185	\$ 125
TELOS, File Vision	\$ 195	\$ 115
VIDEX, MacCalendar	\$ 89	\$ 49
WARNER, Desk Organizer	\$ 149	\$ 89

### COMPUTERS

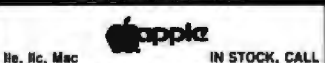

### FLOPPY DISK DRIVES

No., M.C., Mac	IN STOCK, CALL
MICRO-SCI, A2 Disk Drive, 143K	\$ 345 \$ 183
A2 Controller Card	\$ 100 \$ 60
Half Height Drive for II + IIe	\$ 269 \$ 169
Half Height Drive for IIc	\$ 299 \$ 189
RANA, Elite I, 163K, 40 Track	\$ 299 \$ 189
Elite Controller	\$ 145 \$ 79
TEAC, T40 Half HI, 163K, Direct Controller Card for T40 by ComX	\$ 249 \$ 159
	\$ 79 \$ 45

### HARD DISKS

QUARK, OC10 for IIc/IIe/IIIMAC	\$1995 \$1595
--------------------------------	---------------

### OTHER HARDWARE

APPLIED ENGINEERING, Ram Works, 64K	\$ 179 \$ 139
CCS, 7711 or 7710-A Interface, ea.	\$ 115 \$ 85
CPS/EASTSIDE, Wild Card II (copier, +10)	\$ 140 \$ 79
COMX, 16K RAM Card (II + ), 1 yr lid wty	\$ 119 \$ 29
HAYES, Mach II, III Joysticks (II + IIe)	CALL
KENSINGTON, System Saver Fan	\$ 90 \$ 65
KEY TRONIC, KE200 Keyboard (+)	\$ 298 \$ 179
KOALA, Muppet Keys	\$ 80 \$ 44
Touch Tablet w/Micro Illustrator (+H)	\$ 130 \$ 75
KRAFT, Joystick (II/II + IIe)	\$ 50 \$ 35
MICRO-SOI, 80 Col Card + 64K RAM Card (file)	\$ 109 \$ 89
MICRO-SOI, Premium Softcard (file)	\$ 395 \$ 275
Z80 Softcard II, 64K	\$ 425 \$ 295
ORANGE MICRO, Buffered Grappler Plus, 96K	\$ 209 \$ 159
16K Buffer Board for Grappler Plus	\$ 90 \$ 59
PCPI, Applicard, 8 MHz, 14 features	\$ 375 \$ 250
TITAN, Accelerator IIe	\$ 319 \$ 219
128K RAM Card (II + )	\$ 329 \$ 149
TRACKHOUSE, Numeric Key Pad (file)	\$ 100 \$ 50
TRIDGE V, 7 Color 7 RGB Card	\$ 150 \$ 99
V Color IIC	\$ 200 \$ 139
V Color Ite	\$ 250 \$ 169
VIDEX, UltraTerm II (+IIe)	\$ 299 \$ 189
VideoTerm 80 Col. Card (II + IIe)	\$ 279 \$ 175
WICO, Smartcard (spec. II/II + IIe)	\$ 199 \$ 159

### BUSINESS SOFTWARE

	LIST PRICE	CONROY PRICE
ALS, Word or List Handler, ea.	\$ 80	\$ 36
Handler Pak (Word/List/Spell)	\$ 170	\$ 73
APPLE, Appleworks	\$ 250	\$ 215
ASHTON-TATE, dBase II (req. CPM 80)	\$ 495	\$ 289
BPI, AR, AP, PR or INV, each	\$ 395	\$ 240
BRODERBUND, Print Shop	\$ 50	\$ 29
Print Shop & Refill	\$ 85	\$ 39
Bank St. Writer or Speller, ea.	\$ 70	\$ 45
Bank St. Combo (Writer & Speller)	\$ 140	\$ 85
DATA TRANS, Fontmix	\$ 95	\$ 55
DOW JONES, Market Manager	\$ 249	\$ 159
Market Analyzer or Microscope, ea.	\$ 349	\$ 219
HOWARD SOFT, Tax Preparer '85	\$ 250	\$ 159
LIVING EDGE, Sales or Mgmt. Edge, ea.	\$ 250	\$ 165
LIVING VIDEOTEXT, Think Tank	\$ 145	\$ 89
MECA, Managing Your Money	\$ 199	\$ 125
MEGANAUS, Megaworks	\$ 125	\$ 80
MICRO PRO, WordStar (req. CPM)	\$ 350	\$ 189
WordStar w/ Starcard	\$ 485	\$ 265
WordStar Professional, 4 Pak	\$ 485	\$ 265
MainMerge, SpellStar, or StarCheck, ea.	\$ 99	\$ 54
InfoStar and StarCard Combo	\$ 595	\$ 295
MICROSOFT, Multi-Plan (Ap DOS)	\$ 95	\$ 62
QUARK, Word Juggler & Lencheck (file/c)	\$ 189	\$ 129
SENSIBLE, Sensible Speller	\$ 125	\$ 79
SIERRA/ON-LINE, Screen Writer II	\$ 130	\$ 79
SOFTWARE PUBL., PFS File or Wise, each	\$ 125	\$ 79
PFS:Graph or Report, each	\$ 125	\$ 79
PFS:Access	\$ 70	\$ 43
SPRINGBOARD, Newsroom	\$ 50	\$ 32
STONEWARE, DB Master, v. 4+	\$ 360	\$ 225

### UTILITIES SOFTWARE

	LIST PRICE	CONROY PRICE
EPSON, Graphics Dump	\$ 15	\$ 7
FUNK, Sideways	\$ 60	\$ 37
HAYES, Terminal Prog. for Smartmodem	\$ 99	\$ 65
MICROSOFT, Full Line IN STOCK	CALL	
OMEGA, Locksmith	\$ 100	\$ 70
PENQUIN, Complete Graphics System II	\$ 80	\$ 49
Graphics Magician	\$ 60	\$ 40
QUALITY, Bag of Tricks	\$ 40	\$ 29
UNITED SWI, ASCII Express-Pro DOS	\$ 130	\$ 82
UTILICO, Essential Data Duplicator III	\$ 80	\$ 49

### HOME & EDUCATIONAL

BEAGLE BROS., Full Line IN STOCK	CALL	
BRODERBUND, Print Shop	\$ 50	\$ 29
CONTINENTAL, Home Accountant	\$ 75	\$ 43
KOALA, Full Line IN STOCK	CALL	
MICROSOFT, Typing Tutor II	\$ 25	\$ 17
MONOGRAM, Dollars & Sense (II + IIe)	\$ 100	\$ 59
Dollars & Sense (II/IIe 128K)	\$ 129	\$ 69
Forecast	\$ 60	\$ 38
SCARBOROUGH, Mestertype	\$ 40	\$ 25
Build-A-Book	\$ 40	\$ 25
Your Personal Net Worth	\$ 80	\$ 50
SIERRA/ON-LINE, Homeward	\$ 70	\$ 45
SIMON & SCHUSTER, Typing Tutor III	\$ 60	\$ 37

### RECREATIONAL SOFTWARE

BLUECHIP, Millionaire or Barron, ea.	\$ 60	\$ 39
DATASOFT, Aztec or Zaxxon, each	\$ 40	\$ 27
ELECTRON. ARTS, Sly Fox & others, ea.	\$ 40	\$ 29
HAYDEN, Sargon III (Chess)	\$ 50	\$ 30
INFOCOM, Zork I, II, or III, ea.	\$ 40	\$ 25
ORIGIN, Ultima III	\$ 60	\$ 37
PENQUIN, Transylvania	\$ 35	\$ 24
SPECTRUM HOLOBYTE, Gato	\$ 40	\$ 25
SPINNAKER, Full Line IN STOCK	CALL	
SUB LOGIC, Flight Simulator II	\$ 50	\$ 30
PLUS: BRODERBUND, DATAMOST, MUSE, SIR-TECH		

### DISKETTES

**\* CONROY-LAPOINTE \* DISKETTES \***  
We guarantee these top quality products with our famous 3 YEAR LIMITED WARRANTY.

10 ea. SS/DD, (Apple, etc) 35 Trk. W/FLIP BOX	\$ 12
100 ea. SS/DD, (Apple, etc) 35 Trk	\$ 99
100 ea. SS/DD, (Apple, etc) 35 Trk	\$ 840
10 ea. DS/DD, (IBM, HP) 40 Trk. W/FLIP BOX	\$ 15
100 ea. DS/DD, (IBM, HP) 40 Trk	\$ 119
1000 ea. DS/DD, (IBM, HP) 40 Trk	\$ 859
10 ea. SS/DD, 3 1/2" (MAC, HP), W/FLIP BOX	\$ 25
50 ea. SS/DD, 3 1/2" (MAC, HP)	\$ 115
100 ea. SS/DD, 3 1/2" (MAC, HP)	\$ 229

**CONROY-LAPOINTE \* IBM PRE-FORMATTED \***

10 ea. DS/DD, 40 Trk W/FLIP BOX	\$ 19
100 ea. DS/DD, 40 Trk	\$ 149
1000 ea. DS/DD, 40 Trk	\$ 959

### SINGLE-SIDED, DOUBLE DENSITY

	LIST PRICE	CONROY PRICE
CDC, 10 ea. SS/DD, 40 Trk (Apple, etc)	\$ 45	\$ 19
DYSAN, 10 ea. SS/DD, (Apple, etc)	\$ 40	\$ 27
MAXELL, 10 ea. SS/DD, MD1 (Apple)	\$ 47	\$ 19
VERBATIM, 10 ea. SS/DD, MD2-01 (Apple)	\$ 49	\$ 19

**DOUBLE-SIDED, DOUBLE DENSITY**

CDC, 10 ea. DS/DD, 40 Trk (IBM, HP)	\$ 59	\$ 23
DYSAN, 10 ea. DS/DD, (IBM, HP)	\$ 58	\$ 35
MAXELL, 10 ea. DS/DD, MD2 (IBM)	\$ 71	\$ 26
VERBATIM, 10 ea. DS/DD, MD34 (IBM)	\$ 75	\$ 24

**3 1/2" MICRO DISKETTES**

CONROY-LAPOINTE, 10 ea. DS/DD, w/Flip Box	\$ 29	
MAXELL, 10 ea. SS/DD (MAC, HP)	\$ 60	\$ 35
MEMOREX, 10 ea. SS/DD (MAC, HP)	\$ 60	\$ 33
VERBATIM, 10 ea. SS/DD (MAC, HP)	\$ 65	\$ 32

### HIGH DENSITY DISKETTES FOR IBM-AT

MAXELL, 10 ea. DS/DD (IBM-AT)	\$ 77	\$ 49
MEMOREX, 10 ea. DS/DD (IBM-AT)	\$ 77	\$ 49

### \* GENERIC DISKETTES \*

Top quality, w/labels, no labels. Quantity discounts. 90 day "No hassle, money back guarantee"

100 ea. SS/DD, 35 Track (Apple, etc)	\$ 80
100 ea. DS/DD, 40 Track, (IBM, HP)	\$ 95

### MODEMS

	LIST PRICE	CONROY PRICE
ANCHOR, Signalman Mark XII	\$ 399	\$ 259
HAYES, 2400 External Modem	\$ 899	CALL
Smartmodem 1200B (IBM)	\$ 549	\$ 369
Smartcom II Software (IBM or MAC)	\$ 149	\$ 107
Smartmodem 1200 (External)	\$ 595	\$ 419
Smartmodem IIe w/Smartcom (AP)	\$ 199	\$ 139
Transel 1000 -- 128K	\$ 399	\$ 309
NOVATION, Apple Cal II 300 Baud (AP)	\$ 389	\$ 219
212 Apple Cat, 1200 Baud (AP)	\$ 595	\$ 409
SmartCat Plus w/software (MAC)	\$ 495	\$ 349
ACCESS 1-2-3 Modem & Costalt (IBM)	\$ 595	\$ 369
PROMETHEUS, 1200 Standalone Modem	\$ 495	\$ 345
ProModem 1200 w/software (MAC)	\$ 459	\$ 389
ProModem 1200A (AP)	\$ 449	\$ 319
ProModem 1200B (IBM)	\$ 399	\$ 285
VENTEL, PC Hallcard (IBM)	\$ 549	\$ 359

### MONITORS

AMDEK, Color 300 -- Comp/Audio	\$ 349	\$ 249
Color 500 -- Comp/VCR/RGB/Audio	\$ 529	\$ 319
Color 600 -- HI Res/RGB/Audio	\$ 599	\$ 399
300A -- 12" Amber/Comp	\$ 199	\$ 119
300G, 12" Green/Comp	\$ 179	\$ 115
310A, 12" Amber (IBM)	\$ 230	\$ 149
PRINCETON, HX-12 -- HI Res/RGB	\$ 799	\$ 489
SR-12 -- HI Res/RGB	\$ 799	\$ 599
MAX-12 -- Amber (IBM)	\$ 249	\$ 179
QUADRAM, Amberchroms, 12"	\$ 250	\$ 159
ZENITH, ZVM122 -- 12" Amber	\$ 159	\$ 89
ZVM123 -- 12" Green	\$ 149	\$ 85
ZVM124 & ZVM 135	20-30% OFF	

### CABLES

ARBO, IBM-PC to Modem Cable	\$ 31	\$ 19
ASTAR, RF Modulator for T.V. (Apple)	\$ 35	\$ 20
COMPUABLE, Mac/Hayes Smartmodem Cable	\$ 32	\$ 25
CURTIS, Monitor Extension Cable (IBM)	\$ 50	\$ 35
3-9" Keyboard Extens. Cable (IBM)	\$ 40	\$ 30
RCA, Monitor Cable	\$ 15	\$ 9

### PRINTERS

**DOT MATRIX:**

	LIST PRICE	CONROY PRICE
APPLE, Imagewriter Laserwriter	\$8995	\$6500
EPSON, RX / FX Series -- IN STOCK	CALL	
LX80 -- 100 cps DQ/16 cps NQ	\$ 299	CALL
JX80 -- Color Printer, 160 cps	\$ 699	CALL
LQ1500 -- 200 cps DQ/67 cps LO	\$1295	CALL
OKIDATA, Okimate 200 -- Color, HI Res	\$ 268	\$ 208
182 -- 120 cps/80 col	\$ 298	\$ 238
192 -- 160 cps/80 col/para. NEW	\$ 498	\$ 349
85 -- 180 cps/136 col/para.	\$ 798	\$ 589
2410 Pacemaker -- 350 cps/para.	\$2095	\$1875
PANASONIC, P1090 -- 80 cps/10"	\$ 349	\$ 249
P1092 -- 180 cps/10"	\$ 599	\$ 459
QUADRAM, QuadJet -- Inkjet Color	\$ 885	\$ 395
STAR MICRO, SG10 -- 120 cps DQ/30 cps NQ	\$ 299	\$ 249
SG15 -- 120 cps DQ, 30 cps NQ, 16K	\$ 499	\$ 419
SD10 -- 160 cps DQ, 40 cps NQ	\$ 449	\$ 379
SD15 -- 160 cps DQ, 40 cps NQ, 16K	\$ 599	\$ 509
SR10 -- 200 cps DQ, 50 cps NQ	\$ 649	\$ 549
SR15 -- 200 cps DQ, 50 cps NQ, 16K	\$ 799	\$ 679
TOSHIBA, 351 -- 288 cps	\$1885	\$1368

### LETTER-QUALITY:

JIJK, 6300 -- 40cps/para.	\$ 995	\$ 695
6100 -- 18 cps/para/3 pitch	\$ 599	\$ 389
Sheet Feeder for 6300 (single)	\$ 275	\$ 225
PANASONIC, P3151 -- 22 cps/15 1/2"	\$ 999	\$ 539
TOSHIBA, Prop spacing & heavy graphics:		
1351 -- 192 cps DQ & 100 cps LQ	\$1895	\$1389
1340 -- 144 cps DQ & 54 cps LQ	\$ 799	\$ 619
Bi-direction Printer Feeder	\$ 195	\$ 175

### PLOTTERS:

EPSON, 4 Pen Plotter	\$ 599	CALL
----------------------	--------	------

### PRINTER SUPPLIES:

CONROY LAPOINTE, Colored Paper Pack (250)	\$ 13	\$ 8
PAPER: White, Colored, Laser Cut, etc.		
RIBBONS, DAISSWHEELS	CALL	

### PRINTER INTERFACES AND BUFFERS

	LIST PRICE	CONROY PRICE
ARBO, IBM-PC to Para Printer Cable	\$ 80	\$ 30
ASSIMILATION, Mac to Epson Conn I/F	\$ 60	\$ 39
Daisywheel Connection	\$ 99	\$ 79
EPSON, Parallel Interface for LQ1500	\$ 100	\$ 79
Serial Interface Board	\$ 130	\$ 110
OKIDATA, Plug n Play, Tractors, Okigraph	CALL	
ORANGE MICRO, Grappler Plus for Apple	\$ 145	\$ 99
Serial Grappler	\$ 119	\$ 79
Buffered Grappler Plus, 16K	\$ 209	\$ 159
Hot Link Cable, S-P for IIC	\$ 70	\$ 44
Grappler C	\$ 119	\$ 75
QUADRAM, MicroZappers, Full Line IN STOCK	CALL	
MicroZappers 8K, P-P, w/copy	\$ 189	\$ 139
SMT, Apple II I/F & Cable	\$ 89	\$ 39
STAR MICRO, Serial I/F & Cable	\$ 144	\$ 119
Mac/Star Interface	\$ 100	\$ 89

### ACCESSORIES

CURTIS, Diamond, 6 outlets, switched	\$ 50	\$ 29
Emerald, 8 outlets, 6' cord	\$ 60	\$ 35
Ruby, 6 outlets, 6' cord, filter	\$ 90	\$ 52
Sapphire, 3 outlets, w/filter	\$ 80	\$ 46
EPD, Lemon, 5 outlets/w/filter	\$ 45	\$ 29
Lime, 6 outlets/cord	\$ 70	\$ 45
Orange, 6 outlets/cord/filter	\$ 100	\$ 60
Peach, 3 outlets/w/filter	\$ 80	\$ 39
INNOVATIVE, Flip-n-File 50 (desk holder)	\$ 22	\$ 11
KENSINGTON, Printer Stand	\$ 30	\$ 19
NETWORK, Wireless, 4 outlet, w/ft & surge	\$ 70	\$ 39
Wireless Plus, 6 outlets/filtersurge	\$ 100	\$ 59
PROD TECH INTL, Uninterruptible Power Supply		
200 Watts, PC200 for IBM-PC	\$ 359	\$ 269
300 Watts,		

# -LA POINTE INC.

© 1984 by Conroy-LaPointe, Inc. All Rights Reserved

LOW PRICES TO PROFESSIONALS WHO KNOW WHAT THEY WANT AND KNOW HOW TO USE IT!

**(TO ORDER, CALL (800) 547-1289)**

FOR YOUR **IBM-PC, XT, AT** or **JR**

### COMPUTER SYSTEMS

— Call for Details —

**256K**  
IBM-PC

**360K**  
Disk Drives  
by CDC

90 Day  
Limited Warranty  
By Us



**COMPAQ** Computers  
256K, 2 360K Disk Drives

### HARD DISKS & TAPE BACKUP

	LIST PRICE	CONROY PRICE
CDC, Internal 20 meg for AT		CALL
IRWIN, 10 meg Tape Backup	\$ 795	\$ 595
KAMERMAN, Internal 10 meg kit	\$ 895	\$ 719
External 10 meg kit w/pcper	\$1295	\$1049
MF-1010, H Disk, tape back, cont. power	\$2695	\$2095
MICRO SCIENCE, 10 meg w/controllor	\$ 795	\$ 575
20 meg w/controllor	\$1095	\$ 735
TALLGRASS, 25 meg disk, 56 meg tape, int.	\$3990	\$3160

### FLOPPY DISK DRIVES

CDC, Limited 30 day warranty. Call for quantity prices

**SALE!**



Full Height **\$109**  
Half Height **\$ 89**

### OTHER HARDWARE

	LIST PRICE	CONROY PRICE
<b>AST,</b>		
SixPak Plus, 64K	\$250	
StoPak Plus, 256K, S/P/C/C + S/W	\$ 895	\$ 295
StoPak Plus, 384K, S/P/C/C + S/W	\$ 995	\$ 329
Preview Graphics Card w/para, 64K	\$ 399	\$ 299
Adventure™ Multil. Bd. for AT, 128K	\$ 595	\$ 445
IO Plus II, S/P/C/C	\$ 215	\$ 169
IO Plus II, S/P/C/C/G	\$ 265	\$ 225
Port Kits - ser, para, or game, ea.	\$ 50	\$ 35
<b>COMX,</b>		
EconoRAM™ Plus, 384K board, S/P/C/C/G Fastrak	\$265	
EconoRAM™, full 384K board	\$ 295	\$ 195
<b>HAUPPAGE (HCW), 8087 Chip</b>	\$ 175	\$ 125
8087 Math Pak (Chip & softw.)	\$ 295	\$ 235
HAYES, Mach II Joystick	\$ 45	\$ 29
Mach III (PC or Jr.)	\$ 55	\$ 35
HERCULES, Color Card w/para. Mono Graphics Card	\$ 245	\$ 169
	\$ 499	\$ 305
<b>KENNINGTON, Masterpiece™</b>	\$ 140	\$ 99
KEY TRONIC, KB5151, Std. Keyboard	\$ 255	\$ 179
KGALA, Speed Key Software	\$ 100	\$ 63
Speed Key System (Tab w/ softw.)	\$ 200	\$ 115
Koala Pad w/PC Design	\$ 150	\$ 85
<b>MAYNARD, SAND STAR SERIES</b>		
Full Line IN STOCK	CALL	
Multifunction (6) Card	\$ 89	\$ 79
Memory Card no RAM	\$ 122	\$ 89
Floppy Cont. Card (accepts 3 modules)	\$ 265	\$ 195
Hard Disk I/F Module	\$ 499	\$ 359
Serial Port Module	\$ 95	\$ 70
Para or Clock Cal. Module, ea.	\$ 59	\$ 49
<b>MICROSOFT, Mouse (for PC)</b>	\$ 195	\$ 115
Serial Mouse	\$ 195	\$ 115
<b>MOUSE SYSTEMS, PC Mouse &amp; Paint</b>	\$ 220	\$ 135

### OTHER HARDWARE

	LIST PRICE	CONROY PRICE
<b>PARADISE, Modular Graphics Card</b>	\$ 365	\$ 285
Parallel or Serial Port, ea.	\$ 95	\$ 65
<b>PERBSYST,</b>		
PC/Mono Board, w/para port	\$ 250	\$ 195
PC/Color Graphics Bd w/light pen & IF	\$ 244	\$ 178
<b>QUADRAM,</b>		
Quadboard 64K, to 384K, S/P/C/C/G	\$239	
Quadboard, no RAM, expand to 384K	\$ 295	\$ 225
Quadboard 256K, to 384K, S/P/C/C	\$ 675	\$ 269
Quadboard, 384K (full), S/P/C/C/G	\$ 795	\$ 295
Quadboard II, no RAM, to 256K	\$ 295	\$ 215
Quadboard II, 64K, to 256K, 2S/C/C	\$ 395	\$ 265
Quadboard II, 256K, 2S/C/C	\$ 595	\$ 395
Quad 512 + 64K w/serial port	\$ 325	\$ 245
Quadcolor I, board, 4 colors	\$ 295	\$ 195
Upgrade Quadcolor I to II kit	\$ 275	\$ 199
Quadvue, board, Mono, S/P/C/C	\$ 349	\$ 269
Quad 3278	\$1196	\$1050
Quadnet VI	\$1995	\$1545
Quadnet IX	\$2295	\$1745
Quadlink	\$ 495	\$ 385
Quadspint	\$ 645	\$ 495
<b>TALLTREE, J RAM II Board</b>	\$ 219	\$ 165
TG PRODUCTS, Joystick	\$ 30	\$ 22
<b>TITAN, 128K PC Accelerator</b>	\$ 795	\$ 609
<b>WICO, Smartboard Keyboard</b>	\$ 400	\$ 279

**★ 256K ★**  
**CHIP KIT**  
**\$59**  
9 each, 4256 chips  
150 ns



**★ 64K ★**  
**CHIP KIT**  
**\$10**  
9 each, 4164 chips  
90 Day Warranty by us

**★ 128K ★**  
**CHIP KIT**  
**\$75**  
9 each, 4128 chips  
Piggyback for AT

**ComX**  
**EconoRAM Plus™**  
**\$265**  
**384K Multifunction RAM Board**  
Works like AST SixPak Plus™ with game port  
Fastrak™ RAM Disk and Spooler Software  
S/P/C/C/G, 1 Year Limited Warranty.  
(Fastrak for up to 384K.)

**EconoRAM™ 384K**  
**Single Fuction Board**  
**\$195**  
With Fastrak™, Fully Compatible  
Works on DOS 1.1, 2.0 or 2.1  
Prices and availability subject to change. Call.

## SOFTWARE FOR YOUR IBM-PC, XT, AT or JR

### BUSINESS

	LIST PRICE	CONROY PRICE
<b>ASHTON-TATE, Framework</b>	\$ 695	\$ 359
dBase III	\$ 695	\$ 359
dBase II, (req. PC-DOS & 128K)	\$ 465	\$ 279
ATI, Training Programs—Large Inventory	\$ 75	\$ 40
BPI, General Acctg. AR, AP, or PR, ea.	\$ 595	\$ 365
BRODERBUND, Bank St. Writer (PC or Jr.)	\$ 80	\$ 49
CDEX, Training Programs—Large Inventory	\$ 70	\$ 45
CONTINENTAL, Ultrafile	\$ 165	\$ 115
Tax Advantage	\$ 70	\$ 40
Property Management	\$ 495	\$ 295
DATA TRANS., Fontrix	\$ 155	\$ 99
DOW JONES, Investment Evaluator	\$ 149	\$ 97
Market Manager Plus	\$ 249	\$ 159
Market Analyzer or Market Microscope	\$ 349	\$ 219
Spread Sheet Link	\$ 249	\$ 159
FOX & GELLER, Quickcode III	\$ 295	\$ 185
HARVARD, Total Project Manager	\$ 485	\$ 295
HOWARD SOFT, Tax Preparer '85	\$ 295	\$ 195
HUMAN EDGE, Mind Prober (PC or Jr.)	\$ 50	\$ 20
Sales Edge or Management Edge, ea.	\$ 250	\$ 159
Negotiation Edge	\$ 295	\$ 185
IBM, Topview	\$ 355	\$ 365
INFOCOM, Comerations	\$ 485	\$ 319
KENNINGTON, Easy Link Mail Manager	\$ 95	\$ 59
LIFETREE, Volkswriter Deluxe	\$ 295	\$ 159
LIVING VIDEOTEK, Think Tank	\$ 195	\$ 95
LOTUS, 1-2-3	\$ 495	\$ 309
Symphony	\$ 695	\$ 449
WIDS, KnowledgeMan	\$ 500	\$ 275
MECA, Managing Your Money (PC)	\$ 199	\$ 105
Managing Your Money Cartridge (Jr)	\$ 199	\$ 179

### BUSINESS

	LIST PRICE	CONROY PRICE
<b>MICROPRO, WordStar (PC)</b>	\$ 350	\$ 189
WordStar (Jr)	\$ 195	\$ 109
WordStar 2000 (copiable)	\$ 495	\$ 265
WordStar 2000 Plus (copiable)	\$ 595	\$ 295
WordStar Professional Plus	\$ 695	\$ 395
WordStar Professional, 4 Pak	\$ 495	\$ 265
MailMerge, SpellStar or Starfinder, ea.	\$ 99	\$ 54
InfoStar Plus (+ Starburst)	\$ 595	\$ 315
Correct Star	\$ 145	\$ 77
<b>MICROIM, R-Base Series 5000</b>	\$ 695	\$ 379
Upgrade 4000 to 5000	\$ 245	\$ 135
R-Base 4000	\$ 495	\$ 255
R-Base Clout	\$ 249	\$ 129
Extended Report Writer	\$ 150	\$ 85
<b>MICROSOFT, Spell</b>	\$ 50	\$ 32
Multiplan (PC or Jr)	\$ 195	\$ 125
Chart or Project, each	\$ 250	\$ 159
Word	\$ 375	\$ 235
<b>MOBAIC, Twin</b>	\$ 99	\$ 75
<b>MULTIMATE, Multimedia Ver. 3.1</b>	\$ 495	\$ 229
<b>PEACHTREE, Back to Basics</b>	\$ 395	\$ 239
Peach Pak (GL/AR/AP)	\$ 395	\$ 219
<b>QUE, Using 1-2-3 (book)</b>	\$ 18	\$ 14
1-2-3 for Business (book)	\$ 17	\$ 13
Using Symphony (book)	\$ 20	\$ 15
<b>SAMNA, Word Plus</b>	\$ 695	\$ 439
Word III	\$ 550	\$ 279
<b>SATELLITE, WordPerfect (PC)</b>	\$ 495	\$ 209
WordPerfect (Jr)	\$ 69	\$ 39
<b>SOFTW. ARTS, Spotlight</b>	\$ 199	\$ 95
TK Solver (specify DOS)	\$ 359	\$ 269
<b>SOFTWARE GROUP, Enable</b>	\$ 695	\$ 459

### BUSINESS

	LIST PRICE	CONROY PRICE
<b>SOFTWARE PUBL. PFS:Report</b>	\$ 125	\$ 75
PFS:Write, File or Graph, each	\$ 140	\$ 82
PFS:Plan or Access, each	\$ 140	\$ 82
PFS:Proof	\$ 95	\$ 57
<b>SORCHIM, SuperCalc III</b>	\$ 395	\$ 245
<b>STONEWARE, Advanced DB Master</b>	\$ 695	\$ 375
THORN EM, Perfect Pak (Jr) (Write/Spell/Thesaurus)	\$ 139	\$ 89
UNISON, Print Master	\$ 60	\$ 35
<b>WARNER, Desk Organizer (PC or Jr)</b>	\$ 99	\$ 63
<b>XANARO, Ability</b>	\$ 495	\$ 289

### UTILITIES

<b>BORLAND, Sidekick</b>	\$ 55	\$ 29
Turbo Pascal or Super Keys, ea.	\$ 70	\$ 36
Turbo Pascal w/8087 or BCD, ea.	\$ 110	\$ 56
Turbo Pascal w/8087 & BCD	\$ 125	\$ 69
Toolbox or Turbo Graphics, ea.	\$ 55	\$ 26
Turbo Tutor	\$ 35	\$ 19
<b>CENTRAL POINT, Copy II PC</b>	\$ 40	\$ 23
COMIX, Fastrak™, RAM/Disk & spooler	\$ 100	\$ 39
<b>DIGITAL RES., Gem Draw</b>	\$ 150	\$ 95
CP/M-86™ (PC/XT)	\$ 100	\$ 64
DR LOGO-86 (CP/M-86)	\$ 150	\$ 99
<b>FUNK SOFTWARE, Sideways</b>	\$ 80	\$ 37
<b>LIFEBOAT, Lattice C</b>	\$ 500	\$ 279
Dr Halo	\$ 100	\$ 50
<b>MICROSOFT, Macro Assembler</b>	\$ 150	\$ 99
BASIC Compiler or C Compiler, ea	\$ 395	\$ 259
Business BASIC Compiler	\$ 450	\$ 295
COBOL Compiler	\$ 700	\$ 459
FORTRAN Compiler	\$ 350	\$ 229
PASCAL Compiler	\$ 300	\$ 199

### UTILITIES

	LIST PRICE	CONROY PRICE
<b>MICROSTUF, Crosstalk XVI (PC or Jr)</b>	\$ 195	\$ 109
<b>MOUSE SYSTEMS, PC Paint</b>	\$ 98	\$ 69
<b>NORTON, Utilities (14 prgrams) v.3.0</b>	\$ 100	\$ 56
<b>ROBOSOFT, Proxy</b>	\$ 130	\$ 79
<b>WESTERN UNION, Easy Link Mail Mngr</b>	\$ 95	\$ 59

### HOME & EDUCATIONAL

<b>BPI, Personal Accounting</b>	\$ 98	\$ 63
<b>CONTINENTAL, Home Accountant (Jr)</b>	\$ 75	\$ 45
Home Accountant Plus (PC)	\$ 150	\$ 90
<b>DOW JONES, Home Budget</b>	\$ 139	\$ 92
<b>ELECTRONIC ARTS, Get Organized</b>	\$ 95	\$ 75
<b>MONOGRAM, Dollars &amp; Sense w/forecast</b>	\$ 80	\$ 99
<b>SCARBOROUGH, MasterType (PC or Jr)</b>	\$ 40	\$ 25
Your Personal Net Worth	\$ 100	\$ 63
<b>SIMON &amp; SCHUSTER, Typing Tutor III</b>	\$ 50	\$ 33

### RECREATIONAL

<b>BLUECHIP, Millions, Baron, Tycoon, ea.</b>	\$ 60	\$ 38
<b>BRODERBUND, Large Inventory in Stock</b>	CALL	
<b>ELECTRONIC ARTS, Large Inventory in Stock</b>	CALL	
<b>HAYDEN, Sargon III (Chess)</b>	\$ 50	\$ 34
<b>INFOCOM, Hechler's Guide or Zork I, ea.</b>	\$ 40	\$ 25
Zork II or III, each	\$ 50	\$ 29
<b>MICROSOFT, Flight Simulator (PC or Jr)</b>	\$ 50	\$ 33
<b>ORIGIN, Ultima III (PC or Jr)</b>	\$ 80	\$ 39
<b>SIERRA/ON-LINE, Ultima II (PC or Jr.)</b>	\$ 80	\$ 40
<b>SPECTRUM HOLOBYTE, Gato</b>	\$ 40	\$ 25
<b>SPINNAKER, President's Choice, Amazon</b>		
Fahrenheit, Rendezvous, Dragon, each	\$ 40	\$ 25

**CASH-N-CARRY COMPUTER STORES, INC.**  
Retail Sales only. Store prices may vary.

**SAN FRANCISCO** — 550 Washington Street (at Montgomery, opposite the Pyramid), Interstate 80 to Highway 480; take Washington Street Exit. CALL (415) 982-6212.

**PORTLAND, OREGON** — At Park 217, Tigar at intersection of Highways 217 and 99W. CALL (503) 620-5395.

**SEATTLE, WASH.** — 3540 126th Ave. SE Bellevue 98006, in Lochmann's Plaza near Factoria Square. SE of Highway 405 & 90 and at SE 36th and Richards. CALL (206) 641-4736.

**OUR REFERENCES:**

We have been in computers and electronics since 1958, a computer dealer since 1978 and in computer mail order since 1980. Banks: 1st Interstate Bank, (503) 643-4678. We belong to the Chamber of Commerce (503) 228-9411, and Direct Marketing Association; call Dun and Bradstreet if you are a subscriber. Recipient of OREGON BUSINESS MAGAZINE's 1984 Enterprise Award.

MasterCard  
VISA  
Discover  
Conroy-LaPointe CARD

**CALL (800) 547-1289**  
In Oregon: (800) 451-5151 (503) 620-9877

**QUESTIONS** (503) 620-9878  
8:00 AM - 5:00 PM (PDT)  
Weekdays Only

**ORDER DESK HOURS** Mon-Fri 9am to 6pm (PDT)  
Saturday 10am to 4pm (PDT)  
(8 am here is 9 am in New York)

Foreign & Postpaid Residents Call

NO SALES TAX

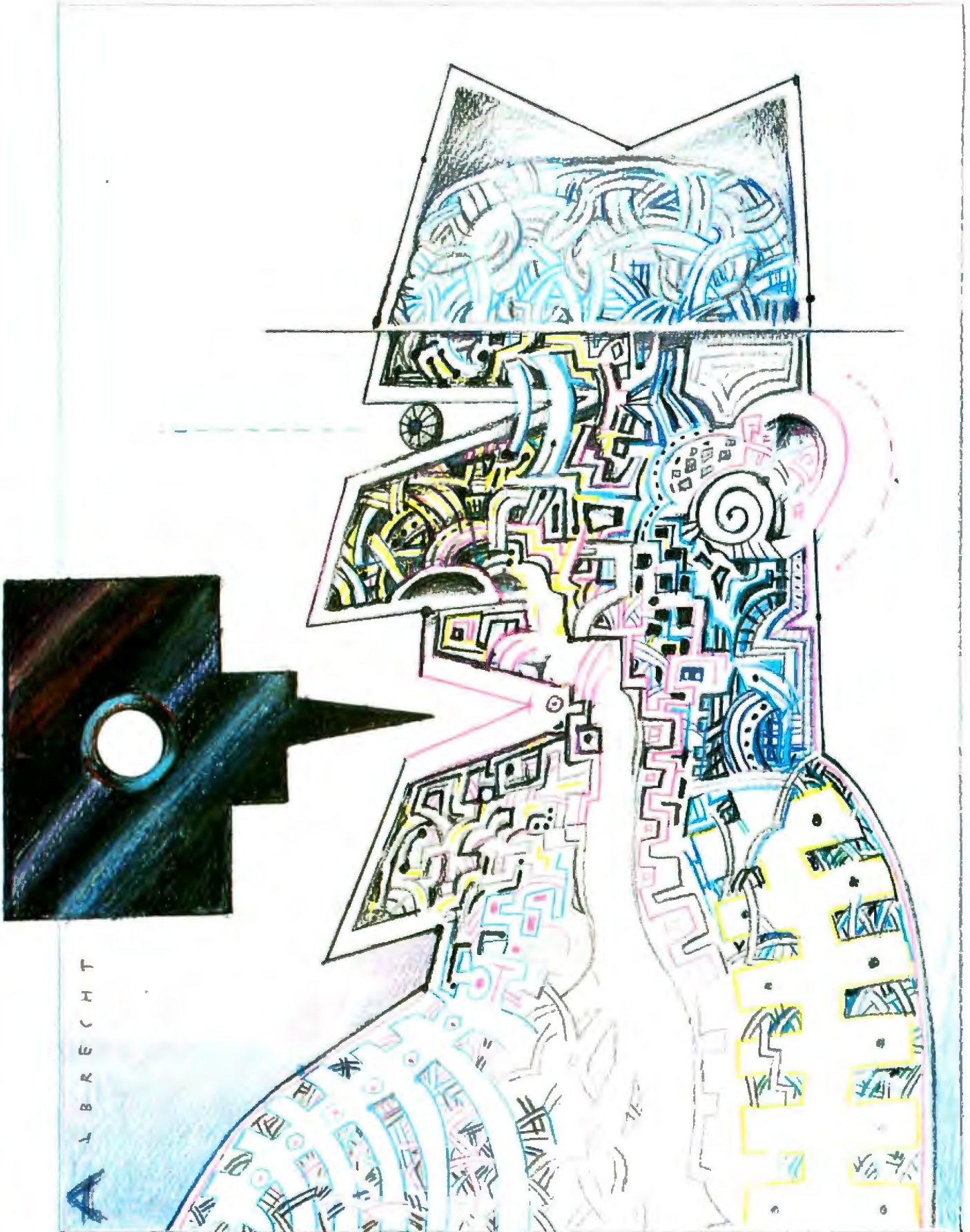

A  
L  
B  
R  
E  
C  
H  
T

# Declarative Languages

---

<b>PROLOG GOES TO WORK</b> <i>by Clara Y. Cuadrado and John L. Cuadrado</i> . . . . .	151
<b>LOGIC PROGRAMMING</b> <i>by Robert Kowalski</i> . . . . .	161
<b>DECLARATIVE LANGUAGES: AN OVERVIEW</b> <i>by Susan Eisenbach and Chris Sadler</i> . . . . .	181
<b>PROGRAM TRANSFORMATION</b> <i>by John Darlington</i> . . . . .	201
<b>FUNCTIONAL PROGRAMMING USING FP</b> <i>by Peter G. Harrison and Hessam Khoshnevisan</i> . . . . .	219
<b>A HOPE TUTORIAL</b> <i>by Roger Bailey</i> . . . . .	235

---

THE THEME OF THIS ISSUE is a programming paradigm called declarative programming, which offers a new look at computing. The major goals of declarative programming are to provide structurally transparent languages, so programs can be verified and optimized mechanistically, and to facilitate the implementation of multiple-instruction, multiple-data parallelism in the coming generation of parallel-processing computers. The way that declarative languages attempt to achieve these goals is by separating the task that the program is to perform from the way that the computer is to do it. That is, unlike imperative programming languages, declarative languages do not specify the flow of control but only the flow of data in a program.

Declarative languages did not grab the attention of most programmers until the Japanese chose to use Prolog as the programming language for their Fifth Generation Computer Systems (FGCS) project. While that project appears now to be mired in bureaucratic difficulties, the interest it sparked in Prolog lives on. We begin the theme with an article on Prolog by Clara and John Cuadrado. They present a brief introduction to the language, take a look at what the FGCS project hoped to achieve, and provide an overview of the hardware and software available that is taking Prolog beyond the development stage into the realm of finished and viable commercial products.

Next, Robert Kowalski discusses why logic programming is such an attractive development tool in the first place. As you may know, Dr. Kowalski was one of the originators of Prolog and has been a major force in the refinement of logic programming to its current high state of sophistication.

The rest of the issue concentrates on declarative-language developments that are not yet polished commercial products. To begin, Chris Sadler and I briefly outline the declarative-language enterprise and present sample programs in each of the better-known declarative languages.

Next, John Darlington explains program transformation, a method of optimization that seeks to ultimately provide a purely computer-generated optimization. As Dr. Darlington details in his article, that ideal is not yet at hand. However, substantial progress in that direction has already been made.

John Backus introduced the syntax of FP in his famous 1977 Turing Award lecture. Peter Harrison and Hessam Khoshnevisan detail the current state of development of FP in their article. They include a number of programming examples that communicate the flavor of this much-discussed but seldom-seen language.

Finally, Roger Bailey provides an in-depth tutorial on the Hope language. Of course, the only way to evaluate a language is by using it. To allow you to get your hands on Hope, Imperial College's Victor Wu has written a Hope interpreter that runs on MS-DOS machines and can be downloaded from BYTEnet Listings at (617) 861-9774. BYTEnet Listings also contains a public-domain version of Prolog, made available by Automata Design Associates.

—Susan Eisenbach

# Golden Common LISP

## Gold Hill Computers brings the language of Artificial Intelligence to Your Personal Computer.

Why every Computer Professional should know COMMON LISP.

You know how frustrating it is to deal with programs that are stupid and inflexible like those buried inside automated bank teller machines and airline reservation systems. You also know how frustrating it is to engineer solutions to today's information-processing problems with languages designed mainly for number crunching. *It doesn't have to be this way.*

Programs based on the ideas of Artificial Intelligence and implemented in COMMON LISP can be intelligent, flexible, and human-like. When you use COMMON LISP in combination with artificial intelligence techniques, you will be able to *solve problems you could never solve before*. You will be able to write powerful programs that can accommodate naive computer users who want intelligible answers to questions quickly.

The best way to get started is to buy GOLDEN COMMON LISP™, the first COMMON LISP for personal computers.

### GOLDEN COMMON LISP: The AI Tutor

GOLDEN COMMON LISP makes it easy for you to learn to use COMMON LISP, on your personal computer, by yourself, at your own pace. The San Marco LISP Explorer™, a 1000-frame interactive software slide show developed by Patrick H. Winston and San Marco Associates, takes you through COMMON LISP and exciting *artificial intelligence applications* like expert systems, intelligent data-access systems, and natural language interfaces.



### GOLDEN COMMON LISP: The Complete LISP Environment

The GOLDEN COMMON LISP package includes:

- the GCLISP interpreter
- the GMACS editor
- the San Marco LISP Explorer
- the On-line Help system
- LISP, 2nd edition by Winston and Horn
- the *COMMON LISP Reference Manual* by Steele
- the GOLDEN COMMON LISP User's Manual

### GOLDEN COMMON LISP: The Powertool for Personal Computing

GOLDEN COMMON LISP is an extensive subset of COMMON LISP, supporting more than *400 LISP primitives*. Advanced features of GOLDEN COMMON LISP include co-routines for multi-tasking, macros for code clarity, streams for I/O, closures for object-centered programming, and multiple-value-returning functions for efficiency.

GOLDEN COMMON LISP requires an IBM, PC XT, PC AT, or 100% IBM PC compatible computer with 512K bytes of memory and PC-DOS 2.0 or higher. More memory is recommended for applications development.

ORDER GCLISP TODAY using the coupon below. Or call our Sales Department at:

**617-492-2071**

Gold Hill Computers		B1-85	
163 Harvard Street Cambridge, MA 02139			
Name _____			
Title _____			
Department _____			
Organization _____			
Address _____			
Phone _____		Today's Date _____	
Type of computer _____			
<input type="checkbox"/> Enclosed is a check to Gold Hill Computers for GCLISP.			
<input type="checkbox"/> Please bill my <input type="checkbox"/> MasterCard <input type="checkbox"/> VISA card.			
Card # _____		Expiration Date _____	
Signature _____			
Quantity	Description	Unit Price	Total Price
	GOLDEN COMMON LISP	\$495	
Subtotal			
MA residents add 5% Sales Tax			
Total Amount			
We welcome inquiries about volume discounts, dealer discounts, and educational discounts for university-affiliated purchasers.			
<input type="checkbox"/> Please send me more information.			

**G O L D H I L L C O M P U T E R S**

163 Harvard Street, Cambridge, Massachusetts 02139

Inquiry 134

GOLDEN COMMON LISP and GCLISP are trademarks of Gold Hill Computers. The San Marco LISP Explorer is a trademark of San Marco Associates. LISP is copyrighted by Addison-Wesley Publishing Company, Inc. The *COMMON LISP Reference Manual* is copyrighted by Digital Equipment Corporation. IBM PC, PC XT, PC AT, and PC-DOS are trademarks of International Business Machines.

# PROLOG GOES TO WORK

BY CLARA Y. CUADRADO AND JOHN L. CUADRADO

*What Prolog is, who's using it,  
and why*

LOGIC PROGRAMMING, simply put, is using symbolic logic as a programming language.

Logic-programming languages are by nature declarative. They are fundamentally different from the more traditional, imperative (or procedural) programming style. When we program in imperative languages (e.g., FORTRAN, Pascal, Ada), we are machine-oriented: We "prescribe" the manner in which we want the computer to go about solving the problem, i.e., we explicitly specify the detailed flow of control necessary to carry out a given computation. In using logic programming to solve problems, we describe or "declare" the logical structure of the problems. [Editor's note: Robert Kowalski discusses some procedural aspects of Prolog in "Logic Programming" on page 161.] A typical logic-programming statement may be

```
smart(X) if reads(X, byte)
```

for "You are smart if you read BYTE."

To further illustrate the difference between a declarative programming language such as Prolog and imperative languages, we have constructed a simple maze for a treasure hunt

(figure 1). The objective is to get through the maze, find the treasure, avoid the various dangers, and come out the other end. Let's approach this problem logically.

First, we express the connectivity of the maze by simple facts like

```
adjacent (cave_entrance,trolls).  
adjacent (fountain,mermaid).
```

Next we define a predicate, path (Here,There,Dangers,Trail), which is used to accumulate nodes (the locations of interest) in a path going from Here to There and make the result available in Trail. The idea is very straightforward: We can get from Here to There if we can get from Here to some Intermediate location and then from the Intermediate location to There.

In order to avoid going around in circles, we also specify that, whenever we choose a new Intermediate location, it should not be one that we have already visited.

Dangerous locations, such as those where bandits or trolls might be lurking, are easily avoided: Whenever we choose a new Intermediate location, we check to see that it is not one of

those that have been designated as dangerous.

Listing 1 is a short Prolog program implementing these ideas. With the aid of the short comments provided (enclosed by /\* \*/), anyone can easily follow the logic without knowing the programming language itself. Notice that we simply specify *what* the predicate path is supposed to accomplish, and not *how* it should do it. The Prolog interpreter does it automatically through its unification and backtracking mechanisms. [Editor's note: Robert Kowalski's text box "The Origins of Logic Programming" on page 192 discusses the concept of backtracking further.]

Now, to achieve the same objective using an imperative language, we would have to specify an explicit flow of control for the path procedure, including the explicit control of the

(continued)

Clara Y. Cuadrado and John L. Cuadrado (Octy Inc., 10920 Oxford Court, Fairfax Station, VA 22039) both earned Ph.D.s from the University of Illinois at Urbana-Champaign. They taught at the University of Maryland and Dartmouth College, respectively, and now run their own company developing AI systems.

depth-first traversal of the graph as represented by the maze.

### LOGIC PROGRAMMING AND THE SOFTWARE CRISIS

The distinction between the implicit, interpreter-supplied flow of control demonstrated in our simple Prolog program and the explicit, user-specified flow of control of imperative languages is not merely an aesthetic one. D. A. Turner, for instance, suggests that the fundamental cause of

the software crisis is the imperative and machine-oriented nature of the programming languages being used (see reference 1).

At the risk of being digressive, we think it important to say a word or two here about the software crisis and its possible alleviation through declarative programming, if only to argue that declarative programming is not only good for the soul but may also be good for the pocketbook.

Figure 2, showing the software and

hardware costs as a proportion of total computer costs, has been flashed through projectors in conferences so many times that it is a familiar sight to many, but the point it makes remains too powerful to ignore. It indicates that something is terribly wrong with our conventional way of producing and maintaining software.

The lack of referential transparency is demonstrated by the assignment statement: A variable can be given different values at various locations in the program, thus overwriting the old values. As a result, the meaning of a variable becomes position-dependent, making program verification and program transformations very difficult. [Editor's note: John Darlington discusses these issues in greater detail in "Program Transformation" on page 201.] Many of the transformations that are easily applicable to declarative languages are simply not available for imperative languages (reference 2).

The verbosity of an imperative language like FORTRAN (the more modern ones like Pascal and Ada tend to be even worse) comes as a result of the need to specify each control path through the program in explicit detail. Then, after large programs have been written, it is very difficult to figure out what they do, partly because of the sheer volume of the code, partly because the problem-solving logic cannot be made transparent in this manner.

Studies have shown that the amount of code a programmer produces tends to be essentially constant regardless of the specific programming language used. It is obvious that the fewer lines of clearer code we use to accomplish a task, the better. And a logic-programming language seems to be the perfect candidate for getting more work out of fewer lines of code. We would like to offer a bit of personal experience to document this point.

A few years ago, while working on various data-flow models for high-performance signal-processing systems (reference 3), we found it necessary at one point to write a

Listing 1: A Prolog program to traverse the maze in figure 1.

```

/* Prolog representatin of the treasure maze */
adjacent(cave__entrance,trolls).    adjacent(cave__entrance,fountain).
adjacent(fountain,limbo).          adjacent(fountain,food).
adjacent(fountain, bandits).       adjacent(fountain,mermaid).
adjacent(bandits,treasure).        adjacent(bandits,exit).
adjacent(food,treasure).           adjacent(trolls,treasure).
adjacent(mermaid,exit).            adjacent(treasure,exit).

avoid([trolls,bandits]).           /* the places to stay away from */

/*
   The following is a predicate to display a path through the
   maze avoiding the Dangers and passing through the treasure room.
   To invoke it use:
       traverse(cave__entrance,exit).
*/

traverse(Here,There) :-
    avoid(Dangers),                /* grab the list of places where not to go
    path(Here,There,Dangers,[Here]).

/* see text for explanation of the path predicate below */

path(Here,Here,Dangers,Trail) :-
    member(treasure,Trail),        /* make sure we go by the treasure room */
    reverse__write(Trail),        /* print the trail starting with Here */
path(From,To,Dangers,Trail) :-
    (                               /* choose an Intermediate location */
    adjacent(From,Intermediate)
    ;
    adjacent(Intermediate,From)
    ),
    not member(Intermediate,Dangers), /* is it a dangerous place? */
    not member(Intermediate,Trail),   /* have we been there before? */
    path(Intermediate,To,Dangers,[Intermediate|Trail]). /* extend path */

/* next, print a list in reverse order */

reverse__write([]).
reverse__write([Head|Tail]) :-
    reverse__write(Tail),
    nl,
    write(Head).

member(X,[X|_]).
member(X,[_|Y]) :-
    member(X,Y).

```



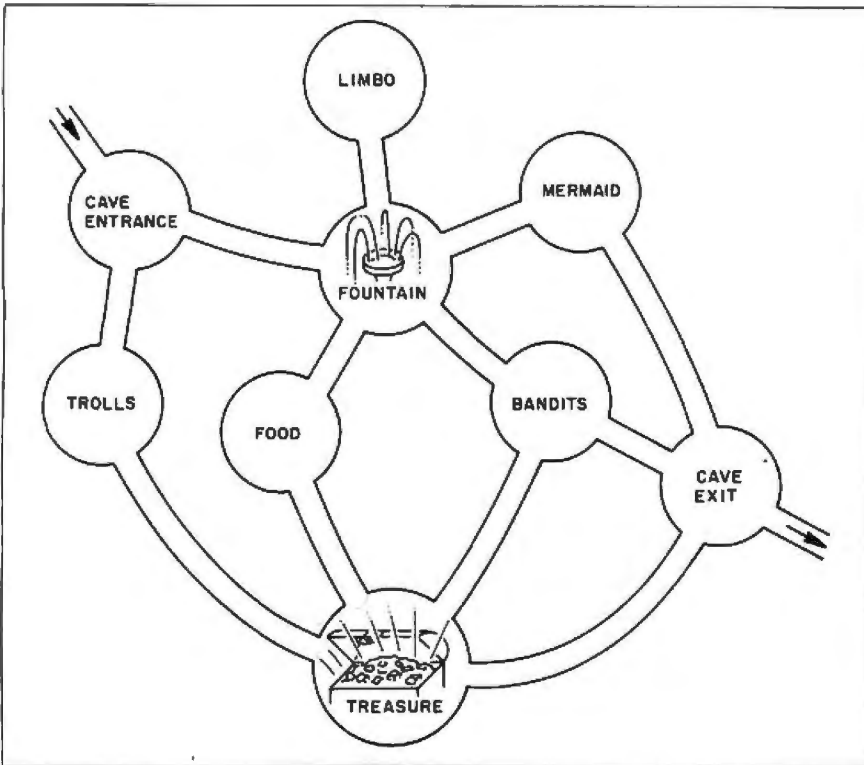

Figure 1: The maze traversed by the Prolog program in listing 1.

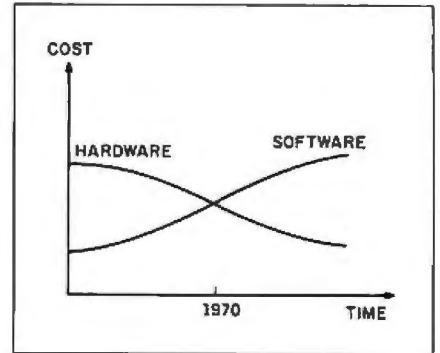

Figure 2: A qualitative graph of software and hardware cost trends.

simulator for one of the data-flow models. One weekend we wrote a specification for the simulator. We used Ada as the program-description language (PDL), and the whole thing came to around five pages of code. A colleague spent the next few weeks turning the PDL into a running Ada program, using Telesoft Ada on the VAX. The final program was around 50 pages long and ran reasonably well.

Some months later, we spent another weekend on a similar task, but this time we used Prolog as the specification language. We had not looked at the Ada specification for quite some time so everything was done from scratch. That is, it was not a matter of simply rewriting the Ada specification in Prolog. The new specification in Prolog was also around five pages long. The difference was that this time the specification was the implementation. It ran the first time we tried it, and, much to our surprise, it actually ran faster than the Ada version. It should be pointed out here

that this was not intended to be a controlled experiment, and the speed factor is probably not very meaningful, given the state of Ada code generators back in 1983. On the other hand, the Prolog interpreter we were using at that time was the University of New Hampshire's interpreter, developed by Jim Weiner. We have a feeling that, even if we could use a very advanced Ada code generator, we would probably still come out ahead using Quintus Prolog on the VAX today. We haven't tried it.

**THE FGCS PROJECT AND LOGIC PROGRAMMING**

Now that we are on the topic of practicality, we should mention the Japanese connection. Only a few years ago, not too many people knew about logic programming. Then the Japanese announced that they had chosen logic programming and Prolog for their ambitious, long-term, nationwide effort known as the Fifth Generation Computer Systems (FGCS) Project.

Among the expressed objectives of the FGCS project is the development of fast, intelligent computer systems with the following capabilities: human-like decision making and learning, natural language and voice I/O (input/output), automatic program generation, and distributed processing.

The project has since been dubbed the "computer science Pearl Harbor," but at the time the greatest surprise to many was the Japanese commitment to Prolog and logic programming. Since then, many people have studied logic programming in earnest. Some of us have even turned evangelical about it.

We will not debate whether, as Kowalski maintains, the Japanese are more objective and insightful and therefore were able to see before the rest of the world that logic programming was "the right way to go" (reference 4). There are less controversial ways to enter the subject. Figure 3, borrowed from Moto-Oka (reference 5), represents a conceptual diagram of a fifth-generation computer system from the programming standpoint.

In the FGCS project, logic programming is envisioned as the link between the fields of software engineering, database systems, computer architecture, and knowledge engineering. It is to be used for problem specification and transformation, unifying functional programming and relational databases, developing single-assignment languages, and construct-

(continued)

*Some new Prolog implementations provide a much-needed module facility.*

ing rule-based expert systems and natural-language processors.

The FGCS project has had a tremendous effect in spurring new research and development in computer science in the United States, not only in academia and in government but in commercial establishments as well. An indication of the impact that logic programming is making on the U.S. computer industry is that a LISP stronghold like Symbolics Inc. is now offering a Prolog compiler for its 3600 series of LISP machines. In the following sections, we will discuss some recent developments in logic programming that are particularly encour-

aging, including the increasing availability of Prolog interpreters and compilers, the development of metalevel facilities, and high-performance Prolog machine development.

**BRAVE NEW WORLD**

One of the things that held back the spread of Prolog in the United States was the lack of good implementations for many of the commercially available machines. Recently, however, the situation has changed radically. There are now excellent implementations, both interpreters and compilers, that are available. It is now possible to obtain very respectable Prolog systems that will run on anything from personal computers to workstations to superminis to mainframes. The portability problems appear to be solving themselves, with the Edinburgh DEC-10 syntax rapidly becoming a de facto standard. On the PC side, several companies, including Logicware and Expert Systems International, are offering integrated Prolog development

environments. The code developed under these PC-hosted systems is directly transportable to these companies' Prolog systems running on superminis like the VAX.

One problem with Prolog has been the fact that, when developing an application, we are forced to write the whole thing as one giant, flat program. Some of the new implementations are now providing a module facility that greatly enhances the software-engineering appeal of the language.

From the point of view of many applications programmers, what is really needed is a facility like the "demo" predicate proposed by Bowen and Kowalski (reference 6). Their basic idea is to be able to have any number of "theories" active at any one time. When attempting to prove a goal, we specify not only the goal to be proved but also the theory under which the goal is to be proved. This facility allows us to maintain incomplete and

(continued)

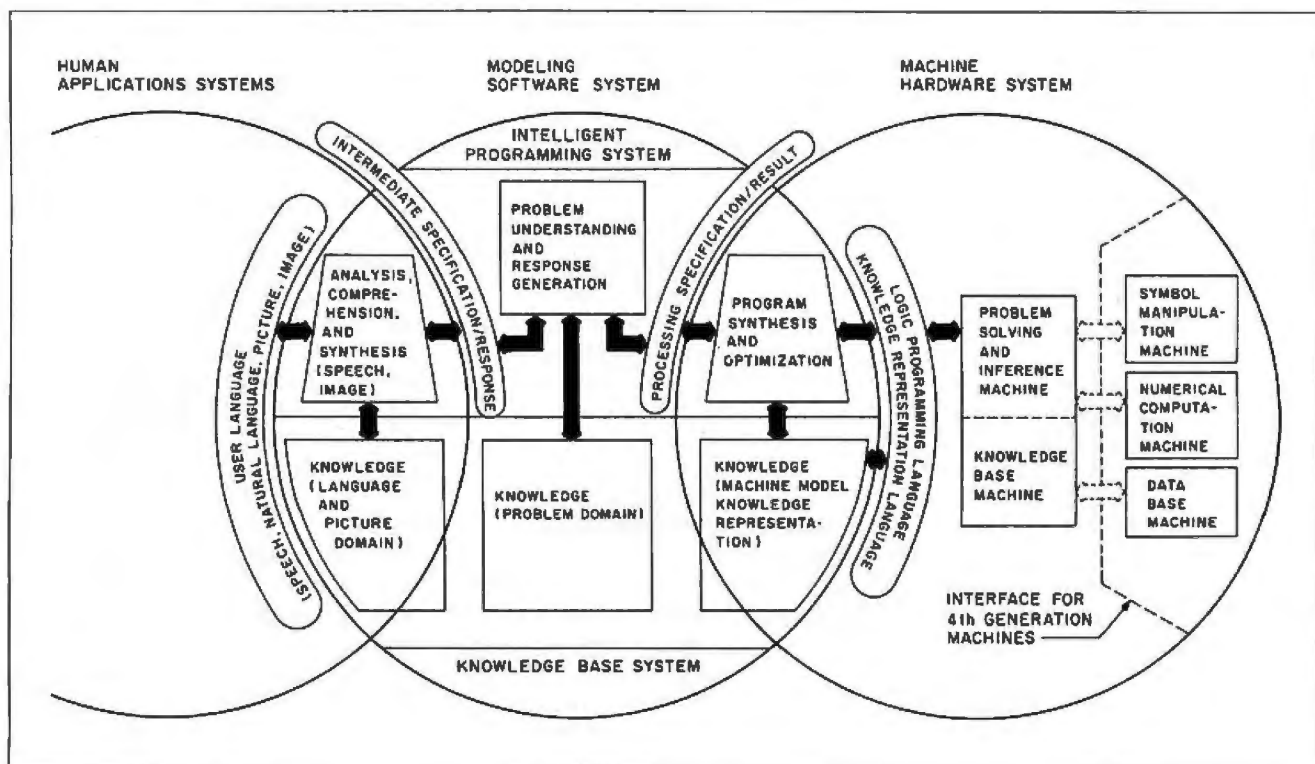

Figure 3: A conceptual diagram of a fifth-generation computer system. Reprinted with permission from Fifth Generation Computer Systems, T. Moto-Oka, ed. (New York: Elsevier, 1982, page 29).

# AMAZING DAISY

NOW! FULL SIZE, FULL FEATURE, LETTER QUALITY AT ONLY \$353

If you have been searching for a letter quality printer you have probably found the flood of claims and counterclaims to be a real roadblock in your search. Not long ago we were in the same position. We tried to determine which daisy wheel printer had all the features our customers wanted, yet would not set them back a month's salary. Recently several manufacturers have introduced machines that had features we were searching for. After a thorough assessment, we eliminated one model after the other for lack of one feature or another until we only had one left.

## THE RESULTS ARE IN

We found the printer which has all the features anyone could want. The winner is the Arotek Daisy 1120, a real heavy-duty workhorse printing at 20 characters per second. The manufacturer is Olympic Co. Ltd., a highly respected Japanese firm.

## FEATURES GALORE

This printer has it all. To start with, it has a front panel Pitch Selector button with indicators which allows 10, 12, 15 characters per inch (CPI) or Proportional Spacing. There is a Select (Online) button (with indicator) and a Line Feed button. You can also set Top-of-Form or Form Feed with the touch of the TOF button. Other front panel indicators include Power and Alarm.

To load a sheet of paper, simply place it in the feed slot and pull the paper ball lever. PRESTO! The paper feeds automatically to a 1 inch top margin and the carriage aligns to the selected left margin. In this manner, each page can have identical margins automatically. You can continue to compute while the Daisy 1120 is

printing. The built in 2K buffer frees up your computer while printing a page or two allowing you to go to your next job.

To really put your printer to work, the Cut Sheet Feeder option is great for automatic printing of those long jobs. Also available is the adjustable Tractor Feed option. Compare our option prices! Best of all the Daisy 1120 is quiet: only 57 dB-A (compare with an average of 62-65 dB-A for others).

## COMPLETE COMPATIBILITY

The Daisy 1120 uses industry standard Diablo® compatible printwheels. Scores of typeface styles are available at most computer or stationary stores. You can pop in a 10, 12, 15 pitch or proportional printwheel and use paper as wide as 14". At 15 CPI you can print 165 columns—great for spreadsheets.

The Daisy 1120 uses the Diablo Hytype II® standard ribbon cartridges. Again universally available.

Not only is the hardware completely compatible, the control codes recognized by the Daisy 1120 are Diablo 630® compatible (industry standard). You can take advantage of all the great features of word processing packages like Wordstar®, pfs: Write®, Microsoft Word® and most others which allow you to automatically use superscripts, subscripts, automatic underlining, boldface (shadow printing) and doublestrike.

The printer has a set of rear switches which allow the use of standard ASCII as well as foreign character printwheels. Page length can be set to 8, 11, 12, or 15". The Daisy 1120 can also be switched to add automatic line feed if required.

## THE BEST PART

When shopping for a daisy wheel printer with all these features (if you could find one), you could expect to pay \$600 or \$700 dollars. The options would add much more. *Not now!* We have done our homework. We can now offer this printer for only \$353. Order yours today!

## NO RISK OFFER

Try the Daisy 1120 for 2 weeks. If you are not satisfied for ANY reason we will refund the full price—promptly. A full 1-year parts and labor warranty is included.

## THE BOTTOM LINE

Arotek Daisy 1120 (Order#1120) \$353 w/standard Centronics parallel interface and 2K buffer.

## Options

Auto Cut Sheet Feeder (#1110) \$188  
Tractor Feed (#1112) \$77

## Accessories

8' Cable for IBM PC® and compatibles (#1103) \$26

Interface with cable: •TI-99/4A (#106) \$66

•Apple II or IIe (#1104) \$76

•All Commodore (except Pet) (#1105) \$44

•All Atari (#1107) \$66

Shipping is \$11—UPS continental USA. If you are in a hurry, UPS Blue or Air Parcel Post (second day air) is \$25. Canada, Alaska, Mexico and Hawaii are \$30 (air). Other foreign is \$60 (air). California residents add 6% tax. Prices are cash prices—VISA and M/C add 3% to total. We ship promptly on money orders, cashier's checks, and charge cards. Allow 14-day clearing for checks. No C.O.D.'s. Payment in US dollars only.

TO ORDER ONLY CALL TOLL FREE

(800) 962-5800 USA (8-8 PST)

(800) 962-3800 CALIF.

Or send payment to address below:

Technical Information & Customer  
Service: (805) 987-2454 (8-5 PST)

Dealer Inquiries Invited

© 1985 AROTEK. All rights reserved.  
Trademarks: Diablo, Hytype II, 630-Xerox  
Corp.; Wordstar-Micropro Corp.; PFS-  
Software Publishing Corp.; Microsoft  
Word-Microsoft Corp.; Apple, II,  
IIe-Apple Computer, Inc.;  
IBM PC-IBM Corp.;  
PET, CBM.



 **AROTEK**  
1071-A Avenida Acaso, Camarillo, CA 93010

even inconsistent theories about an object of interest. It provides us with a very attractive mechanism for the implementation of nonmonotonic features.

Recently, Ken Bowen has made substantial progress in implementing these ideas (reference 7). While adding new facilities to standard Prolog,

he has painstakingly avoided straying outside the realm of logic. This is an important consideration: It is relatively straightforward to "enhance" a Prolog system by introducing extralogical features such as state-dependent features and user-controlled agendas. The problem is that by providing these things we destroy

the well-understood logical foundations upon which logic programming is based. As such, the features that make logic programming attractive in the first place quickly become inapplicable.

Over the past few years a group of researchers in the Computer Science Division of the University of California at Berkeley, headed by Al Despain and Yale Patt, have been investigating the design and implementation of very high performance architectures to support a mixture of numerical and symbolic computations. After looking at various declarative languages such as John Backus's FP, they decided that logic programming offered the best avenue to pursue their goals.

Armed with an extraordinary knowledge of computer architecture, they launched their Prolog Machine (PLM) project, using the work of Tick and Warren (reference 8) as a starting point. A Prolog compiler targeted to the PLM instruction set was written. This compiler, with numerous recent improvements, performs some of the most ambitious data-flow analyses ever attempted for Prolog programs.

The PLM hardware is currently implemented as three wire-wrapped boards and runs as an attached processor on the NCR/32. At the time of this writing, most of the hardware has been debugged and all the microcode has been checked out. The timings predicted by the simulator appear to be very realistic, and the system running on the NCR bus is capable of supporting 305,000 LIPS (logic inferences per second). With a different high-performance bus designed by the Berkeley group, the system will support 425,000 LIPS (reference 9). These numbers are almost an order of magnitude better than anything available until very recently.

While we are on performance, we have been told that the Symbolics Prolog will be able to achieve around 100,000 LIPS (reference 10) when all the microcode support is in place and the system has been carefully optimized. We are currently using a beta-test version of it and like the fact that

(continued)

**TATUNG**

**Terminals and monitors known by the companies they keep.**

TVT-7220 (VT-220 emulation)

CAM-1370 16" RGB High Resolution

For quite some time we've been making terminals and monitors for some of the world's best known, most reliable and best selling computer systems. And we're proud of it! We're happy that our level of quality has become an accepted industry standard; that in almost every instance we've been able to exceed specifications without exceeding cost requirements. And we're delighted the quality of our CRT imagery has made

Tatung Terminals and Monitors an outstanding value. Now you can buy Tatung Terminals and Monitors with our name right up front. Compatible with all popular systems. With superior resolution, operational flexibility and day-in-day-out reliability. But, even more important to you, is that Tatung Terminals and Monitors are now priced to make them the most exceptional value you can buy.

**TATUNG**

For complete information call toll free: 1-800-421-2929. In California, call (213) 979-7055. TATUNG COMPANY OF AMERICA, INC., 2850 El Presidio, Long Beach, California 90810.

# BASF QUALIMETRIC™ FLEXYDISKS.® A GUARANTEED LIFETIME OF OUTSTANDING PERFORMANCE.

*BASF Qualimetric FlexyDisks feature a unique lifetime warranty,\* firm assurance that the vital information you enter on BASF FlexyDisks today will be secure and unchanged tomorrow. Key to this extraordinary warranted performance is the BASF Qualimetric standard... a totally new set of criteria against which all other magnetic media will be judged.*

*You can count on BASF FlexyDisks because the Qualimetric standard reflects a continuing BASF commitment to perfection in magnetic media. One example is the unique two-piece liner in our FlexyDisk jacket. This BASF feature traps damaging debris away from the disk's surface and creates extra space in the head access area for optimum media-head alignment. The result is a guaranteed lifetime of outstanding performance.*

*For information security that bridges the gap between today and tomorrow, look for the distinctive BASF package with the Qualimetric seal. Call 800-343-4600 for the name of your nearest supplier.*

Inquiry 31

\*Contact BASF for warranty details.

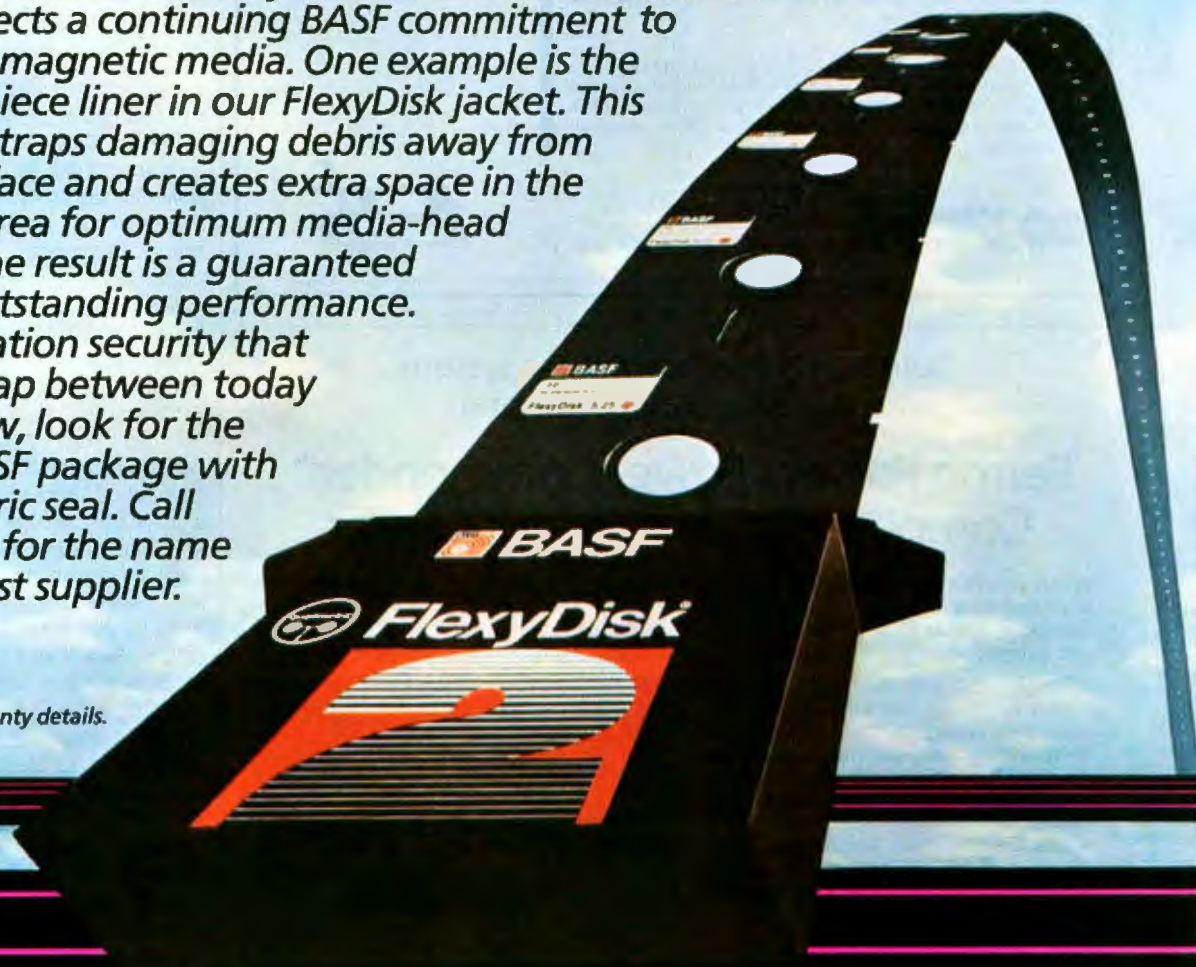

ENTER TOMORROW ON BASF TODAY.

© 1983 BASF Systems Corp., Bedford, MA



**BASF**

# A FULL C COMPILER FOR \$4995

The Eco-C88 C compiler is setting a new standard for price and performance. Compare Eco-C88's performance to compilers costing up to 10 times as much:

	Seive	Fib	Defref	Matrix
Execute	12.1 sec.	43.1 sec.	13.7 sec.	21.3 sec.
Code Size	7782	7754	7772	9120
Compile-link	76 Sec.	77 Sec.	77 Sec.	92 Sec.

Eco-C88 Rel. 2.20, on IBM PC with 2 floppy disks, 256K. Benchmarks from Feb., 1985 *Computer Language*.

Eco-C88 includes:

- \* All operators and data types (except bit fields)
- \* Error messages in English with page numbers that reference the *C Programming Guide* - a real plus if you're just getting started in C.
- \* Over 170 library functions, including color and transcendentals
- \* New Library functions for treating memory as a file
- \* User-selectable ASM or OBJ output (no assembler required)
- \* 8087 support with 8087 sensed at runtime
- \* cc and "mini-make" for easy compiles (with source)
- \* Fast, efficient code for all IBM-PC, XT, AT and compatibles using MSDOS 2.1 or later.
- \* Complete user's manual

If ordered with the compiler, the C library source code (excluding transcendentals) is \$10.00 and the ISAM file handler (as published in the *C Programmer's Library*, Que Corp) in OBJ format is an additional \$15.00. Please add \$4.00 for shipping and handling. To order, call or write:



Ecosoft Inc.  
6413 N. College Avenue  
Indianapolis, IN 46220  
(317) 255-6476 • 8:30-4:30



Eco-C (Ecosoft), MSDOS (Microsoft), UNIX (Bell Labs), CP/M (Digital Research), Z80 (Zilog), 8086, 8087, 8088 (Intel).



## PRACTICAL PROLOG

the entire Symbolics machine development environment is available. For people who are already familiar with the Symbolics machine, it probably offers the best commercially available facilities for developing Prolog applications at the present time.

The world of logic programming is rapidly expanding. There are currently ongoing projects, ranging from expert systems to image processing, that will produce very large systems written entirely in Prolog. Logic programming has won lots of supporters in this country in a short period, and the future looks bright. ■

### REFERENCES

1. Turner, D. A. "Recursion Equations as a Programming Language." *Functional Programming and its Applications*. J. Darlington, P. Henderson, and D. A. Turner, eds. Cambridge: Cambridge University Press, 1982, pages 1-22.
2. Darlington, John. "Functional Programming." *Distributed Computing*. F. B. Chambers, D. A. Duce, G. P. Jones, eds. London: Academic Press, 1984, pages 57-77.
3. Cuadrado, J. L., and G. R. Linsenmayer. "Efficient High Speed Implementation of Directed Graph Signal Processing in a Distributed Processing System." *Proceedings of the IEEE CompCon '83*, pages 460-463.
4. Kowalski, Robert. "Robert Kowalski on Logic Programming." *Future Generations Computer Systems*. July 1984, pages 79-83.
5. Moto-Oka, T., ed. *Fifth Generation Computer Systems*. New York: Elsevier, 1982, page 29.
6. Bowen, Ken, and Robert Kowalski. "Amalgamating Language and Metalanguage in Logic Programming." *Logic Programming*. K. L. Clark and S. A. Tarnlund, eds. London: Academic Press, 1982, pages 153-172.
7. Bowen, Ken. Private communication, January 1985.
8. Tick, Evan, and David Warren. *Toward a Pipelined Processor*. Tech. Report, SRI AI Center, August 1983.
9. Despain, Al. Private communication, April 1985.
10. Cassels, Bob. Private communication, January 1985.

*Editor's note: A screen-oriented implementation of Edinburgh-syntax Prolog has been placed in the public domain by Automata Design Associates and is available for downloading from BYTEnet Listings at (617) 861-9774.*

Safeguard your computer system with the essential peripheral...

## Perma Power® Power Commander™ Computer Power Control Center

When valuable equipment and irreplaceable data are on the firing line, it makes sense to protect them from the dangers lurking in the power line. Trust the Power Commander™ Computer Power Control Center to guard your sensitive circuitry from voltage spikes and surges, while giving you fingertip control of your computer and four peripherals.

- Prevents data loss and physical damage from switching and lightning-induced transient voltage surges
- Provides both common-mode and normal-mode surge suppression
- Reduces line noise from RFI/EMI interference
- Positive Shutdown Mechanism\* prevents operation of unprotected equipment
- Performance specified to IEEE Std. 587 (Category A)
- U.L. listed
- FULL FIVE-YEAR WARRANTY

See the new Power Commander™—along with the full line of Perma Power Surge Suppressors and Sockets Plus™ Multiple Outlet Strips—at computer stores and office supply dealers nationwide.

\*patent pending



**PERMA POWER. Electronics Inc.**

5615 West Howard Avenue • Chicago, Illinois 60648  
Telephone (312) 647-9414

# VTERM. THE FASTEST WAY



## TO THE VAX™

## AND BACK.

**VTERM II AND VTERM/4010: FOR VT100 AND TEKTRONIX™ 4010 EMULATION, AND THEN SOME.**

More and more people make the trip every day. Often several times. They're off to the VAX for a session or a file, then back to PC-DOS.

That's why we wrote VTERM—the fastest, most advanced communications program for PC users who communicate with VAXes, and other minis or mainframes.



Tektronix

Of course, VTERM starts with everything you'd expect from state-of-the-art terminal emulation software. Like full keyboard emulation. Macros. Disk capture. Unlimited setup files. Printer support. True plug compatibility, so you can run any VT100 or Tektronix 4010 program right from your PC keyboard.

### MAKE YOUR PC FLY.

But then VTERM goes beyond everything else on the market. With a Hotkey that instantly toggles between host and DOS sessions while preserving your terminal screen and communications link. That means you can run host and local programs almost simultaneously. And because VTERM is written in assembly language, you get full throughput at 9600 baud.

With VTERM, there's nothing to get in your way or slow you down. It's easy to use, yet packed with time-saving features. Like backscrolling, which redisplay up to 80 scrolled-off screens. And horizontal scrolling, which emulates 132-column display. (Of course, VTERM provides true 132-column display with an optional video board.)

### KERMIT FILE TRANSFER AND MORE.

VTERM delivers the most powerful file transfer system available with any general communications package. You get four error-correcting protocols including XMODEM and Kermit, the emerging micro-to-mainframe standard from Columbia University.

And you also get VTRANS, a remarkably easy-to-use file transfer system that transmits any file under local or host control. It even comes with ready-to-run host software for UNIX and three DEC operating systems – VMS, RSTS/E, and RSX 11-M/M+.

So why waste time? Call Coefficient Systems Corp. to order your copy of VTERM today.

## Coefficient

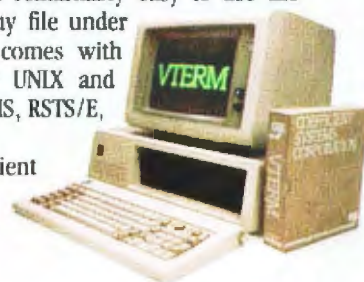

Coefficient Systems Corporation, 611 Broadway, New York, New York 10012, (212) 777-6707, Ext. 216

© 1985, Coefficient Systems Corp. TM signifies manufacturer's trademark

# At NEC, monitors and printers are not peripheral issues.

All too often, brand-name CPUs are "bundled" with mediocre peripherals—a practice that makes for profitable sales, but does nothing for the system's performance.

In Japan, where most computer peripherals are actually built, NEC is the largest personal computer company—by far. And NEC didn't make it to first place by offering second rate peripherals.

## The monitors with the broadcast video heritage.

While dozens of companies market display monitors, only a handful possess the tube technology and manufacturing capability to actually build them. NEC is one of the few. In fact, NEC's complete line of color and monochrome monitors reflects the professional and broadcast video

expertise that twice earned NEC Emmy Awards from the National Academy of Television Arts & Sciences.

## Winning the printer race takes both speed and endurance.

Ask people who really know about printers, and they'll tell you that NEC builds the best. They may also point out that NEC builds printers for other computer companies. And if you ask them to choose one word to sum up what makes NEC printers stand out, it will probably be "reliable." This is why NEC has become the printer of choice for the most demanding installations.

So before you buy a peripheral from any name company, make sure the company puts more into the peripheral than just its name.

PC-PR105A IBM PC PLUG COMPATIBLE TRI-MODE DOT MATRIX PRINTER



JB-1280DA IBM PC PLUG COMPATIBLE GREEN PHOSPHOR BLACK SCREEN MONITOR



# NEC

NEC Home Electronics (U.S.A.) Inc.

Personal Computer Division  
1401 Estes Avenue  
Elk Grove Village, IL 60007  
(312) 228-5900

NEC Corporation, Tokyo, Japan



# LOGIC PROGRAMMING

BY ROBERT KOWALSKI

*Prolog can be used as either a declarative  
or a procedural programming language*

LOGIC PROGRAMMING is based upon attempts begun in the early 1950s to mechanize the proof of mathematical theorems by means of computer. Those attempts were only partially successful. However, the early 1970s brought the discovery that computation is a special case of mechanical, logical deduction. The key to this discovery was the development of mechanical theorem provers that use logic to prove theorems by means of *backward reasoning*.

Simple backward reasoning was not powerful enough to prove significant theorems of mathematics. However, applied to sentences of the form "conclusion if conditions," it behaves like procedure invocation. Such backward reasoning is the basis of both logic programming and the computer language Prolog.

Backward reasoning has two main uses. First, a problem solver can automatically add it to knowledge expressed in logic to obtain machine-executable procedures. This allows us to use logic as a purely *declarative* language in which we express knowledge without worrying about how to use it. In addition, we can explicitly use backward reasoning to control the

reduction of problems to subproblems. This allows us to use logic as a purely *procedural* programming language.

## LOGIC AS A DECLARATIVE LANGUAGE

The following is probably the most familiar of all examples of logical reasoning. It shows how backward reasoning turns declarative statements into procedures.

All humans are mortal.  
Socrates is human.

We can express the two English sentences more formally, each with a single conclusion and several—or possibly no—conditions. The first sentence, for example, has one conclusion, *x* is mortal, and one condition, *x* is human, where the variable *x* stands for any individual. The second sentence has the same structure: It, too, has a conclusion, *Socrates* is human, and a trivial, vacuous condition. Together, these sentences have the same conclusion-conditions form:

*x* is mortal  
if *x* is human.  
*Socrates* is human  
if nothing.

You can express a surprising amount of knowledge in this simple form. We call sentences expressed in the conclusion-conditions form "Horn clauses" in honor of logician Alfred Horn, who studied their logical properties.

Backward reasoning turns knowledge expressed as Horn clauses into procedures. The very first sentence above, in particular, becomes a procedure that, given *x* such as *Socrates*, reduces the problem of showing that *x* is mortal to the subproblem of showing *x* is human.

In general, backward reasoning works backward from the conclusion of a sentence having the form "conclusion if conditions" and reduces problems that match the conclusion to subproblems corresponding to the conditions.

Even the sentence "Socrates is human" can be used as a procedure, to show "Socrates is human" by doing nothing. It solves problems directly, reducing them to no further subprob-

(continued)

Robert Kowalski is professor of computational logic and head of the logic programming group at Imperial College, 180 Queen's Gate, London SW7 2BZ, England.

lems. Taken together, we have the two procedures

To show  $x$  is mortal.  
 show  $x$  is human.  
 To show *Socrates* is human,  
 do nothing.

But the same declarative knowledge can give us other procedures. If, instead of showing that *Socrates* is human, we want to find an individual who is mortal, then, using the first sentence, we get a procedure that finds mortals by finding humans. Using the second sentence, we get a procedure that finds humans by letting the individual be *Socrates*. Taken together, we have the procedures

To find  $x$  which is mortal.  
 find  $x$  which is human.  
 To find  $x$  which is human,  
 let  $x$  be *Socrates*.

We obtain the new procedures from

the same knowledge by the same general method of backward reasoning. Moreover, backward reasoning itself is sufficiently mechanical that we can implement it on a computer.

**LOGIC AS A PROCEDURAL LANGUAGE**

A programmer can also use backward reasoning deliberately to control the reduction of problems to subproblems. Suppose, for example, I want to find something to sell to a customer, John. I can try to solve the problem by reducing it to subproblems. The first thing I might do is try to find out what John does for a living. Then I might try to find something that John can use for his occupation. To find something to sell to John, first I'd find out what John does (e.g., gives lectures, watches films, writes programs), then find something that John could use for his work (e.g., an overhead

projector for giving lectures, a television for watching films, Prolog for writing programs). Having solved the two subproblems, I have found something I can now try to sell to John, namely an overhead projector, a television, or Prolog.

We can analyze the procedure as backward reasoning applied to knowledge expressed in conclusion-conditions form:

$x$  is sellable to  $y$   
 if  $y$  has occupation  $z$   
 and  $x$  can be used for  $z$ .

Prolog, for example, will use this knowledge as a procedure to solve subproblems in the order in which the conditions are written, first finding customers' occupations, then finding goods that can be used for such occupations. Prolog programmers, therefore, can control the order in which the computer solves subproblems by controlling the order in which they write those subproblems.

Thus, not only can we use logic purely declaratively, but we can use it purely procedurally. In between these two extremes is a spectrum of uses. In many expert systems, for example, the programmer determines the general problem-reduction structures, but the "inference engine" makes its own lower-level problem-solving decisions. Our rule for selling goods to customers, for example, can be regarded as the beginning of a salesman's simple expert system.

For the sake of efficiency, Prolog uses a simple problem-solving strategy. It solves subproblems in the order in which the programmer has written them and also tries different ways of solving a subproblem in the order in which the programmer has written the conclusion-conditions rules. As a consequence, we can implement Prolog comparatively efficiently and control its behavior easily. The disadvantage is that if you use Prolog purely declaratively, the arbitrary order in which you write conditions and rules may not be appropriate for all problems.

Consider, for example, using the  
*(continued)*

**ULTIMATE PLACE FOR YOUR COMPUTER SOFTWARE AND COMPONENTS**

**LOOK WHO WE SELL TO**

**Hughes Aircraft**

**Northrop**

**Rockwell International**

**IBM**

**Price Waterhouse**

**TRW**

**Plus Many More . . .**

**AND WHAT WE SELL**

**Lotus 1-2-3**

**dBASE III**

**Hayes 1200B**

**Microsoft**

**Epson**

**Okidata**

**Anchor**

**Orchid Technology**

**Paradise**

**Plus Many More . . .**

**Call today for our quote — You'll be glad you did!**

TOLL FREE OUTSIDE CALIF.

**1-800-423-6326**

IN CALIFORNIA

**(213) 827-1851**



**SOFTWARE GALORE, INC.**

4079 GLENCOE AVENUE • MARINA DEL REY, CALIFORNIA 90292

# MICRO CAP and MICRO LOGIC put your engineers on line... not in line.



## MY OWN WORKSTATION

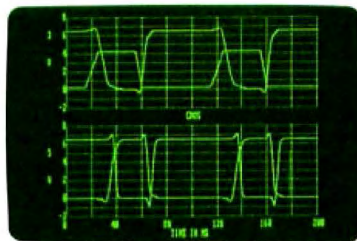

"Typical MICROCAP Transient Analysis"

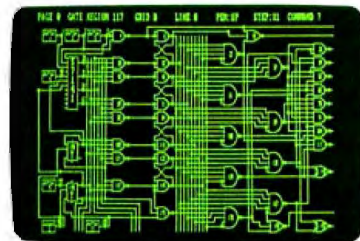

"Typical MICROLOGIC Diagram"

works. In addition, you get even more advanced device models, worst case capabilities, temperature stepping, Fourier analysis, and macro capability.

## MICROLOGIC: Your Digital Solution

MICROLOGIC provides you with a similar interactive drawing and analysis environment for digital work. Using standard PC hardware, you can create logic diagrams of up to 9 pages with each containing up to 200 gates. The system automatically creates the netlist required for a timing simulation and will handle networks of up to 1800 gates. It provides you with libraries for 36 user-defined basic gate types, 36 data channels of 256 bits each, 10 user-defined clock waveforms, and up to 50 macros in each network. MICROLOGIC produces high-resolution timing diagrams showing selected waveforms and associated delays, glitches, and spikes—just like the real thing.

## Reviewers Love These Solutions

Regarding MICROCAP... "A highly recommended analog design program" (PC Tech Journal 3/84). "A valuable tool for circuit designers" (Personal Software Magazine 11/83).

Regarding MICROLOGIC... "An efficient design system that does what it is supposed to do at a reasonable price" (Byte 4/84).

MICROCAP and MICROLOGIC are available for the Apple II (64k), IBM PC (128k), and HP-150 computers and priced at \$475 and \$450 respectively. Demo versions are available for \$75.

MICROCAP II is available for the Macintosh, IBM PC (256k), and HP-150 systems and is priced at \$895. Demo versions are available for \$100.

Demo prices are credited to the purchase price of the actual system.

Now, to get on line, call or write today!

## Spectrum Software

1021 S. Wolfe Road, Dept. B  
Sunnyvale, CA 94087  
(408) 738-4387

Inquiry 306

How many long unproductive hours have you spent "in line" for your simulation? Well, no more. MICROCAP and MICROLOGIC can put you on line by turning your PC into a productive and cost-effective engineering workstation.

Both of these sophisticated engineering tools provide you with quick and efficient solutions to your simulation problems. And here's how.

## MICROCAP: Your Analog Solution

MICROCAP is an interactive analog circuit drawing and simulation system. It allows you to sketch a circuit diagram right on the CRT screen, then run an AC, DC, or Transient analysis. While providing you with libraries for defined models of bipolar and MOS devices, Opamps, transformers, diodes, and much more, MICROCAP also includes features not even found in SPICE.

MICROCAP II lets you be even more productive. As an advanced version, it employs sparse matrix techniques for faster simulation speed and larger net-

salesman's rule to find customers for Prolog. If you use Prolog itself to solve the problem, it tackles subproblems in the order in which you have written them, first finding pairs of potential customers and their occupations, then showing that Prolog can be used for such occupations. This is not an appropriate order in which to tackle the subproblems. In general, although the same procedures may be appropriate for solving a wide range of problems, for the sake of efficiency, the strategy used to solve subproblems may need to be sensitive to the form of the problem to be solved.

In this particular case, a problem solver should first find out what activities Prolog can be used for and then find out who engages in those activities. Once users know they can use Prolog for implementing specifications, prototypes, expert systems, and databases, they can find someone who is engaged in those activities (e.g., software engineers implement specifications and prototypes, engineers of all kinds implement expert systems, data-processing professionals implement databases). Therefore, software engineers, engineers of all kinds, and data-processing staffs are potential customers for Prolog.

This example shows that you can solve subproblems in any sequence. Indeed, for the sake of efficiency, you may need different sequences for different problems. Database-query languages, for example, use query optimizers to determine the order in which to solve subproblems.

Much current research in logic programming is devoted to developing more intelligent problem solvers and to exploiting the possibilities of tackling subproblems in parallel. If the Japanese Fifth Generation Project succeeds in its aims, computers of the future will consist of communities of problem solvers working in parallel on subproblems generated by procedures expressed in logical form.

**BACKWARD VS. FORWARD REASONING**

Backward reasoning, which links logic with computation, is not taught in

```
(x) is a noun phrase
  if x is a name.
John is a name.
Mary is a name.
(x y) is a noun phrase
  if x is an article
  and y is a noun.
a is an article.
the is an article.
girl is a noun.
boy is a noun.
(x) is a verb phrase
  if x is an intransitive verb.
(x|y) is a verb phrase
  if x is a transitive verb
  and y is a noun phrase.
dreams is an intransitive verb.
likes is a transitive verb.
```

Figure 1: Examples of rules defining the concepts of noun phrase and verb phrase.

conventional logic books. Conventional logic teaches us to reason forward, in the same manner that mathematics teaches us to demonstrate proofs: We start with axioms, definitions, and previously proved theorems, and, as if by magic, in the last step we derive the theorem to be proved. Rather than give a mathematical example, we can illustrate the difference between forward and backward reasoning with an example from natural-language parsing. The rule

```
x is a sentence
  if x is list y followed by list z
  and y is a noun phrase
  and z is a verb phrase
```

describes one way that a list of words *x* can be interpreted as a sentence. Thus, the list of words (the boy likes the girl) is a sentence, because (the boy) is a noun phrase and (likes the girl) is a verb phrase. We can use the rule to reason forward as well as backward.

Suppose we are given a list of words and we want to show that we can interpret the list as a sentence. If we use the rule to reason forward, then we find a noun phrase and a verb phrase, put them together, and conclude that we have a sentence, whether or not that sentence is the list of words with which we began.

In order to use the rule that defines the concept of sentence (whether forward or backward), we need other rules to define the concepts of noun phrase and verb phrase. (For the sake of simplicity, let's ignore the definition of what it means for a list *x* to be a list *y* followed by a list *z*.) (See figure 1.) Here we have used a variant of the micro-PROLOG SIMPLE notation, which was developed at Imperial College in London, England, for teaching logic as a computer language for children. Variables such as *x*, *y*, and *z* in different rules are actually different, even though they may look the same. We use parentheses for list notation:

- ( ) stands for the empty list
- (x) stands for the list with one element *x*
- (x y) stands for the list with two elements, *x* followed by *y*
- (x|y) stands for the list with first element *x* followed by list *y*

Given an appropriate definition of the relationship "x is list y followed by list z," Prolog can use the rules to test lists of words for grammatical correctness. For example,

```
(a boy dreams) is a sentence?
Yes
(a boy dreams a girl) is a sentence?
No
```

It can even use the same rules to generate sentences:

```
x is a sentence?
x = (Mary dreams)
x = (Mary likes Mary)
x = (Mary likes John)
x = (Mary likes the girl)
etc.
```

Thus, for example, to show that (a boy dreams) is a sentence, Prolog first splits the list into consecutive sublists, tries to show that the first sublist is a noun phrase, and then tries to show that the second sublist is a verb phrase. If at any stage it fails to solve a subproblem, it backtracks and tries a different way of solving the most recent, previously considered subproblem. In this case, it first splits the ini-

(continued)

# Finally, something Apple and IBM owners can agree on:



## The Sider™ 10 MB hard disk

*from First Class Peripherals*

Decisions, decisions. First you had to choose between Apple and IBM. Now you have to decide which hard disk subsystem to purchase—and they all seem about the same. *But are they?*

First Class Peripherals can make your hard disk decision a lot easier. Because whether you use an Apple II+ or IIe...or IBM PC\* or XT...we offer a Sider 10 MB hard disk subsystem just right for all your storage needs.

### The most reliable, affordable 10 MB hard disk on the market

The Sider features state-of-the-art Winchester disk technology. Direct booting without floppies. Self-contained power supply. And compatibility with the most popular Apple or IBM software.

In addition, the Sider is *plug and play*. Everything you need for quick, easy installation is included: cable, host adapter, software and manual.

### Built to last by Xebec

The Sider has won rave reviews for its

\*Must contain hard disk ROM.



3579 Highway 50 East, Carson City, NV 89701

performance and reliability. That's because it's manufactured exclusively for First Class Peripherals by Xebec, the industry's leading manufacturer of computer disk drives and controllers. And it's sold *direct to you*, so there are no dealers or distributors to hike up the cost.

### Full guarantee and free tech hotline

You can choose your Apple or IBM Sider with confidence. Simply order and use your Sider for 15 days. If you're not 100% satisfied, return it for a full refund. Keep it, and you'll enjoy a full one-year limited warranty...plus access to our toll-free hot-

line, should you ever have a technical or service question.

### It's easy to order your Sider

The Sider is priced at just \$695 for the Apple model...\$795 for the IBM. *That's hundreds of dollars less than what you'd expect to pay for the comparable "big name" models.* To order, use the coupon below...or for faster service, order by phone using Visa, MasterCard or American Express. Call toll-free:

**1 800 538-1307**  
Extension 701

**Yes**, please send me the Sider, including 10 megabyte hard disk drive, host adapter card, cable, complete installation software and documentation for my:  Apple II+ or IIe  IBM PC or XT

I prefer to pay as follows:

- I've enclosed my check or money order for \$695\* (\$795\* for IBM-compatible Sider) plus \$15 shipping and handling, payable to First Class Peripherals.
- Please bill the following credit card account for \$695\* (\$795\* for IBM-compatible Sider) plus \$15 shipping and handling:
- VISA  MasterCard  American Express

\_\_\_\_\_  
Name

\_\_\_\_\_  
Address

\_\_\_\_\_  
City

\_\_\_\_\_  
State

\_\_\_\_\_  
Zip

\_\_\_\_\_  
Telephone (area code)

\_\_\_\_\_  
Card #

\_\_\_\_\_  
Exp. Date

\_\_\_\_\_  
Signature

\*Residents of CA, NV and PA, please add appropriate sales tax.

Mail to: First Class Peripherals  
3579 Highway 50 East, Carson City, NV 89701

# Available, Reliable, Affordable Solutions for Computerization

**Little Board™/186 . . . \$499** with (128K)

Single Board 16-Bit Computer  
with SCSI/PLUS™ Bus

- Data and file compatible with IBM PC
- Three times the COMPUTING POWER of a PC
- Boots PC-DOS 2.10, 3.00
- Runs most MS-DOS generic software
- Mounts directly to a 5-1/4 inch disk drive
- Includes: 8 MHz 80186 CPU, 128K or 512K RAM, 16K-128K EPROM, 2 RS232C Serial Ports, Centronics Printer Port, Floppy Disk Controller, SCSI/PLUS™ Multi-Master bus for: hard disk / networking / I/O expansion
- Available with 512K RAM

**NEW**  
for  
PC-DOS

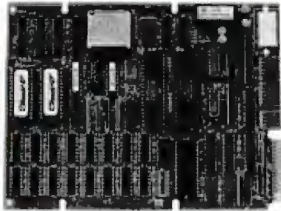

**NEW**  
for  
CP/M

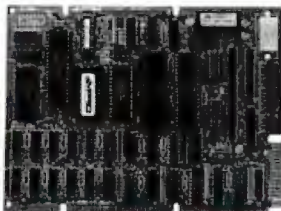

**Little Board™/PLUS . . . \$349**

Single Board 64K CP/M Computer  
with SCSI/PLUS™ Bus

- Same as Little Board/186 except:
- 4 MHz Z80A (8-bit) CPU
  - 64K RAM, 4K to 16K EPROM
  - CP/M 2.2 included

**Little Board™** the (original) **now \$289**  
same as Little Board/PLUS  
except no SCSI, 4K EPROM

### Bookshelf™ Series

Cost Effective, Compact, Versatile  
computer systems

- Choice of Little Board  
CPUs, 1 or 2 floppy drives  
(48 or 96 tpi); 10MB  
internal hard disk option.  
6 1/4" high, 7 1/4" wide,  
10 1/4" deep, 12 1/4 lbs.



### DISTRIBUTORS

Argentina-Factorial, S.A.	1-41-0018
Australia-ASP Microcomputers	613-500-0628
Belgium-Centre Electronique Lempereur	041-23-45-41
Canada-Dynacomp	(604) 879-7737
Denmark-Danbit	03-66-20-20
England-Quant Systems	01-534-3158
Finland-Symmetric OY	358-0-585-392
France-EGAL+	1-502-1800
Israel-Alpha Terminals	03-491695
Spain-Xenios Informatica	3-593-0892
Sweden-AB AKTA	08-54-20-20
USA:	CALL AMPRO

IBM is a registered trademark of Intl. Bus. Mach.  
MS-DOS is a registered trademark of Microsoft.  
Z80A is a registered trademark of Zilog, Inc.  
CP/M is a registered trademark of Digital Research

**AMPRO**  
COMPUTERS INCORPORATED  
67 East Evelyn Ave. • Mountain View, CA 94041  
(415) 962-0230 • TELEX 4940302

## LOGIC PROGRAMMING

tial list into the trivial list ( ) followed by (a boy dreams). After failing to show that ( ) is a noun phrase, it backtracks and splits the initial list into the list (a) followed by (boy dreams). After failing to show that (a) is a noun phrase, because (a) is not a name, Prolog backtracks and splits the initial list into the list (a boy) followed by (dreams). It then shows that (a boy) is a noun phrase by showing "a" is an article and "boy" is a noun. It then shows that (dreams) is a verb phrase by showing that "dreams" is an intransitive verb. In this way it succeeds in solving the initial problem by backward reasoning.

It would be harder to describe how to use forward reasoning to search for a solution to the same problem. But it is comparatively easy to show how to use it to give a proof:

"a" is an article and "boy" is a noun. Therefore, (a boy) is a noun phrase. "dreams" is an intransitive verb. Therefore, (dreams) is a verb phrase. Therefore, (a boy dreams) is a sentence.

This example shows how effective Prolog's simple problem-solving strategy can be. This is not always the case, however, because usually the order in which subproblems are tackled should be sensitive to the form of the problem being solved. Moreover, Prolog's autonomous mode of solving subproblems is not always very effective.

### INTERACTIVE PROBLEM SOLVING

In many cases a collaborative, machine-machine or man-machine problem-solving effort is more appropriate. For this reason, Peter Hammond and Marek Sergot at Imperial College have implemented an extension of Prolog in Prolog itself that asks the user for help. This extension, APES (Augmented Prolog for Expert Systems), has been used for many applications not normally associated with expert systems.

For example, given the problem "(Mary likes Bob) is a sentence?" and our toy English grammar, Prolog, reasoning backward, eventually reduces

the problem to the subproblem "Bob is a name?" which it cannot solve. At this point, Prolog fails to solve the subproblem and eventually terminates in failure. Logically, however, there is no reason not to obtain the knowledge needed to solve the problem from the user. The user can solve the problem with "Yes" and the computer can store the knowledge for its own use on future occasions. In this way the computer learns from the user. It becomes more knowledgeable, if not more intelligent.

### PARALLEL PROBLEM SOLVING

This is an example of man-machine collaboration. Subproblems are solved sometimes by man, sometimes by machine. In general, it is more efficient to collaborate with others, whether they are people or machines, than it is to solve problems on our own.

The classical eight-queens problem illustrates the benefits of such collaboration. The problem is to place eight queens on a chessboard in such a way that no queen can take another.

Every well-educated computer scientist knows that you shouldn't write a computer program to solve a problem before you have a clear idea what the problem is. You write a problem definition—the program specification—before you write a solution—the program. Moreover, even computer scientists who do not support the use of logic as a programming language appreciate the value of logic as a program-specification language. In the case of the eight-queens problem, we can use the conclusion-conditions form of logic to express the uppermost level of the program specification:

$x$  solves the eight-queens problem  
if  $x$  is an assignment of queens  
and  $x$  is safe.

Given appropriate definitions of the "assignment" and "safe" relations, a problem solver can turn the program specification into a procedure by applying backward reasoning. However, Prolog's strategy of solving subprob-

(continued)

# We've been accused of breaking the speed limit.



## You Be The Judge.



Until now, if you wanted true letter quality printing, you needed a daisywheel printer. Then you waited and waited while it plugged along at speeds of about 55 cps.

Now the waiting is over. Because the Genicom 3320 dot

matrix printer offers true letter quality printing at an incredible 180 cps. It's the fastest impact letter quality printer available.

And the Genicom 3320 offers full graphics capability...impossible with a daisywheel.

It also features up to 300 cps data processing, high throughput, heavy duty cycle printing, quiet operation, and Hex dump diagnostics.

Plus the 3320 comes standard with Diablo® 630 and IBM® PC Graphics protocols and works

with most major PC software packages such as Lotus®, Wordstar 2000® and Multimate®.

Call our Toll Free number for all the evidence. You'll find Genicom has five other 3000 models for everything from color printing and bar codes to speeds up to 400 cps.

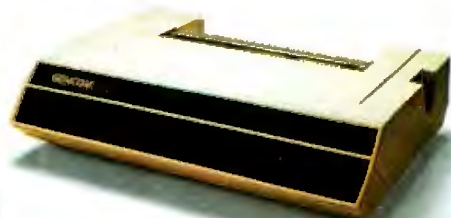

## GENICOM

### The Printers That Mean Business.

Genicom Corporation, Dept. 315J, Waynesboro, VA 22980. TOLL FREE 1-800-437-7468. In Virginia, call 1-703-949-1170.

Diablo® is a registered trademark of Xerox Corporation. IBM® is a registered trademark of International Business Machines. Lotus® is a registered trademark of Lotus Development. Wordstar 2000® is a registered trademark of Micropro International Corporation. Multimate® is a registered trademark of Multimate International Corporation.

lems sequentially in the order in which they are written is extremely inefficient. Prolog will alternatively generate complete assignments of all eight queens to the chessboard and test whether one queen can capture another. If it needs to find all solutions, then it has to consider all  $8^8$  complete assignments. Even though this is extremely inefficient, it may still be useful for testing the specification.

Prolog attempts to solve problems sequentially, one at a time in the order in which the user has written them. But other problem-solving strategies can also be employed. In the case of the eight-queens problem, we can employ two collaborating problem solvers working in parallel. One problem solver can generate assignments and the other can test them for safety. The tester can test partial assignments before they are completed. If a partial assignment (of

the first two queens, for example) is unsafe, it can reject that partial assignment and thereby reject the entire family of all its extensions. The generator can then backtrack and change the position of the queen that caused the partial assignment to become unsafe. Executing the specification in this way, we obtain the classical algorithmic solution.

The algorithm is equivalent to the program you find laboriously encoded in conventional programming languages and even more laboriously proved correct. By analyzing the algorithm as a particular, collaborative problem-solving strategy applied to the program specification, we obtain an immediate, obvious proof of "program" correctness. The algorithm is correct because it is the program specification executed in a correctness-preserving way.

The natural-language understanding

problem also exemplifies the advantages of parallel execution. Consider, for example, the top-level rule

Sentence  $x$  has meaning  $y$   
if  $x$  has syntactic structure  $z$   
and  $z$  has meaning  $y$ .

This models the classical decomposition of the natural-language understanding problem to the separate sub-problems of determining syntax and determining semantics. Prolog (and classical approaches to language understanding) would solve the sub-problems separately, first generating syntactic, then semantic structures.

But the two problems can also be solved collaboratively in parallel. One problem solver can generate syntactic structures, and the other can test them for semantic content. The tester can test partial syntactic structures and reject them if they are meaning-

(continued)

# PROFESSIONAL SCIENTIFIC COMPUTATION

## PC-MATLAB

is a new integrated program for your IBM PC that is, quite simply, the most powerful program anywhere for scientific and matrix computation.

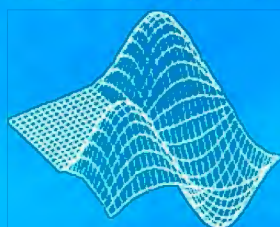

The  
MATH  
WORKS  
Inc.

**Matrix computation is one of the most powerful mathematical tools available for understanding the world. Matrices arise naturally in such diverse disciplines as numerical analysis, statistics, control theory, signal processing, geophysics, economics, and operations research. What's exciting is that matrices provide a beautifully unified mathematical foundation.**

**Fully Loaded:** PC-MATLAB does eigenvalues, linear-equation solution, least-squares, singular value decomposition, and almost anything else you can think of to do with matrices. PC-MATLAB is also chock full of other analytical capabilities including complex arithmetic, FFT's, digital filtering, and multivariate statistics. Altogether, there are over 200 functions available.

**Carefully Integrated:** The precision 2-d and 3-d graphics, data manipulation facilities, and extensibility features will meet all your professional analysis needs.

**Easy-to-use:** This we guarantee. Matrix calculations are indicated to PC-MATLAB in a manner not unlike how they are written

on paper. Finally you'll have a program with a "modern" user interface to scientific and engineering computation!

**Blazingly Fast:** Your PC's powerful numeric coprocessor is fully utilized for near mini-computer performance. For example, it takes only 1 second to multiply  $20 \times 20$  matrices and 2.9 seconds to invert them. A 1024 point FFT finishes in 2.8 seconds!

**Painstakingly Accurate:** The numerical algorithms have been programmed by leading experts in mathematical software. Intermediate calculations use extended 80-bit precision, exceeding the accuracy of many mainframes. Final results are IEEE standard 64 bit numeric format.

**The MathWorks, Inc.**  
124 Foxwood Rd.  
Portola Valley, CA 94025  
415-851-7217

**Call us for information  
on how to unleash the full potential  
of matrix computation!**



# QUAD3278™

## It's almost like a desk-top mainframe.

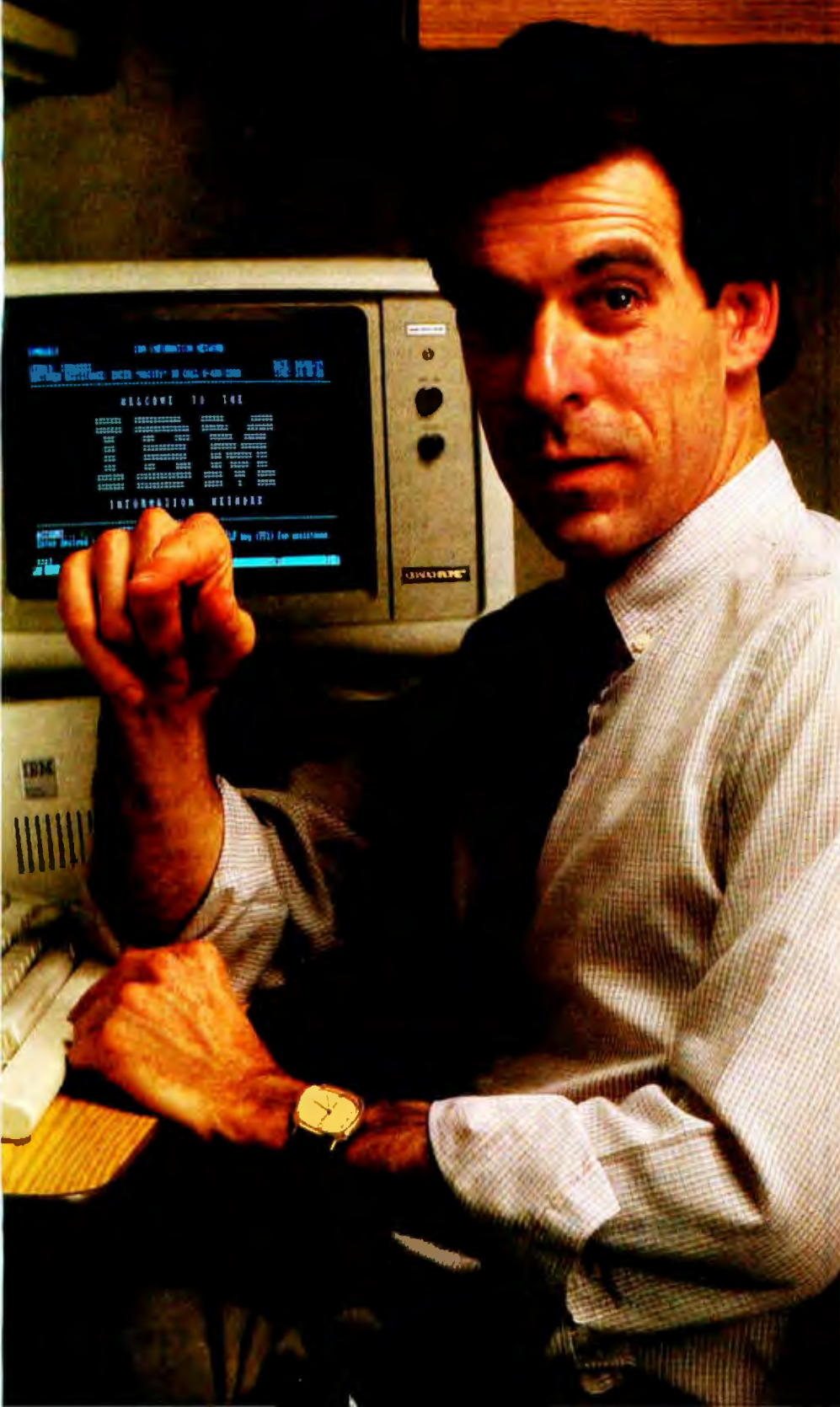

Convert your IBM PC to full 3278 emulation. And back it up with Quadram Quality.

Now you can have all the features of the IBM PC (mass storage and peripherals) plus the incredible power of a mainframe right at your desk. Introducing the new Quad3278 from Quadram. The complete system that makes your IBM PC emulate the 3278 Display Work Station at the touch of a key.

The Quad3278 contains everything you need for converting your PC to total 3278 emulation: hardware, software and full documentation. So you're quickly on-line; where the IBM mainframe sees you as just another 3278 terminal. But thanks to Quadram, you're actually a high-performance, intelligent work station.

And with Quad3278 not only do you retain all the functions of your PC but you can reconfigure your PC keyboard to personal taste. In addition, Quad3278 has its own high-speed microprocessor to keep your PC's microprocessor from being burdened with communications responsibility. And it incorporates the 3279's color mode to give you stunning color displays directly from the mainframe.

Make the connection from micro to mainframe. And back it up with Quadram Quality. Ask for Quad3278. It's the logical step for the future.



Inquiry 256

**QUADRAM**   
An Intelligent Systems Company

4355 International Blvd./Norcross, Ga. 30093  
(404) 923-6666/TWX 810-766-4915 (QUADRAM NCRS)

**INTERNATIONAL OFFICES**  
Interquadram Ltd. 442 Bath Road Slough, England SL6 6BB  
Tel: 6286 63865 Tlx: 847155 Aurema G Interquadram GmbH  
Fasanenweg 7, 6092 Keisterbach, West Germany Tel: 6107 3089  
Tlx: 417770 Seva G Interquadram s.a.r.l. 41 Rue Ybry 92522 Neuilly  
Tel: 758-9240 Tlx: 630842 Iso Bur Cheveo Computing 6581 Kiermat  
Road Mississauga Ontario Canada L5N-2X5 Tel: 416-821-7600

IBM® PC and IBM Information Network are registered trademarks of International Business Machines Corporation.  
© Copyright 1984 Quadram Corporation.  
All Rights Reserved

# WALTZ LISP

The universal, super-efficient  
Lisp for PC-DOS, MS-DOS,  
CP/M-86 and CP/M-80  
systems.

Waltz Lisp is a very powerful and complete implementation of Lisp. It is similar to *Franz* (the Lisp running under *Unix*), and is substantially compatible with *MacLisp* and other mainframe Lisps.

**Ultra fast.** In independent tests, Waltz Lisp was up to twenty(!) times faster than competing microcomputer Lisps.

**Easy to use.** The interpreter can directly load program files created with any ASCII text editor. Full debugging and error handling facilities are available at all times. No debuggers to link or load.

**Practical.** Random file access, binary file support, and extensive string operations make Waltz Lisp suitable for general programming. A text-file difference program and other utilities are included in the package.

**Full Lisp.** Functions of type *lambda (expr), nlambda (fexpr), lexpr, macro*. Splicing and non-splicing character macros. Full suite of mappers, iterators, etc. Long integers (up to 611 digits). Fast list sorting using user defined comparison predicates. Built-in prettyprinting and formatting facilities. Over 250 functions in all.

**Flexible.** Transparent (yet programmable) handling of undefined function references allows large programs to reside partially on disk at run time. Optional automatic loading of initialization file. User control over all aspects of the system. Assembly language interface.

**Superbly documented.** Each aspect of the interpreter is described in detail. The 300+ page manual includes an exhaustive index and hundreds of illustrative examples.

Order Waltz Lisp now and receive free our

## PROLOG Interpreter

**Clog Prolog** is a tiny (but very complete) Prolog implementation written entirely in Waltz Lisp. In addition to the full source code, the package includes a 50 page Clog manual.

16-bit versions require DOS 2.x or CP/M-86 and 90K RAM (more recommended). Z-80 version requires CP/M 2.x or 3.x and 48K RAM minimum. Waltz Lisp runs on hundreds of different computer models and is available in all disk formats.

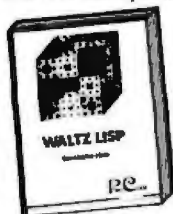

**\$169\***

\*Manual only: \$30 (refundable with order). Foreign orders: add \$5 for surface mail, \$20 for airmail. COD add \$3. Apple CP/M, hard sector, and 3" formats add \$15. MC/Visa accepted.

For further information or to order call

**1-800-LIP-4000 DEPT. 20**

In Oregon and outside USA call 1-503-684-3000

**PC  
RO  
CODE**  
INTERNATIONAL

15930 SW Colony Pl.,  
Portland, OR 97224

## LOGIC PROGRAMMING

less before the syntax generator wastes further effort on them. For example, the attempt to understand the candidate sentence (furious green ideas sleep while others work) can be abandoned as soon as the syntactic analyzer has generated the noun phrase (furious green ideas) and the semantic analyzer has rejected it as meaningless. The argument for understanding natural language by executing syntax generators and semantic analyzers cooperatively as producers/consumers was a major component of Terry Winograd's celebrated Ph.D. thesis, *Understanding Natural Language* (London: Academic Press, 1972).

Several logic-programming languages have the problem-solving facilities needed to run the eight-queens problem and the natural-language understanding problem in collaborative, producer/consumer mode. IC-Prolog, developed by Keith Clark and Frank McCabe at Imperial College, was the first of these languages. A more recent system, MU-Prolog, has been developed by Lee Naish at Melbourne University in Melbourne, Australia. IC-Prolog has also given rise to the more efficient programming-language executors Parlog, developed by Keith Clark and Steve Gregory at Imperial College, and Concurrent Prolog, developed by Ehud Shapiro at the Weizmann Institute. These languages are less powerful problem solvers than IC-Prolog but are more efficient for executing the kind of concurrent processes needed for operating-system applications.

New computer architectures are being developed specifically to exploit the possibility of parallel execution. The Japanese Fifth Generation Project, in particular, has as its main objective the development of highly parallel computers that understand logic as their native language. The ALICE parallel-machine project, led by John Darlington at Imperial College, is pursuing similar objectives.

### EXECUTABLE SPECIFICATIONS ARE NOT ENOUGH

The eight-queens and natural-language understanding problems illus-

trate some of the potential improvements we can obtain by using sequential instead of parallel execution. We should not be misled, however, into concluding that we can always obtain efficient algorithms by clever and more parallel ways of executing program specifications. The sorting problem is a counterexample. A problem solver can execute the top-level specification

$x$  is a sorted version of sequence  $y$   
if  $x$  is a permutation of  $y$   
and  $x$  is ordered

in many different ways, but there seems to be no general execution strategy that converts the specification into an efficient algorithm. This is not to say, however, that we cannot express appropriate sorting algorithms in conclusion-conditions form. Moreover, proving the correctness of such algorithms is much simpler than proving the correctness of conventional programs, because logic programs and logic specifications are expressed in the same formalism.

Thus, we must be prepared to use logic to express efficient algorithms as well as program specifications. But even when it is necessary for a programmer to express such algorithms, the benefits of more intelligent parallel execution can still be worthwhile.

### THE BRITISH NATIONALITY ACT

So far we have concentrated on the different problem-solving strategies that are possible with backward reasoning. But better problem-solving strategies are of use only if we can express knowledge in a form to which we can apply such strategies. Work at Imperial College on the formalization of the British Nationality Act of 1981 illustrates some of the power and limitations of the conclusion-conditions form that is required for backward reasoning.

The first subsection (1.1) of the act states: "A person born in the United Kingdom after commencement (of the act) shall be a British citizen if at the time of birth his father or mother is (a) a British citizen or (b) settled in the United Kingdom." The English is

## LOGIC PROGRAMMING

not as clear as it may seem. First of all, it doesn't tell us when the individual becomes a citizen. Second, it doesn't tell us—what we discover later—that it matters whether you're a citizen by this rule or by another. For example, a child born outside the United Kingdom after commencement of the act is a British citizen *by descent* if at the time of birth his father or mother is a British citizen *otherwise* than by descent. The conclusion is

not simply that you are a citizen, but rather that you are a citizen by 1.1.a or 2.1.b or some other rule.

After several approximations, we eventually discovered that the logic of this subsection of the law is this:

*x* acquires British citizenship by (1.1.a) on date *y*  
 if *x* is born in the U.K.  
 and *x* is born on date *y*  
 and *y* is after commencement

and *z* is parent of *x*  
 and *z* is a British citizen by *w* on date *y*.

This may seem rather tedious, but it needs to be if we are to be absolutely clear what the law really means. Also, it is necessary to formalize explicitly assumptions that are normally taken for granted. For example:

*x* is a British citizen by *w* on date *y*  
(continued)

# FREE SHIPPING ON ORDERS OVER \$100

HEWLETT-PACKARD		
10 Series		
HP-11C	Scientific	\$ 55.95
HP-12C	Financial	\$ 87.95
HP-15C	Scientific	\$ 87.95
HP-16C	Computer Science	\$ 87.95
Solutions Books		
HP-11C	Solutions	\$ 15.00
HP-12C	Real Estate	\$ 15.00
HP-12C	Leasing	\$ 15.00
HP-15C	Advanced Functions	\$ 15.00

HEWLETT-PACKARD		
Thinkjet		
2225B	Thinkjet Printer	\$ 379.00
Accessories		
82199A	Battery Pack	\$ 39.95
92261A	Ink Cartridge	\$ 7.95
92261N	Fanfold Paper (2500)	\$ 44.95
92261S	Printer Stand	\$ 39.95

EPSON		
LX-80	100cps & NLQ	\$ 249.00
LX-90	100cps & NLQ	CALL
HS-80	Inkjet	CALL
FX-80	160cps Dot Matrix	\$ 339.00
JX-80	Color Dot Matrix	\$ 469.00
RX-100	100cps Dot Matrix	\$ 369.00
FX-100	160cps Dot Matrix	\$ 489.00
LQ1500	NLQ Dot Matrix	\$ 899.00
HI-80	Plotter	\$ 369.00
DX-10	Daisywheel	CALL
DX-20	Daisywheel	CALL

HEWLETT-PACKARD		
40 Series		
HP-41CV	Scientific	\$ 169.95
HP-41CX	Scientific	\$ 239.95
Accessories		
82059D	Battery Recharger	\$ 16.00
82104A	Card Reader	\$ 150.15
82120A	Battery Pac.	\$ 28.00
82160A	HP-IL Interface	\$ 96.25
82181A	Extend Memory	\$ 60.00
92266A	Extended Use Battery	\$ 39.95
Software		
41-15002	Statistics	\$ 28.00
41-15003	Math	\$ 28.00
41-15004	Financial Decision	\$ 28.00
41-14005	Surveying	\$ 28.00
41-14006	Circuit Analysis	\$ 36.00

HEWLETT-PACKARD		
Additional Items		
7470A	2-Pen Plotter	\$ 843.15
82143A	Thermal Printer	\$ 295.00
82161A	Cassette Drive	\$ 432.00
82164A	ILRS-232 Interface	\$ 227.15
82166C	IL Interface Kit	\$ 304.15
82168A	Acoustic Coupler	\$ 389.95
9114A	710K Disc Drive	\$ 625.00
92192A	Box of 10 Discs	\$ 55.20

PRINTERS		
Diablo		
D-25	25 cps Daisywheel	\$ 550.00
D-36	36 cps Daisywheel	\$1055.00
D-80	80 cps Daisywheel	\$2195.00
630	45 cps Daisywheel	\$1575.00
Okidata		
ML182	120cps Dot Matrix	\$ 219.00
ML192	160cps Dot Matrix	\$ 359.00
OK120	Color Dot Matrix	\$ 199.00
ML93P	Dot Matrix	\$ 575.00
ML93S	Dot Matrix	\$ 669.00
Brother		
HR-15XL	17cps Daisywheel	\$ 349.00
HR-35	36cps Daisywheel	\$ 699.00
2024L	200cps & NLQ	\$ 850.00
OF100	Sheet Feeder	\$ 199.00

HEWLETT-PACKARD		
70 Series		
HP-71B	Handheld Computer	\$ 389.95
Peripherals		
82400A	Card Reader	\$ 127.05
82401A	HP-IL Interface	\$ 96.25
82420A	4K Memory Module	\$ 60.00
82441A	FORTH Assembler	\$ 115.50
82483A	Surveying	\$ 115.50
82490A	4171 Translator Pac	\$ 96.25
92198A	IL 80 Column Interf	\$ 250.25

MISC. . .		
Panasonic		
printers		
KXP1090		\$ 199.00
KXP1091		\$ 269.00
Hayes	2400 Smartmodem	\$ 615.00
R:Base	4000 for HP-150	\$ 199.00



7600 FLOWER AVENUE  
 WASHINGTON, D.C. 20912

## (800) 544-4442

Western U.S. and Maryland  
 Call Collect  
 (301) 565-3595

AT&T		
PC-6300		
IBM compatible, dual disc drive, monitor, and software CALL for PRICE		

**TERMS:**  
 \*Free Shipping on orders over \$100  
 \*NO ADDITIONAL CHARGE for credit cards.  
 \*MD residents add 5% sales tax.  
 \*Credit references required for open account  
 \*Allow 2 weeks for personal checks



if  $x$  acquires British citizenship by  $w$  on date  $z$   
 and  $z$  is on or before  $y$   
 and  $x$  has not lost British citizenship between date  $z$  and date  $y$ .

My colleagues at Imperial College under the direction of Marek Sergot have succeeded in translating a major portion of the act into a form executable by Prolog. They were able to implement a small but significant portion of the act within the confines of a small microcomputer. Using Augmented Prolog they developed a system that could be used interactively to determine British citizenship in a large number of frequently occurring cases. It is remarkable that despite Prolog's simple problem-solving strategy and except for a few loops removed manually by program-transformation techniques, the rules extracted declaratively from the act behave reasonably efficiently as a logic program.

Our interest in the British Nationality Act, however, was not to develop a running system but to study the problems of knowledge representation. The British Nationality Act includes constructs that are difficult to translate into conclusion-conditions form. Consider, for example, the following statement:

A person is a citizen  
 if ...  
 and his mother is a citizen  
 or would have been a citizen

if she were male.

What we need to handle such statements is an ability not only to express knowledge about the world but also to express *knowledge about knowledge* about the world. In this example we need to be able to refer to our knowledge about the world, imagine an alternate set of beliefs, and derive consequences from those alternative beliefs. This ability is called *metalevel reasoning*.

We can also use metalevel reasoning to analyze the meaning of subsection (2) of the British Nationality Act: "A newborn infant who, after commencement, is found abandoned in the United Kingdom shall, unless the contrary is shown, be deemed for the purposes of subsection (1), (a) to have been born in the United Kingdom after commencement and (b) to have been born to a parent who at the time of birth was a British citizen, or settled in the United Kingdom." Here, although there are other complications, the really problematic phrase is "unless the contrary is shown." The words "unless" and "contrary" both involve negation. Ordinarily, two negations cancel one another out. This is not so in this case because the word "unless" has a metalevel connotation: "unless P" means "if P cannot be proved." It refers implicitly to the current state of knowledge and can lead to conclusions that need to be withdrawn if new knowledge becomes available.

The metalevel reasoning associated with the word "unless" is called *negation by failure* and was first proposed by Carl Hewitt as a feature of the programming language Planner. Several researchers have investigated its relationship with classical logic within a logic-programming framework. Keith Clark, in particular, has shown, under certain fairly natural conditions, that negation by failure is compatible with classical negation. Negation by failure has a very simple (if sometimes incorrect) implementation in Prolog, using its extralogical features.

Prolog also provides more general (extralogical) facilities for metalevel reasoning. Although these facilities are very powerful and very useful, they are not always consistent with classical logic. There is still a great deal of work necessary to incorporate correct and powerful metalevel reasoning within practical logic-programming systems. Such systems would go a long way toward meeting both the critics of logic programming and the critics of logic.

**THE NEED FOR BELIEF REVISION**  
 Many psychologists believe that human beings are not logical. Certain schools of artificial intelligence also argue that logic is inadequate for representing knowledge and belief. They argue that logic is rigid and inflexible and that it requires human beings to be consistent and their knowledge to be complete.

(continued)

# GRAPHS WITHOUT GRAPHICS?

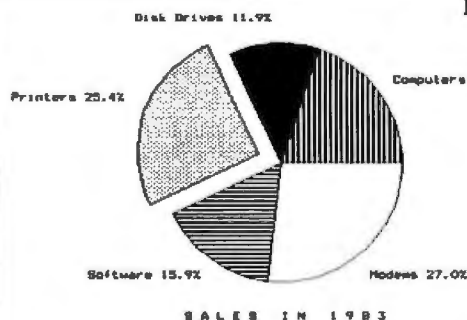

No need for color monitor or graphics board.  
 Make graphs on dot matrix printers.

Easy to Use. No Programming.  
 CP/M 2.2, 3, 80, or 86, MS-DOS or PC-DOS.  
 Excellent Manual. Most disk formats.

## DataPlotter™

Line Graphs & Scatterplots. . . . \$69  
 Bar Graphs & Pie Charts. . . . \$69

Both for \$99

(Prices include manual)  
 Add \$3 shipping.  
 \$8 outside US and Canada.



Lark Software™  
 131 N. Leverett Rd.  
 Leverett, MA 01054 (413) 773-8687 Visa, M/C

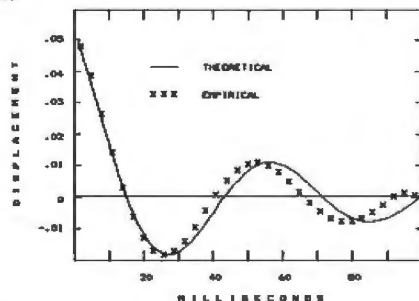

# Tools That Make Your Job Easier

For PC DOS/MSDOS (2.0 and above/128K) • IBM PC/Compatibles, PC Jr., Tandy 1000/1200/2000, & others  
For CPM80 2.2/3.0 (Z80 required/64K) • 8" SSSD, Kaypro 2/4, Osborne 1 SD/DD, Apple II, & others

## MIX EDITOR

Programmable, Full/Split  
Screen Text Processor

Introductory  
Offer

# 29<sup>95</sup>

### Great For All Languages

A general purpose text processor, the MIX Editor is packed with features that make it useful with any language. It has auto indent for structured languages like Pascal or C. It has automatic line numbering for BASIC (255 character lines). It even has fill and justify for English.

### Split Screen

You can split the screen horizontally or vertically and edit two files simultaneously.

### Custom Key Layouts

Commands are mapped to keys just like WordStar. If you don't like the WordStar layout, it's easy to change it. Any key can be mapped to any command. You can also define a key to generate a string of characters, great for entering keywords.

### Macro Commands

The MIX Editor allows a sequence of commands to be executed with a single keystroke. You can define a complete editing operation and perform it at the touch of a key.

### Custom Setup Files

Custom keyboard layouts and macro commands can be saved in setup files. You can create a different setup file for each language you use.

### MSDOS Features

Execute any DOS command or run another program from inside the editor. You can even enter DOS and then return to the editor by typing exit.

## MIX C COMPILER

Full K&R Standard C Language  
Unix Compatible Function Library

Introductory  
Offer

# 39<sup>95</sup>

### Complete & Standard

MIX C is a complete and standard implementation of C as defined by Kernighan and Ritchie. Coupled with a Unix compatible function library, it greatly enhances your ability to write portable programs.

### The Best C Manual

MIX C is complemented by a 400 page manual that includes a tutorial. It explains all the various features of the C language. You may find it more helpful than many of the books written about C.

### Fast Development

MIX C includes a fast single pass compiler and an equally fast linker. Both are executed with a simple one line command. Together they make program development a quick and easy process.

### Fast Execution

The programs developed with MIX C are fast. For example, the often quoted prime number benchmark executes in a very respectable 17 seconds on a standard IBM PC.

### Standard Functions

In addition to the functions described by K&R, MIX C includes the more exotic functions like *setjmp* and *longjmp*. Source code is also included.

### Special Functions

MIX C provides access to your machine's specific features through BDOS and BIOS functions. The CHAIN function lets you chain from one program to another. The MSDOS version even has one function that executes any DOS command string while another executes programs and returns.

### Language Features

- Data Types: char, short, int, unsigned, long, float, double (MSDOS version performs BCD arithmetic on float and double-no roundoff errors)
- Data Classes: auto, static, extern, register
- Struct, Union, Bit Fields (struct assignment supported)
- Typedef, Initialization
- All operators and macro commands are supported

### 30 DAY MONEY BACK GUARANTEE

Orders Only: Call Toll Free 1-800-523-9520, (Texas only 1-800-622-4070)

MIX Editor \_\_\_\_ \$29.95 + shipping (\$5 USA/\$10 Foreign) Texas residents add 6% sales tax

MIX C \_\_\_\_ \$39.95 + shipping (\$5 USA/\$25 Foreign) Texas residents add 6% sales tax

Visa \_\_\_\_ MasterCard \_\_\_\_ Card # \_\_\_\_\_ Exp. Date \_\_\_\_\_

COD \_\_\_\_ Check \_\_\_\_ Money Order \_\_\_\_ Disk Format \_\_\_\_\_

Computer \_\_\_\_\_ Operating System: MSDOS \_\_\_\_ PC DOS \_\_\_\_ CPM80 \_\_\_\_

Name \_\_\_\_\_

Street \_\_\_\_\_

City/State/Zip \_\_\_\_\_

Country \_\_\_\_\_

Phone \_\_\_\_\_

**MIX** 2116 E. Arapaho  
Suite 363  
Richardson, Tx 75081  
software  
Dealer Inquiries Welcome  
Call (214) 783-6001

MSDOS is a trademark of Microsoft PC DOS is a trademark of IBM CPM80 is a trademark of Digital Research WordStar is a trademark of MicroPro

In my opinion, the critics are mistaken. The practical application of logic requires a framework within which new knowledge can be assimilated and beliefs can change. Such a framework for *knowledge assimilation* is completely compatible with logic and has many potential applications both inside and outside computing.

The maintenance of information in computer databases is perhaps the most obvious application. We can regard a relational database, for example, as a special case of a logic program, where all rules have conclusions without any conditions. We can treat the need to change information in a database as a special case of

assimilating new information. Moreover, analyzing the deductive relationship between the new information and the current state of the database can assist the process of knowledge assimilation.

Suppose, for example, that we have a database storing relationships between parents and their children, together with "integrity constraints" that include the statement that no one has more than one father. Suppose the current state of the database contains a statement that Harry is father of John. Suppose an update adds new information that Fred is father of John. A conventional database system would reject the update, laying the blame for inconsistency with the record of the second father, Fred. A more logical analysis of the derivation of contradiction, however, would recognize that it is just as likely that the record of the first father, Harry, is incorrect. Indeed, it is even possible that the blame lies with the integrity constraint. Some people might have more than one father—a natural father and a legal father, for example. Thus logic, far from forcing us to be rigid and unchanging in our beliefs, helps us to be more flexible and to identify different ways we can change our beliefs.

Logic programming blurs the conventional distinction between databases and programs. It encourages incremental development of programs in a manner that is similar to database updates. Consider, for example, how we might extend our salesman's simple expert system. We might update our rules to include additional ways of selling goods to potential customers. Bob, for example, who is a compulsive buyer, will buy anything that is cheap. We can add an extra rule to deal with cases like Bob's:

$x$  is sellable to  $y$   
if  $x$  is cheap  
and  $y$  is a compulsive buyer.

Assimilation of the extra rule changes the knowledge base by extending the class of problems that can be solved. On the other hand, the application of

(continued)

# You already own a computer that can talk. Now let it.

Now you can upgrade almost any personal computer and make it more powerful than ever, by giving it the power of speech.

The Votrax Personal Speech System is the least expensive sophisticated voice synthesizer available today. The PSS's text-to-speech vocabulary is virtually unlimited, and you can define an exception word table and customize your translations. So the PSS can say just about anything!

### It's a speech and sound specialist.

The PSS can also mix speech and sound effects or speech and music. It contains its own speaker, a programmable master clock, 256 programmable frequencies, a programmable speech rate for a more natural rhythm, and 16 programmable amplitude levels for incredible control of word emphasis. You can control the volume. Plus, it doesn't use any of your computer's valuable memory.

### It's computer friendly.

The PSS is unbelievably easy to use. It doesn't need an interface card for most computers. It comes with standard serial and parallel ports. Speech, music, and sound effects are as simple as printing out a document.

### What do you do with a talking computer?

There are countless practical applications. Businesses may want the PSS for spoken transmission of information, narration of displays, and product demonstrations. It makes verification of data input possible for the blind. It can be part of a burglar alarm system. Children can use the PSS as a study aid. And it helps games come alive, speaking while you play.

Whatever your computer can do, the PSS can help it do it better, at a cost that makes it all worthwhile: only \$395.\* Call (313) 583-9884 to hear an actual voice demonstration of the PSS.

\*Suggested retail price

### There's also the Type 'N' Talk.

If you want a less sophisticated unit and want to spend a little less, consider the Votrax Type 'N' Talk (TNT). Its vocabulary is also limited only by what you can type. It doesn't use any computer memory; it's compatible with most computers, and it's only \$249.\* Just plug it in to your own speaker and go!

For more information about the Personal Speech System or the Type 'N' Talk, see your local computer retailer, call toll-free or write:



1394 Rankin  
Troy, Michigan 48063  
1-800-521-1350  
(In Michigan, call collect  
313-588-0341)

GIVE YOUR  
COMPUTER  
THE POWER OF  
SPEECH.



**ORDER  
LINE  
800-354-7330**

# SILICON SPECIALTIES

## COMPUTERS

<b>NEC</b>	
PC-8201 Computer	\$315
PC-8401A	Save
8201 & 8401 Accessories	Save
<b>Sanyo</b> MBC-775 Portable	Save
<b>Televideo</b>	
PM 4T	\$5089
PM 16T	Save
<b>Wyse</b>	
Wyse pc Dual	Save
Wyse pc 10 Mag	Save
<b>Zenith</b>	
Z-150 Single Drive	Save 25%
Z-150 Dual Drive	Save 25%
Z-150 W/10 Megabyte	Save 25%
Z-160 Single Drive	Save 25%
Z-160 Dual Drive	Save 25%

## DISK DRIVES

<b>Alpha Omega</b> Turbo 10	\$599
Turbo 20	\$889
Turbo 30	\$1169
<b>Haba</b> Habadisk for Macintosh	\$289
<b>Omega</b> Bernoulli Box for IBM	
10 Megabyte	Save
20 Megabyte	Save
20 Megabyte Plus	Save
5 Megabyte for Macintosh	Save
<b>Rana</b> Elite I	\$175
Elite II	\$339
Elite III	\$405
Elite IGH/Apple	\$1080
Controller (W/Drive Only)	\$69

## BOARDS

<b>AST</b> Six Pack Plus	\$249
<b>Hercules</b> Color Card	\$145
Graphic Card	\$295
<b>Paradise</b> Modular Graphic 06-1	\$259
Five Pak	\$159
<b>Quadram</b> Quadboard EX OK	\$219
E-Ram 80	\$89
Quadlink	\$325
<b>Tec Mar</b>	
Graphics Master	\$449
128K Dynamic Memory	\$225
256K Dynamic Memory	\$299
Captain 128K	\$289
Captive 256K	\$389

## VIDEO TERMINALS

<b>Altos</b>	
Smart II	\$769
<b>Gume</b>	
QVT Green 101	\$289
QVT Amber 101	\$314
<b>Televideo</b>	
921	\$445
922	\$599
955	\$459
<b>Wyse</b> 50	Save
75	\$365
Wyse 85	Save
<b>Zenith</b> Z-22	\$469
Z-29	\$599
Z-49	Save

## PRINTERS

<b>Anadex</b>	
All Models	Save
<b>Brother</b>	
HR10 w/Tractor	\$239
HR-15XL	\$339
HR-25	\$649
HR-35	\$875
Twinkriter 5	\$819
<b>Canon</b>	
LBP-8A1	Call
<b>C-Itch</b>	
A-10-30	\$469
F-10 Parallel or Serial	\$869
55 CPS Serial or Parallel	\$1035
8510 Parallel (Prowriter)	\$295
8510SP	\$385
8510 SCP	\$465
8510 BP1	\$315

<b>Citizen</b>	
MS-10	\$279
MS-15	\$414
MS-20	\$414
MS-25	\$539

<b>Comrex</b>	
CR-2E	\$364
CR-4	Save
420	\$1529

<b>DaisyLaser</b>	
PR101	Save

<b>Datasouth</b>	
DS180	\$1079
DS220	\$1299
DS-PP#1	\$449
DS-PP#2	\$629

<b>Diablo</b>	
D-25	\$549
630 AP1	\$1484
630 ECS	\$1659
630 ECS/IBM	\$1659
Other Printer Models	Save

<b>Epson</b> All Printer Models	Save
---------------------------------	------

<b>Inforunner</b>	
Rite-man w/Tractor	\$244
Rite-man 15	\$499
Rite-man Blue w/Tractor	\$299

<b>Juki</b>	
5500	Save
6000	\$199
6100	\$385
6300	\$699

<b>NEC</b>	
2010, 2015, 2030, 2050	\$629
3510, 3515, 3530, 3550	\$1009
8810, 8815, 8830, 8850	\$1399
P2, P3	Save

<b>Okidata</b> All Printer Models	Save
-----------------------------------	------

<b>Panasonic</b>	
1091	\$239
1092	\$349
1093	\$429
KXP3151	\$459

<b>Siemens</b>	
PT/88 Ink Jet	Save
PT/89 Ink Jet	Save

<b>Star Micronics</b> All Printer Models	Save
--	------

<b>Silver Reed</b>	
EXP400 Parallel	\$229
EXP500 Parallel or Serial	\$379
EXP350 Parallel or Serial	\$389
EXP770 Parallel or Serial	\$699

<b>Texas Instruments</b>	
850 & 860 Series	Save

<b>Toshiba</b> P1340 Parallel or Serial	\$544
P351 Parallel or Serial	\$1155

## DISKETTES

<b>Maxell</b> MD-1 (Qty 100)	\$149
MD-2 (Qty 100)	\$189
<b>Nashua</b>	
S/S D/D (Qty 100)	\$125
D/S D/D (Qty 100)	\$135

## KEYBOARDS

<b>Keytronics</b> S151	\$179
S151 Jr.	\$179

## MONITORS

<b>Amdek</b> All Monitors	Save
<b>Princeton Graphic</b> HX-12	\$445
<b>Sanyo</b> CRT-36	\$149
<b>Taxan</b>	
121 Green	\$125
122 Amber	\$134
420 RGB	\$399
425 RGB/Green	\$410
440	\$549
<b>Zenith</b>	
ZVM-122 Amber	\$95
ZVM-123 Green	\$89
ZVM-124	\$119
ZVM-130	Save
ZVM-133 Color/RGB	\$410
ZVM-135 Color/RGB W/Audio	\$459
ZVM136	\$575

## PLOTTERS

<b>Enter</b> Sweet-P600	\$780
<b>Epson</b> HI-80	Save

**ZENITH-SS/EPSON**  
Zenith Z-150 Dual Drive 320K Ram  
Zenith Green or Amber Monitor  
**EPSON LX80 Printer**  
Includes Cables  
**\$1899**  
Above System with Z-160 Dual Drive Portable (No monitor)  
**\$1999**

**NEW!**

## SOFTWARE

Bank Street Writer	\$48
PPS: Write	\$79
Leading Edge Word Processor (Basic)	\$59
PPS: Proof	\$53
Flight Simulator (New Version)	\$32
Speed Reader II	\$45
Mind Prober	\$29
Typing Instructor	\$30
Typing Tutor III	\$30
PPS: Graph	\$79
PPS: Plan	\$79
PPS: Report	\$71
Copy II PC	\$20
Desk Organizer	\$59
Notion Utilities 3.0	\$53
Prokey 3.0	\$75
Sidack	\$30
Sidack (Unprotected Ver.)	\$45
Sideways	\$35
Macro Assembler (Microsoft)	\$89
Turbo Pascal 3.0	\$36
Turbo Tool Kit	\$30
CompuServe Starter Kit	\$21
PPS: Access	\$79
Dalton & Sense w/Forecast	\$95
Tobler's Managing Your Money	\$98
Home Accountant Plus	\$82
Nuthel	Save
PPS: File	\$79
Think Tank	\$99

## MODEMS

<b>Anchor Automation</b>	
Anchor Express	\$269
Mark XII	\$239
<b>Hayes</b> Smartmodem 300 Baud	\$129
Smartmodem 1200 Baud	\$379
Smartmodem 1200B (IBM)	\$319
Smartmodem 2400 Baud	Save
Micromodem IIE (Apple)	\$129
<b>Novation</b> Smart Cat Plus	\$279
<b>Prometheus</b> All Models	Save
<b>Rocal-Vadic</b> All Models	Save
<b>US Robotics</b> Password 1200	\$195

**SILICON SPECIALTIES**  
2034 WEST SOUTHERN  
MESA, ARIZONA 85202  
602-969-0909



Inquiry 289 for MS DOS Products. Inquiry 290 for all others.

Prices reflect 3% to 5% cash discount. Product shipped in factory cartons with manufacturer's warranty. Please add \$9.00 per order for UPS ground shipping. Orders 10 lbs. and under you pay for ground service, receive air service at no extra charge. Available on orders 11-20 lbs. \$15 for air service. Orders 21-30 lbs. \$20 for air service. Prices & availability subject to change without notice. Send cashier's check or money order...all other checks will delay shipping two weeks.

# Trouble shooter.



Being on the road doesn't have to mean being out of touch. Whether you're putting out fires, or igniting ideas, a public phone can be a powerful business tool. So the next time you're away on business, call your office on AT&T Long Distance. And make sure your presence is felt.

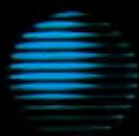

**AT&T**  
The right choice.

our original rule might result in inconsistency. Suppose, for example, that we try to convince John that because he likes watching films and because a cinema is good for watching films, he ought to buy a cinema. We can interpret John's failure to be convinced as giving rise to the new knowledge that a cinema is not sellable to John. When assimilated into the knowledge base, this gives rise to inconsistency that should encourage us to reconsider our rules and in this case might suggest that we modify the original rule by adding an extra condition:

$x$  is sellable to  $y$   
if  $x$  can be used for  $z$   
and  $y$  has occupation  $z$   
and  $y$  can afford  $x$ .

The addition of the extra condition avoids the inconsistency while it preserves previously derived useful consequences of the original rule.

You can also apply knowledge assimilation to *story understanding*. Given our current understanding of a story so far, a new sentence gives rise to new knowledge to be assimilated. A sentence can be ambiguous, however. Different interpretations of the same sentence may differ with respect to their deductive relationships to the current knowledge base. An incorrect interpretation, in particular, may give rise to an inconsistency, which can turn our attention to other interpretations of the input sentences. We might even be motivated to consider other, more logically relevant interpretations, if the current interpretation bears no logical relationship to the current knowledge base. The Linguistics Department at University College in London is investigating a similar, deductively oriented theory of natural-language understanding based on Dierdre Wilson and Dan Sperber's Relevance Theory.

We might even argue that the development of scientific theories can be regarded as an example of knowledge assimilation. New hypotheses and reports of observations need to be assimilated into the current state of the theory. Does the new hypothesis imply that previous hypotheses were



special cases? Is the report of an observation already implied by the existing theory? Or is it inconsistent? If it is inconsistent, does the fault lie with the theory or with the report? The philosopher of science Imre Lakatos has argued that, if the theory is immature and undeveloped, then it is more reasonable to suspect the theory than the report. If the theory is mature, then it is more reasonable to suspect the report. In either case, logic can help us to identify different ways of restoring consistency.

Such a theory of knowledge assimilation and belief revision is necessary for the practical application of logic programming. Even Prolog provides crude but powerful primitives for manipulating sentences and combining ordinary deduction with metalevel reasoning. These primitives can be and have been used for implementing simple but effective knowledge-assimilation systems.

### CONCLUSION

Logic programming combines the use of logic that is congenial to human thinking and logic that is sufficiently goal-oriented to be implemented by computer. It provides a general framework within which many widely differing languages can be developed. It gives scope to the development of both declarative and procedural computer languages as well as to sequential and parallel implementations. Prolog is the first and most important logic-programming language, and it provides a tantalizing preview of the more powerful logic-programming languages of the future. ■

### BIBLIOGRAPHY

- Clark, K. L., and S. A. Tärnlund, eds. *Logic Programming*. London: Academic Press, 1982.
- Ennals, J. R. *Beginning Micro-PROLOG*, 2nd edition. Chichester, England: Ellis Horwood Ltd., 1984.
- Hewitt, Carl. "The Challenge of Open Systems." *BYTE*, April 1985, pages 223-242.
- Hogger, C. J. *Introduction to Logic Programming*. London: Academic Press, 1984.
- Kowalski, R. A. *Logic for Problem Solving*. New York: North-Holland/Elsevier, 1979.

# Remote Control.



When you're on the road, don't leave your office to manage itself. Give them a call on AT&T Long Distance from a public phone. And make sure everything's under control. Wherever you are.

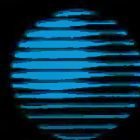

**AT&T**

The right choice.

# Introducing business solutions from Team Xerox.

No matter what kind of business you're in, chances are you need to manage some type of document, whether electronic or on paper.

To that end, Xerox has developed a whole range of new products complete with software as well as networking and communications capabilities.

Say you're like most of the business world and you deal with letters, memos and reports. Team Xerox has a series of capabilities we call Document Solutions, which includes a choice of workstations such as word processors, personal and professional computers, electronic typewriters and printers including dot matrix, daisywheel and a desktop laser printer.

They're all new to the Xerox line, compatible with many of the products you now use and

First Quarter Sales Report, Page 5

can be sent as one report

6068 Word Processor

6064 Personal Computer

645 Memorywriter

4045 Laser CP

6085 Professional Computer System

...an ability factor in decisions to buy from us, or to switch to a new source for supplies so far with our new strategy, suggesting that it is far more comprehensive than our competitor's.

## Document Solutions

Accounting

EXTRA STE

Design Pagination Terminal

Editing Terminal

3700 Laser Printing System

## Production Publisher Solutions

expandable to meet your needs in the future.

If your business has to do with engineering and you need to produce drawings and merge text and graphics, Team Xerox has developed Expert Designer Solutions, which includes a remarkable Xerox engineering workstation, a Xerox laser printer and newly developed software.

For in-house publishing, including manuals, proposals and technical publications, you'll want Production Publisher Solutions, a publishing system complete with hardware and software, that can design and compose and virtually eliminate the need to send work outside your office.

And finally, when it comes to support, no company can analyze your document needs, make

sure you get the right solutions, and be there with the service you require better than Xerox.

When you're ready to talk, call Team Xerox at 1-800-TEAM-XRX, ext. 12 (1-800-832-6979, ext. 12), or write Xerox Corp., Dept. 12192, P.O. Box 24, Rochester, N.Y. 14692. We'll be ready to listen.



Xerox Corporation, P.O. Box 24, Rochester, N.Y. 14692  
Please send me more information on:

Document Solutions       Expert Designer Solutions  
 Production Publisher Solutions       All of the above

NAME \_\_\_\_\_

COMPANY \_\_\_\_\_ TITLE \_\_\_\_\_

ADDRESS \_\_\_\_\_

CITY \_\_\_\_\_ STATE \_\_\_\_\_

ZIP \_\_\_\_\_ PHONE \_\_\_\_\_

12 192-8-85

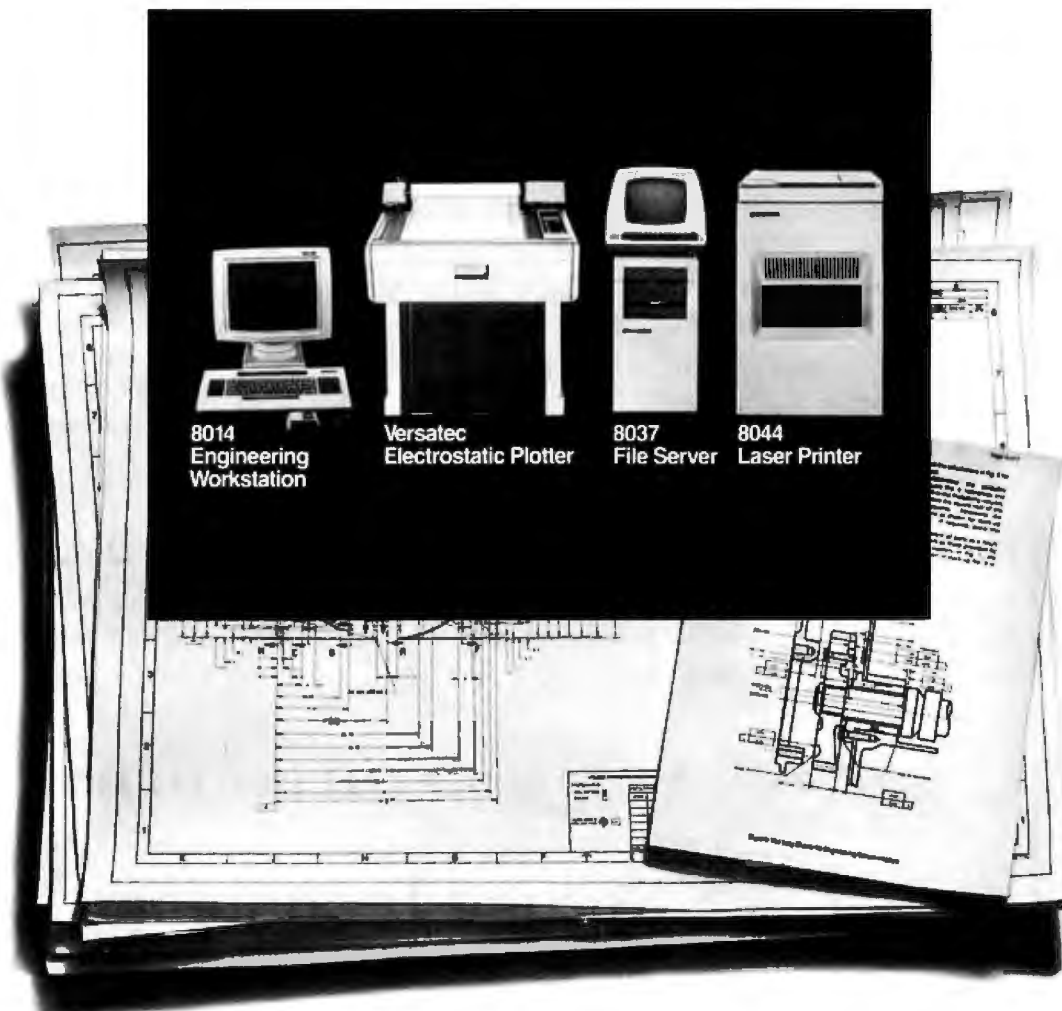
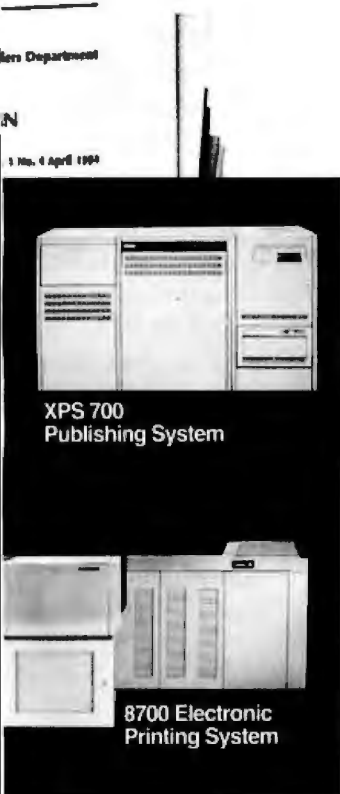

## Expert Designer Solutions

XEROX® and the identifying numbers herein are trademarks of XEROX CORPORATION.

# Slash Programming Time in Half!

With **FirsTime**<sup>TM</sup>

- Fast program entry through single keystroke statement generators.
- Fast editing through syntax oriented cursor movements.
- Dramatically reduced debugging time through immediate syntax checking.
- Fast development through unique programmer oriented features.
- Automatic program formatter.

## FirsTime is a true syntax directed editor.

FirsTime ensures the integrity of your programs by performing all editing tasks like moves, inserts and deletes along the syntactic elements of a program. For example, when you move an IF statement, FirsTime will move the corresponding THEN and ELSE clauses with it.

Even FirsTime's cursor movements are by syntax elements instead of characters. The cursor automatically skips over blank spaces and required keywords and goes directly to the next editable position.

## FirsTime is a Syntax Checker

FirsTime checks the syntax of your program statements, and also:

- Semantics like undefined variables and mismatched statement types.
- The contents of include files and macro expansions.
- Statements for errors as they are entered and warns you immediately.

## FirsTime is a Program Formatter

FirsTime automatically indents statements as they are entered, saving you from having to track indentation levels and count spaces.

## FirsTime has Unique Features

No other editor offer these features:

The *Zoom command* gives you a top down view of your program logic.

The *View command* displays the contents of include files and macro expansions. This is valuable to sophisticated programmers writing complex code or to those updating unfamiliar programs.

FirsTime's *Transform command* lets you change a statement to another similar one with just two keystrokes. For example, you can instantly transform a FOR statement into a WHILE statement.

The *Move at Same Level command* moves the cursor up or down to the next statement at the same indentation level. This is very useful. For example, you can use it to locate the ELSE clause that corresponds to a given THEN clause or to traverse a program one procedure at a time.

## FirsTime is Unparalleled

FirsTime is the most advanced syntax directed editor available. It makes programming faster, easier and more fun.

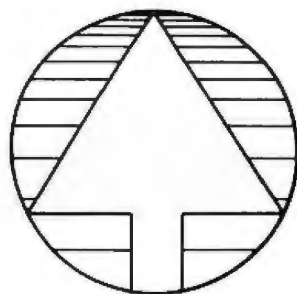

TO ORDER CALL (201) 741-8188

or write:

## **Spruce Technology Corporation**

189 E. Bergen Place  
Red Bank, NJ 07701

Inquiry 307

In Germany, Austria and Switzerland contact:  
Markt & Technik Software Verlag  
Munchen, W. Germany  
(089) 4613-0

# DECLARATIVE LANGUAGES: AN OVERVIEW

BY SUSAN EISENBACH AND CHRIS SADLER

*Why do we need another type  
of programming language?*

SOME PROGRAMMING languages are designed to get the optimum performance out of the systems they run on regardless of the amount of time it takes to produce the program. Others are designed to enhance programmer productivity, usually at the expense of efficient use of machine time. Some are special-purpose languages designed to be applicable only to a restricted range of problems; others attempt a jack-of-all-trades approach by offering features that can be applied to a variety of problems.

Because of the expanding scope and complexity of problems tackled by computers, programming languages tend to exhibit something akin to evolutionary behavior: Some become extinct, some adapt and survive, and some new ones emerge. Underpinning this creation and adaptation of programming languages have been refinements in our understanding of problem solving and programming and changes in our conception of language and machine intelligence. These theoretical considerations have had the effect of founding families of languages. Thus,

most languages can trace their parentage back to one or more original ideas. (See the "Development of Functional Languages" text box on page 182.) This article is about one such family, known as the *declarative languages*. Highly regarded in academic circles, declarative languages are problem-oriented but currently inefficient computationally. The imminent fifth-generation hardware makes it look as though the declarative family may soon be entering its own era.

## **HARDWARE PROBLEMS**

Virtually all currently available computers are architecturally equivalent to the first machines built in the 1940s. One central processor is connected to a relatively large passive memory by a bus that is one word wide. Eventually, after much tuning of the software and several hardware upgrades, most systems become processor-bound; the central processing unit isn't fast enough to cope with the tasks it is supposed to perform. At this stage a new computer is normally obtained, with the same basic architecture but faster components.

Every breakthrough in hardware technology leads to improvements in speed, which raise the expectations of users that can be met only by another technological breakthrough. Things have reached the stage where not many turns are left through this cycle before we hit some natural barrier (e.g., the speed of light) that closes off the line of development.

One way out of this cul-de-sac lies in an examination of the justification behind the conventional machine architecture. The ratio between processor cost and memory cost used to be high since processors were expensive, requiring many boards of components. Today, this is no longer the case. Both processors and memory are made from the same technologies—LSI (large-scale integration) and VLSI (very large scale integration).

*(continued)*

Susan Eisenbach is in the Department of Computing, Imperial College, 180 Queen's Gate, London SW7 2BZ, England. Chris Sadler is in the Department of Mathematics, Statistics, and Computing, Polytechnic of North London, Holloway Rd., London N7, England.

Only the smallest microcomputer systems don't have additional special-purpose processors to deal with storage, I/O (input/output) peripherals, floating-point operations, and so on. But there is still only a single central processing unit. For applications that require higher throughput, it makes sense to try to build machines out of networks of general-purpose processors, each of which can take a

share of the processing load.

Many current users who require substantial processing power have programs that contain large arrays of data. This is especially true in the areas of meteorology, oil exploration, and defense problems. Therefore, one kind of parallel machine consists of an array of processors that simultaneously obey the same instructions. A high throughput can be achieved if the

user's problem can be written to include arrays whose elements all need the same operations performed on them. Another more flexible system consists of a pipeline of processors, each of which performs a portion of the calculation on each piece of data before passing its results on to the next processor down the line. Unfortunately, it is difficult to exploit this

(continued)

## THE DEVELOPMENT OF FUNCTIONAL LANGUAGES

### FOUNDATIONAL STUDIES

- 1924 Schonfinkel introduces combinations to remove the need for variables in logical formulae.
- 1930 Curry develops the theory of pure combinatory logic.
- 1932 Church introduces the lambda-calculus.
- 1936 Kleene introduces recursion equations.
- 1937 Turing shows the equivalence of the lambda-calculus and Turing machines as formal models of computation.
- 1969 Scott introduces the first mathematical model of the lambda-calculus for use in Scott-Strachey denotational semantics.

### FUNCTIONAL LANGUAGES

- 1960 McCarthy presents LISP, a language similar to the lambda-calculus designed for use in symbolic computation.
- 1966 Landin introduces ISWIM, an expression-based language including a purely functional subsystem.
- 1968 Evans introduces PAL, an expression-based language incorporating lambda-notation and designed for use in teaching programming linguistics. Burstall and Popplestone introduce POP-2, an imperative language that includes a functional subset based on the lambda-calculus. POP-2 is used

extensively by the British artificial-intelligence community.

- 1970 Reynolds creates the language GEDANKEN, which is based on the lambda-calculus and introduces the functional approach to data structures.
- 1974 Burstall and Darlington develop NPL, a first-order functional language that uses Kleene recursion equations and incorporates relative set abstraction. It was used in their program-transformation work.
- 1976 Turner introduces SASL, a purely functional language used extensively in teaching.
- 1977 Hankin and Sharp introduce CAJOLE, a purely functional language designed for use in the programming of data-flow systems.
- Backus gives the ACM Turing Award lecture and presents FP, a functional language incorporating powerful program-forming operators.
- 1978 Burstall and coworkers introduce Hope, a strong polymorphically typed functional language with data-abstraction facilities.
- Milner and coworkers introduce ML, the language used to construct proofs in LCF.
- 1980 Turner introduces KRC, a functional language with Zermelo-Fraenkel set abstraction. Henderson presents LISPKIT LISP.
- 1984 Turner introduces MIRANDA.

### MACHINES

- 1965 Landin unveils the SECD machine, an abstract machine for describing the execution of functional languages.
- 1971 Wadsworth introduces the notions of call by need and graph reduction using the lambda-calculus.
- 1976 Henderson and Morris invent lazy evaluation. This was also independently invented by Friedman and Wise. Berkling introduces a string-reduction architecture for executing lambda-calculus programs.
- 1979 Turner shows how combinators can be used as the machine code of a graph-reduction machine for executing functional programs.
- Keller and coworkers introduce AMPS, a loosely coupled multiprocessor system for the execution of flow-graph LISP.
- 1981 LISP machines become commercially available.
- Darlington and coworkers present ALICE, a parallel graph-reduction machine.
- Mago introduces a string-reduction machine for the parallel execution of FP programs.
- 1983 Hughes introduces super-combinators, a method of graph reduction that retains many of the advantages of combinators but operates at a higher level.

# WE THOUGHT YOU SHOULD KNOW

FROM

# QUANTEK

You can now purchase a fully compatible IBM AT type system, fully enhanced, priced far below competition.

Here is what you get for under \$3,300.00

- Microprocessor 80286 ■ Memory 640Kb RAM
- Math co-processor socket for 80287
- System expansion eight I/O slots
- Hard disk drive 20 Mb (40 Mb optional)
- Floppy disk drive 1.2 Mb ■ Serial ports
- Parallel ports ■ Controller card
- Keyboard 84 keys
- Runs current IBM AT software packages

QUANTEK CORPORATION has earned one of the highest ratings in the industry. Our microprocessor boards are now receiving less than 1% rework. This track record permits us to give an unconditional six months warranty on the **QUANTEK 2000 AT** which is twice the competition.

Dealer and distributor inquiries invited.

Inquiry 261 for End-Users. Inquiry 262 for DEALERS ONLY.

QUANTEK CORPORATION  
17975 Main St.  
Irvine, CA 92714  
(714) 250-1909

IBM is the registered trademark of  
International Business Machines.

lock-step parallelism since not all problems are easily cast into a suitable form.

The next alternative is to use languages that explicitly control the parallel execution of processes. This is called concurrency. New languages such as Modula-2 and Ada have constructs that let the programmer ini-

tiate and coordinate multiple concurrent tasks. Typically, these tasks share a single processor, but parallel processors could be used, especially with a limited number of tasks. However, parallel processing becomes less practical to program when the number of simultaneous tasks reaches the thousands.

Just as the procedural languages we use mirror conventional architecture (that is, they are sequential in nature), in order to take full advantage of parallel-processing systems, we need a type of language in which it is natural to describe complex problems in such a way that they can be automatically solved concurrently. One can then gain arbitrary increases in speed simply by adding more processors.

## Lattice® Products Are Your Best Investment

**Lattice TopView Toolbasket**—\$250.00  
—Provides more than 70 functions that eliminate the need for extensive use of assembly language when interfacing with TopView. Includes functions to control window, cursor, pointer, and printer operations. Also provides access to cut-and-paste facility and debugging services.

**LMK™**—Automated product generation utility for MS-DOS, similar to UNIX "Make" \$195.00

**C-Sprite™**—Symbolic debugger for programs written in Lattice C or assembly language \$175.00

**C Compilers**—MS-DOS and PC-DOS—The industry standard \$500.00

**Panel**—High performance screen design and screen management system. Available for MS-DOS, PC-DOS, and UNIX systems \$295.00

**dBC II™ or dBC III™**—C function libraries supporting indexed files that are compatible with dBASE II® or dBASE III™ \$250.00

**C-Food Smorgasbord™** \$150.00  
—Includes a BCD decimal arithmetic package, I/O functions, IBM-PC BIOS interface, terminal independence package, plus many other utility functions

**Text Management Utilities**—(GREP/DIFF/ED/WC/EXTRACT/BUILD)—Essential programming and documentation aids in any environment \$120.00

With Lattice published products you get "Lattice Service" including telephone support, free updates during the warranty period, notice of new products and enhancements when you register, and a money-back guarantee. Corporate site license agreements are available.

**Call us today for further information on these, or our many other C programs, utilities, and tools!**



Lattice, Inc.  
P.O. Box 3072  
Glen Ellyn, IL 60138  
Phone (312) 858-7950  
TWX 910-291-2190

### International Sales Offices

Belgium: Softshop. Phone: (32) 53-664875  
England: Roundhill. Phone: (0672) 54675  
Japan: Lifeboat Inc. Phone: (03) 293-4711

### SOFTWARE PROBLEMS

Much research has gone into improving programmer productivity, especially when it was found that the cost of employing teams of programmers began to outweigh the cost of purchasing and maintaining the computers they were using. Two startling findings have made quite a difference in the way things have developed on the software front in the last decade. The first of these is the fact that, whatever programming language is used, any given programmer produces roughly the same number of lines of code—written, tested, debugged, and documented. (The average output for a professional programmer is around 1500 lines per year—although individual production varies widely.) The implication of this finding is that the more powerful the language (that is, the more computing that can be encompassed in each construct, rather than simply the number of different constructs available to the programmer), the more productive the programmer becomes. Thus, over the years we have seen a trend toward higher-level programming languages.

A second trend follows from an analysis of those elements within programs that appear to be particularly prone to error and the elimination of them in new language definitions. This has the effect of limiting the control that can be exercised over the machine at the programmer's whim. The first step in this direction occurred with the move from assembly languages to the original high-level languages. Instead of laying the entire available memory open to the pro-

(continued)





# SmarTEAM<sup>®</sup> modem Fully Hayes compatible at half the price ...

and  
more ...



**SmarTEAM + MITE** The most powerful communication system for over 130 different computer (CP/M and MS DOS) including the IBM PC/XT/AT, AT&T 8300, Sanyo 555, DEC Rainbow, Kaypro, Televideo and Apple Macintosh... also can turn your computer into any of over 90 different terminals including DEC VT100, Televideo 950 or IBM 3101...

## SmarTEAM 2400

- 0-300 600 1200 2400 bps Bell 103 212A CCITT V22 V22 BIS Full duplex Synchronous Asynchronous
- Auto speed selection (among 0-300, 600, 1200, 2400 bps)
- Auto recall auto answer (tone or pulse)
- Speaker with volume control
- 8 status indicators
- Self test and error free file transfer
- Call progress detection
- Voice/Data switching
- AT commands compatible
- Multiple phone number storage
- MITE Software included



\$599

## SmarTEAM 103/212A

- Fully Hayes compatible support all 20 commands and 6 responses
- Option switches identical to Hayes
- Auto dial auto answer (tone or pulse)
- Auto speed selection (0-300 1200 bps)
- 0-300 1200 bps Bell 103 212A
- Speaker with volume control
- MITE Software optional
- 8 status indicators
- Switch selectable
- Self test



\$299

## SmarTEAM 1200B

- Additional RS232C serial port plugs into IBM PC XT AT and all compatible
- Auto speed selection (0-300 or 1200 bps)
- Auto dial auto answer (tone or pulse)
- 0-300 1200 bps Bell 103 212A
- Compatible with Hayes commands
- Speaker with volume control
- Self test and error free file transfer
- Powerful MITE Software included



\$299

## SmarTEAM 103/202

- 0-300 bps full duplex 600 bps 1200 bps half duplex
- Compatible with Bell 103 202 CCITT V 21 V 23 includes 75 bps and 5 bps back channel
- 10 switches selectable for Bell or CCITT standard
- Auto dial auto answer (tone or pulse)
- Auto line disconnected
- Compatible with Hayes commands
- Speaker with volume control
- Self test
- Call progress detection



\$249

## NEW!! TEAM-NET LAN FOR PC. XT

Makes Less Than \$349/node Possible

### SPECIFICATIONS:

- Topology: Distributor Bus
- Protocol: CSMA/CA
- Addressable Users: 255 maximum
- Data Rate: 1 Megabit/sec
- Operating System: PC-DOS 2.0 MS-DOS 2.0 2.11
- Computer Interface: for IBM PC XT COMPAQ CORONA COLUMBIA, etc
- System Requirements: 128K RAM per PC (min) 1 Expansion slot per PC
- Cabling: RS-422 Twisted pair wires
- Distance: 4000 feet maximum

### FEATURES:

- Transparent to DOS
- Hard disk sharing
- Floppy disk sharing
- Printer/plotter sharing
- No dedicated file server
- File/Record Locking
- TEAM-Mail (Electronic Mail software)
- TEAM-Spool (Printer files spooling)
- Multi-Tasking with high performance
- Enhanced Networking DOS command
- Diskless remote-boot allowed



## TEAM-3278 \$699

- Emulate IBM 3278-2 Information Display Station & IBM 3278-2A Color Station.
- Software provides Terminal Emulation and File Transfer.
- Capable to connect to IBM 3274/3276 Cluster Controller or Integral Type A Terminal Controller.

**TEAM**  
HEAD OFFICE:  
**TEAM TECHNOLOGY INC.**  
11F 270 NANKING E RD SEC 2 TAIPEI  
TAINAN R.D.  
TLX 19725 PETRCHEN ATTN TEAM  
TEL (02)741427 FAX (02) 771-2985

**U.S.A. EXCLUSIVE AGENT:**  
**MORRISON & DEMPSEY COMMUNICATIONS**  
19209 Parthena Unit D Northridge CA 91324  
U.S.A.  
TEL (818)993-0195 ~ 97  
TLX 325524 MODEM NTGE

**U.S.A. DISTRIBUTORS:**  
WEST 1 C HOELZLE ASSOCIATES (Costa Mesa CA) 714-850-9191  
2 DYNATRON ASSOCIATES INC (Newark CA) 415 797-0570  
MID 3 DIRECT ELECTRONICS (Albuquerque NM)  
MID U.S.A (Toll Free) 1-800-826-4747/NM 505-983-9199  
4 Q.C. DISTRIBUTORS (Houston TX) 713-988-2290  
EAST 5 ESK PRODUCTS (Denver CO) 303-650-0051/800 621 8385-Ext 200  
6 COMPUTER CENTER (Minneapolis TN) 901-885-0010  
7 AB COMPUTER (Philsdelphie PA) 215-822-7727/800-822-1211

**CANADA EXCLUSIVE DISTRIBUTOR:**  
**BUDGETRON INC.**  
1801 MATHESON BLVD UNIT 3  
MISSISSAUGA ONTARIO CANADA L4W 1H9  
TEL (416)624-7323  
TELEX 06-960172

Inquiry 371

• Hayes is a registered trademark of Hayes Microcomputer Products Inc.  
• IBM PC XT AT are registered trademarks of International Business Machines Corp.  
• MITE is a registered trademark of MYCROFT LABS INC.

programmer to access and interpret in any way desired, these high-level languages constrained the programmer to naming storage locations (*variables*) and to declaring the type of data that would be stored there. This step simultaneously restricts the freedom of the programmer to maneuver around the data and imposes a layer of organization (structure) on the data (and hence the program).

The next element to come under

the scrutiny of the language designers was the GOTO statement, which seemed to crop up time and again in the more horrendous programming errors. The elimination of GOTO statements gave rise to structured programming, in which programs are built up by means of a set of well-defined constructs designed to ensure a rational and predictable flow of control. Another feature on the blacklist was global data, with its insidious side

effects. A new style of programming was developed—modular programming, which restricts programmers to working on small, manageable sub-problems and passing all data explicitly between modules. When a problem arises, the offending module can be identified and the effects of the error rapidly traced.

Both structured and modular programming philosophies lend them-

(continued)

## DECLARATIVE LANGUAGES GLOSSARY

**APPLICATIVE LANGUAGE:** Synonym for "functional language." Often used loosely for any declarative language.

**COMBINATORICS:** A system for reducing the operational notation of a functional language to a sequence of modifications to the input data structure. All combinators can be defined from two basic combinators—S, which distributes a term throughout an expression, and K, which cancels a term from an expression.

**DATA-FLOW ANALYSIS:** The order of execution in a data-flow language is determined solely by dependencies between different data. Data-flow analysis is the analysis needed to determine those dependencies. For example, given

1.  $X = A + B$
2.  $B = 2 + 2$
3.  $A = 3 + 4$

a data-flow analysis would find that "A + B" in line 1 requires that lines 2 and 3 be evaluated before line 1. Since there are no data dependencies between lines 2 and 3, they may be executed in parallel.

**DECLARATIVE LANGUAGE:** A general term for relational languages and functional languages, as opposed to imperative languages. Imperative languages specify procedures for solving problems, while in declarative languages you specify what kind of solution you are seeking. For example, to find the cube of 7 in an imperative language, you might initialize CUBE to 1, and then let CUBE equal CUBE times 7

(repeat 3 times). In a declarative language, you would define what cube means and then ask what the cube of 7 is.

**FUNCTIONAL LANGUAGE:** A functional language consists of, reasonably enough, functions and arguments to those functions that uniquely identify the program output. For example, plus(4,5) returns 9 and only 9. Hope and FP are examples of functional languages.

**LAZY EVALUATION:** If an expression is evaluated only when some other expression needs its output, the mode of evaluation is called "lazy." If expressions are evaluated as soon as possible, without regard to whether anything else needs the results, the evaluation strategy is termed "eager."

**NEGATION BY FAILURE:** An extralogical feature of Prolog in which failure of unification is treated as establishing the negation of a relation. For example, if Ronald Reagan is not in our database and we asked who the President of the United States is, Prolog would answer that there is no such person.

**REFERENTIAL TRANSPARENCY:** A program is referentially transparent if it prohibits assigning different values to the same named variable during the same run. Functional languages achieve this by using only named constants whose values are passed as data at run time. Relational languages (q.v.) permit the use of variables but require the program to be, in effect, rerun for each different value returned.

**RELATIONAL LANGUAGE:** Relational languages specify output in terms of some property and an argument. For example, if Tom has two brothers, Dick and Harry, a relational language will respond to the query "Who is brother (Tom)?" with either Dick or Harry. Notice that, unlike functional languages, relational languages do not require a unique output for each predicate/argument pair. Prolog is the best-known relational language.

**SIDE EFFECTS:** Statements that modify what was previously in a computer rather than simply adding more to what is already there are said to have side effects. For example, "X=X+1" produces side effects. In particular, a statement such as "IF X=2 THEN Y=0 ELSE Y=1" will evaluate differently at different stages in a program's execution. Side effects make parallel processing difficult.

**TRANSFORMATION:** The systematic development of efficient programs from high-level specifications by meaning-preserving program manipulations.

**UNIFICATION:** The generalization of pattern matching that is the Prolog equivalent of instantiation in logic. For example, to find the smallest even number larger than 7 that is a perfect square, Prolog would search its "database" of numbers, trying to satisfy the necessary relations between the desired number and 2, 7, and an unspecified integer that is its square root. On coming to 16, the necessary set of relations would be "unified."

# THE ADVANTAGES OF BEING IN THE RED.

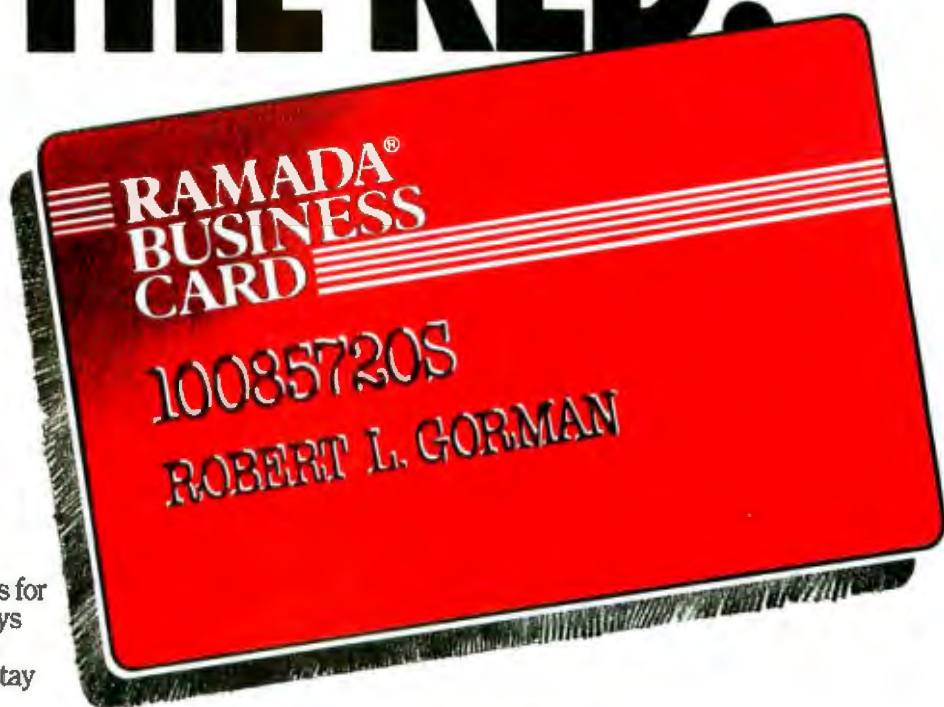

- Earn free airfare and lodging faster.
- Preferred room rates.
- Automatic upgrade when available.
- Bonus Dividend Points for Fri., Sat. and Sun. stays through August 25th.
- Spouse and children stay free in same room.
- 25% Bonus Dividend Points with Hertz.
- 25% Bonus Dividend Points with Eastern Airlines.
- Bonus Dividend Point for joining now.

No other preferred business traveler program gives you more. Membership begins immediately when you fill out an applica-

tion at any of over 500 Ramada locations. Or, if you prefer, simply send us your business card and we'll send you ours. Just mail to: Ramada Response Center, P.O. Box 4500, Woburn, MA 01888.

The Ramada Business Card. You'll come out ahead when you're in the red. Call 1-800-2-RAMADA for reservations.

## NEXT TIME, RAMADA

Ramada Inns, Hotels and Renaissance Hotels 1-800-2-RAMADA

© Ramada Inns, Inc., 1985

selves to an improved correspondence between the specification of a problem (a concise but exhaustive statement of what the program will be expected to do under all circumstances) and the program's final realization (the code running on a given hardware configuration). Nevertheless, this correspondence is usually not rigorous in the sense that no one tends to take the trouble to go through the program actually proving that each module does its job correctly and then passes its results to the right receiving modules in the correct form, even though painstaking mathematical techniques generally exist to do this.

The second startling finding to come out of the research into programmer productivity is that, in the average commercial programming environment, as much as 50 percent of a programmer's effort goes into pro-

gram maintenance, that is, updating the program's performance to meet circumstances not envisaged when the program was originally specified or hunting for deep-seated bugs. Since deep-seated bugs are simply places where the program, as written, diverges from its original specification, a major improvement in efficiency can be gained from improving the precision of program specifications so that the program can be tied more tightly to its specification. If no specification was produced initially, the maintenance programmer must try to deduce what was intended by examining code that is known to be incorrect.

Making a specification more precise means searching for ways to make unambiguous statements about what the program should achieve. Because the most unambiguous language is that of mathematics, the trend has

been toward more mathematical and provable methods of description. By the same token, tying program code to specifications implies not only a trend toward still higher level languages but also toward the use of mathematical methods of proof applied to actual fragments of code. This serves to demonstrate both that the code will have a predictable outcome under all circumstances, rather than those circumstances selected experimentally during testing, and that the outcomes match those called for in the specification.

One noteworthy barrier that prevents the programmer from using reasonably straightforward mathematics for exploring possible solutions to a problem or for testing existing code is the familiar assignment operation. Programmers use the word variable to refer to a named storage location that can be modified by means of assignment statements. Therefore, in order to know what such a variable stands for, it is necessary to know the precise point in the program's execution at which the inquiry is being made—and each variable has a computational history that charts its changing values throughout the program's execution. By contrast, a declarative-language term has a definite value. If that value has not yet been computed, it is simply unknown—it is not some other value. This property is known as *referential transparency*.

In order to make a piece of code amenable to mathematical analysis, it is necessary to free terms from the burden of their computational histories—which means restricting the extent to which programmers may assign values to a term. Languages with referential transparency are known as declarative languages because, without assignments, programmers can declare only what effects should produce what outcomes rather than prescribe the manner and especially the sequence in which processing should occur (these languages are called imperative). Consequently, apart from stabilizing variables so that finite mathematical techniques can be

(continued)

# INSIGHT™

## EXPERT SYSTEMS

"INSIGHT is essentially the equivalent or better than any other tool available for the personal computer."

Paul Harmon, author of *Expert Systems, Artificial Intelligence in Business*

Turn your PC into an expert.

**Give it Insight, or give it Insight 2.** Both let you create knowledge base systems using any PC-compatible text editor.

Insight not only simplifies access to lots of information, it analyzes and offers solutions. For entry-level operators it's a perfect procedural training package to help build and implement knowledge base software.

**Insight 2 is more than just an "expert."** It's a knowledge base engineering tool with application capabilities. It can call up Pascal programs, read and write dBASE II® files, and its decision-making process can tie in directly to your existing databases. Run-only versions also can be developed and distributed.

**Two unique packages from the same expert idea.**



**Level Five Research, Inc.**

Insight™ (\$95) and Insight 2™ (\$485) run on the IBM® PC, DEC® Rainbow, and Victor® 9000.

4980 South A-1-A
Melbourne Beach, Florida 32951
(305) 729-9046

# Pure and simple ... it's our business to help your business.

## PC PROGRAMMERS CORNER

<b>Borland</b>	
Turbo Pascal.....	\$ 37
<b>CompuView</b>	
Vedit .....	\$130
Vedit+ .....	179
<b>Digital Research</b>	
<i>Please call for prices and available products.</i>	
<b>Emerging Technology</b>	
Edix (editor).....	\$139
<b>Heritage</b>	
Smartkey II+ .....	\$ 75
<b>Microsoft</b>	
C Compiler .....	\$319
Pascal Comp .....	199
Basic Comp.....	249
<b>Morgan Computing</b>	
Prof Basic.....	\$ 79
Trace 86 .....	99
<b>Peter Norton</b>	
Norton Util 3.0.....	\$ 59
<b>Supersoft</b>	
Fortran.....	\$209

## IBM/PC SOFTWARE

<b>Anderson Bell</b>	
Abstot .....	\$289
<b>Ashton-Tate</b>	
dBase II .....	Call
dBase III (v. 1.1).....	Call
Framework (v. 1.1) .....	Call
Friday .....	Call
<b>Central Point</b>	
Copy II PC.....	\$ 34
<b>Connecticut Software</b>	
Printer Boss	
NEW v. 5 .....	\$ 99
<b>Dow Jones</b>	
Market Manager +.....	\$169
<b>Ecosoft, Inc.</b>	
Microstat.....	\$239
<b>Enertronics</b>	
Energraphics.....	\$219
w/ Plotter Option.....	279
<b>Fox &amp; Geller</b>	
Grafox .....	\$159
dGraph .....	159
Quickcode (III or II)....	159
Quick Report .....	159
dUtil (III or II).....	58
Quickcode.....	159
Quickreport.....	159
<b>Harvard Software</b>	
Total Project Mgr .....	\$279
<b>Lifetree</b>	
Volkswriter Deluxe.....	\$155
Volkswriter Scientific..	299

## MDBS

Knowledge Man.....	\$275
<b>Micropro</b>	
Wordstar ProPak.....	\$255
Wordstar 2000 .....	255
Wordstar 2000+ .....	295
<b>Microrim</b>	
R-base 4000.....	\$265
R-base Clout (V 2.0)....	159
R-Writer.....	95
Prog Interface .....	259
<b>Microsoft</b>	
Flight Simulator.....	\$ 39
Project 1.01.....	169
Word 1.15.....	229
MuMath/MuSimp .....	179
<b>Microstuf</b>	
Crosstalk.....	\$ 99
<b>Northwest Analytical</b>	
Statpak .....	\$329
<b>Open Systems</b>	
Acct'g Programs ..ea	\$379
<b>Samna Corp.</b>	
Samna Word III.....	\$329
<b>Sensible Designs</b>	
d Programmer.....	\$199

## APPLE SOFTWARE

<b>Alpha Software</b>	
Apple-IBM	
Connection .....	\$169
<b>Dow Jones</b>	
Market Analyzer .....	\$229
Market Manager.....	189
Spreadsheet Link.....	179
<i>Plus many more... PLEASE CALL!</i>	

## CP/M SOFTWARE

All prices below are for 8" standard.	
<b>Ashton-Tate</b>	
dBase II .....	Call
<b>Digital Research</b>	
<i>Please call for prices and available products.</i>	
<b>Infocom</b>	
All Games.....	Call
<b>Micro Pro</b>	
Pro-Pak.....	\$359
<b>Microstuf</b>	
Crosstalk.....	\$ 99
<b>Northwest Analytical</b>	
Statpak.....	\$365
<b>Supersoft</b>	
Disk Doctor.....	\$ 74

## APPLE BOARDS

<b>ALS</b>	
CP/M Card .....	\$269
Smarterm II.....	119
Z-Engine .....	139
<b>CCS</b>	
7711 Asynch Serial.....	\$ 99
<b>Microtek</b> .....	Call
<b>Orange Micro</b>	
Grappler + .....	\$119
<b>Prometheus</b>	
Versocard.....	\$159

## IBM/PC BOARDS

Memory Chips..... Call

<b>AST Research</b>	
Six Pak + .....	\$265
<b>Orchid Technology..</b>	Call
<b>Quadram</b>	
Quadboard 384K	
w/ 64K.....	\$255
Other Products.....	Call
<b>Tecmar</b> .....	Call

## MODEMS

<b>Hayes</b>	
Smartmodem 300.....	\$159
Smartmodem 1200 .....	399
Smartmodem 1200B... ..	369
Smartmodem 2400 .....	Call
<b>US Robotics</b>	
S-100 Modem.....	\$349
Password M or F.....	325

## MONITORS

<b>Amdak</b>	
300A Amber .....	\$149
310A .....	Call
<b>PGS</b>	
HX12 RGB Clr.....	\$479
MAX 12 .....	179
SR12 (690 x 480 Res)...	639
Doubler Card.....	175
<b>Quadram</b> .....	Call
<b>Zenith</b> .....	Call

## PRINTERS

<b>C. Itoh Electronics, Inc.,</b>	
Diablo, Epson, NEC,	
Okidata, Quadram,	
Star Micronics.....	Call

## PC Jr ACCESSORIES

<b>KeyTronic</b>	
KB 5151 Jr .....	\$173
KB 5149 (Numeric	
Keypad) .....	89
<b>Quadram</b>	
Quad Jr .....	
Exp Chassis .....	\$479
Quad Jr Exp Mem	
(for Chassis) 128K.....	\$199
<b>Tecmar</b>	
Jr. Captain.....	\$319

## DISK DRIVES

FULL HEIGHT —  
CDC, Tandon  
HALF HIGH..... Call

**HARD DISKS —**  
Corvus, Davong,  
I-Omega Bernoulli Box,  
Maynard Electronics,  
Mountain, Inc .....

## MISC.

<b>Hauptpage</b>	
8087 w/o software ....	\$149
80287 AT Chip	
w/o .....	269
<b>Kensington</b>	
Masterpiece.....	\$109
<b>Keytronic</b>	
KB 5150 .....	\$169
KB 5151.....	169
KB 5151 Dvorak.....	173
<b>Touchtone Technology</b>	
Touchtone II	
(PC Keypad).....	\$169

**This is only a sample of the nearly 10,000 products we carry. If you're interested in something that is not listed, PLEASE CALL!**

## POLICY:

- ▶ Wisconsin residents add 5% for sales tax.
- ▶ Minimum \$4.00 for shipping, handling and insurance for orders to \$200.
- ▶ For orders over \$200, add 2½% for shipping, handling and insurance.
- ▶ For cash prepayment of orders \$200 or more, add ONLY 2% for shipping, handling and insurance.
- ▶ Prices are subject to change without notice.
- ▶ All items subject to availability.

BYAD 0885

## WE WELCOME:

- ▶ Visa, MasterCard and American Express. (No charge for credit cards.)
- ▶ Corporate, government, educational or volume purchasers, please ask for special accounts desk for additional discount.
- ▶ COD (Add \$2.00 per box/parcel. Cash or certified check required.)
- ▶ Checks. (Allow 1-2 weeks for clearing.)

## INTERNATIONAL POLICY:

We welcome foreign orders. Shipping and handling charges per order are actual shipping costs plus \$50. international handling fee. Canadian orders — please call.

## WORKING HOURS:

Monday-Friday 8:30-6:00 ; Saturday 10:00-2:00 ; Central Time  
Technical Support/Order Status/Customer Service:  
Call (715) 848-1374.

# 1 800 826-1589

WITHIN WISCONSIN **1 800 472-3535**

INT'L TELEX: 260101 ORYX SYS WAU

## ORYX SYSTEMS, INC.

CRAFTSMEN OF THE NEW TECHNOLOGY

425 First St. • P.O. Box 1961 • Wausau, WI 54401

# Mac Inker

Re-ink any fabric ribbon **AUTOMATICALLY** for less than 5¢. Extremely simple operation with built-in electric motor. We have a **MAC INKER** for any printer: cartridge/spool/harmonica/zip pack. Lubricant ink safe for dot matrix printheads. Multicolored inks, uninked cartridges available. Ask for brochure. Thousands of satisfied customers.

\$54.95 +



# Mac Switch

**Mac Switch** lets you share your computer with any two peripherals (serial or parallel). Ideal for word processors—never type an address twice. Ask us for brochure with tips on how to share two peripherals (or two computers) with **MAC SWITCH**. Total satisfaction or full refund.

\$99.00

Mac Switch

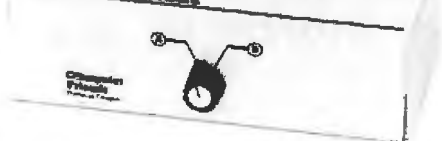

Order toll free 1-800-547-3303

## Computer Friends

6415 SW Canyon Court  
Suite #10  
Portland, Oregon 97221  
(503) 297-2321

## OVERVIEW

applied to code fragments, referential transparency serves to remove the flow mechanisms (specifically, sequencing and loops) from explicit mention in the code. This in turn allows for the possibility of parallel processing: since any function in a program can be executed whenever all its inputs exist, rather than when the programmer decides that the processor is available for this purpose, there is no reason why a program cannot be spread over a collection of processors so that each function can get its own processor or share one with a small subset of the whole program.

Referential transparency has other implications for the declarative languages. Since the unknown terms in any expression are simply unevaluated function calls that become known as the function code is executed, one effect is to blur the distinction between functions (code) and terms (data). This leads to the idea of *higher-order functions*, which are implemented in most declarative languages. These functions are capable of accepting as arguments, and also of returning, other first- and higher-order functions so that the programmer can structure and manipulate functions and data with equal facility.

Static data structures such as arrays necessarily have computational histories. They must therefore be replaced in declarative languages by dynamic data structures where memory for an item is allocated only when that item comes into existence. Some imperative languages such as Pascal and C implement these structures rather primitively by means of *pointers* that require the programmer to reference memory locations explicitly. In declarative languages, dynamic structures are treated in more abstract terms (for example, as *lists*). Lists serve to bring code and data together even more closely since they incorporate implicit operations (or functions) for including components in the structure (*constructors*) and for extracting components from the structure (*selectors*). What follows is a brief description of a representative sample of declarative languages, showing some of the dif-

ferences in approach, mathematical paradigms, and syntax.

### PURE LISP

LISP stands for "list processing." It is by far the oldest of the declarative languages, having been designed by John McCarthy at the Massachusetts Institute of Technology in 1960. Numerous imperative features are incorporated into different versions of the language so that most LISP programs are not actually declarative, but a large enough subset (Pure LISP) allows declarative programming to be done. (Peter Henderson of Stirling University in Scotland has a system called Lispkit, which is fully declarative.) LISP has more different dialects than any other declarative language. Since it is the most mature of the declarative languages, a large range of software tools and custom-designed hardware is available. MIT's MacLISP will be used in our programming example.

Data structures in a LISP program are constructed from atoms; an atom is either a numeral or a literal string. Although some LISPs have other data structures, the only standard data structure is the list. Lists need not contain homogeneous elements because LISP is an untyped language. Types are actually determined at run time. For example,

```
( A 1 (ABC 123) )
```

is a list containing three elements. Access methods built into the language include selector functions (*car* and *cdr*), constructor functions (*list* and *cons*), and a predicate (*null*) to test for an empty list.

Not only is a LISP data structure a list, but programs are lists as well. Therefore, a list can be executed and will return a value, or it can be used as an argument for another program. Higher-order functions are implemented through a device called the lambda expression, which enables a LISP programmer to define and manipulate functions as data objects. The basic unit of a LISP program is the expression (compared to the statement

(continued)

# STATGRAPHICS®

## ONE KEYSTROKE TURNS LIFELESS DATA...



Date Updated: 02/01/88      Data Editor      Maximum Row: 100  
Number of Cols: 9

Row	X	Y	z	z	z	z	z	z
1	42.1	1991	1	16.1	2.819	42000		
2	36	1985	1	16.2	2.823	29000		
3	32.8	1985	1	16.3	2.795	84000		
4	38.4	2000	1	16.2	2.721	11800		
5	36.7	1993	1	16.1	2.948	18200		
6	19.9	1799	1	16.2	2.282	46000		
7	29.2	1970	1	16.2	2.212	11000		
8	16.2	3000	1	16.1	2.822	16000		
9	31.8	1989	1	16.2	4.261	78000		
10	39.2	2000	1	16.2	3.822	21000		
11	25.2	1980	1	16.2	1.794	12000		
12	25.7	1700	1	16.7	2.712	22700		
13	25.3	1400	1	16.7	2.541	14700		
14	19.4	3000	1	16.2	2.413	26000		

Length: 48    W: 100    H: 100    X: 100    Y: 100  
Type: M    M    M    M    M    M    M    M    M

Cursor at Row 1      and Column 1

\*HELP \*SCALE \*SORT \*SORT \*SORT \*SORT \*SORT \*SORT \*SORT \*SORT  
INPUT \*FN \*MAX \* MIN \*MAX \*MIN \*VERSION 1.0    REC OFF

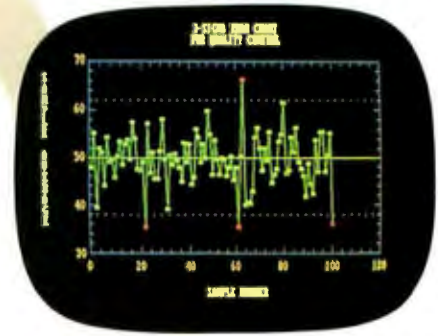
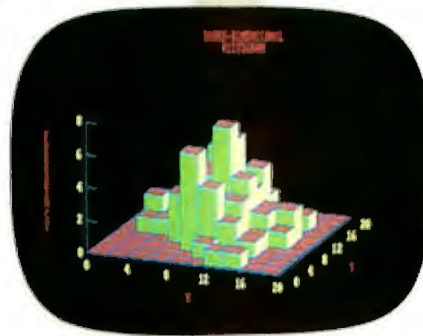
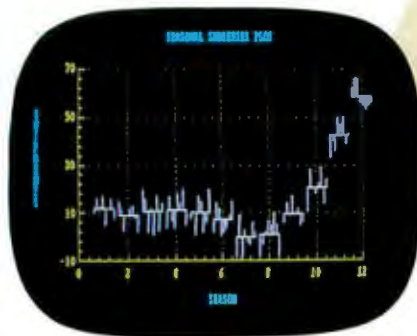
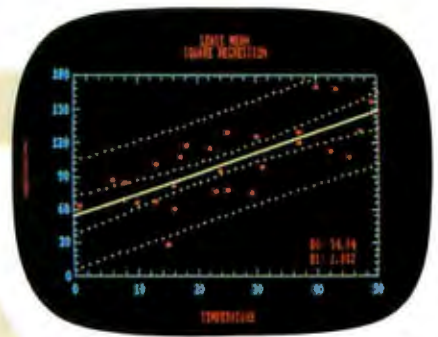

## INTO VITAL STATISTICS.

Data. You live with it every day. What you need are the tools to make it come alive. Comprehensive analytical tools. Mathematical precision. And graphics capabilities to broaden your insights—to help you visualize, analyze, and communicate your findings quickly and convincingly.

And now you've got it. With STATGRAPHICS—a new PLUS\*WARE™ product from STSC. STATGRAPHICS is the only PC software to fully integrate a wide variety of statistical functions with high-resolution color graphics. Giving you the power and precision you used to find only with mainframe software.

STATGRAPHICS' unique interactive environment allows you to generate graphs from within the statistical procedures. You can change a variable and see the effect—immediately. So your job is easier and you're more productive.

### MORE OPTIONS FOR MORE COMPREHENSIVE ANALYSIS.

STATGRAPHICS features over 250 functions for analyzing data—including analysis of variance, regression analysis, experimental design, quality control procedures, multivariate techniques, nonparametric methods, and extensive forecasting and time series analysis.

It also lets you enter data at the keyboard or access data stored in standard ASCII files, LOTUS® 1-2-3 worksheets, and DIF files used by other popular software packages.

### TELL A CLEARER, MORE DRAMATIC STORY.

STATGRAPHICS includes a wide variety of graphics programs such as two and three-dimensional line and surface plots, bar and pie charts, histograms, time sequence plots, and quality control charts.

The graphics are supported on color and monochrome graphics boards, dot-matrix printers, and pen plotters for presentation quality graphics.

### SOPHISTICATED STATGRAPHICS IS SURPRISINGLY SIMPLE TO USE.

STATGRAPHICS is completely menu-driven, and includes a comprehensive user's guide, online HELP screens, tutorial, and handy reference card. And STSC's HELP-Line is only a phone call away—giving you ready access to our staff of technical experts.

### TAKE A LOOK AT STATGRAPHICS.

### AND LOOK NO FURTHER.

STATGRAPHICS is the most advanced statistical graphics software available for PC's. And the complete system is just \$695.

To order STATGRAPHICS, or for more information, contact your local dealer or call 800-592-0050 (in Maryland, 301-984-5123). Or write STSC, Inc., 2115 E. Jefferson St., Rockville, MD 20852. Major credit cards accepted.

**Problem-solving at the speed of thought.**

# THE ORIGINS OF LOGIC PROGRAMMING

BY ROBERT KOWALSKI

*Prolog attempts to solve subproblems in the order in which they are written.*

Logic programming owes its origins to the development of logic in general and to advances in mathematical logic in particular.

In the early 1950s, computationally inclined logicians began to investigate techniques for automating the proofs of mathematical theorems. They reduced the problem to the subproblems of expressing the axioms of mathematics in symbolic logic and of mechanizing the process of logical deduction.

Two developments in mechanical theorem proving took place in the mid-1960s that are significant for the development of logic programming. Alan Robinson developed the resolution rule of inference, and Donald Loveland developed the model-elimination proof procedure. These two theorem-proving methods, expressed in completely different notations, appeared for many years to be entirely unrelated. In 1970-1971 Donald Kuehner and I showed that model elimination and a form of resolution (called *linear resolution*) could be viewed as variants of one another. We developed a synthesis of the two methods, which we called SL-resolution. Independently, at about the same time, Donald Loveland and Raymond Reiter developed similar theorem-proving methods.

In 1972, after a period of collaboration between Alain Colmerauer in Marseille and me in Edinburgh, Colmerauer, with Phillippe Roussel, designed and implemented Prolog as a development of SL-resolution. By the summer of 1972 in Marseille a significant French-language question-answering system had already been implemented in Prolog. Collaboration between Edinburgh and Marseille continued with the support of research grants until about 1975.

A number of research developments outside mechanical theorem proving

involved the exploration of related ideas. The most important of these was the work of Cordell Green, Carl Hewitt, and Pat Hayes.

In the late 1960s, Cordell Green at Stanford showed how to formulate programs in symbolic logic and *simulate* their execution with resolution theorem proving methods. This work was frustrated by the redundancy and inefficiency inherent in the resolution theorem provers of that time.

Partly inspired by Cordell Green's problems, Carl Hewitt at MIT developed a procedural theorem-proving language, Planner. The new language had a great influence on the field of artificial intelligence and was interpreted as advocating a procedural rather than a declarative approach to knowledge representation. It was also associated with an advocacy of domain-specific problem-solving methods in contrast to the uniform, general-purpose problem-solving methods of resolution.

Pat Hayes in Edinburgh attempted to reconcile Cordell Green's advocacy of logic with Carl Hewitt's advocacy of procedural knowledge representation. Hayes argued in quite general terms that computation is controlled deduction and that control itself should be expressed in formal logic.

In addition to these developments, Colmerauer was influenced by his previous work in formal language theory and natural-language processing. During his work on French-English

mechanical translation at the University of Montreal in the late 1960s, he developed a form of grammar, the Q-system, which foreshadowed the treatment of grammars in Prolog.

## THE FALLIBLE GREEK

In his influential Ph.D. thesis on natural-language understanding, Terry Winograd advocated the use of Carl Hewitt's Planner. He illustrated programming in Planner with his example of the Fallible Greek. We can use the same example to illustrate programming in Prolog. Suppose we make the following assumptions, in the following order:

Turing is human	FG1
Socrates is human	FG2
Socrates is Greek	FG3
x is fallible if x is human	FG4

Suppose we have to solve the problem of finding a fallible Greek and suppose the subproblems are written in the following order:

*y is fallible and y is Greek?* Q1

Prolog (like Planner) attempts to solve subproblems in the order in which they are written. In this case it matches the first subproblem to the conclusion of the rule FG4 and replaces the subproblem by the condition of FG4, obtaining the new subproblems

*y is human and y is Greek?* Q2

Again, working on the first subproblem, Prolog tries the first statement whose conclusion matches (like Planner). In this case it matches the subproblem to the conclusion of FG1. There are no conditions in FG1, so it solves the subproblem without introducing any new ones, leaving the remaining subproblem with *y = Turing*:

*Turing is Greek?* Q3



But this subproblem is unsolvable because it matches the conclusion of no statement. Therefore, Prolog (like Planner) backtracks to the last state where it could have tried to solve a subproblem differently. In this case it backtracks to the state Q2, where it tries to use the next statement, FG2, whose conclusion matches the subproblem. Like FG1 before it, FG2 has no conditions, leaving the remaining subproblem, this time with the substitution  $y = Socrates$ :

*Socrates* is Greek? Q4

Prolog now solves the single remaining subproblem in the only possible way by matching it with the conclusion of FG3. Since FG3 has no conditions, there are no new subproblems. Since there are no old subproblems either, Prolog (like Planner) is finished, having successfully solved the original problem. Moreover, the substitution

$y = Socrates$

can be readily extracted from the "proof":

Notice that a more intelligent problem solver, having reached state Q2, might recognize that the database contains more ways of finding humans than it contains ways of finding Greeks. It would make sense, therefore, to tackle the subproblem that can be solved in fewer ways first:

$y$  is human and  $y$  is Greek? Q2'

The second subproblem can be solved in only one way, using FG3, which leaves the subproblem

*Socrates* is human? Q3'

But this can be solved only by using FG2, which completes the solution of the original problem without any search.

Such intelligent selection of subproblems is a feature of most database-query optimizers. It is necessary for more intelligent problem solving, but it involves overheads that may be prohibitive for routine program execution.

in most imperative languages), and every LISP construct computes a value. Recursion is the only control mechanism.

As an example of a LISP program, the function shown in listing 1 will calculate the length of a list, 1. This program works on a list in which each element can be of any type. In English it says: Length is a function that takes a list as its only argument. If the list is empty, the number 0 is returned; otherwise (represented by the `t`), the length of the list is one more than the length of the list without the first element.

Listing 1: An example of a LISP program.

```
(defun length (l)
  (cond (( null l) 0)
        (t (add1 (length (cdr l)))))
```

Listing 2: An example of a Prolog program.

```
( ) has-length 0
(x|X) has-length z if
  X has-length y and SUM (y 1 z)
```

**PROLOG**

Prolog stands for "programming in logic." (See the "Origins of Logic Programming" text box at left.) Since 1972, several implementations (Marseilles, Edinburgh, Imperial College, and Waterloo, among others) have appeared, each with a different syntax. Preprocessors written in Prolog are available to make programs more readable. In this article, the syntax used is Imperial College's micro-PROLOG with the Simple preprocessor.

Unlike other languages in which programs are formed out of collections of functions, a Prolog program consists of a sequence of relations (assertions) and rules about a subject. These form a database of information that can be queried or added to. Examples of assertions are

```
is-functional( Hope )
is-logic( Prolog )
```

An example of a rule is

```
x is-declarative if (either x is-
functional or x is-logic)
```

Notice the rule has a variable,  $x$ . Prolog variables have scope only in the statement where they are defined. The left-hand side of a rule is termed a *goal* and the right-hand side the *subgoals*. To reach a goal, the subgoals must be reached. When the subgoals cannot be reached, Prolog backtracks and searches for another statement that matches an earlier subgoal. This type of logic is called Horn clause logic.

A Prolog query can be used either to discover a fact or to check whether it is true, a feature called *invertibility*. For example, from the relation `TIMES(x y z)`

```
all (x: TIMES( 4 3 x ))
```

can be used for multiplication, while

```
all (x: TIMES( 4 x 12 ))
```

can be used for division. Note that Prolog acts as though arithmetical operations were database queries.

Prolog supports the list structure. Finally, to enable programs to be written in small, self-contained, testable chunks, Prolog has modules with import and export lists containing names of relations.

As an example of a Prolog program, the relations shown in listing 2 will calculate recursively the length of a list in which each element can be of any type.

The LISP program uses the conditional `cond` to distinguish between alternative forms of the list (i.e., an empty list or a nonempty list). In this example, rather than referring to the list symbolically by name, the two cases are represented explicitly by the *patterns* `( )` (the empty list) and `(element | sublist)`. Instead of using a conditional, the program is expected to make the appropriate selection by *matching* the actual list against the possible patterns. In general, constructor and selector functions (in this case, `( )` and `| )` are used to form a set

(continued)

**Internal 20 Meg \$599**  
**External 20 Meg \$749**



The affordable PC20 hard disk system is one of the most IBM compatible setups around--you'll be able to boot directly from the quiet, 3-1/2 in. drive. This highly reliable and rugged drive uses plated media. Our free software lets you get the most out of your hard disk--1dir organizes directories with a visual shell that speeds operation and frees you from the intricacies of DOS commands. And our exclusive 5-1/4 in. controller fits into a short slot--perfect for computers like the Tandy 1000, Panasonic Sr. Partner, and IBM Portable PC. PC20 comes complete with a low power drive, controller, bezels, cables and illustrated instruction manual.

Inquiry 263

**HR31 200 RGB Color**  
**(.31mm) Monitor \$399**



Assembling your dream machine? Start with a high resolution (.31mm dot pitch--28% finer than IBM's) RGB monitor at a price hundreds less than Princeton's. A black matrix picture tube (large 14 in. diagonal) provides for brilliant colors and reduces screen glare. HR31 200 plugs into an IBM color/graphics adapter (640 x 200) card. And you'll pay no extra for our tilt and swivel base.

Inquiry 264

**QUBIE'**

Inside California  
 (805) 987-9741

Outside California  
 (800) 821-4479

*FP stands for  
 functional programming  
 and was designed by  
 John Backus of IBM  
 and described in his  
 Turing Award  
 lecture in 1977.*

of patterns that distinguish between different cases pertinent to a particular problem. In English it says: The empty list has a length of zero, and the list that starts with the element  $x$  followed by the list  $X$  has the length  $z$  if the list  $X$  has the length  $y$  and  $z = y + 1$ .

#### FP

FP stands for "functional programming." The language was designed by John Backus of IBM and described in his Turing Award lecture in 1977. At first glance, FP shows the influence of APL in its syntax (APL without any variables).

Backus's claim is that programmers tend to manipulate data rather than functions, starting with input data and putting this through a series of functions until the required output data is reached. In the FP style of programming, primitive functions are combined in such a way as to produce a final function, the program. This is then applied to the input data to produce the output--hence, no variables are required.

FP programs map single objects onto each other; a single object is either an atom (integers or finite strings of uppercase letters) or a sequence of atoms. FP's atoms and sequences are comparable to LISP's atoms and lists. Primitive functions provided by FP include arithmetic and sequence operations, a set of predicates, and APL's iota operator for producing the first  $n$  integers.

The following are ways of combining functions (the *combining forms*):

1. *Composition*—written as  $f \circ g$ . Given two functions called  $f$  and  $g$ ,  $f \circ g$  is the function obtained by first applying  $g$  to the argument of the function and taking the result of this function as the argument of  $f$ .
2. *Construction*—written as  $[f_1, f_2, \dots, f_n]$ . Creating a sequence of  $n$  elements whose  $i$ th element is obtained by applying  $f_i$  to the input.
3. *Conditional*—written as  $p \rightarrow f;g$ . If the predicate  $p$  is true, apply  $f$  to the argument; if  $p$  is false, apply  $g$ .
4. *Apply to all*—written as  $\alpha f$ . Create a sequence of the same length as the input sequence by applying  $f$  to each element of the input data.
5. *Insert*—written as  $I f$ . Apply  $f$  to the sequence formed by the first element of the input data followed by  $I f$  applied to the rest of the input sequence. This function is illustrated in the sample program, where  $f = +$ .  $A+$  is inserted after the first element and between all subsequent entries.

The FP style of programming is not explicitly recursive like the other declarative languages because recursion is implicit within the combining forms.

As an example of an FP program, the following returns the length of a list:

```
def length = I+ o αT
```

This program works on a sequence in which each element can be of any type. Notice the absence of variables. In English it says: Treat each element of the sequence as a 1 and add them up.

**HOPE**

Hope (named after Hope Park Square, home of the University of Edinburgh's Department of Computer Science) was designed by Dave MacQueen of Bell Labs and Rod Burstall and Don Sannella of the University of Edinburgh. It is one of several *recursion-equation* languages, in which each function is represented by a set of equations that together will provide a

(continued)

# BT60 Streamer \$895 The Stack \$999

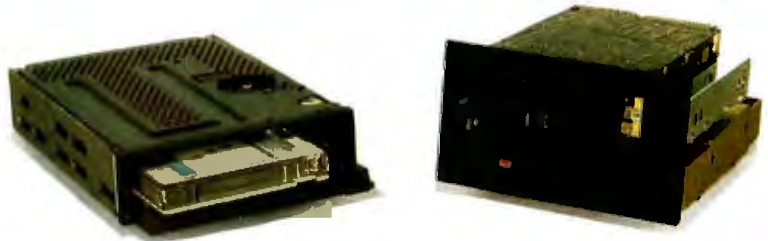

Don't suffer the loss of losing data. **BT60 Streamer** uses a half-height streaming cartridge tape unit that runs on a 5-1/4 in. controller card. Menu-driven software makes it easy of use. Copies up to 60 Megs on one tape at an amazing 5 Megs per minute! Recommended for systems with at least 130 watt power supplies. **The Stack** includes our **PC20** internal hard disk system and the **BT/SP10** tape backup system. **BT/SP10** plugs into the floppy controller card--no extra slot needed--and is accessed like a floppy. It uses spools of tape (\$12.95 each or 6 for \$59.95) that hold up to 10 Megs each. Software provided allows you to back up the **PC20**.

Inquiry 265

# HR 134 (Amber) \$149 HR 39 (Green) \$139



Looking for an exceptional value on a high resolution monochrome TTL monitor? Our models offer super crisp text and graphics capabilities (720 x 348 resolution) and plug into an IBM monochrome (or compatible graphics) adapter card. Both the **HR 134** and **HR 39** have 12 in. diagonal screens, IBM-matched color styling and include a tilt and swivel base.

Inquiry 266

# QUBIE'

Inside California  
(805) 987-9741

Outside California  
(800) 821-4479

# AT Enhancement Kit (ATK-1) \$1595

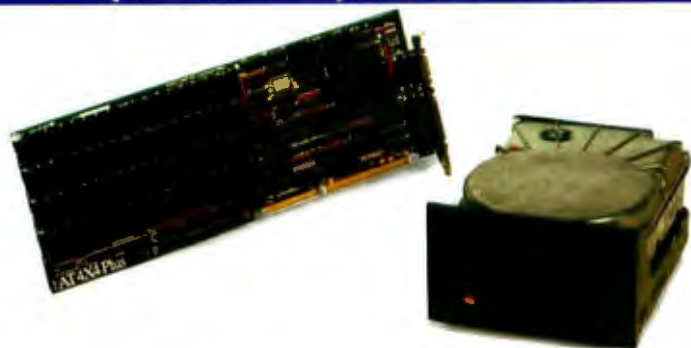

Our AT enhancement kit is the best way to turn your Basic AT into an enhanced version--and then some! By adding the Basic Time AT4X4Plus with 512K of memory to your system, you'll have 640K of contiguous memory with 128K above 1 Megabyte (double split memory addressing) for use with VDISK. AT4X4Plus comes standard with a serial and parallel port. Up to 4 Megabytes of memory, three more serial ports and a game port are optional. The 44 Meg (as opposed to a 20 Meg) hard disk is a high-speed voice-coil-driven model with a 30 ms. average access time.

Inquiry 267

# BT6Plus 64K \$179 BT6Plus 384K \$279



Simply, the best deal on a PC multifunction board--bar none. Basic Time's six function board, the BT6Plus, includes memory sockets for adding 64K to 384K, parallel printer port, asynchronous (RS-232C) serial communications port, battery-powered clock/calendar and electronic disk emulation & print spooling software. Optional game port. Comes complete with an easy-to-understand installation instructions/user's manual.

Inquiry 268

## QUBIE'

Inside California  
(805) 987-9741

Outside California  
(800) 821-4479

result for the whole range of function arguments. A program is simply a hierarchy of these functions, together with a single invocation of the highest-level function.

Hope lets the programmer define specific or *polymorphic* data types that are checked by the compiler. Polymorphic types allow for the creation of functions that can be applied to more than one type of data (for instance, a routine that can sort numbers, characters, strings, or records). The data types num (positive integer), truval (Boolean), char, list, and set are predefined and can be used to build up more sophisticated data structures by means of type variables and data statements.

Constructor functions, defined when the data structure is defined, are associated with each structure in the normal way, but selection is done by pattern matching (as in Prolog). In the programming example in listing 3, items are selected from a list by representing the list as the pattern `First::RestOfList`, where `First` is an item and `::` is the constructor that joins the item to `RestOfList`, which is another list.

To solve a problem using Hope, the programmer designs data structures that match the problem, produces higher-order functions (like FP's combining forms) to traverse these data structures, and then invokes the higher-order functions with arguments that represent instances for which specific results are required.

Finally, Hope has a modular structure. Thus, a programmer can implement an abstract data type (e.g., a queue) with a type declaration and a collection of functions to operate on that type. The implementation of these functions and the representation of the type itself can be hidden

### Listing 3: An example of a Hope program.

```
dec length : list( alpha ) -> num
--- length( nil ) <= 0
--- length( First :: RestOfList ) <=
  1 + length( RestOfList );
```

from the user, who relies solely on the specified properties of the abstract type.

Listing 3, an example of a Hope program, computes the length of a list. This program works on a list whose elements are all of the same unspecified type. In English it says: Length is a function that takes a list of type (alpha) and returns a number. If the list is empty, the number returned is 0; otherwise, the length of the list is one more than the length of the list without the first element.

**CONCLUSION**

The key to the solution of some of our hardware and software problems seems to lie in incorporating referential transparency of variables into the design of declarative programming languages. This course of action appears to improve the coupling between compilable source code and the abstractions of a specification language, to make the code amenable to direct mathematical verification, to open up a way to perform true parallel processing, to bring code and data conceptually closer together, and to permit the implementation of polymorphic abstract data types. ■

**BIBLIOGRAPHY**

Backus, J. "Can Programming be Liberated from the von Neumann Style? A Functional Style and Its Algebra of Programs." *Communications of the ACM*, volume 21, number 8, page 613.

Burstall, R. M., D. B. MacQueen, and D. T. Sannella. "Hope: An Experimental Applicative Language." University of Edinburgh Internal Report, 1980.

Clark, K., and F. G. McCabe. *micro-PROLOG: Programming in Logic*. Englewood Cliffs, NJ: Prentice-Hall, 1984.

Darlington, J., P. Henderson, and D. Turner, eds. *Functional Programming and Its Applications, An Advanced Course*. Cambridge, England: Cambridge University Press, 1982.

BYTE, August 1979. LISP is the issue theme.

*Proceedings of the ACM Conference on Functional Programming Languages and Computer Architecture*. Boston, MA: 1981.

Yourdon, E. *Techniques of Program Structure and Design*. Englewood Cliffs, NJ: Prentice-Hall, 1975.

# Enhanced Keyboard ff5151 \$159



An affordable, productive solution to your non-standard keyboard. ff5151 uses solid-state capacitive key switches--giving you tactile feedback through your fingers. Avoid Num Lock confusion with our separate cursor control and numeric keypads and LED indicators on the Lock keys. We've returned keys to their standard setup including an extra wide Control key adjacent to the A for Wordstar users. Other features include an extra Control key in the function key row, 3-position height adjustment and sleek color matched styling. Plugs into IBM PC, PC/XT and Compaq Deskpro.

Inquiry 269

## Take The Qubie' Acid Test

Going to a dealer and watching a few color demonstration programs or typing a few lines of text is no match for the test you can make with Qubie'. We are so confident that you'll like our products, that we'll give you 30 days to try them out. If you are not positively satisfied, return the item for a complete refund (even the cost to send it back). Furthermore, we have a fast 48 hour turnaround on repairs during the 1 year limited warranty period. Additionally, we offer our Preferred Customer Plan with 24 hour repairs and 2 years of coverage--call for details.

California residents add 6% sales tax. No extra charges for surface freight, insurance, COD, Visa or Mastercard. Personal checks allow 18 days to clear. Company purchase orders accepted, call for prior authorization. UPS Blue Label available at an additional charge.

Hours: Mon.- Fri. 8 am - 5 pm PTZ  
Sat. 9 am - 1 pm PTZ  
4809 Calle Alto  
Camarillo, California 93010

London (01) 871-2855  
Paris (01) 321-5316  
Sydney (02) 579-3322  
Canada (403) 438-0994

Inquiry 270



# QUBIE'

Inside California  
(805) 987-9741

Outside California  
(800) 821-4479

"Symphony 1.1 now makes translating data from and to others, push button simple. It is the first program I've seen that is actually fun to install."

*Bob Harris, Deputy Assistant Director For Budget Analysis  
Congressional Budget Office.*

"I'm thoroughly impressed by Symphony 1.1 and glad to have it. You're going to have to use dynamite to get it out of my machine. It's almost my whole wish list in one."

*Dwight Muse, Assistant V.P., Internal Reporting  
American Medical Int'l, Beverly Hills, CA*

"In our work in financial planning and analysis we have found that Symphony 1.1 does two things. First, it allows us to build spreadsheets which are a little bit bigger than would otherwise fit in the computer...Second, in doing a spreadsheet layout design, we now have greater flexibility because of the new memory allocation."

*Ron Diederich, Manager, Financial Planning and Analysis Consulting  
Ernst & Whinney, Cleveland, OH*

# LOTUS PRESENTS SYMPHONY 1.

It was a sneak preview.

We gave advance copies of Symphony™ release 1.1—the new version of the popular five-function PC software—to some of the most sophisticated software experts. The reaction was overwhelmingly enthusiastic. Here's why:

1. **NEW EXPANDED MEMORY.** Symphony release 1.1 works with the new expanded memory boards to provide a solution to the "big data" issue, allowing users to store formulas, labels, and floating point numbers in up to 4MB RAM.

2. **NEW MEMORY ALLOCATION SCHEME.** The new

sparse matrix scheme provides greater flexibility and eliminates the need to arrange worksheets to conserve memory.

3. **MACRO LIBRARY MANAGER.** This allows the creation of libraries of macros that can be stored separately from data and can be accessed from any worksheet. This also allows the development of multiple worksheet applications.

4. **8087/80287 SUPPORT.** Symphony release 1.1 can take advantage of 8087/80287 math co-processor chips, increasing calculation speed by up to 60 times.

5. **1-2-3 COMPATIBILITY.** New Symphony can create

"With Symphony 1.1, Lotus has again set the industry standards so high that they'll force the rest of the industry to shoot for the same."

*R. L. Martin, Manager Decision Support Systems  
Eaton Corporation, Cleveland, OH*

"I am very excited about the memory feature. It's a breakthrough for Symphony in that it significantly broadens the universe of Symphony users."

*Robert Schmitzer, V.P. Computer Systems (Corporate Finance)  
Bankers Trust Co., New York, NY*

"The Macro Library function is great. Symphony's strength lies in its command language."

*Sally Nagy, Senior Information Systems Analyst  
Aerofit ElectroSystems Co., Azusa, CA*

## THE TOUGHEST CRITICS RAVE.

translated files readable by 1-2-3® release 1A, and can also translate Jazz™ worksheet files. This fall, Symphony and a new version of 1-2-3 will have compatible spreadsheets, allowing the sharing of data files with no need for translation.

The critics have already acclaimed the programming potential found in Symphony's Command Language – with its conditional statements, branching and parameter passing – the Lotus® File Format and Add In Tools. And they've praised Symphony Link™ – the micro to mainframe Add In. All

of which makes Symphony one of the most powerful PC application development tools around.

And now Symphony is easier to learn, with a new install program and new documentation.

For your own private performance, visit your authorized Lotus dealer today.



**Symphony™**  
**Lotus®**

# Introducing the first IBM™ AT Compatible Kit!

## Building your own AT is as easy as it looks.

Now, it's easy to have the IBM AT that you want by building your own from ADTEK's SERIES 286AT™ compatible, board-level kit. Choose from a complete kit (chassis, motherboard, cables, disk controller, keyboard and enhancement boards) and add your own monitor and disk drives. Or buy just the parts you need for your project. Either way, all series 286AT products are hardware and software AT compatible.

But you won't be on your own. The ADTEK SERIES 286AT comes with illustrated, step by step instructions that even a beginner can follow. (Some basic knowledge of electronics will be helpful.) With just a few simple household tools you can put your new computer together in a Saturday afternoon. And you'll feel confident about your SERIES 286AT because every ADTEK product is protected by a full, one year factory warranty.

## And amazingly frugal.

If you're ready for AT power and speed, but don't want to pay IBM's premium price, rest easy. A complete ADTEK SERIES 286AT kit is priced significantly less than a comparably assembled IBM AT. That's engineering excellence at a real bargain! Call or write today for a detailed brochure and price list on the SERIES 286AT and other fine ADTEK products.



Fully assembled SERIES 286AT



Fixed disk and floppy disk controller.



AT compatible, switchable power supply.



AT compatible keyboard. LED on cap, num and scroll lock keys.



80286 motherboard, 256K standard memory, upgradable to 1M. Clock upgradable to 8MHz.



Fully AT compatible chassis, optional lock. Mounts standard floppy and fixed disk drives.



User supplied disk drives. Kit supplied with list of compatible drive suppliers.



I/O expansion and user expandable memory cards.



User supplied monitor. Kit supplied with list of recommended CRTs.



Video display and printer adaptor boards are fully interfaced with SERIES 286AT system.

Manufacturers of Personal Computers, Peripherals, Accessories

3001 LBJ Freeway Suite 213 Dallas, Texas 75234

(214) 386-6554

Inquiry 9

**ADTEK**

IBM is a registered trademark of International Business Machines Corporation and SERIES 286AT is a registered trademark of ADTEK Corporation.



# PROGRAM TRANSFORMATION

BY JOHN DARLINGTON

*A program-development methodology explained*

IS PROGRAMMING a craft or a science? Most professional (and amateur) programmers would like to claim that what they do is scientific, but compared with the standards attained in other, more mature engineering disciplines such as aeronautical or civil engineering, programming has a long way to go. If one were asked to build a bridge, I doubt that it would be acceptable to construct an initial version, try it out, and, when it fell down, correct the mistakes made in the design, and then repeat the process until the bridge stayed up. This is, however, the paradigm that most practicing programmers follow as they debug their programs toward a working state. At present, programming suffers from a lack of notations for building models or ini-

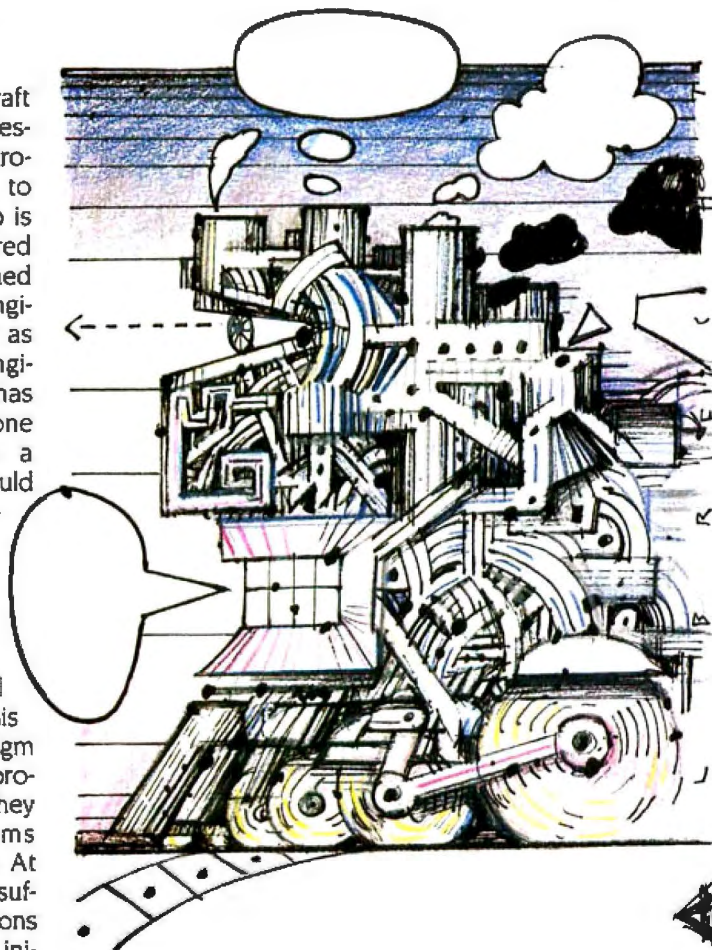

tial specifications of systems and of any criteria for judging the correctness of solutions to such specifications.

As the cost of hardware decreases, the proportion of the cost of any total system that is attributable to software becomes larger. If it is difficult enough to develop complex software in the first place, the problems get even worse if one wishes to maintain or enhance an existing complex software system.

Advances have been

*(continued)*

John Darlington is a professor of programming methodology at the Department of Computing, Imperial College (180 Queen's Gate, London SW7 2BZ, England). Dr. Darlington is the head of a research group at Imperial College that concentrates on program transformation, functional languages, and parallel architectures.

made toward solving this problem. The invention of the first high-level languages, such as FORTRAN, represented a significant advance over the use of machine code and improved programmer productivity tenfold. It is a pity that not many other quantum leaps have been made on the software side. Modern high-level languages do not differ radically from FORTRAN. Structured programming, the white hope of the sixties and seventies, has demonstrably failed to provide the final solution.

All these developments, from new languages to fancy editors and other utilities, seem to be of a kind that, although they will undoubtedly increase programmers' output (often not always of correct code), are incapable of enabling programming to make the transition from an inexact to an exact science. Our goal should be the precision of mathematics. No one feels the need to debug a mathematical theorem or relies on laws that are probably correct apart from a few residual bugs. Programs are superficially similar to mathematical notations, so why can't we share their degree of certainty?

The proponents of declarative languages claim that it is possible to make programming an exact mathematical science with all the accompanying economic benefits but that a necessary condition for this to happen is abandonment of the conventional languages and the adoption of declarative ones.

There is a fundamental distinction between the declarative languages and conventional (or even unconventional) procedural ones such as Pascal or LISP. Declarative languages are referentially transparent, while procedural ones are not. Referential transparency is a property of language systems. A system is referentially transparent if the meaning of a whole can be derived solely from the meaning of its parts. All mathematical notions are referentially transparent. Thus the meaning (value) of a mathematical expression such as  $(3 + 2) * (2 + 1)$  can be derived from the

## A REFERENTIALLY OPAQUE PASCAL PROGRAM

The following program fragment illustrates how the behavior of a Pascal program can be history-sensitive.

```
var switch:boolean;
begin
    switch:=false;

    function f(n:integer):integer;
    begin
        switch:=true;
        f:=2*n
    end;

    function g(n:integer):integer;
    begin
        if switch then g:=3*n else g:=4*n
    end;

    writeln(g(2) + f(1));
    writeln(f(1) + g(2));
end;
```

The presence of the global variable switch makes the meaning of g dependent on the history of the computation performed prior to its evaluation. Therefore,  $g(2) + f(1)$  evaluates to 10, but  $f(1) + g(2)$  evaluates to 8. Thus, commutativity, one of the simplest manipulation laws (namely,  $X+Y = Y+X$ ) does not apply to Pascal programs. [Editor's note: This is a standard computer science usage of the term referential opacity. It should not be confused with the mathematical notion of the same name.]

meaning of its components. Thus  $3 + 2$  has value 5 and  $2 + 1$  has value 3. Knowing these, we can derive the meaning of the whole expression, 15.

A consequence of this property is that there is a simple substitutive equality relation between expressions in any referentially transparent system. Expressions that have the same meaning can be freely substituted for one another in any context without changing the meaning of the whole. Thus, since  $3 + 2$  and  $4 + 1$  have the same meaning (5),  $4 + 1$  can be substituted for  $3 + 2$  in  $(3 + 2) * (2 + 1)$ , giving  $(4 + 1) * (2 + 1)$ . It is the possession of this property that makes mathematics an exact deductive science.

Laws can be developed that allow the formal (syntactic) manipulation of expressions and are guaranteed to preserve the meaning of the expressions being manipulated. The distributive law of arithmetic,  $(x + y) * z = (x * z) + (y * z)$ , is an example of such a law. Using this, we can convert  $(4 + 1) * (2 + 1)$

to  $4 * (2 + 1) + 1 * (2 + 1)$  and know that the meaning is not changed. Referential opacity means that a system's behavior may be time-dependent: i.e., the meaning of a fragment may depend on the history of what happened prior to the evaluation of that fragment. No simple, meaning-preserving, deductive rules can be developed for that system.

Conventional programming languages are not referentially transparent. The presence of assignment statements and variables that are shared between procedures means that the meaning of any conventional program is potentially time-dependent and there is no simple substitution property. See the text box titled "A Referentially Opaque Pascal Program" above.

Declarative languages are, by definition, referentially transparent. The meaning of any fragment of a declarative language program depends only on the meaning of its components and not at all on the history of any computa-

(continued)

# Meet The Princeton Graphic Systems Family.

**The right monitor at the right price.** Princeton Graphic Systems offers you a complete family of high performance personal computer monitors. Monitors that deliver the compatibility, resolution, and reliability you need for any application and any budget: from word processing to sophisticated business graphics.



**HX-12E.** High resolution RGB monitor 640x350 lines noninterlaced - .28 mm dot pitch -Compatible with IBM Enhanced Graphics Adapter -Nonglare screen -**\$785**



**MAX-12.** Amber monochrome -720 x 350 lines -Enhanced to interface with IBM color or monochrome adapter card -Nonglare screen -Can display 16 shades of amber -**\$249**

**HX-12.** High resolution RGB monitor -640 x 200 lines noninterlaced -.31 mm dot pitch tube-Nonglare screen -**\$695**



**HX-9/9E.** Nine inch, high resolution RGB monitor non-interlaced -.28mm dot pitch tube -9E compatible with IBM Enhanced Graphics Adapter -Nonglare screen -Green/amber switch -Apple/IBM colors - Etched dark glass screen -**\$650/\$750 (9E)**



**SR-12P.** PGS's top of the line RGB monitor 640x480 lines noninterlaced - .26 mm dot pitch - Analog input allows for the display of 4,096 possible colors -Compatible with IBM Professional Graphics Adapter -Nonglare screen -**\$999**



**SR-12.** Super-high resolution RGB monitor -640 x 400 lines noninterlaced -.31 mm dot pitch tube - Nonglare screen - Requires interface card -**\$799**



**Princeton accessory product line.** Undergraduate tilt/swivel monitor base, ColorView card, Green/Amber switch, RGB-80 card and Scan Doubler card.

## Princeton Graphic Systems. The only real choice.

For office or home use, Princeton Graphic Systems has a monitor that's right for you. Inquire at your local computer store about our complete line of high resolution color and monochrome monitors; monitors that live up to the Princeton Graphic Systems' tradition of quality, performance, and value. **Princeton Graphic Systems.** 601 Ewing Street, Bldg. A, Princeton, N.J. 08540. (609) 683-1660 Telex: 821402PGSPRIN (800) 221-1490. Ext. 304.

**PRINCETON**  
GRAPHIC SYSTEMS  
AN INTELLIGENT SYSTEMS COMPANY

IBM Enhanced Graphics Adapter, and IBM Professional Graphics Adapter are trademarks of International Business Machines, Inc. Compaq is a trademark of Compaq Computer Corp. Corona is a trademark of Corona Data Systems, Inc. Apple is a trademark of Apple Computer Corp. PC World is a trademark of CW Communications Inc. SR-17 screen courtesy of Mouse Systems, Inc.

tion performed prior to the evaluation of that fragment. From this simple distinction many benefits flow.

The absence of any time-dependent behavior implies that declarative programs are easier to write and understand. Many burdens concerned with organizing or comprehending the sequencing of

events are removed from the programmer. Declarative languages are therefore intrinsically more powerful descriptive notations.

The absence of time-dependent behavior also means that subexpressions can be evaluated in any order and therefore in parallel, leading to a whole range of new, highly parallel machines designed specifically for declarative languages.

From the software-development viewpoint, the critical advantage referential transparency brings to the declarative languages is the ease with which formal manipulation systems can be developed for declarative programs.

The existence of such manipulation systems makes the process of program development by program transformation feasible in the declarative languages. The ideas behind program transformation stem from a diagnosis that many of the difficulties met in developing programs arise from trying to satisfy two often conflicting goals simultaneously. A program must be correct; that is, it must meet its specification and be free of bugs. A program must also be efficient: It must compute the required results in a reasonable time and make minimal use of resources. The first goal is best met by making a program as clear and obvious as possible. Meeting the second often involves sacrificing clarity for the sake of an intricate, but efficient, evaluation strategy. Given this diagnosis of the disease, the cure prescribed by transformation is fairly obvious. It is to develop your program in two separate stages, concentrating on satisfying one goal at each stage. Thus, you first write an initial version or specification of your program, concentrating on making it as clear and obviously correct as possible. Only when you are satisfied that you have a correct and complete initial version do you turn your attention to satisfying the requirement of efficient execution. This is achieved by successively manipulating or transforming the program into more and more efficient versions. It is crucial that the manipulations performed do not change the meaning of the program. Thus, to be successful, transformation depends on the existence of a set of manipulation rules capable of improving performance but guaranteed to preserve the meaning of a program. It is the availability of such manipulation rules that makes transformation feasible in declarative languages and very difficult in procedural ones.

Note that the initial specification is itself a program. As

**Listing 1: An inefficient Hope program for calculating the average of a list of numbers.**

```

dec average,sum,count:list(num)-> num;
--- average(l) <= sum(l) div count(l);      (A)
--- sum(nil) <= 0;                          (B)
--- sum(n::l) <= n + sum(l);                (C)
--- count(nil) <= 0;                        (D)
--- count(n::l) <= 1 + count(l);           (E)
    
```

we will see later, if one really puts one's mind to it, one can write such wonderfully inefficient programs that it is straining the meaning somewhat to call them executable! But that is the whole point. By maximizing the clarity and obviousness of the initial version, one is making it much more likely to be correct. It does, how-

ever, mean that the transformations have to be pretty powerful and capable of achieving improvements in performance way beyond that achievable by conventional optimizing compilers. Characteristically, one is looking for improvements in the order of the program's efficiency. For example, we want to transform algorithms that compute in exponential time to linear or logarithmic ones. As we will see below, such improvements are possible.

The design of optimizing compilers for conventional languages, such as FORTRAN or Pascal, has developed to a fine art. Some of the optimizations these compilers perform, such as strength reduction or code lifting, can be expressed as source-to-source manipulations and are therefore strictly program transformations. However, the sort of transformations we are seeking can be characterized as ones that can cause changes of nature, not just changes of degree. Only in rare, pathological cases are optimizing compilers capable of producing as output a program recognizably different from their input. We need to be able to do this routinely.

The second consequence of having specifications that are executable as programs is that they can be exercised and tested against the informal requirements or modified to meet changing requirements. Thus, a process of rapid prototyping is possible.

## A SIMPLE TRANSFORMATION

Let us now look at a transformation. The example I have chosen to start with is fairly trivial and will not require large improvements in efficiency. Nevertheless, it will serve to introduce the transformations used and illustrate that simple manipulations can produce significantly altered programs.

Say we have been asked to find the average of a list of numbers. The textbook definition of average is the sum of all the numbers divided by how many of them there are. If we take this as the basis for our obviously correct initial program, in Hope we get something of the form shown in listing 1.

This program is clearly correct, but on a sequential machine involves the slight inefficiency that the list is traversed twice. Any self-respecting Pascal programmer would collect both the sum and the count on one pass over the list.

*(continued)*

# The ARC turbo personal computer combines 8088-2 turbo speed and maximum 640K memory to take you further, faster....



**10% more speed and 150% more memory than the PC**

- ▶ The systems foundation is the four-layered 8088-2 X-turbo motherboard. It's processing speed is 40% faster than the PC's and with a maximum 640K on-board memory you get high speed and maximum memory. On one board.
- ▶ More CPU speed means you can reduce the valuable time you now waste waiting for your PC to record, retrieve and process data.
- ▶ The 640K on-board memory makes it easier to design your own customized testing programs and eliminates all those time-consuming memory/diskette data transfers. Any excess memory can be used for RAMdisk or spool programs.
- ▶ The X-turbo was designed to be used in conjunction with all PC compatible software, which means access to nearly all the most popular software packages.
- ▶ The 7-Plus. This multifunction card provides a complete solution to your most essential hardware add-on requirements. It includes a parallel printer port, a floppy disk controller and a fully system

integratable clock/calendar. And even more. The RAMdisk Plus and Spool Plus software.

- ▶ The ARC turbo keyboard supports 100 full-function, finger-sized keys, a spacious display, a separate cursor control panel, and LED displays for power, turbo, caps and numeric.
- ▶ A monochrome or color/graphics card completes the system.
- ▶ The X-turbo itself is built around four layers instead of the standard two, making the board itself, and the system as a whole more stable and less susceptible to power loss. So along with the unsurpassed speed you get a quality you can always rely on. And our seal of confidence—a one year warranty.
- ▶ This system will give you more processing speed, memory, function concentration, and reliability than any comparable system. And cost you less. For more information on where to try out an ARC turbo, contact American Research Corporation.

**ARC** American  
Research  
Corporation  
THE TECHNOLOGICAL BRIDGE TO YOUR FUTURE

2001 W. CHESTNUT ST., ROOM 103 ALHAMBRA, CA 91803  
TEL: (818) 289-8742 TLX: 285653

Let us derive such a program in Hope by systematic manipulation of the original one. We will present the transformations in an informal manner. Each step will take a set of equations, i.e., a program, and produce new equations. Informally, we hope that it will be obvious that all the new equations are consequences of the existing equations and thus cannot change the meaning of the program as a whole. Formally, all our transformations will use rules from the unfold/fold transformation system (see the text box below).

The first step in our transformation is to introduce a definition for a new function, *av*.

```
dec av:list(num) -> num x num;
--- av(l) <= (sum(l), count(l));
```

 (1)

For correctness, the only thing we have to concern ourselves with is that introducing this new definition cannot change the meaning of our program. As *av* is not mentioned at all in the previous equations, this is clearly true. Why we introduced this particular definition is another

question. The situation is analogous to the use of constructions in geometry. Introducing the right construction assists proofs to be carried out and can never enable anything false to be proved. Where the idea for the right construction comes from in the first place is more mysterious.

The formal reading of an equation such as --- *av(l) <= (sum(l), count(l))*; is that the expression on the left-hand side, *av(l)*, is equal to the expression on the right-hand side, *(sum(l), count(l))*, for all values of *l*. If the equation is true for all *l* it is true for some particular instance of *l*. Thus we can instantiate this equation by setting *l* to *nil*, getting the equation

```
--- av(nil) <= (sum(nil), count(nil));
```

 (2)

Statement (2) is obviously a consequence of statement (1) and so cannot alter meaning. But statements (B) and (D) in listing 1 give values for *sum(nil)* and *count(nil)*, allowing us to deduce

```
--- av(nil) <= (0, 0);
```

 (3)

which, as well as being true about *av*, begins to look like part of a program for *av*.

Returning to statement (1) and this time instantiating *l* to *x::l* we get

```
--- av(x::l) <= (sum(x::l), count(x::l));
```

 (4)

Statements (C) and (E) allow us to deduce

```
--- av(x::l) <= (x + sum(l), 1 + count(l));
```

 (5)

But we can rearrange this using the Hope where construct to

```
--- av(x::l) <= (x + u, 1 + v)
   where (u,v) == (sum(l), count(l));
```

 (6)

Now we see that *(sum(l), count(l))* appears as the right-hand side. But this is the right-hand side of (A). What's more, it is equal to the left-hand side of (A), *av(l)*. Because of referential transparency, the *<=* can be read as *=*. Thus, we can replace *(sum(l), count(l))* by *av(l)*, getting

```
--- av(x::l) <= (x + u, 1 + v)
   where (u, v) == av(l);
```

 (7)

Statements (3) and (7) now constitute an efficient program for *av* but do not at the moment help us with *average*. Returning to (A), we get

```
--- average(l) <= u div v
   where (u,v) == (sum(l), count(l));
```

and thus

```
--- average(l) <= u div v
   where (u, v) == av(l);
```

Collecting the useful equations together, we get a new program for *average* (see listing 2).

This final program, we would claim, is not so obviously correct as our initial version but is more efficient in that only one pass is performed over the list. The crucial point

## THE UNFOLD/FOLD TRANSFORMATION SYSTEM

The unfold/fold system consists of six rules that allow new equations to be introduced that are consequences of existing equations.

1. Definition. Introduce a new recursion equation whose left-hand expression is not an instance of the left-hand expression of any previous equation.

2. Instantiation. Introduce a substitution instance of an existing equation.

3. Unfolding. If *E <= E'* and *F <= F'* are equations and there is some occurrence in *F'* of an instance of *E*, replace it by the corresponding instance of *E'* obtaining *F''*, then add the equation *F <= F''*.

4. Folding. If *E <= E'* and *F <= F'* are equations and there is some occurrence in *F'* of an instance of *E'*, replace it by the corresponding instance of *E* obtaining *F''*, then add the equation *F <= F''*.

5. Abstraction. We may introduce a where clause by deriving from a previous equation *E <= E'* a new equation:

```
E <= E' [u1/F1, ..., un/Fn]
   where (u1, ..., un) == (F1, ..., Fn)
```

[*E[E1/E2]* means *E* with all occurrences of subexpressions *E2* replaced by *E1*.]

6. Laws. We may transform an equation by using on its right-hand expression any laws we have about the primitives (associativity, commutativity, etc.) obtaining a new equation.

is that there is no need to conduct a separate proof to show that the final program is equivalent to the initial one. It is correct by construction. Neither do we have to conduct proofs to show the intermediate steps are legitimate. The correct application of the rules can be checked syntactically (and therefore mechanically).

The above example illustrated the transformation techniques but only achieved a moderate increase in performance. To give credence to our claim that transformation can achieve substantial performance increases, let us quickly look at a classic transformation, the conversion of the exponential definition of the Fibonacci function to a linear version, i.e., converting a definition that takes  $2^n$  steps to compute  $\text{fib}(n)$  to one that takes  $n$  steps (see listing 3). Here the improvement in performance is much greater, but the similarity between this and the previous transformation is appealing. Our pulling the correct definitions out of a hat may be slightly off-putting, but their origin is not quite as mysterious as it seems. They can be systematically derived by investigating the pattern of computation of the specification program and identifying repeated, and therefore unnecessary, computations.

**PRACTICALITY AND USEFULNESS OF TRANSFORMATION**

If we are proposing, as we are, that transformation can place software development and programming onto a new plateau of scientific rigor, we must evaluate its potential very severely. To be ultimately useful, any transformation methodology must satisfy three criteria. First, it must be correct, that is, meaning-preserving. Second, it must be adequate or complete, so that all desired program developments can be achieved using the methodology. Finally, it must be expressive enough that, not only can all developments be expressed, but they can be expressed in an intelligible and communicable manner. Let us see how functional languages and the unfold/fold methodology being proposed here meet these criteria.

**CORRECTNESS**

It is, of course, crucial that any system used for transformation preserve meaning. This property has been shown to hold for the unfold/fold system. There is one thing to watch out for in doing transformations, however. It is possible, using the unfold/fold system, to produce a program that will fail to terminate, using input values for which the original specification program will terminate. Happily, there are simple guidelines that ensure that the system can be used without fear of introducing nontermination. See the text box "Correctness and Completeness of the Unfold/Fold System" on page 210.

**COMPLETENESS**

The other question that needs to be asked of any transformation system is: How adequate or complete is it? Can any transformation that you would like to achieve be expressed using only rules from the system? The answer for

**Listing 2: A more efficient Hope program for calculating numerical averages, generated by transformation of listing 1.**

```
dec average:list(num) -> num;
dec av:list(num) -> num x num;
--- average(l) <= u div v
                    where (u, v) == av(l);
--- av(nil) <= (0, 0);
--- av(x::l) <= (x+u, 1+u)
                    where (u, v) == av(l);
```

**Listing 3: A transformation of an exponential-time Fibonacci function program to a linear-time program.**

**Initial Program**

```
dec fib:num -> num;
--- fib(0) <= 1;
--- fib(1) <= 1;
--- fib(succ(succ(n))) <= fib(n+1) + fib(n);
```

**Transformation**

```
dec g:num -> num x num;
--- g(n) <= (fib(n+1), fib(n));      Definition
--- g(0) <= (fib(1), fib(0));      Instantiation
    <= (1, 1);                      Unfold
--- g(succ(n)) <= (fib(n+2), fib(n+1)); Instantiation
    <= (fib(n+1) + fib(n), fib(n+1)); Unfold
    <= (u+v, u)
        where (u, v) == (fib(n+1), fib(n)); Abstract
    <= (u+v, u)
        where (u, v) == g(n);      Fold
--- fib(succ(succ(n)))
    <= u+v
        where (u, v) == (fib(n+1), fib(n)); Abstract
    <= u+v
        where (u,v) == g(n);      Fold
```

**Final Program**

```
dec fib:num -> num;
dec g:num -> num x num
--- fib(0) <= 1;
--- fib(1) <= 1;
--- fib(succ(succ(n))) <= u + v
                        where (u,v) == g(n);
--- g(0) <= (1, 1);
--- g(succ(n)) <= (u+v, u)
                        where (u, v) == g(n);
```

the unfold/fold system is theoretically no but practically yes. There are some pathological examples of pairs of (functional) programs that are demonstrably equivalent

(continued)

but which cannot be transformed one to the other without stepping outside the strict confines of the system. A simple example of this is contained in the "Correctness and Completeness" text box. However, much work based on the unfold/fold system has demonstrated its practicality and wide range of applicability.

The repertoire of the types of transformational operations that can be expressed by utilizing the unfold/fold system is quite impressive. It includes the following:

**LOOP COMBINATIONS:** The essence of the average example is that there are two computationally independent loops that needed to be combined for efficiency. Many transformations are instances of this type of transformation.

**RECURSION REMOVAL:** Using transformation it is possible to convert fully recursive definitions such as listing 4a to linear forms such as listing 4b. The important point about the latter definition is that it can be executed without using a run-time stack and can be simply converted to a program using only a while loop in a language such as Pascal. The early work on transformation viewed the functional program as an initial specification and aimed at a program in an imperative language as the final output. With the development of efficient implementations for functional languages and the imminent arrival of specially designed parallel machines, this aspect of the transformation work has tended to become less important.

**ABSTRACT DATA TYPES:** One of the more impressive applications of the basic transformation methodology has been the work on the systematic derivation of implementations for abstract data types. In order to support abstract data types such as trees or priority queues in an imperative language such as Pascal, one has to write a lot of code providing implementations for the access functions of the abstract type in terms of the primitives of the concrete types provided in the language. This often results in an inefficient final program that is cumbersome and difficult to maintain or move to other implementation bases. Work based on functional languages and transformation has shown how efficient implementations can be automatically synthesized from a specification of the abstract and concrete types and a single mapping function formalizing how the concrete type is to be used to represent the abstract one.

**PROGRAM SYNTHESIS:** As we shall see below, in a functional language we are able to write specifications that define

**Listing 4a:** A recursive definition of factorial in Hope.

```
dec fact:num -> num;
--- fact(0) <= 1;
--- fact(succ(n)) <= (n + 1) * fact(n);
```

**Listing 4b:** A linear definition of factorial in Hope.

```
dec fact:num -> num;
dec factit:num x num -> num;
--- fact(n) <= factit(n, 1);
--- factit(0, acc) <= acc;
--- factit(succ(n), acc) <= factit(n, (n + 1) * acc);
```

a program more by properties it must satisfy rather than by a computational recipe, however inefficient, for its evaluation. Such specifications can also be converted to efficient programs, but we should perhaps talk more of program synthesis rather than program transformation. The crucial point is that both specification and program are still expressed using the same notation. There is no discontinuity between forms of expression that are specifications and

forms of expression that are programs.

**TRANSFORMATION FOR PARALLEL EVALUATION:** Early work on transformation concentrated on producing programs that would run efficiently on conventional sequential machines. For a parallel machine, different program forms are needed for efficient execution. Happily, exactly the same transformation methodology enables us to produce these forms as enables us to produce efficient sequential ones.

Among the significant transformational developments studied by transformation workers are sorting algorithms, compilers, parsing algorithms, text formatters, editors, operating systems, and numerical algorithm libraries. Particular academic interest has been shown in analyzing the relationships between different algorithms for a particular task, such as sorting, by systematically synthesizing all the algorithms in the class from a common very high level specification. Studies of algorithms for sorting, parsing, and searching have exposed pleasing symmetries and relationships between algorithms previously considered unrelated.

It would be misleading to give the impression that work has reached the stage whereby any program development, however large or complex, can be easily expressed using transformation, and even more misleading to imply that the whole process is about to be mechanized and programmers are about to become redundant. What we would claim is that transformation offers the possibility that programming can progress from an art to a science and that even this possibility is precluded if one continues with the conventional languages. Furthermore, sufficient progress is being made on extending the practicality of transformation techniques, particularly in the area of partial mechanization, that we can feel optimistic about the prospects of achieving a mechanical realization of program optimization and proof in the future.

(continued)



# THE CASE OF THE DISAPPEARING CABLES



Here's a puzzle for you, Watson! Look at this new MicroManager!

Can't say I see anything out of the ordinary, Holmes.

Think, Watson, not about what you see, but rather what you don't see.

But, Holmes, everything seems perfectly in order.

Precisely! When did you ever see a printer station that was perfectly in order, Watson?

Zounds, Holmes! Some rascal has stolen the cables!

So it seems, Watson, but observe carefully—there's more to this than meets the eye. The cables have been cleverly concealed right under our very noses! Notice how each cable disappears through a knock-out hole and enters a channel in the rear of the device. Remove these vertical panels and—voila!—we discover the cables passing from level to level through secret compartments.

## THE MICROMANAGER

S Y S T E M

Holmes, you've solved the Case of the Disappearing Cables!

Elementary, my dear Watson. But the MicroManager has solved an even deeper mystery—*where to put the printer!* See how this Basic Floor Unit is actually composed of individual sections—'modules,' Americans call them. Consider the possibilities, Watson—single modules used as desktop printer or monitor stands, for keyboard storage, or what-have-you. Combined, they can form any sort of work station we need! The base has locking casters for instant mobility. There's even an optional paper refolding attachment! Cunning, isn't it?

By Jove, Holmes, this new MicroManager is the most diabolically clever device we've ever encountered!

Indeed, Watson. Thank Heaven its creators are on our side!

**MicroComputer Accessories, Inc.**



USA: P.O. Box 3725, Culver City, CA 90231. Telephone 213/641-1800. EUROPE: Rue de Florence 37, 1050 Bruxelles, Belgique. Telephone 02/538.61.73.

Inquiry 387 for End-Users. Inquiry 388 for DEALERS ONLY.

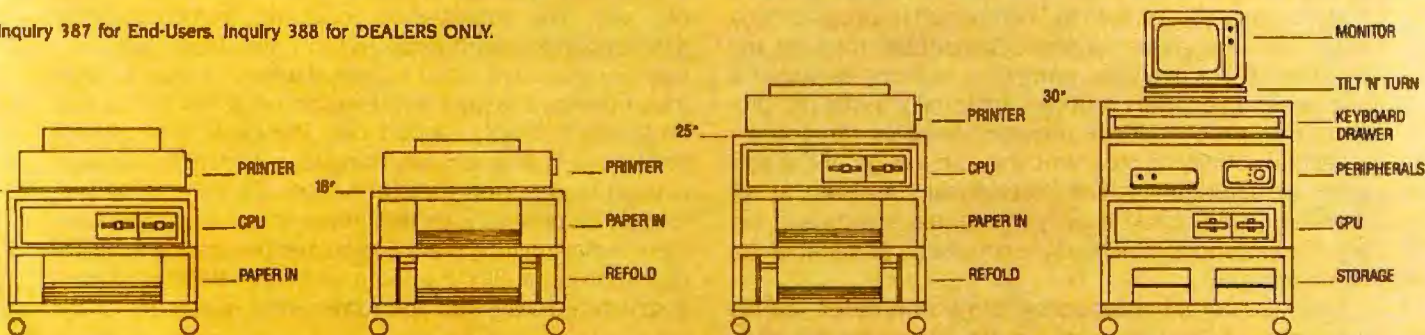

**EXPRESSIBILITY**

The final parameter governing transformation's ultimate usefulness is: How expressive can we be using transformation? There is no point having a wonderfully formal system if any significant transformational development needs pages and pages of intricate mathematics to express. This is not the level at which any programmer, even of the next generation, would feel happy. Furthermore, it is not the level at which professional mathematicians work. The success of mathematics lies in the fact that it is able to combine a rigorous formal base with the development of powerful high-level concepts and methods of discovering and communicating mathematical proofs. We must do the same for transformational programming.

The concept of expressibility and intelligibility is intimately tied up with the prospects for mechanization, which we see as the ultimate payoff for program transformation. Do not be alarmed. We are not predicting the demise of the programmer or promising fully automatic programming systems. Rather, we are intimating that some time in the not-too-distant future the power and accuracy that computers have brought to bear on productivity in other disciplines may be applied to programming itself. We exaggerate slightly. Computers, through the medium of, for example, compilers, editors, debuggers, and program-analysis routines, materially assist the programming process at the present. However, the core intellectual activity of programming, the design of the program or algorithm, is not mechanically assisted at all. Transformation attacks exactly this central activity and, being formal and syntactically expressed, is suitable for mechanization.

Several different approaches to mechanization are being explored. The high road consists of viewing the prob-

## CORRECTNESS AND COMPLETENESS OF THE UNFOLD/FOLD SYSTEM

**N**ontermination can be introduced. Consider the very simple Hope program

```
dec f:num -> num;
--- f(n) <= 3;
```

If we fold this with itself we get

```
--- f(n) <= f(n);
```

which is undoubtedly true about *f* but not a very useful method of computing values for *f*!

Generally, there is a danger of producing a nonterminating program from one that terminates if the transformation used contains more fold steps than unfold steps. Thus, to be safe we need to keep a count of the different steps used during a transformation. Alternatively, we can check that the final program still terminates. This is not possible to do for the general case, but practically it is often very simple.

Some transformations are not possible. Consider the functions *f1* and *f2*:

```
dec f1:num -> num'
--- f1(0) <= 0;
--- f1(succ(n)) <= 1 + f1(n);
```

```
dec f2: num -> num;
--- f2(n) <= n;
```

*f1* and *f2* are obviously equivalent and *f2* can be transformed to *f1*, but *f1* cannot be transformed to *f2*, which is the direction we would like to go. The problem is that *f2* has no recursion at all on the right-hand side and so cannot be produced using a fold step. To derive *f2*, we would have to guess its definition and then prove equivalence. Happily, realistically sized programs never have this problem.

lem as a problem in artificial intelligence and attempting to construct a fully automatic system that accepts a high-level specification as input and, without further user intervention, produces an efficient program. Many people, myself included, have had much fun constructing such systems. Much has been learned about the problems of search and the power of heuristics, but such systems will only become remotely practicable when solutions are found to many fundamental problems in artificial intelligence.

At the other end of the scale, it is relatively simple to construct transformation checkers. Such systems rely totally on the user to select what transformation to apply next, but they do relieve users of many clerical burdens and ensure that the transformations are correctly applied. The problem is that, for any moderate-size transformational development, the number of steps needed, if all the steps are at the level of the fundamental rules of the system, becomes inordinate and difficult to comprehend.

The most promising medium-term prospect lies in the development of so-

called metalanguage systems. These represent the middle way. The intelligence to guide transformational developments is still expected to come from users, but they are given structured high-level ways of conveying their intentions to a system that is responsible for seeing that these are correctly carried out. The basic idea of such systems is that a separate language, the metalanguage, is used to describe transformations that are to be performed on programs written in the object language. Thus, if the metalanguage is a full language possessing function-definition capability, transformations can be expressed in a structured way with the lowest-level operators of the

(continued)



## You know that choosing the right software is serious business. So does WATCOM.

So before you make any decisions about your software needs, talk to WATCOM—the people major software users around the world have trusted for years. WATCOM has the products you need to get the job done right. Proven performers like WATFOR\*, WATFIV\*, WATBOL\*, and SCRIPT. Plus new leaders in software for PC workstations and micro-to-mainframe communications. Networks, language interpreters and compilers. Text preparation and data management. All WATCOM products are human engineered to provide the optimum in people efficiency and productivity. And they're designed to run compatibly on IBM mainframes and PC's, Digital main-

frames and micros, and Commodore micros.

Whatever you need is backed up by WATCOM's innovative maintenance and support services. You'll be kept up to date with the latest in product enhancements and information. And our publications and seminars will help you get the most out of your software investment. WATCOM. Quality products. Professional service. And a reputation built on more than 150,000 licensed mainframe and micro software programs throughout the world. So talk to us before you decide. After all, choosing the right software is serious business. For you. And for WATCOM.

### Make the right choice: *Waterloo C Compiler*

Full implementation of the C language, run-time library, and macro processor make Waterloo C from WATCOM the right choice.

Waterloo C is ideal for file processing, graphics, numerical analysis, and system software using the IBM 370 VM/SP CMS\* system. Waterloo C makes porting existing C programs easy because it supports UNIX\* Version 7 extensions. New applications are conveniently written because of relaxed struct member rules. Waterloo C produces production-quality object code.

Code is re-entrant for shared segments. Waterloo C supports the CMS file structure directly. And all standard library routines are implemented. Make the right choice. Call or write WATCOM today and we'll tell you all about Waterloo C or any of WATCOM's other people-efficient products.

# WATCOM

The right choice in software.

Yes! I want to make the right choice in software. Send me more information on:  Waterloo C Compiler  WATCOM Software Catalogue

Name: \_\_\_\_\_

Company: \_\_\_\_\_

Title: \_\_\_\_\_

Address: \_\_\_\_\_

City: \_\_\_\_\_ State: \_\_\_\_\_ Zip: \_\_\_\_\_

**WATCOM PRODUCTS INC.**

415 Phillip Street  
Waterloo, Ontario, Canada  
N2L 3X2

(519) 886-3700

Telex 06-955458

BYT-3

\*WATFOR, WATFIV and WATBOL are registered trademarks of the University of Waterloo.

\*IBM PC and 370 VM/SP CMS are registered trademarks of International Business Machines Corporation.

\*UNIX is a registered trademark of Bell Laboratories.

metalanguage corresponding to the guaranteed meaning-preserving operations and the higher-level, more meaningful operations being constructed out of these.

In our work at Imperial College, we have developed a system for transforming Hope programs that also uses Hope as the metalanguage. Thus, the six rules of the unfold/fold system become Hope (metalanguage) functions that operate on Hope (object) programs represented as Hope data structures. Out of these primitive operations, more powerful transformation operators can be built using the normal function-definition capability. The trick is to ensure that these defined operators inherit the correctness-preserving nature of the basic operations. In Hope, this is achieved using the module and typing mechanisms. The Hope data type used to represent Hope object programs, together with the basic operators, are formed into a module from which only the correctness-preserving operators are exported. These operators are the only way programs can be altered. Thus, the system designer or user is free to define any new operation in terms of the ones provided, secure in the knowledge that there is no way he or she can conspire to produce an incorrect program.

A range of meaningful second-level operations can be

identified, corresponding to transformation operations such as combine loops, remove recursion, and implement one data type in another. Each tactic involves a limited search to try to express the requested transformation in terms of the lower-level primitives. Each tactic either succeeds, returning the altered program, or fails, indicating either that the requested transformation is impossible or that the tactic failed to find it. There is no way an incorrect program can be produced.

Thus, a transformation plan emerges as a structured Hope metalanguage program that is understandable, communicable, and machine-checkable. The Hope metalanguage program in a real sense provides a formal and precise notation in which to express the design of a program. This, we feel, has important consequences not only for initial program development, but also for program modification and maintenance.

If, after a program has been successfully developed, the specification from which it was derived is retained along with the metalanguage program, then any subsequent modifications or enhancements can be performed on the specification. Because of the nature of specifications, this

(continued)



## MTI's Special Edition of the AT&T PC Model 6300.

Buy, lease or rent at low prices.

The AT&T PC 6300 is operationally compatible with PC-DOS and Concurrent CP/M-86. Its powerful 8086 16-bit processor and its 16-bit data bus give the AT&T 6300 twice the throughput of most other personal computers.

And now MTI has configured a "Special Edition" of the 6300 to give you the most powerful computing package for your money. Since MTI is an authorized VAR for AT&T, you get the additional benefit of an AT&T warranty on its hardware and software.

Whether you buy, lease or rent, MTI is the one source for all the computer and data communications equipment, applications expertise and service you need. At great prices. Call MTI and save.

### LOOK AT THIS POWERFUL PACKAGE:

- 640 KB RAM
- 20 Megabyte Hard Disk
- 360 KB Floppy Disk
- Intel 8087 Numeric Co-Processor for the fastest number crunching
- Keyboard and High-Resolution Monitor (Monochrome 640 x 400 Pixels)
- MS-DOS Operating System & GW Basic

### AVAILABLE OPTIONS:

- Xenix 3.0 Operating System
- Key Tronic Keyboard



### Computer & Data Communications Equipment Sales / Leasing / Service / Systems Integration

Digital Equipment Corp., Intel, Texas Instruments, AT&T, ADDS, Qume, HP\* Dataproducts, Diablo, Epson, Lear Siegler, Esprit, Wyse, Link, C.Itoh, PCI Racal-Vadic, MICOM, Ven-Tel, Develcon, Control Data, Emulex, U.S.Design

New York: 212/226-2337 516/621-6200 518/449-5959	New Jersey: 201/227-5552 Pennsylvania: 412/931-9351	California: 818/883-7633 714/220-6487	Ohio: 216/464-6688 Kentucky: 502/449-6656
---	--	---	--

Visa

Or call 800/645-6530

MasterCard

MS-DOS and Xenix are trademarks of Microsoft Corporation, Concurrent CP/M-86: Digital Research Corp.

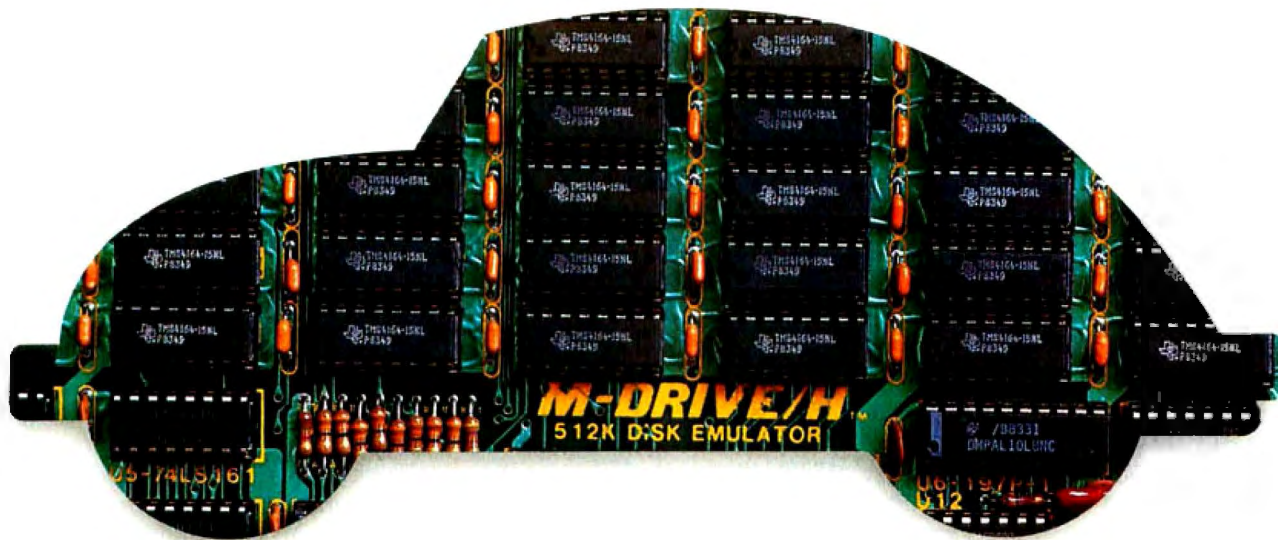

## You can still buy quality and dependability at a reasonable price.

That's exactly what we drive home at Viasyn. We offer you a whole line of CompuPro® IEEE 696/S-100 Bus boards. Along with single- and multi-user systems compatible with over 3,000 standard business applications, plus a wide variety of scientific and industrial programs. Each one's a value our competition finds hard to beat.

You can choose from a broad range of CPU boards, memory boards, disk controllers, network and interface boards, plus PC Video, in color or black and white. You can mix or match 8-bit and 16-bit software on the same machine or on different machines. And pick just the power and memory you need. Object: to grow and multiply in capabilities, at optimum cost efficiencies. Without sacrificing quality or dependability.

If that's what you're driving for, write us for our new short-form catalog or simply call our toll-free number.

# VIASYN™

The CompuPro People

## Where Computers Grow

3506 Breakwater Court, Hayward, CA 94545  
Call 800/VIASYN-1. In CA, 800/VIASYN-2. TWX: 510-100-3288 VIASYN CORP

CompuPro is a registered trademark of Viasyn Corporation.

# 64K \$100 STATIC RAM

## \$139<sup>00</sup> KIT

**NEW!**

LOW POWER!  
150 NS ADD \$10



BLANK PC BOARD  
WITH DOCUMENTATION  
\$49.95

SUPPORT ICs + CAPS  
\$17.50

FULL SOCKET SET  
\$14.50

FULLY SUPPORTS THE  
NEW IEEE 696 \$100  
STANDARD  
(AS PROPOSED)

FOR 56K KIT \$125

ASSEMBLED AND  
TESTED ADD \$50

### FEATURES: PRICE CUT!

- Uses new 2K x 8 (TMM 2016 or HM 6116) RAMs.
- Fully supports IEEE 696 24 BIT Extended Addressing.
- 64K draws only approximately 500 MA.
- 200 NS RAMs are standard. (TOSHIBA makes TMM 2016 as fast as 100 NS. FOR YOUR HIGH SPEED APPLICATIONS.)
- SUPPORTS PHANTOM (BOTH LOWER 32K AND ENTIRE BOARD).
- 2716 EPROMs may be installed in any of top 48K.
- Any of the top 8K (E000 H AND ABOVE) may be disabled to provide windows to eliminate any possible conflicts with your system monitor, disk controller, etc.
- Perfect for small systems since BOTH RAM and EPROM may co-exist on the same board.
- BOARD may be partially populated as 56K.

## 256K S-100 SOLID STATE DISK SIMULATOR!

WE CALL THIS BOARD THE "LIGHT-SPEED-100" BECAUSE IT OFFERS AN ASTOUNDING INCREASE IN YOUR COMPUTER'S PERFORMANCE WHEN COMPARED TO A MECHANICAL FLOPPY DISK DRIVE.

### PRICE CUT!

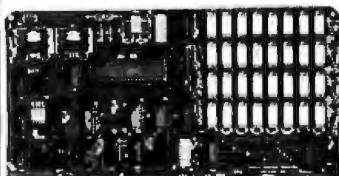

BLANK PCB  
(WITH CP/M 2.2  
PATCHES AND INSTALL  
PROGRAM ON DISKETTE)  
\$69.95  
(8203-1 INTEL \$29.95)

### FEATURES:

- 256K on board, using + 5V 64K DRAMS.
- Uses new Intel 8203-1 LSI Memory Controller
- Requires only 4 Dip Switch Selectable I/O Ports.
- Runs on 8080 or 280 \$100 machines.
- Up to 8 LS-100 boards can be run together for 2 Meg. of On Line Solid State Disk Storage.
- Provisions for Battery back-up.
- Software to mate the LS-100 to your CP/M 2.2 DOS is supplied.
- The LS-100 provides an increase in speed of up to 7 to 10 times on Disk Intensive Software.
- Compare our price! You could pay up to 3 times as much for similar boards.

#LS-100  
(FULL 256K KIT) **\$169<sup>00</sup>**  
(ADD \$50 FOR A&T)

## THE NEW ZRT-80 CRT TERMINAL BOARD!

A LOW COST Z-80 BASED SINGLE BOARD THAT ONLY NEEDS AN ASCII KEYBOARD, POWER SUPPLY, AND VIDEO MONITOR TO MAKE A COMPLETE CRT TERMINAL. USE AS A COMPUTER CONSOLE, OR WITH A MODEM FOR USE WITH ANY OF THE PHONE-LINE COMPUTER SERVICES.

### FEATURES:

- Uses x 280A and 6845 CRT Controller for powerful video capabilities.
- RS232 at 16 BAUD Rates from 75 to 19,200.
- 24 x 80 standard format (60 Hz).
- Optional formats from 24 x 80 (50 Hz) to 64 lines x 98 characters (60 Hz).
- Higher density formats require up to 3 additional 2K x 8 6116 RAMS.
- Uses N.S. INS 9250 BAUD Rate Gen. and USART combo IC.
- 3 Terminal Emulation Modes which are Dip Switch selectable. These include the LSI-ADM3A, the Heath H-19, and the Beehive.
- Composite or Spill Video.
- Any polarity of video or sync.
- Inverse Video Capability.
- Small Size: 6.5 x 9 inches.
- Upper & lower case with descenders.
- 7 x 9 Character Matrix.
- Requires Par. ASCII keyboard.

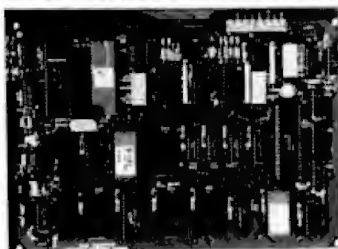

**\$89.95** #ZRT-80  
(COMPLETE KIT, 2K VIDEO RAM)

BLANK PCB WITH 2716  
CHAR. ROM. 2732 MON. ROM  
**\$49.95**  
SOURCE DISKETTE - ADD \$10  
SET OF 2 CRYSTALS - ADD \$7.50

FOR 8 IN.  
SOURCE DISK  
(CP/M COMPATIBLE)  
ADD \$10

## Digital Research Computers

P.O. BOX 461565 • GARLAND, TEXAS 75046 • (214) 225-2309

Call or write for a free catalog on Z-80 or 6809 Single Board Computers, SS-50 Boards, and other S-100 products.

TERMS: Add \$3.00 postage. We pay balance. Orders under \$15 add 75¢ handling. No C.O.D. We accept Visa and MasterCard. Texas Res. add 5-1/8% Tax. Foreign orders (except Canada) add 20% P & H. Orders over \$50 add 85¢ for insurance.

should result in fewer errors being introduced than is normally the case when complex executable code is modified. The old metalanguage program can then be applied to the new specification. It is to be hoped that, as the metalanguage program encapsulates the higher-level ideas behind the design of the program, it will still be applicable to the modified specification. If it is, then no further work has to be done. If not, the worst that can happen is that the system fails to produce an acceptably efficient program from the specification. This is an indication that the modifications made are substantial enough to require a rethink on our design ideas, and these can be expressed as modifications to the metalanguage program necessary to achieve a successful transformation.

### SPECIFICATION TECHNIQUES

The essence of a specification is to say what is to be computed, not how it is to be computed. The area of specification techniques deserves an article to itself. Here, I will confine myself to giving a few simple examples to illustrate the directions in which the work is leading.

In a functional language, the forms that one can write are restricted to facilitate the construction of efficient interpreters. One route to languages of greater expressive power for use in specification is to remove some of these restrictions. For example, what we can write on the left-hand sides of equations in Hope is severely limited. If we remove some of these restrictions, we can write equations that define functions implicitly rather than explicitly.

For example, given that integer multiplication is defined as the Hope function mult, one could simply define the division function, div, thus:

$$\text{mult}(\text{div}(n, m), m) = n$$

Such a specification can be transformed to a directly executable version using the standard manipulation rules. It is interesting to note that such specifications can also be executed but require more sophisticated, and less efficient, interpretation regimes than are currently used for functional languages.

Another line of development for specification is specialized, often tabular, specification languages for specific domains. One route to such languages is to regard them as syntactic extensions to an underlying functional language and use transformation techniques to convert them to efficiently executable programs.

### OTHER LANGUAGES, OTHER TOOLS

Transformation is a general technique and has been applied to many styles of language other than the functional ones. Transformation techniques and systems based on conventional procedural languages have been extensively studied. It will come as no surprise to the reader to learn that we have doubts about the ultimate success of these enterprises.

In contrast, transformation techniques have been very

(continued)

ALL SALES SUBJECT TO THE TERMS OF OUR 90 DAY LIMITED WARRANTY. FREE COPY UPON REQUEST.

# DATAEASE™

## The Corporate Database Standard.

### DATAEASE

#1 with Corporate users.

Thousands of businesses, both large and small, use DATAEASE to solve their needs. Because DATAEASE, with its ideal combination of power and ease-of-use, allows you to gather, link, calculate and report information key to decision making — all without programming skills.

*"We chose DATAEASE over dBASEII™ and Lotus 1-2-3™ because most of the programming was already done."*

**Joe Dane, Human Resources Director**  
MCI Telecommunications Corporation

*"Office staff members with little to no computer experience are actively using DATAEASE to improve productivity in handling large amounts of information."*

**Louis M. Brigando, Senior VP,**  
MetPath, Inc.

*"We switched from a \$250,000 mini system to a \$15,000 system of IBM PC's and DATAEASE. Now orders, inventory, sales . . . everything is easier. All without the help of a programmer."*

**J.A. Fulmer**  
**Robinson**  
**Foundry, Inc.**

### DATAEASE

#1 with Reviewers

*"I was very impressed with its overall performance and features."*

**Bill Jacobson**  
BYTE, October 1984

*"DATAEASE is a true winner."*

**Business Computer Systems**  
April 1984

*DATAEASE was rated good or excellent in performance, documentation, ease-of-use, error handling, support...in all areas.*

**InfoWorld**  
March 25, 1985

*"DATAEASE is perhaps the most effective blend of ease-of-use and performance available for PC users to date."*

**Data Decisions**  
January 1985

For information or the dealer nearest you call:

**800-243-5123**

### DATAEASE

#1 in Corporate sales.

According to several recent best seller lists, DATAEASE is now the industry standard for corporate users who want a database that doesn't require programming:

*DATAEASE tops dBASEII, R:BASE™ in Corporate Software sales.*

**Infosystems, March 1985**  
Corporate Best Seller List

*DATAEASE outsold all other database management systems — ahead of dBASEIII™, Symphony™ Framework™ and R:BASE 4000.*

**MIS, Inc., September 1984**  
A leading supplier to Corporate America

*DATAEASE ranked #3 on best sellers list; outselling Lotus 1-2-3™, R:BASE and Powerbase™*

**Software News, March 1985**  
Corporate Best Sellers List

Why settle for less? Contact Software Solutions, Inc. for more information on DATAEASE, the #1 choice of Corporate America.

**Software Solutions, Inc.**  
305 Bic Drive, Milford, CT 06460  
203-877-9268  
Telex: 703972

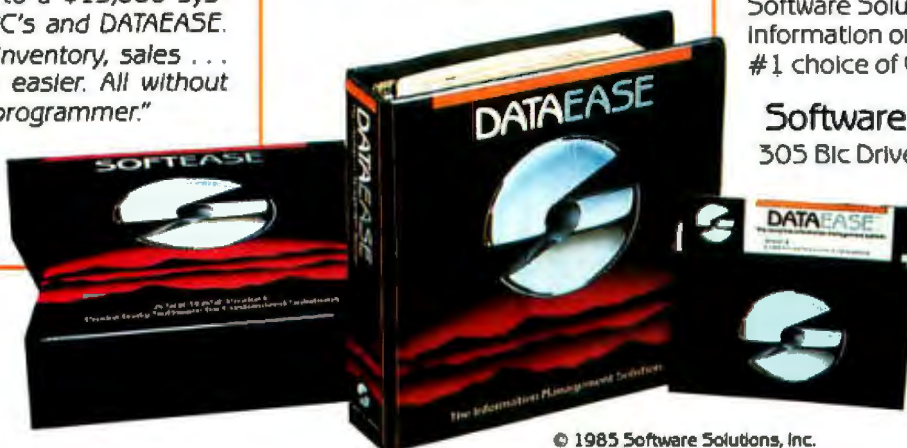

© 1985 Software Solutions, Inc.

Scandinavia  
West Soft A/S, Alesund, Norway; (47) 71-41141

South Africa  
Dataflex, Craighill; 11724-8553

Switzerland, France  
Softsource, SA 1222 Vesenz, Switzerland; 022-3518-35

United Kingdom  
Sapphire Systems, Essex; 01-554-0582

West Germany, Austria  
M&T Software Verlag, Munich; 089-4613-0

# The Ultimate Cable Assembly

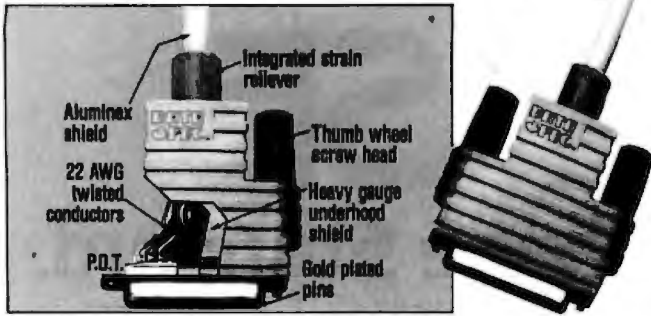

## Inside and Out

You've never seen a cable that looks or works quite like this. The result of extensive research into functional design, the DATA SPEC cable assembly not only visually enhances your computer equipment, but provides superior quality with the following features:

- Full shielding (Exceeds F.C.C. EMI/RFI emission requirements)
- Positive strain relief
- Large convenient thumbscrews
- Exclusive P.D.T. underhood for maximum integrity
- Lifetime warranty
- Gold plated pins

DATA SPEC makes cable assemblies for all your interface needs: printers, modems, disk drives and monitors. For your IBM, Apple, AT&T and other popular PC's. Ask for DATA SPEC cables at your nearest authorized DATA SPEC dealer.

### DATA SPEC®

FROM ALLIANCE RESEARCH CORPORATION

20120 Plummer Street • Chatsworth, CA 91311 • 1-818-993-1202

IBM, Apple and AT&T are registered trademarks respectively of International Business Machines Corp., Apple Computer Inc. and AT&T Information Systems Patent PND. © Copyright 1985 Alliance Research Corporation

## TRANSFORMATION

successfully applied to the other main class of declarative languages, the logic programming ones. The unfold/fold methodology can be directly translated into logic programming terms and all the same derivations performed on logic programs as can be performed on functional ones. Furthermore, one can use the full descriptive capability of unrestricted first-order predicate calculus for a specification language and transform these specifications into efficient Horn clause logic programs.

The mathematical well-foundedness of the declarative languages allows the construction of other useful tools besides transformation systems. For example, one can analyze functional and logic programs to assess their efficiency, check their consistency, and also derive consequences from programs. For example, we may be able to infer that the result of a computation can never be greater than some bound.

Our vision for a programming environment of the future is one founded on machine-assisted transformation as the main program-development activity, but supported by a collection of intelligent programming tools that offer material assistance to the programmer because they understand the developing program at a level much deeper than the textual level at which most present-day program-support tools operate.

## FUTURE PROSPECTS

Transformation is a promise for the future, not a present-day practical reality. However, the current problems and costs associated with the development and maintenance of large-scale, complex software systems seems to point to a need for some radical solution that is not accessible via present-day languages and methodologies.

The next few years promise to be fascinating ones for workers in declarative languages. The coming together of parallel machines, mature declarative languages, and transformation-based programming environments means that all the mutually supporting components are in place for a searching appraisal of the ultimate practicality of this approach. Much needs to be done to deliver on all the promises, but we are confident that the well-foundedness of the approach will ultimately prevail. ■

## BIBLIOGRAPHY

- Clark, K. L., and S. Sickel. "Predicate Logic: A Calculus for Deriving Programs." *Proceedings of the 5th International Joint Conference on Artificial Intelligence*, vol. 1. Cambridge, MA: 1977.
- Darlington, J. "The Structured Description of Algorithm Derivations." *Algorithmic Languages*. J. W. de Bakker and J. van Vliet, eds. New York: Elsevier, 1982.
- Darlington, J., and R. M. Burstall. "Some Transformations for Developing Recursive Programs." *Journal of the ACM* 24:1, 1977, page 44.
- Partsch, H., and R. Steinbruggen. "A Survey of Program Transformation Systems." *ACM Computing Surveys* 15:3, September 1983.
- Pepper, P., ed. *Program Transformation and Programming Environments*. Report on a workshop directed by F. L. Bauer and H. Remus. Springer-Verlag, 1984.

### HARMONY VIDEO & COMPUTERS

2357 CONEY ISLAND AVE., BROOKLYN, NY 11223  
800-VIDEO84 OR 800-441-1144 OR 718-627-1000

	<b>IBM PC 256K</b>	<b>PANASONIC 1091</b>
	\$1309.95 <b>STAR SG 10</b> \$209.50	\$229.50 <b>APPLE 2E w/DRIVE</b> \$819.95

**"PRINTER SPECIALS"**

Brother HR15 XL	324	NEC 2050	809	Panasonic KXP 1093	481
Brother HR 35	678	NEC 3350	873	Panasonic KXP 3151	378
Citizen MSP 10	268	NEC 6850	1383	Powertype	275
Citizen MSP 15	468	NEC p3 or p2	891	Star SG 10	208
Corona Laser	2481	Okidata 90	541	Star SG 15	326
Daisywheel	728	Okidata 192	329	Star SD10	308
Epson LX80	216	Okidata 193	520	Star SD15	404
Epson RX 100	389	Okidata 192	276	Star SR10	436
Epson FX 80	323	Okimate 10	119	Star SR15	543
Epson LX20	548	Olympic Compact 2	338	Star SB10	671
Epson FX 100 +	515	Olympic	288	Silver Reed Exp 550	374
Epson LQ 1500	820	Panasonic KXP 1081	229	Silver Reed Exp 500	224
HP Laser Jet	2788	Panasonic KXP 1090	187	Silver Reed Exp 770	850
Juki 8100	354	Panasonic KXP 1092	331	Toshiba 1340	515
Mannesman Spirit 80	177			Toshiba 351	1113

## WOW! WOW! WOW!

IBM	APPLE	MONITORS			
AT Enhanced	4399	2E w/Disk Drive	819	Amdet 300 Green	108
AT Unenhanced	3215	Apple 2C	983	Amdet 300 Amber	109
IBM Monitor	208	Imagewriter	486	310 Amber	136
PC 256K	1309	Adsk Drives	from 104	Color 300	188
PC XT	1789	Orange Interface	39	Color 500	296
IBM Drive	156			Color 800	374
AST Sm Patch	209	<b>ATARI</b>		Color 700	411
Tallgrass 25 Meg	2498	130 XE	126	Color 710	489
Quad Board	319	800XL	83	Princeton HX12	419
Keytronics	129	1027 Printer	174	Princeton Max 12	156
Hand I	289	1050 Drive	148	Toscan 122A	130
Hercules Color	140	Instst. Drive	303	Toscan 420	380
Hercules Monochrome	280	1025 Printer	141		
Mitsuba Monochrome	289	Keats Pad	39	<b>SANYO</b>	
Mitsuba Multifunction	239			555 D.S	856
Paradise Graphics	250	<b>MODEMS</b>		MBC 775	1884
Paradise Multi Display	271	Hayes 1200	381		
STB Graphics + 2	244	Hayes 1200C	326	<b>COMMODORE</b>	
Tecmar Graphics	427	Hayes 300	122	Commodore 64	145
Tecmar Copystan	154	Hayes 2400	582	1541 Disk Drive	168
Purysat Monocord	148	Microcommod 2E	127	1702 Monitor	175
Bernoulli Box	1798	Novation J-cat	89	1F6 802	189
10 Meg Drive	883			Instst. Drive	213
Joystick	26			Card io Interface	34

800-441-1144

Items reflect cash discount! For your protection we check for stolen credit cards.



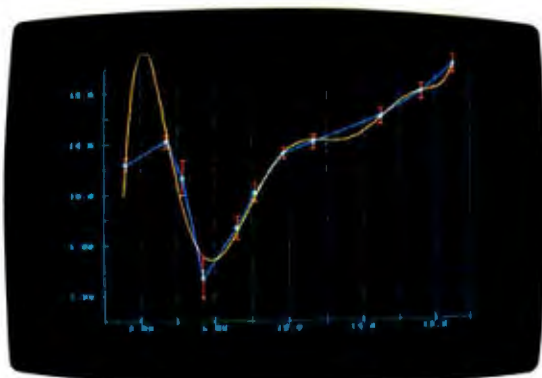

ASYST high-resolution graphics now include error bars, labels, axes, grids, and multiple colors.

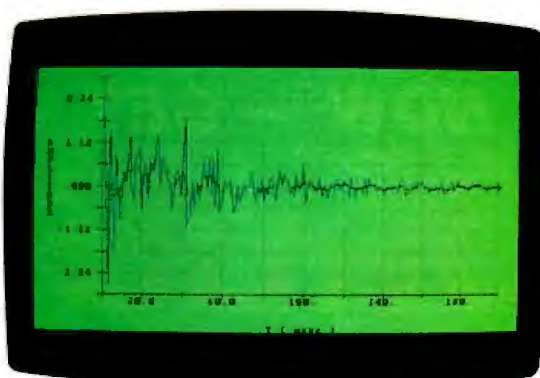

New color graphics enhance comparison of experimental data with filtered data.

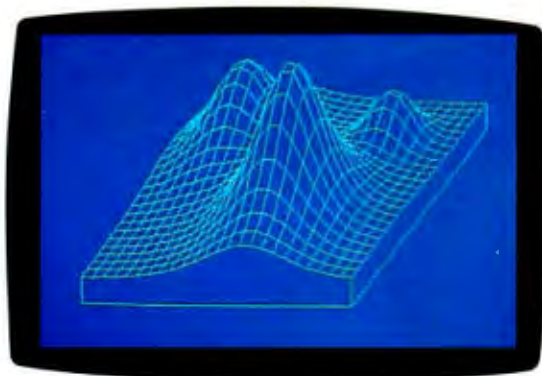

ASYST axonometric plots simplify analysis of complicated 3-dimensional surfaces.



Contour plotting adds an alternative approach to meaningful 3-D representation.

# ASYST adds new muscle.

## More hardware support, more analysis capabilities for the IBM PC.

ASYST™ Scientific Software turns your IBM PC, XT,™ AT, or compatible into a complete scientific workstation. And now it's even more versatile, with:

- Expanded analysis capabilities
- High-resolution color graphics
- GPIB/IEEE-488 hardware support
- Axonometric and contour plotting
- Additional A/D hardware support

### Minicomputer speed and precision— at a fraction of the cost.

ASYST on an IBM PC does a 1024-pt. FFT in less than 3 seconds (as fast as 1.2 on some compatibles). For the same task, an optimum performance routine on a DEC 11/23+ minicomputer using FPF 11™ took 2 seconds—at 5 times the price!

### Built-in routines. Full programmability.

Straightforward, pre-programmed commands, such as XY.DATA.PLOT, FFT, and A/D.IN, put you in total control right away. Commands can be used interactively, or combined and modified as needed—from simple macros to fully customized programs. And all com-

mands co-reside in memory—no disk shuffling.

### ASYST is four separate, fully-integrated modules:

**Module 1: System/Graphics/Statistics** establishes the environment. It provides basic mathematics operators, descriptive statistics, array manipulation and control, automatic plotting and color graphics support (including IBM standard/enhanced and Hercules boards), a text editor, file I/O, and a built-in programming language.

**Module 2: Analysis** reduces and analyzes data. Includes eigenvalues, eigenvectors, polynomials, ANOVA, axonometric and contour plotting, least squares approximations, curve fitting, convolutions, integration, differentiation, smoothing, and fast Fourier transform.

**Module 3: Data Acquisition** allows communication with lab equipment and analog signal sources. Includes A/D and D/A conversions, digital I/O, timing, and triggering. Supports standard interface boards including IBM DACA.

**Module 4: GPIB/IEEE-488** allows additional interfacing to some 10,000 instruments through a variety of plug-in cards.

• Purchase Module 1 alone—or with any combination of the other modules—to tailor the system to your specific applications.

**Try ASYST for 30 days.** For details, call (800) 348-0033; in NY, (212) 702-3241.



# ASYST

MACMILLAN SOFTWARE CO.  
An Affiliate of Macmillan Publishing Company  
866 Third Avenue, New York, NY 10022

**YOU'VE GOT THE BEST PASCAL COMPILER.**

**NOW — GET THE BEST UTILITY!**

# TURBO SCREEN™

**\$49.95**

**NEVER AGAIN WRITE SOURCE CODE FOR SCREEN DISPLAYS!**

*If you LIKE Turbo Pascal\*, you'll LOVE TURBO SCREEN™!*

Tired of writing line after line of source code just to create effective screen displays and error-proof data handling? Then use TURBO SCREEN's Editor to create the screens, the Collator to define a list of screens... and then relax for a few seconds while the Generator writes the code!

## TURBO SCREEN™

- 100 Fields per screen, and up to 80 screens in your application.
- One screen or eighty, the size of your program doesn't change.
- I/O field types of:  
Real, Integer, String, Character, Boolean.
- "Bullet-proof" data entry.
- Create Window-Style overlays or Full-screen pictures in CP/M\*, MS-DOS\*, or PC-DOS.
- Supports video attributes for your terminal. And YES, if you have an RGB monitor, you can create screens in COLOR on your IBM PC or true compatible.
- A SINGLE LINE of source code invoking TURBO SCREEN'S "display" procedure controls:  
—picture selection  
—output to screen, printer, or disk  
—I/O field update
- TURBO SCREEN™ is completely menu-driven and includes a built-in Screen Editor, Collator, and Generator, each called up with a single keystroke!
- ADVANCED EDITOR:  
—Turbo Pascal\*-like commands include:  
—Block commands for copy, fill, exchange, erase.  
—Draw lines in any direction with any character.  
—Supports IBM color monitor and graphics characters.
- FAST—Generates code for 20 screens in about 60 seconds!
- DISK UTILITIES built-in:  
—directories  
—erase files
- REQUIRES:  
—Turbo Pascal any version  
—80x24 or larger video screen
- AVOID software "bottlenecks!"

## PASCOM COMPUTING

23611 Chagrin Blvd., Suite 101  
Cleveland, Ohio 44122

Check \_\_\_\_\_ TURBO SCREEN™  
package \$49.95  
Money Order \_\_\_\_\_ Plus Ship.  
(UPS) 5.00  
Visa \_\_\_\_\_ Total \$54.95  
Master Card \_\_\_\_\_  
Card # \_\_\_\_\_  
Exp. Date: \_\_\_\_\_

Start letting TURBO SCREEN™ write your I/O source code today!



ONLY — Call TOLL-FREE: 1-800-243-184

Inside Ohio call 1-216-292-8745 (Lines Open 24 hours, 7 days)

Computer System: \_\_\_\_\_ 8-bit \_\_\_\_\_ 16-bit  
Operating System: \_\_\_\_\_ CP/M80 \_\_\_\_\_ PC-DOS  
\_\_\_\_\_ CP/M86 \_\_\_\_\_ MS-DOS  
Computer Model: \_\_\_\_\_ Disk Format: \_\_\_\_\_  
Name: \_\_\_\_\_  
Address: \_\_\_\_\_  
City: \_\_\_\_\_ State \_\_\_\_\_ Zip \_\_\_\_\_  
Telephone: \_\_\_\_\_

Ohio residents add 6 1/2 % sales tax. Outside U.S.A. add \$20.00

U.S. Dealer Inquiries Welcome

\*Turbo Pascal is a trademark of Borland International. IBM is a trademark of International Business Machines. MS-DOS is a trademark of Microsoft. CP/M is a trademark of Digital Research.

# FUNCTIONAL PROGRAMMING USING FP

BY PETER G. HARRISON AND HESSAM KHOSHNEVISAN

## *How to program without objects*

IN 1977, JOHN BACKUS introduced a functional style of programming in which variable-free programs are built from a set of primitive programs by a small set of combining forms (functionals that are also often referred to as program-forming operations or PFOs) and by recursive definitions. This style is embodied in the language FP, which facilitates the manipulation of the functions themselves rather than repeatedly creating new objects from old ones in an auxiliary domain. FP thus relates to a higher level of analysis than do the more common, object-oriented functional languages. In fact, FP has its own functional algebra that prescribes rules for manipulation of functions and so simplifies reasoning about programs. FP systems have the following properties:

- Programs have extremely simple semantics.
- There often exist nonrecursive expressions for many functions that are normally recursively defined (similar to using a loop in Pascal).
- Programs exhibit a clear hierarchical structure.
- The principal combining forms are the operations of the powerful algebra of FP programs. This algebra can be used to solve equations for recursively defined programs and to transform programs into versions that run more efficiently or consume less space.
- Transformation of recursive to nonrecursive functions and to loops can often be achieved automatically in FP.

The main obstacle to the advancement of functional programming languages has been their poor run-time per-

formance on conventional computers. This is primarily due to the large number of (mainly stack-based) manipulations required to preserve referential transparency in the languages. Von Neumann computers execute instructions sequentially and so are tailored toward supporting sequential languages with destructive assignment. One way to improve performance is to offer a radically different computer architecture, specifically tailored toward supporting functional languages (see references 1 and 2). But there is also a need to provide efficient implementations of these languages on conventional machines. These are likely to remain widespread for the foreseeable future, in particular in the personal computer market, whatever the impact of any new architectures. A route to improved performance is to transform recursively defined solutions into iterative ones. FP programs lend themselves to this type of transformation very well since they do not refer to the auxiliary domain of objects, which often obscures the process of program transformation. Transformations of this sort may also prove beneficial to parallel implementations by increasing the size of the basic unit of work performed by each processor. This naturally reduces communication overhead, which often limits the performance of parallel machines.

(continued)

Dr. Peter G. Harrison is a lecturer in the Department of Computing, Imperial College. Hessam Khoshnevisan received his bachelor's degree in computing science from Imperial College, where he now works as a research assistant on the ALICE project. They can be reached at Imperial College, 180 Queen's Gate, London SW7 2BZ, England.

The FP algebra provides a formal basis for program transformation and so facilitates its automation. [Editor's note: The idea of program transformation is discussed in "Program Transformation" by John Darlington on page 201.] Conventional transformation techniques prescribe algorithms for transforming functions when applied to certain arguments. The transformation strategy in FP is based upon theorems that state identities between functional expressions. A transformation is then simply an instance of the application of a theorem.

**FP SYSTEMS**

An FP system consists of the following:

- A set of primitive functions (for example, the arithmetic operators +, -, \*, etc.).
- A set of PFOs. These are programming constructs analogous to while loops, conditionals, and so on, found in conventional languages like Pascal, and they may be used to create more complex functions from simpler ones.
- A domain of objects that might be, for example, integers, characters, sequences, etc.

User-defined functions are defined in terms of these FP system components.

PFOs are the programming constructs of FP (like while, if . . . then . . . else, etc., of Pascal) and differ from the programming constructs of other languages (including other functional languages) in that they are predefined operations on functions as opposed to objects. We are all familiar with the conditional statements, such as if P then Q else R in Pascal. The conditional operation of FP ( $f \rightarrow g ; h$ ) is similar except that the predicate and the true and false branches of the conditional are expressions involving only functions, namely  $f$ ,  $g$ , and  $h$ . These expressions can be primitive functions, user-defined functions, or expressions built using the PFOs. In short, all PFOs take a number of functions as arguments and return a single FP function. All FP functions take a single object as input and produce a single object as their result; i.e., they are of type  $\text{Object} \rightarrow \text{Object}$ . All FP systems are equipped with an operation called application, which, given a function and an object, produces the result of applying the function to the object. The notation  $f \cdot x$  is used to represent the application of function  $f$  to the object  $x$ .

To define an FP system, we must specify the set of primitive functions, the set of PFOs, and the set of objects. Listed in the text box "FP Syntax" on page 228 are some examples of primitives and PFOs that might be present in an FP system. The meaning of each is given by specifying the result of its application to various kinds of objects. If PFOs are applied to any other kind of object, not mentioned in their meaning, the result of the application will be  $\perp$ . This is read as "bottom" and denotes the undefined object or error. So, for example, an attempt to add the integer 1 to the character a will yield  $\perp$  since a is not the correct type for the + primitive.

The set of objects is determined by the set of atoms chosen. For example, if we choose to consider the set of integers, the set of nonempty strings, and the atoms T and F denoting true and false, then T, 66, -88, 0, c, Hello, F, and GHJ are all valid atoms.

Considering now the set of objects that we can write down, we know that

- Every atom is an object.
- All sequences of objects, denoted by  $\langle x_1, x_2, \dots, x_m \rangle$   $m \geq 0$  (where each  $x_i$  is an object other than  $\perp$   $1 \leq i \leq m$ ), are objects.
- $\perp$  is an object.
- Thus,  $\langle \langle 66.7 \rangle \text{ ALA} \langle \text{GAB FO W} \rangle \rangle$  is an object.

**USER-DEFINED FUNCTIONS**

The set of primitives and PFOs determines the set of functions that can be defined. The user can define functions using the def statement in FP. For example,

`def MyFun = AFun  $\rightarrow$  BFun; CFun`

defines a function in terms of an FP PFO—in this case, the conditional. Note that AFun, BFun, and CFun must all be functions (which can themselves be built by the use of PFOs).

Each PFO takes a number of functions as parameters. The number of parameters is determined by the particular PFO. The "conditional" PFO takes three parameters, whereas the "construction" PFO can accept any number of function parameters. Recursive function definitions are allowed, so in the above example any of the expressions AFun, BFun, or CFun can refer to MyFun.

Note that the syntax for function application and composition in basic FP can be rather clumsy; for example, `add: <2,3>` as opposed to `2 + 3` or `al: <2, <3,4,5>>` as opposed to `2::<3,4,5>`. However, it is easy to incorporate infix notation into many variable-free functional expressions. For example (using infixes `::`, `+`), `f::g` represents `al[f, g]` and `f + g` represents `+o[f, g]`. But note that if  $f = \{h, g\}$ , `+of` is clearer than `(1of) + (2of)` or `(1 + 2)of`.

**PROGRAMMING IN FP**

A user-defined function is defined by one and only one definition. The name given to the function must be unique and must not coincide with the names associated with the primitive functions and PFOs. Remember that no part of a definition is a result itself; instead, each part is a function that must be applied to an argument to obtain a result.

Here are four simple examples of recursive user-defined functions:

```
def last = nullotl  $\rightarrow$  1; lastotl
def len = null  $\rightarrow$  0 ; +o[1, lenotl]
def cat = nullol  $\rightarrow$  2 ; al[1ol, catotl[1ol,2] ]
def fact = eq0  $\rightarrow$  1 ; *o[id, factosub1]
```

(continued)

# TAXAN

**TOTAL COMPATIBILITY FOR \$995**

The New 710S Color Plotter and Taxan 440 Ultra High Res RGB Monitor. Now you can plot your exciting software diagrams on the dynamic and innovative new Model 710S Color Plotter. The New 710S is compatible with the HP7475A\* Plotter. That means software programs like Autocad®, Lotus 1-2-3®, and many others are totally compatible! The new Taxan 710S Color Plotter offers a colorful six pen compatibility! Hardware compatible with IBM®, COMPAQ® TI® and many other personal computers allows interface with functional software programs, and a complete compliment of business graphics software programs. You can take full advantage of this new Taxan 710S Plotter for only \$995.00! Create those graphic masterpieces using the razor sharp resolution of the Taxan Model 440 Monitor. The Taxan 440 is the first Ultra High Resolution monitor to offer a 640x400 flicker free resolution.



**TAXAN** | RGB vision 440

BRIGHT  
COLOR →  
GREEN ■

Autocad software courtesy of Control Systems

## RESOLUTION BEYOND IBM EGA

The Taxan Model 440 works with the Taxan Model 555®, Persyst B.O.B. Board®, Sigma 400L®, Artist Board®, and many others. Taxan gives you superior quality text and double scan graphics when used with software programs like Lotus 1-2-3. The Model 440 offers the type of resolution you used to dream about having! Even the IBM EGA® cannot support existing graphic software with 640x350 resolution. Taxan. For Highest Resolution and even Higher Quality.



\*HP7475 is a registered trademark of Hewlett Packard Corp. \*Autocad is a registered trademark of Auto Desk Inc. \*Persyst B.O.B. Board is a registered trademark of Emulex Corp. \*IBM and EGA are registered trademarks of IBM Corp. \*Lotus 1-2-3 is a registered trademark of Lotus Development Corp. \*Artist Board is a registered trademark of Control Systems. \*Sigma 400L is a trademark of Sigma Designs. \*Taxan 555 is a registered trademark of Taxan Corp. © 1985 Taxan Corporation

**TAXAN CORPORATION, 18005 CORTNEY CT., P.O. BOX 8698, CITY OF INDUSTRY, CA 91748 (818) 810-1291**

The first returns the last element of a sequence, the second returns the length of a sequence, the third concatenates two sequences, and the last defines the factorial function.

Observe that the examples of function definitions given above, although written in FP, are written in a recursive style that is familiar from conventional functional languages such as Hope, LISP, and KRC. For instance, the definition of last says that if the tail of the sequence is empty then select the first element of object; otherwise, look for the last element of the tail of the object using a recursive call to last. In the FP style, it is often possible to replace an explicitly recursive definition by an equivalent nonrecursive functional expression.

The function last could, in most systems, be expressed purely in terms of primitives; for example,  $\text{def last} = 1r$ . Similarly a more natural FP definition for factorial is  $\text{def f} = (/ *) \circ \text{iota}$  or, alternatively,  $\text{def f} = (\backslash *) \circ \text{iota}$ . This "inserts" a \* between each element of the sequence  $\langle 1, 2, \dots, n \rangle$ .

A function to concatenate (append in Hope) two sequences is  $\text{def cat} = (/ \text{al}) \circ \text{ar}$ . This nonrecursive definition successively appends an item from the end of the first sequence onto the beginning of the second. Note that / cat will then be a function that concatenates any number of sequences.

The function len, for length, would be a primitive in most systems, but if not, the more natural FP definition could be  $\text{def len} = \text{null} \rightarrow \bar{0} ; + \circ (\alpha \bar{1})$

This definition says that  $\text{len}:x$  is 0 if  $x$  is empty; otherwise, change each element of  $x$  into 1, and then add up the 1s. The items are literally counted!

Observe that the more natural FP solutions are nonrecursive (effectively the recursion has been pushed into the PFOs used). Although these nonrecursive definitions may look strange initially, they express an equally obvious solution. By becoming familiar with the high-level PFOs and their concise syntax, you can give concise, expressive, and flexible definitions that are often nonrecursive, using just a few symbols. (It has been suggested that programmer productivity is inversely proportional to the number of characters required in a program.)

Here, then, are some more complex examples that make use of the PFOs:

**VECTOR PRODUCT:** We can define the function VectorProduct to be  $\text{def VP} = (/ +) \circ (\alpha *) \circ \text{trans}$ . Application of VP to a pair of equal-length vectors first creates the sequence of matched pairs of components (result of trans), then multiplies each pair, and finally sums these results. For nonequal-length vectors, the result of trans is  $\perp$  and so therefore is the result of VP. We can explain each step in evaluating VectorProduct applied to the pair of vectors  $\langle \langle 1, 2, 3 \rangle, \langle 6, 5, 4 \rangle \rangle$  as shown in table 1.

**MATRIX MULTIPLY:** We can define the function MatrixMultiply to yield the product of any pair  $\langle y, z \rangle$  of conformable matrices, where each matrix is represented as the sequence of its rows:

$$y = \langle y_1, \dots, y_m \rangle$$

$$\text{where } y_i = \langle y_{i1}, \dots, y_{in} \rangle \text{ for } i = 1, \dots, m$$

$$z = \langle z_1, \dots, z_n \rangle$$

$$\text{where } z_i = \langle z_{i1}, \dots, z_{ip} \rangle \text{ for } i = 1, \dots, n$$

The function is then defined as

$$\text{def MM} = (\alpha \alpha \text{VP}) \circ (\alpha \text{distl}) \circ \text{distr} \circ [1, \text{trans} \circ 2]$$

**BINARY TREE INSERT:** Suppose that a binary tree is represented by a sequence of three elements, where the first element is the left binary tree, the second is the data at the node (which we will assume is a number), and the third is the right binary tree. A function InsertInSorted-BinaryTree (IISBT), which inserts a number into a tree in such a way that all elements in the left subtree are less than the smallest number in the whole of the right subtree, might look like this:

$$\text{def IISBT} = \text{null} \circ 1 \rightarrow [ [], 2, [] ];$$

$$1 \circ [ 2 \circ 1, 2 ] \rightarrow [ 1 \circ 1, 2 \circ 1, \text{IISBT} \circ [ 3 \circ 1, 2 ] ];$$

$$[ \text{IISBT} \circ [ 1 \circ 1, 2 ], 2 \circ 1, 3 \circ 1 ];$$

**PART PRODUCT:** A function ParProds, when given a sequence of integers  $\langle x_1, \dots, x_m \rangle$ , produces a sequence of integers  $\langle y_1, \dots, y_m \rangle$  such that, for  $1 \leq i \leq m$ ,

$$y_i = x_1 * \dots * x_i$$

Thus  $\text{ParProds} \circ \text{iota} : 5 = \langle 1, 2, 6, 24, 120 \rangle$

i.e., the sequence of factorials of the numbers 1 through 5. We may start from the observation that

(continued)

Table 1: A step-by-step explanation of the operation of VP.

VP : $\langle \langle 1, 2, 3 \rangle, \langle 6, 5, 4 \rangle \rangle$	
By def of VP	$\Rightarrow (/ +) \circ (\alpha *) \circ \text{trans} : \langle \langle 1, 2, 3 \rangle, \langle 6, 5, 4 \rangle \rangle$
Effect of Composition	$\Rightarrow / : (\alpha * : (\text{trans} : \langle \langle 1, 2, 3 \rangle, \langle 6, 5, 4 \rangle \rangle))$
Applying Transpose	$\Rightarrow / : (\alpha * : \langle \langle 1, 6 \rangle, \langle 2, 5 \rangle, \langle 3, 4 \rangle \rangle)$
Effect of Apply to All	$\Rightarrow / : \langle * : \langle \langle 1, 6 \rangle, * : \langle 2, 5 \rangle, * : \langle 3, 4 \rangle \rangle$
Applying *	$\Rightarrow / : \langle 6, 10, 12 \rangle$
Effect of Insert	$\Rightarrow + : \langle 6, + : \langle 10, 12 \rangle \rangle$
Applying +	$\Rightarrow + : \langle 6, 22 \rangle$
Applying + Again	$\Rightarrow 28$

**Kimtron**

# MULTI-USER SOLUTION for IBM PC, XT, AT

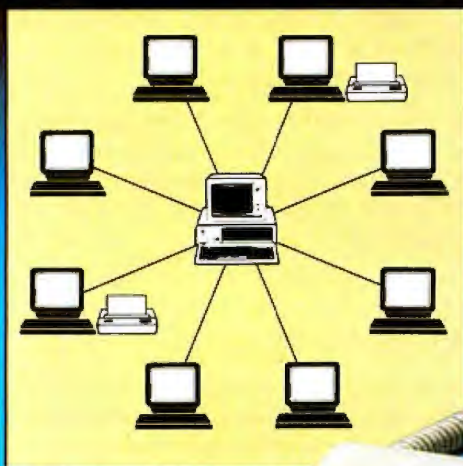

## Compare the Solution!

The Multi-User Solution of the future is now available.

Convert your IBM PC, XT, AT or Compatibles to a true multi-user system while maintaining display, keyboard and software compatibility.

Since the KT-7/PC display is the same as your PC monochrome monitor, with its look-alike keyboard, operators will feel they're using an IBM PC and can also use the same software manual. Kimtron's multi-user solution includes file and record locking, shared data access, and communication between users. It is the intelligent alternative.

The KT-7/PC supports Time Sharing, Enhanced Time Sharing

and Multi-Processor implementation under PC DOS, MS DOS, UNIX, XENIX, CPM 86, Multilink, Concurrent PC DOS, and other compatible multi-user operating systems.

Kimtron's multi-user solution may be tailored for cost effectiveness; as low as \$1095 for an additional user, and for speeds more than ten times faster than LAN. You can add one or as many as 31 additional users per PC. Kimtron delivers the future now by allowing an ever-widening network of multi-user PC's.

The KT-7/PC may be complemented with one (or more) I/O Card, Memory Card, 8086 Speed

Enhancer Card, 80286 AT Card, 8088 Multi-Processor Card, 80186 Speed Enhancer Card, 68000 Card, and related software.

For more information about Kimtron's Multi-User Solution, or general video data terminals for other mini or micro multi-user systems, call your local computer dealers, distributors or Kimtron Corporation Today!

**(408) 727-1510**

NOTE: IBM PC, XT, AT, PC DOS, MS DOS, UNIX, XENIX, CPM 86, Multi-Link, Concurrent PC DOS are registered trademarks of IBM Corporation, Microsoft Corp., Bell Labs., Digital Research Inc., Software Link Inc. respectively.

1705 Junction Court  
Building #160  
San Jose, CA 95112  
**Kimtron**

Express Computer Presents:

# a DISKETTE SALE

You CAN buy quality diskettes at low PRICES including a LIFETIME WARRANTY.

**SS DD .81**

**DS DD .90**

minimum quantity of 50 diskettes

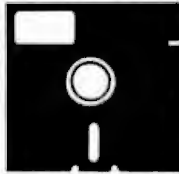

Includes:

- \* Box
- \* Labels
- \* Envelope

- 100% Error Free
- Lifetime Guarantee

TO ORDER

CALL TOLL FREE:

**800-437-5200**

ask for operator 213

MD. residents call:

**1-800-638-8890**

(24 hours a day)

Dealer Inquiries Invited

## LIFETIME WARRANTY!

Send defective diskette back and we'll replace it (if there is a defect in original material and workmanship).

C.O.D. and prepaid orders accepted



# EXPRESS COMPUTER

1101 Valley Glen Rd.  
Elkins Park, PA 19117

Isn't it time  
you had  
a Guru?

# GURU

ARTIFICIAL INTELLIGENCE  
FROM MDBS. COMING SOON.

Guru is a trademark of MDBS. P.O. Box 248, Lafayette, IN 47902 317-463-2581

## PROGRAMMING IN FP

*From a set of axioms that  
are not self-contradictory,  
an algebra may be defined.*

ParProds :  $\langle x_1, \dots, x_m \rangle$   
 = PARAr :  $\langle \text{ParProds} : \langle x_1, \dots, x_m \rangle, y \rangle$   
 where PARAr =  $\text{aro}[1, \text{ro}[1\text{ro}1, 2]]$

Unfortunately, we cannot simply right-insert the PARAr function because it requires that the sequence to which it is applied has a sequence for its first element. We first have to make this element into a sequence. The function ParProds therefore becomes

def ParProds = null  $\rightarrow$   $\bar{0}$ ;  
 ( \ PARAr )  $\circ$  al  $\circ$  [ 1 ],  $\bar{1}$  ]  
 def PARAr =  $\text{aro}[1, \text{ro}[1\text{ro}1, 2]]$

We may now use this nonrecursive function in the definition of other useful functions. For example, it is a relatively simple matter to extend these concepts for the evaluation of polynomials.

### THE FP ALGEBRA OF PROGRAMS

Just as a set of functions mapping a domain of objects into itself may define an algebra on that domain, so too may a set of functionals define an algebra on a domain of functions. The reader will probably be quite familiar with the concept of the field of real numbers (objects) under the composition rules of addition and multiplication (functions) that possess the necessary properties such as associativity; he or she is surely familiar with the well-known algebra that follows. In the same way, a set of axioms that are not self-contradictory may be defined on a set of functions under composition rules given by a set of functionals. From these axioms, it may be possible to establish, as theorems, further properties about the sets of functions and functionals; i.e., an algebra may be defined. Through the algebra, relationships between functions may be established as identities, independent of the domain of objects to which they are applied. The two sides of such an identity yield an equation at the object level for every argument to which they are each applied. Thus the functional algebra provides a more general, higher level of reasoning in which quite powerful arguments can be expressed and results deduced. Note that any set of axioms could be chosen provided they are consistent, but in order that the resulting algebra be useful, the axioms should not contradict known properties of conventional functional languages when the functions of each side of an identity are applied to objects. Thus, for example, we would not choose for an axiom the statement

$$f \circ [g, h] = [f \circ g, f \circ h]$$

(continued)



# ECCELL™ VS. ADVANTAGE!™

Multifunction Board	Orchid ECCELL	Advantage!
Error Correction Code (ECC)	YES	NO
Switchless Installation	YES	NO
Maximum RAM Capacity 4 Mbytes	YES	NO
Free Productivity Software	YES	NO
2 Year Warranty	YES	NO
Supports Lotus/Intel Specification -Breaks the 640K DOS Barrier	YES	NO

Parity Version Available

Attention IBM AT™ owners. Your choice of multifunction boards is about to be simplified.

Because once you find out what ECCELL has to offer, you'll have only one choice: ECCELL by Orchid Technology.

ECCELL is the only multifunction board with ECC (Error Correction Code). ECC actually detects and corrects memory errors *before* they do any harm. So you can keep on working without worrying about the disastrous consequences

of losing your data. In fact, ECC is so critical, virtually no mainframe or minicomputer operates without it.

And ECCELL is the *only* multifunction board with switchless installation; the same advanced technology chosen by IBM when they built their AT. Technology so advanced we can back it with an unprecedented 2 year warranty.

Want more proof? Pick up a pen and prove it yourself.

Then pick up the phone and call Orchid Technology at 415-490-8586.

**Finally, advanced technology for the IBM AT.**

Inquiry 235



47790 Westinghouse Dr., Fremont, CA 94539, TXL: 709289

ECCELL is a trademark of Orchid Technology. Advantage! is a trademark of AST Research, Inc. IBM AT is a trademark of International Business Machines Corp.

DISK/COVERS  
\$100  
MAIN/FRAMES  
SINGLE BOARD

8" & 5"  
WINCHESTER  
& FLOPPY

C  
H  
A  
S  
S  
I  
S  
L  
A  
N  
D  
/  
U  
S  
A

100  
STANDARD  
MODELS

CUSTOM  
TOOL

DON'T  
SEE  
WHAT  
YOU NEED?  
CALL  
&  
ASK

FROM  
\$100  
INCLUDING  
POWER SUPPLY

32 Page  
Free Fakt  
Pakt Catalog

BUILT LIKE  
A TANK —  
WON'T  
BREAK  
THE BANK!

\* 1 Piece: Prices lower in quantity.

**3310**  
5" Floppy &  
Winchester  
4 Cards \$100  
\$387\*

**3307**  
8" Floppy  
& 5" Winchester  
7 Cards \$100  
\$494\*

**3002T**  
5" Floppy  
& Winchester  
10 Cards \$100  
\$565\*

(Disk drives and computer cards not included.)

Write or call for our brochure which includes our application note: "Making micros, better than any 'ol box computer."

**NIERAND**

RESEARCH CORPORATION

8620 Roosevelt Ave./Visalia, CA 93291  
209/651-1203

We accept BankAmericard/Visa and MasterCard

## PROGRAMMING IN FP

### Backus's set of axioms

for FP is consistent but has  
not been shown to be complete.

for all functions  $f, g, h$ , since for object  $x$ , it is not true in general that

$$f: \langle g:x, h:x \rangle = \langle f:(g:x), f:(h:x) \rangle$$

However, we can and do choose

$$[g,h] \circ f = [g \circ f, h \circ f]$$

Backus has presented consistent axioms of the FP functional algebra (reference 3), although the set has not been shown to be exhaustive. When applied to an arbitrary object, each is duly seen to yield an equality that is known to hold. As a simple example of the use of the FP algebra in formal reasoning, we first prove the equivalence between the recursive and nonrecursive definitions of factorial considered above.

We know that, by definition,

$$\text{iota} = \text{eq}0 \rightarrow \text{null}; \text{ar} \circ [\text{iota} \circ \text{sub}1, \text{id}]$$

and FP laws state that for all functions  $f, g, h$ ,

$$(\backslash f) \circ \text{ar} \circ [g, h] = f \circ (\backslash f) \circ g, h]$$

(this is easily checked from the definition of  $\backslash$ ), and for Boolean-valued function  $p$ ,

$$f \circ (p \rightarrow g; h) = p \rightarrow f \circ g; f \circ h$$

(easily checked from the definition of  $\rightarrow$ ). Thus,

$$\begin{aligned} (\backslash *) \circ \text{iota} &= \text{eq}0 \rightarrow (\backslash *) \circ \text{null}; (\backslash *) \circ \text{ar} \circ [\text{iota} \circ \text{sub}1, \text{id}] \\ &= \text{eq}0 \rightarrow \top; * \circ [(\backslash *) \circ \text{iota} \circ \text{sub}1, \text{id}] \end{aligned}$$

and writing  $!$  for  $(\backslash *) \circ \text{iota}$  gives

$$! = \text{eq}0 \rightarrow \top; * \circ [! \circ \text{sub}1, \text{id}]$$

The power of the algebra has been further developed and exploited by Williams (reference 4) and Backus (reference 5), who introduced the linear class of functional forms. A functional form is a functional expression that contains function variables, and a linear form possesses certain properties relating to function expansion, discussed below. A function  $f$  is defined to be (functionally) linear if it has the "else part" given by a linear form in  $f$ , i.e.,  $f = p \rightarrow q; Hf$  for some fixed functions  $p$  and  $q$  and linear form  $H$ . Linear functions such as  $f$  satisfy the Linear Expansion Theorem (LET), which states, loosely, that for object  $x$ , if  $f:x$  is defined,  $f:x = (H'q):x$  for some integer  $i$ , given by another form  $H_1$  (the "predicate transformer") known in terms of  $H$ . Specifically,  $i$  is the least integer such that  $(H_1'p):x = \top$ . This solution is clearly iterative at the function level of description—if a function

(continued)



# THE BETTER LETTER BOX

**Introducing EasyPlex™. The new, easy-to-use electronic mail system from CompuServe.**

Finally! Electronic Mail that's so easy to use you can start composing and sending messages the first time you get online.

Designed for various experience levels, EasyPlex has a menu mode with simple, easy-to-follow directions for beginners, and it lets experienced users save time by working in the prompt or command modes. With EasyPlex, you can compose, edit, send, file, and take advantage of sophisticated

options previously available only with more expensive services.

CompuServe's EasyPlex lets friends and relatives, associations and club members communicate any time of the day or night. And small business owners, real estate professionals, insurance agents, lawyers, writers, etc. can communicate quickly and simply—either interoffice or interstate. "It's Easy." "Just Plex it!"

Best of all, EasyPlex is available to all CompuServe subscribers. And, along with EasyPlex, you get hundreds of valuable and entertaining computing options. Plus the assurance of belonging to the largest, fastest

growing computer information service in the world and the premier supplier of business information to FORTUNE 500 companies.

Start communicating! To buy a CompuServe Subscription Kit, see your nearest computer dealer. To receive our informative brochure or to order direct, call or write:

**CompuServe®**

Information Services, P.O. Box 20212  
5000 Arlington Centre Blvd., Columbus, Ohio 43220

**800-848-8199**

In Ohio, call 614-457-0802

Inquiry 64

An H&R Block Company

# FP SYNTAX

**E**xamples of primitives that might be present in an FP system include the following:

**Add. Subtract. Multiply. Equals, etc. (+, -, \*, eq, etc.)**

When  $x$  is of form  $\langle y, z \rangle$  and  $y, z$  are numbers.  
then  $+ : x$  yields the sum of  $y$  and  $z$   
otherwise  $+ : x = \perp$   
(The others are defined similarly.)

**Greater Than. Less Than. Less Than or Equal, etc. (gt, lt, le, etc.)**

When  $x = \langle y, z \rangle$  and  $y, z$  are numbers  
then (if  $y > z$  then  $gt : x = T$  else  $gt : x = F$ )  
(The others are defined similarly.)

**And, Or, Not (and, or, not)**

When  $x = \langle T, T \rangle$  then  $and : x = T$   
When  $x = \langle F, T \rangle$  or  $x = \langle T, F \rangle$  or  $x = \langle F, F \rangle$   
then  $and : x = F$   
(The others are defined similarly.)

**Null (null)**

When  $x = \langle \rangle$  then  $null : x = T$   
When  $x = \perp$  then  $null : x = \perp$   
otherwise  $null : x = F$

**Append Left (al)**

When  $x = \langle y, \langle \rangle \rangle$  then  $al : x = \langle y \rangle$   
When  $x = \langle y, \langle z_1, \dots, z_m \rangle \rangle$  then  $al : x = \langle y, z_1, \dots, z_m \rangle$

**Append Right (ar)**

When  $x = \langle \langle \rangle, y \rangle$  then  $ar : x = \langle y \rangle$   
When  $x = \langle \langle z_1, \dots, z_m \rangle, y \rangle$  then  $ar : x = \langle z_1, \dots, z_m, y \rangle$

**Selectors (1, 2, 3, ...)**

When  $x = \langle z_1, \dots, z_m \rangle$  then if  $m \geq i$  then  $i : x = z_i$  else  $\perp$

**Right Selectors (1r, 2r, 3r, ...)**

As above, selects first, second, etc., from the right of the sequence.

**Identity (id : x)**

$x$

**Transpose (trans)**

When  $x = \langle \langle \rangle, \dots, \langle \rangle \rangle$  then  $trans : x = \langle \rangle$   
When  $x = \langle x_1, \dots, x_m \rangle$  where  $x_i = \langle x_{i1}, \dots, x_{ik} \rangle$   
for  $1 \leq i \leq m$  then  $trans : x = \langle z_1, \dots, z_k \rangle$   
where  $z_j = \langle x_{1j}, \dots, x_{mj} \rangle$  for  $1 \leq j \leq k$   
otherwise  $trans : x = \perp$

**Distribute Left (distl)**

When  $x = \langle y, \langle \rangle \rangle$  then  $distl : x = \langle \rangle$  When  $x = \langle y, \langle z_1, \dots, z_m \rangle \rangle$   
then  $distl : x = \langle \langle y, z_1 \rangle, \dots, \langle y, z_m \rangle \rangle$

**Distribute Right (distr)**

When  $x = \langle \langle \rangle, y \rangle$  then  $distr : x = \langle \rangle$   
When  $x = \langle \langle z_1, \dots, z_m \rangle, y \rangle$   
then  $\langle \langle z_1, y \rangle, \dots, \langle z_m, y \rangle \rangle$

**Iota (iota)**

if  $x = 0$   $iota : x = \langle \rangle$  if  $x$  is a positive integer  $iota : x =$

$\langle 1, 2, \dots, x \rangle$   
otherwise  $iota : x = \perp$

**Others**

Some other possible primitives are head (hd), tail (tl), right tail (trl), rotate left (rotl), rotate right (rotr), subtract one (sub1), is equal to zero (eq0), and so on. Note that all these are just as easily written in FP using top primitives and the PFOs below. For example,

def eq0 = eq0[id, 0]  
def sub1 = -o[id, 1]

Listed below are some examples of the type of PFOs that could be chosen for an FP system.

**Composition**

$(f \circ g) : x = f : (g : x)$

**Construction**

$[f_1, f_2, \dots, f_m] : x = \langle f_1 : x, f_2 : x, \dots, f_m : x \rangle$

**Condition**

$(p \rightarrow f; g) : x =$  if  $(p : x)$  is T then  $f : x$   
else if  $(p : x)$  is F then  $g : x$   
else  $\perp$

**Insert Left**

$/f : x =$  if  $x = \langle y \rangle$  then  $y$   
else if  $x = \langle y_1, \dots, y_m \rangle$  and  $m \geq 2$   
then  $f : \langle y_1, /f : \langle y_2, \dots, y_m \rangle \rangle$   
otherwise  $\perp$

**Insert Right**

$\backslash f : x =$  if  $x = \langle y \rangle$  then  $y$   
else if  $x = \langle y_1, \dots, y_m \rangle$  and  $m \geq 2$   
then  $f : \langle \backslash f : \langle y_1, \dots, y_{m-1} \rangle, y_m \rangle$   
otherwise  $\perp$

**Apply To All**

$af : x =$  if  $x = \langle \rangle$  then  $\langle \rangle$   
if  $x = \langle y_1, \dots, y_m \rangle$  then  $\langle f : y_1, \dots, f : y_m \rangle$

**Constant**

$f : x =$  if  $x = \perp$  then  $\perp$   
otherwise  $f$

(Here  $f$  is an object parameter.)

To date, FP has been available only to researchers. Interpretive FP systems for relatively large computers have been implemented at such institutions as INRIA; the University of Paris; the University of California at Berkeley; and Westfield College and Imperial College, London. However, we at Imperial College hope to make an FP compiler for VAX and for conventional microcomputers such as the IBM PC available to the general public by the end of this year.

# Introducing the Most Powerful Business Software Ever!

TRS-80™ (Model I, II, III, or 16) • APPLE™ • IBM™ • OSBORNE™ • CP/M™ • XEROX™



## The VERSABUSINESS™ Series

Each VERSABUSINESS module can be purchased and used independently, or can be linked in any combination to form a complete, coordinated business system.

**VERSARECEIVABLES™** \$99.95  
VERSARECEIVABLES™ is a complete menu-driven accounts receivable, invoicing, and monthly statement-generating system. It keeps track of all information related to who owes you or your company money, and can provide automatic billing for past due accounts. VERSARECEIVABLES™ prints all necessary statements, invoices, and summary reports and can be linked with VERSALEDGER II™ and VERSAINVENTORY™.

**VERSAPAYABLES™** \$99.95  
VERSAPAYABLES™ is designed to keep track of current and aged payables, keeping you in touch with all information regarding how much money your company owes, and to whom. VERSAPAYABLES™ maintains a complete record on each vendor, prints checks, check registers, vouchers, transaction reports, aged payables reports, vendor reports, and more. With VERSAPAYABLES™, you can even let your computer automatically select which vouchers are to be paid.

**VERSAPAYROLL™** \$99.95  
VERSAPAYROLL™ is a powerful and sophisticated, but easy to use payroll system that keeps track of all government-required payroll information. Complete employee records are maintained, and all necessary payroll calculations are performed automatically, with totals displayed on screen for operator approval. A payroll can be run totally, automatically, or the operator can intervene to prevent a check from being printed, or to alter information on it. If desired, totals may be posted to the VERSALEDGER II™ system.

**VERSAINVENTORY™** \$99.95  
VERSAINVENTORY™ is a complete inventory control system that gives you instant access to data on any item. VERSAINVENTORY™ keeps track of all information related to what items are in stock, out of stock, on backorder, etc., stores sales and pricing data, alerts you when an item falls below a preset reorder point, and allows you to enter and print invoices directly or to link with the VERSARECEIVABLES™ system. VERSAINVENTORY™ prints all needed inventory listings, reports of items below reorder point, inventory value reports, period and year-to-date sales reports, price lists, inventory checklists, etc.

**VERSALEDGER II™** \$149.95  
VERSALEDGER II™ is a complete accounting system that grows as your business grows. VERSALEDGER II™ can be used as a simple personal checkbook register, expanded to a small business bookkeeping system or developed into a large corporate general ledger system without any additional software.

- VERSALEDGER II™ gives you almost unlimited storage capacity (300 to 10,000 entries per month, depending on the system),
- stores all check and general ledger information forever,
- prints tractor-feed checks,
- handles multiple checkbooks and general ledgers,
- prints 17 customized accounting reports including check registers, balance sheets, income statements, transaction reports, account listings, etc.

VERSALEDGER II™ comes with a professionally-written 160 page manual designed for first-time users. The VERSALEDGER II™ manual will help you become quickly familiar with VERSALEDGER II™, using complete sample data files supplied on diskette and more than 50 pages of sample printouts.

### SATISFACTION GUARANTEED!

Every VERSABUSINESS™ module is guaranteed to outperform all other competitive systems, and at a fraction of their cost. If you are not satisfied with any VERSABUSINESS™ module, you may return it within 30 days for a refund. Manuals for any VERSABUSINESS™ module may be purchased for \$25 each, credited toward a later purchase of that module.

To Order: **Write or call Toll-free (800) 431-2818**  
(N.Y.S. residents call 914-425-1535)

- \* add \$3 for shipping in UPS areas
- \* add \$4 for C.O.D. or non-UPS areas

- \* add \$5 to CANADA or MEXICO
- \* add proper postage elsewhere

Inquiry 136

DEALER INQUIRIES WELCOME

All prices and specifications subject to change / Delivery subject to availability.

# COMPUTRONICS

50 N. PASCACK ROAD, SPRING VALLEY, N.Y. 10977

\* TRS-80 is a trademark of the Radio Shack Division of Tandy Corp. • \*APPLE is a trademark of Apple Corp. • \*IBM is a trademark of IBM Corp. • \*OSBORNE is a trademark of Osborne Corp. • \*CP/M is a trademark of Digital Research. • \*XEROX is a trademark of Xerox Corp.

# FASTEST SERVICE IN THE INDUSTRY

## IT'S OUR REPUTATION

**Standard Forms Shipped From Our Plant To You...In 3 Days!**  
 Standard computer forms compatible with over 400 software programs can be shipped from our plant to you...in just 3 days! That's fast. Even, our custom service is fast. Most custom orders are shipped in 5 to 10 days. Service this fast means no unnecessary delay. You are guaranteed what you want — when you want it!



**FREE CATALOG and COMPATIBILITY GUIDE . . .**  
 Request your FREE 32 page catalog complete with a software/forms Compatibility Guide. Call Toll Free: **1-800-328-5727, Ext. 515**  
 In Minnesota, 1-800-742-5685

**DELUXE**  
 COMPUTER FORMS  
 A DIVISION OF DELUXE CHECK PRINTERS, INC.

7762

## PROGRAMMING IN FP

*Linear functions are typically translatable into iterative form.*

could be "accumulated" by successively passing round a loop, its result after  $i$  cycles could simply be applied to the object  $x$ . Translation into a loop at the object level appears possible. The importance of expansion theorems in general is that they give nonrecursive solutions to the recursion equations defining certain functions. Further use of the FP algebra may also derive nonrecursive solutions as pure FP expressions from linear expansions (reference 4).

We have demonstrated that the linear functions constitute a well-behaved class. We will conclude the discussion of linearity by identifying some linear forms and indicating how they may be detected automatically. It can be shown that the primitive forms of composition, condition, and construction are linear and that the linear class is closed under functional composition. The closed property means that if a linear form is applied to a function argument, which is itself the result of applying another linear form to a function variable, the resulting, composite form is linear in the function variable. Thus the compiler can detect in many cases whether a defined function is linear and, if so, determine its predicate transformer, referred to above. For example, any form that is built up from the PFOs composition, construction, and condition and has only one occurrence of its function variable argument must be linear. More important, linear functions are typically translatable into iterative form, and the subject of current research at Imperial College is to automatically generate an iterative implementation (a loop) for a linear function, in particular any defined by a multiple composition of primitive linear forms.

Clearly then, the class of linear forms is an important one, and recent results (reference 6), again relying on the functional algebra, facilitate automatic transformation of a significant class of nonlinear functions into linear form, from which an iterative implementation follows (it is hoped). Mutually recursive definitions also may be similarly transformed under appropriate conditions, further extending the class of optimizable functions. Probably the prime example of these results is the transformation of the Fibonacci function into  $f = 1 \circ g$  where

$$g = \text{let } \rightarrow [T, T]; [+ , 1] \circ g \circ \text{sub1}$$

By application of the linear expansion theorem for the linear form  $H$  given by  $Hg = [+ , 1] \circ g \circ \text{sub1}$ , with  $H_1 a = a \circ \text{sub1}$  for function  $a$ ,

$$g : x = [+ , 1]^{-1} : \langle 1, 1 \rangle = [+ , 1]^{-2} : \langle 2, 1 \rangle \\ = [+ , 1]^{-3} : \langle 3, 2 \rangle = \dots$$

(continued)

# The fastest micro in the world



No micro in its right mind would want a showdown with Pinnacle.

Its awesome fire power is provided by the superb Motorola 68000 charging along at 12MHZ with no wait states (giving about 3MIPS).

And Pinnacle's ammo belt is just bristling with high powered options to give rapid fire to all seven users.

P-System, Unix,<sup>™</sup> CP/M-68K,<sup>™</sup> Mosys, BOS, Mirage, Tripos all obey instantly – along with their armies of applications.

Up to 8 Megabytes of directly addressable RAM and 110 Megabytes of Winchester storage dance when Pinnacle barks its sharp orders.

And that's just for starters. There's also the Pinnacle IX with TWO 68000's, DMA, and Memory Management hardware. Ideal for disk intensive operating systems like Unix<sup>™</sup> and Pick.

And a Pinnacle LX expansion chassis allowing nine 68000 processors to network 56 users.

A micro's gotta do what a micro's gotta do.

And starting at under \$4000 Pinnacle's just the fastest there is.

**PINNACLE**  
The accessible peak of performance

US DISTRIBUTORS **Pinnacle Systems Inc.** 10410 Markinson Road, Dallas, Texas 75238. Tel. (214) 340-4941. Telex 88-8442

ELECTRONIC MANUFACTURING/SERVICE **Lamtech Electronics Corporation**, 620 Easy Street, Garland, Texas. Tel. (214) 272-3504

INTERNATIONAL SYSTEMS GROUP **ISG Pinnacle**, Dallas, Texas. Tel. (214) 340-4941. (Distributor enquiries invited).

VERTICAL MARKET SYSTEMS **VMS Pinnacle**, Dallas, Texas. Tel. (214) 340-4941.

EUROPEAN DISTRIBUTORS **TDI Pinnacle Ltd**, 29 Alma Vale Road, Bristol BS8 2HL, England. Tel. (0272) 742796. Telex 444653.

UNIX is a Registered Trade Mark of Bell Labs. CP/M-68K is a Registered Trade Mark of Digital Research.

Inquiry 247

When You Want The Best, Call...

**nbs** inc.

National Business Software and Supplies

**ORDER LINE 800-225-8800**

## IBM PC SOFTWARE

VOLKSWRITER DELUXE	\$154	SUPERCALC III	\$215
LEADING EDGE W.P.	57	WORD PERFECT	229
NUTSHELL	60	ELECTRIC DESK	189
ABILITY	285	R BASE 5000	420
TURBO PASCAL	29	NORTON UTILITIES	59
WORDSTAR 2000 +	CALL	SMART SOFTWARE SYS	549
MULTIPLAN	118	SUPER KEY	39

## PRINTERS

OKIDATA	CALL	NEC 2050	\$666
EPSON	CALL	TOSHIBA 1340	\$559

## MISC.

AST 6 PAK	\$259	CHIPS 64 K SET	\$20
TEAC 55-B DRIVE	\$115	PRINTWHEELS &	
HAYES 1200 B	\$359	RIBBONS	CALL

## TWO LOCATIONS:

500 W. Broadway, Suite 116  
Tempe, AZ 85282  
(602) 966-8005

P.O. Box 23,  
Painesville, OH 44077  
(216) 352-1262

Monday-Friday 8am-5pm

VISA &amp; MasterCard Welcome

Shipping & handling add \$5 per order (printers \$10 per order). VISA & M/C add 3%. AZ residents add 5%. Allow two weeks for personal or company checks to clear. Returns subject to 15% restocking fee. All items are new with manufacturer's warranty. Machine compatibility not guaranteed. Prices subject to change, product subject to availability.

8/85

Announcing the First

## OPTICAL DISC READ ONLY MEMORY FORUM

October 23-25, 1985  
Pentagon City Quality Inn  
Arlington, Virginia

## Presentations Cover:

- Applications
- Market Potential/Investment Opportunities
- Computer Systems' Enhancement Potential
- Optical Disc-Read Only Memory Technology
- Standards & Specifications

Pre-conference tutorials are scheduled for October 22.

Exhibits of representative technology will be available to conference registrants in an adjacent exhibit area.

For further information contact:

**LEARNING TECHNOLOGY INSTITUTE**  
50 Culpeper St., Dept. B  
Warrenton, VA 22186 (703) 347-0055

## PROGRAMMING IN FP

This reflects the usual way of implementing the Fibonacci iteration using two accumulators. [Editor's note: Compare this with the Hope transformation of the same function in John Darlington's article on page 201.] Further optimization is often possible for a set of mutually recursively defined functions (see reference 6). When such functions are combined with the linearization techniques used in the previous example, some powerful optimization becomes possible. Dijkstra's FUSC function satisfies the appropriate conditions and can be converted into iterative form. Denoting "divide by two" by  $d$ ,  $s = \text{sub1}$  and  $p = \text{add1}$ , FUSC is defined by

$$\text{fusc} = \text{le1} \rightarrow \text{id}; \text{even} \rightarrow \text{fusc} \circ d; + \circ [\text{fusc} \circ d \circ p, \text{fusc} \circ d \circ s]$$
The theorem gives  $\text{fusc} = 1 \circ g$  where
$$g = \text{le1} \rightarrow [\text{id}, s];$$

$$\text{le2} \rightarrow (\text{even} \rightarrow [L_0g, s]; [M_0g, s]);$$

$$\text{even} \rightarrow [L_0g, M_1g]; [M_0g, L_1g]$$

where  $L_0g = 1 \circ g \circ d$ ,  $L_1g = 2 \circ g \circ d \circ p$ ,  
 $M_0g = + \circ g \circ d \circ p$ ,  $M_1g = + \circ g \circ d$

Thus the last branch of the definition for  $g$  ( $>2$ ) becomes  
 $\text{even} \rightarrow [1, +] \circ g \circ d; [+ , 2] \circ g \circ d \circ p$

This reflects precisely the iteration of Dijkstra, and since the function is readily recognizable as linear in this form, the corresponding loop in an imperative programming language could be generated by the compiler. ■

## REFERENCES

1. Darlington, J., and M. Reeve. "ALICE: A Multiprocessor Reduction Machine for the Parallel Evaluation of Applicative Languages." *Proceedings of the ACM Conference on Functional Languages and Computer Architecture*. Boston, MA: 1981.
2. Keller, R. M., G. Lindstrom, and S. Patil. "An Architecture for a Loosely Coupled Parallel Processor." Technical Report UUUCS-78-105, Department of Computer Science, University of Utah, 1978.
3. Backus, J. "Can Programming Be Liberated from the von Neumann Style? A Functional Style and Its Algebra of Programs." *Communications of the ACM*, volume 21, number 8, 1978, page 613.
4. Williams, J. "On the Development of the Algebra of Functional Programs." *1982 ACM Transactions on Programming Languages and Systems*, volume 4, October 1982, page 733.
5. Backus, J. "The Algebra of Functional Programs: Functional Level Reasoning, Linear Equations, and Extended Definitions." *Lecture Notes on Computer Science #107, Formalization of Programming Concepts*. New York: Springer-Verlag, 1981.
6. Harrison, P. G. "Optimisation of FP Programs By Linearisation." Imperial College Research Report Number Doc 85/2.

## BIBLIOGRAPHY

- Darlington, J., and R. M. Burstall. "Some Transformations for Developing Recursive Programs." *Journal of the ACM* 24:1, 1977, page 44.
- Dijkstra, E. W. "Lecture Notes on Program Development." *Proceedings of International Summer School on Program Construction*. Marktoberdorf, West Germany: 1978.



# Put your blue box out to pasture.

## Genesis Has Better Choices for Superior 8086 Designs.

Genesis development tools turn your IBM PC or compatible computer into the most flexible, comprehensive development system made for 8086-family designs. Genesis offers the widest choice of proven languages, superior debugging tools, and even in-circuit emulators. It all starts with ACCESS, the superior Genesis operating environment that allows Intel's 8086 development software to run under MS-DOS. And not only do we sell ACCESS and all the Intel languages for 8086 and 80186 designs — we also offer an ACCESS system for 8-bit designs as well.

## Genesis Is Faster.

You get performance as well as flexibility with Genesis. For example, in our tests the ASM 86 assembler running under ACCESS on an IBM PC AT runs 4.7 times as fast as the assembler on a hard-disk based Series III and an incredible eleven times faster than a

floppy-disk based Intel system. The ASM 86 assembler we tested under ACCESS even ran 1.53 times faster than a VAX 11/782 running competing cross-software.

## Genesis Is Easier to Use.

Of course, Genesis offers more than speed of execution. The GeneScope family of symbolic debuggers and in-circuit emulators share the most powerful and easiest to use human interface available today. GeneScope offers high-level macro facilities, an on-line symbolic assembler, alphanumeric and graphic support, and many more features that make Genesis tools a better solution than other systems.

## Genesis Costs Less.

With Genesis you get all the flexibility of a personal computer and all the power of expensive dedicated development systems. You can get your products to market faster, at a fraction of the cost.

Is there really any reason to keep using obsolete, expensive equipment — when you can have Genesis instead? **Quit chewing your cud** — give us a call and find out how Genesis tools

can make your life easier.



Genesis Has a Better Solution.



**Genesis**<sup>™</sup>  
Microsystems

Genesis Microsystems Corporation  
196 Castro Street  
Mountain View, California 94041  
Phone: (415) 964-9001  
Telex: 4998093 GENMS UI

Inquiry 131





## MAKE THE CONNECTION . . .

Our **Connection** systems will solve your problem of trying to read and write diskettes or tapes from almost any computer system using your PC.

The **Diskette Connection** is a hardware system that enables the IBM PC or compatible to read and write most 8 inch, 5¼ inch, or 3½ inch diskettes.

With our **File Connection** software programs you can transfer data files between most computer systems, including CP/M, DEC, Honeywell, Univac, IBM 3740, S/1, S/3, S/23, S/32, S/34, S/36, and S/38.

Our **Word and Typesetting Connection** programs use IBM standard Document Content Architecture (DCA-RFT) to transfer document files between most word processing and typesetting systems, including Compugraphic MCS, CPT, Displaywriter, OS/6, Multiset, NBI, Quadex, Xerox, and Wang.

Our **Tape Connection** system will read and write IBM or ANSI standard ½ inch 1600 BPI magnetic tape. A full size 2400 foot tape can store a 45 MByte file and be written in 6 minutes.

Since 1982, we have supplied thousands of systems to customers around the world, including IBM, NASA, AT&T, Kodak, and General Motors.

Our specialty is conversion systems and we can provide a solution to your problem. Call us today to discuss your requirements.

*This ad is one of a series featuring NASA missions. For a free poster, send us your written request.*

**Box 1970 Flagstaff, AZ 86002  
(602) 774-5187 Telex 705609**

Inquiry 120 for End-Users. Inquiry 121 for DEALERS ONLY.

# A HOPE TUTORIAL

BY ROGER BAILEY

*Using one of the new generation  
of functional languages*

*Editor's note: In this article we have boldfaced the output of the Hope interpreter to distinguish it from the input. The Hope interpreter is available for downloading from BYTENet Listings at (617) 861-9774.*

*This version runs under PC-DOS 2.0; you will need the files HOPE.EXE and SYS.HOP. Related articles are the BYTE U.K. column on page 341 of this issue and BYTE U.K. on page 385 of the May issue.*

IN A LANGUAGE LIKE PASCAL, a function is a piece of "canned" program for doing standard operations like finding square roots. When we want the square root of a positive number stored in a variable *x*, we write `sqrt(x)` at the point in the program where we want the value, such as `writeln(1.0 + sqrt(x))`. This is called an application of the function. The value represented by *x* is called the argument or actual parameter. In this context the function `sqrt` computes the square root of *x*. 1.0 is added to it, and the result is then printed.

We can also define our own functions specifying how the result is computed using ordinary Pascal statements. Here's a function that returns the greater of its two argument values:

```
function max(x,y:INTEGER):INTEGER;  
begin  
  if x>y  
  then max := x  
  else max := y  
end;
```

The identifiers *x* and *y* are called formal parameters. They're used inside the definition to name the two values that will be supplied as arguments when the function is

applied. Here's how we might use `max` to filter out negative values: `writeln(max(z,0))`.

A more interesting case is when the actual parameter is a function application itself or involves one. We can use `max` to find the largest of three numbers by writing `max(a,max(b,c))`.

Combining functions like this is called composition. The expression is evaluated "inside out" because the outer application of `max` can't be evaluated until the value of its second argument is known. The inner application of `max` is therefore evaluated first using the values of *b* and *c*; the result is used as the actual parameter in the outer application.

Another way to combine functions is to define more powerful ones by using simpler ones as building blocks. If we often need to find the largest of three numbers, we might define

```
function MaxOf3(x,y,z:INTEGER):INTEGER;  
begin  
  MaxOf3 := max(x,max(y,z))  
end;
```

and apply it by writing `MaxOf3(a,b,c)`.

## PROGRAMMING WITH FUNCTIONS

Pascal is called an imperative language because programs written in it are recipes for doing something. If our programs consist only of functions, we can concentrate on the results and ignore how they're computed. Forget that

*(continued)*

Roger Bailey can be reached at the Department of Computing, Imperial College, 180 Queen's Gate, London SW7 2BZ, England.

sqrt is a piece of code and think of sqrt(x) as a way of writing a value in your program, and you'll get the idea. You can think of MaxOf3 in the same way if you ignore the way it works inside. By defining a toolkit of useful functions and combining them, we can build powerful programs that are short and easy to understand.

In Pascal, functions can return only simple data objects such as numbers or characters, but real programs use big data structures and can't easily be written using these functions. In Hope, functions can return any type of value, including data structures equivalent to Pascal's arrays, records, and much more. Programming in Hope has the flavor of simply writing down the answer by writing an expression that defines it. This expression will contain one or more function applications to define smaller parts of the answer. These won't usually be built in like sqrt, so we'll have to define them ourselves, but we'll still think of them as definitions of data objects, not as algorithms for computing them.

#### A SIMPLE HOPE EXAMPLE—CONDITIONALS

Let's see how we can define max in Hope. Like Pascal, Hope is a strongly typed language; we must tell the compiler about the types of objects in our programs so it can check that they're used consistently. The function definition comes in two parts—the declaration followed by one or more recursion equations. First we declare the argument and result types:

```
dec max : num # num -> num;
```

dec is a reserved word (must be in lowercase) signaling the start of the declaration of the function max, which takes two numbers as arguments and returns a single number as its result. Read the symbol : as "takes a." Names consist of uppercase and lowercase letters (which are distinct) and digits and must start with a letter. The current fashion is to use lowercase. You can separate symbols with any number of blanks and new lines for clarity. A space or new line is needed only when adjacent symbols might be confused as one symbol without it.

The next part of the declaration gives the types of the arguments. Integers are of the predefined type num (in lowercase). Read # as "and a"; alternatively, you can use the reserved word X. Read -> as "yields." The semicolon marks the end of the declaration. max needs only one recursion equation to define it.

```
--- max(x,y) <= if x>y then x else y;
```

Read the symbol --- as "the value of." The expression max(x,y) is called the left-hand side of the equation. It defines x and y as formal parameters or local names for the values that will be supplied when the function is applied. Parameter names are local to the equation, so x and y won't be confused with any other x or y in the program. The symbol <= is read as "is defined as."

The rest of the equation (called the right-hand side)

defines the result. It's a conditional expression. The symbols if, then, and else are reserved words. If the value of the subexpression x > y is true, the value of the whole conditional expression is the value of x; otherwise, it's the value of y. The two alternative values can be defined by any Hope expression.

While Pascal's conditional statement causes one of two actions to be performed, Hope's conditional expression specifies one of two values. Hope doesn't specify the order in which the two expressions are evaluated. On a computer that uses parallel processing, such as the Imperial College ALICE machine, it's even possible to evaluate all three expressions in parallel and throw away one of the results when the value of the condition is known.

#### USING FUNCTIONS WE'VE DEFINED

A Hope program consists of a single expression containing one or more function applications. When the expression is evaluated, the result and its type are printed on the screen. Here's a simple program that uses max:

```
max(10,20) + max(1,max(2,3));
23 : num
```

The rules for evaluating the expression are the same as those in Pascal. Function arguments are evaluated first, the functions are applied, and finally other operations are performed in the usual order of priority.

We can also use existing functions to define new ones. Here's the Hope version of MaxOf3:

```
dec MaxOf3 : num # num # num -> num;
--- MaxOf3(x,y,z) <= max(x,max(y,z));
```

#### A MORE INTERESTING EXAMPLE

Just as Pascal's conditional statement is replaced by Hope's conditional value, so the repetitive statement is replaced by the repetitive value. Here's a Pascal function that multiplies two numbers using repeated addition:

```
function mult(x,y:INTEGER):INTEGER;
var prod:INTEGER;
begin
  prod := 0;
  while y>0 do
  begin
    prod := prod + x;
    y := y - 1;
  end;
  mult := prod;
end;
```

It's hard to be sure this function does enough additions (it took me three tries to get it right), and this seems to be a general problem with loops in programs. A common way of checking imperative programs is to simulate their execution. If we do this for input values of 2 and 3, we'll

(continued)

# You can't judge a scope by its cover.

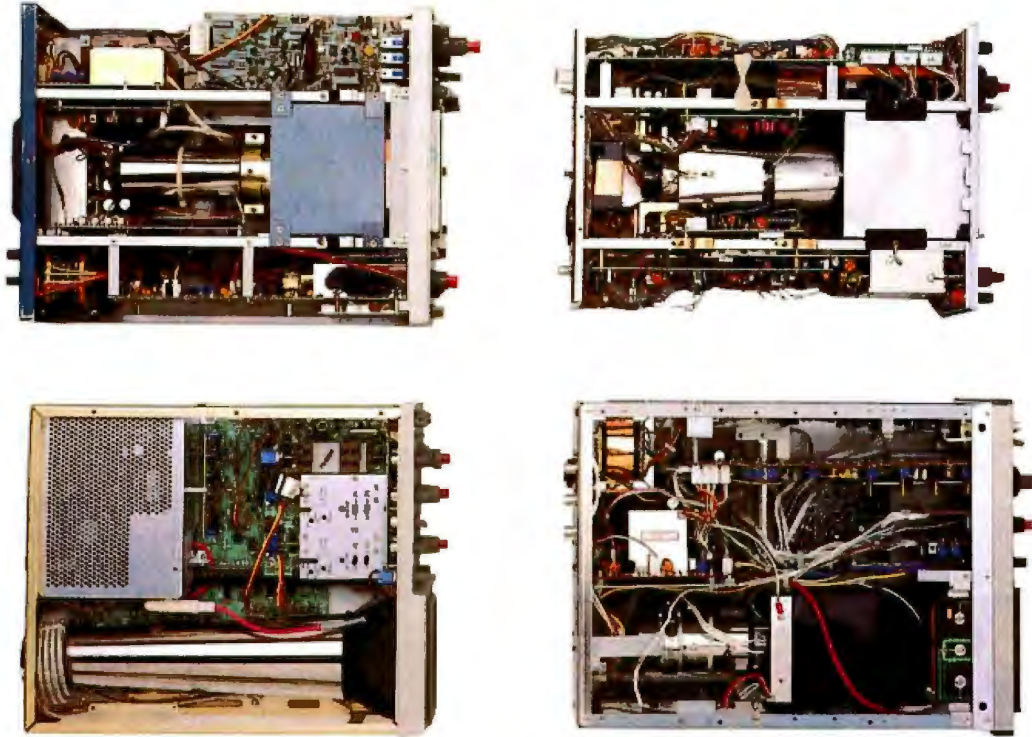

When you look at our simplified, practical internal design, you see why the Tek 2200 Series delivers unparalleled high performance and reliability in the field. You get quality that's unmistakably Tektronix in scopes so advanced, they cost you less to buy and own.

Through an innovative new concept in scope design we reduced the number of mechanical parts by 65%. Reduced cabling by 90%. Virtually eliminated board electrical connectors. And eliminated the need for a cooling fan.

**The result: a scope with designed-in simplicity that increases reliability as it cuts downtime and repair costs.** All of which means outstanding value in

a compact, lightweight package that your service technicians will appreciate.

Plus, you get a selection of performance to precisely match your needs. There are the 60 MHz single time base delay 2213A at \$1275\* and the 60 MHz dual time base 2215A at \$1525\*. And at 100 MHz, the dual time base 2235 at \$1750\* and the 2236 with an integrated counter/timer/multimeter at \$2650\*.

**The industry's first three-year warranty† is testimony to 2200 Series dependability.** Adding value to value are a variety of optional service plans that can economically extend this coverage to five years.

Consider what you're paying

now in downtime, in service, in back-up scopes. On the bottom line, a Tek 2200 Series scope will save you money, time and trouble now and in the years to come.

**Contact your Tek Sales Engineer for a demo today. Or call 1-800-426-2200, Ext. 201.**

In Oregon, call collect: (503) 627-9000, Ext. 201.



**Tektronix**  
COMMITTED TO EXCELLENCE

\*Prices F O B Beaveron, Oregon  
†3-year warranty includes CRT and applies to 2200 family oscilloscopes purchased after 1/1/83. Scopes are UL listed, CSA and VDE approved

Copyright © 1985, Tektronix, Inc. All rights reserved. TTA-S17-1  
Prices subject to change

## COMPETITIVE EDGE

P.O. Box 556 — Plymouth, MI 48170 — 313-451-0665  
 Compupro®, LOMAS, EARTH, TELETEK, Macrotech  
**S-100 CIRCUIT BOARDS**

CompuPro 286 CPU™	\$750	Lomas 286	\$621	Macrotech 286/Z80H	\$995
CompuPro SPU Z™ 8MHz	281	Lomas 8088	420	Lomas 10MHz 8088	320
CompuPro 8085/86™	245	Lomas Octoport™ 8 Smd	320	Lomas 4 serial	200
CompuPro Disk 1A™	347	Lomas LDP™ 72	208	LDP NU Disk 2048K	1271
CompuPro Disk 3™	417	Lomas 250K Dram	445	Teletek SBC 8088 128K	989
CompuPro Ram 22™	795	Lomas 512K Dram	962	Macrotech 512K static	1585
CompuPro Ram 23™	240	Lomas Ram 87™	725	LDP 1024K Dram	921
CompuPro Ram23 128	485	Lomas Hazrat™	244	Lomas Color Magic™ 16K	478
CompuPro CPU Z™	189	Thunder 186™	1095	Lomas MSDOS™ 2.11	200
CompuPro CCP/M® 815*	250	Lomas CCP/M® 86™	290	CompuPro MDrive H® 512K	417
System Support One™	245	CompuPro I/O 4	245	CompuPro I/O 3 8 port	347
Teletek HD/	375	Teletek SBC 1	525	Teletek SBC 1 8MHz 128	659
Teletek Systemmaster®	557	Systemmaster II®	899	Turbodoc® for Teletek	850

Lomas 2 Megabyte Ram-(2048K) just \$1495.

**Earth Computer TURBO SLAVE I 8MHz 128K \$395.**  
 Turbo Slave I runs with Teletek, North Star Horizon, Advanced Digital and Others under Turbodoc™

### SYSTEMS

40 MB Hard Disk, Tape Back up, 5" Floppy Sub-System for CompuPro	\$2895
CompuPro 65/88,256K,CDOS, SS1,I/O 4,2-96TP1 DRS, 15 Slot	\$3095
CompuPro 85/88,256K,CDOS, SS1,I/O 4,1-96TP1,20MB, 15 Slot	\$4295
286/Z80H,1024K,20MB, AutoCad 2 System — Ready to Run	\$7495
Lomas 286,1024K,20MB HD,1-5",CDOS, 6 SERIAL, 2 Par, 15 Slot	\$8395
Lomas Thunder 186, 256K, 20 MB HD, 1-5", CDOS, 4 Slot	\$4995
Teletek 8MHz Master, 4-8MHz 128K SLVS, 1-5", 20 MB HD, TDOS	\$2695
	\$4495

### UPGRADE YOUR IBM® PC™ !!

<b>MONITORS</b>	<b>GRAPHIC BOARDS</b>	<b>HARD DRIVE KITS</b>
Amdax 310A	Hercules Monochrome	PC 10MB PC
Tanen Color 440	Hercules Color Card	PC 21MB PC
Princeton Color HP-12	Tecmar Graphics Master	AT 21MB AT
Princeton Color SR-12	Paradise Graphics	AT 30MB AT
	STB Graphs .II	AT 70MB AT
		AT 80MB AT
		AT 119MB AT
<b>MULTI-FUNCTION BOARDS</b>	<b>FLOPPY DRIVES</b>	
AST 8 Pak 68k	TEAC 12 MT FD550	1,2,3,4 MB Memory
Quantum Expanded Quadboard 0K	Mitsubishi 96 TPI	Boards for IBM PC
Tecmar Captain 54K	5" DSDO Color Diskettes	\$ 31
		Call

### ALL PRICES SUBJECT TO CHANGE AND STOCK ON HAND

CompuPro is a Registered Trademark of Visbyn, CPU Z, Disk 1A, Disk 3, Interlocor 3, Interlocor 4, CPU 286, CPU 8088/86, System Support 1, MDRIVE-H, Ram 22, Ram 23 are trademarks or registered trademarks of Visbyn. CPM 2.2, CPM/II, are registered trademarks of Digital Research Inc. MSDOS is a registered trademark of Microsoft. Systemmaster & Systemmaster II are registered trademarks of Teletek. Enterprise, Turbodoc is registered trademark of Software 2000. IBM is a registered trademark of International Business Machines. AutoCad 2 is a registered trademark of Autodesk, Inc.



## UNLOCK THE SECRETS OF MACHINE LANGUAGE.

Our Visible Computer teaching systems do more than tell you about machine language, they show you — by turning your computer into an animated simulation of its micro-processor chip. You'll actually see the registers change as the processor executes instructions; you'll see how instructions are executed, not just the result.

The extensive manual may just be the clearest tutorial on machine language ever written. You'll work "hands-on-keyboard," at your own pace, as you progress through 30 demonstration programs stored on disk.

Apple II version: \$49.95. Commodore 64 version: \$39.95.  
 NEW! The Visible Computer: 8088 (IBM PC): \$69.95. At better software dealers or direct from Software Masters, 3330 Hillcroft, Suite BB, Houston, Texas 77057. (713) 266-5771. MC/Visa accepted. Mail orders enclose \$3.00 shipping.

**Software Masters™**

## A HOPE TUTORIAL

find that prod starts with the value 0 and gets values of 2, 4, and 6 on successive loop iterations, which suggests that the definition is correct.

Hope doesn't have any loop structures, so we must write all the additions that the Pascal program performed in a single expression. It's much easier to see that this has the right number of additions:

```
dec mult : num # num -> num ;
--- mult(x,y) <= 0 + x + x + ...
```

or would be if we knew how many times to write + x. The hand simulation suggests we need to write it y times, which is tricky when we don't know the value of y. What we do know is that for a given value of y, the expressions mult(x,y) and mult(x,y-1)+x would have the same number of + x terms if written out in full. The second one always has two terms, whatever the value of y, so we'll use it as the definition of mult:

```
--- mult(x,y) <= mult(x,y-1) + x;
```

On the face of it we've written something ridiculous, because it means we must apply mult to find the value of mult. Remember, however, that this is really shorthand for 0 followed by y occurrences of + x. When y is zero, the result of mult is also zero because there are no + x terms. In this case, mult isn't defined in terms of itself, so if we add a special test for it, the definition terminates. A usable definition of mult is

```
--- mult(x,y) <= if y=0 then 0 else mult(x,y-1) + x;
```

Functions that are defined using themselves like this are called recursive. Every Pascal program using a loop can be expressed as a recursive function in Hope. All recursive definitions need one case (called the base case) where the function isn't defined in terms of itself, just as Pascal loops need a terminating condition.

### ANOTHER WAY OF USING FUNCTIONS

Hope enables us to use a function with two arguments as an infix operator. We must assign it a priority and use it as an infix operator everywhere, including the equations that define it. The definition of mult used as an infix operator looks like this:

```
infix mult : 8;
dec mult : num # num -> num;
--- x mult y <= if y=0 then 0 else x mult(y-1) + x;
```

A bigger number in the infix declaration means a higher priority. Since a priority of 8 is higher than that of the subtraction operator, mult's second argument, y-1, in the recursion equation must be in parentheses. Most of Hope's standard functions are supplied as infix operators.

### OTHER KINDS OF DATA

Hope provides two other primitive data types. A trival is equivalent to Pascal's Boolean data type and has values

(continued)

# TIME & MONEY

SemiDisk is the disk emulator that saves you more of both.

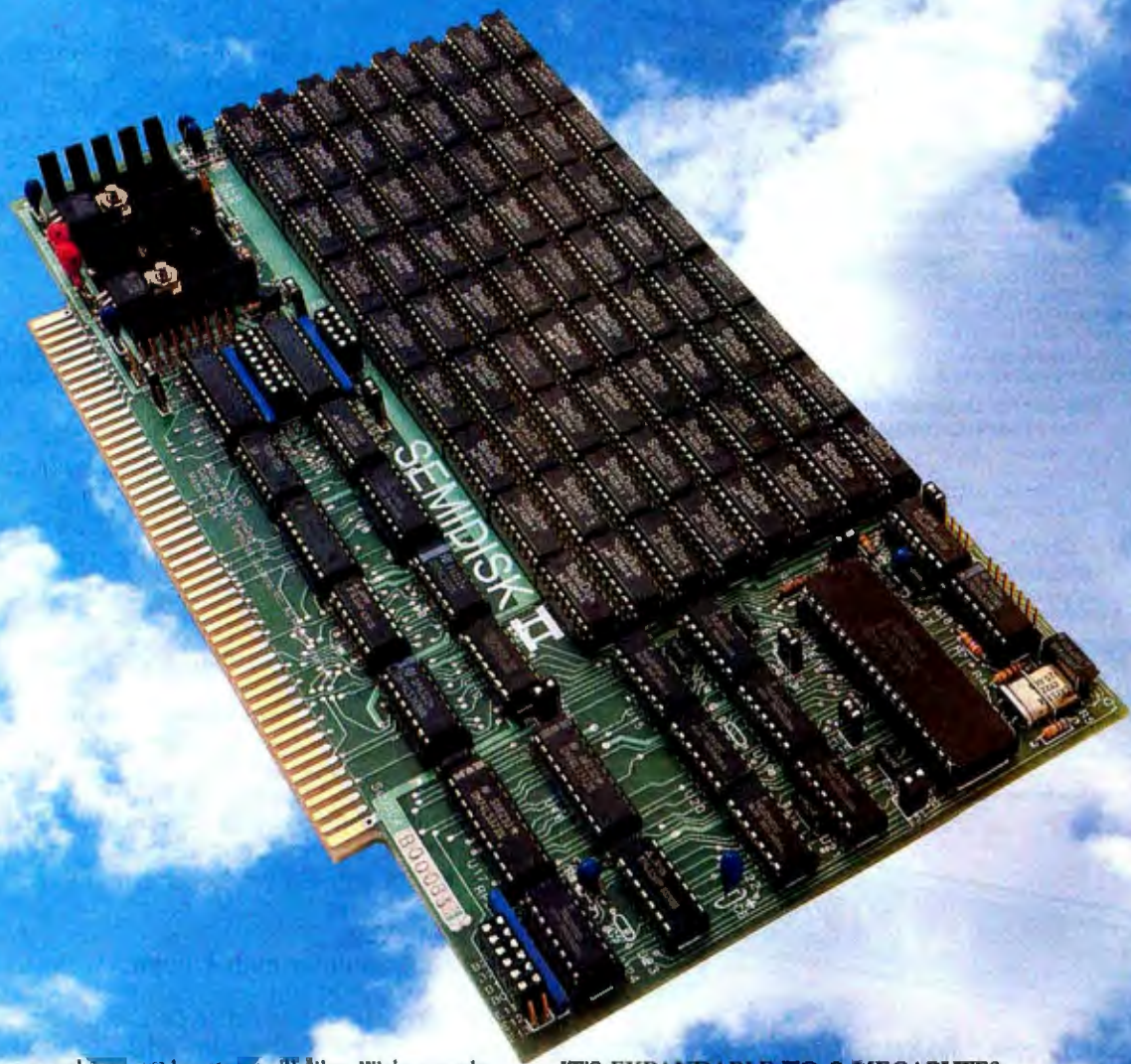

We've just done something we know you'll like. We've made the SemiDisk far more affordable than ever before. With price cuts over 25% for most of our product line. Even our new 2 megabyte units are included.

#### COMPARE WITH THE OTHERS.

SemiDisk Systems builds fast disk emulators for more microcomputers than anyone else. S-100, IBM-PC, Epson QX-10, TRS-80 Models II, 12, and 16. Up to 2 megabytes per board, standard. Up to 8 megabytes per computer, using only four bus slots, max! Software drivers are available for CP/M 80, MS-DOS, 2DOS, TurboDOS, VALDOCS 2, and Cromix. SemiDisk turns good computers into great computers.

#### GREAT NEWS FOR IBM PC AT USERS.

New MS-DOS 3.0 software drives take full advantage of the 80286's expanded instruction set, moving data four times faster than can be done on PC or XT.

#### BATTERY BACKUP, TOO.

At 0.7 amps per 2 megabytes, SemiDisk consumes far less power than the competition. And you don't have to worry if the lights go out. The battery backup option gives you 5-10 hours of data protection during a blackout. Nobody else has this important feature. Why risk valuable data?

#### IT'S EXPANDABLE TO 8 MEGABYTES.

You can start with as little as 512K bytes, and later upgrade to 2 megabytes per board. At your own pace, as your needs expand.

In an IBM PC, XT, and AT you can have multiple drives on a single system. And the SemiDisk gives you mainframe performance on the top of your desk.

#### AND THE BEST NEWS IS SAVED FOR LAST:

	<u>512K</u>	<u>1Mbyte</u>	<u>2Mbyte</u>
SemiDisk I, S-100	\$695	\$1395	
SemiDisk II, S-100	\$995		\$1995
IBM PC, XT, AT	\$695		\$1795
QX-10	\$595		\$1795
TRS-80 II, 12, 16	\$695		\$1795
Battery Backup Unit	\$150	\$150	\$150

## SEMIDISK

SemiDisk Systems, Inc.

P.O. Box GG, Beaverton, Oregon 97075

503-642-3100

Inquiry 287



No More WAITing with . . .

# FASTBREAK™

8087 SPEED for  
LOTUS 1-2-3™

FASTBREAK speeds up 1-2-3 recalculations by up to 36 to 1 on a 4.77 MHz PC and by 79 to 1 on a NUMBER SMASHER equipped PC. It extends DOS functionality to include the 8087 and comes with a daughterboard which fits into the 8087 socket, an 8087, a break button and the necessary software. A number of additional features are invoked through its novel break button. These enable the user to lock out the keyboard, exchange information with programs written in BASIC, FORTRAN or C that are running concurrently, spool LOTUS output to a printer and install a single protected copy of 1-2-3 and FASTBREAK on your hard disk. An optional LOCK BOX makes it possible to RESET your PC and remove the break button from the computer . . . . . \$339 LOCK BOX . . . . . \$60

See our full page ads elsewhere in this issue for other MicroWay products including:

8087 5MHz .....	\$109
64K RAM Set .....	\$9
256K HMOS RAM Set .....	\$49
256K CMOS RAM Set .....	\$135

Contact MicroWay, Inc. or your local MicroWay® Installation Center to order.

Lotus and 1-2-3 are trademarks of Lotus Development Corp. MicroWay, FASTBREAK and NUMBER SMASHER are trademarks of MicroWay, Inc.

**MicroWay**

P.O. Box 79  
Kingston, Mass.  
02364 USA  
(617) 746-7341

**The World Leader  
in 8087 Support!**

## AMX

8080 8086 8088  
Z80 Now  
68000

### Real-Time Multitasking Executive

- No royalties
- Source code included
- Fault free operation
- Ideal for process control
- Timing control provided
- Low interrupt overhead
- Inter-task messages

Options:

- Resource Manager
- Buffer Manager
- Integer Math Library

■ Language Interfaces :

C Pascal  
PL/M Fortran

■ DOS File Access :

CP/M-80  
IBM PC DOS

AMX for 8080	\$ 800 US
8086	950
6809	950
68000	1600
Manual (specify processor)	75

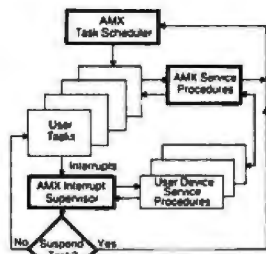

AMX is TM of KADAK Products Ltd  
CP/M-80 is TM of Digital Research Corp  
IBM, PC DOS are TM of IBM Corp



**KADAK Products Ltd.**

(604) 734-2796

Telex: 04-55670

206-1847 W. Broadway, Vancouver, B.C., Canada V6J1Y5

## A HOPE TUTORIAL

true or false. We've already seen an example of an expression that defines a truval:  $x > y$ .  $>$  is a standard function whose type is  $\text{num} \# \text{num} \rightarrow \text{truval}$ . We can use truvals in conditional expressions and combine them with the standard functions  $\text{and}$ ,  $\text{or}$ , and  $\text{not}$ .

Single characters are of type  $\text{char}$ , with values 'a', 'b', and so on. Characters are most useful as components of data structures such as character strings.

### DATA STRUCTURES

Practical programs need data structures, and Hope has two standard kinds already built in. The simplest kind, called a tuple, corresponds to a Pascal record. We can bind a fixed number of objects of any type together into a tuple. For example: (2,3) and ('a',true) are tuples of the type  $\text{num} \# \text{num}$  and  $\text{char} \# \text{truval}$ , respectively.

We use tuples when we want a function to define more than one value. Here's one that takes the time of day defined in terms of seconds since midnight and converts it to hours, minutes, and seconds:

```
dec time24 : num -> num # num # num;
--- time24(s) <= (s div 3600,
                  s mod 3600 div 60,
                  s mod 3600 mod 60);
```

$\text{div}$  is the built-in integer division function, and  $\text{mod}$  gives the remainder after integer division. If we type an application of  $\text{time24}$  at the terminal, the resulting tuple and its type will be printed on the screen in the usual way.

```
time24(45756);
(12,42,36) : (num # num # num)
```

The second standard data type, called a list, corresponds roughly to a one-dimensional array in Pascal. It can contain any number of objects (including none at all), but they must all be the same type. For example, [1,2,3] is an expression of type  $\text{list}(\text{num})$ .

There are two standard functions for defining lists. The infix operator  $::$  (pronounced "cons") defines a list in terms of a single object and a list containing the same type of object:

```
10 :: [20,30,40] defines the list [10,20,30,40]
```

Don't think of  $::$  as adding 10 to the front of [20,30,40]. It really defines a new list, [10,20,30,40], in terms of two other objects without changing their meaning, rather in the same way that  $1 + 3$  defines a new value of 4 without changing the meaning of 1 or 3.

The other standard list function is  $\text{nil}$ , which defines a list with no elements in it. We can represent every list by an expression consisting of applications of  $::$  and  $\text{nil}$ . When we write an expression like

```
['c','a','t']
```

Hope considers it to be just a shorthand way of writing

(continued)



# THE ARK 24K IS THE FIRST UNIVERSAL FDX 2400 DIAL MODEM

## THE ARK 24K HAS IT ALL!

### MULTIPLE MODEMS IN ONE

- State-of-the-ARK MODE: User friendly help commands, Sync/Async operation, DTE buffer to 9600 bps, Separate Sync/Async connectors, Extensive diagnostic capabilities, and much more.
  - ARQ Error Free Transmission based on MNP\*
  - Hayes™ "AT" Mode Compatible
  - Front Panel Operation
- On-Site Service Available Nationwide

Also available: IBM® PC Card 1200, IBM PC Card 2400, 12 Card Rack Mount, 1200 Circuit Board and 2400 Circuit Board

## INTRODUCTORY OFFERS

The ARK 24K...multiple modems in one... **\$595<sup>00†</sup>**  
2400 bps FDX...  
*Quantity discounts available.*

The ARK 1200 bps FDX Compatible Version...  
**NOW \$365.00.** At a later date factory upgrade to 2400 bps—\$275.00

To order call 800 228-0914. For more information call (305) 724-5260 or write ARK Electronic Products, Inc., Dept. A, P.O. Box 2169, Melbourne, FL 32902-2169 for your brochure about the most versatile modem on the market today.

 **ARK<sup>TM</sup> ELECTRONIC PRODUCTS, INC.**  
A PARADYNE COMPANY



```
'c' :: ('a' :: ('t' :: nil))
```

Another shorthand way of writing lists of characters is to enclose the character string in double quotes: "cat". When the result of a Hope program is a list of numbers, it's printed out in the concise bracketed notation; if it's a list of characters, it's printed in quotes.

Every data type in Hope is defined by a set of primitive functions like :: and nil. They're called constructor functions and aren't defined by recursion equations. When we defined a tuple, we were actually using a standard constructor called , (pronounced "comma"). Later on we'll see how constructors are defined for other types of data.

## FUNCTIONS THAT DEFINE LISTS

If we wanted to write a Pascal program to print the first n natural numbers in descending order, we'd probably write a loop that printed one value out on each iteration. For example,

```
for i := n downto 1 do write(i);
```

In Hope we write one expression that defines all the values at once, rather like we did for mult:

```
dec nats : num -> list(num);
--- nats(n) <= if n=0 then nil else n::nats(n-1);
```

nil is useful for writing the base case of a recursive function that defines a list. If we try the function at the terminal by typing

```
nats(10);
[10,9,8,7,6,5,4,3,2,1] : list(num)
```

the numbers are in descending order because that's the way we arranged them in the list, not because they were defined in that order. The values in the expression defining the list are treated as though they were all generated at the same time. On the ALICE machine they actually are generated at the same time. To get the results of a Hope program in the right order, we must put them in the right place in the final data structure.

If we want the list of the natural numbers n through 1 in ascending order, we need to use another built-in operation, <> (pronounced "append"), that concatenates two lists.

```
--- nats(n) <= if n=0 then nil else nats(n-1) <> [n];
```

We put n in brackets to make it into a (single-item) list because <> expects both its arguments to be lists. We could also have written (n::nil) instead of [n].

## DATA STRUCTURES AS PARAMETERS

Suppose we have a list of integers and we want to write a function to add up all its elements. The declaration will look like this:

```
dec sumlist : list(num) -> num;
```

We need to refer to the individual elements of the actual

parameter in the equations defining sumlist. We do this using an equation whose left-hand side looks like this:

```
--- sumlist(x :: y) . . .
```

This is an expression involving list constructors and corresponds to an actual parameter that is a list. x and y are formal parameters, but they name individual parts of the actual parameter value. In an application of sumlist like sumlist([1,2,3])

the actual parameter will be "dismantled" so that x names the value 1 and y names the value [2, 3]. The complete equation will be

```
--- sumlist(x :: y) <= x + sumlist(y);
```

Notice there's no base case test. As we might expect, it's the empty list, but we can't test for it directly in the equation because there's no formal parameter that refers to the whole list. In fact, if we write the application

```
sumlist(nil)
```

we'll get an error message because we can't dismantle nil to find the values of x and y. We must cover this case separately using a second recursion equation:

```
--- sumlist(nil) <= 0;
```

The two equations can be given in either order. When sumlist is applied, the actual parameter is examined to see which constructor function was used to define it. If the actual parameter is a nonempty list, the first equation is used, because nonempty lists are defined using the :: constructor. The first number in the list gets named x and the remaining list y. If the actual parameter is the empty list, the second equation is used because empty lists are defined using the constructor nil.

## PATTERN MATCHING

An expression composed of constructors appearing on the left-hand side of a recursion equation is called a pattern. Selecting the right recursion equation and dismantling the actual parameter to name its parts is called pattern matching. When you write a function, you must give a recursion equation for each possible constructor defining the argument type.

Sometimes we don't need to dismantle the actual parameter, and we can use a formal parameter in the pattern that matches the whole object, irrespective of what constructors were used to define it. As an example, let's see how we could define our own version of the append function to concatenate two lists. Let's call it cat.

```
infix cat : 4;
dec cat : list(num) # list(num) -> list(num);
--- (h :: t) cat r <= h :: (t cat r);
--- nil cat r <= r;
```

The first list parameter is matched by the pattern (h::t)

*(continued)*

# Now Showing In Black And White

**i**f you own an IBM-PC or PC work-alike, Roland's new MB-142 monitor lets you show off your text and graphics in today's hottest colors—black and white. That's right! The MB-142 gives you black characters on a paper-white background—just like people have been reading for centuries. You can also have white characters on a black background with just the touch of a button.

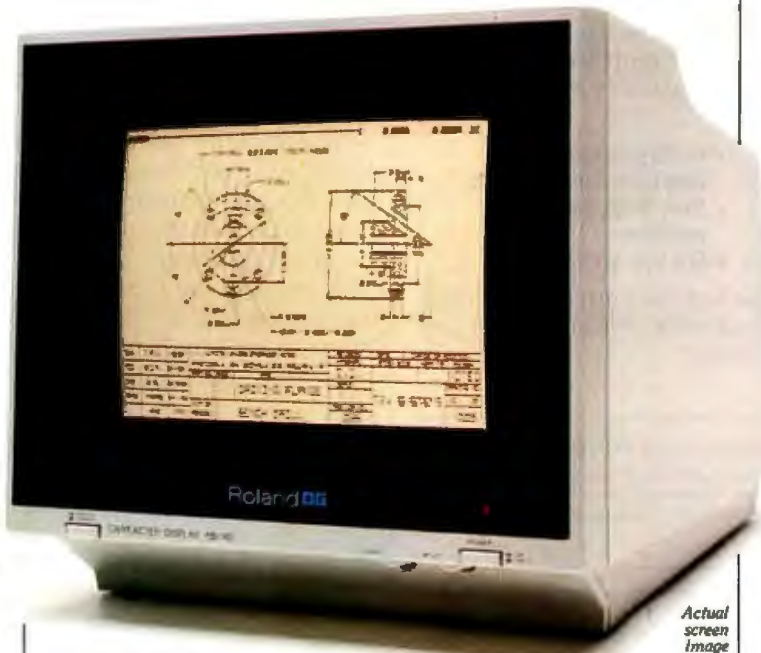

Actual screen image

MODEL  
MB-142



**P**ush a button for instant reverse screen

Both of these black and white display formats are easier on the eyes and less fatiguing than the green or amber phosphor used in standard monochrome monitors. The MB-142's large 14-inch screen, combined with its ultra-high 720 x 350 resolution, can display characters that are larger and more legible than what you can get with ordinary monochrome monitors. Another great plus is that the MB-142 plugs directly into the monochrome board of your IBM or compatible—just like your present monochrome monitor, with nothing more to buy.

Because of the MB-142's advanced electronic circuitry, you even have the ability to mix graphics and text on the same display when using graphics and text boards from leading manufacturers such as Persyst, STB, Paradise, Hercules, AST and many others. What makes it all possible? The same sophisticated technology used in color monitors.

**t**he MB-142 supports all the winning cards

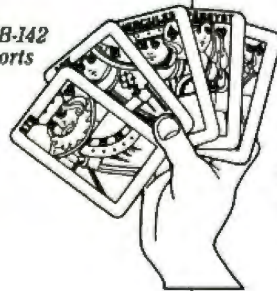

**f**or business, black and white makes more sense than green and black



**t**he big difference is that the MB-142 monitor does the job for significantly less money. The MB-142 is designed to interface economically, too. Imagine seeing your favorite business graphics or CAD/CAM packages, such as Lotus 1-2-3, Energraphics, Chart-Master, AutoCAD, CADDraft and VersaCAD, in ultra-high resolution black and white. Also, take full advantage of your program's windowing capability using the large 14-inch screen.

Take a good look at the differences that set the MB-142 apart from the rest. No other monochrome monitor gives you the fatigue-free black and white viewing, text and graphics capabilities and easy interface. Naturally enough, the MB-142 is from Roland DG—the new computer peripherals company that's pointing the way to the future. Look for this and other Roland products at fine computer dealers everywhere.

For more information, contact: Roland DG, 7200 Dominion Circle, Los Angeles, CA 90040. (213) 685-5141.

The software programs listed are trademarks of the following companies: AutoCAD, AUTODESK, Inc.; CADDraft, Personal CAD Systems, Inc.; Chart-Master, Decision Resources, Inc.; Energraphics, Enertron Research, Inc.; Lotus 1-2-3, Lotus Development Corp.; VersaCAD, T&W Systems, Inc.

**Roland DG**

# The \$59.95 Data Switch



DATA SPEC presents the affordable data switch. At \$59.95\* you can conveniently switch between your peripherals without the need for expensive equipment. You also gain outstanding durability with the following quality features:

- Full metal construction
- Complete shielding (Exceeds F.C.C. requirements)
- Reinforced printed circuit boards
- Anti-skid feet
- All 25 pins switched
- Gold plated connector pins
- Safe "break before make" operation
- One year warranty

Isn't it about time you benefit from high performance at affordable prices? The \$59.95 data switch from DATA SPEC. Ask for it at your nearest authorized DATA SPEC dealer.

## DATA SPEC®

FROM ALLIANCE RESEARCH CORPORATION  
20120 Plummer Street • Chatsworth, CA 91311 • 1-818-993-1202

\*Manufacturer's suggested retail price for model AB-25. A/B switch. A/B/C (25 or 36 pin configurations) and cross matrix data switches are also available.

©Copyright 1985 Alliance Research Corporation

## A HOPE TUTORIAL

so that its first item (the "head") and the remaining list (the "tail") can be referred to separately on the right-hand side. The second recursion equation covers the case when the first list is empty. The second list parameter is matched by the pattern  $r$  whether it's empty or not.

In addition to writing enough recursion equations to satisfy all the parameter constructors, we must also be careful not to write sets of equations in which more than one pattern might match the actual parameters, because that would be ambiguous.

We can write patterns to match arguments that are tuples in the same way. When we wrote  $\text{mult}(x,y)$  you probably thought the parentheses and the comma had something to do with the function application. In fact, we were constructing a tuple, and the parentheses were needed only because the tuple constructor  $(,)$  has a low priority. Hope treats all functions as having only one argument. This can be a tuple when you want the effect of several arguments. Without the parentheses

$\text{mult } x, y$

would be interpreted as

$(\text{mult } (x), y)$

A recursion equation with the left-hand side

$\text{--- mult } (x, y) \leftarrow \dots$

is just a pattern match on a tuple. The first item in the tuple gets named  $x$  and the second one  $y$ .

We can even use pattern matching on num parameters. These are defined by two constructors called succ and 0. succ defines a number in terms of the next lower one. 0 has no arguments and defines the value zero. Surely 0 is a value, not a function? Well, we're already used to thinking of function applications as another way of writing values, so it's quite consistent to think of 0 as a function application. Here's a version of mult that uses pattern matching to identify the base case:

```
infix mult : 8;
dec mult : num # num -> num;
--- x mult 0      <= 0;
--- x mult succ(y) <= (x mult y) + x;
```

We can read  $\text{succ}(y)$  as "the successor of some number that we'll call  $y$ ." Instead of naming the actual parameter  $y$  as we did in the original version of mult, we're naming its predecessor.

### SIMPLIFYING EXPRESSIONS

In Pascal programs we can simplify complex expressions by removing common subexpressions and evaluating them separately. Instead of  $\text{writeln}((x+y)*(x+y));$ , we would probably write  $z := x+y; \text{writeln}(z*z);$ , which is clearer and more efficient. Hope programs consist only of expressions, and it's even more important to simplify them. We do this by using a qualified expression:

(continued)

## NOVA PC/XT

### THE TOP OF THE LINE IBM COMPATIBLE SUMMER SPECIALS

#### FEATURES:

- Affordably priced PC/XT/AT Computer
- Runs PC, MS-DOS, CP/M/86
- Of course, this versatile computer runs Flight simulator, Lotus 1-2-3, Symphony, Framework, Peachtree, D base II & III, PC Paint, Auto C.A.D., and tons of software.
- We have a demo system available for your testing.

#### COMPUTER SYSTEMS

NOVA XT Entry Model ..... \$2000  
NOVA AT 640K mother board, Intel #80286 CPU (Option 8MHz), 195W P.S. Two 1.2MB floppy dr., DTC hard disk/floppy controller

NOVA PC Bare Base ..... \$495  
64K mother board, case, 130W power supply, floppy controller, keyboard

NOVA PC 254K ..... \$225  
256K mother board, case, 130W power supply, 3 1/2 in. drive, 5 pack compatible multifunction, color graphic card, 4-drive controller card.

NOVA XT Enhance Model ..... \$3000  
NOVA AT 1MB mother board, Intel #80286 CPU (Option 8MHz), 195W power supply, Two 1.2MB floppy dr., 20MB hard disk, 2 Serial/1 parallel card, keyboard.

NOVA XT 254K ..... \$1895  
254K mother board, case, 130W power supply, 3 1/2 in. drive, 5 pack compatible multifunction card, 10MB hard disk, DTC H.D. controller color graphic, 4-dr controller



#### UPGRADE KIT for PC to XT

Internal, Two 10MB H.D.+DTC controller... \$595  
Internal, Microchannel 20MB+DTC controller \$695  
Internal, Irwin 10MB Tape back up with cartridge and cable, free installation ..... \$595  
High quality XT 130W power supply ..... \$130

#### NOVA Series Add On Board

NOVA base board w/installation manual ..... \$79  
NOVA 6-function board w/64K (AST 6 pack compatible) ..... \$105  
Mono-graphic card ( Hercules compatible) ..... \$170  
Floppy controller with cable ..... \$30  
High quality XT 130W power supply ..... \$130

NOVA external, 10MB, 20MB, 10MB Tape back up system from ..... \$150  
NOVA external case with 60W power supply for II D & tape backup ..... \$17

#### DISK DRIVE and MONITOR and ACCESSORIES

Two 5 1/4 in. 360KB floppy drive ..... \$105  
Microchannel 10MB, 20MB ..... (Lowest price)  
Minicrite or Two 10MB hard disk ..... \$420  
Keytronics compatible #5161 keyboard ..... \$130  
Harc keyboard (made in U.S.A.) ..... \$130  
Amdel 310A amber monitor ..... \$147  
Amdel color IV (730x240) ..... \$385

DEALER INQUIRIES WELCOME. - NOVA PC/XT KITS AVAILABLE  
COMPUTRADE COMPANY (in Koll Commercial Center)  
780 Trimble Road, Suite 605, San Jose, CA 95131  
Tel. (408) 946-2442, Telex: 171605  
Hours: Mon-Fri 9:00 a.m.-6:00 p.m.

# New Generation Communications

Our new Crosstalk Mark 4 behaves just as reliably as the Crosstalk you've always trusted. But when you ask it for a bit extra, you're in for some surprises.

## Up To 15 Concurrent Sessions

Mark 4 supports the X.PC multiple-session protocol, so it's capable of up to 15 concurrent communications sessions, each with the end-to-end error-checking needed for tomorrow's higher speed modems.

With more than one session going on at once, you need some way to keep track of them all. Crosstalk Mark 4 has that, too.

## What You Get Is What You See

Mark 4 identifies each session with a "page" number. You can flick from one session to another with one keystroke. See each one full screen.

But if you'd like to keep an eye on more than one session at once, you can create windows — as many as you need in any size or shape — to display them all.

## Menu? Or Command?

No matter how expert you are, Mark 4 is just your speed. It operates on command, or with a menu, or any combination of the two.

Inquiry 213



If you need help at any point in your command sequence, Mark 4 gives you suggestions that apply precisely to the task at hand.

## Why Repeat Yourself?

If you make the same calls often, as most people do, Mark 4 can save you a lot of dull repetition. It has built-in command programs to call up and log in to most of the major information utilities.

But Mark 4 goes one step further. It can "memorize" any command sequence you perform, then repeat it that way any time you ask it to. You can't make programming much easier than that.

## And Now, By Popular Request ...

— Mark 4 has a text-editor built in. You can create and edit files without having to leave Crosstalk.

— Mark 4 emulates the most popular terminals, including

IBM 3101, DEC VT-52, VT-100, and the TeleVideo 900 series. Most other programs emulate one or two.

— In addition to X.PC, Crosstalk Mark 4 supports Kermit, Xmodern, and of course our own Crosstalk protocol.

## How New Is New Generation Communication?

New enough for the advanced breed of modem that's already coming around the corner. New enough to give you the best high-speed, error-checked communication possible on noisy phone lines — or secure dedicated lines.

Finally, because Crosstalk is already the industry standard for small business computers, Mark 4 is at home in a broader universe than any other communications software.

It may be new and improved and revolutionary — but it's still Crosstalk.

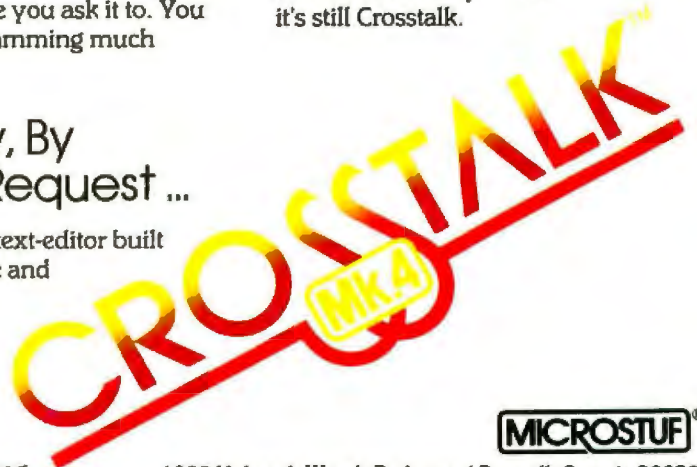

**MICROSTUF**<sup>®</sup>

1000 Holcomb Woods Parkway / Roswell, Georgia 30076

AUGUST 1985 • BYTE 245

# MACROTECH

THE PRICE PERFORMANCE LEADER  
IN PC-AT MEMORY  
EXPANSION

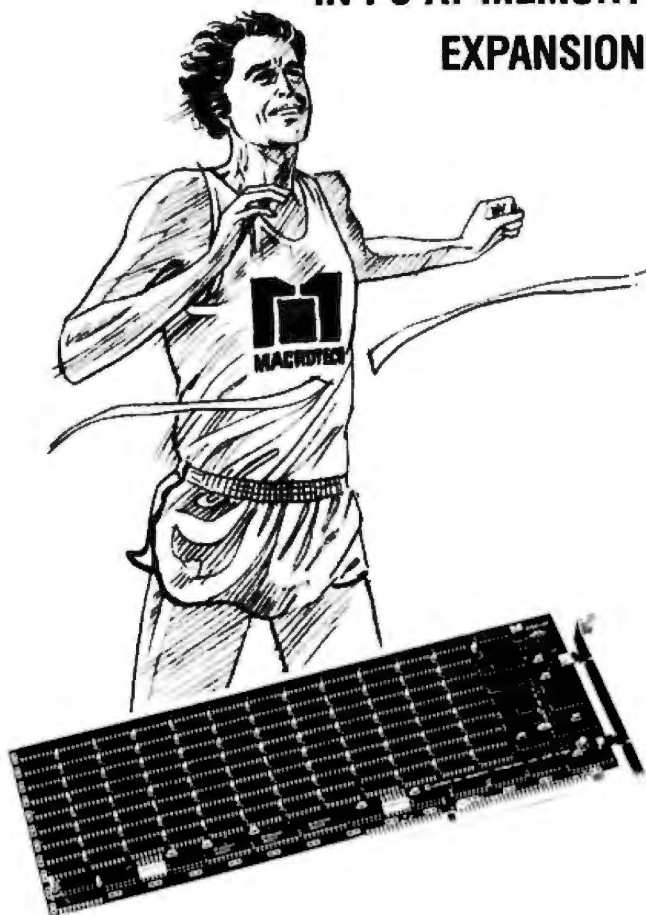

NOW – The absolute best value in PC-AT memory expansion is available from Macrotech, a leader in memory products for nearly four years. With 120 nanosecond ram chips and low power consumption, Macrotech's **MSR-AT** sets a new performance standard. The **MSR-AT** is available in up to 3 megabytes at the lowest price in the industry.

#### Features:

- Addressing flexibility; XENIX users can address up to 3 megabytes on any 128k boundary. DOS users can add system memory up to 640k and also create ram disks of up to 2.5 megabytes.
- High quality multi-layer PC board is fully assembled and tested. Fully soldered construction provides highest possible reliability.
- Low power consumption and single card design provide optimal cooling even when more than one MSR-AT is installed.
- 120 nanosecond ram chips assure optimal performance even with clock speeds above 6mhz.
- Full one year warranty.

ONLY \$1450 for full 3 megabytes. Check our low price on other configurations.

Dealer and OEM inquiries welcome.

 **MACROTECH International Corp.**  
9551 Irontdale Avenue  
Chatsworth, CA 91311  
Phone: (800) 824-3181  
In Calif: (818) 700-1501 • Telex: 9109970653



## A HOPE TUTORIAL

```
let z == x + y in z*z;
```

This looks like an assignment, but it isn't. == is read as "is defined as," and z is local to the expression following the in. If we write something like

```
let z == z + 1 in z*z;
```

we're actually introducing a new variable, z, to use in the subexpression z\*z. It hides the original one in the subexpression z + 1.

There's a second form of qualified expression for people who like to use variables first and define their meanings later. It looks like this:

```
z*z where z == x + y;
```

The result of the qualified expression is the same whether we define it using let or where. x + y is evaluated first, and its value is used in the main expression.

The qualifying expression will often be a function application that defines a data structure. If we want to name part of the structure, we can use a pattern on the left-hand side of the == symbol.

```
dec time12 : num -> num # num;  
--- time12(s) <= (if h > 12 then h - 12 else h,m) where  
                  (h,m,s) == time24(s);
```

We'll use this construction most often when we write recursive functions that define tuples. Suppose, for example, that we want to form a string of words from a sentence. For simplicity, a word is taken to be any sequence of characters, and words are separated in the sentence by any number of blanks. The sentence and a single word will be list ( char ) objects and the final sequence of words a list(list(char)).

It's fairly straightforward to obtain the first word. Here's a function that does it:

```
dec firstry : list(char) -> list(char);  
--- firstry(nil) <= nil;  
--- firstry(c :: s) <= if c = ''  
                          then nil  
                          else c :: firstry(s);
```

One of the nice features of Hope is that we can type in and print out any kind of value, so it's easy to check out the individual functions of our program separately. If we test firstry we'll see

```
firstry ( "You may hunt it with forks and Hope" ) ;  
"You" : list ( char )
```

But there's a problem here, because we're going to need the rest of the sentence if we're to find the remaining words. We must arrange for the function to return the remaining list as well as the first word. This is where tuples come in:

```
dec firstword : list(char) -> list(char) # list(char);  
--- firstword(nil) <= (nil, nil);
```

(continued)

# IT'S NICE TO HAVE A WORKAHOLIC PERSONALITY AROUND THE OFFICE.



## Relax.

When you need hard copy, leave the hard work to your office workaholic—a Datasouth printer. There's a high performance workaholic Datasouth for every hard copy job around your office.

Move mountains of words and data with a never-say-die DS 180 or a DS 220. Type out correspondence with a speedy DaisyWheel 36. Or get an all-purpose Personal Printer to work overtime next to your desktop PC.

And get personal support direct from Datasouth, toll-free.

Set up an interview with a high performance workaholic today. Call for the name of your nearest Datasouth distributor.



**datasouth**

H I G H P E R F O R M A N C E P R I N T E R S

AVAILABLE NATIONWIDE  
THROUGH OUR NETWORK OF  
SALES AND SERVICE DISTRIBUTORS

Datasouth Computer Corporation  
Box 240947 • Charlotte, NC 28224  
704/523-8500 • Tlx 6843018 DASOU UW

CALL TOLL FREE:  
1-800-222-4528  
Ext. 503

```

--- firstword(c :: s) <= if c = ''
    then (nil,s)
    else ((c :: w, r) where
        (w,r) == firstword(s));

```

The qualified expression is in parentheses so it only applies to the expression after else; otherwise we would evaluate firstword recursively as long as the sentence is nonempty, even if it starts with a blank. This version of the function produces

```

firstword("Hope springs eternal . . .");
("Hope", "springs eternal . . .") : (list(char) # list(char))

```

We can use this to define a function to split the sentence into a list of its individual words:

```

dec wordlist : list(char) -> list(list(char));
--- wordlist(nil) <= nil;
--- wordlist(c :: s) <= if c = ''
    then wordlist(s)
    else (w :: wordlist(r) where
        (w,r) == firstword (c :: s));

```

which we can test by typing an application at the terminal:

```

wordlist(" While there's life there's Hope ");
["While", "there's", "life", "there's", "Hope"] :
list(list(char))

```

So far we've concentrated on features of Hope that have something in common with traditional languages such as Pascal, but without many of their limitations, such as fixed-size data structures. We've also been introduced to the functional style of programming in which programs are no longer recipes for action but definitions of data objects.

Now we'll introduce features of Hope that lift it onto a much higher level of expressive power and enable us to write programs that not only are extremely powerful and concise but that can be checked for correctness at compile time and mechanically transformed into more efficient versions.

### MORE POWERFUL FUNCTIONS

The Hope compiler can spot many common kinds of errors by checking the types of all objects in expressions. This is harder than checking at run time, but it is more efficient and saves the embarrassment of discovering an error at run time in a rarely executed branch of the air traffic control system we just wrote.

However, strict type checking can be a nuisance if we want to perform some operation that doesn't depend on the type of the data. Try writing a Pascal procedure to reverse an array of either 10 integers or 10 characters, and you'll see what I mean.

Hope avoids this kind of restriction by allowing a function to operate on more than one type of object. We've already used the standard constructors :: and nil to define a list(num), a list(char), and a list(list(char)). The standard equality function = compares any two objects of the same

type. Functions with this property are called polymorphic. Pascal's built-in functions abs and sqr and operators like > and = are polymorphic in a primitive kind of way.

We can define our own polymorphic functions in Hope. The function cat we defined earlier concatenates lists of numbers, but we can use it for lists containing any type of object. We do this by first declaring a kind of "universal type" called a type variable. We use this in the declaration of cat where it stands for any actual type.

```

typevar alpha;
infix cat : #;
dec cat : list (alpha) # list(alpha) -> list(alpha);

```

This says cat has two parameters that are lists and defines a list, but it doesn't say what kind of object is in the list. However, alpha always stands for the same type throughout a given declaration, so all the lists must contain the same type of object. The expressions [1,2,3] cat [4,5,6] and "123" cat "456" are valid, while the expression [1, 2, 3] cat "456" is not. The interpretation of a type variable is local to a declaration so it can have different interpretations in other declarations without confusion. [Editor's note: In the version of Hope available on BYTEnet, the type variables alpha and beta are predefined.]

Of course, it only makes sense for a function to be polymorphic as long as the equations defining it don't make any assumptions about types. In the case of cat, it's defined using only :: and nil, which are polymorphic themselves. However, a function like sumlist uses + and can only be used with lists of numbers as parameters.

### DEFINING YOUR OWN DATA TYPES

Tuples and lists are quite powerful, but for more sophisticated applications we'll need to define our own types. User-defined types make programs clearer and help the type checker to help the programmer. We introduce a new data type in a *data declaration*.

```

data vague == yes ++ no ++ maybe;

```

data is a reserved word and vague is the name of the new type. == is pronounced "is defined as" and ++ is pronounced "or." yes, no and maybe are the names for the constructor functions of the new type. We can now write function definitions that use these constructors in pattern matches:

```

dec evade : vague -> vague ;
--- evade ( yes ) <= maybe ;
--- evade ( maybe ) <= no ;

```

The constructors can be parameterized with any type of object, including the type that's being defined. We can define types like lists, whose objects are of unlimited size using this kind of recursive definition. Here's a user-defined binary tree that can contain numbers as its leaves:

```

data tree == empty ++ tip(num) ++ node(tree # tree);

```

(continued)



# LASER WARS

Attention Earth. The BDS Laser invasion is proof that all 8-page/minute laser engines are not created equal. BDS Corporation is the planet's largest manufacturer of devices using the Dataproducts printer mechanisms. And now, at the risk of causing permanent brain damage to anyone with a large stock of ordinary laser or daisy wheel printers, we are proud to announce our first laserprinter, the BDS Laser 630/8.

## OFFICE-READY AT \$3495, BATTERIES NOT INCLUDED

As the designation "630/8" implies, the new BDS laserprinter is Diablo 630-compatible and operates at 8 pages per minute. At \$3495, this is exactly what you need for a clean landing in your office and word-processing environment. No software conversions. No retraining all the secretaries. No more cumbersome sound-proofing enclosures or long walks to the printing room (the BDS laserprinter is quiet enough to sit next to you in a public library). And no surprises. Like paying \$4750 by the time you add all the options you really need for your office.

Now, however, the distance between BDS and the other laser/daisy competition *really* starts opening up.

You'll start out using your standard word-processing software. Even before you teach people how to imbed typefont-changing codes into their text, they'll be able to customize documents via the intelligent control panel.

For example, they may want to change magnification factors. Like blowing up text size for speeches and overheads, reducing for text compaction, or printing sideways for spreadsheets. And the BDS laserprinter will remember these new settings even after a power failure (we don't even need batteries, because we use non-volatile memory!).

Nine typefonts are provided in the basic configuration. Complete, for \$3495. With optional font cartridges, up to sixteen typefonts may be simultaneously online for use in any document.

Competitive distance becomes parsecs with the BDS *open* architecture. One of the optional font cartridges allows custom or user-defined typefonts to be downloaded from the host computer. Which ought to create a brisk third-party business for suppliers of corporate logos, bar codes and special-purpose character sets.

The final leap into hyperspace, and ahead of the competition, is achieved with dual-porting. Two computers can connect to the laserprinter, via one parallel and one serial interface. Yep. \$3495.

For the office which hasn't yet standardized on a local area network, two independent workstations can be connected. Eventually, one of the laser ports can connect to a LAN printer server, while the other can connect to a Diablo-compatible host supermini or PC.

All of the above capabilities combine to open up vast possibilities. Both for today and tomorrow.

## TAKE THIS AD TO YOUR LEADER

If you're a Fortune 1000-size company, we can Federal Express your BDS Laser 630/8 the same day you call us with your purchase order number.\* If you're a smaller company, we'll launch a communication probe in your direction, that will give you the name of our nearest, authorized dealer.

Oh. We don't mind landing the BDS unit next to the other, inferior daisy wheels or lasers you may already have. Of course, after running them side by side, you may want to shoot your old printer straight out of (no pun intended) a cannon.

Inquiry 34



BDS  
Corporation  
800 Maude Ave.  
Mtn. View, CA 94043  
(415)964-2115

UK (734)730025 Australia (03)690-1222

## MICRO CONTROLLED DIGITAL DATA RECORDER

### FEATURES:

Microprocessor controlled data buffering • Buffers data in RAM • Data comes in at any standard baud rate, plays back at any baud rate (switchable) • Tape runs only during block record/playback • RS232 input/output 110/220 v ac or 12 v dc • 1.2 MB per tape side • Uses chrome oxide audio cassettes • Has hold-off during playback via CTS line • No data hold-off during record.

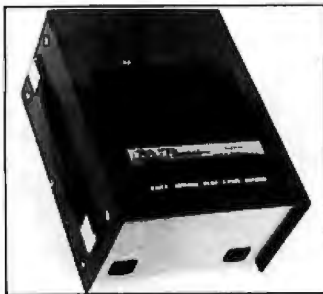

### APPLICATIONS:

PROCESS CONTROL • POINT OF SALE • TELEPHONE SWITCH LOGGING (SMDR) • INSTRUMENTATION • DIAGNOSTIC SUPPORT • PROGRAM LOADING • DATA LOGGING.

BUFFERED VERSION MODEL PD1-BF ..... \$595.00  
NON BUFFERED VERSION - MODEL PD-1 ..... \$335.00

TO ORDER, DIAL:  
(201) 356-9200



# ATTENTION DISK JOCKEYS

Give your PC Drive Power!

Vfeature  
for IBM AT, XT and compatibles  
supports BIG disks  
secures disk data.

Vfeature operates with AT- and XT-compatible hard disk controllers.

## Golden Bow Systems

\$70.00  
Add \$3 for shipping/  
handling  
California residents add  
6% sales tax



3368 Second Ave., Suite F  
San Diego, CA 92103  
(619) 298-9349

## A HOPE TUTORIAL

There are three constructors: `empty` has no parameters and defines a tree with nothing in it. `tip` defines a tree in terms of a single number, and `node` defines a tree in terms of two other trees. Figure 1 shows a typical tree.

Here's an example of a function that manipulates trees. It returns the sum of all the numbers in the tree:

```
dec sumtree : tree -> num;
--- sumtree (empty) <= 0;
--- sumtree (tip(n)) <= n;
--- sumtree (node(l,r)) <= sumtree(l) + sumtree(r);
```

(continued)

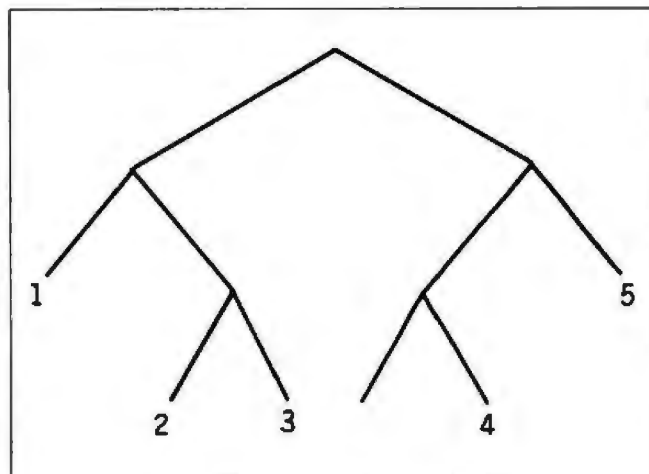

Figure 1: A typical binary tree.

Listing 1a: The polymorphic function `flatten` can operate on trees of any type object.

```
dec flatten : tree(alpha) -> list(alpha);
--- flatten(empty) <= nil;
--- flatten(tip(x)) <= x :: nil;
--- flatten(node(x,y)) <= flatten(x) <> flatten(y);
```

Listing 1b: These examples demonstrate the function `flatten` on various types of trees.

```
flatten(node(tip(1),node(tip(2),tip(3))));
[ 1, 2, 3 ] : list
flatten(node(tip("one"),
             node(tip("two"),
                  tip("three"))));
["one", "two", "three"] : list(list(char))
flatten(node(tip(tip('a')),
             node(tip(empty),
                  tip(node(tip('c'),
                          empty)))));
[ tip('a'),empty,node(tip('c'), empty) ] : list(tree(char))
```



## This will renew your trust in the phone company.

**A**nbody who's ever sent data over phone lines knows the problems it can present.

Information gets mumble-jumbled. \$4,000 invoices become \$40,000 invoices. And soon your company's lost a pretty penny over some modem foul-up.

Well, now you can say good-bye to all that.

\*MNP is a trademark of Microcom, Inc. ©Copyright 1985 Codex Corp.

Because Codex just came out with a modem that overcomes the inadequacies of phone line performance.

(Codex, as your friends in data processing will tell you, is the industry's acknowledged leader in state-of-the-art products, in service, in just about everything that has to do with networking.)

The Codex error-correcting pc modem is a serious business modem.

It gives you data transmissions more than 10,000 times more reliable than most other modems. Over anybody's phone lines.

A sophisticated error-correction system called MNP™ detects breakdowns in phone line performance and retransmits data. And the beauty is all this happens without you ever knowing it.

Just think. Data you can trust.

Now don't you feel better about those crazy phone lines?

If you're a data

communications manager responsible for purchasing modems, call **800-426-1212. Extension 225.**

Or write Codex Corporation,  
Department  
707-225,  
20 Cabot  
Boulevard,  
Mansfield,  
MA 02048.



**codex**  
 **MOTOROLA**

IBM



IBM

# 5 MEGS FREE!

## THE WORLD OF PC UPGRADES

### PC HARD DISKS

IS10	10 Mbyte Hard Disk with Controller	\$ 525
IS10R	10 Mbyte Removable Hard Disk Controller	\$1295
IS20	20 Mbyte Hard Disk with Controller	\$ 625
IS30	30 Mbyte Hard Disk with Controller	\$ 995

All the above available for the Tandy 1000

### TAPE BACKUP

MT10	10 Mbyte Micro Tape Backup "works like a floppy"	\$ 425
MT45	45 Mbyte Streaming Tape Backup	\$1195

### AT HARD DISKS

AT20	20 Mbyte Hard Disk	\$ 695
AT33	33 Mbyte Hard Disk	\$ 995
AT120	120 Mbyte Hard Disk	CALL

### SPECIAL SOFTWARE

COMMAND/ASSIST	DOS MANUAL ON DISK	\$49.95
CACHE/ASSIST	SPEED UP DISK ACCESS	\$49.95
FREE/ASSIST	*FREE SOFTWARE WITH ANY PC HARD DISK (COMES ON YOUR HARD DISK)	FREE

### AND OTHER PC ACCESSORIES

FS20	FILE SERVER NETWORK:	CALL
------	----------------------	------

"WITH THE PURCHASE OF ANY PC HARD DISK"

# \*FREE SOFTWARE 5 MEGA BYTES

- PROGRAMS INCLUDE:**
- 100 GENERAL PURPOSE
  - 100 DATA BASE II
  - 20 PASCAL PROGRAMS
  - 80 "C" PROGRAMS
  - ACCOUNTING PACKAGES
  - FINANCIAL PROGRAMS
  - WORD PROCESSOR
  - VT100 EMULATOR
  - AND FOR CHILDREN:**
  - 90 GAMES
  - I.Q. BUILDER
  - WORD PROCESSING
  - MATH

— AND —  
MUCH, MUCH MORE

ORDER LINE  
OUTSIDE FLORIDA

# 1-800-228-0891

1 YEAR WARRANTY, 30 DAY MONEY BACK GUARANTEE ON ALL OUR PRODUCTS

VISA  
MASTERCARD

## Micro Design International Inc.

6566 University Boulevard, Winter Park, Florida 32792 (305) 677-8333 TELEEX 335258P MICRO INTL

Inquiry 201

IBM is a Registered Trademark



## A HOPE TUTORIAL

Unfortunately, there's no shorthand for writing tree constants like there is for list constants, so we've got to write them out the long way using constructors. If we want to use `sumtree` to add up all the numbers in the example tree, we must type in the expression

```
sumtree(node(node(tip(1),
    node(tip(2),
        tip(3))),
    node(node(empty,
        tip(4)),
        tip(5))));
```

This isn't really a drawback because programs that manipulate complex data structures like trees will generally define them using other functions. However, it's very useful to be able to type any kind of constant data structure at the terminal when we're checking out an individual function like `sumtree`. If we want to test a Pascal program piecemeal, we'll usually have to write elaborate test harnesses or stubs to generate test data.

### MAKING DATA MORE ABSTRACT

The identifier `list` isn't really a Hope data type. It's called a type constructor and must be parameterized with an actual type before it represents one. We did this every time we declared a `list(num)` or a `list(char)`. The parameter can be a user-defined type, as with a `list(tree)`, or even a type variable, as in `list(alpha)`, which defines a polymorphic data type. Constructing new data types like this is a compile-time operation, not to be confused with constructing new data values, which is a run-time operation.

You can define your own polymorphic data types. Here's a version of the binary tree we defined earlier that can have any type of value in its leaves:

```
data tree(alpha) == empty ++
    tip(alpha) ++
    node(tree(alpha) # tree(alpha));
```

Once again, `alpha` is taken to be the same type throughout one instance of a tree. If it's a number, then all references to `tree(alpha)` are taken as references to `tree(num)`.

We can define polymorphic functions that operate on trees of any type of object because our tree constructors are now polymorphic. Listing 1 shows a function to "flatten" a binary tree into a list of the same type of object.

### EVEN MORE CONCISE PROGRAMS

The importance of polymorphic types and functions is that they let us write shorter, clearer programs. It's rather like the way Pascal subroutines let us use the same code to operate on different data values, but much more powerful. We can write one Hope function to reverse a list of numbers or characters, while we'd need to write two identical Pascal subroutines to reverse an array of integers and an array of characters.

We can use polymorphic functions whenever we're con-

(continued)

# DISKETTES

CALL TOLL FREE → West of Rockies 1-800-621-6221  
Central & East 1-800-654-4058

<b>Dysan</b> 5 1/4 Disks S-SIDE 1695 D-DEN D-SIDE 2195 D-DEN S-SIDE 2895 96 TPI D-SIDE 3895 96 TPI HIGH DEN. 5195	<b>maxell</b> 5 1/4 Disks S-SIDE 1395 D-DEN D-SIDE 1995 D-DEN S-SIDE 2495 96 TPI D-SIDE 3095 96 TPI HIGH *DEN. 3995	<b>BONUS</b> Disks-10 pk \$9.95 per box SS DD Verbatim Kits 4.95 Refills 8.95 Media Mate 8.95 ea. *2.00 Shipping 100 Disk Bulk Pack 85.00 SS DD 97.00 DS DD	<b>3M</b> 5 1/4 Disks S-SIDE 1495 D-DEN D-SIDE 1995 D-DEN S-SIDE 2495 96 TPI D-SIDE 3095 96 TPI 3 1/2 Disks S-SIDE 2895 8" Disks S-SIDE 1995 S-DEN S-SIDE 2495 D-DEN D-SIDE 2895 D-DEN	<b>Verbatim</b> Datalife 5 1/4 Datalife S-SIDE 1495 D-DEN D-SIDE 1995 D-DEN S-SIDE 2495 96 TPI D-SIDE 3095 96 TPI 3 1/2 Datalife S-SIDE 2795 8" Datalife S-SIDE 1995 S-DEN S-SIDE 2295 D-DEN D-SIDE 2695 D-DEN
---	---	--	--	---

**the Diskette Connection**

 1-800-621-6221 P.O. Box 1213  
 Boulder City, NV 89005  
 1-800-654-4058 P.O. Box 1674  
 Bethany, OK 73008

**TERMS:** Minimum 20 disks or \$35.00 — VISA or MasterCard accepted  
 COD orders add 2.00 for special handling **SHIPPING:** 3/4" & 5 1/4" Diskettes:  
 Add 3.00 for every 100 Diskettes or any fraction thereof 8" Diskettes: Add  
 4.00 for every 100 Diskettes or any fraction thereof. We ship UPS; orders  
 requiring other delivery methods add shipping, plus 2% of total order.

## UNLOCK™ Removes Copy Protection!

**Runs on IBM® PC, XT, AT, and Many Compatibles**

New UNLOCK (4.0) provides the user with: 1) reliable archival back-up copies, and 2) ease of program use. Because UNLOCK removes copy protection, you can conveniently run protected software from a hard disk, RAM disk or a Data General/One.™ Often you can combine two disks into one, saving disk swaps on floppy systems.

UNLOCK runs on DOS 2.0 or higher and requires 256K of memory. To utilize the UNLOCK copy requires no co-resident software. UNLOCK does not risk or change your original distribution disk. UNLOCK is intended for use only to improve the useability of legally acquired and operated software.

**New UNLOCK (4.0) Disk Produces Non-Protected DOS Copies from:**

**ORDER TODAY BY TELEPHONE!  
(305) 474-7548  
OR USE COUPON BELOW**

- LOTUS 1-2-3™ (1.A & 1.A\*)
- dBASE III™ (1.0 & 1.1)
- FRAMEWORK™ (1.0 & 1.1)
- SYSTAT™ (1.3 & 2.0)
- SPOTLIGHT™ (1.0)
- GRAPHWRITER™ (4.3)
- REALIA COBOL (1.20)

**\$49.95**

Version 4.0

(PLUS \$4.00 SHIPPING AND HANDLING)

**TRANSEC™**



TranSec Systems, Inc.  
701 E. Plantation Circle, Plantation, FL 33324

Please send me \_\_\_\_\_ copies of UNLOCK (4.0) @ \$49.95 ea. plus \$4.00 Ship/Handl.

Check enclosed \_\_\_\_\_ MC \_\_\_\_\_ VISA \_\_\_\_\_

Card No \_\_\_\_\_

Exp. Date \_\_\_\_\_

Name \_\_\_\_\_

Title \_\_\_\_\_

Company \_\_\_\_\_

Address \_\_\_\_\_

City \_\_\_\_\_ State \_\_\_\_\_ Zip \_\_\_\_\_

Tel. No. \_\_\_\_\_ Signed \_\_\_\_\_ B8

TRADEMARKS (OWNER) IBM, PC, XT, AT (International Business Machines), Lotus 1-2-3 (Lotus Development Corp.), dBase III and Framework ( Ashton-Tate), Systat (Systat, Inc.), Spotlight (Software Arts), Graphwriter (Graphwriter Communications, Inc.), Data General/One (Data General Corp.), Relia Cobol, (Relia, Inc.)

cerned only with the "shape" of a data structure and not with the objects in it. Sometimes, however, we'll also want to apply some function to the primitive data items in the structure. Here's a function that defines a `list(num)` whose elements are the squares of another `list(num)` using a function called `square`:

```
dec square : num -> num;
--- square(n) <= n*n;

dec squarelist : list(num) -> list(num);
--- squarelist(nil) <= nil;
--- squarelist(n :: l) <= square(n) :: squarelist(l);
```

Every time we write a function to process every element of a list, we'll write something almost identical to `squarelist`. Here's a function to define a list of factorials:

```
dec fact : num -> num;
--- fact(0) <= 1;
--- fact(succ(n)) <= succ(n) * fact(n);

dec factlist : list(num) -> list(num);
--- factlist(nil) <= nil;
--- factlist(n :: l) <= fact(n) :: factlist(l);
```

`factlist` has exactly the same "shape" as `squarelist`; it just applies `fact` instead of `square` and then applies itself recursively. Values that differ between applications are usually supplied as actual parameters. Hope treats functions as data objects, so we can do this in a perfectly natural way. A function that can take another function as an actual parameter is called a higher-order function. When we declare it we must give the type of formal parameter standing for the function in the usual way. The declaration of `fact` tells us it's `num -> num`. Read this as "a function mapping numbers to numbers."

Now let's see how we can use this idea to write `factlist` and `squarelist` as a single higher-order function. The new function needs two parameters—the original list and the function that is applied inside it. Its declaration will be

```
dec allist : list(num) # (num -> num) -> list(num);
```

The "shape" of `allist` is the same as `factlist` and `squarelist`, but the function we apply to each element of the list will be the formal parameter.

```
--- allist(nil, f) <= nil;
--- allist(n :: l, f) <= f(n) :: allist(l, f);
```

We use `allist` like this:

```
allist( [2,4,6], square );
[ 4,16,36 ] : list ( num )

allist( [ 2,4,6 ], fact );
[ 2,24,720 ] : list ( num )
```

Notice that there is no argument list after the functions `square` or `fact` in the application of `allist`, so this construction will not be confused with functional composition. `fact(3)` represents a function application, but `fact` by itself

represents the unevaluated function.

Higher-order functions can also be polymorphic. We can use this idea to write a more powerful version of `allist` that will apply an arbitrary function to every element of a list of objects of arbitrary type. This version of the function is usually known as `map`:

```
typevar alpha, beta ;

dec map : list(alpha) # (alpha -> beta) -> list(beta);
--- map(nil, f) <= nil;
--- map(n :: l, f) <= f(n) :: map(l, f);
```

The definition now uses two type variables, `alpha` and `beta`. Each one represents the same actual type throughout one instance of `map`, but the two types can be different. This means we can use any function that maps `alphas` to `betas` to generate a list of `betas` from any list of `alphas`.

The actual types aren't restricted to scalars, which makes `map` rather more powerful than we might realize at first sight. Suppose we've got a suitably polymorphic function that finds the length of a list:

```
typevar gamma;
dec len : list(gamma) -> num;
--- len(nil) <= 0;
--- len(n :: l) <= 1 + len(l);

len( [2,4,6,8] ) + len("cat");
7 : num
```

We can use `map` to apply `len` to every element of a list of words defined by `wordlist`:

```
map(wordlist("The form remains, the function never
dies"), len);
[ 3,4,8,3,8,5,4 ] : list ( num ) ;
```

In this example `alpha` is taken to be of type `list(char)` and `beta` to be a number, so the type of the function must be `(list(char) -> num)`. `len` fits the bill if `gamma` is taken to be of type `char`.

### COMMON PATTERNS OF RECURSION

`map` is powerful because it sums up a pattern of recursion that turns up frequently in Hope programs. We can see another common pattern in the function `len` used above. Here's another example of the same pattern:

```
dec sum : list(num) -> num;
--- sum(nil) <= 0;
--- sum(n :: l) <= n + sum(l);
```

The underlying pattern consists of processing each element in the list and accumulating a single value that forms the result. In `sum`, each element contributes its value to the final result. In `len`, the contribution is always 1 irrespective of the type or value of the element, but the pattern is identical. Functions that display this pattern are of type `(list(alpha) -> beta)`.

(continued)

For IBM-PC Add-On Users

# In A Pinch? Give QIC The Inch

## We Have the Right Products ... at the Right Prices

### ... Right Now!

Mass Storage at Massive Savings

**QIC-01 Internal Hard Disk Subsystem**

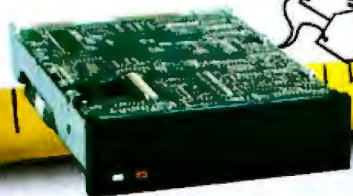

This low power Microscience subsystem comes complete with controller, cables, drive, easy instructions. Fits inside your floppy slot. Compatible with DOS 2.0, 2.1, and 3.0 without any patches. 33 MB half-height with controller, \$1,295 ... 20 MB Drive for the PC AT, \$895. Mounting hardware for Compaq is available. External 10 MB \$795, external 20 MB \$995.

10MB \$545  
20MB \$695

**QIC-03 300/1200 Baud Modems**

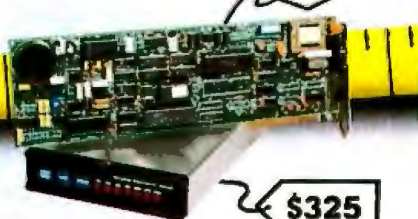

Our modems are fully Hayes compatible with features such as low heat dissipation, low power consumption, software volume control for the speaker, and large-scale-integration "Modem on a chip" for high reliability. It also comes with communications software which lets you emulate VT100 or IBM 3101. External \$325, Internal \$275.

\$215

\$325

**QIC-05 Five-Function Card**

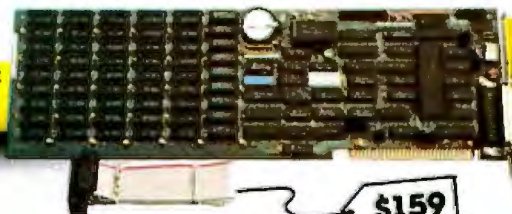

It gives you more than just added memory. It gives you reliable memory expansion (up to 384K), a serial port, a parallel port, a game port, and a battery back-up clock calendar. Includes RAM disk, print spooler, and clock utilities. (The 64K RAM set is only \$15.) With 2 serial ports \$175.

\$159

**QIC-2020 External Hard Disk with Tape Backup.**



Offers a 20 MB hard disk with a 20 MB tape backup unit in a chassis with two extra I/O slots. Comes with cable and a half size host adapter card. 20 MB hard disk with 60 MB tape is only \$2450.

\$1955

**QIC-02 10, 20, 60 MB Half-Height Tape Back-up Systems**

Out of slot? Now on budget? Our 10 MB reel tape back-up unit plugs into the back of your floppy controller. It works like a floppy disk so you can use all the DOS file commands such as COPY or DIR. Back-up 10 MB in 15 minutes. Our



20 MB cassette and 60 MB cartridge back-up systems come with controller, cables and drive. Back-up 20 MB in 6 minutes. You can even do fast Image back-up and then file-by-file retrieval. Works on IBM PC, XT or AT. Internal 10 MB \$499, 20 MB \$699, 60 MB \$899. External 10 MB \$675, 20 MB \$875, 60 MB \$995.

10MB \$499

#### Graphics Boards

- Hercules, Color ..... \$185
- Hercules Compatible, Mono \$245
- Paradise Graphics ..... \$295
- Everex Graphics Edge ..... \$295

#### Half Size Cards

- Memory card with
  - 256K ..... \$165
  - 384K ..... \$199
  - 576K ..... \$225

- IO card with 2 serial ports, 1 parallel port, clock/calendar, game port ..... \$150

- Internal Power Supply
  - 150 Watt ..... \$135
  - 200 Watt ..... \$155

- Expansion Chassis with I/O Slots ..... \$695
- IBM PC, 256K, 2 Drives ..... \$1499

#### We Guarantee Satisfaction!

No Risk. All our products carry the manufacturer's warranty. And remember, if for any reason, you are not completely satisfied within 30 days, you can return it for a full refund.

**Call Us Today!**  
**(408) 942-8086**

Telex: 5101002379 QICRCH

**QIC RESEARCH**  
INCORPORATED

Inquiry 254  
QIC-404

489 Valley Way  
Milpitas, Ca 95035

In the function definition, the equation for a nonempty list parameter specifies an operation whose result is a beta. This is + in the case of len and sum. One argument of the operation will be a list element, and the other will be defined by a recursive call, so the type of the operation needs to be

```
( alpha # beta -> beta )
```

This operation differs between applications, so it must be a parameter. Finally, we need a parameter of type beta to specify the base case result. The final version of the function is usually known as reduce, and its definition looks like this:

```
dec reduce : list(alpha) #
            (alpha # beta -> beta) #
            beta
            -> beta;

--- reduce(nil,f,b)  <= b;
--- reduce(n :: l,f,b) <= f(n,reduce(l,f,b));
```

To use reduce as a replacement for sum we'll need to supply the standard function + as an actual parameter. The word nonop must precede the function + in the parameter list, so the compiler won't try to use it as an infix operator here.

```
reduce([1,2,3],nonop +, 0);
6 : num
```

If we use reduce as a replacement for len, we're not interested in the first argument of the reduction operation because we always add 1 whatever the list element is. Here's a function that ignores its first argument:

```
dec addone : alpha # num -> num;
--- addone( __ , n ) <= n + 1;
```

We use \_\_ to represent any argument we don't want to refer to.

```
reduce("a map they could all understand", addone, 0);
31 : num
```

Like map, reduce is much more powerful than it first appears because the reduction function needn't define a scalar. Here's a candidate that inserts an object into an ordered list of the same kind of object:

```
dec insert : alpha # list(alpha) -> list(alpha);
--- insert(i,nil)  <= i :: nil;
--- insert(i, h :: t) <= if i < h
                        then i :: (h :: t)
                        else h :: insert(i,t);
```

Actually, this isn't strictly polymorphic, as its declaration suggests, because it uses the built-in function <, which is only defined over numbers and characters, but it shows the kind of thing we can do. If we use it to reduce a list of characters,

```
reduce ( "All sorts and conditions of men", insert, nil ) ;
" Aacddefiillmnnnnnooorssstt" : list ( char )
```

we'll see that it actually sorts them. The sorting method (insertion sort) isn't very efficient, but the example shows something of the power of higher-order functions and of reduce in particular. It's even possible to use reduce to get the effect of map, but that's left as an exercise for the reader, as they say.

Of course, map and reduce work only on list(alpha), and we'll need to provide different versions for our own structured data types. This is the preferred style of Hope programming because it makes programs largely independent of the "shape" of the data structures they use. Here's an alternative kind of binary tree and a reduce function for it. The tree holds data at its nodes rather than its tips.

```
data tree(alpha) == empty ++
                  node(tree(alpha) # alpha #
                       tree(alpha));

dec redtree : tree(alpha) #
            (alpha # beta -> beta) #
            beta -> beta;

--- redtree (empty, f, b)  <= b;
--- redtree (node(l, v, r), f, b) <=
    redtree(l, f, f (v, redtree(r,f,b)));
```

Here's the Hope version of tree-sort using the new kind of tree and the two kinds of reduce to construct and flatten them. First, a suitable tree-insertion function:

```
dec instree : alpha # tree (alpha) -> tree(alpha);
--- instree (i,empty)  <= node(empty,i,empty);
--- instree (i,node(l,v,r)) <=
    if i < v
    then node(instree(i,l),v,r)
    else node(l,v,instree(i,r));
```

The tree-sort function is now almost trivial to write:

```
dec sort : list(alpha) -> list(alpha);
--- sort(l) <= redtree(reduce(l,instree,empty),
                       nonop ::,nil);

sort("Mad dogs and Englishmen");
" EMAadddegghilmnnoss" : list ( char )
```

### ANONYMOUS FUNCTIONS

When we used map and reduce, we had to define extra functions like fact and square to pass in as parameters. This is a nuisance if we don't need them anywhere else in the program and especially if they're trivial, like sum or addone. For on-the-spot use in cases like this, we can use an anonymous function called a lambda-expression. Here's a lambda-expression corresponding to sum:

```
lambda(x,y) => x + y
```

The symbol lambda serves to introduce the function and x and y are its formal parameters. The expression x + y

(continued)





*Leaders have always recognized good advice...*

## Bring your company's presentation graphics into the computer age with the best recommendation you can make: Hewlett-Packard.



**H**ewlett-Packard's Graphics Plotters introduce *professional-quality* graphs and charts to the office... quality that, quite frankly, makes the competition look stone-age by comparison.

Combine our brilliant color capability, precise line quality, and proven reliability—and HP becomes the obvious choice for your presentation graphics needs. When it comes to plotters, it's easy to see why HP has become the world's Number One recommendation.

### Compare the quality of an HP Plotter...

Before making *your* graphics plotter recommendation, find out how HP stacks up against the competition. Here's a quick checklist:

Are the lines sharp and bold? Do they meet precisely? Are the diagonal lines smooth? Is the text easy to read?

In a chart, is the area fill uniform? With HP the answer is always yes, yes, and...yes.

### Runs with leading PC's and software packages.

HP Graphics Plotters are compatible with most of the personal computers in your office, including IBM, Compaq, and AT&T—as well as a host of HP computers. You even have a choice of many off-the-shelf software packages, such as Lotus 1-2-3<sup>®</sup> and Symphony,<sup>™\*</sup> that give you "first-day" productivity.

### Send today for your FREE sample plots—and see exactly what we mean.

Return the coupon—or call us toll-free at (800) FOR-HPPC. We'll send you a detailed brochure, a list of available software, plus sample plots from both an HP Graphics Plotter and a leading printer. Don't resort to stone-age methods before seeing the difference an HP Graphics Plotter can make. Call Hewlett-Packard *today*.

\*1-2-3 and Symphony are trademarks of Lotus Development Corporation

*Leadership in Business Graphics.  
For Leaders in Business.*



**HEWLETT  
PACKARD**

Inquiry 141



1101502

**YES,** I'd like to make the most informed business graphics recommendation I can. Please send me your detailed brochure, plus sample plots so I can see exactly what my company's presentations have been missing. I understand I will receive this information without cost or obligation.

Name \_\_\_\_\_

Title \_\_\_\_\_

Company \_\_\_\_\_

Address \_\_\_\_\_

City \_\_\_\_\_

State \_\_\_\_\_

Zip \_\_\_\_\_

Mail to: Hewlett-Packard, 16399 W. Bernardo Dr.  
San Diego, CA 92127-1899.

Attn: Marketing Communications.

11502 BT8

*Hope functions possess "full rights"  
and can be passed as actual  
parameters like any data object.*

is the function body. The definition is just a recursion equation with `=>` instead of `<=`. Here's another lambda-expression used as the actual parameter of `reduce`:

```
reduce( [ "toe","tac","tic" ], lambda(a,b) =>
      b <> a, nil);
"tictactoe" : list(char)
```

There can be more than one recursion equation in the function definition. They're separated from each other by the symbol `|`, and pattern matching is used to select the appropriate one. Here's an example that uses pattern matching in a lambda-expression to avoid division by zero when the function it defines is executed:

```
map([1,0,2,0,3],lambda(0) => 0 |
    (succ(n)) => 100 div succ(n));
[ 100,0,50,0,33 ] : list ( num )
```

#### FUNCTIONS THAT CREATE FUNCTIONS

As we've seen, Hope functions possess "full rights" and can be passed as actual parameters like any data object. It should be no surprise that we're allowed to return a function as the result of another function. The result can be a named function or an anonymous function defined by a lambda-expression. Here's a simple example:

```
dec makestep : num -> (num -> num);
--- makestep(i) <= lambda x => i + x;

makestep ( 3 ) ;
lambda x => 3 + x : num -> num
```

As we can see from trying `makestep`, its result is an anonymous function that adds a fixed quantity to its single argument. The size of the increment was specified as an actual parameter to `makestep` when the new function was created and has become "bound in" to its definition. If we try the new function, we'll see that it really does add 3 to its actual parameter.

```
makestep (3) (10);
13 : num
```

There are actually two applications here. First we apply `makestep` to 3, then the resulting anonymous function is applied to 10. Finally, here's a function that has functions as both actual parameter and result:

```
dec twice : (alpha -> alpha) -> (alpha -> alpha);
--- twice(f) <= lambda x => f(f(x));
```

Here we're creating a new function that has a single argument and some other function `f` bound into its definition. The new function has the same type as `f`. We can see its

effect using a simple function like `square`:

```
twice(square);
lambda x => square(square(x)) : num -> num

twice (square) (3);
81 : num
```

The new function applies the bound-in function to its argument twice. We can even bind in `twice` itself, generating a new function that behaves like `twice` except that the function eventually bound in will be applied four times.

```
twice(twice);
lambda x => twice(twice(x)) :
(alpha -> alpha) -> (alpha -> alpha)
```

```
twice(twice) (square) (3);
43046721 : num
```

#### CONCLUSION

You've seen how a Hope program is just a series of functions that are regarded as definitions of parts of a data structure—the "results" of the program—and how the powerful idea of higher-order functions allows us to capture many common program patterns in a single function.

Some of these ideas will already be familiar to users of LISP, but they appear in a purer form in Hope because there are no mechanisms for updating data structures like LISP's `SETQ` and `RPLACA` or for specifying the order of evaluation like `GO` and `PROG`. Unlike LISP programs, Hope programs are free from side effects and possess the mathematical property of referential transparency.

You've seen features that are primitive or lacking in LISP and in most imperative languages. The data declaration lets you define complex data types without worrying about how they're represented, and pattern matching lets you decompose them, so you can use abstract data types directly without writing access procedures and without the hassle of inventing lots of new names. The typing mechanism lets the compiler check that you're using data objects in a correct and consistent way, while the idea of polymorphic types stops the checking from being too restrictive and lets you define common data shapes with a single function.

Higher-order functions and polymorphic types let us write very concise programs. Programmers are more productive and their programs are easier to understand and to reason about. Referential transparency further improves our ability to reason about programs and makes it possible to transform them mechanically into programs that are provably correct but more efficient in their use of space or time. You can find out more about this by reading John Darlington's "Program Transformation" on page 201. Finally, referential transparency frees the meaning of Hope programs from any dependence on the order they're evaluated in, making them ideal for parallel evaluation on suitable machines. You'll be seeing more of Hope and languages like it in the future. ■

**The next step  
for your PC  
isn't as big as  
you think.**



# Introducing the

## The best of both worlds.

For owners of IBM Personal Computers, combining personal productivity and business applications is now less of a leap than ever before.

There's a new IBM product that marries the IBM System/36 and the IBM Personal Computer to give you the best of both worlds.

### Meet the newest member of the System/36 Family.

It's called the IBM System/36 PC. Very small but it opens up new worlds for your personal computer. Very affordable with a price starting at \$5,995, yet capable of running System/36 programs that will help you run your business.

Even if you've never owned a computer before, this can be your first business system, instantly offering the capability of running your business right now and expanding it in the future.

### Multiuser system.

System/36 PC can be a standalone computer for small companies or a departmental system or even part of a distributed network for larger companies, providing multiuser access to data.

The System/36 PC is made up of a 5364 Processor attached to an IBM PC, PC XT or PC AT. And you can connect up to three more of these personal computers. Or you can connect terminals such as System/36 printers or displays.

### Flexibility.

Whether your business has two employees or more than 2,000, the System/36 PC can combine the personal productivity of your PC with the business applications of the System/36 Family.

The System/36 can handle all facets of your business—distribution, sales analysis and general ledger functions. Accounts payable, inventory control and payroll.



# IBM System/36 PC.

And you can get traditional PC functions such as spreadsheets and word processing.

Software for the System/36 has been developed over the years and has proven invaluable in all kinds of businesses of all sizes. And with the thousands of programs written for both IBM PC and System/36, the sky's the limit for business and planning applications.

The System/36 PC even provides you with data security features so that the right data gets into the right hands.

## Small yet powerful.

All of this processing power can sit right on a desk or under it—either horizontally or vertically. It measures a mere 21¼" x 16¾" x 6½"—about the size of a small suitcase.

Yet as small as it is, this little box has multiple processors, with main memory that can be dedicated to running your business functions. In plain English, this means you can get better response time. The System/36 PC comes with a 1.2 MB diskette drive and either 40 or 80 MB disk storage, depending on your information storage needs.



## Easy to use.

The System/36 PC is easy to learn and to use. If you need assistance, it has over 2,800 "help" screens that take you step-by-step through any rough spots. You can merge data you've generated on your PC with information that's on your System/36 PC. And you can share information that is stored in the System/36 PC with other attached IBM Personal Computers or System/36 terminals.

Compatibility is high so that you can keep on using many of the PC peripherals and programs you may already own.

## Easy growth.

What happens when your small office becomes bigger?

That's what the System/36 Family is all about. No matter what size your business, there's a member of the System/36 Family that can help you do whatever you do, better.

As your needs become greater, there's the mid-sized 5362 processor that offers greater performance and can handle up to 22 personal computers or System/36 terminals.



Then there's the original System/36—the 5360 processor—the largest member of the System/36 Family, which can handle up to 36 personal

computers or System/36 terminals.

Any one of these processors can function as the central processor in your office. Each can communicate with PCs or larger systems, giving communication and connectivity new meaning by allowing departments to share data.

So if your dreams are big but your office is small, the new System/36 PC is the perfect step for you to take. You not only get the best of both worlds, you also get IBM product reliability. And authorized IBM on-site service is available anywhere in the U.S.A.

For a free brochure on the IBM System/36 PC or for information on product availability from participating IBM Product Centers, Authorized PC Dealers or Value Added Dealers, call 1 800 IBM-2468, ext. 104, LL. Or call your IBM marketing representative.

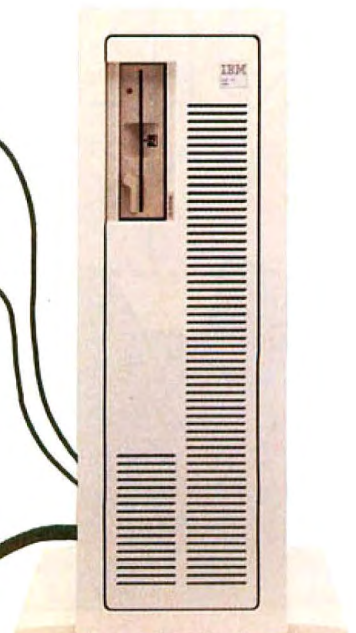

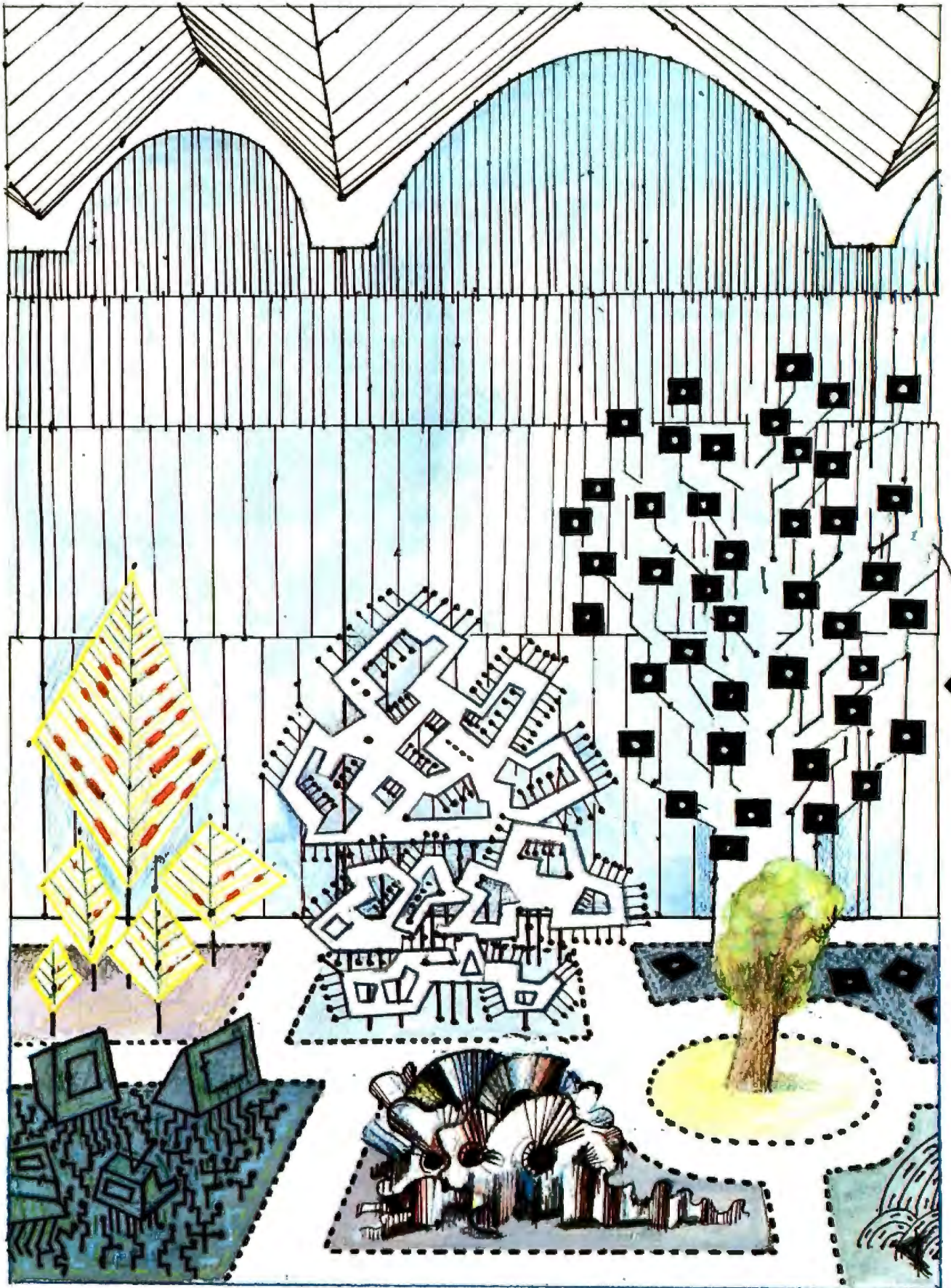

# Reviews

---

<b>REVIEWER'S NOTEBOOK</b>	
<i>by Glenn Hartwig</i> .....	265
<b>THE TANDY 1000</b>	
<i>by Rich Malloy</i> .....	266
<b>IBM PASCAL 2.00</b>	
<i>by Patrick J. Finan</i> .....	275
<b>REVIEW FEEDBACK</b> .....	283

---

OUR REVIEW OF THE TANDY 1000 focuses on a system that is earning a good reputation for its combination of features and for its relatively low price. In fact, Rich Malloy, our senior technical editor in New York, called to revise the pricing, which had dropped since he had written the review. Now the basic single-floppy system sells for just less than \$1000 instead of almost \$1200, as originally reported. Prices for systems with either two floppy-disk drives or the 15-megabyte hard-disk drive were correspondingly reduced. While some of its interface characteristics seem to have been consciously modeled after the IBM PCjr (light pen, graphics, and sound), other features (position of primary and secondary drives) remain staunchly Tandy.

Mr. Malloy reports he is generally impressed with the Tandy 1000, especially with its keyboard design. Its layout and feel (and the inclusion of indicator lights) are identical, he says, to the Tandy 2000 and carry on a laudable tradition. A fly in the ointment is the location of the function keys, which tend to crowd the regular numeric keys. Other aspects of the machine show generally logical design and an emphasis on making things easier for, and more accessible to, the user.

Patrick J. Finan notes that while IBM's first Pascal compiler conformed closely to the way the language was first specified, users wanted features that simply weren't there. Such things as good documentation, increased memory access, path names on files, and support of a math coprocessor were on the wish list. With version 2.00 a lot of features have been added, but some are still missing. Furthermore, those that have been added are sometimes not immediately apparent if you're used to version 1.00.

One of the obvious improvements is the fact that the documentation is now about twice as big as before. Mr. Finan reports that much of the information in the first of the two new volumes is the same as in the original edition; however, better organization and the inclusion of numerous examples make it far easier to find your way around. Mr. Finan takes a detailed look at each aspect of IBM Pascal 2.00, making this review as good a guide as you're likely to find.



**Sometimes the best way to get ahead is to go sideways.**

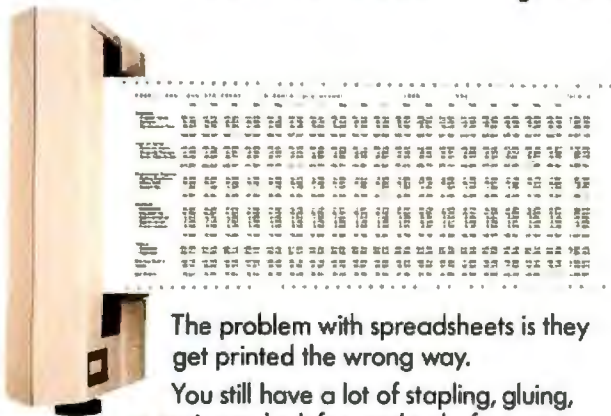

The problem with spreadsheets is they get printed the wrong way.

You still have a lot of stapling, gluing, or taping to look forward to before your printout is readable.

To really get ahead, go Sideways.™

Sideways is the clever software program that prints your spreadsheets—you guessed it—sideways. So your spreadsheet columns need never fall off the edge of your printer paper again.

With Sideways on your side, no spreadsheet you invent with Lotus 1-2-3,® Symphony,™ VisiCalc,® Multiplan,® or SuperCalc™ is too wide! And it's just as powerful an ally when you're creating far-into-the-future schedules and pert charts. So for a presentable printout, get rid of that glue stick and scotch tape—put your best foot forward and go Sideways.

You can go Sideways today with an IBM® PC or an Apple® II, and over a dozen different printers, including Epson,® Okidata, IBM,® Apple,® C. Itoh and Mannesmann Tally. Ask for Sideways at your local Computer Land,® Entre, or other computer store. Or mail a \$60 check to Funk Software, P.O. Box 1290, Cambridge, MA 02238. Or call 617-497-6339. MC/Visa accepted.

**SIDEWAYS™**  
SIDEWAYS PRINTS SPREADSHEETS SIDEWAYS.



# R·E·V·I·E·W·E·R'S N·O·T·E·B·O·O·K

---

Three new systems we received this month have provoked special interest. Each represents a different road for the user—different from each other and different from what most users are already familiar with.

First to arrive was the Epson QX-16. The Epson gives you the choice of MS-DOS, CP/M-80, or an upgraded Valdocs operating system. It has a user-programmable keyboard; two quad-density, 720K-byte floppy-disk drives (that can also be configured as 380K- or 360K-byte drives); 512K bytes of RAM; and both Z80A and 8088 microprocessors. The QX-16 can take three option cards. A green monochrome, bit-mapped, 640- by 400-pixel monitor is standard, as are both serial and parallel interfaces.

First glances indicate this is a nice machine, especially if you're now bound to one type of operating system and software and would like to get the benefit of other programs without abandoning your present library. Getting a full review through the mill is definitely on the boards.

We've encountered several of the new 80286 machines over the past months, mostly at shows and in the hands of software developers. The Kaypro 286i is one of the first production-run hardware units we've seen, however, that is available to users. Even so, there are lags. Ours, for example, came with a notice that its own DOS 3.0 was still under development and that the user should pop in a copy of IBM's PC-DOS 3.0. In a pinch, and with some tweaking, you can even get MS-DOS 2.0 to run. This, however, seems a little like running a Ferrari on economy unleaded.

Kaypro's 286i is a no-bones-about-it IBM PC AT look-alike, right down to the little luggage keys that lock the redesigned keyboard (which should, finally, bring some relief to touch-

typists). It also costs less than the IBM PC AT and, so far, seems to have few widely reported problems living up to its advanced billing.

The Ericsson Ergo-Screen Portable gave us one pleasant surprise and a number of pleasant nonsurprises in our cursory prereview look. Primarily, the unit we got has the full-blown 512K bytes of main memory instead of the 256K bytes mentioned as standard equipment in the company's advertisements. It partially compensates for the lack of a second disk drive by letting you configure a RAM disk and run your programs from drive C. I happen to be relatively comfortable with RAM disks in spite of occasional minor disasters. Most people I know are not. Whether or not you feel this is a computer you can use will depend a lot, I suspect, on how you feel about RAM disks.

The gas-plasma screen is certainly more readable than an LCD screen in most lighting conditions. If you really want the screen to stand out, however, you lower the blinds and turn off the overheads. When you cut down the ambient light, the screen background tends to fade into the general gloaming; it's easy to imagine (and see) the gas-plasma characters as simply floating before your eyes. I don't know how I'd care for this effect on a long-term basis, but it has seemed natural, even enjoyable, for the short time I've looked at it.

As with the Ericsson desktop, the Portable's keyboard seems a little light to me and I tend to bounce it around while typing. Unlike the desktop, which is so quiet as to be almost eerie, the Portable establishes a pretty firm background hum (and still seems to get warm). One thing: I have to keep myself from thinking of it as a laptop in spite of its size and shape. Not only do you plug it in to use it,

but it weighs about 16 pounds. It is a portable desktop system and, seen from that vantage, is an interesting example of what can be done to alter the standard physical profile of functional, yet mobile, computing resources.

Quite a nice utility for the Macintosh is the TurboCharger from Nevins Microsystems Inc. This is a disk-caching program. The company claims it can increase performance by 500 percent simply because reading a sector from RAM is 500 percent faster than reading it from a disk. The simple brochure that serves as documentation states that normal performance increases of around 200 to 300 percent are more typical. This kind of speed increase for the Macintosh is not to be taken lightly. And indications so far seem to be that it does what it claims with no nasty surprises. I use it with a modified Finder and can get in and out of most programs even faster than what Nevins claims for an average time. On top of that, you can increase performance a little more by buffering your writes in RAM as well as caching program sectors. In this case you get full RAM-disk capability and only save to disk when you eject the disk. Nevins warns against this practice, and I'm not sure the company's wrong to do so. I've used the "buffer writes" function a little; while it increases speed somewhat, it's not much of an increase over what caching will do by itself. If you're at all unsure of your software, you'll probably want to maximize the benefits and minimize the risk. Not that caching is completely safe, either. I accidentally kicked the plug out of the wall socket just after I printed this column and lost the whole thing.

—Glenn Hartwig, Technical Editor, Reviews



## The Tandy 1000

### A low-cost PC-compatible computer

BY RICH MALLOY

**W**hen I first heard about the Tandy 1000, I was quite impressed. It seemed to have almost everything I would want in an IBM Personal Computer clone. Plus, it had some of the better features of the PCjr.

For those who haven't seen this machine yet, the Tandy 1000's features include one 360K-byte disk drive (expandable to two, plus one 15-megabyte hard-disk drive), 128K bytes of memory (expandable to 640K bytes), a parallel printer port, interfaces for composite monochrome and RGB (red-green-blue) monitors and a light pen, graphics and sound similar to those of the PCjr, joystick ports, three IBM-compatible expansion slots, a general-purpose collection of software (DeskMate), and a fairly good price (\$999). Even a full BYTE configuration (two floppy drives, 256K bytes of memory, monochrome monitor, and serial port) has a reasonable cost (\$1746), considering that you get some free software bundled with it.

#### DESCRIPTION

Since BYTE has published a product description of the Tandy 1000 (see "The Tandy 1000" by G. Michael Vose, December 1984, page 98), I will skip most of the details. Suffice it to say that the system Tandy sent me (two drives, 256K bytes of memory, RGB monitor) fits nicely on my desk and has attracted quite a bit of attention (see photo 1). The system's fan is quieter than that in my IBM PC, and I doubt it will be a disturbance in the office or the home. I have left it on for long periods without noticing it.

The disk drives follow the Tandy tradition of putting the primary A drive below the optional B drive. And while the disk drive latches do not have that feel of quality I have noticed on other machines, the disk drives themselves are fairly quiet and seem to work well.

The machine's general design is logical. The on/off switch is on the far end of the right side of the machine (just like IBM), but

many other items are on the front where they are accessible. These include the keyboard and joystick connectors and a red reset button. You access the expansion-board slots through the front as well.

#### KEYBOARD

Tandy seems to know how to design keyboards. Apparently recognizing a good thing when they see it, Tandy's designers re-issued the Tandy 2000 keyboard with hardly a key label changed. The Tandy 1000 keyboard (see photo 2) has the same layout, the same superior feel, and the same welcome relief from the standard clone keyboards that keep appearing on the market. Some of its better features are a separate inverted-T cursor-key layout, a left Shift key and carriage return in the places where you would expect them, indicator lights for the Caps and Num Lock keys, 12 function keys arranged horizontally, and a Hold key. In short, it is one of the better keyboards on the market.

The only aspect of it I don't like is that the function keys are too close to the numeric keys. For example, I sometimes hit the 5 key when I mean to hit F5. Also, if you are accustomed to IBM's vertical function keys, the horizontal arrangement can be confusing. And since some of the keys have different key codes than those on the IBM PC, you might find that in a small number of programs these keys do not work as they should. For example, the XyWrite II Plus word processor does not recognize the Tandy's cursor keys. It looks to the numeric keypad, as on the IBM PC. Fortunately, XyWrite II Plus lets you reconfigure the keyboard as you wish.

#### DISPLAY

Two displays are available for the Tandy 1000: a green monochrome display (\$150) and an RGB display (\$550). I didn't get a chance to look at the monochrome display, but the RGB display looks good (see photos 3 and 4). It is IBM PC-compatible and pro-

*Rich Malloy is the New York editor for BYTE magazine. He can be reached at BYTE, McGraw-Hill, 43rd floor, 1221 Avenue of the Americas, New York, NY 10020.*

duces a fairly sharp picture with good colors. In fact, it has better resolution and color than the \$429 IBM display often bundled with the PCjr.

One problem with this display is that the picture is sometimes a bit jumpy, as if it were hypersensitive to power-line noise. Also, the monochrome text characters are not as sharp as those of the IBM PC monochrome adapter, the Compaq, or the AT&T 6300. However, the monochrome display has the capacity to display graphics, and it can even display colors as shades of gray.

#### INTERFACES

The Tandy 1000 comes with a number of interfaces as standard equipment. These include a parallel printer connector, two joystick connectors, and a light-pen connector. Surprisingly, a serial RS-232C connector is missing; this seems to be another tradition in the TRS-80 Model III/4 family.

I did not try the joystick or light-pen ports, but the printer port seemed to work fairly well. Those readers with a Model III or 4 will be glad to find that the 1000 uses the same 34-pin card-edge connector to Centronics-connector printer cable (\$40). I tried this port with a Star Micronics Gemini-10X printer, and it worked fine.

#### EXPANSION

When it comes to expansion, the good news is that the 1000 has three expansion slots that Tandy claims are IBM PC-compatible. But they are only about 11½ inches long, instead of the usual 13 inches. This is a consequence of the 1000's small footprint. Since all the IBM boards I had were big, multifunction 13-inchers, I had no way of testing how compatible these slots are.

The size of these slots might be a major fault of this system. If your intended use of the Tandy system depends on an unusual expansion board, you should make sure that board will be short enough to fit into the 1000.

Most of the more routine boards are

already available from Tandy (e.g., extra memory, serial port, modem). But note that if you fill up the 1000 with a full complement of memory (640K bytes on two boards) and a serial port, all your slots will be in use.

One of the advantages of the IBM PC is the large number of expansion cards available for it. If only a small number of these cards are short enough for the Tandy 1000, Tandy owners might miss out on one of the main advantages of an IBM PC-type system.

I did get a chance to use two boards produced by Tandy. One was a memory board that boosted the Tandy's memory up to 256K bytes. It also included direct memory access (DMA) capability, which speeds up

*(continued)*



Photo 1: The Tandy 1000 with RGB display and two floppy-disk drives.

the system and helps explain the high price (\$300) of this board.

The other board I tested was Tandy's 300-bits-per-second modem board. I admit to a bias against internal modems. An external modem can tell you instantly when you dial a wrong number or the line has been disconnected. That said, I was also disappointed to find that this modem is not Hayes-compatible (it is, of course, Radio Shack-compatible), and none of my software would work with it. The 1000's DeskMate did work but had several problems. My advice is to avoid this board. Get the serial board and a good external modem.

**SOFTWARE**

The Tandy 1000 comes standard with MS-DOS version 2.11, Microsoft's GW-

BASIC, and DeskMate, a simple, integrated software package. This is a pretty good bundle of software, but I had a minor problem with all three packages.

First, the operating system seems to work pretty well. It has all the basic features and, if you want, you can even run IBM PC-DOS 3.0 on the Tandy. The problem is that the documentation overall is very skimpy, worse even than Microsoft's own manual for its operating system. In fact, there was nothing at all in the way of a separate DOS manual. I hope that better documentation will soon be available.

The version of BASIC I received was quite good but incomplete. For example, it enables you to access the Tandy's 16-color graphics, but it would

not access the modem port too well. Here again, the manual was a bit skimpy. This is unfortunate, since many people might be using BASIC for the first time on this machine. Tandy has informed me that by the time this article appears, a new complete version of BASIC will be available.

**DESKMATE**

DeskMate is a fairly good software package that has several interesting features. It has a word processor, a database manager, a spreadsheet, a calendar/alarm, an auto-dialer, a communications program, and a bulletin-board program. Unfortunately, the quality of the individual parts might leave some serious users a little disappointed. Most of the parts can be described as fairly good, and some are very friendly. But a few, such as the auto-dialer, are downright ornery. I have yet to get that part of the program to work.

Also, it seems to me that a little extra programming work could have turned DeskMate into a much better program. For example, the Text word processor has most of the features you would expect to find in a word processor and, in fact, is very similar to the text processor on the portable Model 100. To top it off, it is pretty fast (see table 1). But it does not contain a Move command. You have to copy a block of text and then go back and delete the original block.

I have another example. The spreadsheet documentation gives you a formula for amortization payments. This is a laudable idea, but if you try to calculate your monthly payments for a 30-year mortgage, you are in for a surprise. The spreadsheet cannot raise a number to a power greater than 20, and this means that you cannot calculate the payments for any loan longer than 20 months. There is no logical reason why this limitation should exist.

I like a lot of DeskMate's features. I particularly appreciate the menu system that lets you access any document or spreadsheet very easily. But my feeling is that if you intend to do

(continued)

Table 1: A comparison of the word-processor portion of DeskMate with WordStar 3.3 running on the Tandy 1000. Except for scrolling, DeskMate performs fairly well. Tests were done using a standard 4000-word (22K bytes) document.

	DeskMate	WordStar
Document load	6.0	5.4
Document save	8.7	27.2
Search for last word	5.1	11.7
Scroll	78	38



Photo 2: The keyboard of the Tandy 1000. Note that it is very similar to the Tandy 2000's keyboard.

## AT A GLANCE

### Name

Tandy 1000

### Manufacturer

Tandy/Radio Shack  
1500 One Tandy Center  
Fort Worth, TX 76102  
(817) 390-3011

### Size

(without display)  
16.5 by 13.4 by 5.9 inches

### Components

**Processor:** 16-/8-bit 8088,  
4.77 MHz

**Memory:** 128K to 640K bytes  
of memory

**Mass storage:** One or two  
360K-byte 5¼-inch floppy-disk  
drives, MS-DOS format

**Monochrome display:** Green  
phosphor, composite video,  
80-character by 25-line text,  
IBM PC-compatible char-  
acters; graphics are 640 by  
200 pixels with four levels of  
gray

**Color display:** IBM PC-  
compatible RGB; graphics are  
640 by 200 pixels with four  
colors, or 320 by 200 with 16  
colors

**Keyboard:** 90 keys, including  
four cursor keys, 12 program-  
mable function keys

**Interfaces:** Parallel printer port

### Software

MS-DOS 2.11, GW-BASIC,  
DeskMate integrated software

### Options

Monochrome display (\$150),  
RGB display (\$550), serial  
port (\$99), 256K bytes of  
memory total (\$300), second  
disk drive (\$300), internal  
300-bps modem (\$180),  
15-megabyte hard disk  
(\$2345)

### Documentation

DeskMate tutorial (140 pages),  
DeskMate reference (82  
pages), BASIC reference (74  
pages)

### Price

With 128K bytes of memory  
and one drive \$999

With 256K bytes of memory,  
two drives, and monochrome  
display: \$1746



MEMORY SIZE (K BYTES)

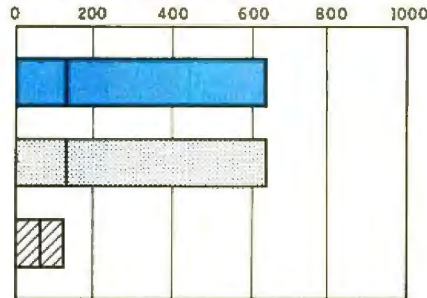

DISK STORAGE (K BYTES)

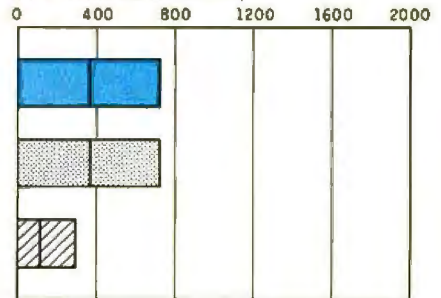

BUNDLED SOFTWARE PACKAGES

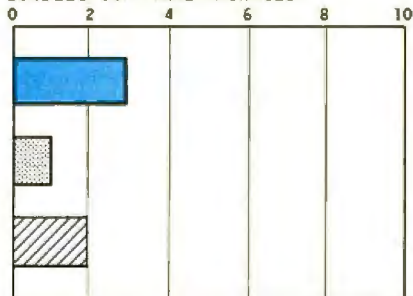

PRICE (\$1000)

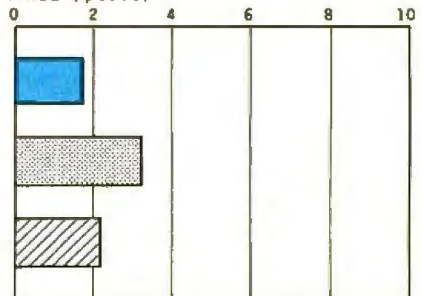

■ TANDY 1000    ■ IBM PC    ■ APPLE II E

The Memory Size graph shows the standard and optional memory available for the three computers under comparison. The Disk Storage graph shows the highest capacity of one and two floppy-disk drives for each system. The Bundled Software Packages graph shows the number of software packages included with

each system. The Price graph shows the list price of each system with two high-capacity floppy-disk drives, a monochrome monitor, a printer port and a serial port, 256K bytes of memory (64K bytes for 8-bit systems), and the standard operating system and BASIC interpreter for each system.



The rear panel of the Tandy 1000. Note the three expansion slots on the right, one of which is occupied by an internal modem.

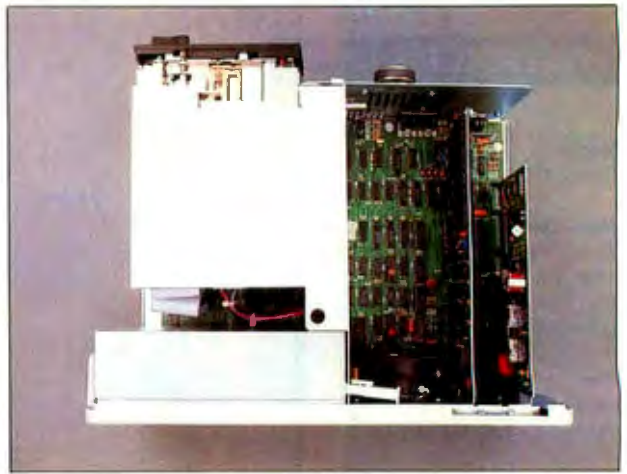

Inside the Tandy 1000. Note the short expansion-card slots.

DISK ACCESS IN BASIC (SEC)

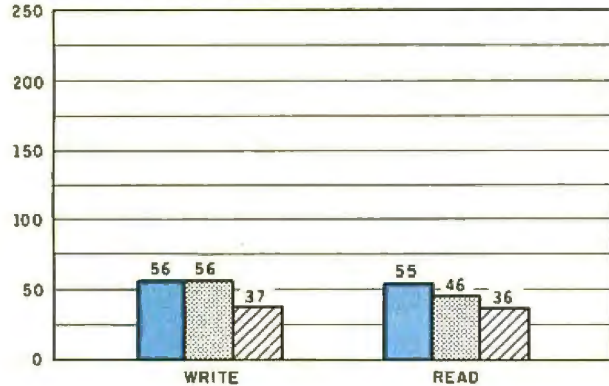

BASIC PERFORMANCE (SEC)

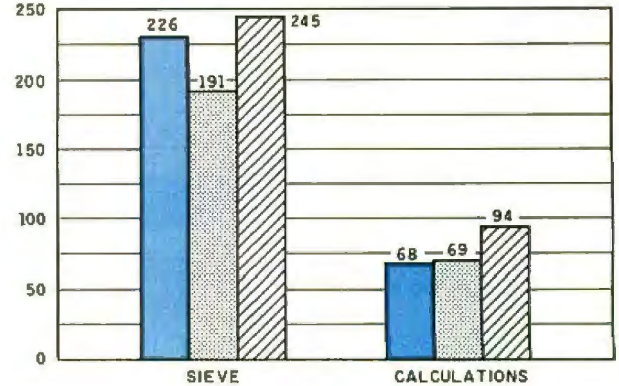

SYSTEM UTILITIES (SEC)

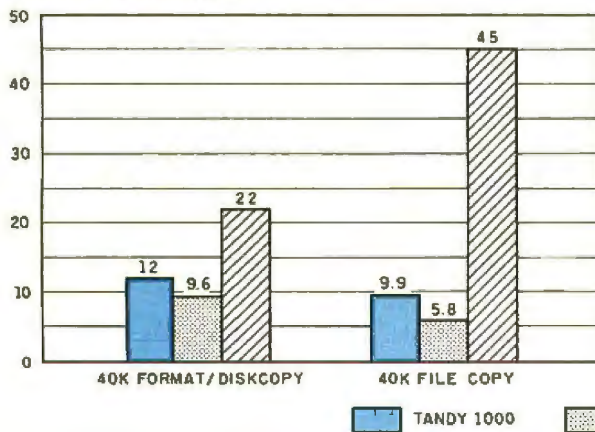

SPREADSHEET (SEC)

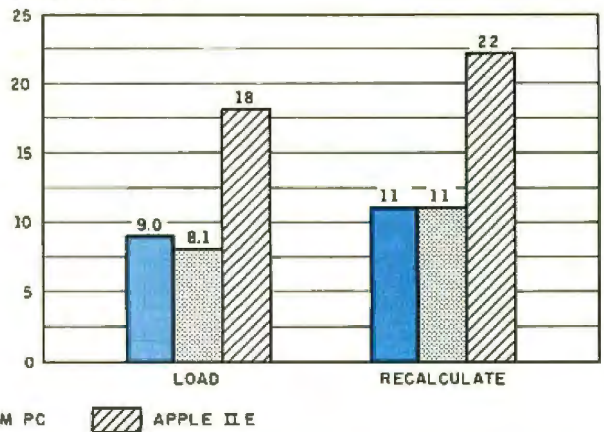

The graph for Disk Access in BASIC shows how long it takes to write and to read a 64K-byte sequential text file to a blank floppy disk. (For the program listings, see June 1984 BYTE, page 327, and October 1984, page 33.) In the BASIC Performance graph, the Sieve results show how long it takes to run one iteration of the Sieve of Eratosthenes prime-number benchmark. In the same graph, the Calculations column shows how long it takes to do 10,000 multiplication and 10,000 division operations using single-precision numbers.

The System Utilities graph shows how long it takes to format and copy a disk (adjusted for 40K bytes of disk data) and to transfer a 40K-byte file using the system utilities. The Spreadsheet graph shows how long the computers take to load and recalculate a 25-by-25-cell Microsoft Multiplan spreadsheet where each cell equals 1,001 times the cell to its left. The tests for the Tandy 1000 used MS-DOS 2.11 and GW-BASIC. The tests for the Apple IIe were done with ProDOS. The IBM PC was tested with PC-DOS 2.0 and BASICA.

serious work, you will probably have to purchase one of the good single-purpose software packages, such as pfs:Write, Multiplan, PC-Talk, or dBASE II. Use DeskMate for simple applications and experimentation.

**PERFORMANCE**

As you might know, the IBM PCjr was not only a bit incompatible with the IBM PC, it was also a bit slower (see "The IBM PCjr" by Rowland Archer Jr., August 1984 BYTE, page 254). My question was: Would the Tandy be as slow as the PCjr or as slow as the PC? I tested the 256K-byte version of the Tandy 1000 with its BASIC interpreter and with Multiplan. I also removed the optional memory board and tried some of the tests again to see if the DMA capability on that board made much of a difference. Finally, I put DeskMate through some standard tests to see how capable it was. The results were interesting.

In the BASIC tests, the Tandy 1000 was as fast as the IBM PC for Disk Write and the Sieve. But it was significantly slower in the Disk Read and Floating-Point Calculations tests, although not as slow as the PCjr. In the System Utilities and Spreadsheet tests, the Tandy was again appreciably slower. However, in one test, the 40K File Copy, the Tandy 1000 was even slower than the PCjr.

When I took out the extra memory board with DMA, I expected some difference in disk access times, but the BASIC tests showed practically no difference. The Spreadsheet tests were appreciably slower: The Spreadsheet Load was 38 percent slower, and even the Recalculate was about 9 percent slower. For some reason, the File Copy was a little faster than it was with the DMA.

I tried to do some tests using the spreadsheet in DeskMate, but this program is not designed for speed. It took DeskMate 75 seconds to recalculate BYTE's standard 625-cell spreadsheet, about seven times as long as it takes Multiplan. The word processor was a different story. DeskMate performed quite admirably with BYTE's standard 4000-word docu-

ment (see table 1). Except for scrolling, DeskMate was as fast or faster than WordStar 3.3 running on the same machine.

Overall, the Tandy 1000 fares well

against the IBM PC. Tandy designers have claimed that, in many tests, the 1000 is actually faster than the IBM, but I saw no evidence of this. How-

*(continued)*

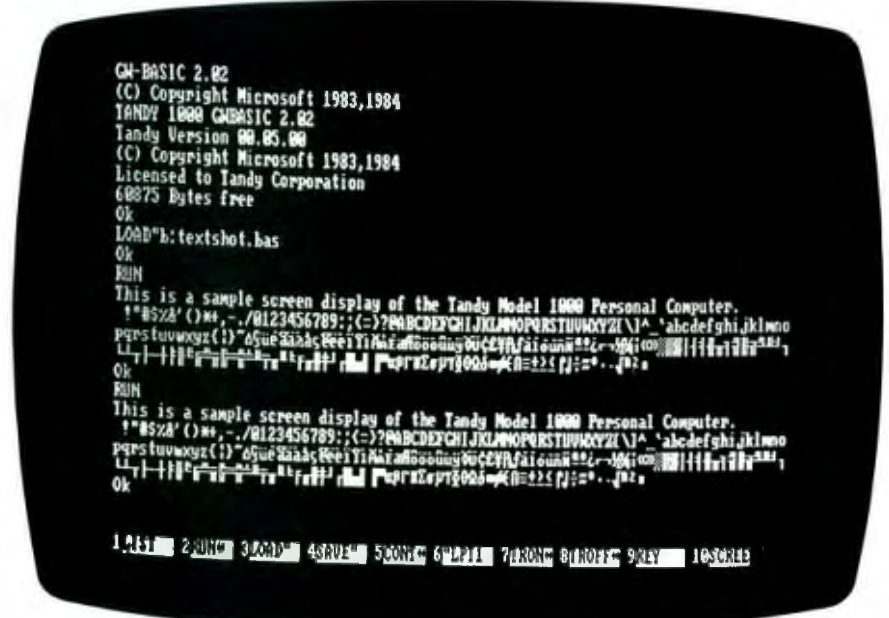

Photo 3: Text on the Tandy 1000's RGB display.

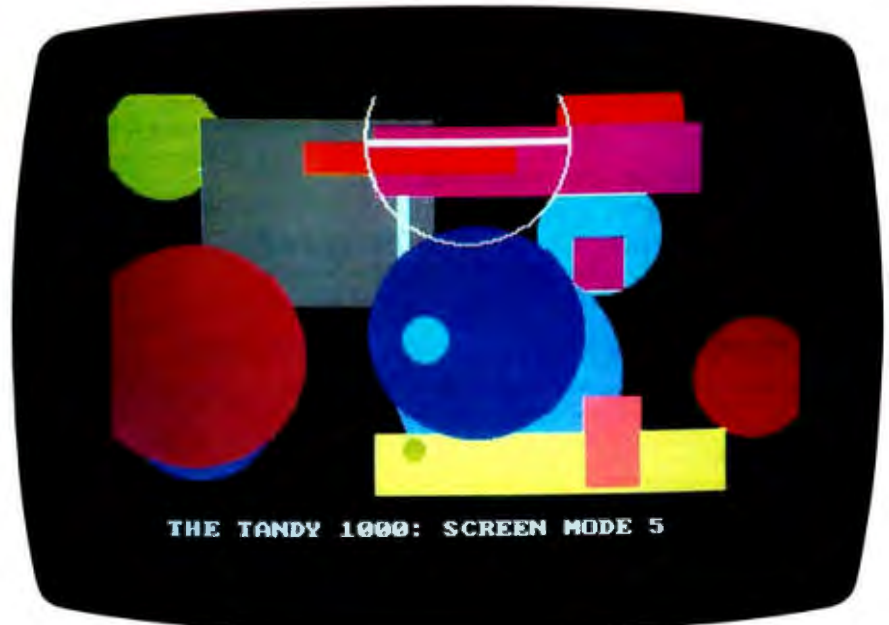

Photo 4: An example of color graphics on the Tandy 1000's RGB display. Note that in medium-resolution mode (320 by 200 pixels) the monitor can display a total of 16 colors, four times the number available on the IBM PC.

# Program Editing with

# BRIEF™

is More Productive and Less Frustrating  
because it will work YOUR way, and BRIEF elegantly integrates:

- A high-level, readable **Macro Programming Language** - allows full parsing or syntax analysis . . . Complete, unlimited variables, etc.
- Edit multiple files of **unlimited size** (2 Meg is OK)
- Multiple **Windows** on screen with different or same file, fragments, etc.
- A bona-fide **UNDO** stack (up to 300) of all operations: deletions, reading files, search, translate, more
- Full "**regular expression search**" - wild cards, complex patterns
- A completely **reconfigurable keyboard**
- **Keystroke macros** - for common typing sequences
- Suspend BRIEF to execute, **exit to DOS** - run another program (like a compiler, dir, XREF, DIFF, or DEBUG) then resume BRIEF session
- **Compiler-specific** support like auto indent, syntax check, compile within BRIEF  
For PC, AT, and compatibles.

**FREE WITH ORDER:** Best of BRIEF Macros™ — includes Fortran, C, Calculator. Call before 11/30/85.

Only \$195

**Full Refund** if not satisfied in 30 days.  
CALL 800-821-2492.

**Solution  
Systems™**

335- Washington St., Norwell, MA 02061  
617-659-1571

# PROLOG-86™

## Become Familiar in One Evening

Thorough tutorials are designed to help learn the PROLOG language quickly. The interactive PROLOG-86 Interpreter gives immediate feedback. In a few hours you will begin to feel comfortable with it. In a few days you are likely to know enough to modify some of the more sophisticated sample programs.

**Sample Programs are Included like:**

- an **EXPERT SYSTEM**
- a **NATURAL LANGUAGE INTERFACE**  
(It generates a dBASEII "DISPLAY" command)
- a **GAME** (it takes less than 1 page of PROLOG-86)

### PROTOTYPE Ideas and Applications QUICKLY

Serious development of experimental systems and prototypes is practical with the full syntax of PROLOG-86. 1 or 2 pages of PROLOG is often like 10 pages in "C".

**Programming Experience is not required** but a logical mind is. PROLOG-86 supports the de facto STANDARD.

**RECENT IMPROVEMENTS:** Access to MSDOS, on-line help, load Editor.

**AVAILABILITY:** All MSDOS, PCDOS systems.

**FREE** with order: "Best of Prolog-86 Programs"—contest entries include: a primate expert system, an automobile expert system, a blocks world natural language system, etc. Call before November 30.

Only  
\$125.

Full refund if not  
satisfied during  
first 30 days.

**Solution  
Systems™**

335-B Washington St.,  
Norwell, Mass. 02061  
617-659-1571  
800-821-2492

## REVIEW: TANDY 1000

ever, the 1000 does match the PC on some tests and is not too far behind on the others.

### MANUALS

I received three manuals with the system: a DeskMate tutorial that includes information on setting up the computer hardware, a DeskMate reference manual, and a BASIC reference manual. As I mentioned earlier, a DOS manual was nowhere to be seen and sorely missed. Tandy did a nice job with the DeskMate manuals, although some parts of the program are not explained very well. And, of course, a little bit of Radio Shack bias is evident. For example, it would be nice if the writers had included some information about how to set up DeskMate for a non-Radio Shack modem.

The BASIC reference manual has almost everything you really need, but not a sentence more. And some information is missing. For example, it doesn't mention that the INKEY\$ command will interpret the cursor keys as 2-byte codes rather than the single-byte codes used for almost every other key.

### SUMMARY

The Tandy 1000 seems to be a good, reasonably priced IBM PC clone that has most of the best features of the IBM PC and PCjr. It is compatible with all the IBM software that I have tried. Also, it has three IBM PC-compatible expansion slots, but these slots are too short for most IBM expansion boards. The keyboard is good. And this system seems to have the same superior color graphics and sound capabilities as the PCjr. Its only deficiencies are the above-mentioned short expansion slots, the lack of a high-quality monochrome text font, and an incomplete (as yet) BASIC interpreter.

Of course, the attractiveness of the machine depends to a great extent on its competition. At current prices it is a very good alternative to the IBM PC. I would recommend the Tandy 1000 for all applications that do not depend on special expansion boards or a highly compatible BASIC. ■



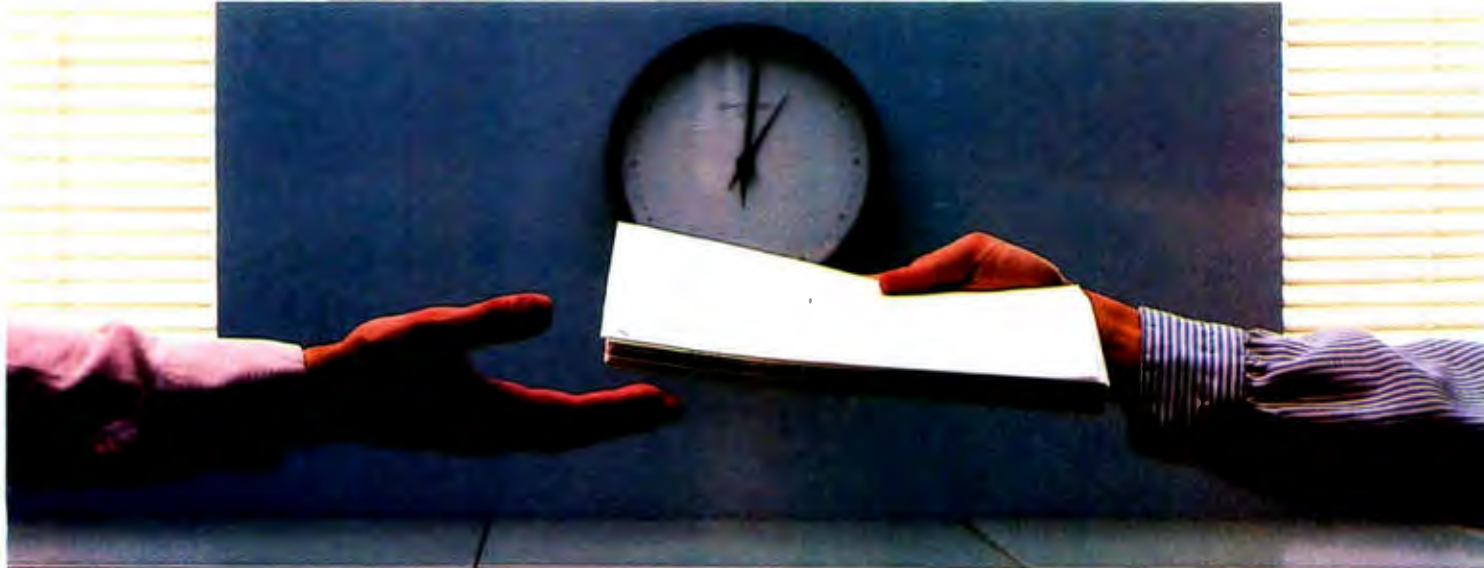

## 2400 bps modems: Do you Really need another speed?

- Is the shift from 300 to 1200 bps going to repeat itself at 2400 bps? The answer is both yes and no. There certainly are applications for 2400 bps asynch dial-up modems, but we shouldn't expect 1200 bps to die overnight.
- 2400 bps modems can improve throughput, thereby getting tasks done quicker and more economically. However, 1200 bps has become the virtual standard for professional dial-up communications, and most users are satisfied with it. So why consider a 2400 bps modem at all?
- One reason is flexibility. If the modem you select operates at all three speeds (300, 1200 & 2400) in accordance with accepted industry standards, it will serve virtually all dial-up applications now and in the foreseeable future.
- The modem you select should be the MultiModem224. It is Bell 212A and 103 compatible at 1200 and 300 bps, and CCITT V.22bis compatible at 2400. It is also 100% compatible with the Hayes command set, meaning that it will work with virtually all communications software packages, at all three speeds. Other features include both synchronous and asynchronous operation, full intelligence and a phone number memory.
- The MultiModem224 is available in both desktop and IBM PC™ internal card versions. (There is also a rack-mounted version for central sites.) And as a bonus, we provide free offers from ten of the most popular on-line information services, including CompuServe™, Dow Jones™ and The Source™.
- A 2400/1200/300 bps modem is just a plain good investment. Why not let the MultiModem224 provide your communications for both today and tomorrow?

Inquiry 221

**MultiTech**   
Systems

*The right answer every time.*

82 Second Ave. S.E., New Brighton, MN 55112 (612) 631-3550 TWX 910-563-3610

**MultiTech**   
Systems

**MultiModem 224**  
2400/1200/300 BPS Intelligent Modem

SP

RD

CD

24

12

OH

TR

1200 Ans  
300  
2400 On

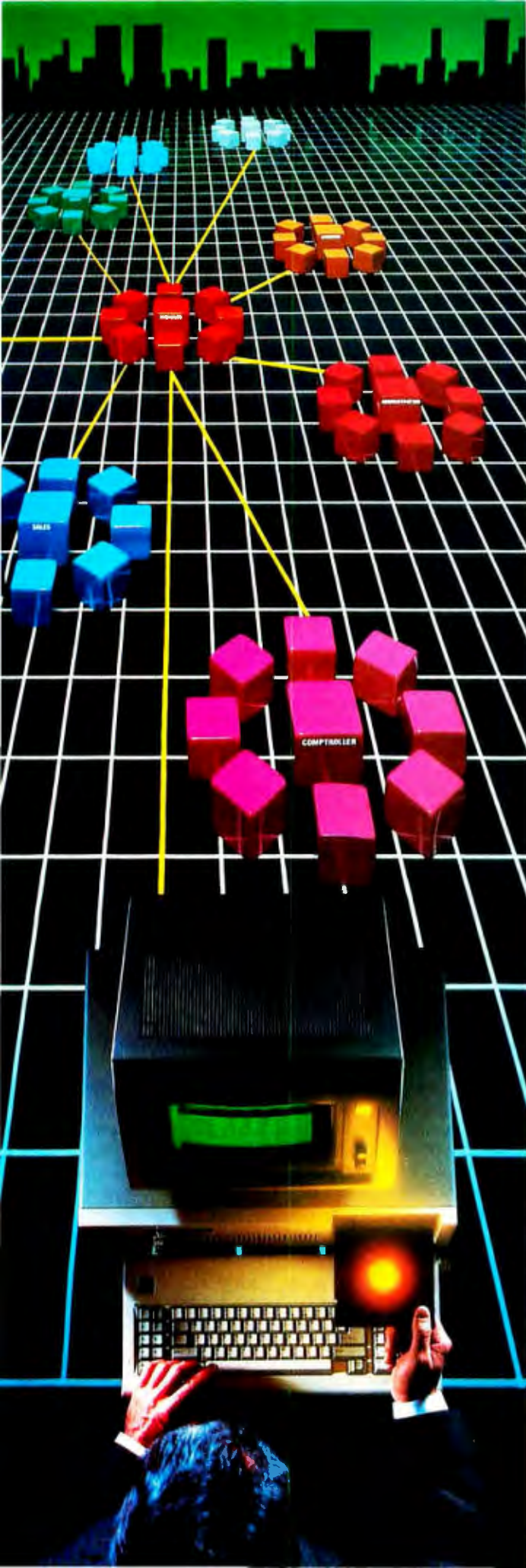

# We've Put a Local Area Network on a Disk

Corporate Information Sharing. It's been described as the key to increasing a company's productivity. It's also why large networks of PC's are becoming more and more common in the workplace...in spite of the fact that they're costly, difficult to install, and incompatible with much existing software.

Finally, there's a solution to this corporate dilemma. Its name is LANLink™

**A Software-Driven LAN That Uses Standard, RS-232 Ports.** A major breakthrough in local area networks, LANLink™ uses your computers' existing serial ports and runs under PC-DOS.

Because all of the intelligence the network requires is on the server and satellite diskettes, expensive network interface boards aren't required.

**A Powerful Network That's Cost-Conscious.** If you've been pricing board-driven LAN's, you already know that they can cost over \$1,000 per workstation. LANLink™ is different.

Boasting a data transfer rate in excess of 100,000 BPS, LANLink™ is compatible with a wide range of programs. And because special boards aren't required, installation costs are one-third that of a traditional network.

**A Network Designed the Way Business Works.** With LANLink™ you're able to customize your network along departmental lines using a data-sharing hierarchy and password-protected access.

**Get Started With LANLink™ TODAY.** Call The Software Link TODAY for complete details and the authorized dealer nearest you. The LANLink™ Starter Kit, priced at \$495, comes complete with network software for both a server and a satellite computer. For a limited time, 50 feet of RS-232 cable will be included free of charge.

LANLink™ is immediately available and comes with a money-back guarantee. VISA, MC, AMEX accepted.

# LANLink™

 **THE SOFTWARE LINK, INC.**

Developers of MultiLink™ and MultiLink Advanced™

8601 Dunwoody Place, Suite 632, Atlanta, GA 30338 Telex 4996147 SWLINK

CALL: 404/998-0700

Dealer Inquiries Invited

THE SOFTWARE LINK, INC./CANADA

400 Esna Park Drive, Suite 18, Toronto (Markham), Ont. L3R 3K2 CALL: 416/477-5480

MultiLink, MultiLink Advanced & LANLink are trademarks of The Software Link, Inc. PC-DOS is a trademark of IBM Corp.



# IBM Pascal 2.00

**This version  
has many  
improvements,  
including  
better  
documentation  
and 8087  
coprocessor  
support**

BY PATRICK J. FINAN

**P**ascal has always been a popular language for developing large, complex applications. Its highly structured nature and strong data-typing capabilities have made it a successful teaching tool and application-development language. While version 1.00 of the IBM PC Pascal Compiler conformed closely to the original Pascal description, most users wanted improvements—better documentation, access to all memory on a machine, the ability to use path names on files, and support of the 8087 math coprocessor. Version 2.00 of the IBM Pascal Compiler offers several new features that greatly extend the product's capabilities. However, not all the changes will be transparent for those moving from version 1.00 to 2.00.

## DOCUMENTATION

The first change that an IBM Pascal user will notice in version 2.00 is that the amount of documentation has doubled. The two manuals are well organized and easier to understand than the original manual.

The first book consists of 11 chapters and five appendixes that cover fundamentals. It explains how to use the compiler and describes the major parts of a Pascal program—types, constants, variables, expressions and statements, and procedures and functions. A full chapter treats program structure, units, and modules, and a complete discussion explains how to call assembly-language and FORTRAN routines. This book covers most of the same topics as the original manual, although it has been rewritten to include better explanations and many more examples.

The second book is a language reference guide containing detailed explanations and examples of all the available commands, keywords, procedures, functions, and compiler-directive metacommands.

## THE COMPILER

IBM provides a SETUP program that you must run to build your PAs1, PAs2, and

library work disks. In building the library disks, you must choose one of three different math modules and one of two DOS interface modules. Selection of the math module is based on whether or not you have an 8087 math coprocessor chip installed. In addition, each library has a different effect on the speed, precision, and size of your executable (.EXE) files.

To use the first module, 8087ONLY, you must have an 8087 math coprocessor installed in the PC. Of the three math modules, 8087ONLY generates the least code, runs the fastest, and produces the highest-precision results.

The REGMATH module will not use the 8087 math coprocessor, even if one is installed and enabled. It generates results of normal precision and is optimized for speed.

The EMULATOR module uses the 8087 math coprocessor if it is present and emulates the device if it is not. If the 8087 is installed, programs run as fast and with as much precision as the 8087ONLY module. If the 8087 is not installed, the program runs much slower but with the same precision as with 8087ONLY. In either case, the run-time modules created are larger than those produced by 8087ONLY and REGMATH.

Thus, if you have an 8087 installed, create the library disk with the 8087ONLY module. Otherwise, you need to consider the level of precision required by the application. Normal-precision applications would probably use the REGMATH module, while extended-precision applications would use EMULATOR.

The compiler comes with a source program called DEMO.PAS that serves as a practice file for users. The manual lists the speed and file-size comparisons for DEMO.PAS using each library module (see table 1).

The DOS interface library modules determine which version of the operating system

(continued)

Patrick J. Finan (10519 Wycarver Rd., Cincinnati, OH 45241) is a senior systems analyst with a large manufacturing company in Cincinnati. He has a B.S. in electrical engineering from the University of Dayton and an M.B.A. in finance from Xavier University.

## AT A GLANCE

**Name**

IBM PC Pascal Compiler 2.00

**Type**

Two-pass compiler

**Manufacturer**

IBM National Distribution Division  
1000 Westchester Ave.  
White Plains, NY 10604  
(800) 426-2468

**Format**

Three 5¼-inch master disks, not copy-protected

**Computer**

IBM PC with 160K bytes of memory and two floppy-disk drives or one floppy drive and a hard-disk drive; printer recommended

**Documentation**

Two manuals

**Price**

\$350; upgrade \$100

**Audience**

Systems and application software developers

your programs will run under. The DOS11 library module lets programs run under DOS 1.10, 2.00, and 2.10. Path names, however, are not supported, since paths were not available in versions before DOS 2.00.

If you select the DOS20 module, your programs can use path names in file specifications at run time but will only run under DOS 2.00 or later. This library module is also required if you want to create code overlays using the LOADER function.

Even though you can create applications that run under DOS 1.10, 2.00, or 2.10, version 2.00 of the compiler only runs under DOS 2.00 or 2.10. You cannot compile programs with version 2.00 of the compiler using DOS 1.10.

### REALS AND INTEGERS

Version 2.00 offers two real-number data types—REAL is set equal to REAL4 or REAL8 by the \$REAL = n (where n equals 4 or 8) compiler metacommand. REAL4 is a 32-bit representation (1 sign bit, an 8-bit exponent, and a 23-bit mantissa) ranging from 8.43E-37 to 3.37E+38. REAL8 is a 64-bit representation (1 sign bit, an 11-bit exponent, and a 52-bit mantissa) ranging from 4.19E-307 to 1.67E+308.

Unfortunately, IBM has changed the internal storage format of real numbers in version 2.00. This means that you have to convert existing binary data files containing real numbers to the new format before they can be used by programs created with the new compiler. The

manual states that you "must convert these data files" before they can be used but does not offer a utility or even an explanation of how to do the conversion.

New arithmetic and transcendental functions are included in the Pascal library to support these higher-precision quantities. Unfortunately, IBM has also renamed many of the version 1.00 transcendental functions, which means you must modify the programs that use them when you upgrade from version 1.00 to 2.00. For example, in version 1.00 the log base 10 function was called LNDROQ, while in version 2.00 there are two: LDDROQ for REAL8 numbers and LDSROQ for REAL4 real numbers.

Version 2.00 has a new data type called INTEGER4, which is a 32-bit integer ranging from -2,147,483,647 to +2,147,483,647. You can use the operators AND, OR, XOR, and NOT on INTEGER4 variables.

### DATE AND TIME

Version 2.00 offers four new procedures and function calls that use the system clock. GETDAT and GETTIM return the date and time components as integer values. SETDAT and SETTIM let you set the system date and time from Pascal by specifying the integer components.

When prompted for library names by the linker, you must specify the library IBMPAS.LIB. These routines eliminate the processing required to extract one component of the date or time from the traditional string for-

(continued)

Table 1: A comparison of speed and file size for DEMO using each of the library modules: 8087ONLY, REGMATH, and EMULATOR.

Math Module	Execution Time	File Size
8087ONLY	9.26 seconds	25,138 bytes
REGMATH	26.25 seconds	28,918 bytes
EMULATOR (without 8087)	36.18 seconds	31,842 bytes
EMULATOR (with 8087)	9.26 seconds	31,842 bytes

# Innovation

A system that keeps  
your private computer files  
from becoming public.



**GTX-100. Computer security so advanced, it could even keep secrets from Mata Hari.**

Does your computer talk to strangers? Before you answer no, remember, today's computer intruders are very skillful.

In fact, even a famous spy like Mata Hari would be hard pressed to match their inventiveness. With one deft phone call, these electronic trespassers can tamper with such secret items as privileged customer reports, confidential correspondence, and marketing intelligence.

Inquiry 179

Data thieves can steal information like that. Or erase it. Or alter it to their advantage.

That's why your computer needs the protection of GTX-100. It's a new kind of security subsystem developed from Lockheed's years of experience with high technology and strict security.

GTX-100 puts an electronic wall around your sensitive computer files and keeps your private data private.

Use the coupon to get a GTX-100 brochure plus the name of your nearest sales office. They'll show you how GTX-100 can guard your secrets the next time a stranger comes calling.



© Lockheed-GETEX 1985

#### Mail to:

Lockheed-GETEX, Suite 945,  
1100 Circle 75 Parkway, Atlanta,  
GA 30339. (404) 951-0878.

#### Please send me:

- GTX-100 brochure.
- The name of my nearest sales office.

Name \_\_\_\_\_

Title \_\_\_\_\_

Company Name \_\_\_\_\_

Address \_\_\_\_\_

City \_\_\_\_\_

State \_\_\_\_\_

Zip \_\_\_\_\_

 **Lockheed-GETEX**

Giving shape to imagination.

AUGUST 1985 • BYTE 277

mats. The procedures DATE and TIME are still available for situations where the string representations are more useful.

### SYSTEM INTERFACES

Several new system-related functions and capabilities should make programming easier and eliminate the need for many assembly-language subroutines. The DOSXQQ function lets you call DOS functions directly from Pascal (via interrupt 21 hexadecimal). This function was available in version 1.00 but was totally undocumented and almost impossible to use. The function parameters pass values to the AX and DX registers. You can use the external variable CRCXQQ to specify the desired value of the CX register. After you invoke the DOSXQQ function, it returns the AL register as its return value and loads the value of the CX and DX registers into the external variables CRCXQQ and CRDXQQ. The declarations of the external variables and the function syntax are as follows:

```
VAR [EXTERN] CRCXQQ,CRDXQQ:
    WORD;
FUNCTION DOSXQQ(AX,DX:
    WORD):BYTE; EXTERN;
```

The major limitation of the DOSXQQ function is that it only uses the AX, CX, and DX registers, while most DOS function calls use additional registers.

A more general way to access DOS function calls is with the procedure INTRP, which lets you execute any software interrupt directly. The format of the call is

```
INTRP (intnum, inregs, outregs);
```

The software interrupt number to be performed is intnum, while inregs and outregs are special variables of the type REGLIST that contain the register and flag values before and after you invoke the interrupt. The data definition for REGLIST is included in a special file called IBMINTRP.INT that must be included in your source file. Listing 1 shows how to declare and use the INTRP function. Again, you must specify the IBMPAS.LIB library when the linker prompts you for

Listing 1: Program segment showing how to declare and use the INTRP function. This function lets you access DOS function calls.

```
(*$INCLUDE: 'IBMINTRP.INT'*)
PROGRAM INTRPDEMO (INPUT,OUTPUT);
    USES IBMINTRP;
VAR
    INREGS,OUTREGS:REGLIST;
    ROW,COL:BYTE;
BEGIN {INTRPDEMO}
.
.
.
    INREGS.AX := 16#0300;           {REQUEST CURSOR POSITION}
    INREGS.BX := 16#0000;           {DEFAULT PAGE}
    INTRP(16#10,INREGS,OUTREGS);    {INVOKE VIDEO INTERRUPT X'10}
    ROW := HIBYTE(OUTREGS.DX);      {CURSOR ROW NUMBER   }
    COL := LOBYTE(OUTREGS.DX);      {CURSOR COLUMN NUMBER}
.
.
.
END. {INTRPDEMO}
```

Listing 2: This program is an example of how to use the LOADER function to bring in code overlays.

```
PROGRAM MAIN(INPUT,OUTPUT);
VAR
    SELECTION:CHAR;
    RETVAL:WORD;
FUNCTION LOADER (CONSTS MODULE NAME:STRING) : WORD; EXTERN;
PROCEDURE ADD; EXTERN;
PROCEDURE CHANGE; EXTERN;
PROCEDURE DELETE; EXTERN;
PROCEDURE LIST; EXTERN;
BEGIN
    SELECTION := ' ';
    WHILE SELECTION <> 'E' DO
    BEGIN
        WRITELN(OUTPUT,'Enter the desired function - (A)dd');
        WRITELN(OUTPUT,'                (C)hange');
        WRITELN(OUTPUT,'                (D)elete');
        WRITELN(OUTPUT,'                (L)ist');
        WRITELN(OUTPUT,'                (E)nd');
        READLN(INPUT,SELECTION);
        CASE SELECTION OF
            'A': BEGIN
                RETVAL := LOADER ('MOD1.OVL');
                IF RETVAL = 0
                    THEN ADD
                     ELSE ABORT('UNSUCCESSFUL LOAD OF MOD1',RETVAL,0);
            END; {CASE OF A}
```

```

'C': BEGIN
  RETVAL := LOADER ('MOD2.OVL');
  IF RETVAL = 0
    THEN CHANGE
    ELSE ABORT('UNSUCCESSFUL LOAD OF MOD2',RETVAL,0);
  END; {CASE OF C}
'D': BEGIN
  RETVAL := LOADER ('MOD3.OVL');
  IF RETVAL = 0
    THEN DELETE
    ELSE ABORT('UNSUCCESSFUL LOAD OF MOD3',RETVAL,0);
  END; {CASE OF D}
'L': BEGIN
  RETVAL := LOADER ('MOD4.OVL');
  IF RETVAL = 0
    THEN LIST
    ELSE ABORT('UNSUCCESSFUL LOAD OF MOD4',RETVAL,0);
  END; {CASE OF L}
'E': WRITELN(OUTPUT,'End of Program');
  OTHERWISE;
END; {CASE OF SELECTION}
END; {WHILE}
END. {MAIN}

```

```

MODULE MOD1;
PROCEDURE ADD;
  BEGIN
    WRITELN(OUTPUT,'This is the ADD function');
  END;
END. {MOD1}
MODULE MOD2;
PROCEDURE CHANGE;
  BEGIN
    WRITELN(OUTPUT,'This is the CHANGE function');
  END;
END. {MOD2}
MODULE MOD3;
PROCEDURE DELETE;
  BEGIN
    WRITELN(OUTPUT,'This is the DELETE function');
  END;
END. {MOD3}
MODULE MOD4;
PROCEDURE LIST;
  BEGIN
    WRITELN(OUTPUT,'This is the LIST function');
  END;
END. {MOD4}

```

*A useful function,  
 LOADER, lets you  
 break up large  
 programs into a main  
 routine and one or  
 more code overlays.*

library names.

While INTRP appears to be a more universal approach, you should remember that it must load and store all the registers. Time-critical applications should use DOSXQQ if they require only the AX, CX, and DX registers. Otherwise, you might still need an assembly-language routine.

The routines INP and OUTP let you read and write information directly to a specific hardware port address. This might be used to read the game paddles or set the mode on the monitor cards. You must include the file IBM-PORT.INT at the top of the program, and a USES IBMPORT must follow the program declaration. You must also specify the library IBMPAS.LIB to the linker.

A new data attribute called ORIGIN lets you locate a variable at a specific memory address. This makes the job of looking at system data areas easier. They are defined by specifying both the segment base and offset of the variable. For example, you could use the following definition for a word variable that contains the bit mask of the keyboard status:

```

VAR KEYSTATUS [ORIGIN
  16#0040:16#0017] : WORD;

```

**PROGRAM OVERLAYS**

Another new and useful function, LOADER, lets you break up large programs into a main routine and one or more code overlays. As the main program executes, it can bring in one overlay at a time. You must explicitly load the overlay before any of the

*(continued)*

FROM:

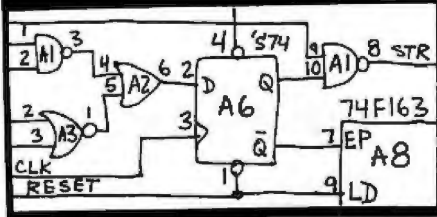

TO:



8051 8048 6804 6301

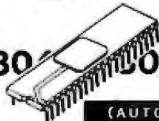

(AUTOMATICALLY)

## WHY WASTE TIME?

Why spend hours on programming  
when ALDEC can do it for you!

ALDEC Logic Compiler converts logic  
schematics and equations directly into  
standard processor object code  
Whether your schematic has thousand

gates, flip-flops or counters

- in ANY configuration -

**IT DOES NOT MATTER**

Aldec can do it!

### LOW COST "Entry" SYSTEMS:

**\$38/Mini, \$68/Small, \$395/Pro**

PROVIDE LOGIC CIRCUIT SIMULATION

The "ENTRY" systems simulate logic equations and circuits built with the 7400 series ICs. The Mini, Small and Pro handle logic circuit complexities of 5, 10 and about 1,000 chips, respectively. There is no practical limitation on the connections among the chips; any unstable condition is displayed in a special SPIKE mode, and a warning is given at all times. Any chip's I/O can be overwritten individually and the circuit's response is displayed immediately, without recompilation. Each ENTRY system has "demos" for teaching schematic entry, compilation and simulation. The Aldec Logic Compiler (\$1980), simulator (\$985) and processor modules (\$870 ea.), provide logic circuit emulation on standard microprocessors such as 8051, 8048, 6804 etc. Besides 7400 TTL library, Aldec can deliver other library of chips at extra charge.

ALDEC software allows intermixing logic equations with any netlist statements. Also, "Black Boxes", described by logic equations, can be placed anywhere within a schematic and compiled together with the schematic netlist.

ALDEC runs on IBM PC and compatibles

#### ORDERING:

- MINI       SMALL       PRO  
 ALDEC COMPILER       ALDEC SIMULATOR  
 PROCESSOR MODULE, type .....

Charge my credit card: expires .... / .....

- MASTERCARD (n/c)       VISA (n/c)

CARD # .....

Signature .....

\*\* Attach your shipping address and tel. # \*\*

 **ALDEC-Automated Logic Design Co.**

Tel. (805) 499-5827

3525 OLD CONEJO RD., NEWBURY PARK, CA 91320  
280 BYTE • AUGUST 1985

## REVIEW: IBM PASCAL 2.00

```
PAS1 MAIN.PAS,;
PAS2

PAS1 MOD1.PAS,;
PAS2

PAS1 MOD2.PAS,;
PAS2

PAS1 MOD3.PAS,;
PAS2

PAS1 MOD4.PAS,;
PAS2

MKOVL MOD1
MKOVL MOD2
MKOVL MOD3
MKOVL MOD4

LINK PLOADER + MAIN + MOD1 + MOD2 + MOD3 + MOD4, MAIN,;
```

Figure 1: How to compile and link the overlay program of listing 2. MKOVL.COM marks the specified object file as an overlay. PLOADER.OBJ performs the loader function and is included as the first object in the link process.

```
LIB PASCAL.LIB + NEWPROC;      {adds NEWPROC.OBJ to library}
LIB PASCAL.LIB - OLDPROC;      {erases OLDPROC from library}
LIB PASCAL.LIB * OLDPROC;      {removes OLDPROC from the library and }
                                  {places it in a file named OLDPROC.OBJ}
```

Figure 2: How the library manager modifies PASCAL.LIB.

procedures and functions defined in that overlay can be called. An overlay routine can call procedures and functions defined in the main routine, but it cannot call routines that are part of another overlay. The main program requests the code overlay by issuing the command

```
RETVAL := LOADER
('drive: \ path \ filename.OVL');
```

If the load is successful, RETVAL is zero and the overlay's procedures and functions are available until the next overlay is performed. Otherwise RETVAL contains the error code. Listing 2 shows an example of a program using overlays. [Editor's note: Listing 2 is available as OVERLAYS.PAS for downloading via BYTE.net Listings. The telephone number is (617) 861-9774.]

Two special files on the PAS1 disk handle overlays. MKOVL.COM marks

the specified object file as an overlay. PLOADER.OBJ performs the loader function and is included in the LINK command as the first object file of the list. Figure 1 shows how you use these two files. After you compile all five source-code files individually using PAS1 and PAS2, you run MKOVL.COM on the four overlay files and link them together. The final result is a file called MAIN.EXE; the four overlay modules have the file extension "OVL".

### DYNAMIC MEMORY ALLOCATION

One of the most useful features of Pascal is the ability to dynamically allocate variables in an area called the heap. Version 1.00 of the IBM Pascal Compiler used ALLHQQ, NEW, and DISPOSE to manage the heap. This area (64K bytes maximum) is shared between constant, stack, and heap data. Version 2.00 has a new function called FREECT that returns the space



## REVIEW: IBM PASCAL 2.00

Listing 3: A program segment that shows how to build a name and address list on the long heap.

```
PROGRAM HEAPTEST (INPUT,OUTPUT);
TYPE
  LONG_PTR = ADS OF MAIL_LIST;
  MAIL_LIST = RECORD
    NAME : STRING (20);
    ADDRESS : STRING (25);
    CITY : STRING (15);
    STATE : STRING (2);
    ZIP : STRING (9);
    NEXT : LONG_PTR;
  END;
VAR
  NEWPTR : LONG_PTR;
FUNCTION GETMQQ (BLKSIZE:WORD):LONG_PTR; EXTERN;
PROCEDURE DISMQQ (ADDRESS:LONG_PTR); EXTERN;
BEGIN {HEAPTEST}
  .
  .
  NEWPTR := GETMQQ(SIZEOF(NEWPTR*)); {allocates heap variable}
  .
  .
  DISMQQ(NEWPTR); {frees heap variable}
  .
  .
  END. {HEAPTEST}
```

remaining in this area (called the short heap in version 2.00).

In addition to the short heap, version 2.00 has another area called the long heap that starts in memory above the short-heap data area and extends up to the total memory on the machine (minus the space used by DOS). The routines GETMQQ and DISMQQ allocate and free memory blocks from the long heap. The only difference between these routines and the short-heap routines is that the pointer variable used is a 32-bit value (segment:offset) rather than a 16-bit value. You define the 32-bit pointer by using the built-in segmented data type. For example, listing 3 shows how to build a name and address list on the long heap.

#### LIBRARY MANAGER

Another useful improvement over version 1.00 is the addition of a library

manager. The operations you can perform include adding, erasing, and replacing of modules in a library. Figure 2 demonstrates how you might modify PASCAL.LIB.

In addition to changing existing libraries, you can create new ones. To create a new library called MYLIB, you could issue the command

```
LIB MYLIB + PROC1 + PROC2 +
  PROC3 + ... + PROCn;
```

#### CONCLUSION

The benefits of the new compiler far outweigh its few problems. The list price for version 2.00 of the IBM PC Pascal Compiler is \$350. Current owners can upgrade to version 2.00 for \$100 by sending a copy of the receipt for version 1.00 and an upgrade order form to IBM. Upgrade order forms are available at most stores that carry IBM equipment. ■

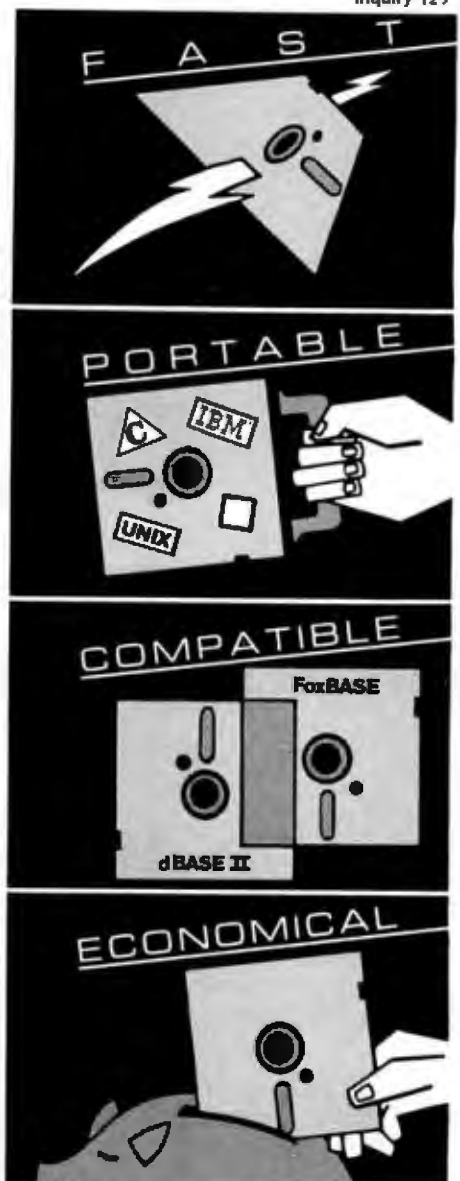

**At last, the breakthrough you've been seeking in a database management system.**

FoxBASE™ is more than just a relational database management system. Because it's written in C, FoxBASE is a highly portable, sophisticated interpreter/compiler that's ultraquick. Very economical. And dBASE II™ source compatible (including full macro usage).

FoxBASE emits compact object code and makes automatic use of an 8087 or 80287 chip to let you develop and run applications with unsurpassed speed.

And for as little as \$10 per license, you can distribute FoxBASE with your applications. FoxBASE even comes with a 30-day moneyback guarantee.

MS DOS \$395. AOS/VS \$995.  
UNIX™ (priced according to host).

Don't be outfoxed by the others. Call or write Fox Software today.

dBASE II is a registered trademark of Ashton-Tate.

**FoxBASE** 

From FOX SOFTWARE INC.

Developed by

**DACOR**

COMPUTER SYSTEMS

13330 Bishop Road, P.O. Box 269, Bowling Green, OH 43402  
419-354-3981/TWX 810-499-2989

# TeleVideo is the multiuser system for companies who expect to grow.



## The TeleVideo Personal Mini Family

Growing companies need a computer system that will grow right along with them. Simply and economically.

A computer system that lets people communicate and share resources. Even work on the same file simultaneously.

The TeleVideo® Personal Mini™ Family is that system.

**Runs PC, mini and multiuser software.**

With the TeleVideo Personal Mini, users of IBM® or TeleVideo PCs, XT's, and portable computers can share data, as well as expensive peripherals, like printers and plotters.

The Personal Mini dramatically increases computing power. So it not

only runs PC software, but also hundreds of popular, fast mini-computer and multiuser programs. Without destroying your established PC environment.

And, unlike less advanced networks, the Personal Mini never sacrifices performance or speed regardless of how many workstations are on line.

**Build on your original PC investment.**

Even our system expansion costs are substantially less than what you'd pay to add new IBM PCs. And your original investment in hardware, software and personal computer education is never lost.

Your TeleVideo dealer has the Personal Mini. Arrange to see it today by calling toll free, 800-521-4897. In California, call 800-821-3774. Ask for operator 10.

The TeleVideo Personal Mini. The growing business computer.

**Regional Sales Offices:** Northwest (408) 971-0255, Southwest (714) 476-0244, Southcentral (214) 258-6776, Midwest (312) 397-5400, Southeast (404) 447-1231, Mid-Atlantic (703) 556-7764, Northeast (617) 890-3282, East (516) 496-4777, Rocky Mountain (714) 476-0244.



Systems

TeleVideo Systems, Inc.

IBM is a registered trademark of International Business Machines

## DESKPRO GRAPHICS

In general I agree with Jerry Grady's review of the Compaq Deskpro (May, page 260). I have had a Model 2 for many months and find it reliable, compatible, and fast. But I believe you've overlooked a significant area of incompatibility.

The Deskpro has improved video functions and incorporates both monochrome and color graphics ability, but it will not accept common IBM graphics boards like the Hercules graphics card. This is a disappointing limitation if you want to take full advantage of the graphics ability of programs like Microsoft Word or Lotus 1-2-3.

I have called Compaq, Hercules, and AST Research, and none can offer any help or hope. Had I realized that I would not have access to improved graphic resolution on the Deskpro, I might have chosen a more compatible machine.

BRYAN MUMFORD  
Summerland, CA

## INSIGHT

Bruce D'Ambrosio's software review of Level 5 Research's Insight expert-system shell (April, page 345) misses the point on the utility of expert systems as assistants in general and the ability of the Insight shell to serve this purpose in particular.

Artificial-intelligence expert systems might have been born in educational institutions, but they are now being developed by many engineers in government and industry. Engineers are the ones who are putting the theory into practice. Further, we are finding important applications for this type of software that do not require the large efforts, funds, and research typical of the systems coming from the academic community.

Insight is a most useful and reasonably priced tool for small-domain knowledge bases. Almost all the limitations Mr. D'Ambrosio describes have work-arounds that you learn from experience with the software. This is no different from any other commercial software. The fact that Insight (like several other expert-system shells) does not support closed-form mathematics is being addressed in an enhancement now undergoing beta testing. However, expert systems used as assistants for ad-

visory or diagnostic purposes in many cases do not require closed-form mathematics.

PHIL CHAPMAN  
La Crescenta, CA

*I reviewed Insight, not in comparison to mainframe or LISP machine-based research systems, but according to my estimate of what should be possible on a personal computer. I believe that the ability to include variables in rules and to use simple arithmetic are essential in any general-purpose knowledge-based system shell.*

*Of course, you can often work around limitations, and they might not even cause problems in any one application. However, the development teams for TI's Personal Consultant, Teknowledge's M.I., and Artelligence's OPS5+ feel that both variables and arithmetic are important enough to include in their systems. While these packages all cost substantially more than Insight, Tpsi, a \$75 variant of OPS5+ from Dynamic Master Systems, also provides both facilities.*

*I am glad to hear that arithmetic computation capability is being incorporated into a future release of Insight. Also, I consider variables somewhat analogous to arrays in a procedural programming language. I imagine that you don't use arrays in every program you write; you may not even use them often. But once you learn about them, would you buy a compiler that didn't support some kind of array construct?*

*I am glad to hear that you are successfully using Insight. Insight is not a bad system; I just don't think it is representative of all that could be done on a PC.*

—BRUCE D'AMBROSIO

## HARDWARE BENCHMARKS

You need to rethink your policy regarding comparison charts in hardware reviews. You constantly compare micros to the IBM PC and Apple IIe, regardless of how appropriate that is. For example, in the March issue (page 247) you compare the \$8990, 10-MHz, 8086 Altos 586 to the \$3200, 4.77-MHz, 8088 IBM PC and the

\$2100, 1-MHz, 6502 Apple IIe. Really, shouldn't you compare it to the IBM PC AT and the Stride? Then you have the \$1240, 1.79-MHz, 6502C Atari 800XL up against the PC and IIe (page 267). Shouldn't that be the Apple IIc, not IIe? And wouldn't the Commodore 64 be more realistic than the IBM? You should be making comparisons to a given machine's real competition.

It looks as if you use charts with the IBM PC and Apple IIe because it is convenient to do so, not because any thought goes into selecting the comparisons. So next time, compare apples to apples, oranges to oranges, and Osbornes to Kaypros.

RICK DOWNER  
Seattle, WA

*The purpose of our benchmarks and "At a Glance" boxes is to offer comparisons between the system under evaluation and other systems with widely known capabilities. By consistently using products with known performance characteristics, we intend to provide benchmarks that most readers can interpret in terms of their own experiences with familiar machines and software.*

*Comparing a new product only against a look-alike or work-alike product has drawbacks. That type of comparison puts the reader in a technological game of musical chairs: The music stops every time any company updates or announces a new product. Relatively few people have resources great enough to permit them experience with a wide selection of expensive equipment.*

*We are not in the business of predetermining which machines are each other's appropriate competitors.*

—GLENN HARTWIG  
Technical Editor, Reviews

## THE HP 110

In reference to Manly W. Mumford's letter in Review Feedback (March, page 303) regarding Ezra Shapiro's review of the HP 110 (June 1984, page 111), I'd like to say that I have been very pleased with the HP 110's capabilities, apart from the need for good lighting conditions. In fact, a whole

(continued)

# ABSOLUTELY THE LOWEST PRICES!

We will beat any price advertised in this magazine!

**More than IBM compatible!**



**ZENITH data systems**

**Standard Features**  
(Costs extra with IBM)

- 2 - DS-DD 36K Disk Drives
- 320K RAM
- Amber 20 MHz Monitor-P3
- Built-in ROM diagnostics
- Pearl Database \$100 w/ system

**\$1,850**

CZF 15152A

**10-20Mg Hard Disk Systems starting at \$2,590**

**ZENITH DOES IT AGAIN!**

**New advanced technology PC IBM PC/AT Compatible**

**Basic System:**

- Single OS DD 1.2 megabyte disk drive
- 512K RAM
- Amber 20MHz Monitor (P13)
- Serial parallel
- Expandable to 40 Mg hard disk
- Expandability for up to 12 simultaneous users

Quantities limited CALL for Pricing

**AB Computers' own PC**



**100% IBM Compatible**

- 256K RAM
- 2 - 360K Disk Drives
- Serial & Parallel Ports
- Your choice of 20 MHz Amber or Green Monitor
- Pearl Database only \$100 w/ system
- Lotus 123 only \$250 w/ system

Introductory Offer **\$1,595**

**10-20Mg Hard Disk Systems starting at \$2,350**

If you are ever in the Philadelphia area, please come by and visit our showroom.

**Panasonic**



**Fraction & Tractor Feed**

**With IBM Cable and Software disk to change type size & style**

1090 80 cps	219
1091 120 cps	299

Specify computer

Two Reliable Workhorses

**OKIDATA**

82 83, 84, 92, 93, 182 2350, 2410 Okimate-20	Call
Okimate (Specify CB4 or Atari)	199

**star**

SG10/SG15 (120 cps)	239/399
SD10 (160 cps)	359
SD15 (160 cps)	479
SR10 (200 cps)	499
SR15 (200 cps)	639
PowerType Letter Quality	319

**dosywriter**

**LETTER QUALITY**

When you want your letter to look like a million \$ 40 cps 700 REGULARLY 1,495

Factory reconditioned 90 Day guarantee

**Canon**

**Canon Dot Matrix**

This one a Special Purchase Commercial Quality Very Limited Quantity 1/6 Speed 180 cps IBM Push Tractor Comp to OKIDATA-92 Only 379

**C. ITCM**

Prowriter 1500	219
Prowriter 8510P	299
Prowriter 1550P	469
Son of Starwriter A10P	459
Hot Dot Matrix	459
F10-40P Starwriter	899
F10-55 Proewriter	1049

**EPSON**

RX-80 FX-80+, LX-80 JX-80	Call
FX-100+, RX-100, LQ1500	Call
Homeewriter 10	Call

**MicroFazer Printer Buffers**

ME parallel Epson 8K 135 16K 145	
32K 165 64K 195	
MP parallel 8K 145 16K 155	
32K 175 64K 205	
MSP ser-parallel 8K 165 16K 175	
32K 195 64K 225	
MSS ser-serial 8K 165 16K 175	
32K 195 64K 225	
MPS par-serial 8K 165 16K 175	
32K 195 64K 225	

**USI**



**Hi Res Metal Cabinet**

1-9	79	Large Qty
10-19	70	Call
20 up	68	

**AMDEK**

300 Green Amber	129 149
300 Color/Audio	259
310 Amber IBM-Plug	169
Color 500 Composite/RGB	389
Color 600 Hi Res(640x240)	439
OCcolor 700 Hi Res(720x240)	499
Color 710 Long Phosphor	579

**TAXAN**

115-116 12" Grn Amb Mono	99
121 Green TTL	139
122 Amber TTL	149
210 Color RGB	239
400 Med-Res RGB	319
415 Hi-Res RGB	399
420 Hi-Res RGB (IBM)	429
440 Ultra Hi-Res RGB	589

**ZVM**

ZVM 122 123 Amb Grn	89
ZVM 124 IBM Amber	149
ZVM 131 Color	299
ZVM 133 RGB	429
ZVM 135 RGB/Color	459
ZVM 136 RGB/Color	629
9191U Color	199

**BMC**

**HARD DISKS**

10 Mg Add-on	629
20 MG Add-on	Call
Atasi 53 Mg AT Kit	Call

**TEAC**

DS DD Disk Drive	120
64K RAM Kit	10

We carry full software lines by Electronic Arts, Scholastic, Scarborough, PFS, Spinnaker and Batteries Included.

**AST**

Sea Pack Plus	239
Mega Plus II	269
I O Plus II	139
Memory MB II	249
Advantage AT	399
Preview Monograph	299
Graph Pak Menu 64K	599
MonoGraph Plus	399
5251	579
3780	639

**Software Macintosh**

Typing Tutor III	40
Hitchhikers Guide to Galaxy	28
Multiphan	129
Mind Probe	35
Milwaukee	40
Ensemble	230
Jazz	Call
Helix dBase	Call

**IBM**

**Software**

dBase III	458
Lotus 123	290
Prokey 3 0	87
Milwaukee	40
Summer Games	28
Typing Tutor III	35
Hitchhikers Guide Galaxy	28
Multiphan	129
Copy II PC	35
Mind Probe	35
Turbo Pascal 3 0	54
PFS Graft/Report	79
PFS Write, file/glan	89

**Utility Programs**

Side Kick	36
Norton Utilities	75
Copy II PC IBM install Lotus dBase etc protected software on hard disk	30

**DISK BANK 5**



**AMARAY**

Media Mate	8 95
Rep H File 25	18 50
Rep H File 50	27 95

**3M Certified Data Cartridges**

DC 100A H-P, etc.	14 25 10' 13 50
DC 300A	19 25 10 18 25
DC 300XL	22 45 10/21 45
DC 600MC 600	27 00 10 25 90
DC 615HC 150'	20 00 10 18 90
DC 600A 600'	25 00 10 23 85
DC 615A 150'	18 40 10 17 45

**QUADRANT**

Quadboard II	229
Expanded Quadboard	239
Quad 512+	249
Quad 2 Meg	879
Memory Board	229
Quad Jr Exp Chassis	539
Quad Jr Exp Memory	219
Quad Memory Jr	229
Chronograph	89

**Software Apple**

Typing Tutor III	35
Hitchhikers Guide to Galaxy	28
Multiphan	84
Copy II	35
Mind Probe	35
Turbo Pascal 3 0	54
Corner Stone	Call
Milwaukee	35

**Hayes**

1400	Call
1200 300	489
1200B w/Smartcom Slt	419

**ANCHOR**

2400	Call
Mark XII	269
Volts 12 w/cable	199
Volts 3 w/cable	68

**Nobody Beats our Price on Disks!**

**AB DISKETTES**

30 - 3.5"	125
100 - 5 DS/DD	160

**DATATECH**

SS DD	1 00
DS DD	1 05
AT	4 40

Over 100 000 in stock at all times

3 1/2" AT HDNS disks for all models

**ORDERING INFORMATION** Order by check, Mastercard or VISA. Personal checks take 15 days to clear. No waiting on certified checks or money orders. Add 3% shipping and handling on all orders (minimum \$2 00). Mail, APO TPO. An may require additional charges. PA residents add 6% sales tax. MA residents add 5%. All items subject to availability. Prices subject to change. Additional discounts available to qualified educational institutions. Requests for bid on volume requirements invited.

**AB SATISFACTION GUARANTEE**

Every product sold by AB Computers is factory packed and comes with the manufacturer's warranty. However, if an item is defective when received, you may return it to us within 15 days for repair, adjustment or replacement at our option. Returns must be accompanied with copy of your invoice, letter detailing defect, blank warranty card and all original factory packing. To expedite handling, please call for return authorization number (Sorry, no return on computer software once opened).

Some store prices slightly higher

**PARADISE**

Modular Graphics Card	279
Multi Display Card	299
Five Pack C S	169

**Hercules**

Graphics	319
Color	169

**POWER DEVICES**

Desktop back-up power source	
200 PC-200 watt	265
300 XT-300 watt	390
Tripp 425	433
Brooks 6 Outlet-Surge Suppressor	
Noise Filter	54

**CABLES**

Parallel Cable (36pin/36pin)	23
RS232 Male to Male 6'	17
RS232 Male to Female 6'	18
Parallel Cable for Columbia	25
IBM Cable	19



Use TOLL FREE Order Line Mon. - Sat. 9am - 6pm EST

**800-822-1211**

In PA: 215-822-7727

252 BETHLEHEM PIKE, COLMAR, PENNSYLVANIA 18915

We support Apple, Macintosh, Commodore, IBM & compatibles



Customer Service 215-822-7727

## REVIEW FEEDBACK

range of screen-control functions are built into the computer, irrespective of programming language, and you invoke them with escape sequences. The owner's manual appendix D-6 to D-9 lists these sequences, but note that the "toggle caps" sequence should read

ESC &k{0,1}P

To use these within, say, Microsoft BASIC, simply program a statement to print the relevant escape sequence. I usually create user-defined functions at the start of my programs to simplify often used sequences. For Mr. Mumford's benefit, the sequence for screen clear is ESC [2J. You can program this as PRINT CHR\$(27) + "[2J" where CHR\$(27) is the ASCII code for the escape key.

One disappointment is the omission of graphics-control sequences. These are available either using GW-BASIC or from the HP 110 programmer's toolkit. The basic graphics sequences (circle, line, etc.) could have been included. After all, the HP 150 has these as standard.

D. HARPER

Stockton-on-Tees, Cleveland County,  
England

## MULTIMATE

The repagination problem in MultiMate to which CJ Puotinen (November 1984, page 287) and several letter writers thereafter alluded has been fixed. It's a pity to see this fine program criticized because of one bug in an early version. I used MultiMate 3.22 for multipaged articles for months without difficulty repaginating. Occasionally I had to remove a misplaced format line. I have never lost text, either. The current version (3.30) is even better, since it lets you keep the format lines attached to either text or pages.

The slight backup inconvenience to which Maureen Fleming referred (April, page 348) is also altered in version 3.30. The user can now back up the document automatically if he or she wishes to do so. This was a fix for a nonexistent problem, since all you had to do was copy the document to another disk. You could do this easily either from DOS or from within MultiMate itself.

ROBERT JACOBS  
Ellensburg, WA

## MT 160 PRINTER

I recently read Mark J. Welch's review of the Mannesmann Tally MT 160 printer (February, page 325) and felt I must comment. I am a data communications technician for the Washington State Patrol—

administered ACCESS (A Central Computerized Enforcement Support System).

All our remote terminals (over 250 of them) use MT 160s exclusively, and I would be happy to replace them with something better (and cheaper). After directing about 10 operators throughout the state in reprogramming the printers' parameters after an electrical storm, I would rather have DIP-switched parameter setting. Irregular line voltage and other power-line disturbances play havoc with this otherwise convenient arrangement. Having to run through the complete menu every time this happens is tedious.

On the other hand, the printer is physically well built and prints without much complaint at the workload. The three in our communications center operate without serious problems 24 hours a day. Our State Patrol avoids the problem of hard-to-get and expensive ribbons with reinking equipment. I have no data on how long an individual ribbon lasts, but I have not seen a new one come through here for a long time, and we use more ribbons than anyone else in the state.

MICHAEL L. CLARK  
Olympia, WA

## ITT XTRA

Having purchased an ITT XTRA last year, I have a few comments to add to John D. Unger's review (April, page 338). I'm not a professional programmer and have had no prior experience with micros, but I've had little difficulty in upgrading our XTRA with IBM-specific hardware. Unlike the PC, the XTRA does not require 256K bytes on the motherboard before you add extra memory.

I popped for IBM PC-DOS 3.0 and abandoned ITT DOS (2.11). I've not found any incompatibilities in the IBM PC versions of software we use. The only software incompatibility discovered so far is ITT BASIC's local field statement elucidated in Melvin Duke's letter to BYTE (March, page 434).

Prospective owners should purchase ITT's technical reference manual for the diagnostics and in the event that the machine must be repaired by technicians unfamiliar with it. Taking into account the superior keyboard, smaller footprint, larger tilt-swivel monitor, and other engineering features, I wouldn't trade our XTRA for a fully loaded PC XT.

GEORGE BRIDGFORTH  
Dallas, TX

(continued)

## CLOSEOUT CORNER

## CPM Special ALSPA ACI

64K, 2 SS/DD 8" Half Height Drives  
Original Price \$1,995: **AB Closeout \$499**  
Freedom 110 CRT intelligent terminal  
with above system ..... only \$500

HP Calculators  
and Accessories

Below Cost — Limited Supplies

Electrohome RGB Monitors w/IBM Cable . . . \$235  
Panasonic Monitor 12" green w/sound. . . . \$99  
AMDEK Daisy Wheel Printers 25CPS . . . . \$499  
MSD Disk Drives for CBM & 64 . . . . . Call

## ATTENTION

## Commodore User Groups

Price Break Through  
C64 Modem Auto Dial/Auto Answer w/Free Software  
100/\$40 50/\$45 10/\$56 Sample/\$50  
**AMRAY Media Mate 5** holds 50 disks  
100/\$7.50 48/\$7.75 24/\$8.00 Sample/\$8.95

## 8" DISK RIOT

Maxell Sentinel BASF Wabash SS/DD  
1000 \$1.00 500 \$1.10 100 \$1.25

Commodore Close Outs  
50% to 80% OFF

Comsense C64 . . . . . Call  
Comclock C64 . . . . . Call  
Comvoice C64 . . . . . Call  
Promqueen C64 Programmer . . . . . \$121  
**C64 Programming Aids by SM**  
SM Text . . . . . \$34  
SM Adreva . . . . . \$24  
SM Ka . . . . . \$29  
SM ISM . . . . . \$30  
**ALL FOUR ONLY . . . . . \$99**

## NEW! JUST ARRIVED

SUMICOM Hi Quality Daisy Wheel Printer  
18 CPS QUME Print Wheels, Parallel Interface  
13" Paper Width Introductory Offer . . . . \$399

Software Close Out  
for C64 Over 100 Titles  
Up to 70% OFF

We carry full software lines by Electronic Arts, Scholastic, Scarborough, PFS, Spinnaker, Batteries Included and many others. If you don't see the program you want listed, call our TOLL-FREE order phone number 1-800-822-1211.

## BUSINESS EDUCATIONAL

Wordpro 3+ . . . . . 85 Agent USA . . . . . 21  
Microsoft MultiPlan . . . . . 69 Spell Diver . . . . . 21  
Omniwrite/speller . . . . . 45 Secret Flier . . . . . 14  
Bank Street Writer . . . . . 49 Kinder Comp. . . . . 20

## ENTERTAINMENT

Lode Runner . . . . . 26 Flight Simulator . . . . . 41  
Mind Proger . . . . . 20 Zaxxon . . . . . 30

**AB**  
COMPUTERS

Use our Toll FREE Order  
Line Mon-Sat 9am-6pm

CUSTOMER SERVICE  
215-822-7727

**800-822-1211**

In PA 215-822-7727

252 BETHLEHEM PIKE, COLMAR, PA 18915

I read John D. Unger's article on the ITT XTRA with disbelief. In July of 1984 I purchased an ITT, initially for word processing with the intention of using it for other applications later.

My original choice of software was Microsoft Word without the mouse. However, when I used Word, the computer slowed to a snail's pace. The monitor would show only a fraction of the characters input from the keyboard. The salesperson couldn't explain the problem but replaced the package with Satellite Software's WordPerfect.

Initially WordPerfect's performance was satisfactory on short documents. However, when the length of the documents and the amount of formatting increased, the system froze with a "RAM parity check error" displayed. The salesperson spent several days calling ITT and Satellite Software. Both companies assured him that there was no problem with using the IBM version of WordPerfect on the ITT XTRA.

At this point, my \$3300 package of equipment would not work. Technicians

checked the processor and found no problems. The salesperson was in the uncomfortable position of having sold a machine that was allegedly IBM-compatible but would not run two popular word-processing packages. In order to keep me happy, the dealer bought back my XTRA at full credit toward a computer of my choice. I selected an AT&T and have had no problems.

TERRY L. BRINK  
Pittsburgh, PA

### JUKI 6100

The Juki 6100 printer reviewed by G. Michael Vose in BYTE (August 1984, page 305) has a number of problems that severely limit its usefulness. Letter spacing is irregular, the ribbon doesn't advance properly, and with the add-on tractor unit it's impossible to print lines parallel to one another. Juki's service department has not returned my dealer's repeated calls.

The irregular letter-spacing problem seems insoluble—it has to do with the mechanism for shifting the print head across the page.

The Juki 6100 has two ribbon problems. First, a toothed wheel on the take-up side is supposed to engage the ribbon and draw it onto the take-up spool. At the start of a new ribbon, the toothed wheel frequently exerts insufficient pressure, and the ribbon doesn't move. However, if you turn the take-up spool manually for a page or so, the ribbon eventually advances on its own. The second problem is that the ribbon-advance mechanism is incapable of using all the ribbon. It always jams, leaving twenty or thirty feet of ribbon unused.

The last problem is with the add-on tractor unit. I had to wait two months to get it. When it arrived, it was incapable of printing lines horizontally. One line slanted in one direction, and the next line slanted in the opposite direction. After a short time, I managed to identify the problem: The paper-advance mechanism consists of a pair of gear wheels and a ribbed plastic band. Unfortunately, this ribbed band is only 1/8 inch wide. However carefully it is adjusted, it's incapable of advancing the paper without stretching. The result is that the lines slant.

DAVID LEWISTON  
Kihei, HI

IF POWER FAILS, DATASaver® TAKES OVER!

**PROTECTION** - saves data during power failures.  
- saves hardware from overvoltage transients.

**PORTABILITY** - allows mobile or extended holdup time using auxiliary 12 volt battery.

**FEATURES** - internal battery provides 5 min. + operating time - AC line conditioning  
- audible and visual alarms, interrupt signal - compact, desktop styling  
- no installation required.

200 WATT - \$495 / 90 WATT - \$350  
For special applications and product information, call 805-541-4160.

Instant power order line  
**805-541-4161**

**CUESTA SYSTEMS, INC.**  
3440 Roberto Court, San Luis Obispo, California 93401

INSTANT AC POWER



### MT SPIRIT 80

I have to agree with Shel Kagan's comments in Review Feedback (April, page 348) regarding the Mannesmann Tally Spirit 80 review (November 1984, page 335). I'd also like to point out that the Spirit 80 takes only ribbon cartridges that you can't reink and that are expensive, are hard to find, and provide good impressions for about three weeks of moderate use.

Mannesmann Tally estimates print head life at 30 million characters—not long compared to most print heads. And this one does not seem to stand up well in graphics mode. I have had two heads fail within 15 months while printing graphics (new heads cost \$65 each).

The printer now needs repair at an estimated cost of \$150.

Spend another \$150 on this printer? Thanks, but I'll get an Epson.

RICK GOULIAN  
New York, NY

REVIEW FEEDBACK is a column of readers' letters. We welcome responses that support or challenge BYTE reviews. Send letters to Review Feedback, BYTE Publications, POB 372, Hancock, NH 03449. Name and address must be on all letters.

# *Presenting* JC + PC NETWORK



## WHAT YOU SHOULD, WHAT YOU SHOULD NOT, NOW AND LATER

You don't want to buy a multi-user system without a PC file server capability. You don't want to buy a PC file server without a multi-user capability. The Multi-User File Server (MUFS) is what compliments your needs in performance, growth, and cost.

Selecting the right computer system is the most crucial requirement for your company



growth, because of ever-increasing demand in computer performance and capacity. The computer you purchase now should not be a bottleneck later.

JC Multi-User, Multi-Processor, File Server is the only computer system you can afford to speculate. And Nothing else. . .



### JC INFORMATION SYSTEMS

469 Valley Way  
Milpitas, CA 95035  
408/945-0318 TLX: 910-381-7041

In Australia: Synox Systems, Ctr. Pacific Hwy & Beaconsfield, Lindfield N.S.W. Australia 2070, Tel: 467-1166 TLX: (790)25468

In The United Kingdom: Interam Corporation 62 Weir Road Wimbledon, London SW19 8UG, England, Tel: 879-1888 TLX: (851)8954072

In Europe: COSTEC GmbH Holländische Strasse 19, 3500 Kassel, West Germany, Tel: 56147268 TLX: (841)99695

ARECTA System AB Ekensbergsvagen 117, S-171 41 Solna, Sweden, Tel 898-6790 TLX: (854)08986790



*Voice Management*



*Data Management*



*Networking*

**WHAT THE  
MOST POWERFUL,  
MOST FLEXIBLE  
COMMUNICATIONS  
SYSTEMS IN THE  
WORLD CAN DO  
FOR YOU.**





*System Management*



*Office Management*

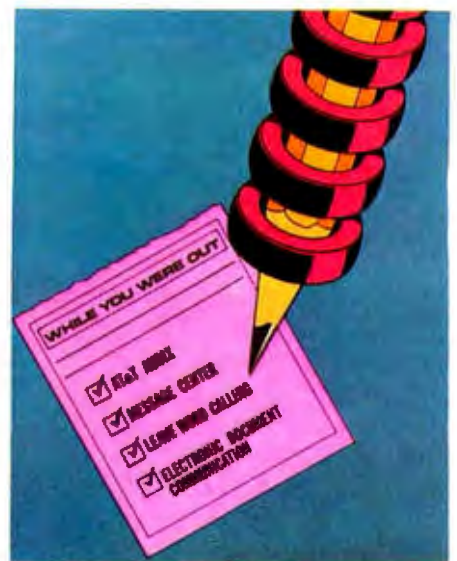

*Unified Messaging*

**ONLY AT&T SYSTEM 85 AND AT&T SYSTEM 75 FULLY INTEGRATE SO MANY VITAL MANAGEMENT FUNCTIONS.**

Decisions, decisions, decisions. It wasn't too long ago that if you wanted the most sophisticated office communications equipment in the world, you'd get a telephone.

Now it's a whole new ball game. You've got to have more than a telephone. You've got to have an entire communications and information system. You've got to choose from among a number of vendors and justify a substantial capital investment. You've got only one chance to make the right decision. And you've got to be right.

Relax. The decision is easy. System 85 and System 75 from AT&T Information Systems offer you more power, flexibility and control than any other system in the world. Because they can grow and change as technology advances, you can be sure your investment is protected. And because they're from AT&T, you know they meet the highest standards of manufacturing quality and reliability.

Here are just a few ways they can help your office operate more efficiently and effectively.

**Voice Management** Our experience in voice communications speaks for

itself. There are over 150 calling features to choose from, so you can custom-tailor a system that meets the particular needs of your business.

**Data Management** This ties the whole system together. Our Digital Communications Protocol integrates voice and data transmissions, resulting in more productive use of your equipment and easy future expansion.

**Networking** Different businesses need different networks. Our Distributed Communications System and Electronic Tandem Network let you link all your locations, either across the street or across the country.

**System Management** Adaptability is the key here. You'll have a hands-on ability to monitor and change the entire system day by day, to respond to your changing needs.

**Office Management** This streamlines your everyday office procedures into one easy-to-use system. By integrating Electronic Document Communication, Message Center, and Directory, you can create, store and send information easily and more productively.

**Unified Messaging** This complete, easy-to-use service is the answer to unanswered calls. It completely integrates all your messaging ser-

vices, including Message Center Coverage, Leave Word Calling, and AUDIX, our powerful voice mail service.

**100 YEARS OF EXPERIENCE**

There's another aspect of our system which you can look at as something of an insurance policy. It's called Information Systems Architecture. It is this framework that ensures that anything new we develop for your system will fit right in. System 85 and System 75 are designed according to its guidelines, as our future products will be. That's protection.

We've been the undisputed leader in communications for over 100 years, and we plan to keep it that way. Today, more than 4000 systems designers and others formerly at AT&T Bell Laboratories are working exclusively to develop new business products at Information Systems Laboratories. And they're supported by the largest sales and service staff in the industry to help you along every step of the way.

There are two ways you can distinguish yourself in the business world—either get a little gray at the temples worrying about it, or choose AT&T Information Systems.

To find out more about System 85 and System 75, call your AT&T Information Systems Account Executive or 1-800-247-1212.

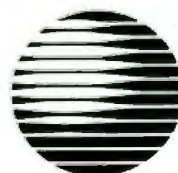

**AT&T**

The right choice.

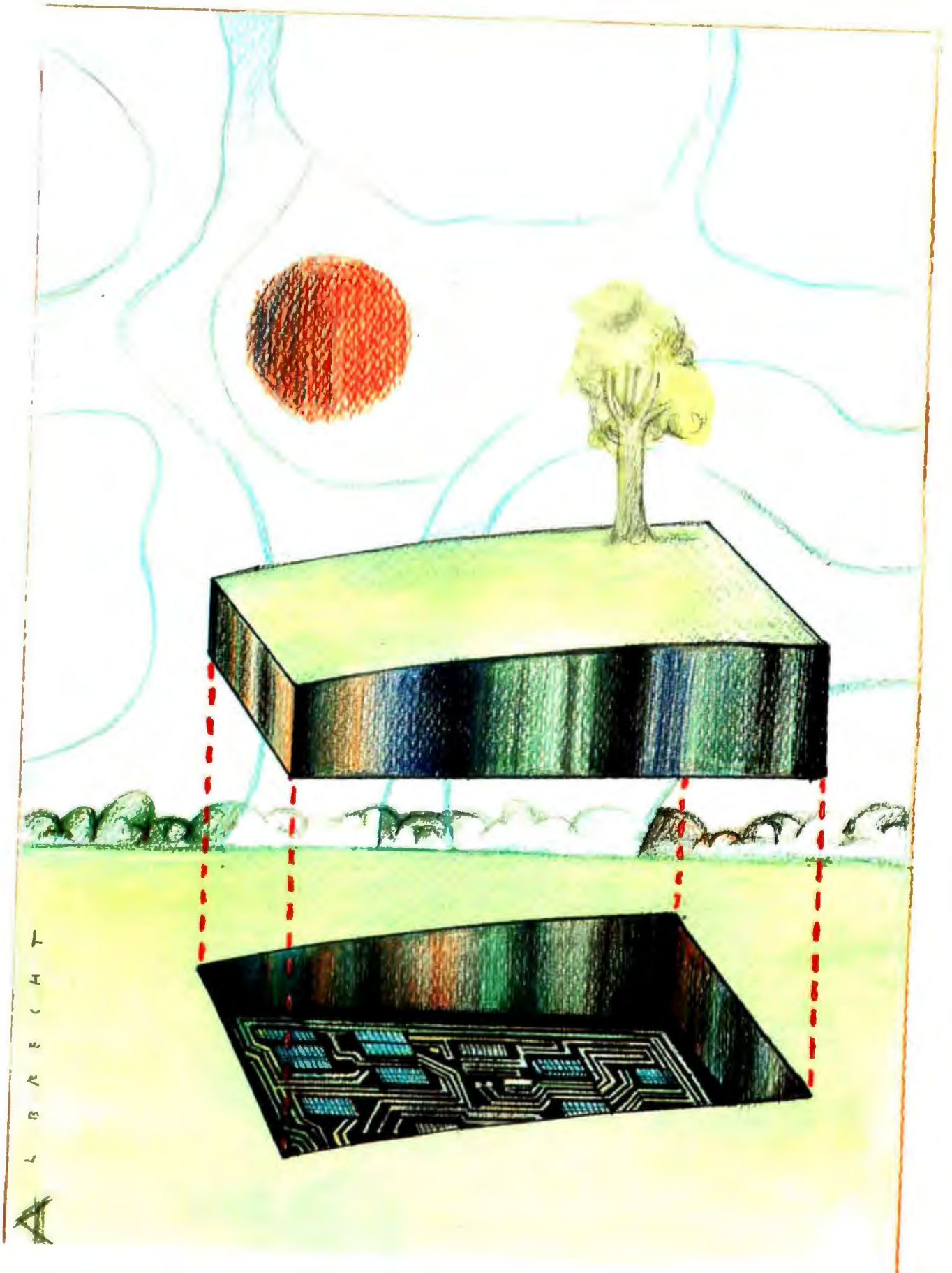

L  
B  
R  
E  
C  
H  
T



# Kernel

---

<b>COMPUTING AT CHAOS MANOR: THE WEST COAST COMPUTER FAIRE</b> <i>by Jerry Pournelle</i> .....	293
<b>BYTE JAPAN: COMDEX IN JAPAN</b> <i>by William M. Raike</i> .....	331
<b>BYTE U. K.: DECLARATIVE UPDATE</b> <i>by Dick Pountain</i> .....	341
<b>ACCORDING TO WEBSTER: GREETINGS AND AGITATIONS</b> <i>by Bruce Webster</i> .....	355
<b>BYTE WEST COAST: NEW MICROPROCESSOR CHIPS</b> <i>by Phillip Robinson</i> .....	369
<b>CIRCUIT CELLAR FEEDBACK</b> <i>conducted by Steve Ciarcia</i> .....	376
<b>BYTELINES</b> <i>conducted by Sal Libes</i> .....	378

---

DUE TO A HEAVY schedule, Jerry Pournelle went to this year's West Coast Computer Faire only because of a commitment to give a talk. However, he's happy that he decided to make the trip. He discovered that the magic is still there, met old friends, and saw many new products.

Bill Raike attended the first-ever COMDEX in Japan this spring and found several interesting products on display. He describes the "anonymous" Fujitsu lap-size portable, several laser printers, the latest addition to the NEC PC-9801 computer family, and a Brother portable word processor that he "discovered" at the show.

In keeping with this month's declarative languages theme, Dick Pountain looks at two books on the subject—one on functional and the other on logic programming. He also introduces us to two new language systems. One, developed at Imperial College, is a new interpreter for the Hope language that runs on the IBM PC. The other is MacProlog, which has many improvements on the older micro-PROLOG and is an implementation for the 512K-byte Macintosh.

Our new man in the Kernel, Bruce Webster, continues with his inspection of new computer products. As was the case with his debut column—and will probably be true in the future—this month's column deals largely with Macintosh items. Particular attention is given to three development systems for the Mac.

And, on the West Coast, Phillip Robinson looks at Intel's iAPX 386, the 80C86, and Atron's AT Probe—a "hardware-assisted software debugger" for the 86 family.

# THE PROGRAMMER'S SHOP™

helps save time, money and cut frustrations. Compare, evaluate, and find products.

## SERVICES

- Programmer's Referral List
- Dealer's Inquire
- Compare Products
- Newsletter
- Help Find a Publisher
- Rush Order
- Evaluation Literature Free
- Over 700 products
- BULLETIN BOARD - 7 PM to 7 AM 617-826-4086

## Free Literature - Compare Products

Evaluate products. Compare competitors. Learn about new alternatives. One free call brings information on just about any programming need. Ask for any "Packet" or Addon Packet.  ADA, Modula  AI  BASIC  C  COBOL  Editors  FORTH  FORTRAN  PASCAL  UNIX-PC or  Debuggers, Linkers, etc.

## RECENT DISCOVERIES

PC LINT - full C program checking and big, small model.  
C86, Lattice. MSDOS \$ 95

## ARTIFICIAL INTELLIGENCE

ARITY/PROLOG - full, debug, to ASM&C, 16 Meg use, windows, strings. With compiler \$1950. MSDOS \$495

ExpertEASE - Expert system tool. Develop by describing examples of how you decide. PC DOS \$625

Expert LISP - Interpreter: Common LISP syntax, lexical scoping, toolbox, graphics. Compiler. 512K MAC \$465

EXSYS - Expert System building tool. Full RAM, Probability. Why, serious, files. PC DOS \$275

GC LISP - "COMMON LISP", Help. tutorial, co-routines, compiled functions, thorough. PC DOS Call

M Prolog - full, rich, separate work spaces. MSDOS \$725

PROLOG-86 - Learn fast. Standard, tutorials, samples of Natural Language. Exp. Sys. MSDOS \$125

TLC LISP - "LISP-machine"-like. all RAM, classes, turtle graphics 8087 CPM-86. MSDOS \$235

WALTZ LISP - "FRANZ LISP" - like, 611 digits, debugger, large programs. CPM80 MSDOS \$159

MicroProlog - improved MSDOS \$235

## BASIC

ACTIVE TRACE, DEBUGGER - BASICA, MBASIC, interactive, well liked. MSDOS \$ 79

CADSAM FILE SYSTEM - full ISAM in MBASIC source. MSDOS \$150

BASCOM-86 - Microsoft 8086 279

CB-86 - DRI CPM86, MSDOS 419

Data Manager - full source MSDOS 325

InfoREPORTER - multiple PC DOS 115

Prof. Basic - Interactive, debug PC DOS 89

TRUE BASIC - ANSI PC DOS 125

Ask about ISAM, other addons for BASIC

## EDITORS FOR PROGRAMMING

BRIEF Programmer's Editor - undo, windows, reconfig. PC DOS \$195

VEDIT - well liked, macros, buffers, CPM-80-86. MSDOS. PC DOS \$119

C Screen with source 86/80 75

Epsilon - like EMACS PC DOS 185

PMATE - powerful 8086 185

XTC - multitasking PC DOS 95

## COBOL

Microsoft Version II - upgraded. Full Lev. II, native, screens. MSDOS \$500

Dig Res-decent MSDOS 525

Macintosh COBOL - Full. MAC 1850

MBP - Lev II, native, screen MSDOS 885

MicroFocus Prof.-full PC DOS call

Ryan McFarland-portable MSDOS 695

## C LANGUAGE

C-terp Interpreter by Gimpel, full K&R, .OBJ and ASM interface. 8087 MSDOS \$275

INSTANT C - Interactive development - Edit. Source Debug, run. Edit to Run - 3 Secs. MSDOS \$445

"INTRODUCING C" - Interactive C to learn fast. 500 page tutorial. examples, graphics PC DOS \$ 95

Wizard C - Lattice C compatible, full sys. III syntax, lint included, fast, lib. source. MSDOS \$450

MSDOS C86-8087, reliable call

Lattice C - the standard call

Microsoft C 3.0 - new 279

Williams - debugger, fast call

CPM80 - EcoPlus C-faster, SLR 275

BDS C - solid value 125

MEGAMAX C - native Macintosh has fast compile, tight code, K&R. toolkit, .OBJ, DisASM MAC \$275

MACINTOSH Hippo II 375

Consulair's MAC C, toolkit 395

Compare. evaluate. consider other Cs

## C ADDONS

APPLICATION TOOLKIT by Shaw - Complete: ISAM, Screen, Overlay mgmt, report gen. Strings, String math. Source. CPM, MSDOS \$395

COMMUNICATIONS by Greenleaf (\$159) or Software horizons (\$139) includes Modem7, interrupts, etc. Source. Ask for Greenleaf demo.

C SHARP Realtime Toolkit-well supported, thorough, portable, objects, state sys. Source MANY \$600

CIndex + - full B+Tree, vari. length field. Source, no royal. MSDOS \$369

dbVista FILE SYSTEM - full indexing, plus optional record types, pointers. Source, no royal. MSDOS \$450

CHelper: DIFF, xref, more 86/80 135

CTree - source, no royal ALL 369

dBC ISAM by Lattice 8086 229

Greenleaf-200+ MSDOS 159

OTHER: C Utilities by Essential MSDOS 129

PHACT-up under UNIX, addons MSDOS 225

ProScreen - windows PC DOS 275

SCREEN: CURSES by Lattice PC DOS 125

Software Horizons - Blocks I PC DOS 139

Turbo V - Greenleaf C, fast PC DOS 159

Windows for C MSDOS 175

## FORTRAN LANGUAGE

MacFORTRAN - full '77, '66 option. toolbox, debugger, 128K or 512K. ASM-out option MAC \$375

RM/Fortran - Full '77. BIG ARRAYS. 8087, optimize, back trace, debug. MSDOS \$525

Ask about Microsoft, Supersoft, others.

MS FORTRAN-86 - Improved. MSDOS 239

DR Fortran-86 - full '77 8086 249

PolyFORTRAN-XREF, Xtract PC DOS 165

## LANGUAGE LIBRARIES

MultiHALO Graphics-Multiple video boards, printers, rich. Animation, engineering business. Any MS language, Lattice C86 \$195, for Turbo \$95.

Screen Sculptor - slick, thorough, fast, BASIC, PASCAL. PC DOS \$115

GRAPHMATIC - 3D. FTN, PAS PC DOS 125

File MGNT: BTRieve - all lang. MSDOS 215

Micro: SubMATH - FORTRAN full 86/80 250

MetaWINDOW - icons, cup PC DOS 139

PANEL - many lang. term MSDOS 249

## OTHER LANGUAGES

ASSEMBLER-ask about Turbo ASM (\$95), ED/ASM (\$95) - both are fast, compatible. or MASM (\$125), improvements.

BetterBASIC all RAM, modules. structure. BASICA - like PC DOS \$185

SNOBOL4+ -great for strings, patterns. CPM86, MSDOS \$ 85

MacASM - full, fast, tools MAC 115

Assembler & Tools - DRI 8086 159

PL1-86 8086 495

PCFORTH - well liked MSDOS 95

## SUPPORT PRODUCTS

PLINK - a program-independent overlay linker to 32 levels for all MS languages. C86 and Lattice. \$315

Multilink - Multitasking PC DOS 265

Pinish - Profile by routine MSDOS 345

Polylibrarian - thorough MSDOS 95

PolyMAKE PC DOS 95

ZAP Communications-VT100.

TEK 4010, full xter PC DOS 65

DEBUGGERS

Periscope Debugger - load after "bombs", symbolic, "Reset Box", 2 Screen, own 16K. PC DOS \$279

Advanced Trace 86 Symbolic PC DOS 149

Atron Debugger for Lattice PC DOS 395

CODESMITH-86 - debug PC DOS 129

PFIX-86 Debugger MSDOS 169

TRACE86 debugger ASM MSDOS 115

Call for a catalog, literature, and solid value

# 800-421-8006

## THE PROGRAMMER'S SHOP™

128-B Rockland Street, Hanover, MA 02339  
Mass: 800-442-8070 or 617-826-7531 8517

Note: All prices subject to change without notice. Mention this ad. Some prices are specials. Ask about COD and PDs. All format s available. UNIX is a trademark of Bell Labs.

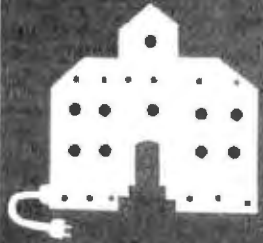

# C·O·M·P·U·T·I·N·G A·T· C·H·A·O·S· M·A·N·O·R

## The West Coast Computer Faire

Union Problems

PC-Write

Disk Maker I

Multiple Choice

EM-it

Color-400

SR-12

SuperKey

PC-MATLAB

Badges and Flowers

NaturalLink

BY JERRY POURNELLE

**T**he floors aren't in, there are painters and carpenters everywhere, and we're working off folding banquet tables for fear that they'll drip paint on the furniture. The storeroom is filled with equipment and boxes full of incoming software. Chaos Manor lives up to its reputation. Withal, we're upstairs at last, and it's wonderful.

### WEST COAST COMPUTER FAIRE

On the last weekend of March, I drove up to San Francisco for the Tenth West Coast Computer Faire. My taxes were due, and I was behind in deadlines; if I hadn't agreed to be a speaker, I probably wouldn't have gone this year.

This year the Faire was in the Moscone Center rather than Brooks Hall. Moscone is much larger than Brooks, so everything was on one floor. Even so, there was empty space. Of course, it wasn't as large as the 1983 Faire—the one that had Priority One and MicroPro out in the garbage area, and exhibits in the chair-storage room, otherwise known as the Black Hole of Calcutta—but it was about as big as last year. More important: the magic was still there. The Faire mixes hackers, publishers, vendors, dealers, and end users, and it is the only show where we all get together. I'm glad I went, and I liked it a lot—but I wonder if the Faire will survive.

The problem wasn't the new Prentice-Hall management. There were more than 100 first-rate speakers and panelists. More important, David Sudkin and his troops worked hard to give the smaller exhibitors—who are the real lifeblood of the Faire—a break. There were 60 minibooths, those postage-stamp-size affairs where many of the miracles we all take for granted now were introduced. When the smaller exhibitors had problems, David Sudkin paid attention. Alas, the problems were beyond his control.

San Francisco is a much unionized city. Moscone Center is a city-owned facility, and

the city politicians have signed contracts giving control of Moscone to the shop stewards, who miss no opportunity to gouge exhibitors no matter what their size or wealth. For example, all exhibit space must be carpeted. They'll rent you carpet at their prices. If you try to save money by bringing your own, you then have to pay for having it spread out for you—even if you lay it down yourself. Exhibitors weren't allowed to assemble booths or carry equipment.

This sort of thing was bad enough at Brooks Hall, but Jim Warren was able to cajole and wheedle. There's a different crowd at Moscone Center, one unwilling to listen to reason. As an example: Barry Workman brought up a copy machine and unloaded it himself. Every few minutes some guy stuck his head into the Workman booth and pointed to the copy machine. "You'll pay for that," he muttered. Other exhibitors who attempted to do any of their own work had similar harassments.

It seems counterproductive to me. The small companies simply can't afford to pay hundreds of dollars for work they can do themselves. They don't make that much from the Faire in the first place. Many larger companies, who don't sell anything at the Faire but used to come to show the flag, have decided they've had enough and won't go to the Faire or indeed to any other show in San Francisco. Surely San Francisco didn't invest all that money in the Moscone Center just to drive conventions to San Jose?

### CHOCOLATE BRIBERY . . .

One reason I enjoy the Faire is the chance to meet old friends like Walt Bilofsky. It's a bit odd. Walt's Software Toolworks is actually located no more than a mile from Chaos Manor, but the only time we see each other is at a Faire 400 miles north.

As usual, Walt had a bewildering line of CP/M, Zenith, and IBM PCompatible software: chess players, text editors, C compilers, an operating-system enhancement

(continued)

*Jerry Pournelle holds a doctorate in psychology and is a science-fiction writer who also earns a comfortable living writing about computers present and future.*

## Why I recommend Logitech's Modula-2

Logitech Modula-2™ combines many of the best features of both C and Pascal. My product Time Line™ contains over a million bytes of source code. It is fast and indisputably powerful. I estimate that it would have taken 20 to 50 percent more time to develop in C, and would not be as reliable. I anticipate half the maintenance costs using Logitech Modula-2. Six years ago I was recommending C for serious programming. Today, I recommend Logitech Modula-2.

  
Andrew Layman, San Francisco, Ca. Author of  
Time Line, a project management program

### Further comments:

**Access to the machine:** Logitech Modula-2 gives you direct access to the hardware.

**Speed:** Logitech Modula-2 compiles to native machine code.

**Strong Typing:** Catches many programming errors that would slip past a C compiler.

**Modularity:** It is very easy to insulate one part of a program from changes in another.

**Debugging:** Logitech provides you with a run-time and a post-mortem debugger. Both are symbolic, and show source code, call chains, variables, modules, and raw memory.

**Overlays:** Your main program can bring overlays into memory. You do not even have to decide in advance which overlays or their order.

**Version Control:** The compiler, linker and loader all check that version of modules, programs and overlays are consistent.

**Good Library:** Includes modules for file I/O, string handling, real number math, operating system access, screen and keyboard, and you can substitute your own.

Modula-2 from Logitech is the proven, professionally supported native code compiler and cross compiler for VAX™ and PC systems. For more information, call Christopher Cale at Logitech, 805 Veterans Blvd., Redwood City, CA 94063, (415) 365-9852. In Europe, call (41)(21) 77 45 45.

 LOGITECH

Logitech Modula-2—Logitech, Inc.; Time Line—Breakthrough Software Corporation; VAX—Digital Equipment Corporation.

## CHAOS MANOR

called C/NIX that's said to give CP/M systems a UNIX-like capability, and too much other stuff to mention. He also sells The Original Chocolate Byte, which is a thick chunk of excellent chocolate shaped like a 5¼-inch floppy; it comes in a reusable plastic disk box and makes a pretty good gift, except that if you're a chocolate addict like me, it won't last long enough to be given away.

The Software Toolworks catalog is full of good stuff at reasonable prices—none of it copy-protected—with a sensible copyright. "Copying this software or document for other than original purchaser's use is prohibited." If you don't have Walt's catalog, do yourself a favor and get one.

### MORE OLD FRIENDS

Bob Wallace was at the Faire. Bob pioneered the concept of *shareware* with his PC-Write text editor. It's a good editor, worth more than the 85 bucks he wants you to pay for it—especially now that he's added mail merge and some other features. Under the shareware concept, you don't have to pay \$85, though; you get PC-Write from Quicksoft for 10 bucks, or you get a copy from a friend for free. If you like it, you send \$75 to Quicksoft and become a registered user, which entitles you to a printed manual, telephone support, and update information. It also entitles you to a commission if you give a copy to anyone who subsequently sends in the registration fee.

The shareware concept seems to be working: Bob and his friends aren't getting rich, but they're paying the rent and making enough to keep improving PC-Write. I wish them well.

Another friend I seldom see except at the West Coast Computer Faire is Bruce Tonkin, who writes the most amazing programs in compiled BASIC. His MyWord! is a really neat text editor and word processor with features like list sorting and calculating that you won't find in some of the really expensive programs. He's constantly adding to MyWord!'s capabilities, and it will run on quite a few

machines, including just about all the PCCompatibles. He does other stuff, too, all at superlow prices.

Bruce shared exhibit space with Barry Workman, who bundles some of Tonkin's best programs into a set called The Software Essentials. In fact, Workman's booth did yeoman service: in addition to their own stuff (including WRITE, the CP/M text editor I'm using to write this), they had demonstrations of Disk Maker I from New Generation Systems, a system that will transform disks from just about any format to any other (we have one and we love it). Mycroft Laboratories, whose MITE communications programs have kept me in touch with the world these past several years, also gave demonstrations. While you're writing for catalogs, get Workman's.

Disk Maker I works so well that I seldom get a chance to review any other product. However, the chaps at Berkeley Software have added another dozen or so formats to what their XenoCopy software can handle, and while I haven't used it myself, people I trust swear by their stuff. If you have data-transformation problems—and who doesn't?—you might want to write for Berkeley's data sheets.

### A QUICK RUN-THROUGH

The problem with writing about the Faire is that there's too much to cover. I used to do a separate article about the Faire and still felt there wasn't enough room. That leaves me two choices: I can try to cover a few things well, or I can follow my instincts and say fewer words about more stuff. I've opted for the latter. Do understand the ground rules for show reports: I can describe what I've seen, but I make no guarantees. I think I can usually tell if I'm being fed a line, and I certainly won't favorably mention anything I have some reason to believe is flawed; but my opinions remain tentative about anything that hasn't been put through the wringer here at Chaos Manor. With that warning, we can get on with it.

One thing I have no trouble recom-

(continued)

*Imagine  
dBASE III™  
running up  
to 20 times  
faster.*

*The time  
for Clipper  
has arrived.*



## *Clipper introduces you to the time of your life.*

Time is your most valuable commodity. Because how you spend your time, is how you live your life.

At Nantucket, we believe you should live life to the fullest.

Clipper, the first true compiler for dBASE III™ is a timely example. Now, dBASE compiled by Clipper runs 2 to 20 times faster than dBASE with its standard interpreter.

A dBASE interpreter painstakingly checks and executes your source code one line at

a time, every time you run a program. With Clipper, once you've debugged your source code, it's compiled into more efficient machine code. Your program runs without the time-consuming overhead of redundant translation. Clipper compiles all your existing and future dBASE III programs.

Developing a compiler for dBASE III was just a matter of time. Call your dealer or our toll free 800 number and ask for Clipper.

Then go make the most of your life time.



NANTUCKET

mending is Rachel Holmen's *Truly Portable* (POB 2916, Oakland, CA 94609), which is an excellent 16-page newsletter about lapboard computers. It comes out 10 times a year, and a subscription is \$16. Anyone interested in lapboard machines—and especially anyone contemplating buying one—will find *Truly Portable* worth the invest-

ment; it has product information, reviews, programs, letters from users, and lots more.

I can also recommend Carl Landau's *Computer Language* magazine (131 Townsend St., San Francisco, CA 94107) for anyone interested in what's going on in the language world. This has become an important magazine for

hackers, and anyone seriously thinking about professional work in computer programming—or who wants to know what hackers are reading—will find it valuable. I'm not sure precisely how it happened, but *Computer Language* was partly designed on my kitchen table; my son Alex is a friend of the founders. Neither of us has any special relationship (or financial interest) with the magazine; I just find it interesting to read.

An award for sheer persistence should go to Ken Snapp of Beta Tools Systems. He has been sending me his BASIC Development System for six months; I must have received a dozen copies. This time he handed me one in person.

The BASIC Development System is a set of tools to use when writing programs in BASIC for PCompatibles. (Due to the way IBM implemented BASICA, there are separate versions of the BASIC Development System for PCs and PCompatibles. Note also that you must have your own copy of BASICA or GW-BASIC.)

This looks like something I'll use; the manual seems clear enough, and the features—cross-referencing, trace, dynamic dumps of variable values, selective renumbering, and compression/expansion—certainly ought to make it easier to write BASIC programs. Indeed, I have a good bit of BASIC programming to do (I have to work on Mrs. Pournelle's reading program); alas, what with the reconstruction of Chaos Manor, I haven't written a line of BASIC (or any other kind of code) for months, which is why I've done no more with the BASIC Development System than look at the manual. I'd be astonished if it didn't work as claimed, though: why in the world would anyone so persistently work at getting me to try something that wasn't pretty well debugged? Anyway, I'll know soon enough: Mrs. Pournelle is increasingly impatient to have her program finished.

**POOR MAN'S TOPVIEW**

Jason Loveman, who left Digital Research to found a company called

(continued)

**Thinking of...  
8087, High-Speed  
Math Support?**

**THINK  
C-86 OPTIMIZING C86 FROM  
COMPUTER INNOVATIONS**

The 8087/80287 Math Co-processor chips provide a major leap in the computing capability of the IBM family of personal computers. The fast, accurate, math computational ability provided by these chips not only speeds typical applications but opens a range of applications once reserved exclusively for mini and mainframe systems. The key question is HOW CAN THE C PROGRAMMER TAKE ADVANTAGE OF THE 8087/80287's capabilities? The answer is C86 by Computer Innovations.

**EXECUTION SPEED, ACCURACY, IN-LINE CODE**  
C86 has offered the highest level of 8087/80287 support since the chips became available. Specialized libraries make program development a snap. A math function library provides full trig, log and a wide variety of other functions. But most important, C86 produces **IN-LINE** code. This means that math functions can be performed by the co-processor in immediate succession **WITHOUT** separate subroutine calls. This eliminates library call "overhead" and results in the highest execution speed attainable.

**LIBRARY SOURCE PROVIDES CONFIDENCE - CONTROL**  
Library Source Code is **INCLUDED**. - It always has been with C86. This means you have total control over your development environment, and total control means better and faster code.

**TECH SUPPORT - GET INTO 8087/80287 PAINLESSLY**  
Computer Innovations' experienced tech support team is available to get you through the rough spots and provide the assistance/advice/expertise required to get you into 8087/80287 quickly and efficiently. Plus you can take advantage of Computer Innovations' user newsletter, technical notes, and On-Line bulletin board. No other Compiler offers more.

**CALL FOR FREE BULLETIN**  
To receive Computer Innovations' free bulletin entitled "How C86 Takes Advantage of Intel 8087/80287 Math Co-processors," or for more information about C86 Call:

800-922-0169



**COMPUTER  
INNOVATIONS, INC.**

980 Shrewsbury Avenue,  
Tinton Falls, NJ 07724 (201) 542-5920

C86 for all PC-MSDOS computers. \$395.00. Visa, Mastercard, personal check and corporate PO's accepted.



# THE SIMPLE APPROACH IS THE SYMBOL APPROACH.

```
10 S=0
20 FOR I=1 TO 100
30 INPUT X
40 IF X = 0 GOTO 70
50 S=S+X
60 NEXT I
70 PRINT S/(I-1)
```

## BASIC

*A program to calculate averages...*

```
REAL X(100)
READ*,N,(X(I),I=1,N)
S=0
DO 10 I=1,N
10 S=S+X(I)
PRINT *,S/N
END
```

## FORTRAN

*just shrunk from seven lines...*

$(+ / X) + pX \leftarrow \square$

## POCKET APL

*to one.*

## INTRODUCING POCKET APL™

Pocket APL, a new PLUS★WARE™ product, symbolizes a whole new way to solve problems. Faster than Fortran. Simpler than Basic. And at a cost much less than Cobol and many other programming languages. Its use of symbols makes it concise and efficient—powerful and productive.

### WORKING IN SHORTHAND = WORKING FASTER, SMARTER.

Pocket APL allows you to shrink the length of your programs. Because just a few symbols say what takes lines and lines to say in other programming languages. So Pocket APL cuts the drudgery and need for tedious sub-routines and long lists of commands.

### GET FLEXIBILITY > WITH CANNED SOFTWARE.

Pocket APL is a complete APL implementation with enhancements like online HELP, windowing, report formatting, dual file system, and debugging aids. It's also a powerful online calculator. So you don't have

to switch back and forth between programs or from your hand-held calculator to the computer.

And the symbols? Simple. You'll learn them fast. They'll become as second nature to you as +, -, ×, and ÷. Once you start using them, you'll be programming four to 10 times faster than with conventional languages. And as your needs grow, you can easily upgrade to STSC's APL★PLUS®/PC

System for even more features—like communications and graphics.

### POCKET APL COSTS MUCH < YOU'D EXPECT.

Pocket APL makes programming easy. And priced at just \$95, it's easy on the budget, too. It works with IBM PC's and compatibles and requires only 128K. So if problem-solving is taking up too much of your time, the answer is symbol. Pocket APL.

To order, or for more information, call 800-592-0050. In Maryland, call (301) 984-5123.

Or write STSC, Inc., 2115 East Jefferson St., Rockville, MD 20852. All major credit cards accepted.

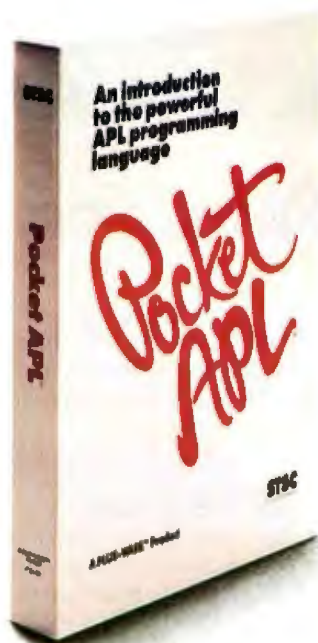

**Problem-solving at the speed of thought.**

**STSC**  
A Coritel Company

Pocket APL uses a soft character set for computers with IBM-compatible graphics board or color monitor; keywords for computers with monochrome. Optional character generating ROM can be ordered for IBM PC monochromes or Hercules monochrome boards.

PLUS★WARE and Pocket APL are trademarks of STSC, Inc. APL★PLUS is a service mark and trademark of STSC, Inc., registered in the U.S. Patent and Trademark Office and in other countries.

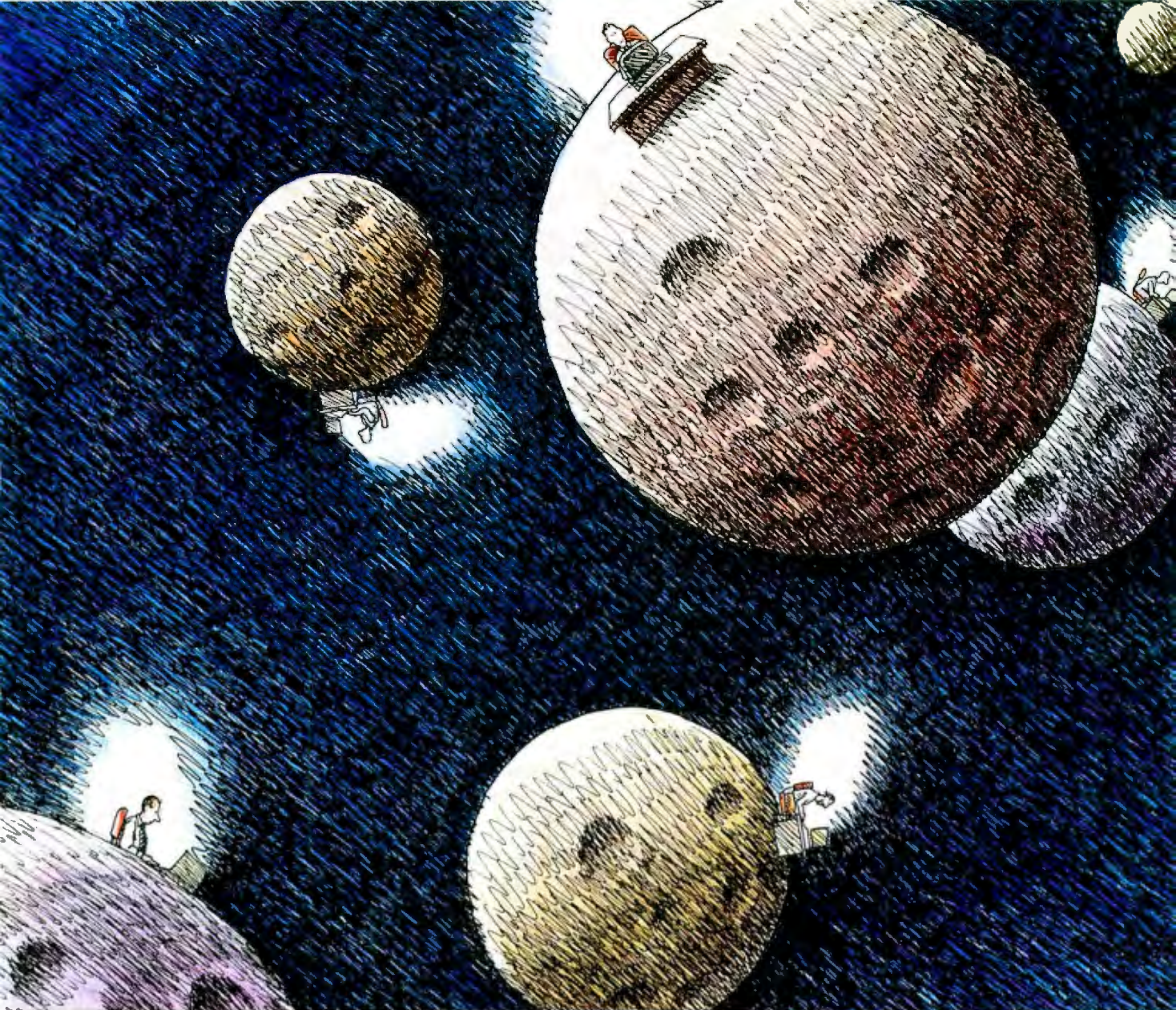

## With Network Revelation<sup>®</sup>, you're not alone.

Span the void that separates you from other PC's. Be as one with a universe of data. Be a true network with Network Revelation<sup>®</sup>.

Network Revelation is more than a relational database management system. It's a complete applications environment for most microcomputer networks. That's not dreaming about the future. It's low-key raving about a capability of the present.

With Network Revelation, you can send and receive data on local area networks and remote file servers. Rev's data dictionaries let you add or restruct-

ture fields at will, saving ages of programming time. And our menu-driven applications generator and procedural language are eons ahead of other databases.

The possibilities are infinite. Distributed processing systems linking worlds. Accounting, inventory and order entry systems connected for instant access to data by a galaxy of users. And your data is secure with complete file or record locking.

REVELATION co-exists with MS-DOS<sup>™</sup>. So you can transport Lotus 1-2-3<sup>™</sup>, Multiplan<sup>®</sup> or other data from

PC to PC—using popular routes like Novell, Ethernet or 3 Com<sup>™</sup>. You can even evolve files from primitive, single-user databases into a powerful Rev application.

Encounter the future of distributed data processing today. Revelation costs just \$950.00\* Network Revelation starts at only \$1495.00\* for a complete four-user system. So call us and we'll arrange for an unforgettable demonstration with a Cosmos rep in your area.

MS<sup>™</sup> and Multiplan<sup>®</sup> of Microsoft Corporation. 1-2-3<sup>™</sup> of Lotus Development Corporation. 3 Com<sup>™</sup> of 3 Com Corporation.

\*Suggested U.S. list price.

Cosmos, Inc., 19530 Pacific Highway S.

# COSMOS<sup>™</sup>

Seattle, WA 98188, 206-824-9942

## CHAOS MANOR

Awesome Technology (yeah, I know), brought around a PC-DOS program called Multiple Choice, also billed as Poor Man's TopView. This program makes three computers out of your PC or PCompatible. That is, you run the program. It puts 4K bytes of code up in high memory. Now you enter Control 1, Control 2, or Control 3, and you're in job 1, 2, or 3. It works invisibly, and we've run it with the IBM PC with the Orchid Pcturbo 186 board, as well as with the Zenith Z-150 and Z-160 PClones. It's compatible with SideKick. I've got it here at Chaos Manor (I'm running it now on the Z-160), and it works fine. For \$64 you can have WordStar, DOS, and Lotus 1-2-3 running all at the same time (with SideKick in the background already yet). Who needs Symphony? Recommended.

### YET ANOTHER EMACS

Another minibooth featured EM-it, an EMACS imitator. EMACS is the macro editor written at MIT by Richard M. Stallman (otherwise known as RMS). EMACS was one of the very first full-screen editors in existence. I recall several long-distance debates (I have an account on one of MIT's large computers) with RMS over the virtues of EMACS versus Electric Pencil, which was the editor I was using at the time. The debates were futile, of course: Pencil and WRITE (derived from Pencil) were *much* better editors for creative writing, but EMACS was far and away better for programming, and indeed it became a bit of a legend among hackers.

Stallman, who believes software ought to be available to everyone, put EMACS in the public domain instead of getting rich from it. The chaps at Sayansi have implemented it for PCompatibles and sell their version for \$49.95, a reasonable price. Needless to say, it's not copy-protected. It's also not full EMACS. One of the main features of EMACS is its extensibility: you can add nearly any feature you might want from right inside the editor. EM-it can't do that, but it does

(continued)

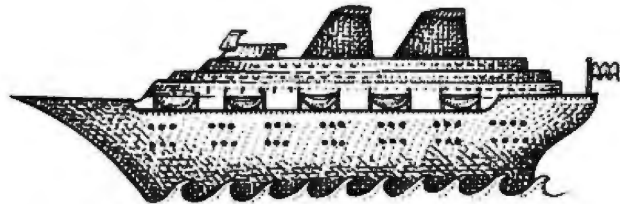

M2SDS

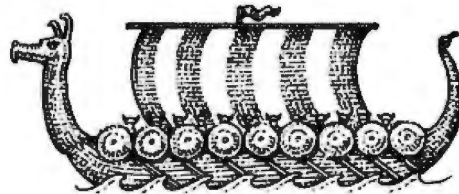

TURBO PASCAL™

Now that there's the Modula-2 Software Development System (M2SDS), Turbo Pascal is all washed up. But you're not. Because Modula-2 is like Pascal. So you can launch into greater programming efficiency head-first. It's an easy-to-learn language. In an easy-to-use system. At a price that's easy to swallow. Just \$80.88. Join the new wave of programming efficiency. Order today.

1-800-922-9049 (In Texas, call 713/523-8422.)

Checks, MasterCard, VISA, American Express accepted. Shipping & handling not included. In Texas add sales tax. International orders add \$30. Turbo Pascal is a trademark of Borland International.

**INTERFACE  
TECHNOLOGIES**

3336 Richmond Ave., Suite 200  
Houston, Texas 77098

**IBM AT THE OFFICE  
APPLE AT HOME**

**NO PROBLEM!**

A "Wireless file transfer" package for the IBM PC® to Apple II and back. **APPLE TURNOVER™** is a firmware board which fits into any slot in the IBM PC and some compatibles. NO modems, NO serial links, NO hassles, NO problems. **APPLE TURNOVER™** will format Apple CP/M® and Apple DOS 3.3 disks. Leave your IBM and Apple computers where they are. Simply bring your Apple disk to work and transfer your file to a PC-DOS disk. Allows for modifications to text and data files. It's a simple, inexpensive, high performance alternative to complicated serial links and modems.

"NEW!" **APPLE TURNOVER™** version 2.0 will read, write and format PRO-DOS and Apple P-System Too.

See your dealer or call  
for information:

**(213) 938-0857**

**Vertex  
systems inc.**

Innovation in microcomputer products 6022 W. Pico Blvd., Los Angeles, CA 90035

You would think when IBM needs EPROM Programmiers they would choose the best and the most expensive.

They don't. They only choose the best. GTEK.



MODEL 7956 (w/RS-232 option) ..... \$1099  
MODEL 7956 (stand alone) ..... \$ 979

GTEK's outstanding Gang Programmer with intelligent algorithm can copy 8 EPROMS at a time! Use the 7956 in a production environment when you need to program a large number of chips. Programs all popular chips through the 27512 EPROMS; supports CMOS EPROMS through the 27C256; supports EEPROMS through the X2864A; supports Intel's 2764A & 27128A chips. The 7956 will also program single chip processors.

MODEL 7228 ..... \$ 599

GTEK's 7228 has all the features of the 7128, plus Intelligent Programming Algorithms! It supports the newest devices available through 512K bits. The 7228 programs 6 times as fast as standard algorithms. It programs the 2764 in one minute! Supports CMOS EPROMS through the 27C256; supports EEPROMS through the X2864A; supports Intel's 2764A & 27128A chips. Supports Tektronics, Intel, Motorola and other formats.



MODEL 7324 ..... \$1499

The 7324 has a built-in compiler. It programs all MMI, National and TI 20 & 24 pin PALS. It has non-volatile memory and operates stand-alone or via RS-232.

MODEL 7322 ..... \$1249

Same as Model 7324 but operates only via RS-232.

MODEL 7316 ..... \$ 749

This PAL PROGRAMMER programs Series 20 PALS. It has a built-in PALASM compiler.

MODEL 7283 ..... \$1199

This BI-POLAR PROM PROGRAMMER programs all popular BI-POLAR PROMS. It operates stand-alone (for production) or RS-232 (for development).

MODEL 705 ..... \$ 299

68705V3, R3, P3 PROGRAMMER.

## EPROM, PROM & PAL PROGRAMMERS

— These features are standard from GTEK —

Compatible with all RS-232 serial interface ports • Auto select baud rate • With or without hand-shaking • Bidirectional Xon/Xoff • CTS/DTR supported • Read pin compatible ROMS • No personality modules • Intel, Motorola, MCS86 Hex formats • Split facility for 16 bit data paths • Read program, formatted list commands • Interrupt driven—program and verify real time while sending data • Program single byte block or whole EPROM • Intelligent diagnostics discern bad and/or unerased EPROM • Verify erasure and compare commands • Busy light • Complete with Textool zero insertion force socket and integral 120 VAC power (240 VAC/50Hz available) •

## UTILITY PACKAGES

GTEK's PGX Utility Packages will allow you to specify a range of addresses to send to the programmer, verify erasure and/or set the EPROM type. The PGX Utility Package includes GHX, a utility used to generate an Intel HEX file.

PALX Utility Package—for use with GTEK's Pal Programmers—allows transfer of PALASM\* source file or ASCII HEX object code file.

Both utility packages are available for CPM\*, MS-DOS\*, PC-DOS\*, ISIS\* and TRSDOS\* operating systems. Call for pricing.

## CROSS ASSEMBLERS

These assemblers are available to handle the 8748, 8751, Z8, 6502, 68X and other microprocessors. They are available for CPM and MS-DOS computers. When ordering, please specify processor and computer types.

## ACCESSORIES

Model 7128-L1, L2, L2A

(OEM Quantity) \$259.

Model 7128-24 ..... \$329.

Cross Assemblers CPM-80 ..... \$200.

MSDOS; CPM 86 ..... \$250.

PGX Utilities ..... Call for pricing

PALX ..... Call for pricing

Erasers ..... DE4 \$80; PE14T \$129

C25 \$349; C50 \$599

U/V Eraser DE-4 ..... \$ 80.

RS-232 Cables ..... \$ 30.

8751 Adapter ..... \$174.

8755 Adapter ..... \$135.

48 Family Adapter ..... \$ 98.

# GTEK

Development Hardware/Software  
P.O. Box 289, Waveland, MS 39576  
601/467-8048; telex 315-814 (GTEK UD)  
, INC.

GTEK, PALASM, CPM, MS-DOS, PC-DOS, ISIS, TRSDOS, & CPEmulator are registered trademarks.

"All you CPM people who wanted to move to IBM, but couldn't... now you can — and bring your CPM software with you!"

From GTEK, the leader in development hardware and software, comes the CPM user's dream.

The majority of advances being made in the computer industry today are being made for PC-DOS and MS-DOS machines.

If you are a CPM user who wanted to convert to these operating systems but didn't because you had to abandon or rewrite your CPM programs, now you can make your move without losing or rewriting a single program!

The dream from GTEK is a package that makes your PC-DOS (IBM PC, XT, AT) or MS-DOS (IBM clones like COMPAQ, Leading Edge, Televideo) machines think they're being run by an 8080 or Z80 microprocessor with CPM!

The GTEK package contains a CPEmulator™ and CPM Conversion Utility that allows you to read and write popular CPM disk formats such as Kaypro and Osborne.

How easy is it to use? Two steps. (1) Use the Conversion Utility to copy the CPM program to an MS-DOS or PC-DOS diskette. (2) Use the Bind Utility to attach the CPEmulator to your program. And that's it. It's ready to run.

You won't see any difference when you run the CPM program! Now all the work you did in CPM is still valuable when you change to your PC-DOS or MS-DOS machine.

And here's the happy ending to the dream. The CPEmulator is just \$199.

Call GTEK's CPM Hotline...  
1-601-467-9019

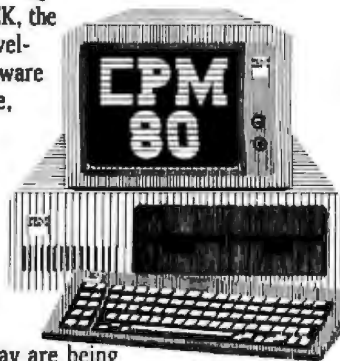

If you've been using CPM on any of these machines you can now move to PC-DOS or MS-DOS operating systems.

Kaypro • Osborne • Heath/Zenith • Radio Shack • Epson • DEC • IBM • Morrow • Xerox • HP • Sanyo • Intertec • Cromenco • Televideo • Compupro.

have some impressive macro capabilities. I saw it run on a PCompatible, and it looked very EMACS-like to me.

FORMIT from Emerald City Software is a text-formatting program that works something like WRITE does. That is: WordStar, and many other text editors, print on a "what you see is what you get" basis. This is fine for letters but not so hot for complex documents—and a decided nuisance for very simple things like manuscripts. WRITE has a number of "dot" commands (the command is given by starting a new line with a period, something you never do in ordinary English) that tell the program what I want done with the line. For example, .ce3 means center the next three lines, .pw65 means make the lines 65 characters wide (on average if we're doing right justification), etc.

FORMIT works the same way. It has a rich command structure and works with Epson dot-matrix printers. The authors claim they're continually adding other printers it will work with and that they're at work on "full, font-level support for all smart printers."

FORMIT is *freeware*; that is, you can have a copy free (it's available on bulletin boards, or by sending a formatted disk with return postage to the authors, or from anyone who has a copy), but you're expected to pay \$15 if you use it. Fair warning: FORMIT is intended for users willing to pay attention and do a bit of experimenting. The manual (which is on disk—you print it out yourself) is complete enough, but the nature of the program requires you to do a bit of thinking. FORMIT requires an IBM PC or a generic MS-DOS machine with at least 128K bytes. Recommended for those who don't have a text formatter; it's sure easier to use this than to go through a document making changes.

### CHECKS AND BALANCES

My friend and colleague David Gerrold was at the Faire, but I didn't see much of him. He did hand me a copy of a program called Checks and Balances, which was written by a

(continued)

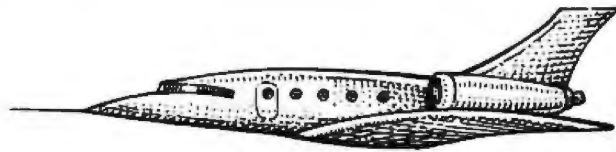

M2SDS

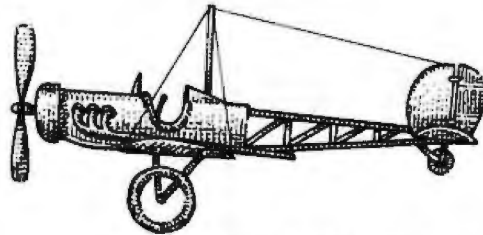

TURBO PASCAL

Now that there's the Modula-2 Software Development System (M2SDS), Turbo Pascal has been grounded. Because Modula-2 is the language that lets programming efficiency soar to new heights. You know Pascal. So you can take off and use Modula-2 right away. It's an easy-to-learn language. In an easy-to-use system. Priced at a low \$80.88. Send your programming efficiency flying. Order today.

1-800-922-9049 (In Texas, call 713/523-8422.)

Checks, MasterCard, VISA, American Express accepted. Shipping & handling not included. In Texas add sales tax. Internet orders add \$30. Turbo Pascal is a trademark of Borland International.

**INTERFACE  
TECHNOLOGIES**

3336 Richmond Ave., Suite 200  
Houston, Texas 77098

## Computers For The Blind

**Talking computers give blind and visually impaired people access to electronic information. The question is how and how much?**

**The answers can be found in "The Second Beginner's Guide to Personal Computers for the Blind and Visually Impaired" published by the National Braille Press. This comprehensive book contains a Buyer's Guide to talking microcomputers and large print display processors. More importantly it includes reviews, written by blind users, of software that works with speech.**

Send orders to:

**National Braille Press Inc., 88 St. Stephen Street  
Boston, MA 02115, (617) 266-6160**

NBP is a nonprofit braille printing and publishing house.

# Store this in your memory: buy two packs of Xerox Floppy Diskettes and get one pack free.

It's true. When you buy two packs of our new 3½" micro diskettes or selected 5¼" diskettes, you'll receive an additional pack absolutely free.\* It's our way of introducing you to our superior new floppies.

Try them out on your IBM-PC, PC-AT, Macintosh, Compaq, AT&T, ITT, Olivetti, HP or on our own PC's and word processors. You'll see how superior they are, both in quality and performance. And they're packed in a durable library case as well.

To get your free diskettes (or for more information) simply call 1-800-822-2200 Dept. 20 and order any of the items specified below:

- 11R66003: 5¼" double-sided/double density diskettes (10 per pack) for your IBM-PC or IBM-compatible PC
- 8R2467: 5¼" high density diskettes (10 per pack) for your IBM-AT
- 8R2466: 3½" single-sided micro diskettes (5 per pack) for your Apple Macintosh



This offer ends December 31, 1985 and is limited to five free packs per customer.

So remember, call 1-800-822-2200 Dept. 20 and order your free diskettes today. That's a pretty memorable offer!

\*Your free pack will be of comparable or lesser value than the two you purchase. XEROX® is a trademark of XEROX CORPORATION.



## CHAOS MANOR

friend of his. As the name implies, it gives checkbook balances; but it does a lot more than that. Indeed, it seems to be a pretty fair accounting program. It has room for 64 categories of income or expense entries; things like "Income from books" or "Utilities." Each of these would then be a ledger page. Alas, I have more than 225 pages in my chart of accounts, so I'm not too likely to have a use for it; but someone with simpler requirements would probably like it. I guarantee this program is easier to set up than my accounting program is.

### REAL BARGAINS

A few readers have sent letters wondering why I mention Workman and Associates as often as I do. It's simple enough, and it has nothing to do with friendship. They put out real bargains. As an example: Disk One in the new PC version of the Software Anthology Series. This disk is *crammed* with routines to defeat copy protection, recover lost data, set up special batch files, and generally make life simpler for PC-DOS and MS-DOS users. Some of the software is free-ware for which Workman has bought an unlimited-distribution license. Some is public-domain stuff gathered from bulletin boards and users groups. It would take a while to assemble this much software, and if you were doing it yourself, you'd still have to figure out what works and what doesn't. As with Workman's CP/M Software Anthology disks, there are several programs each worth more than he charges for the disk: I know, because I use the stuff all the time.

### WONDERFUL WORLD OF COLOR

There was a time when the West Coast Computer Faire was the place to announce new hardware. I recall startling new stuff introduced at the Faire by CompuPro (now Viasyn), Sage (now Stride), Osborne (now recovering from Chapter 11), Fortune 32 (now—oh, well), and others. There wasn't anything like that this year (or if so I missed it). There was, however,

*(continued)*

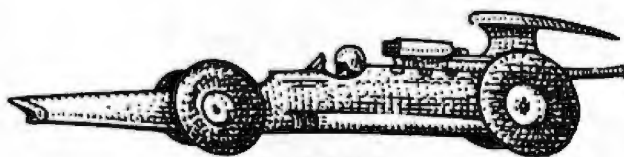

M2SDS

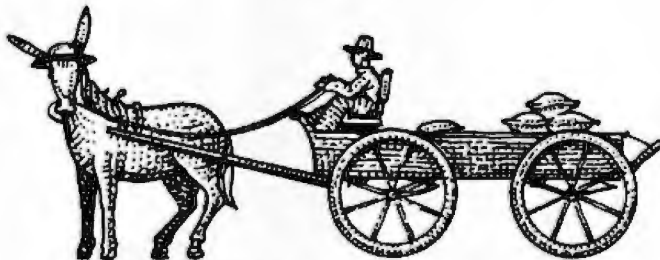

TURBO PASCAL™

Programming efficiency? The Modula-2 Software Development System (M2SDS) leaves Turbo Pascal in the dust. Even the learning curve won't slow you down. Because the language is like Pascal. Only better. M2SDS has a price that's tough to beat, too. Just \$80.88. Pick up your programming speed. Order today.

1-800-922-9049 (In Texas, call 713/523-8422.)

*Checks, MasterCard, VISA, American Express accepted. Shipping & handling not included. In Texas add sales tax. International orders add \$30. Turbo Pascal is a trademark of Borland International.*

**INTERFACE  
TECHNOLOGIES**

3336 Richmond Ave., Suite 200  
Houston, Texas 77098

**The right  
place at the  
right price.**

**Make reservations at any  
Best Western, see your  
travel agent, or call  
1-800-528-1234.**



**Best  
Western®**

**WORLDWIDE  
LODGING**

"World's largest chain of independently owned and operated hotels, motor inns, and resorts"

©1985 Best Western International

# THE GRIZZLY™ MAKES BLACKOUTS BEARABLE.



## No one can hold a candle to The GRIZZLY.™

It's the one Backup Power Supply System that gives your hardware, software and data complete protection against blackouts, brown-outs and power sags as well as surges.

When your power goes down, the advanced VRS technology of The GRIZZLY™ provides an instant switchover to battery backup, while it warns you with an audible alarm, giving you ample time to calmly shut down your computer

system to avoid damage or critical data loss. Even momentary voltage fluctuations, which constantly occur, are tamed by The GRIZZLY. The Pulse Width Modulated, regulated output is your assurance that you receive constant, stable, clean power.

The GRIZZLY VRS, available in 200W, 300W, 500W, 1000W and 2000W models. Each tested for complete reliability and designed for ease of use. Just plug it into

any standard three-wire grounded outlet, switch it on and you have all the power of the king of the forest.

*DON'T BE OUT IN WOODS WITHOUT US!*



P.O. Box 487, Stoneham, MA 02180  
(617) 279-0424 • 1-800-343-1813



a lot of stuff that was new to me.

The most impressive was a combination: the Sigma Designs Color-400 PC graphics board and the SR-12 color monitor by Princeton Graphics. The SR-12 has 640- by 400-pixel resolution that's steady as a rock; and the Color-400 board drops invisibly into the PC to give monochrome quality to color software. I stood there and stared: text is as crisp and steady as if painted on the screen, good enough to write with hour after hour.

I've arranged to get both the SR-12 and the Color-400. The SR-12 gets hooked up to a video switch so we can compare the Color-400 to our new CompuPro PC Video board that goes in our big CompuPro S-100 80286/Z80 system. Princeton also has the MAX-12, a crisp amber-screen monitor that knows whether it's being fed input from a PC monochrome or PC color board and adjusts accordingly, and other impressive monitors I hadn't seen before. I'm told by people I respect a lot that Princeton Graphics has long had the reputation for being among the very best in its field, and they're astonished I didn't know that; which just goes to show . . . or something. I can plead that because I wear bifocals I tend to prefer 15-inch monitors, but in fact it's plain that neither I nor anyone else can keep up with this wonderful kaleidoscope we call the micro revolution.

**BORLAND'S SUPERKEY**

The saga of Philippe Kahn's Borland International is a graphic illustration of the plus side of the history of the micro revolution. Two years ago Borland wasn't at the Faire at all. Last year they hurriedly put together an exhibit. This year they had as large a presence as anyone except IBM and AT&T.

Borland introduced SuperKey, their new keyboard macro package that does just about everything my former favorite, Magic Keyboard, did, plus a bit more. I'll miss Magic Keyboard's toggle to PC graphics characters, but SuperKey is more versatile—and of course it's guaranteed to work with

the indispensable SideKick. I don't run many PC programs that won't work with SideKick.

Borland now has Turbo Pascal 3.0, a distinct improvement on the already impressive version 2. I particularly like Borland's new licensing agreement: treat the software like a book, which is to say, make all the copies you want but don't have more than one copy in use at any given time. This seems quite fair to me.

The Turbo manual isn't quite good enough to learn Pascal with no other aid, but it's close. There are lots of examples, and the whole thing is written in good English. Turbo Pascal has got to be the best value in languages on the market today—and Borland International, by delivering excellent products at reasonable costs, is leading the software industry where it has to go.

I've said this before. In my judgment, the \$500 program is a dinosaur. One reason for this is Borland: Turbo Pascal is more than just a good program at a low cost. It's also a low-cost, well-conceived programming language making it possible for lots of people to produce good programs.

**LAPLACE**

One example: LaPlace, by P. L. Hagelstein, is a program written in Turbo Pascal. It's hardly a slick item: it took me five minutes of hard work to find the name and address of the publisher! It's nowhere given on the instruction sheets and given in only one place in the program display.

LaPlace is a program for calculating and displaying potential fields. To quote its manual: "LaPlace solves the Laplace, Poisson, and inhomogeneous Poisson equations in 2-D through numerical finite element methods. The matrix equations resulting from the finite element analysis are solved using the fast incomplete Cholesky conjugate gradient technique, which allows problems with 1000 nodes to be solved in less than 10 minutes."

That's specialized stuff. I doubt any commercial software house would develop something like that—but it's the

(continued)

# SAVE MONEY

with Flexforms.

*Flexforms are pre-written, ready to use contracts, agreements and letters designed to save your company time and money. Flexforms work with any word processor. You literally "fill in the blanks" and create customized, professional and legally-binding documents for every situation.*

*Each of the forms can be quickly tailored to suit your individual needs without wading through confusing manuals.*

*Flexforms help protect your legal rights, avoid tax problems, dramatically improve efficiency, increase profits and eliminate costly misunderstandings.*

Four Popular Series:

## BUSINESS

*Ideal for expanding businesses:*

*Employee Agreements & Letters, Credit & Collection Letters, Subcontractor Agreements, Lease Forms & Amendments, Buying & Selling Forms, Credit Forms & Applications, Guaranties, Loan & Debt Notices & Letters, Assignments & Transfers, Affidavits & Notices, Promissory Notes & 83 more!*

## REAL ESTATE

*Designed for investors, developers, and property managers:*

*Residential & Commercial Forms, Purchase & Sales Forms, Broker & Agent Contracts & Forms, Partnership Agreements, Rental Forms, Lease Forms, Tenancy Agreements & Applications, Illegal Detainer Forms, Loan Agreements, Financing Agreements, Exchange Forms & Contracts, Disclaimers & Disclosures, Contractor Agreements and 75 more!*

## CORPORATE

*Exceeds State and Federal Corporate Law requirements:*

*Articles of Incorporation, Shareholder & Director Meeting Minutes, Corporate By-Laws, By-Law Amendments, Shareholder & Director Resolutions, Merger Resolutions, Compensation Resolutions, Dividend Resolutions, Loan Resolutions, Fringe Benefit Resolutions, Employee Benefit Resolutions and 86 more!*

## PERSONNEL

*Created for growing organizations:*

*Personnel Policy Manual, Employee Safety Manual, Employment Agreements & Applications, Secrecy & Invention Forms, Confidentiality Agreements, Non-Compete Agreements, 25 Job Descriptions, Consultant Agreements, Agency Agreements, Personnel Letters, Performance Reviews and 25 more!*

*Flexforms have been prepared under legal counsel. Unlike forms written by lawyers for lawyers, they are concise and easy to understand without needless legalese. Available in IBM and Apple disk formats.*

*Each series only*

# \$49.95

*(plus \$5 shipping), includes hard copy. All four for \$175 and we pay the shipping! Visa and Mastercard accepted. Inquiry 25*

**Atkins Associates**  
**P.O. Box 781 • Santa Cruz, CA 95061**  
**(408) 426-7638**

• PLUS • PLUS • PLUS • PLUS •



• PLUS • PLUS • PLUS • PLUS

## PRODUCE STUDIO-QUALITY TRUE-COLOR PICTURES ON YOUR PC



Now you can create and edit studio-quality pictures on your IBM\* PC or compatible computer with the IMiGIT PLUS™ color system.

Anything a video camera can see — people, products, scenery and artwork — can be computerized in 256 colors using the IMiGIT PLUS color system. Pictures are captured and displayed in their original “true color” so you do not have to spend hours recoloring to attain a “real-life look”. Images can be enhanced with text, line art and other graphics for business presentations, art studio, education, engineering, architecture and television applications.

### Professional Quality — Special Effects

Pictures are captured at a resolution of 512 x 512 x 256 colors selectable from a 16 million color palette. Captured images can be modified with editing tools such as: multi-font annotation, line and freehand drawing, filled and unfilled boxes and

circles, texturing, color fill, curve fitting and rubberstamping. A cut and paste feature allows “cut art”, previously saved to disk as picture sections, to be recalled and overlaid on the display. This editing sophistication lets you create complex graphics as well as dramatic and illusionary special effects.

### Designed for the User

The IMiGIT PLUS color system is easy-to-use and versatile. Completely icon-driven, you can quickly learn to master the powerful editing tools. Also, you can select the various editing commands using the keyboard, popular mouse devices or digitizing tablets. Captured color pictures can be displayed for editing, saved and retrieved from disk, printed, and recorded on 35mm slides for professional presentations.

IMiGIT PLUS is available as a hardware/software combination, an add-on system, and as a complete IBM AT graphic workstation. The software and PC-EYE color capture board are priced at \$1,295. The IMiGIT PLUS system includes a color camera, RGB monitor, graphics adapter, software/hardware package with expansion chassis priced at \$9,500. The workstation is priced at \$18,000 and includes an IBM AT with 20MB disk, IMiGIT PLUS software, PC-EYE™ capture board, Colorverter™, graphics display card, digitizing tablet, color camera/accessories, and a high resolution RGB analog monitor.

**For more information on IMiGIT PLUS or our other imaging products for applications in data base management, communications and image capture, please write or call 1-800-OCHORUS or 603-424-2900.**

Inquiry 53

TM: IMiGIT PLUS, Colorverter and PC-EYE are trademarks of Chorus Data Systems, Inc.

\*: IBM is a trademark of International Business Machines

# CHORUS

kind of thing that if you need it, you need it bad. I intend to use LaPlace to play about with gravitational fields made complicated by the presence of small black holes. I expect a more conventional use would be in fluid dynamics or electrostatics.

Obviously I'm not competent to say whether or not LaPlace gives the right answers. The diagrams and displays look right, and there's a very extensive manual: the computer parts are in baby talk. The rest is written for people who understand inhomogeneous Poisson equations.

**MATRICES**

Another specialized program, PC-MATLAB from The Math Works, does just about anything you might want done with matrices: addition, multiplication, inversion, eigenvalues, and the like, and by making use of the 8087 coprocessor available in most PC-compatibles, does it *fast*. I'm going to have to come up with a different "benchmark of sorts": the one I devised a couple of years ago is performed by PC-MATLAB so fast that I can't time it.

Matrix operations are important to anyone trying to do multiple regression analysis, stationary time series, factor analysis, operations research, and just about any other kind of statistical prediction. Over the past few years a program called MATLAB has become a sort of standard for doing matrix operations on mainframe computers. Now it's available for a PC (but only one with an 8087 math chip).

PC-MATLAB comes with a rather complete manual. It's plenty easy to install and use, provided that you understand something about matrix operations to begin with. Matrices are input rather simply. A = [1 2 3; 4.1 5.6 6.7; 7 8 9] enters the 3 by 3 matrix

```
1 2 3
4.1 5.6 6.7
7 8 9
```

and, mercifully, the entries are put into a file that can be edited with a normal full-screen text editor, so that if you have a data-entry mistake, you don't have to input the whole matrix again.

I've found matrix math both interesting and useful since my days at the University of Washington, when Paul Horst taught us to apply matrix algebra to such problems as grade prediction. Matrices are very powerful tools; the only problem is the horrendous amount of arithmetical calculations required. One of the nice

things about small computers is that they make it simple. Anyone wanting to understand the world would be better off for mucking about with this program; and of course every math teacher, at any level, ought to have it.

Alas, there are two problems. First, PC-MATLAB is copy-protected. It's not  
*(continued)*



With the Digi-Data 2000 PC 1/2" tape system you can move data between your IBM PC, XT, or AT and a mainframe or minicomputer. IBM/ANSI compatible 9-track 1600 bpi 1/2" tape is the only truly standardized and interchangeable medium between the PC and mainframes or minis.

The 2000 PC includes tape drive, PC controller board, cables, and complete ready-to-run DOS software utilities for just \$3,995. The utilities provide file interchange in ASCII, EBCDIC, or binary—as well as high speed disk backup and restore functions.

Make the PC/Mainframe connection. Call us today at (301) 498-0200.

**DIGI-DATA CORPORATION**  
8580 Dorsey Run Road  
Jessup, MD 20794-9990  
\* (301) 498-0200 Telex 87-580

In Europe contact: Digi-Data Ltd. • Unit 4 • King's Grove • Maidenhead, Berkshire • England SL6 4DP  
Telephone No. 0628 29555/6 • Telex 847720

an obnoxious form of protection, and I suspect that fully half the people who'd be interested in the program know enough about small computers to remove the copy-protection scheme in five minutes. Still, it's there.

More seriously, they want \$695 for it. That's a lot of money. PC-MATLAB is probably worth that to the relatively

small number of people who want to use it professionally; but at that price it's not going to put matrix tools in the hands of social scientists and others who need to know about these things.

#### SOFTWARE TOOLS

All—well, nearly all—programmers keep hoping for the magic "software

bus": a set of programs and libraries that lets you patch together a bunch of concepts to get the job done without extensive writing, editing, and debugging. It's one of the main reasons for the popularity of UNIX among hackers.

Back in the early days of micros there weren't many good books on computing, but one stood out so far above the crowd that there almost wasn't a second. That was Brian W. Kernighan and P. J. Plauger's *Software Tools* (still in print and very much worth reading). This was a book about programming philosophy; but it gave many examples as part of the discussion. These software tools became legendary. Walt Bilofsky named his software house Software Toolworks in their honor. My mad friend MacLean daily lamented that we didn't have them, and all of us wanted them. Alas, they were written for big machines and in a language called RATFOR. RATFOR = RATIONAL FORTRAN; it was a preprocessor that allowed FORTRAN programmers a chance at writing structured code. A public-domain Z80 RATFOR precompiler was obtainable, but FORTRAN for our early 8-bit machines left a lot to be desired.

Then, at a West Coast Faire, I found an outfit called Unicorn Systems that published the software tools for small microcomputers. Eagerly I brought them home, only to find that most of them were already pretty outdated, and they didn't work too well under CP/M anyway; too slow. Unicorn also wanted too much money, although given what you got—15 disks of source code—it's hard to see what they could have done to keep the price much lower. Everything worked just fine, but the availability of the software tools for micros had far less impact than I'd have thought.

Unicorn has since become Carousel Tools. They've put the Legendary Software Tools into MS-DOS 2.0, which is *much* better suited to their structure than CP/M ever was. The tools use UNIX-like pipes, which is to say that the output of one program can become the input for another; it's

(continued)

NOT COPY  
PROTECTED

# Learn the C Language Interactively

## Step-by-Step With *Introducing* C

Introducing C is a powerful C language training system that combines a thorough, self-paced manual with a unique C INTERPRETER to provide a fast efficient method of learning C.

#### A COMPREHENSIVE APPROACH

Introducing C covers all the essential elements of C. The Interpreter utilizes standard K&R syntax and operators — full structures and unions, arrays, pointer and data types. It provides the standard I/O library and an extended graphics library.

The package has many user oriented features including a screen text editor and extensive error diagnostics (includes dynamic trace capabilities).

#### INTRODUCE YOURSELF, TODAY

Introducing C is available for immediate delivery. System requirements are IBM PC, XT or AT with one disk drive and 192K bytes of memory. Price: \$125.00. Not copy protected.

**TO ORDER CALL 800-922-0169**

 **COMPUTER  
INNOVATIONS, INC.**

980 Shrewsbury Ave., Tinton Falls, NJ 07724 • (201) 542-5920

# XEROX

## Three more firsts from the people who invented the wheel.

From day one, Xerox and Diablo have been known as the two best names in daisywheel printers. And now there are three more in the Xerox line to choose from.

The Xerox Advantage D-25 Diablo printer turns out letter quality documents quickly and quietly. And it does all that for the price of a dot matrix printer.

At 80 c.p.s., the D-801F is the fastest daisywheel printer ever made by Xerox. It has a built-in double bin

sheet feeder. As well as the capacity to handle up to 16 computers at once.

Then there's the D-36. It's so reliable, it averages 4,000 hours of printing

between maintenance calls. And each of these new printers is compatible with most computers on the market, including the IBM-PC.

So if you're looking for the latest in daisywheel printing technology, call 1-800-833-2323, ext. 25, your local Xerox office, an authorized Diablo or Xerox dealer or send your business card to Xerox Corporation, Dept. 25192, P.O. Box 24, Rochester, NY 14692.



Xerox Advantage  
D-801F Diablo Printer

Xerox Advantage  
D-36 Diablo Printer

Xerox Advantage  
D-25 Diablo Printer

possible to do an enormous job employing half a dozen different programs applied one after the other with a single command. MS-DOS 2.0 knows how to do that with the tools.

Anyone trying to learn how to hack should become familiar with the Kernighan and Plauger book and would likely benefit from having the

Legendary Software Tools to play with. I haven't used the new set, but knowing the people at Carousel, I'd be astonished if there were significant undocumented bugs.

#### BEYOND COMPARE

Larry Niven and I write books together. We both use computers to

write. Generally we don't work on the same part of a book at the same time unless we're working together. Sometimes it happens, though, in which case we have two versions of the same text—and neither is "latest."

When that happens we haul out COMPEN, a file comparator that looks at CP/M text files and displays their differences. COMPEN (from Compare Pencil files, showing just how venerable that program is) is available in the Workman CP/M Software Anthology Series.

Beyond Compare from General Transformation Company is a program for the IBM PC that does a great deal more than COMPEN does for CP/M files. If you use a PC or 100 percent PCompatible and have 256K bytes or more of RAM, I recommend Beyond Compare: it's worth the cost.

#### FOR THE RECORD

Epson America had a big display extolling the virtues of Valdocs 2.0, a program announced last fall and available Real Soon Now, for sure. I understand that Rising Star Industries, the outfit that's supposed to produce Valdocs 2.0, recently laid off a number of its programmers. As I heard the rumor, the people laid off were those who had finished their part of the project. This gives interesting incentives to those who haven't.

The last time I mentioned Rising Star's problems getting Valdocs 2.0 completed, Roger Amidon, chief programmer for Rising Star, called me. He wanted to know if I'd do a fair evaluation of Valdocs 2.0 when I got it. I promised I would, but I'm not holding my breath until I have to pay that debt. I've also got a self-promotional newsletter from Rising Star promising Valdraw and Valpaint, which require Valdocs 2.0. "Ready for shipment May 15, 1985." I wonder if I can get odds on that bet?

I'd have lost. We received Valdocs 2.0 in mid-May. It seems to work; more next time.

#### AT&T BADGE WATCH

AT&T's people had a big booth at the Faire. They had one at the Winter

## The Line Tamer™ UPS speaks for itself.

Its on-board micro and RS-232 port let it talk with your computer for power system monitoring and control. And its energy-efficient design slashes your operating cost.



A conventional UPS calls for the battery and inverter to run constantly, wasting up to 40% of the power used. The Line Tamer Uninterruptible Power System for microcomputers is up to 80% efficient because it bypasses the battery and inverter during normal operation. Its unique design will save you money without sacrificing the performance of an on-line UPS.

The built-in Line Tamer Power Conditioner cleans and regulates AC power, removing spikes, transients, noise, overvoltages and undervoltages. When a blackout occurs, or line frequency varies beyond specified tolerances, the battery and inverter activate in phase, with no break in the sine wave output to your equipment.

The on-board microprocessor and RS-232 port let the Line Tamer UPS alert you automatically in the event of a power emergency, so you can begin an orderly shutdown. Among the user-defined warning and alarm parameters are High or Low Battery Voltage, Over or Undervoltage, Over-temperature and Battery Capacity.

It also keeps you informed of System Status, including Number of Power Outages, Number of Minutes on Inverter, Number of Hours on System, Number of Overloads, and Battery Time Remaining.

The Line Tamer UPS also features five front panel LED's for System Ready, Inverter On, Charger On, AC Present and Alarm. An audible alarm backs up the LED and automatic interrupts.

The complete specifications for the Line Tamer UPS for microcomputers speak well, too. For your copy, call or write Shape Magnetronics today.

**SHAPE** THE CLEAN  
MAGNETRONICS, INC. POWER  
SOURCE

901 DuPage Avenue, Lombard, IL 60148  
Phone 1 312 620-8394 • TWX 910-991-2352

Line Tamer is a trademark of Shape Magnetronics, Inc.

COMDEX in Anaheim, too. You'll recall a year ago in Las Vegas I could tell the rank of the AT&T employee by the badge: plastic or paper for low ranks, then moving up through short silver, wide silver, narrow gold, to the senior officer present who had a wide gold badge. Apparently someone read my column; at Winter COMDEX all of the AT&T people had narrow gold badges. I fear I made a couple of untoward remarks that may have been overheard.

At the Faire they all had identical white plastic badges. However, they also wore carnations: white for PR people, colored for technical personnel. They'd solved The Great Badge Problem!

On the other hand, there was no one there who'd admit ever having heard of me or BYTE, and I didn't care to explain myself, so I didn't see anything. I suspect that if they'd spend

more time having their media specialists learn something about computer publications, and less worrying about the size and color of their badges, they'd sell more computers; but perhaps they know something I don't.

#### HYPERDRIVE AND CORVUS

Just before the Faire my Macintosh returned from General Computer with the HyperDrive installed. HyperDrive is an internal hard disk plus conversion to the 512K-byte Fat Mac. It took General about 12 days (including shipment to and from the east coast) to do mine. I love it. It works splendidly, it seems quite rugged, and it's *fast*. I'll have a lot more to say about HyperDrive in upcoming issues.

My son Alex works with Barry Workman and managed to wheedle me into lending him the HyperDrive Mac to use at the Faire as the demonstra-

tion machine for Workman's Macintosh software. They took it up in a truck; when it returned, it made a slight rattling noise.

I had visions of warped bearings in the hard disk. The noise was intolerable. With trepidation I got out the #5 Torx driver and opened up the Mac—something I don't recommend that readers do, since there's about 28,000 volts stored in condensers, and the insides of a Mac can be dangerous for *months*. Anyway, once inside, the problem became obvious. As part of the HyperDrive conversion, General puts in a small fan at the top of the Mac. The fan is put in with double-sided sticky tape, and it had slipped just enough that the fan blade hit the tape. A tiny nudge—which could have been done from outside, had I but known—took care of the problem.

As I said, the HyperDrive seems

(continued)



## YOU CAN BRING DOWN THE COST OF EUROPE WHEN YOU BRING BACK A NEW MERCEDES-BENZ.

IF YOU PLAN on touring Europe this year, you can take overseas delivery of any 1985 Mercedes-Benz gasoline or diesel model you choose.\*

Pick it up at the Stuttgart Delivery Center and enjoy a driving vacation unmatched for comfort, convenience and freedom. Avoid costly car rentals while saving on the price of your new Mercedes-Benz.

For details, get our free "European Delivery" color brochure. Just clip and send the coupon at right.

\*Subject to availability.

Send coupon to:  
Mercedes-Benz of North America, Inc.  
Marketing Communications Division  
One Mercedes Drive, Montvale, NJ 07645



Name \_\_\_\_\_

Address \_\_\_\_\_

City \_\_\_\_\_ State \_\_\_\_\_ Zip \_\_\_\_\_

© 1985 Mercedes-Benz of N.A., Inc., Montvale, N.J. M11-MA-85

# PC NETWORK

## BUY HARDWARE AND SOFTWARE AT WHOLESALE +8%, AND GET 14-30 DAY SOFTWARE RENTALS†...

### Listed below are just a few of the over 20,000 products available at our EVERYDAY LOW PRICES. The Network carries products for Apple, IBM, CP/M and most other popular computer families.

#### GAMES & EDUCATIONAL SOFTWARE FOR APPLE II & MACINTOSH

(Please add \$1 shipping and handling for each title ordered from below.)

	Wholesale		Wholesale
Arrays Home Accountant-Mac Only	\$65.00*	Miles Computing Mac Attack-Mac Only	\$23.00*
Axlon Art Portfolio & Card Shoppe	35.97*	Palatit Mac Type-Mac Only	24.50*
Beeching Baron Millionaire/Action	28.25*	Penguin Graphics Magician	28.97*
Broderbund Loadrunner	18.75*	Penguin Postcard or Xyphus	20.50*
Broderbund Chopster	19.00*	Penguin Personality Mac Only	30.97*
Broderbund Print Shop	28.75*	Professional Software: Invis Fever	22.00*
Broderbund Dazzle Draw	31.97*	Priority Software: Forbidden Quest	22.00*
CBS Murder by the GORE	53.50*	Scarborough Master Type	26.50*
CBS Gorn Bridge Made Easy	28.97*	Scarborough Run for the Money	27.00*
Counterpoint The News Room	45.00*	Simon & Schuster Typing Tutor II	28.25*
Davidson Speed Reader II	28.97*	Sir-Tech Wizardry	26.97*
Davidson Math Blaster	37.97*	Sir-Tech Knight of Diamonds	18.97*
Davidson Word Attack	29.97*	Sir-Tech Rescue Raiders	18.97*
1st Byte Smooth Talker-Mac Only	70.00*	Sublogic Night Mission Pinball	20.00*
Hayden Davinci-House/Interior/Landscapes	24.75*	Spinmaker Alphabet Zoo Face Maker	15.97*
Hayden Sargon III	25.75*	Kinder Comp: Hey Diddle Diddle	20.77*
Infocom Deadline or Suspended	27.00*	Rhymes & Rhodies: Story Machine	20.77*
Infocom Enchanter Planescape	29.50*	Spinmaker The Most Amazing Thing	24.97*
Infocom Hitchhiker's Guide to Earth	22.00*	Spinmaker Delta Drawing	24.97*
Infocom Suspended Sorcerer or Intid	25.00*	T-Maker Check Art-Mac Only	29.97*
Infocom Zork II or III	23.50*	Warner Desk Organizer	65.00*
Layered Front Desk-Mac Only	65.00*	Videx Fun Pack-Mac Only	18.77*
Mirage Concepts Invis	24.00*	Videx Mac Checkers & Reversi	25.17*
Mark of the Unicorn Mouse Stampede	19.00*	Videx Mac Vegas-Mac Only	31.00*
		Videx Mac Gammon & Cribbage-Mac Only	25.17*
		Virtual Combinatorics Micro Cookbook	21.00*

#### BUSINESS SOFTWARE FOR YOUR APPLE II & MACINTOSH

(Please add \$2.50 shipping and handling for each title ordered from below.)

	Wholesale		Wholesale
Apple Apply Works	\$178.97*	Microsoft Word For Macintosh	\$102.25*
Borland International Turbo Pascal	30.00*	Microsoft Fax for Macintosh	102.25*
BPI GL, AP, AR, PR, or INV	211.50*	Microsoft Mail for Macintosh	102.25*
Broderbund Bank Street Writer	40.00*	Microsoft Basic for Macintosh	85.00*
Central Point Copy II Plus or Copy II Mac	20.00*	Microsoft Chart for Macintosh	86.25*
Funk Software Sideways	35.00*	Monogram Utilities & Sense	52.00*
Funsoft MacDraw	60.00*	Monogram Dollars & Sense for Macintosh	89.98*
Haba Habades	40.00*	Onesta Help for Macintosh Reg 512K	237.00*
Haba Quartet Jazz Features Available Now!	101.95*	Sensible Software Sensible Speller IV	87.50*
Harvard Mac Manager	29.95*	SoftKraX Fancy Fonts	125.00*
Human Edge Mind Prober	25.50*	Software Arts 'n' Solver for Mac	134.00*
Human Edge Sales Edge	110.00*	Software Publishing PFS: File Write or Graph	68.00*
Human Edge Communications Edge	98.00*	Stoneware DB Master-Mac I/II	115.00*
Living Videotext: Term-Talk-Mac Real	75.00*	Provue Overview-Mac Only	135.00*
Main Street Filer-Mac Only	85.00*	Rio Grande Software Softmaker II	85.00*
MECA Managing your Money	105.50*	Teles Television for Mac	87.50*

#### HARDWARE FOR YOUR APPLE II & MACINTOSH

(Please add shipping and handling charges found in italics next to price.)

##### DISK DRIVES

	Wholesale		Wholesale
Alps AP-100A Dual Apple Drives in One Case	\$308.00* (7.00)	Hayes Microdotmod II w/Smartcom	\$125.00* (2.50)
Alps AP-100C Same/Different in Case	159.00* (4.00)	Novation Apple Car II	174.45* (3.50)
Apple MAC 400KB External Drive	349.95* (7.50)	Prometheus 1200 A	276.00* (6.00)
Haba MAC 800KB Double sided Drive	315.00* (7.00)	Low Cost 1200 Baud Internal Modem for Apple II	
Rece the Capacity-Reeds Standard Disk II	165.00* (5.00)	Prentice Pro Com Mac Cable	322.00* (2.50)
Micro Bell AD 1.2KB Drive		1700 Baud Modem, Cable, Straight	
Just like Apple's Drive			
Micro Bell Floppy Controller	55.00* (2.50)		
PC Network 140K External Drive for Apple IIc	115.00* (2.50)		
Rana Elite II 163K Drive	225.00* (5.00)		
Rana Elite II 326K Drive	320.00* (7.00)		
Rana Elite II 652K Drive	388.99* (10.00)		
Tecmar 3MB Removable Drive for MAC	1,350.00* (29.16)		
Tecmar 10MB MAC Drive	1,350.00* (29.16)		
Tecmar 5MB MAC Drive Upgrade	1,295.00* (27.97)		

##### BOARDS AND BUFFERS

	Wholesale		Wholesale
ALB 2-Engine	\$129.00* (2.50)		
AST Main 210-2 Serial/Clock	155.00* (2.50)		
Microsoft Premium Software II	243.67* (2.50)		
Microtek Dumping GX	55.00* (2.50)		
Orange Micro Grappler+	96.90* (2.50)		
Orange Micro Serial Grappler	78.00* (2.50)		
PC Network 280 Card	35.00* (2.50)		
Quadram APC/IG Graphics Interface	62.00* (2.50)		
Quadram e-RAM-80	88.00* (2.50)		
Quadram Multicolor-1 Parallel 1 Serial	140.00* (2.50)		
Clock/Expandable to 256K			
Thunderware Thunderclock	104.00* (2.50)		

##### MEMORY CHIPS

(All Memory Chips Guaranteed for Life!)

	Wholesale		Wholesale
64K Memory Upgrade Kits (3 Chips)	\$7.20* (1.00)		
Quantity Discounts Available!			
64K Dynamic Ram Chips (Each)	.80* (1.00)		
256K Dynamic Ram Chips (Each)	4.35* (1.00)		
128K IBM AT Puggback Chips (Each)	7.50* (1.00)		

##### EXTERNAL MODEMS

	Wholesale		Wholesale
Anchor Mark II	\$230.00* (5.00)		
Hayes Smartmodem 300	125.00* (5.00)		
Hayes Smartmodem 1200	355.00* (5.00)		
Hayes Smartmodem 2400	568.00* (5.00)		
Prometheus Promodem 1200	279.00* (6.00)		
External 100% Hayes Compatible			
U.S. Robotics Courier 2400BPS Modem	525.00* (5.00)		
U.S. Robotics Passport	195.00* (4.00)		

##### TERMS & CONDITIONS

PC NETWORK - Members may buy 8% above the wholesale price, plus shipping. All prices reflect a 3% cash discount. Minimum shipping \$2.50 per order. International orders call for shipping & handling charges. Personal checks please allow 10 working days to clear.

PLEASE BEFORE YOU BUY - Members are eligible to join the NETWORK'S Business and Game software Rental Libraries and evaluate products for a full 14 (Regular) or 30 (VIP) days to see if it meets your needs. And THE NETWORK'S rental charges are far less than other software rental services - just 20% OF THE MEMBER WHOLESAL PRICE. Rental titles available in IBM/Apple/MAC and CP/M Formats. Hardware prices highlighted by \* reflect recent major price reductions.

#### GAMES & EDUCATIONAL SOFTWARE FOR YOUR IBM

(Please add \$1 shipping and handling for each title ordered from below.)

	Wholesale		Wholesale
ATI How to Use Multimate	\$42.00*	Infocom Zork or Witness	\$20.50*
ATI Intro to PC DOS Vol 1 & II	23.00*	Infocom Deadline or Suspended	27.00*
ATI Intro to BASIC	23.00*	Microsoft Flight Simulator	59.00*
Bluebash Chess (Your Toughest Opponent)	34.00*	Mouse Systems PC Paint-Turn your PC into A Color Macintosh!	27.00*
Bluechip Millionaire/Off Baron or Lycoon	28.25*	Scarborough MasterType	27.00*
Broderbund Lode Runner	19.75*	Serre On-Line King's Quest	37.00*
CBS Gorn-Brigde Made Easy	45.00*	Sierra On-Line Crossfire	18.00*
COEX Training for Word Star	37.25*	Solologic Night Mission Pinball	20.00*
Comprehensive Intro to Personal Computing	32.00*	Spinmaker Alphabet Zoo Kinder Comp	15.97*
Davidson Math Blaster Word Attack	26.50*	Story Machine, Face Maker, Hey Diddle, Diddle Rhymes & Rhodies	
Davidson Speed Reader II	36.50*	Spinmaker Delta Drawing	24.97*
Hayden Sargon II	26.97*	Spinmaker Most Amazing Thing	20.77*
Individual Professor DOS	32.50*	Virtual Combinatorics Micro Cookbook	21.00*
Individual The Instructor	24.50*		

#### BUSINESS SOFTWARE FOR YOUR IBM

(Please add \$2.50 shipping and handling for each title ordered from below.)

	Wholesale		Wholesale
Ashton-Tate 1-2-3	\$310.00*	Micro Pro Wordstar 2000+	\$382.00*
Borland Turbo Pascal	310.00*	MicroSim Clair	110.00*
Borland SideKick (Protected)	25.75*	MicroSim Release 5000	125.00*
Borland Turbo Pascal 8087	26.00*	MicroSim C Compiler	275.00*
Borland Superkey	49.75*	Microsoft Word-Latest Version 2.0	205.00*
BPI 3- A/R or A/I	34.75*	Microsoft Multiplan	105.00*
BPI Aura	205.00*	Microsoft Mouse	107.00*
BPI Personal Accounting	48.00*	Monogram Dollars & Sense	102.00*
Central Point Copy II PC	20.00*	Nertron Norton Utilities 3.0	200.00*
Conceptual Instruments Desk Organizer	157.00*	Omni The Word Plus	48.00*
Digital Research CPA-86	33.00*	Open Systems PRO Sales A/R INV G/L A/P Item Age	90.00*
Digital Research CRM Logo	57.00*	Power Base Power Base	325.00*
Digital Research Gem Desktop	28.00*	Real World G/L A/P A/R or OE/INV	345.00*
Enertronics Energizegraph with Plotter Option	235.00*	Rosesoft Prokey Version 3	74.00*
Funk Software Sideways	34.00*	Ryan McFarland IBM COBOL (Dev. System)	570.00*
Harvard Harvard Project Manager	185.00*	Sanna Sanna III Word Processor	277.00*
Harvard Total Project Manager	240.00*	Sanna Word	320.00*
Hayes Smartgraph II - New XT DOS Emulator	68.00*	Sensible Software Word Processor	155.00*
Human Edge The Management Firm	137.98*	SoftKraX Fancy Fonts	125.00*
Human Edge The Sales Edge	137.98*	Softstyle SE7-FX	35.00*
Lotus Development Lotus Prolog	78.25*	Software Arts T/O Solver	222.00*
Lotus NoteMaker: New Version	135.00*	Software Publishing PFS: File Write Graph	72.00*
Lotus Development Lotus 1-2-3	265.00*	Software Publishing PFS: Report	64.00*
MDBS Knowledgebase	245.00*	Sorcam SuperCalc III	159.00*
Micro Pro Wordstar 2000	222.00*	Kenaco Alpha	252.00*

#### HARDWARE FOR YOUR IBM

(Please add shipping and handling charges found in italics next to price.)

##### DISK DRIVES

	Wholesale		Wholesale
Apparat 512K Memory Board with 64K	\$132.00* (2.85)	Hayes Smartmodem 1200B w/Smartcom II w/100 Emulator	\$317.00* (2.50)
IOmega Barron II Box Drive	2,275.00* (19.14)	Prometheus Promodem 1200B Internal Modem	225.00* (2.50)
Maynard WS-1 10MB Internal Hard Disk	730.00* (17.77)	AST Reach/Smart 1200 1200 Baud Internal Modem	345.00* (2.50)
Maynard WS-2 same as WS-1 but with SmartStar Floppy Controller Issues 1/300	930.00* (20.30)	Quadram Quadmodem II 1200 Baud Half Card w/CrossTalk 3V	275.00* (2.50)
PC Network 10MB INTERNAL Floppy Controller Drive - New Version	409.00* (9.42)		
Drives by Shugart or Sandisk			
PC Network 10MB Internal Floppy Controller Same unit used in Compaq's DeskPro	475.00* (10.26)		
PC Network 8MB Hard Drive	77.50* (1.67)		
(Use Volume 1 on all Import these Brand Name (Quality Priority from the Source)			
Tandon T44 100 2 Full Height DSDO Drives	93.00* (2.20)		
Tellagrae 2.5MB External Hard Disk	2,375.00* (51.30)		
with 60MB Tape Backup			
Tec 35-B Half Height DSDO Drives	90.00* (1.94)		
Tec 1 2MB Half Height Disk Drive for AT	110.00* (2.40)		

##### MULTIFUNCTION CARDS

	Wholesale		Wholesale
Apparat 256K Memory Board with 64K	\$110.00* (1.75)	Brand Name DSDO Drives	31.50* (1.00)
AST 30 Plus II	222.00* (2.50)	Guaranteed for Life! Not Interim!	
AST i/o Plus II	120.00* (2.50)	Curious PC Protocol II	84.00* (2.50)
AST Advantage for AT	375.00* (2.50)	Keele Speed Key System	101.50* (2.50)
AST Megaic Card 64K	160.00* (2.50)	PC Network Replacement 130 Watt IBM-PC AT Power Supply-Gives your PC the same Capacity as a X'T Good for add in Tape Drives (without need for a piggyback unit) and large capacity disk drives	90.00* (2.70)
Full Set Pack Features - Game Port Included Extra Software		IBM-PC AT Power Supply-Gives your PC the same Capacity as a X'T Good for add in Tape Drives (without need for a piggyback unit) and large capacity disk drives	
ORCHIB Bissom w/64K	200.00* (2.50)	SMA PC Document-KeyBoard Templates (Requires Interface)	8.99* (1.00)
Quadram Improved Quadboard w/OK	175.00* (2.50)		
Tecmar Captain Multifunction Card w/OK	148.00* (2.50)		

#### COMPLETE SYSTEMS

	Wholesale		Wholesale
Apple Macintosh Base System	CALL	Columbia Desktop & Portable Systems	CALL
AT&T 7300 Unix PC	\$3,899.00* (19.90)	IBM PC Base System 20SD/FDC/256K	1,495.00* (32.50)
IBM Hard Disk II Floppy/512K		IBM PC Professional Hard Disk	1,868.50* (40.75)
COMPAG Hard Disk Portable	2,285.00* (49.38)	IBM PC AT-486 Config	CALL
IBM Hard Disk Floppy/256K		Sampo ABC 500 1/2 Smart Card Computer	520.00* (11.99)
COMPAG DeskPro Tape Backup System w/640K/1 Floppy/10MB Hard Disk/10MB Tape Drive/Monitor	3,018.14* (65.20)	Sampo ABC 775 Color Portable IBM Clone 2 Drives Color Monitor 256K	1,775.00* (38.00)

##### PRINTERS

	Wholesale		Wholesale
Citizen MSP-10 NEW	\$280.00* (6.00)	NEC IBM 387PS Laser Quality Printer	880.00* (19.79)
1600PS/800CP/Fric + Trac		NEC AT&T 550PS Printer	1,338.00* (19.38)
Citizen MSP-15 NEW	\$399.00* (8.62)	Okidata M1 80 New 1200PS/LJ	200.00* (4.74)
800PS/1320CP/Fric + Trac		Apple FDC/IBM Graphics 1-memo	
Citizen MSP-20 NEW	\$399.00* (8.62)	Okidata M1 192 New Speed Design	325.00* (7.35)
2000PS/800CP/Fric + Trac		1600PS/LJ Model IBM Graphics	
Citizen MSP-25 NEW	\$520.00* (11.23)	Okidata NEW Color 20 800PS/1100	109.00* (2.35)
2000PS/1320CP/Fric + Trac		Colors/LD Model IBM Graphics/1100	
C. Itoh F1014 8120 40 CPS LQ	875.00* (18.90)	Okidata NEW IBM interface for Okidata Color II	65.00* (1.38)
C. Itoh Presenter 8120 AP	285.00* (6.20)	Okidata M1 840 2000PS/1320CP	599.00* (12.94)
Epson L 8 80 1000PS/800CP/LQ Model	205.00* (4.43)	Okidata M1 930 1600PS Wide Platen	1,111.00* (11.50)
New Model!		Okidata 2410P Pagemark 3500PS	1,620.00* (35.00)
Epson FX 10	285.00* (6.27)	Quam Sprint 1140 400PS Letter Quality	1,155.00* (24.00)
Epson FX 100	410.00* (8.99)	Star Microform Paper type 180PS	300.00* (6.49)
CALL		Letter Quality	
NEC 2030 2000PS/LQ Parallel	605.00* (13.00)		
NEC 2100 2000PS Letter Quality Parallel	805.00* (13.00)		
NEC 8140 1320PS/LQ Parallel	950.00* (19.74)		



# COMPLETE SYSTEMS

(Local warranty service available in most major metro areas)

## IBM PC BASE SYSTEM

IBM PC w/256K

Floppy Drive Controller  
2 Double Sided Double  
Density Disk Drives



**\$1,495.02\***

## IBM PC HARD DISK SYSTEM

IBM PC w/256K

Floppy Drive Controller  
1 Double Sided Double  
Density Disk Drive  
Half Height 10MB  
Disk Subsystem

**\$1,886.62\***

CALL FOR  
LATEST IBM  
ANNOUNCEMENTS

CUSTOM  
CONFIGURATIONS  
WELCOME

# COMPAQ™

## PORTABLE HARD DISK SYSTEM

w/256K/1 Floppy/10MB Hard Disk



**\$2,285.00\***

## DESKPRO SYSTEM WITH TAPE BACKUP

640K CPU/1 Floppy/10MB Hard Disk  
10MB Tape Drive/Monitor



**\$3,018.14\***

APPLE IIc

MACINTOSH  
BASE SYSTEM

Prices Too Low To Print!!!

## 64K MEMORY EXPANSION KITS

Quantity Discounts Available.  
Guaranteed for Life!



Set of 9 Chips  
**\$7.20\***

## BRAND NAME DISKETTES *Guaranteed for Life!*

(Quantity Discounts Available.)

SS/DD For APPLE II & III Box of 10

**\$9.00\***

DS/DD Box of 10

**14.00\***

MACINTOSH Box of 10 Includes free Flip & File Case

**24.95\***

## 1/2 HEIGHT DS/DD DISK DRIVES



**\$77.50\***

## INTERNAL PC HARD DISK



10MB  
**\$419.00\***

20MB  
**\$555.00\***

**\$265.00\***

**\$310.00\***

\*Members pay 8% above this wholesale price plus shipping.

CALL TOLL FREE 1-800-621-S-A-V-E (orders and memberships only)

In Illinois call (312) 280-0002 Validation code: B385

TM & R—Registered trademark of IBM/COMPAQ/APPLE Inquiry 242

# PC

# NETWORK

## GET THE NETWORK ADVANTAGE!!!

SEE WHY OVER 70,000 HAVE JOINED—  
MAKING US THE NATION'S #1 SOURCE  
FOR EVERYTHING IN COMPUTING...

- **Our 600 Page Wholesale Catalog**  
Over 20,000 products priced at Wholesale + 8%. Anything you will ever need at a Consistent low price...
- **Quarterly Catalog Updates**  
Your Catalog is never obsolete! Keep on top of the newest products and latest price changes.
- **The Printout**  
Our newsletter gives you fantastic specials along with unbiased analysis of new products and industry trends.
- **10 Day Returns on any Hardware!!**  
If you don't like any hardware product—for any reason—return it for a refund.
- **1000+ Title Rental Library**  
14 to 30 day rentals on over 1000 different titles. Try before you buy!!
- **Low Freight—No hidden Charges**  
We don't use hidden charges or inflated shipping, handling and insurance fees to make our prices seem lower than they are...
- **And Much Much More!**

## CALL TOLL FREE 1-800-621-S-A-V-E

In Illinois call (312) 280-0002

Your Membership Validation Number: **B385**

You can validate your membership number and, if you wish, place your first money-saving order over the phone by using your VISA, MASTERCARD or AMERICAN EXPRESS. Our knowledgeable service consultants are on duty Mon-Fri 8 AM to 7 PM, SAT 9 AM to 5 PM CST.

**PERSONAL COMPUTER NETWORK**  
320 West Ohio  
Chicago, Illinois 60610

Call now... Join the PC NETWORK and start saving today!

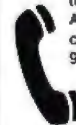

## PC NETWORK • MEMBERSHIP APPLICATION

**YES!** Please enroll me as a member in the PC NETWORK™ and rush my catalog featuring thousands of computer products, all at just 8% above DEALER WHOLESALE PRICES. I will also periodically receive "THE PRINTOUT", a special up-date on merchandise at prices BELOW even those in my wholesale catalog, and all the other exclusive, money-saving services available to Members.

**385**

I am under no obligation to buy anything. My complete satisfaction is guaranteed. Please check (✓) all boxes that apply:

- |   |  |
|---|--|
| <p><b>Basic Membership</b><br/>With 14 Days Rental</p> <p><input type="checkbox"/> One-year membership for \$8</p> <p><input type="checkbox"/> Two-year membership for \$15 (SAVE \$1)</p> <p><input type="checkbox"/> Business Software Rental Library for \$25 add'l. per year—with 14 day rentals</p> <p><input type="checkbox"/> Games Software Rental Library for \$10 add'l. per year</p> | <p><b>Special V.I.P. Membership*</b><br/>With 30 Days Rental.</p> <p><input type="checkbox"/> One-year membership for \$15</p> <p><input type="checkbox"/> Two-year membership for \$25 (SAVE \$5)</p> <p><input type="checkbox"/> BOTH Business and Game Software Rental Libraries for \$30 add'l. per year—with 30 day rentals</p> <p>*VIP members receive advance notice on limited quantity merchandise specials</p> |
|---|--|

Bill my credit card:  VISA  MasterCard  American Express

Account Number:

Exp. Date \_\_\_\_\_  
mo. year

Check or money order enclosed for \$ \_\_\_\_\_

Name \_\_\_\_\_

Address \_\_\_\_\_ Apt. No. \_\_\_\_\_

City \_\_\_\_\_ State \_\_\_\_\_ Zip \_\_\_\_\_

Telephone ( ) \_\_\_\_\_

My computer(s) is:  IBM PC  IBM-XT  IBM-AT  Apple II  
 Macintosh  Other \_\_\_\_\_

Signature \_\_\_\_\_

(Signature required to validate membership)

Copyright © 1984, PC NETWORK, INC.

rugged enough. It's quiet again, and it sure is faster than a normal Mac.

David Ramsey of Corvus Systems heard that Alex was bringing my machine up and arranged to bring one of the new Corvus hard-disk drives for the Macintosh over to the Workman booth. They plugged it in. Worked fine. Workman now had the

most complete Macintosh in the show: two floppy-disk drives, 512K bytes of memory, and two hard-disk drives. Needless to say, in that configuration the Macintosh is *speedy*.

I'm told that my second Macintosh just arrived. It's being converted to a MegaMac (full megabyte of memory), after which it gets the Corvus hard

disk. I'll then compare MegaMac plus Corvus with the HyperDrive. Report Real Soon Now.

### GAMES AND SYNTAX

One chap who came looking for me at the Workman booth was Bob Woodhead, coauthor of the popular Wizardry I game. He had the latest version for the Macintosh, and it didn't take long to get me playing it. If you have a 512K-byte Mac, the whole game (more or less) fits into and fills memory; this speeds things up considerably. You can play Wizardry I on the 128K-byte Mac, but be prepared to wait for disk accesses.

Wizardry I is complex. At bottom it's supposed to be like the dungeon-esque game TSR bombastically threatens to sue you for mentioning, in that you take a party of adventurers into a maze-like dungeon, where you encounter all sorts of monsters. You can fight or run, and if you fight, your magic-using characters can cast spells.

It's all very interesting, and when I got Wizardry I home, I spent too much time playing about with it. I'm not sure what the game's fascination is. I *hate* mapping mazes, and there's more of that than anything else with Wizardry I.

Mostly, though, it got me to thinking about games and programs.

Adventure/exploration games come in a lot of flavors, but tonight I'm interested in two basic classifications: menu-driven, like Wizardry I, and command-driven, like the original Adventure game of Crowther and Woods.

Menu games can be fascinating. Wizardry I has lots of graphics and considerable ingenuity. At bottom, though, what you can do is known in advance to both you and the computer. You give a command, and the machine does it. The program needs no ingenuity, since if you give a command that's not on the menu, neither you nor the machine has a problem. In Wizardry I the machine either beeps or responds with "What?" In both cases, you simply enter a new command.

(continued)

# You're in Good Company When You Program in BetterBASIC



All of these companies rely on BetterBASIC to write their software programs. They have found that BetterBASIC combines the features they need from BASIC, Pascal, C and Forth in one familiar environment. Some of these features include the following.

**640K** Now you can use the full memory of your PC to develop large programs.

**STRUCTURED** Create well organized programs using procedures and functions that are easily identified and understood and completely reusable in future programs.

**MODULAR** Use procedures and functions grouped together to form "library modules."

**INTERACTIVE** BetterBASIC acts like an interpreter, responding to the users' commands in an immediate mode. However, each statement is actually compiled as it is entered.

**EXTENSIBLE** Create your own BetterBASIC modules which contain BetterBASIC extensions (ideal for OEMs).

**COMPILED** Each line of the program is compiled as it is entered

**Better  
BASIC™**

ALSO AVAILABLE FOR THE TANDY 2000, 1200 AND 1000

into the computer's memory rather than interpreted at runtime. The optional Runtime System generates EXE files.

**BetterBASIC** Runs on IBM PC, IBM PC/XT and compatibles.

**CALL 1-800-225-5800** (In Canada: 416-469-5244) Order BetterBASIC now, or write Summit Software Technology, Inc.™, P.O. Box 99, Babson Park, Wellesley, MA 02157. Prices are listed below.

BetterBASIC: \$199 Runtime System: \$250  
8087 Math Module: \$99

Order the BetterBASIC sample disk which includes a demo, a tutorial, compatibility issues and more. Only \$10.

MasterCard, VISA, P.O. Checks, Money Order, C.O.D. accepted.

BetterBASIC is a registered trademark of Summit Software Technology, Inc.

IBM PC and IBM PC/XT are registered trademarks of International Business Machines Corp. Tandy is a registered trademark of Tandy Corp. Illustrated above are registered trademarks of the following companies: Mobil Oil Corp.; A T & T; General Electric Co.; Westinghouse Electric Corp.; TRW, Inc.

# SNEAK PREVIEW

of a powerful

# NEW SOFTWARE METAPHOR

WANTED: People with Imagination, an IBM PC, and \$59.95.

by Paul Heckel

President, QuickView Systems and author, *Elements of Friendly Software Design*

Rarely does a software product introduce a new conceptual metaphor. VisiCalc introduced the electronic spreadsheet; Thinktank, the electronic outliner; and now *Zoomracks*, the electronic rack. Let me tell you what electronic racks are, why I think they are important, and how you can get to try them risk-free at a savings now and maybe help shape their final form to your liking.

## New Metaphor:

Originally designed to keep track of lists, names and addresses, appointments, notes, and other information on portable computers, electronic racks provide a simple, consistent and rich organizational metaphor for data base, text, and other applications.

*Zoomracks* starts with something familiar: racks—like those filled with

time cards next to time clocks in factories. You can see the first line of each card, and take out a card to look at it in detail. You expect the cards in a rack to be in order, several racks to be next to each other; and to be able to move cards from one rack to another.

You might put names and addresses in one, appointments in a second, notes in a third, sales orders in a fourth, memos in a fifth, and archived appointments or notes (moved or copied from the second or third rack) in a sixth rack. To do something with *Zoomracks*, first ask yourself: "How could I do it with cards in racks?"

## Windows illuminate like a flashlight in a dark room

Racks are displayed with Smart Zooms. While windows sacrifice the big picture to let you see the detail, Smart Zooms squeeze out the detail to always show you a recognizable big picture—whether a long shot of several racks, a closeup of one rack, or an extreme closeup of a single card.

## One time offer for Byte Readers

If you like to stretch new products and influence their final form, we want your feedback. That is why we are introducing *Zoomracks* in this issue of *Byte*. We are making a one time offer of a Sneak Preview Edition of *Zoomracks* at an affordable price so you can try it and give us your feed-

Before developing *Zoomracks*, Paul Heckel studied what made *VisiCalc* and other software powerful, useful, easy to use, and successful. He crystallized his thoughts in a book. This is what people are saying about this book, *The Elements of Friendly Software Design*:

*It is the first computing book I've ever read nonstop from cover to cover . . . one of the few books I've read on any topic that actually delivers what it promises . . .*

—Dave Bunnell, PC World Publisher

*Entertaining and instructional . . . will affect the way I program from now on.*

—David Clark, Byte Magazine

*Informative, useful and entertaining. Will help improve your communications skills in any medium . . .*

—Robert Burton, President, Rolodex

*The Elements of Friendly Software Design* is available at your local bookstore for \$8.95 or by calling 800-443-0100 EXT 341. You can also order by writing QUICKVIEW SYSTEMS, 146 Main St., Suite 404, Los Altos, CA 94022. Add an additional \$2.50 for postage and handling. Payment must accompany order.

### ZOOMRACKS SPECIFICATIONS:

- Copy and move fields, cards, and text into different fields, cards and racks.
- Define and change card templates.
- ASCII MS/DOS file format for conversion to other data formats.
- Utilities to convert DBASE II files.
- Macros.
- Simple Wordstar-like editor.
- Easy to learn and easy to use for both occasional and frequent users.
- Display sizes: 6 x 25 to 25 x 80.
- 8 racks on screen, in memory; 30 fields/card; 80 characters/line; 250 lines/field, 20,000 cards/rack.
- Runs on 256K IBM PC.

The Wide key (function f1) toggles between displaying the working racks (left two screens) and the current rack full (right two screens). Smart Zooms compress out detail to keep the big picture.

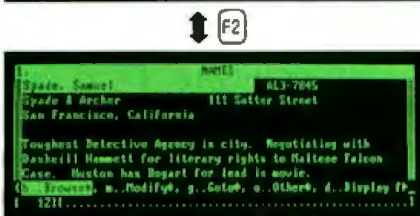
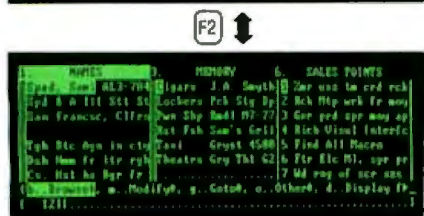

The Yank key (function f2) toggles between displaying the first lines of cards in racks (top two screens), and the current card (bottom two screens). In these pictures *Zoomracks* is using a 10 by 60 screen.

back in time to make a difference before we officially introduce *Zoomracks* in November.

## What you get for \$59.95

- The Sneak Preview edition of *Zoomracks*;
- A free upgrade to the first run edition of *Zoomracks*;
- An acknowledgement in the user manual if you are the first to suggest an improvement we use;
- A six-month unconditional moneyback guarantee.

To order the Sneak Preview Edition  
\$59.95 copy protected  
\$79.95 copy unprotected

CALL  
800-443-0100 EXT 341  
OR WRITE  
QUICKVIEW SYSTEMS  
146 Main Street, Suite 404  
Los Altos, CA 94022

## THE CMO ADVANTAGE

- ✓ THE BEST PRICES!
- ✓ Next day shipping on all in stock items.
- ✓ Free easy access order inquiry.
- ✓ Orders from outside Pennsylvania and Nevada save state sales tax.
- ✓ Free technical support with our factory trained technical staff.
- ✓ There is no limit and no deposit on C.O.D. orders.
- ✓ There's no extra charge for using your credit card. Your card is not charged until we ship.
- ✓ No waiting period for cashiers checks.
- ✓ We accept purchase orders from qualified corporations. Subject to approval.
- ✓ Educational discounts available to qualified institutions.
- ✓ FREE CATALOG MEMBERSHIP.

### ORDER LINE

**1-800-233-8950**  
In PA 1-800-242-4215  
**CUSTOMER SERVICE & TECH SUPPORT**  
1-717-327-1450  
Dept. A108

### MAILING ADDRESS

**EAST**  
Dept. A108, 477 E. Third St.  
Williamsport, PA 17701

**WEST**  
Dept. A108, P.O. Box 6689  
Stateline, NV 89449



MEMBER DIRECT MARKETING ASSOCIATION

### CREDIT CARDS



Inquiry 72



### SHIPPING

Add 3% minimum \$5.00 shipping and handling on all orders. Larger shipments may require additional charges.

All items subject to availability and price change.

Returned shipments may be subject to a restocking fee.

### CANADIAN ORDERS

**1-800-268-3974**  
Ontario/Quebec

**1-800-268-4559**  
Other Provinces

**1-416-828-0866**  
In Toronto

**TELEX: 06-218960**

2505 Dunwin Drive,  
Mississauga, Ontario  
Canada L5L1T1

All prices shown are for U.S.A. orders.  
Call The Canadian Office for Canadian prices.

## HOME COMPUTERS

### APPLE

APPLE IIe.....	CALL
APPLE IIc.....	CALL
MacINTOSH.....	CALL
IIc LCD Display.....	CALL

### Macintosh Software

Lotus Jazz.....	CALL
Microsoft Excel.....	CALL
Microsoft Business Pak.....	\$375.00
Living Videotext	
ThinkTank 512.....	\$159.00
Manhattan Ready, Sel. Co.....	\$79.99

<b>Craighton Development</b>	
Mac Spell.....	\$69.99
<b>Monogram Dollars &amp; Sense.....</b>	\$99.99
<b>Peachtree Back to Basics - GLS109.00</b>	
<b>PFS File &amp; Report (New Version) \$129.00</b>	
<b>Silicon Beach Airborn.....</b>	\$25.99

### ATARI

<b>130XE (128K).....</b>	<b>CALL</b>
<b>520ST (512K).....</b>	<b>CALL</b>

800XL 64K.....	CALL
850 Interface.....	\$119.00
1010 Recorder.....	\$49.99
1020 Color Printer.....	\$79.99
1025 Dot Matrix Printer.....	\$199.99
1027 Letter Quality Printer.....	\$269.99
1030 Direct Connect Modem.....	\$59.99
1050 Disk Drive.....	\$179.99
Touch Tablet.....	\$64.99
7097 Atari Logo.....	\$69.99
4018 Pilot (Home).....	\$57.99
5049 VisiCalc.....	\$49.99
4011 Star Raiders.....	\$12.99
4022 PacMan.....	\$16.99
8036 Atari Writer.....	\$79.99

### BOARDS FOR ATARI

Axlon 32K.....	\$39.99
Axlon 48K (400).....	\$69.99
Axlon 128K.....	\$269.99
Microblis 84K (800).....	\$109.00
Bit 3 Full View 80.....	\$229.00

### Commodore

C128 Computer.....	SNEW
C1571 (Disk Drive for C128).....	SNEW
C1902 (RGB 13" Monitor for C128).....	SNEW
C1870 (Modem for C128).....	SNEW
SX-84 Portable.....	CALL
Commodore Plus 4.....	\$199.00
CBM 84.....	\$149.00
C1541 Disk Drive.....	\$199.00
C1530 Datasette.....	\$39.99
M-801 Dot Matrix Printer.....	\$189.00
M-802 Dot Matrix/Serial.....	\$219.00
MCS 803 Dot Matrix.....	\$179.00
C1802 Color Monitor.....	\$199.00
C1660 Auto Modem.....	\$59.99
DPS 1101 Daisy Printer.....	\$339.00

### Professional Software

Fleet System II w/Spell.....	\$49.99
Trivia Fever.....	\$29.99
Word Pro 4 Plus/5 Plus each.....	\$239.00
Info Pro.....	\$179.00
Administrator.....	\$399.00
Power.....	\$69.99

### pfs:

File (64).....	\$59.99
Report (64).....	\$49.99

### Precision Software

Superbase 84.....	\$54.99
-------------------	---------

### BATTERIES INCLUDED

PaperClip w/Spell Pack.....	\$79.99
The Consultant DBMS.....	\$69.99
Bus Card II.....	\$139.00
80 Col Display.....	\$139.00

## PORTABLE COMPUTERS

### hp HEWLETT PACKARD

41CV.....	\$189.99
41CX.....	\$249.99
HP 71B.....	\$419.99
HP 11C.....	\$82.99
HP 12C/15C/18C.....	\$89.99
HP 75D.....	\$999.99
HPIL Module.....	\$98.99
HPIL Cassette or Printer.....	\$359.99
Card Reader.....	\$143.99
Extended Function Module.....	\$63.99
Time Module.....	\$63.99

We stock the full line of  
HP calculator products

### NEC

PC-8401.....	CALL
PC-8201 Portable Computer.....	\$299.00
PC-8231 Disk Drive.....	\$599.00
PC-8221A Thermal Printers.....	\$149.00
PC-8281A Data Recorder.....	\$99.99
PC-8201-08 8K RAM Chips.....	\$105.00

### SHARP

PC-1350.....	\$159.99
PC-1261.....	\$159.99
PC-1260.....	\$109.99
PC-1500A.....	\$165.99
PC-1250A.....	\$88.99
CE-125 Printer/Cassette.....	\$128.99
CE-150 Color Printer Cassette.....	\$171.99
CE-161 16K RAM.....	\$134.99

### DRIVES

#### HARD

#### ALLOY

PC Stor.....	CALL
--------------	------

#### IDEA Associates

5 meg Removable/Internal.....	\$1399.00
10 meg Fixed/Internal.....	\$1249.00
15 meg 5 Removable/10 Fixed.....	\$2149.00
25 meg 5 Removable/20 Fixed.....	\$2499.00

#### i-MEGA

10 Meg Bernoulli Box.....	\$2099.00
20 meg Bernoulli Box.....	\$2599.00
5 meg "MacNoulli".....	\$1599.00

#### TALLGRASS TECHNOLOGIES

COMMITTED TO SUPPORT

12, 25, 35, 50, 80 meg (PC)	
.....	from \$1499.00

### FLOPPY

#### INDUS

Apple GT.....	\$209.00
Atari GT.....	\$239.00
C-64 GT.....	\$259.00

#### µ-SCI

A1.5 Apple.....	\$199.00
A2 Apple.....	\$199.00

#### MSD

SD1 C-64 Single.....	\$219.00
SD2 C-64 Dual.....	\$469.00

#### Tandon

320K 5 1/4" (PC).....	\$119.00
-----------------------	----------

#### TEAC

320K 5 1/4".....	\$119.00
------------------	----------

### ACCESSORIES

#### key tronic

KB5150/KB5151/KB5151 Jr.....	CALL
KB5152B/KB5153/KB5149 Jr.....	CALL

#### MEMORY CHIPS

4164 RAM Chips.....	(ea.) \$1.99
---------------------	--------------

#### Microphonics

Pronounce	
Speech Input System.....	\$499.00

## MODEMS

### ANCHOR

Volkmodem.....	\$59.99
Volkmodem XII.....	\$109.99
Mark XII (1200 Baud).....	\$259.00
Signalman Express.....	\$299.00
Lightning 2400 Baud.....	\$399.00

### Hayes

Smartmodem 300.....	\$145.00
Smartmodem 1200.....	\$389.00
Smartmodem 1200B.....	\$359.00
Smartmodem 2400.....	\$699.00
Micromodem IIe.....	\$249.00
Smart Com II.....	\$69.99
Chronograph.....	\$199.00
Transet 1000.....	CALL

### AST

Reach 1200 Baud Half Card.....	\$399.00
--------------------------------	----------

### MPP MICROBITS

MPP-1000E AD/AA (Atari).....	\$79.99
MPP-1064 AD/AA (C-64).....	\$69.99

### Novation

Smart Cat Plus.....	\$319.00
J-Cat.....	\$99.99
Novation 2400.....	CALL
Apple Cat II.....	\$229.00
212 Apple Cat II.....	\$379.00
Apple Cat 212 Upgrade.....	\$229.00
Macmodem.....	\$319.00

### QUADRAM

Quadmodem II	
300/1200.....	\$338.00
300/1200/2400.....	\$499.00

### TELELEARNING

C64 300 Baud.....(Closeout).....	\$39.00
----------------------------------	---------

### TENITY

ZT-1.....	\$339.00
ZT-10.....	\$309.00
ZT-11.....	\$369.00
Z-22 Video Data Terminal.....	\$529.00

## DISKETTES

### maxell.

3 1/2" SS/DD.....	\$39.99
3 1/2" DS/DD.....	\$54.99
5 1/4" MD-1 w/Hardcase.....	\$17.99
5 1/4" MD-2 w/Hardcase.....	\$23.99
5 1/4" MD-2-HD for AT.....	\$44.99

### Verbatim.

5 1/4" SS/DD.....	\$21.99
5 1/4" DS/DD.....	\$28.99
Disk Analyzer.....	\$24.99

### Dennison

Elephant 5 1/4" SS/SD.....	\$13.99
Elephant 5 1/4" SS/DD.....	\$15.99
Elephant 5 1/4" DS/DD.....	\$16.99
Elephant EMSP 5 1/4".....	\$24.99

### IBM

5 1/4" DS/DD.....	\$26.99
-------------------	---------

## DISK HOLDERS

### INNOVATIVE CONCEPTS

Flip-in-File 10.....	\$3.99
Flip-in-File 50.....	\$17.99
Flip-in-File 50 w/lock.....	\$24.99
Flip-in-File (400/800 ROM).....	\$11.99

### AMARAY

50 Disk Tub 5 1/4".....	\$9.99
30 Disk Tub 3 1/2".....	\$8.99

### SMITH-BIRDAWS

Wood Disk Holder.....	CALL
-----------------------	------

## GRAPHICS

### Koala

IBM.....	\$89.99
Apple/Franklin.....	\$79.99

### Polaroid

Palette.....	\$1299.00
--------------	-----------

CALL TOLL-FREE

## MONITORS

### AMDEK

300 Green.....	\$129.00
300 Amber.....	\$139.00
310 Amber IBM-Plug.....	\$169.00
Color 300 Composite.....	\$239.00
Color 500 Composite/RGB.....	\$389.00
Color 600 Hi-Res (640x240).....	\$399.00
Color 700 Hi-Res (720x240).....	\$499.00
Color 710 Long Phosphor.....	\$579.00



12" Amber/Green Composite.....	\$99.99
12" Amber/Green TTL.....(ea.)	\$119.00

### NEC

JB 1260 Green.....	\$59.99
JB 1201/1205 (ea.).....	\$99.99
JB 1270 Green.....	\$139.00
JB 1275 Amber.....	\$149.00
JB 1280 G TTL/1285 A TTL.....	\$149.00
JC 1460 Color.....	\$269.00
JC 1410 RGB.....	\$869.00

### PRINCETON

MAX-12E Amber.....	\$189.00
HX-9 9" RGB.....	\$469.00
HX-9E Enhanced.....	\$519.00
HX-12 12" RGB.....	\$469.00
HX-12E Enhanced.....	\$559.00
SR-12 Hi-Res.....	\$599.00
SR-12 P Enhanced.....	\$649.00

### TAXAN

115 12" Green Mono.....	\$119.00
116 12" Amber Mono.....	\$119.00
121 Green TTL.....	\$139.00
122 Amber TTL.....	\$149.00
400 Med-Res RGB.....	\$299.00
420 Hi-Res RGB (IBM).....	\$429.00
440 Ultra Hi-Res RGB.....	\$559.00

### QUADRAM

8400 Quadchrome I.....	\$479.00
8410 Quadchrome II.....	\$429.00
8420 Amberchrome.....	\$179.00
8500 Quad Screen.....	\$1499.00

### ZENITH

ZVM 122/123.....	\$79.99
ZVM 124 IBM Amber.....	\$149.00
ZVM 130 Color.....	\$269.00
ZVM 131 Color.....	\$249.00
ZVM 133 RGB.....	\$429.00
ZVM 135 RGB/Color.....	\$459.00
ZVM 136 RGB/Color.....	\$599.00
1220, 1230, 1240.....	CALL

## INTERFACES

Graphcard	\$79.99
Serial Card.....	\$99.99
Microbuffer II +.....	\$169.00
Microbuffer 32K.....	\$189.00

### QUADRAM

Microfazer.....	from \$139.00
Etazer (Epson).....	from \$79.99

### Orange Micro

Grappler CD (C64).....	\$99.99
Grappler + (Apple).....	\$89.99
Grappler 16K + (Apple).....	\$159.00

## DIGITAL DEVICES

Ape Face (Atari).....	\$49.99
U-Print A (Atari).....	\$54.99
U-A16/Buffer (Atari).....	\$74.99
U-Call Interface (Atari).....	\$39.99
U-Print C (C64).....	\$49.99
P-16 Print Buffer.....	\$74.99

### MPP MICROBITS

MB1150 Parallel (Atari).....	\$79.99
MPP-1150 Parallel (Atari).....	\$69.99
MP-1150XL (Atari 1200XL).....	\$69.99
MicroStuffer 64K Print Buffer.....	\$109.00

## PRINTERS

### AXIOM

AT-100 Atari Interface Printer.....	\$139.00
AT-550 Atari Dual Mode.....	\$249.00
GP-100 Parallel Interface.....	\$189.00
GP-700 Color Printer.....	\$449.00
GP-550 Parallel Printer.....	\$239.00
Penman 3-pen.....	\$289.00

### CITIZEN

MSP-10 (80 col.).....	\$349.00
MSP-15 (132 col.).....	\$499.00
MSP-20 (80 col.).....	\$489.00
MSP-25 (132 col.).....	\$679.00

### C. ITOH

Prowriter 7500.....	\$219.00
Prowriter 8510P.....	\$299.00
Prowriter 8510 NLO.....	\$329.00
Prowriter 1550P.....	\$469.00
F10-40P Starwriter.....	\$869.00
F10-55 Printmaster.....	\$1049.00

ComWriterII Letter Quality.....	\$399.00
---------------------------------	----------

### corona

Lazer LP-300.....	\$2799.00
-------------------	-----------

### DIABLO

D25 Daisywheel.....	\$599.00
630-109 Daisywheel.....	\$1749.00
D801F Daisywheel.....	CALL

### daisywriter

2000.....	\$749.00
-----------	----------

### EPSON

RX-80, FX-80 +, LX-80, JX-80.....	CALL
FX-100 +, RX-100, LQ1500.....	CALL
Homewriter 10.....	CALL
NEW! LX-90, SO-2000, DX10, DX20, HS-80.....	CALL

### JUKI

6000 Letter Quality.....	CALL
6100 Letter Quality.....	CALL
6300 Letter Quality.....	CALL

### NEC

8027 Transportable.....	\$299.00
2000 Series.....	\$699.00
3000 Series.....	\$1099.00
8000 Series.....	\$1499.00
ELF 360.....	\$449.00

### OKIDATA

84, 182, 192, 193 2410.....	CALL
Okinate 10 (Specially C64/Atari).....	\$109.00
Okimate 20 (IBM).....	CALL

### OLYMPIA

Needlepoint Dot Matrix.....	\$299.00
Compact RO.....	\$339.00
Compact 2.....	\$369.00

### Panasonic

KX1090.....	\$199.00
KX1091.....	\$279.00
KX1092.....	\$409.00
KX1093.....	\$599.00

### QUADRAM

Quadjet.....	\$399.00
Quadlaser.....	CALL

### SILVER-REED

500 Letter Quality.....	\$279.00
550 Letter Quality.....	\$419.00
770 Letter Quality.....	\$759.00

### stora

SB/SD/SG/SR Series.....	CALL
Powertype Letter Quality.....	CALL
SG-10C (C64 Interface).....	\$NEW

### TOSHIBA

1340 (80 column).....	\$599.00
P351 (132 column).....	\$1299.00

## PC COMPATIBLES

## IBM PC SYSTEMS

Configured to your specification.  
Call for Best Price!  
IBM-PC, IBM-PC II, IBM-XT, IBM-AT

### ITT

ITT X-TRA.....	CALL
256K, 2 Drive System.....	CALL
256K, 10 meg Hard Drive System.....	CALL

### AT&T

Satan (7300).....	CALL
6300.....	CALL

## SOFTWARE FOR IBM

### ALPHA

Electronic Desk.....	\$189.00
----------------------	----------

### ANHTON-FATE

Framework.....	\$399.00
dBase II.....	\$299.00
dBase III.....	\$389.00

### BORLAND

Turbo Pascal 3.0.....	\$49.99
Sidekick.....	\$39.99

### ELECTRONIC ARTS

Get Organized.....	\$69.99
Cut-n-Paste.....	\$39.99
Music Construction.....	\$29.99
One-on-One.....	\$29.99
Financial Cookbook.....	\$34.99

### Harvard Software Inc.

Harvard Project Manager.....	\$209.00
Total Project Manager.....	\$269.00

### Human Edge™

Communication Edge.....	\$99.99
Management Edge.....	\$119.00
Negotiation Edge.....	\$139.00
Sales Edge.....	\$119.00

PC Paintbrush	\$94.99
---------------	---------

Symphony	\$439.00
----------	----------

1-2-3.....	\$309.00
------------	----------

WordStar 2000.....	\$249.00
--------------------	----------

WordStar 2000+.....	\$319.00
---------------------	----------

Flight Simulator.....	\$39.99
-----------------------	---------

MultiPlan.....	\$129.00
----------------	----------

CrossTalk.....	\$89.99
----------------	---------

R:Base 4000.....	\$249.00
------------------	----------

R:Base 5000.....	\$399.00
------------------	----------

Clout 20.....	\$129.00
---------------	----------

Multi Mate	\$249.00
------------	----------

PeachPack (GL/AP/AR).....	\$199.00
---------------------------	----------

Access (NEW).....	\$79.99
-------------------	---------

Write/Graph/File/Plan.....(ea.)	\$79.99
---------------------------------	---------

Report.....	\$74.99
-------------	---------

Proof.....	\$59.99
------------	---------

Mac Software.....	CALL
-------------------	------

Professional Software.....	CALL
----------------------------	------

PC Plus/The Boss.....	\$249.00
-----------------------	----------

Enable.....	\$369.00
-------------	----------

Accounting.....	\$295.00
-----------------	----------

AP/AR/GL/INV/OE.....(ea.)	\$195.00
---------------------------	----------

Supercalc III.....	\$195.00
--------------------	----------

EasyWriter II System.....	\$195.00
---------------------------	----------

Super Project.....	\$195.00
--------------------	----------

Open Access.....	\$379.00
------------------	----------

Word Perfect.....	\$239.00
-------------------	----------

File Manager (IBM).....	\$39.99
-------------------------	---------

Trigger.....	\$289.00
--------------	----------

Self, Sell, Sell.....	\$299.00
-----------------------	----------

Training.....	\$179.00
---------------	----------

Application.....	\$179.00
------------------	----------

### ZENITH

PC-151-21 Single Desktop.....	CALL
PC-151-53 Dual Desktop.....	CALL
PC-151-53 10 meg Desktop.....	CALL
PC-161-21 Single Portable.....	CALL
PC-161-52 Dual Portable.....	CALL
Z-200 (AT).....	CALL
171 (Portable).....	CALL
138 (Transportable).....	CALL
148 (DeskTop).....	CALL

### corona

PPC400 Dual Portable.....	\$1799.00
PPCXT 10 meg Portable.....	\$2399.00
PC40022 10 meg Desktop.....	\$1999.00

### SANYO

MBC 550-2 Single Drive.....	\$699.00
MBC 555-2 Dual Drive.....	\$969.00
MBC 775 Portable.....	\$1599.00
MBC 511 10 meg.....	CALL
MBC 675 Portable.....	CALL
MBC 880 Desktop.....	CALL

## MULTIFUNCTION CARDS

### AST

Six Pack Plus.....	\$239.00
Mega Plus II.....	\$269.00
I/O Plus II.....	\$139.00
Advantage-AT.....	\$399.00
Graph Pak.....	\$599.00
Monograph Plus.....	\$399.00
Preview Mono.....	\$299.00
PC Net Cards.....	\$379.00
5251/11 On-line.....	\$799.00
5251/12 Remote.....	\$579.00
3780 Emulation Card.....	\$639.00
BSC Bisyne.....	\$489.00

IRMA 3270	\$879.00
-----------	----------

IRMA Print.....	\$999.00
-----------------	----------

### EVEREX

Color Card (Graphics Edge).....	\$299.00
Magic Card.....	\$199.00

### HERCULES

Graphics.....	\$299.00
Color.....	\$159.00

### IBU Associates

IDEAmax - ZPR, B4K, C, S, P.....	\$229.00
IDEAmini - YPR, C, S, P.....	\$189.00
IDEAminimax - MPR 128K.....	\$229.00
IDEAshare Software.....	\$219.00
IDEA 5251.....	\$699.00

### MYLEX

The Chairman.....	\$489.00
-------------------	----------

### PARADISE

Modular Graphics Card.....	\$274.00
Multi Display Card.....	\$289.00
Five Pack C, S.....	\$159.00

### PERSYST

Bob Board.....	\$389.00
----------------	----------

### PLANTRONICS

Color Plus.....	\$369.00
-----------------	----------

### LESMAR

Captain - 64.....	\$239.00
Captain Jr. 128K.....	\$339.00
Graphics Master.....	\$469.00

### QUADRAM

Quadport-AT.....	\$119.00
Quadmeg - AT (128K).....	\$349.00
The Gold Quadboard.....	\$449.00
The Silver Quadboard.....	\$239.00
Expanded Quadboard.....	\$219.00
Quad 512+.....	\$229.00
Liberty.....	\$309.00
QuadPrint.....	\$499.00
QuadLink.....	\$399.00
Quadcolor 1.....	\$199.00
Quad Jr. Expansion Chassis.....	\$469.00
Expansion Chassis Memory.....	\$199.00
Quadmem Jr.....	\$199.00
Chronograph.....	

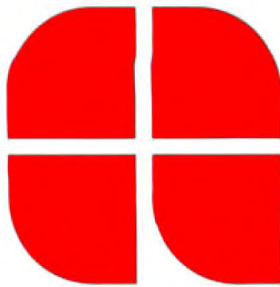

# GenTech

CHAOS MANOR

## COMPUTERS

<b>IBM SYSTEM SPECIALS</b>	
256K, 2 Drives	\$Call
256K, 1 Drive & 10 MB Hard	\$Call
IBM AT All Models	\$Call
CORDNA 400 Series	\$Call
FIJITSU Micro 1Bs (8086/Z8DA)	\$1995



<b>KAYPRO All Models</b>		\$Call
<b>LEADING EDGE PC</b>		\$Call
<b>MORROW DESIGNS All Models</b>		\$Call
<b>NCR All Models</b>		\$Call
<b>NEC APC-III PACKAGES</b>		
w/2 Dr, Wordstar Pro Pk, 2050		\$2299
w/plotter, digitizer & AutoCAD		\$Call
<b>SEEDUA Chameleon/Plus</b>		\$Call
<b>WANG</b>		
PC w/256K, 2 Dr.		\$Call
Office Assistant w/printer		\$Call
<b>ZENITH</b>		
ZF-151-52 w/Zenith Monitor		\$Call
ZF-151-21 w/10 MB Hard Disk		\$Call
ZF-161-52 (Portable, 2 Dr)		\$1675

## FOR IBM PC/AT/JR & COMPAT

<b>BLUE LYNX 3278</b>	\$Call	
<b>DCA Irma/Irmaline/IrmaKey</b>	\$Call	
<b>IDEAComm 3278</b>	\$Call	
<b>ANCHOR Mark XII</b>		\$239
<b>HAYES</b>		
Smartmodem 1200/2400		\$385/\$Call
1200B w/Smartcom II		\$355
NOVATION SmartCat Plus		\$329
PRENTICE POPCOM		
C100X100		\$249/\$265
VEN-TEL 3001200 Half Card		\$409



<b>AST RESEARCH INC.</b>	
ADVANTAGE I (for AT)	\$Call
SIX PACK PLUS w/64K	\$Call
ICOMBO (exp. to 512K)	\$Call
HERCULES Graphics Card	\$288
Color Card (RGB/Comp/Par)	\$155
INTEL 8087/80287	\$Call
ORCHID PC Turbo 186 w/28K	\$655
PARADISE SYSTEMS Multi-Display	\$280
Modular Graphics Card	\$288
Module A/B	\$75/\$178
PROMETHEUS Promodem Ext.	\$315

<b>QUADRAM</b>	
EXPANDED QUADBOARD w/64K	\$239
QUAD 512+ w/384K	\$309
<b>SIGMA DESIGNS Color 400</b>	
/Mouse	\$499/\$575
STB SYSTEMS Graphix Plus II	\$259
Super Rio w/64K	\$279
TALL TREE JRAM-2	\$Call
TANDON TM-100-2 (DSDD)	\$129
TEAC FD-558 (Thinline DSDD)	\$109
TECMAR Graphics Master	\$495
Captain w/DK	\$179
JrCaptain w/128K	\$309

## HARD DISK

AMPEX 20 MB w/25 MB Tape	\$Call
<b>CORVUS</b>	
11.1 MB Omnidrive Starter Kit	\$1649
45 MB Omnidrive	\$4149
Trimline Combo (TLC)	\$Call



INTERDYNE Tape Back Up	\$Call
IRWIN Internal Tape Back Up	\$549
OMEGA Bernoulli 20 MB	\$2499
MICROSCIENCE/SEAGATE	\$Call
MAYNARD ELECTRONICS	\$Call
SYSGEN Image/Oic-File/XL	\$Call

<b>TALLGRASS</b>	
TG-5025 (25 MB w/60 MB Tape)	\$2759
TG-6180 (80 MB w/60 MB Tape)	\$Call

## DOT MATRIX PRINTERS

<b>C-ITDH All Models</b>		\$Call	
<b>CITIZEN</b>			
MSP-10	\$329	MSP-15	\$489
MSP-20	\$Call	MSP-25	\$Call

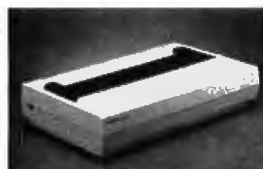

EPSON IX-80 Color	\$489			
LQ-1500	\$899	LX-80	\$229	
FX-80+	\$345	FX-100+	\$485	
NEC P2/P3 Pinwriters			\$525/\$735	
<b>OKIDATA</b>				
192	\$359	ML 84P	\$Call	
Okimate 20	\$Call	Pacemark	\$Call	
<b>PANASONIC KX-P1091</b>				\$249
<b>STAR MICRONICS</b>				
Gemini 15X	\$345	SG-10	\$229	
SD-1Q15	\$Call	SR-15	\$619	
<b>TOSHIBA</b>				
P1340	\$559	P351	\$Call	

## LETTER QUALITY

<b>BROTHER/DYNAX</b>			
HR-15 XL (20 CPS)	\$359		
HR-25HR-35	\$495/\$729		
<b>HEWLETT-PACKARD Laser Jet</b>		\$Call	
DIABLO 630 ECS/IBM	\$1779		
JUKI 6100/6300	\$Call		
<b>NEC</b>			
ELF 360	\$415	2050	\$669
3550	\$1068	8850	\$1499
QUME Sprint 1140/1155/1190			\$Call
SILVER REED EXP 500/550			\$250/\$419
STAR MICRONICS Power Type			\$415

## PLOTTERS & DIGITIZERS

POLAROID PALETTE	\$1099
ENTER COMPUTER Six Shooter	\$779



<b>HOUSTON INSTRUMENTS</b>			
PC-695	\$555	DMP-4142	\$2369
DMP-29	\$1799	DMP-5V52	\$3559
DT-11 Digitizer			\$679
ROLAND DXY800/880			\$699/\$920
SUMMAGRAPHICS SummaSketch			\$Call

## MONITORS & TERMINALS

<b>AMDEK</b>			
Video 300/300A/310A	\$125/\$30155		
Color 500/710	\$319/\$539		
<b>PRINCETON GRAPHICS Max-12E</b>		\$175	
HX-12SR-12		\$469/\$599	
<b>QUME All Models</b>		\$Call	
<b>ROLAND</b>			
MB-122G	\$155	MB-142	\$Call
CB-141	\$269	CC-141	\$559
<b>TAXAN</b>			
115	\$115	118	\$125
420/L	\$Call	440	\$559
<b>TELEVIDEO All Models</b>		\$Call	
<b>WYSE</b>			
WY50	\$459	WY350	\$Call
<b>ZENITH</b>			
ZVM-123A	\$79	ZVM-124	\$Call
ZVM-135	\$439	ZVM-136	\$Call
Z-29A	\$Call	Z-49	\$Call

## FOR APPLE II/IIe

ALS Smarterm II (80 Cal. Card)	\$129
AST RESEARCH INC. Multi I/O	\$Call
DIGITAL RESEARCH CP/M Gold Card	\$268
FOURTH DIMENSION IBM RAM Card	\$55
80 Column Card (Re)	\$55
<b>HAYES</b>	
Micromodem II w/Smartcom I	\$149
MICROSOFT Softcard II	\$339
MICROTEK Dumping GX	\$69
<b>NOVATION Apple Card II</b>	
212 Apple Card II (1200)	\$209
212 Apple Card II (1200)	\$389
ORANGE MICRO Grappier +	\$79
Buffered Grappier +	\$145
PCPI Applicard 6 MMz.	\$Call
MACINTOSH DRIVE	CALL FOR \$8

## MISCELLANEOUS

<b>RAM CHIPS</b>				
64K SET	\$14	256K SET	\$Call	
call for quantity pricing				
<b>DOUBLE-SIDED DISKETTES</b>				
3M	\$27	Dysan	\$30	
Maxell	\$25	Wabash	\$19	
<b>PRINT BUFFERS</b>				
<b>QUADRAM Microfazer</b>				
Parallel/Parallel	16K		\$139	
64K	\$185	128K	\$238	
Serial/Serial, Ser/Par, Par/Ser				
8K	\$139	64K	\$159	
<b>INTER.STRUCT. Shuffle</b>				
Buffer 32K			\$269	
<b>SURGE PROTECTORS</b>				
EPD/CURTIS All models			\$Call	
NETWORK Wire Tee/Plus			\$39/\$55	
<b>KENSINGTON Masterpiece</b>				\$Call
<b>EMERGENCY POWER SYSTEMS</b>				
<b>SOLA Mini UPS</b>				\$Call
TrippLite BC425-FC (425 Watts)			\$375	
<b>SWITCHBOXES</b>				
<b>CABLECO 3 Way Serial/Parallel</b>				\$Call
<b>COMPUTER ACCESSORIES</b>				
Data Directors (All Models)				\$Call

## CUSTOMER SERVICE

401-781-0020

## ORDERS ONLY

800-843-4302

150 Broadway, Suite 2212, NY, NY 10038

HOURS 9-8 EST, MONDAY-SATURDAY  
Personal Ch. (2 Weeks To Clear), Cashier's Ch.  
Money Order Accepted  
APO Orders Add 8% (maximum \$7). Add 3%  
For Net Terms All Returned Non-Defective  
Merchandise Are Subject To A 20% Restocking  
Charge. GenTech Reserves the Right to Change  
Advertised Prices



Command-driven adventure games are much different. You don't know what you'll be allowed to do. The machine knows what you're permitted, but it doesn't know precisely how you'll give the command. Sophisticated games, like the excellent Infocom series, have highly complex program structures, including a *command parser* that looks at what you ordered and tries to make sense of it. Often it succeeds.

In command-driven games you must experiment. Sometimes you have to do a lot. Badly designed games of this sort are terribly frustrating: you sit there and try what look like perfectly reasonable actions, only to be given some stupid generic message like, "I don't understand that." In the ideal case, though, the game designer will have thought of everything you might want to try and has built in some kind of response appropriate to what you tried. "Dig." "I see no shovel here."

Even the well-designed games can be frustrating, since you're trying to solve a puzzle, and you can't be *sure* that the designer even considered the ingenious idea you've just come up with for getting past the forest of skeletons or whatever blocks your path. Moreover, because you have to figure out what you're allowed to do, it takes longer to learn how to play command-driven games.

By contrast, you can play menu games almost instantly. All you have to do is read through the rule book or examine the help file or whatever. Thus I find that menu-driven games catch my attention quicker than the command type.

However, I also find that I tire of them sooner. In Wizardry I, for example, once I learned the menu of commands, it was easy to move about in the dungeon. (Not too easy: I managed to lose no fewer than 11 first-rate characters before I caught on to what I was doing wrong and tried a new approach.) At first that was fun. Then, as I learned the shape of the maze and the nature of the puzzles, I longed for the ability to do multiple moves. In-

(continued)

# COMPUTER WAREHOUSE

CALL TOLL FREE **1-800-528-1054**

## PRINTERS

<b>Anadex</b> All Models	Call
<b>Brother</b> HR10 w/Tractor	\$239
HR-15XL	\$339
HR-25	\$599
HR-35	\$809
Telexwriter 5	\$819
<b>Canon</b> LBP-8A1	Call
<b>C-Itch</b> A-10-30	\$469
F-10 Parallel or Serial	\$869
55 CPS Serial or Parallel	\$1035
8510 Parallel (Prowriter)	\$295
8510 SP	\$385
8510 SCP	\$465
8510 BP1	\$315
<b>Citizen</b> MSP-10	\$279
MSP-15	\$414
MSP-20	\$414
MSP-25	\$539
<b>Comrex</b> CR-2E	\$364
CR-4	Call
420	\$1529
<b>DaisyLaser</b> PR101	Call
<b>Datasouth</b> DS160	\$1079
DS220	\$1299
DS-PP#1	\$449
DS-PP#2	\$629
<b>Diablo</b> D-25	\$549
630 API	\$1484
630 ECS	\$1659
630 ECS/IBM	\$1659
Other Printer Models	Call
<b>Epson</b> All Printer Models	Call
<b>Inforunner</b> Riteman w/Tractor	\$244
Riteman 15	\$499
Riteman Blue w/Tractor	\$299
<b>Juki</b> 5500	Call
8000	\$199
6100	\$385
6300	\$699
<b>NEC</b> 2010, 2015, 2030, 2050	\$629
3510, 3515, 3530, 3550	\$1009
6810, 6815, 6830, 6850	\$1399
P2, P3	Call
<b>Okidata</b> All Printer Models	Call
<b>Panasonic</b> 1091	\$239
1092	\$349
1093	\$429
KXP3151	\$459
<b>Siemens</b> PT/88 InkJet	Call
PT/89 InkJet	Call
<b>Star Micronics</b> All Printer Models	Call
<b>Silver Reed</b> EXP400 Parallel	\$229
EXP500 Parallel or Serial	\$279
EXP550 Parallel or Serial	\$389
EXP770 Parallel or Serial	\$699
<b>Texas Instruments</b> 850 & 880 Series	Call
<b>Toshiba</b> PT340 Parallel or Serial	\$544
P351 Parallel or Serial	\$1155

## MONITORS

<b>Amdek</b> All Monitors	Call
<b>Princeton Graphic</b> HX-12	\$445
<b>Sanyo</b> CRT-36	\$149
<b>Taxan</b> 121 Green	\$125
122 Amber	\$134
420 RGB	\$399
425 RGB/Green	\$410
440	\$549
<b>Zenith</b> ZVM-122 Amber	\$95
ZVM-123 Green	\$89
ZVM-124	\$119
ZVM-130	Call
ZVM-133 Color/RGB	\$410
ZVM-135 Color/RGB w/Audio	\$459
ZVM-136	\$675

**Purulator COURIER FEDERAL EXPRESS**

**FREE**  
**Air Express Shipping**

See Details Below

## SOFTWARE IBM PC and 100% Compatibles

Crosstalk 16	.....	\$95
D Base III	.....	\$359
Enable	.....	\$329
Framework	.....	\$339
Multimate 3.3	.....	\$225
Smart System	.....	\$459
Super Calc 3 (ver. 2)	.....	\$159
Word Perfect 4.0	.....	\$209
Wordstar 2000	.....	\$239
Wordstar Professional	.....	\$239

Many other titles available.

We do not guarantee computer compatibility.



**Canon**  
**«PC»**  
PERSONAL COPIERS

**Canon PC-10**  
Compact. Convenient. Personal. With the exclusive Canon cartridge copying system for easy maintenance. **\$509**



**Canon PC-25**  
Reduction and enlargement comes to Personal Cartridge copying. Make copies up to legal size from originals as big as 10" x 14" **\$939**



**Canon PC-20**  
Compact, yet efficient for any business. With the exclusive Canon cartridge copying system. Plus automatic paper feeding. Make 6 copies a minute. **\$719**

## MODEMS

<b>Anchor Automation</b> Anchor Express	\$269
Mark XII	\$239
<b>Hayes</b> Smartmodem 300 Baud	\$129
Smartmodem 1200 Baud	\$379
Smartmodem 1200B (IBM)	\$319
Smartmodem 2400 Baud	\$609
Micromodem IIE (Apple)	\$129
<b>Novation</b> Smart Cat Plus	\$279
<b>Prometheus</b> All Models	Call
<b>Racal-Vadic</b> All Models	Call
<b>US Robotics</b> Password 1200	\$195

## BOARDS

<b>AST</b> Six Pack Plus	\$249
<b>Hercules</b> Color Card	\$145
Graphic Card	\$295
<b>Paradise</b> Modular Graphic OS-1	\$259
Five Pak	\$159
<b>Quadram</b> Quadboard EX Ok	\$219
E-Ram 80	\$89
Quadlink	\$325
<b>Tec Mar</b> Graphics Master	\$449
128K Dynamic Memory	\$225
256K Dynamic Memory	\$299
Captain 128K	\$289
Captain 256K	\$389

## COMPUTERS

<b>NEC</b> PC-8201 Computer	\$315
PC-8401A	Call
8201 & 8401 Accessories	Call
<b>Sanyo</b> MBC-775 Portable	\$1859
<b>Televideo</b> PM 4T	\$5089
PM 16T	Call
<b>Wyse</b> Wyse pc Dual	Call
Wyse pc 10 Meg	Call
<b>Zenith</b> Z-150 Single Drive	Save 25%
Z-150 Dual Drive	Save 25%
Z-150 W/10 Megabyte	Save 25%
Z-160 Single Drive	Save 25%
Z-160 Dual Drive	Save 25%
<b>VIDEO TERMINALS</b> <b>Altos</b> Smart II	\$769
<b>Qume</b> QVT Green 101	\$289
QVT Amber 101	\$314
<b>Televideo</b> 921	\$445
922	\$599
955	\$459
<b>Wyse</b> 50	\$429
75	\$565
Wyse 85	Call
<b>Zenith</b> Z-22	\$469
Z-29	\$599
Z-49	Call

## DISKETTES

<b>Maxell</b> MD-1 (Qty 100)	\$149
MD-2 (Qty 100)	\$189
<b>Nashua</b> S/S D/D (Qty 100)	\$125
D/S D/D (Qty 100)	\$135

## KEYBOARDS

<b>Keytronics</b> 8151	\$179
8151 Jr.	\$179

## PLOTTERS

<b>Enter</b> Sweet-P600	\$780
8151 Jr.	Call

## DISK DRIVES

<b>Alpha Omega</b> Turbo 10	\$599
Turbo 20	\$859
Turbo 30	\$1169
<b>Haba</b> Habadisk for Macintosh	\$289
<b>lomega</b> Bernoulli Box for IBM 10 Megabyte	Call
20 Megabyte	Call
20 Megabyte Plus	Call
5 Megabyte for Macintosh	Call
<b>Rana</b> Elite I	\$175
Elite II	\$339
Elite III	\$405
Elite 10H/Apple Controller (W/Drive Only)	\$1080
	\$69

# COMPUTER WAREHOUSE

Order Processing & Order Line: 1-800-528-1054  
Other Information: 602-954-6109

2222 E. Indian School Rd.  
Phoenix, Arizona 85016

Inquiry 77 for MS DOS Products. Inquiry 78 for all others.



Store Hours: Mon-Fri 10-5:30 Saturday 9-1  
Order Line Hours: Mon-Fri 8:30-5:30 Saturday 9-1



Prices reflect 3% to 5% cash discount. Product shipped in factory cartons with manufacturer's warranty. Please add \$9.00 per order for UPS ground shipping. Orders 10 lbs. and under you pay for ground service, receive air service at no extra charge. Available on orders 11-20 lbs. \$15 for air service. Orders 21-30 lbs. \$20 for air service. Prices & availability subject to change without notice. Send cashier's check or money order...all other checks will delay shipping two weeks.

## IBM PC/XT COMPATIBLE XT-16 SELF-ASSEMBLY KIT

*Build Your Own IBM PC/XT Fully  
Compatible Computer At Super Low Cost*

- Including: 256K XT-16 CPU Mother Board, Color Graphic Card, Floppy Controller, One DS/DD Slim Drive, Flip-Top Case, 135W Power Supply, Keyboard, 10-minute Step-by-Step Assembly Instruction, and User's System Manual. **Only \$799.00**



- Optional 2nd Drive, **\$95.00**  
For Monitor, 10MB Hard Disk Drive, and Assembled System. Please Call

### FLIP-TOP CASE

- Open from Top for Easy and Quick Access to Inside
- For IBM PC/XT Mother Board and Compatibles
- Slide-out IBM Style Case Also Available
- Mounting Parts Included



**\$85.00**

### 135 W POWER SUPPLY

*Upgrade Your IBM PC to XT*

- 4 Drives Power Plugs
- Side Switch model has same dimensions & power plug as IBM power supply.
- Back switch model can fit Mega case perfectly.

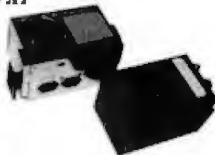

**\$115.00**

### KEYBOARD

- LED for Cap Lock & Numb. Lock
- Big Return Key.
- IBM PC/XT Compatible Keyboard.



**\$89.00**

### XT-16 CPU MOTHER BOARD

- IBM PC/XT Fully Compatible
- 8088 Micro-Processor w/8087 Optional
- 8 I/O Slots
- Up to 256K Memory on Board
- Same Dimension As IBM PC/XT Mother Board



Assembled & Tested Board (OK) ..... **\$285.00**

### PCP-128 EPROM PROGRAMMER

- Read and Program 2716, 2732, 2732A, 2764, 2764A, 2728, and 2816
- Super Fast Speed. 1 K/sec



**\$179.00**

- Disk I/O Card ..... **\$169.00**  
handle 2 Dr., Parallel, Serial (2nd Serial optional), Clock, Game Port
- Color Graphic Card ..... **\$119.00**
- Disk Controller w/Cable (handle 4 Drives) **\$75.00**
- IBM AT Compatible Keyboard, Power Supply, Case & Add-on Card ..... **Please Call**

## C.J. COMPUTERS CORP.

(Manufacturer & Distributor)  
2424 W. Ball Road, STE B  
Anaheim, CA 92804

Mail Order Hot Line: (714) 821-8922, (714) 821-8923

- ATTN: DEALERS  
CALL FOR OUR SPECIAL DEALER'S PRICE  
\*\*OEM Dealer Welcome\*\*

(IBM is a trademark of International Business Machines Corporation)

## CHAOS MANOR

### NaturalLink converts a command-driven program into a menu-driven program.

focom's designers have built in the capability for inputting whole strings of commands: Go east. Take sword. Kill troll with sword. Attack. Run away. Go south. The whole command string is considered one move at a time; if, for example, you killed the troll with the first stroke, the program would ignore the other commands to attack and ask for new instructions.

I wish I could do that in Wizardry I. For that matter, I wish I could use the Adventure trick of dropping objects to mark various passages and rooms; most of the Wizardry I dungeon is a maze of twisty little passages, all alike, and mapping them is tedious at best.

The conclusion from this is obvious: when you're first starting, it's best to have a menu; but after you've been at it for a while, you'll prefer commands.

Games may be thought frivolous, but the fact is that a good game command parser, like Infocom's, is a fairly hefty achievement, with profound implications for the whole field of artificial intelligence. After all, what we're really seeking is a way to let us control computers without having to use special commands. In the ideal case, we'd simply tell the machine what we wanted and watch it do it. Some of the Infocom games get pretty close to that ideal—but of course they're working in a restricted universe.

A computer program is a restricted universe.

### TI'S NATURAL LANGUAGE

Something of the above seems to be the philosophy of Texas Instruments' new natural-language front ends. You can get a natural-language shell for DOS, Lotus 1-2-3, WordStar, Word

Plus, the excellent BPS Business Graphics, EasyWriter, PeachText 5000, Knowledgeman, SuperCalc, Multi-Mate, and probably more that I didn't hear about. In addition, there's a sort of generic NaturalLink toolkit that can be used to generate NaturalLink shells for other command-driven programs.

NaturalLink in essence converts a command-driven program into a menu-driven program. With NaturalLink you begin to build "sentences" whose grammar and syntax are set by the application program the shell is built around. As you add words to the sentence, your choices become more restricted. Using WordStar as an example, begin with "I want to"; this is appropriate to any legal command in the program. Now add "edit," and the legal choices become only two: a document and a data (or nondocument) file.

As soon as your choices are narrowed down to one and only one, the NaturalLink program fills it in for you. It still doesn't execute the command. You get a chance to change things first.

The NaturalLink programs were delivered to me by Tom Siep of TI's corporate Human Factors facility (and I sure wish some of the other hardware outfits would start a human-factors center). TI's human-factors people classify users as beginners, experts, and occasional. The NaturalLink programs are designed for the first and last of those categories. Experts don't need them.

The NaturalLink shells have quick ways to get outside them and into the regular program the shell surrounds: into regular WordStar, or SuperCalc, or whatever. When you do that, the NaturalLink shell vanishes. It can be brought back easily.

Tom Siep was accompanied by Peggy Hart of TI's Austin research facility. They were visiting in Southern California ostensibly for the Winter COMDEX in Anaheim; that show was so small that I drove down for only one day and saw little to keep me there any longer. After COMDEX.

(continued)





*"Without question [NFL Challenge] is the finest computer game I've ever seen—but then I like football."  
John C. Dvorak San Francisco Examiner*

# Put the NFL at your fingertips.

Hands-on pro football excitement is as close as your keyboard with **NFL Challenge** from Xor. This is the officially licensed NFL action computer game with offensive plays and defensive sets based on the ones in NFL playbooks, plus complete updatable rosters for all 28 NFL teams.

Every game can be the Super Bowl when you take the field with Xor **NFL Challenge** software. Feel the pressure as you choose starting lineups, drive down-field against the clock, and go head-to-

head, down-by-down against the league's most innovative offenses and formidable defenses. It's the most intense computer simulation of the pro football experience ever devised.

Xor's **NFL Challenge** requires IBM® PC or PC/XT with DOS 2.0, 256K bytes of memory, monochrome monitor with IBM® monochrome card or RGB color monitor with IBM® color graphics adapter. Also runs on the IBM® PC/AT.

With **NFL Challenge** from Xor, you have 50-yard line seats for every game!

## Ordering Information

**NFL Challenge** will be in short supply. To kick off your NFL season, contact us for the name of the dealer nearest you:

**1-800-328-8322 ext. 538**  
(in MN call (612) 938-0005)

**NFL Challenge** will be reserved for you. Product will be available in limited quantities beginning in August, 1985.

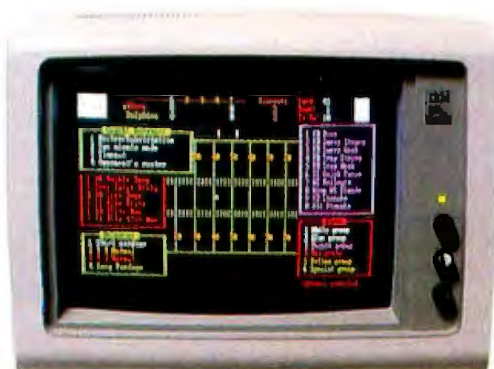

**XOR**<sup>TM</sup>  
CORPORATION

5421 Opportunity Court  
Minnetonka, Minnesota 55343  
(612) 938-0005

Inquiry 345



IBM is a registered trademark of International Business Machines. NFL Challenge is a trademark of Xor Corporation and NFL Properties, Inc. © 1985. All rights reserved.

they came up to Chaos Manor.

It's always interesting to see people here for the first time. I think no one really believes that my descriptions are accurate until they get here. Anyway, Tom and Peggy brought a box full of software, including the NaturalLink shells, and a TI Portable.

The Portable is a luggable version of the TI Professional. Big Tex, our TI Professional, is full of boards, including speech synthesis. The Portable is comfortably less filled up, although, give it time . . .

The Portable has color. The TI Professional is one of the few machines

with color good enough to do word processing on; the Portable lives up to that reputation. It also has a jack on the back so that you can pipe out the video display and put it on a large monitor.

Peggy Hart is involved in the design of the NaturalLink software. She isn't

## ITEMS DISCUSSED

**BASIC DEVELOPMENT SYSTEM** . . . \$125  
Beta Tools Systems  
8972 East Hampden Ave., Suite 179  
Denver, CO 80231  
(303) 793-0145

**BEYOND COMPARE** . . . . . \$30  
General Transformation Company  
POB 10083  
Berkeley, CA 94709  
(415) 644-0702

**CHECKS AND BALANCES** . . . . \$74.95  
CDE Software  
2463 McCready Ave.  
Los Angeles, CA 90039  
(213) 661-2031

**COLOR-400 PC GRAPHICS BOARD** . . . . . \$795  
Sigma Designs  
2023 O'Toole Ave.  
San Jose, CA 95131  
(408) 943-9480

**DISK MAKER I** . . . . . \$1995  
New Generation Systems Inc.  
1800 Michael Faraday Dr., Suite 206  
Reston, VA 22090  
(800) 368-3359

**EM-IT** . . . . . \$49.95  
Sayansi  
2605 Sierra Village Court  
San Jose, CA 95132  
(408) 729-3619

**FORMIT**  
you supply disk . . . . . \$15  
company supplies disk . . . . . \$20  
Emerald City Software  
POB 1001  
Ben Lomond, CA 95005  
(408) 336-3354

**HITCHHIKER'S GUIDE TO THE GALAXY**  
for Atari and  
Commodore 64 . . . . . \$34.95  
for all other machines . . . . \$39.95  
Infocom  
125 Cambridge Park Dr.  
Cambridge, MA 02140  
(617) 492-6000

**HYPERDRIVE**  
for 512K-byte Macintosh . . . \$2195  
for 128K-byte Macintosh . . . \$2795  
(includes \$600 upgrade to  
512K-byte Mac)  
General Computer Company  
215 First St.  
Cambridge, MA 02142  
(800) 422-0101

**LAPLACE** . . . . . Price unavailable  
P. L. Hagelstein and Associates  
POB 2723  
Livermore, CA 94550

**THE LEGENDARY SOFTWARE TOOLS**  
MS-DOS versions 2.0, 2.1, and  
3.0 . . . . . \$90  
CP/M-80 version 2.2 . . . . . \$90  
Carousel Tools  
Strong Consulting  
5706 Van Fleet Ave.  
Richmond, CA 94804

**MAXTHINK**  
copy-protected . . . . . \$59.95  
not copy-protected . . . . . \$120  
MaxThink Inc.  
230 Crocker Ave.  
Piedmont, CA 94610  
(415) 428-0104

**MAX-12 AMBER MONITOR** . . . . \$249  
**SR-12 COLOR MONITOR** . . . . \$799

Princeton Graphics  
601 Ewing St., Bldg. A9  
Princeton, NJ 08540  
(609) 683-1660

**MEGAMAC** . . . . . \$1395  
Micrographic Images  
21040 Victory Blvd., Suite 210  
Woodland Hills, CA 91367  
(818) 368-3482

**MITE COMMUNICATIONS** . . \$150-\$220  
Mycroft Laboratories  
2615 North Monroe St.  
Tallahassee, FL 32303  
(904) 385-1141

**MULTIPLE CHOICE** . . . . . \$64  
Awesome Technology  
177 Webster St., Suite A-416  
Monterey, CA 93940  
(800) 548-2255 ext. 803  
(outside California)  
(800) 624-2644 ext. 803  
(inside California)

**MYWORD!** . . . . . \$35  
TNT Software  
34069 Hainesville Rd.  
Round Lake, IL 60073  
(312) 223-0832

**NATURALLINK** . . . . . Contact company  
Texas Instruments  
POB 809063  
Dallas, TX 75380-9063  
(800) 527-3500

**OMNIDRIVE FOR MACINTOSH**  
5.5 megabytes . . . . . \$1495  
11 megabytes . . . . . \$1995  
21 megabytes . . . . . \$2995

**CHAOS MANOR**

a computer-science type—which helps. Her husband is a professor of rhetoric at the University of Texas at Austin, which probably helps too.

TI is hoping that the NaturalLink systems will be a key factor in selling the notion that people, especially businesses, ought to use TI PClones. They

just may succeed. I find the Natural-Link shells just the thing for programs I use only every now and then.

There's only one problem, which I brought up with TI executives during my trip to Austin. TI intended to license use of the NaturalLink tools to  
*(continued)*

Corvus Systems Inc.  
2100 Corvus Dr.  
San Jose, CA 95124  
(408) 559-7000

**THE ORIGINAL CHOCOLATE**

BYTE ..... \$9.95  
Software Toolworks  
15233 Ventura Blvd., Suite 1118  
Sherman Oaks, CA 91403  
(818) 986-4885

PC-MATLAB ..... \$695  
The Math Works  
124 Foxwood Rd.  
Portola Valley, CA 94025  
(415) 851-7217

PC-WRITE.....\$10 for disk and  
\$75 to register  
Quicksoft  
219 First North, #224  
Seattle, WA 98109  
(206) 282-0452

SAVVY ..... \$295  
Excalibur Technologies Corporation  
800 Rio Grande Blvd. NW  
Albuquerque, NM 87104  
(505) 242-3333

SIDEKICK  
copy-protected.....\$54.95  
not copy-protected.....\$84.95  
SUPERKEY.....\$69.95  
TURBO PASCAL 3.0.....\$69.95  
Borland International  
4585 Scotts Valley Dr.  
Scotts Valley, CA 95066  
(408) 438-8400

SOFTWARE ANTHOLOGY SERIES  
for CP/M (seven disks  
available) ..... \$32.50/disk  
for MS-DOS (one disk  
available).....\$32.50

Workman and Associates  
112 Marion Ave.  
Pasadena, CA 91106  
(818) 796-4401

STAR FLEET I.....\$49.95  
Cygnus  
POB 57825  
Webster, TX 77598  
(800) 622-4070  
(credit card orders)  
(713) 486-4163  
(check or COD orders)

VALDOCS 2.0  
for QX-10 (OEM product)..\$49.95  
Epson America Inc.  
2780 Lomita Blvd.  
Torrance, CA 90505  
(213) 539-9140

VALDRAW AND VALPAINT  
PACKAGE.....\$495  
Rising Star Industries  
25500 Hawthorne Blvd., Suite 2000  
Torrance, CA 90505  
(213) 373-9112

WIZARDRY I: PROVING GROUNDS OF  
THE MAD OVERLORD  
for Apple II.....\$49.95  
for Macintosh.....\$59.95  
for IBM PC, PCjr, and  
monochrome ..... \$59.95  
SifTech  
6 Main St.  
Ogdensburg, NY 13669  
(315) 393-6633

XENOCOPY.....Price unavailable  
Berkeley Software  
2124 Kittredge St.  
Berkeley, CA 94704  
(415) 524-8578

**WHY WAIT FOR  
ANSWERS FROM YOUR  
IBM PC/AT/XT  
NOW THERE'S  
MEGA-MATH™**

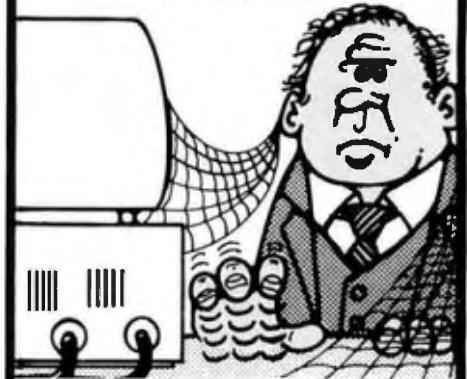

Engineers, scientists and statisticians are discovering the time saving capability of New "Mega Math" II. A library of over 45 assembly language subroutines for fast numeric calculations, up to 11 times faster than your present compiler. The pretested routines use the 8087 or 80287 coprocessor for optimum performance. The routines reduce development time, code size and testing time.

- "Mega Math" II includes:  
**MATRIX OPERATIONS**  
**VECTOR OPERATIONS**  
**VECTOR SCALAR OPERATIONS**  
**STATISTICAL OPERATIONS**  
**FAST FOURIER TRANSFORM**  
**CONVOLUTION**  
**SOLUTION OF LINEAR EQUATIONS**

The library is callable from Microsoft Fortran, Basic, "C" and Pascal compilers. Also IBM Professional Fortran and Macro Assembler. Get "Mega Math" II Performance for only

**\$299.00 (U.S.)**

Also available is the "Mega Math" A.T. "Booster". A single PC board, designed to reduce execution time in numeric processing applications.

If your IBM AT is equipped with the 80287 coprocessor, the "Booster" will enhance its performance by up to 50%.

PRICE **\$349.00 (U.S.)**

For increased performance of Mega Math Routines, inquire about Micray's high performance floating point processor for the IBM AT or compatibles.

**MICRAY  
ELECTRONICS LTD.**

(403) 250-1437  
Bay 1, 4001A - 19 Street N.E.  
Calgary, Alberta, Canada T2E 6X8



TRADE INQUIRIES WELCOME.

TRADEMARKS:

(IBM, PC/XT/AT)

INTERNATIONAL BUSINESS MACHINES  
(MICROSOFT) MICROSOFT CORPORATION  
(MEGA MATH) MICRAY

*Savvy seems to be  
the most interesting  
of the database  
systems that I've  
looked at so far.*

software houses. They'd charge stiff up-front fees and even stiffer royalties.

"Who can afford to use them?" I asked.

They stammered a bit.

"Didn't you learn from the TI-99 disaster?" I asked. "Freezing out small developers is a sure way to doom."

"We know that. We're encouraging small developers."

"By charging anyone who wants to experiment with NaturalLink \$1500 just to try it?"

"Well—that was expensive stuff to develop. How can we recover our costs? Because if we can't, then we've not got a lot of incentive to continue. Corporate will shut down the research effort."

I thought about that for a while and came up with what I think is an ingenious idea. "Look, you don't want 20 companies to pay you \$5000 for NaturalLink. That hundred grand would be nice, but it's not a patch on what it cost to develop the program."

No one wanted to touch that one.

"What you really want is five bucks

each from half a million copies."

"Sure—"

"But since no one can pick which software developer will come up with something that sells a million copies, what you need is to get the NaturalLink toolkit into the hands of as many developers as possible," I continued. "So. Give it away. If you have to charge anything at all, set the charge at your production cost. Don't charge royalties on products developed, either. Not at first. What you have them do is sign an agreement that they'll pay royalties on all the copies they sell after the first hundred are sold. That way you'll collect from the successful, and you won't discourage start-ups from using NaturalLink."

The TI people thought about that one. Last I heard they were going to try to get the corporation to adopt the policy.

I hope they do. NaturalLink is a, er, natural for occasional users like me. I can start work using the NaturalLink shell and switch over to command structure when I've refreshed my memory about the program.

More on NaturalLink and the TI Portable (well, Luggable) another time. I'm impressed with both.

**WINDING DOWN**

I'm running out of space, and there's still more to cover. There's a new version of Savvy, the odd database language that not only uses natural-language concepts but lets you spell the commands wrong. I find Savvy about

the easiest-to-use PC database of them all. However, I have a letter from a reader who doesn't like the fact that Savvy isn't just a database but a whole database programming language that you have to learn to get its real benefits. It's all true; to me, having a database language is a feature, not a bug.

Savvy bills itself as "The Artificial Intelligence Database" and pretty well lives up to the reputation. It's not copy-protected. The license agreement is silly but not as stupid as most. There's a nice tutorial, and the manual has examples. Before he left us to go back to graduate school, Peter Flynn (who *cannot* spell) studied a number of the databases here at Chaos Manor and decided that Savvy was the one he wanted to implement on PCs and compatibles. I've a bit less experience with Savvy's rivals, but I'm coming to the same conclusion: Savvy seems complete enough, is easy to get started with, and seems the most interesting of the database systems I've looked at so far.

There's also MaxThink. This is an "idea processor" that purports to solve most problems writers face. There's even a section on overcoming writer's block. The authors of MaxThink claim it's much more useful than ThinkTank, which was the first of the idea-processor programs (or at least the first I was ever aware of). I find ThinkTank indispensable. I *think* I'm going to like MaxThink. Alas, it has

*(continued)*

**THE \$2995 I<sup>2</sup> DEVELOPMENT SYSTEM**

Turns any personal computer into a complete micro-computer DEVELOPMENT SYSTEM. Our integrated control/display program runs under MS-DOS, CP/M, ISIS, or Apple and controls the UDL via an RS-232 port.



**32K bytes of EMULATION ROM (128K max)** allows you to make program patches instantly. Since the target ROM socket connects data and address lines to both the analyzer and the emulator, no expensive adaptors or personality modules are needed.

The powerful **BUS STATE ANALYZER** features four-step sequential triggering, selective trace, and pass and delay counters. Symbolic trace disassemblers and debuggers are available for Z-80, NSC-800, 8048, 6301, R65, 6500, 6800, 6801, 6802, 6805, 6809, 8051, 8085, Z-8, 1802, 8088/80188, 8086/80186, and 68000/8.

The **PROM GENERATOR** also doubles as a **STIMULUS GENERATOR**.

For further information, call or write:

**ORION** Instruments 702 Marshall Street, Suite 614, Redwood City, CA 94064 (415) 361-8883

**Want to hear  
a demonstration of  
Hewlett-Packard's  
ThinkJet Printer?**

many features, and the documents are formidably thick (and come in an awkward—for me—three-panel loose-leaf notebook). When I read random passages, I find intriguing thoughts and concepts, but I've so far been unable to get involved in the tutorial. It's probably a combination of sloth and the fact that I'm used to Think-

Tank. Unlike ThinkTank, MaxThink is not copy-protected. It seems to have advanced text-entry/editing features. There's much to like about it. Real Soon Now . . .

The game of the month has to be Wizardry I for the Macintosh; I've sure invested enough time in it. The boys have divided their time between In-

focom's Hitchhiker's Guide to the Galaxy and Cygnus's Star Fleet I. I guarantee you won't enjoy Hitchhiker if you haven't read the book. For that matter, I wouldn't buy the game without the clues; even if you've memorized the book, those puzzles are hard.

There are three books of the month. *Modula-2, A Software Development Approach* by Gary Ford and Richard Wiener (Wiley, 1985) is an excellent discussion of why you want to write programs in Modula-2 and a good intermediate text on the language. Beginners will find it tough slogging but well worth the effort it takes. *Surely You're Joking, Mr. Feynman* by Richard Feynman (Norton, 1985) is a series of autobiographical anecdotes by the Caltech Nobel laureate who also is known as a wonderful teacher, and it has to be the most interesting book I've read in at least a year, just as *The Pentagon and the Art of War* by Edward Luttwak (Simon and Schuster, 1984) is the most important book I've read in some time.

Meanwhile, Tony Pietsch has Concurrent DOS and my CompuPro PC Video board ready to install in our big CompuPro S-100 80286/280 system. We've held off until we can get the machine upstairs; I've found that computers don't like to be moved, and I want to see it working "as was" in its new location before opening it up. We also have a pile of machines that have come in during construction and thus haven't even been uncrated. There's an HP with a ton of software; an Eagle Turbo PC; AT&T's 3B2 UNIX V box; the Stride 400; and the thoroughly updated Lilit. My new quarters have been designed to let me set up a mess of machines and work on them, and I'm already running out of bench space. It's a great life if you don't weaken . . . ■

Jerry Pournelle welcomes readers' comments and opinions. Send a self-addressed, stamped envelope to Jerry Pournelle, c/o BYTE Publications, POB 372, Hancock, NH 03449. Please put your address on the letter as well as on the envelope. Due to the high volume of letters, Jerry cannot guarantee a personal reply.

## Tools for the Programmer from Blaise Computing

Save Up To \$130 On These Special Offers!

### TOOLS & TOOLS 2

For C or Pascal

For a limited time, pick up both packages and save \$50 off our regular list price. The C version comes with libraries for the Lattice, Computer Innovations and Microsoft (version 2.03 and

3.00) compilers. The Pascal version supports IBM and Microsoft Pascal. **\$175.**

### VIEW MANAGER With Source

All libraries are included. Please specify C or Pascal. Regular \$425. Save \$130. **\$295**

Blaise Computing provides a broad range of fine programming tools for Pascal and C programmers, with libraries designed and engineered for the serious software developer. You get clearly written code that's fully commented so that it can serve both as a model and also be easily modified to grow with your changing needs. Our packages are shipped to you complete with comprehensive manuals, sample programs and source code. None of the programs are copy-protected.

#### FOR C AND PASCAL PROGRAMMERS:

##### TOOLS ♦ \$125

Extensive string and screen handling, graphics interface and easy creation of program interfaces. Includes all source code.

##### TOOLS 2 ♦ \$100

Memory management, general program control and DOS file support. Interrupt service routines support. Includes all source code.

##### VIEW MANAGER ♦ \$275

General screen management. Create data entry screens that can be easily manipulated from your application program. Block mode data entry and retrieval with fast screen access.

##### VIEW LIBRARY Source ♦ \$150

Source code to the VIEW MANAGER library functions.

##### ASYNCH MANAGER ♦ \$175

Powerful asynchronous communications library providing interrupt driven support for the COM ports. All source code included.

#### FOR THE TURBO PASCAL PROGRAMMER:

##### Turbo POWER TOOLS ♦ \$99.95

Extensive string support, extended screen and window management, interrupt service routines, program control and memory management. Interrupt filters. All source code included.

##### Turbo ASYNCH ♦ \$99.95

Interrupt driven asynchronous communication support callable from Turbo Pascal. ASYNCH is written in assembler and Turbo Pascal with all source code included.

#### PACKAGES FOR ALL PROGRAMMERS:

##### EXEC ♦ \$85

Program chaining executive. Chain one program from another even if the programs are in different languages. Common data area can be specified. Source code included if you're a registered C TOOLS and G TOOLS 2 user.

##### SPARKY ♦ \$75

Run-time resident (or stand-alone) scientific, fully programmable, reverse polish notation calculator. No limit on stack size; variables or tape. Includes all standard scientific functions and different base arithmetic.

**TO ORDER, call Blaise Computing Inc. at (415) 540-5441**

♦ 2034 Blake Street ♦ Berkeley, CA 94704 ♦ (415) 540-5441



# Want to hear it again?

You made about as much noise turning the page as the  
ThinkJet Printer makes turning one out.

So it lets you do two things at once. Print. And think.  
Without sound hoods. Without remote printing stations.  
Without aspirin. (And without a lot of clutter. The only thing  
smaller than the ThinkJet Printer is its price: \$495\*.)

Better still, it works with just about every personal computer.

Hear the ThinkJet Printer sound off.

Call (800) FOR-HPCC, Dept. 276X, for the  
Hewlett-Packard dealer nearest you.



**HEWLETT  
PACKARD**

 **HEWLETT  
PACKARD**

**Introducing  
The Single  
Solution To  
Many Problems  
That Can  
Tie Up Your  
Personal  
Computer.**





# Transet 1000™ The print buffer, communications buffer, port expander, printer sharer and I/O switcher. All in one.

Anyone with a personal computer and one or more peripherals has faced the all-too-familiar dilemma. You need your computer to do an important job. But you're forced to wait for the system to finish one job (printing, communicating, whatever) before you can go on to the next one. Or you need to stop what you're doing to switch cables when you want to use another peripheral.

Wait no more. Now Hayes introduces an innovative new device that lets you perform many jobs—at the same time—independent of your computer, Transet 1000. It works with a wide range of systems and configurations. And it allows you to continually expand your system as your needs grow.

Transet 1000 frees your computer from waiting on your printer or modem—so you and your computer can go on to another task. It even lets you

print out documents in pre-set formats without having to go back into your computer. At the same time, Transet 1000 can operate unattended mailbox communications—24 hours a day—even if your computer is turned off.



Two computers can share one printer with Transet 1000. Or, you can use Transet 1000 to let two computers communicate with each other.

In addition, Transet 1000 is a port expander and software-controlled I/O switcher. Now files can be easily directed and redirected to different peripherals, without physically changing cable connections.

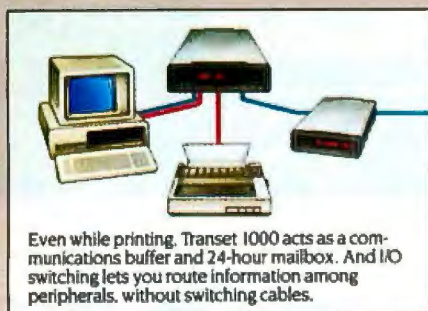

Even while printing, Transet 1000 acts as a communications buffer and 24-hour mailbox. And I/O switching lets you route information among peripherals, without switching cables.

Transet 1000 contains a stand-alone microprocessor, and comes with 128K of memory. It operates with any RS-232 interface computer, and has optional accessory kits available for the IBM® PC and PC XT, Macintosh™ and

Apple® IIc. Kits contain the necessary host cable, a user guide and menu-driven software that lets you graphically set up or customize port

parameters and printing formats. Cables available for IBM PC AT, other computers and peripherals.

Like all Hayes products, Transet 1000 combines sophisticated capabilities with easy operation. Just as Hayes set the standard in personal computer communications, now Hayes is taking the lead in computer task management.

Contact your authorized Hayes dealer to see how Transet 1000 can help you get a lot more productivity



Transet 1000 allows printing on both a dot matrix printer and letter quality printer, while freeing your computer for other tasks.

out of your computer system—without tying up your computer or you.

**Hayes Microcomputer Products, Inc.**, P.O. Box 105203  
Atlanta, Georgia 30348  
404/441-1617



# Hayes® Transet 1000

Innovative products for enterprising people



*"Put more performance in less space"*

#### Look into the new Princeton HX-9 Series

See high-resolution RGB color with the Princeton HX-9 and HX-9E Color Monitors.

Observe exceptionally sharp high resolution graphics and text created by color phosphor dots which are within a mere .28mm of one another.

Enjoy Princeton performance on a 9-inch screen in less desk space than most any other monitor on the market today.

#### Display images of clearly superior quality

Flicker-free technology enables you to view colorful images with clear, sharp definition. Dark-glass, non-glare screens further enhance viewing clarity.



A built-in green/amber switch allows you to switch from multi-color to either a green or amber mode. It's like owning both a color and a monochrome monitor.

The Princeton HX-9 Color Monitor is perfect for viewing up to 16 vivid colors with the IBM Color/Graphics Monitor Adapter (or equivalent).

And, the enhanced member of the HX-9 Series, the Princeton HX-9E Color Monitor, offers one big extra: It also allows you to use the IBM Enhanced Graphics Adapter (or equivalent) to view up to 64 brilliant colors.

What's more, they tilt. They swivel. Both have a built-in base to adjust your monitor to a comfortable viewing angle.

#### Princeton quality is built in

Both monitors in the Princeton HX-9 Series are manufactured to provide years of reliable use. Verified by tough quality-control procedures. And backed by a full one-year warranty.

#### Visit your local computer store today

See the HX-9 Series and all other products bearing the world-respected Princeton name. To find the Princeton dealer nearest you, call: **800-221-1490 (Extension 404)**, 609-683-1660 (NJ only), Telex: 821402 PGS PRIN.

Princeton Graphic Systems, 601 Ewing Street, Bldg. A, Princeton, NJ 08540.

# PRINCETON™

GRAPHIC SYSTEMS  
AN INTELLIGENT SYSTEMS COMPANY

IBM is a registered trademark of International Business Machines Corp.

# COMDEX in Japan

Fujitsu lap-size  
portable

New laser printers

NEC PC-9801M3

APC III versus  
PC-9801M2/3

Brother WP-600  
and FB-100

BY WILLIAM M. RAIKE

**A**s I'm writing this it's cherry blossom time in Tokyo; spring has finally sprung, and just about everyone is trying to arrange a little free time for *o-hanami* (flower viewing), walking or picnicking under the canopies of blossoms often found near local temples or shrines, as well as in the major parks. My favorite spot is Todoroki Fudosen, on the southwest outskirts of Tokyo; I was able to enjoy it for an afternoon just after the close of the first-ever COMDEX in Japan.

The COMDEX show was held at a strange time of year, only two months before the annual Microcomputer Show. It was also heavily oriented toward products for export, rather than for the Japanese market. The show attracted only about 40,000 people (including lots of non-Japanese) over three days, in a city of about 12 million. I think many companies were waiting for the Microcomputer Show to introduce their new goodies.

However, there were some interesting products on display. The long-rumored Fujitsu lap-size portable made its appearance, along with the NEC Starlet, the PC-8401A, which I previewed in January in this column. Ampere Corporation's APL-based lap-size machine (see What's New, October 1984 BYTE, page 42), now christened the WS-1, was finally on display, despite being some months behind schedule. Brother Industries showed its new portable word processor/typewriter and the companion floppy-disk unit. And laser printers were there in force, some of them downright cheap.

## BADGE NEWS

Usually, the procedure for registering and entering a computer show here is simple and brief: You fill out a card, pay your money, get a badge, and go in. Not so for this show. After filling out a full-page questionnaire (with no desks on which to write) and standing in line for 30 minutes, I handed in my form to someone who

entered the information into a computer terminal while I waited. Then an on-line badge-making machine coughed up my plastic badge (with my name misspelled).

The theory was that if you wanted an exhibitor to mail you additional information, the exhibitor would run the plastic badge through a credit-card imprinter, and that information would later be sent to the address already stored in the computer. At other computer shows, the usual procedure is simply to drop one of your business cards in a box at the exhibitor's booth; the exhibitor can mail off the additional information later and doesn't have to do anything about it in the midst of a crowded booth. In this case the badges were too flimsy, so the imprinters chewed them up; naturally, the exhibitors hated the whole process because it was such a hassle. Some sensible people just ignored the badges altogether and collected business cards. This is a perfect example of an ill-thought-out computer application that never should have seen the light of day. And I still haven't received any of the literature I requested.

## ANONYMOUS FUJITSU LAP-SIZE PORTABLE

I may end up being the last one on my block to buy a lap-size portable computer. So far, I just haven't seen anything irresistible. Even so, I've been looking forward for months to the long-rumored Fujitsu portable, and I finally got a look at one at COMDEX. It's still so new that it doesn't have a model name or number; it was scheduled to be available in Japan in July of this year, with a target price equivalent to about \$1350.

The Fujitsu portable is based on the MBL8086L microprocessor, a CMOS (complementary metal-oxide semiconductor) version of the 8086. Standard RAM (random-access read/write memory) is 128K bytes. You can expand the memory up to 448K bytes, and you can configure part of

(continued)

William M. Raikes, who has a Ph.D. in applied mathematics from Northwestern University, has taught operations research and computer science in Austin, Texas, and Monterey, California. He holds a patent on a voice scrambler and was formerly an officer of Cryptext Corporation in the United States. In 1980, he went to Japan looking for 64K-bit RAMs. He has been there ever since as a technical translator and a software developer. He can be contacted c/o BYTE, POB 372, Hancock, NH 03449.

# Lycó Computer Marketing & Consultants



## SAVE ON THESE PRINTERS IN STOCK



AXION	
GP 550 AT (Atari)	249
GP 550 CD (C-64)	249
GP 550 FC (IBM)	239
GP 550 AP (Apple)	279
GP 700 AT (Atari)	459
GP 700 AP (Apple)	459
Elite 5CD (C-64)	329

BLUE CHIPS	
M12010	\$275
M12010 C-64	\$275

C. ITOH	
Prowriter 8510 AP	279
8510 BC2	389
8510 BP1	319
8510 SP	379
8510 SR	429
8510 SCP	459
8510 SCR	479
7500 AP	205
7500 AP	245
1520 P	449
1550 BCD	489
A-10-20-P	459
F 10 40 PU or RDU	888
F10 SSPU or RDU	1089

CARDCO	
LO1	369
LO3	279

CITIZEN	
MSP 10	329
MSP 15	499
MSP 20	479
MSP 25	599

COMREX	
CR II EC Comriter II E Parallel	359
CR II ES Comriter II E Parallel	379
CR IV C Comriter IV Parallel	689
CR IV S Comriter IV Serial	689

Corona	
LP300 Laser Printer	7699
200361 Toner Cartridge	89

DIGITAL DEVICES	
16K printer buffer	99 75
12K printer buffer	119 75
64K printer buffer	169 95

EPSON	
FX 80	249
LX 80	239
FX 100	579
JX 80	499
LO 1500 P	1089
LO 1500 S	1149
Hi 80 color plotter	399

JUKI	
Juki 6100	379
RS 232 Serial Board	55
Tractor	119
Sheet Feeder	209
Juki 6300	769

LEGEND	
880	219
1080	239
1200	249

★ **PRINTER INTERFACING** ★  
Available

MANNESMANN TALLY	
Sprint 80	255
MTL 180L	549
MTL 180L	739

NEC	
NEC 8025	\$699
NEC 8027	\$ 159

OKIDATA	
Climate 10	179
192	249
84	645
84	349
93	349
92	565
92	425
92 IBM Version	349

OLIVETTI	
DY 250 Parallel	739
DY 250 Serial	729
DY 450 Parallel	1099
DY 450 Serial	1079

PANASONIC	
1090	189
1091	239
1092	305
1093	429
1151	539

Smith Corona	
Fastest 80	189 00
D100	219 00
D200	389 00
D300	519 00
L1000	339 00

STARMICRONICS	
SG-10	219
SG 15	379
SD-10	339
SD-15	445
SR-10	489
SR-15	585
PowerType	309
SB-10	CALL

## MONITORS

AMDEK	
300 Green	125
300 Amber	139
310 Amber IBM	155
Color 300 Audio	245
Color 500 Composite	369
Color 600	229
Color 700	495
Color 710	569

GORILLA	
12" Green	78
2" Amber	84

NEC	
JB 1260 Green	95
JB 1301 Green	135
JB 1315 Color	235
JC 1518 RGB	375
JC 1460 Color	265
JB 1205 Amber	131

PANASONIC	
DT 1300 RGB composite	329
PRINCETON GRAPHICS	
MAX-12 Amber	189
HX 12 RGB	475
SR 12 RGB	599

SAKATA	
SC 100 Color	219
STS1 Stand	29
SG 1000 Green	99
SA 1000 Amber	109

TAXAN	
210 Color RGB	249
115 Green	119
116 Amber	125
400 Color RGB	275
410 Color RGB	339
420 Color IBM	429
121 Green IBM	139
122 Amber IBM	145

X-TRON	
Comcolor 11 Composite Color	199

ZENITH	
ZVM 122A Amber	84
ZVM 123G Green	75
ZVM 124 Amber IBM	129
ZVM 131 Color	275
ZVM 133 RGB	389
ZVM 135 Composite	449
ZVM 136 Hi Res Color	589

## MODEMS

NOVATION	
J Cat	89
Smart Cat Plus	319
Smart Cat 103	169
Smart Cat 103/212	389
Auto Cat	209
212 Auto Cat	539
Apple Cat II	239
Apple Cat	439
Apple Cat 212	249

CARDCO MOD I (C-64)	CALL
NESTRIDGE (C-64)	CALL
MITEV MO (C-64)	CALL
1687 AUTO MODEM (C-64)	95
COMPUERVE	23 95 (1200 baud)

HAYES	
Smartmodem 300	189
Smartmodem 1200	409
Smartmodem 1200B	379
Micromodem IIE	249
Micromodem 100	289
Chronograph	179
Smart Com II	75

ANCHOR	
CALL Volsmodem	55 99
CALL Mark VII	95 99
CALL (Auto ans/99)	259 00
CALL Mark VII	259 00

MICROBITS	
MPP 1000 E (Atari)	99 00
MPP 1064 (C-64)	99 95

TELE LEARNING	
CM-250 C-64	39 95
AP-250 (Apple)	109 95
IB-250 (IBM)	109 95

## DISK DRIVES

INDUS	
GT Atari	\$219 00
GT Commodore	\$249 00

MSD	
SD1 Drive	\$229 00
SD2 Drive	\$469 00

## DISKETTES

MAXELL	
5 1/4" MD-1	16 99
5 1/4" MD-2	23 75
(Box 10)	

SKC	
(Box 10)	
5 1/4" SKC-SSDD	10 99
5 1/4" SKC-SSDD	13 99
5 1/4" SKC-DSDD	15 99

ELEPHANT	
(Box 10)	
5 1/4" SSSD	13 99
5 1/4" SSDD	15 99
5 1/4" DSDD	19 99

## IBM-PC COMPATIBLE

CORONA	
PPC 28A	
Portable 256K Amber	17 99
PPC 220	
Portable 256 K Green	16 99
PPCXTA	
Portable 256K 10Meg	28 99
CORII 28K 128K RAM	15 99

Zenith	
Z 150	Call
Leading Edge	
PC Compatible	Call

LOTUS	
Lotus 1 2 3	309 00
Synphony	439 00

PARADISE	
5 Page Multifunction	179 00
Modular Graphics	289 00
13.1" High Contrast Color	315 00

WE MAKE YOUR COMPUTER FUN TO USE

TOLL FREE 1-800-233-8760



TO ORDER



or send order to

CALL TOLL FREE

800-233-8760

Lycó Computer  
P O Box 5088

Customer Service 1-717-327-1825 Jersey Shore PA 17740

### RISK FREE POLICY

In stock items shipped within 24 hours of order. No deposit on C.O.D. orders. Free shipping on prepaid cash orders within the continental U.S. Volume discounts available. PA residents add sales tax. APO, FPO, and international orders add \$5.00 plus 3% for priority mail service. Advertised prices show 4% discount for cash, add 4% for MasterCard or Visa. Personal checks require 4 week clearance before shipping. Ask about UPS Blue and Red label shipping. All merchandise carried under manufacturer's warranty. Free catalog with order. All items subject to change without notice.

RAM as a RAM disk. It acts like an extremely fast floppy-disk drive for fast file operations. You get 512K bytes of standard ROM (read-only memory): 256K bytes include the kanji ROM and a 19,000-word Japanese-language dictionary; the other 256K bytes are in a ROM cartridge that includes the operating system (Japanese-language CP/M-86) and languages or other software. At this point, Fujitsu offers cartridges that support Japanese-language extensions of BASIC and COBOL Level II (yes, COBOL); the company won't say what applications software will be available, but at the show I played with both WordStar and a Japanese word-processing program.

The computer includes an RS-232C serial interface, so some kind of telecommunications software support is certain to be present. Unfortunately, unlike some other lap-size machines, it has no built-in modem (Fujitsu does supply a separate acoustic coupler). This will be a serious disadvantage if Fujitsu decides to market the machine in the U.S., but it is not a problem here in Japan, which lags far behind the U.S. in the area of computer communications. People still use acoustic couplers over here, although the recent breakup of the Japanese telephone company, paralleling that of AT&T, will probably mean that affordable direct-connect modems will start appearing on the market here soon.

For external data storage, the Fujitsu includes a microcassette recorder, although an external 3½-inch micro-floppy-disk drive will be available as an option. The disk interface is standard, along with the RS-232C interface, a bar-code-reader interface, and a standard parallel printer interface.

The Fujitsu has a very clear, easily readable liquid-crystal display (LCD): I had no trouble reading it even in the bright fluorescent glare of the exhibit hall. The 640- by 200-dot screen offers four display modes: an 80-character by 25-line mode for normal alphanumeric use; an 80-character by 20-line mode that allows on-screen underlining and better line separation; an 80-character by 11-line mode that gives double-height characters;

and a 40-character by 11-line kanji display mode that displays kanji characters in a clear 16- by 15-dot font. The display adjusts to any convenient viewing angle and folds down to cover the keyboard when it's not in use.

Internal nickel-cadmium batteries supply the power, and an additional memory backup battery protects main memory for at least one month. An AC adapter is available, and Fujitsu says it will run off a car battery (called a *kaabatteri* by Fujitsu).

**LASER PRINTERS**

Laser printers have yet to make their impact in Japan, if you'll forgive a bad pun. Mostly, they're still expensive, bulky, desk-size contraptions. But the quality they offer is startling: You get magazine-quality printing at speeds of around 10 pages per minute. TEC (Tokyo Electric Company), whose

*Laser printers have yet to make their impact in Japan, if you'll forgive a bad pun.*

daisy-wheel printers are marketed in the U.S. under the C. Itoh name, showed a tabletop laser printer at the show. The new BP-10 laser printer isn't available to consumers yet, but OEM (original equipment manufacturer) samples are going for only about \$1200 apiece. The BP-10 is quiet, weighs only about 60 pounds, and comes with both 8-bit parallel and RS-232C interfaces. It prints 10 letter-size pages per minute at a dot den-

(continued)

# FASTER

USRobotics' swift new Courier 2400™ modem cuts data transmission time in half, decreasing phone costs and increasing productivity. The auto-dial, auto-answer Courier adjusts itself from 2400 to 1200 or 300 bps. And if you prefer an internal slot modem for IBM-PCs or compatible computers, the Microlink 2400™ gives you the same great features at the same great price. Courier and Microlink 2400 modems. They're going fast.



**courier 2400™**  
**U-Robotics**

8100 McCormick Blvd., Skokie, IL 60076  
Phone: (312) 733-0497  
Outside Illinois: 1-800-Dial-USR

Contact us for other low prices on hardware and software.  
Next Day Air Extra

# FREE SHIPPING. NO SURCHARGE FOR OR .

Call for latest prices.

## 10, 20, 33 AND 44 MEG INTERNAL AND EXTERNAL HARD DISK SYSTEMS

	10 MEG	20 MEG	33 MEG	44 MEG
<b>Internal</b>	<b>\$469</b>	<b>\$595</b>	<b>\$929</b>	<b>\$1129</b>
<b>External</b>	<b>\$619</b>	<b>\$745</b>	<b>\$1029</b>	<b>\$1229</b>



Half Height

Externals mounted with independent power supply and fan. Fully DOS 2.X or 3.X compatible. Both Internals and Externals boot from Hard Disk. 33 and 44 Meg Internal Disks include extender power supply. The system comes complete and ready to install with the Hard Disk, Controller, Cables, Manual, Software, and Mounting Hardware. One Year Warranty.



10, 20, and 33 Meg Hard Disks are available with combined Floppy/Hard Disk Controller Card for additional \$75.

**COMPAQ**

**\$2549**

256K, 1/360K drive,  
10 Meg Internal



Functional equivalent to a Compaq Plus™.

Now using 3 1/2" shock-mounted Winchester drives. The same as used in the Compaq Plus™. Also available with 2 half-height drives and 10 MEG HD—**\$2749**

Or upgrade your Compaq to a Compaq Plus™ equivalent with our 3 1/2" shock-mounted Winchester disk kit. Includes Hard Disk, Controller, Cables, Manual, software, and Mounting Hardware. One year warranty. **\$549**

**COMPAQ**

It simply works better

**DESKPRO™**

640K, One 360K Drive,  
One 10 Meg Internal Hard Drive  
Tape Backup Unit.

**\$3495**

Includes Monitor



With 20 Meg Internal Hard Drive—**\$3621**  
With 33 Meg Internal Hard Drive—**\$3955**  
With 44 Meg Internal Hard Drive—**\$4155**

Compaq is a registered trademark and Compaq Plus and Compaq Design are trademarks of Compaq Computer Corporation.

**IBM AT™  
CALL**

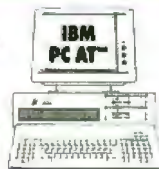

**IBM PC™  
CALL**

IBM is a trademark of IBM Corp.

Call us for competitive prices on larger quantities of RAM chips.

**64K RAM**

Set of 9 chips, 200 or 150 Nanoseconds

**\$10**

**256K RAM**  
Set of 9 chips

**\$39**

Quantities of 50  
or more sets **\$29**

**AST SixPak Plus™**



w/64K **\$249**  
w/384K **\$299**

One Year Warranty

- Upgradable to 512K
- Clock/Calendar
- Software Included

**PC'S LIMITED  
Six Function Card**



w/384K **\$209**

Two Year Warranty

- Parallel Port
- Serial Port
- Optional Game Port, \$25

**MITSUBISHI DISK DRIVES**

Half-Height, DS/DD

**\$85**

**TEAC**

15-H, Half-Height, DS/DD

**\$95**



**PC'S LIMITED**

Half-Height, DS/DD

**\$75**

**INTEL 8087  
Math Co-processor**



**CALL**

8087-2—CALL 80287—CALL

**SOLVE YOUR POWER PROBLEM.**

**XT™ POWER 135W**



**\$89**

Fully XT™ compatible.  
One Year Warranty.  
Directly Replaces Power Supply in PC™

150W **\$119**

**IBM PC AT™  
PRODUCTS**



128K RAM **\$49**  
20 MEG Internal Hard Disk **\$559**  
32 MEG Internal Hard Disk **\$729**

Fully compatible w/IBM PC AT™ Disk Controller, DOS 3.0 or 3.1

These are high-performance disk drives,  
well-suited for the AT™.

IBM is a trademark of IBM Corp.

**Irwin Tape  
Backup System**

**\$595**

- Uses Floppy Controller Card
- 10.5 Meg Formatted Capacity
- Used in Compaq Desktops
- Half Height
- Low Power

Notice: Due to our low prices and assurance that all merchandise is new, unused product, all sales are final. Call technical support for return authorization number on all warranty repairs. Any unauthorized repair subjects to a 10% reworking fee. Prepaid checks, money orders, VISA, MasterCard, American Express, or approved company purchase orders are accepted. No surcharge for VISA or MasterCard. 3% charge for American Express.

Compaq, TEAC, IBM, Irwin, Intel and Mitsubishi are trademarks of their respective companies. All brand names are registered trademarks. We are an independent sales organization.

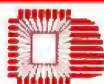

**PC'S LIMITED™**

**OUTSIDE TEXAS, ORDERS ONLY, CALL 1-800-IBM-5150**

**7801 N. Lamar, #E-200, Austin, Texas 78752**

**All calls for technical support and inside Texas,  
call (512) 452-0323.**

Telex No. 9103808386 PC LTD



Ad number 408

sity of 300 dots per inch. I want one.

Another printer that impressed me was Fujitsu's latest dot-matrix printer, the DPL 24. It's a 24-pin printer with the best letter-quality printing I've seen from a dot-matrix printer. It is reasonably fast at 80 characters per second (cps), and it also has a 160-cps correspondence-quality mode and a 240-cps draft-quality mode. The DPL 24 has other nice features too, like selectable fonts using optional cartridges and the ability to download special fonts. It comes in two models: The Model D is Diablo 630 API-compatible, while the Model I was designed for use with the IBM Personal Computer (PC). Unfortunately, Fujitsu informed me that the DPL 24 was an export model and that there was no way I could buy one in Japan.

**NEW FROM NEC**

A recent addition to NEC's PC-9801 computer family is the PC-9801M3. The PC-9801 machines hold the dominant position in the microcomputer market in Japan, analogous to the IBM PC in the U.S. market. The latest model, the M3, is similar in most respects to its predecessor, the F3. The machine is based on the 8086-2 processor running at 8 MHz and comes with 256K bytes of standard RAM, expandable to 640K bytes. It has extensive Japanese-language capabilities, supported at the operating-system level by either CP/M-86 or MS-DOS or PC-UX, NEC's version of UNIX System III. (PC-UX is a \$1200 option, though.) The machine is similar in most respects to the APC III sold in the U.S., but the main unit of the PC-9801M3 includes both a 1-megabyte 5¼-inch floppy-disk drive and a 20-megabyte hard-disk drive. (The PC-9801M2 I wrote about in the May BYTE Japan, page 355, has two 1-megabyte floppy disks.)

The price for all this is not unreasonable: the M3 costs about \$3285, but the usual 20 percent discounts available in the Akihabara electronics district in Tokyo would bring that down to only about \$2630.

Incidentally, NEC finally managed to put together a comparison sheet

listing the differences between the U.S.'s APC III and Japan's PC-9801M2 and M3 computers. The major differences are that the Japanese computers have standard kanji-support ROM and a standard 1-megabyte floppy-disk interface, along with 256K bytes of RAM—versus 128K bytes in the APC III. The M3 also comes with a standard 20-megabyte hard disk. (The PC-9801M3 also contains an interface for 5¼-inch, 320K-byte floppy-disk drives, which can be connected externally.)

The basic character sets of the two countries' machines also differ slightly. The APC III is IBM-compatible but the PC-9801M2 and M3 use the JIS (Japan Industrial Standard) character set. The graphics video RAM configuration is also somewhat different. And there is an extra 8K bytes of text video RAM for kanji support in the Japanese machines. Finally, with the

*A recent addition  
to NEC's PC-9801  
computer family  
is the PC-9801M3.*

Japanese machines you can select the processor speed: It can be either 8 or 5 MHz, while the APC III runs at a fixed 8-MHz rate.

Other than that, the differences involve the availability of optional boards and peripherals. For the Japanese machines, you can buy a cassette-tape interface, a music board, a 68000 central processor board and its companion RAM board, and a GPIB (general-purpose interface bus)

*(continued)*

**SMARTER**

USRobotics' new high-speed Courier 2400™ modem responds to the industry standard AT command set—so it works with any of today's popular telecom software, including our own Telpac™. Courier reports the length of each call, lets you automatically repeat a command, and provides an on-screen summary of its settings. Courier even adjusts to phone line conditions to assure nearly perfect performance on every call. This smarter modem is clearly a wise choice.

**U-Robotics**  
courier 2400™  
8100 McCormick Blvd., Skokie, IL 60076  
Phone: (312) 733-0497  
Outside Illinois: 1-800-Dial-USA







- ✓ *Tougher*
- ✓ *Quieter*
- ✓ *Smarter*
- ✓ *Thriftier*
- ✓ *Easier*
- ✓ *Quicker*
- ✓ *Finer*
- ✓ *Cleaner*
- ✓ *Sharper*
- ✓ *Sturdier*
- ✓ *Abler*
- ✓ *Prettier*
- ✓ *Slimmer*
- ✓ *Trimmer*
- ✓ *Friendlier*

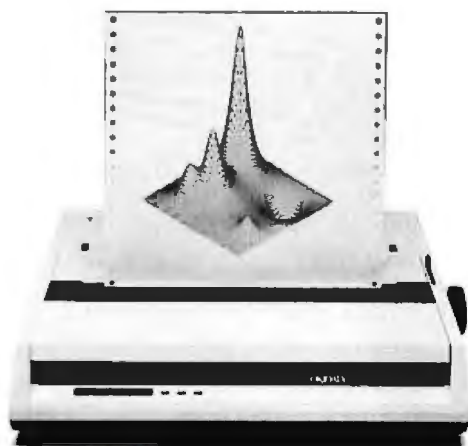

*and smaller.*

The new Okidata Microline 192 does everything the bigger, bulkier printers do. And more. But in a much smaller space.

It's easier to operate, too. With push-button menu select programming, so you never have to touch a DIP switch to set fonts, line widths, underlines and such.

It's compatible with your computer. Just plug it in and put it to work, without changing control codes. And, it's compatible with you. Long-life cartridge ribbons pop in and out without so much as smudging a finger.

Super-quiet operation and super-fast bidirectional throughput make the new Microline 192 one handy printer to own. All this, plus our full one-year warranty (try to find that on most printers), makes it the only one you should own.

The new Okidata 192 and the wide-column 193. Simply stated . . . better.

For more information, call toll free 1-800-OKIDATA.

**OKIDATA**  
an OKI AMERICA company  
Mt. Laurel, NJ 08054

We put business on paper.

# Save

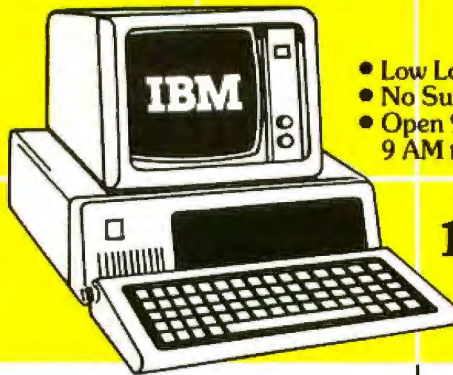

- Low Low Prices
- No Surcharge for MasterCard and VISA
- Open 9 AM to 7 PM Eastern (Mon-Fri)  
9 AM to 2 PM Eastern (Sat)

**1-800-237-4048**  
(ORDERS ONLY)

## COMPUTERS

IBM ENHANCED AT . . . . .	5355
IBM ENTRY LEVEL AT . . . . .	3647
IBM PC, 1 DSDD DR, 256K . . . . .	1559
IBM PC, 2 DSDD DR, 256K . . . . .	1669
IBM PC, NO DRIVES, 64K . . . . .	1304
IBM PC, 2 HALF/HYTES, 256K . . . . .	1669
IBM XT, 1DSDD DR/10MB, 256K . . . . .	3355
IBM XT, 1DSDD DR/TANDON HD, 256K . . . . .	2108
COMPAQ, 2 DSDD, 256K . . . . .	2153

## MONITORS

AMDEK 300G . . . . .	
AMDEK 300A . . . . .	133
AMDEK 310A . . . . .	145
AMDEK 600 RGB COLOR . . . . .	420
AMDEK 710 SUPER HI RES COLOR . . . . .	557
IBM COLOR . . . . .	636
IBM MONOCHROME . . . . .	253
PRINCETON MAX-12 . . . . .	160
PRINCETON HX-12 RGB COLOR . . . . .	479
PRINCETON SR-12/SCAN DOUBLER . . . . .	890
QUADRAM AMBERCHROME . . . . .	171
QUADRAM QUADCHROME II . . . . .	438

## MISCELLANEOUS

MEMORY, 64K CHIPS . . . . .	10
MEMORY, 256K CHIPS . . . . .	54
PRINTER CABLE . . . . .	25
MICROFAZER BUFFER, 8K . . . . .	131

MICROFAZER BUFFER, 64K . . . . .	217
VERBATIM, DSDD DISKS . . . . .	22

## DISPLAY CARDS

STB SUPER HI RES 400 . . . . .	402
HERCULES COLOR . . . . .	149
IBM MONOCHROME . . . . .	242
IBM COLOR . . . . .	228
EVEREX GRAPHICS EDGE . . . . .	341
GENOA SPECTRUM . . . . .	331
TECMAR GRAPHICS MASTER . . . . .	459
PARADISE MODULAR GRAPHICS . . . . .	272

## BOARDS

AST SIX PACK PLUS, 64K . . . . .	261
AST MEGAPLUS, 64K . . . . .	285
AST MP-2, 64K . . . . .	228
AST ADVANTAGE, 128K . . . . .	396
AST I/O PLUS . . . . .	122
JRAM-2 . . . . .	169
QUADRAM QUADBOARD, ØK . . . . .	240
QUADSPRINT . . . . .	435
TECMAR CAPTAIN, ØK . . . . .	219
TECMAR FIRST MATE, ØK . . . . .	200
TECMAR WAVE XT, 64K . . . . .	187
TECMAR JR CAPTAIN, 128K . . . . .	303

## MODEMS

HAYES 2400 . . . . .	655
HAYES 300B . . . . .	208
HAYES 300/1200 . . . . .	429
HAYES 1200B w/ SOFTWARE . . . . .	395
HAYES 1200B . . . . .	351
VEN-TEL HALF CARD . . . . .	374
VEN-TEL 300/1200 INTERNAL . . . . .	341
AST REACH HALF CARD 1200 . . . . .	362

## PRINTERS

OKIDATA 83A, WIDE CARRIAGE . . . . .	567
OKIDATA 84P, WIDE CARRIAGE . . . . .	679
OKIDATA 92P . . . . .	385
OKIDATA 93P, WIDE CARRIAGE . . . . .	602
OKIDATA 2410P . . . . .	1823
OKIDATA 182 . . . . .	220
OKIDATA 192 . . . . .	363
EPSON RX-80 . . . . .	240
EPSON FX-80, TRACTOR . . . . .	382
EPSON LX-80 . . . . .	248
EPSON RX-80FT PLUS . . . . .	268
EPSON RX-100, WIDE CARRIAGE . . . . .	417
EPSON FX-100, WIDE CARRIAGE . . . . .	531
EPSON JX-80 COLOR PRINTER . . . . .	531
EPSON LQ-1500 PARALLEL . . . . .	1042
NEC 2050 . . . . .	710
NEC 3550 . . . . .	1425
NEC 8850 . . . . .	1845
JUKI 6100 . . . . .	362
JUKI 6300 . . . . .	695

## ACCESSORIES

OKIDATA 82/92 TRACTOR . . . . .	46
NEC BI-DIRECTIONAL TRACTOR . . . . .	156
NEC CUT SHEET GUIDE . . . . .	77
JUKI 6100 BI-DIRECTIONAL TRACTOR . . . . .	105
JUKI 6300 BI-DIRECTIONAL TRACTOR . . . . .	124

**1-800-237-4048**

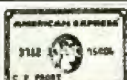

# COMPUTER MART

1901 S. TAMiami TRAIL, VENICE, FL 33595

Call for Non-Advertised and Lower Current Prices. IBM is a registered Trademark of International Business Machines. Prices subject to change. We accept MasterCard, VISA, American Express, Diners Club, Money Orders, certified and personal checks and COD shipments. Returns are subject to a 15% restocking fee.

**IN FLORIDA CALL 813-493-2736**

# Declarative Update

Two new  
language  
systems and  
two new  
books

BY DICK POUNTAIN

**S**ince the theme this month is declarative programming languages, I'm devoting my column to a miscellany of items that help personal computer users get in on the declarative act. To be more specific, I'll take a brief look at two new books on logic and functional programming and at two new language systems for the IBM Personal Computer (PC) and the Macintosh.

## A GLIMMER OF HOPE

I have recently begun to learn the Hope language (see "A Hope Tutorial" by Roger Bailey, page 235) using an interpreter that runs on the IBM PC. This interpreter, developed at Imperial College, is available for downloading from BYTEnet Listings, (617) 861-9774.

The original Hope system runs at Edinburgh University as a compiler on a DEC-10 mainframe computer. A group at Imperial College subsequently produced an interpreter for a large subset of Hope for the VAX under VMS.

The computer department at Imperial College has been quicker off the mark than most in embracing the personal computer age. Research assistant Victor Wu has written a version of the Imperial College interpreter in Pascal for the IBM PC. Although Hope is still very much an experimental language, this interpreter is robust enough and easy enough to use that it can serve as an excellent learning tool; a degree in computer science is not required to get it running.

This new version of Hope runs under PC-DOS 2.0 and comes as two 8088 segments (i.e., 128K bytes), which leaves very little workspace to play with; an enhanced version will be able to use bigger memories.

The interpreter is booted by simply typing HOPE from the PC-DOS prompt, and it takes about 30 seconds to come up (mostly in-memory pointer juggling time rather than disk-access time). You are then presented with the Hope prompt >: and

are ready to enter programs.

Using the Hope interpreter will be a familiar experience to anyone who has used a LISP interpreter on a personal computer; it works in a similar way.

Those readers who have only used BASIC interpreters will find it less familiar. Since Hope is a functional language, the activity of programming consists of declaring functions, whose definitions are then stored in memory; there can thus be a number of different "programs" in memory at the same time, whereas BASIC normally permits only one.

This raises a rather delicate point of semantics. In Hope, strictly speaking, a "program" is the application of a function to its actual arguments. As in LISP or FORTH, a series of definitions is entered, culminating in the definition of the function that does the job. To run a program, you type the name of this last-defined function with appropriate arguments. Nevertheless, to keep us on familiar territory, I shall talk about the definitions themselves as "programs" as they more or less correspond to the source code of a conventional program.

The Hope interpreter provides some facilities for inspecting and editing function definitions that have already been entered, though they could not be described as adding up to a full editor. I found that these are sufficient for entering small programs and learning your way around the system. For larger programs a separate editor makes sense.

I was pleased to find that the Notepad in Borland's SideKick program works extremely well in this role and gives you an editor that is available at a keypress from inside the interpreter (more on this later).

A Hope program consists of a declaration containing the name and type of a function, followed by a series of recursion equations that describe the value of the function for all possible patterns of its arguments. The required pattern matcher is built into the

*(continued)*

Dick Pountain is a technical author and software consultant living in London, England. He can be contacted c/o BYTE, POB 372, Hancock, NH 03449.

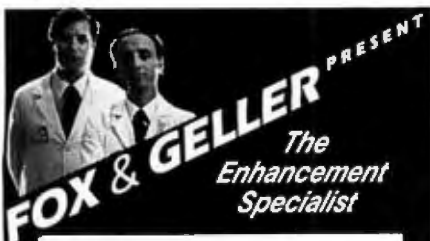

## dBASE

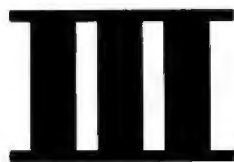

POWER TOOLS

### QUICKREPORT™

dBASE Report Writer

- Prints *any kind* of report or form
- Up to 6 databases per report!
- Use bold, italics, etc.
- Incredibly easy to use
- No programming required

### QUICKCODE III™

dBASE Program Generator

- Create PRG files *automatically*
- Data entry screens
- Data input error checking
- Computed fields & totals
- Link up to 8 databases!

Why write programs yourself?  
Let QUICKCODE III do it!

### dGRAPH III™

dBASE Graphics System

- Pie, line, bar charts
- Printer, plotter, or CRT
- Many automatic features

### dUTIL III™

dBASE Program Utility

- Finds program errors
- Improves code
- Saves time

### NEW QUICKINDEX™

- Index dBase files up to 10 times faster than dBASE

—Versions available for dBASE II—

INFORMATION  
HOTLINE

800-221-0156

FOX & GELLER

Fox & Geller, Inc. 604 Market St., Elmwood Park, N.J. 07407

dBASE II and dBASE III are trademarks of Ashton Tate.  
QUICKCODE and QUICKINDEX are trademarks of Fox & Geller, Inc.

## BYTE U.K.

interpreter. For example, a program to count the number of elements in a list looks like this:

```
typevar : alpha ;
dec listcount : list(alpha) -> num ;
--- listcount(nil) <= 0 ;
--- listcount(x :: y) <=
    1 + listcount(y) ;
```

This program counts lists of objects of type alpha, where alpha can be any type that Hope supports. The Imperial College implementation supports types num (which are positive integers only), char (characters), and truval (Boolean truth values), together with lists and sets of those types. So we could run the program either as

```
> : listcount({3,4,5,6}) ;
> : 4 : num
```

or

```
> : listcount("zeitgeist") ;
> : 9 : char
```

or even

```
> : listcount({true,false,true,true,
    false}) ;
> : 5 : truval
```

Note that the terminating semicolon is essential for all inputs to Hope, that list arguments need their square brackets, and that a literal string like "zeitgeist" is treated by Hope as an alternative way of writing a list of char. The declaration of typevar alpha is actually redundant because alpha and beta are predeclared in the system and ready for use.

If you enter listcount ; alone without arguments, Hope returns its type, list(alpha) -> num. It's generally true that all defined objects will return either their type or status (in the case of switches like trace and time) if they are entered without arguments.

The program can be entered merely by typing each line at the prompt, followed by a carriage return. Hope allows you to format the code with spaces and tabs for indentation and it "remembers" such formatting.

There is no block structure (as is found in Pascal or C) and no marker for the end of a program. New recursion equations can be entered at any

time (like adding lines to a BASIC program), and they are appended to the end of the program, the equations being stored in the order in which they were typed.

Type and syntax checking are performed immediately upon program entry. A recursion equation that contains either a type or syntax error will not be accepted and must be retyped correctly.

The error messages are in plain English; for example:

```
> : --- listcount(x) <= 0 ;
%HOPE Types incompatible
list(alpha)
num
```

The two offending types are printed out below the message (%HOPE indicates a message from the Hope interpreter).

The philosophy of Hope is that as many errors as possible can be caught upon entry; run-time error reporting is much less powerful, although it can tell you that no matching equation was found for a particular argument, thus inviting you to add a suitable one.

Some run-time errors, especially those involving memory management, may trigger more cryptic error reports from the underlying Pascal run-time system.

A program can be inspected by typing the command display ;, which lists the source for all the user-defined functions on the screen, or by display listcount ;, for instance, which just lists listcount.

The listing might not be in the order in which you entered the program, as operators, typevars, and data declarations are listed first before all function declarations. It's also possible that in the listed version, Hope may have altered the parentheses, adding some extra levels on occasion.

The modify command allows a limited editing of programs. If modify listcount ; is typed, Hope offers the declaration line first, thus permitting its type specification to be altered (you can't actually delete the declaration

(continued)

Announcing

THE NATIONAL HISTORICAL SOCIETY

# CIVIL WAR CHESS SET

Richly detailed portrait sculptures of great American heroes  
—in solid pewter, solid brass and fine enamels.  
An heirloom chess set to be enjoyed for generations.  
Created by the world-famous craftsmen of The Franklin Mint.



Major General  
William Tecumseh Sherman  
BISHOP



General in Chief  
Ulysses S. Grant  
KING



This handsome pewter-finished chessboard and fitted presentation case will be provided as part of the set.



General in Chief  
Robert E. Lee  
KING



Major General  
J.E.B. Stuart  
KNIGHT

Available only by direct subscription.

Issue Price:

\$17.50 per sculptured chess piece.

Limit: One complete set per subscriber.

Please enter your subscription  
by August 31, 1985.

The National Historical Society Civil War Chess Set is a dramatic and fascinating tribute to the heroes of both North and South. For the playing pieces include richly-detailed 3-dimensional *portrait sculptures* of the great Generals on both sides, as well as enlisted men.

Each figure will be captured for the ages in solid pewter, then set atop a solid brass pedestal base encircled by a richly colored enamel band—blue for the Union, gray for the Confederacy. And every nuance of facial expression, uniform and weaponry—right down to buttons, braiding, sabers and carbines—will be depicted with uncompromising accuracy.

The result is a work that will bring lasting pleasure to chess enthusiasts, history

buffs, collectors of military miniatures—anyone who appreciates our nation's heritage. A work of heirloom quality, certain to evoke admiration and envy from all who see it dramatically displayed in your living room, den or office.

Crafted for the Society by The Franklin Mint, each figure is scaled to suit the role assigned to it in the game of chess. The chessmen will be issued at the attractive price of \$17.50 each. The handsome pewter-finished playing board, the fitted protective case, a Certificate of Authenticity and specially written reference materials will be provided at no added cost.

As a subscriber, you will receive two sculptured pieces every *other* month. You will, however, be billed for only *one* chessman at a time—a total of just \$17.50 per month. In addition, you will be given the option to complete your set even earlier—but will be under no obligation to do so.

No advance payment is required. But please note that the accompanying application is dated and should be mailed no later than August 31, 1985.

© 1985 FM  
SUBSCRIPTION APPLICATION

Please mail by August 31, 1985.

The National Historical Society  
c/o The Franklin Mint  
Franklin Center, Pennsylvania 19091  
Please enter my subscription for The National Historical Society Civil War Chess Set, consisting of 32 chessmen.

I need send no money now. I will receive two new playing pieces every *other* month, but will be billed for just one piece at a time—\$17.50\* per month—beginning when my first shipment is ready to be sent. I will receive the fitted presentation case and pewter-finished chess board at no additional charge.

\*Plus my state sales tax and \$.50 per chessman for shipping and handling.

Signature \_\_\_\_\_

ALL APPLICATIONS ARE SUBJECT TO ACCEPTANCE

Mr./Mrs./Miss \_\_\_\_\_

PLEASE PRINT CLEARLY

Address \_\_\_\_\_

City \_\_\_\_\_

State, Zip \_\_\_\_\_

Limit: One set per subscriber.

Canadian residents will be billed \$49 (Cdn. \$) for each shipment of two chess pieces, payable in two equal monthly installments, with the first payment due prior to shipment. 49

## Your Best Buy

### AB SWITCHING BOXES



<b>RS232 SERIAL</b> AB 2-WAY DU-2500 All 25 leads Switched	<b>Centronics Parallel</b> AB 2-WAY DU-3600 All 36 leads Switched
<b>\$59<sup>00</sup></b>	<b>\$79<sup>00</sup></b>

#### COMPARE FEATURES

- Indestructible Hi Impact Case
- Mil Grade Fiberglass P.C. Board
- Sealed-Push button Switches
- All 25 or 36 Lines Switched
- High Grade at economy prices
- 100% Satisfaction Assured!
- Distributor or Qty. prices available

#### DATA CABLES



- Lengths from 2.5 to 50 ft.
- Male-Male or Male-Female
- Shielded, Unshielded Cables
- RS232 or Centronics & Coax.

We carry over 500 std. cable items in stock including D-Sub 9, 15, 25, 37, Centronic, IEEE 488, Coaxial, Twinax, etc. Please call for price information and delivery.

#### TOP OF THE LINE



- Sturdy Steel Case-RFI Proof
- Gold Plated Switch Contacts
- LED Line Monitors (Optional)
- Harmonizing Light Tan Color
- 18 Std. Models To Choose from
- RS232 Centronics or Coax Types
- 1, 3, 4 Position & X Sw-Over
- Size 7.25" x 5" x 2.25"
- Description & Prices On Request
- Immediate Delivery from Stock

More than 800 DP Essentials  
Add \$4.50 Shipping & Handling

TO ORDER **800-343-1455**  
TECHNICAL SUPPORT: 617-682-6936



**DATA PRODUCTS**  
175 Osgood St. Rte 125  
No Andover MA 01845

tion, so once declared, a function is there to stay). We could, for instance, change listcount to list(num) -> num.

Then the equations are presented one after another, and a menu offers the choice of deleting or replacing each equation, or inserting a new one before or after it.

It is not possible to edit the text of an individual equation, which must be retyped in full if necessary—hence the value of a separate editor.

Hope programs can be traced or timed by commands called, oddly enough, trace and time. Tracing can be applied to a list of named functions (e.g., trace listcount ;) or it can be applied to everything (trace all ;). It must be switched on with trace on ;. Timing is switched on in the same way and returns the execution time in 10-millisecond units, rather too coarse grained to time very simple evaluations, which always return 0.

The save command saves the contents of the workspace to disk under a filename, which is given the default extension of .HOP automatically. Such files can be read back in using the load command. The files contain plain ASCII (American Standard Code for Information Interchange) and are accessible to any standard software tools.

One feature of these commands that may cause surprise at first is that in a file written by save, function declarations are separated from their equations and saved at the beginning of the file. This is to ensure that when a file is read back in, all functions will have been legally declared before they are used in other function bodies. Unlike LISP, Hope does not tolerate the use of a function's name before it has been declared.

Input/output (I/O) is often rudimentary in functional languages, but Hope supplies an interface to PC-DOS on two levels. Character I/O is provided by the built-in functions putch and getch, while file I/O can be performed by treating named PC-DOS devices as "lazy lists" (that is, lists whose elements are only produced on demand).

I've found SideKick to work well as an editor for Hope, apart from the annoying fact that when an edited file is loaded, the new equations don't overwrite the previous versions but are appended at the end of the program.

The definition of Hope forbids "overlapping left-hand sides," that is, more than one equation with the same left-hand side. The interpreter used at Imperial College currently ignores them (a limitation that is clearly documented) and executes the first version, which in my case is the unedited version.

This makes deletion of the old versions necessary before or after loading the new versions, although in practice I find it easier to restart Hope from DOS and then load (I'm using a RAM disk, which makes this a fast operation).

A more satisfactory behavior in an interactive interpreter, short of an integral full-screen editor, would be for new equations to overwrite "overlapped" old ones just as is done by BASIC lines with the same line number. Alternatively, if this is unacceptable, a global delete command to remove whole definitions is needed. Using one of these solutions, the system could provide interaction as fast and convenient as the best of BASIC or FORTH systems.

The full solution is the implementation of modules, which Victor Wu is incorporating into the next version. Sealed program modules will be able to be saved, loaded, and killed, thus tidying up the ergonomics at the same time as providing a powerful mechanism for hiding private program and data definitions.

Don't expect miracles on the performance front. Functional languages are generally slow and memory-consuming on conventional hardware, and Hope is no exception. I tried running the Sieve of Eratosthenes benchmark and discovered that, even using "lazy evaluation" for the number list (lcons rather than :), only primes up to 174 could be computed in the available workspace. If you use an "eager" list,

(continued)



It'll be a warm day in Prague before most Americans learn to spell correctly. And no wonder. "I before E unless it's preceded by C, or sounds like A" . . . It's enough to drive anyone to defect.

But now, in a burst of American ingenuity, CYMA/McGraw-Hill introduces Final Draft, the word processor that makes spelling as easy as ABC.

Well, actually, spelling correctly is as easy as S. You see, after you've completed your document, you need only press S, and Final Draft will check your spelling with its 80,000-word dictionary. Typos need never

again become an international incident.

But although the spelling check is certainly worth its weight in korunas, Final Draft also offers features like automatic red-lining and strike-out, table of contents and index, floating footnotes, thesaurus and merge-print, features you won't find in comparably-priced systems. Nor in systems twice our price.

Now you're probably wondering if power is synonymous with difficulty. Check your thesaurus and relax. Final Draft has only 35 commands. Not 305, like most of our complicated competitors. And our

commands are alphabetically-assigned so that you can learn them quickly and remember them easily. You can learn Final Draft the first day and master it the second. Now *that's* American ingenuity.

So whether you're a *champion* speller, or just a college graduate, Final Draft will cover you. From aardvark to zymurgy. And everywhere in between. Like Czechoslovakia.



Inquiry 355 for End-Users.  
Inquiry 356 for DEALERS ONLY.

The word processor  
from CYMA/McGraw-Hill.  
Call 800-292-CYMA.

# SPELLING CZECH



# One Board... One Family



At the heart of every Stride 400 Series microcomputer, from the floppy-based 420 to the 448M byte 460, is an identical CPU board. This guarantees compatibility throughout the entire product family. And it means, our CPU board was designed with standard features that are either options or simply unavailable on other microcomputers:

- 68000 microprocessor (10 MHz with no wait states)
- VMEbus
- 256K bytes RAM
- 5 1/4" 640K byte floppy
- Battery-backed real time clock
- 4K CMOS RAM
- Four RS-232C serial ports (Stride multiuser BIOS)
- Centronics bi-directional parallel port
- Omninet Local Area Network (Liaison LAN software)

**COBOL**  
**Modula-2**  
**Pascal** **FORTTRAN**  
**RN/COS** **LISP**  
**UNIX** **CBASIC**  
**Cp-System**  
**CP/M** **MSK**

All this, and still the best price/performance ratios in the industry, from \$2900 to over \$60,000. But it begins with the powerful Stride CPU board, a standard feature of every 400 series system. It's what we call "Performance By Design."

With this basic design, Stride is able to explore the full range of 68000 applications from an advanced multiuser, multi tasking BIOS to built-in local area networking. No other microcomputer offers the flexibility to run over a dozen different operating systems and more than 30 languages/compiler.

The basic design is backed by a rich option list:

- 12 MHz 68000 processor
- VMEbus (Eurocard) cage
- Low cost, high speed graphics
- NOD™ cursor control
- 12M bytes of RAM
- 448M bytes of hard disk storage
- 22 serial ports
- Floating point processor (NS16081)
- Cartridge streaming tape backup
- Memory Management Unit



**STRIDE**  
MICRO

Formerly Sage Computer

For more information on Stride or the location of the nearest Stride Dealer call or write us today. We'll also send you a free copy of our 32 page product catalog.

**Corporate Offices:**  
4905 Energy Way  
Reno, NV 89502  
(702) 322-6868

**Regional Offices:**  
Boston: (617) 229-6868  
Dallas: (214) 392-7070

only 76 can be handled.

The point of including this information is to dissuade anyone who might think they're going to use this free Hope to write a real-time airline booking system. Instead, regard it as a sampler with which to investigate the very real advantages of the functional programming style; then you'll be ready for the next generation of parallel hardware that will make such languages a practical proposition.

In summary, this system is pleasant to use and remarkably complete, given that this is a "laboratory" language hitherto confined to mainframes and superminicomputers. The only features omitted, apart from modules, are "overloaded" operators (e.g., using the same operator + for adding numbers and concatenating strings), prefix and "distfix" operators, and certain of the more advanced set and mapping functions.

Victor Wu told me that these will be included in the next version, which will be able to use more than 128K bytes of memory. A Macintosh version (Fat Mac only) with a full windowing editor is in preparation and due to be released sometime this year.

## DECLARATIVE BOOKS

Until very recently there has been a noticeable dearth of readable books on the subject of declarative programming. A few years ago the only such book available to the nonacademic reader was *LISP* by Patrick Henry Winston and Berthold K. Horn (Reading, MA: Addison-Wesley, 1981). The reason is simply that most of the work on such languages occurs in universities, which tend to disseminate information through papers rather than books.

Two books published recently in London, one on functional and the other on logic programming, are very welcome additions to the understocked library. Both books are pitched at undergraduate computer science level but are written clearly enough to be accessible to any experienced programmer. A proviso is that both books contain a formal mathe-

(continued)

# When designing and building the Stride 400 microcomputers, why did you select the MC68000 Motorola processor over the newer Intel iAPX 286?

[This is one of a series of design philosophy discussions with Rod Coleman, President of Stride Micro (formerly Sage Computer).]

**RC:** With the introduction of the IBM AT, many people have been spending a lot of time comparing the 286 with the 68000. We also

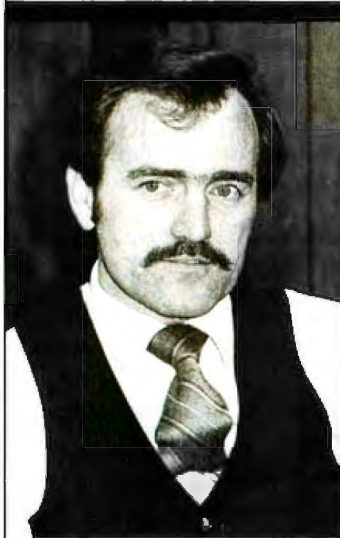

**"... the 68000 is at least one generation ahead of the 286 in terms of microprocessor design."**

surveyed the marketplace closely when we decided to build a second generation of our successful Sage computer, but came to a quick conclusion: the 68000 is at least one generation ahead of the 286 in terms of microprocessor design. Admittedly, the Intel microprocessor was a newer chip, and it had an impressive pedigree from the popularity of the 8088. But, in my view, the 286 was so steeped in its own history that the architecture suffered critically. In reality, today's 286 is little more than an 8086 with a memory management unit tacked on.

**Q:** What's wrong with that?

**RC:** Well, it certainly maintains compatibility with the Intel chip family, but it's not the way to design a state-of-the-art microprocessor. I like to use the example of a remodeled house. As your needs grow, you can build a new front porch, attach a garage, remodel the kitchen, and add a few bedrooms. But the end result never ends up as efficient as a larger house built from scratch. The halls are often too narrow and full of annoying twists and turns. The folks at Motorola apparently felt the same way, because they started with a clean sheet of paper when they designed their 32-bit architecture with no concessions to an 8-bit past.

**Q:** Can you give us an example?

**RC:** Just look at the registers and addressing modes. They are much larger and far more flexible in the 68000 than in the 286. The 8086 design was based on the 8080, which was an extension of the world's first 8-bit processor, the 8008. Strange as it may seem, the brand-new 286 has, as a subset, the registers from a processor designed back in 1972. Intel's motive was compatibility with current software; Motorola simply wanted to build the best possible chip. By creating a totally new design with the 68000, they were also able to apply several new concepts undeveloped in '72. The 68000 was designed from the ground up to execute high-level languages, as opposed to the 8008's roots as a simple industrial controller. Motorola provides 16 general purpose 32-bit registers to give greater flexibility and a clean orthogonal design. Thus, it efficiently and directly

addresses 16 megabytes with no preferred boundaries. The 286, by contrast, has only special purpose registers which can address just 64 kilobytes. It must use a segment register to exceed those boundaries, just as the earlier 8088 did.



**"Sooner or later, even IBM will be forced to build a PC using a processor with a large regular addressing architecture."**

**Q:** Are there other critical differences?

**RC:** Yes. There's also the question of access. For a given generation of silicon design and feature size, any two contemporary processors should be able to do about the same number of instructions per second. Unfortunately, the 286 has a bottleneck where it forces single pins into double duty. It shares the use of its address and data bus which means that, for a given bus

bandwidth, its transfer rate will always be less than a non-multiplexed processor. The 68000 escapes the problem by dedicating a single pin for each function.

**Q:** What does it really mean to those on the software application level?

**RC:** As micros move into the late 80's, software will have to lead the way by becoming more functional and less complicated to use. Ironically, software that's easier to use actually has to be larger and more complex internally. It simply cannot be written when stifled by artificial hardware constraints like 64K byte boundaries. It's like building a new car with a one quart gas tank. Sooner or later, even IBM will be forced to build a PC using a processor with a large regular addressing architecture. But don't hold your breath: we got tired of waiting back in 1981. Apparently so did several thousand others: they have been buying our machines for four years.



Formerly Sage Computer

For more information on Stride or the location of the nearest Stride Dealer call or write us today. We'll also send you a free copy of our 32 page product catalog.

**Corporate Offices:**  
4905 Energy Way  
Reno, NV 89502  
(702) 322-6868

**Regional Offices:**  
Boston: (617) 229-6868  
Dallas: (214) 392-7070

# IF you're satisfied with BASIC on your Apple or Commodore, THEN

If you've been writing programs for your Commodore 64, Apple IIe or Apple IIc in BASIC you can take a giant step forward in speed of execution and in programming productivity for just \$49.95.

You can get program performance that you only thought possible from machine language programs. While still using a powerful, understandable high-level language. A language that's similar to Pascal, but much easier to learn and use.

You can create programs with our advanced, full-screen editor—much like you would on a word processor, and it even locates your compilation errors.

And when you compile your programs, you have a fast one-pass compiler, a recursive descent compiler that can compile a 100-line source program in 10 seconds or less.

PROMAL™ also gives you an elegant operating system "Executive," which includes powerful file, program and memory management commands and even I/O redirection.

You get all of that with PROMAL—improved programming productivity, faster compile and run time and power that you may never have thought possible.

**PROMAL—for the beginning or advanced programmer.**

Whether you are just beginning to write or are an experienced programmer, you can be more productive with PROMAL (PROgrammer's Micro Application Language). It's easier to learn than Pascal, C or Forth. It provides you with a full range of powerful structured statements like IF-ELSE, WHILE, REPEAT, FOR and CHOOSE. And, because indentation is part of the language's syntax, it helps you write programs neatly and logically. There are no line numbers to worry about, and since comments don't take up memory space, you can document your programs completely.

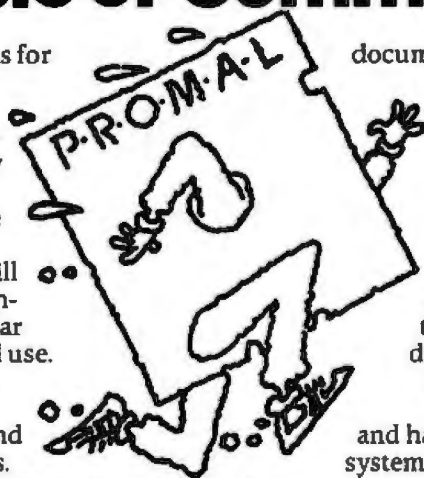

## GOSUBwhere else.

documentation and PROMAL system diskette including sample programs) for just \$49.95. There's a 15-day, no-risk moneyback guarantee. And the entire \$49.95 may be credited against later purchase of the "Developer's Version."

The "Developer's Version"—all the components of the "End User" system plus the "run time" object module generation capability, additional documentation and an unlimited right to sell or distribute PROMAL applications—is only \$99.95.

Or—for only \$10.00 plus \$2.50 postage and handling you can get the PM-100 demo system. It includes a 32-page manual and all the

capabilities of the PM-200 except the ability to print or save

files to disk. It's a very inexpensive way to explore the wonders of PROMAL.

**Our Guarantee:** Try PROMAL for 15 days. If you are not completely satisfied, return it to us undamaged and we'll refund your money. No questions asked. Dealer inquiries invited.

For quicker response on credit card orders, call Toll Free:

**1-800-762-7874**

In NC: 919-787-7703.

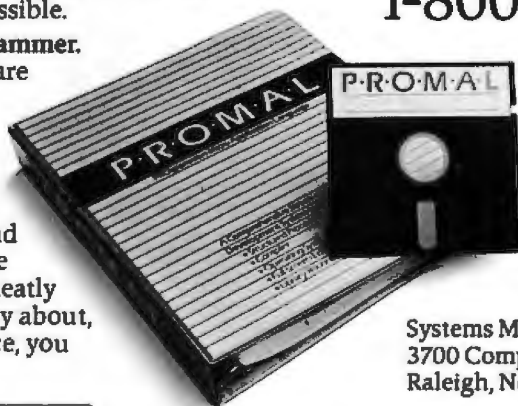

Only  
**\$49.95**



Systems Management Associates  
3700 Computer Drive, Dept. PB-4  
Raleigh, North Carolina 27609

### COMMODORE 64 BENCHMARK

(Siege of Eratosthenes)

	PROMAL	BASIC	COMAL	FORTH	PASCAL
Execution Time (secs.)	30	630	490	51	55
Object Code Size (bytes)	128	255	329	181	415
Program Load Time (secs.)	3.2	3.8	6.3	11.2	23.5
Compile Time (secs.)	8.5	—	—	3.9	108

**PROMAL—a language especially for small systems.**

Unlike languages developed for larger systems and squeezed into small systems environments, PROMAL was conceived and developed specifically for the small system. With PROMAL there's finally a language created for the environment in which you work.

**Speed up your programs and step up your programming productivity.**

You get all of that speed and productivity—with the PROMAL PM-200 "End-User" system (220 pages of

#### Order Form

Please send me my copy of PROMAL

My system is (check one):  Commodore 64  Apple IIe  Apple IIc  
PROMAL Package Desired (check one):

- PM-200 (for systems listed above) \$49.95 plus \$5.00 for shipping and handling at a total cost of \$54.95. Satisfaction Guaranteed.  
 PM-300 Developer's Version \$99.95 plus \$5.00 for shipping and handling for a total cost of \$104.95. Satisfaction Guaranteed.  
 PM-100 demo diskette \$10.00 for the diskette plus \$2.50 for postage and handling for a total cost of \$12.50. (Non-refundable.)  
 My check is enclosed.  Please charge my purchase to my  Visa  Mastercard

Card Number \_\_\_\_\_ Expiration Date \_\_\_\_\_

Signature \_\_\_\_\_

Name \_\_\_\_\_

Address \_\_\_\_\_

City, State, Zip \_\_\_\_\_

North Carolina Residents add 4-1/2% sales tax.  
Foreign orders add \$15.00 additional shipping and handling.

## COMPILED LANGUAGE

- Structured language with indentation as syntax element
- Fast, 1-pass recursive compiler
- Simplified syntax requirements
- No line numbers, no terminators
- Long variable names (31 characters)
- Global, Local & Argument variables
- Byte, Word, Integer & Real data types
- Decimal or Hexadecimal number types
- Functions with passed arguments
- Predefined DATA of any type
- Procedures with passed arguments
- Built-in I/O library
- Arrays, strings, pointers
- Control Statements: IF, IF-ELSE, WHILE, FOR, CHOOSE, REPEAT-UNTIL, BREAK, NEXT, INCLUDE, ESCAPE, REFUGE
- Bit-operators, shifts, casts
- Compiler I/O from/to disk or memory
- Variables at defined location
- Simple Machine Language interface
- Recursion fully supported
- Compilation errors trapped for Editor

## EXECUTIVE

- Command oriented, with line editing
- Memory resident at all times
- Allows multiple user programs in memory at once
- Function key definitions
- Program abort and pause
- 22 Resident system commands, 8 user-defined resident commands, no limit on disk commands
- Prior command recall facility
- I/O Re-direction to disk or printer or from disk or keyboard
- File system management commands
- Memory map, set and display commands
- Batch job file support

## EDITOR

- Full-screen, cursor driven
- Function key controlled
- Line insert, delete, search
- String search and replace
- Block copy, move, delete & write to/read from file
- Auto indent, unindent support
- Edit-after-error facility

## LIBRARY

- 45 Machine-language commands, memory resident at all times
- Call by name with arguments
- String handling (9 routines)
- Re-directable standard input and output files (STDIN, STDOUT)
- Formatted I/O (including Reals)
- Decimal & Hexadecimal I/O
- Block fill, Block move
- Block read, Block write
- Cursor control & line editing
- Data type conversion
- Random number function
- Real function support (in PROMAL): ABS, ATAN, COS, EXP, LOG, LOG10, POWER, SIN, SQRT, TAN



mathematical chapter, but this could be skipped over without too much loss of sense.

*Principles of Functional Programming* by Hugh Glaser, Chris Hankin, and David Till is published by Prentice-Hall International (1984). The authors are lecturers at London University.

The book starts on a commendably down-to-earth note, by looking at examples of top-down program design in plain English. In the subsequent chapter, the authors show how a simple and elegant functional language called SUGAR emerges quite naturally from these program specifications. The remainder of the first part of the book then discusses the syntax of SUGAR, profusely illustrated with example programs and exercises for the reader. One of the examples concerns functional turtle graphics, which is a welcome departure from the mathematically biased problems that authors in this field have a tendency to rely on.

The second part of the book begins with a chapter on Alonzo Church's *lambda-calculus*, which is the mathematical underpinning of functional languages. Nonmathematical readers may prefer to skip this, but I found it quite fascinating, if only to find out where that cryptic word LAMBDA in LISP came from. More important, it clarifies the reasons why functional programs are susceptible to mathematical analysis and transformation, while procedural programs are not, in general.

A subsequent chapter explains the development of an interpreter for SUGAR written in SUGAR, and this leads into a discussion of three different models for machines (virtual or real) that have been devised to execute functional languages. These architectures (SECD, SK Reduction, and Data Flow) are described by algorithms written in a mixture of pseudo-Pascal and plain English (far more approachable for "outsiders"), which are sufficiently detailed to serve as a guide for serious readers who wish to experiment with real programs. The section ends with a chapter on formal semantics, which will make little sense

to computer novices.

The third part of the book consists of a survey of some existing functional languages. The largest chapter is devoted to FLISP, which is a functional subset of LISP, and smaller sections to KRC, Hope, and John Backus's FP systems. Useful appendices include rules for translating SUGAR programs into FLISP and the listing for an FP system written in FLISP.

While the book is not a tutorial in any particular functional language, it provides an informed overview and a rationale that could be of use not only to potential implementors but to anyone who plans to learn functional programming. The functional style of programming is very different from the procedural style most of us have grown up with; for myself at least, understanding the reasons behind it makes the transition a lot easier.

The second book, *Introduction to Logic Programming* by Christopher Hogger (Academic Press, 1984), is more theoretical and, to the nonacademic reader, more difficult than the first, although it covers analogous ground. It is not specifically about Prolog, though it concedes that Prolog is the one widely used logic-programming language.

Like *Principles of Functional Programming*, it starts from first principles, with an explanation of logical predicates, interpretations, and implications. Some of this treatment is quite formal, but the author suggests parts that may be skipped on first reading. The discussion of inference leads to discussions of *resolution* and *unification*, the techniques that permit computers to solve logic problems.

Attention is then directed to logic programs on computers, with a discussion of the standard strategy of a logic interpreter, the structure of logic programs, and data structures. I learned a lot from this section, particularly about control flow in logic programs, which is almost a taboo subject in Prolog tutorials; it came as something of a surprise to read about sequencing, branching, and iteration, as well as recursion. The difficult sub-

(continued)

jects of nondeterminism and negation are covered in some depth.

Two chapters cover the verification of correctness of logic programs and the synthesis of programs from specifications—the area in which the strongest claims are made for the superiority of logic programming over the conventional kind.

A chapter on implementation is well illustrated with structure diagrams and algorithms in pseudo-Pascal. Special attention is paid to the pursuit of efficiency and to techniques for conserving memory or processor time (almost always a trade-off).

The book ends with a chapter called "Broader Contribution to Computing," which discusses the influence of logic programming on computing theory, and the various implementations of Prolog worldwide, including the Japanese Fifth Generation Project.

My conclusions about the first book

hold true for this one, too; knowing the background can only help in learning the languages. I found *Introduction to Logic Programming* a more difficult book, but that's because I find logic harder than programming. The specialist will appreciate that this is the first book that covers all aspects of the field, and apparently it is currently the only book that covers the implementation of Prolog.

I highly recommend both books to anyone who wants to find out what is happening in the evolution of programming and who isn't afraid of some rigorous thought.

**MACPROLOG**

In the December 1984 BYTE U.K. ("Prolog on Microcomputers," page 355) I described micro-PROLOG for CP/M-80 machines. Frank McCabe, one of its authors, recently loaned me a beta-test copy of MacProlog, his implementa-

tion for the 512K-byte Macintosh.

MacProlog has many improvements over the older micro-PROLOG, not the least of which is that it compiles rather than interprets; this, combined with the Mac's 68000, makes it very fast indeed for an artificial-intelligence language. McCabe has taken the trouble to fully integrate Prolog with the Macintosh user interface, which makes it much easier and nicer to use, too.

It's based on sigma-PROLOG, a UNIX version of micro-PROLOG, and one of the great improvements in sigma-Prolog is that you can use long variable names instead of *x*, *y*, and *z*. What's more, the system remembers variable names so that they are not all changed when you list a program as they were in micro-PROLOG. The naming convention is that all variables must begin with an underscore.

(continued)

# STEAL AN INDUSTRIAL SECRET.

American companies trust their most important computer information to special premium grade unbranded "industrial quality" diskettes. These diskettes, manufactured by select American and Japanese firms, must meet or surpass stringent specifications.

You can now purchase these 5¼" diskettes from Holmes & Company. Even better, you can buy them at the low price paid by the big corporations . . . as low as \$.80 each (SS/DD, with reinforced hub ring, TYVEC sleeve, write protects, labels). Each diskette has been tested prior to shipment and carries a lifetime replacement warranty.

To order today, call toll-free 1-800-4-HOLMES (In California 408-241-1505). Ask about quantity discounts and special prices on hardware and supplies.

**Holmes & Co., 900 Lafayette Street, Suite 605, Santa Clara, California 95050**

Quant.	Description	Price	Total	Name _____
	SS/DD	\$1.00		Address _____
	DS/DD	\$1.30		City _____ State _____ ZIP _____
	Subtotal:	_____		Phone (____) _____
	CA Res. Add 7% Tax:	_____		Signature _____
	Handling Charge:	\$2.50		MC _____ VISA _____ Card # _____ Exp. date _____
	Total:	_____		



# FIVE REASONS TO BUY THE AT&T PERSONAL COMPUTER IN 1985:

1. 1986
2. 1987
3. 1988
4. 1989
5. 1990

There are lots of reasons to buy the AT&T PC for your business this year. It offers more computer for the money. It's faster than the IBM PC, and has superior graphics. The AT&T PC is a hardworking, high-performance computer designed to meet all your immediate needs.

And it has something more. A commitment to your future.

That commitment can be seen in our new enhancements. They include the Communications Manager with simultaneous voice and data transmission, the 8087 co-processor which speeds mathematics computing up to 100 times, and a display enhancement board for even better color graphics.

That's just the beginning for the AT&T PC, and the starting place for a fully integrated office.



## THE COMPUTERS WITH THE FUTURE BUILT IN

Because AT&T PCs can be linked together in small groups through the STARLAN local area network or networked into an entire system with the AT&T Information Systems Network.

In fact, wherever your needs take you, with the AT&T PC you know that your growth path is clear, and that you'll have plenty

of options. That's what gives us the edge over our competition. And you the edge over yours.

It's what makes the AT&T PC the right choice this year, next year, and in the years to come.

For more information, call your AT&T Information Systems Account Executive, visit an authorized AT&T dealer, or call 1-800-247-1212.



**AT&T**

The right choice.

*Compared to  
micro-PROLOG,  
MacProlog syntaxes  
are better controlled  
and less potentially  
confusing thanks to  
the Mac interface.*

This enhancement is apparently the product of much blood, sweat, and tears at Logic Programming Associates. I hadn't realized until I read Hogger's book (discussed previously) that the capricious treatment of variable names stems from the nature of the logical inference process itself and was no mere whim of the implementors; the cure was not trivial.

On booting up the Mac and opening the sigma-PROLOG icon, the top menu bar offers the choices File, Edit, Search, Program, Windows, and Queries. The only window open on the screen is called Default Output Window.

Programs are written using a new window for each separate relation defined. To write a program you pull down the Program menu and select New, which opens a new window. The relation definition is typed into this

window, and it is then named by selecting Relation Info from the menu.

Of course, the full editing power of the Mac interface, including Cut and Paste, is available during this input, which is a huge improvement over the line-oriented editor of micro-PROLOG. The standard Mac Edit menu has an added option that checks for unbalanced parentheses in a selected text.

When finished, the new code can be syntax-checked and compiled by selecting Check Program from the Program menu. Compilation also occurs automatically when a query is made to a relation that has been edited; it's very quick.

When a relation window is named, MacProlog puts this name onto the Windows menu. The current window can then be hidden to avoid the screen becoming too full of windows, and it can be reopened by selecting from the Windows menu.

In practice, you will more likely want to use Search to find a particular relation name, whereupon its window is automatically opened and made current. Search can also do global search and replace on any name.

There is no command line input to MacProlog at all; all interaction is performed through menus and templates. To actually run programs, you pull down the Queries menu, and choose either Which or Command.

Choosing Which produces a template box for you to enter a query into, and this query becomes the default until altered so you can

evaluate it repeatedly with a single button press. Trace and All Answers options can be set by buttons in the template box. Command produces a similar box for entering system commands.

All the answers to a query appear in the Default Output Window, followed by the time taken for the evaluation.

Errors are reported in a Macintosh dialog box, which offers the options to Continue, Fail, or Succeed the query, and presents a Prolog description of the problem.

MacProlog, like micro-PROLOG, comes with a choice of different syntaxes. Although there are actually more of them (no less than seven), they are much better controlled and less potentially confusing thanks to the Mac interface. Instead of loading modules (and forgetting which one is loaded), a Syntax option is selected from the Program menu.

This presents a control panel, similar to those used for printing and selecting type fonts. You can see at a glance which syntax is selected, and you can change it by clicking on a button.

The syntaxes available are Micro (for compatibility with micro-PROLOG), Edinburgh, MITSU (a new simplified English-like form for novice programmers), Prefix, Core, and Lambda, which was not implemented in the beta-test version.

Core syntax is what the compiler  
*(continued)*

**BYSO™ LISP with  
VISUAL SYNTAX™**

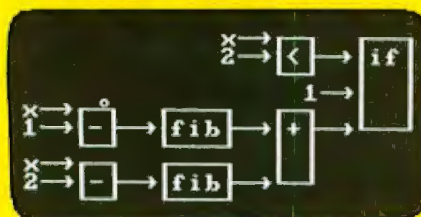

Levien Instrument Co. has done it. We've created **VISUAL SYNTAX**, a program as easy to use as MacPaint, but as powerful as a whole programming language. It allows you to program with pictures. As you can see from the picture of the

Fibonacci function above, it offers a clear picture into your programs.

You have all the power of a full LISP interpreter in a package as fun to use as MacPaint. You can do a lot more with it than MacPaint, though.

The power under Visual Syntax is **BYSO LISP**. It comes with a full screen editor, so you can write in conventional LISP notation if you like.

**BYSO LISP** has one of the most complete libraries of functions of any LISP. There are list manipulation functions for **LISP 1.5**, **MACLISP**, and **COMMON LISP**. It has library management and very advanced datatypes (multidimensional arrays and DEFSTRUCTs). **BYSO LISP** also has lexical binding.

Included in the 119 page manual are application notes that describe graphics, sound, BIOS functions, MSDOS functions, and interface to assembly language programs.

**BYSO** is very fast and reliable. It has been out since Aug. 1984 and there are no known bugs! It will run circles around a VAX.

**BYSO LISP** was written completely in assembly language and has a very efficient memory allocation. It leaves ample room for your programs, with no disk swapping.

**BYSO LISP** is for the IBM PC and most compatibles (min 128K). **VISUAL SYNTAX** is included. Single machine licenses are \$150. 119 page manual included. Multiple license, academic, and industrial rates on request. O.E.M. rates on request.

Order from **LEVIEN INSTRUMENT CO.**, Sittlington Hill, POB 31, McDowell, VA 24458. For immediate delivery call **(703) 396-3345**. VISA, MC, or C.O.D. accepted. \$5 shipping — \$15 foreign. **BYSO** and **VISUAL SYNTAX** are trademarks of R.L. Levien. **IBM PC**, **VAX**, and **MacPrint** are registered trademarks of IBM Corp., Digital Equip. Corp., and **APPLE Computer Inc.**, respectively.



# DECLARE YOUR DATA INDEPENDENCE.

THE NEW STANDARD OF  
MODERN OFFICE DATA STORAGE.



Free yourself  
from the limi-  
tations of

shared and finite hard disk storage. Your dynamic and expanding business data needs demand a more versatile way to deal with critical information.

The Bernoulli Box,<sup>™</sup> with its totally interchangeable 5- and 10-megabyte cartridges, lets you manage data the way you manage your business—directly, efficiently, by job function and application. You create, update, store, and back up

software and data bases on individual cartridges. You expand your capacity infinitely, by adding more cartridges, not more disk drives. You enjoy the convenience of taking or mailing cartridges anywhere—and the security of putting them under lock and key.

The Bernoulli Box works with the IBM PC, XT, AT, most compatibles, and the Macintosh.<sup>™</sup> For your nearest dealer, call 1-800-556-1234 ext. 215. In California, call 1-800-441-2345 ext. 215.



**I-MEGA**

IOMEGA Corporation  
1821 West 4000 South  
Roy, Utah 84067

# BERNOULLI BOX

uses (only needed by serious hackers) while Prefix is the preferred syntax for experienced users; it looks like this:

```
can__buy(__person __thing)
  if in__stock(__thing)
    & LESS(price(__thing)
      funds(__person))
```

A final option in the Syntax panel is Interpret: this enables interpretation instead of compilation, which permits greater flexibility in tracing and

debugging at the expense of speed.

The built-in predicates of MacProlog have been expanded to include a whole set for controlling Mac menus and dialogue boxes. It's possible for the user to create pull-down menus and attach Prolog programs to them to create Macintosh-style applications.

The test version of MacProlog has 24-bit integer arithmetic only, but later versions may have floating-point and

transcendental functions as UNIX sigma-PROLOG does. Modules are not implemented in the test version.

In summary, MacProlog looks like a nicely integrated product that goes a long way toward the sort of friendly programming environment available on \$30,000 LISP machines. The U.S. distributor is Programming Logic Systems, 31 Crescent Dr., Milford, CT 06460, (203) 877-7988, but I have no date for its release. ■

## A PROTOTYPE FOR YOUR PROTOTYPES



**METHODS BY DIGITALK. A SMALLTALK PROGRAM DEVELOPMENT ENVIRONMENT FOR THE IBM PC. AN OBJECT-ORIENTED SPEED DEMON. AN EXCITING WAY TO PROGRAM.**

Think about your problem. Browse the Methods Smalltalk source code. Select some building blocks like pop-up menus, windows, text-editors and dictionaries. Put them together. Try it. Oops, Methods tells you something is missing. No problem. Continue thinking, changing and trying. Now you're prototyping! Try out new ideas. Redefine your problem. And you don't have to throw this prototype away. Refine it until you like the finished product.

Methods by Digitalk. A new way to develop software for the PC. Use it for windowing, simulation and artificial intelligence applications. Use it by prototyping.

Methods is Smalltalk-80™ language compatible. It includes its own Smalltalk source code. You can extend it in Smalltalk and assembly language.

Methods operates on IBM PCs with 512K bytes RAM using MS-DOS or PC-DOS. Color and monochrome monitors are supported. No mouse is required. A Smalltalk language manual and an environment guide are included.

Smalltalk-80™ is a trademark of Xerox Corporation. IBM is a registered trademark of International Business Machines Corporation. MS is a trademark of Microsoft Corporation.

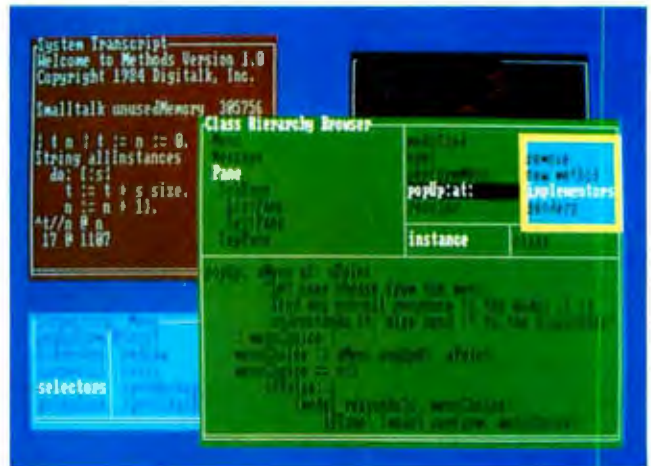

Available from Digitalk for \$250. Outside U.S. add \$15.00 for shipping and handling. California residents add 6% sales tax. Visa and MasterCard accepted. Educational and Dealer Discounts Available.

### DIGITALK, INC.

5200 West Century Boulevard  
Los Angeles, California 90045  
(213) 645-1082



# A·C·C·O·R·D·I·N·G T·O W·E·B·S·T·E·R

## Greetings and Agitations

### Methods

Turbo Pascal 3.0

Copy II Mac

MacTools

MacASM

MacModula-2

Megamax C

QC-20

BY BRUCE WEBSTER

**L**ike last month, this month's column will talk mostly about Macintosh stuff, although it does start out with a few non-Mac products. These columns will probably continue to contain about 60 to 70 percent Mac-related items since most of the hardware and software that comes in is for the Mac. Also, there is substantial coverage of CP/M, MS-DOS, and IBM stuff elsewhere in BYTE.

### METHODS

In the May issue of BYTE, Tom Yonkman and I wrote a product preview of Methods, a version of Smalltalk for the IBM PC from Digitalk Inc. ("Methods: A Preliminary Look," page 152). Methods is now being shipped. It comes with two manuals: *Smalltalk Language Guide* (51 pages) and *Environment Guide* (67 pages). The first manual is unfinished (four chapters are simply "to be completed" pages), and the documentation itself is terse and jargon-laden.

If you're already familiar with Smalltalk, you probably won't have much of a problem with Methods. If you're not familiar with Smalltalk, then be warned: This package is not an easy one to sit down and use on your own. You should buy it only if you are very interested in Smalltalk and are willing to put in a lot of time unlearning conventional software development and switching over to the Methods/Smalltalk environment.

### TURBO PASCAL 3.0

About two years ago, Philippe Kahn of Borland International started something of a software revolution by releasing Turbo Pascal for \$49.95. Very few people believed the claims in the ads; I sure didn't. The product seemed too good to be true, especially in light of the JRT Pascal fiasco. I was writing a Pascal column for *Softtalk for the IBM PC* at the time, so I asked for a review copy, fully intending to rip it to shreds. Instead, I wrote such a glowing review that excerpts were later quoted in Turbo Pascal ads. Turbo Pascal became a software hit, selling some

250,000 copies in two years, an amazing figure for a computer language.

Borland has continued to improve the product over that time, releasing version 2.0 last year. Now version 3.0 has come out, with a number of fixes, a large list of improvements, and a 376-page manual (about 100 pages longer than the 2.0 manual). It also comes with a slightly higher price tag of \$69.95. Turbo Pascal is best known for its small size, incredible compile speeds, and fast execution times. Version 3.0 is still small (less than 40K bytes for the compiler and editor) and is actually faster in compile and execution times. On top of that, the MS-DOS version has a large assembly-language graphics library (including, but not limited to, a turtle graphics implementation). The MS-DOS version also provides better support for DOS (disk operating system) 2.0 and 3.0 file I/O (input/output) and directory calls. A BCD (binary-coded decimal) version is available, designed primarily for financial applications where you need large precision (18 digits) and minimal round-off error. And, of course, an 8087 version of 3.0 is out as well.

Turbo Pascal is not a perfect implementation. Program code is limited to 64K bytes resident at any one time. You can use overlays and chaining to get around that, but it can still make for awkward development. Libraries are not as convenient to use as in UCSD Pascal; ditto for assembly-language routines. But it is fast, small, and cheap; it has a tremendous number of built-in routines to do low-level system work; and it's fun to play around with. The language and the documentation have improved with age. Even at the increased price, it's probably still the best software deal on the market.

### A BRIEF ASIDE

In the interests of integrity, I would like to point out that I have had one financial dealing with Borland International. Last October, just as I was quitting my job, Philippe Kahn

(continued)

Bruce Webster is a consulting editor for BYTE and a charter member of the PMS Commandos. He can be contacted c/o BYTE, 425 Battery St., San Francisco, CA 94111.

called me with a problem. Borland had contracted with an author to write a book on Turbo Pascal. For various reasons, that author couldn't complete it; Philippe, familiar with my Pascal column in *Softalk for the IBM PC*, asked if I could help finish the book. I accepted the job (for a flat fee) and in two weeks wrote parts II and III of *Turbo Tutor*, basing it largely on my *Softalk* columns. Since I receive no royalties from sales of *Turbo Tutor*, my wallet doesn't really care if you buy it or not (though my ego has some concern). And, of course, the same applies to Turbo Pascal itself.

**COPY II MAC/MACTOOLS**

Since most of the Macintosh application software is copy-protected, it was inevitable that a Mac bit-copying program would soon appear. It did—Copy II Mac from Central Point Software—and it's good. I tried it out on almost every piece of copy-protected software I had, and all the copies seemed to work just fine. What's more, the package includes MacTools, a file-manipulation and file-editing routine that lets you set attribute bits (invisible, locked, protected) for files, as well as view and edit them in hexadecimal/ASCII (American Standard Code for Information Interchange) format. And, yes, you can copy the Copy II Mac master disk using itself.

While I am strongly against software piracy—I don't give out software, nor do I receive it—I do feel the need to back up my master disks, especially

for application packages. Copy protection on games doesn't bother me at all, but it can be a real pain on business or productivity software. The firm I used to work for had two business-type software packages on the market: neither was copy-protected, and both had instructions asking the user to immediately make backup copies and then store the masters somewhere safe (and leave them there).

If you're using copy-protected software on the Mac, you should have Copy II Mac to back up and preserve your masters. But please don't use it to steal.

**MAC DEVELOPMENT SOFTWARE**

Here's a quick look at three more development systems for the Mac and some benchmarks for the different languages. The three packages we're looking at are MacASM (from Mainstay), MacModula-2 (from Modula Corporation), and Megamax C (from Megamax Inc.). The benchmarks include these languages as well as several others we've talked about.

MacASM is a Mac assembly-language development system with a decidedly non-Mac interface. In fact, the user interface resembles nothing so much as your typical BASIC environment. Your statements have line numbers; you use commands like LIST, RENUMBER, DELETE, LOAD, SAVE, DIR, ASM, and RUN; and you edit by listing part of the program to the screen, then moving the cursor up

and changing it. Despite that (or maybe even because of it), MacASM is fast and easy to use. You can edit programs using MacWrite or, better yet, Bill Duvall's program editor (found in several other development packages), but it means that you have to pop out of the MacASM environment each time you want to go back to the editor. Your best bet is to do the bulk of your program entry using a regular editor, then use the MacASM environment to debug your code.

The MacASM documentation is an 80-page manual explaining the system commands and assembly-language directives. You will need one or two books on 68000 assembly language, as well as *Inside Macintosh*, to do any serious development.

Because of the quick, familiar nature of its user interface, MacASM is a great tool for learning 68000 assembly language. What's more, you can create stand-alone applications (complete with resource files). According to Mainstay, more than 1000 developers are using MacASM to do just that. And, nicest of all, there are no licensing fees. If you do get MacASM, though, be sure to save your source code out often; whenever you start messing with assembly language, especially on the Mac, you stand a good chance of repeatedly crashing the system.

MacModula-2 is, of course, a Modula-2 compiler from the same people who build the Lilith (a

*(continued)*

**Q. Business Systems Consulting?**

**A. Masterbyte.**

**MASTERBYTE COMPUTERS OF NEW YORK, INC.**  
 Ste. 815, 19 W. 34 St., NY, NY 10001 • (212) 760-0341  
**SERVING BUSINESSES SINCE 1984**

# ATTENTION: \$100 BUS USERS!

## LOMAS DATA PRODUCTS PRESENTS: IBM-PC COMPATIBILITY FOR ONLY

LDP is offering a compatibility upgrade package to convert your current S100 BUS system quickly and easily to IBM-PC compatibility. This upgrade includes the high performance THUNDER 186 and COLOR MAGIC, IBM-PC compatible color graphics board. You get 10 Mhz 8086 performance, 256K bytes of no wait state RAM, two serial ports and a parallel printer port. No other S100 bus boards are required. Included with this set is the advanced CONCURRENT DOS operating system bringing PC-DOS compatibility and multitasking to the system. This board out performs the IBM-PC by a three to one margin. Gain IBM-PC compatibility without sacrificing S100 bus compatibility.

**THUNDER 186 / COLOR  
MAGIC SET . . . . . \$1749.00**



# \$ 1749\*

\*User supplied keyboard and monitor required.



### IBM COMPATIBLE S100 BUS COLOR GRAPHICS

LOMAS DATA PRODUCTS presents COLOR MAGIC, the most complete compatibility solution for S100 bus computer products. COLOR MAGIC includes three major hardware sub-functions which allow it to emulate the IBM-PC: An entirely compatible video function, an IBM-PC keyboard interface and an IBM-PC compatible timer interface including IBM-PC sound compatibility. HOW COMPATIBLE IS IT? Currently we are running MICROSOFT's FLIGHT SIMULATOR recognized as one of the severest tests of compatibility. We can also directly boot PC-DOS for the IBM-PC with no alterations. Other programs which have been tested and function without problems are: LOTUS 1-2-3, DBASE III, WORDSTAR and VOLKSWRITER.

**COLOR MAGIC (16K byte version) .. \$595.00**

■ **THUNDER 186** single board computer provides a high performance 16 bit computer all on one board. It is an ideal companion to the COLOR MAGIC to provide a low cost, high performance IBM-PC compatible system. The 8Mhz 80186 offers 10Mhz 8086 performance. THUNDER 186 provides all the components necessary to form a complete system including: 256K bytes of no wait-state RAM, 2 serial ports, a parallel printer port, high performance floppy disk controller controls both 5 1/4" and 8" drives simultaneously, full IEEE 696 (S100) bus

for system expansion. The COLOR MAGIC and THUNDER 186 combine to provide performance you won't find in other compatibles. The price includes the powerful Concurrent DOS operating system.

**THUNDER 186 . . . . . \$1195.00**

■ **NV-DISK** is a solid state memory with software to emulate a disk drive under MS-DOS, Concurrent DOS, and CP/M-86. NV-DISK is entirely COMPUPRO software compatible allowing COMPUPRO users to take advantage of the lower cost and battery protection support offered by NV-DISK. It offers the advantage of high speed access and no moving parts. It can be battery protected to allow data to stay even while powered down. The board is available in either 512K or 2 Megabyte configurations and multiple boards may be used to create disk drives with up to 16 Megabytes of storage.

**NV-DISK 512K, \$595.00 2 MBYTE, \$1695.00**

■ **MEGARAM** is a high density, high performance dynamic RAM board with up to two Megabytes of storage. Megaram offers no wait state performance in 8086 systems with up to 10 Mhz processors in a fraction of the cost of comparable performance static RAM.

**MEGARAM . . . . . 1/4 MBYTE, \$595.00  
1/2 MBYTE, \$749.00 . . . . . 1 MBYTE, \$1095.00  
2 MBYTE, \$1795.00**

MS-DOS, trademark of Microsoft  
PC-DOS, trademark of IBM  
Concurrent CP/M-86, concurrent DOS, trademark of Digital Research

Dealer inquiries invited.

## LOMAS DATA PRODUCTS, INC.

# LDP

182 CEDAR HILL ROAD, MARLBORO, MASSACHUSETTS 01752 □ TELEPHONE: (617) 460-0333 □ TELEX: 4996272

For orders outside the U.S., contact our exclusive dealers: □ **Australia** - LAMRON PTY. LTD., (02) 808-3666 □ **Malaysia** - EXA COMPUTER (M) SENDIRIAN BERHAD, 795284 □ **England** - RATIONAL SYSTEMS, 0908-613209 or 0908-611349; SHARPBORN LTD., 018764559.

Inquiry 184

AUGUST 1985 • BYTE 357

# Color Diskettes BY CenTech

The Colorful Solution to Data Organization\*

## TIMELESS WARRANTY

SS-DD DS-DD

**\$119** ← 5¼" QTY. 60 BULK → **\$145**

**\$135\*** ← 5¼" QTY. 20 BOXED\* → **\$175\***

**\$199\*** ← 96 TPI → **\$245\***

**Color!** High Density for IBM AT **\$319\*** OS-HD

Quantity discounts available. Certified and tested 100% error-free beyond 65% clipping level. Available in 13 useful colors. Double density with reinforced hubs. Includes tyvek sleeves, user ID labels and write/protect tabs. For every order of 10 pack boxed diskettes, get a plastic Disk Storage Case/12-A \$4.95 value ..... **FREE!!!**

\*FREE 3M Flip 'n' File™ Offer...



## LIFETIME WARRANTY

SS-DD DS-DD

**\$144\*** ← 5¼" QTY. 20 → **\$184\***

**\$225** ← 96 TPI → **\$284**

**\$265** ← 3-5" MICRO → **\$359**

FOR IBM AT → **\$392**

Factory fresh and prepackaged with a FREE Flip 'n' File/15 for every purchased 10 pack of 3M diskettes while supply lasts.

**3M Headcleaning Kit .... \$9.95**

ECONOMICAL PRICE American-Made EXCELLENT QUALITY

# BULK DISKETTES

## LIFETIME WARRANTY

SS-DD DS-DD

**79c** ← 5¼" QTY. 60 → **94c**

Includes white tyvek sleeves, reinforced hubs, user ID labels and write-protect tabs. Every track, every sector, every diskette tested at 163% of industry standards. Certified 100% Error-Free and free of all manufacturing defects or we will replace it at no charge. American made by a leading manufacturer of magnetic media to surpass the best the diskette world has to offer.

### PRINTER RIBBONS

Epson MX 70/80 ..... **\$3.57**  
 Epson MX-100 ..... **\$4.94**  
 Okidata 80, 82, 83, 92, 93 ..... **\$1.51**  
 Okidata 84 ..... **\$3.64**

### DISK STORAGE

Ameray Media Mate 50 ..... **\$5.75**  
 Disk Minder II-75 ..... **\$10.95**  
 Micro Disk Minder-38 ..... **\$9.75**

**PRICE PROMISE:** We will better any lower delivered price on the same quantities advertised nationally.

**TERMS:** FREE USE OF VISA AND MASTERCARD. American Express also accepted. **Shipping:** Add \$3.00 per 100 diskettes or fraction thereof. Other items add \$3.00 for disk storage or headcleaning kit or dozen ribbons. C.O.D. orders add \$3.00 P.O. accepted from institutions and schools. Utah residents add 5% sales tax. Minimum order \$30.00

### TOLL FREE ORDER LINE:

**1-800-233-2477**  
**(1-800-AFFAIRS)**  
 INFORMATION AND INQUIRIES:  
**1-801-942-6717**



2028 E. FT. UNION BLVD., #105  
 SALT LAKE CITY, UTAH 84121  
 CALL 1-800-AFFAIRS  
 HOURS: 8AM-5PM M-F (Min. Time)

## ACCORDING TO WEBSTER

Modula-2-specific computer). MacModula-2 compiles down to m-code, a p-code that then runs on an interpreter. It runs under a standard Mac environment, with Bill Duvall's editor, a linker, a resource maker, and a large number of library modules. Most of these tools have a transfer menu that lets you go from one to another without having to go back into (and then out of) the Finder. Ironically, the one transfer that is missing is the one that would be most useful: from the editor to the compiler.

The compiler goes through four passes and is slow. Since you must link as well, the time from the start of compilation to able-to-execute can drag on quite a bit. For the Sieve of Eratosthenes program (which is not very big), the total elapsed time from the start of compilation to the end of linking was nearly 90 seconds. Large programs would be even worse, so your best bet is to really use the benefits of Modula-2 and break your programs up into small chunks, which you can compile, debug, and then leave alone.

The MacModula-2 documentation is an excellent, large (8½ by 11 inches) 550-page softbound manual, but it does not include a Modula-2 reference guide. If you're familiar with Pascal, you may be able to get by with just Niklaus Wirth's thin text, *Programming in Modula-2* (2nd ed., New York: Springer-Verlag, 1983); if you're not, you'll probably need to find a more extensive book. And, of course, you'll need *Inside Macintosh*.

Like MacASM and 68000 assembly language, MacModula-2 is probably an ideal environment for learning Modula-2 (short of owning a Lilith). Unlike MacASM, I'm not sure yet how well MacModula-2 works as a development system. Modula-2 itself is great for software development, but the long compilation and link times could lead to frustrated programmers wasting time staring at Mac screens. Since MacModula-2 uses an m-code interpreter, you can't produce true stand-alone applications; instead, you would have to distribute the m-code interpreter along with the object-code

file. One piece of good news, though, is that Modula Corporation has dropped all licensing fees for MacModula-2.

Megamax C is one of several C compilers out for the Mac. It has basically the same editor and resource maker as MacModula-2, MacAdvantage, and a few other development packages. It also has a linker, a librarian, a code improver, a batch processor, a disassembler, and several libraries.

The compiler is fast. The first time I compiled the Sieve program, it was done so quickly that I thought I had done something wrong. And since you can transfer over to the linker or to any other program, you can avoid having to drop back into the Finder in between steps. You can also transfer out of the linker to your finished code or to anything else. Megamax C produces fast stand-alone code; its features include floating-point support, in-line assembly language, and a low price (\$295).

I can't really compare Megamax to the other C compilers until I see them. What I heard of Megamax, though, was enough to convince me to go out and buy a copy, rather than wait for a review copy to show up. The manual, about 200 pages in a three-ring binder, is adequate; if you don't know C, you'll need an introductory text (*C Primer Plus* by Mitchell Waite, Steven Prata, and Donald Martin [Indianapolis, IN: Howard W. Sams, 1984] seems to be a good one) and (all together now) *Inside Macintosh*.

## SOME BENCHMARKS

Mark Twain once said that there are three kinds of lies: lies, damned lies, and statistics. Benchmarks can fit into that list without much difficulty. Nevertheless, having all this development software, I decided to run the Sieve of Eratosthenes benchmark, just to get some rough comparisons. Table 1 shows the results.

All these benchmarks were run on a 512K-byte Mac with a Bernoulli Box, with one exception: The p-System benchmarks were done on a 128K-

(continued)

# A Telecommunications Engineering Revolution in Progress from Atlanta & San Francisco

The time is now and the company is Hayes Microcomputer Products, Inc. Atlanta or San Francisco...America's emerging super high technology arena.

Here at Hayes we've designed and supported an engineering environment free of constraints. We've promoted an atmosphere that encourages each individual's unique ability to make a contribution—to see a project through from concept to completion.

For those among you who look to achieve, perhaps it's time to take a good hard look at Hayes. There's a future in it.

- VLSI/DSP DEVELOPMENT ENGINEERS
- HARDWARE/SOFTWARE DESIGN ENGINEERS
- SOFTWARE PROGRAMMERS & ANALYSTS
- MANUFACTURING/TEST ENGINEERS
- PRODUCT DEVELOPMENT ENGINEERS
- QUALITY/RELIABILITY ENGINEERS

Interested, qualified candidates should forward a confidential resume to: **HAYES MICROCOMPUTER PRODUCTS, INC.**, Dept. 92-216, P.O. Box 105203, Atlanta, GA 30348. An Equal Opportunity Employer. M/F.

**Hayes**  
Innovative products  
for enterprising people

Inquiry 369



byte Mac with two disk drives. In addition, I made the C, Modula-2, FORTH, and MacAdvantage:UCSD Pascal programs time themselves using the TickCount routine in the Toolbox. This didn't affect the execution times, but it did increase the compile and link times. Incidentally, the last column in table 1 is the execution speed in the previous column divided by the fastest time (2.9 seconds for MacASM, using a long-word fill). The result shows how many times slower that version was than the fastest one.

Comments? Megamax C is comfortably close to MacASM, especially since you can use the disassembler and in-line assembly language to speed up key sections. I suspect that the other C compilers are in the same ballpark. MacFORTH isn't that far behind, either. The p-code systems (MacModula-2, Mac p-System, MacAdvantage) are in the same ballpark.

roughly 10 to 25 times slower than the C compiler. The exception is the native-code-generated version under the p-System, which competes well with the C compilers. MacPascal and MS-BASIC, which are here just for completeness, are 400 to 500 times slower than MacASM code.

For some non-Mac comparison, table 2 shows execution times (both regular and normalized for table 1) of the same program running under Turbo Pascal on a 256K-byte Compaq with two floppies. The compile times (which were in the standard Turbo RAM-to-RAM mode) were all about 0.8 second. (No, that's not a typo: It was four-fifths of a second.) Incidentally, the Turbo defaults are no user interrupt and no range checking, so the 14.5-second time is what you would normally get. You would have to deliberately set the {SU+} and {SR+} options to get the slowest

speed; looking at the table, you can see why.

**FOR MAC DEVELOPERS**

I have found (along with a lot of other people) what is probably the best magazine for Macintosh software developers. It's a homebrew journal called *MacTutor* (formerly *MacTech*). It's not fancy or slick, but each issue (monthly, about 44 to 48 pages) is full of explanations of the Mac's intricacies. The format is a series of columns dealing with the different languages: FORTH, C, Pascal, Modula-2, BASIC, 68000 assembly language, and more. Worth its weight in 3½-inch floppies. Back issues are available.

**UPDATE: SOFTECH MICROSYSTEMS**

Warren Williamson, who does the copy editing on my column, must be (continued)

**MSC-LAT1**  
\$649



**ZENET NETWORK though twist pair**

- 6Mhz HD64B180 (Z80 upward compatible) 512K byte on board (256K installed, 384K RAM DISK)
- LAN:ZENET port 800K baud CSMA CD twist pair bus type upto 500 meters
- Floppy: 3.5, 5 and 8 inch, d/s density, d/s sided and d/s track automatic density/format checking
- Hard disk: SCSI interface on board
- Video: 80 X 24 characters (color) and 640 X 200 pixels color graphic 128K byte video RAM character set is downloaded from disk
- Timer: battery back up calendar

**MSC-MTC**



**WORLD SMALLEST COMPUTER**

- Full personal CP/M system in palm 4mhz Z80 256K RAM (128K RAM DISK)
- Serial: RS232C X 2 automatic baud rate checking
- Pararell: centronics type printer port
- Floppy: 3.5 inch micro floppy disk drive 800K byte (option 5, 3.5 inch drive d/s sided d/s track automatic density checking)

**MSC-PCX**  
8088 expansion card for LAT1 soon available

- Serial: RS232C X 2 and TTL X 1
- Pararell: centronics type, 16 bit TTL, 7/8 bit keyboard port (32 characters FIFO)
- O.S.: Turbo Dos, MP/M (multiuser) banked CP/M plus (single user)
- Size: 10 X 6 inch 4 layered
- Assembled and tested
- BIOS source code available
- Complete faster than other Z80SBC

**MSC-ICO**  
\$499



**Full futured CP/M plus system**

- Z80 4mhz 128K Byte RAM Floppy: 3.5, 5 and 8 inch d/s density, d/s sided and d/s track upto 4 disk drives Automatic density/format check
- Serial: RS232C X 2
- Pararell: Centronics type, 16 bits I/O, 7/8 bit keyboard port
- Timer: battery back up calendar
- Video: 80 X 24 high speed CRT controller
- O.S.: CP/M plus bank version included
- Size: 10 X 6 inch 4 layered

**MSC-MTC P**  
\$299

Full assembled pcb of MTC Under \$189 in OEM quantity

- O.S.: CP/M plus bank version
- BIOS source code available
- Complete faster than other Z80SBC

**MSC-HCS**  
\$199

Expansion card for ICO RAM disk (upto 2M byte) and SCSI hard disk interface card for ICO with installation program

- BIOS source code available
- DRI CP/M plus manual \$50
- New word word processor program for MSC-ICO ADD \$50
- Complete faster than other Z80SBC

CP/M plus is a registered trademark of Digital Research Inc. Z80 is a registered trademark of Zilog Inc. Turbo Dos is a registered trademark of Software 2000 Inc. Mountain Side Computer and ZENET are trademark of Southern Pacific Limited

**Distributors**  
 England-Quanta systems 01-253-8423  
 Denmark-Danbit 03-662020  
 Finland-BB Solt 90-692-6297  
 India-Betamatix PVT Ltd. 0812-71989

**Manufacturer and international distributor**  
**SOUTHERN PACIFIC LIMITED**  
 Sanwa Bldg., 2-16-20 Minamisaiwai, Nishi, Yokohama, JAPAN 220  
 Phone: 045-314-9514 Telex: 3822320 SPACIF J  
**Advanced single board computer technology company**

**Write For A Free Info Today.**

**USA distributor**  
**SOUTHERN PACIFIC(USA) INC.**  
 P.O.BOX 4427, Berkeley, CA 94704-0427 U.S.A.  
**Dealer and distributor Inquiries welcome**



# THE POSITION OF POWER

Wouldn't you want to talk to this man if you knew all corporate micro purchasing decisions depended on his advice? But do you speak his language?

BYTE speaks his language. We are the only micro publication that does. BYTE is his for the latest in micro technology - information that keeps him in a very enviable position of power.

Corporations everywhere rely on the BYTE reader. You know you can rely on BYTE to deliver this unique market. Now you

**BYTE MEANS BUSINESS**

know that BYTE is business - and the business is micros.

To reach the business professional who is at the leading edge of micro technology, advertise in BYTE. For more information, call (603) 924-9281.



For subscription information, call 1-800-258-5485.



# BYTE

THE SMALL SYSTEMS JOURNAL  
70 Main Street, Peterborough, NH 03458

# Your System/Controller should fit you like a good suit.



## LET MICROMINT CUSTOM FIT YOU

Whether it's suits or system controllers, you can't buy off the rack when you need a custom fit.

That's why Micromint individualizes its system controllers to meet your particular needs and budget. What's most important to you? Software compatibility? Speed? Everything on one board? Economical computing power?

**#1: "I want software compatibility."**

**Solution:**

### THE SB180 COMPUTER/CONTROLLER

The SB180, only 4" by 7½", offers a Z80 compatible CPU running at 6MHz, 256K bytes of RAM, up to 32K bytes of ROM, two serial ports, a parallel port, SCSI expansion bus, and an industry standard 765A-compatible disk controller for up to four disk drives—any combinations of 3½", 5¼" or 8" drives. The SB180 is based on the Hitachi HD64180 CPU, a microcoded CMOS chip which provides high performance, reduced system costs, and low power operation while maintaining complete compatibility with the large base of standard CP/M software.

SB180-1 w/8K ROM monitor... \$369.00  
 SB180-5 w/8K ROM monitor, BIOS source and Z-system... \$418.00

**#2: "I need speed."**

**Solution:**

### THE Z8 FORTH SYSTEM/CONTROLLER

The Z8 FORTH System/Controller is only 4" by 4½" and includes a custom masked Z8 version of the FORTH

language with a full screen editor, cassette I/O driver primitives, EPROM programmer primitives, and other utility words. It also contains up to 4K bytes of RAM or EPROM, an RS-232 serial port with selectable baud rates, and two parallel ports. Additional Z8 peripheral boards include memory expansion, a smart terminal board, serial and parallel I/O, real time clock an A/D converter, and an EPROM programmer. It's perfect for data reduction and high speed control applications.

BCC21 w/utilities... \$225.00

**#3: "Let me have an entire development system on one board."**

**Solution:**

### THE BCC52 SYSTEM/CONTROLLER

The BCC52 is a new stand alone single board microcomputer which is bus compatible with the Micromint BCC11/BCC21 Z8 System/Controllers and expansion boards. The BCC52 features the Intel 8052AH-BASIC microprocessor which includes a ROM resident 8K byte floating point BASIC inter-

preter with extensions for process control work. It contains sockets for up to 48K bytes of RAM/EPROM, an "intelligent" 2764/128 EPROM programmer, 3 parallel ports, a serial terminal port, and a serial printer port.

BCC52... \$239.00

**#4: "Give me lots of economical computing power."**

**Solution:**

### THE BCC11 BASIC SYSTEM/CONTROLLER

The Z8 BASIC System/Controller is nearly identical to the FORTH System/Controller but contains a tiny BASIC interpreter, up to 6K bytes of RAM and EPROM, an RS-232 serial port with switch selectable baud rates, and two parallel ports. Add a power supply and terminal to start programming in BASIC or machine language. Programs can be transferred to 2732 EPROMS with the optional EPROM programmer for auto-start applications. It can also use any of the expansion boards mentioned under the Z8 FORTH System/Controller.

BCC11... \$149.00

Additional information on peripheral boards and OEM pricing is available.

**Order Toll Free**

**1-800-635-3355**

In Connecticut call: 1-871-6170



For a System Controller suited to your needs, give us a call.



MICROMINT, INC.  
 25 Terrace Drive  
 Vernon, CT 06066

getting upset with me. You see, this is the second month in a row where I've had to make major changes to the author's proof due to developments in the real world.

Last month, I had to change a couple of paragraphs where I took SofTech to task over licensing fees for MacAdvantage:UCSD Pascal. You see, SofTech had dropped all licensing fees and (according to what they told me) had cut the price as well, from \$295 to \$119. This was all to go into effect July 1, which is when my first column was going to show up.

A few weeks after having made that change, word came that SofTech Inc. was going to sell off SofTech Microsystems. I talked with officials at SofTech Microsystems, who assured me that all the product changes they had told me about were going to go into effect anyway. . . except for the drop in price for MacAdvantage. In short, I don't know *what* SofTech is going to charge for MacAdvantage. So my first piece of news is that you'll have to contact SofTech yourself to find out exactly what the status is for MacAdvantage, as well as the products I'm going to mention in the next few paragraphs.

Second, SofTech is reorganizing the IBM PC p-System into three separate packages: the basic MS-DOS-hosted p-System, with editor, UCSD Pascal compiler, and filer; an assembler/native-code-generator package; and utilities package (disassembler, debugger, etc.). Furthermore, each package will sell for only \$49.95 (shades of Borland!). Since this is the MS-DOS-hosted version of the p-System, your files are on DOS-formatted disks, and your programs can read and write DOS files. Since the p-System offers more sophisticated memory management and library facilities than Turbo Pascal, and since p-code is very compact, this might be an attractive alternative for those of you writing large Pascal programs on the IBM PC. Again, there has been a change in licensing policy: Any program that is released as public-domain software or shareware ("Send me \$xx if you like it") requires no

licensing fee. Any commercial product—something that is sold through mail order or dealers and that has a suggested list price—still has to pay the standard fee.

**AND NOW FOR SOMETHING COMPLETELY DIFFERENT**

This same SofTech, a company known mostly for a runner-up development system, is releasing a product that may have reverberations throughout the industry much on the same order as Turbo Pascal and SideKick. A few years ago, two programmers developed and shipped an integrated software package for the Apple called The Incredible Jack. Their success got them some venture capital, and they wrote an improved version for the IBM PC, called Jack2. Then the rumblings about Ovation, Symphony, and Framework started, and the venture

capitalists got cold feet. SofTech now owns the product; its people have improved it even more and plan to start shipping it on the 1st of July under the name TeamMate. That would be ho-hum news at best, except for one important change: A package that used to cost \$500 will go out on the market for \$69.95. Yes, you saw that right. Sales of Symphony and Framework have been sluggish; what will happen when TeamMate hits the shelves?

**UPDATE: MAC MASS STORAGE**

I talked last month about the Quark QC-10 hard disk for the Apple II, Apple III, and Macintosh. Since then, Quark has announced the QC-20, which is a 20-megabyte version of the QC-10. Quark has also released the Apple Pascal (version 1.2) support software, but since I no longer have

*(continued)*

Table 1: Macintosh Sieve benchmarks.

Language	Compilation	Linking	Execution	Normalized
MacASM	1.1	--	3.1	1.1
long-word fill	1.1	--	2.9	1.0
Megamax C	3.2	27.8	6.5	2.2
and improver	+6.8	--	6.2	2.1
register vars	3.1	26.8	4.4	1.5
and improver	+6.4	--	4.2	1.4
MacFORTH (1.1)	1.3	--	25.3	8.7
using FILL	1.3	--	20.0	6.9
MacModula-2	46.4	22.8	84.8	29.2
range check off	44.6	22.5	71.6	24.7
Mac p-System	16.9	--	92.6	31.9
no rcheck, FillChar	18.8	--	59.6	20.6
native code gen	18.6	19.3	6.5	2.2
MacAdvantage	22.6	--	104.1	35.9
range check off	22.4	--	88.6	30.6
and FillChar	22.7	--	69.1	23.8
MacPascal (Beta)	--	--	1235.0	425.9
MS-BASIC (2.0)	--	--	1294.0	446.2

Table 2: Sieve execution benchmarks on the IBM PC-compatible Compaq. The program is identical to the one used to generate the benchmarks in table 1.

	Execution	Normalized
Turbo Pascal (3.0)	173.8	59.9
user interrupts turned off {\$U-}	25.9	8.9
and range checking turned off {\$R-}	14.5	5.0
and using FillChar	11.6	4.0

## ITEMS DISCUSSED

**COPY II MAC/MACTOOLS**.....\$39.95  
 Central Point Software Inc.  
 9700 Southwest Capitol Hwy., #100  
 Portland, OR 97219  
 (503) 244-5782

**MAC BERNOULLI BOX**.....\$1895  
**MAC BERNOULLI SLAVE DRIVE**...\$1195  
 Iomega Corporation  
 1821 West 4000 South  
 Roy, UT 84067  
 (801) 776-7730

**MACADVANTAGE:UCSD PASCAL**...\$???  
**UCSD P-SYSTEM FOR IBM PC**...\$49.95  
**TEAMMATE**.....\$69.95  
 SofTech Microsystems  
 16875 West Bernardo Dr.  
 San Diego, CA 92127  
 (619) 451-1230

**MACASM**.....\$125  
 Mainstay  
 28611-B Canwood St.  
 Agoura Hills, CA 91301  
 (818) 991-6540

**MACMODULA-2**.....\$150  
 Modula Corporation  
 1673 West 820 North  
 Provo, UT 84601  
 (801) 375-7400

**MEGAMAX C**.....\$295  
 Megamax Inc.  
 POB 851521  
 Richardson, TX 75085-1521  
 (214) 987-4931

**METHODS**.....\$250  
 Digitalk Inc.  
 5200 West Century Blvd.  
 Los Angeles, CA 90045  
 (213) 645-1082

**QC-10**.....\$1995  
**QC-20**.....\$2595  
 Quark Inc.  
 2525 West Evans, Suite 220  
 Denver, CO 80219  
 (800) 543-7711

**TURBO PASCAL 3.0**.....\$69.95  
 Borland International  
 4113 Scotts Valley Dr.  
 Scotts Valley, CA 95066  
 (408) 438-8400

a QC-10 to test it on, I can't tell you how well it works.

I also talked about the Iomega Bernoulli Box (which, thankfully, I still have). I have used the partitioning software, which let me divide each 5-megabyte disk into five 1-megabyte "disks." A simple mount program then lets me decide which "disks" are

mounted or dismounted. It isn't as flexible or convenient as the Quark Volume Manager, but it's a lot better than having to work with a single 5-megabyte disk. Iomega also announced a slave drive for the Mac Bernoulli Box. It costs \$1195, plugs into the back of the Box, and gives you another 5-megabyte drive. Great

for backups; if I can get one on review, I'll let you know how it is.

### COMING EVENTS

Next month, I hope to take a good look at SofTech's integrated package, more Mac C compilers, and other odds and ends. Until then, hang loose, and I'll see you on the bit stream. ■

## Quality PC Products from MULTITECH

- CPU board with 256K memory and up to 640K on board, serial, parallel ports, socket for 8087, 6 slots. Run MS DOS CPM/86. Complete documentation .....\$350  
 Power supply .....\$125  
 Case for the CPU board .....\$70  
 Floppy controller.....\$60  
 Keyboard.....\$80
- Fully assembled IBM compatible PC with 256K, 1 serial, 1 parallel, color card, keyboard & 2(1/2) HT drives .....\$1150

*OEM and dealer discount available.*

CALL TOLL FREE TO ORDER (800) 538-1542  
 In California call (408) 730-1795 Technical Support Service (408) 773-8400

**U.S. SERVEX** 195 West El Camino Real  
 Sunnyvale, California 94087

- Multifunction board (64K-384K) ..\$160  
 1 parallel, 2 serial, clock/calendar, ramdisk, print spooler, & memory expansion (0-384K) .....\$80
- Serial card (2 ports) .....\$60
- Color/graphic card .....\$120
- Mono display adaptor with 1 printer port .....\$120
- Mono/graphic card with 1 printer port (Hercules compatible, flicker free) .....\$170
- 8087 math coprocessor .....\$95
- Color monitor (640x500 interlaced) .....\$375
- Microscience Hard disk 20 MB with controller.....\$750

\* One-year warranty for all add-on cards!

# \$198

# MODEM CARD FOR IBM® - 1200 BPS

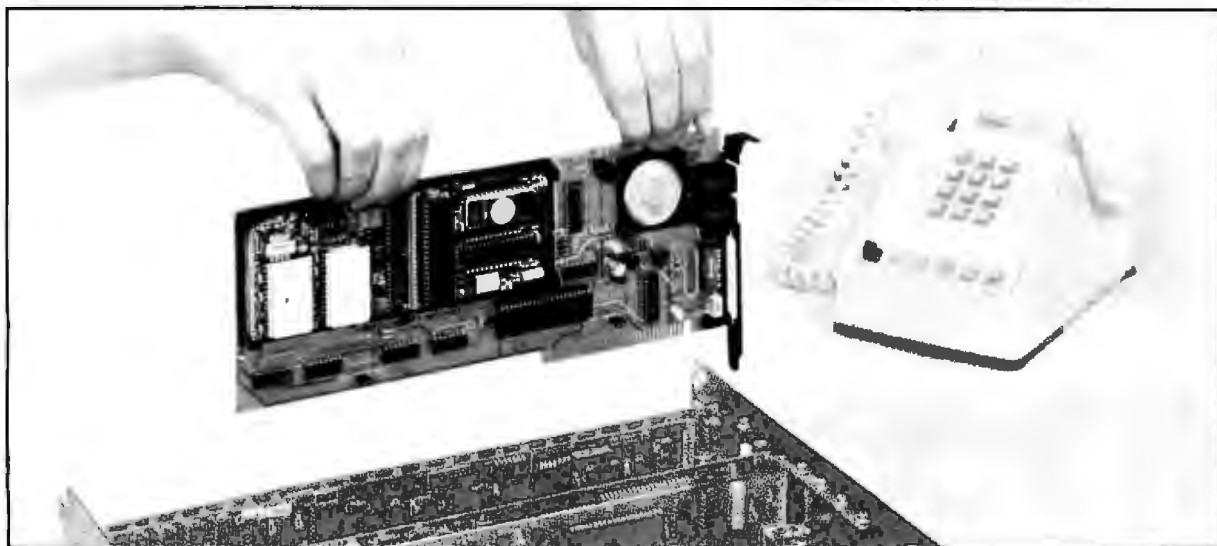

## HAYES® COMPATIBLE MODEM INCOMPATIBLE PRICE!

### FEATURES

	HAYES SMART- MODEM 1200B	INFO- MATE 1200 TPC
<b>PRICE</b>	<b>\$489</b>	<b>\$198</b>
<b>HAYES "AT" COMMAND COMPATIBLE</b>	<b>YES</b>	<b>YES</b>
Communications software included	YES	YES
1200/300/110 bits per second	YES	YES
Bell 212A and 103 compatible	YES	YES
Auto-dial, Auto-answer	YES	YES
Auto-speed, Auto-parity	YES	YES
Built-in speaker	YES	YES
Volume control	YES	YES

### MINIMUM COMPUTER REQUIREMENTS

- IBM/PC/XT/AT or compatible
- PC DOS or MS DOS (2.0 or higher)
- 128K RAM
- 1 2-sided disk drive
- 80-column screen display  
(monochrome or color)

## SHIP TO:

NAME \_\_\_\_\_

ADDRESS \_\_\_\_\_  
\_\_\_\_\_

DAY PHONE \_\_\_\_\_

 CHECK ENCLOSED VISA MASTERCARD

ACCT NO \_\_\_\_\_

EXP. DATE \_\_\_\_\_

SIGNATURE \_\_\_\_\_

California residents add 6% sales tax. All orders add \$4 per modem card  
for shipping and handling. Additional freight charges will be added for  
Canadian and international orders. No COD's or purchase orders  
accepted. Please allow four weeks for delivery. (800) 862-6271 (CALIF  
(408) 752-5095)

MAIL TO:

SUNNYVALE COMMUNICATIONS /  
A CERMETEK COMPANY  
1308 BORREGAS AVENUE  
SUNNYVALE, CA 94088-3565

## INFO-MATE 1200 TPC

**Concerning  
the nature of  
speed and its  
rightful place  
within the  
Macintosh.**

The Macintosh™ gave the world the notion of “radical ease of use.” But in order to do so, it had to do a great deal of extra work. A process that also consumes a great deal of time.

Then along came the external hard disk drive. Which made the Macintosh work faster, but still not fast enough for most business people.

So we thought of our own solution. HyperDrive.™

**HyperDrive. It's the fastest, because it's where it belongs.**

HyperDrive is the only hard disk made to go inside the Macintosh.



HyperDrive is precisely where every disk drive should be.

Which obviously means one more port free for other things, like Apple Talk.™ But more important, HyperDrive works up to 15 times faster than a floppy. And 50 to 100%

faster than external drives.

Because it hooks right onto the Macintosh circuit board.

**HyperDrive. It's engineered to give the Macintosh a place in the business world.**

Unlike other hard disks, HyperDrive will run any software that a regular Macintosh runs. Including Apple's® own Finder.™ What's more, HyperDrive's own software will

If it runs on a Macintosh, it'll run on a HyperDrive Macintosh.

™Apple Talk, Apple, Finder and LaserWriter are registered trademarks of Apple Computer, Inc. ™Lotus and Jazz are registered trademarks of the Lotus Development Corporation. ™HyperDrive is a registered trademark of the General Computer Company. ™Macintosh is a trademark licensed to Apple Computer, Inc.



allow you to back up and restore whatever's on the hard disk to and from floppies. At a rate of one floppy in under 50 seconds.

And for really going to work with items like Apple's LaserWriter™ or Lotus™ Jazz,™ you'll find you need HyperDrive. Because HyperDrive will actually make them work to their maximum, something no other disk drive can do.

**HyperDrive. It will actually keep you busy.**

With HyperDrive, a Lake Tahoe resort manager doubled his business in four months. Simply by being able to produce twice as many reports and mailings.



Will Donahue slip in the ratings now that there's HyperDrive?

Unfortunately, you can't please everyone.

One software developer used to watch the Phil Donahue show while waiting for his Macintosh to compile. But once he started using HyperDrive, he didn't have that free time. And as he said, “I don't know what's going on in the world anymore.”

Find out how to keep yourself busy. Call us at 1-800-422-0101. In Massachusetts (617) 492-5500.

# HyperDrive

General Computer Company  
215 First St., Cambridge, MA 02142

New from McGraw-Hill.

# X-VIEW 86™

Lets you observe the internal operations of DOS application software.

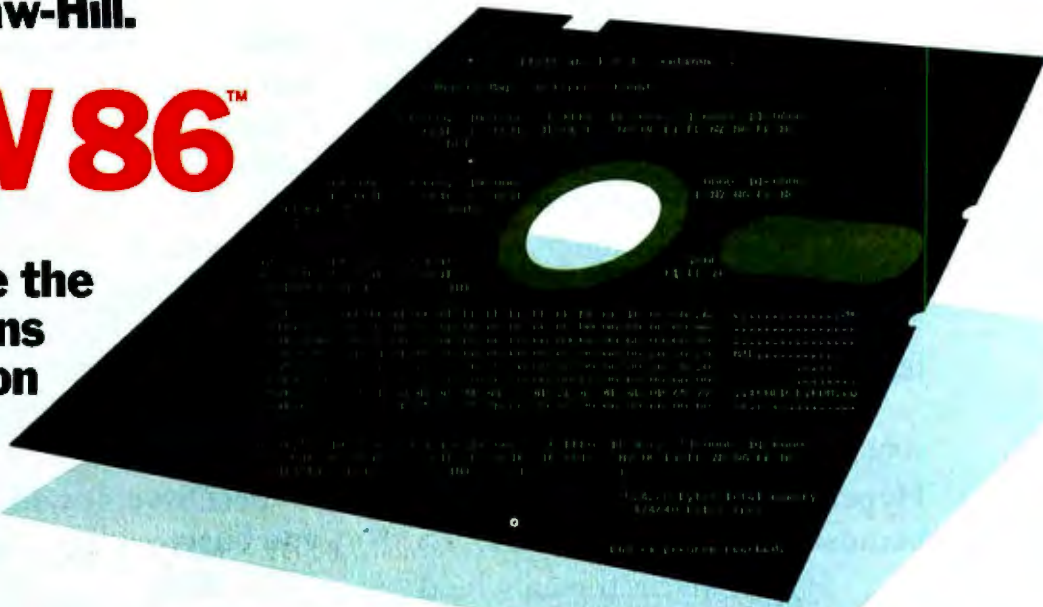

Maybe you've never put it into words. But you know the feeling.

It's the frustration that gets you every time you analyze, debug, test, port, or convert DOS application software.

To do the job right, you need something no one has invented.

You've got to see what's going on inside the software, how it's acting and reacting.

You need something that gives you x-ray vision.

Now you've got it. X-VIEW 86™, new from McGraw-Hill, lets you observe the internal operations of DOS application software.

Developed, tested, and refined in the highly respected technical labs of Future Computing, it helps you generate a thorough, reliable technical analysis. Far better than what you could produce on your own.

This powerful new tool — we call it a software analyzer — is an affordable \$59.95.

Future Computing Incorporated is a unit of McGraw-Hill Information Systems Company.

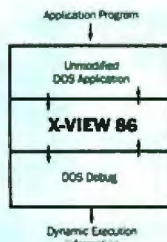

X-VIEW 86™ runs on any member of the IBM PC family — or any operationally compatible machine — with any memory configuration. You use it with PC-DOS Debug 2.0 or 2.1.

Single-stroke commands allow you to interrupt the application program:

- on any processor I/O access
- on any processor interrupt instruction
- when its execution reaches a specified address
- when it uses a specified memory location

In addition, you can:

- automatically collect and analyze technical information on an application program
- start program execution at a specified address
- display the results of the analysis on screen

X-VIEW 86™. A new kind of software. For developers and engineers with vision.



Inquiry 127

IBM is a registered trademark and PC-DOS is a trademark of International Business Machines Corporation.

To order X-VIEW 86™ by credit card, call toll free 1-800-221-VIEW. In Texas call 1-800-233-VIEW or send the coupon today.

Customer Service  
McGraw-Hill Inc.  
8111 LBJ Freeway  
Dallas, Texas 75251

X-VIEW 86™ is \$59.95. All orders are subject to acceptance by McGraw-Hill Inc. Prices are subject to change without notice.

Check enclosed (Make check payable to McGraw-Hill Inc. Orders paid by check are subject to delay.)  
 A.E.  M.C.  VISA  D.C.

Please send me X-VIEW 86™.

Name \_\_\_\_\_

Title \_\_\_\_\_

Company \_\_\_\_\_

Address \_\_\_\_\_

City \_\_\_\_\_ State \_\_\_\_\_ Zip \_\_\_\_\_

Phone (\_\_\_\_\_) \_\_\_\_\_

Qty	Price	Total
_____	\$59.95	_____

Signature \_\_\_\_\_

Credit card no. \_\_\_\_\_

Expiration date \_\_\_\_\_





## New Microprocessor Chips

The iAPX 386,  
the 80C86,  
and the AT Probe

BY PHILLIP ROBINSON

**T**his month I'll look at an excellent example of the activity in the chip trade: the iAPX 86 family from Intel.

First, there's the 80386. This 32-bit microprocessor has two important ancestors: the 8088, which is in the IBM Personal Computer (PC) and PC XT, and the 80286, which is in the IBM PC AT (see the review of the IBM PC AT by Alan Finger, May BYTE, page 270).

Then there is the 80C86. The CMOS (complementary metal-oxide semiconductor) process used to make the 80C86 uses far less power than the process used to make the standard 8086; the CMOS technology improves both the portability and reliability of systems.

I'll also look at Atron's AT Probe, a "hardware-assisted software debugger" for the 86 family. This device lets software engineers be software engineers, rather than candidates for burnout, by helping to trace, isolate, and record software bugs.

### THE IAPX 386

The 80386—the first 32-bit member of the iAPX 86 family—is almost here, after years of speculation. Although most of the big semiconductor makers are interested in the 32-bit microprocessors, the recent battle has been largely fought between Intel's 8086 family and Motorola's 68000 family.

Intel's first run in the 32-bit arena was the 432, a chip that just recently was given the ax. Intel refers to this experimental chip as a learning experience; the 432 didn't turn up on the shelf in any computer store. It was optimized to run Ada, and Intel trumpeted it as a chip of the future. Today it's just a philosophical conversation piece.

But now there is a real 32-bit microprocessor. Many people assume that the 80386 is the front runner for a 32-bit IBM PC for the following reasons: IBM was first to carpet the world with 8088 boxes, it is now selling as many 286 machines as it can make, and it has acquired a big chunk of Intel.

If IBM doesn't get to the 386 first, you can bet that plenty of other companies will. Those designers who have been pitting 8086 and 80186 boards against IBM's 8088 are ready to grab the first working 80386 to gain an advantage in the marketplace.

Here are some details I garnered from the advance information sheet on the 80386 (dated October 1984; order number 231247-001).

The iAPX 386 (the official name for the 80386) is made using CHMOS III technology. CHMOS is Intel's latest version of the CMOS process. The 386 is pipelined, has a high-bandwidth 32-bit bus, and supports full 32-bit addressing (4 gigabytes of physical space, 4 gigabytes per segment, and 64 terabytes of virtual address space per task).

The 386 also has memory management and protection (compatible with the 286), virtual-memory support, caches, and paging (optional) all on chip. It can handle 8-, 16-, and 32-bit data, has a multiple-coprocessor interface, and supports integrated multitasking.

The 386 is *object-code* software-compatible with the 86, 88, 186, 188, and 286. The 386 instruction set is a superset of the 286 set. All instructions are extended to support the 32-bit addresses and operands. As is typical in new-generation microprocessors, new instructions have also been added. That means 8088 programs (such as those for the IBM PC) should run without recompilation on an 80386 box.

The 16-bit general-purpose registers found on the 286 are extended to 32 bits on the 386. In addition, Intel has added two segment registers for simultaneous manipulation of multiple data structures.

Address generation is the same as on the other 86 family chips: An optional base is added to an optional index and an optional displacement.

The on-chip memory management of the 386 will save designers from having to use a

(continued)

BYTE West Coast is prepared monthly by BYTE's editors and staff in San Francisco and Palo Alto. Correspondence should be addressed to BYTE West Coast, BYTE Magazine, 425 Battery St., San Francisco, CA 94111.

**Intel is also  
showing off its  
new versions of  
the 8088, 8086,  
and peripherals.**

memory-management chip. The hardware protection of memory areas, with its four privilege levels, is the same as on the 286. Separate program tasks can be isolated from one another.

The 386 is available with either a 12- or 16-MHz clock; Intel figures that the 386 offers two to three times the performance of the 286. Also, Intel is promising an 80387 numeric copro-

cessor that will be compatible with the 8087 and 80287 but will operate at four times the 287's speed.

So, when can you get one? Sample chips should be available in the fourth quarter of 1985. Production is scheduled for mid-1986. If you're interested, get the literature; there should be more available by the time you read this. Unfortunately, unless you're a prized Intel customer, paper is all you'll probably be able to get for a while yet.

**LOW POWER AND LONG LIFE:  
THE 80C86**

Intel is also showing off its new CMOS versions of the 8088, 8086, and peripherals. The 80C88 and the 80C86 (with speeds up to 8 MHz) are accompanied by an 82C84A clock, 82C88 bus controller, 82C59A interrupt controller, 82C54 timer/counter, 82C55A peripheral interface, 82C08 dynamic

RAM (random-access read/write memory) controller, the 27C64 EPROM (erasable programmable read-only memory), and CMOS memories.

Harris has been offering the 80C88 for a while and is now also offering an 80C86. Harris also has a family of chips including the 82C52 serial-controller interface, 82C54 programmable interval timer, 82C55A programmable peripheral interface, 82C59A priority-interrupt controller, and 82C37A DMA (direct memory access) controller. To add to the stew, Harris has CMOS gate arrays, bus-support circuits, RAMs, and PROMs.

Why is everyone so excited about CMOS? As a September 1983 BYTE article ("Inside CMOS Technology" by Martin B. Pawloski, Tony Moroyan, and Joe Altnether, page 94) pointed out, the enormous drop in power re-

*(continued)*

# How a software engineer got to captain the lunar landing module.

The Computer Museum is everything you'd expect, and a lot of things you wouldn't.

Of course, the museum contains a collection of the most significant accomplishments in the history of information processing. But it's not just a great place to see things, it's also a great place to do things.

There are over twenty interactive exhibits at The Computer Museum. You can design a car, create your own fractal landscape, or even captain the lunar landing



module on the Apollo flight simulator.

So, the next time you're in Boston, stop by The Computer Museum. You'll discover it's more than a lot of machines, it's also a lot of fun.

For more information, or to become a Museum Member, write The Computer Museum, or call (617) 423-6758.

**The Computer Museum**

B O S T O N  
There's something in it for everyone.

300 Congress Street, Boston, MA 02210

# MICROWAY'S 8087 RUNS 1-2-3™!

MicroWay is the world's leading retailer of 8087s and high performance PC upgrades. We stock a complete selection of 8087s that run at 5 and 8mhz. All of our coprocessors are shipped with a diagnostic disk and the best warranty in the business - 180 days! We also offer daughterboards for socketless computers such as the NEC PC and PCjr, and a board which increases the clock speed of the 80287 in the PC AT. Our new NUMBER SMASHER™ includes 512K ram. It will run the IBM PC at clock speeds up to 9.5mhz and achieves a throughput of .1 megaflops

with 87BASIC/INLINE, Intel Fortran, or Microsoft Fortran. Software reviewers consistently cite MicroWay software as the best in the industry! Our customers frequently write to thank us for recommending the correct software and hardware to meet their specific needs. They also thank us for our same day shipping! In addition to our own products which support the 8087 and 80287, we stock the largest supply of specialized software available anywhere. For information call us at

**617-746-7341**

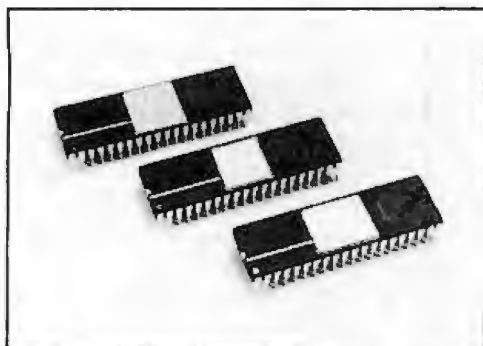

## MicroWay® 8087 Support

For the IBM PC, PC XT, PC AT and Compatibles.

**87FFT™** Written in assembly language, performs Forward and Inverse FFTs on real and complex arrays which occupy up to 512K bytes of RAM. Also does convolutions, auto correlations, hamming, complex vector multiplication, and complex to radial conversions. Callable from C, MS Fortran, 87MACRO, TURBO PASCAL and 87BASIC/INLINE..... **\$200**

**87FFT-2™** performs two-dimensional FFTs. Ideal for image processing. Requires 87FFT..\$75

**MATRIXPAK™** manages a MEGABYTE! Written in assembly language, our runtime package accurately manipulates large matrices at very fast speeds. Includes matrix inversion and the solution of simultaneous linear equations. Callable from MS Fortran 3.2, 87MACRO, and 87BASIC/INLINE..... each **\$150**

### GRAPHICS PACKAGES

Grafmatic for MS Fortran or Pascal..... **\$125**  
Plotmatic for Grafmatic..... **\$125**  
MultiHalo (one language)..... **\$189**

### DFixer™

A disk utility which thoroughly checks PC or AT hard disks for bad sectors and updates the MS DOS file allocation table accordingly..... **\$149**

**87DEBUG™** - a professional debugger with 8087 support, a sophisticated screen-oriented macro command processor, and trace features which include the ability to skip tracing through branches to calls and software and hardware interrupts. Breakpoints can be set in code or on guarded addresses in RAM..... **\$150**

**HARDSCOPE™** includes a version of 87DEBUG which interfaces a Breaker Box which makes it possible to reset your PC and break program execution independent of DOS..... **\$249**

**AST Advantage™**..... **\$439**

**JRAM-2™ (ØK)**..... **\$189**

**JRAM™ AT (ØK)**..... **\$229**

**87BASIC/INLINE™** converts the output of the IBM Basic Compiler into optimized 8087 inline code which executes up to seven times faster than 87BASIC. Supports separately compiled inline subroutines which are located in their own segments and can contain up to 64K bytes of code. This allows programs greater than 128K! Requires the IBM Basic Compiler and Macro Assembler. Includes 87BASIC..... **\$200**

**87BASIC™** includes patches to the IBM Basic Compiler and both runtime libraries for USER TRANSPARENT 8087 support. Provides super fast performance for all numeric operations including trigonometrics, transcendental, addition, subtraction, multiplication, and division.... **\$150**

**87MACRO™** - our complete 8087 software development package. It contains a "Pre-processor," source code for a set of 8087 macros, and an object library of numeric functions including transcendental, trigonometrics, hyperbolics, encoding, decoding and conversions. For the IBM Macro Assembler, Version 1.0 or 2.0..... **\$150**

**OBJ-ASM™** - a multipass object module translator and disassembler. Produces assembly language listings which include public symbols, external symbols, and labels commented with cross references. Ideal for understanding and patching object modules and libraries for which source is not available..... **\$200**

**RTOS - REAL TIME OPERATING SYSTEM**  
RTOS is a multi-user, multi-tasking real time operating system. It includes a configured version of Intel's iRMX-86, LINK-86, LOC-86, LIB-86, OH-86, and MicroWay's 87DEBUG. Runs on the IBM-PC, XT, PC-AT and COMPAQ..... **\$400**

### INTEL COMPILERS<sup>1</sup>

FORTAN-86..... **\$750**  
PASCAL-86..... **\$750**  
PL/M-86..... **\$500**  
87C (LATTICE/MICROWAY)..... **\$750**  
ASM-86..... **\$200**

<sup>1</sup>Requires RTOS or iRMX-86. All Intel compiler names and iRMX-86 TM Intel Corp.

### FASTBREAK™

MicroWay's daughterboard turns on your 8087 during 1-2-3™ execution and extends DOS functionality. Recalculations run up to 36 times faster. Includes an 8087 chip. When used with the NUMBER SMASHER™ it can provide a total increase in 1-2-3™ execution speed of up to 79 to 1.

#### CONFIGURATIONS:

**FASTBREAK™** 5mhz..... **\$339**  
**FASTBREAK™** 8mhz..... **\$479**  
**FASTBREAK™** without 8087..... **\$249**  
**FASTBREAK™** 80287 Turbo 6mhz... **\$524**

**8087 5mhz..... \$109**  
Including DIAGNOSTICS and one-year warranty  
For IBM PC and compatibles.

**8087-6 4mhz..... \$99**  
Obsolete sub spec; overheats, not recommended.

**8087-2 8mhz..... \$175**  
For Wang, AT&T, DeskPro, NEC, Leading Edge

**80187-2 8mhz..... \$299**  
For the Tandy 2000

**80287-3 5mhz..... \$199**  
For the IBM PC AT

**80287 Turbo™..... \$375**  
Increases 80287 clock speed to 6 mhz

**64K RAM Set..... \$8**

**256K RAM Set..... \$49**

**256K CMOS RAM Set... \$49**

**128K RAM Set PC AT ... \$150**

**NUMBER SMASHER™..... 1500**  
9.54mhz 8087 coprocessor board with 512K

### FORTAN, C and BASIC

Microsoft Fortran Version 3.3..... **\$229**  
IBM Professional Fortran..... **\$45**  
Ryan-McFarland Fortran..... **399**  
FORLIB+ or STRINGS and THINGS..... **65**  
Lattice C..... **299**  
Microsoft C Version 3.0..... **299**  
C86..... **299**  
FLOAT87..... **150**  
IBM Basic Compiler..... **270**  
87BASIC/INLINE..... **200**  
Summit BetterBASIC™..... **175**  
Summit 8087 Module..... **87**

### MACRO ASSEMBLERS

IBM Assembler with Librarian..... **155**  
Microsoft Assembler Version 3.0..... **125**

### PASCAL and APL

Microsoft Pascal Version 3.2..... **199**  
Borland Turbo with 8087 Support..... **85**  
STSC APL★PLUS/PC..... **450**  
Pocket APL..... **85**

COSMOS Revelation..... **750**  
SPSS/PC..... **595**

FASTBREAK and NUMBER SMASHER are trademarks of MicroWay, Inc. Lotus and 1-2-3 are trademarks of Lotus Development Corp.

**MicroWay** P.O. Box 79  
Kingston, Mass.  
02364 USA  
(617) 746-7341

**The World Leader  
in 8087 Support!**

quirements from old-fashioned NMOS (negative-channel metal-oxide semiconductor) to CMOS has many advantages. Not only do you have to supply only one-tenth as much power to CMOS as to NMOS chips, but the chips run much cooler. That temperature change means a much higher reliability, longer chip life, and no

need for fans and other cooling apparatus (in many situations). CMOS even yields greater noise protection.

The Intel and the Harris chips have the same power ratings. The 80C86's power use is rated at 10 milliamps per megahertz (mA/MHz). In fact, the CMOS 80C86 can run right down to zero speed. In that standby state,

without losing any data, the 80C86 uses less than 500 microamps. An NMOS circuit uses the same amount of power whether it is running slowly or quickly; an NMOS 8088/8086 typically uses 300 mA of supply current.

Intel and Harris hope the advantages of CMOS will move them beyond the portable-system environment into desktop machines and telecommunications.

Intel's 80C88 was actually designed by Harris. Development kits are available now, and Intel promises quantity shipments in the fourth quarter of 1985. Harris's 80C88 has been used in the field, and its 80C86 is available now. Harris uses a 2-micron process; Intel works with a 1.5-micron process.

Intel representatives see CMOS rising from 10 or 15 percent of the market today to 50 percent by 1988. In 10 years, they think HMOS (the Intel version of NMOS) will be gone.

### IRON HELPS MAKE THE 80286 WORK: THE AT PROBE

Debugging software frequently takes more time than writing it. And there's good reason to believe that the new generation of chips, including the 80286, will make debugging tougher than ever before. Atron, a small firm in Saratoga, California, is making a good living battling that debugging problem.

Founded in 1983 by former Intel employees, Atron makes a variety of software and hardware debugging aids. It has become very successful because of its PC Probe, a debugger that consists of both an add-on card for the IBM PC and some software. A ribbon cable from the card plugs into the 8088 socket; the hardware multiplies the power of the software debugger.

Now Atron is peddling the AT Probe. Like the PC Probe, it consists of both an add-on card and software. However, Atron couldn't just plug a cable from the card into the 80286 socket of the PC AT. The 80286 in the PC AT uses a nonstandard package (a pin-grid array), and a corner of it is

(continued)

# E-Z-DOS-IT™

gives you  
concurrent processing  
in only 8K of RAM.



Unique, E-Z-DOS-IT™ Concurrent Processing Software lets your PC wear several different hats *at the same time*—and it operates in only 8K of RAM.

With E-Z-DOS-IT, your IBM PC, PC/XT, or PC/AT can run your choice of background tasks while you continue to work at the screen. No waiting, because your single-tasking PC now behaves like two or more PCs. And E-Z-DOS-IT is compatible with the most popular software and hardware on the market today.

To find out more about E-Z-DOS-IT, or to order directly, call toll-free:

**800/228-9602**

In California, call 800/423-5592

Ask for operator #10.

**HAMMER**  
Redefining Your PC Productivity.

Hammer Computer Systems, Inc.  
900 Larkspur Landing Circle, Suite 250  
Larkspur, CA 94939. 415/461-7633

E-Z-DOS-IT is a trademark of Hammer Computer Systems, Inc.

The following registered trademarks are acknowledged: IBM PC, PC/XT, and PC/AT — International Business Machines; Lotus 1-2-3 and Symphony — Lotus Development Corp.; dBase II and Framework — Ashton-Tate; Wordstar — Micro Pro International; PFS File — Software Publishing; Multi-Plan — Microsoft Corp.; Crosstalk — Microsoft, Inc.

# The Source Is Friendly.<sup>SM</sup>



Many online information services claim to be "user friendly." But only one really lives up to that promise.

**The Source.**

You see, The Source is specifically designed to save you time online. With new, shorter menus. Simpler commands. And a user's manual so well-written and easy to understand, it's setting an industry standard.

The Source is also the only service that gives you free introductory lessons. So you get up-to-speed on our dime, not yours.

You get to the information you need in record

time, without frustration. Everything from the hour's headlines to travel reservations. From special interest groups to online stock trading. So you don't waste your valuable time. Or money.

Call 1-800-336-3366, send the coupon, or visit your nearest computer dealer.

And make friends with America's friendliest online information network.



The Source is a service mark of Source Telecomputing Corp., a subsidiary of The Reader's Digest Assn., Inc. © 1985 Source Telecomputing Corp.

INFORMATION NETWORK  
**The Source**<sup>SM</sup>

The most powerful resource any personal computer can have.

I'd like to make friends with The Source. Please send more information to:

Name

Address

City, State  Zip

Mail to: Source Telecomputing Corporation,  
1616 Anderson Road, McLean, VA 22102



## PROGRAMMER'S UTILITIES especially for Turbo Pascal on IBM PC/XT/AT and compatibles

### MORE POWERFUL THAN UNIX UTILITIES!!!

These Ready-to-Use programs fully support Turbo Pascal versions 2.0 and 3.0, and PCDOS 2.X and 3.0. Here's what you get:

#### Pretty Printer

Standardize capitalization, indentation, and spacing of source code. Don't waste your own time! Several adjustable parameters to suit your tastes (works with any standard Pascal source).

#### Program Structure Analyzer

Find subtle problems the compiler doesn't: uninitialized and unused variables, modified value parameters, "sneaky" variable modification, redefined standard identifiers. Also generates a complete variable cross reference and an execution hierarchy diagram. Interactive or write to file (works with any standard Pascal source).

#### Execution Timer

Obtain a summary of time spent in each procedure and function of your program, accurate to within 200 microseconds. Also counts number of calls to each subprogram. Fully automatic.

#### Execution Profiler

Obtain a graphic profile of where your program spends its time. Interactive, easy-to-use. Identify weak code at the instruction level. (Profiler and Timer for Turbo Pascal Source code only.)

#### Command Repeater

Customize any operation by reading and parsing the standard input. Send up to 255 keystrokes to any executed program. Automatically generate DOS batch files.

#### Pattern Replacer

Find and REPLACE versatile regular expression patterns in any text file. Supports generalized wildcards, nesting, alternation, lagged words and more. Over a dozen programmer's applications included.

#### Difference Finder

Find differences between two text files, and optionally create an EDLIN script which rebuilds one from the other. Disregard white space, case, arbitrary characters and Pascal comments if desired.

#### Super Directory

Replace PCDOS DIR command with extended pattern matching, sort capability, hidden file display, date filtering, and more.

#### File Finder

Locate files anywhere in the subdirectory tree and access them with a single keystroke. Display the subdirectory tree graphically.

### AVAILABLE IN SOURCE AND EXECUTABLE FORMAT

**Executable:** \$55 COMPLETE including tax and shipping. Compiled and ready to run, includes 140-page printed user manual, reference card and one 5¼" DSDD disk. Ideal for programmers not using Turbo. NOT copy protected.

**Source:** \$95 COMPLETE including tax and shipping. Includes all of the above, and two additional DSDD disks. Disks include complete Turbo Pascal source code, detailed programmer's manual (on disk) and several bonus utilities. Requires Turbo Pascal 2.0 or 3.0.

**Requirements:** PCDOS 2.X or 3.0, 192K RAM — programs run in less RAM with reduced capacity. Two drives or hard disk recommended.

#### TO ORDER:

VISA/MasterCard orders, call 7 days toll-free 1-800-538-8157 x830. In California, call 1-800-672-3470 x830 any day. Or mail check/money order to:

TurboPower Software  
478 W. Hamilton Ave., Suite 196  
Campbell, CA 95008

For technical questions, call 408-378-3672

## BYTE WEST COAST

tucked underneath one of the system's disk drives. However, because the PC AT's socket for the 80287 is accessible and is connected in parallel to the 80286, Atron decided to use it for the interface.

The \$2500 Atron system competes with debugging and development systems costing between \$30,000 and \$50,000 from companies such as Intel and Hewlett-Packard. Intel's system depends on a special bond-out version of the 286 chip that brings internal signals to the outside for analysis.

Atron handles the signal analysis in a different way. The AT Probe saves all the signals from the last 2048 instructions in its bank-switched 1-mega-byte on-board memory. When the 286 hits a trap, the system returns to the user and—on the way—analyzes the signals.

The AT Probe can reverse-match its recorded real-time signal trace data to high-level-language source code (C, for example). This lets you use the AT Probe menus to step through a high-level-language program and yet watch the machine-level effects. This single stepping shows upcoming code, emulates instructions, lists variables and contents, and even describes jump decisions. The AT Probe will

## The AT Probe

can reverse-match

its recorded

real-time signal

trace data to

high-level-language

source code.

also give complete 287 floating-point support.

The AT Probe intercepts processor signals and can trap or trace anything that happens with those signals. It even has performance- and timing-analysis software with which you can create histograms showing where a program spends its time.

Atron feels that many aspects of today's popular programs—dynamic memory allocation, complex interrupts, operating-system-protected modes—require hardware to seize and manipulate data that could evade yesterday's software debuggers. ■

## COMPANIES MENTIONED

80C86 and 80C88 chips:

HARRIS SEMICONDUCTOR  
Digital Products Division  
POB 883 MS 53-035  
Melbourne, FL 32902-0883  
(305) 724-7000

INTEL CORPORATION  
2625 Walsh Ave.  
Santa Clara, CA 95051  
(408) 496-4580

iAPX 386 chip:

INTEL CORPORATION  
3065 Bowers Ave.  
Santa Clara, CA 95051  
(408) 987-8080

PC Probe and AT Probe:

ATRON  
20665 Fourth St.  
Saratoga, CA 95070  
(408) 741-5900

# COMPUTER HUT

COMPARE  
OUR  
SERVICE & PRICE!

## SPECIAL OF THE MONTH

IBM-PC, XT & AT  
CALL FOR  
PRICE

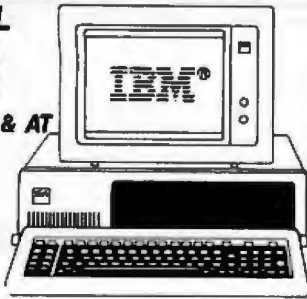

**COMPAQ** ..... CALL

### DISK DRIVES

<b>Tandon</b> TM100-2 DS/DD	\$159
<b>MATSUSHITA</b> JA 551	\$139
<b>TEAC</b> FD-55B Slimline	\$139
IBM drives w/logo	\$169

### HARD DISKS/TAPE

#### ME MAYNARD ELECTRONICS

WSO.....	\$695	WSI.....	\$795
20/30 Meg H.D. with Cont.	CALL		
Mayn Stream Tape Backup	CALL		
<b>IOMEGA</b>			
Bernoulli Box 20 Meg.....	\$2595		
ALLOY.....	CALL		

### ADD-ON BOARDS

#### QUADRAM

Quadboard 64K exp. to 384K...	\$269
Quad 512+ 64K	\$239

#### AST RESEARCH

SixPak Plus 64K.....	\$269
I/OPlus II.....	\$129
Advantage 128K.....	\$409

#### TECMAR

Graphics Master.....	\$489
MAESTRO.....	CALL

#### HERCULES

Hi Res Mono Graphics.....	\$319
Color Graphics w/Par Port.....	\$185

#### PARADISE

Modular Graphics.....	\$275
5-PACK OK.....	\$159

#### PERSYST

Mono Card w/par port	\$195
Color Card	\$169

### MODEMS

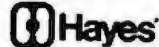

Smartmodem 1200.....	\$419
Smartmodem 1200B.....	\$379
Smartmodem 2400.....	\$649

#### NOVATION

SmartCat.....	\$349
---------------	-------

### PRINTERS

#### EPSON

FX-80+ ....	FX-100+ ....
LX-80 ..... BEST	RX-100 ..... BEST
JX-80 ..... DEAL	LQ-1500... DEAL
Hi-80 plotter.....	CALL

#### brother

HR-10.....	\$299	HR-15.....	\$389
HR-35.....	\$795	2024L....	CALL

#### C-ITOH

PROWRITER	CALL
STARWRITER F-10P	\$995

#### OKIDATA

182P.....	84P.....
92P..... BEST	192P..... BEST
93P.... PRICES	193P.... PRICES
OKIMATE 20	

#### NEC

2050.....	\$699	3550.....	\$1149
8850.....	\$1595		
Pinwriter P2	\$589	P3.....	\$795

#### TOSHIBA

P351.....	\$1295	P1340.....	\$595
-----------	--------	------------	-------

#### DAISYWRITER

2000 w/48K Buffer.....	\$849
------------------------	-------

### ACCESSORIES..... CALL

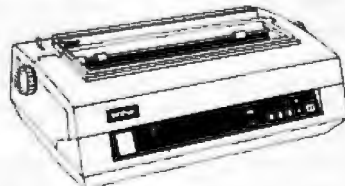

ASK ABOUT OUR  
TRAINING & REPAIR  
SERVICES.

### MONITORS

<b>AMDEK</b>	
Video 300G...	\$135
300A...	\$145
Video 310A.....	\$179

#### CGS

Mono Monitor w/tilt & swivel	\$159
------------------------------	-------

#### PGS

HX12 Hi Res RGB monitor.....	\$489
MAX-12 Hi Res Mono.	\$189
SR-12 Super Hi Res RGB.....	\$599



### SOFTWARE

#### WORDPROCESSING

MS Word	\$239	Multimate	CALL
Volkswriter Deluxe.....	\$159		
PFS: Write	\$89	PFS: Proof	\$69
WordPerfect	\$269		
WordStar 2000			\$289

#### DATABASE/INTEGRATED

dBase III	CALL	Quickcode III	\$179
RBase 4000	\$279	Clout 2.0	\$169
LOTUS 1-2-3 & Symphony.....	CALL		
Framework			CALL

#### UTILITIES/COMPILERS

Crosstalk	\$109	SmartcomII	\$109
Sideways	\$49	Norton Utilities	\$59
Sidekick	\$45	Turbo Pascal	\$55
LIFEBOAT Lattice C.....	\$299		
MS Basic	\$259	MS Fortran	\$239

#### BUSINESS

MICROSOFT Project	\$159	Chart	\$159
STAR Acct. Partner I & II			CALL
BPI SYSTEMS.....	CALL		
PFS: File	\$89	PFS: Graph	\$89
PFS: Plan	\$89	Multiplan	\$129
Harvard Total Proj.....	\$309		

#### OTHER

Mastertype	\$35	Typing TutorIII	\$39
Flight Simulator.....	\$39		
Managing your money.....	\$129		

### AND LOTS MORE

ANY PRODUCT NOT  
LISTED? CALL

### EAST COAST

**COMPUTER HUT**  
OF NEW ENGLAND INC.

101 Elm St. Nashua, NH 03060

**(603) 889-0666**

For Orders Only — (800) 525 5012

### CANADA

**MICROCONTEXT**  
AUTHORIZED DEALER

4847 Ave Du Parc  
Montreal Que H2V4E7.

**(514) 279-4595**

### MID-WEST

**COMPUTER HUT INC.**

524 S. Hunter  
Wichita, Kansas 67207

**(316) 681-2111**

For Orders Only — (800) 572 3333

All products usually in stock for immediate shipment and carry full manufacturers' warranty. Price subject to change — this ad prepared two months in advance. You get the lowest price. We honor personal checks — allow 10 days to clear. COD up to \$300 add 2%. Visa, MasterCard add 2%. For shipping & insurance add 2% or \$6.00 min. for small items and \$12. min. for monitors, printers, etc. We accept company checks and P.O.'s from Fortune 1000 Companies.

IBM is a trademark of IBM Corp.

Return authorization and order status call information line

Inquiry 69

75

Conducted by Steve Ciarcia

## VOICE-STORAGE PACKAGE

Dear Steve,

In any of your Circuit Cellar articles, have you used a voice-storage package operating from an analog microphone? I am interested in such a package capable of storing and playing back up to 15 seconds of speech. Playback will be repeated until the power is interrupted to load a new message.

CHARLES R. BANKS  
Alexandria, VA

*Two of my Circuit Cellar projects will do what you want. "Talk to Me!: Add a Voice to Your Computer for \$35" (June 1978, page 142) described a pulse-code-modulation technique. This technique is the simplest but the least memory-efficient. It can be used with many digital-to-analog converters.*

*"Use ADPCM for Highly Intelligible Speech Synthesis" (June 1983, page 35) describes an adaptive differential pulse-code-modulation method. This method, which is more complicated, uses a special chip from Oki Semiconductor for the ADPCM synthesis but uses less memory to store the speech. It takes advantage of the fact that speech contains portions of silence and few rapid changes in signal amplitude.*

*With PCM, you can get reasonable speech by sampling at 4000 8-bit samples per second, with storage at the rate of 4000 bytes per second. With ADPCM, sampling at the same rate of 4000 bytes per second yields 3 bits per sample, so it uses storage at the rate of 1500 bytes per second. If you needed 15 seconds of speech, these techniques would require 60,000 and 22,500 bytes of memory, respectively.*

*The sampling rate of either method can be changed to decrease storage requirements but at the expense of fidelity.*  
—Steve

## CLOCK INTERFACE

Dear Steve,

I am writing in regard to your response to Lance Walley about the interface of the MM58174A clock chip with the Apple II (January, page 413).

There is an additional subtle problem

regarding repeat-interrupt generation using the MM58174A (in an Apple or elsewhere). In order for a series of interrupts to occur, the interrupt must first be properly initialized by reading the interrupt/status register three times (I can count only two reads being necessary from the explanations of what's supposed to be happening, but the data sheet says three). Then the interrupt handler must read the interrupt register of the clock chip, address 15 base 10 or 1111 base 2, three times after each interrupt has occurred. The interrupt output is active low; it stays low until the interrupt register is read.

Thus, in order for a chain of interrupts to occur, CS (pin 1, active low) must be low; DB3 must be high, plus DB2, DB1, or DB0 must be high; pin 2 (READ, active low) must be high; the interrupt-register address must be selected (all four address lines = 1); and pin 3 (WRITE, active low) must be strobed low. With WRITE high, READ must then be strobed low three times to clear and initialize the interrupts.

After each interrupt occurs, the interrupt-register address must be read three times in order to clear it and restart the internal interrupt timer. If the interrupt handler fails to clear the interrupt, the result would be the same as described by Mr. Walley: a single pulse. A single read of the register would fail to restart the internal counter, and no subsequent interrupts would occur. Similarly, a single initial pulse would also occur if the interrupts were enabled without being cleared.

This all gets somewhat confusing fast. Anyone attempting to interface this chip with anything should get the full National Semiconductor data sheets and study them carefully; they aren't paragons of clarity. They can be found in National Semiconductor's 1984 CMOS Data Book.

That book also contains information on the MM58274 chip, which has a larger number of interrupt intervals available but is otherwise similar to the MM58174A.

FRANK KUECHMANN  
Vancouver, WA

## BUILDING OR BUYING

Dear Steve,

Your column has helped inspire me; I'm now pretty sure that I want to build my

own computer. I got some basic skills as an electronics technician in the military, but I have been dealing with the software end of things lately.

Would a project of building a computer around the Motorola 68000 be too steep a hill to climb right off the bat? I haven't worked out a complete cost analysis, but I am assuming that building your own computer is cheaper than buying one. Am I right?

MARK JOHNSON  
Seattle, WA

*I would not suggest building your own computer unless you are interested in using the experience for learning. While it is usually cheaper to build your own, it is hard to beat the likes of a VIC-20 or IBM PC for convenience. All the hardware and software needed is in one small package, and many software programs are available. The cost savings is not large, especially when you consider your time, and it would be hard to build a VIC-20 for less than \$80. Troubleshooting the finished computer often requires some expensive test equipment, which should be included in the bottom-line price comparison.*

*If you want to build one for the experience, use a design based on one of the earlier 8-bit chips (Z80, 6502, or 6800). The newer 16-bit chips certainly have more power, partly due to the many high-level support chips designed to work with them. A design to incorporate these chips and the software necessary to utilize them are best left to professionals.*  
—Steve ■

*Over the years I have presented many different projects in BYTE. I know many of you have built them and are making use of them in many ways.*

*I am interested in hearing from any of you telling me what you've done with these projects or how you may have been influenced by the basic ideas. Write me at Circuit Cellar Feedback, POB 582, Glastonbury, CT 06033, and fill me in on your applications. All letters and photographs become the property of Steve Ciarcia and cannot be returned.*





## Conducted by Sol Libes

Mitsubishi Japan has disclosed that it is in the very early stages of developing manufacturing technology needed for production of 4-megabyte IC memory devices. Production is expected in about three to four years. . . . Lotus is reportedly introducing a word processor with an integrated desktop manager that will marry packages recently obtained from an outside source and an acquisition. . . . There are rumors that Microsoft will soon release a BASIC compiler for the Macintosh. . . . NEC is expected to introduce an aggressively priced laser printer to take up the slack in sales of its once popular Spinwriter printer. And they are not alone, as Canon, Epson, and Ricoh are also expected to enter the market with their own products. . . . Look for several companies, including AT&T, to introduce concurrent PC compatibility to their UNIX-based systems at the upcoming November COMDEX show. . . . Now that we have print and file servers on our networking systems, expect the next server to be a modem server. . . . and MicroPro should soon announce a UNIX version of the long-time favorite WordStar word processor. . . . Quantity prices for 64K-bit RAM chips are reportedly 70 cents each and retail street prices are under 80 cents each.

### IBM WATCHING

In my July column (page 393) I predicted that IBM would release the PC II this month. It now appears that IBM has pushed back its introduction to the fourth quarter with deliveries to begin in early 1986 so as not to impact current PC sales. Usually, IBM introduces a new product line every three years and makes the previous line obsolete. In the case of the PC, IBM has supported the design for over four years.

The delayed introduction will no doubt give competitors, such as Apple and IBM clone makers, some much-needed breathing room to fill out and establish their product lines. When introduced, the PC II is expected to sell at a price somewhere between the current XT and AT.

IBM has also been showing prototype versions of a laptop computer to selected dealers to get their reactions. These units

use 25-line liquid-crystal displays. IBM is rumored to have ceased production of its Portable PC in May. The product never really was a success because most buyers (an estimated 9 to 1) turned to the Compaq when they needed a transportable. Estimates indicate that IBM sold only 50,000 units.

It is interesting to note that several IBM PC-compatibles already have a list price under \$1000 (e.g., Tandy, Apricot, and Sanyo). No doubt IBM considered this change in the marketplace when it decided to cease manufacturing the PCjr. There is strong speculation that IBM will soon have another go at the consumer marketplace. However, it must first clear out its huge PCjr inventory. A recent list-price cut from \$999 to \$725 for the PCjr and a cut from \$429 to \$399 for the color monitor is expected to stimulate sales. However, this is still a long way from the \$900 package price offered last Christmas, which moved a lot of PCjrs and severely cut into sales of the Apple, Commodore, and Atari systems. It is estimated that IBM has sold 240,000 PCjrs (Apple sold over 1.1 million units last year alone).

IBM appears to have caught up with its production backlog of AT systems, just as AT clone makers are beginning to ship their first units. This will no doubt cause some street price cutting. And IBM is rumored to be working on an AT redesign to reduce manufacturing labor cost by as much as 50 percent; this new version is expected to be out in mid-1986.

### APPLE

Apple cut more than 1600 employees from its payroll this year, with more cuts expected. At the beginning of the year it had about 6000 employees. Apple also disclosed substantial cuts in advertising, marketing, and new-product development expenditures. For example, Apple withdrew from this year's National Computer Conference after having huge exhibits for several years in a row.

Sales of the Apple II (Apple's traditional bread-and-butter product) are reportedly "sluggish," as are sales of other consumer systems (Commodore recently suffered its first loss ever). In the meantime, sales of the Macintosh are reportedly picking up

as more application software becomes available. Sales of the LaserWriter and AppleTalk network are also giving Apple its much-needed penetration in the office marketplace. When coupled with some of the newly introduced page makeup and font-generating software, the Mac is proving quite a success to publishers, newsletter producers, advertising agencies, and commercial art services.

Apple is expected to enhance the Mac with a new keyboard that includes a numeric keypad and trackball cursor control. It has also announced a 20-megabyte hard disk that should start shipping next month. A 40- to 80-megabyte file server for the AppleTalk network is expected toward year's end with speculation that it might contain a parallel port or slots for plug-in boards. Also likely is a new Mac ROM with file-handling software better suited to supporting a hard disk.

Sales of the Macintosh are estimated at 30,000 to 35,000 per month, far below the 80,000 per month capacity of Apple's highly automated production facilities. The Mac is now Apple's chief revenue producer, having passed the Apple II in dollar volume.

There are reports that Apple has already built prototype Macs with 640- by 480-pixel color and 1000- by 800-pixel black-and-white displays. And rumor has it that Apple is experimenting with compact disk and voice input.

In the meantime, Apple IIe owners who have given up on Apple introducing the 16-bit 65816 processor option should check out Micro Magic (Millersville, MD). It is reported to be nearly ready to ship a 65816 add-on board with proprietary operating system capable of addressing up to 16 megabytes of RAM. ■

*BYTE LINES, news and speculation about personal computing, is conducted by Sol Libes, the author of numerous books and articles on computers. He is the founder of the Amateur Computer Group of New Jersey and a coorganizer of the Trenton Computer Festival. He edits and publishes Micro! Systems Journal, a bimonthly publication for system programmers and integrators. He can be contacted at BYTE, POB 372, Hancock, NH 03449.*

*NASA has one shot to Jupiter. They'll go with dBASE III.*



dBASE III and Ashton-Tate are trademarks of Ashton-Tate. © Ashton-Tate 1985. All rights reserved.

NASA has only one shot at Jupiter with Project Galileo, so there's no room for error. The purpose of the project is nothing less than to find out the origin of the solar system and seek the answer to the nature and origin of life itself.

Galileo's success is all in the timing, and that's where dBASE III™ from Ashton-Tate™ takes control. dBASE III tracks the details of the sequence of launch events.

dBASE III was easy to bring on board. It's powerful (one billion records) and has a built

in programming language that has been taught to speak "Galileo." dBASE III deals with the complex test details for Galileo as easily as it will deal with the complex details of your business for you.

When you've only got one shot at getting something right, you need the most powerful and popular data management system on Earth ... or Jupiter.

For a dealer near you, call (800) 437-4329, ext. 232. In Colorado call (303) 799-4900, ext. 232.

Karen Boyle,  
Data Programming Coordinator,  
Project Galileo

*dBASE III. The data management standard.*



**ASHTON-TATE**  
SOFTWARE

## NEW SYSTEMS

**The Amstrad CPC6128 PC**

**A**mstrad's CPC6128 is a 128K-byte microcomputer based on Zilog's 4-MHz Z80A microprocessor. It has 48K bytes of read-only memory for BASIC and the operating system. An AY-3-8912 sound-generator chip provides three-voice, eight-octave capability.

The system's standard equipment includes the CP/M and AMSDOS operating systems, the BASIC and Logo languages, a built-in 3-inch disk drive, a color or monochrome monitor, and software. Its 76-key QWERTY-style keyboard has a separate numeric keypad and enlarged enter, shift, caps lock, tab, delete, clear, control, and escape keys. Built-in ports let you add peripherals such as a printer, speech synthesizer, modem, second disk drive, stereo amplifier, joystick, and tape saver. The system comes with three blank 3-inch floppy disks.

The CPC6128 comes in two configurations. The first has a 640- by 200-pixel RGB monitor, one 3-inch floppy-disk drive, and a word processor; it has a suggested retail price of \$799. The other model has the same single disk drive, a green monochrome monitor, and WordStar; it costs \$699. The manufacturer offers more than 100 applications packages available in the 3-inch-disk format. Contact Amstrad Computers (USA), Indescomp International Inc., Merchandise Mart, Chicago, IL 60654, (312) 295-7100. Inquiry 615.



*Amstrad's CPC6128 personal computer.*

**MicroVAX II**

**D**igital Equipment Corporation's MicroVAX II system is based on the "VAX-on-a-chip" 32-bit MicroVAX 78032. According to the manufacturer, this custom ZMOS VLSI processor has benchmarked performance averaging 90 percent of the VAX-11/780 CPU, depending on application. In most environments, the MicroVAX 78132, which is a matching floating-point chip, provides 85 percent of the VAX-11/780's floating-point performance with a floating-point accelerator.

The MicroVAX II is available in two systems, each of which comes in two configurations. All packaged systems have the console interface and floating-point coprocessor as standard features.

The first MicroVAX II configuration is a single-user, entry-level Ethernet node. It has 2 megabytes of main memory, a 31-megabyte RD52 Winchester hard-disk subsystem, a 400K-byte RX50 dual floppy-disk subsystem, and a DEQNA Ethernet adapter housed in

the BA23 pedestal enclosure. The second configuration is a four-user, entry-level, stand-alone system. It also features 2 megabytes of main memory plus a 71-megabyte RD53 hard-disk drive, a 95-megabyte TK50 streaming-tape cartridge drive, a DZQ11 four-line asynchronous multiplexer, and the BA23 pedestal enclosure.

The eight-user department system features 3 megabytes of main memory, the RD53 disk, the RX50 dual floppy-disk drive, the TK50 tape drive, a DHV11 eight-line asynchronous multiplexer, and a BA123 expansion cabinet.

The 16-user, high-end system has 5 megabytes of main memory, three RD53 drives, a TK50 tape drive, two DHV11 eight-line asynchronous multiplexers, and the BA123 expansion cabinet.

Also, a field upgrade kit is available for the MicroVAX I. For \$9700, the kit includes a MicroVAX II CPU with 1 megabyte of on-board memory, software, a cabling kit, a

disk controller, diagnostics, documentation, installation, and warranty.

DEC offers a choice of software environments for MicroVAX II. You can select MicroVMS, a general-purpose operating system; ULTRIX-32m UNIX software; or VAXELN for dedicated real-time applications. DEC plans to also offer ALL-IN-1, its integrated office and information system for large organizations, and A-to-Z, its integrated business system software for smaller organizations, on the MicroVAX II.

Prices for the MicroVAX II systems range from \$18,840 to \$43,780, depending on configuration. Contact Digital Equipment Corp., Maynard, MA 01754-2198. Inquiry 616.

**Leading Edge Model D PC**

**T**he Model D PC from Leading Edge is an IBM PC-compatible system based on the 8088 processor. Its standard configuration has 256K bytes of memory expandable to 640K bytes on the motherboard, dual 5¼-inch double-sided double-density disk drives, four IBM-compatible I/O slots, parallel and serial ports, a battery-backed clock/calendar, Hercules graphics emulation, and monochrome and RGB monitor output.

The Model D's 83-key keyboard has a numeric keypad and 10 function keys. The 12-inch monochrome monitor comes in green or amber and has an 80-column by 25-line display. An 8087 numeric coprocessor is available as an option.

Leading Edge provides GW-BASIC and MS-DOS with the system. Documentation includes a technical refer-

## NEW SYSTEMS

ence manual and an operators guide.

The price for the Model D's basic configuration is \$1495. Optional configurations can feature a 14-inch RGB monitor and a combination of a single 5¼-inch floppy-disk drive and a 10-megabyte fixed-disk drive. Contact Leading Edge Products Inc., Systems and Software Division, 225 Turnpike St., Canton, MA 02021, (800) 343-6833; in Massachusetts, (617) 828-8150. Inquiry 617.

### TeleVideo's AT

The TeleVideo AT is an IBM PC AT-compatible that uses Intel's 8-MHz 80286 microprocessor. It comes in two configurations. The entry-level Model I unit includes the system module with 256K bytes of RAM, a keyboard, a 1.2-megabyte floppy-disk drive, an RS-232C serial port, a parallel printer port, a clock/calendar with battery backup, and eight I/O expansion slots. The Model II has



The TeleVideo AT workstation.

the same features as the Model I, but it has 512K bytes of RAM and a formatted 20-megabyte Winchester disk drive.

The 14-inch monitor has a

nonglare screen. A single graphics controller supports alphanumeric text and graphics. Text resolution consists of a 7- by 9-dot character formed in an 8- by

16-dot cell. The TeleVideo AT supports standard AT-compatible graphics applications written for 640- by 200-pixel resolution as well as those written for enhanced 640- by 400-pixel bit-mapped graphics. The keyboard features a numeric keypad, function keys, and LED-type indicators.

The TeleVideo AT's disk controller has double buffering that eliminates sector interlacing to speed up large disk-file transfers. Transferring a track of data takes only one disk revolution.

MS-DOS 3.1, GW-BASIC 3.1, and the VDISK virtual-disk utility program are available for the TeleVideo AT. Other options are a 20-megabyte tape device, a 360K-byte floppy-disk drive, an 80287 coprocessor, and TeleVideo's Personal Mini network interface boards.

List price for the TeleVideo AT is \$3395 for the Model I and \$4795 for the Model II. Contact TeleVideo Systems Inc., 550 East Brokaw Rd., POB 6602, San Jose, CA 95150-6602, (408) 971-0255. Inquiry 618.

## PERIPHERALS

### Chip Interfaces 80286 Processor with 8088 System

Edsun Labs has developed a CMOS chip that helps interface an 80286 processor to an 8088 system or an IBM Personal Computer bus. Called the EL286-88 Processor Converter, it is a custom VLSI chip that converts 80286 signals and sequences into equivalent signals for the 8088. The company says

that to the 80286, the EL286-88 appears as a 16-bit memory or peripheral device operating at the 80286 clock rate; to the 8-bit circuitry, the EL286-88 chip appears as an 8-bit 8088 operating at its own clock rate. The two clocks can operate simultaneously.

When the 80286 requests a 16-bit data transfer from an 8-bit peripheral, the EL286-88 hardware transparently converts the request into multiple 8-bit transfers. The gate array uses about 4000 gates and combines 2- and 3-micron features. The 68-pin

leadless-chip-carrier package Edsun uses is the same as that of the 80286. Edsun claims this chip will replace about \$60 worth of TTL (transistor-transistor logic) bus-interface chips that would normally occupy 6 square inches of an IBM PC board.

The EL286-88 will reportedly cost from \$61 (1 to 99 pieces) to \$39 (5000 to 9000). Contact Edsun Labs, 7 Sears Rd., Wayland, MA 01778, (617) 358-5667. Inquiry 619.

### RAM Extension for Macintosh

The DASCH (Disk Acceleration/Storage Control Hardware) memory system stores information electronically on a RAM array rather than mechanically on tape or disk. The manufacturer, Western Automation Laboratories, says this method accelerates the rate of data access, with files like MacPaint being accessed instantaneously.

DASCH plugs into either of the Macintosh's serial

(continued)

## PERIPHERALS

ports. The device can share the printer port with an Imagewriter printer, with DASCH intercepting memory commands while enabling printer commands to pass through. DASCH can also attach to the modem port of the Macintosh, allowing device capability for systems networked by AppleTalk and systems with a nonstandard printer. As many as eight DASCH units can be daisy-chained.

Three memory sizes are available: 500K bytes for \$495, 1000K bytes for \$975, and 2000K bytes for \$1785. All units can be factory upgraded to the maximum. Contact Western Automation Laboratories Inc., 1700 North 55th St., Boulder, CO 80302, (800) 227-4637; in Colorado, (303) 449-6400. Inquiry 620.

### Hard-Disk/Tape Subsystem for IBM PCs

Alloy Computer Products offers the microSTOR memory subsystem, which integrates a hard disk and tape backup for the IBM PC, PC AT, PC XT, and compatibles. The 5¼-inch Winchester disk drive has a formatted capacity of 20 megabytes, while the file-oriented, streaming-tape unit has a formatted capacity of 23 megabytes per microcartridge.

The microSTOR is an external unit measuring 16 by 8 by 5 inches, and it requires just one controller card for use of both hard disk and tape drive. Packaged with the subsystem, the microTIP software permits complete file-oriented backup and restoration of data. The hard disk uses 11-bit error-correcting code.

The microSTOR retails for \$2995. Contact Alloy Computer Products Inc., 100 Pennsylvania Ave., Framingham, MA 01701, (617) 875-6100. Inquiry 621.

### 700-cps Serial Printer

Output Technology's OT-700 printer produces 700 characters per second in single-pass and 350 cps in dual-pass printing. The device incorporates three print heads to achieve these rates. The OT-700 offers both serial and parallel ports coupled with a 4000-character data buffer.

Dot-addressable graphics printing is available in two operating modes: 50 by 69 dots per inch for high-speed output and 100 by 69 dpi for higher resolution. Menu-driven commands let you configure the machine.

For software compatibility, the OT-700 responds to a modified set of Epson command codes. The printer costs \$1795. Contact Output Technology Corp., East 9922 Montgomery, Bay #33, Spokane, WA 99206, (509) 926-3855. Inquiry 622.

### Compact Laser Printer

Konica's LP-3010 laser printer produces 10 pages per minute with a resolution of 300 by 300 dots per inch. Among its features are a rotation function, character elongation and condensation, superscript and subscript, reverse characters, and underline.

Interfaces include video, optional print controller (equipped with a form character), and RS-232C and Centronics parallel ports.

The compact printer weighs 30 kilograms and measures 415 by 530 by 220 millimeters. Without the print controller, the LP-3010 costs \$2500. Contact Konica/TMC Co., POB 423, Wayne, PA 19087, (215) 964-8862. Inquiry 623.

### Low-Cost Seven-Port Multiplexer

Complexx Systems' TX7 point-to-point statistical multiplexer compresses data from up to seven devices onto one phone line, replacing multiple phone lines and modems. All seven devices may communicate simultaneously at speeds up to 9600 bps.

The TX7 automatically corrects any errors caused by noise in the transmission line. Using its 32K bytes of internal buffer, the multiplexer also allows devices operating at different speeds and setup parameters to communicate. RAM-stored menus enable each user port to be individually programmed.

The TX7 costs \$1495. Contact Complexx Systems Inc., 4930 Research Dr., Huntsville, AL 35805, (205) 830-4310. Inquiry 624.

### Graphics Display for DEC, Hazeltine Terminals

Series 1500 Graphics Display Terminals provide a Tektronix 4010/4014 graphics display for such terminals as the DEC VT-102 and the Hazeltine 1500.

The series offers a 1024-by-800-pixel display (with a 1024 by 1024 physical memory area). The 14-inch screen features amber or green display with 24 rows by 80 or 132 columns. You may select four scrolling speeds. Other features include data-transmission rate of 38,400 bits per second, 32 programmable function keys, built-in printer port, and tilt-and-swivel motion.

The Model 1575 lists for \$2395 and is compatible with the VT-102; the Model 1550 lists for \$2295 and is compatible with ADM, TVI, ADDS, and Hazeltine terminals. Contact Cleveland Codonics Inc., 18001 Englewood Dr., Cleveland, OH 44130, (216) 243-1198. Inquiry 625.

### Monochrome Monitors for IBM PCs

NEC's two monochrome monitors, the green IB-1280DA and the amber IB-1285DA, are TTL plug-compatible with the IBM PC and PC work-alikes. Both monitors are priced at \$199.

The 12-inch screens feature an active display area of 210 millimeters wide by 150 millimeters high. Video bandwidth is 20 MHz, providing a resolution of 720 dots horizontal by 350 lines vertical.

Both monitors require the PC to have a monochrome display/printer adapter card. The connecting cable is built into the monitors. Contact NEC Home Electronics Inc., Suite 10, 700 Nicholas Blvd., Elk Grove Village, IL 60007, (312) 228-5900. Inquiry 626.

## ADD-INS

## Kache Board for the Apple

Ohio Kache Systems' Kache Board is an SCSI hard-disk interface with a cache host adapter. It can reside in slots 4 through 7 of the Apple II+ or IIe and holds up to one-quarter megabyte of hard-disk data. This buffer memory reduces the apparent hard-disk access time.

The Kache Board has a Z80 microprocessor that manages the cache buffers' operation without drawing on the Apple's 6502 main processor. The data most frequently accessed is maintained in these buffers, while the contents of infrequently accessed buffers are rotated to hold new data. The manufacturer uses SMD (surface-mounted devices) technology to combine the necessary circuitry on a single board.

The Kache Board sells for \$695. Contact Ohio Kache Systems Corp., 75 Tahlequah Trail, Springboro, OH 45066, (800) 338-0050; in Ohio, (513) 746-9160. Inquiry 627.

## MAS 2122 Two-Chip Modem

The MAS 2122 modem from Micronas is an integrated two-chip product that operates in two modes. In basic mode, it functions as a stand-alone modem with the standard CCITT interface circuits. In extended mode, its two chips operate under the control of a microprocessor. The circuitry allows for serial or parallel I/O interface.

This product provides CCITT V.22 A, B, and V.21 and Bell 212A, 103, and 113 modem capability. It also gives you dual-tone multifre-

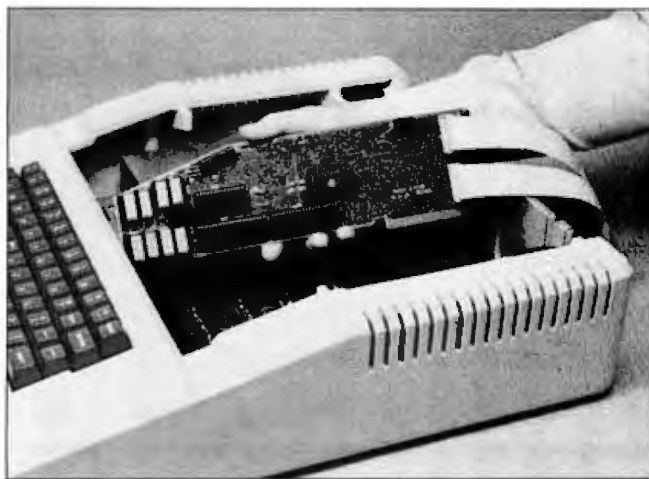

Ohio Kache Systems' Kache Board.

quency generation, call-progress tone detection, internal UART, and timing sequences for automatic handshaking. With these features, the MAS 2122 can dial, monitor calls, create asynchronous data, and provide worldwide modem capability.

The MAS 2122's design consists of two ICs: the MAS 7246 and the MAS 7247. The MAS 7246 includes all the circuitry required for a microprocessor or RS-232C interface, a UART, 300- and 1200-bps modulators and demodulators, a scrambler and descrambler, and complete timing and logic for generating and answering the modem handshake. It also has six internal control and status registers that provide access to signals on both ICs in the microprocessor configuration.

The MAS 7247 contains the filters, line equalizers, transmitter amplifier, DTMF pilot tone generator, call-progress tone detector, digital AGC, carrier detector, and system clock. If you

need a different equalization network, the MAS 7247 allows for adding an alternative network.

The two-chip, 1000-piece price for the MAS 2122 is \$65 to \$75 depending on the interface. Contact Micronas Inc., P.O. Box 42, SF-00441 Helsinki, Finland; tel: 562 3300; Telex: 8100691.

Inquiry 628.

## UNIX/MMU for Stride 400 Series

Stride Micro offers UNIX System V and a memory-management unit (MMU) for its 400 Series of microcomputers. UNIX System V for the Stride runs with no wait states at 10 MHz on the 68000 while using active memory management. It applies up to 2 megabytes of RAM on the main CPU board. An optional 10 megabytes of RAM adds a single wait state. The MMU option plugs into the 68000 microprocessor socket.

UNIX is shipped on a 45-megabyte ¼-inch streaming-tape cartridge. The UNIX package includes four compilers (C, FORTRAN 77,

SNO, and BS) and all the standard development tools. An EMACS editor is available separately. The system supports all the Stride hardware options, such as tape backup, floating point arithmetic, and local-area networking.

Suggested retail price for UNIX is \$1175; you can also order it on disk for an additional charge. The MMU hardware option is \$500. Contact Stride Micro, 4905 Energy Way, Reno, NV 89502, (702) 322-6868. Inquiry 629.

## Micro Speech Lab

Software Research's Micro Speech Lab consists of a printed circuit board, software, a microphone, a headphone set, and a users manual. To use this speech- and signal-analysis system, you need an IBM PC or compatible with a minimum of 192K bytes of RAM, PC-DOS, and an IBM color/graphics card.

The package has five major modules: signal input, waveform display, audio output, analysis, and file management. You use function keys to manipulate the program.

Micro Speech Lab's suggested retail price is \$1350 (\$1800 Canadian). Contact Software Research Corp., 3939 Quadra St., Victoria, British Columbia V8X 1J5, Canada, (604) 727-3744. Inquiry 630.

(continued)

## BASIC-to-Pascal Translator

Woodchuck Industries has developed a language translator that converts Applesoft BASIC programs to Apple Pascal. P-tral reads the BASIC source program from disk and generates the equivalent Pascal source code. The disk-based package is capable of translating commercial applications and has no restrictions on the size of programs it will convert.

P-tral breaks the BASIC program into its parts and analyzes actions, formulas, and instruction sequences before translation rules build up Pascal code. Syntax errors are pinpointed during conversion; you can either continue or abort. You can make corrections to the BASIC program using a Pascal editor and don't have to return to the BASIC system.

Requirements are an Apple II+, IIe, or IIc with at least 64K bytes of memory, two drives, an 80-column card, Apple DOS 3.3, and Apple Pascal 1.1 or 1.2. P-tral sells for \$125; an upgrade is slated for the fall and will reportedly sell for \$250 (or for \$25 to owners of version 1). Contact Woodchuck Industries Inc., 340 West 17th St. #2B, New York, NY 10011, (212) 924-0576. Inquiry 631.

## Circuit-Design Package Runs on the Mac

You can design and test computer circuitry on the Macintosh with a program called LogiMac. The interactive software presents a "live" circuit on the

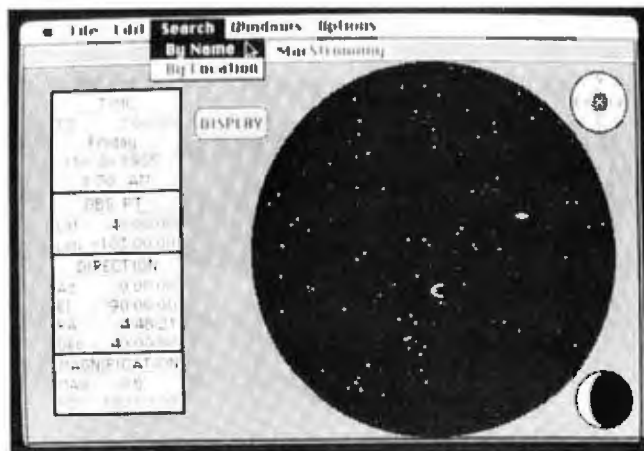

A display from Alphabyte's MacStromy program.

screen; the circuit responds immediately to connection, input, and device-parameter changes. You have complete control over device delay, clock speed, timing display resolution, and other parameters.

LogiMac lets you catch design errors before they are wired into the real hardware by simulating circuit operation. Circuit output can be displayed on simulated devices or in the form of a timing diagram that graphs signal changes over time. The diagram is updated continuously to reflect design and input alterations. The program uses five signal states to correctly simulate circuits with design errors such as unconnected inputs or conflicting outputs.

Maximum drawing size is 38 by 38 feet; it is limited only by available memory. Circuit or timing diagrams may be passed to MacPaint in one-page segments for printing, enhancement, or incorporation in other documents.

LogiMac is priced at \$59.95 for single use; an institutional license allows up

to 20 copies and costs \$200. For more information, contact Capilano Computing Systems Ltd., POB 86971, North Vancouver, British Columbia V7L 4P6, Canada, (604) 669-6343. Inquiry 632.

## Bulletin Board for Apple IIs

The Universal Bulletin Board runs on Apple IIs and features up to 10 message bases, uploading and downloading, on-line games, variable system access, electronic mail, a text editor, and report capabilities. The package is designed to operate as a remote-access message system suitable for business and personal use. A password function allows either public or private access at the discretion of the sysop.

The bulletin-board software sells for \$149.95. Developed by Universal Computers (Highland Park, Illinois), the program is distributed by the Association of Independent Microdealers, 3010 North Sterling Ave., Peoria, IL 61604, (309) 685-4843. Inquiry 633.

## Map the Stars with Mac

An astronomy program for the Macintosh, MacStromy maps the stars, moon, and planets in their proper locations for any given date and time. You can select the region of the sky you want mapped by setting the location on the earth from which the "observation" is to be made, the date and time, the direction of the observation, and the field of view diameter.

You can set the direction in one of two ways: azimuth and elevation relative to the point from which you're observing or right ascension and declination relative to the stars. Thus you can use MacStromy to determine in what direction to look for objects in the sky at a specific time or location or to determine what objects will be visible. MacStromy can also display the location of Halley's comet for any time you choose; an alternate map shows the comet's orientation around the sun.

Using the mouse, you can point to any celestial object on the sky map. The program will display the coordinates of the star or planet, its name, and a brief description. The astronomical information provided with the program is also supplied in text form: MacStromy has a translator to convert the text into an internal form used by the program, which lets you edit the database to add stars, planets, and galaxies.

MacStromy lists for \$90. Contact Alphabyte Software, POB 649, Lafayette, CO 80026, (303) 665-3444. Inquiry 634.



## TopView Tools

**L**attice has released a set of tools for developers who write applications that employ IBM's TopView window environment. The TopView Toolbasket is a library of more than 70 C functions you can use to control window, cursor, and pointer operations. Other functions handle debugging and cut-and-paste operations. The Toolbasket also contains sample source programs you can use as models.

Developed for Lattice by Strawberry Software, TopView Toolbasket runs on the IBM PC, PC XT, PC AT, and compatibles with at least 256K bytes of RAM (512K bytes is recommended). The price is \$250; source code costs \$250 more. For additional information, contact Lattice Inc., POB 3072, Glen Ellyn, IL 60138, (312) 858-7950. Inquiry 635.

## Mapping Package

**G**MX-3300 is a mapping package designed to assist geologists and engineers in exploration, resource analysis, mine planning, and civil-engineering applications. Based on Magnum's GeoMetriX for mainframes, the program features grid value interpolation and manipulation, area and volume calculation, boundary definition, and line and point data input.

You can use the program to generate trend surfaces (polynomial and trigonometric) for analysis of data tendencies. Contour, resource, and slope maps (with boundary clipping) can be produced on the graphics screen or with a pen plotter. Interfaces are

available for Summagraphics digitizers as well as Amdek and Houston Instrument plotters; other interfaces are available upon request.

GMX-3300 runs on the IBM PC and compatibles using MS-DOS, PC-DOS, or UNIX. It also requires a high-resolution graphics board, 512K-byte memory, and 10-megabyte hard disk. Software alone costs \$3300, or you can buy it bundled with a NEC APC III, digitizer tablet, and six-pen plotter for \$9990. Contact Magnum Computer Systems Inc., POB 620038, Littleton, CO 80162, (303) 973-4407. Inquiry 636.

## Signal Processing on the PC

**I**LS-PC 2 is an integrated program for data display and manipulation, digital filtering, and advanced signal processing on the PC, PC XT, and PC AT. You can use the package for computing and storing fast Fourier transforms and Hilbert transforms, estimating spectral densities and transfer functions, performing auto- or cross-correlation on time-series data, and convolving time series and filter impulse responses.

ILS-PC 1, which you need to run the signal-processing package, is a set of analysis programs for data acquisition and manipulation, waveform display and editing, spectral display, statistical computation, and digital filtering.

Both ILS programs require 256K bytes of memory and a graphics board on a PC running DOS 2.1. In order to get the programs running at

minicomputer speeds, the vendor states that you'll need a math coprocessor. The license fee for ILS-PC 1 is \$995; for ILS-PC 2, it's \$1495. Contact Signal Technology Inc., 5951 Encina Rd., Goleta, CA 93117, (805) 683-3771. Inquiry 637.

## A Bridge to Macintosh Office

**T**angent Technologies' IBMacBridge enables IBM PCs and compatibles to tap into the Apple Macintosh Office. The IBMacBridge card slips into a PC expansion slot and lets you directly access Apple products, including the Laser-Writer, through the AppleTalk network. The package includes software that converts text created with PC word processors (WordStar, for example) into PostScript files.

In addition to printing text and graphics on the Laser-Writer, you can use a PC to transfer files with Macs, act as a file server for the Macintosh Office, access other servers on AppleTalk, and serve as a gateway to other networks.

IBMacBridge has a suggested retail price of \$595. For more information, contact Tangent Technologies, Suite 100, 5720 Peachtree Parkway, Norcross, GA 30092, (404) 662-0366. Inquiry 638.

## Pascal for 8086 Family

**P**rofessional Pascal is a resident and cross compiler that runs under MS-DOS on all the processors in Intel's 8086 family. It can

generate code for any of the processors, including the instructions special to the 80186 and 80286. A VAX resident compiler is also available.

The Professional Pascal compiler produces the optimized code. Among the optimizations are common subexpression elimination, retention and reuse of register contents, short-circuit evaluation of Boolean expressions, and constant folding. The compiler supports five memory models: small, compact, medium big, large, and ROMable. Using the Microtec Linker or other Intel-compatible linker, you can specify areas of RAM or ROM for any code section.

Microtec's package supports more than 200 distinct error and warning diagnostics. Run-time library routines and utilities include string and heap operations, a portable I/O library, access to the command line and environment variable, and system interfaces. Extensions provide machine-dependent operators, varying-length strings (up to 64K bytes), three precisions of integer and floating arithmetic, and IEEE floating-point math.

A single license with one-year warranty costs \$895. Professional Pascal requires 225K bytes of main memory for operation and at least 1.2 megabytes of hard-disk memory for installation. For more information, contact Microtec Research Inc., POB 60337, Sunnyvale, CA 94088, (408) 733-2919. Inquiry 639.

(continued)

### Programming Environment with AI Module

**S**uperforth 64 + AI, an integrated package for the Commodore 64, is a programming environment that includes an artificial-intelligence module and advanced math capabilities. The package is designed to help you develop expert systems.

At Superforth's core is a programming language that lets you define your own English-like "word" functions. These words are stacked to create rules; an interpreter then applies the rules to make decisions. Antecedent and consequent reasoning are possible.

The program incorporates the utilities needed to write applications, including full control of color graphics; sound, music, and sprite editors; trace and decompiler facilities; and virtual memory. Superforth 64 + AI sells for \$99. For more information, contact Parsec Research, Drawer 1766, Fremont, CA 94538, (415) 651-3160. Inquiry 640.

### Four for Color Computer

**C**omputerware has released four programs for the TRS-80 Color Computer.

The OS-9 Macro Conditional Assembler, or Mac, produces OS-9 modules and supports standard 6809 assembler mnemonics and directives. It can handle conditional assembly, repeat sequences, and inclusion of source library files. All Mac source files are compatible

with those produced by the Microware assembler. Mac requires OS-9 and 64K bytes of memory. It costs \$49.95.

The OS-9 Text Formatter interfaces with any editor that produces standard ASCII text files. It's also NROFF-compatible. Among its features are centering, page numbering, and dynamic dates. The formatter requires 64K bytes of RAM and OS-9 and costs \$34.95.

For development under OS-9, Computerware offers CBUG, a screen-oriented debugger with a disassembler, single-step capabilities, memory window, and access to the OS-9 shell. It also has a built-in hexadecimal calculator. CBUG, which sells for \$39.95, requires 64K bytes of RAM and OS-9.

Color Connection III is a communications package that works with Hayes and Radio Shack modems. It incorporates CompuServe's Protocol B, XMODEM protocols that download directly to and from disk, and an automatic XON/XOFF protocol that downloads directly to disk. The price is \$49.95. At least 32K bytes of RAM is necessary.

When you order any of these packages, add \$2 to the cost for shipping. Contact Computerware, POB 668, Encinitas, CA 92024, (619) 436-3512. Inquiry 641.

### Atari EEPROM/ EPROM Programmer

**D**esigned to convert an Atari into a development tool, the Proburner can be used to program EPROM types 2716 through 27128 (plus the 2532) and a variety of 2K-byte through 8K-byte EEPROMS. The cartridge plugs into the slot of the Atari 400/800 and XL/XE series.

Among the functions the Proburner provides are copy, erase check, verify, and burn in. Binary files can be stored or loaded to disk or cassette. You can call a monitor for memory display and changes, block moves, and printer dumps. The unit can also run chips from its socket. Because Proburner offers electronic configuration for each EPROM type, you don't need adapters or switches.

Proburner costs \$149. Contact Thompson Electronics Ltd., Suite 502, 7 Jackes Ave., Toronto, Ontario M4T 1E3, Canada, (416) 960-1089. Inquiry 642.

### Widen Your Screen

**Y**ou can enlarge the 40-column LCD screens of the Tandy Model 100 and the NEC PC-8201 with TView 80. The software transforms a 40-column screen into a movable 60-column window on an 80-column display.

TView 80 can use the machines' text-processor and telecommunications programs. You can adjust word wrapping to any width up to 80 columns. The package has a suggested retail price of \$39.95 and comes with a utility that keeps track of file sizes and manages memory. It's available at Radio Shack stores or from Traveling Software Inc., 11050 Fifth Ave. NE, Seattle, WA 98125, (206) 367-8090. Inquiry 643.

### Improvising Commodore

**C**antus, a music program for the Commodore 64, improvises its own tunes based on your input. Instead of typing notes, you enter choices for tempo, harmony, rhythm, counterpoint, voice range, and tone color. Cantus uses these selections to create, in real time, its three-voice improvisations.

Each set of choices becomes a patch. The software comes with more than 65 patches representing a variety of musical styles. You can modify and store any patch while Cantus is performing. A graphic display shows the notes as they play.

Cantus was created by Michael Riesman, a composer and performer who has worked as musical director of the Philip Glass Ensemble.

No musical knowledge is required to operate the program, but you do need a Commodore and \$54 (plus \$2 shipping). Contact Algo-Rhythm Software, 176 Mineola Blvd., Mineola, NY 11501, (800) 645-4441; in New York, (516) 294-7590. Inquiry 644.

### WHERE DO NEW PRODUCT ITEMS COME FROM?

*The new products listed in this section of BYTE are chosen from the thousands of press releases, letters, and telephone calls we receive each month from manufacturers, distributors, designers, and readers. The basic criteria for selection for publication are: (a) does a product match our readers' interests? and (b) is it new or is it simply a reintroduction of an old item? Because of the volume of submissions we must sort through every month, the items we publish are based on vendors' statements and are not individually verified. If you want your product to be considered for publication (at no charge), send full information about it, including its price and an address and telephone number where a reader can get further information, to New Products Editor, BYTE, 425 Battery St., San Francisco, CA 94111.*

# What the world really needs is a 99 cent Double Sided, Double Density Diskette with a LIFETIME WARRANTY!

## And DISK WORLD! has it.

### Introducing Super Star Diskettes: the high quality diskette with the lowest price and the best LIFETIME WARRANTY!

In the course of selling more than a million diskettes every month, we've learned something: higher prices don't necessarily mean higher quality.

In fact, we've found that a good diskette manufacturer simply manufactures a good diskette...no matter what they charge for it. (By way of example, consider that none of the brands that we carry has a return rate of greater than 1/1,000th of 1 percent!)

In other words, when people buy a more expensive diskette, they aren't necessarily buying higher quality.

The extra money might be going toward flashier advertising, snazzier packaging or simply higher profits.

But the extra money in a higher price isn't buying better quality.

All of the good manufacturers put out a good diskette. Period.

#### How to cut diskette prices ...without cutting quality.

Now this discovery posed a dilemma: how to cut the price of diskettes without lowering the quality.

There are about 85 companies claiming to be "diskette" manufacturers.

Trouble is, most of them aren't manufacturers.

Rather they are fabricators or marketers, taking other company's components, possibly doing one or more steps of the processing themselves and pasting their labels on the finished product.

The new Eastman Kodak diskettes, for example, are one of these. So are IBM 5 1/4" diskettes. Same for DYSAN, Polaroid and many, many other familiar diskette brand names. Each of these diskettes is manufactured in whole or in part by another company!

So, we decided to act just like the big guys. That's how we would cut diskette prices...without lowering the quality.

We would go out and find smaller companies to manufacture a diskette to our specifications...specifications which are higher than most...and simply create our own "name brand" diskette.

Name brand diskettes that offered high quality at low prices.

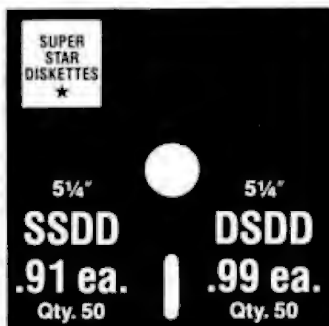

Super Star diskettes are sold in multiples of 50 only. Diskettes are shipped with white Tyvec sleeves, reinforced hubs, user ID labels and write-protect tabs.

#### Boy, did we get lucky. Our Super Star Diskettes are the same ones you've been using for years...without knowing it.

In our search for the low priced, high quality diskette of our dreams, we found something even more interesting.

We found that there are several manufacturers who don't give a hoot about the consumer market for their diskettes. They don't spend millions of dollars in advertising trying to get you, the computer user, to use their diskettes.

Instead, they concentrate their efforts on turning out the highest quality diskettes they can...because they sell them to the software publishers, computer manufacturers and other folks who (in turn) put their name on them...and sell them for much higher prices to you!

After all, when a software publisher or computer manufacturer or diskette marketer puts their name on a diskette, they want it to work time after time, everytime. (Especially software publishers who have the nasty habit of copy-protecting their originals!)

#### Super Star Diskettes. You already know how good they are. Now you can buy them...cheap.

Well, that's the story.

Super Star diskettes don't roll off the boat from Pago-Pago or emerge from a basement plant just east of Nowhere.

Super Star diskettes have been around for years...and you've used them for years as copy-protected software originals, unprotected originals. Sometimes, depending on which computer you own, the system master may have been on a Super Star diskette. And maybe more than once, you've bought a box or two or more of Super Star diskettes without knowing it. They just had some "big" company's name on them.

Super Star Diskettes are good. So good that a lot of major software publishers, computer manufacturers and other diskette marketers buy them in the tens or hundreds of thousands.

We buy them in the millions.

And then we sell them to you.

Cheap.

#### When every little bit counts, it's Super Star Diskettes.

You've used them a hundred times...under different names.

Now, you can buy the real McCoy, the same diskette that major software publishers, computer manufacturers and diskette marketers buy...and call their own.

We simply charge less.

#### Super Special!

Order 50 Super Star Diskettes and we'll be happy to sell you an Amaray Media-Mate 50 for only \$8.75, shipping included...a lot less than the suggested retail price of \$15.95.



Regular DISK WORLD! price: \$9.69 ea.  
+ \$2.00 Shpng.

#### DISKETTE STORAGE CASES

##### DISK CADDIES

The original (flip-up) holder for 10 5 1/4" diskettes. Beige or Grey only.

\$1.65 ea. + .20 Shpng.

##### DISKETTE 70 STORAGE

Dust-free storage for 70 5 1/4" diskettes. Six dividers included. An excellent value.

\$11.95 ea. + \$3.00 Shpng.



#### HOW TO ORDER:

##### ORDERS ONLY:

1-800-621-6827

(In Illinois: 1-312-256-7140)

##### INQUIRIES:

1-312-256-7140

FOR FASTEST SERVICE, USE NO-COST MCI MAIL: Our address is DISK WORLD!. It's a FREE MCI MAIL letter. No charge to you. (Situation permitting, we'll ship these orders in 24 hours or less.)

SHIPPING: 5 1/4" & 3 1/2" DISKETTES—Add \$3.00 per each 100 or fewer diskettes. OTHER ITEMS: Add shipping charges as shown in addition to other shipping charges. PAYMENT: VISA, MASTERCARD and Prepaid orders accepted. COD ORDERS: Add additional \$3.00 special handling charge. APO, FPO, AK, HI & PR ORDERS: Include shipping charges as shown and additional 5% of total order amount to cover PAL and insurance. We ship only to United States addresses, except for those listed above. TAXES: Illinois residents, add 8% sales tax.

MINIMUM ORDER: \$35.00 or 20 diskettes

#### The Super Star LIFETIME WARRANTY!

Super Star Diskettes are unconditionally warranted against defects in original material and workmanship so long as owned by the original purchaser. Returns are simple: just send the defective diskettes with proof of purchase, postage-paid by you with a short explanation of the problem, and we'll send you the replacements. (Incidentally, coffee stained diskettes and diskettes with staples driven through them don't qualify as "defective".)

WE WILL MEET OR BEAT ANY NATIONALLY  
ADVERTISED PRICE  
ON THE SAME PRODUCTS AND QUANTITIES  
SUBJECT TO THE SAME TERMS AND CONDITIONS.

HOURS:  
Human: 9AM-6PM Central Time, Monday through Friday  
Answering Machine: 6PM-3AM, All Times  
MCI MAIL: 24 hours a day.

# DISK WORLD!, Inc.

629 Green Bay Road  
Wilmette, Illinois 60091

# CCT-4 SYSTEM SERIES

The latest CCT implementation of the new generation Intel 16-Bit Processor technology. This means extreme speed, unequalled power, and the ultimate in reliability, and of course, the innovators at CCT behind it.

This series in the CCT line exploits the speed and power of the Intel 80286 and Zilog Z-80H (8MHz), on the 286Z CPU board. This combination, along with CompuPro DMA controllers and I/O boards, yields a dramatic improvement in system throughput speeds, from basic CP/M operation, up to large powerful multi-user/multi-tasking machines. The CCT-4 represents the most advanced hardware presently available in a microcomputer to run the thousands of CP/M type software programs on the market, and with CONCURRENT DOS 8-16 and the CompuPro PC Graphics board (when available), all software written for the IBM PC machines. This series is for the serious business/scientific user.

**CCT-4A** State-of-the-art power in it's basic form. Consists of CCT-286Z CPU board and CCT-M256 (256K), along with CompuPro: Enclosure 2 Desk (21 slot MF), Disk 1A, System Support 1, Interfacer 4, the CCT-2.4 floppy drive system, and CP/M 80 and CP/M 86, and with SF-200 surge suppressor system. . . . . **\$5,495.00**

**CCT-4B** Single-user/hard disk power. As the 4A, except priced without the CCT-2.4, to add in your choice of CCT hard/floppy combination drive subsystem, at the published pricing. . . . . **\$4,375.00**  
*(Example: CCT-4B Mainframe with CCT-10/1 = \$6,548.00)* Plus cost of selected drive subsystem

**CCT-4C** Multi-user/hard disk power. As the 4B, with the CCT-M512 (512K static RAM board) instead of M256; Interfacer 3 instead of Interfacer 4; SF-400 instead of SF-200, plus Concur. DOS 8-16 O.S. (6 user system) . . . . . **\$6,075.00**  
*(Example: CCT-4C Mainframe with CCT-40/1 = \$9,248.00)* Plus cost of selected drive subsystem

**NEW RAM BOARD**

**Limited Time Offer - FREE Supercalc 86 with any CCT-4**

The above systems include all necessary cabling, assembly, testing, minimum 20 hour burn-in, and the CCT unconditional 12 month direct warranty.

**CCT-M512** CCT introduces it's 512K static RAM board. IEEE Standard 12MHz. 512K in one slot! **Introductory Price: \$1,799**  
**CCT-M256** 256K version of M512 upgradeable to full 512K. Perfect 256K RAM board for any CompuPro system . . . . . **\$949**

**CUSTOM COMPUTER TECHNOLOGY / BOX 4160 / SEDONA, ARIZONA 86340**  
**TOLL FREE ORDERING: 800-222-8686 / For technical support / service: 602-282-6299**

## BYTE Back issues for sale

	1981	1982	1983	1984	1985
Jan.	\$3.25		\$3.70	\$4.25	\$4.25
Feb.	\$3.25	\$3.70	\$3.70	\$4.25	\$4.25
March		\$3.70	\$3.70	\$4.25	\$4.25
April	\$3.25	\$3.70	\$3.70	\$4.25	\$4.25
May		\$3.70	\$3.70	\$4.25	\$4.25
June		\$3.70	\$3.70	\$4.25	\$4.25
July		\$3.70	\$4.25	\$4.25	\$4.25
Aug.		\$3.70	\$4.25	\$4.25	
Sept.		\$3.70	\$4.25	\$4.25	
Oct.	\$3.25	\$3.70	\$4.25	\$4.25	
Nov.	\$3.25	\$3.70	\$4.25	\$4.25	
Dec.	\$3.25	\$3.70	\$4.25	\$4.25	

Prices include postage in the US. Please add \$.50 per copy for Canada and Mexico; and \$2.00 per copy to foreign countries (surface delivery).

Check enclosed

Payments from foreign countries must be made in US funds payable at a US bank.

VISA

MasterCard

Card # \_\_\_\_\_

Exp. \_\_\_\_\_

Signature \_\_\_\_\_

Please allow 4 weeks for domestic delivery and 12 weeks for foreign delivery.

**NAME** \_\_\_\_\_

**ADDRESS** \_\_\_\_\_

**CITY** \_\_\_\_\_

**STATE** \_\_\_\_\_ **ZIP** \_\_\_\_\_

Special BYTE Guide to IBM PC's — \$4.75

Circle and send requests with payments to:  
**BYTE Back Issues**  
**P.O. Box 328**  
**Hancock, NH 03449**

**TOLL-FREE  
ORDERING:  
800-222-8686**

# CCT<sup>®</sup> CUSTOM COMPUTER TECHNOLOGY

**FOR TECHNICAL SUPPORT/  
SERVICE / IN ARIZONA:  
602-282-6299**

**1 CCT PLAZA — P.O. BOX 4160 — SEDONA, ARIZONA 86340**

Purchase your Hardware and Software directly from an OEM / Systems Integrator. Take advantage of our buying power! We stock a full line of Board Level Components, Software and Peripherals. Call for your needs. We'll give you the Lowest Prices, and the Technical Support and Know-How we are quickly becoming well-known for. Satisfied Customers Nationwide. The Nation's Custom Systems House for Business, Education and Science. Call for a system quote. CCT implements tomorrow's technology today!

**• FOREMOST QUALITY • ADVANCED SUPPORT • REASONABLE COST •**



### 80286 NOW!

□ CCT-286Z is our model designation for the MI-286 dual processor board from **Macrotech**. It features the super high speed combination of Z-80H and 80286, with provision for the 80287 math chip. Directly replaces 8085/88 and 8086 CPUs running CP/M, MP/M Concurrent DOS, and MS-DOS, at throughput increases of 3X to 5X!

**SPECIAL PRICE-\$895**

**80287 Option - Installed - \$250**

**SEE THE CCT-4 SERIES  
USING THIS BOARD  
DETAILED ON THE FACING PAGE**

### NEW—TRUE IBM PC INTERFACE ULTRA HI-RES GRAPHICS!

CCT S-100/PC is a break-through for the Science/Business user. Mini-enclosure accepts PC & compatible boards and directly connects to your S-100 system, running PC-DOS or Concurrent DOS. Hercules™ Graphics System—Coming this May!  
**!! THE BEST OF BOTH WORLDS !!**

### LIBERTY TERMINALS

• Superior Reliability •

110-14" GREEN-80/132 Column .... \$499  
110-14" AMBER ..... \$519  
200-14" GREEN-80/132 Super Deluxe \$569  
200-14" AMBER ..... \$589

### OKIDATA PRINTERS - Top Quality

82 - 80 Col. .CALL 83 - 132 Col. .CALL  
92 - 80 Col. .CALL 93 - 132 Col. .CALL  
84 - 132 Col/200cps—Top of the line. .CALL  
For Serial Interfaces—Add. .... CALL

**TOSHIBA P351 - 288 CPS/24 PIN - \$1499**

**DIABLO — Letter Quality Series**

Model 620 .. \$969 Model 630 .. \$1799

**WE HAVE ALL SOFTWARE—CALL**

## \$ ACROSS THE BOARD PRICE REDUCTIONS \$

### INDUSTRIAL GRADE SUPERIOR QUALITY **CCT DISK DRIVE SYSTEMS** ROLLS ROYCES OF THE INDUSTRY

#### S-100 HARD DISK SUBSYSTEMS

Professionally engineered ST-506 type systems for the business market S-100 Computer user. Includes industry top quality drives, CompuPro Disk 3 DMA controller, all cabling, A&T, formatted, burned-in. Provisions for up to two hard disks in each system. We include operating system update. CP/M 80, CP/M 86, CP/M 8-16, MP/M 8-16, CP/M 68K. (†1 Systems are CCT innovated hard/floppy combinations, with Mitsubishi DSDD 8" drive.) 12 month warranty.

CCT-10 (11 + MEG) .....	\$1499	CCT-10/1 .....	\$2049
CCT-20 (22 + MEG) .....	\$2019	CCT-20/1 .....	\$2569
CCT-40 (36 + MEG) .....	\$2499	CCT-40/1 .....	\$3049
CCT-60 (58 + MEG) (New) .....	\$3699	CCT-60/1 .....	\$4249
CCT-90 (87 + MEG) (New) .....	\$4909	CCT-90/1 .....	\$5459
CCT-125 (123 + MEG) (New) .....	\$6099	CCT-125/1 .....	\$6649

### NEW 10 MEG REMOVABLE CARTRIDGE DRIVE SYSTEM

for hard disk back-up — DMA using Disk 3 controller.  
Super fast/Ultra reliable — Available April

### FLOPPY SYSTEMS

**CCT-2.4 • Dual 8" DSDD**  
Mitsubishi 2.4 Megabyte in Extra Heavy horizontal enclosure, removable filter air system, all cabling, A&T, Burned in. The fastest system available: ..... \$1229

**CCT-5 • 5 1/4" DSDD**  
IBM Compatible Tandon 320K. Extra Heavy Cabinet accommodates two drives, hard or floppy. All cabling, A&T, Burned-in. Perfect for our PC-DOS Package .... \$399

**CCT-8/5 • FULL IBM COMPATABILITY**  
One Mitsubishi 8" DSDD (1.2 Meg)/One 5-1/4" DSDD (360K) IBM Drive  
Both 3ms step rate — For Concurrent DOS and PC DOS ..... \$1029

### ★ SUPER PRICES ★ COMPUPRO COMPONENTS ★ IN STOCK ★

CPU-Z - \$229 • Disk 1A - \$399 • Disk 1A w/CP/M - \$499 • CPU 8086/10 - \$359 • SPU-Z - ?  
CPU 8085/88 - \$229 • CPU 286 - \$849 • CPU 68K - 10Mhz - \$359  
PC Graphics - \$399 • Disk 3 - \$459 • RAM 22 (256K) - \$1179 • RAM 23/64K - \$279/128K - \$489

**NEW → M-Drive/H - \$12K - \$469 / 2 Meg - \$1969**

Enclosure 2 Desk - \$899/Rack - \$749 • Interfacer 3 - \$409 • Interfacer 4 - \$289 • System Support 1 - \$299  
Concurrent DOS 8-16 (CCTCMX) - \$309 • CP/M 80 (CCTHMX) - \$125 • CP/M 86 (CCTTMX) - \$175  
CP/M 8-16 (CCTTMX) - \$199 • CP/M 68K (CCTCX) - \$279 • Operating System Updates/Remakes - \$30

**16 BH Upgrade Kit: CP/M 86, RAM 23, System Support 1, Cable \$729 □ CP/M 8-16 - Kit - \$753**

### CCT-1 — ENTRY LEVEL S-100 BUSINESS SYSTEM

- Enclosure 2-Desk-21 Slot Mainframe •
- CPU 8085/88 - 6Mhz 8085/8Mhz 8088 •
- Disk 1A - DMA Floppy Disk Controller •
- RAM 23 - 64K Static RAM - 12Mhz •
- Interfacer 4 - 3 Serial/2 Parallel I/O •
- CCT-2.4-Dual 8" Mitsubishi DSDD Drive System - 2.4 Megabytes •
- CP/M 80 - 2.2 HMX - CCT Modified •
- All Cabling, Complete CCT Assembly, Testing, and Minimum 20 Hour Burn-in •

**SPECIAL PRICE  
\$3,375**

**RUNS ALL STANDARD 8" CP/M SOFTWARE - INCLUDES OUR EXCLUSIVE 12 MONTH DIRECT WARRANTY**

Prices & availability subject to change. All products new, and carry full manufacturer's warranties. Call for catalog. Free technical help to anyone. All products we sell are CCT individually tested and set up for your system - Plug-in & Go! Arizona residents add sales tax. CCT<sup>®</sup> Trademark — Custom Computer Technology; MS-DOS<sup>®</sup> Trademark — Microsoft; IBM<sup>®</sup> Trademark — International Business Machines; CompuPro<sup>®</sup> Trademark — W.J. Godbout; CP/M<sup>®</sup> MP/M<sup>®</sup> Trademarks — Digital Research; HERCULES<sup>™</sup> Trademark — Hercules Computer Technology



# SUNTRONICS CO., INC.

12603 Crenshaw Blvd., Hawthorne, CA 90250

1-800-421-5775 (Order Only)  
 (213) 644-1160 (CA Order & Info)  
 STORE HOURS  
 Mon-Fri 9 a.m. to 6 p.m.  
 Sat 10 a.m. to 5 p.m.

TERMS: VISA, MASTERCARD, C.O.D. (Cash or Certified Check Required) Check Allow 2-3 Weeks for Clearing  
 Shipping & H.C. \$3.00 for 3 Lbs. plus \$1.00 for each add'l lb.  
 Calif. residents add Calif. Sales Tax \$10.00/Minimum Order  
 IBM and Apple are registered trademarks of IBM & Apple

## SUN-XT COMPUTER SYSTEM



- 2 DSDD DISK DRIVES
- 256 K RAM
- MONOCHROME GRAPHICS CARD
- 135 W POWER SUPPLY
- MONOCHROME MONITOR (TTL)
- PARALLEL PRINTER PORT
- IBM-XT COMPATIBLE **\$995.00**

### SUN-XT CPU BOARD

- 8088 MPU
- 8 EXPANSION SLOTS
- FULLY IBM COMPATIBLE
- DIMENSION SAME AS IBM PC/XT
- NO RAM

**\$195.00**

### MULTI-FUNCTION BOARD

- EXPANDABLE TO 384K
- SERIAL/PARALLEL PORT
- CLOCK CALENDAR w/BATTERY BACK UP
- GAME PORT
- SPOOL & RAM DISK
- NO RAM

**\$159.00**

### MONOCHROME GRAPHICS CARD

- HIGH-RES MONOCHROME CHARACTER
- 720(H) x 348(V)
- 80 x 25 TEXT MODE
- RUN LOTUS 1-2-3 ETC.
- WITH PARALLEL PRINTER PORT

**\$149.00**

### COLOR GRAPHICS CARD

- RGB & COMPOSITE VIDEO
- 640 x 200 HI-RES
- 320 x 200 LO-RES
- 80 x 25 TEXT MODE
- WITH LIGHT PEN INTERFACE

**\$105.00**

### FLOPPY DISK CONTROLLER

- STANDARD DOUBLE SIDE/DOUBLE DENSITY
- RUN 2 INTERNAL & 2 EXTERNAL
- WITH CABLE

**\$59.00**

### IBM STYLE CABINET

- 8 SLOT BACK PANEL
- COMES WITH MOUNTING BRACKET & HARDWARE
- FITS IBM POWER SUPPLY

**\$59.00**

- 135 WATT POWER SUPPLY ..... **\$ 97.00**
- 150 WATT POWER SUPPLY ..... **\$118.00**
- FULL-FUNCTION KEYBOARD ..... **\$ 79.00**
- MULTI I/O CARD (FDC, CLOCK/CALENDAR, SERIAL/PARALLEL)... **\$189.00**
- HARD DISK CONTROLLER W/CABLE (10MB & 20MB) ..... **\$219.00**
- PARALLEL PRINTER PORT ..... **\$ 39.00**
- ASYNC RS 232 CARD ..... **\$ 58.00**
- APPARAT EPROM BLASTER (28 PIN, 24 PIN) ..... **\$129.00**
- TEAC 558 DISK DRIVE (360K) ..... **\$ 89.00**
- IBM UP GRADE KIT (4164 150NS) ..... **\$9.50/Kit**
- IBM UP GRADE KIT (41256 150NS) ..... **\$49.00/Kit**
- MICROLOG Z80B CO-PROCESSOR (MULTI-FUNCTION) NO RAM ..... **\$450.00**

## DEALER & OEM INQUIRIES INVITED!!!

### APPLE COMPATIBLE & GENERAL PRODUCTS

- SUN Z80 CARD (W/O SOFTWARE APPLE II & II+ ONLY)..... **\$ 39.00**
- SUN 80 COLUMN CARD (APPLE II & II+ ONLY) ..... **\$ 89.00**
- POWER SUPPLY (SAMP)..... **\$ 52.00**
- COOLING FAN..... **\$ 36.00**
- FLOPPY DISK CONTROLLER ..... **\$ 33.00**
- 16K RAM CARD..... **\$ 39.00**
- PARALLEL PRINTER CARD W/CABLE..... **\$ 38.00**
- APPLE COMPATIBLE DISK DRIVE ..... **\$139.00**
- APPARAT EPROM BLASTER..... **\$119.00**
- SAM SUNG TTL MONITOR (AMBER OR GREEN) FOR IBM ..... **\$105.00**
- 12" SAM WOD MONITOR (HIGH-RES. COMPOSITE) ..... **\$ 85.00**
- 14" SUPER COLOR MONITOR (RGB 654 x 490) ..... **\$385.00**

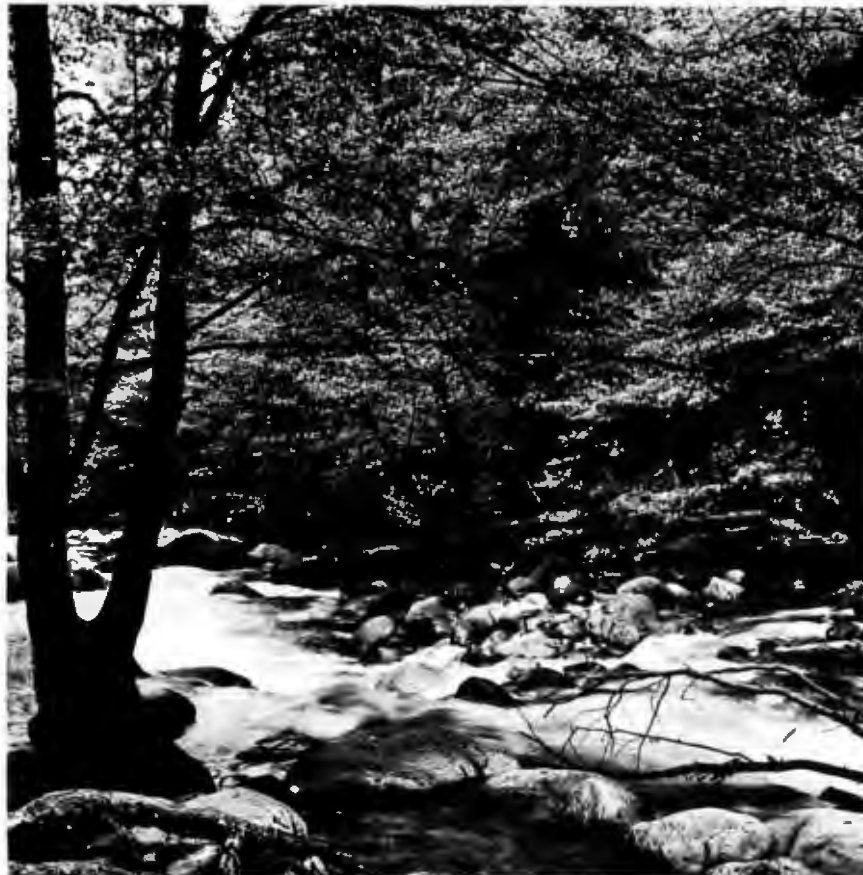

Bruce Barnbaum

## To Explore, Enjoy, and Protect

You and I share a great love of this earth.

The ocean's pounding surf, Spring covering the earth with that season's newness, a bird's song reaching out... and we are moved.

We enjoy the earth's beauty, its grandeur. The endless sweep of colors, and sounds, and everywhere, the excitement of life.

And we of the Sierra Club join together to protect the earth.

We invite you to join with us. To explore, to enjoy. To protect this wondrous earth. For all of us... forever.

For membership information, write Sierra Club, 530 Bush Street, San Francisco, CA 94108, (415) 981-8634.



# Sierra Club

# Compu\$ave

Call Toll Free: 1-800-624-8949

ARIZONA RESIDENTS CALL (602) 967-3532

## PRINTERS

<b>C. ITOH</b>	
8510 .....	294
1550 .....	435
A10-30 .....	486
All Other Models .....	CALL
<b>EPSON</b>	
All Models .....	CALL
<b>JUKI</b>	
6100 .....	385
All Other Models .....	CALL
<b>NEC</b>	
3550 .....	1067
8850 .....	1505
All Other Models .....	CALL
<b>OKIDATA</b>	
All Models .....	CALL
<b>PANASONIC</b>	
1090 .....	186
1091 .....	262
1092 .....	348
All Other Models .....	CALL
<b>SILVER-REED</b>	
EXP 400 .....	234
EXP 500 .....	278
All Other Models .....	CALL
<b>STAR MICRONICS</b>	
All Models .....	CALL
<b>TOSHIBA</b>	
P1340 .....	548
P351 .....	1172
All Other Models .....	CALL

TRACTORS, SHEET FEEDERS,  
AND PRINTER SUPPLIES  
AVAILABLE FOR MOST ALL  
PRINTERS

## MODEMS

<b>ANCHOR</b>	
Volsmodem/External .....	48
Volsmodem 12/External .....	184
<b>NOVATION</b>	
Novation Cal/External .....	142
Apple Cat II/External .....	192
Smartcat/External .....	384
Smartcat +/Macintosh .....	307
Smartcat +/PC Internal .....	309
Smartcat +/PC External .....	318
All Other Models .....	CALL
<b>QUBIE</b>	
PC212AS/IBM Internal .....	252
212A/IBM External .....	272

## SUPER SPECIAL

### HAYES SMARTMODEM 1200

- Auto Dial
- 1200 Baud



- Auto Answer
- External

**HAYES SMARTMODEM 1200B/IBM-INTERNAL \$334**

For All Other Models And Modem Software...Call

## COMPUTERS

<b>ALTOS</b>	
586-20 Multiuser .....	5332
All Other Models .....	CALL
<b>APPLE</b>	
Ile W/64K/1 Drive .....	858
Ile Professional .....	1430
Ile And Macintosh .....	CALL
<b>IBM</b>	
PC W/256K/2 Drives .....	1772
XT And AT .....	CALL
<b>ZENITH</b>	
All Models .....	CALL

## BOARDS

<b>AST</b>	
Six Pac Plus .....	255
Mega Plus II .....	255
All Other Types .....	CALL
<b>HERCULES</b>	
Color Card .....	144
All Other Types .....	CALL
<b>MICROTEK</b>	
All Types .....	CALL
<b>ORANGE MICRO</b>	
Grappier + .....	71
Buffered Grappier + .....	137
All Other Types .....	CALL
<b>PARADISE</b>	
Multi Display Card .....	285
Modular Graphics Card .....	258
All Other Types .....	CALL
<b>QUADRAM</b>	
Quadboard W/64K .....	280
Quad 512+ W/64K .....	225
All Other Types .....	CALL
<b>STB</b>	
All Types .....	CALL

## TERMINALS

<b>ADDS</b>	
All Models .....	CALL
<b>ALTOS</b>	
AI II .....	768
AI III .....	594
<b>AMPEX</b>	
210G .....	373
230G .....	461
<b>HAZELTINE</b>	
All Models .....	CALL
<b>QUME</b>	
QVT 101G .....	305
QVT 102G .....	428
All Other Models .....	CALL
<b>TELEVIDEO</b>	
All Models .....	CALL
<b>VISUAL</b>	
Viewpoint 80 .....	439
All Other Models .....	CALL
<b>WYSE</b>	
WY 50 .....	456
WY 75 .....	561
All Other Models .....	CALL

## DISK DRIVES

FLOPPY AND HARD DRIVES  
FOR ALL APPLE, IBM AND  
COMPATIBLES

- Alpha Omega
- Apple
- Cogita
- Gamma
- Hitachi
- IBM
- Mitsubishi
- IOMEGA
- Micro Sci
- Rodine
- Seagate
- Tandon
- Teac
- Matsushita

LOW PRICES.....CALL

## MONITORS

<b>AMDEK</b>	
310A-Amber .....	142
Color 300 .....	208
Color 500 .....	303
All Other Models .....	CALL
<b>PRINCETON</b>	
MAX 12-Amber .....	169
HX 12-Color .....	469
All Other Models .....	CALL
<b>QUADRAM</b>	
Amberchrome-Amber .....	158
All Other Models .....	CALL
<b>TAXAN</b>	
420-Color .....	395
440-Color .....	545
All Other Models .....	CALL
<b>ZENITH</b>	
ZVM 122-Amber .....	85
ZVM 123-Green .....	85
All Other Models .....	CALL

## ACCESSORIES

<b>CHIPS</b>	
4164 Ram Chips 64K .....	17
8087 Coprocessor Chip .....	139
<b>DISKETTES</b>	
Maxell MD1 (Qty 50) .....	74
Maxell MD2 (Qty 50) .....	94
Verbatim SS/DD (Qty 50) .....	80
Verbatim DS/DD (Qty 50) .....	109
Bulk, IBM-AT, Macintosh .....	CALL

## CALL

- External Printer Buffers
- Power Surge Protectors
- Houston And Other Plotters
- Kurta And Other Digitizers
- 2 And 4 Position Switch Boxes
- Key Tronic And Other Keyboards
- All Types of Standard Cables
- Disk Drive Cleaning Kits
- Printer And Other Stands

**ORDER LINE HOURS: MONDAY - FRIDAY  
8AM-6PM / SATURDAY 9AM-2PM**

Send Orders & Payments to: CompuSave, 3010 S. 48th St., Suite 8, Phoenix, AZ 85040  
For Customer Service & Other Information Call Mon-Fri: (602) 967-3533

Prices reflect a cash discount of 3% to 5%. Prices and availability are subject to change without notice. Merchandise is shipped in factory cartons with manufacturer's warranty. Minimum shipping charge is \$4.00. Pay by wire, cashier's check, money order, or charge. Business or personal checks delay shipment 2 weeks. CompuSave is a Division of Adlanko Corporation. (85-7)

**PURCHASE ORDERS  
& BID REQUESTS  
WELCOME**  
Inquiry 63

**WE ACCEPT MAJOR  
CHARGE CARDS**



"KING OF THE ELECTRONICS JUNGLE"



**LEO ELECTRONICS, INC.**  
P.O. Box 11307  
Torrance, CA 90510-1307  
Tel: 213/212-8133 800/421-9565  
TLX: 281 985 LEO UR  
FAX: 213/212-8108

**MEMORY EXPANSION CHIPS**

RANDOM ACCESS MEMORY		PRICE EACH	SET OF 8	SET OF 9
4184-150ns	64K	1.10	\$ 8.80	\$ 9.90
4184-200ns		1.20	\$ 9.80	\$10.80
4128-150ns (8MAAT)		6.75	—	\$40.75
41256-150ns(256K)		4.85	\$37.20	\$41.85
H466118P-3		2.50	\$20.00	—

  

EPROMS	PRICE	WE NOW CARRY:
2716	\$ 2.80	Disk drives, Power supplies,
2732	\$ 3.50	384K Multifunction boards,
2764	\$ 3.30	Colorgraphic boards, and
27128	\$ 4.50	more.
27256	\$ 9.75	<b>CALL FOR BROCHURE</b>

We accept checks Visa MasterCard Purchase Orders from qualified firms and institutions U.S. funds only Call for C.O.D. California residents add 6% tax Shipping @ UPS Add \$2.00 for ground and \$5.00 for air All major manufacturers All parts 100% guaranteed Pricing subject to change without notice Call for volume pricing

Inquiry 175

**An RS-232 Break-Out-Box at a Fraction of the Cost.**

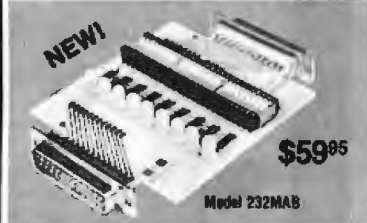

**RS-232 Multi-Adapter Board:** 9 LED's for signal monitoring. 24 switches to open any line (except line 1). 20 jumper wires allow re-wiring to any configuration. 1 male and 1 female connector. Order direct! Only \$59.95. All cash orders postpaid. (IL res. add 6% sales tax). We Accept MC, Visa. Free illustrated catalog of RS-232 interface and testing equipment. Phone: 815-434-0846. Make checks payable to:

**B & B electronics**  
MANUFACTURING COMPANY  
P.O. Box 1008B, OTTAWA, IL 61350

Inquiry 30

**384K RAM/CLOCK FOR IBM PC & XT With Lifetime Warranty\***



**Increases your system memory and provides a clock/calendar function.**

The 384K RAM/CLOCK can increase your memory by 64K, 128K, 192K, 256K, 320K or 384K depending on the number of banks of RAM chips installed on the card. RAM expansion is user upgradable. Parity checking standard on RAM. Electronic Disk. Spooler. Battery backup Clock/Calendar. Software driver for Clock/Calendar Function. Switch Selectable starting address. Expands memory to 640K DOS limit.

With 64K RAM ..... \$169

**Apparat, Inc.**  
ADD ON AND ON AND ON AND ON AND ON

4401 So. Tamarac Parkway / Denver, CO 80237 / 303/741-1778

ORDERING AND DEALER INFORMATION

800/525-7674

Stores in Denver & Chicago / \*On all cards add after June 1, 1994

Inquiry 21

**RS-422 Communications Board**

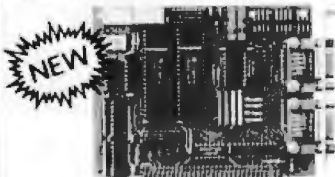

- For IBM-PC/AT/XT and compatibles
- Dual RS-422 serial interface
- Programmable to 56k baud
- Differential drivers to 4000 ft.

**\$345.00**

**QUA TECH, INC.**

478 E. Exchange St. Akron OH 44304  
(216) 434-3154 TLX: 5101012726

Inquiry 255

**Crescent Com, Inc.**

**CONTACT US TODAY!  
Remarkably  
LOW Prices—  
Very Competitive**

- IBM PC, XT, AT and peripherals
- ALL APPLIES including "Fat" MAC and peripherals
- COMPAQ Computers
- Most Popular Software

**Call TOLL-FREE**

**1-800-325-1287**

**California Only**

**1-800-492-3003**

**Telex 855771**

**Crescent Com, Inc.**

3517 Ryder Street  
Santa Clara, CA 95051  
408-738-2480

Inquiry 248

**AMBER CRTs**

- Eliminates strobe, flicker, and eye fatigue
- Made with Lead/Strontium impregnated glass that stops X-ray emission
- Available in slow decay green or medium decay "European Amber" (the standard in Europe)
- High-contrast double dark face glass that also cuts U.V. radiation
- Tube face is etched to stop glare
- Ideal for word processing and programming, yet fast enough for games and graphics
- Warranted for one full year against manufacturing defects or tube failure
- Comes with a 30-day money back guarantee
- Easily installed (comes with pre-mounted hardware)

Now, you can easily upgrade your monitor to exceed European standards for persistence and color with the installation of a Langley-St. Clair Soft-View™ CRT! Available for the TRS-80™ TeleVideo™ Kaypro™ Heath™ DEC™ Zenith™ IBM PC™ Apple III™ and a wide variety of other monitors.

Call now to order your Soft-View™ CRT from Langley-St. Clair — \$99.95 Plus \$7 for packing and UPS Shipping (\$17 for Overseas, Parcel Post or UPS Blue Label) Add sales tax where applicable. Visa/MasterCard orders welcomed

**TO ORDER:  
CALL 800  
221-7070**

Langley-St. Clair  
Instrumentation Systems, Inc.  
132 W. 24th St.  
New York, NY 10011  
In New York call 212 989-6876



**SafeSkin™**  
KEYBOARD PROTECTOR

Remains in place during keyboard use. Prevents damage from liquid spills, dust, ashes, etc. Fits like a second skin, excellent feel. Available for: IBM-PC, AT, Apple (all), Compaq, Model 100, NEC 8201, C64, Zenith 150, DEC, Kaypro and many others. Send \$29.95, check, M.O., Visa & MC include exp. date. Specify computer type. Dealer inquiries invited. Free brochure avail.

Merritt Computer Products, Inc.  
2925 LBJ Fwy, #180 / Dallas, Texas 75234  
(214) 942-1142

Inquiry 197

**64K & 256K DRAMS PIGGY BACKS**

80287-3

8087-3

8087-2

BITTNER



ELECTRONICS

899 SOUTH COAST HIGHWAY  
SUITE THREE  
LAGUNA BEACH, CA 92651  
(714) 497-6200

Inquiry 36

**webashi DATATECH DISKETTES**

Value Priced Diskettes!

Lifetime Warranty! Hub Rings! 100% Error-Free!

3 1/2" Diskettes—Boxed 10/Box

SS SD	\$ .97 Each
SS DD	\$1.07 Each
DS DD	\$1.17 Each
HD for PC/AT	\$2.49 Each

3 1/4" Diskettes

SS	\$2.25 Each
DS	\$2.95 Each

**SUPER-SAVINGS ON POLY-PACK DISKETTES**  
With Envelopes WP Tabs User ID Labels

SS SD	\$ .89 Each
SS DD	\$ .79 Each
DS DD	\$ .89 Each

Minimum order — 50 Diskettes Quantity Discounts Available MI Residents add 4% Sales Tax Shipping & Handling \$4.00 100 Diskettes C.O.D. add \$3.00 Cert. Check/Money Order

**TO ORDER: Call or Write...**

**Precision Data Products**  
P.O. Box 8367  
Grand Rapids, MI 49508  
(616) 452-3457  
Michigan 1-800-632-2468  
Outside Mich. 1-800-258-0028

**C.O.D.**

Inquiry 248



# IBM PC SPECIALS!

IBM PC, 256K, One Half Height 320K Disk Drive DS/DD, Persyst Color Card With Printer Port, Taxan Green Monitor, DOS 2.1, PLUS a 10MB Hard Disk Sub System All For:

**\$2599.**

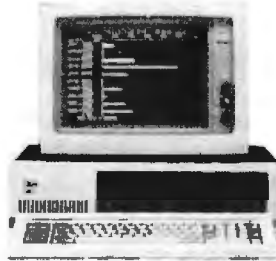

IBM PC, 256K, Two Half Height Drives DS/DD, Persyst Color Card With Printer Port, Taxan Green Monitor, DOS 2.1, 130 Watt Power Supply, 20MB Hard Disk Sub System All For:

**\$3299.**

IBM PC, 256K, Two Half Height Drives DS/DD, Persyst Color Card With Printer Port, Taxan Green Monitor, DOS 2.1, 130 Watt Power Supply, 10MB Hard Disk Sub System, PLUS 10MB Tape Back Up System All For:

**\$3499.**

IBM PC, 256K, Two Half Height Drives DS/DD, Persyst Color Card With Printer Port, Taxan Green Monitor, DOS 2.1, 130 Watt Power Supply PLUS a 10MB Hard Disk Sub System All For:

**\$2899.**

IBM PC, 256K, Two Half Height Drives DS/DD, Persyst Color Card With Printer Port, Taxan Green Monitor, DOS 2.1, 130 Watt Power Supply, 20MB Hard Disk Sub System, PLUS 10MB Tape Back Up System All For:

**\$3899.**

## MONITORS

AMDEK 300 Green	\$135.00
AMDEK 300 Amber	\$149.00
AMDEK 310 Amber W/TTL Plug	\$185.00
PGS HX-12	\$465.00
PGS MAX-12	\$185.00
PGS SR-12	\$625.00
TAXAN #115 Green Composit	\$125.00
TAXAN #116 Amber Composit	\$135.00
TAXAN #121 Green W/TTL Plug	\$149.00
TAXAN #122 Amber W/TTL Plug	\$159.00
TAXAN #425 COLOR MONITOR	\$449.00
TAXAN #440 COLOR MONITOR	\$569.00
IBM MONOCHROME DISPLAY	\$260.00
IBM COLOR DISPLAY	\$590.00

## PRINTERS

OKIDATA 182	\$235.00
OKIDATA 192	\$385.00
OKIDATA 193	\$599.00
OKIDATA 83A	\$555.00
OKIDATA 92P	\$385.00
OKIDATA 93P	\$599.00
OKIDATA 84P	\$725.00
OKIDATA 235OP	\$1925.00
OKIDATA 241OP	\$1899.00
NEC 3550	\$1550.00
NEC PINWRITER 80 Col.	\$699.00
NEC PINWRITER 130 Col.	\$899.00
EPSON LX 80	\$249.00
EPSON FX 80	\$399.00
EPSON FX 100	\$525.00
EPSON RX 100	\$399.00
EPSON JX 80	\$525.00
EPSON LQ 1500	\$925.00
COMREX CR 420	\$1895.00
TOSHIBA 351	\$1275.00
STAR MICRONICS SG 10	\$259.00
STAR MICRONICS SG 15	\$395.00
CITIZEN PRINTER MSP-10	\$375.00
CITIZEN PRINTER MSP-15	\$585.00
CITIZEN PRINTER MSP-20	\$545.00
CITIZEN PRINTER MSP-25	\$740.00
JUKI LQ 8100	\$425.00
JUKI LQ 6300	\$745.00
BROTHER HR-25	\$665.00
BROTHER HR-35	\$895.00
DYNAX DX 15XL	\$389.00

## MODEMS

HAYES SMART MODEM 1200	\$459.00
HAYES SMART MODEM 300	\$209.00
HAYES 1200B PLUG IN CARD	\$399.00
HAYES 2400 BAUD MODEM	\$714.00
POP COM 1200 EXTERNAL	\$375.00
AST REACH MODEM	\$389.00
QIC MODEM INTERNAL	\$275.00

## DRIVES

TANDON TM-100-2 DS/DD	\$155.00
TOSHIBA SLIMLINE DS/DD	\$139.00
TEAC SLIMLINE DS/DD	\$139.00

## HARD DISKS

10MB SUB SYSTEM INTERNAL	\$750.00
EXTERNAL	\$925.00
20MB SUB SYSTEM INTERNAL	\$975.00
EXTERNAL	\$1150.00
40MB SUB SYSTEM INTERNAL	\$1295.00
EXTERNAL	\$1475.00

## HARD DISKS & TAPE BACK-UP UNITS (EXTERNAL)

10MB HARD DISK	
W/10MB TAPE BACK UP	\$1250.00
20MB HARD DISK	
W/10MB TAPE BACK UP	\$1475.00
40MB HARD DISK	
W/10MB TAPE BACK UP	\$1795.00

## MULTIFUNCTION BOARDS

AST I/O MINI CARD, 1-SER.	\$150.00
AST SIX PACK 64K, 1-SER., 1-PAR.	\$265.00
AST PREVIEW	\$309.00
AST ADVANTAGE CARD	
128K FOR AT	\$495.00
ALR CHALLENGER CARD	
128K FOR AT	\$395.00
PERSYST COLOR	
PRINTER ADAPTER	\$179.00
PERSYST MONOCHROME	
PRINTER ADAPTER	\$199.00
PERSYST BOB CARD	\$395.00
HERCULES COLOR	
PRINTER ADAPTER	\$179.00
HERCULES GRAPHIC	
PRINTER ADAPTER	\$325.00
STB GRAPHIC PLUS II	\$325.00
IBM COLOR GRAPHIC ADAPTER	\$225.00
IBM MONO PRINTER ADAPTER	\$230.00
GENOA SPECTRUM GRAPHIC CARD	\$349.00
ORCHID TURBO-186, 126K	\$975.00
ORCHID DAUGHTER	
TURBO-186, 128K	\$219.00

## GENERAL

MAXELL DISKETTES MD2	\$35.00/box
MAXELL MD2-HDM FOR AT	\$65.00/box
CONTROL DATA DISKETTES	\$30.00/box
KEYTRONIC KEYBOARD KB 5151	\$189.00

Many other products available, Please call for Low, Low Prices!

*Microshop*  
COMPUTER PRODUCTS

**(714) 838-7530**

2640 Walnut Avenue, Unit K, Tustin, California 92680

Prices & availability subject to change without notice - IBM is a registered trademark of IBM Corporation

# VT100 \$150\*

plus your  
PC, jr, XT, AT or compatible

ZSTEMpc-VT100 Smart Terminal Emulator  
132-col. by windowing - no addit. hardware  
Double High Double Wide Characters  
Full VT100 line graphics. Smooth scrolling  
2-way file transfers incl. XMODEM and KERMIT  
Full keyboard softkeys/MACROS  
Speeds to 38.4KB. High Throughput  
Color/graphics, monochrome & EGA support  
International Font Support  
Single Key DOS Access  
ZSTEMpc-VT100 \$150. ZSTEMpc-D200 \$125.  
30 day money back guarantee. MC/VISA.

## KEA SYSTEMS LTD.

#412 - 2150 W. Broadway  
Vancouver, B.C. CANADA V6K 4L9  
Support (804) 732-7411  
TELEX 04-352848 VCR

Orders Toll Free (800) 663-8702



Inquiry 347

# SUMMER SALE

FREE LQP PRINTER  
VIVITAR TRANSTAR 120  
RETAILS FOR \$699.00

CPM PORTABLE



TELEVIDEO TPC-1

## FEATURES:

- 64K Ram (Expandable to 128K)
- Dual 5 1/4" Floppy Disk Drive (368.6K per drive)
- 9" Amber Graphic Monitor
- Low Profile Keyboard with 10 function keys
- TeleWrite, TeleCalc, TeleChart CP/M

List: \$1,995.00 **SALE \$850.00\***

\* INCLUDES FREE LQP PRINTER

**EXSEL** OFFICE EQUIPMENT BROKERS  
315 ALEXANDER STREET  
ROCHESTER, NEW YORK 14607

800-624-2001  
716-325-5530

Inquiry 117

## 9-TRACK MAG. TAPE SUBSYSTEM FOR THE IBM PC/XT/AT



\$4757

For information interchange, backup and archival storage, IBEX offers a 9-track, IBM format-compatible "W" magnetic tape subsystem for the IBM PC, featuring:

- 42 M-Bytes on a single reel.
- IBM format 1600 cpl.
- Software for PC-DOS, MS-DOS.

**IBEX**

IBEX COMPUTER CORP.  
20741 Norfolk St.  
Chatsworth, CA 91311  
(818) 708-5100  
TWX: 910-622-2371

Write, phone or TWX for information

Inquiry 148

# DATA BROKERS

1-800-833-2600  
in Ohio (513) 561-0099  
**FREE SHIPPING**  
NO EXTRA CHARGES!

Hayes Compatible

## MODEMS

USR Courier 300/1200/2400 .....	\$469
USR Password 300/1200 .....	\$229
USR IBM 300/1200 IBM int. ....	\$299
Anchor Express 300/1200 .....	\$279
Anchor Volksmodem 12 300/1200 ...	\$179
Anchor Mark XII 300/1200 .....	\$220
Anchor Mark X 300 .....	\$ 99
Hayes 1200 The standard .....	\$399
Hayes 1200B IBM int. ....	\$379
Multitech MT 212AH2 300/1200 .....	\$349
Multitech MT 224AH 300/1200/2400 ..	\$559
Cermetek Security w/callback security	\$599
Cermetek 1200PC IBM int. ....	\$349

DATA BROKERS ..... THE MODEM EXPERTS  
3535 Roundbottom Rd. Cinti., OH 45244

Inquiry 93



Is programming  
the latest game  
of Trivial Pursuits?

TSF's Source Locator helps you stay productive by identifying your listings and comprehensively indexing your programs.

Source code listings: file identification  
• your headings & footings •  
• page/line formatting •

Cross-reference listings: your comments  
• usage • scope •  
• Asm. Basic. C. Pascal •

System cross-reference combining any number of files and languages.

## The Source Locator

Introductory Price **\$29.95**  
For the IBM PC, XT, AT, and compatibles, DOS 2.0.  
Price includes shipping. Not copy protected.

TSF Dept. A-2

649 Mission St., San Francisco, CA 94105

(415) 957-0111

Via and MasterCard phone orders accepted. California residents add sales tax. Dealer and Site License Inquiries Invited.

Inquiry 323

Finally!

"No-Stretch" Viewing  
**ANGLED PRINTER STAND**



Deluxe Model

Standard & Deluxe Models available

Deluxe fits over Disk Drive

80/132 column available

Priced from \$21.95

**COMPUTER MEDIA MARKETING**

Dept. B-8 P.O. Box 614

Katy, Texas 77492

713/392-2385

Dealer Inquiries Welcome

Inquiry 74

INTRODUCING  
MULTIPLE CHOICE.  
THE ONE KEYSTROKE SOLUTION  
TO SWITCHING  
APPLICATION PROGRAMS

on your IBM PC XT AT  
or compatible.



SPECIAL  
INTRODUCTORY  
OFFER\*

**\$64**

**AWESOME**  
TECHNOLOGY INC.

177 Webster Street, Suite A-416  
Monterey, CA 93940, For info, call (408) 646-1364

Order TOLL FREE (VISA/MC)  
Outside CA (800) 548-2255 Ext. 803  
In CA (800) 624-2644 Ext. 803

\*Good until September 1, 1985



**American**  
**Semiconductor**

Computers, Components, Hardware and Software

**4164**

INT | INT  
OBI | NAT

**79¢**

**128K**

FOR AT

**4.90**

**41256**

MSI | OBI  
NAT | INT

**3.50**

CDC DSDD DRIVES ..... 89.  
80287 FOR AT ..... 175.  
8087 Math Coprocessor .... 99.  
AT TURBO KITS ..... CALL  
10 mb 1/2 Winchester ... 399.  
AT-20 mb Hi Speed ..... 475.  
EPSON FX-100 ..... 499.  
COLOR CARDS ..... 149.  
HAYES 1200B ..... 385.  
AT 386K 1/8 Height ..... 109.

**800-237-5758**

SALES EXT. 502

Vendor Line  
813-848-3183

ADD 3%

Inquiry 19

Software for  
**Engineers**

**Electronic Circuit Analysis**

- Nonlinear transient, DC, AC analysis
  - Worst Case, Monte-Carlo
  - Frequency, time dependent parts
- \$450.**

**Logic Simulation System**

- Full delay analysis (min, max, typical, load dependent)
  - Ability to save simulation results
- \$395.**

Both have:

- Built in editor, fully interactive
- Macros (unlimited)
- Large circuits

For MS-DOS, 192k minimum

**Tatum Labs**

33 Main Street

Newtown, CT 06470

(203) 426-2184

Inquiry 316

# BACK TO SCHOOL SPECIAL SALE

**COMPUTER CONNECTION**  
TOLL FREE ORDER LINE

## PRINTERS

<b>OKIDATA</b>	
ML182P 120 cps	\$ 225
ML182 IBM Graphics Comp	225
ML182S 10" Carriage	265
ML182P, 160 cps	359
ML182 IBM Graphics Comp	359
ML182S, 160 cps	435
ML183P, 160 cps	525
ML183 IBM Graphics Comp	525
ML183S, 160 cps	599
ML84P, 200 cps	669
ML84 IBM	669
ML84S, 200 cps	769
Okimate 20	135
<b>STAR MICRONICS</b>	
SG-10, 120 cps, 2K buffer	\$ 229
SG-15, 120 cps, 2K buffer	369
SD-10, 160 cps, 10" carriage	355
SD-15, 160 cps, Corr. Qual.	479
SB-10 Draft & NLQ 24 wire printhead	799
<b>EPSON</b>	
LX80, 100 cps, 10" carriage	Call
FX80 +, 160 cps, 10" carriage	Us
RX100, 100 cps, 15" carriage	First
FX100 +, 160 cps, 15" carriage	For
LQ1500 Draft NLQ	Lowest
SO2000, All New	Prices
*We Are An Authorized Dealer	

<b>COPAL</b>	
SC-1200, 120 cps FT & Graphics	\$ 215
SC-1200L, 120 cps w/NLQ	245
SC-1500, 180 cps FT & Graphics	295
SC-1500L, 180 cps NLQ w/IBM Char. Set	335
SC-5500L, 15" NLQ IBM Char. Set	475
Very Quiet — 1 Yr. Warranty	

<b>DYNAX</b>	
DX15XL, 20 cps By Brother	\$ 369

<b>JUKI</b>	
8100, L.Q. 18 cps w/proportional spc.	\$ 379
6300 L.Q. 40 cps	689

<b>TOSHIBA</b>	
P1340 P	\$ 575
P1340 S	575
P351 P, Faster than 1351	1229
P351 PIS, Faster and More Versatile	1275

<b>PANASONIC</b>	
1091 w/Tractor, 120 cps, 1 yr. war.	\$ 265
1092, 10" carriage, 180 cps	439
1093, 15" carriage, 160 cps	689

## HARD DISK DRIVES

<b>RODIME</b>	
10 Meg w/Cont., 1 yr. warr.	\$ 595

<b>SEAGATE</b>	
10 Meg w/Cont., 1 yr. warr.	\$ 650

<b>ALPHA OMEGA</b>	
10 Meg w/Controller Card	\$ 665
20 Meg w/Controller Card	1099
30 Meg w/Controller Card	1395

## DISK DRIVES

<b>TANDON</b>	
TM100-2 for IBM PC	\$ 99

<b>QUME</b>	
1/2 Ht. ds/did 360K, 100% IBM Comp.	\$ 85

<b>TEAC</b>	
558 Double Sided 360K	\$ 99
Quad Density	159

## Drives For Apple & Franklin

<b>MICRO-BCI</b>	
A-2	\$ 169
A-5C for IIG w/cable	178
A-5 1/2 height for IIE	189
Controller Add	55

## PRINTER ACCESSORIES

<b>ORANGE MICRO</b>	
Grappier +	\$ 85
Buffered Grappier +, 16K exp. 64K	155
<b>TOSHIBA</b>	
Bi-Directional Trac. 1351/351	\$ 149/155
Font Disk for Down loading P1351	50
<b>MICROTEK</b>	
Dumping GX (same as Grappier +)	\$ 69
Dumping GX w/16K buffer	136
Dumping GX w/32K buffer	147
Additional Buffering 16K	12
<b>FOURTH DIMENSION</b>	
Par. Card & Cable for Apple	\$ 47
<b>OKIDATA</b>	
Plug and Play for IBM	\$ 49
Tractor for 82A & B2	49
<b>JUKI</b>	
Bi-Direc. Tractor for 6100/6300	\$ 125/135
Serial Interface	65
<b>CABLES</b>	
IBM PC to Parallel Printer	\$ 18
Serial Cable	18
Centronics M/M or M/F	18

## DISPLAY MONITORS

<b>QUADRAM</b>	
Amber chrome IBM compatible	\$ 165
<b>AMDEK</b>	
V300G	\$ 125
V300A	135
V310A for IBM PC	169
Color 500 Color Composite	339
Color 600 RGB Hi-Res	429
Color 710 Super Hi-Res	545
<b>TAXAN</b>	
IBM Green Monochrome #121	\$ 129
IBM Amber Monochrome #122	139
RGB IBM w/Gr Comp Text Mode #425	429
RGB Super Hi-Res. #415	383
RGB Super Hi-Res. #440 Best Buy	499
RGB/Comp. Med. Res. #210	259
<b>PRINCENTON GRAPHICS</b>	
HX-12 for use with IBM PC	\$ 445
Max 12E Amber for IBM	179
SR 12 Super Hi-Res	565
Scan Doubler	185
<b>QUIMAX</b>	
PX-IV, RGB Hi-Res w/Gr. Text Mode	\$ 415
DM-14 Monochrome Amber	155

## BACK TO SCHOOL SPECIALS!!

### COMPAQ DESK TOP

- One Drive
  - 256K of Memory w/Par. Port
  - 10 Meg Hard Disk
  - Taxan Green or Amber
- \$2450**

### IBM PC XT

- 256K of Memory
  - One IBM Floppy
  - 10 Meg. Hard Disk
  - Color Card
  - Taxan #425 RGB Hi-Res & Comp. Gr.
- \$3190**

### AST 6 PAK +

- w/384K
- \$299**

### ANCHOR AUTOMATION

- Mark XII/Volksmodem XII
- \$215 / \$179**

### 64K OF MEMORY

- \$9.95

### TANDON

- TM 100-2
- \$99**

"THE COMPANY THAT DELIVERS"

## IBM PC ACCESSORIES

<b>IBM</b>	
IBM Dos 3.1	\$ 69
Tech Ref. for Dos 2.1 or 3.0	69
<b>PARADISE</b>	
Modular Graphics Card	\$ 269
Module A	79
Module B	120
5-Pak	165
<b>64K MEMORY UPGRADE</b>	
64K (9 chips) 200ns & 150ns	\$9.95
<b>PERSYST BOARD</b>	
Bob Hi-Res Display Adaptor	\$ 369
<b>QUADRAM</b>	
Quad Color 1 Board	\$ 175
Exp. Quadboard w/64K & Game Port	239
Quadlink 3000 Run Apple soft on IBM	329

<b>VUTEK (2 yr. war.)</b>	
Vutek • CPS Board, RGB & Composite w/Par. & Ser. Ports, 2 Yr. War.	\$ 239
Color Card (Herc. comp.) w/Para.	159
Monographic Card (Herc. comp.)	269

<b>AST RESEARCH</b>	
Six Pak w/64K	\$ 239
Game Port	49

<b>KEYTRONICS</b>	
K85151	\$ 179

<b>MICROTEK</b>	
Monochrome Text Par. & Ser.	\$ 185
Color Graphics Card	165

<b>TECHMAR</b>	
PC Mate 64K exp. to 256K Mem. exp.	\$ 99
PC Mate Mem. Brd. w/256K Installed	175

## APPLE & FRANKLIN ACCESSORIES

<b>ACCESSORIES</b>	
Kensington System Saver	\$ 69
Fan for Apple II & IIE w/surge	37

<b>MICROTEK</b>	
Serial Interface	\$ 75

<b>MICROMAX</b>	
Viewmax 128K extended 80 col. card for Apple IIE w/64K	\$ 124
80 col. card for Apple II & II +	139

<b>ADVANCED LOGIC SYSTEMS</b>	
Z Engine 2.2	\$ 119

<b>APPLE</b>	
Super Serial Card	\$ 135

<b>ASTAR</b>	
RF Modulator	\$ 17

<b>MICRO-BCI</b>	
64K, 80 Col. Card	\$ 85

## PERSONAL SYSTEMS

<b>APPLE</b>	
Professional Sys. incl: Apple IIE w/128K & 80 col. till mon., duo disk w/con't kit	\$ 1345
Apple IIC Lightweight Portable	Call
<b>IBM</b>	
IBM PC Bare w/cont. & keyboard	\$ 1345
IBM PC 64K, 1 Drive	1475
IBM PC, 2 Drives w/256K	1699
IBM XT, 10 Meg, 360K Dr. w/256	2795
IBM XT Bare w/256K & IBM Floppy	2095

<b>SANYO</b>	
MBC 550-2 w/1 320K Drive & stwr	\$ 750
MBC 555-2 w/2 320K Drives & more software	990
Portable	Call
Serial Port for Sanyo	79

<b>COMPAQ</b>	
256K, w/2-320K Drives	\$ 1885
Desk Top Model 1	1725
Desk Top Model 2	2150
Desk Top Model 3	3785
Desk Top Model 4	4485

<b>WYSE</b>	
1100-1 Incl. 256K w/1wo 360K Drives, 1 par & 2 ser. ports	\$ 1399
1100-2 Incl. 10 meg, 1 floppy, 256K, 1 par. & 2 ser. ports	2599

## SOFTWARE

<b>LOTUS DEVELOPMENT CORP.</b>	
Lotus 1-2-3	\$ 295
Symphony	437

<b>ASHTON TATE</b>	
D Base II	\$ 329
D Base III	419

## PRINTER SWITCH BOX

<b>EXPONENT</b>	
Centronics Two Switch	\$ 84
Centronics Four Switch	110
Serial Two Switch	75
Serial Four Switch	99

## MODEMS

<b>ANCHOR</b>	
Mark XII	\$ 215
Volksmodem XII	179
Anchor Express	Call

<b>HAYES MICRO</b>	
300 Baud Smart Modem	\$ 189
1200 B for IBM PC w/SM II	379
2400 Baud Modem	845
Micro Modem IIE	259
Chronograph	189
300 For Apple IIC w/Softwr	Call

<b>PC DISKETTES</b>	
Sgl./Dbl. (Box of 10)	\$ 18
Dbl./Dbl. (Box of 10)	18

<b>COMPUTER CONNECTION</b>	
Sgl./Dbl. w/Disk Container (10)	\$ 20
Dbl./Dbl. w/Disk Container	20
Bulk 50 & Up — Dbl./Dbl.	1.35 ea.

## DISKETTES

<b>PC DISKETTES</b>	
Sgl./Dbl. (Box of 10)	\$ 18
Dbl./Dbl. (Box of 10)	18

<b>COMPUTER CONNECTION</b>	
Sgl./Dbl. w/Disk Container (10)	\$ 20
Dbl./Dbl. w/Disk Container	20
Bulk 50 & Up — Dbl./Dbl.	1.35 ea.

## We Stock What We Sell!!

IF YOU SEE IT ADVERTISED FOR LESS, CALL  
COMPUTER CONNECTION FIRST FOR LOWEST QUOTE!

**MAIL ORDER:**  
17121 S. Central Avenue, Unit L  
Carson, California 90746



NO SURCHARGE FOR CREDIT CARDS

We accept VISA, MasterCard, CDD (w/Deposit), Certified Checks or Wire Transfers. Minimum Shipping Charge \$4.00. Some items subject to back order. California Res. add 6 1/2% Sales Tax. All returns are subject to a 15% restocking charge and must be authorized by store manager within 10 days. Prices subject to change without notice. This Ad supersedes all others.

## ORDER LINE (800) 732-0304

(Outside California)  
(213) 635-2809  
(Inside California)

Mon.-Fri. 7 a.m. to 6 p.m.  
Saturday 11 a.m. to 3 p.m.

## CUSTOMER SERVICE:

(213) 635-5065  
Mon.-Fri. 9 a.m. to 3 p.m.

**COMPUTER CONNECTION**

# DISK WORLD! is proud to introduce the lowest-priced, LIFETIME-WARRANTY diskettes ever!

## And they're BRAND NAME PRODUCT to boot!

5.25" SSDD → .79 ea. 5.25" DSDD → .89 ea.

5.25" DSDD-HD → \$2.35 ea.

3.50" SSDD → \$2.25 ea. 3.50" DSDD → \$2.65 ea.

Based on multiples of 100 each.  
Boxed in 10's with heavy-duty cardboard sleeves, user ID labels,  
reinforced hubs (where appropriate) and write-protect tabs.

### Introducing Wabash Pinnacle Series Diskettes.

Two years ago, if you'd told me I'd be writing this ad, I would have laughed.

At that time, Wabash diskettes were synonymous with "s---".

Just saying that quality control was poor would be charitable.

So much was wrong that DISK WORLD wouldn't sell them.

#### That was yesterday.

Kearney-National Inc., a \$202-million division of a much larger company, came into Wabash.

Out went the old management, the old methods, the old production techniques... and in went a lot of new people, ideas, production lines and some really imaginative thinking.

#### The end result.

Today, I'm proud to offer you the Wabash Pinnacle Series of diskettes at the prices shown.

This isn't evolution in diskette manufacturing; it's revolution.

#### Here's what you get.

Wabash Pinnacle diskettes are

- ... certified 100% Error Free
- ... are covered by a LIFETIME WARRANTY
- ... meet or exceed all industry specifications (by quite some distance)
- ... and are simply the best value in diskettes available today.

#### The torture test.

Considering Wabash's earlier dubious reputation, I wasn't exactly a true believer when their Director of Marketing came into my office with samples.

So I took a box at random, selected a disk, bent the thing every which way and slipped it into my IBM-PC.

It formatted. It booted. It stored and retrieved data.

#### That wasn't enough.

I gave samples of the diskettes to Curt Rostenbach and, in turn, to Tom Strait, both hackers of long experience and members of the Waukegan (Illinois) Apple Users Group.

Tom really went at it.

He took a quartz-halogen lamp, aimed it at the diskette until it started to smoke (and melt)... and then formatted, booted the diskette and stored and retrieved data!

The same terribly (and intentionally) mutilated diskette ran on an ITT, Corona and IBM.

Curt was nicer.

He simply bent the diskette every which way... and it still formatted, booted and ran on his Apple.

#### The best buy I've ever seen.

DISK WORLD!, Inc. sells more flexible magnetic media by mail-order than anyone else in the world.

I, as President of the corporation, won't tolerate a product with a failure rate of more than 1/1000th of 1 percent.

I also don't like companies who try to milk a "quality" or "premium" image for a higher price like Dyan and Verbatim did... until they failed.

As President of DISK WORLD!, Inc., my motto is simple: "the best diskette for the least amount of money."

#### Wabash is it.

Right now, there is no better value than the Wabash Pinnacle Series of diskettes.

Granted, you have to buy a hundred at a time, but so what? Split the order with friends, relatives, co-workers or even your worst enemies.

The key thing is to get the most diskette for the money.

And this is it.

(Incidentally, as a corporation, we put our money where our

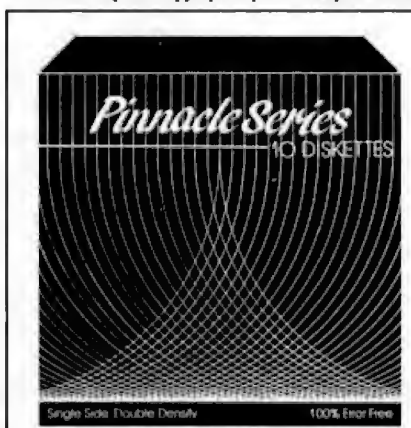

mouth is. Our first order for Wabash Pinnacle Diskettes was 1.5-million units.)

That's an awful lot of faith and confidence.

But, then again, I have the diskette that Tom Strait literally melted... and kept on running.

#### The truth about \$1.00 or less diskettes.

More and more ads are popping up offering diskettes for \$1.00 or less.

By the same token, more and more people who were selling used cars a few months ago are now selling diskettes by mail.

We did a little survey of current ads for diskettes advertised for a dollar or less and did some analysis of the market and here's what we found as it applies to 5.25" DSDD diskettes "supposedly" selling for a dollar or less.

VENDOR:	ADVERTISED LOW PRICE:	ACTUAL PRICE PER 100:	ACTUAL MFGR.:
Unitach	.89 ea.	.92 ea.	Unspecified.
Datatech	.99 ea.	.99 ea.	Unspecified.
Computer Club	.95 ea.	.95 ea.	Unspecified.
	.99 ea.	1.02 ea.	Unspecified.
Communications & Electronics	.49 ea.	.80 ea.	Unspecified.
Precision Data	.89 ea.	.93 ea.	Unspecified.
Diskette Connec.	.93 ea.	.93 ea.	Unspecified.
Comp Soft Serv.	.77 ea.	.77 ea.	Unspecified.
		+ shipp.	
Computer/Computer	.99 ea.	.99 ea.	Unspecified.
DISK WORLD	.89 ea.	.92 ea.	Wabash Datatech

#### The real truth about \$1.00 or less diskettes.

It costs all diskette manufacturers about the same to produce a diskette. Some may charge more because they want to project a "premium quality" image, ala the late, lamented Dyan who bought their basic media from 3M.

Some charge less because they sell a sub-standard product... and we're not foolish enough to name names here.

But here's the truth about the \$1.00 or less diskette market. It falls into four categories:

1. The DISK WORLD's of the universe who simply are so big that they can buy first quality product in massive quantities and choose to pass on the savings to you. (Precision Data and Diskette Connection on BRAND NAME products also fall into this category.)

2. The people who buy "cosmos"... stuff from major manufacturers that usually hits quality control standards, but is cosmetically blemished and thus can't be packaged and sold under the manufacturer's own name.

3. "Duplicate Quality". Uncertified media, usually below manufacturer's own standards and frequently below ANSI and IBM standards. Sold on an "as-is" basis with the understanding that the manufacturer's name will never be divulged. Usually about a 20% reject rate... as compared to DISK WORLD's standard of less than 1/1000th of 1% reject/return rate. Next to garbage, this is the source of most diskettes advertised at a dollar or less.

They may work... and then again they may not. (Frankly, the odds at the Blackjack table in Las Vegas are more in your favor.)

4. Garbage. Stuff that shouldn't be sold at all. But some manufacturers are hurting for cash, so they sell it anyway (After all, they want to meet their payroll. Look what happens when you don't: you become a Dyan or Verbatim. Lots of history, but no money.) More and more garbage is being dumped into the market as manufacturers become pressed for cash and are motivated into selling anything and everything they can manufacture. (Read the article in FORBES about Verbatim and its "Bonus" brand.)

Finally, the Taiwanese counterfeiters are moving into the act. Perfect duplicates of the packaging of major manufacturers with one exception: the quality isn't there.

#### The Critical Factor.

Only DISK WORLD!, Inc. offers fully brand-identified, LIFETIME-WARRANTY product for less than a dollar.

Every one else offering 5.25" product for less than a buck doesn't tell you who makes it.

We do.

And that ought to tell you a lot right there.

## Ordering & Shipping Instructions

SHIPPING: Wabash Pinnacle Diskettes are sold in multiples of 100 only. Shipping charges are \$3.00 per 100, regardless of type or size.

PAYMENT: VISA, MASTERCARD and PREPAID orders accepted. Corporations rated 3A2 or better and government and quasi-government open accounts are accepted on a NET 15 basis.

C.O.D. orders are subject to a \$5.00 special handling charge. (Sorry for the increase, but too many people have been refusing C.O.D. orders or using bad checks. It's a classic example of a few "bad eggs" making life more expensive for everyone else.)

AP0, FPO, AK, HI & PR ORDERS: Include shipping as shown and an additional 5% of the total amount of the order to cover PAL and insurance.

No other non-continental U.S. orders are accepted. TAXES: Illinois residents only, add 7%.

All orders subject to acceptance. Not responsible for typographical errors.

#### ORDERS ONLY:

1-800-621-6827

(In Illinois: 1-312-256-7140)

#### INQUIRIES & INFORMATION

1-312-256-7140

#### FOR FASTEST SERVICE,

USE MCI MAIL:

Just address "DISK WORLD"

(24-hour shipping on any item in stock if you order via MCI MAIL.)

# DISK WORLD!, Inc.

629 Green Bay Road  
Wilmette, Illinois 60091

# PRIORITY **1** ELECTRONICS

ONE

## QUME Trak 842



**8" Double Sided/Double Density  
BRAND NEW! 90 DAY WARRANTY!**

**\$199 each \$189 \$179**

BTQMETRAK842 Each 2 - 5 Each 6 or More

(Shipping weight 18 lbs.)

BTQMETRAK842M Manual, not included with drive \$15

## SURGE SUPPRESSORS

*Don't let power spikes pull you  
down! Protect your equipment  
from All angles*

AC Power line  
With 6 outlets  
BTWBROG115S

Sh.Wt.2lbs.

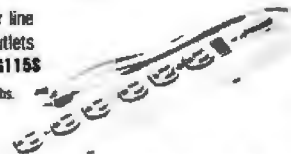

**\$29.95**

## 150VA & 300VA

### Line Conditioners

*Better Than A Surge Suppressor!*

Provides both surge and noise suppression  
along with brownout protection as well

**150VA 300VA**  
Great for Your PC! Great for Your XT!

**\$79 \$99**

BTSHPI50  
Sh.Wt.15lbs.

BTSHPS00  
Sh.Wt.30lbs.

## 20Mbyte Add-On Hard Disk For Your IBM PC™ and Compatibles

Comes Complete With Half High  
Disk Drive, Controller, and Cables

**INTERNAL EXTERNAL**  
**\$799 \$999**

BTPRIPCSUB201

BTPRIPCSUB20X

Include \$5.00 (Internal), \$9.00 (External) for Shipping



## Mr. Chips

**256K Multifunction  
PC Add-On Card**

- Chips supplied to populate to 256K
- 1 parallel, 1 serial interface
- Clock calendar
- Dual game port
- Real world interface
- BSR AC line controller
- RAM disk & print spooler software

BTORMMC258

**\$169**  
Each

(Sh. wt. 2 lbs. each)

## Memory Expansion

*150ns  
or Better! Chip Sets*

**64K 256K**  
Set of 9 = 64K Set of 9 = 256K

**\$9.95**

BTSP0B1MEM0

Set of 36 = 256K

**\$35.**

BTSP0B1MEM36

**\$59.**

BTPOB256MEM0

Set of 36 = 1 Meg

**\$219.**

BTPOB256MEM36

CALL FOR QUANTITY PRICING

## Disk Drive Cabinets

Part Number	Description	Price
BTJMR1C6	5 1/4" Sgl Floppy 5lbs.	\$ 59.
BTJMR2C6	5 1/4" Dbl Floppy 9lbs.	\$ 89.
BTJMR2C6C	JMR2C6 with data cable	\$ 99.
BTJMR2V6	Dual 5 1/4" 1/2Hi Flop 7lbs.	\$ 65.
BTJMR2C6	Dual 8" Floppy 35lbs.	\$229.
BTJMRDTC6	Dual 8" 1/2Hi Floppy 12lbs	\$179.
BTJMRNDCS1	Sgl 5 1/4" Hard Disk 16lbs.	\$199.
BTJMRNDCS1HH	Sgl 5 1/4" 1/2 Hi Hard 16lbs.	\$199.
BTJMRNDCS2	Dual 5 1/4" Hrd Dsk 20lbs.	\$289.

## Intellicom In-Line Print Buffer & Interface Adaptors



Low-Power AC  
Adaptor Included!

Serial to Parallel to Parallel to  
Parallel Parallel Serial  
64K 256K 64K

**\$229 \$229 \$229**

BTINTBSP64

BTINTBPP256

BTINTBPS64

(Shipping weight 1 lb. each)

**5-YEAR  
WARRANTY!**

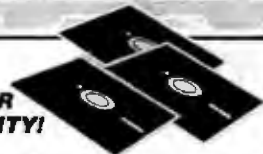

## 5 1/4" Double Sided Double Density Diskettes

**99¢ 90¢ 80¢**  
Each in Packs Each in Boxes Each in Cartons  
of 50 of 250 of 1000

99¢ x 50 = 90¢ x 250 = 80¢ x 1000 =

\$49.50/pack \$225.00/box \$800.00/carton

BT50S50 2 lbs. BT50S250 6 lbs BT50S1000 30 lbs

## POWERPLAY

Dual 5 1/4"  
1/2-high disk  
enclosure &  
power supply  
for hard disks  
or floppy drives  
with surge suppressor  
and 6 switched AC outlets



**\$299**

FTJMR1 (10 lbs.)



## PRIORITY **1** ELECTRONICS

9161 Deering Ave., Chatsworth, CA 91311-5887



**ORDER TOLL FREE (800) 423-5922, Local: (818) 709-5111**

MINIMUM PREPAID ORDER \$25.00. Terms U.S. VISA, MC, BAC, Check, Money Order, U.S. Funds ONLY. CA residents add 6%, 6 1/2%, or 7% Sales Tax, depending on your local rates. Include MINIMUM SHIPPING & HANDLING of \$3.00 for the first 3 lbs., plus 40¢ for each additional pound (20¢ if within Calif.) Plus 25¢ per \$100.00 value of your order for insurance. Orders over 70 lbs. sent freight collect. Just in case, include your phone number. Prices subject to change without notice. We will do our best to maintain prices through August 1985. Credit card orders will be charged appropriate freight. We are not responsible for typographical errors.

**FREE DEMO DISK** **DON'T CALL A PROGRAMMER**  
**Let Your Secretary Do It!**  
**EASY TO USE**  
**DATAMASTER™**  
 Allows you to maintain complete control of building and styling your own database without complicated programming.

**FREE DEMO DISK** Circle Reader Service Number or Call us at (818) 986-3233.  
**LIMITED PACKAGE** Try our limited package for \$15.00 (applied to purchase).

**DATAMASTER** **INTRODUCTORY SPECIAL**  
 When you order, ask about our money back guarantee! Through Sept 85, **\$175<sup>00</sup>**  
 Regular price \$495.

Use your Master Card or VISA and call today!  
 IN CALIF OUTSIDE CALIF  
**800-423-0320 800-482-DATA**  
**C.D.A. INTERNATIONAL SOFTWARE CORP.®**  
 (818) 986-3233 Telex: 215666

Inquiry 52

**MARYMAC INDUSTRIES INC.**  
**800-231-3680**  
**Radio Shack TRS-80's**  
**Epson Printers**  
 People you Trust to give you the very best!



- Lowest Discount Prices
- Reliable Service
- Quality Products

"World's largest independent authorized Tandy dealer."  
 22511 Katy Fwy., Katy (Houston) Texas 77450  
 (713) 392-0747 Telex 774132

Inquiry 191

**ICs PROMPT DELIVERY!!!**  
 SAME DAY SHIPPING (USUALLY)  
 OUTSIDE OKLAHOMA NO SALES TAX

**8087-3 MATH \$105.00**  
**8087-2 COPROCESSORS 140.00**  
**DYNAMIC RAM**  
**256K 256Kx1 120 ns \$ 4.49**  
**256K 256Kx1 150 ns 3.25**  
**64K 64Kx1 150 ns .99**  
**EPROM**  
**27C256 32Kx8 250 ns \$15.99**  
**27256 32Kx8 250 ns 9.10**  
**27128 16Kx8 250 ns 3.47**  
**27C64 8Kx8 200 ns 7.85**  
**2764 8Kx8 250 ns 2.50**  
**2732A 4Kx8 250 ns 2.75**  
**STATIC RAM**  
**6264LP-15 8Kx8 150 ns \$4.99**  
**6116LP-3 2Kx8 150 ns 1.95**

ADD 640 Kbytes to PCXT & SLOT MOTHERBOARD  
 CONSUME NO EXPANSION SLOTS: \$78.50

OPEN 6 1/2 DAYS WE CAN SHIP VIA FED-EX ON SAT

MasterCard/VISA or UPS CASH COD  
**Factory New, Prime Parts** **µP<sup>000</sup>**  
**MICROPROCESSORS UNLIMITED**  
 24,000 S. Pecos Ave., (918) 267-4961  
 BEGGS, OK. 74421

Prices shown above are for July 2, 1985  
 Please call for current prices. Prices subject to change. Please expect higher or lower prices on some items due to supply & demand and our changing costs. Shipping & insurance extra. Cash discount gross shown. Orders received by 5 PM CST can usually be delivered to you by the next morning, via Federal Express Standard Air or 8:00, or Priority One or 9:00.

NO EXTRA COST ON FEK DELIVERY

QUANTITY ONE PRICES SHOWN

Inquiry 210

**The Statistician**  
**CPM IBM-PC**  
**TRS-DOS XENIX**

- Multiple Regression Stepwise Ridge All Subsets Backward Elimination
- Time Series Analysis
- Descriptive Statistics
- Transformations
- Survey Research
- Nonparametrics
- XY Plots
- ANOVA
- Random Samples
- Data Base
- Search & sort
- Hypothesis tests

Please call **TOLL FREE**  
**1-800-334-0854 (Ext. 814)**

**Q** for more information or write:  
 Quant Systems  
 Box 628  
 Charleston, SC 29402  
 VISA-M/C Accepted

Inquiry 260

**3M Diskettes**  
**Lifetime Warranty**  
**TIRED OF WAITING FOR SERVICE AND PRICE?**  
**9 out of 10 SURVEYED DISK BUYERS PREFERRED**  
**NORTH HILLS**  
**#1 IN SERVICE AND PRICE**  
**1-800-328-3472**

Formatted and hard sector disks in stock-Dealer inquiries invited.  
 COD, VISA, MASTERCARD  
 All orders shipped within 24 hrs.

  
**NORTH HILLS CORP.**  
**INTERNATIONAL**  
 3564 Rolling View Dr.  
 White Bear Lake, MN. 55110  
 MN. call collect-612-770-0485

**SAVE TIME AND MONEY WITH LOW COST PI-SWITCH BOXES.**

 Starting at \$59.95

- Quickly shares your computer among multiple terminals, printers, modems, etc. with just a flick of the wrist.
- Compact black & beige aluminum enclosure features a high quality rotary switch with rear mounted connectors.
- Serial RS-232 Models have 1cm. 25-Pin Conn. (Lines 1-7 & 20)

**PI-02-S switches 2 to 1 ..... \$59.95**  
**PI-03-S switches 3 to 1 ..... 79.95**  
**PI-05-S switches 5 to 1 ..... 109.95**

- Parallel models have 1cm. 36-Pin cent. conn.
- PI-02-P switches 2 to 1 ..... 84.96
- PI-04-P switches 4 to 1 ..... 154.95
- Dealers, schools & custom inquiries welcome.
- One Year Warranty. COD, VISA, M/C.
- Shipping UPS \$2.00/ea. AIR \$4.00/ea.

 **7301 NW 41 St.**  
**MIAMI, FL 33166**  
**(305) 592-6092**

Inquiry 283

**I/O Bus for Data Acquisition & Control**  
 now available for IBM PC & Apple II series computers



The Local Applications Bus... **LAB 40™**  
 (In photo are LAB 40-PC generator & LAB 40-1 signal acquisition module.)

- Modular approach to data acquisition and control. A 40 conductor ribbon cable bus is generated by a card in the host computer. Up to 8 low cost modules can be located anywhere on a cable up to 100 ft. long. Our LAB 40 generator cards for the IBM PC or Apple II are priced at \$175.
- Signal Acquisition and Control Module, model LAB 40-1. Features: 8 bit resolution, 4 channels, differential inputs, sampling rate up to 650KHz, software programmable gains and offset, digital output port, low price of \$175. Twelve bit module available soon.
- Full featured 'digital oscilloscope' software. Documented and user modifiable. PC version \$175. Apple II version \$100. Complete data acquisition packages (hardware and software) start at \$450.
- Development tool.
- Unique to LAB 40 is its ability to interface directly to microprocessor compatible integrated circuits and hybrids. We encourage users to develop projects and products. LAB 40 is also an ideal educational tool.

Demonstration Disk... only \$4.  
 Please call or write for free brochure.

**Computer Continuum**  
 75 Southgate Ave., Suite 6 • Daly City, CA 94018  
 (415) 755-1978

 **Sure it's insured?**

**SAFEWARE®** Insurance provides full replacement of hardware, media and purchased software. As little as \$39/yr. covers:

- Fire • Theft • Power Surges
- Earthquake • Water Damage • Auto Accident

For information or immediate coverage call:  
**1-800-848-3469**  
 In Ohio call 1-614-262-0559

  
**SAFEWARE, The Insurance Agency Inc.**

Inquiry 284

**NOW C HERE!**  
**CROSS SOFTWARE**  
 for the NS32000

Also Available for IBM PC

**INCLUDES:**

- Cross Assembler \*
- Cross Linker \*
- Debugger \*
- N.S. ISE Support \*
- Librarian \*
- Pascal Cross Compiler \*
- C Cross Compiler \*

U.S. prices start at \$500

**SOLUTIONWARE**  
 1263 Mt. View-Alvino Rd.  
 Suite B  
 Sunnyvale, Calif. 94089  
 408/745-7818 • TLX 4994284

Inquiry 303

# SUMMER SPECIALS

**Micro Products International**  
714/898-0840

Terms: We accept Visa, M/C, Pre-Pay by Check or Money Order. COD's are accepted by Telephone & Mail. COD Terms are: Cashier's Check for first time orders over \$1000.  
Fax: 714/897-3963 Tlx: 887841 XORDATA HTBH

**New Hayes SmartModem Compatible!**  
Finally a price breakthrough on a Hayes compatible, external 300/1200 baud modem. This low price is without driver software, but if you need it add \$25.00. Call for a 26 page catalog of our special deals. Look in this spot every month for Hot, New items sure to catch your interest.



- Runs the popular Hayes communications software
- FCC approved direct RJ-11 connection
- Phone Cable & power supply one low price

MOD-8100-00 ..... \$199.00

**IBM PC-XT SELECTRIC KEYBOARDS**  
Our volume purchase of these excellent Selectric type keyboards will bring the features you have been wanting down to a price you can't resist. So many features you'll love it!

- Single row read
- Separate numeric keypad
- Separate "Arrow" keypad
- Dimple marked "S", F, 6 J keys

KEY-1051-00 Selectric ..... \$129.00  
KEY-1050-00 Standard ..... 89.00



**ADD-ON POWER SUPPLIES**  
Two new, thoroughly tested IBM PC/XT power supplies for your system upgrade. Best price in Byte with ONE YEAR warranty!!

POW-1040-00 135 watt ..... \$ 99.00  
POW-1044-00 150 watt ..... \$115.00



**TURBO MOTHERBOARD**  
Micro Products announces a powerful new IBM XT type motherboard. 4 layers for superior reliability & speed. Turbo mode allows 75% higher thru-put by increasing system clock to 7 MHz under software control. Designed to use new 256K RAM chips or 64K chips. 840K memory expansion does not require use of valuable card slots. Many outstanding features combined with our new 7 PAK Multifunction board make previously expensive options standard features at a LOW LOW Cost.

BOA-6078-00 Supplied with OK ..... \$349.00



**SUPER 12 PAK MULTI-FUNCTION**  
This one is really loaded! Features: One Parallel Port, One RS232-C Serial Port, One Game Port, RealTime Clock / Calendar with Battery Back-up, Expandable to 384K of Parity-checked Memory, Supplied OK Memory, all cables, PrintSpooler and RAM Disk Software.

BOA-6335-00 ..... \$129.95  
Additional (9) 64K Memory Chips  
KIT-8000-00 ..... \$ 10.00



**We Cater to IBM™ Dealers**  
\* Hardware \* Software \* Training Tapes  
Call for our Catalog now!

## Do it Yourself!

## \$1395<sup>00</sup> WOW!

Complete System! **XPC TURBO**

## Add-On H.D. & Tape

three ways to begin - an Empty cabinet - a "Basic" Full system - all that you assemble yourself!

**CABINET ONLY**  
Slot CAB-3068-00 ..... \$75.00  
"BASIC"  
Cabinet, Keyboard, Power Supply, Motherboard w/OK  
YS-8000-00 ..... \$525.00



**NEW 17,000 in Service!**

**Features!**

- RAM Disk
- Game Port
- 640K cpcy
- PrintSpooler
- Turbo mode!
- 4.77MHz to 7MHz!
- Ser, Par
- Clock



**10 Meg H.D.**  
Complete System!  
\$1995<sup>00</sup>

**20 Meg Color**  
Complete System!  
\$2550<sup>00</sup>

**40 Meg w/Tape**  
Complete System!  
\$3035<sup>00</sup>

10 or 20 Megabyte on the top, your choice of Hard Disk on the bottom. Super appearance! Requires one slot in your PC for SASI interface and an extension connector on the floppy card. Everything else is supplied by us.

10 Meg \$1095	40 Meg \$1695
20 Meg \$1295	105 Meg \$4195
28 Meg \$1395	140 Meg \$4695



**This is OUR Junior!**  
Use this "driveless" workstation for low-cost Networking. Features: • 4-slot IBM™ compatible Motherboard • 128K Standard Memory • 8088, 8087 Math Co-processor • Optional Floppy Drive with Controllers.

YS-8100-00 ..... \$475.00  
Full System w/Keyboard, Mono Monitor, Video Display card, 256K 1 RAM Drive ..... SYS-8725-00 \$895.00



**Check These Standard Features:**

- Full-Size, Feather-Touch, Capacitance Keyboard, 10 Function Keys, Calculator-Type Numeric Keypad
- Parallel & Serial I/O • Real Time Clock • Game Port • 2-Simultaneous 5 1/4" DS/DD 48 TPI 360K Drives
- 8 IBM expansion slots • RAM Disk • Print Spooler • 4 DMA & 3 Timer channels
- Full 640K capacity on-board • 8088 16-bit CPU • Monochrome Video Card
- Up to 32K of EPROM (full 9K supplied) • Supports PC-DOS • MS-DOS • CP/M-86
- Power Supply Hard-Disk-Ready, no need to add-on additional power
- High resolution 12" Monitor, Green Screen, 22 MHz bandwidth

**Add-On Hard Disk**  
Two ways to go. The Internal system is cheaper because it does not need a PIS & Chassis. The same PIS & Chassis can be used for a 10 Meg Tape Back-up on your XT!

10 Megabyte \$25 Int/\$895 ext	40 Megabyte \$1195 Int/\$1295 ext
20 Megabyte \$650 Int/\$795 ext	105 Megabyte \$3795 Int/\$3995 ext
28 Megabyte \$795 Int/\$895 ext	140 Megabyte \$4395 Int/\$4695 ext

**Add-On 20 Meg Tape**  
If your IBM-AT needs a little help in the Back-up category, you won't be able to beat this price! Cables, software and everything!

SUB-8300-00 ..... \$595.00



# Not enough room here - Call for Catalog

**PROM LASER**  
This is the One! Our PROM Burner allows reading, storing-to-disk, recalling, and burning. Hi-speed algorithms burns 2764 in 45 seconds! Also handles 2716, 2732, 27128, 27256. Features: Zero insertion force sockets, On-board Voltage Generator; No Interference with normal computer operations.

BOA-8640-00 ..... \$199.00



**We want your DRIVE business!**

Shugart 360K	TEAC 360K	NEC 10meg	Tulin 20meg	Memtek meg
\$85 <sup>00</sup>	\$95 <sup>00</sup>	\$345 <sup>00</sup>	\$695 <sup>00</sup>	\$495 <sup>00</sup>

**Now XPC-XT in a Kit!**  
Completely XT Compatible  
**\$1095<sup>00</sup>**



**Why didn't anybody think of it before? If you have a phillips screwdriver and 1 - 2 hours available, SAVE yourself a bundle of MONEY! No where will you beat this deal on a complete 8 slot ready-to-assemble and run XT compatible.**

- Cabinet
- 135 watt Power Supply
- Keyboard
- 8 Slot Motherboard
- 2-360K Shugart Drives
- Floppy Controller & Cable
- Mono Video Card
- TTL Amber Monitor

**MISCELLANEOUS \$\$\$ SAVERS**

7 PAK Multifunction Floppy, RTC, 2 Serial, 1 Parallel, Game, RAM Disk BOA-8250-00	\$189.00
64K Memory Chips (9) NEC for IBM KIT-8000-00	\$ 10.00
256K DRAM Memory Chips (9) = 256K KIT-8000-00	\$ 45.00
Add-On Memory, (up to 512K) supplied OK BOA-6350-00	\$ 99.00
Floppy Controller, Controls up to four drives, 5 1/4" 48/96 TPI BOA-6100-00	\$ 95.00
Monochrome Graphics Card, (Hercules type) (1-2-3 compatible) 720x 348x BOA-6150-00	\$175.00
Color Graphics Card, 320 x 200 Res. Color, 640 x 200 Monochrome BOA-6200-00	\$145.00
Clock Calendar Board, fits in "short slot" w/battery Back-up BOA-6375-00	\$ 55.00
Hard Disk Controller, standard ST-508 interface for DOS 2.1 & 3.1 BOA-8080-00	\$155.00
300 / 1200 Baud Modem Internal w/PC Talk III Communications Software BOA-8725-00	\$210.00
Monochrome Monitor, 22MHz bandwidth, composite input or TTL MON-1725-00 Green/Comp 99.00	MON-1700-00 Amber/Comp 104.00
MON-1775-00 Green/TTL 104.00	MON-1750-00 Amber/TTL 109.00

**INTERNATIONAL ORDERS**  
Micro Products is ready to serve your needs in several countries. Each Office has Sales Literature, Local Pricing, Inventory and Technical Service available to support your needs. There are no problems with U.S. Export Forms.

**USA OFFICE**  
15392 Assembly Lane, Unit A  
Huntington Beach, CA 92649  
Tel: 714/898-0840  
Tlx: 887841 XORDATA HTBH

**AMSTERDAM OFFICE**  
Building 70, 4th Floor  
1117 ZH Schiphol-East  
Amsterdam, The Netherlands  
Tel: (020) 45 26 50 - Tlx: 18305

**AUSTRALIAN OFFICE**  
8 Irwin Street, Bellevue  
W. Australia 6058  
Tel: 274-3701

**MARACAIBO OFFICE**  
Av. 3F Esq. Calle 81  
Centro Com. Maricao - Local #5  
Maracaibo, Venezuela 4001-A  
Tel: 081-9133328 - Tlx: 62344 PEMIN

**BOMBAY OFFICE**  
311 Sindhi Lane  
Manabhai Dastar Rd.  
Bombay 400-004 India  
Tel: 357172 - Tlx: 011-2968

**CANADA OFFICE**  
264 Principale, St. Basile,  
Quebec, Canada J0J 1W0  
Tel: 541291-3118

## IBM PC/VT100

EM100 for IBM PC, XT, AT, JR.

- VT102 emulation
- File Transfer
- 132 Column modes
- Color Support

### EM100-4010

- Tektronix 4010 emulation
- VT102 emulation
- Picture files
- High resolution hardcopy
- Supports IBM, IBM Enhanced, Hercules and Tecmar graphics cards.

Multicopy discounts



**Diversified Computer Systems, Inc.**

100 Arapahoe, Boulder, CO 80302  
(303) 447-9251

Trademarks: VT100 - Digital Equipment; IBM PC, XT - IBM Corp; Hercules - Hercules Computer Technology.

Inquiry 373

## NEW LOCKIT II

- Password Protected Subdirectories
- Hides files-makes files Read-Only
- Runs on any PC or compatible with Hard Disk under DOS 2.0 or Higher—
- Easy to use - only \$79.95

## LOCKIT I

- Password Enabled Boot-up
- For IBM PC or PC/XT
- Optional Hard-Disk-Only Boot.
- Invulnerable! \$129.95

## PC RESET/QUICKON

- Reset without turning off power
- Eliminate turn-on & Reboot wait
- Saves time, frustration & damage to PC & PC/XT \$89.95

Specify PC or XT, MC/VISA

SECURITY MICROSYSTEMS CONSULTANTS  
16 Flagg Place Suite 102B S.I., NY 10304  
(718) 667-1019

Inquiry 286

## OK-WRITER™

LETTER QUALITY



Enhancement for Okidata ML620, ML630, ML640, ML650, ML660, ML670, ML680, ML690, ML700, ML710, ML720, ML730, ML740, ML750, ML760, ML770, ML780, ML790, ML800, ML810, ML820, ML830, ML840, ML850, ML860, ML870, ML880, ML890, ML900, ML910, ML920, ML930, ML940, ML950, ML960, ML970, ML980, ML990, ML1000, ML1010, ML1020, ML1030, ML1040, ML1050, ML1060, ML1070, ML1080, ML1090, ML1100, ML1110, ML1120, ML1130, ML1140, ML1150, ML1160, ML1170, ML1180, ML1190, ML1200, ML1210, ML1220, ML1230, ML1240, ML1250, ML1260, ML1270, ML1280, ML1290, ML1300, ML1310, ML1320, ML1330, ML1340, ML1350, ML1360, ML1370, ML1380, ML1390, ML1400, ML1410, ML1420, ML1430, ML1440, ML1450, ML1460, ML1470, ML1480, ML1490, ML1500, ML1510, ML1520, ML1530, ML1540, ML1550, ML1560, ML1570, ML1580, ML1590, ML1600, ML1610, ML1620, ML1630, ML1640, ML1650, ML1660, ML1670, ML1680, ML1690, ML1700, ML1710, ML1720, ML1730, ML1740, ML1750, ML1760, ML1770, ML1780, ML1790, ML1800, ML1810, ML1820, ML1830, ML1840, ML1850, ML1860, ML1870, ML1880, ML1890, ML1900, ML1910, ML1920, ML1930, ML1940, ML1950, ML1960, ML1970, ML1980, ML1990, ML2000, ML2010, ML2020, ML2030, ML2040, ML2050, ML2060, ML2070, ML2080, ML2090, ML2100, ML2110, ML2120, ML2130, ML2140, ML2150, ML2160, ML2170, ML2180, ML2190, ML2200, ML2210, ML2220, ML2230, ML2240, ML2250, ML2260, ML2270, ML2280, ML2290, ML2300, ML2310, ML2320, ML2330, ML2340, ML2350, ML2360, ML2370, ML2380, ML2390, ML2400, ML2410, ML2420, ML2430, ML2440, ML2450, ML2460, ML2470, ML2480, ML2490, ML2500, ML2510, ML2520, ML2530, ML2540, ML2550, ML2560, ML2570, ML2580, ML2590, ML2600, ML2610, ML2620, ML2630, ML2640, ML2650, ML2660, ML2670, ML2680, ML2690, ML2700, ML2710, ML2720, ML2730, ML2740, ML2750, ML2760, ML2770, ML2780, ML2790, ML2800, ML2810, ML2820, ML2830, ML2840, ML2850, ML2860, ML2870, ML2880, ML2890, ML2900, ML2910, ML2920, ML2930, ML2940, ML2950, ML2960, ML2970, ML2980, ML2990, ML3000, ML3010, ML3020, ML3030, ML3040, ML3050, ML3060, ML3070, ML3080, ML3090, ML3100, ML3110, ML3120, ML3130, ML3140, ML3150, ML3160, ML3170, ML3180, ML3190, ML3200, ML3210, ML3220, ML3230, ML3240, ML3250, ML3260, ML3270, ML3280, ML3290, ML3300, ML3310, ML3320, ML3330, ML3340, ML3350, ML3360, ML3370, ML3380, ML3390, ML3400, ML3410, ML3420, ML3430, ML3440, ML3450, ML3460, ML3470, ML3480, ML3490, ML3500, ML3510, ML3520, ML3530, ML3540, ML3550, ML3560, ML3570, ML3580, ML3590, ML3600, ML3610, ML3620, ML3630, ML3640, ML3650, ML3660, ML3670, ML3680, ML3690, ML3700, ML3710, ML3720, ML3730, ML3740, ML3750, ML3760, ML3770, ML3780, ML3790, ML3800, ML3810, ML3820, ML3830, ML3840, ML3850, ML3860, ML3870, ML3880, ML3890, ML3900, ML3910, ML3920, ML3930, ML3940, ML3950, ML3960, ML3970, ML3980, ML3990, ML4000, ML4010, ML4020, ML4030, ML4040, ML4050, ML4060, ML4070, ML4080, ML4090, ML4100, ML4110, ML4120, ML4130, ML4140, ML4150, ML4160, ML4170, ML4180, ML4190, ML4200, ML4210, ML4220, ML4230, ML4240, ML4250, ML4260, ML4270, ML4280, ML4290, ML4300, ML4310, ML4320, ML4330, ML4340, ML4350, ML4360, ML4370, ML4380, ML4390, ML4400, ML4410, ML4420, ML4430, ML4440, ML4450, ML4460, ML4470, ML4480, ML4490, ML4500, ML4510, ML4520, ML4530, ML4540, ML4550, ML4560, ML4570, ML4580, ML4590, ML4600, ML4610, ML4620, ML4630, ML4640, ML4650, ML4660, ML4670, ML4680, ML4690, ML4700, ML4710, ML4720, ML4730, ML4740, ML4750, ML4760, ML4770, ML4780, ML4790, ML4800, ML4810, ML4820, ML4830, ML4840, ML4850, ML4860, ML4870, ML4880, ML4890, ML4900, ML4910, ML4920, ML4930, ML4940, ML4950, ML4960, ML4970, ML4980, ML4990, ML5000, ML5010, ML5020, ML5030, ML5040, ML5050, ML5060, ML5070, ML5080, ML5090, ML5100, ML5110, ML5120, ML5130, ML5140, ML5150, ML5160, ML5170, ML5180, ML5190, ML5200, ML5210, ML5220, ML5230, ML5240, ML5250, ML5260, ML5270, ML5280, ML5290, ML5300, ML5310, ML5320, ML5330, ML5340, ML5350, ML5360, ML5370, ML5380, ML5390, ML5400, ML5410, ML5420, ML5430, ML5440, ML5450, ML5460, ML5470, ML5480, ML5490, ML5500, ML5510, ML5520, ML5530, ML5540, ML5550, ML5560, ML5570, ML5580, ML5590, ML5600, ML5610, ML5620, ML5630, ML5640, ML5650, ML5660, ML5670, ML5680, ML5690, ML5700, ML5710, ML5720, ML5730, ML5740, ML5750, ML5760, ML5770, ML5780, ML5790, ML5800, ML5810, ML5820, ML5830, ML5840, ML5850, ML5860, ML5870, ML5880, ML5890, ML5900, ML5910, ML5920, ML5930, ML5940, ML5950, ML5960, ML5970, ML5980, ML5990, ML6000, ML6010, ML6020, ML6030, ML6040, ML6050, ML6060, ML6070, ML6080, ML6090, ML6100, ML6110, ML6120, ML6130, ML6140, ML6150, ML6160, ML6170, ML6180, ML6190, ML6200, ML6210, ML6220, ML6230, ML6240, ML6250, ML6260, ML6270, ML6280, ML6290, ML6300, ML6310, ML6320, ML6330, ML6340, ML6350, ML6360, ML6370, ML6380, ML6390, ML6400, ML6410, ML6420, ML6430, ML6440, ML6450, ML6460, ML6470, ML6480, ML6490, ML6500, ML6510, ML6520, ML6530, ML6540, ML6550, ML6560, ML6570, ML6580, ML6590, ML6600, ML6610, ML6620, ML6630, ML6640, ML6650, ML6660, ML6670, ML6680, ML6690, ML6700, ML6710, ML6720, ML6730, ML6740, ML6750, ML6760, ML6770, ML6780, ML6790, ML6800, ML6810, ML6820, ML6830, ML6840, ML6850, ML6860, ML6870, ML6880, ML6890, ML6900, ML6910, ML6920, ML6930, ML6940, ML6950, ML6960, ML6970, ML6980, ML6990, ML7000, ML7010, ML7020, ML7030, ML7040, ML7050, ML7060, ML7070, ML7080, ML7090, ML7100, ML7110, ML7120, ML7130, ML7140, ML7150, ML7160, ML7170, ML7180, ML7190, ML7200, ML7210, ML7220, ML7230, ML7240, ML7250, ML7260, ML7270, ML7280, ML7290, ML7300, ML7310, ML7320, ML7330, ML7340, ML7350, ML7360, ML7370, ML7380, ML7390, ML7400, ML7410, ML7420, ML7430, ML7440, ML7450, ML7460, ML7470, ML7480, ML7490, ML7500, ML7510, ML7520, ML7530, ML7540, ML7550, ML7560, ML7570, ML7580, ML7590, ML7600, ML7610, ML7620, ML7630, ML7640, ML7650, ML7660, ML7670, ML7680, ML7690, ML7700, ML7710, ML7720, ML7730, ML7740, ML7750, ML7760, ML7770, ML7780, ML7790, ML7800, ML7810, ML7820, ML7830, ML7840, ML7850, ML7860, ML7870, ML7880, ML7890, ML7900, ML7910, ML7920, ML7930, ML7940, ML7950, ML7960, ML7970, ML7980, ML7990, ML8000, ML8010, ML8020, ML8030, ML8040, ML8050, ML8060, ML8070, ML8080, ML8090, ML8100, ML8110, ML8120, ML8130, ML8140, ML8150, ML8160, ML8170, ML8180, ML8190, ML8200, ML8210, ML8220, ML8230, ML8240, ML8250, ML8260, ML8270, ML8280, ML8290, ML8300, ML8310, ML8320, ML8330, ML8340, ML8350, ML8360, ML8370, ML8380, ML8390, ML8400, ML8410, ML8420, ML8430, ML8440, ML8450, ML8460, ML8470, ML8480, ML8490, ML8500, ML8510, ML8520, ML8530, ML8540, ML8550, ML8560, ML8570, ML8580, ML8590, ML8600, ML8610, ML8620, ML8630, ML8640, ML8650, ML8660, ML8670, ML8680, ML8690, ML8700, ML8710, ML8720, ML8730, ML8740, ML8750, ML8760, ML8770, ML8780, ML8790, ML8800, ML8810, ML8820, ML8830, ML8840, ML8850, ML8860, ML8870, ML8880, ML8890, ML8900, ML8910, ML8920, ML8930, ML8940, ML8950, ML8960, ML8970, ML8980, ML8990, ML9000, ML9010, ML9020, ML9030, ML9040, ML9050, ML9060, ML9070, ML9080, ML9090, ML9100, ML9110, ML9120, ML9130, ML9140, ML9150, ML9160, ML9170, ML9180, ML9190, ML9200, ML9210, ML9220, ML9230, ML9240, ML9250, ML9260, ML9270, ML9280, ML9290, ML9300, ML9310, ML9320, ML9330, ML9340, ML9350, ML9360, ML9370, ML9380, ML9390, ML9400, ML9410, ML9420, ML9430, ML9440, ML9450, ML9460, ML9470, ML9480, ML9490, ML9500, ML9510, ML9520, ML9530, ML9540, ML9550, ML9560, ML9570, ML9580, ML9590, ML9600, ML9610, ML9620, ML9630, ML9640, ML9650, ML9660, ML9670, ML9680, ML9690, ML9700, ML9710, ML9720, ML9730, ML9740, ML9750, ML9760, ML9770, ML9780, ML9790, ML9800, ML9810, ML9820, ML9830, ML9840, ML9850, ML9860, ML9870, ML9880, ML9890, ML9900, ML9910, ML9920, ML9930, ML9940, ML9950, ML9960, ML9970, ML9980, ML9990, ML10000, ML10001, ML10002, ML10003, ML10004, ML10005, ML10006, ML10007, ML10008, ML10009, ML10010, ML10011, ML10012, ML10013, ML10014, ML10015, ML10016, ML10017, ML10018, ML10019, ML10020, ML10021, ML10022, ML10023, ML10024, ML10025, ML10026, ML10027, ML10028, ML10029, ML10030, ML10031, ML10032, ML10033, ML10034, ML10035, ML10036, ML10037, ML10038, ML10039, ML10040, ML10041, ML10042, ML10043, ML10044, ML10045, ML10046, ML10047, ML10048, ML10049, ML10050, ML10051, ML10052, ML10053, ML10054, ML10055, ML10056, ML10057, ML10058, ML10059, ML10060, ML10061, ML10062, ML10063, ML10064, ML10065, ML10066, ML10067, ML10068, ML10069, ML10070, ML10071, ML10072, ML10073, ML10074, ML10075, ML10076, ML10077, ML10078, ML10079, ML10080, ML10081, ML10082, ML10083, ML10084, ML10085, ML10086, ML10087, ML10088, ML10089, ML10090, ML10091, ML10092, ML10093, ML10094, ML10095, ML10096, ML10097, ML10098, ML10099, ML10100, ML10101, ML10102, ML10103, ML10104, ML10105, ML10106, ML10107, ML10108, ML10109, ML10110, ML10111, ML10112, ML10113, ML10114, ML10115, ML10116, ML10117, ML10118, ML10119, ML10120, ML10121, ML10122, ML10123, ML10124, ML10125, ML10126, ML10127, ML10128, ML10129, ML10130, ML10131, ML10132, ML10133, ML10134, ML10135, ML10136, ML10137, ML10138, ML10139, ML10140, ML10141, ML10142, ML10143, ML10144, ML10145, ML10146, ML10147, ML10148, ML10149, ML10150, ML10151, ML10152, ML10153, ML10154, ML10155, ML10156, ML10157, ML10158, ML10159, ML10160, ML10161, ML10162, ML10163, ML10164, ML10165, ML10166, ML10167, ML10168, ML10169, ML10170, ML10171, ML10172, ML10173, ML10174, ML10175, ML10176, ML10177, ML10178, ML10179, ML10180, ML10181, ML10182, ML10183, ML10184, ML10185, ML10186, ML10187, ML10188, ML10189, ML10190, ML10191, ML10192, ML10193, ML10194, ML10195, ML10196, ML10197, ML10198, ML10199, ML10200, ML10201, ML10202, ML10203, ML10204, ML10205, ML10206, ML10207, ML10208, ML10209, ML10210, ML10211, ML10212, ML10213, ML10214, ML10215, ML10216, ML10217, ML10218, ML10219, ML10220, ML10221, ML10222, ML10223, ML10224, ML10225, ML10226, ML10227, ML10228, ML10229, ML10230, ML10231, ML10232, ML10233, ML10234, ML10235, ML10236, ML10237, ML10238, ML10239, ML10240, ML10241, ML10242, ML10243, ML10244, ML10245, ML10246, ML10247, ML10248, ML10249, ML10250, ML10251, ML10252, ML10253, ML10254, ML10255, ML10256, ML10257, ML10258, ML10259, ML10260, ML10261, ML10262, ML10263, ML10264, ML10265, ML10266, ML10267, ML10268, ML10269, ML10270, ML10271, ML10272, ML10273, ML10274, ML10275, ML10276, ML10277, ML10278, ML10279, ML10280, ML10281, ML10282, ML10283, ML10284, ML10285, ML10286, ML10287, ML10288, ML10289, ML10290, ML10291, ML10292, ML10293, ML10294, ML10295, ML10296, ML10297, ML10298, ML10299, ML10300, ML10301, ML10302, ML10303, ML10304, ML10305, ML10306, ML10307, ML10308, ML10309, ML10310, ML10311, ML10312, ML10313, ML10314, ML10315, ML10316, ML10317, ML10318, ML10319, ML10320, ML10321, ML10322, ML10323, ML10324, ML10325, ML10326, ML10327, ML10328, ML10329, ML10330, ML10331, ML10332, ML10333, ML10334, ML10335, ML10336, ML10337, ML10338, ML10339, ML10340, ML10341, ML10342, ML10343, ML10344, ML10345, ML10346, ML10347, ML10348, ML10349, ML10350, ML10351, ML10352, ML10353, ML10354, ML10355, ML10356, ML10357, ML10358, ML10359, ML10360, ML10361, ML10362, ML10363, ML10364, ML10365, ML10366, ML10367, ML10368, ML10369, ML10370, ML10371, ML10372, ML10373, ML10374, ML10375, ML10376, ML10377, ML10378, ML10379, ML10380, ML10381, ML10382, ML10383, ML10384, ML10385, ML10386, ML10387, ML10388, ML10389, ML10390, ML10391, ML10392, ML10393, ML10394, ML10395, ML10396, ML10397, ML10398, ML10399, ML10400, ML10401, ML10402, ML10403, ML10404, ML10405, ML10406, ML10407, ML10408, ML10409, ML10410, ML10411, ML10412, ML10413, ML10414, ML10415, ML10416, ML10417, ML10418, ML10419, ML10420, ML10421, ML10422, ML10423, ML10424, ML10425, ML10426, ML10427, ML10428, ML10429, ML10430, ML10431, ML10432, ML10433, ML10434, ML10435, ML10436, ML10437, ML10438, ML10439, ML10440, ML10441, ML10442, ML10443, ML10444, ML10445, ML10446, ML10447, ML10448, ML10449, ML10450, ML10451, ML10452, ML10453, ML10454, ML10455, ML10456, ML10457, ML10458, ML10459, ML10460, ML10461, ML10462, ML10463, ML10464, ML10465, ML10466, ML10467, ML10468, ML10469, ML10470, ML10471, ML10472, ML10473, ML10474, ML10475, ML10476, ML10477, ML10478, ML10479, ML10480, ML10481, ML10482, ML10483, ML10484, ML10485, ML10486, ML10487, ML10488, ML10489, ML10490, ML10491, ML10492, ML10493, ML10494, ML10495, ML10496, ML10497, ML10498, ML10499, ML10500, ML10501, ML10502, ML10503, ML10504, ML10505, ML10506, ML10507, ML10508, ML10509, ML10510, ML10511, ML10512, ML10513, ML10514, ML10515, ML10516, ML10517, ML10518, ML10519, ML10520, ML10521, ML10522, ML10523, ML10524, ML10525, ML10526, ML10527, ML10528, ML10529, ML10530, ML10531, ML10532, ML10533, ML10534, ML10535, ML10536, ML10537, ML10538, ML10539, ML10540, ML10541, ML10542, ML10543, ML10544, ML10545, ML10546, ML10547, ML10548, ML10549, ML10550, ML10551, ML10552, ML10553, ML10554, ML10555, ML10556, ML10557, ML10558, ML10559, ML10560, ML10561, ML10562, ML10563, ML10564, ML10565, ML10566, ML10567, ML10568, ML10569, ML10570, ML10571, ML10572, ML10573, ML10574, ML10575, ML10576, ML10577, ML10578, ML10579, ML10580, ML10581, ML10582, ML10583, ML10584, ML10585, ML10586, ML10587, ML10588, ML10589, ML10590, ML10591, ML10592, ML10593, ML10594, ML10595, ML10596, ML10597, ML10598, ML10599, ML10600, ML10601, ML10602, ML10603, ML10604, ML10605, ML10606, ML10607, ML10608, ML10609, ML10610, ML10611, ML10612, ML10613, ML10614, ML10615, ML10616, ML10617, ML10618, ML10619, ML10620, ML10621, ML10622, ML10623, ML10624, ML10625, ML10626, ML10627, ML10628, ML10629, ML10630, ML10631, ML10632, ML10633, ML10634, ML10635, ML10636, ML10637, ML10638, ML10639, ML10640, ML10641, ML10642, ML10643, ML10644, ML10645, ML10646, ML10647, ML10648, ML10649, ML10650, ML10651, ML10652, ML10653, ML10654, ML10655, ML10656, ML10657, ML10658, ML10659, ML10660, ML10661, ML10662, ML10663, ML10664, ML10665, ML10666, ML10667, ML10668, ML10669, ML10670, ML10671, ML10672, ML10673, ML10674, ML10675, ML10676, ML10677, ML10678, ML10679, ML10680, ML10681, ML10682, ML10683, ML10684, ML10685, ML10686, ML10687, ML10688, ML10689, ML10690, ML10691, ML10692, ML10693, ML10694, ML10695, ML10696, ML10697, ML10698, ML10699, ML10700, ML10701, ML10702, ML10703, ML10704, ML10705, ML10706, ML10707, ML10708, ML10709, ML10710, ML10711, ML10712, ML10713, ML10714, ML10715, ML10716, ML10717, ML10718, ML10719, ML10720, ML10721, ML10722, ML10723, ML10724, ML10725, ML10726, ML10727, ML10728, ML10729, ML10730, ML10731, ML10732, ML10733, ML10734, ML10735, ML10736, ML10737, ML10738, ML10739, ML10740, ML10741, ML10742, ML10743, ML10744, ML10745, ML10746, ML10747, ML10748, ML10749, ML10750, ML10751, ML10752, ML10753, ML10754, ML10755, ML10756, ML10757, ML10758, ML10759, ML10760, ML10761, ML10762, ML10763, ML10764, ML10765, ML10766, ML10767, ML





# FORTRON CORPORATION

3797 YALE WAY, FREMONT, CA 94538

INFORMATION & CALIF. RES. (415) 490-8171

FOR YOUR IBM PC, XT, AT OR COMPATIBLES  
- Dealer & OEM Are Invited -

ORDER TOLL FREE:  
[800] 821-9771



## POWER SUPPLIES

### For PC/AT



219.00

#FC 5192,  
200 WATTS (max.)

- +5W/18.8A, +12W/7.3A
- -5W/1A, -12W/1A
- 110/230 VAC Switchable
- Comes with 4 Drives Connector
- (U) Pending
- ONE YEAR WARRANTY
- Fully Tested in U.S.A.

#FC-130 40  
130 Watt power supply for  
PC/XT



139.00

- Fully Tested in U.S.A.
- Good for Faraday, DTC Megaboard, and other PC/XT compatibles
- Back side on-off switch
- Use cabinet FC 630
- 110/230 VAC convertible
- (U) Pending

140 W.(MAX)  
POWER SWITCHER  
#FC 135-40

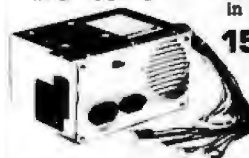

Fully Tested  
in U.S.A.

159.00

- Direct replacement to IBM PC power supply
- High air flow, low noise fan
- (U) Pending
- Outstanding quality, 1 yr. warranty

## KEYBOARD

#FC 527

- IBM® PC AT key layout
- Enlarge return & shift key
- Capacitance low profile key switch

PC/AT ..... 169.00

#FC 427

- IBM® PC/XT compatible
- Light on num. & caps lock keys

PCXT..... 109.00

#FC 630 A-T

## COMPUTER CHASSIS

#FC-630 A-2

#FC-630



159.00

- IBM® PC/AT identical dimension
- Heavy duty metal frame & front plastic panel
- Completed hardware and accessories
- Use our power supply FC-5192 and keyboard FC 527



99.00

- IBM® PC/XT identical dimension
- Righthand side on-off switch position
- Hardwares included
- 7 & 8 slot rear panels. Good for 0.75" or 1" apart slot connectors
- Use FC 135 40 power supply



99.00

- Rear side on-off switch position
- Good for Faraday, DTC megaboard and other compatibles
- 6 or 8 slot on rear panel
- Use FC-130-40 power supply

## IBM PC, XT ADD-ON CARDS

FC 230 Floppy  
Disk Controller

- Drives 4 x 5 1/4" FDD
- IBM fully compatible
- w/cable



69.00

DTC 5150 BX Hard  
Disk Controller

- Up to 2 Hard Disk Drives
- Fully Buffered I/O Bus
- Built-in ECC



219.00

FC 530  
Monochrome  
Controller  
w/Printer port

- 8 x 25 Screen
- 9 x 14 Character Box
- 7 x 9 Character
- TTL level of output

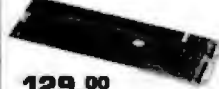

129.00

FC 940 RS232C/  
REAL TIME  
CLOCK

- To 9600 Baud
- Battery Back-up



89.00 69.00  
Clock Only

Monochrome/Graphic with  
Printer Port, CT-6040

- 80 x 25 Text mode
- 720 x 348 Graphic mode
- Can run Lotus 1-2-3
- 64K Graphic Display memory
- Monitor & printer interface



179.00

MORE. ....

- 384K Multifunction Card ..... 149.00
- RS232/Printer Card ..... 89.00
- Color Graphic Card with Printer Port ..... 159.00
- 512K Memory Exp. Card ..... 118.00 (QK)

## Get a Full Function PRINTER at 99.00

(Listed 199.00)

- Comes with:
- 25-36 pin cable adapter
  - 4 Batteries
  - 1 roll paper



- 11 1/4" x 4 1/4" x 1 1/4"
- 2.2 pounds weight

- Dot Matrix Thermal Printer
- 80 Standard Character/Line
- 40 cps (DC 6V) 50 cps (AC)
- Battery Back-up
- 55 db noise
- Centronic Type Parallel Interface

Limited Stock On Hand!

I.C.

- 64K RAM (150 ns) ..... 8.00/9 pcs.
- Piggy back 128K RAM for PC/AT ..... 53.00/9 pcs.
- 256K RAM (150 ns) .... 44.00/9 pcs.
- 8237A-S ..... 3.00/ea.
- 8284A ..... 1.00/ea.
- 2764 ..... 3.00/ea.

TERMS:

- Minimum handling & shipping \$6.00
- 1. Please call for actual charges.
- 2. CA Res. add 6.5% tax
- 3. A RMA NO. is required for return merchandise, unauthorized return goods will be refused.
- 4. Restocking charge 15%
- 5. Prices subject to change without notice
- 6. Not responsible for typos

## MONITOR

Monochrome

109.00

- 17", TTL Level
- 1000/800 Lines
- 2000 (Characters)

## CABLES

- Hard Disc Drive Cable (34 pin-34 pin) ..... 19.85
- Floppy Drive Cable ..... 11.85
- 9 Pin D Type to 25 Pin D Type for PCAT ..... 29.00
- Printer Cable 25 Pin D Type to Centronics ..... 19.00
- RS232 to RS232 Cable ..... 19.00
- AC Input/Output Power Cord ..... 3.00

## DRIVES

5 1/4" FLOPPY

Teac/Panasonic  
DS/DD  
95.00  
(Drive Only)

10 MEG

Teac. 1/2 Height  
519.00  
(w/Cable  
Controller)

20 MEG

Teac. 1/2 Height  
669.00  
(w/Cable  
Controller)

# \$91.00

## Single Board Computer



6800 MPU, serial I/O, parallel I/O, RAM, EPROM, 44-pin 4.5" x 6.5" PCB  
**EXPANSION MODULES:** RAM, EPROM, CMOS RAM/battery, analog I/O, serial I/O, parallel I/O, counter/timer, IEEE-488, EPROM programmer, floppy disks, cassette, breadboard, keyboard/display.

**WINTeK**  
 Wintek Corp.  
 1801 South Street  
 Lafayette, IN 47904  
 317-742-8428

Inquiry 340

## ROSE DATA SWITCHES



SHARE computers, printers, any parallel or serial device  
 ELIMINATE cable swapping  
 INEXPENSIVE way to network  
 COMPATIBLE with all computers

Businesses, Schools, Homes  
**WE ALSO OFFER:**  
 Data Buffers, Line Drivers, Modems, Protocol Converters, Parallel - Serial Converters, Cable, Computers, Printers, Disk Drives, and more

**AUTOMATIC - CARETAKER** is ideal for a business or school to share a printer or modem among many computers. Operation is fully automatic with no software required.  
 Parallel or Serial 4 channels - \$285 8 channels - \$385

**MANUAL - HARDSWITCH** is operated with the flip of a switch. 2:2 and 2:4 models allow simultaneous communication.  
 Serial 1:2 - \$50 1:4 - \$ 90 2:2 - \$100 2:4 - \$180  
 Parallel 1:2 - \$80 1:4 - \$150 2:2 - \$180 2:4 - \$270  
 LED and spike protection on serial models add \$20.

**CODE ACTIVATED - PORTER** connects one computer to multiple peripherals. A software code selects the peripheral.  
 Parallel or Serial 4 channels - \$295 8 channels - \$385  
 Buffer option B4K - \$100 256K - \$250

**REMOTE - TELEPATH** connects multiple computers to multiple peripherals. A selector at each computer or terminal chooses up to 4 peripherals and displays busy status.  
 4:4 - \$495 4:8 - \$795 selector \$39

*Give a Rose to your computer*

**ROSE ELECTRONICS (713) 240-7673**  
 P.O. BOX 742571 MC & VISA Accepted  
 HOUSTON, TX 77274 Dealer Inquiries Invited  
**CALL US FOR ALL YOUR INTERFACE NEEDS**

Inquiry 280

## FORTH ON THE STD-BUS

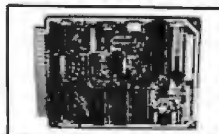

as  
 Low  
 as  
 \$179

The ForthCard provides the ability to develop Forth code using a single board, including on-card EEPROM programming. Operating as a stand alone computer or as an STD bus CPU, this card is perfect for projects that require a simple dedicated SBC, while allowing for memory and I/O expansion. Forth programs can be entered directly via CRT or downloaded from your PC's serial port, blown into optional non-volatile RAM or EEPROM, and auto-executed on power-up.

The evaluation unit is available for as little as \$299. OEM Versions of the card may be purchased for \$179 each (Qty 10). The ForthBox is a complete STD bus oriented system including the ForthCard, Disk Controller, Disk Drive(s), STD card cage, Cabinet and Power Supply.

**CALL TODAY FOR COMPLETE INFORMATION**

**Hifreeh Equipment Corporation**

9560 Block Mountain Road, San Diego, CA 92126

FOR IMMEDIATE ACTION CALL

**619-566-1892**

Inquiry 144

## DATA ACQUISITION TO GO INTERFACE FOR ANY COMPUTER



Connects via RS-232. Built-in BASIC. Stand alone capability. Expandable. Battery Option. Basic system: 16 ch. 12 bit A/D, 2 ch. D/A, 32 bit Digital I/O. Expansion boards available. Direct Bus units for many computers.

**SPECIALISTS IN PORTABLE APPLICATIONS**  
**(201) 299-1615**

P.O. Box 246, Morris Plains, NJ 07950

**ELEXOR**

Inquiry 111

## LOW COST UNIVERSAL B(K) FROM PROGRAMMER

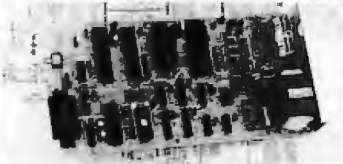

- SUPPORTS: (EPROMS) 2516 THRU 64, 2716 THRU 512, 27C16 THRU 120, 68732 THRU 66 (EPROMS) 52813 THRU 33, 28164 THRU 64A (MICROS) 8741 THRU 492
- NO PERSONALITY MODULES, ONBOARD POWER SUPPLY
- RS232C INTERFACE, NON-KOFP, RTS, CTS, DTR
- ACCEPTS KEYBOARD ENTRY WITH LINE EDITING
- ACCEPTS ASCII, INTEL, AND MOTOROLA FORMATS
- USER FRIENDLY MONITOR FOR I/O DEBUGGING
- FAST PROGRAMMING SUPPORTED: 2704 UNDER 3 MIN.
- LOW/HIGH BYTE PROGRAMMING FOR 16 BIT DATA PATH
- BYTE, BLOCK, OR CHIP ERASE (EPROMS ONLY)
- LIST IN INTEL OR MOTOROLA HEX FORMAT
- VERIFY PROGRAM AND VERIFY BLANK COMMANDS

- 1409-01: 4K FIRMWARE, PCB, XPROMER, DOC \$90.00
- 1409-02: 1409-01 + FULL SET OF PARTS \$200.00
- 1409-03: ASSEMBLED AND TESTED UNIT \$300.00
- 1409-11: 8K FIRMWARE, PCB, XPROMER, DOC \$125.00
- 1409-12: 1409-11 + FULL SET OF PARTS \$250.00
- 1409-13: ASSEMBLED AND TESTED UNIT \$350.00
- COMMUNICATION DRIVERS FOR MOST PC'S \$25.00

**BAC MICROSYSTEMS**  
 8322 NEJAVE DR., SAN JOSE, CA 95120  
 Tel. (408) 997-7686, TWX 4906363

Inquiry 280

## NEC PRINTERS

2050 ..... \$ 625  
 3550 ..... \$ 990  
 8850 ..... \$1400

2010/15/30 ..... \$ 625  
 3510/15/30 ..... \$ 990  
 8810/15/30 ..... \$1400

Elf 360 ..... \$ 399  
 Pinwriter P-2 ..... \$ 490  
 (w/Interface & Tractor)

Pinwriter P-3 ..... \$ 690  
 (w/Interface & Tractor)

**Terms: PREPAID - FREE FREIGHT!!**

**QUALITY PRINTERS**  
 8415 Cement City Rd.  
 Brooklyn, Michigan 49230  
 Phone: 517-592-3749

Inquiry 259

## Get the Proportional Printing Program which Really Works!

Get type-set quality true proportional spaced printing from unmodified WordStar and NewWord document files. PropStar prints on most daisy-wheel printers with pe type-wheels including Diablo, Gume, NEC, Brother, Juki, S-R, C.Itoh and many others.

PropStar is a stand-alone program, not a patch to your w.p. program, it maintains correct letter spacing, never crowds capitals (even on short lines), gives higher quality print than modified WordStar. PropStar supports most of the common WordStar and NewWord print enhancements. No installation patching required. For CP/M-80 systems on 8" and 5-1/8" media, also for MS-DOS systems on 5-1/4" PC media. Only \$ 49.95, Visa & M/C o.k. Specify computer and printer. Dealers wanted.

**CIVIL COMPUTING CORPORATION**

2111 Research Drive, Suite 1  
 Livermore, California 94550 (415) 455-8086

Inquiry 54

## PC/XT USERS!

- **COGTREE Utilities by**  
 Cogitate ..... \$129.95
- **LYNC by Norton-Lamber** ..... \$199.95
- **DATAFLEX by Data Access** ...Varies
- **RMICOBOL by Ryan**  
 McFarland .....Varies
- **Universe by Omnitrond** ..... \$ 95.00
- **Blue MacI by Cogitate** ..... \$599.00
- **CadPower + by Trillex** ..... \$995.00
- **Softext Teaching Aids** ..... \$ 95.00
- **PrintSet by Cogitate** ..... \$ 79.95
- **CogITAPE by Cogitate** .....CALL!!
- **Anti-Static Products** .....Varies
- **Uninterruptible Power Backups** .....Varies
- **TeleVideo Software** .....CALL!!

**COGITATE**

"A Higher Form of Software"  
 24000 Telegraph Road  
 Southfield, MI 48034  
 (313) 352-2345/Telex 386581

VISA/MASTERCARD ACCEPTED  
 Dealer Inquiries Welcomed

Inquiry 57

## Queo™ 68000 Software Development Tools

### 88000/88010 Assembler Package

Assembler, linker, object librarian and extensive indexed typeset manuals.

Conforms to Motorola structured assembler, publication M68KMASM(4). Macros, cross reference and superb load map, 31 character symbols.

Optimized for CP/M-80, 86, 88K, MS-DOS, PC-DOS . . \$ 565  
 Portable Source written in "C" ..... \$1495

### Complete 88000 Development Package for MS-DOS

Lattice 88000 "C" Compiler and Queo 68000 Assembler Package ..... \$1095

### 68200 Assembler Package

Assembler and linker for Mostek MK68200.

Optimized for CP/M-80, MS-DOS, PC-DOS ..... \$ 95

For more information contact **Queo Inc.**  
 2484 33rd W. Suite #173  
 Sea116, WA 98199  
 Patrick Adams Phone (206) 265-2528  
 COD, Visa, MasterCard telex II (TWX) 8103338171  
 CP/M, TM DRI MS-DOS TM Microsoft, PC-DOS TM IBM.

Inquiry 271

# DoKay

COMPUTER  
PRODUCTS,  
Inc.

ORDER TOLL FREE

(800)  
538-8800

(CALIFORNIA RESIDENTS)

(800)  
848-8008



## STATIC RAMS

256 x 4	450ns	1.90
1K x 1	450ns	.70
1K x 1	450ns	.80
2K x 1	250ns	1.20
2K x 4	450ns	2.20
2K x 4	450ns	.90
4K x 4	450ns	.90
16 x 25	1K x 4	2.10
16 x 4	450ns	1.20
16 x 4	300ns	1.30
16 x 2	200ns	1.40
4K x 1	450ns	3.90
256 x 4	450ns	2.95
4K x 1	450ns	2.95
4K x 1	300ns	3.45
4K x 1	200ns	3.95
4K x 1	250ns	3.95
2K x 2	200ns	2.40
2K x 2	150ns	2.90
2K x 2	100ns	4.40
2K x 2	200ns	2.40
2K x 2	150ns	2.90
2K x 2	120ns	3.40
2K x 2	120ns	3.40
4K x 2	300ns	28.80
8K x 2	150ns	CMOS 7.85
8K x 2	150ns	CMOS 8.95
8K x 2	120ns	CMOS 10.95

## DYNAMIC RAMS

4K x 1	250ns	1.45
4K x 1	300ns	1.95
4K x 1	300ns	1.95
4K x 1	200ns	.49
4K x 1	250ns	.49
16K x 1	200ns	.79
16K x 1	150ns	.99
16K x 1	120ns	1.49
16K x 1	150ns	1.99
64K x 1	250ns	6v 1.50
64K x 1	200ns	6v 1.75
64K x 1	150ns	6v 2.00
256 x 1	200ns	7.95
256 x 1	150ns	8.95

## EPROMS

256 x 8	1 us	3.95
1K x 8	450ns	2.40
1K x 8	450ns	6.80
2K x 8	450ns	3v 2.95
2K x 8	350ns	3v 3.95
2K x 8	450ns	6v 3.95
4K x 8	450ns	6v 6.95
4K x 8	450ns	6v 3.95
4K x 8	450ns	21v 3.95
4K x 8	450ns	21v 2.95
4K x 8	250ns	21v 6.95
4K x 8	200ns	21v 8.95
8K x 8	450ns	6v 4.25
8K x 8	250ns	6v 4.95
8K x 1	200ns	6v 7.95
8K x 8	450ns	6v 9.95
8K x 8	450ns	17.95
8K x 8	350ns	10.95
16K x 8	250ns	6v 8.95
128 x 20	70K x 8	9.95
128 x 25	16K x 8	10.95
128 x 25	32K x 8	24.95

## 74LS00

74LS00	.23	74LS126	.48	74LS260	.58
74LS01	.24	74LS126	.48	74LS260	.54
74LS02	.24	74LS132	.58	74LS273	1.45
74LS03	.24	74LS133	.58	74LS275	3.30
74LS04	.23	74LS138	.38	74LS279	.40
74LS06	.24	74LS137	.58	74LS280	1.95
74LS08	.27	74LS139	.54	74LS283	.88
74LS09	.29	74LS138	.54	74LS290	.88
74LS10	.24	74LS145	1.16	74LS295	.88
74LS11	.34	74LS147	2.45	74LS299	.88
74LS12	.34	74LS148	1.30	74LS300	.88
74LS13	.44	74LS151	.54	74LS309	1.70
74LS14	.58	74LS153	.54	74LS323	3.45
74LS15	.34	74LS154	1.85	74LS324	1.70
74LS20	.24	74LS156	.88	74LS324	1.25
74LS21	.28	74LS158	.88	74LS353	1.25
74LS22	.24	74LS157	.54	74LS383	1.30
74LS23	.28	74LS158	.58	74LS384	1.90
74LS27	.29	74LS180	.88	74LS385	.45
74LS28	.34	74LS181	.54	74LS388	.44
74LS30	.24	74LS182	.58	74LS387	.44
74LS32	.29	74LS183	.54	74LS388	.44
74LS33	.54	74LS184	.58	74LS373	1.25
74LS37	.34	74LS186	.54	74LS374	1.35
74LS38	.34	74LS186	.58	74LS377	1.35
74LS46	.24	74LS188	1.70	74LS378	1.13
74LS47	.49	74LS188	1.70	74LS378	1.30
74LS47	.74	74LS170	1.45	74LS385	1.95
74LS48	.74	74LS173	.58	74LS388	.44
74LS49	.74	74LS174	.54	74LS390	1.10
74LS51	.24	74LS176	.54	74LS393	1.10
74LS54	.29	74LS181	2.10	74LS395	1.15
74LS56	.29	74LS188	0.90	74LS399	1.45
74LS58	1.20	74LS190	.88	74LS424	2.90
74LS73	.38	74LS191	.88	74LS447	.38
74LS74	.34	74LS192	.78	74LS490	1.90
74LS75	.38	74LS193	.78	74LS924	3.95
74LS76	.38	74LS194	.58	74LS940	2.15
74LS78	.48	74LS195	.58	74LS945	2.15
74LS83	.58	74LS196	.78	74LS980	1.65
74LS85	.88	74LS197	.78	74LS980	1.85
74LS86	.38	74LS221	.88	74LS970	1.45
74LS89	.54	74LS240	.94	74LS974	9.80
74LS91	.88	74LS241	.98	74LS982	3.15
74LS92	.54	74LS242	.98	74LS983	3.15
74LS93	.54	74LS243	.98	74LS984	3.15
74LS95	.88	74LS244	1.25	74LS985	3.15
74LS96	.88	74LS245	1.45	74LS988	2.35
74LS107	.38	74LS247	.74	74LS989	3.15
74LS109	.38	74LS248	.88	74LS753	23.95
74LS112	.38	74LS249	.88	81LS95	1.45
74LS113	.38	74LS251	.58	81LS96	1.45
74LS114	.38	74LS253	.58	81LS97	1.45
74LS122	.44	74LS257	.58	81LS98	1.45
74LS123	.78	74LS258	.58	26LS2821	2.75
74LS124	2.85	74LS290	2.70	26LS2888	4.20

We will try to BEAT  
All Competitor's Prices  
CALL for Quote!

## DISC CONTROLLERS

1801	.....	8.90	2795	.....	38.90
1771	.....	14.90	2797	.....	38.90
1701	.....	22.90	8843	.....	38.90
1793	.....	22.90	8272	.....	18.90
1795	.....	22.90	M88070	.....	22.90
1797	.....	22.90	M88077	.....	22.90
2143	.....	8.90	M88077	.....	22.90
2701	.....	38.90	MC3170	.....	4.90
2703	.....	38.90	0P705	.....	18.90

## CRT CONTROLLERS

8845	.....	11.90	CRT6027	.....	18.90
8847	.....	10.90	CRT6037	.....	28.90
8847	.....	23.90	DP8350	.....	38.90
8845	.....	18.90	HC4806	.....	11.90
7220	.....	38.90	MC1372	.....	8.90
8275	.....	28.90	T88091A	.....	38.90

## UV ERASERS

QUV-T8/1 \$49.95  
ECONOMY Model

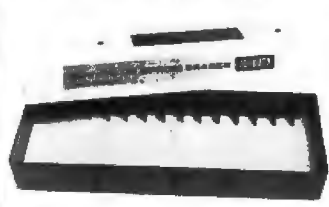

- Erases 15 EPROMS in 20 minutes
- Plastic Enclosure

## 6500

5502	.....	4.90	6502A	.....	5.90
5504	.....	8.90	6520A	.....	5.90
5505	.....	9.90	6522A	.....	9.90
5507	.....	9.90	6522A	.....	10.90
5520	.....	4.90	6545A	.....	12.90
5522	.....	4.90	6557A	.....	10.90
5532	.....	8.90			
5545	.....	9.90			
5551	.....	8.90			

## 6500 A

6000	.....	2.90	68000	.....	24.80
6002	.....	7.90	68001	.....	9.90
6003	.....	17.90	68002	.....	11.90
6004	.....	12.90	68003	.....	11.90
6005	.....	8.90	68004	.....	11.90
6006	.....	8.90	68005	.....	11.90
6010	.....	2.90	68010	.....	5.90
6020	.....	4.90	68021	.....	5.90
6021	.....	2.90	68040	.....	10.90
6028	.....	13.90	68045	.....	18.90
6040	.....	11.90	68050	.....	5.90
6043	.....	32.90			
6044	.....	24.90			
6045	.....	11.90			
6047	.....	18.90			
6050	.....	2.90			
6052	.....	5.90			
6054	.....	7.90			
6055	.....	18.90			
6056	.....	1.90			
6059	.....	21.90			

## 1 MHz

6000	.....	2.90	68000	.....	24.80
6002	.....	7.90	68001	.....	9.90
6003	.....	17.90	68002	.....	11.90
6004	.....	12.90	68003	.....	11.90
6005	.....	8.90	68004	.....	11.90
6006	.....	8.90	68005	.....	11.90
6010	.....	2.90	68010	.....	5.90
6020	.....	4.90	68021	.....	5.90
6021	.....	2.90	68040	.....	10.90
6028	.....	13.90	68045	.....	18.90
6040	.....	11.90	68050	.....	5.90
6043	.....	32.90			
6044	.....	24.90			
6045	.....	11.90			
6047	.....	18.90			
6050	.....	2.90			
6052	.....	5.90			
6054	.....	7.90			
6055	.....	18.90			
6056	.....	1.90			
6059	.....	21.90			

## 6800

6000	.....	2.90	68000	.....	24.80
6002	.....	7.90	68001	.....	9.90
6003	.....	17.90	68002	.....	11.90
6004	.....	12.90	68003	.....	11.90
6005	.....	8.90	68004	.....	11.90
6006	.....	8.90	68005	.....	11.90
6010	.....	2.90	68010	.....	5.90
6020	.....	4.90	68021	.....	5.90
6021	.....	2.90	68040	.....	10.90
6028	.....	13.90	68045	.....	18.90
6040	.....	11.90	68050	.....	5.90
6043	.....	32.90			
6044	.....	24.90			
6045	.....	11.90			
6047	.....	18.90			
6050	.....	2.90			
6052	.....	5.90			
6054	.....	7.90			
6055	.....	18.90			
6056	.....	1.90			
6059	.....	21.90			

## 8000

8031	.....	14.90	8253	.....	8.90
8035	.....	5.90	8253-5	.....	7.90
8036	.....	5.90	8256	.....	4.45
188-8080	.....	18.90	8256-5	.....	4.80
188-8073	.....	20.80	8257	.....	7.85
8080A	.....	3.80	8257-5	.....	8.80
8085	.....	4.80	8258	.....	5.80
8085A-2	.....	11.80	8258-5	.....	8.80
8090	.....	24.90	8271	.....	88.90
8097-3 (8 MHz)	.....	124.85	8272	.....	18.90
8097-2 (8 MHz)	.....	100.85	8274	.....	28.90
8098	.....	19.90	8275	.....	28.90
8099	.....	59.90	8279	.....	8.90
			8279-5	.....	7.90
			8282	.....	8.45
			8283	.....	8.45
			8284	.....	8.45
			8285	.....	8.45
			8286	.....	8.



# 100% GUARANTEED ICs - MONEY BACK!

## 1-800-245-2235

### SPECIAL 64K DRAM .45

FULLY FUNCTIONAL  
WITH SLIGHTLY  
SHORTER LEADS  
200ns or FASTER

That's right! . . . 100% money-back guaranteed ICs at prices never before possible! Krueger Technology's unique patented IC removal process is the key to our ability to sell so low. The fact is, it costs less to retrieve and refurbish an IC from an obsolete PC board than manufacture a new one. Since we maintain an inventory in excess of six million ICs and process over 100,000 ICs per day (over thirty million in the past ten years) we can supply you with most, if not all of your IC needs.

Until this year our vast inventory of ICs was available to only manufacturers and distributors. The phenomenal growth of the catalog market has allowed us to open our inventory to you. You can now buy direct and cut out all middlemen.

Call today and discover what seven of the ten largest computer manufacturers already know . . . 'The Krueger Alternative'. Don't forget, you get an additional 30% discount on orders over \$500!

### SPECIALS

2114-300ns	.50
FDC1793	5.00
74LS322	.50
6116-120ns	1.75
8080A	.75
Z80ASIO/0	3.75

#### MICROPROCESSORS

2901	3.00	8039	2.00
2903	5.00	8080A	.75
68000-8	18.00	8085	2.00
68008-8	18.00	8086	4.00
Z8001	7.50	8086-2	5.00
80186-3	15.00	8088	7.50
8031	5.00	8X300	6.00
8035	2.00	8741A	10.00

#### ADC/DAC

ADC08XX	3.50
DAC08XX	1.50
DAC80	8.00

#### CONTROLLERS/UARTS

1691	5.25	2661	4.00
1771	6.50	5027	3.00
1791	10.00	5037	5.00
1793	5.00	7201	4.50
1795	10.00	765	4.00
1797	10.00	COM8116	5.00
2651	4.00	3250	4.00

#### SOUND CHIPS

76477	2.00
AY3-8910	2.00
AY3-8912	2.00

#### 82XX PERIPHERALS

8202	14.00	8259	2.00
8212	1.00	8272	4.00
8216	1.00	8273	10.00
8224	3.00	8274	9.00
8228	3.00	8275	9.00
8237	3.00	8276	15.00
8238	2.90	8279	3.50
8243	1.50	8281	7.50
8251	2.00	8283	5.50
8253	2.00	8284	2.00
8254	4.00	8288	4.00
8255	2.00	8291	20.00
8257	2.00	8292	21.00

#### TMS 9900 SERIES

9901	1.50
9918	20.00
9927	5.00
9980	10.00
ALL OTHER 99XX SERIES	3.00

#### DYNAMIC RAMS

4164-120ns	1.75
4164-150ns	.95
4164-200ns	.85
4164-250ns	.65
4416-150ns	1.50
4116-150ns	.75
4116-200ns	.35
4116-250ns	.25

#### STATIC RAMS

6264-150ns	6.00
6116-150ns	1.25
6116-200ns	.90
6116-250ns	.65
1420-55ns	2.00
2147, 2148, 2149	2.00
2114-300ns	.50
2114-FASTER	.80

## 1-800-245-2235

#### EPROMS

27128-250ns	5.00
27128-350ns	4.00
27128-450ns	3.00
2764, 2732, 2716	
250ns	3.50
300ns	3.00
350ns	2.75
450ns	2.25
650ns	1.75

1702	1.50
2708	2.00
68766	6.00
68708	4.00

CMOS version at double the above prices

25 Series EPROMS are the same price as 27 Series EPROMS

#### ECL

ANY 10K LOGIC	1.00
ANY ECL RAM	3.00
ANY 100K LOGIC	5.00

#### Z80 SERIES

2.5 MHZ	
CPU, CTC, PIO	1.00
DMA, DART, SIO	3.00
4.0 MHZ (A)	
CPU, CTC, PIO	2.00
DMA, DART, SIO	4.50
6.0 MHZ (B)	
CPU, CTC, PIO	3.00
DMA, DART, SIO	9.00

#### MISCELLANEOUS

0026	1.50
1488	.50
1489	.50
3232	1.00
3242	4.00
3470	1.50
3486	1.00
3487	1.50
CA3XXX	1.00
MC4024	2.00
MC4044	2.00
555	.35
75XXX	.50
8131	2.25
8136	4.00
8303	3.00
8304	1.75
88XX	.50
8TXX	.50
9602	.75
96LS02	1.50

#### 74 SERIES

74XX	.25	74SXX	.35
741XX	.35	74S1XX	.45
742XX	.50	74S2XX	.60
743XX	.50	74S3XX	.60
74LSXX	.25	74ALSXX	.35
74LS1XX	.35	74ALS1XX	.45
74LS2XX	.50	74ALS2XX	.60
74LS3XX	.50	74ALS3XX	.60

74FX	.35
74F1XX	.45
74F2XX	.60
74F3XX	.60

#### CMOS

ANY 4000 SERIES	.25
ANY 4500 SERIES	.50

#### 6500/6800 SERIES

ANY 65XX	2.00
ANY 65XXA	2.50
ANY 65XXB	3.00
ANY 68XX	2.00
ANY 68AXX	2.50
ANY 68BXX	3.00
6810	.75

#### OUR POLICY

Delivery: Orders normally shipped within 2 business days. Add \$3 for UPS ground-5# & under. Add \$4 for UPS blue (air), 2# & under; for each additional air pound add \$1. Arizona residents add 6% sales tax.

Payment: Visa, MC, cashiers check, certified check, money order, personal check accepted. (Allow 10 days for personal checks to clear.) No surcharge on credit card orders. CODs welcome with cash, certified check, cashiers check or money order. Add \$3 COD handling charge.

Pricing: Prices subject to change without notice. All items limited to stock on hand. We reserve the right to limit quantities.

# KRUEGER Technology, Inc.

2219 South 48th Street • Tempe, AZ 85282

## 800-245-2235

In Arizona 602-438-1570

HOURS: 7a.m. - 5:30p.m.  
(MOUNTAIN TIME)  
Monday Thru Friday



Incredible value!

# Nashua™ Diskettes

LIFETIME WARRANTY!

97¢ ea. 5 1/4" SSDD Qty. 50 \$107 ea. 5 1/4" DSDD Qty. 50

These are poly-bagged diskettes packaged with Tyvek sleeves, reinforced hubs, user identification labels and write-protect tabs. NASHUA Corporation is a half-billion dollar corporation and a recognized leader in magnetic media.

SOFT SECTOR ONLY! Sold in multiples of 50 only!

FOR ORDERS ONLY: 1-800-621-6827 (In Illinois 1-312-256-7140) INFORMATION & INQUIRIES: 1-312-256-7140 HOURS: 8AM-5PM Central Time, Monday-Friday WE WILL BEAT ANY NATIONALLY ADVERTISED PRICE ON THE SAME PRODUCTS AND QUANTITIES!

DISK WORLD!, Inc. 629 Green Bay Road • Wilmette, Illinois 60091

DISK WORLD!

Authorized Distributor NASHUA MAGNETIC MEDIA

FANTASTIC LOW PRICES ON

# BASF

## QUALIMETRIC DISKETTES!

LIFETIME WARRANTY!

\$114 ea. 5 1/4" SSDD Qty. 20 \$131 ea. 5 1/4" DSDD Qty. 20

5 1/4" SSDD-96TPI — \$1.46 ea. 5 1/4" DSDD-96TPI — \$1.75 ea.

PACKED IN CARDBOARD CASES!

BASF QUALIMETRIC DISKETTES have a LIFETIME WARRANTY with Tyvek sleeves, reinforced hubs, user identification labels and write-protect tabs.

SOFT SECTOR ONLY! MINIMUM ORDER 20 DISKETTES

BASF 3 1/2" MICRO-FLOPPIES BASF 5 1/4" HIGH DENSITY FOR IBM PC-AT

SSDD-135 TPI — \$2.34 ea. DSDD-HD — \$3.14 ea.

FOR ORDERS ONLY: 1-800-621-6827 (In Illinois 1-312-256-7140) INFORMATION & INQUIRIES: 1-312-256-7140 HOURS: 8AM-5PM Central Time, Monday-Friday

WE WILL BEAT ANY NATIONALLY ADVERTISED PRICE ON THE SAME PRODUCTS AND QUANTITIES!

DISK WORLD!

Authorized Reseller Information Processing BASF Media

## ATHANA DISKETTES

The great unknown!

97¢ ea. 5 1/4" SSDD Qty. 50 \$101 ea. 5 1/4" DSDD Qty. 50

You've used these diskettes hundreds of times...as copy-protected originals on some of the most popular software packages. They're packed in poly-bags of 25 with Tyvek sleeves, reinforced hubs, user identification labels and write-protect tabs.

LIFETIME WARRANTY!

SOFT SECTOR ONLY! Sold in multiples of 50 only.

FOR ORDERS ONLY: 1-800-621-6827 (In Illinois 1-312-256-7140) INFORMATION & INQUIRIES: 1-312-256-7140 HOURS: 8AM-5PM Central Time, Monday-Friday WE WILL BEAT ANY NATIONALLY ADVERTISED PRICE ON THE SAME PRODUCTS AND QUANTITIES!

DISK WORLD!, Inc. 629 Green Bay Road • Wilmette, Illinois 60091

DISK WORLD!

Authorized Distributor ATHANA MAGNETIC MEDIA

## DISK WORLD!

### Ordering & Shipping Instructions

Shipping: 5 1/4" & 3 1/2" DISKETTES—Add \$3.00 per each 100 or fewer diskettes. Other Items: Add shipping charges as shown in addition to other shipping charges. Payment: VISA and MASTER-CARD accepted. COD Orders: Add additional \$3.00 Special Handling charge. APO, FPO, AK, HI & PR Orders: Include shipping charges as shown and additional 5% of total order amount to cover PAL and insurance. Taxes: Illinois residents only, add 7% sales tax.

Prices subject to change without notice

This ad supercedes all other ads

Not responsible for typographical errors

MINIMUM TOTAL ORDER: \$35.00

FOR ORDERS ONLY: 1-800-621-6827 (In Illinois 1-312-256-7140) INFORMATION & INQUIRIES: 1-312-256-7140

HOURS: 8AM-5PM Central Time Monday-Friday

WE WILL BEAT ANY NATIONALLY ADVERTISED PRICE ON THE SAME PRODUCTS AND QUANTITIES!

DISK WORLD!, Inc. 629 Green Bay Road • Wilmette, Illinois 60091

DISK WORLD!

## DISKETTE STORAGE CASES

### AMARAY MEDIA-MATE 50: A REVOLUTION IN DISKETTE STORAGE

Every once in a while, someone takes the simple and makes it elegant! This unit holds 50 5 1/4" diskettes, has grooves for easy stacking, inside nubbles to keep diskettes from slipping and several other features. We like it!

\$9.69 ea. + \$2.00 Shpg.

### DISKETTE 70 STORAGE: STILL A GREAT BUY.

Dust-free storage for 70 5 1/4" diskettes. Six dividers included. An excellent value.

\$11.68 ea. + \$3.00 Shpg.

### DISK CADDIES \$1.65 ea.

The original flip-up holder for 10 5 1/4" diskettes. Beige or grey only. + 20¢ Shpg.

FOR ORDERS ONLY: 1-800-621-6827 (In Illinois 1-312-256-7140) INFORMATION & INQUIRIES: 1-312-256-7140

HOURS: 8AM-5PM Central Time, Monday-Friday

WE WILL BEAT ANY NATIONALLY ADVERTISED PRICE ON THE SAME PRODUCTS AND QUANTITIES!

DISK WORLD!, Inc. 629 Green Bay Road • Wilmette, Illinois 60091

DISK WORLD!

The value leader in Computer supplies And accessories.

## PRINTER RIBBONS:

### at extraordinary prices!

Brand new ribbons, manufactured to Original Equipment Manufacturer's specifications, in housings. (Not re-inked or spools only.)

LIFETIME WARRANTY!

Epson MX-70/80 .. \$3.58 ea. + 25¢ Shpg.  
Epson MX-100 ... \$4.95 ea. + 25¢ Shpg.  
Okidata Micro83 .. \$1.48 ea. + 25¢ Shpg.  
Okidata Micro84 .. \$3.66 ea. + 25¢ Shpg.

FOR ORDERS ONLY: 1-800-621-6827 (In Illinois 1-312-256-7140) INFORMATION & INQUIRIES: 1-312-256-7140

HOURS: 8AM-5PM Central Time, Monday-Friday

WE WILL BEAT ANY NATIONALLY ADVERTISED PRICE ON THE SAME PRODUCTS AND QUANTITIES!

DISK WORLD!, Inc. 629 Green Bay Road • Wilmette, Illinois 60091

DISK WORLD!



Now, the lowest prices ever on

## 3M Scotch® DISKETTES

LIFETIME WARRANTY!

### The best deal on 3M diskettes you've ever seen!

# FREE!

FLIP N' FILE 15 with every order for 5.25" SSDD and DSDD.



\$1.42 ea. — 5.25" SSDD with FREE Flip n' File 15  
5.25" DSDD with FREE Flip n' File 15 — \$1.74 ea.

### 100% LIFETIME WARRANTY

This is a Super Special promotion. It was supposed to end around the end of May.

But we decided to buy more than 1,000,000 3M diskettes packed in the FREE Flip n' File 15's...and give you the benefits of this terrific value.

One word of warning: this offer is limited only to supplies on hand. Once these supplies are used up, the prices stay the same...but there's no free Flip n' File.

The last time we ran an offer like this, everything was sold out in about six weeks.

So don't wait. Order now.

### Other 3M diskettes:

(Flip n' File offer does not apply.)

5.25" SSDD-96TPI ..... \$2.06 ea.

5.25" DSDD-96TPI ..... \$2.57 ea.

5.25" DSDD-HD for

IBM PC/AT ..... \$3.93 ea.

3.50" SSDD-135TPI for

Apple Mac ..... \$2.86 ea.

### DATA CARTRIDGES

100% certified 3M data cartridges.

DC-1000 ..... \$13.90 ea.

DC-300XLP ..... \$19.83 ea.

DC-600A ..... \$22.13 ea.

Sold in cases of 10 only.  
Add \$5.00 shipping per 10.

DISK WORLD!

Authorized Distributor Information Processing Products



## Computer Systems

Please call w/ your System Requirements so that we may quote the configuration that best fits your needs.

**CROMEMCO 10MHz 68000 UNIX-5 Systems**  
CS-100H50X20E 2Mb ECC RAM 50Mb H.D. \$13,849  
INTERCONTINENTAL MICRO SYSTEMS 12 User HI-Speed 16 Bit System. Includes 1Mb Automatic Cache Buffer, Dual 8" Floppies, 25Mb Fixed and 25Mb Removable Hard Disk (Complete Back-Up in 5-Min.) 256K Ram Per User, Turbosos 1.41, NewWord Word Processor, w/ Spell Check & Merge Print \$750/Mo.  
MORROW MD3, MDT70 & HR15-XL Printer \$1,595  
MORROW MD11, MDT70 & HR15-XL Printer \$2,295  
MORROW PIVOT I & II 11.5 Lb Portable w/4 HR Battery IBM Compatibility, Expansion Capability, S/W & More Call For Our Dual Drive Lumicon Screen Special  
MOTOROLA 18 User MEGAFRAME with Parallel Processing, UNIX System 5 & VAX 750 Power CALL  
ST-100 PC/XT COMPAT. w/Dual 5 1/4" DRVS., PARA. & SERIAL PORTS, 8 SLOTS, MONO or RGB Video CTRL, 256K RAM MS-DOS 2.1 \$1,095 w/ 10Mb H.D. \$1,595  
VIASYN 816/286 w/ 40Mb & Tape \$8,095  
VIASYN 816/C-H40 w/ 5 1/4" X 8" FLPY'S \$8,795  
VIASYN 816/10-H40 w/ Two 5 1/4" FLPY'S \$5,395  
CALL FOR OTHER SYSTEM CONFIGURATIONS  
ZENITH 150-PC COMPATIBLE SEE PAGE 50

## S-100 Bus Boards

If you purchased before calling us, you probably paid too much! We stock ACKERMAN DIGITAL, ADVANCED DIGITAL, CCS, VIASYN, CROMEMCO, HUDSON, ELECTROLOGICS, INTERCONT. MICRO, KONAN, MULLEN, PICKLES & TROUT, SYNTech DATA, TARBELL, TECMAR, TRANSEND, VECTOR ELEC. A few Of This Month's SPECIALS Are:

COMPUPRO/VIASYN RAM 22, 256K STATIC \$779  
COMPUPRO/VIASYN RAM 23, 128K STATIC \$415  
DUAL NEW BOARD SPECIALS CALL  
MACROTECH 256-ST/512-ST STATIC \$695/\$1,295  
MACROTECH ADIT-4 Intelligent I/O \$699  
MACROTECH M1-286 80286/280H DUAL PROC. \$679  
MACROTECH MSR-II 1Mb DYNAMIC RAM \$680  
SYNTech DATA SYS --- 40% OFF PRESENT STOCK  
VECTOR RAM 17 64K Static \$319  
VECTOR INTERFACER I Dual Serial \$209  
VECTOR INTERFACER II 3 Para., 1 Serial \$229

## Mainframe & Drive Enclosures

INTEGRAND 1100 7 Slots and 2 X 8" Drives \$475  
JMR 1H5 5 1/4" H.D. Cabinet \$189  
MPS 5500 5 1/4" H.D. & FLYP OR TAPE \$209  
MICROWARE 511001 Dual Hor. 1/2 HI. 5 1/4" FLPY \$75  
PARA DYNAMICS 3820S PRONTO \$1,160

## Floppy Disk Drives

MITSUBISHI 2894 STD/2896 1/2 HT. 8" \$395/\$399  
MITSUBISHI 4853 HALF HT. 5 1/4" 96TPI DSSD \$139  
TANDON 100-2A IBM-PC Compatible \$109  
TEAC FD55B & MITSUBISHI 4851 5 1/4" 1/2 HT. \$95

## Hard Disk Subsystems

PC-INSIDER/PC-OUTSIDER H.D. SERIES FOR IBM 10 to 116Mb Formatted w/ Controller & All Cables, Hardware & P/S or PC Style Cabinet from \$599  
WANTEK 60Mb 1/2 HT. Streaming Tape for PC \$1,200  
CALL FOR DLR & OR QTY. PRICES ON HARD DISKS:

MITSUBISHI Magstar RODIME  
MICROPOLIS QUANTUM Amcodyne  
S-100 BUS SUBSYSTEMS Supporting Turbosos, Concur. Dos, CP/M 80 & 816 Operating Systems CALL  
TAPE BACK-UP 10Mb 5 1/4" 1/2 HT \$539

## PC-Multifunction Boards

We Have a Good Selection of Multifunction and Memory Boards for PC, XT, AT, JR, AT & T, and PC Portables

STB BIG BYTE 384K \$210  
STB GRANDE BYTE/PC-AT 2.5Mb \$789  
STB RIO GRANDE/PC-AT 1.5Mb, 2 S. P. & G \$859  
STB RIO PLUS II/PC & XT 384K \$299  
TECMAR CAPTAIN 384K w/Treasure Chest \$220  
TECMAR JR. CAPTAIN 128K w/Treasure Chest \$289  
TECMAR EXPANSION CHASSIS With 8 Slots \$675  
TECMAR MAESTRO 2.5Mb \$695  
TECMAR WAVE 256K File XT Short Slot \$209

## PC-Slave Boards

ADVANCED DIGITAL PC-SLAVE W/256K, 8 MHz 8088 CPU, 2 S Ports, RTNX S/W-For Multi-User PC \$595  
ALLOY PC-SLAVE/16 256K to 768K RAM CALL

## PC-Video/Graphics Boards

STB GRAPHICS PLUS II with Paral. PRT Port \$240  
STB MONO PLUS II with Paral. PRT. Port \$155  
STB CHAUFFER No Drivers Needed \$255  
TECMAR GRAPHICS MASTER 16 Color Hi-Res \$439  
TECMAR GRAPHICS TENDER RGB/PRT. PORT \$189

## Graphics And CAD

PFS Graph CALL  
VETRIX Graphics Systems Utilize 8 Bit Planes and have 384K RAM to Operate Independently of Host Video Controller and RAM Memory

VETRIX VX384A Stand Alone RS232 Co-proc. CALL  
VETRIX VX1301 13" RGB Analog Monitor CALL  
VETRIX VX1901 19" RGB Analog Monitor CALL  
VETRIX VX/PCB 512 Col./Pal. of 16,800,000 CALL  
VETRIX VXTB 11"X11" Graphics Tablet CALL

## PC-Scientific/Industrial Boards

TECMAR BASE BOARD 96 Digital I/O Lines \$219  
TECMAR DADIO D to A Up to 24 Devices \$249  
TECMAR IEEE-488 Board \$249  
TECMAR LABMASTER w/ TM40 PGL Option \$385

## Monitors & Terminals

TATUNG CM-1322 640X200 RGB-SATISFACTION GUARANTEED. It Puts Competition to Shame! \$395  
TATUNG CM-1300 Like 1322 with Great Amber Switch PLEASE ASK ABOUT OUR "HOT SPARES"  
LOANER POLICY \$419  
TATUNG CM-1370 720X480 RGB w/GRN Switch Long Persist Phos. Works w/ STB's SUPER RES 400 \$499  
TATUNG MM-1222G/A Hi-Res 12" TTL(IBM) \$119/125  
TAXAN MONITORS Call for Low Prices  
TECMAR 640X480 RGB, GRN Switch Long Phos \$519  
ZENITH ZVM123A (Green) 122A (Amber) \$85/\$89  
ZENITH ZVM135 HI-RES RGB w/ Green Switch \$449  
LIBERTY TERMINALS w/Variable Scrolling, Green, Amber 14", DEC Compatibility, Extra Pages of Memory, and Graphics Options at Unbeatable Prices.  
LINK 125 WYSE50 Compat. 14" GRN or AMB \$449  
LINK 125/PC w/ PC Emulating Video & Keybd CALL  
WYSE 50/75 TERMINALS In Stock \$439/\$599

## Printers & Plotters

BROTHER HR-10 12CPS Daisy w/ TRAC., S&P \$265  
BROTHER HR-15-XL 17CPS Daisywheel 8 or P \$359  
BROTHER HR-35 36 CPS Daisywheel S or P \$699  
BROTHER M1009 50 CPS Dot Matrix 6.8 Lbs. \$189  
CITIZEN MSP-25 200/50 CPS 15" ULTRA QUIET \$599  
EPSON LX80, RX100+, FX100+, LQ1500 CALL  
HOUSTON INST. PLOTTERS & DIGITIZERS CALL  
OKIDATA New 182 Quiet 120 CPS & 60 CPS CALL

## Networking & Switch Boxes

GILTRONIX MANUAL AND AUTOMATIC SWITCHING UNITS to Fit all of Your SHARED Printer, Terminal, Modem, and Other Peripheral Needs. From \$79  
INTERCONT. MICRO LAN-PC/LANS-100 \$469/\$599

## Printer Buffers

JOHNATHON FREEMAN UPB 64K FORMERLY TTX in and/or Out Serial and/or Parallel \$169  
PRACTICAL PERIPH. MICROBUFFER 64K CALL

## Modems

HAYES SMART MODEM 1200, RS-232 \$449  
HAYES SMART MODEM 2400 Universal \$669  
PRENTICE POPCOM w/ PFS Access C150/X150 \$315  
PROMETHEUS PROMODEM 1200 Hayes Compatible w/ Built-in PWR Supply-RS232 Stand Alone Unit \$269  
OPTIONS FOR PROMODEM 1200 ARE:  
OPTION: PROCESSOR/64K MEMORY \$75/\$35  
OPTION: ALPHANUMERIC DISPLAY \$79  
PROMETHEUS 1200A Apple II, II+, IIc Card \$295  
PROMETHEUS 1200 B/PC w/ PROCOM S/W \$265  
PROMETHEUS 1200M MAC-PAC w/ Software \$329  
U.S. ROBOTICS COURIER 2400 Baud \$499  
U.S. ROBOTICS S-100 BOARD 300/1200 \$295  
U.S. ROBOTICS PC MODEM w/Telpac Software \$249  
U.S. ROBOTICS PC-MODEM With Clock-Cal/Battery, Printer Port, 256K & Telpac \$459

## Software

We have Access to all Well Known Brands - ORDER CORRECTLY - SOFTWARE IS NOT RETURNABLE!

## Accounting

CORE SOFTWARE'S FASTRAK: A DATA FLEX Application for all Your Accounting Needs Supporting All Networks & Operating Systems CALL

## Spreadsheets & Integrated Pkgs.

ASHTON-TATE Framework CALL  
LOTUS 1-2-3/SYMPHONY \$299/\$429  
MOSS KnowledgeMan \$319  
PFS Plan CALL  
SORCIM Supercalc-3 Better Than 1-2-3!!! \$209

## Operating Systems & Utilities

BORLAND SideKick Windows & Calculator CALL  
COMPUPRO/VIASYN CPM at Affordable Prices  
CROMEMCO COMPLETE LINE GOOD ECONOMIES  
DIGITAL RESEARCH Complete line up to 35% OFF

## Language And Tools

BD SOFTWARE "C" Compiler 8" SS SD 8 BIT \$85  
COMPUTER INNOVATIONS C-86 "C" Compiler \$299  
COMPUVIEW VEDIT/VEDIT-PLUS \$115/\$169  
DIGITAL RESEARCH Most Products in Stock CALL  
LATTICE "C" Compiler (Ask About Options) \$299  
MICROSOFT Complete Line CALL

## Data Base Managers

ASHTON-TATE dBASE II & III BEST PRICE  
DATAFLEX FILE/RECORD Locking Multi-User CALL  
PFS FILE/REPORT CALL

## Communications

MYCROFT LABS MITE AND MITE PLUS From \$79  
MICROSTUF CROSS TALK XVI \$99  
PFS Access CALL

## Word Processors

MICROPRO WORDSTAR, Etc. CALL  
NEWSTAR NEWWORD w/ Money Back Guar. \$129  
OASIS THE WORD PLUS Spell Check, CP/M86 \$89  
PFS WRITE/PROOF CALL/CALL

## Diskettes & Cartridges

3M TAPE CARTRIDGES 300XL & 600A In Stock \$29.95  
DYBAN DISKETTES Low Prices From \$19.50  
DYBAN Hard Disk Cartridges 5 1/4" & 8" \$99/\$150  
FUJI FILM FLOPPY DISKS Low Prices From \$18.50

## Power Solutions

FORTRON PC/XT Replacement P/S 140 Watt \$149  
SAFT SP5100VA/SINE WAVE 1mSEC Switch CALL  
SOLA MINI UPS 750 Watt Sine Wave HIGH INRUSH (4500 Watt) 100% Batt. Op. w/o Switch-Over CALL  
TRIPPLITE PC-425-FC 425 Watts 15-20 Minutes \$439  
TRIPPLITE ISOBAR Line Suppressor-Filters from \$40  
TRIPPLITE SB-1000 Watt w/80 Amp/Hr. Battery \$695

## Testing Devices & Software

DATACOM TRI-STATE RS232 V.24 Breakout \$175  
DYBAN Floppy Analyzers CALL  
FLUKE 77 DVM w/ Holster \$119  
RID-DYMEK FLYP DRV DIAGNOSTIC DISKETTE \$25

## Chips

We Have Some of the LOWEST PRICES in the Nation!  
64K, 256K, 8087 & 80287 CALL

## Hobby Corner

APPLE PASCAL \$95  
CCS 2810 280 CPU w/ Serial Port \$209  
DIGIAC 64K Dram w/o Ram. Works for N.S. Horiz \$89  
ITHACA BDS 64K, 8 SIO w/ I, XPU, Pascal from \$100  
MICROSOFT SOFTCARD APPLE II or II+ CP/M \$95  
MORROW AB11 8" SSSD Add-On Drive \$495  
NORTHSTAR ADVANTAGE 8/16 UPGD. w/64K \$229  
NORTHSTAR ADVANTAGE G/MSSDOS w/ CP/M \$195  
S-100 EPROM BOARD 16K \$89  
SYNTech DATA PROM 100 KIT \$89  
TRANSEND VBSA (24) Kil Video Board \$295



**NEW!!**

# MEGA-CASE™

**NEW!!**

**IDEAL FOR OEM MANUFACTURERS, UNIVERSITIES,  
RESEARCH LABS ETC.**

## "The MegaKit™"

**BUILD YOUR OWN PC-XT**

**No Soldering Required – You Only need To Assemble Parts  
Learn As You Build – Fully Illustrated Instructions  
All Parts Compatible**

Only  
**\$1,295**  
Plus  
Shipping

**SYSTEM KIT INCLUDES:**

**MotherBoard**

- Fully Assembled and Tested Mega-Board
- Mega-Bios Rom
- 256k RAM

**Enclosure**

- Mega-Case

**Power Supply**

- 130 Watt/ Switching

**Keyboard**

- Keytronics

**Data Storage**

- One DD/DS Floppy Disk Drive
- Disk Drive Controller Card



**ALL ITEMS SOLD SEPARATELY**

**ALL PARTS TESTED TO BE COMPATIBLE WITH MEGA-BOARD**

	<u>Good Quality</u>	<u>High Quality</u>
• 12" Color Monitor with RGB	/call	\$499.00
• Color Graphic Card	\$129.00	\$250.00
• Floppy Disk Drive	\$125.00	\$145.00
• 10 MBYTE Disk Drive And Controller	\$499.00	/call
• 20 MBYTE Disk Drive And Controller	\$700.00	/call
• Addition Memory Kits		
64k – (64k RAMS)	/call	/call
256k – (256k RAMS)	/call	/call

**DTC™** DISPLAY TELECOMMUNICATIONS CORPORATION

214-607-1382

**TERMS:** We accept cash, checks, money orders, or purchase orders from qualified firms and institutions. Prices and availability subject to change without notice. Shipping and handling charges extra.



# Mega-BOARD™ XT

**#1 CHOICE OF MAJOR OEM MANUFACTURERS, UNIVERSITIES, RESEARCH LABS ETC.** A THOROUGHLY FIELD PROVEN DESIGN. HIGH VOLUME PRODUCTION ENGINEERED.

- **FULL IBM PC-XT\* COMPATIBILITY!**
- **FULL MEGA-BYTE RAM CAPACITY ON MOTHERBOARD!**

**THOUSANDS SOLD WORLD WIDE!**

**DEALERS AND OEM MANUFACTURERS QUANTITY DISCOUNTS AVAILABLE**

**Eight Compatible I/O Interface Connectors**  
(Full PC compatible)  
(compatible with all IBM-PC\* plug-in cards)

**Special J1 Interface**  
(Allows horizontal mounting of compatible expansion cards for easy bus expansion and custom configuring) (Board has 62 pin gold plated compatible connector)

**Extended ROM Capability**  
(Runs all compatible PC ROMS) (Jumper programmable to accommodate all popular 8K, 16K, 32K and 64K ROM chips and NEW EE ROMS! VPP power pin available for EP ROM burning!) (External VPP voltage required)

**Full Mega-Byte Ram Capacity! On board!**  
(With parity)  
 256K Bytes using 64K chips  
 1 Mega Bytes using 256K chips

**Standard Keyboard Interface**  
(Full PC compatible)

**Hardware Reset**  
(Overcomes reset flaw in PC)

**Power Connector**  
(Full IBM\* pinout compatible)

**8088 Processor**  
(Same as PC)

**8087 Numeric Processor**  
(Same as PC)

**Peripheral Support Circuits**  
(Same as PC)

**Configuration Switches**  
(Same as PC)

**Speaker/Audio Port**  
(Same as PC)

**Wire Wrap Area**  
To facilitate special custom applications!

**Only \$499.95**  
Fully Socketed and Assembled  
256k RAM

Mega-Board™ Triple-tested, fully socketed and assembled with IC's.

Includes highest quality PC board with gold plating, silk screen, solder mask

**Board Size** 10.5 inch X 13.5 inch

*MegaBoard Products On Display at the following locations:*

Hawaiian Industrial Instruments  
1154 Fort Street Mall, Suite 200  
Honolulu, Hawaii 96813  
808 533-4132  
Electronics Projects Inc.  
30 Airport Blvd  
Mobile, Alabama 36608

**FREE OFFER**

**FREE! Displaytel™ Exclusive.**  
Our Commitment to Microcomputer Education!

**FREE Intel 8088 Data Book** with each Mega-Board™ Order!

**ORDER NOW!!!** Fast, friendly service

**CALL: 214-607-1DTC**

100% SATISFACTION GUARANTEE



Immediate shipment!  
Most instock items shipped same or next day!

10 Day money back guarantee if not completely satisfied!

**DTC™ DISPLAY TELECOMMUNICATIONS CORPORATION**

InterFirst Place  
8445 Freeport Parkway, Suite 445  
P.O. Box 27  
Irving, Texas 75062  
(214) 607-1382  
Telex 510600176 DTC UD

# 49¢ Diskettes

## Name Brand Quality

### Toll-Free Ordering

### Fast Delivery

**Call Communications Electronics**

Diskette order desk

**800-USA-DISK**

In Canada 800-CA1-DISK

Choose your brand

Choose your price



**Super Disk**  
diskettes  $\frac{100}{\text{box}}$   
**\$0.49 each**



**Wabash**  
diskettes  $\frac{100}{\text{box}}$   
**\$0.72 each**



**BASF**  
diskettes  $\frac{100}{\text{box}}$   
**\$1.12 each**

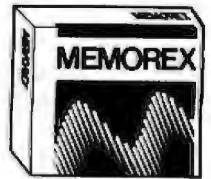

**Memorex**  
diskettes  $\frac{100}{\text{box}}$   
**\$1.12 each**

**Product Description**

Product Description	Super Disk Part #	CE quant. 100 price per disk (\$)	Wabash Part #	CE quant. 100 price per disk (\$)	BASF Part #	CE quant. 100 price per disk (\$)	Memorex Part #	CE quant. 100 price per disk (\$)
8" SSSD IBM Compatible 128B/S, 26 Sector	_____	_____	F111-Z	1.59	_____	_____	3052-Z	1.84
8" SSSD Shugart Compatible, 32 Hard Sector	_____	_____	F31A-Z	1.79	_____	_____	3015-Z	1.94
8" SSDD IBM Compatible (128 B/S, 26 Sectors)	_____	_____	F131-Z	1.89	_____	_____	3090-Z	2.19
8" DSDD Soft Sector (Unformatted)	_____	_____	F14A-Z	2.09	_____	_____	3182-Z	2.59
8" DSDD Soft Sector (266 B/S, 26 Sectors)	_____	_____	F144-Z	2.09	_____	_____	_____	_____
8" DSDD Soft Sector (512 B/S, 15 Sectors)	_____	_____	F145-Z	2.09	_____	_____	_____	_____
8" DSDD Soft Sector (1024 B/S, 8 Sectors)	_____	_____	F147-Z	2.09	_____	_____	3104-Z	2.59
5 1/4" SSSD Soft Sector w/Hub Ring	8431-Z	0.74	M11A-Z	0.89	_____	_____	_____	_____
5 1/4" SSSD Same as above but bulk product	8437-Z	0.54	M11AB-Z	0.79	_____	_____	_____	_____
5 1/4" SSSD 10 Hard Sector w/Hub Ring	_____	_____	M41A-Z	0.89	_____	_____	_____	_____
5 1/4" SSDD Soft Sector w/Hub Ring	8401-Z	0.84	M13A-Z	0.99	54974-Z	1.24	3401-Z	1.24
5 1/4" SSDD Same as above, but bulk product	8407-Z	0.64	M13AB-Z	0.89	_____	_____	_____	_____
5 1/4" SSDD 10 Hard Sector w/Hub Ring	_____	_____	M43A-Z	0.99	_____	_____	_____	_____
5 1/4" DSDD Soft Sector w/Hub Ring	8491-Z	0.94	M14A-Z	1.09	54980-Z	1.44	3491-Z	1.69
5 1/4" DSDD Same as above, but bulk product	8497-Z	0.74	M14AB-Z	0.99	_____	_____	_____	_____
5 1/4" DSDD 10 Hard Sector w/Hub Ring	_____	_____	M44A-Z	1.09	_____	_____	_____	_____
5 1/4" DSDD 16 Hard Sector w/Hub Ring	_____	_____	M54A-Z	1.09	_____	_____	_____	_____
5 1/4" DSDD Soft Sector 96 Tracks per inch	8591-Z	1.49	M18A-Z	2.49	_____	_____	3501-Z	2.49
5 1/4" DS High Density Soft Sector for IBM PC AT	_____	_____	M18A-Z	3.99	_____	_____	5508-Z	3.99
3 1/2" SSSD Soft Sector micro-floppy	_____	_____	C13A-Z	2.74	84112-Z	2.99	6100-Z	2.49

**For more information about this brand call:**

**Lifetime warranty**  
For more info on Super Disk call  
**800-USA-DISK**  
In Michigan 313-873-1111

**Lifetime warranty**  
For more info on Wabash call  
**800-323-9868**  
In Illinois 312-593-5363

**Lifetime warranty**  
For more info on BASF call  
**800-343-4600**  
In Massachusetts 617-271-4000

**Lifetime warranty**  
For more info on Memorex call  
**800-448-1422**  
Monday-Friday 9am-4pm ET



# DISK DRIVES



**FREE Disk Tub With Every Order Over \$20 — Holds 60 5 1/4" Disks**

## Hard Disk

- ★ 10 Meg Hard Disk
- ★ w/IBM Controller

**\$475**

## Apple Compatible Drives

### Micro Sci

A-2 or A-20 Full HT ..... \$ 159  
Controller ..... 60

### CCU

FD525A Slimline for IIE ..... \$ 129  
FD525C for IIC ..... 139  
FD555A Fully Compatible Full Ht ..... \$ 139

**Hard Disk**  
10 Meg w/cont. & pwr supply ..... \$ 995

## 5 1/4" Disk Drives

**Teac**  
FD55A, 160K ..... \$ 99  
FD55B, 360K ..... 95  
FD55F, Quad Density ..... 129  
All Teac's are Half Heights

### Tandon

TM100-2, 360K ..... \$ 99  
TM101-4, Quad Density ..... 269

### Mitsubishi

4851, 360K 1/4 Height ..... \$ 129  
4853, Quad Den. 1/4 Height ..... 139

### Hard Disk

10 Meg w/IBM Controller ..... \$ 499

## 8" Disk Drives

### Siemens

FDD-100-8 Sgl Side ..... \$ 129  
FDD-200-8 Dbl Side ..... 189

### Sanyo

1/4 Height 360K ..... \$ 89

### Tandon

84B-1E, Sgl Side, 1/4 Ht. .... \$ 279  
84B-2E, Dbl Side, 1/4 Ht. .... 379

### Mitsubishi

M2894-63, Dbl./Dbl. .... \$ 399  
M2896-63, Dbl./Dbl. 1/2 Ht. .... 399

## 5 1/4" & 8" Power Supply & Cabinets

### JMR 5 1/4"

Single Cabinet w/pwr ..... \$ 79  
Dual Thinline Cab w/pwr ..... 89  
Dual Cabinet & Power ..... 89

All have 6 month Warranty

### JMR 8"

Sgl. Cabinet w/pwr & fan ..... \$ 229  
Dual w/pwr for 2 thinlines ..... 239  
Dual w/pwr & fan ..... 279

# PRINTERS



## Brother HR-15XL

- ★ 18cps
- ★ Letter Quality

**\$349**

### Brother Dist. by Dynax

HR15XL, 12 cps ..... \$ 349  
HR25, 25 cps ..... 625  
HR35, 36 cps ..... 835

### Epson

LX-80  
RX-80 (120 cps)  
RX-80FT  
RX-100+  
FX-80+  
FX-100+  
LQ1500  
JX-80

We Will  
Beat ALL Pricing

We are an Authorized Dealer

### Okidata

OKI 182 ..... \$ 229  
OKI B4P ..... 669  
OKI B4S ..... 749  
OKI 192 ..... 359  
OKI 193 ..... 585  
OKI MATE20 Color Printer ..... 239

### A B SWITCHBOX

Par. or Ser. .... \$ 69

## PRINTER INTERFACES

### Fourth Dimension

Card & Cable (For Apple) ..... \$ 45

### Microtek

Dumpling GX (Grappler Compatible) \$ 75  
Dumpling GX exp to 64K ..... 145  
Dumpling GX 16K w/16K exp to 64K ..... 160

### Okidata Options

Tractor for 82 & 92 ..... \$ 59  
Serial interface ..... 85

### Orange Micro

Grappler + ..... \$ 84  
Grappler + w/16K ..... 149

### Epson Accessories

Epson Serial Interface ..... \$ 99  
Letter Writer NCG Kit ..... 59  
LX-80 or FX-80 Tractor ..... 39

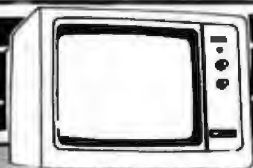

# MONITORS

## Taxan 425

- ★ Hi-Res Color
- ★ Switchable to Green

**\$389**

### Amdek

300G, Hi-Res Green ..... \$ 125  
300A, Hi-Res Amber ..... 134  
310A, Monochrome Amber ..... 158  
300 Hi-Res Color Comp. .... 275  
500 RGB Composite ..... 399  
DVM Board for Apple RGB ..... 119

### Taxan

425 Color RGB ..... \$ 389  
440 Ultra Hi-Res ..... 519

### Stand

Tilt & Turn Stand ..... \$ 15

### Princeton Graphics

MAX12, Monochrome Amber ..... \$ 169  
HX12, RGB Color ..... 449  
SR-12 w/Doubler Board ..... 775

### IBM

Monochrome Green ..... \$ 239  
Color Hi-Res ..... 559

### Zenith

ZVM122 ..... \$ 95  
ZVM123 ..... 95

### BMC

12AUW HI-Res Green ..... \$ 79

**Computer  
Components  
Unlimited**  
A California Corporation

Inquiry 01



No Surcharge for Credit Cards

All Prices Reflect a Cash,  
Pre-Paid Discount

This Ad Supersedes All Others

**Customer Service & Technical**

**(213) 618-0487**

**Sales Desk**

**(800) 847-1718**

Outside California

**(213) 618-0477**

Inside California

# SYSTEMS

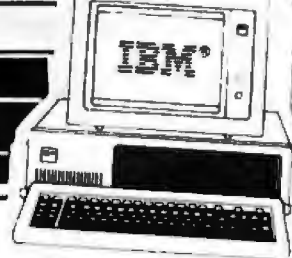

## IBM XT

- ★ One 360K Drive
  - ★ One 10 Meg Hard Disk
- \$2595**

## IBM AT

- ★ Enhanced
- \$4495**

### Apple

IIE cpu	.....	\$ 790
Macintosh	.....	1895
IIC Portable	.....	899

### Compaq

Portable (PC Compatible) 2, 360K Drives	
256K of Memory	\$1899
Compaq + w/10 Meg	3300
Deskpro 1	1995
Deskpro 2	2250
Deskpro 3	3900
Deskpro 4	Call

### IBM

PC 256K, 2 Drives	.....	\$1499
XT w/10 Meg, 256K	.....	2595
Additional Memory 64K	.....	9
AT Standard Config.	.....	Call
AT w/20 meg	.....	Call

Add \$50 for Configurations & Testing

# MODEMS

## US Robotics

- ★ 2400 Baud
  - ★ Hayes Compatible
- \$569**

### Hayes

Micro Modem IIE	.....	\$ 169
300 Baud	.....	169
1200B IBM Internal	.....	349
1200	.....	379
2400 Baud	.....	599

### Anchor Automation

Mark XII, 1200 Baud	.....	\$ 219
Mark X, 300 Baud Stand alone	.....	149
Express 1200 Baud	.....	269

### Prometheus

Promodem	.....	\$ 289
Pro 1200A Apple Int w/sw	.....	329
Pro 1200B IBM Int w/sw	.....	299
Pro Mac w/cable & sw	.....	379
No. C Cable	.....	12
Alpha Disp.	.....	89
Options Proc.	.....	89

### U.S. Robotics

Password	.....	\$ 219
Courier 2400 Baud	.....	569

# IBM & APPLE ACCY'S



## 64K Upgrades

- ★ Nine 4164, 200ns
  - ★ 1 Year Warranty
  - ★ Nine to a Set
- \$6.95**

### APPLE EXTRAS

<b>ALS</b>	
Z Engine	..... \$ 119
CPM 3.0 Card	..... 240
<b>CCU</b>	
RF Modulator	..... \$ 9
Fan w/Surge	..... 34
16K Mem. Card 1 yr war	..... \$ 45
<b>Micro Max</b>	
Viewmax 80, 80 col. card	..... \$ 135
Viewmax 80E (F for IIE) 64K	..... 120
<b>Micro Soft</b>	
Premium Soft Card IIE	..... \$ 369
Soft Card (280) w/64K	..... 279
<b>Micro Tek</b>	
Serial Interface	..... \$ 89

### IBM EXTRAS

<b>Ast Research</b>	
Six Pack + w/384K	..... \$ 299
<b>Hercules</b>	
Color Card	..... \$ 149
Graphics Card	..... 304
<b>Helix Technology</b>	
Memory Board 0-K to 512K	..... (0-K) \$ 119
<b>IBM</b>	
Monochrome Adapter	..... \$ 219
Color Card	..... 225
<b>Paradise Systems</b>	
Multi-display Card	..... \$ 329
New Modular Card	..... 260
S Pack Multifunction	..... 160
<b>Quadram</b>	
Quadlink	..... \$ 349
<b>64K Upgrade</b>	
64K of Mem. ..\$6.95	
<b>AT Upgrade</b>	
200ns ..\$89	
<b>Ports</b>	
Parallel	..... \$ 79
Serial	..... 79
<b>CCU</b>	
Color Graphics Card	..... \$ 119
<b>Everex</b>	
Graphics Edge	..... \$ 329

### CCU Multifunction Card

Par. & Ser. Ports w/64K exp 384K	
Clock, Calendar, Sftwr & Manuals	..... \$ 155
w/384K	..... 209
<b>8087's</b>	
8087-2	..... \$ 149
8087-3	..... 109
8087-6	..... 99

### 5 1/4" DISKETTES

<b>CCU</b>	
Sgl/Dbl reinforced hub	..... \$11 100 for 100
Dbl/Dbl reinforced hub	..... 13 100 for 110
Not Bulk Packed	
<b>Dysan</b>	
Sgl/Dbl	..... \$33 100 for 300
Dbl/Dbl	..... 39 100 for 370
<b>Verbatim</b>	
Sgl/Dbl	..... \$26 100 for 240
Dbl/Dbl	..... 36 100 for 340

8" Diskettes Available — Call

### DISK ACCESSORIES

<b>Verbatim</b>	
8" or 5 1/4" Head Cleaning Kit	..... \$ 9
<b>Flip Tub</b>	
5 1/4" Holds 60 disks, plexiglass	..... \$ 9

Inquiry 61

### RETAIL STORES:

11976 Aviation Blvd.  
Inglewood, CA 90304

16129 Hawthorne Blvd., Suite E  
Lawndale, CA 90260

### MAIL ORDER:

P.O. Box 1936  
Hawthorne, CA 90250

### Retail Hours:

10 a.m. - 6 p.m. Mon.-Fri.

10 a.m. - 3 p.m. Sat.

### Customer Service Hours:

10 a.m. - 4 p.m. Mon.-Fri.

John Aurentz

(213) 618-0487

### Mail Order Hours:

8 a.m. - 6 p.m. Mon.-Fri.

10 a.m. - 3 p.m. Sat.

(800) 847-1718 (213) 618-0477

(Outside California) (Inside California)

All merchandise new. We accept MC, Visa, Wire Transfer, COD, call, Certified Check, P.O.s from qualified firms, APO accepted. Shipping Minimum \$4.50 first 5 pounds. Tax: California Res. Only add 6 1/2% sales tax. All returns subject to 15% restocking charge. Advertised prices for Mail Order only. Retail prices slightly higher.  
Prices Subject to Change

# California Digital

17700 Figueroa Street • Carson, California 90248

# XEROX

# \$299

## SUNRISE COMPUTER

~~\$2995~~

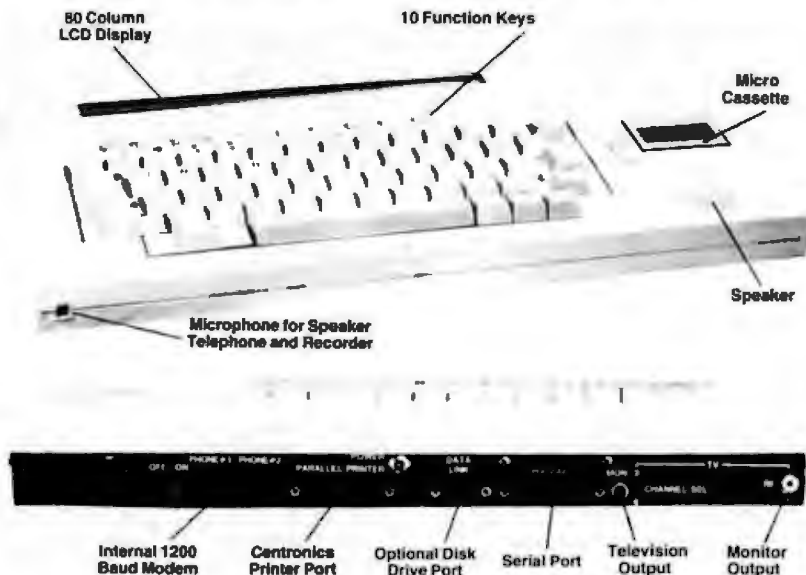

The Xerox Sunrise 1810 is by far the best value we have ever seen in a micro computer. This is a self contained battery and AC operated portable. The Sunrise was originally priced at \$2995. Xerox has since elected to drop the computer from their product list. California Digital has purchased all the remaining inventory and is making the unit available at a fraction of its original cost.

This portable features a built in 80 column liquid crystal display, along with both RF monitor and television outputs. The internal 300/1200 baud modem includes an auto dial telephone assembly. The units has both centronics parallel and a serial port programmable to 19,200 baud.

The self contained micro cassette is capable of capturing data from the keyboard as well as doubling as an recorder for dictating messages.

An optional dual floppy disk drive module, pictured above, is available for only \$219. (when purchased with the Sunrise 1810). Also available, for \$59 is an 80 column printer that mounts in the drive module. The Sunrise features a CP/M operating system which allows the operator to use any CP/M program in Xerox 5 1/4" disk format and over 5000 CP/M programs available in public domain.

## PRINTERS

### MATRIX PRINTERS

Star Gemini-10X 120 char/sec	STR-G10X	249.00
Star Gemini 15X 100 char/sec 15 paper	STR-G15X	365.00
Star Gemini Delta 10 180 Char/sec	STR-D10	259.00
DotMatrix P1251 192 char/sec letter quality	TD06-1651	1495.00
Okidata 82A serial & parallel 8 1/2" paper	OKI-82A	299.00
Okidata 92A parallel interface, 160 char/sec	OKI-92A	379.00
Okidata 95A & parallel 15" paper	OKI-95A	549.00
Okidata 94A & parallel 15" paper	OKI-94A	929.00
Epson LX-80 10 120 Char/sec	EPS-LX80	239.00
Epson FX-80 10 120 Char/sec	EPS-FX80	289.00
Epson FX-80PT 10 160 char/sec with graphics	EPS-FX100	589.00
Epson FX-100PT 15 160 char/sec with graphics	EPS-LQ1500	1079.00
Epson LX-1500 15 correspondence quality	EPS-L80	579.00
Epson 3020 Color printer	PRQ-3610P	329.00
Proprinter II parallel 8 1/2" paper	PRQ-2P	589.00
Proprinter II parallel 15" paper, graphics	DP-8800	995.00
Dataproducts B-600-3 band printer 800 LPM	PTX-P300	2995.00
Proprinter F300 high speed printer 300 lines per minute	PTX-P800	5795.00
Proprinter F600 ultra high speed 600 lines per minute		

### WORD PROCESSING PRINTERS

Scanmate F10 parallel, 40 char/sec	FNQ-F10P	499.00
NE CB810 55 char/sec serial, serial interface	NEC-8B10	1959.00
NE CB830 55 char/sec, par I interface	NEC-8B30	1959.00
NE C2550 popular printer designed for the IBM/PC	NEC-C550	1599.00
NE C2550 designed for IBM/PC 20 char/sec, par I	NEC-C550	999.00
Shiva Reed EXP500, 14 char/sec, par I interface	SRD-EXP500	319.00
Shiva Reed EXP550 17 Char/sec, par I interface	SRD-EXP550	429.00
Table 630 49 char/sec serial	DBL-630	1599.00
Dialog 520 proportional spacing, horiz & vert tab 20 cps	DBL-420	799.00
Juki G100 18 char/sec	JUK-G100	399.00
Juki G200 18 char/sec	JUK-G200	699.00
Comtron CR2 24 baud, proportional spacing, par I	CRX-CR2P	295.00

## 1200 BAUD UNIVERSAL DATA

**\$119**

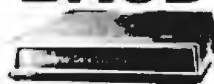

The UDS-212LP is a compact desktop modem designed to obtain all its operating power entirely from the telephone line thus eliminating the need to connect to an external AC power source. NOT Hayes compatible but the ideal 1200 baud modem to connect to any CRT terminal or computer when accessing dial up data bases. The Universal Data Division of Motorola original suggested list price on the 212/LP was \$ 495, but California Digital is offering at only \$119

### SMARTTEAM 1200

**\$229**



The Team 212A offers all the features of the Hayes Smart Modem 1200 for a fraction of the price. Now is your opportunity to purchase a 1200 baud modem at the price of a 300 baud modem

## MODEMS

Hayes Smartmodem 2400 baud modem	HYS-2400	619.00
Fujitsu 2400 1200 baud auto answering	FUJ-1915D	419.00
Team 1200 Hayes Compatible	TEA-1200	219.00
Worldata same as QUBE 1200 baud dual internal	WLF-PC120A	159.00
CTS 212AH 1200 baud auto dial	CTS-212AH	299.00
Terminal software for CTS 212AH	CTS-212SFT	35.00
Prometheus 1200 super features	PRM-P1200	319.00
Prometheus 1200B internal PC	PRM-P1200B	279.00
Signalman-Mark 12 1200 baud Hayes compatible	SGL-MK12	239.00
Signalman-Mark V1 300 baud internal PC	SGL-MK6	89.00
Hayes SmartModem 1200 baud auto answer auto dial	HYS-212AD	429.00
Hayes 1200B for use with the IBM PC 1200 baud	HYS-1200B	399.00
Hayes Smartmodem 300 baud only auto answer auto dial	HYS-100AD	229.00
Hayes Micromodem II 110 Apple direct connect	HYS-MM2	279.00
Hayes Chronograph time & date	HYS-CHRCZ2	199.00
Poflex 300 1200 industrial quality	PEN-12AD	495.00
Universal Data 103JLP line power auto answer	UDS-103LP	69.00
Universal Data 212A.P full 1200 baud duplex line power	UDS-212A.P	119.00
Universal Data 212A 1200 baud industrial Line	UDS-212A	199.00

## PLOTTER

**\$219**



The Comrex Comscriber I is the ideal solution to make short work of translating financial and numeric data into a graphic presentation. Many ready to run programs such as Lotus 1-2-3 Vis-on and Apple business graphics already support this plotter.

The Comscriber I features programmable paper sizes up to 8 1/2 by 120 inches, 6 inch per second plot speed and 0.001" step size. Easy to implement Centronics interface allows the Comscriber I immediate use with the printer port of most personal computers.

The Comscriber I is manufactured for Comrex by the Enter Computer Corporation. This plotter is marketed by Health Kit and also sold under Enters own Sweet P Label. This is your opportunity to purchase a plotter which was originally priced at \$795 for only \$219.

Also available is a support package which includes demonstration software, interface cable a multicolor pen assortment and a variety of paper and transparency material.



## NEC RGB COLOR MONITOR

**\$259**

The NEC JC-1401D is a 13" medium/high resolution RGB monitor suitable for use with the Sanyo MBC-550/555 or the IBM/PC. The monitor features a resolution of 400 dots by 244 lines. Colors available are Red, Green, Blue, Yellow, Cyan, Magenta, Black and White.

The NEC monitor carries the Litton-Monroe label and was originally scheduled for use in their "Office of the Future" equipment. A change in Litton's marketing strategy has made these units excess inventory which were sold to California Digital. We are offering these new RGB monitors at a fraction of their original cost. Sanyo compatible NEC-1401/S IBM/PC Computer compatible NEC-1401/PC

## TERMINALS

Freedom F10 split screen, detachable keyboard	LDB-F100	499.00
Quime 102 green phosphor terminal	QUM-102	539.00
Ampex Dialogue 125 green screen	APX-D125G	675.00
Ampex Dialogue 175 amber screen, two page, func keys	APX-D175A	719.00
Wyse 50 14" green phosphor	WYS-50	595.00
Wyse 300, Eight color display split screen	WYS-300	1159.00
Zerwin 29 terminal, VT52 compatible, detachable keyboard	27H-229	769.00
Televideo 910 Plus, black matrix	TVR-910P	575.00
Televideo 925, detachable keyboard, 22 function keys	TVR-925	759.00
Televideo 950, graphic char, split screen, 22 func	TVR-950	859.00
Televideo 970 14" green, 132 column, European	TVR-970	1089.00

TOLL FREE ORDER LINE  
**(800) 421-5041**

TECHNICAL & CALIFORNIA  
**(213) 217-0500**

# California Digital

17700 Figueroa Street • Carson, California 90248

## F10 DAISY WHEEL PRINTER

# \$499

## LETTER QUALITY

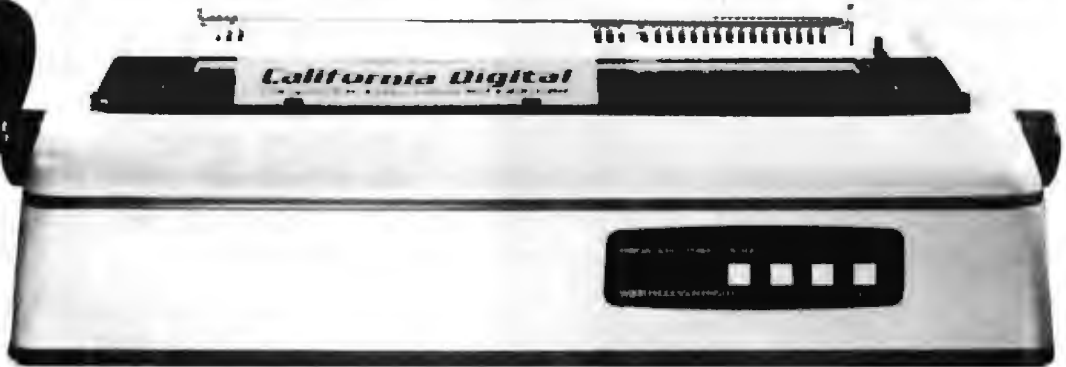

The TEC F-10 Daisy Wheel printer is the perfect answer to a reasonably priced 40 character word processing printer. While this printer is "extremely" similar to C.Itoh's F-10/40 Starwriter printer. Legal counsel for the C.Itoh Company have advised us that we should refrain from referring to the TEC printer as a Starwriter.

This 40 character per second printer auto installs with Wordstar and Perfect Writer. Features extensive built-in word processing functions that allow easy adaptability and reduced software complexity. Industry standard Centronics interface provides instant compatibil-

ity with all computers equipped with a parallel printer port. The TEC F-10 accepts paper up to 15 inches in width.

These printers were originally priced to sell at over \$1400. Through a special arrangement California Digital has purchase these units from a major computer manufacturer and is offering these printers at a fraction of their original cost.

Options available include tractor feed, buffered memory and an assortment of printer cables for a variety of computers.



### ROULETTE FREE

California Digital is offering this \$19.95 value Roulette game with clock calendar absolutely FREE with any purchase over \$50.

To receive your FREE Roulette game your order must be placed by mail before the end of this month, payment must accompany your order and the FREE Roulette game must be requested.

### DUAL SHUGART SUBSYSTEM \$239

The dual Shugart subsystem features two SA485 (96 tpi) 5 1/4" double sided disk drives. Also supplied within the subsystem is 50 watt power supply and a shielded signal cable.



# \$99

## MEMORY

### 4164 DYNAMIC MEMORY 150ns



# Quantity 100 \$ .99

#### DYNAMIC MEMORY

4164 150ns. 64K 128 refresh	ICM-4164150	1.31	23 +	100 +
4126 150ns. 256K	ICM-4126150	6.95	8.50	6.25
4116 150ns. 16K	ICM-4116150	1.76	1.88	1.46
4115 200ns. 16K	ICM-4115200	1.76	1.88	1.46
4128 for 68M/AT	ICM-4128150	6.95	6.75	6.30
CDP-609 dynamic controller	IC7-609	26.00	26.00	26.00

#### STATIC MEMORY

21L02 300ns. 1K static	ICM-21L02300	1.40	1.29	1.15
21L02 480ns. 1K static	ICM-21L02480	1.20	1.15	.99
21L2 450ns. 2K static	ICM-21L2450	2.99	2.85	2.75
21L4 300ns. 1K x 4	ICM-21L4300	1.95	1.80	1.75
4044TMS 410ns. 4K x 1	ICM-4044480	3.49	3.25	2.80
5257 300ns. 4K x 1	ICM-5257300	2.99	2.85	1.80
6116 P4 200ns. 2K x 8	ICM-6116200	3.95	3.80	3.70
6116 P3 150ns. 2K x 8	ICM-6116150	4.55	4.35	4.15

#### EPROMS

2708 450ns. 1K x 8	ICM-2708	4.95	4.75	4.65
2716 450ns. 2K x 8	ICM-2716	4.50	4.35	3.87
2716TMS 480ns. Tri-voltage	ICM-2716TMS	7.50	7.65	7.20
2732 450ns. 4K x 8	ICM-2732	4.50	4.35	4.55
2764 350ns. 8K x 8	ICM-2764	8.90	8.75	8.30
27128 350ns. 16K x 8	ICM-27128	7.95	7.30	6.90

## Shugart 604 WINCHESTER

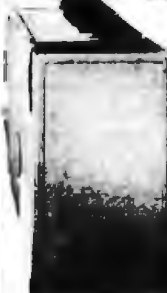

# \$99

These 6.7 Megabyte drives are new units recently released by the Shugart division of Xerox. The Shugart 604 is fully 506 industry compatible. Each drive is tested before shipment and is supplied with a 90 day warranty. SHU-604

#### Five Inch Winchester Hard Disk Drives

FUJITSU M2235AS 27 Meg.	899	859
RODIME RO-208 53 Meg.	1589	1493
MAXTOR XT10140 140 Meg.	3895	3795
SHUGART 712 13 Meg. 1/2 Ht.	495	465
SHUGART 604 6.7 Meg.	99	89
TANDON 502 10 Meg.	419	395
TANDON 503 19 Meg.	695	675
SEAGATE 225 25 Meg.	695	625

## TEAC 55B 48 TPI

One Two Ten  
Five Inch Double Sided Drives

TEAC FD55B half height	99	95	89
TEAC FD55F 96 TPI, half ht.	119	115	109
CONTROL DATA 9409 PC	169	159	155
SHUGART SA455 Half Height	99	95	89
SHUGART SA465 1/2 Ht. 96TPI	99	95	89
TANDON 100-2 full height	129	125	119
TANDON 101-4 96TPI full ht.	199	189	179
MITSUBISHI 4851 half height	139	135	129
MITSUBISHI 4853 96TPI 1/2 Ht.	155	149	139
MITSUBISHI 4854 8" elec.	295	285	275
QUME 142 half height	119	105	99

#### Eight Inch Single Sided Drives

SHUGART 801R			
SIEMENS FDD 100-8	119	115	109
TANDON 848E-1 Half Height	369	359	349

#### Eight Inch Double Sided Drives

SHUGART SA851R	495	485	475
QUME 842 "QUME TRACK 8"	319	310	313
TANDON 848E-2 Half Height	459	447	435
REMEX RFD-4000	219	219	209
MITSUBISHI M2896-63 1/2 Ht.	459	449	409

Shipping: First five pounds \$3.00, each additional pound \$.50. Foreign orders: 10% shipping, excess will be refunded. California residents add 6 1/2% sales tax. • COD's discouraged. Open accounts extended to state supported educational institutions and companies with a strong "Dun & Bradstreet" rating.

VISA



## MAJOR BRAND LIQUIDATION



Retail Value \$5000  
 Save up to 60%  
**ACP PRICE**  
 NOW ONLY!  
**\$2095<sup>00</sup>**

*Color 14" RGB Included  
 10 Mb Hard Disk*

ACP is proud to make this one-time special offer for a complete IBM PC™ Compatible Computer System. This is by far the most significant bargain that we at ACP have offered in our 10 year history. This

system was successfully designed and manufactured to exceed IBM's PC™ in terms of quality, expansion modularity and capability, aesthetic appearance, and performance.

The system design utilizes the latest in state-of-the-art technology including:

- VLSI - Large Scale Integration Circuit Design
- Ergonomic CRT Design with Tilt Screen
- Professional Molded Packaging and Design
- High Quality 100 Watt Switching Supply
- Complete Integrated System
- Microsoft Compatible Mouse Function

The system is not a Taiwan or Korean knock-off. Each component is specifically designed and specified to meet the highest performance and reliability standards in the industry. It represents the best that Japanese craftsmen have to offer and you will be equally proud to own one of your own. ACP has a limited quantity of these systems in several different configurations. IBM PC-DOS™ v1.1/2.1, MS-DOS™ v2.11 and Concurrent v3.1 compatible. We have found no known incompatibility with any IBM PC application. Our technical staff has 8.5 Megabytes of various MS-DOS software packages installed including Lotus 1-2-3 and Flight Simulator. Each system comes complete with a 90 day warranty.

### ACP Base System Consists of:

- (1) 360K DD/DS Floppy Disk Drive
- Mouse with Software
- 256K Memory Expandable to 640K on the Motherboard
- Deluxe Keyboard with LEDs
- Serial Port and Parallel Port
- Color or Monochrome Controller
- 4.77MHz, 8088 CPU
- 100 Watt Switching Supply w/Fan
- Three Expansion Slots
- Optional 6 Slot Expansion Chassis with Power Supply (add \$399)

	SYSTEM CONFIGURATION	Est IBM List*	Your Price
<b>SYSTEM A</b>	Base System (see left) PC with 360K Floppy, Keyboard & Mouse.	\$2100.00	<b>\$995.00</b>
<b>SYSTEM B</b>	Base System (see left) plus Add'l 360K Floppy Drive	\$2295.00	<b>\$1099.00</b>
<b>SYSTEM C</b>	Base System plus 12" Green Monitor with Detachable Tilt/Swivel Base.	\$2575.00	<b>\$1399.00</b>
<b>SYSTEM D</b>	Base System plus 12" Color Monitor with Detachable Tilt/Swivel Base.	\$2995.00	<b>\$1699.00</b>
<b>SYSTEM E</b>	Base System plus Ctr Monitor, 10Mb Hard Disk and Boot Diagnostics.	\$5000.00	<b>\$2095.00</b>
<b>SYSTEM F</b>	Base System plus 80 Col. x 25 Line LCD Screen	N/A	<b>\$1299.00</b>

Base System A (as above) **\$995.00**

\*Assumes required add-in boards to provide same capacity

IBM PC is a trademark of IBM Corp.

### LQP PRINTER SPECIAL

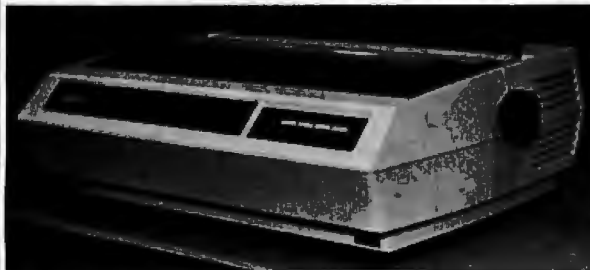

Major Manufacturer  
 Daisy Wheel Model 620  
 Letter Quality Printer  
 with Serial Interface.

Perfect for IBM PC and  
 Compatibles. Prints 25cps and  
 comes with 90 day warranty.

List \$1495

**\$495<sup>00</sup>**



**10 Mb \$449.00**

**HARD DISK**  
 w/Controller for IBM PC and  
 Compatibles.

At This Price, Supply  
 Is Limited.

### PC UPGRADE SPECIAL

**\$10<sup>00</sup>** SET OF (9) 64K RAMS

**\$45<sup>00</sup>** SET OF (9) 256K RAMS

**\$5.95** 128K PIGGYBACKS

### IBM Brand ASYNCH

INTERFACE CARD

List \$100 **ACP \$49.95**



### 5 Mb EXTERNAL

Sharp IBM Look-a-like w/contr. for  
 IBM PC. Sub-System Price: **\$429.00**  
 External Enclosure Add **\$195.00**

Internal w/controller

Sub-System Price: **\$299.00**

### DELUXE JOYSTICK

**\$11.95**



Compatible w/Atari  
 2600, 400, 800, VIC-20/  
 64 and Apple. Apple re-  
 quires optional cable  
 adapter. Add **\$2.95**

### APPLE DISK DRIVE

**\$115.00**



High quality 1/2 high  
 drive for Apple II, II+,  
 IIfx or IIfx. Apple IIfx re-  
 quires optional cable  
 adapter. Add **\$10.00**







### TALL TREE JRAM-2 2 MEGABYTE

Multi-Function Board for your  
IBM, PC, XT, AT

WITHOUT MEMORY **\$199<sup>95</sup>**

**NEW  
JRAM-3  
In Stock**

- Up to 2 megabytes of RAM
- Optional Parallel, Serial & Clock
- Free Jet Drive/J Spool Software
- Uses only 1 slot
- No loose cables!

	LIST	JADE
J RAM-2 without memory	\$219	\$199 <sup>95</sup>
J RAM-2 with 1 megabyte	\$519	\$449 <sup>95</sup>
J RAM-2 with 2 megabytes	\$819	\$699 <sup>95</sup>
Serial/Parallel/Clock module	\$180	\$149 <sup>95</sup>
Serial/Serial/Clock module	\$180	\$149 <sup>95</sup>
J RAM-AT without memory	\$299	\$229 <sup>95</sup>
J RAM-AT with 1 megabyte	\$599	\$479 <sup>95</sup>
J RAM-2 with 2 megabytes	\$869	\$749 <sup>95</sup>
AT Serial/Parallel module	\$130	\$119 <sup>95</sup>
AT Serial/Serial module	\$130	\$119 <sup>95</sup>
JFORMAT-2 Software	\$60	\$49 <sup>95</sup>

### JADE ExpandoRam Multifunction Card For Your IBM PC **\$169<sup>95</sup>**

Up to 384K, parallel printer port, RS-232 serial port, game port, clock/calendar, RAM disk/printer buffer and diagnostic software package.

	LIST	JADE
OK JADE Expando RAM	\$299	\$169 <sup>95</sup>
64K JADE Expando RAM	\$449	\$194 <sup>95</sup>
256K JADE Expando RAM	\$549	\$259 <sup>95</sup>
384K JADE Expando RAM	\$649	\$279 <sup>95</sup>

### AST for IBM PC

	LIST	JADE
Six Pak Plus 64K	\$395	\$249 <sup>95</sup>
Six Pak Plus 256K	\$695	\$319 <sup>95</sup>
Six Pak Plus 384K	\$945	\$349 <sup>95</sup>
Mega Plus 64K	\$395	\$269 <sup>95</sup>
Mega Plus 256K	\$665	\$349 <sup>95</sup>
Mega Plus 512K	\$1095	\$699 <sup>95</sup>
I/O Plus	\$165	\$119 <sup>95</sup>
Preview	\$399	\$309 <sup>95</sup>

**135 WATT**  
Drop-in replacement  
**POWER SUPPLY**  
For your IBM PC  
List Price \$199 **\$99<sup>95</sup>**

# PRICE WAR!

## Name Brands, Fast Service, & Satisfaction Guaranteed

### IBM PC-XT

10 Megabyte, 256K, Serial Port

## \$2895

---

### IBM PC-AT

Enhanced With 20 Megabyte

## \$4995

### 10 MEGABYTE Hard Disk System

FOR YOUR IBM PC

## \$499<sup>95</sup>



Complete with controller card, data cable, and mounting hardware, totally PC/XT compatible. External model includes cabinet & power supply.

	LIST	JADE
10 MEGABYTE Internal 1/2 High	\$1350	\$499 <sup>95</sup>
10 MEGABYTE External	\$1585	\$799 <sup>95</sup>
15 MEGABYTE Internal	\$1765	\$879 <sup>95</sup>
15 MEGABYTE External	\$1897	\$1049 <sup>95</sup>
20 MEGABYTE Internal	\$1800	\$999 <sup>95</sup>
20 MEGABYTE External	\$2060	\$1199 <sup>95</sup>
30 MEGABYTE External	\$3298	\$1569 <sup>95</sup>
33 MEGABYTE Internal	\$3388	\$1799 <sup>95</sup>
33 MEGABYTE External	\$1000	\$579 <sup>95</sup>
10 MEGABYTE 1/2 High Tape	\$1000	\$579 <sup>95</sup>
20 MB Disk w/ 10 MB Tape	\$2980	\$1799 <sup>95</sup>

### Expansion Boards for Your IBM-AT

	LIST	JADE
128K AST Advantage-AT	\$595	\$449 <sup>95</sup>
3.0 MB AST Advantage-AT	\$4145	\$1299 <sup>95</sup>
Quadport-AT 1S, 1P	\$154	\$139 <sup>95</sup>
128K Upgrade Kit	\$395	\$129 <sup>95</sup>
20 Megabyte Hard Disk	\$1790	\$895 <sup>95</sup>

### COLOR CARD FOR YOUR IBM

	LIST	JADE
JADE RGB w/Parallel Port	\$199	\$99 <sup>95</sup>
JADE RGB w/Parallel & Serial	\$299	\$189 <sup>95</sup>
JADE TTL Monochrome 720x348	\$299	\$149 <sup>95</sup>

### IBM Video Boards

	LIST	JADE
Hercules Color	\$245	\$189 <sup>95</sup>
Hercules Graphic	\$499	\$339 <sup>95</sup>
Tecmar Graphics Master	\$699	\$499 <sup>95</sup>
Quadcolor I	\$295	\$209 <sup>95</sup>
Quadcolor II	\$275	\$209 <sup>95</sup>
Paradise Graphics Card	\$395	\$319 <sup>95</sup>
Everex Graphics Edge	\$599	\$349 <sup>95</sup>

### HAYES SMARTMODEM

YOUR CHOICE **\$169<sup>95</sup>**

HAYES Smartmodem 300  
HAYES Micromodem IIe  
HAYES Smartmodem IIc

## SAVE UP TO \$200!

### HAYES Smartmodems



Sophisticated direct-connect auto-answer/auto dial modem, touch tone or pulse dialing RS232 interface programmable

	LIST	JADE
HAYES Smartmodem 2400	\$899	\$629 <sup>95</sup>
HAYES Smartmodem 1200	\$699	\$389 <sup>95</sup>
HAYES 1200B w/o Smartcom II	\$539	\$339 <sup>95</sup>
HAYES 1200B for IBM PC	\$589	\$359 <sup>95</sup>
HAYES Smartmodem 300	\$289	\$169 <sup>95</sup>
HAYES Chronograph	\$249	\$199 <sup>95</sup>
HAYES Micromodem IIe	\$299	\$169 <sup>95</sup>
HAYES Smartmodem IIc	\$399	\$169 <sup>95</sup>
HAYES Transet 1000	\$389	\$299 <sup>95</sup>
HAYES Smartcom II	\$149	\$99 <sup>95</sup>
Modem Cable	\$35	\$24 <sup>95</sup>

### Expand Your PC jr

	LIST	JADE
External 360K Disk Drive	\$499	\$369 <sup>95</sup>
AST 512K Jr Combo w/ 128K	\$395	\$299 <sup>95</sup>
Tecmar Captain Jr w/ 128K	\$489	\$349 <sup>95</sup>
Parallel Printer Port	\$120	\$94 <sup>95</sup>

### JADE 1200 BAUD MODEM

Hayes Smartmodem compatible, 1200 BAUD modem at a fraction of the price. FCC approved.

	LIST	JADE
JADE 1200 BAUD Modem	\$399	\$229 <sup>95</sup>
JADE 1200B for IBM	\$389	\$239 <sup>95</sup>
JADE 2400 BAUD Modem	\$699	\$449 <sup>95</sup>

### PROMODEMS As Low As \$149<sup>95</sup>



	LIST	JADE
ProModem 300c for Apple IIc	\$199	\$149 <sup>95</sup>
ProModem 1200B for IBM PC	\$399	\$289 <sup>95</sup>
ProModem 1200 RS-232	\$495	\$299 <sup>95</sup>
ProModem 1200A for Apple	\$449	\$349 <sup>95</sup>
ProModem 1200 for Macintosh	\$495	\$349 <sup>95</sup>
Alpha/num Display Option	\$99	\$79 <sup>95</sup>
Options Processor	\$99	\$79 <sup>95</sup>
64K Mem Expansion for Above	\$99	\$19 <sup>95</sup>
Modem Cable	\$35	\$24 <sup>95</sup>

### Mouse by MOUSE SYSTEMS

	LIST	JADE
PC MOUSE with Pop-ups	\$195	\$139.95
PC MOUSE with Paint	\$220	\$159.95
FIELD MOUSE (male or female)	\$175	\$129.95
PC PAINT Software	\$99	\$69.95
MOUSE WINDOW Software	\$150	\$109.95

### 256K RAM Chip Upgrade Kits **\$5985**

High speed RAM upgrade kit with FREE! parity (error detection) and one year warranty. We ship thousands of these kits to satisfied customers every week.

	LIST	JADE
64K RAM Chip Kit For PC	\$49	\$14.95
128K RAM Chip Kit For AT	\$355	\$99.95

### QUADRAM for IBM PC

	LIST	JADE
Quadboard No RAM	\$269	\$214.95
Quadboard 64K	\$395	\$235.95
Quadboard 384K	\$795	\$299.95
Quadlink	\$680	\$349.95

### TEAC 55B 360K Disk Drive for IBM PC **\$9995**



	LIST	JADE
Double-sided, double density		
TANDON 100-2	\$299	\$119.95
TEAC 55B	\$249	\$99.95

### The LITTLE BOARD with FREE! CP/M 2.2

Miniature single board CP/M computer designed to mount directly on top of a 5 1/4" floppy disk drive (7.75" x 5.75").

	LIST	JADE
Little Board with CP/M	\$400	\$329.95
Serial Cable	\$13	\$11.95
Diskless Monitor Eprom	\$30	\$24.95
SCSI/Plus I/O Adapter	\$99	\$89.95

### MICROSOFT For IBM PC

	LIST	JADE
Microsoft Word	\$495	\$319.95
Microsoft Mouse, RS-232 Serial	\$199	\$129.95
Microsoft Mouse, IBM Bus	\$199	\$129.95

**HIGH RESOLUTION  
640 x 260, .38 Dot Pitch  
TAXAN 415  
RGB COLOR  
MONITOR**

LIST PRICE \$699  
For cable add \$1900 **\$295**

### High Resolution Video Monitors



	LIST	JADE
Amdek 300G	\$179	\$139.95
Amdek 300A	\$199	\$149.95
Amdek 310A	\$230	\$179.95
Amdek Color 500	\$525	\$399.95
Amdek Color 600	\$650	\$449.95
Amdek Color 710	\$799	\$589.95
PGS MAX-12	\$269	\$179.95
PGS HX-12 640x240	\$699	\$449.95
PGS SR-12 720x480	\$799	\$629.95
PGS Scan-Doubler	\$299	\$199.95
Taxan 440 Ultra Hi-res RGB	\$799	\$599.95
Taxan TV Tuner for Monitor	\$99	\$89.95

### KEYTRONICS



	LIST	JADE
5150 Improved IBM Keyboard	\$209	\$159.95
5151 Deluxe IBM Keyboard	\$299	\$199.95

### High Speed 8087 APU

LIST PRICE \$293 ..... SALE PRICE \$119.95

### ISO-BAR



These industrial quality ISO-BARS look like a standard multi-outlet power strip but contain surge suppression circuitry and built-in noise filters plus a 15 amp circuit breaker.

	LIST	JADE
4 Receptacle Iso-Bar	\$89	\$59.95
8 Receptacle Iso-Bar	\$99	\$69.95

### UNINTERRUPTABLE POWER SUPPLY

Emergency back-up power to save your computer system and your valuable data. A must for every computer system.

	LIST	JADE
200 Watt UPS	\$359	\$279.95
425 Watt UPS	\$539	\$459.95
1000 Watt UPS	\$1179	\$995.95

### Disk Drive for Your Apple IIc



**\$12995**

	LIST	JADE
Disk Drive for Apple IIc	\$249	\$129.95
Printer Parallel Cable For Iic	\$99	\$59.95
Full Height Disk Drive	\$299	\$139.95
Half Height Disk Drive	\$249	\$129.95
ALS Z Engine	\$299	\$145.95
16K RAM Card	\$99	\$39.95
64K 80 Column Card for Iic	\$219	\$119.95
Best 80 Column Card II/II+	\$219	\$139.95
Printer Card & Cable	\$109	\$49.95
Fan with Surge Protection	\$99	\$59.95
Grappler Plus	\$175	\$99.95
64K Buffered Grappler+ w/16K	\$275	\$149.95

## JADE XPC IBM PC

- ▶ 256K of RAM Expands to 640K on Main Board
- ▶ 140 Watt Power Supply
- ▶ 4.77 or 7 MHz Clock
- ▶ 8 Expansion Slots
- ▶ Deluxe Keyboard
- ▶ 90 Day Warranty



- ▶ 256K of RAM Maximum on Main Board
- ▶ 63 Watt Power Supply
- ▶ 4.77 MHz Clock
- ▶ 5 Expansion Slots
- ▶ IBM Keyboard
- ▶ 90 Day Warranty

256K of RAM, Two 360K Disk Drives, & Disk Controller

**\$1295**

### OPTION #3

- 640K of RAM
- 10 Megabyte of Hard Disk
- One 360K Drive
- 130 Watts of Power
- Parallel & Serial Ports
- Color Card
- Taxan RGB Monitor

### OPTION #1

- 256K of RAM
- Two 360K Drives
- Color Card
- Amdek 300

IBM PC **\$1995**  
JADE XPC **\$1595**

**\$1695**

### OPTION #2

- 256K of RAM
- Two 360K Drives
- Parallel & Serial Ports
- Taxan RGB Monitor

IBM PC **\$2995**  
JADE XPC **\$2295**

IBM PC **\$2395**  
JADE XPC **\$1995**

Place Orders Toll Free!



# JADE

## Computer Products

4901 West Rosecrans Ave. Hawthorne, CA 90250

Continental U.S.A. Inside California Los Angeles Area  
(800) 421-5500 (800) 262-1710 (213) 973-7707

## EPSON Printers

### NEW EPSON FX-85 & FX-185 IN STOCK!

Call For Low, Low Prices

EPSON/COMREX 420 cps	\$2495	<del>\$1495.95</del>
2K Serial Board for FX/FX	\$149	<del>\$99.95</del>
NLO Board for FX/FX	\$219	<del>\$99.95</del>
LetterWriter NLO Kit for FX	\$75	<del>\$59.95</del>
LX-80 Tractor	\$59	<del>\$29.95</del>
FX-80 Tractor	\$59	<del>\$39.95</del>
LQ-1500 Tractor	\$89	<del>\$49.95</del>
LQ-1500 Sheet Feeder	\$499	<del>\$399.95</del>

## NEW! OKIDATA PRINTER MICROLINE

# 192 \$349.95

Call For Price

160 CPS. Near Letter Quality, & Graphics

	LIST	JADE	CALIFORNIA PRICE
OKIMATE 20 Color printer	\$150	<del>\$159.95</del>	\$150
PLUG-N-PRINT for OKI 20	\$75	<del>\$69.95</del>	\$75
OKI 182 120 cps, graphics	\$299	<del>\$259.95</del>	\$299
OKI 192 160 cps, graphics	\$499	<del>\$349.95</del>	\$499
OKI 193 160 cps, 15" paper	\$699	<del>\$449.95</del>	\$699
OKI 92 160 cps, graphics	\$599	<del>\$349.95</del>	\$599
OKI 93 160 cps, 15" paper	\$995	<del>\$599.95</del>	\$995
OKI 84 200 cps, parallel	\$1399	<del>\$799.95</del>	\$1399
OKI 84 200 cps, serial	\$1499	<del>\$949.95</del>	\$1499
Tractor for OKI 192	\$50	\$44.95	\$50
Tractor for OKI 92	\$89	\$54.95	\$89
2K Serial Board for 192/193	\$99	\$69.95	\$99
2K serial Board for 92/93	\$120	\$99.95	\$120
Extra Ribbon	\$9	\$4.95	\$9

## Double-sided Double-density Diskettes

# 99c Each

Includes envelopes and labels.

	LIST	JADE
Single-sided, double-density	\$34	\$15.90
Double-sided, double-density	\$42	\$19.90
Double-sided, 1.2 MB for AT	\$69	\$49.90
3 1/2" Single-sided for Mac	\$69	\$39.90
3 1/2" Double-sided for DG/1	\$89	\$49.90
Bulk Diskettes as low as		90c

Continental U.S.  
800-421-5500  
Inside California  
800-262-1710

For Technical Inquiries  
or Customer Service call:  
213-973-7707

## CITIZEN Printers

Best Near-Letter-Quality printers for under \$1000!!!

	LIST	JADE
CITIZEN MSP-10 FT 160 cps	\$499	\$299.95
CITIZEN MSP-15 FT 160 cps	\$749	\$429.95
CITIZEN MSP-20 FT 200 cps	\$699	\$429.95
CITIZEN MSP-25 FT 200 cps	\$949	\$599.95
CITIZEN Serial Option	\$60	\$49.95

## Printer Accessories

	LIST	JADE
IBM PC style cable	\$54	\$19.95
Standard parallel cable	\$40	\$19.95
Dual Printer Switch Box	\$149	\$69.95
Apple Card & cable	\$109	\$49.95
RS-232C serial cable	\$30	\$24.95
Ribbons	as low as	\$4.95
Apple IIC cable	\$39	\$19.95

## SHUGART 851R

Double-sided, Double-density

# 8" DISK DRIVE

LIST PRICE \$605  
**\$249.95**

	LIST	JADE
Dual 851 Sub-System KII	\$1445	\$599.95
Dual 851 Sub-System AAT	\$1645	\$799.95

Complete dual 851 disk drive sub-system with two Shugart SA-851R, cabinet, power supply, fan, etc.

WHY PAY \$1149 FOR A C. ITOH

# STARWRITER™ F-10

When Our 40 CPS Letter-Quality Daisywheel  
From The Same Manufacturer

IS ONLY **\$499.95**

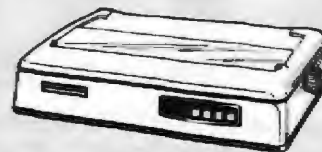

\* StarWriter is a Trademark of C. Itoh Digital Products, Inc.

## G. ITOH Printers

C. Itoh's best-selling ProWriter and StarWriter printers are now available with parallel interfaces for Apple & IBM, or a serial interface for Apple IIC, Macintosh, Data General, etc. Full one year manufacturers warranty.

	LIST	JADE
ProWriter 7500 FT 105 cps	\$289	\$209.95
ProWriter 8510 AP 120 cps	\$429	\$299.95
ProWriter II 1550 FT 120 cps	\$619	\$439.95
StarWriter Y10-20 20 cps	\$489	\$359.95
StarWriter A10-30 29 cps	\$669	\$479.95
StarWriter F10-40 40 cps	\$1199	\$899.95
StarWriter F10-55 58 cps	\$1449	\$1089.95
StarWriter F10 Tractor	\$249	\$159.95
StarWriter A10 Tractor	\$199	\$139.95

## Letter Quality Printers On Sale!

	LIST	JADE
JUKI 6100 18 CPS	\$599	\$399.95
JUKI 6300 40 CPS	\$995	\$649.95
COMREX CR-11a 20 CPS	\$599	\$399.95
NEC 3550 33 CPS	\$2250	\$1399.95
DIABLO 630 40 CPS	\$2340	\$1589.95
TOSHIBA P1340 180 CPS	\$995	\$599.95
TOSHIBA P1351 180 CPS	\$1895	\$1249.95
TOSHIBA P351 288 CPS	\$1850	\$1299.95
T.J. 855 150 CPS	\$935	\$689.95
T.J. 865 150 CPS	\$1299	\$949.95

## STAR Printers

	LIST	JADE
SG-10 120 CPS	\$299	\$239.95
SG-15 120 CPS	\$499	\$399.95
POWERTYPE 18 CPS	\$499	\$359.95

## A-B Printer Switch

Fully bi-directional switch allows your computer to run either of two printers, or allows two computers to share one printer, standard parallel switch box.

	LIST	JADE
Printer Switch	\$149	\$99.95
Extra Cable	\$40	\$29.95

## Data Switches

	LIST	JADE
SERIAL A-B Switch	\$129	\$79.95
PARALLEL A-B Switch	\$129	\$79.95
SERIAL A-B-C-D Switch	\$175	\$89.95
PARALLEL A-B-C-D Switch	\$175	\$89.95

## QUADRAM MICROFAZER Buffers



Expandable to 64K (parallel model expands to 512K)

8K Parallel in/Parallel out	\$169	\$139.95
64K Parallel in/Parallel out	\$225	\$164.95
128K Parallel in/Parallel out	\$445	\$269.95
8K Serial in/Parallel out	\$199	\$169.95
64K Serial in/Parallel out	\$260	\$199.95
8K Parallel in/Serial out	\$199	\$169.95
64K Parallel in/Serial out	\$260	\$199.95
8K Serial in/Serial out	\$199	\$169.95
64K Serial in/Serial out	\$260	\$199.95

## PRACTICAL PERIPHERAL MICROBUFFERS

Stand alone Microbuffers for Printers & Modems

	LIST	JADE
32K Parallel in/Parallel out	\$299	\$229.95
64K Parallel in/Parallel out	\$349	\$249.95
32K Serial in/Serial out	\$299	\$229.95
64K Serial in/Serial out	\$349	\$249.95
64K Add-on Board	\$179	\$149.95

We accept cash, checks, credit cards, or purchase orders from qualified firms and institutions. Minimum prepaid order \$15.00 California residents add 6 1/2% tax. Export customers outside the US or Canada please add 10% to all prices. Prices and availability subject to change without notice. Shipping and handling charges via UPS Ground 50c/lb. UPS Air \$1.00/lb. minimum charge \$3.00.

# JADE Computer Products

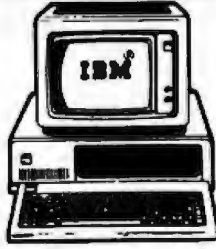

<b>IBM PC</b> 256k, 2 floppies (360k)	<b>IBM PC 10 MB</b> 256k, 1 or 2 floppies (360k) 10 MB Hard Disk (auto boot)		<b>IBM XT</b> 256k, 2 floppies (360k)	<b>IBM XT 10 MB</b> 256k, 1 or 2 floppies (360k) 10 MB Hard Disk
<b>IBM PC 20 MB</b> 256k, 1 or 2 floppies (360k) 20 MB Hard Disk (auto boot)	<b>IBM PC 30 MB</b> 256k, 1 or 2 floppies (360k) 30 MB Hard Disk (auto boot)		<b>IBM XT 20 MB</b> 256k, 1 or 2 floppies (360k) 20 MB Hard Disk	<b>IBM PC 30 MB</b> 256k, 1 or 2 floppies (360k) 30 MB Hard Disk
<b>IBM PC 10 + 10</b> 256k, 1 or 2 floppies (360k) 10 MB HD & 10 MB Tape Backup	<b>IBM PC 20 + 20</b> 256k, 1 or 2 floppies (360k) 20 MB HD & 20 MB Tape Backup		<b>IBM XT 10 + 10</b> 256k, 1 or 2 floppies (360k) 10 MB HD & 10 MB Tape Backup	<b>IBM XT 20 + 20</b> 256k, 1 or 2 floppies (360k) 20 MB HD & 20 MB Tape Backup
<b>IBM AT 20 MB</b> 512k, 1 or 2 floppies (360k/1.2 MB), 20 MB HD	<b>IBM AT 40 MB</b> 512k, 1 or 2 floppies (360k/1.2 MB), 40 MB HD		Call for the latest prices for your custom configuration. All systems are configured and tested at no extra cost and come only with CompuMail's 90 day warranty.	<b>IBM AT 80 MB</b> 512k, 1 or 2 floppies (360k/1.2 MB), 80 MB HD

**★ PRICE WAR ★ CALL US LAST WITH YOUR BEST QUOTES ★**

**PRINTERS      FLOPPY/HARD DISKS      DISPLAY CARDS      MODEMS**

<b>EPSON FX-80+</b> \$339	<b>FX-100+</b> \$459	<b>LX-80/HR-80/JX-80</b> \$219/\$359/\$469	<b>Tractor LX-80/FX-80/HR-80</b> \$50/\$60/\$70	<b>LO 1500 Parallel/Serial</b> \$699/\$969	<b>LO Tract/Sing/Dual Sht Fdr</b> \$70/\$450/\$750	<b>LX-90 w/Par Interface &amp; Tractor</b> \$279	<b>SO-2000</b> CALL	
<b>DK/DATA TOO LOW TO QUOTE</b>								
<b>OKIMATE 20 w/IBM Plug &amp; Print</b>								
<b>182-P/182-IBM</b>	<b>192-P/192-IBM</b>	<b>193-P/193-IBM</b>	<b>84-P/84-IBM</b>	<b>192 Tractor</b> \$70	<b>84 Sht Fdr</b> \$390	<b>TOSHIBA 1340P/351P</b> \$519/\$1099	<b>351 Tractor/Sht Fdr</b> \$190/\$790	
<b>JUKI 6100/6300</b>	<b>6100/6300 Tractor/Sht Fdr</b> \$349/\$679	<b>6100/6300 Tractor/Sht Fdr</b> \$150/\$250	<b>5510P (160cps)</b> \$369	<b>5510 Color Kit</b> \$150	<b>BROTHER HR-10/HR-15XL</b> \$299/\$349	<b>HR-15 Trac/Kybord/Sht Fdr</b> \$110/\$160/\$190	<b>HR-25P/HR-35P</b> \$449/\$649	
<b>HR-25/35 Tractor/Sht Fdr</b>	<b>2024L/2024L Graphics-24 pin, 160/80 cps</b> \$899	<b>2024L Sht Fdr-Narrow/Wide</b> \$220/\$290	<b>TWINWRITER 5</b> World's First Dot Matrix & Daisy Wheel combined in ONE \$999	<b>TWINWRITER 5 Tractor/Sht Fdr</b> \$250/\$350	<b>C. ITON ProWriter Jr w/NLO</b> \$229	<b>8510BP1</b> \$309	<b>8510SEP + NLO</b> \$399	
<b>8510SCEP + NLO</b> \$469	<b>1550EP</b> \$429	<b>1550SEP + NLO</b> \$539	<b>1550SCEP + NLO</b> \$639	<b>24LP</b> \$999	<b>A10-30SP</b> \$439	<b>Y10-20P</b> \$399	<b>A10 Tractor</b> \$160	
<b>F10-40P</b> \$899	<b>F10-55P</b> \$1099	<b>F10 Tractor/Sht Fdr</b> \$190/\$290	<b>CJX-4800P 4 Pen Plotter</b> \$449	<b>QUJME LetterPro 20P (20 cps)</b> \$399	<b>20P Trac/Sht Fdr</b> \$150/\$390	<b>SPRINT 1140 + /1155 +</b> \$1299/\$1399	<b>SPRINT Interface Module</b> \$80	
<b>SPRINT Trac/Sht Fdr</b> \$210/\$690	<b>PANASONIC KX-P3151 LO (22cps)</b> \$469	<b>KX-P1090/91/92/93</b> \$179/\$249/\$349/\$449	<b>STAR MICRONIX Power Type/SB-10</b> \$329/CALL	<b>SG-10/SB-15 (120cps)</b> \$239/\$389	<b>SD-10/SD-15 (160cps)</b> \$349/\$459	<b>SR-10/SR-15 (200cps)</b> \$499/\$599	<b>NEC PINWRITER P-2/P-3</b> \$499/\$699	
<b>Sht Fdr for P-2/P-3</b> \$350/\$420	<b>2050/3550/8850</b> \$649/\$999/\$1399	<b>SPINWRITER Trac/Sht Fdr</b> \$190/\$790	<b>ELF 360 Par (16cps)</b> \$419	<b>DIABLO Advantage D-25</b> \$529	<b>630 API</b> \$1599	<b>630 ECS-IBM</b> \$1799	<b>Trac/Mech Single Bin Sht Fdr</b> \$230/\$470	
<b>CITIZEN</b> 18 months manufacturer warranty	<b>MSP-10/15 (160/40cps)</b> \$319/\$479	<b>MSP-20/25 (200/50cps)</b> \$469/\$639	<b>LEGEND CP-VII</b> \$949	<b>1200</b> \$279	<b>880/1380/1385</b> \$229/\$299/\$359	<b>AMADEX 9620B/9625B-PLUS</b> \$1199/\$1299	<b>9725B COLOR</b> \$1399	
<b>WFS6000/DF6500</b> \$2299/\$2569	<b>Anadex Tractor/Sht Fdr</b> \$150/\$950	<b>SILVER REED Letter Quality Printers</b>	<b>400/500/550/770</b> \$249/\$329/\$399/\$739					

<b>CDC/PANASONIC/TANDON/TEAC</b>	<b>Hali HI DSDO</b> \$92	<b>Warranted for IBM PCs only</b> 10+ \$85	<b>CDC/TANDON Full Ht DSDO</b> \$99
<b>HARD DISKS FOR IBM PC/XT</b>			
<b>10 MB Int w/Controller</b> \$499	<b>10 MB Ext w/Controller</b> \$699	<b>20 MB Int w/Controller</b> \$599	<b>20 MB Ext w/Controller</b> \$799
<b>33 MB Int w/Controller</b> \$849	<b>33 MB Ext w/Controller</b> \$1049	<b>44 MB Int w/Controller</b> \$1049	<b>44 MB Ext w/Controller</b> \$1249
<b>70 MB Int or Ext w/Controller</b> CALL	<b>140 MB Int or Ext w/Controller</b> CALL	<b>HARD DISKS FOR IBM PC AT</b>	
<b>CORE ATplus 20,30,40,56,72 &amp; 144 MB</b> CALL			
<b>BACKUP FOR IBM PC/XT</b>			
<b>10 MB Int/Ext</b> \$499/\$669	<b>20 MB Int/Ext</b> \$599/\$749	<b>40/60 MB Int/Ext</b> CALL	<b>TALL GRASS NEW PC/T FORMAT</b>
<b>25/35 MB w/60 MB Backup</b> \$2599/\$3399	<b>50/80 MB w/60 MB Backup</b> \$4299/\$5499	<b>60 MB Tape Backup only</b> CALL	<b>Controller</b> \$40
<b>EVEREX 10/20 MB Int w/Cont</b> \$579/\$699	<b>EXCEL 4500 45MB B/U-Int/Ext</b> \$949/\$999	<b>APEX MEG-1000 100MB Tape B/U-EXT</b> \$1399	<b>EXTERNAL EXPANSION SYSTEMS</b> CALL
<b>INTERDYNE TAPE BACKUP</b>			
<b>10 MB Int/Ext</b> \$499/\$669	<b>20 MB Int/Ext</b> \$599/\$749	<b>IRWIN MAGNETICS TAPE BACKUP REDUCED</b>	
<b>IDOMEGA Bernoulli Box 10 + 10</b> CALL			
<b>AMPEX PC Megastore</b> CALL			
<b>EMULEX JAVELIN HD &amp; BACKUP</b> CALL			
<b>PWR SUPPLY 130/150 Watts</b> ↓ \$88/\$128			

<b>MULTI-FUNCTION CARDS</b>			
<b>AST SDPAK O-K</b> \$239	<b>384K</b> \$279	<b>AST Advantage O-K</b> \$399	<b>ORCHID Blossom O-K</b> \$169
<b>384K</b> \$209	<b>ORCHID Excell (up to 4 MB)</b> CALL	<b>TECMAR Captain O-K</b> \$179	<b>384K</b> \$219
<b>MAESTRO AT w/Treasure Chest</b> Best Price	<b>INTEL Above Board (up to 4 MB)</b> CALL	<b>PARADISE 5-Pack O-K</b> \$159	<b>384K</b> \$199
<b>BT6 Plus w/64k</b> \$179	<b>384k</b> \$209	<b>IDS B-512 O-K</b> \$179	<b>384k</b> \$219
<b>P/S/G Ports, Clock/Cal &amp; sockets for 512k</b>	<b>QUADBOARD O-K</b> \$189	<b>384k</b> \$229	<b>Silver Quadboard: O-K to 640k</b> CALL
<b>Gold Quadboard: Multifunction &amp; Color</b> CALL	<b>Quadmag-AT (up to 4 MB)</b> CALL	<b>Quadport-AT/Expansion Kit</b> CALL	<b>INSTALL RAM &amp; test brd for PC/AT</b> \$20/\$40

<b>HERCULES MonoGraphics</b> \$279	<b>Color</b> \$149	<b>EVEREX The Edge</b> Best Price Ever	<b>Graphics Edge</b> Even Better Price
<b>AST Monograph Plus</b> \$339/\$369	<b>Preview for Mono Graphics</b> \$279	<b>Graphpack w/64k</b> \$549	<b>PERSYST Short Color/Mini Mono</b> \$159/CALL
<b>Color Combo: Multifunction &amp; Color</b> from \$299	<b>Mono Combo: Multifunction &amp; Mono</b> from \$299	<b>PERSYST BoB Board</b> \$339 w/TAXAN 440 \$799	<b>QUADRAM Quadcolor I</b> \$179
<b>Gold Quadboard: Multifunction &amp; Color</b> CALL	<b>STB Chaffier</b> CALL	<b>PARADISE Modular Brd</b> from \$269	<b>IDS B-450 Mono, Color &amp; Par Port</b> \$229
<b>TECMAR Graphics Master</b> \$439	<b>G Master w/TECMAR Color Monitor</b> \$939	<b>G Master w/AMDEK 710 Color Monitor</b> \$899	<b>GENOA Spectrum</b> Best Price
<b>MYLEX Chairman</b> \$399	<b>SIGMA COLOR 400 (specify Monitor)</b> \$479	<b>COLOR 400 w/PGS SR-12</b> \$999	<b>COLOR 400 w/TAXAN 440</b> \$939
<b>3 Button PC Mouse w/PC Paint</b> Add \$100	<b>MONITORS</b>		
<b>P88 MAX-12E/HX-12/HX-12E</b> \$169/\$419/\$499	<b>H8-9/HX-9E/SR-12</b> \$419/\$499/\$549	<b>SR-12 w/Scan Doubler</b> \$699	<b>SR-12 w/Sigma 400</b> \$999
<b>TAXAN COMPOSIT 115 Green/116 Amber</b> \$129	<b>MONO 121 Gr/122 Amb</b> \$139/\$149	<b>COLOR 410/411/420</b> \$289/\$299/\$359	<b>COLOR 420L/425/440</b> \$369/\$369/\$489
<b>COLOR 440 w/TAXAN 555 RGB Card</b> \$749	<b>COLOR 440 w/Persyst BoB Brd</b> \$799	<b>COLOR 440 w/Sigma 400</b> \$939	<b>AMDEK 300G/300A/310A(M)</b> \$139/\$149/\$159
<b>COLOR 300/500/600</b> \$239/\$349/\$419	<b>710 \$489 w/TECMAR Graphics Master</b> \$899	<b>QUADRAM AMBERCHROME</b> \$149	<b>ROLAND MB-142 14" Mono B/W</b> \$289
<b>TECMAR Color</b> \$529 w/Graphics Master \$939	<b>TILT/SWIVEL Monitor Pedestal</b> \$30	<b>SPECIAL ITEMS</b>	
<b>IRMA, IRMAlette, IRMAline, IRMAprint</b>	<b>Emulates 3278, 3279</b>	<b>CXI: PCOX Emulates 3274, 3278, 3279</b>	<b>FORTE: PJ Card Emulates 3278, 3279, 3287</b>
<b>3270PC, 278RJE, 3780RJE (Specify)</b>	<b>AST 3780, 5251/11, 5251/12, BSC, SNA, PCOX</b>	<b>ORCHID PCnel Plus Complete Line</b> CALL	<b>OBORON OMNI READER Optical Character Reader</b>
<b>w/IBM Interface Software</b> CALL	<b>POLAROID Palette</b> \$1249		

<b>EasyData 128 300/1200 Bd Int w/PCTalk III</b> \$199	<b>HAYES 1200 B w/SmartCom II</b> \$329	<b>HAYES 1200 Ext. w/o Software</b> \$349	<b>Smartcom II \$99 NEW 2400 Bd Ext.</b> \$589
<b>POPCOM C-100/X-100 w/o sft</b> \$269/\$289	<b>POPCOM Action Pack Int w/PFS:Access</b> \$289	<b>POPCOM Action Pack Ext w/PFS:Access</b> \$299	<b>AST Reach! 1200 Bd short card w/Crosstalk</b> \$379
<b>PROMETHEUS PROMODEM 1200 Ext</b> \$279	<b>Options Processor</b> \$89 w/Modem \$75	<b>Alpharum Display</b> \$89 w/Modem \$75	<b>PROMODEM 1200 Ext + Both Options</b> \$419
<b>Comm Buffer for 1200 Ext</b> CALL	<b>PROMODEM 1200 B Int w/MITE software</b> \$249	<b>QUADMODEM II shorthand w/Crosstalk XVI</b> CALL	<b>2400 Bd Upgrade Kit for Quadmodem II</b> CALL
<b>Van-Tel Hail Card w/Crosstalk XVI</b> \$379	<b>1200 Plus Ext w/o software</b> \$349	<b>BIZCOMP IntelliModem EXT</b> \$319	<b>ST/XL/XT</b> \$289/\$319/\$358
<b>WATSON Integrated Voice Data Modem</b> CALL	<b>MISC. ADD ONS</b>		
<b>BAK RAM Set \$7 10+ Sets \$6 50+ \$5</b>	<b>256K RAM Set \$35 10+ Sets \$33 50+ \$30</b>	<b>8087 5mhz for IBM PC</b> \$699	<b>80287-3 5mhz for IBM AT</b> \$629
<b>ORCHID PC turbo w/128k</b> \$540k	<b>ORCHID QUADROSPRINT</b> \$499	<b>MICROWAY'S Fastbreak #7 Smasher</b> CALL	<b>CABLE Parallel, 6R, 320 Serial, 6 ft</b> \$25
<b>Keyboard Extension, 6 ft</b> \$10	<b>MAXELL MD-2 DSDO 10+ Boxes</b> \$18	<b>FLOPPY Drive Controller</b> \$109	<b>FLOPPY Controller w/P.S.G &amp; Clock/Cal</b> \$199
<b>HAYES Transel 1000</b> CALL	<b>MOUSE SYSTEMS PC Mouse w/PC Paint</b> \$129	<b>MICROSOFT MOUSE w/PC Paintbrush</b> \$129/\$139	<b>Bus/Serial</b> \$129/\$139
<b>KEYTRONIC KB 5151 \$165 AT Upgrade Kit</b> \$15	<b>KB 5153T w/Touch Pad</b> CALL	<b>ABC Switch Box: Allows 3 Computers to share 1 printer/peripheral &amp; vice versa</b> CALL	<b>COMPUTER ACCESSORIES P1-2-3</b> \$299
<b>POWER DIRECTOR P2(5), \$89 P12(6)</b> \$129	<b>KENSINGTON Master Piece (5 outlets)</b> \$89	<b>KENSINGTON Universal Printer Stand</b> \$20	<b>PC Keyboard Storage Drawer</b> \$89
<b>STANDBY PWR SUPPLY w/surge protection</b>	<b>200 Watts \$269</b>	<b>300 Watts</b> CALL	<b>800 Watts (Sane Wave)</b> \$679
<b>TILT/SWIVEL Monitor Pedestal</b> \$30	<b>PWR SUPPLY 130/150 Watts</b> ↓ \$88/\$128		

**COMPANY POLICY:** Min. order \$100. Prices & availability subject to change. We ship UPS only. Shipping/handling charges vary. Prices reflect cash discount on prepaid orders. Add 1% for C.O.D. orders. 3% for MC/VISA & 5% for AMEX. C.O.D. requires cashiers check. All merchandise sold as new and all sales are final. Returned shipments subject to 20% charge (Min \$50). Products shipped in factory cartons come with manufacturer warranty. For others, including IBM systems, call tech support for return auth. If for warranty repairs, Non-defective items returned as defective subject to 10% service charge (Min. \$50). Not responsible for hardware or software compatibility of any product. No open acct PO's or foreign orders. No showroom, demonstrations or walk-in sales. Personal or company checks take 3 weeks to clear. FOR ADVANCE PAYMENTS or PICKUP, PLEASE CALL FIRST FOR WORKORDER #.

**CALL FOR OUR WEEKLY UNADVERTISED SPECIALS**



**COMPU**  **805-987-7015**

406-C CONSTITUTION AVE., CAMARILLO, CA 93010      WHEN ORDERING PLEASE REFER TO AD #B802

## Lotus™ User?

Free Mail Order Catalog for Lotus Software users, includes:

- Lotus Programs
- Lotus Enhancement Software
- Books and Training Aids
- Hardware and Utilities

We are a unique mail order company specializing in Lotus related products.

4-5-6 WORLD  
Dept. A-108  
P.O. Box 22657  
Santa Barbara, CA 93121  
(800) 524-5678 Toll Free  
(805) 564-2424 In California



Your definitive Lotus enhancement source

Inquiry 2

## 68701/705 PROGRAMMER

28 and 40 PIN Packages

- Single Switch Operation
- LED Status Displays
- Copies from 2732
- Self Contained

Many features are included to insure trouble free operation. Can be used with Logical Devices PP8 or Prompro-XP to eliminate the need for the intermediate EPROM.

SEE OUR AD ON PAGE 24.

**LOGICAL DEVICES, INC**  
Order Toll Free  
1-800-EE1-PROM

Inquiry 181

## BAR CODE READER



- IBM PC/XT COMPATIBLE (AND MOST CLONES)
- CONNECTS BETWEEN KEYBOARD AND THE PC
- NO CARD SLOT REQUIRED/SIMPLE INTERCONNECT
- NO CUSTOM SOFTWARE DRIVERS REQUIRED
- HIGH FIRST READ RATE
- READS DOT MATRIX & PRINTED BAR CODE LABELS
- CODE 3 OF 9, INTERLEAVED 2 OF 5, UPC
- AUTOMATIC BAR CODE SELECTION
- AUDIO AND VISUAL INDICATORS
- READS HIGH, MED. AND LOW DENSITY LABELS
- SWITCH SELECTABLE OPTIONS
- SELF-TEST DIAGNOSTICS

**\$495 ea.**

PC/MS DOS BAR CODE PRINTING SOFTWARE \$79 ea.

**AMERICAN MICROSYSTEMS**

P.O. BOX 830551, RICHARDSON, TX. 75080

(817) 834-9659

MASTERCARD AND VISA ACCEPTED



## DATAFLEX™

- Multi-user Databases
- Powerful!
- Multiple Operating System Compatibility!
- Attractive Dealer Pricing!
- Full Dealer Support!

Dataflex is a trademark of Data Access  
Dealer Inquiries Invited

## COGITATE

24000 Telegraph Road  
Southfield, Michigan 48034 USA  
(313) 352-2345

Inquiry 58

## INTERACTIVE VIDEO TAPE CONTROLLER

Interface card that allows your IBM PC to control Panasonic video tape players. Works with the McGraw-Hill Interactive Authoring System. For only \$995 you can be producing interactive video programs.

For more information call  
David Ayala  
McGraw-Hill Training Systems  
1-800-421-0833  
In California call  
1-800-662-6222

**McGraw-Hill Training Systems**

Apple II + Paper Tape I/O Is This Easy  
01010101010001010:.....  
01010101010010100.....  
One minute you're without, the next you're up and running! Just plug into your APPLE II PLUS. A neat and complete package.

- Model 600-1 Punch — 50cps, rugged
- Model 605 Reader — 150cps
- Parallel Interface Board/Cable
- Data Handling Program

Code conversion available. TRS-80 package soon. ADDMASTER CORP. 416 Junipero Serra Dr., San Gabriel, CA 91776 \* 213/285-1121.

Inquiry 8

## EPROM PROGRAMMER



APROTEK 1000 ONLY

**\$265.00**

COMPLETE WITH PERSONALITY MODULE

117 AC POWER-RS232  
-6 BAUD RATES - HANDSHAKE TO HOST  
ALLOWS READ, WRITE, VERIFY & COPY  
Comes complete with CPM, IBM and Apple BASIC Driver Program Listings. Driver Programs on Disk only \$20.00.

Programs the following 5 Volt 24 or 28 pin devices: 2716 series through 27255, 25xx series, 88784 plus others. Please Specify Personality Module desired with order. Additional Personality Modules only \$15.00 ea. Full 1 year warranty.

TO ORDER: CALL 1-800/962-5800 OR WRITE

APROTEK

1071 A AVENIDA ACASO  
CAMARILLO CA 93010  
Info: (805) 987 2454

Add  
\$4.00 Shipping/USA  
VISA or MC Add 3%

Inquiry 22

## SUPERCOPY FOR IBM PC

Powerful utility copier, it allows making of backups of any diskette for IBM PC and compatibles.

Very compact, it replaces the Diskcopy without virtually losing any space. Its menu offers easy access to functions such as protection against copies from a diskette; analysis diagnosis; parameter modification and erasing of the target diskette.

Available in English, French and Spanish with instructions included in the diskette.

Frequently updated, its price is \$30 each or \$15 for orders of ten or more. This product is provided for the purpose of enabling you to make archival copies only.

N.Y. residents add sales tax.

Send check or money order to:

**Yetiware**  
P.O. Box 1368  
New York, NY 10025  
212-222-6682

IBM PC is a trademark of IBM Corporation.

**WE WANT DEALERS.**

Inquiry 346

## FREE SOFTWARE FROM THE PUBLIC DOMAIN

User Group Software isn't copyrighted, so no fees to pay! 1000's of CP/M and IBM software programs in .COM and source code to copy yourself! Games, business, utilities! All FREE!

	Rent	Buy
IBMPC-SIG 1-370 Diskettes .....	400.	800.
IBMPC-BLUE 1-118 Diskettes .....	145.	375.
SIG/M UG 1-222 Diskettes .....	130.	625.
CP/M UG 1-92 Diskettes .....	45.	250.
PICO NET 1-34 Diskettes .....	25.	100.
KAYPRO UG 1-39 Diskettes .....	45.	90.
EPSON UG 1-38 Diskettes .....	45.	90.
Commodore CBM 1-28 Diskettes ..	25.	65.

Public Domain User Group Catalog Disk \$5 pp. (payment in advance, please)

Rental is for 7 days after receipt, 3 days grace to return. Use a credit card, no disk deposit.

Shipping, handling & insurance \$9.50 per library.  
(818) 941-0928 Orders & Technical (9 to 5)  
(818) 927-1015 24 Hr. 3 Min. Info Recording  
Have your credit card ready!

**National Public Domain Software**

1533 Avonhill Dr.  
Vista, CA 92083



BBB



AM EX

Inquiry 226

**STATIC RAMS**

2701	256x4	(450ns)	1.88
5101	256x4	(450ns)(cmos)	3.88
2102-1	1024x1	(450ns)	1.88
2102L-1	1024x1	(450ns)(LP)	.89
2102L-2	1024x1	(250ns)(LP)	1.46
2125	1024x1	(45ns)	2.95
2111	256x4	(450ns)	2.49
2111L	256x4	(450ns)(LP)	2.49
2112	256x4	(450ns)	2.39
2114	1024x1	(450ns)	8/3.95
2114-25	1024x1	(250ns)	8/10.95
2114L-4	1024x1	(450ns)(LP)	8/12.95
2114L-3	1024x1	(300ns)(LP)	8/13.48
2114L-2	1024x1	(200ns)(LP)	8/13.95
2114L-15	1024x1	(150ns)(LP)	8/18.95
TC5514	1024x4	(650ns)(cmos)	4.88
2147	4096x1	(200ns)	2.95
2147	4096x1	(55ns)	4.88
2148	1024x1	(70ns)	4.88
TMS4044-4	4096x1	(450ns)	3.49
TMS4044-3	4096x1	(300ns)	3.99
TMS4044-2	4096x1	(200ns)	4.49
TMS4044-1	4096x1	(200ns)(LP)	4.88
UPD4110	4096x1	(100ns)	3.95
MK4118	4096x1	(200ns)	8/3.95
TMM2016-200	2048x8	(200ns)	3.25
TMM2016-150	2048x8	(150ns)	3.78
TMM2016-100	2048x8	(100ns)	4.75
HM6116-4	2048x8	(200ns)(cmos)	3.69
HM6116-3	2048x8	(150ns)(cmos)	3.95
HM6116-2	2048x8	(120ns)(cmos)	5.95
HM6116LP-4	2048x8	(150ns)(cmos)(LP)	3.95
HM6116LP-3	2048x8	(150ns)(cmos)(LP)	4.25
HM6116LP-2	2048x8	(120ns)(cmos)(LP)	5.95
TC5518	2048x8	(250ns)(cmos)	9.95
TMS4016	2048x8	(200ns)	6.95
Z-6132	4096x8	(300ns)(Qstat)	34.95
HM6284P-15	8192x8	(150ns)(cmos)	7.75
HM6284LP-15	8192x8	(120ns)(cmos)(LP)	7.95
HM6284LP-12	8192x8	(120ns)(cmos)(LP)	8.99

LP-Low power Qstat-Quasi-Static.

**DYNAMIC RAMS**

TMS4027	4096x1	(250ns)	1.99
2107	4096x1	(200ns)	1.95
MM5280	4096x1	(300ns)	1.95
TMS4050	4096x1	(300ns)	1.95
UPD4111	4096x1	(200ns)	1.95
TMS4060	4096x1	(300ns)	1.95
MK4108	8192x1	(200ns)	.49
MM5298	8192x1	(250ns)	.49
4116-300	16384x1	(300ns)	8/6.95
4116-250	16384x1	(250ns)	8/6.95
4116-200	16384x1	(200ns)	8/9.95
4116-150	16384x1	(150ns)	8/10.95
4116-120	16384x1	(120ns)	8/12.95
2118	16384x1	(150ns)(5v)	4.95
MK4332	32768x1	(200ns)	9.95
4164-200	65536x1	(200ns)(5v)	9/3.95
4164-150	65536x1	(150ns)(5v)	9/3.95
4164-120	65536x1	(120ns)(5v)	3.95
MM6665	65536x1	(200ns)(5v)	4.95
TMS4164-20	65536x1	(200ns)(5v)	4.95
TMS4164-15	65536x1	(150ns)(5v)	4.95
4164-REFRESH	65536x1	(150ns)(5v)(REFRESH)	8.95
TMS4416-20	16384x4	(200ns)(5v)	8.95
TMS4416-15	16384x4	(150ns)(5v)	8.95
41128-150	131072x1	(150ns)(5v)	13.95
41256-200	262144x1	(200ns)(5v)	3.95
41256-150	262144x1	(150ns)(5v)	3.95

5v-Single 5 Volt Supply REFRESH-Pin 1 Refresh

**EPROMS**

1702	256x8	(1us)	4.80
2708	1024x8	(480ns)	3.95
2710	1024x8	(450ns)(5V)	5.95
2710-6	2048x8	(650ns)	2.95
2715	2048x8	(450ns)(5V)	3.50
2718-1	2048x8	(350ns)(5V)	4.95
TMS2716	2048x8	(450ns)(5V)	4.95
TMS2716	2048x8	(450ns)	7.95
TMS2732	4096x8	(450ns)(5V)	4.95
2732A-4	4096x8	(450ns)(5V)	4.95
2732A-35	4096x8	(350ns)(5V)(21V PGM)	4.95
2732A	4096x8	(250ns)(5V)(21V PGM)	6.95
2732A-2	4096x8	(200ns)(5V)(21V PGM)	10.95
2764	8192x8	(450ns)(5V)	3.75
2764-250	8192x8	(250ns)(5V)	3.95
2764-200	8192x8	(200ns)(5V)	6.95
TMS2764	8192x8	(450ns)(5V)	10.95
MCM68764	8192x8	(450ns)(5V)(24 pin)	24.95
MCM68766	8192x8	(350ns)(5V)(24 pin)	42.95
27128-30	16384x8	(300ns)(5V)	5.95
27128	16384x8	(250ns)(5V)	8.95
27256	32768x8	(250ns)(5V)	12.95

5V-Single 5 Volt Supply 21V PGM-Program at 21 Volts

**CRYSTALS**

32.768 KHz	1.95
1.0 MHz	3.95
1.8432	3.95
2.0	2.95
2.097152	2.95
2.4576	2.95
3.2768	2.95
3.579545	2.95
4.0	2.95
4.032	2.95
5.0	2.95
5.0688	2.95
5.195	2.95
5.7143	2.95
6.0	2.95
6.144	2.95
6.5536	2.95
8.0	2.95
10.0	2.95
10.738635	2.95
14.31818	2.95
15.0	2.95
16.0	2.95
17.430	2.95
18.0	2.95
18.432	2.95
20.0	2.95
22.0	2.95
24.0	2.95

**CRYSTAL OSCILLATORS**

1.0MHz	7.95	8.0	7.95
1.8432	7.95	10.0	7.95
2.0	7.95	12.0	7.95
2.4576	7.95	15.0	7.95
2.5	7.95	16.0	7.95
4.0	7.95	18.432	7.95
5.0688	7.95	20.0	7.95
7.95	7.95	24.0	7.95
6.144	7.95		

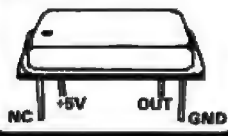

**74LS00**

74LS00	.24	74LS130	.89
74LS01	.25	74LS131	.89
74LS02	.25	74LS132	.79
74LS03	.25	74LS133	.79
74LS04	.24	74LS134	.69
74LS05	.25	74LS135	.69
74LS06	.25	74LS136	.79
74LS07	.25	74LS137	.79
74LS10	.25	74LS138	.89
74LS11	.25	74LS139	.89
74LS12	.25	74LS240	.95
74LS13	.25	74LS241	.99
74LS14	.25	74LS242	.99
74LS15	.25	74LS243	.99
74LS16	.25	74LS244	1.29
74LS17	.25	74LS245	1.49
74LS18	.25	74LS246	1.49
74LS19	.25	74LS247	1.49
74LS20	.25	74LS248	.95
74LS21	.25	74LS249	.99
74LS22	.25	74LS250	.99
74LS23	.25	74LS251	.99
74LS24	.25	74LS252	.99
74LS25	.25	74LS253	.99
74LS26	.25	74LS254	.99
74LS27	.25	74LS255	.99
74LS28	.25	74LS256	.99
74LS29	.25	74LS257	.99
74LS30	.25	74LS258	.99
74LS31	.25	74LS259	.99
74LS32	.25	74LS260	.99
74LS33	.25	74LS261	.99
74LS34	.25	74LS262	.99
74LS35	.25	74LS263	.99
74LS36	.25	74LS264	.99
74LS37	.25	74LS265	.99
74LS38	.25	74LS266	.99
74LS39	.25	74LS267	.99
74LS40	.25	74LS268	.99
74LS41	.25	74LS269	.99
74LS42	.25	74LS270	.99
74LS43	.25	74LS271	.99
74LS44	.25	74LS272	.99
74LS45	.25	74LS273	.99
74LS46	.25	74LS274	.99
74LS47	.25	74LS275	.99
74LS48	.25	74LS276	.99
74LS49	.25	74LS277	.99
74LS50	.25	74LS278	.99
74LS51	.25	74LS279	.99
74LS52	.25	74LS280	.99
74LS53	.25	74LS281	.99
74LS54	.25	74LS282	.99
74LS55	.25	74LS283	.99
74LS56	.25	74LS284	.99
74LS57	.25	74LS285	.99
74LS58	.25	74LS286	.99
74LS59	.25	74LS287	.99
74LS60	.25	74LS288	.99
74LS61	.25	74LS289	.99
74LS62	.25	74LS290	.99
74LS63	.25	74LS291	.99
74LS64	.25	74LS292	.99
74LS65	.25	74LS293	.99
74LS66	.25	74LS294	.99
74LS67	.25	74LS295	.99
74LS68	.25	74LS296	.99
74LS69	.25	74LS297	.99
74LS70	.25	74LS298	.99
74LS71	.25	74LS299	.99
74LS72	.25	74LS300	.99
74LS73	.25	74LS301	.99
74LS74	.25	74LS302	.99
74LS75	.25	74LS303	.99
74LS76	.25	74LS304	.99
74LS77	.25	74LS305	.99
74LS78	.25	74LS306	.99
74LS79	.25	74LS307	.99
74LS80	.25	74LS308	.99
74LS81	.25	74LS309	.99
74LS82	.25	74LS310	.99
74LS83	.25	74LS311	.99
74LS84	.25	74LS312	.99
74LS85	.25	74LS313	.99
74LS86	.25	74LS314	.99
74LS87	.25	74LS315	.99
74LS88	.25	74LS316	.99
74LS89	.25	74LS317	.99
74LS90	.25	74LS318	.99
74LS91	.25	74LS319	.99
74LS92	.25	74LS320	.99
74LS93	.25	74LS321	.99
74LS94	.25	74LS322	.99
74LS95	.25	74LS323	.99
74LS96	.25	74LS324	.99
74LS97	.25	74LS325	.99
74LS98	.25	74LS326	.99
74LS99	.25	74LS327	.99
74LS100	.25	74LS328	.99
74LS101	.25	74LS329	.99
74LS102	.25	74LS330	.99
74LS103	.25	74LS331	.99
74LS104	.25	74LS332	.99
74LS105	.25	74LS333	.99
74LS106	.25	74LS334	.99
74LS107	.25	74LS335	.99
74LS108	.25	74LS336	.99
74LS109	.25	74LS337	.99
74LS110	.25	74LS338	.99
74LS111	.25	74LS339	.99
74LS112	.25	74LS340	.99
74LS113	.25	74LS341	.99
74LS114	.25	74LS342	.99
74LS115	.25	74LS343	.99
74LS116	.25	74LS344	.99
74LS117	.25	74LS345	.99
74LS118	.25	74LS346	.99
74LS119	.25	74LS347	.99
74LS120	.25	74LS348	.99
74LS121	.25	74LS349	.99
74LS122	.25	74LS350	.99
74LS123	.25	74LS351	.99
74LS124	.25	74LS352	.99
74LS125	.25	74LS353	.99
74LS126	.25	74LS354	.99
74LS127	.25	74LS355	.99
74LS128	.25	74LS356	.99
74LS129	.25	74LS357	.99
74LS130	.25	74LS358	.99
74LS131	.25	74LS359	.99
74LS132	.25	74LS360	.99
74LS133	.25	74LS361	.99
74LS134	.25	74LS362	.99
74LS135	.25	74LS363	.99
74LS136	.25	74LS364	.99
74LS137	.25	74LS365	.99
74LS138	.25	74LS366	.99
74LS139	.25	74LS367	.99
74LS140	.25	74LS368	.99
74LS141	.25	74LS369	.99
74LS142	.25	74LS370	.99
74LS143	.25	74LS371	.99
74LS144	.25	74LS372	.99
74LS145	.25	74LS373	.99
74LS146	.25	74LS374	.99
74LS147	.25	74LS375	.99
74LS148	.25	74LS376	.99
74LS149	.25	74LS377	.99
74LS150	.25	74LS378	.99
74LS151	.25	74LS379	.99
74LS152	.25	74LS380	.99
74LS153	.25	74LS381	.99
74LS154	.25	74LS382	.99
74LS155</			



## 74S00

74500	.32	745135	.89	745251	.95
74502	.38	745138	.85	745253	.95
74503	.38	745139	.85	745257	.95
74504	.38	745140	.85	745258	.95
74505	.38	745151	.95	745259	.79
74506	.38	745153	.85	745273	2.45
74509	.40	745157	.95	745274	19.95
74510	.35	745158	.95	745276	19.95
74511	.36	745161	1.95	745280	1.95
74515	.36	745162	1.95	745283	3.29
74520	.36	745163	1.95	745287	1.90
74522	.36	745168	3.95	745288	1.90
74532	.40	745174	.95	745299	7.25
74537	.88	745176	.95	745301	6.95
74538	.86	745180	11.95	745373	2.45
74540	.38	745181	3.95	745374	2.45
74551	.35	745182	2.95	745381	7.95
74556	.40	745188	.95	745387	1.95
74555	.40	745189	6.95	745399	2.95
74574	.50	745194	1.45	745412	2.95
74585	1.89	745195	1.49	745470	6.95
74586	.50	745196	1.49	745471	4.95
745112	.50	745197	1.49	745472	4.85
745113	.50	745201	6.95	745474	4.85
745114	.50	745225	7.95	745475	2.95
745124	2.75	745226	.95	745477	2.95
745132	1.24	745240	2.20	745478	2.95
745133	.45	745241	2.20	875181	18.25
745134	.45	745244	2.20		

## CMOS

4000	.29	4531	.95
4001	.25	4532	1.95
4002	.25	4538	1.95
4006	.89	4539	1.95
4007	.29	4541	1.95
4008	.95	4543	1.19
4009	.38	4553	5.79
4010	.45	4555	.95
4011	.25	4556	.95
4012	.25	4558	2.45
4013	.38	4560	4.25
4014	.79	4569	3.49
4015	.38	4581	1.95
4016	.38	4582	1.95
4017	.89	4584	.75
4018	.79	4585	.75
4019	.39	45151	12.95
4020	.75	4702	12.95
4021	.79	4724	1.50
4022	.79	74C00	.38
4023	.29	74C02	.35
4024	.86	74C04	.35
4025	.29	74C08	.35
4026	1.85	74C10	.35
4027	.45	74C14	.59
4028	.89	74C16	.35
4029	.79	74C30	.35
4030	.39	74C32	.39
4034	1.95	74C42	1.29
4035	.85	74C48	1.99
4040	.75	74C73	.65
4041	.75	74C74	.65
4042	.89	74C76	.80
4043	.89	74C78	1.95
4044	.79	74C85	1.95
4046	.85	74C88	.39
4047	.95	74C89	4.50
4048	.69	74C90	1.19
4049	.38	74C93	1.75
4050	.35	74C95	.95
4051	.79	74C99	8.79
4052	1.89	74C151	2.25
4053	.79	74C154	3.25
4060	.89	74C157	1.75
4066	.39	74C160	1.19
4068	.39	74C161	1.19
4069	.29	74C162	1.19
4070	.29	74C163	1.19
4071	.29	74C164	1.39
4072	.29	74C165	2.00
4073	.29	74C173	.79
4075	.29	74C174	1.19
4076	.79	74C175	1.19
4077	.89	74C182	1.49
4078	.29	74C193	1.49
4081	.29	74C196	1.95
4082	.29	74C200	8.75
4085	.95	74C221	1.75
4086	.95	74C244	2.25
4093	.49	74C373	2.45
4094	2.99	74C374	2.45
4098	1.95	74C901	.39
4099	1.95	74C902	.39
14409	12.95	74C903	.85
14410	12.95	74C905	10.95
14411	11.95	74C906	.95
14412	12.95	74C907	1.00
14419	7.95	74C908	2.00
14433	14.95	74C908	2.75
14490	4.95	74C910	8.95
4502	.95	74C911	8.95
4503	.85	74C912	8.95
4507	1.25	74C914	1.95
4508	1.95	74C915	1.19
4510	.85	74C918	1.75
4511	.85	74C920	20.95
4512	.85	74C921	19.95
4514	1.25	74C922	4.95
4515	.75	74C923	4.95
4516	1.85	74C925	8.95
4518	.89	74C926	7.95
4519	.38	74C927	7.95
4520	.79	74C928	7.95
4521	4.99	74C929	19.95
4522	1.25	80C96	.85
4523	1.95	80C97	.95
4528	1.19	80C98	1.20
4529	2.95		

## HIGH SPEED CMOS

A new family of high speed CMOS logic featuring the speed of low power Schottky (Bis) typical gate propagation delay), combined with the advantages of CMOS: very low power consumption, superior noise immunity, and improved output drive.

### 74HC00

74HC: Operate at CMOS logic levels and are ideal for new, all-CMOS designs.

74HC00	.59	74HC175	.95
74HC02	.59	74HC182	1.25
74HC04	.59	74HC194	.40
74HC08	.59	74HC195	1.09
74HC10	.59	74HC238	1.35
74HC11	.59	74HC240	1.89
74HC14	.79	74HC241	1.89
74HC20	.59	74HC242	1.89
74HC27	.59	74HC243	1.89
74HC30	.59	74HC244	1.39
74HC32	.89	74HC245	1.89
74HC51	.59	74HC251	.89
74HC74	.75	74HC257	.95
74HC75	.85	74HC259	1.39
74HC85	1.25	74HC273	1.89
74HC86	1.25	74HC275	4.99
74HC93	1.19	74HC367	.99
74HC125	1.19	74HC373	2.29
74HC132	1.19	74HC374	2.29
74HC138	.99	74HC393	1.39
74HC139	.99	74HC400	1.89
74HC151	.89	74HC402	1.39
74HC153	.89	74HC424	1.39
74HC154	2.49	74HC440	1.39
74HC157	.89	74HC448	.89
74HC161	1.15	74HC460	.89
74HC164	1.25	74HC460	1.29
74HC166	2.95	74HC451	2.29
74HC174	.99	74HC458	2.29

### 74HCT00

74HCT: Direct, drop-in replacements for LS TTL and can be intermixed with 74LS in the same circuit.

74HCT00	.69	74HCT175	1.09
74HCT02	.69	74HCT193	1.39
74HCT04	.69	74HCT194	1.19
74HCT08	.69	74HCT195	1.29
74HCT10	.69	74HCT238	1.59
74HCT11	.69	74HCT240	2.19
74HCT14	.89	74HCT241	2.19
74HCT20	.69	74HCT242	2.19
74HCT27	.69	74HCT243	2.19
74HCT30	.69	74HCT244	2.19
74HCT32	.79	74HCT245	2.19
74HCT38	.69	74HCT251	1.09
74HCT74	.85	74HCT257	.99
74HCT75	.95	74HCT259	1.59
74HCT85	1.49	74HCT273	2.09
74HCT86	1.79	74HCT299	5.25
74HCT93	1.29	74HCT367	1.39
74HCT125	1.29	74HCT373	2.49
74HCT126	1.29	74HCT374	2.49
74HCT138	1.15	74HCT383	1.59
74HCT139	1.15	74HCT407	1.19
74HCT151	1.05	74HCT402	1.59
74HCT153	1.05	74HCT404	1.59
74HCT154	2.99	74HCT404	1.59
74HCT157	.99	74HCT409	.99
74HCT161	1.29	74HCT405	.99
74HCT164	1.29	74HCT406	1.49
74HCT166	3.05	74HCT451	2.69
74HCT174	1.09	74HCT458	2.59

## VOLTAGE REGULATORS

### TO-220 CASE PACKAGE

7805T	.75	7905T	.85
7808T	.75	7908T	.85
7812T	.75	7912T	.85
7815T	.75	7915T	.85
7824T	.75	7924T	.85

### TO-3 CASE PACKAGE

7805K	1.39	7905K	1.49
7812K	1.39	7912K	1.49
7815K	1.39	7915K	1.49
7824K	1.39	7924K	1.49

### TO-92 CASE PACKAGE

78L05	.89	79L05	.79
78L12	.89	79L12	.79
78L15	.89	79L15	.79

### OTHER VOLTAGE REGS

78M05C	5volt	1/2amp	TO-220	.35
LM323K	5volt	3amp	TO-3	4.95
LM338K	Adj.	5amp	TO-3	3.99
78L40K	5volt	1amp	TO-3	3.95
78H12K	12volt	1amp	TO-3	9.95
78P05K	5volt	10amp	TO-3	14.95
UA7854D		FAIRCHILD	DIP	1.95

## 7400

7400	.19	7483	.50	74172	5.95
7401	.19	7485	.59	74173	.75
7402	.19	7488	.38	74174	.89
7403	.19	7489	2.15	74175	.85
7404	.19	7490	.75	74176	.75
7405	.25	7481	.40	74177	.75
7406	.29	7482	.50	74178	1.15
7407	.29	7493	.38	74179	1.75
7408	.24	7494	.65	74180	.75
7409	.19	7495	.55	74181	2.25
7410	.19	7496	.70	74182	.75
7411	.25	7497	2.79	74183	2.00
7412	.30	74100	1.75	74185	2.00
7413	.38	74105	1.14	74189	2.99
7414	.49	74107	.30	74190	1.15
7415	.25	74109	.45	74191	1.15
7417	.25	74110	.45	74192	.79
7420	.19	74111	.65	74193	.79
7421	.35	74115	1.55	74194	.85
7422	.35	74120	1.20	74195	.85
7423	.29	74121	.29	74196	.79
7425	.29	74122	.45	74197	.75
7426	.29	74123	.49	74198	1.35
7427	.29	74125	.45	74199	1.35
7428	.45	74126	.45	74221	1.35
7429	.19	74128	.55	74248	1.35
7432	.29	74132	.45	74247	1.25
7433	.45	74138	.50	74248	1.85
7437	.29	74141	.65	74249	1.95
7438	.29	74142	2.95	74251	.75
7439	.79	74143	4.95	74259	2.25
7440	.19	74144	2.95	74265	1.35
7442	.49	74145	.95	74273	1.95
7443	.65	74146	1.55	74276	1.35
7444	.89	74148	1.20	74278	3.11
7445	.89	74150	1.35	74279	.75
7446	.89	74151	.65	74283	2.00
7447	.89	74152	.85	74284	3.75
7448	.89	74153	.65	74285	3.75
7450	.19	74154	1.25	74290	.95
7451	.19	74155	.85	74293	1.35
7453	.23	74156	.65	74298	.85
7454	.23	74157	.55	74351	2.25
7460	.23	74159	1.65	74365	.65
7470	.35	74160	.85	74366	.65

# DB25S RS232 FEMALE SOLDER CUP 2.25

# DB25P RS232 MALE SOLDER CUP 1.90

## BARGAIN HUNTERS CORNER 12VDC CAR CLOCK

**\$4.95**

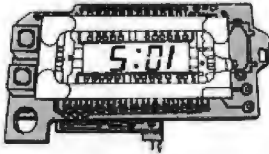

- \* EASY TO READ 1/4" FLUORESCENT DISPLAY
- \* DESIGNED FOR USE IN AUTOS
- \* HOURS/MIN. SET SWITCHES MOUNTED ON BOARD

**SPECIAL ENDS 8/31/85**

## RF MODULATOR (ASTECUM1082)

QUANTITIES LIMITED

- PRESET TO CHANNEL 3
- USE TO BUILD TV-COMPUTER INTERFACE
- 15 VOLT OPERATION

**\$6.95**

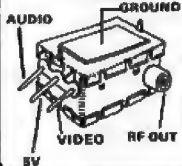

## EMI FILTER

- MAJOR MANUFACTURER
- LOW COST
- FITS LC-HP BELOW



## LINE CORDS

- LC-2 2 CONDUCTOR 6 ft .39
- LC-3 3 CONDUCTOR 6 ft .99
- LC-HP 3 CONDUCTOR WITH STANDARD FEMALE SOCKET 6 ft 1.49
- LC-CIR CIGARETTE LIGHTER PLUG WITH 6 FOOT CORD 2.95

## MUFFIN FANS

- 4.66" SQUARE 14.95
- 3" SQUARE 14.95

## RESISTORS

- 1/4 WATT 5% CARBON FILM ALL STANDARD VALUES FROM 1 OHM TO 10 MEG OHM
- 50 PIECES SAME VALUE .025
- 100 PIECES SAME VALUE .02
- 1000 PIECES SAME VALUE .015

## BYPASS CAPS

- .01 µF DISC 100/.48.00
- .01 µF MONOLITHIC 100/.12.00
- 1 µF DISC 100/.48.00
- 1 µF MONOLITHIC 100/.15.00

## DIODES

- 1N751 5.1 VOLT ZENER .25
- 1N759 12.0 VOLT ZENER .25
- 1N4148 (1N914) SWITCHING 25/1.00
- 1N4001 50PIV 1A 12/1.00
- 1N4004 400PIV RECTIFIER 10/1.00
- 1N5402 200PIV 3A .25
- KBP02 200PIV 1.5A BRIDGE .45
- KBP04 400PIV 1.5A BRIDGE .55
- MDA890-1 50PIV 12A BRIDGE 1.95
- MDA890-2 100PIV 12A BRIDGE 2.25
- MDA890-2 100PIV 27A BRIDGE 2.49
- VW48 DIP-BRIDGE .35

## CAPACITORS TANTALUM

1.0µl	15V .40	.47µl	35V .50
6.8	15V .70	1.0	35V .45
10	15V .80	2.2	35V .65
22	15V 1.35	4.7	35V .85
.22	35V .40	10	35V 1.00

## DISC

10µl	50V .05	560	50V .05
25	50V .05	680	50V .05
26	50V .05	820	50V .05
27	50V .05	.001µl	50V .05
33	50V .05	.0015	50V .05
47	50V .05	.0022	50V .05
56	50V .05	.005	50V .05
68	50V .05	.01	50V .07
82	50V .05	.02	50V .07
100	50V .05	.05	50V .07
220	50V .05	.1	12V .10

## MONOLITHIC

.01µl	50V .14	.1µl	50V .18
.047µl	50V .15	.47µl	50V .25

## ELECTROLYTIC

RADIAL		AXIAL	
1µl	25V .14	1µl	50V .14
2.2	35V .15	4.7	16V .14
4.7	50V .15	10	16V .14
10	50V .15	10	50V .16
47	35V .18	22	16V .14
100	16V .18	47	50V .20
220	35V .20	100	16V .20
2200	25V .30	100	35V .25
	16V .60	220	25V .30
		330	16V .40

## COMPUTER GRADE

44,000µl 30V 3.95	500	16V .42
	1000	16V .60
	2200	16V .70
	6000	16V .85

## LED DISPLAYS

HP5082-7790	CC	.43"	1.25
MAN-72	CA	-.3"	.99
MAN-74	CC	-.3"	.99
FMD-35(1359)	CC	.375"	1.25
FMD-50(503)	CC	.5"	1.49
FMD-50(7510)	CA	.8"	1.49
TIL-311 4x7 HEX W/LOGIC	.270"	9.95	

## DIFFUSED LEDS

JUMBO RED	T1 1/4"	1.99	100-µp
JUMBO GREEN	T1 1/4"	.18	.15
JUMBO YELLOW	T1 1/4"	.18	.15
MOUNTING HDW	T1 1/4"	.10	.09
MINI RED	T1	.10	.09
MINI GREEN	T1	.18	.15
MINI YELLOW	T1	.18	.15
RECT RED	2x5mm	.25	.22
RECT GREEN	2x5mm	.30	.27
RECT YELLOW	2x5mm	.30	.27

## HARD TO FIND "SNAPABLE" HEADERS

Can easily be snapped apart to make any size header, all with .1" centers

1x40	STRAIGHT LEAD	.99
1x40	RIGHT ANGLE	1.49
2x40	STRAIGHT LEAD	2.49
2x40	RIGHT ANGLE	2.99

## SHORTING BLOCKS

SPACED AT .1" CENTERS IDEAL FOR DISK DRIVES OR ANY .1" HEADER

**5/1.00**

## DIP SWITCHES

4 POSITION	.85
5 POSITION	.90
6 POSITION	.90
7 POSITION	.95
8 POSITION	.95
10 POSITION	1.29

## EDGE CARD CONNECTORS

3-100 ST	3-100	3.95
3-100 WW	3-100	4.95
72 PIN ST		6.95
72 PIN WW		7.95
62 PIN ST	IBM PC	4.95
50 PIN ST	APPLE	4.95
44 PIN ST		2.95
44 PIN WW		4.95

## 36 PIN CENTRONICS

IDCEN36	RIBBON CABLE MALE	8.95
IDCEN36/F	RIBBON CABLE FEMALE	8.95
CEN36	SOLDER CUP MALE	7.95

## DIP CONNECTORS

DESCRIPTION	ORDER BY	CONTACTS								
		8	14	16	18	20	22	24	28	40
HIGH RELIABILITY TOOLED ST IC SOCKETS	AUGATxxST	.99	.99	.99	1.89	1.89	1.89	1.99	2.49	2.99
HIGH RELIABILITY TOOLED WW IC SOCKETS	AUGATxxWW	1.30	1.80	2.10	2.40	2.50	2.90	3.15	3.70	5.40
COMPONENT CARRIES (DIP HEADERS)	ICCxx	.49	.59	.69	.99	.99	.99	.99	1.09	1.49
RIBBON CABLE DIP PLUGS (IDC)	IDPxx	---	.95	.95	---	---	---	1.75	---	2.95

FOR ORDERING INSTRUCTIONS SEE IDC CONNECTORS BELOW

## HEAT SINKS

TO-220	SCREW ON	.35
TO-220	CLIP ON	.38
TO-3	SCREW ON	.98
TO-220	INSULATOR	10/1.00
TO-3	INSULATOR	10/1.00

## SWITCHES

SPDT MINI-TOGGLE ON-ON	1.25
DPDT MINI-TOGGLE ON-ON	1.50
DPDT MINI-TOGGLE ON-OFF-ON	1.75
SPST MINI-PUSHBUTTON N.O.	1.39
SPST MINI-PUSHBUTTON N.C.	.39
BCD OUT 10 POSITION 6 PIN DIP	1.95

## D-SUBMINIATURE

DESCRIPTION	ORDER BY	CONTACTS				
		9	15	25	37	50
SOLDER CUP	MALE DBxxP	1.19	1.59	1.90	2.85	4.25
	FEMALE DBxxS	1.50	1.85	2.25	3.80	5.25
RIGHT ANGLE PC SOLDER	MALE DBxxPR	1.65	2.20	3.00	4.83	---
	FEMALE DBxxSR	2.18	3.03	3.00	6.19	---
WIRE WRAP	MALE DBxxPWW	1.69	2.56	3.69	5.80	---
	FEMALE DBxxSww	2.76	4.27	6.84	9.95	---
IDC RIBBON CABLE	MALE IDBxxP	2.95	3.90	4.75	6.95	---
	FEMALE IDBxxS	3.29	4.29	5.25	7.95	---
HOODS	BLACK HOOD-B	---	---	.99	---	---
	GREY HOOD-xx	.89	.95	.99	1.09	1.19

MOUNTING HARDWARE-\$1.00

FOR ORDERING INSTRUCTIONS SEE IDC CONNECTORS BELOW



IDB37S



DB37S



DB25SR

## TEXTOL ZERO INSERTION FORCE SOCKETS AND RECEPTACLES



SCREWDRIVER CLAMP ECONO ZIF LEVER CLAMP ZIF SOCKET WW RECEPTACLES ZIF RECEPTACLE

TYPE	CONTACTS				
	14	16	24	28	40
ECONO ZIF	---	4.95	6.75	7.75	9.95
ZIF SOCKET	4.95	4.95	5.95	6.95	9.95
ZIF RECEPTACLE	8.25	9.75	9.75	10.50	12.75

## IDC CONNECTORS

DESCRIPTION	ORDER BY	CONTACTS					
		10	20	26	34	40	50
SOLDER HEADER	IDHxxS	.82	1.29	1.68	2.20	2.58	3.24
RIGHT ANGLE SOLDER HEADER	IDHxxSR	.85	1.35	1.76	2.31	2.72	3.38
WW HEADER	IDHxxW	1.86	2.98	3.84	4.50	5.28	6.63
RIGHT ANGLE WW HEADER	IDHxxWR	2.05	3.28	4.22	4.46	4.80	7.30
RIBBON HEADER SOCKET	IDBxxS	.79	.98	1.39	1.59	1.99	2.25
RIBBON HEADER	IDBxxP	---	6.50	6.25	7.00	7.50	8.50
RIBBON EDGE CARD	IDExx	1.75	2.25	2.85	2.75	3.80	3.85

ORDERING INSTRUCTIONS: INSERT THE NUMBER OF CONTACTS IN THE POSITION MARKED "x" OF THE ORDER BY PART NUMBER LISTED. EXAMPLE: A 10 PIN RIGHT ANGLE HOLDER STYLE WOULD BE IDH10SR



IDH20W



IDE50

## RIBBON CABLE

CONTACTS	SINGLE COLOR		COLOR CODED	
	1'	10'	1'	10'
10	.18	1.60	.83	7.30
16	.28	2.50	1.00	8.80
20	.36	3.20	1.25	11.00
25	.45	4.00	1.32	11.60
26	.46	4.10	1.32	11.60
34	.61	5.40	1.95	14.50
40	.72	6.40	1.92	16.80
50	.89	7.50	2.50	22.00

RETAIL STORE - 1256 S. BASCOM AVENUE  
HOURS: M-W-F, 9-5 TU-TH, 9-9 SAT, 10-3

PLEASE USE YOUR CUSTOMER NUMBER WHEN ORDERING

TERMS: Minimum order \$10.00. For shipping and handling include \$2.50 for UPS Ground and \$3.50 for UPS Air. Orders over 1 lb. and foreign orders may require additional shipping charges - please contact our sales department for the amount. CA. residents must include 6% sales tax. Bay Area and LA residents include 5.4%. All merchandise is warranted for 90 days unless otherwise stated. Prices are subject to change without notice. We are not responsible for typographical errors. We reserve the right to limit quantities and to substitute manufacturer. All merchandise subject to prior sale.

# JDR Microdevices

1224 S. Bascom Avenue, San Jose, CA 95128  
800-538-5000 • 800-662-6279 (CA) • (408) 995-5430  
FAX (408) 275-8415 • Telex 171-110

# IBM PC PROTOTYPE CARD WITH DECODING LAYOUT \$29.95

## WIRE WRAP PROTOTYPE CARDS

FR-4 EPOXY GLASS LAMINATE WITH GOLD-PLATED EDGE-CARD FINGERS

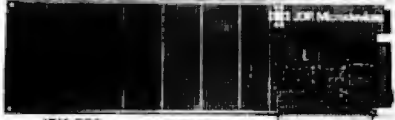

IBM PR2

BOTH CARDS HAVE SILK SCREENED LEGENDS AND INCLUDES MOUNTING BRACKET

IBM-PR1 WITH -5V AND GROUND PLANE . . . \$27.95  
IBM-PR2 AS ABOVE WITH DECODING LAYOUT \$29.95

### S-100

P100-1 BARE - NO FOIL PADS . . . . . \$15.15  
P100-2 HORIZONTAL BUS . . . . . \$21.80  
P100-3 VERTICAL BUS . . . . . \$21.80  
P100-4 SINGLE FOIL PADS PER HOLE . . . . . \$22.75

### APPLE

P500-1 BARE - NO FOIL PADS . . . . . \$15.15  
P500-3 HORIZONTAL BUS . . . . . \$22.75  
P500-4 SINGLE FOIL PADS PER HOLE . . . . . \$21.80  
7060-45 FOR APPLE IIe AUX SLOT . . . . . \$30.00

### GENERAL PURPOSE

22/44 PIN EDGE-CARD (1.56" SPACING)  
P441-1 BARE - NO FOIL PADS 4.5" x 6.0" . . . . . \$9.45  
P441-3 VERTICAL BUS 4.5" x 6.0" . . . . . \$13.95  
P441-4 SINGLE FOIL PADS 4.5" x 6.0" . . . . . \$14.20  
P442-1 BARE - NO FOIL PADS 4.5" x 9.0" . . . . . \$10.40  
P442-3 VERTICAL BUS 4.5" x 9.0" . . . . . \$14.20  
P442-4 SINGLE FOIL PADS 4.5" x 9.0" . . . . . \$13.50  
36/72 PIN EDGE-CARD (.1" SPACING)  
P721-1 BARE - NO FOIL PADS 4.5" x 6.0" . . . . . \$9.45  
P721-3 VERTICAL BUS 4.5" x 6.0" . . . . . \$13.25  
P721-4 SINGLE FOIL PADS 4.5" x 6.0" . . . . . \$14.20  
P722-1 BARE - NO FOIL PADS 4.5" x 9.0" . . . . . \$10.40  
P722-3 VERTICAL BUS 4.5" x 9.0" . . . . . \$14.20  
P722-4 SINGLE FOIL PADS 4.5" x 9.0" . . . . . \$15.15

### BARE GLASS BOARDS

NO EDGE-CARD FINGERS OR FOIL  
P25x45 2.5" x 4.5" \$2.40  
P45x65 4.5" x 6.5" \$4.70  
P45x85 4.5" x 8.5" \$4.20  
P85x170 4.5" x 17.0" \$11.35  
P85x170 8.5" x 17.0" \$18.95

### EXTENDER CARDS

IBM \$45.00  
APPLE \$45.00  
MULTIBUS \$86.00

### WIRE WRAP WIRE

#### PRECUT AND STRIPPED

Note: 1 inch of insulation is stripped on each end. A 3.5" wire has only 1.5" of insulation.

LENGTH (INCHES)	QUANTITY		
	100	500	1000
2.5	1.60	4.70	8.20
3	1.60	4.70	8.20
3.5	1.65	5.00	8.90
4	1.75	5.40	10.30
4.5	1.80	5.75	10.30
5	1.85	6.10	11.00
5.5	1.90	6.50	11.75
6	2.00	6.85	12.60
6.5	2.30	7.80	14.30
7	2.40	8.20	15.05
7.5	2.50	8.55	15.85
8	2.60	8.95	16.60
8.5	2.65	9.30	17.40
9	2.70	9.80	18.15
9.5	2.80	10.00	18.95
10	2.90	10.50	19.70

#### PRECUT ASSORTMENT IN ASSORTED COLORS \$27.50

100ea: 5.5", 6", 6.5", 7"  
250ea: 2.5", 4.5", 5"  
500ea: .3", 3.5", 4"

#### SPOOLS

100 feet \$4.30 250 feet \$7.25  
500 feet \$13.25 1000 feet \$21.95  
Please specify color:  
Blue, Black, Yellow or Red

### GE NICKEL-CADMIUM RECHARGABLE BATTERIES

#### NI-CAD CHARGER PACKAGE

PRICE INCLUDES CHARGER (WALL PLUG), BATTERIES, & MODULAR BATTERY HOLDER

AAA CELLS QTY. 2 \$11.71  
AA CELLS QTY. 2 \$11.71  
C CELLS QTY. 2 \$13.21  
D CELLS QTY. 2 \$13.21  
9 VOLT QTY. 1 \$13.21

#### BATTERIES ONLY

AAA CELLS PKG. 2 \$6.07 pr.  
AA CELLS PKG. 1 \$3.03 ea.  
C CELLS PKG. 1 \$3.78 ea.  
D CELLS PKG. 1 \$3.78 ea.  
9 VOLT PKG. 1 \$7.57 ea.

### DISK DRIVES

TM 100-1 5 1/4" (FOR IBM) SS/DD \$119.95  
TM 100-2 5 1/4" (FOR IBM) DS/DD \$99.95

#### MPI

MPI-BS2 5 1/4" (FOR IBM) DS/DD \$89.95

#### TEAC

FD-55B 1/2 HEIGHT DS/DD \$89.95  
FD-55F 1/2 HEIGHT DS/QUAD \$89.95

#### SHUGART

SA 400L 5 1/4" (40 TRACK) SS/DD \$199.95  
SA 460 5 1/4" (60 TRACK) DS/QUAD \$199.95

#### 8" DISK DRIVES

FD100-8 BY SIEMENS, SHUGART 801 EQUIV. SS/DD \$129.00  
FD200-8 BY SIEMENS, SHUGART 851 EQUIV. DS/DD \$180.00

JFORMAT-2 \$49.95  
SUPPORT FOR QUAD DENSITY DRIVES FROM TALL TREE SYSTEMS  
PLEASE INCLUDE SUFFICIENT AMOUNT FOR SHIPPING ON ABOVE ITEMS



TEAC FD-55B

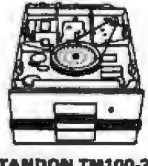

TANDON TM100-2

### DISK DRIVE CABINETS

CABINET #1 \$29.95  
• Fits one full height 5 1/4" disk drive  
• Color matches Apple

CABINET #2 \$79.00  
• Fits one full height 5 1/4" disk drive  
• Complete with power supply, switch, line cord, fuse and standard power connector  
• Please specify Gray or Tan

CABINET #3 \$89.95  
• Fits two half height 5 1/4" disk drives  
• Complete with power supply, switch, line cord, fuse and standard power connectors

8" DISK DRIVE CABINETS ALSO AVAILABLE- PLEASE CALL  
PLEASE INCLUDE SUFFICIENT AMOUNT FOR SHIPPING ON ABOVE ITEMS

### SWITCHING POWER SUPPLIES

PS-IBM \$99.95  
• FOR IBM PC-XT COMPATIBLE  
• 130 WATTS  
• -5V @ 15A, -12V @ 4.2A  
• -5V @ .5A, -12V @ .5A  
• ONE YEAR WARRANTY



PS-A \$49.95  
• USE TO POWER APPLE TYPE SYSTEMS  
• -5V @ 4A, -12V @ 2.5A  
• -5V @ .5A, -12V @ .5A  
• APPLE POWER CONNECTOR

PS-3 \$39.95  
• AS USED IN APPLE III  
• -5V @ 4A, -12V @ 2.5A  
• -5V @ .5A, -12V @ .30A,  
• 15.5" x 4.5" x 2", 384 LBS.

PS-ASTEC \$19.95  
• CAN POWER TWO 5 1/4" FDDs  
• -5V @ 2.5A, -12V @ 2A  
• -12V @ .1A  
• -5V @ .5A IF -12V IS NOT USED  
• 6.3" x 4.6" x 1.5"

### OK INDUSTRIES

EX-1 IC EXTRACTION TOOL  
• ONE PIECE METAL CONSTRUCTION  
• EASILY EXTRACTS 8-24 PIN DEVICES  
• LOW COST \$2.19



EX-2 IC EXTRACTION TOOL  
• EXTRACTS 24-40 PIN DEVICES  
• HEAVY DUTY METAL CONSTRUCTION  
• GROUND LUGS FOR MOS EXTRACTIONS  
• EASY ONE HAND OPERATION \$12.74

#### IC INSERTION TOOLS

INS-1416 for 14-16 pin IC's \$5.15  
MOS-1416 for 14-16 pin IC's \$10.92  
MOS-2428 for 24-28 pin IC's \$10.92  
MOS-40 for 40 pin IC's \$12.43  
MOS series insertion tools have metal construction and include grounding lug for CMOS applications.

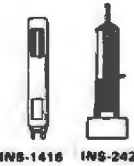

BW-630 WIRE WRAP GUN  
• BATTERY POWERED-USES 2 NI-CAD C CELLS (NOT INCLUDED)  
• POSITIVE INDEXING  
• ANTI-OVERWRAP DEVICE \$41.55



#### WSU-30 WIRE WRAP TOOLS

• WRAPS, STRIPS, AND UNWRAPS  
• WSU-30M WRAPS AN EXTRA TURN OF INSULATION  
WSU-30 \$8.84 / WSU-30M \$10.14

#### WIRE WRAP TERMINALS

WWT-1 SLOTTED 25/\$7.06  
WWT-2 SINGLE SIDED 25/\$4.25  
WWT-3 IC SOCKET 25/\$7.06  
WWT-4 DOUBLED SIDED 25/\$2.80  
INS-1 INSERTION TOOL \$3.84



#### WIRE DISPENSER

• WITH 50' ROLL OF WIRE  
• BUILT IN PLUNGER CUTS WIRE  
• BUILT IN STRIPPER STRIPES 1"  
• REFILLABLE  
WD-30 \$6.50 WD-30TRI \$9.50  
Specify Blue, white, Yellow or Red With 50' of each: Red, Blue and White



#### SOCKET-WRAP I.D.™

• SLIPS OVER WIRE WRAP PINS  
• IDENTIFIES PIN NUMBERS ON WRAP SIDE OF BOARD  
• CAN WRITE ON PLASTIC, SUCH AS IC #

PINS	PART#	PCK. OF	PRICE
8	IDWRAP 08	10	1.95
14	IDWRAP 14	10	1.95
16	IDWRAP 16	10	1.95
18	IDWRAP 18	5	1.95
20	IDWRAP 20	5	1.95
22	IDWRAP 22	5	1.95
24	IDWRAP 24	5	1.95
28	IDWRAP 28	5	1.95
40	IDWRAP 40	5	1.95

PLEASE ORDER BY NUMBER OF PACKAGES (PCK. OF)

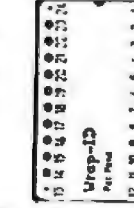

### TRANSFORMERS

FRAME STYLE  
12.6V AC 2 AMP 4.95  
12.6V AC CT 2 AMP 5.95  
12.6V AC CT 4 AMP 7.95  
12.6V AC CT 8 AMP 10.95  
25.2V AC CT 2 AMP 7.95

PLUG CASE STYLE  
12V AC 250ma 3.95  
12V AC 500ma 4.95  
12V AC 1 AMP 5.95  
12V AC 2 AMP 6.95

DC ADAPTER  
6, 9, 12V DC SELECTABLE WITH UNIVERSAL ADAPTER 8.95

### MICROCOMPUTER HARDWARE HANDBOOK

FROM ELCOMP \$14.95

Over 800 pages of manufacturer's data sheets on the most commonly used IC's  
• TTL - 74, 74LS & 74F  
• CMOS  
• Voltage regulators  
• Memory - RAM, ROM, EPROM  
• CPU'S - 6800, 6500, Z80, 8080, 8085 & 8086/8  
• MPU Support & Interface, 6800, 6500, Z80, 8200, etc.

VISA  
MasterCard  
**ORDER TOLL FREE 800-538-5000**  
**800-662-6279**  
(CALIFORNIA RESIDENTS)

### 20 MHz DUAL TRACE OSCILLOSCOPE

UNSURPASSED QUALITY AT AN UNBEATABLE PRICE

• BAND WIDTH- DC: DC TO 20MHz (-3db)  
AC: 10Hz TO 20MHz (-3db)  
• SWEEP TIME- 2 μSEC TO 1 SEC/DIV ON 20 RANGES  
• VERT./HORIZ. DEFLECTION: 5mV TO 20V/DIV ON 20 RANGES  
• COMPLETE MANUAL AND HIGH QUALITY  
HOOK-ON PROBES INCLUDED  
• INPUT IMPEDANCE: 1 MEG OHM  
• TV VIDEO SYNC FILTER  
• X, Y AND Z AXIS OPERATION  
• 110/220 VOLT 50/60Hz OPERATION  
• COMPONENT TESTER  
• LP CONSUMPTION - 19 WATTS  
• BUILT IN CALIBRATOR  
• AUTOMATIC OR TRIGGERED TIMEBASE

**\$399.95**  
WITH PROBES  
**FULL ONE YEAR WARRANTY**

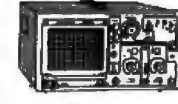

### MULTIMETER PEN



#### AUTO RANGING, POLARITY & DECIMAL!

• LARGE 3 1/2" DIGIT DISPLAY  
• DATA HOLD SWITCH FREEZES READING  
• FAST, AUDIBLE CONTINUITY TEST  
• LOW BATTERY INDICATOR  
• OVERLOAD PROTECTION  
• ONLY 1 1/2" x 6 1/4" x 1 1/4"  
• DC VOLTS 1mV-500V  
• AC VOLTS 1mV-500V  
• 1 OHM-20 MEG OHMS  
• WEIGHS ONLY 2.3 OUNCES  
• LOW PARTS COUNT-CUSTOM 80 PIN LSI INSURES RELIABILITY  
• INCLUDES MANUAL, BATTERIES, SOFT CASE, 2 PROBE TIPS, AND ALLIGATOR CLIP

**ONLY \$49.95**

# TEAC FD-55B DS/DD HALF HEIGHT FOR IBM PC \$89.95

## EPROM PROGRAMMER FOR APPLE COMPUTERS



RP525  
\$79.95

- DUPLICATE OR BURN ANY STANDARD 27xx SERIES EPROM
- EASY TO USE MENU-DRIVEN SOFTWARE INCLUDED
- MENU SELECTION FOR 2716, 2732, 2732A, 2764 & 27128
- HIGH SPEED WRITE ALGORITHM
- LED INDICATORS FOR ACTIVITY
- NO EXTERNAL POWER SUPPLY REQUIRED

## DISK DRIVES FOR APPLE COMPUTERS



BAL-525  
\$119.95

- 1/2 HEIGHT-ALPS MECHANISM
- 100% APPLE COMPATIBLE
- FULL 1 YEAR WARRANTY



BAL-500  
\$139.95

- TEAC MECHANISM- DIRECT DRIVE
- 100% APPLE COMPATIBLE
- FULL 1 YEAR WARRANTY

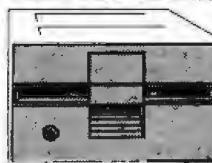

JDR  
AP-135  
\$129.95

- FULL HT. SHUGART MECHANISM
- DIRECT REPLACEMENT FOR APPLE DISK II
- SIX MONTH WARRANTY

### DISK DRIVE ACCESSORIES

DISK CONTROLLER CARD \$49.95  
APPLE IIc ADAPTOR CABLE \$19.95

## NEW FOR APPLE IIc

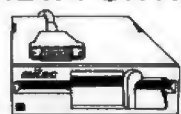

MITAC  
AD-3C  
\$139.95

- 100% APPLE IIc COMPATIBLE, READY TO PLUG IN W/ SHIELDED CABLE & MOLDED 19 PIN CONNECTOR
- FAST, RELIABLE SLIMLINE DIRECT DRIVE
- SIX MONTH WARRANTY

## MF-100 MULTIFUNCTION CARD FOR IBM PC/XT

ALL THE FEATURES OF AST'S 6-PACK+  
AT HALF THE PRICE!

- 0-384K RAM
  - SERIAL PORT
  - PARALLEL PORT
  - GAME PORT
  - SOFTWARE INCLUDED
- \$129.95**  
ONE YEAR WARRANTY

## TAXAN MODEL 415 RGB VISION III MONITOR

ORIGINALLY MADE FOR ACORN COMPUTER

- 18 Mhz BANDWIDTH
- 640 x 262 PIXEL RESOLUTION
- 16 COLORS WITH INTENSITY CONTROL
- 12 INCH BLACK MATRIX
- IBM AND LOTUS COMPATIBLE

**ONLY \$299.95**

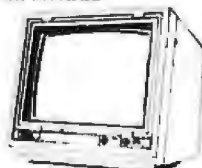

RGB MONITOR CABLE FOR IBM \$15.95  
COLOR DISPLAY ADAPTOR \$129.95  
• SAME AS IBM COLOR CARD  
• SUPPORTS COMPOSITE OR RGB MONITOR

## MODEM FOR APPLE OR IBM

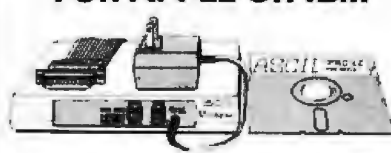

- INCLUDES ASCII PRO-EZ MENU DRIVEN SOFTWARE  
(AT LEAST A \$100.00 VALUE IN ITSELF!)
- FCC APPROVED
  - BELL SYSTEM 103 COMPATIBLE
  - 300 BUAD
  - AUTO-DIAL/AUTO-ANSWER
  - DIRECT CONNECT
  - INCLUDES AC ADAPTOR

**ONLY \$69.95**

PLEASE SPECIFY  
APPLE OR IBM WHEN ORDERING

## 16K RAM CARD \$39.95 FOR APPLE II+

- 2 YEAR WARRANTY
- EXPAND YOUR 48K APPLE TO 64K
- USE IN PLACE OF APPLE LANGUAGE CARD

BARE PC CARD AND INSTRUCTIONS \$9.95

## DISKETTE FILE

**\$8.95** IF PURCHASED  
WITH 50 DISKETTES  
OR MORE

\$9.95 IF PURCHASED ALONE

HOLDS 70 5 1/4"  
DISKETTES,  
WITH ROOM  
TO SPARE



## NASHUA DISKETTES

5 1/4" BULK PACKAGED  
DS/DD WITH HUB RINGS

**\$.89ea.** QTY 250  
**\$.95ea.** QTY 100  
**\$.99ea.** QTY 50

## VERBATIM DATALIFE DISKETTES

SS/DD SOFT SECTOR \$29.95  
SS/DD 10 SECTOR HARD \$29.95  
DS/DD SOFT SECTOR \$34.95

## MONITOR STAND \$14.95 MODEL DS-12

TILTS AND SWIVELS  
TO PROVIDE  
OPTIMUM VIEWING  
ANGLE, REDUCES  
OPERATOR FATIGUE



## IBM COMPATIBLE POWER SUPPLIES

**130 WATT \$99.95**

XT COMPATIBLE

- 5V @ 15A, +12 @ 4.2A
- 5 @ 5A, -12 @ 5A
- UPGRADE YOUR PC, POWERS HARD DISK
- POWER CABLES FOR 4 FDDs
- ONE YEAR WARRANTY
- SWITCH ON SIDE (FITS IBM CASE)



**100 WATT \$89.95**

- SWITCH ON REAR
- FOR USE IN OTHER IBM TYPE MACHINES
- AVAILABLE IN 100W OR 130W VERSIONS
- 90 DAY WARRANTY



**130 WATT MODEL \$99.95**

RETAIL STORE - 1256 S. BASCOM AVENUE  
HOURS: M-W-F, 9-5 TU-TH, 9-9 SAT, 10-3

PLEASE USE YOUR CUSTOMER NUMBER WHEN ORDERING

TERMS: Minimum order \$10.00. For shipping and handling include \$2.50 for UPS Ground and \$3.50 for UPS Air. Orders over 1 lb. and foreign orders may require additional shipping charges - please contact our sales department for the amount. CA. residents must include 6% sales tax. Bay Area and LA residents include 6.5%. All merchandise is warranted for 90 days unless otherwise stated. Prices are subject to change without notice. We are not responsible for typographical errors. We reserve the right to limit quantities and to substitute manufacturer. All merchandise subject to prior sale.

APPLE IS A TRADEMARK OF APPLE COMPUTER CO.

# JDR Microdevices

1224 S. Bascom Avenue, San Jose, CA 95128  
800-538-5000 • 800-662-6279 (CA) • (408) 995-5430  
FAX (408) 275-8415 • Telex 171-110

© Copyright 1985 JDR Microdevices

# U·N·C·L·A·S·S·I·F·I·E·D A·D·S

**WANTED:** Operation California, an international organization active in African famine relief, needs donation of full system for supply acquisition, monitoring use of donations, and donor lists. Operation California Inc., 7615 1/2 Melrose Ave., Los Angeles, CA 90046, (213) 658-8876.

**WANTED:** Nonprofit organization for cultural support to foreign-born adopted children and moral support to parents seeks donation of computer equipment and peripherals for national office. Parents and Friends of the Nest, POB 235, West Nyack, NY 10994, (914) 358-6452.

**NEEDED:** Tax-deductible computers, peripherals, and public-domain software sought by nonprofit university sponsoring a volunteer group of graduating MBAs to help improve managerial skills and economic conditions in developing nations. Ron Robbins, 806 North Fourth St., Fairfield, IA 52556, (515) 472-9464.

**WANTED:** Nonprofit training program for developmentally disabled adults seeks tax-deductible donation of IBM PC with printer for educational and administrative purposes. Will pay shipping. John Schiermeister, Tri-City Care Inc., 15 1st St. SE, POB 423, Stanley, ND 58784, (701) 628-2990.

**NEEDED:** Missionary, responsible for introduction of computer system in Christian publishing organization, needs books, magazines, or information about UNIX, C, office automation, computer-assisted translation, and typesetting. Ingo Haake, POB 1688, 90000 Porto Alegre RS, Brazil.

**WANTED:** Nonprofit charitable organization that uses TRS-80 equipment in every aspect seeks contributions of additional equipment. Robert Epstein, Cambridge Center for Behavioral Studies, 11 Ware St., Cambridge, MA 02138, (617) 495-9020 (collect).

**WANTED:** Housebound child with juvenile arthritis seeks computer Johanna Avella, 112 Denton Ave., Lynbrook, NY 11563, (516) 599-7425.

**WANTED:** Student in research and experimentation in computer science seeks correspondence about Macintosh or Apple IIc. Henry E. Jara Melgarejo, Las Lilas 0483, Pob. Imperial, Temuco IXa Region, Chile.

**WANTED:** Low-income older student needs Atari 800 or 800XL with disk drive and color monitor. Can pay up to \$300. Concierge Taylor, Apt. 6B, 67-08 Parsons Blvd., Flushing, NY 11365.

**WANTED:** Graduate student seeks correspondence in microcomputer field to discuss hardware/software trends with reference to engineering/scientific applications. Also need help in obtaining magazines and public-domain software. Can provide some remuneration. Malcolm Silberman, 15 Villa Savoy, Savoy Estates, 2090, Johannesburg, South Africa.

**WANTED:** Public-domain dictionary (i.e., word list) good for use in word games. Also, public-domain information or software for playing crossword games from PC to PC. Will pay expense or send disk Steven Alexander, Apt. 300, 905 Union St., Brooklyn, NY 11215.

**WANTED:** BYTE, December 1984 Richard Boehmer, 134 Beechwood Rd., Braintree, MA 02184.

**WANTED:** Tractor-feed adapter and cut-sheet feeder for Comrex CR-I ComRiter wide-carriage daisy-wheel printer. Bob Hall, 24621 Highway 29, Middletown, CA 95461.

**FOR SALE:** Franklin Ace 1200, 64K RAM, two drives, Z80 CPU with added 64K RAM, 80-column card, serial and parallel ports, Amdek Color I monitor, Kraft joystick, speech synthesizer, magazines, manuals and more. Excellent condition. I will pay shipping. \$2400 or best offer. Brian Gimelson, The Peddie School, Hightstown, NJ 08520.

**FOR SALE:** Two Siemens FDD 100-8 8-inch SS/DD floppy-disk drives. Includes power supply and enclosure. System has 9 months light usage. \$200. Darrow Kirkpatrick, POB 1049, Carpinteria, CA 93013, (805) 684-8307, days.

**FOR SALE:** HP 41CV calculator (needs repair), 82104A card reader, XFUNCTIONS/XMEM module, XMEM module, Circuit Analysis Pac ROM, 82059B recharger, 120 magnetic cards, High Level Math solutions book, keyboard-overlay kit: everything as is: \$150. Dwight W Hughes, 413 East St. Andrew Ave., Forrest City, AR 72335, (501) 633-8415.

**FOR SALE:** Tektronix 4052A graphics computer sys-

tem, 64K, communications backpack (Option 1), tapes, and manuals. Excellent condition. Well below \$5950 list price. David F. Rogers, 817 Holly Drive E, Route 10, Annapolis, MD 21401, (301) 757-5724.

**FOR SALE:** Three Okidata 82/92 tractors unused: \$20 each. NEC modems, 2400/4800 bps, good condition. Hector Saviotti, 29 Cheryl Lane Dr., Waterbury, CT 06705, (203) 753-1058, evenings or weekends.

**FOR SALE:** Memory upgrade board that brings 8K PET 2001 to 64K. \$35. Also, Texas Instruments Silent 700 RIO thermal printer (friction feed, RS-232C, 80-column) originally \$895, asking \$300 or best offer. Call F. G. Volpicelli, (914) 738-1071.

**NEEDED:** An Insight Enterprises EQ-4 single-board computer user to solve a problem. Can pay for the help. Write to Pablo Gaggino, Arturo Bas 146, Cordoba 5000, Argentina.

**FOR SALE:** Tektronix dual floppy-disk unit Model 4922 with two 8-inch Memorex SS/SD drives, controller cards, and power supply in one cabinet. All manuals. Best offer or trade. John Strupat, 77 Elmwood Ave., London, Ontario N6C 1J4, Canada.

**WANTED:** Teacher needs nonworking Commodore printers and disk drives (1520, 1525, 1526, and 1540-1541). If donated, will pay shipping. If selling, please state lowest price. Send SASE for reply. Carl Bogardus, Chaparral Elementary School, 1220 Birch Dr., Las Cruces, NM 88001.

**TRADE:** TI-99/4A software written by me for your TI user-written software. Also homebrew attachments for TI, designs, ideas for software projects, etc. Craig Lewis, 2940 Callendar Rd., Rome, OH 44085.

**NEEDED:** Incarcerated computer science students studying toward AA degree seek typewriters and anything that may aid in rehabilitation. Robert W. Mallette III and Gerald D. Fuller, Maryland Penitentiary, 954 Forrest St., Baltimore, MD 21202.

**FOR SALE:** Xerox 820; S125, TVT-III; S75, 18-slot Godbout motherboard; S30, Thinker Toys ATE tape; S5, Wamco CPU-I (8080); S50, Wamco EPM-I ROM board (no ROM); S25, Five Wamco MEM-I RAM boards (no RAMs); S25 each. More assorted equipment available. Warren E. Greenberg, 145 Cottage Rd., West Roxbury, MA 02132.

**FOR SALE:** Sharp PC-1500A pocket computer with 8K RAM, Commodore VIC-20 with 16K RAM plus Datasette. Must sell; mint condition; best offer. Peter Sutter, 4125 North Monticello, Chicago, IL 60618.

**FOR SALE:** Back issues of BYTE, July, August, and December 1978, February through December 1979; and January through March, and June 1980, \$4 an issue. Vlad Kievsky, 5904-9 Stevens Forest Rd., Columbia, MD 21045.

**FOR SALE:** Digital Letterprinter Model 100-PC, high-speed, heavy-duty dot-matrix printer with tractor feed, 6 months old and hardly used; original crating, instructions, etc., \$750. Michael Bach, 2115 Frederick Ave., Kalamazoo, MI 49008, (616) 385-7074, days or 344-8289, evenings.

**WANTED:** Sets of the magazines *TI 99er*, *Home Computer*, and *Personal Computer*. Will trade or sell early issues of *Kilobaud* and *Interface*. Merle Vogt, POB 145, Von Ormy, TX 78073.

**FOR SALE:** NEC APC-H12 color-graphics board with 128K RAM expansion memory for the NEC APC H03 color computer. New, unused, and in original box. \$575 including UPS in the continental U.S. Howard D. Roney, 4840 Andrea Dr. NW, Salem, OR 97304, (503) 378-1826, after 6 p.m.

**FOR SALE:** BYTE, May 1977 through October 1983 and a few issues before May 1977. Buyer pays shipping. Dave Lamb, 3501 Kingston Circle, Ft. Collins, CO 80525, (303) 223-7131.

**FOR SALE:** TI-99/4A, disk controller and drive, peripheral expansion box, extended memory card, and more. Never used. Paid \$750; asking \$500 or best offer. Bruce Ransom, 13278 Paramount Dr., Saratoga, CA 95070, (408) 741-1492, evenings.

**FOR SALE:** Micromint MPX-16 single-board computer system, MPX-17 IBM keyboard interface, and more. \$900. Lee W. Sorensen, 6555 Lawndale Lane, Maple Grove, MN 55369, (612) 420-2425.

**FOR SALE:** ICs including eight 4116s, 68000, two 4802s, TTL, and CMOS. Also over 900 miscellaneous components including transistors, ceramic resistors, metal film and carbon resistors, diodes, and capacitors. Most new, all marked. \$1000 value; asking \$300 firm. T. Atiyeh, 6 Munnisunk Dr., Simsbury, CT 06070, (203) 651-0819.

**FOR SALE:** DEC Rainbow 100 unit with keyboard, black-and-white monitor, owner's manual, new: \$1200. James Gullford, POB 15060, Cleveland, OH 44115, (216) 961-0462.

**FOR SALE:** TI-99/4A computer with expansion box, 32K card, RS-232C, disk drive, speech synthesizer, and more. \$1000 plus shipping. Bill Stefek, 36 Sedgwick, Oswego, IL 60543, (312) 554-8256.

**WANTED:** PC Magazine, volume 1, numbers 1, 2, and 6. W. A. Winshall, 3 Ferndale Rd., Weston, MA 02193, (617) 235-5360.

**FOR SALE:** Breadboard interface for TRS-80 Model I/III; plugs into expansion slot and has on-board logic probe, 8-trace scope multiplexer, cables, and manuals: \$250. Also, HUH TRS-80 to S-100 bus adapter; \$35. U.S. postal money order only. I will pay shipping. Steve Griffith, POB B39708, Butte Ave., Florence, AZ 85232.

**WANTED:** Users of Times Sinclair 1000 for correspondence and practical information sharing. Wish to form club. A. M. Bailey, c/o POB 161815, Sacramento, CA 95816-1815.

**FOR SALE:** North Star Horizon S-100 bus mainframe (12 slots) with Z80, two serial and two parallel ports, MS6C DMB6400 64K DRAM, SDS Versafloppy-II disk controller, cabinet and power supply with two Seimens FDD 100-8 8-inch floppy drives, Heathkit H-19 terminal, and Epson MX-80 printer. \$2500. Send SASE. Richard Palmer, 72 Alda Dr., Poughkeepsie, NY 12603.

**WANTED:** Software driver (8080 code) for Heuristics SpeechLab Model 20S (S-100 model). The manufacturer's out of business, and the board's ROM is not working. Will pay postage, cost of disk or photocopying, etc. Bud Stokler, 101 South Whiting St. #1506, Alexandria, VA 22304, (703) 370-2242.

**FOR SALE:** LA34 DECwriter IV printer/terminal, mounted on matching stand (on casters) with output/input trays, complete with optional tractor, manual, cable, and ribbons, perfect condition: \$450. Paul Morgenstern, 59 Vernon St., Waltham, MA 02154, (617) 894-9120.

**FOR SALE:** DEC Rainbow 100A with 256K, two 400K drives, monitor, keyboard, one communication port, one parallel port, all cables, and manuals. Asking \$2350 or best offer. Jirayu Theraprasert, 385 North Rockvale #8, Azusa, CA 91702, (818) 334-1185.

**WANTED:** Atari 800XL owner would like to correspond with other Atari users to explore its capabilities and potential by exchanging information, ideas, advice, and public-domain or user-written programs. Ferit Saracoglu, MD, Gazi Mustafa Kemal Bulvari, No: 120/19, Maltepe, Ankara, Turkey.

**FOR SALE:** Two IMSAI VDP 80s with 64K RAM, two 8-inch disk drives. Excellent condition. Best offer. A. M. Agapos, POB 352, Dauphin Island, AL 36528, (205) 460-7171 or 861-7326.

**FOR SALE:** Complete set of BYTE, first issue through present. Excellent condition. Best offer. Marlene Iadavaia, Suite 410, 5725 Paradise Dr., Corte Madera, CA 94925, (415) 924-0840.

**FOR SALE:** Sage II computer with Cume QVT211 GX amber graphics terminal, 500K 150-nm RAM, two low-profile 640K floppies, RS-232C port, IEE-488 port, Centronics parallel port, modem port, all manuals and more. Originally \$5700; asking \$4500. Wayne Britton, 3800 McKinley, Plano, TX 75023. ■

UNCLASSIFIED ADS MUST BE noncommercial, from readers who have computer equipment to buy, sell, or trade on a onetime basis. All requests for donated computer equipment must be from nonprofit organizations. Programs to be exchanged must be written by the individual or be in the public domain. Ads must be typed double-spaced, contain 50 words or less, and include full name and address. This is a free service; ads are printed as space permits. BYTE reserves the right to reject any unclassified ad that does not meet these criteria. When you submit your ad (BYTE, Unclassified Ads, POB 372, Hancock, NH 03449), allow at least four months for it to appear.

# B.O.M.B

## BYTE'S ONGOING MONITOR BOX

ARTICLE#	PAGE	ARTICLE	AUTHOR(S)	ARTICLE#	PAGE	ARTICLE	AUTHOR(S)
1	9	Microbytes	staff	10	161	Logic Programming	Kowalski
2	39	What's New	staff	11	181	Declarative Languages: An Overview	Eisenbach, Sadler
3	49	Book Reviews	Bharath, Sklar, Welch, Kirwan	12	201	Program Transformation	Darlington
4	70	Ask BYTE	Ciarcia	13	219	Functional Programming Using FP	Harrison, Khoshnevisan
5	83	The Amiga Personal Computer	Williams, Edwards, Robinson	14	235	A Hope Tutorial	Bailey
6	104	Ciarcia's Circuit Cellar: Build the BASIC-52 Computer/Controller	Ciarcia	15	266	The Tandy 1000	Malloy
7	120	The DSI-32 Coprocessor Board, Part I: The Hardware	Marshall, Scolaro, Rand, King, Williams	16	275	IBM Pascal 2.00	Finan
8	138	Programming Project: Context-Free Parsing of Arithmetic Expressions	Amsterdam	17	293	Computing at Chaos Manor: The West Coast Computer Faire	Poumelle
9	151	Prolog Goes to Work	Cuadrado, Cuadrado	18	331	BYTE Japan: COMDEX in Japan	Raike
				19	341	BYTE U.K.: Declarative Update	Pountain
				20	355	According to Webster: Greetings and Agitations	Webster
				21	369	BYTE West Coast: New Microprocessor Chips	Robinson
				22	378	BYTELINES	Libes

## BOMB Results

### PERFECT PRODUCT PREDOMINATES

In the May BYTE Jerry Pournelle took Computing at Chaos Manor "In Search of the Perfect Product." The readers gave it the blue ribbon. In second place is Gregg Williams's product description of "The AT&T UNIX PC." The continuation of Ciarcia's Circuit Cellar project on how to "Build the Home Run Control System, Part 2: The Hardware" came in third. In fourth place is "Multiprocessing: An Overview" written by Rich

Krajewski. And winner of the \$100 prize is Alan Finger, author of the fifth-placed review of the "IBM PC AT." Next in line is Computers and Law coauthored by Robert G. Sterne and Perry Saidman. Their study of "The Sale of Computer Products" placed sixth. Ask BYTE, conducted by Steve Ciarcia, won seventh place. In eighth place, and the winner of the \$50 bonus, is Jerry Grady's review of "The Compaq Deskpro."

### BYTE ADVERTISING SALES STAFF:

**J. Peter Huestls, Advertising Sales Manager, 70 Main Street, Peterborough, NH 03458, tel. (603) 924-9281**

#### NEW ENGLAND

ME, NH, VT, MA, RI,  
EASTERN CANADA  
Paul McPherson Jr. (617) 262-1160  
McGraw-Hill Publications  
4170 Ashford-Dunwoody Road—  
Suite 420  
Boston, MA 02116

#### ATLANTIC

NY, NJ, CT, VA (NORTH)  
Leah Goldman (212) 512-2096  
McGraw-Hill Publications  
1221 Avenue of the Americas—  
39th Floor  
New York, NY 10020

Dick McCork (203) 968-7111  
McGraw-Hill Publications  
Building A—3rd Floor  
777 Long Ridge Road  
Stamford, CT 06902

#### EAST

PA (EAST), NJ (SOUTH),  
MD, VA, W.VA, DE, D.C.  
Daniel Ferro (215) 496-3833  
McGraw-Hill Publications  
Three Parkway  
Philadelphia, PA 19102

#### SOUTHEAST

NC, SC, GA, FL, AL, TN  
Maggie M. Dorvee (404) 252-0626  
McGraw-Hill Publications  
4170 Ashford-Dunwoody Road—  
Suite 420  
Atlanta, GA 30319

#### MIDWEST

IL, MO, KS, IA, ND, SD, MN, WI, NB, IN  
Bob Denmead (312) 751-3740  
McGraw-Hill Publications  
Blair Building  
645 North Michigan Ave.  
Chicago, IL 60611

#### GREAT LAKES, OHIO REGION

MI, OH, PA (ALLEGHENY), KY,  
ONTARIO, CANADA  
Mike Kisseberth (313) 352-9760  
McGraw-Hill Publications  
4000 Town Center—Suite 770  
Southfield, MI 48075

#### SOUTH PACIFIC

SOUTHERN CA, AZ, NM, LAS VEGAS  
Jack Anderson (714) 557-6292  
McGraw-Hill Publications  
3001 Red Hill Ave.  
Building #1—Suite 222  
Costa Mesa, CA 92626

Karen Niles (213) 480-5243, 487-1160  
McGraw-Hill Publications  
3333 Wilshire Boulevard #407  
Los Angeles, CA 90010

#### NORTH PACIFIC

HI, WA, OR, ID, MT, NORTHERN CA,  
NV (except LAS VEGAS), W. CANADA  
David Jern (415) 362-4600  
McGraw-Hill Publications  
425 Battery Street  
San Francisco, CA 94111

Bill McAfee (415) 964-0624  
McGraw-Hill Publications  
1000 Elwell Court—Suite 225  
Palo Alto, CA 94303

#### SOUTHWEST, ROCKY MOUNTAIN

UT, CO, WY, OK, TX, AR, MS, LA  
Dennis Riley (214) 458-2400  
McGraw-Hill Publications  
Prestonwood Tower—Suite 907  
5151 Beltline  
Dallas, TX 75240

**WEST COAST SURPLUS  
AND RETAIL ACCOUNTS**  
Tom Harvey (805) 964-8577  
3463 State Street—Suite 256  
Santa Barbara, CA 93105

**The Buyer's Mart**  
Karen Burgess (603) 924-9281  
BYTE Publications  
70 Main Street  
Peterborough, NH 03458

**Post Card Mailings  
National**  
Bradley Browne (603) 924-6166  
BYTE Publications  
70 Main Street  
Peterborough, NH 03458

### International Advertising Sales Representatives:

Mr. Hans Csokor  
Publimedia  
Reisnerstrasse 61  
A-1037 Vienna, Austria  
222 75 76 84

Mrs. Gurit Gepner  
McGraw-Hill Publishing Co.  
PO Box 2156  
Bat Yam, 59121 Israel  
3 866 561 321 39

Mr. Fritz Krusebecker  
McGraw-Hill Publishing Co.  
Liebigstrasse 19  
D-6000 Frankfurt/Main 1  
West Germany  
69 72 01 81

Mrs. Maria Sarmiento  
Pedro Teixeira 8, Off. 320  
Iberia Mart 1  
Madrid 4, Spain  
1 45 52 891

Mr. Andrew Karnig  
Andrew Karnig & Associates  
Finnbodavagen  
S-131 31 Nacka, Sweden  
8-44 0005

Mr. Jean Christian Acis  
McGraw-Hill Publishing Co.  
17 rue Georges Bizet  
F 75116 Paris  
France  
1 720 33 42

Mr. Arthur Scheffer  
McGraw-Hill Publishing Co.  
34 Dover St.  
London W1X 3RA  
England 01 493 1451

Mr. Savio Pesavento  
McGraw-Hill Publishing Co.  
Via Flavio Baracchini 1  
20123 Milan, Italy  
02 86 90 617

Seavex Ltd.  
400 Orchard Road, #10-01  
Singapore 0923  
Republic of Singapore  
Tel: 734-9790  
Telex: R535539 SEAVEX

Seavex Ltd.  
503 Wilson House  
19-27 Wyndham St.  
Central, Hong Kong  
Tel: 5-260149  
Telex: 60904 SEVEX HX

Hiro Morita  
McGraw-Hill Publishing Co.  
Overseas Corp  
Room 1528  
Kasumigaseki Bldg.  
3-2-5 Kasumigaseki,  
Chiyoda-Ku  
Tokyo 100, Japan  
3 581 9811

# R.E.A.D.E.R S.E.R.V.I.C.E

Inquiry No.	Page No.	Inquiry No.	Page No.	Inquiry No.	Page No.	Inquiry No.	Page No.	
349	1ST PLACE SYSTEMS.....	400	68	COMPUTER FRIENDS.....	190	133	GIFFORD COMP SYS.....	5
2	4-5-6 WORLD.....	423	69	COMPUTER HUT OF N.E.....	375	134	GOLD HILL COMPUTERS.....	190
3	A.S.T. RESEARCH.....	19	70	COMPUTER INNOVATIONS.....	308	351	GOLDEN BOW SYSTEMS.....	250
4	A.S.T. RESEARCH.....	19	71	COMPUTER INNOVATIONS.....	296	135	GTEK INC.....	300
5	AB COMPUTERS.....	284	72	COMPUTER MAIL ORDER.....	316, 317	136	HGE COMPUTRONICS.....	229
6	AB COMPUTERS.....	285	73	COMPUTER MART.....	340	366	HAMMER COMP SYS.....	372
7	ABC DATA PRODUCTS.....	404	74	COMPUTER MEDIA MARKETING.....	394	137	HARMONY VIDEO & COMP.....	216
8	ADDMASTER CORP.....	423	75	COMPUTER PARTS MART.....	421	138	HAYES MICROCOMP PROD.....	328, 329
9	ADTEK.....	200	77	COMPUTER WAREHOUSE.....	319	369	HAYES MICROCOMP PROD.....	359
10	ADVANCED COMP PROD.....	416, 417	78	COMPUTER WAREHOUSE.....	319	139	HERCULES COMPUTER TECH.....	129
360	ALDEC.....	280	79	COMPUTERBANC.....	66	140	HERCULES COMPUTER TECH.....	131
361	ALDEC.....	280	80	COMPUTRADE.....	244	141	HEWLETTPACKARD.....	257
13	ALF PRODUCTS INC.....	58	81	CONCORD TECHNOLOGY INC.....	421	142	HEWLETTPACKARD.....	325
14	ALLIED MICRO DEVICES.....	421	82	CONROY-LAPOINTE.....	146, 147	143	HEWLETTPACKARD.....	327
	AMBER SYSTEMS.....	28, 29	83	CONROY-LAPOINTE.....	146, 147	144	HI TECH EQUIP CORP.....	402
	AMERICAN MICRO SYSTEMS.....	423	84	CONROY-LAPOINTE.....	146, 147	145	HOFFMAN INT'L.....	421
17	AMERICAN RESEARCH.....	205	85	COSMOS.....	298	146	HOLMES & COMPANY.....	350
18	AMERICAN RESEARCH.....	205		CRESCENT COM INC.....	392	147	HOUSTON INSTR/BAUSCH&LOMB.....	97
19	AMERICAN SEMICONDUCTOR.....	394	86	CUESTA SYSTEMS.....	286	148	IBEX COMP CORP.....	394
20	AMPRO COMPUTERS INC.....	166	87	CUSTOM COMP TECH.....	388		IBM CORP.....	INSERT 32 A-D
21	APPARAT INC.....	392	88	CUSTOM COMP TECH.....	389	150	IBM CORP.....	102, 103
	APPLE COMPUTER INC.....	CII, I	355	CYMA CORPORATION.....	345	152	IBMSMALL SYS DIV.....	259, 260, 261
	APROTEK.....	135	356	CYMA CORPORATION.....	345	365	IC EXPRESS.....	54
22	APROTEK.....	423	89	DAC SOFTWARE INC.....	25	153	INFOCOM.....	36, 37
23	ARK ELECTRONICS PRODUCTS.....	241	383	DATA SPEC.....	216	154	INTEGRAND.....	226
24	ASHTON-TATE.....	379	384	DATA SPEC.....	216	156	INTERFACE INC.....	31
	AT&T COMMUNICATIONS.....	176, 177	385	DATA SPEC.....	244	157	INTERFACE INC.....	31
	AT&T INFORMATION SYS.....	288, 289	386	DATA SPEC.....	244		INTERFACE TECH CORP.....	299
	AT&T INFORMATION SYS.....	351	92	DATA TRANSLATION INC.....	52		INTERFACE TECH CORP.....	301
25	ATKINS ASSOCIATES.....	305	93	DATABROKERS.....	394		INTERFACE TECH CORP.....	303
26	AUTOMATION FACILITIES CORP.....	26	94	DATASOUTH COMP CORP.....	247	158	IOMEGA.....	353
27	AUTOMATION FACILITIES CORP.....	26	95	DAYNA COMM.....	46, 47	372	IC INFORMATION SYSTEMS.....	287
28	AVOCET.....	99	96	DELUXE COMP FORMS.....	230	159	IAD COMP PROD.....	418, 419, 420
	AWESOME TECHNOLOGY INC.....	394	97	DIGI DATA CORP.....	307	161	IAMECO ELECTRONICS.....	68, 69
30	B&B ELECTRONICS.....	392	98	DIGITAL RESEARCH COMPUTERS.....	214	162	IDR MICRODEVICES INC.....	424, 425
	B&C MICROSYSTEMS.....	402	99	DIGITALK.....	354	163	IDR MICRODEVICES INC.....	426, 427
31	BASF SYSTEMS.....	157	348	DISK MERCHANT.....	50	164	IDR MICRODEVICES INC.....	428
33	BAY TECHNICAL ASSOC.....	23	101	DISKETTE CONNECTION.....	253	165	JOHN WILEY & SONS.....	75
34	BDS CORPORATION.....	249	103	DISKWORLDS! INC.....	387	166	KADAK PRODUCTS.....	240
	BEST WESTERN INT'L.....	303	363	DISKWORLDS! INC.....	396	347	KEA SYSTEMS LTD.....	394
35	BINARY TECHNOLOGY.....	404	104	DISKWORLDS! INC.....	406	167	KEITHLEY DAC.....	22
36	BITTNER ELECTRONICS.....	392	105	DISPLAY TELECOMMNTNS.....	408, 409	168	KIMTRON CORP.....	223
37	BLAISE COMPUTING INC.....	326	374	DITRON CORP.....	404	375	KRUEGER TECHNOLOGY INC.....	405
38	BORLAND INT'L.....	41	373	DIVERSIFIED COMPUTER SYS.....	400	376	KRUEGER TECHNOLOGY INC.....	405
39	BORLAND INT'L.....	41	106	DOKAY COMP PROD INC.....	403	170	L'COM INC.....	344
40	BORLAND INT'L.....	43	107	DOW JONES NEWS RETRIEVAL.....	67	171	LABORATORY MICROSYS.....	62
41	BORLAND INT'L.....	43	108	EASTMAN KODAK CO.....	135		LANGLEYST CLAIR.....	392
42	BORLAND INT'L.....	45	109	ECOSOFT.....	158	172	LARK SOFTWARE.....	172
43	BORLAND INT'L.....	45	110	ELECTRONIC PROTECTION DEV.....	304	173	LATTICE INC.....	184
	BUEHLER SERVICES.....	421	111	ELEXOR INC.....	402	174	LEARNING TECHNOLOGY INST.....	232
44	BUSINESS TOOLS INC.....	377		ELLIS COMPUTING INC.....	76	175	LEO ELECTRONICS.....	392
	BYTE BACK ISSUES.....	388		EPSON AMERICA.....	78, 79	176	LEVEL 5 RESEARCH.....	188
	BYTE MARKETING.....	361	113	EVEREX SYSTEMS.....	48	177	LEVIEU INSTRUMENT CO.....	352
	BYTE SUBSCRIBER SERVICE.....	136	114	EXPRESS BUSINESS SOFTWARE.....	117	178	LINTEK INC.....	421
45	BYTEK COMP SYS CORP.....	127	115	EXPRESS COMPUTER INC.....	234	179	LOCKHEED-GETEX.....	277
	C WARE/DESMET C.....	144	116	EXPRESS SYSTEMS INC.....	12, 13	180	LOGICAL DEVICES.....	24
52	CDA INT'L SOFTWARE.....	398	117	EXSEL INC.....	394	181	LOGICAL DEVICES.....	423
46	CI COMPUTERS.....	320	119	FIRST CLASS PERIPHERALS.....	165	332	LOGIC PROGRAMMING ASSOC.....	54
47	CI COMPUTERS.....	320	120	FLAGSTAFF ENGINEERING.....	234	389	LOGIC SOFT.....	INSERT 112 A-B
	CALIF DIGITAL.....	414, 415	121	FLAGSTAFF ENGINEERING.....	234	182	LOGICWARE.....	53
49	CALIF SCIENTIFIC SFTW.....	404	122	FORTRON INC.....	401		LOGITECH INC.....	294
50	CAPITAL EQUIPMENT CORP.....	114	123	FORTRON INC.....	401	184	LOMAS DATA PRODUCTS.....	357
368	CAPITAL MICRO.....	171	124	FOX AND GELLER INC.....	342		LOTUS DEVELOPMENT.....	198, 199
53	CHORUS DATA SYSTEMS.....	306	125	FOX SOFTWARE INC.....	281	185	LYBEN COMP SYS.....	404
54	CIVIL COMPUTING CORP.....	402		FRANKLIN MINT.....	343	186	LYCO COMPUTER.....	332
	CODEX CORPORATION.....	251	126	FUNK SOFTWARE.....	264	187	MACMILLAN SOFTWARE.....	217
56	COEFFICIENT SYS CORP.....	159	128	GENERAL COMPUTER.....	366, 367	188	MACROTECH INT'L.....	246
57	COGITATE.....	402	130	GENERAL TECHNOLOGY.....	318	189	MANX SOFTWARE SYS.....	55
58	COGITATE.....	423	131	GENESIS MICROSYSTEMS.....	233	190	MARK WILLIAMS CO.....	51
	COMMODORE BUSN MACHINES.....	137	132	GENICOM.....	167	191	MARYMAC INDUSTRIES INC.....	398
60	COMMUNICATIONS ELECTR.....	410, 411						
61	COMP COMPNYS UNLTD.....	412, 413						
62	COMPETITIVE EDGE.....	238						
	COMPUMAIL.....	422						
63	COMPUSAVE.....	391						
64	COMPUSERVE.....	227						
65	COMPUTER AFFAIRS INC.....	358						
67	COMPUTER CONNECTION INC.....	395						
	COMPUTER CONTINUUM.....	398						
68	COMPUTER FRIENDS.....	190						
69	COMPUTER HUT OF N.E.....	375						
70	COMPUTER INNOVATIONS.....	308						
71	COMPUTER INNOVATIONS.....	296						
72	COMPUTER MAIL ORDER.....	316, 317						
73	COMPUTER MART.....	340						
74	COMPUTER MEDIA MARKETING.....	394						
75	COMPUTER PARTS MART.....	421						
77	COMPUTER WAREHOUSE.....	319						
78	COMPUTER WAREHOUSE.....	319						
79	COMPUTERBANC.....	66						
80	COMPUTRADE.....	244						
81	CONCORD TECHNOLOGY INC.....	421						
82	CONROY-LAPOINTE.....	146, 147						
83	CONROY-LAPOINTE.....	146, 147						
84	CONROY-LAPOINTE.....	146, 147						
85	COSMOS.....	298						
	CRESCENT COM INC.....	392						
86	CUESTA SYSTEMS.....	286						
87	CUSTOM COMP TECH.....	388						
88	CUSTOM COMP TECH.....	389						
355	CYMA CORPORATION.....	345						
356	CYMA CORPORATION.....	345						
89	DAC SOFTWARE INC.....	25						
383	DATA SPEC.....	216						
384	DATA SPEC.....	216						
385	DATA SPEC.....	244						
386	DATA SPEC.....	244						
92	DATA TRANSLATION INC.....	52						
93	DATABROKERS.....	394						
94	DATASOUTH COMP CORP.....	247						
95	DAYNA COMM.....	46, 47						
96	DELUXE COMP FORMS.....	230						
97	DIGI DATA CORP.....	307						
98	DIGITAL RESEARCH COMPUTERS.....	214						
99	DIGITALK.....	354						
348	DISK MERCHANT.....	50						
101	DISKETTE CONNECTION.....	253						
103	DISKWORLDS! INC.....	387						
363	DISKWORLDS! INC.....	396						
104	DISKWORLDS! INC.....	406						
105	DISPLAY TELECOMMNTNS.....	408, 409						
374	DITRON CORP.....	404						
373	DIVERSIFIED COMPUTER SYS.....	400						
106	DOKAY COMP PROD INC.....	403						
107	DOW JONES NEWS RETRIEVAL.....	67						
108	EASTMAN KODAK CO.....	135						
109	ECOSOFT.....	158						
110	ELECTRONIC PROTECTION DEV.....	304						
111	ELEXOR INC.....	402						
	ELLIS COMPUTING INC.....	76						
	EPSON AMERICA.....	78, 79						
113	EVEREX SYSTEMS.....	48						
114	EXPRESS BUSINESS SOFTWARE.....	117						
115	EXPRESS COMPUTER INC.....	234						
116	EXPRESS SYSTEMS INC.....	12, 13						
117	EXSEL INC.....	394						
119	FIRST CLASS PERIPHERALS.....	165						
120	FLAGSTAFF ENGINEERING.....	234						
121	FLAGSTAFF ENGINEERING.....	234						
122	FORTRON INC.....	401						
123	FORTRON INC.....	401						
124	FOX AND GELLER INC.....	342						
125	FOX SOFTWARE INC.....	281						
	FRANKLIN MINT.....	343						
126	FUNK SOFTWARE.....	264						
128	GENERAL COMPUTER.....	366, 367						
130	GENERAL TECHNOLOGY.....	318						
131	GENESIS MICROSYSTEMS.....	233						
132	GENICOM.....	167						
133	GIFFORD COMP SYS.....	5						
134	GOLD HILL COMPUTERS.....	190						
351	GOLDEN BOW SYSTEMS.....	250						
135	GTEK INC.....	300						
136	HGE COMPUTRONICS.....	229						
366	HAMMER COMP SYS.....	372						





# NEC PRINTERS. THEY ONLY STOP WHEN YOU WANT THEM TO.



Color Pinwriter CP2  
dot matrix printer.

Spinwriter 8800  
letter-quality printer.

Pinwriter P3  
dot matrix printer.

NEC printers are incredibly reliable.

In fact, with normal use, an NEC printer can run an average of 5 years before it needs a repair. And chances are, that repair will take only about 15 minutes.

To become that reliable, an NEC printer has to go through some of the most demanding tests in the industry.

First, we test every single part before it goes into the printer. Then we test the printer itself. Nothing is forgotten. Nothing is left to chance.

But reliability is only part of the story. There's much more. Our printers work with every popular PC. With more leading software programs. And with more forms handlers to make paperwork a snap.

So no matter what your printing needs—and no matter what size your budget—NEC has a printer for you. Our full line of Spinwriter® printers, for low to high speed letter quality printing. And our versatile Pinwriter™ and Color Pinwriter printers, for high resolution dot matrix printing.

To find out more about NEC printers, call 1-800-343-4418 (in Mass. 617-264-8635).  
Or write: NEC Information Systems, Department 1610,  
1414 Massachusetts Ave., Boxborough, MA 01719.

**NEC PRINTERS. THEY ONLY STOP WHEN YOU WANT THEM TO.**

**NEC**  
NEC Information Systems, Inc.

**C&C**

Computers and Communications

Spinwriter is a registered trademark of NEC Corporation. Pinwriter is a trademark of NEC Corporation.

Inquiry 229

# TANDY... Clearly Superior™

We edged out the competition with the Tandy® 2000, giving you the performance of IBM's PC AT for only \$1599.



Like the IBM® PC AT, the Tandy 2000 offers two to three times the speed and two times the disk storage of IBM's PC. The Tandy 2000 also offers twice the graphics resolution, with twice the colors of the IBM PC, for color charts and graphs that are nothing short of spectacular.

You'll see the difference using popular programs like Lotus 1-2-3® and SuperCalc®. The Tandy 2000 races through spreadsheets and graphs the results with razor-sharp precision.

At \$3999, a PC AT is \$2400 more than a 2-disk, 256K Tandy 2000. In fact, you can get a complete Tandy 2000 system with color monitor and graphics for \$2622.90—still over \$1000 less than an AT *without* a monitor!

If you're thinking an AT costs more because of the support IBM is famous for, think again.

We offer a free customer support "hotline"! IBM's telephone support will cost you \$40. *Per call.* We also offer on-site customer support and

training in major markets. Something IBM doesn't offer at all to its PC AT owners.

So come in and find out how your business can lease a Tandy 2000 system for only \$90 per month\*. And get the edge on *your* competition.

Available at over 1200  
Radio Shack Computer Centers and at  
participating Radio Shack stores and dealers.

**Radio Shack®**  
**COMPUTER CENTERS**

A DIVISION OF TANDY CORPORATION

\*Commercial lease for a Tandy 2000 with color monitor and graphics, plus applicable use/sales tax. Tandy 2000 prices apply at Radio Shack Computer Centers and participating stores and dealers. Lotus 1-2-3 is a registered trademark of Lotus Development Corp. SuperCalc3 is a registered trademark of Sorcim/US. IBM and the IBM logo are registered trademarks of International Business Machines Corp. Pricing and service availability as of 5/1/85.