

10th Anniversary Issue

# BYTE

THE SMALL SYSTEMS JOURNAL

SEPTEMBER 1985 VOL. 10, NO. 9

\$3.50 IN UNITED STATES  
\$4.25 IN CANADA / £2.10 IN U.K.  
A MCGRAW-HILL PUBLICATION  
0360-5280

HOMEBREWING

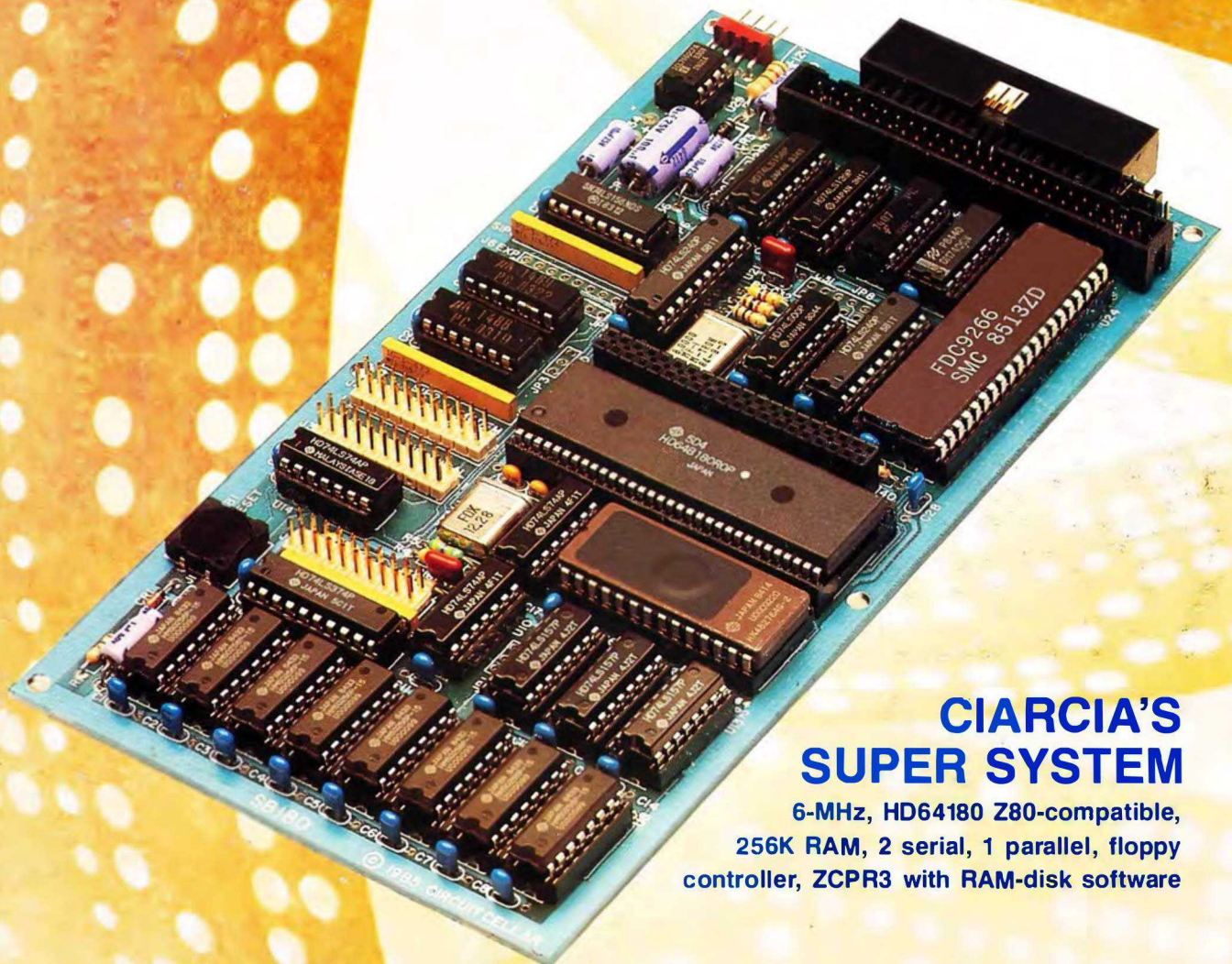

## CIARCIA'S SUPER SYSTEM

6-MHz, HD64180 Z80-compatible,  
256K RAM, 2 serial, 1 parallel, floppy  
controller, ZCPR3 with RAM-disk software



# No matter what you're in

## Candidate Search Update

FILE: Resumes  
SEARCH DATE: 5/20/85  
CLIENT: Splendora Gourmet Baby Foods

**FIND**  
EXPERIENCE - Marketing Manager  
FIELD - Food/Infant  
SIZE - 500+ Employees  
SALARY REQ. - \$40-\$50,000 Per Annum  
LOCATION REQ. - Domestic  
-or-  
RELOCATABLE - Yes

Name	Experience	Salary	Education	Age
Antosz, Hank	1978—Present Pinz-Pinz Baby Food 1976—1978 Heath Baby Products	\$45,000	Harvard MBA/Mktg.	33
Brown, Bob	1984—Present Liz for Kids 1982—1984 Bonnie Babe, Inc.	\$48,000	CSUN/Marketing BA	26
Hayden, Steve	1979—Present Heath Baby Products 1975—1979 Nummy Tummies	\$43,000	UCLA/Sociology BA Harvard MBA	35
Morrison, John	1977—Present Camille Grocers, Ltd. 1974—1977 Georgie Porgie of London	\$40,000	Oxford/Marketing	32
West, Nick	1961—Present Bonnie Babe, Inc.	\$47,000	UCLA MBA/Mktg.	42



**Recruit-A-Suit**  
180 Adams Avenue  
Suite 7-1  
Detroit, Michigan

May 20, 1985

Mr. Greg Hain  
Vice President, Marketing  
Splendora Gourmet Baby Foods  
2200 Michigan Place East  
Winnetka, Illinois

Dear Mr. Hain:

As a busy executive you know that accomplishing your many professional objectives is a full-time job.

And the last thing you need is to take time out of your hectic schedule to search for a new team player. That's where **Recruit-A-Suit** can help.

We're a full-service recruitment firm with our finger on more than 5,000, meticulously selected, aggressive, ambitious, highly-qualified professionals not unlike yourself.



Our selective screening processes help us locate candidates who not only meet your specified work experience and salary requirements, but who are well suited to the corporate culture of your company.

One more reason we enjoy the highest success rate in the industry! Though our fees remain among the most competitive in the industry.

Enclosed, please find more information on our client references, case histories and terms of business for your reading pleasure.

And next time you find yourself faced with an empty swivel chair, don't hesitate to call **Recruit-A-Suit**.

Sincerely,

*Cynthia Sham*

Cynthia Sham  
Senior Associate

CS:sh

enc.

### Personality



### Leadership



### Experience

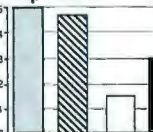

### Communication



Using database management programs you can store, retrieve and sort information in an almost unlimited number of combinations. As opposed to the way you're probably doing it now. Above, we've located eligible candidates by salary and work experience. But database management is also handy for things like generating master mailing lists. Creating invoices. Sorting by zip code. Checking inventory. No files to lose. No cross-referencing your Rolodex. No paperclips.

In business, people often meet your letterhead before they meet you. Ever wondered what a typewritten page stiff with white-out says about your business? With The Macintosh Office you can even design and print your own letterhead, plus combine publication quality text and graphics for a lasting first impression. More important, you can send personalized letters to as many prospects as you have paper.

\* Manufacturer's suggested retail price. © 1985 Apple Computer, Inc. Apple, the Apple logo, LaserWriter, AppleTalk and MacDraw are trademarks of Apple Computer, Inc. Macintosh is a trademark of McIntosh Laboratory, Inc. and is being used with its express permission. Nabisco is a registered trademark of Nabisco, Inc. Rokodex is a registered trademark of Zephyr American Corporation, a subsidiary of Insico. \*\* Multiplan is a registered trademark of Microsoft Corporation.



# Business you're in, business.

## Candidate Profile Analysis



Each graph represents seven to ten pages of test information per candidate.

Individual tests are available for your review at your request.

As these comparative charts indicate, all candidates tested competitively in the four areas.

However, based on further in-depth study, including extensive personal interviews, we highly recommend you interview candidates 4 and 5 as soon as possible.

Our office will be contacting you immediately to set up these interviews at your earliest convenience.

Recruit-A-Suit Income Statement  
Fiscal Year Ending 9/30/84

	Q1	Q2	Q3	Q4	Year-end
<b>SALES</b>					
Ann Arbor					
Fees	29,000	19,000	22,000	17,000	76,000
Commissions	52,000	45,000	48,000	42,000	187,000
Total Ann Arbor	72,000	64,000	70,000	59,000	265,000
Detroit					
Fees	44,000	46,000	42,000	39,000	171,000
Commissions	88,000	72,000	84,000	82,000	266,000
Total Detroit	112,000	118,000	106,000	101,000	437,000
<b>TOTAL SALES</b>	<b>184,000</b>	<b>182,000</b>	<b>176,000</b>	<b>160,000</b>	<b>702,000</b>
<b>OPERATING EXPENSES</b>					
Ann Arbor					
Payroll	30,000	30,000	33,000	30,000	123,000
Taxes	2,500	2,500	2,600	2,500	10,100
Auto	1,200	1,200	1,200	1,200	4,800
Telephone	600	600	600	600	2,400
Rent	8,000	8,000	8,000	8,000	32,000
Utilities	500	500	500	500	2,000
Dues/Subscrip.	100	100	200	100	500
Advertising	3,000	3,000	4,000	4,000	14,000
Travel	1,000	1,000	1,000	1,000	4,000
Entertainment	1,500	1,500	1,750	1,500	6,250
Office Supplies	300	300	300	300	1,200
<b>Ann Arbor Total</b>	<b>48,700</b>	<b>48,700</b>	<b>63,180</b>	<b>48,700</b>	<b>209,280</b>
Detroit					
Payroll	50,000	52,000	60,000	60,000	202,000
Taxes	4,200	4,400	4,200	4,200	17,000
Auto	2,400	2,400	2,400	2,400	9,600
Telephone	1,200	1,500	1,500	1,200	5,400
Rent	9,100	9,100	9,100	9,400	36,700
Utilities	800	800	800	800	3,200
Dues/Subscrip.	200	250	200	200	850
Advertising	3,000	3,500	3,500	3,000	13,000
Travel	1,200	1,500	1,200	1,400	5,300
Entertainment	1,800	1,800	1,800	1,400	6,400
Office Supplies	400	400	400	400	1,600
<b>Detroit Total</b>	<b>74,100</b>	<b>77,880</b>	<b>74,900</b>	<b>74,400</b>	<b>301,280</b>
<b>EXPENSES TOTAL</b>	<b>122,800</b>	<b>126,580</b>	<b>138,080</b>	<b>124,100</b>	<b>511,560</b>
<b>NET PRE-TAX PROFIT</b>	<b>61,200</b>	<b>55,420</b>	<b>47,920</b>	<b>35,900</b>	<b>200,700</b>

Whether you're Nabisco® or Ms. Priss' Cookie Company you worry about the bottom line. Write letters. Keep track of inventory. Keep your overhead under control. Pay taxes. Retrieve files. Schedule projects.

Which is why you can dramatically increase your business' productivity with The Macintosh™ Office.

The cornerstone of The Macintosh Office is our Macintosh 512K computer. All you need to know about its powerful, 32-bit, mouse-driven technology is that it reduces the time it takes to become productive with a computer from well over a work week to just under a lunch hour.

But more important, Macintosh runs more than 500 software programs that can solve a multitude of business problems.

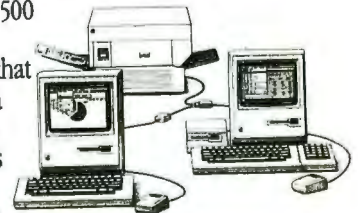

When you team up Macintosh with the second hardest worker in The Macintosh Office, our LaserWriter™ printer, you can bring a new level of professionalism to your paperwork.

It produces publication-quality text and graphics in letters, internal documents, presentations, even business forms. There's no telling what it can save you in outside printing costs alone. And the LaserWriter can be shared with as many as 31 Macintosh computers. So it becomes more cost efficient with every Macintosh you connect to it.

Butcher, baker, candlestick-maker... or Nabisco, for more information about The Macintosh Office call 800-446-3000.

No job too big.  
Or too small.

The Macintosh Office.



If a picture is worth a thousand words, business graphics like these could cut meetings and presentations in half.

We've taken information on five candidates stored in one software program, copied it into another program, where it was used to create these comparative bar graphs. Once your data is entered, this particular software program gives you your choice of 42 different graph configurations. You can preview your material (whether it's candidates, costs or cookies) in each configuration to decide which chart or graph most persuasively makes your point.



As you well know, business involves innumerable number-related tasks, not the least of which is generating income and expense statements like this one. Should you want to change any of the entered items—to take a look at the effects of opening a new office or decreasing your staff—a spreadsheet program like Multiplan™ will automatically recalculate the entire document. (Here, we've copied it into MacDraw™ and enhanced it for presentation purposes.) It not only saves hours of entering, double-checking and erasing, but when teamed up with our LaserWriter printer, it produces a printout impressive enough to show a bank president. Fast enough for this afternoon's meeting.





197

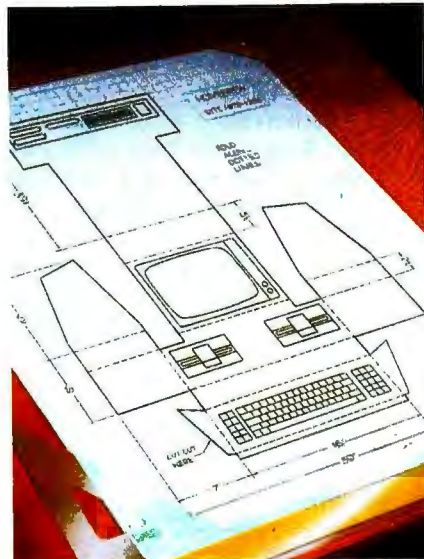

84

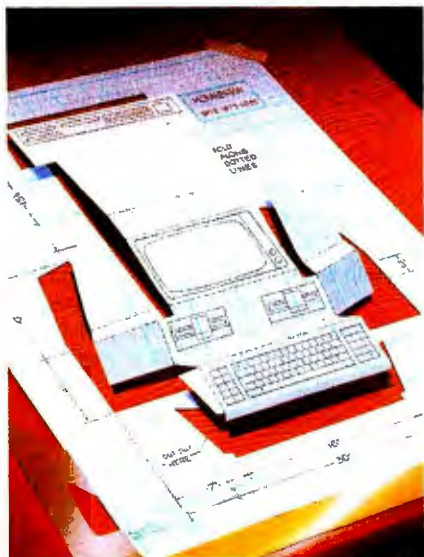

226

# C·O·N·T·E·N·T·S

## FEATURES

INTRODUCTION .....	84
<b>CIARCIA'S CIRCUIT CELLAR: BUILD THE SB180 SINGLE-BOARD COMPUTER.</b>	
<b>PART I: THE HARDWARE</b> by Steve Ciarcia .....	86
The SB180 is the 29-chip equivalent of a large S-100 system.	
<b>PROGRAMMING PROJECT: AN ANALYSIS OF SORTS</b> by Jonathan Amsterdam .....	104
This article analyzes the efficiency of three sorting algorithms.	
<b>THE DSI-32 COPROCESSOR BOARD, PART 2: THE SOFTWARE</b>	
by Trevor G. Marshall, George Sclaro, David L. Rand, Tom King, and Vincent P. Williams .....	116
The software environment for the DSI board lets it run both UNIX and MS-DOS applications.	
<b>AN ALGORITHM FOR DISK CACHING WITH LIMITED MEMORY</b> by Brian McKeon .....	129
Several C routines execute an algorithm for efficient disk buffering in a limited memory space.	
<b>ASTROPHYSICAL NUMBER CRUNCHING</b> by A. G. W. Cameron .....	141
A Harvard astronomy professor reminisces about the various computers he's used since the fifties.	
<b>TWO GENERALIZED FLOATING-POINT REPRESENTATIONS</b> by David Salomon .....	154
Partitioned and variable-base representations are the two designs proposed here.	
<b>TURBO PASCAL DRIVES THE MOUSE</b> by John Figueras .....	161
The procedure described lets you use the Microsoft Mouse with Borland's Pascal.	
<b>IBM COMPATIBILITY FOR THE NEC APC III</b> by Herbert Stein .....	171
An operating-system patch and a few other alterations give the NEC APC III clone status.	
<b>PROGRAMMING INSIGHT: BUILD A TRAVESTY TREE</b> by Peter Wayner .....	183
A tree data structure speeds up travesty generation.	
<b>PROGRAMMING INSIGHT: PRINTING PASCAL GRAPHICS</b> by Kelly W. Davis .....	193
Dump Apple Pascal graphics to any Epson MX-series printer.	

## THEMES

INTRODUCTION .....	226
<b>EGO: A HOMEBUILT CPU, PART I: THE SOFTWARE</b> by Clifford Kelley .....	229
The first in this two-part series covers the instruction set and software aspects of the EGO computer.	
<b>THE QUARTER-MEG ATARI 800XL</b> by Claus Buchholz .....	247
Upgrade your 8-bit microprocessor to 256K bytes and add a RAM disk.	
<b>A PARALLEL-TO-SERIAL PRINTER PORT ADAPTER</b> by Howard Austerlitz .....	257
With this \$35 adapter you can use your parallel port for serial devices.	
<b>ADD FUNCTION KEYS TO YOUR MICROCOMPUTER</b> by Mark Hanslip .....	263
Expand your parallel keyboard.	

## REVIEWS

INTRODUCTION .....	272
<b>REVIEWER'S NOTEBOOK</b> by Glenn Hartwig .....	275
<b>THE KAYPRO 16</b> by Steve McMahon .....	276
A transportable IBM PC- and PC XT-compatible.	
<b>THE OSBORNE 3</b> by Donna Osgood .....	284
A 12-pound system based on the 80C86.	

BYTE (ISSN 0360-5280) is published monthly with one extra issue per year by McGraw-Hill Inc. Founder James H. McGraw (1860-1948). Executive, editorial circulation and advertising offices: 70 Main St., Peterborough, NH 03458 phone (603) 924-9281. Office hours: Mon-Thur 8:30 AM - 4:30 PM, Friday 8:30 AM - 1:00 PM Eastern Time. Address subscriptions to BYTE Subscriptions, POB 590, Martinsville, NJ 08836. Postmaster: send address changes. USPS Form 3579, undeliverable copies, and fulfillment questions to BYTE Subscriptions, POB 596, Martinsville, NJ 08836. Second-class postage paid at Peterborough, NH 03458 and additional mailing offices. Postage paid at Winnipeg, Manitoba, Registration number 9321. Subscriptions are \$21 for one year, \$38 for two years and \$55 for three years in the USA and its possessions. In Canada and Mexico, \$23 for one year, \$42 for two years, \$61 for three years, \$69 for one year air delivery to Europe, 17,100 yen for one year surface delivery to Japan, \$37 surface delivery elsewhere. Air delivery to selected areas at additional rates upon request. Single copy price is \$3.90 in the USA and its possessions, \$3.95 in Canada and Mexico, \$4.50 in Europe and \$5 elsewhere. Foreign subscriptions and sales should be remitted in United States funds drawn on a US bank. Please allow six to eight weeks for delivery of first issue. Printed in the United States of America.



# BYTE September

VOLUME 10, NUMBER 9, 1985

<b>WORDSTAR 2000</b> by Malcolm C. Rubel .....	291
MicroPro makes changes to its classic.	
<b>XyWRITE II PLUS</b> by Rubin Rabinovitz .....	297
A word processor written by some of the designers of Atex, with macro routines and programming capability.	
<b>FILEVISION</b> by Scott L. Norman .....	305
Data management with an emphasis on graphics.	
<b>DB MASTER FOR THE MACINTOSH</b> by Jeffrey M. Jacques .....	311
Stoneware's database manager on another Apple.	
<b>PARADISE MODULAR GRAPHICS CARD</b> by Harry Krause .....	321
A graphics board for color and monochrome monitors.	
<b>THE RAMDISK-64</b> by Warren Block .....	325
Speed for the Commodore.	
<b>KEYPORT 717</b> by David L. Salah .....	331
A programmable keyboard for the Apple II line.	
<b>REVIEW FEEDBACK</b> .....	335
Readers respond to previous reviews.	

## KERNEL

<b>INTRODUCTION</b> .....	344
<b>COMPUTING AT CHAOS MANOR: PCs, PERIPHERALS, PROGRAMS, AND PEOPLE</b> by Jerry Pournelle .....	347
A new spreadsheet for the Mac prompts Jerry to look at the concept of integrated software.	
<b>CHAOS MANOR MAIL</b> conducted by Jerry Pournelle .....	382
Jerry's readers write, and he replies.	
<b>BYTE U.K.: SEVENTH ANNIVERSARY OF MICROCOMPUTING</b> by Dick Pountain .....	385
Our U.K. correspondent brings us a brief history of computing in Great Britain.	
<b>BYTE JAPAN: A HISTORY OF JAPAN'S MICROCOMPUTERS</b> by William M. Raike .....	395
Bill takes a look at the progress of microcomputing from his part of the world.	
<b>ACCORDING TO WEBSTER: WEST COAST FAIRE, MAC STUFF, AND THE AMIGA</b> by Bruce Webster .....	401
A trip to the West Coast Computer Faire highlights Bruce's month.	
<b>MATHEMATICAL RECREATIONS: <math>\pi</math>, <math>e</math>, AND ALL THAT</b> by Robert T. Kurosaka .....	409
This month's column looks at transcendental numbers.	
<b>CIRCUIT CELLAR FEEDBACK</b> conducted by Steve Ciarcia .....	416
Steve answers project-related queries from readers.	
<b>BYTELINES</b> conducted by Sol Libes .....	418
News and speculation about personal computers.	

### EDITORIAL:

TEN GOOD YEARS .....	6
MICROBYTES .....	9
LETTERS .....	14
FIXES AND UPDATES .....	33
WHAT'S NEW .....	37, 431
ASK BYTE .....	44

CLUBS & NEWSLETTERS .....	54
BOOK REVIEWS .....	57
EVENT QUEUE .....	80
UNCLASSIFIED ADS .....	485
BYTE'S ONGOING MONITOR BOX.	
BOMB RESULTS .....	486
READER SERVICE .....	487

Address all editorial correspondence to the Editor, BYTE, POB 372, Hancock, NH 03449. Unacceptable manuscripts will be returned if accompanied by sufficient first-class postage. Not responsible for lost manuscripts or photos. Opinions expressed by the authors are not necessarily those of BYTE. Copyright © 1985 by McGraw-Hill Inc. All rights reserved. Trademark registered in the United States Patent and Trademark Office. Where necessary permission is granted by the copyright owner for libraries and others registered with the Copyright Clearance Center (CCC) to photocopy any article herein for the flat fee of \$1.50 per copy of the article or any part thereof. Correspondence and payment should be sent directly to the CCC, 29 Congress St., Salem, MA 01970. Specify ISSN 0360-5280/85 \$1.50. Copying done for other than personal or internal reference use without the permission of McGraw-Hill Inc. is prohibited. Requests for special permission or bulk orders should be addressed to the publisher, BYTE, is available in microform from University Microfilms International, 300 North Zeeb Rd., Dept. PR, Ann Arbor, MI 48106 or 18 Bedford Row, Dept. PR, London WC1R 4EJ England. Subscription questions or problems should be addressed to: BYTE Subscriber Service, POB 328, Hancock, NH 03449.



PICTURED ON THE COVER IS THE NEW SB180 SINGLE-BOARD COMPUTER FROM CIARCIA'S CIRCUIT CELLAR. AS WITH ALL CIRCUIT CELLAR PROJECTS, THIS PRINTED-CIRCUIT BOARD WAS DESIGNED BY CUSTOM PHOTO AND DESIGN OF WALLINGFORD, CONNECTICUT. THE BOARD WAS MANUFACTURED BY TECH CIRCUITS, ALSO OF WALLINGFORD. STEVE CIARCIA WOULD LIKE TO EXTEND SPECIAL THANKS TO GREG PETERSON, PHIL WALTON, AND RAY LONG FOR THEIR FAST TURNAROUND ON THIS PROJECT TO MEET PUBLICATION DEADLINES.

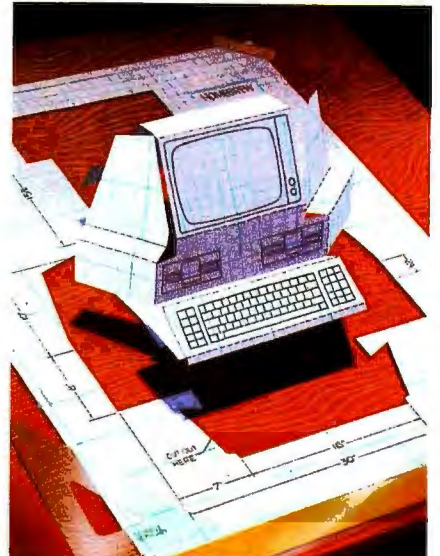

272



344



# BYTE



2

# GPIB

IEEE-488 Interfaces and Bus Extenders For:

IBM PC, PCjr & COMPATIBLES

DEC UNIBUS, Q-BUS & RAINBOW 100

MULTIBUS, VMEbus STD & S-100

Full IEEE-488 functionality, with the most comprehensive language and operating system coverage in the industry. It takes experience to make IEEE-488 systems work with nearly 4000 devices available from more than 500 different manufacturers, and experience is what enables National Instruments to take the GPIB to the second power and beyond.



2 Your personal guarantee of unsurpassed customer support and satisfaction. CALL 1-800-531-GPIB for instant access to 100+ man-years of GPIB experience.

**NATIONAL INSTRUMENTS**  
12109 Technology Blvd.  
Austin, TX 78727  
1-800-531-5086 512/250-9119  
Telex: 756737 NAT INST AUS

IBM and PCjr are trademarks of International Business Machines. MULTIBUS is a trademark of Intel. DEC, UNIBUS, Q-BUS, and Rainbow 100 are trademarks of Digital Equipment Corporation.

**EDITOR IN CHIEF**  
PHILIP LEMMONS  
**MANAGING EDITOR, PRINT**  
GENE SMARTE  
**MANAGING EDITOR, ELECTRONIC PUBLISHING AND COMMUNICATIONS**  
GEORGE BOND  
**CONSULTING EDITORS**  
STEVE CIARCIA  
JERRY POURNELLE  
BRUCE WEBSTER  
**SENIOR TECHNICAL EDITORS**  
G. MICHAEL VOSE, *Themes*  
GREGG WILLIAMS  
**TECHNICAL EDITORS**  
THOMAS R. CLUNE  
ION R. EDWARDS  
RICHARD GREHAN  
GLENN HARTWIG, *Reviews*  
KEN SHELDON  
JANE MORRILL TAZELAAR  
CHARLES D. WESTON  
EVA WHITE  
STANLEY WszOLA  
MARGARET COOK GURNEY, *Associate*  
ALAN EASTON, *Drafting*  
**NEWS AND TECHNOLOGY**  
EZRA SHAPIRO, *Bureau Chief, San Francisco*  
RICH MALLOY, *Senior Technical Editor, New York*  
PHILLIP ROBINSON, *Senior Technical Editor, Palo Alto*  
TONY LOCKWOOD, *Senior News Editor, Peterborough*  
**ASSOCIATE NEWS EDITORS**  
DENNIS BARKER, *Peterborough*  
BRENDA MCLAUGHLIN, *San Francisco*  
LYNNE M. NADEAU, *Peterborough*  
MARK WELCH, *San Francisco*

**CONTRIBUTING EDITORS**  
JONATHAN AMSTERDAM, *programming projects*  
MARK DAHMKE, *video, operating systems*  
MARK HAAS, *at large*  
RIK IADRNICKEK, *CAD, graphics, spreadsheets*  
MARK KLEIN, *communications*  
ALASTAIR J. W. MAYER, *software*  
ALAN MILLER, *languages and engineering*  
JOHN C. NASH, *scientific computing*  
DICK POUNTAIN, *U.K.*  
WILLIAM M. RAIKE, *Japan*  
PERRY SAIDMAN, *computers and law*  
ROBERT STERNE, *computers and law*

**COPY EDITORS**  
BUD SADLER, *Chief*  
DENNIS BARKER  
ELIZABETH COOPER  
ANNE L. FISCHER  
NANCY HAYES  
LYNNE M. NADEAU  
PAULA NOONAN  
JOAN VIGNEAU ROY  
WARREN WILLIAMSON

**ASSISTANTS**  
PEGGY DUNHAM, *Office Manager*  
MARTHA HICKS  
CATHY KINGERY  
JUNE N. SHELDON

**ART**  
ROSSLYN A. FRICK, *Art Director*  
NANCY RICE, *Associate Art Director*

**PRODUCTION**  
DAVID R. ANDERSON, *Production Director*  
DENISE CHARTRAND  
MICHAEL J. LONSKY  
JAN MULLER

**SENIOR VICE PRESIDENT/PUBLISHER**  
HARRY L. BROWN  
**PUBLISHER'S ASSISTANT**  
BEVERLY JACKSON

**PERSONNEL**  
CHERYL HURD, *Office Manager*  
PATRICIA BURKE, *Personnel Coordinator*

**ADVERTISING SALES (603-924-6137)**  
DENNIS J. RILEY, *Director of Sales and Marketing*  
SANDRA FOSTER, *Administrative Assistant*  
**ADVERTISING/PRODUCTION (603-924-6448)**  
LISA WOZMAK, *Supervisor*  
ROBERT D. HANNINGS, *Senior Account Coordinator*  
MARION CARLSON  
KAREN CILLEY  
LYDA CLARK  
MICHELE GILMORE  
DENISE PROCTOR  
WAI CHIU LI, *Quality Control Manager*  
JULIE NELSON, *Advertising Production Coordinator*

**CIRCULATION (800-258-5485)**  
GREGORY SPITZFADEN, *Director*  
ANDREW JACKSON, *Subscriptions Manager*  
CATHY A. RUTHERFORD, *Assistant Manager*  
LAURIE SEAMANS, *Assistant Manager*  
SUSAN BOYD  
PHIL DECHERT  
MARY EMERSON  
LOUISE MENEZES  
AGNES E. PERRY  
JENNIFER PRICE  
JAMES BINGHAM, *Single-Copy Sales Manager*  
LINDA RUTH, *Assistant Manager*  
CAROL AHO  
CLAUDETTE CARSWELL  
KAREN DESROCHES

**MARKETING COMMUNICATIONS**  
HORACE T. HOWLAND, *Director (603-924-3424)*  
VICKI REYNOLDS, *Marketing Production Manager*  
PRISCILLA ARNOLD, *Marketing Assistant*  
STEPHANIE WARNECKY, *Marketing Art Director*  
SHARON PRICE, *Assistant Art Director*  
DOUG WEBSTER, *Director of Public Relations (603-924-9027)*  
WILBUR S. WATSON, *Operations Manager, Exhibits*

**PLANNING AND DEVELOPMENT**  
MICHELE P. VERVILLE, *Manager*  
PATRICIA AKERLEY, *Research Manager*  
CYNTHIA DAMATO SANDS, *Reader Service Coordinator*  
FAITH KLUNTZ, *Copyrights Coordinator*

**MANUFACTURING/FINANCE/SERVICES**  
DANIEL RODRIGUES, *Director*

**ACCOUNTING**  
KENNETH A. KING, *Assistant Controller*  
VICKI WESTON, *Accounting Manager*  
LINDA SHORT, *D/P Manager*  
EDSON WARE, *Credit*  
MARIE CAGGIANI  
MARILYN HAIGH  
DIANE HENRY  
VERN ROCKWELL  
JOANN WALTER

**TYPOGRAPHY**  
SHERRY MCCARTHY, *Chief Typographer*  
NAN FORNAL  
LEN LORETTE  
DONNA SWEENEY

**BUILDING SERVICES/TRAFFIC**  
ANTHONY BENNETT, *Building Services Manager*  
BRIAN HIGGINS  
MARK MONKTON  
**RECEPTIONISTS**  
L. RYAN MCCOMBS  
CHERYL CASTRO, *Assistant*

**Editorial and Business Office:** 70 Main Street, Peterborough, New Hampshire 03458, (603) 924-9281

**West Coast Offices:** McGraw-Hill, 425 Battery St., San Francisco, CA 94111 (415) 362-4600

McGraw-Hill, 1000 Ellwell Court, Palo Alto, CA 94303 (415) 964-0624

**New York Office:** 1221 Avenue of the Americas, New York, NY 10020 (212) 512-2000

Officers of McGraw-Hill Information Systems Company: President: Richard B. Miller; Executive Vice Presidents: Frederick P. Jannott, Construction Information Group; Russell C. White, Computers and Communications Information Group; I. Thomas Ryan, Marketing and International; Senior Vice Presidents: Francis A. Shinal, Controller; Robert C. Violette, Manufacturing and Technology; Senior Vice Presidents and Publishers: Laurence Altman, Electronics Week; Harry L. Brown, BYTE and Popular Computing; David J. McGrath, Construction Publications Group; Vice President: Peter B. McCuen, Communications Information; Vice President: Fred O. Jensen, Planning and Development.

Officers of McGraw-Hill, Inc.: Harold W. McGraw, Jr., Chairman; Joseph L. Dionne, President and Chief Executive Officer; Robert N. Landes, Executive Vice President and Secretary; Ralph J. Webb, Vice President and Treasurer; Shel F. Asern, Vice President, Manufacturing; George R. Elsing, Vice President, Circulation; Ralph R. Schulz, Senior Vice President, Editorial (Publishing Operations).



# Great Giff™ suggestion for under \$9,000:



It's the MC-186/EL™, Gifford's four-user entry level system—just \$8,995.

It's a complete multiuser system with a 23 megabyte hard disk. Just add terminals, turn it on, and start using over 100 Gifford productivity tools and utilities. You even get word processing, electronic mail, and telecommunications.

You can also use it as a building block in a fast local area network with IBM PCs, compatibles, and other MC-186 family members. Run Lotus™ 1-2-3 and other MS-DOS™ favorites, plus thousands of single and multiuser, 8- and 16-bit CP/M® programs.

Call 415/895-0798 for your nearest dealer. Or write to us at 2446 Verna Court, San Leandro, CA 94577.

The features make it a Giff. The price makes it a present.

 **GIFFORD**  
**COMPUTER SYSTEMS**  
*A subsidiary of Zitel Corporation*  
**THE MULTIUSER COMPANY™**

2446 Verna Court, San Leandro, CA 94577 415/895-0798 Telex 704521 2050 North Loop West, Suite 116 Houston, TX 77018 713/680-1944  
In Europe: London (01) 337-2372 Telex 28106 (UK)

MC-186 and MC-186/EL are trademarks of Gifford Computer Systems. IBM PC is a trademark of International Business Machines, Inc.  
CP/M is a trademark of Digital Research, Inc. MS-DOS is a trademark of Microsoft Corp. Lotus is a trademark of Lotus Development Corp.



## TEN GOOD YEARS

Cast yourself back. The hot new computers from major vendors are the Amdahl V-6, the Cray-1, and the DEC LSI-11. The C and Pascal programming languages are approaching the age of four. LCDs have just been introduced. The first programmable calculator, the HP-65, is one year old. An electrical engineer named Steve Ciarcia works for Control Data and is designing a computer-controlled casting facility for Pratt & Whitney. A writer named Jerry Pournelle is pounding the keys of his Selectric II typewriter, certain that technology should give him a more efficient way of producing manuscripts. The time is September 1975—and into this world drops the first issue of *BYTE*, *The Small Systems Journal*.

*BYTE* marks its 10th anniversary this month. We remember the early days in several ways. We devote our theme section to homebrewing. Our lead feature article, on Steve Ciarcia's remarkable SB180 computer system, will give new vitality to the tireless and fertile CP/M-compatible world. The SB180, with its 256K-byte RAM, ZCPR3, and RAM-disk software, towers over Steve's original 8008-based microcomputer built in early 1975.

We also devote a special section to the celebration of the anniversary. The section contains a timeline of developments in personal computing spanning the last 10 years and an article describing progress in microprocessors during this period. The section honors four people who have made outstanding contributions to *BYTE* through the years: Carl Helmers, the founding editor, who saw the possibilities in small computers from the very beginning; Steve Ciarcia, our hardware wizard, whose output is itself an implicit history of personal computers; Jerry Pournelle, the master

of colloquial style, whose unique perspective on small computers both entertains and informs; and Robert Tinney, our popular cover artist, who has yielded the cover of this issue to Steve Ciarcia's SB180 but has done art to introduce each section.

We can only marvel at how far technology has advanced in *BYTE*'s lifetime. Several microcomputers were available for readers of *BYTE*'s first issue: the Scelbi-8B and the RGS 008A, both based on the Intel 8008; the MITS Altair 8800, based on the Intel 8080; the IMP-16, based on an older 16-bit microprocessor from National Semiconductor; and the Sphere I, based on the Motorola 6800. These early machines typically had 1K to 4K bytes of RAM and used cassettes or paper tape for mass storage. Compare these early machines with Steve Ciarcia's SB180 system, introduced this month, or with the Amiga from Commodore, last month's cover story, and you'll see how far we've come.

Another measure of progress is the comparison of advertising copy in the first issue and this one. A September 1975 advertisement from Godbout Electronics says, "You'll appreciate the 7 segment readouts for easy octal debugging on both address and data, as well as the integral audio cassette and serial/Teletype interfaces . . . plus 2K bytes of integral memory." People jumped at the chance to buy this new computer. The field of microcomputers was about to explode. For *BYTE*'s readers, the idea of enjoying full ownership and control of a real computer was and is irresistible.

*BYTE* was there at the birth of microcomputing. We hope you will enjoy a look backward at *BYTE* and microcomputing as well as our usual efforts to keep you informed about the latest technical developments and tomorrow's trends.

*BYTE* has scheduled a series of anniversary-related events at The Computer Museum in Boston during September. Starting September 4th there will be a month-long showing of original *BYTE* covers by Robert Tinney. On September 8th, at 4:00 p.m., noted British computer scientist Professor C. A. R. Hoare of Oxford University will deliver a talk, open to museum visitors, on "The Mathematics of Programming." On September 22nd, from 1:00–4:00 p.m., Steve Ciarcia will hold informal discussions about some of his projects.

## WANTED: EARLY PERSONAL COMPUTERS, ETC.

We'd like to ask some of the computer pioneers in our readership to help The Computer Museum complete its collection of early microcomputer hardware, software, and other relics. The Computer Museum, ComputerLand, and CW Communications are jointly sponsoring a contest to bring personal computing artifacts into the museum. Especially sought are kit machines, programs, newsletters, etc., from the days of the first hobbyists and hackers, including early serial-number, pre-1980 machines and first releases of operating systems, languages, and applications programs. Send photos or descriptions of your relics to Curator, Personal Computers, The Computer Museum, 300 Congress St., Museum Wharf, Boston, MA 02210. Donors of the five best finds will receive all-expenses-paid trips to Boston for the resulting exhibition's grand opening party. All donors will be invited to the party and receive a catalog of the exhibition. Entries will be judged on significance, date, rarity, completeness, and condition. Donations are tax-deductible.

—Phil Lemmons, Editor in Chief





# Maxell Gold.

The floppy disk  
that turns Apples<sup>®</sup>  
golden,  
keeps AT&T on-line,  
and makes every  
Texas Instrument<sup>®</sup>  
a gusher.

Whether you're exploring for profits, reaching out for projections, or polishing your argument, there's a Maxell floppy disk perfect for your computer. Consider the unique way we pack and bind our oxide particles for quality over the long run. Or our lifetime warranty. Maxell. The Gold Standard in floppy disks. Precious metal for virtually every computer made.

**maxell**<sup>®</sup>  
IT'S WORTH IT.





## YOUR DAYS OF BUYING GRAPHICS TERMINALS ARE OVER!

Now there are two ways to use your PC to access popular mainframe graphics products like SAS/GRAPH\*, TELLAGRAPH\*, RS/1\*, DISSPLA\*, and PLOT-10\*. Joining our popular **SmarTerm 125** DEC\* VT125 ReGIS graphics emulator, our **NEW SmarTerm 4014** product gives you full Tektronix\* 4010/4014 plus DEC VT102 emulation. View the entire graphics image on the PC screen, or use the powerful instant ZOOM feature to magnify a selected portion of the

screen image to full Tektronix 1024 x 780 resolution.

Using Picture Playback, pictures drawn by the host can be saved, sent to other users, examined in detail using ZOOM mode, and printed or plotted offline. Like all SmarTerm emulators, SmarTerm 4014 includes powerful text and binary file transfer facilities, PDIP\* and XMODEM protocol support, and TTY mode to link you to popular time sharing services.

By the way, if you only need text terminal emulation, be sure to ask about our SmarTerm 220, SmarTerm 100, and SmarTerm 400 products.

Join the more than 25,000 "FIRST CLASS" people who use SmarTerm. Try it for 30 days with full refund privileges.

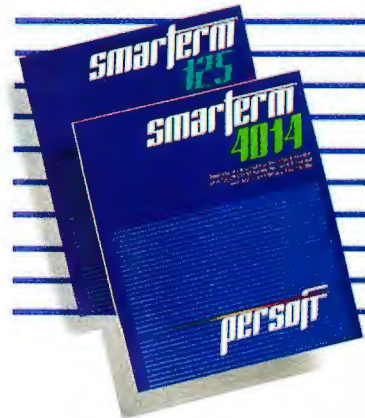

Available from Computerland, your local software dealer, or Persoft, Inc. - 2740 Ski Lane, Madison, WI 53713 (608) 273-6000 - TELEX 759491

# AFTER SMARTERM®, WHAT DO YOU DO WITH YOUR OBSOLETE TERMINAL?



**IDEA CREDIT:** Jill Roth of Chino, California. Send us your ideas for uses of obsolete terminals replaced by SmarTerm. The best ideas will be used in future ads. Write Persoft, Dept. MAILBOX, 2740 Ski Lane, Madison, WI 53713.

\*SMARTERM is a registered trademark of Persoft, Inc. \*PDIP is a trademark of Persoft, Inc. \*DEC, VT and ReGIS are trademarks of Digital Equipment Corp. \*Tektronix and PLOT-10 are registered trademarks of Tektronix, Inc. \*SAS/GRAPH is a trademark of SAS Institute, Inc. \*RS/1 is a trademark of Bolt Beranek and Newman, Inc. \*TELLAGRAPH is a trademark of ISSCO Graphics Corp. \*DISSPLA is a trademark of Control Data Corp.

# persoft

Inquiry 292



## Optical Discs, Image Scanners, Laser Printers at NCC

---

At the National Computer Conference in Chicago, at least four Japanese companies—Ricoh, Minolta, Canon, and Toshiba—showed document-filing systems that link digitizing image scanners, computers, and laser printers. Toshiba's and Ricoh's systems also use an optical laser disc to store images. Except for Toshiba, all of the companies were merely testing the waters and declined to speculate on pricing or availability of complete systems since they sell primarily to OEMs.

**Optical drives:** Toshiba showed both 12-inch and 5¼-inch write-once optical-disc drives; the 5¼-inch drive should be available to OEMs by next summer. Verbatim, a maker of magnetic floppy disks, displayed a 3½-inch erasable optical disc that stores 40 megabytes but predicted that drives and media would not be available in that format until at least 1987. Hitachi showed a \$25,000 optical videodisc recorder that can store 24,000 video frames (13 minutes of video) on a \$260 disc. The company said it has no plans to pursue data applications for the unit.

**CD ROMs:** Hitachi, Panasonic, and Toshiba showed compact-disc ROM drives, all scheduled for mass production early in 1986 at unspecified cost. As many industry observers expected, Grolier Electronic Publishing announced that its complete *Academic American Encyclopedia* will be sold on a CD with Activenture software for \$199. Grolier will also offer a videodisc version of the encyclopedia for \$90.

**Image scanners:** Microtek Lab is selling a dual-resolution (200- and 300-dpi) scanner for \$2300. Ricoh's IS-30 provides 300-, 240-, and 180-dpi scanning capabilities; it will be available only to OEMs. Also for OEMs only: four image scanners from Canon.

**Laser printers:** Ricoh displayed an 8-page-per-minute laser printer it said might be sold by OEMs for considerably less than \$4000. (Ricoh also offers 12- and 40-page-per-minute laser printers.) Casio showed its LCS-2400, a liquid-crystal-shutter printer that outputs text and graphics at 240 dpi. Sanyo showed a 20-page-per-minute LED-array printer with a 300-dpi resolution. The company said the printer would be available in early 1986 for less than \$4000 and possibly less than \$3000.

## Motorola Asks FCC to Allow Radio-Based LANs

---

Motorola Inc. filed a petition with the Federal Communications Commission in June requesting that the FCC authorize radio local-area networks (LANs) in the 1700- to 1710-MHz signal range. The petition reveals that Motorola's LAN would use less than 100 milliwatts to transfer data over a range of about 1000 feet. No information on the speed or the price of the LAN was included in the petition, and Motorola declined to comment until the FCC acts on the request.

A radio network would enable LANs to operate without point-to-point wiring but would require that each node on the network have a radio transceiver.

## Epson, ABC, and Indesys on FM Radio

---

Epson America, American Broadcasting Company, and Indesys (for Information Delivery System) have signed an agreement to deliver electronic information over subcarriers of FM radio stations. Under the plan, Indesys (based in Mountain View, CA) will distribute information at 38 kbps over microwave towers and via satellite to some of ABC's affiliated FM stations. These stations will then channel the information over the subcarrier portion of their FM signals. The information can be received by a small box that connects directly to an Epson or Epson-compatible printer or by a card inserted in an IBM Personal Computer or Epson QX-16. Neither the box nor the card can relay information back to Indesys via FM, but the card has a proprietary modem that can be used to call back to Indesys using telephone lines.

The box that connects to the printer costs \$299; the card for the IBM PC, \$250. The price of sending a page of information reportedly will range from 10 cents (overnight delivery) to 20 cents (delivery within one hour). Each receiver box and card will have its own EPROM-based ID code and will receive only that information addressed specifically to it.

(continued)



## NANOBYTES

William C. Lowe, president of **IBM Entry Systems Division**, was quoted in a recent *New York Times* interview as saying that the IBM PC II "is a mythical product," which seems to end any discussion of that matter. Another IBM spokesperson fingered a defective chip "in less than 10 percent" of IBM's PC ATs as the culprit responsible for its notorious crashes. . . . **International Measures and Communications (Meacomm)** of Houston, TX, is offering a 6502 and Applesoft BASIC emulator for Apple's Macintosh computer, allowing many Apple II programs to run on the Mac. Mac+II has communications software for the Apple II and Macintosh so programs can be exchanged using the Imagewriter cable. . . . **Personics** of Concord, MA, offers a head-rotation-detection system that replaces the mouse on Apple's Macintosh. The View Control System includes a small unit that generates high-frequency sound, a headband with three small sound detectors, and a two-button keyboard add-on to activate the headband and simulate the mouse button. The \$200 Macintosh version is available now; an IBM PC version is also planned. . . . **Graphic Software Systems** has developed software allowing microcomputers to act as intelligent graphics workstations when attached to a host computer that also uses the software. GSS-Grafstation employs the Virtual Device Interface (VDI) developed by GSS. The company will license the software to OEMs for \$250 per copy. . . . **Future Computers**, Croydon, U.K., is offering to OEMs a low-cost computer compatible with IBM's PC AT. Called the FX 100, the machine features a 10-MHz 80286, two 1.2-megabyte floppy-disk drives, 512K bytes of memory, a proprietary display-adaptor card compatible with the Hercules monochrome graphics card, and a mouse. End-user price is reportedly \$2995. . . . Korean electronics giant **Samsung** has added its name to the long list of makers of IBM PC AT-compatible computers. With a color monitor and a 20-megabyte hard disk, the Samsung OX-85 reportedly will cost \$4895. . . . **Micrografx Inc.**, Richardson, TX, announced In\*a\*Vision, a drawing program that runs either alone or under Microsoft Windows using pull-down menus and multiple-window viewing. The \$495 program is targeted at drafting and CAD applications. . . . **McTel** of Bala Cynwyd, PA, has a \$50 program, Electronic Envelope, that encodes binary files for transmission through electronic mail systems that permit only ASCII text to be exchanged. . . . **Hitachi** displayed a portable computer with a detachable keyboard and a liquid-crystal display. The company predicted that OEMs could sell the system with 256K bytes of RAM and one 3½-inch floppy-disk drive for less than \$2000. . . . **NEC Electronics** said its two-chip set allows design of a hard-disk controller using only 10 chips. The  $\mu$ PD7261 and  $\mu$ PD9306 pair will sell for \$25 in OEM quantities. . . . **Qume**, San Jose, CA, has obtained exclusive rights to market a **Hitachi** 10-page-per-minute laser printer in the U.S. beginning in early 1986. No additional details about the printer were available at press time. . . . **Addison-Wesley** said its Macintosh version of True BASIC would be available late this year. . . . **Digital Research** formally introduced the GEM DOS operating system for the 68000 series of microprocessors. The debut followed an agreement with **Northern Telecom**, whose 68010-based Meridien computer system will now support GEM and GEM DOS. . . . **National Semiconductor's** proprietary two-board computer includes its 32016 processor along with floating-point and memory-management chips. With 1 megabyte of RAM, the board set is \$2800. . . . **Charles River Data Systems** has developed a UNIX System V computer system that uses Motorola's 68020 processor. Initial buyers will get a 140-megabyte hard disk, 4 megabytes of RAM, UNIX System V, 12 serial ports, and other software for \$24,900. . . . **Sord Computer** also has a six-user UNIX System V computer. Sord's 68010-based Unibox includes a 20-megabyte hard-disk drive, one 1.2-megabyte floppy-disk drive, 1-megabyte RAM, and ports for two users for \$4695. A 68020-based version is planned for early next year. . . . **General Motors** has purchased exclusive rights to include **Etak's** electronic navigation system in its cars. Etak, based in Sunnyvale, CA, will offer the system as an aftermarket product for other automobiles. The prototype Etak system currently uses motion sensors and cassette-based map information to track vehicle movement on a map. . . . **MaxThink**, Piedmont, CA, said it will release MaxThink 4.0 in September. The new version emulates the commands of several popular word processors, including Volkswriter, Microsoft Word, MultiMate, and WordStar; other new features include hierarchical charts and disk-directory reorganization capabilities. The \$60 price is unchanged. . . . **Priam Corp.** has added 140- and 191-megabyte drives to its line. The units use six and eight disks, respectively. In large OEM quantities, the drives will cost \$1750 and \$1910. . . . **Sharp** announced an IBM-compatible transportable computer with a backlit LCD. With 320K bytes of memory, two 5¼-inch drives, and MS-DOS, the PC-7000 will be available in October for about \$2000. . . . From *Nikkei BYTE* in Japan: **Bravis International** in Tokyo introduced Japanese-to-English translation software for several Japanese MS-DOS computers with 512K bytes and a 20-megabyte hard disk. The company plans to follow up the \$2600 package with English-to-Japanese and Japanese-to-Korean translators.



# Pure power.

QIC-60 streaming tape backup is more than just fast and simple to operate. It's also the leader in powerful processing.

For example, our unique five-head tape deck offers immediate read-after-write verification. No rewinding necessary. And no re-recording of the entire backup after an error.

Another powerful advantage is automatic adjustment of the head mechanisms to seek the best track alignment every time a tape is inserted. Plus our exclusive power sensor is designed to alert and freeze the write head if PC power is reduced, which eliminates the chance of disk damage. We're so confident in the technical excellence of QIC-60 that we offer an aggressive one-year limited warranty on the entire line, compared to the 90-day warranty provided by other manufacturers.

Best of all are a pair of backup bonuses that turn QIC-60 into a sophisticated data management tool. When you select mirror-image restore, QIC-60 sees bad disk sectors and automatically reroutes data to safe locations for improved data reliability.



Tecmar offers AT owners a special enhancement with an internally-mounted QIC-60 tape drive that costs even less than external systems. And when you add our internal AT Hard Disk to the package, you have a fully upgraded system ready to use today.

Pure speed. Pure power. Pure innovation from Tecmar.

For a free demonstration of the new standard in tape backup, see your Tecmar dealer or call us at 216/349-1009 for the location of the dealer nearest you.

**Tecmar**  
THE POWER BEHIND THE PC

6225 Cochran Road Solon, Ohio 44139



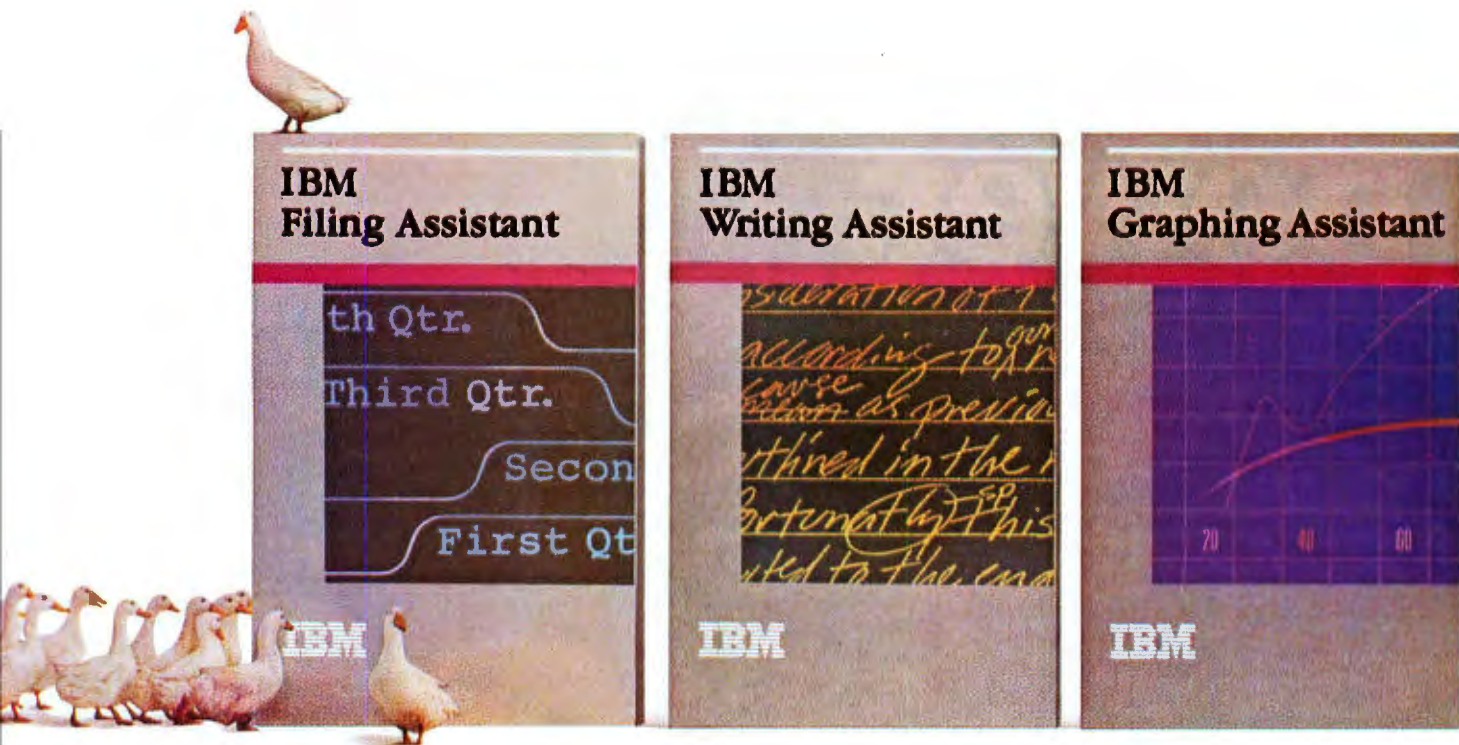

# How to get all your

Now you can easily control even hard-to-manage facts and figures with the Assistant Series from IBM.

If you line up the right software, getting your ducks in a row is not only possible, but easy.

There's a program in IBM's Assistant Series to handle each of the most important jobs people are using personal computers for these days: spreadsheets, word processing, and database



management.

But unlike software programs that can't share information with other programs, the IBM Assistants work together as a team, as well as alone.

And unlike other programs that can be challenging to learn, all the complicated inner workings of these programs have been hidden from view. So using them is almost intuitive.

*Filing Assistant* is a database program that allows you to organize and store information in any format that

suits you, and retrieve it instantaneously, according to your own specifications.

*Writing Assistant* is a word processing program that shows you on the screen just what your words will look like on paper. It helps correct misspelled words and even lets you insert forecasts or graphs from other Assistants into your text.

*Graphing Assistant* turns numbers into pictures. Like all the Assistants, it accepts information from the keyboard.



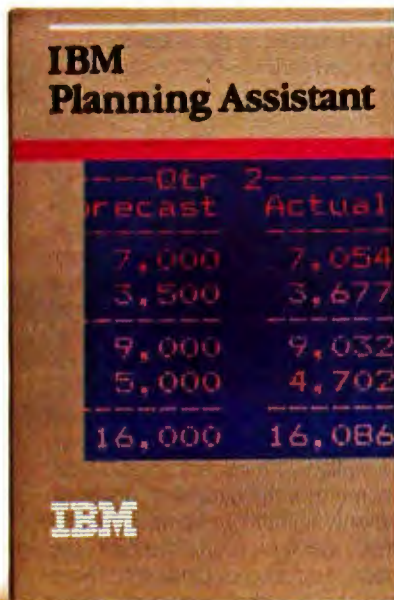

## ducks in a row.

or directly from Filing Assistant. So you can see what the bottom line looks like as a pie chart, a bar chart or a line chart. Or all three. In minutes.

*Planning Assistant* is a powerful new spreadsheet that replaces the complex commands used in earlier programs with plain English (TOTAL instead of C21+D21+E21+F21). It's smart enough to widen columns automatically to fit your entries. It will even fill in the blank after "Dec 85" with "Jan 86."

*Reporting Assistant* helps you cre-

ate customized reports (complete with totals, subtotals and averages) of your Filing Assistant data.

If you generate so many Writing Assistant files that you can't remember them all by name, there's *Document Retrieval Assistant* to help you find them anyway.

And there's *Mainframe Communication Assistant* to do just what its name suggests: link your PC to your company's mainframe computer.

To assist your pocketbook, most

IBM Assistants cost less than \$150\*.

Any Authorized IBM Personal Computer Dealer or IBM Product Center can give you a demonstration of the Assistant Series. Just seeing them in action may make you feel more organized. For the location of the store nearest you and a free brochure, call 1-800-447-4700. In Alaska or Hawaii, 1-800-447-8090.

Personal Computer Software

Inquiry 179



## EVIDENCE OF SUPPORT

During the past few months I have read several letters from your readers complaining about the poor support that they have received from the manufacturers of their personal computers. Recently I needed additional information about the I/O ports on my AT&T PC 6300. I tried in vain to find a computer store that sold the *System Programmers Guide* or a person who could answer my questions. In desperation, I sent a letter to AT&T describing my problem and asking for additional information. To my surprise, I received a letter from AT&T less than 10 days later. The letter explained that the *System Programmers Guide* had just been released, so some computer stores would not yet have it, and gave instructions on how to order the manual directly. The letter also answered my technical questions completely and even included photocopies of the pertinent pages from the *System Programmers Guide*. I ordered a copy of the manual over the telephone and received it less than a week later. Well done, AT&T! Keep up the good work! I am very happy with my AT&T 6300 and the support from AT&T.

DR. MICHAEL J. PELLETIER  
Cincinnati, OH

Many times I have read about how a particular software firm provided less than adequate service. However, I would like to be one individual from the silent majority who speaks out for a company that went above and beyond the call of duty.

I read an evaluation of a product from Morgan Computing called Trace86. The article described a save-screen function that Morgan Computing (MC) did not implement. I wrote to MC, and the people there said it was their fault and that they would provide an update with that feature when they had it working properly. I waited several months, and I had almost given up when I received the update and documentation free of charge (the call of duty).

Later, I read about Advanced Trace86 (AT86). I called MC. The cost of the update was \$99. The people at MC must have remembered me, since they provided me with AT86, a letter stating they appreciated

my business despite the long wait for an update last time, and a complimentary copy of Disk Toolkit, a \$75 value (above and beyond the call of duty).

I feel that Morgan Computing deserves to be recognized as one company that puts customer satisfaction high on its list of priorities.

STEPHEN MOFFETT  
Bryan, TX

## BOTH SIDES OF DEC'S RAINBOW

I must take issue with Jared Sherman's letter in the June issue (page 32) attacking the DEC Rainbow 100. I own a Rainbow 100B with 256K, CP/M, and MS-DOS. I also assembled, tested, and use several of these in my job at the University of Louisville. I must take exception to Sherman's criticisms and to Rainbow critics in general.

His first assertion was that CP/M-86/80's BACKUP utility "eats" files. I have backed up hard disks on several occasions with absolutely no problem. I have a feeling that Mr. Sherman has not correctly specified all of the parameters in his backup setup commands. Digital does not know of any errata in its documentation regarding the hard-disk backup.

MAINT does have a known bug regarding hard disks. Digital should have told Sherman that MAINT was not designed to be used with a full hard disk (by full I mean 100+ files) to begin with.

I find it hard to believe that DEC's customer-service line was purposefully evasive in answering his questions. I have called the line on three separate occasions, and I found the people in Atlanta to be both courteous and knowledgeable, even when one of my problems involved a non-Digital modem.

I am writing this letter with WordStar 3.3. We use WordStar extensively here, and I have heard no complaints about it not editing a file over 30K. Again, I believe the user and not the system to be at fault.

MS-DOS manuals are a problem. It is too bad that to get the programming documentation, one must shell out \$75 for the MS-DOS programming manual (not \$250; the manuals have been repackaged and are now sold separately from DEC direct). However, the hierarchical directory struc-

ture is documented in the *Advanced User's Guide* provided with MS-DOS in chapter 3, which is entitled "More About Files."

I recently purchased the \$75 *Hardware Documentation* set and find both manuals complete and well written. Why DEC didn't include this with the machine is unclear to me. DEC would probably develop a real following among programmers if it would include these with the machine. The Rainbow is a well-designed and well-documented machine, and Digital should take advantage of this more than it does.

I was most interested in Mr. Sherman's story about his hard-disk upgrade. I personally installed 25 hard-disk upgrades for U of L some months back with no problem. The only thing I can figure is that he had a 100A with a motherboard problem. Nowhere in the documentation that I have can I find the fact that you need a new CPU motherboard to install that upgrade. According to the documents we received, to upgrade a 100A requires a new power supply (included with the 100A hard-disk upgrade), the controller board (included), and the drive cable.

Like any complex piece of electronic equipment, proper maintenance is essential. Mr. Sherman probably does not have his system under any kind of maintenance agreement with Digital. When I purchased my Rainbow, a year of on-site maintenance was included. I believe the company has discontinued that offer, but I plan to put my system on depot (carry-in) maintenance when my warranty expires. Mr. Sherman should consider doing the same. One bad system board will pay for the agreement for about a year and a half.

(continued)

LETTERS POLICY: To be considered for publication, a letter must be typed double-spaced on one side of the paper and must include your name and address. Comments and ideas should be expressed as clearly and concisely as possible. Listings and tables may be printed along with a letter if they are short and legible.

Because BYTE receives hundreds of letters each month, not all of them can be published. Letters will not be returned to authors. Generally, it takes four months from the time BYTE receives a letter until it is published.



# *Hard Drives*

## *You Can Forget About.*



The nicest thing about Maynard's hard drives is their humility. They never draw attention to themselves. They simply do what you tell them to do, so you can keep your mind on your work, not your hardware. Unsurpassed performance. Versatile design. Superb reliability. We give you an awful lot to forget about.



*Internal, external, or portable  
hard drives from 10 to 30MB.*



 **Maynard Electronics**

430 E. SEMORAN BLVD., CASSELBERRY, FL 32707

305/331-6402

Inquiry 235



# Why you should ignore 95% of the news

**Because NewsNet automatically finds the 5% you need.** From our database of authoritative, up-to-date business news, you get just the stories you want, delivered instantly to your microcomputer. You choose your own, unique keywords, and NewsNet saves—just for you—every new article containing those words. Or, you can find that critical 5% on your own, with NewsNet's powerful keyword searching and text scanning.

Just what's in NewsNet's database? The full text of over 300 valuable business newsletters. In-depth news, written by experts, filled with analysis and interpretation. News from 34 different industries and professions—everything from Computers to Investments, from Management to Telecommunications. Plus extras such as wire services, online stock quotes, air fares, and business credit reports.

**Computer News: Your Specialty is our Specialty.** Here are just a few of the 25 Electronics and Computers newsletters on NewsNet:

The Artificial Intelligence Report  
The Business Computer,  
The Computer Cookbook  
Consumer Electronics  
Data Base Informer  
Electronic Mail News  
Outlook on IBM  
Japan High Tech Review  
Micro Moonlighter

Mini/Micro Bulletin  
Personal Computers Today  
Robotronics Age  
Newsletter  
Semiconductor Industry & Business Survey  
The Seybold Report on Professional Computing  
Stanley Klein Newsletter on Computer Graphics

**ONLINE  
BUSINESS  
NEWS**

# NewsNet

**Call Today!**  
We'll send all you need to subscribe.

**(800)  
345-1301**

(In PA 215-527-8030)

NewsNet Inc. 945 Haverford Road, Bryn Mawr, PA 19010

Inquiry 272

It is unfortunate that horror stories like this continue to plague the Rainbow. I have owned my machine for about a year now and have had no problem with it. The Rainbow is an excellent product for those of us who would rather use the machine than spend our time buying upgrade boards to give our PC the functionality that the Rainbow comes bundled with. Digital should take note of the features the Rainbow has and price it more competitively. Including the manuals would help also, because no one can know how good the machine is if Digital won't tell.

MICHAEL E. HARPE  
Louisville, KY

As a DEC Rainbow owner, I sympathize with Jared Sherman's difficulties. Unfortunately, not all DEC support people are equally knowledgeable and helpful. I can provide answers to two of his complaints. I am not familiar with the others.

First, the WordStar bug is an "undocumented feature" of WordStar version 3.30 that promiscuously destroys parts of files longer than 32K without telling the user. After several attempts at communication, I got the following cure from MicroPro, implemented using DDT86: First call up DDT86 with no command-line prompt. At the "-" DDT86 prompt, enter

```
RWSOVLY1.OVR <return>
  {to read WSOVLY1.OVR into
  memory}
S4A52 <return>
  {to set bit at 4A52 hex}
```

The program will respond with "B1." Enter "B2," a carriage return, and a "." to tell the program you are finished changing bytes. Then enter

```
WWSOVLY1.OVR <return>
  {to rewrite the program on disk}
```

Finally, enter ^C to exit.

Obviously, this should be tried and checked on a copy of the overlay file, not on the original.

Second, Mr. Sherman owns a Rainbow 100A with MS-DOS version 2.01, which has a user's manual best described as abysmal. The software itself also has several deficiencies (including an inability to work with a hard disk or use memory as a "RAM disk") that are remedied in later versions. If Mr. Sherman calls (800) DEC-8000 and asks for contract support, he can arrange to buy version 2.05 for \$65 or version 2.11 for \$95, both of which come with adequate user's manuals. And

(continued)



# Introducing In·a·Vision

## Complex Drawing Made Easy

We created In·a·Vision just for you. The engineer who needs more productive drafting support. The designer who needs versatility for alternate ideas or quick revisions. The architect who needs to manage a variety of working drawings. And the businessman who needs first-class presentation materials as well as detailed flow charts and organization charts.

### Point. Click. Draw.

Now all you do to create complex technical drawings, systems designs, blueprints, diagrams, illustrations, and proposals is point,

click and draw. With In·a·Vision's mouse support, windowing, icons, and pull-down menus, you produce drawings more quickly, accurately and efficiently than ever before.

In·a·Vision's advanced technology includes many features not found on comparable systems costing thousands more. For example,

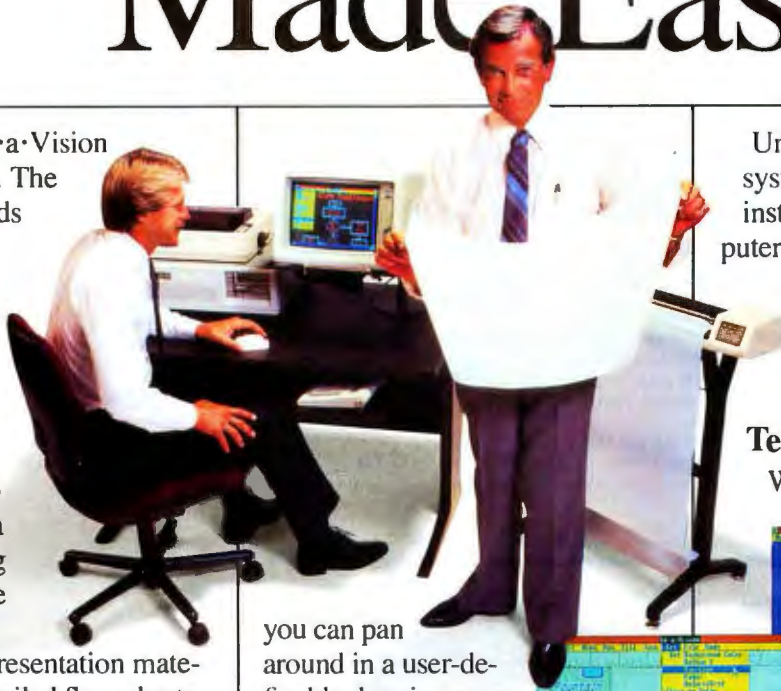

you can pan around in a user-definable drawing space up to 68" x 68" and zoom in on specific areas for greater detail. Scale, rotate and dimension symbols, fill an area with your choices of predefined colors and patterns, as well as draw lines with multiple styles and widths. Other features include overlays, predefined and user-definable page sizes, rulers, grids, and symbol libraries.

### Multi-tasking in a PC-based CAD system.

In·a·Vision uses multi-tasking to enable you to continue drawing while printing hard copies as well as edit multiple drawings simultaneously.

Unlike more expensive CAD systems, In·a·Vision is easy to install and use. Even the computer novice can be productive in less than a day. And In·a·Vision is not copy-protected.

### Ten Day Trial Period.

We're so sure In·a·Vision will

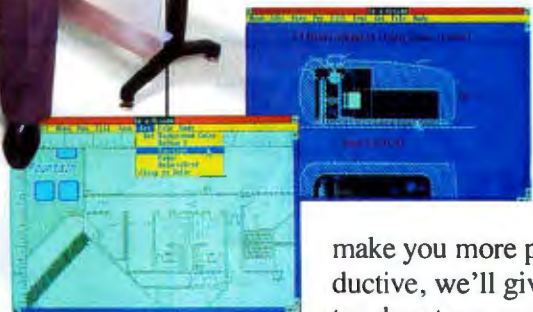

make you more productive, we'll give you ten days to prove it to yourself. If In·a·Vision doesn't improve your productivity, return it within ten days for a full refund.

In·a·Vision will make your complex drawing tasks simple and make you more productive. Satisfaction guaranteed. Dial 800-272-3729 to order or for a free brochure.

In Texas or for customer support, call (214) 234-1769. MICROGRAFX, Inc., 1820 North Greenville Avenue, Richardson, Texas 75081.



**MICROGRAFX™**  
The Picture of Success.



Introducing the Apple<sup>®</sup> compatible  
**LASER 3000<sup>™</sup>**  
 Personal Computer System



**More features  
 than Apple<sup>®</sup> for less than  
 a Commodore<sup>®</sup>... only \$499!\***

**A total package  
 including 64K main unit,  
 Disk Drive and software package  
 (word processor, data base  
 and spread sheet)  
 ... all for \$499!**

- Apple<sup>®</sup> and optional CP/M compatibility
- Built-in Microsoft<sup>®</sup> BASIC
- Built-in RGB and composite video output
- Built-in 80 column display
- Built-in Centronics printer interface
- Built-in 4 channel, 6 octave sound
- 64K RAM expandable to 192K
- 6-month Warranty



For your nearest dealer, write or call:  
**VIDEO TECHNOLOGY (U.S.) INC.**  
 2633 Greenleaf Avenue, Elk Grove Village, IL 60007 (312) 640-1776

APPLE<sup>®</sup> and COMMODORE<sup>®</sup> are registered trademarks of Apple<sup>®</sup> Computer Inc., and Commodore<sup>®</sup> Business Machines, Inc., respectively.

LETTERS

yes, I would agree that DEC is charging too much for these upgrades. If Mr. Sherman is happy with version 2.01, a cheaper solution would be to buy a book on MS-DOS from an independent publisher. Files with technical information on Rainbow firmware interrupts are available on the VAX Forum (PCS 16) of CompuServe.

Mr. Sherman is correct that DEC made the inexcusable decision to solder in the ROM, at least on the 100A. This ROM requires the system to be booted from a floppy disk at start-up but otherwise allows installation and use of a hard disk.

That said, I should add that I am happy with my DEC Rainbow. It is basically a very good machine. Its shortcomings seem to result from Digital's being oriented to the mainframe market. Its design approach as well as upgrade and service policies are geared toward corporate customers owning large machines. When you tell Digital people that you're an individual owning one personal computer, they know not what to think.

CARL D. NEIBURGER  
 Los Osos, CA

**COVER  
 STORY**

**TOUCHDOWN<sup>™</sup> KEY OVERLAYS**

provide new or additional PC keyboard commands for compatibility with your software programs. Made of heavy, nonglare material similar to the original keytops, with commands printed on the underside for durability... These are not ordinary stick-on labels! Hooleon also makes custom overlays to your exact specs, including foreign language and special symbols.

**TOUCHDOWN<sup>™</sup> KEYTOP EXPANDERS**

enlarge small keys (Return, Shift, etc.) on the IBM PC and most look-alikes. They fasten securely over existing keys with a special adhesive provided, yet are easily removed without damage to the keyboard.



**CUSTOM KEY OVERLAYS** can be made to your exact specs at a much lower cost than engraving.



**P. O. Box 201, Dept. B, Cornville, AZ 86325 (602) 634-7517**

**KEY OVERLAYS**

Qty.	Price	Qty.	Price
___ 5250/5251 (48 keytops/fronts)	\$21.95	___ MultiMate (44 keytops)	\$29.95
___ 5520 (101 keytops)	29.95	___ EasyWriter II (22 keytops/7 key fronts/Handy Card)	29.95
___ 3270 (30 key fronts)	18.95	___ Lotus 1-2-3 (24 keytops/Handy Card)	29.95
___ DisplayWrite 2 (36 keytops)	21.95	___ WordPerfect (32 keytops/Handy Card)	29.95
___ DisplayWrite 3 (38 keytops)	21.95	___ WordPerfect 3.2 (32 keytops/10 key fronts/Handy Card)	29.95
___ Dvorak (43 keytops)	26.95	___ WordPerfect 4.0 (24 key tops/11 key fronts/Handy Card)	29.95
___ Wordstar (29 keytops)	26.95		
___ Central Key English (5 keytops)	6.95		
___ Blank Overlays (99 keytops)	21.95		
___ Do-it-yourself Kit (200+ pieces)	29.95		

**KEYTOP EXPANDERS**

Qty.	Price
___ IBM PC, PC/XT, PC Port. (12 keys)	\$21.95
___ IBM 5291 Display Station (13 keys)	21.95
___ Compaq, Columbia (10 keys)	21.95
___ Corona, Eagle Spirit, Qubia, Keytronic (10 keys)	21.95
___ IBM 3270 PC "Enter" (1 keytop)	3.95
___ Individual Expanders	2.75

TOTAL (Min. order \$10.00) \$ \_\_\_\_\_  
 Prices include first class postage.  
 (Orders shipped within 24 hours.)  
 Arizona residents add 5% tax  
**TOTAL ENCLOSED \$ \_\_\_\_\_**

Name \_\_\_\_\_  
 Address \_\_\_\_\_  
 City \_\_\_\_\_ State \_\_\_\_\_ Zip \_\_\_\_\_

Visa  MC Exp. Date \_\_\_\_\_ Card # \_\_\_\_\_

Visa or MC orders phone 602-634-7517

Your satisfaction guaranteed or your money refunded.

The June Letters column contained yet another blast at the DEC Rainbow. A Mr. Sherman decried "bugs" he had found, some so terrible one cannot imagine how anyone could use such a machine. I have been developing software on just such a machine day in, day out for more than two years, and I have never experienced any of the bugs Mr. Sherman mentioned. The only bug I've ever found is a very minor one in the Rainbow Editor (RED), where a randomly huge number of pages often display when one requests to page backward. The Rainbow works quickly, dependably, and effortlessly. I truly enjoy using it.

I do, however, share Mr. Sherman's disdain for DEC's documents. They are often sinfully incomplete. But all in all, I find them easier to garner information from than most.

PAUL HENDERSON  
 Waynesboro, VA

**ENOUGH ON THE IBM PC!**

I greatly enjoyed the multiprocessor articles (May). Keep up the excellent coverage of new technologies in hardware and software.

Let me register a vote against IBM PC coverage. It's available in overabundance from almost every other magazine. The IBM PC was out-of-date technology the day it was released, and that was a long

(continued)



# And you thought there was only one "Graphics Card."

## AST introduces Preview!™ for \$100 Less.



SYMPHONY™



WORD™

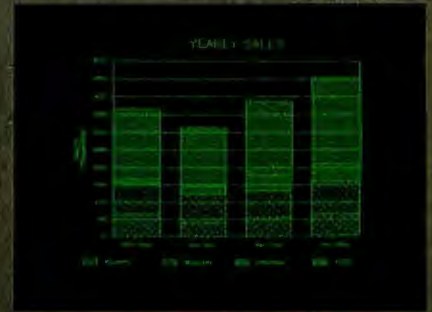

1-2-3™



FRAMEWORK™



MetaWINDOW™

Now you have a choice for bit-mapped graphics. Priced at \$399—\$100 less than what you'd expect—AST's Preview! brings high resolution bit-mapped graphics and clear, crisp text to your IBM® PC, XT or AT monochrome screen. And there's no standard like AST quality.

Preview! provides all the features and functions you'd expect, like bit-map addressing the maximum supported 720 horizontal pixels by 348 vertical lines for two pages of full-screen high resolution graphics, an IBM PC-compatible parallel printer port and Hercules™ bit-mapped graphics card compatibility.

It works with all kinds of software too, no other card offers more. New generation integrated business programs, bit-mapped text processing and advanced windowing applications are specialties.

Then there's the nonstandard features AST is famous for—consistent quality, reliability, comprehensive documentation, service, support and extra value. We include our

SuperPak™ RAM disk simulator and printer spooler utility diskette. Judged by PC WORLD readers as a World Class Winner for the past two years, it's worth \$45 by itself.

The leadership strength that makes our consistent quality so affordable is carried throughout our complete line of PC enhancement products. We offer a family of graphics products which provide a variety of features from serial ports to expansion memory, as well as multifunction boards, micro-to-mainframe communications, local area networks and disk subsystems.

So you can settle for the common, ordinary graphics card and hope for the best. Or you can pay \$100 less and know you have the best—Preview! only from AST. For more information and dealer locations call our Customer Information Center (714) 863-1333, Ext. 5249. Or write, AST Research, Inc., 2121 Alton Avenue, Irvine, CA 92714 TWX: 753699AST UR.

### FEATURES

- 64K Screen Memory
- Two Pages of High Resolution 720 Horizontal PELS by 348 Vertical Line Bit-Mapped Monochrome Graphics
- 80 Character By 25 Line IBM PC-Compatible Text Display
- Standard IBM Character Set
- Compatible With Popular Bit-Mapped Graphics, Text and Windowing Applications Software
- Parallel Printer Port
- SuperPak Utility Diskette
- Hercules Compatible

Preview! and SuperPak trademarks of AST Research, Inc. IBM trademark of International Business Machines Corp. Hercules Graphics Card trademark of Hercules Computer Technology. Lotus 1-2-3 and Symphony trademarks of Lotus Development Corp. Framework trademark of Ashton-Tate. Word trademark of Microsoft, Inc. MetaWINDOW trademark of Metagraphics.

Inquiry 3 for End-Users.  
Inquiry 4 for DEALERS ONLY.



# AST RESEARCH INC.





*cheetah*

*Acinonyx jubatus*

44.53 in. 86.143 lb

A SLEEK NEW STRATEGY FOR



**T**allgrass ends the hunt for the perfect mass storage system.

Until now, all Personal Computer tape backup systems have seemed unnecessarily cumbersome and complex. Then along came PC/T,<sup>®</sup> from Tallgrass.

PC/T stores and retrieves data on tape in a way that makes all streaming tape systems obsolete. Because it makes tape work like disk. With DOS simplicity. Rapid access to the file you need. And uncompromised data integrity.

The key: PC/T *formats* tape, creating directories, just like with floppies or hard disks. So defective blocks are locked out. And all 60 megabytes of tape are on line, to be accessed, updated or deleted at the stroke of a key. And if recorded data is accidentally damaged, PC/T's error correction capabilities can completely reconstruct it.

PC/T is available in a wide range of Tallgrass systems, offering tape only or tape plus 25 to 80 megabytes of hard disk storage. Just call 1-800-228-DISK for your Tallgrass dealer. And end the hunt for the perfect mass storage system.

*For a framable print of the Acinonyx jubatus Cheetah, send a check for \$3 to: The Tallgrass Collection, Dept. C, 11100 W. 82nd St., Overland Park, KS 66214. Proceeds, plus an additional donation from Tallgrass, will be forwarded to the World Wildlife Fund.*



**TALLGRASS  
TECHNOLOGIES**

WHEN IT'S WORTH SAVING.

Tallgrass<sup>®</sup> and PC/T<sup>®</sup> are registered trademarks of Tallgrass Technologies Corporation © 1985 Tallgrass

# TAPE: PC/T

Inquiry 361 for End-Users. Inquiry 362 for DEALERS ONLY





# Market Manager PLUS.™

## The investment software that helps you stay ahead of the odds.

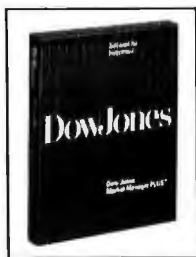

In today's dynamic market, staying ahead of the odds means staying on top of your investments—making sure you have the right information at the right time to manage your portfolio effectively.

Market Manager PLUS offers portfolio management for the active investor. By linking you with Dow Jones News/Retrieval®, it provides comprehensive automatic updating and reports.

### Here's what it gives you:

- Automatic portfolio valuation updates.
- Automatic dividend distribution.
- Automatic stock-split routines.
- Automatic bond and treasury bill maturity alerts.
- Automatic option expiration and stock long-term alerts.
- Interest and dividend tax reports.
- Holdings reports by portfolio and security symbol.
- Plus much more.

Market Manager PLUS gives you easy access to the portfolio information you need to make informed investment decisions.

### Demonstration disk. Just \$5\*.

We've prepared a demo disk to show you how easy it is to manage investment portfolios. Learn how you can stay ahead of the odds, call:

**1-800-345-8500**, extension 48.

(Alaska, Hawaii and foreign call, 1-215-789-7008 ext 48.)

Have your credit card information ready, including expiration date. VISA, MasterCard, and American Express accepted.

**Act now** — Offer good for a limited time only.

\*Please add \$2.50 for shipping and handling.

Market Manager PLUS works with IBM® PC, IBM XT, Apple® Macintosh™, Apple IIC and IIe.

# Dow Jones™

## Software

For Informed Decisions

Inquiry 125



*"Heads I buy.  
Tails I sell."*



time ago. I predict that the IBM PC AT will be in the same position very soon.

ALAN ROBINSON  
Jamaica Plain, MA

### THE HISTORY OF Ø

G. Michael Vose's conjecture (Book Reviews, February, page 65) that Alan Turing originated the practice of writing zero as Ø to differentiate it from the letter O is wrong, and William D. A. Geary [Letters, June, page 18] has correctly identified it as being common in telegraphy long before Turing. Military radiograms in World War II were always so typed. But there is more to the slashing story.

Telegraphic messages were chiefly alphabetic letters so the rarer symbol, the numeral, was slashed. In early computing the opposite was the case; the numerals were common while the letters were rare, so for years it was considered good computing practice to slash the handwritten letter O. As late as the 1970s programming textbooks gave this advice and further suggested putting a horizontal bar through Z to distinguish it from 2 and putting a horizontal cap and foot on I to distinguish it from l.

Now that the majority of the symbols used in computing are letters, we have gone back to slashing the zeros, and since input is increasingly entirely prepared on a keyboard and not handwritten we are less concerned with the Z/2 and I/l confusions.

ERIC A. WEISS  
Springfield, PA

### MORE ON STRUCTURED PROGRAMMING

Nearly 20 years after the structured programming revolution began and roughly a decade since Pascal and C became important languages and at a time when almost everyone recognizes the value of structured programming, it is sad to see a letter such as the one titled "Toward a Less Structured Approach" (May, page 458) by Erwin S. Strauss. I'm sure that it is important that people who are new to the field see the opposite point of view.

There is hardly one sentence in the entire letter that can pass unchallenged! Mr. Strauss presents two programs side by side and claims that one is structured while the other is not. In fact, both are examples of structured "code"—i.e., both use a counted loop, and one uses an IF... THEN... ELSE. The flow is from top to bottom, and neither uses a GOTO. I call both of these examples "code" rather than

(continued)

# Adapt a PC to point-of-sale, data collection, and process control applications



You have multiple cash registers, security systems, bar-code readers, digital scales, etc. that you want to control or access from one computer. Your options? An expensive, multi-user computer system. Or a small, single-port computer, such as an IBM PC, linked to an economical, BayTech multiport controller.

A multiport controller is a microprocessor-controlled unit that can allow up to 17 devices (more by cascading) to share one RS-232C serial port on a computer. Separate input/output buffers and UARTS enable you to receive and transmit data simultaneously on all ports, and mix and match devices of different configurations.

Several methods of transferring or multiplexing data are available from BayTech. The A-series multiports provide computer-controlled switching. The ES-series features time-division multiplexing, and the AC11 series, buffered message multiplexing. The H-series combines the A, ES and AC11 modes of operation plus three additional modes into one user-programmable unit. 5, 9, 12 or 18 ports, \$279 to \$1,795.

### OTHER APPLICATIONS, TOO!

BayTech also manufactures units for printer-sharing, networking, port contention. Call or write for details.



**BAY TECHNICAL ASSOCIATES, INC.**  
DATA COMMUNICATIONS PRODUCTS

800/523-2702 or 601/467-8231

Highway 603, P.O. Box 387, Bay Saint Louis, Mississippi 39520

Telex: 910-333-1618 (BAYTECH)

EasyLink: 6277-1271

Inquiry 32



programs because both are terrible examples of programs, structured or otherwise.

The attack by Mr. Strauss was prompted by the poorly designed index in the Modula-2 book. Sequential entries in the index are printed horizontally adjacent to each other rather than vertically. As poor as it is, it is at least an index for the book. The first code segment presented by Mr.

Strauss works only for even values of  $N$ —a restriction stated by him but given in the same breath that he attacks the other code that works for all values of  $N$ . I dislike this indexing scheme as much as anyone, and I haven't the foggiest idea why it was done this way. I am certain, however, that the strange form of the index has about as much to do with structured programming as does the color of the cover.

The second code segment, which Mr. Strauss claims contains a higher level of "sensitivity to the user," is so bug-infested that it is insulting to the user! If  $N$  (the number of elements in the index) is less than or equal to  $PL$  (the number of lines on the page), it omits printing every other index element. If  $N$  is one greater than  $PL$  but still less than  $2*PL$ , the program produces a correct listing for indexes 1, 2, . . . ,  $N-PL$ ,  $PL+1$ ,  $PL+2$ , . . . ,  $N$  but again omits all the even indexes between  $N-PL$  and  $PL$ . Finally, if  $N$  is greater than or equal to  $2*PL$ , it will print out a correct index for the first few pages but will always foul up the last page. It turns out that this collection of code will produce the correct answer only when  $N$  is an even multiple of  $PL$ . So much for sensitivity!

The letter continues stating that the first is a structured program because it "has fewer lines, fewer statements, fewer variables, it's easier to read and understand at a glance, etc." (One could only imagine what "etc." includes.) I don't know of any texts that claim any of these are characteristics of structured programming. Certainly structured programs are easier to understand, although not necessarily at a glance. Often structured programs are longer and use more variables than unstructured code! (See listing 1 for an example.)

Clearly, structured programming has nothing to do with sensitivity (or its lack) to the user. Years ago it was demonstrated that any "correct" program could be written in a structured fashion. Only programmers are responsible for the program's sensitivity to the user. The letter continues by attacking structured programmers because they insist on producing bug-free code! Bug-free code? I consider myself a "structured programmer" and I program that way because it produces clean code early on in the code-development cycle; it gives me more time for other programming projects because I don't spend much time chasing down foolish bugs. The cost of structured programming that Mr. Strauss speaks of is not one of sensitivity but one of sitting down with a problem and solving it long before you begin to type characters at a computer. I enjoy programming so much that the satisfaction of working on many projects and producing well-written programs is worth the so-called cost of thinking out ahead of time. Strauss's two code segments are prime examples of what happens if you are not willing to pay that price.

The rest of the letter's attack on struc-  
(continued)

## ONE-STOP ARCnet™ LAN SOLUTIONS

Now you can get all the tools you need to build industry standard **TOKEN-PASSING** networks from one source.

InterContinental Micro.

Our networking packages let you configure any combination of nodes (PC's and compatibles, ATs, XTs, Jrs., Z-100s) to a common Fileserver in just a few minutes with our menu-driven installation program.

Active and passive hubs allow you to integrate up to 255 users on a single network with *increased* efficiency as the network grows.

In addition, our stand-alone ARCnet™ Workstation/Fileserver and complete line of S-100 Bus products (single board computers, slaves and controllers) give you and your customers even more options.

ARCnet is a trademark of Datapoint Corporation.

We're also compatible with other industry-leading ARCnet™ PC™ and S-100 products, and our PC net™ working boards include an optional 256K of system RAM.

All with InterContinental Micro's reputation for outstanding reliability, exceptional service, and highly competitive pricing.

Call InterContinental Micro today, or circle the bingo number below for ARCnet™ LAN solutions.



**InterContinental  
Micro Systems**

4015 Leaverton Court, Anaheim, CA  
92807; Phone: (714) 630-0964  
Telex: 821375 SUPPORT UD; Easylink: 62562040.







**If you own an Apple IIc,  
you'd have to add all this**



**to match the versatility, expandability  
and higher intelligence of the  
new Commodore 128**  
(and it costs less too).

The new Commodore 128™ personal computer is breakthrough technology at a breakthrough price. It outshines the Apple® IIc in performance capability, performance quality and price. It is expandable to 512K RAM while the IIc isn't expandable at all.

And the new Commodore 128 has a numeric keypad built right into its keyboard that makes crunching numbers a lot easier. And the Commodore 128 has graphic and sound capabilities that far exceed those of the Apple IIc. But the most important news is that

the new Commodore 128 jumps you into a whole new world of business, productivity, education and word processing programs while still running over 3,000 programs designed for the Commodore 64.™ That's what we call a higher intelligence.

**COMMODORE 128 PERSONAL COMPUTER**  
A Higher Intelligence



Listing 1: David R. Stampf's example of a structured program.

```

PL := 60;                                { Lines/page }
FULL_PAGES := N DIV (2*PL);              { N is the number of entries }
START := 1;                               { Full pages - Hmmmm, maybe k columns? }
FOR PAGE := 1 TO FULL_PAGES              { Start with the first entry }
    DO BEGIN                               { Full pages first - even if none }
        FOR ENTRY := START TO START + PL - 1
            DO WRITELN(INDEX[ENTRY], ' ', INDEX[ENTRY + PL]);
        START := START + 2*PL;
    END;

{ Any partial pages? }
LINES := N - START + 1;                   { Find lines left to print }
IF (LINES > PL)                            { Watch out for > half pages }
    THEN LINES := PL;
FOR ENTRY := START TO START + LINES - 1
    DO IF (ENTRY + PL) <= N
        THEN WRITELN(INDEX[ENTRY], ' ', INDEX[ENTRY + PL])
        ELSE WRITELN(INDEX[ENTRY]);

{ The above works for all values of N - even/odd/big/small/+/- }

```

tured programmers, gurus, and the like is simply redundant—Strauss has an equally naive opinion of good programmers as he does of structured programming.

Finally, the last paragraph seems to be hedging a bit—structured programming is okay if . . . . Evidently, he hasn't the foggiest notion of what the goals of structured programming are. I will never program my zillionth database application. If I ever do it, I hope to do it once, then reuse the same code. If I do it right the first time, I can use the same technique over and over, freeing up time for me to explore new systems. Too bad Mr. Strauss will be trying to debug his index program, for if you start by writing buggy programs, debugging always comes later.

DAVID R. STAMPF  
Shoreham, CT

Erwin Strauss seems to be confusing two important ideas, that of the structure of a program on the one hand and that of its "usefulness for any specific purpose" (which most vendors go to a lot of trou-

*(continued)*

# DREAMER

Inquiry 360

## Make 1-2-3™, WordStar™, VisiCalc™, easier!

### NO MORE MEMORIZING AND TRAINING

- Are you always forgetting those keystroke sequences required for your sophisticated business software?
- Wouldn't it be easier to press a key labelled "Format Right" instead of typing "/ R L R" to right-justify a cell in Lotus 1-2-3? or a key labelled "Save File" instead of typing "Ctrl K S" in WordStar?
- Now, with the help of Dreamer's descriptive keys, you can execute oddly-constructed commands with no more memorization, no more flipping through instruction manuals.
- Cut training time and costs for yourself and your staff to a minimum by putting a Dreamer next to your system. The Dreamer will make your computer a dream to use.
- The Dreamer is available for the IBM PC or XT and the Apple //e or ][ Plus.

#### DREAMER FEATURES:

- 20-key numeric pad with separate cursor controls
- IBM version:
  - 70 Lotus 1-2-3 commands
  - 30 WordStar commands
- Apple version:
  - 60 WordStar commands
  - 40 VisiCalc commands
- Templates included for alternate command pages
- Easy selection between command pages
- Easy installation
- Full 90-day warranty

**T. S. MICROTECH INC.**  
(213) 644-0859  
12565 Crenshaw Blvd.  
Hawthorne, CA 90250



**\$259**



# Ven-Tel's Half Card™ modem is in all the best computers. Here's why...

Ven-Tel gives you lots of reasons to buy our Half Card™ modem for your IBM PC or compatible. The Half Card™ is a complete system that lets you communicate with other PCs, mainframes, and databases effortlessly. It includes Crosstalk-XVI® software. It's reliable. It's got all of the features you want. And it's a good value.

## Do You Own One of These Computers?

Chances are you do. And if you're thinking of buying a modem, consider the Half Card™. Because of its small size, the Half Card™ fits in more computers, including all of the models we've listed here. The Half Card™ is small, so it fits in short slots or long. That means you can save your long slots for other expansion uses.

## Effortless Communication

Each Half Card™ comes with Crosstalk-XVI® communications software, by Microstuf. It's the easiest to use, whether you're a beginner or an old hand, and the most powerful. A full on-line help menu makes using Crosstalk® for the first time a snap. It can turn your PC into a terminal on a mainframe computer with its powerful terminal emulation feature. It will even operate your PC when you're not there. You can call into an information service such as The Source or Dow Jones News Retrieval, or transfer files and electronic mail, all at the touch of a button. The Half Card™ connects your computer to the world. Effortlessly.

## More Modem for Your Money

When you buy the Half Card™, you don't need anything else. The Half Card™ is a complete communications package that includes a full-featured modem and the best known software on the market. Complete easy-to-understand instructions with full technical support on installation and use. And a very competitive price. The Half Card™ with Crosstalk-XVI® software, retails for only \$549.

## Features

- 1200/300 baud auto-dial, auto-answer.
- Uses the industry standard "AT" command set.
- Runs with virtually all communications software, including Smartcom II and PC Talk III and integrated packages such as Symphony and Framework.
- Includes Crosstalk-XVI® software.
- On-board speaker and extra phone jack for easy switching from voice to data mode.
- Selective tone or pulse dialing; full or half duplex.
- Automatic answer on any ring.
- True ring or busy signal detection.

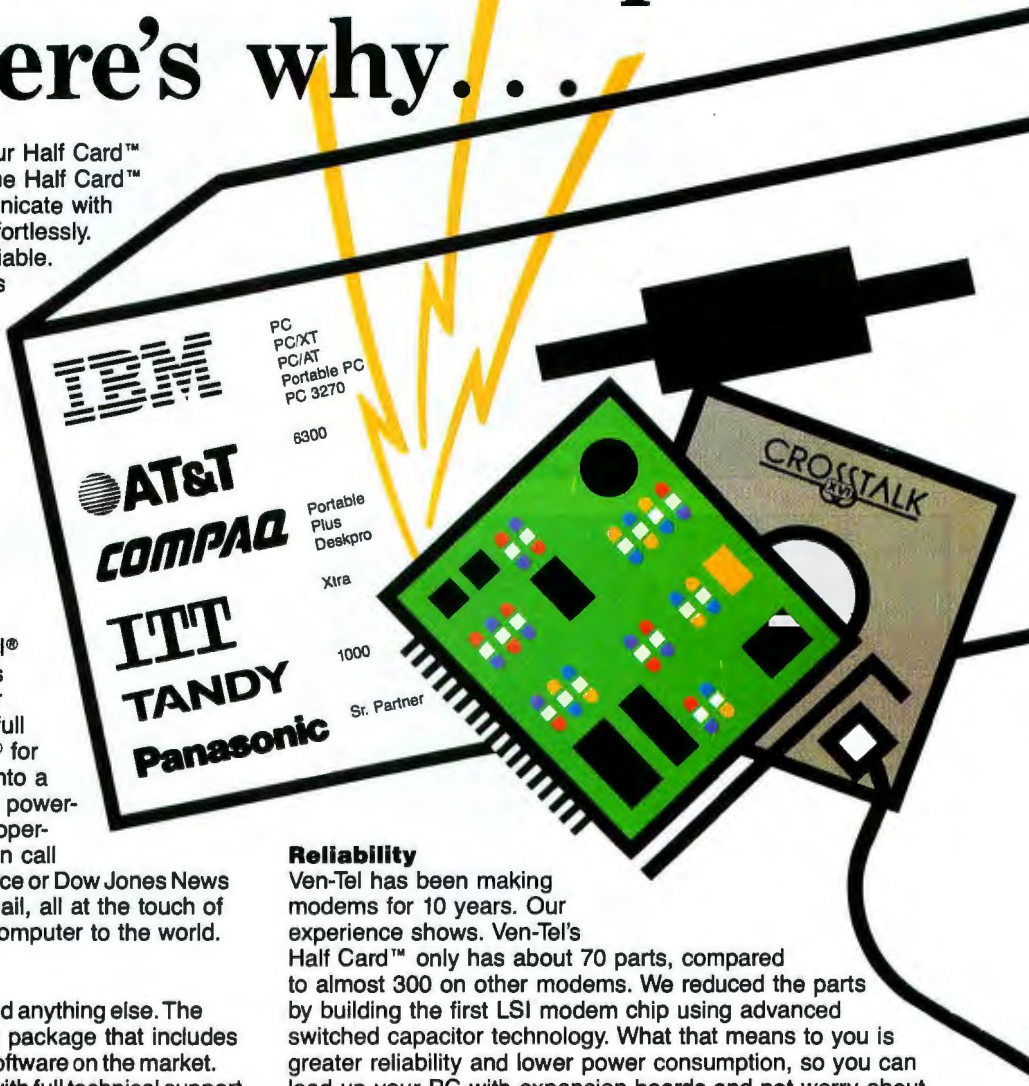

## Reliability

Ven-Tel has been making modems for 10 years. Our experience shows. Ven-Tel's Half Card™ only has about 70 parts, compared to almost 300 on other modems. We reduced the parts by building the first LSI modem chip using advanced switched capacitor technology. What that means to you is greater reliability and lower power consumption, so you can load up your PC with expansion boards and not worry about heat or power problems. And we back the Half Card™ with a full two-year warranty on parts and labor.

## You Can Buy the Half Card™ Anywhere

You can get the Half Card™ at ComputerLand, Businessland, the Genra Group, Entré Computer Centers, Macy's Computer Stores and other fine dealers nationwide. Also from Ven-Tel: the 1200 Plus™, an external modem and the PC Modem 1200™, an IBM internal with V.22 international capability.



## Effortless Communication

# Ven-Tel Inc.

2342 Walsh Avenue  
Santa Clara, CA 95051  
(408) 727-5721



# See what EnerConnect can do with mainframe graphics on your PC.

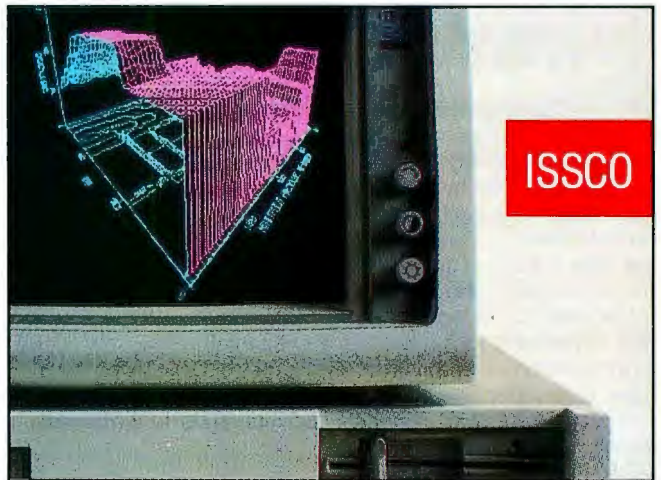
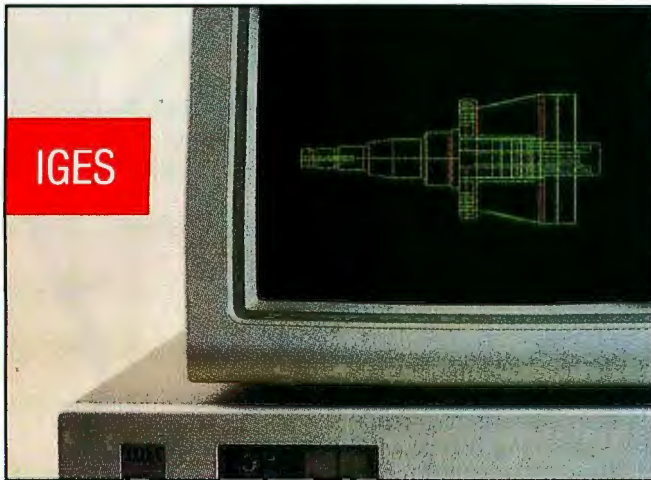
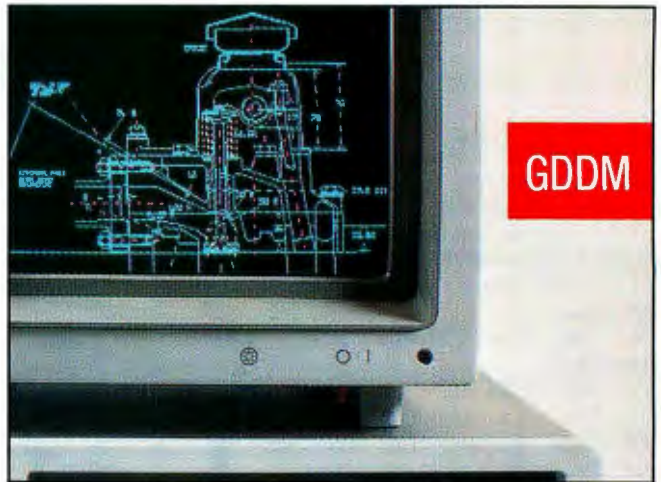

*EnerConnect® is the first software package that puts mainframe graphics capability into the hands of anyone with an IBM PC/XT/AT or 3270 PC.*

*Now a PC user can have desktop access to business and technical graphics applications generated by GDDM, ISSCO's Tell-A-Graf® and DISSPLA®, SAS/GRAPH® and IGES datafiles.*

*Once they're displayed, EnerConnect lets you manipulate them in a variety of ways. You can rotate, enlarge, reduce, cut-and-paste with other elements from different mainframe files, add text and even direct output on low-cost PC*

*printers and plotters. All without using expensive mainframe connect and processing time.*

*You can also use our PC-based graphics program, EnerGraphics, to interface with spreadsheet data from LOTUS 1-2-3, VISICALC and other packages, turn the data into easy-to-understand bar charts and then combine them with mainframe graphics.*

*EnerConnect. Your Mainframe-to-PC software link. Developed by the specialists in graphics applications software.*

*Call or write for our free brochure and see what EnerConnect can do for you.*

**ENERTRONICS** SEEING IS BELIEVING



# CHECK-OUT ENERGRAPHICS™

## YOUR TOTAL GRAPHICS SOFTWARE

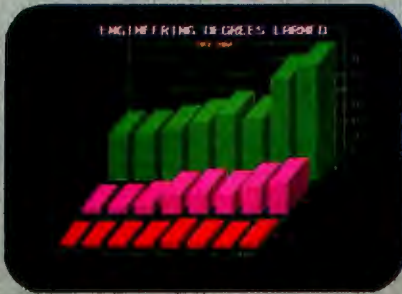

**Presentation Business Graphics**  
EnerGraphics delivers pie charts, flowcharts, bar charts, line graphs and more with easy interface to Lotus 1-2-3, MultiPlan and other spread sheets. You'll learn it quickly because we're menu-driven.

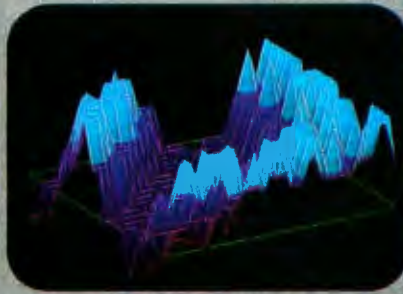

**Drawing Capability** With EnerGraphics, simple keystroke commands enable you to create text, flow, gantt, PERT and organization charts with the capability to enlarge, reduce, rotate, draw, modify, duplicate and overlay.

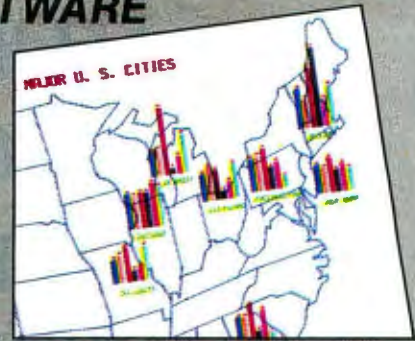

**3-D Object & Surface Drawings**  
EnerGraphics gives you entry-level 3-D CAD features such as zoom, rotate and hidden line removal.

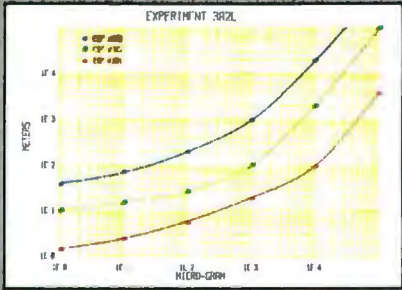

**Statistics** EnerGraphics enables you to analyze data using linear and log scales to do linear and polynomial regression. Statistical information can be represented in scatter graphs.

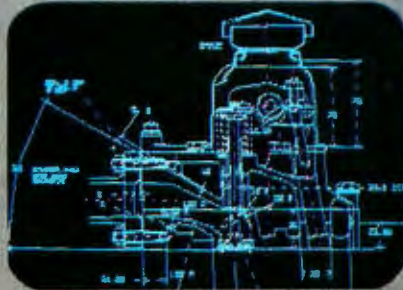

**Mainframe Link** Our new EnerConnect program allows you to combine PC-based graphics with mainframe graphics such as GDDM, ISSCO'S Tel-A-Graf®, Disspla® and IGES data files.



**PC Compatibility** EnerGraphics can give you an unlimited number of graphics applications on Wang, TI, IBM PC/XT/AT, 3270/PC and compatibles.



**Slide Show** Any of our attractive graphics can be converted into color or b&w slides, or overhead or on-screen presentations using the Polaroid Palette.

# FORTUNE 500

**Corporate Use** You'll find EnerGraphics is the graphics software choice of over 100 leading corporations with more being added all of the time.



**Price** At a retail price of just \$350 (\$450 with plotter) EnerGraphics actually costs less than many packages that offer only a few of these features.

EnerGraphics. Brought to you by the specialists in graphics application software.

Find out why users rate us at the top among stand alone business graphic packages. Just check with your local EnerGraphics dealer today.

## ENERTRONICS

Enertronics Research, Inc. • 150 N. Meramec

## SEEING IS BELIEVING

St. Louis, MO 63105 • (314) 725-5566 • Toll Free 800-325-0174



# How to go from UNIX to DOS without compromising your standards.

It's easy. Just get an industry standard file access method that works on both.

C-ISAM™ from RDS.

It's been the UNIX™ standard for years (used in more UNIX languages and programs than any other access method), and it's fast becoming the standard for DOS. Why?

Because of the way it works. Its B+ Tree indexing structure offers unlimited indexes. There's also automatic or manual record locking and optional transaction audit trails. Plus index compression to save disk space and cut access times.

How can we be so sure C-ISAM works so well?

We use it ourselves. It's a part of INFORMIX®, INFORMIX-SQL and File-it!™, our best selling database management programs.

For an information packet, call (415) 424-1300. Or write RDS, 2471 East Bayshore Road, Palo Alto, CA 94303.

You'll see why anything less than C-ISAM is just a compromise.



**RELATIONAL DATABASE SYSTEMS, INC.**

© 1985, Relational Database Systems, Inc. UNIX is a trademark of AT&T Bell Laboratories. INFORMIX is a registered trademark and RDS, C-ISAM and File-it! are trademarks of Relational Database Systems, Inc.

ble to advertise but then disclaim in their license agreements) on the other. I wholeheartedly agree with Mr. Strauss's view that a program should not be simplified to the point that it does no useful work.

In his example of two programs to print an index in two columns, he is in error when he describes the first as structured and the second as unstructured. In fact, his second program clearly shows the same structure as the first, extended to add the concept of a page and to rearrange the data. I could give an unstructured version of the second program, but yours is a family publication. Suffice it to say that it would use GOTOs in the manner Dijkstra considered harmful. The two programs illustrate the concept of stepwise expansion of a simple algorithm to solve a more complicated problem. Structured methods were developed in response to the problems of developing large, complex programs. Of course, if two programs solve the same problem, the simpler one is to be preferred. If Mr. Strauss's gurus tell him his two programs do the same thing, or that he should choose the first anyway, then they are false prophets and he should cast them out.

A programmer can be competent but fail to understand the methods he uses. Structure in a programming language is like good grammar in a natural one. It lends clarity of expression. Spoken language may exhibit looser grammar than formal written language, but a speaker who has mastered grammar is more likely to be correctly understood by his listeners. Not all programs should be written in the formal style appropriate to a legal contract, but a programmer with a good grasp of structure can use it even in his less formal utterances. If he does so, it is more likely that his program will tell his computer what he really wants it to do.

Our choice of a language may be like using the jargon appropriate to a profession. It can provide a useful shorthand for communication with other initiates, but it can be limiting if used to express thoughts in a wider realm. Jargon frequently reads as very poor English. Some computer languages are also poorly suited to general applications, even though they may be quite satisfactory for chosen purposes.

If a language enforces a structure, an experienced user will think within that structure. That is why it is important to teach structured languages like Pascal or Logo early if possible. You can then learn other languages as appropriate. For example, Pascal is not suitable for systems program-

*(continued)*





## We make it simple.

An Interface disk or tape subsystem is simple to install and simple to use for IBM PC, XT, AT, and most PC-compatibles

### For the PC and compatibles we give you:

- External DiskSystems<sup>®</sup> from 10 to 119MB.
- Internal with 10 to 55MB.
- 10MB removable cartridge Winchester.
- 10MB TapeSystem<sup>®</sup>.
- DualStor<sup>®</sup> with 10, 22, or 33MB of fixed storage plus 10MB tape or 10MB removable Winchester.

*DualStor with combination disk and tape*



### For the PC-XT, we give you:



*10-megabyte TapeSystem*

- Internal 10 to 55MB.
- DoubleBarrel<sup>®</sup> is an internal combination with 10, 22, or 33MB fixed storage combined with 10MB of tape back-up.
- External 10MB tape cartridge drive.
- External ExtraDrive<sup>®</sup> is a 10MB removable cartridge Winchester.
- External DiskSystem with 10 to 55MB of additional storage.

### For the PC-AT, we give you:

- Internally mounted hard disk drives with 21 to 117MB.
- Internal 10MB removable cartridge Winchester.



*AT up-grade kit*

Since 1978, Interface has been providing quality storage subsystems at affordable prices for the personal computer market.

DiskSystems, TapeSystems, DualStor, DoubleBarrel and ExtraDrive are copyrights of Interface, Inc. IBM is a registered trademark of IBM Corporation



## Interface, Inc.

Inquiry 191 for End-Users.  
Inquiry 192 for DEALERS ONLY.

21101 Osborne Street,  
Canoga Park, CA 91304  
Or call (818) 341-7914

Canada: Santronic Sales, Ltd.  
(604) 522-1658



ming (not because of the structures provided for flow of control but because it imposes restrictions on access to memory and I/O in order to guarantee correct matching of data types in common application programming situations and doesn't provide for multitasking). When using an unfamiliar language, a programmer may well display the accents of languages he knows better. Perhaps a Pascal

accent could add real charm to a BASIC or assembly-language program.

JOHN MAINWARING  
Raleigh, NC

### MAKING BASIC MORE POWERFUL

I programmed a bit of FORTRAN in college in the early 1960s and then got into programming in a bigger way in about

1967 with BASIC. It's the language I cut my programming teeth on.

BASIC didn't have a very good reputation in those days. I taught after-hours classes in a largely FORTRAN-oriented company, and some of my students would come to class shaking at their very foundations because their "sophisticated" FORTRAN colleagues in the terminal room would chide them about their choice of language, even corrupting the BASIC acronym to mean Baby's All-purpose, Simple Instruction Code.

But we had an extraordinarily good version of BASIC at our disposal, and I was a master of it. I'd accumulated many imaginative and provocative tricks up my sleeves to use things like strings, logical variables, complex numbers, and matrix functions to solve complex problems in elegant, unexpected, and simple ways. Had any one of those 1960s computer yuppies challenged me to a FORTRAN-versus-BASIC shoot-out and let me pick any one of two dozen problems to solve, I'd have beat the diapers off them.

Since then, I've gone on to program a fair amount in APL, FORTRAN, Pascal, Ada, some C, and bits and pieces of other languages on UNIX and other operating systems. And what I've found is that each language has its application.

I don't do much hands-on programming any more. But I make a hobby of devising yet other new tricks for BASIC; these days, I get a kick out of programming it to mimic the good software and engineering features of other languages. And that's what drew my attention to Arthur Huston's article "Structuring BASIC" (June, page 243).

Mr. Huston did a good service for the BASIC world with his article on building libraries, but we can go farther than he went when we start talking about mimicking the type-checking, procedure, error-processing, GOTO-less programming, and other features inherent in other languages. For (believe it or not) it is possible to emulate these things in a good BASIC and make your programs incredibly readable and debuggable along the way. Why, I've even emulated, in a crude, first-cut way, Ada's *generic* package—not to mention TBD's workers-and-managers architecture and the principles of top-down programming and interface development.

It's fun, intellectually stimulating, and doable—if you set your mind to it and don't victimize yourself with that sense of Baby BASIC.

GENE BARNETT  
Redondo Beach, CA  
(continued on page 424)

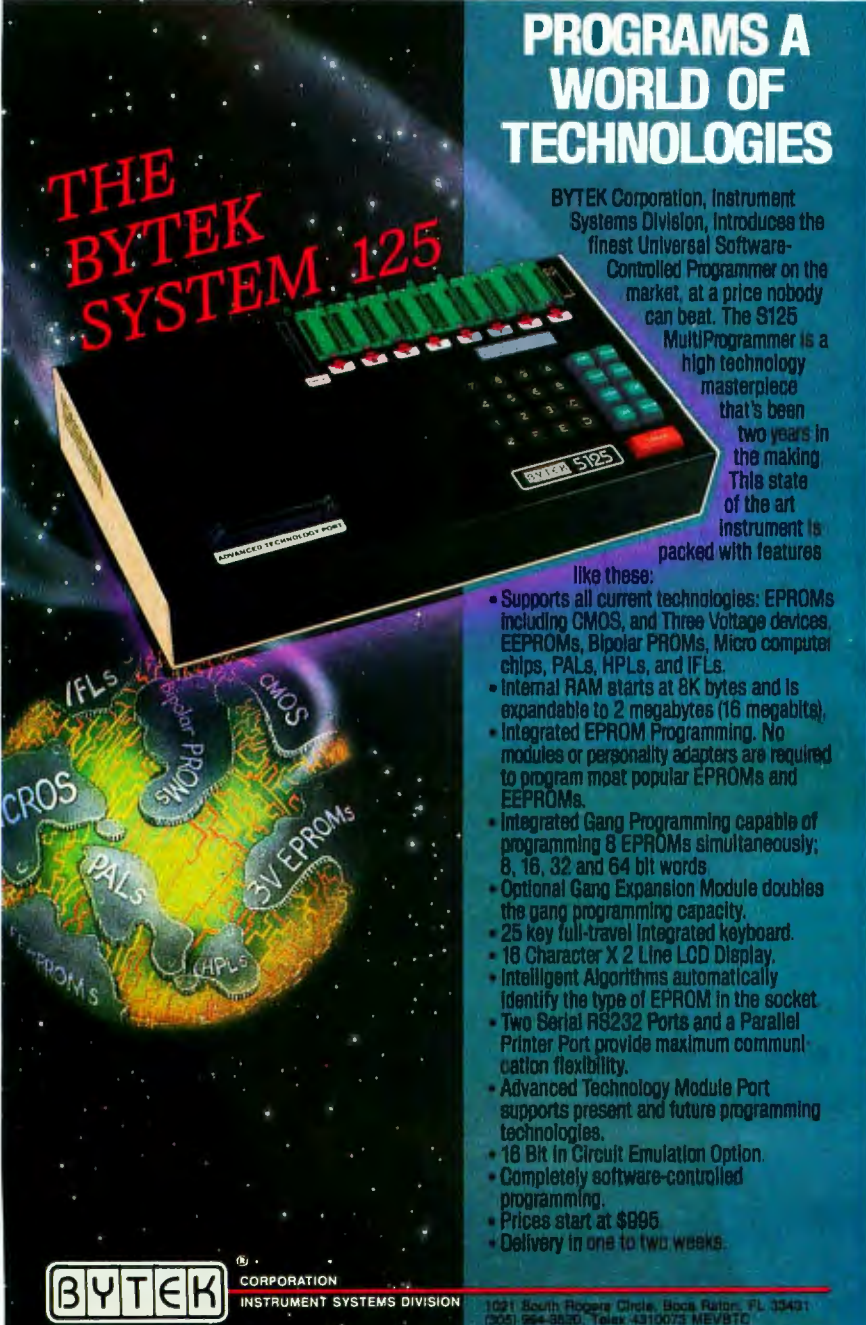

THE BYTEK SYSTEM 125

PROGRAMS A WORLD OF TECHNOLOGIES

BYTEK Corporation, Instrument Systems Division, introduces the finest Universal Software-Controlled Programmer on the market, at a price nobody can beat. The S125 MultiProgrammer is a high technology masterpiece that's been two years in the making. This state of the art instrument is packed with features like these:

- Supports all current technologies: EPROMs including CMOS, and Three Voltage devices, EEPROMs, Bipolar PROMs, Micro computer chips, PALs, HPLs, and IFLs.
- Internal RAM starts at 8K bytes and is expandable to 2 megabytes (16 megabits).
- Integrated EPROM Programming. No modules or personality adapters are required to program most popular EPROMs and EEPROMs.
- Integrated Gang Programming capable of programming 8 EPROMs simultaneously; 8, 16, 32 and 64 bit words.
- Optional Gang Expansion Module doubles the gang programming capacity.
- 25 key full-travel integrated keyboard.
- 18 Character X 2 Line LCD Display.
- Intelligent Algorithms automatically identify the type of EPROM in the socket.
- Two Serial RS232 Ports and a Parallel Printer Port provide maximum communication flexibility.
- Advanced Technology Module Port supports present and future programming technologies.
- 18 Bit In Circuit Emulation Option.
- Completely software-controlled programming.
- Prices start at \$895.
- Delivery in one to two weeks.

CORPORATION

INSTRUMENT SYSTEMS DIVISION

1021 South Rogers Circle, Boca Raton, FL 33431  
(305) 994-9530, Telex: 4310073 MEV/STC



TEAR AND COMPARE! TEAR AND COMPARE! TEAR AND COMPARE! TEAR AND COMPARE!

**LOGIC SOFT INCREDIBLE  
NEW SERVICE BREAKTHROUGH**

**FREE  
OVERNIGHT  
DELIVERY!**

On Orders Totalling  
Over \$100...Shipped  
UPS FREE if  
Under \$100

VIA... **Purolator  
courier**



MEMBER  
Direct Marketing  
Association Inc.



**PLUS... For a Limited Time...  
Any Price \$10 We'll Continue To Beat  
By.....**

**THAT'S RIGHT! OUR LOWEST PRICE GUARANTEE IS STILL EFFECTIVE!**  
Tell us the advertiser and price of any software or hardware item on these pages currently advertised in any popular computer publication and we'll beat that price by \$10. This offer does not apply to items under \$100 or where the price is not lower than Logicsoft's

**SOFTWARE for IBM PC**

**DATA BASE MANAGEMENT**

<b>KNOWLEDGEMAN</b> .....	\$259
Clout 2.....	145
Tim IV.....	189
R:Base 4000.....	265
<b>R:Base 5000</b> .....	399
DB Master.....	475
<b>d BASE III</b> .....	365
Quickcode III.....	159
d Base II (New Release).....	269
Condor III.....	349
Data Base Mgr. II (alpha).....	175
Extended Report Writer.....	119
Friday.....	169
pts: file & pts: report.....	165
<b>REVELATION</b> .....	745
Powerbase.....	255
Easyfiler.....	99

**FINANCIAL**

<b>DOLLARS AND SENSE</b> .....	\$115
Market Mgr. Plus (Dow Jones).....	179
<b>MANAGING YOUR MONEY</b> .....	119

**GRAPHICS**

<b>CHARTMASTER</b> .....	\$275
--------------------------	-------

**GRAPHICS (cont.)**

BPS Graphics.....	\$289
<b>SIGNMASTER</b> .....	195
pts: graph.....	85
Graphwriter.....	319
Graphwriter Extension.....	319
Graphwriter Combo Pak.....	485
Microsoft Chart.....	175
<b>ENERGRAPHICS</b> .....	259
Energraphics (w/plotter opt.).....	325
PC Draw.....	295

**LANGUAGES/UTILITIES**

<b>CONCURRENT PC DOS</b> .....	\$175
Pascal MT + (PC DOS).....	349
PL/1-(DR).....	489
Display Manager-(DR).....	359
Access Manager-(DR).....	269
<b>LATTICE C COMPILER</b> .....	305
C-Food Smorgasbord.....	119
CIS Cobol 86 (DR).....	479
Pascal Compiler (MS).....	245
C Compiler (MS) (New Release).....	305
Microsoft Sort.....	159
Cobol Compiler (MS).....	479

**LANGUAGES/UTILITIES (cont.)**

Business Basic (MS).....	\$299
<b>FORTRAN COMPILER (MS)</b> .....	229
C86 C Compiler (Computer Innovations).....	329
<b>INTEGRATED/SPREADSHEETS</b> LOTUS 1-2-3 (While They Last).....	\$329
Enable.....	305
Smart Series.....	579
<b>FRAMEWORK</b> .....	355
Open Access.....	395
Electric Desk.....	229
<b>SYMPHONY (Limited Quantity)</b> .....	459
Supercalc 3.....	175
Multipian.....	129
TK! Solver.....	279
pts: plan.....	85

**PROJECT SCHEDULERS**

<b>MICROSOFT PROJECT</b> .....	\$165
SuperProject (IUS).....	245
<b>HARVARD TOTAL PROJECT MGR.</b> .....	285

**WORD PROCESSING**

Wordstar 2000.....	\$259
<b>WORDSTAR 2000 PLUS</b> .....	309

**WORD PROCESSING (cont.)**

Wordstar Pro Pac.....	\$265
Wordstar Pro Plus.....	345
<b>WORD PERFECT</b> (New Release).....	245
Microsoft Word.....	245
<b>MULTIMATE</b> .....	249
Volkswriter Deluxe.....	165
Peachtext 5000.....	199
Easywriter II/Speller/Mailer.....	199
Edix & Wordix.....	255
Finalword.....	225
Samna III.....	325
Xy Write II Plus.....	255
Think Tank.....	125
pts: write.....	85
<b>MISCELLANEOUS UTILITIES</b> PROKEY 3.0.....	\$89
Norton Utilities (New Release).....	65
<b>SIDEKICK (unprotected)</b> .....	65
Crosstalk XVI (New Release).....	115
Sideways.....	45
Copy II PC.....	39
<b>DESK ORGANIZER</b> .....	129

**HARDWARE for IBM PC**

**GRAPHICS BOARDS**

<b>AST</b> Preview.....	\$279
<b>EVEREX</b> Graphics Edge.....	\$375
<b>HERCULES</b> Graphics Card.....	\$325
Color Card.....	169
<b>PLANTRONICS/FREDERICK</b> Colorplus.....	\$385
<b>STB</b> Graphics Plus II.....	\$315
<b>TECMAR</b> Graphics Master.....	\$459
<b>TSENG LABORATORIES</b> Ultra Pak.....	\$545

**GRAPHICS BOARDS (cont.)**

<b>PARADISE SYSTEMS</b> Multi-Display Card.....	\$279
Modular Graphics Card.....	289
Options A&B.....	Lowest Price
<b>MODEMS (INTERNAL)</b> PROMETHEUS Pro-modem 1200B.....	\$319
<b>QUADRAM</b> Asher.....	\$395
<b>HAYES</b> Smartmodem 1200B (w/Smartcom II).....	\$385
<b>NOVATION</b> Smart-Cat Plus.....	\$355
<b>RACAL-VADIC</b> Maxwell 1200PC.....	\$395

**MODEMS (INTERNAL) (cont.)**

<b>VEN-TEL</b> PC Modem Half Card.....	\$439
---	-------

**COMMUNICATIONS BOARDS**

<b>AST</b> AST-5251-11.....	\$699
AST-3780.....	749
<b>DCA</b> IRMA Board.....	\$949
<b>QUADRAM</b> Quadlink.....	\$449

**MULTI-FUNCTION BOARDS**

<b>AST RESEARCH</b> Six Pak Plus (64k).....	\$259
Mega Plus II (64k).....	275
I/O Plus II.....	135

**MULTI-FUNCTION BOARDS (cont.)**

<b>AST RESEARCH (cont.)</b> Advantage (128k).....	\$429
<b>QUADRAM</b> Quadboard (64k).....	\$259
<b>STB</b> Rio-Plus II (64k).....	\$259
Rio Grande.....	375
Grande Byte.....	275
<b>TECMAR</b> Captain.....	\$235

**KEYBOARDS**

<b>KEYTRONIC</b> 5150.....	\$159
5151 (Deluxe).....	179
5152 B.....	645

Prices subject to change without notice.

Immediate Replacement on any Defective Product.



National Sales  
Hot Line

**1-800-645-3491**

Customer Service 1-800-431-9037

New York State...516-249-8440 Canada.....416-283-2354 Domestic/International Telex...286905 Soft UR

**LOGIC SOFT**

THE LOGICAL CHOICE  
A Member of The Logic Group

110 Bi-County Blvd., Farmingdale, N.Y. 11735

SEE OTHER SIDE  
FOR MORE SAVINGS!



WE WILL BEAT ANY PRICE BY **\$10**

See Other Side for Details

**NEW! Expanded Special Order Dept.**  
We know there are many products that simply cannot be found through mail order. We've solved that problem...just ask for our **SPECIAL ORDER** department...We've got the suppliers...still at low mail order prices!

**FREE**

Overnight Delivery  
See Other Side for Details

**SOFTWARE for Macintosh**

**DATABASE**

DB Master	\$125
Filevision	105
1st Base	105
Habadex	29
Helix	249
Mainstreet Filer	155
Megafile	135
Microsoft File	140
Omni 2	155
Omni 3	Lowest Price
Dview	179
pfs: File & Report	105
MacLion	245
Factfinder	95

**GRAPHICS**

Animation Tool Kit	\$39
Da Vinci Series (Buildings, Interiors, Landscapes)	100

**GRAPHICS**

Da Vinci Commercial Int.	\$149
Da Vinci Building Blocks	49
McPic	35
Microsoft Chart	95
Click Art Series (Graphics, Pub's, Letters, Effects)	125

**LANGUAGES/UTILITIES**

Basic Interpreter (MS)	\$95
MacForth (Level 1)	95
MacForth (Level 2)	135
Smoothtalker	115
Softmaker II	119
Softworks "C"	275
PC to Mac & Back	95
Hippo-C (Level 1)	115

**MANAGEMENT/FINANCE**

Dollars & Sense	\$99
Front Desk	85

**MANAGEMENT/FINANCE (cont.)**

Home Accountant Plus	\$89
MacManager	35
MacProject	Lowest Price
Management Edge	125
Market Analyzer	Lowest Price
Market Manager Plus (Dow Jones)	129
Peachtree G.A.	99
Sales Edge	165
Straight Talk	49
Financial Planning (Apropos)	80
Investment Planning (Apropos)	60
Communications Edge	110
Negotiation Edge	175
Tax Manager (MicroLab)	110
Forecast	45
Electric Checkbook	50
MacCalendar	50

**MANAGEMENT/FINANCE (cont.)**

General Financial Analysis	\$70
Real Estate Dev. (Comm. or Res.)	70
<b>SPREADSHEETS/INTEGRATED</b>	
Jazz	Lowest Price
Multiplan	\$125
Microplanner	Lowest Price
TKI Solver	169
Ensemble	185
<b>WORD PROCESSING</b>	
Microsoft Word	\$149
Think Tank (128k)	85
MacSpell+Right	55
MacSpell +	50
Hayden: Speller	45
Think Tank (512k)	135
TECH (Linguist)	70
Megaform	195

**HARDWARE for Macintosh**

**ASSIMILATION PROCESS**

Mac Daisywheel Connection	\$85
Mac Turbo Touch	85

**CURTIS SURGE PROTECTOR**

Diamond	\$39
Emerald	49
Sapphire	59
Ruby	69

**HAYES**

Smartmodem 300	\$205
Smartmodem 1200	\$445

**INTERMATRIX**

Macphone	\$159
----------	-------

**KENSINGTON**

300 Baud Modem	\$95
Surge Suppressor	39

**MICROCOM**

MacModem	\$450
----------	-------

**MICRON TECHNOLOGY**

Micron Eye	\$325
------------	-------

**MICROSOFT**

MacEnhancer	\$170
-------------	-------

**NOVATION**

Cal	\$375
-----	-------

**OPTIMUM**

MacTote	\$65
---------	------

**PROMETHEUS**

Promodem 1200	\$375
Mac Pak	105

**DISKS**

Maxell 3 1/2" (Box of 10)	\$35
Memorex 3 1/2" (Box of 10)	39
3M 3 1/2" (Box of 10)	39

**GENERAL HARDWARE**

**PRINTERS\***

<b>DIABLO</b>	
36**	\$1229
D25**	619
630-API	1699
630-ECS**	1799
<b>EPSON</b>	
LO1500	\$1199
Parallel Interface	79
JX-80	599
LX-80**	265
RX-100	399
FX-80**	379
FX-100**	599
<b>C. ITDH</b>	
Prowriter 8510 BPI	\$375
Starwriter A10P	529
Starwriter F10-40P	969
Printmaster F10-55P	1249
<b>JUKI</b>	
6100	\$439
6300	799
<b>MANNESMANN TALLY</b>	
Sprint	\$279
160	579
180	849
<b>NEC</b>	
2030**	\$719
2050**	695
3530	1329
3550	1395
8850**	1949
Pinwriter P2**	675
Pinwriter P3**	895
<b>OKIDATA</b>	
182-IBM	\$239
84-IBM	799
192-IBM	409
93-IBM	639
2410P	2295
<b>QUADRAM</b>	
Quadjet	\$789
<b>QUME</b>	
Sprint 11/40**	\$1290
Sprint 11/55**	1595
Sprint 11/90**	2199
<b>SILVER REED</b>	
400	\$279
500	349
550	449
770	795

**PRINTERS\* (cont.)**

<b>TOSHIBA</b>	
P351	\$1375
P351 Tractor	165
1340	779
<b>CITIZEN</b>	
MSP10	\$409
MSP15	619
MSP20	579
MSP25	789
<b>PRINTER/PLOTTERS*</b>	
<b>HOUSTON INSTRUMENT</b>	
PC Plotter	\$475
<b>MONITORS*</b>	
<b>AMDEK</b>	
Color 300	\$255
Color 500	389
Color 600	479
Color 710	579
12" Green 300G	135
12" Amber 300A	145
12" Amber 310A	199
<b>NEC</b>	
JB 1201	\$159
JB 1205	149
JC 1215	239
JC 1216	399
<b>PRINCETON GRAPHICS</b>	
RGB HX-12	\$489
RGB SR-12	599
Scan Doubler Board (for SR-12)	185
Amber Max 12E	185
<b>QUADRAM</b>	
Quadchrome 12"	\$465
Quadscreen 17"	1595
Quadchrome II 14"	465
Amberchrome 12"	165
<b>TAXAN</b>	
100G	\$125
105A	135
121	149
122	149
210	259
420	409
440	699
<b>VIDEO TERMINALS*</b>	
<b>ADDS</b>	
A-2 Green	\$465
A-3	\$465

**VIDEO TERMINALS\* (cont.)**

<b>ALTOS</b>	
Smart II	\$695
<b>QUME</b>	
QVT 102-Green	\$395
QVT 102-Amber	415
QVT 103-Green	810
QVT 103-Amber	845
QVT 108-Green	445
QVT 108-Amber	515
<b>TELEVIDEO</b>	
800	\$1220
800A	975
910	420
910 +	565
921	445
922	750
924	635
925	695
925E	595
<b>WYSE</b>	
50	\$485
75	560
<b>ZENITH</b>	
Z-22	\$465
Z-29	595
Z-49	Lowest Price
<b>MULTI-FUNCTION BOARDS</b>	
<b>AST RESEARCH</b>	
Six Pak Plus (64k)	\$259
<b>IDEA</b>	
IDEAmax 384 (64k)	\$259
<b>DRCHD</b>	
Blossom (0-k)	\$235
<b>STB</b>	
Super Rio (64k)	\$329
<b>COMMUNICATIONS BOARDS</b>	
<b>AST</b>	
AST-SNA	\$699
AST-BSC	699
<b>GRAPHICS BOARDS</b>	
<b>AST</b>	
Monograph plus	\$425
<b>MA SYSTEMS</b>	
Peacock Color Board	\$245
<b>PERSYST</b>	
Monochrome Card	\$199
<b>QUADRAM</b>	
Quadcolor I	\$195
Quadcolor II	465

**MODEMS (External)**

<b>PROMETHEUS</b>	
Pro-modem 1200	\$375
<b>QUADRAM</b>	
Quadmodem 1100	\$555
<b>HAYES</b>	
Smartmodem 300	\$205
Smartmodem 1200	445
Smartmodem 2400	719
<b>NOVATION</b>	
Access 1-2-3	\$475
Professional 2400	635
<b>PRENTICE</b>	
Popcom X100	\$379
Popcom C100	355
<b>RACAL-VADIC</b>	
Maxwell 1200 V	\$439
2400 PC	635
<b>VEN-TEL</b>	
PC Modem 1200	\$399
1200 Plus	399
<b>BACK-UP DEVICES</b>	
<b>ALLOY</b>	
PC Quick Tape	\$1719
<b>SYSGEN</b>	
Image	\$835
<b>MOUSE INPUT DEVICES</b>	
<b>MOUSE SYSTEMS</b>	
PC Mouse w/paint brush	\$139
<b>MICROSOFT</b>	
Microsoft Mouse (Serial)	149
Microsoft Mouse (Bus)	139
<b>SURGE PROTECTORS</b>	
<b>KENSINGTON MICROWARE</b>	
Masterpiece	\$115
<b>CURTIS</b>	
Diamond	\$39
Emerald	49
Sapphire	59
Ruby	69
<b>MEMORY CHIPS</b>	
(200ns) 64k	\$35
(150ns) 256k	69
<b>DISKETTES</b>	
<b>LOGICTRAK 5 1/4" 100% Guaranteed,</b>	
Double side, double density	
10 per box	
20 + boxes	per disk \$2.35
10-19 boxes	per disk \$2.50
2-9 boxes	per disk \$2.99
1 box	per disk \$3.99

\* Due to weight restrictions, Printers and Monitors are shipped UPS...FREE! \*\* Parallel interface req...Ask sales agent

\* NO SURCHARGE for VISA or MasterCard \* No Sales Tax on Orders Outside N.Y. State \* Purchase Orders Welcomed from Qualified Institutions...NO SURCHARGE! (Please call for price verification) \* Please add 2% for handling and insurance (Int'l orders add'l) \* Payment: MasterCard, VISA, American Exp., C.O.D., Money Order or Check



National Sales Hot Line

**1-800-645-3491**

Customer Service 1-800-431-9037

New York State...516-249-8440

Canada....416-283-2354

Domestic/International Telex...286905 Soft UR

**LOGICSOFT**

THE LOGICAL CHOICE

A Member of The Logic Group

110 Bi-County Blvd., Farmingdale, N.Y. 11735



TEAR AND COMPARE! TEAR AND COMPARE! TEAR AND COMPARE!



## BYTE'S BUGS

### Conversion Algorithm Bug

Mark Werley, a BYTE reader from Yuma, Arizona, reported a bug in David L. Kahn's article "A Unit-Conversion Algorithm." (See page 151 of the March BYTE.)

Line 310 in listing 1 (page 154) should read as follows:

```
310 IF MID$(I$,X,1) = " " OR X >= LEN(I$)
    THEN 320 ELSE X = X + 1:GOTO 310
```

Mr. Werley also modified the program so that it will run on his Commodore computer, which has neither an ELSE nor an ELSE IF command. He recommends inserting

```
310 IF MID$(I$,X,1) = " " OR X >= LEN(I$)
    THEN 320
315 X = X + 1:GOTO 310
```

Mr. Kahn tells us that other readers have pointed out one more error. In line 7250 (page 156), the DATA has an incorrect value statement. As it appears now, the

program will produce inaccurate answers in any conversion involving the term ACRE. The correct value is 2.4710536E-4.

Our thanks to Jack Heddon and Ray Isenson for taking the time out to report this bug.

The PRINT CHR\$(12) in lines 10, 130, and 4000 requires some clarification, according to Mr. Kahn. In most versions of BASIC a CLS statement would have been preferable to the PRINT CHR\$(12), but Mr. Kahn's BASIC compiler does not support the CLS statement. With both his compiler and his interpreter, the PRINT CHR\$(12) worked just fine.

Also note that line 130 is unnecessary in the MS-DOS version of the program. In addition, the TRS-80 version prints some material between lines 10 and 130 that is not needed with MS-DOS. The line was left in to minimize the differences between the two versions.

### "In Brief" Error

In the "In Brief" column that accompanied Laine Stump's article "The Kit Solution," we supplied some erroneous information. (See page 196 of the March BYTE.)

The Slicer comes with a CP/M-86 BIOS. The operating system itself is \$85. Concurrent CP/M, as of press time, is unavailable and unpriced.

### AI Book Available

A number of readers have reported that Focal Press of Stoneham, Massachusetts, no longer carries Mike James's *Artificial Intelligence in BASIC*, which was recently reviewed by Norman J. Chaplin. (See April, page 68.)

This book can be ordered from Newnes Books, 84-88 The Centre, Feltham, Middlesex TW13 4BH, England.

Our thanks to Norman J. Chaplin for tracking down a distributor for this book.

## FEEDBACK

### Alternative Approaches to Structured BASIC Programming

Jack M. Fischer, network manager for the Tulsa Computer Consortium, recently wrote us lauding Arthur Huston for the "excellent case [he makes] for writing structured BASIC programs." (See "Structuring BASIC," June, page 243.)

Mr. Fischer notes that Mr. Huston's approach to structured BASIC programming relies heavily upon adherence to rules for

line numbering and for the naming of variables and subroutines.

Programmers at the Consortium, reports Mr. Fischer, have developed a number of tools and techniques that eliminate the need for strict rules. One such technique, FLOAT, lets you float BASIC subroutines between programs and libraries by providing you with an insert capability to

eliminate the need for line numbering. Another tool compensates for the lack of local and global variables.

If you want to learn about the Consortium's approach to structured BASIC programming, write to the Tulsa Computer Consortium—Structured BASIC, POB 707, Owasso, OK 74055. Please enclose return postage.

## UPDATES

### Systems Transfer Documents Between Word Processors

Flagstaff Disk Conversion Equipment distributes systems that transfer document files between most word-processing equipment and the IBM PC, PC XT, and PC AT. Word processors supported include CP/M systems, Displaywriter, OS/6, Wang, Xerox, and IBM S/32, S/34, and S/38.

The Diskette Connection lets you read and write most 8-, 5¼-, and 3½-inch disks. It comes with a PC controller card, an 8-inch floppy-disk drive, and a cable.

The Word Connection, used in conjunction with the Diskette Connection, lets you transfer disk-based document files between word processors. Word Connection programs use IBM-standard Document Content Architecture (DCA-RFT) to transfer document files and such parameters as page size, tabs, headers, margins, and typesetting control characters. The conversion is said to take place at 40 pages per minute. Transferred documents can be

sent directly to a mainframe via IBM's PROFS and DISOSS electronic mail.

Flagstaff Disk Conversion Equipment is a distributor for Flagstaff Engineering Inc., which produces the Diskette Connection and the Word Connection. The Diskette Connection is \$1099, and the Word Connection is \$695. Contact Flagstaff Disk Conversion Equipment at 1805 North Beaver, Flagstaff, AZ 86001, (800) 821-7493, ext. 236; in Arizona, (602) 774-5422. ■



# Introducing The B



## ADVANCED TECHNOLOGY COMPUTER BT/AT

44 Mb Hard Disk Drive.  
640K Internal RAM.  
8 I/O Expansion Slots.  
1.2 Mb Floppy Disk Drive.  
2 Asynch Serial  
Communication Ports.  
2 Parallel Printer Ports.

Monochrome Graphics  
Adapter (720 x 348).  
Monochrome Monitor (Green).  
Tilt/Swivel Monitor Base.  
IBM PC AT Hardware and  
Software Compatibility.  
GW-BASIC and MS-DOS 3.1.



## HIGH RESOLUTION COLOR MONITORS HR31 200 HR31 350 (Enhanced)

.31mm Dot Pitch.  
14" Diagonal Screen.  
Black Matrix Picture Tube  
Plugs Into IBM Color/Graphics or  
Compatible Adapter Card.  
Resolution (640 x 200).  
Enhanced (640 x 350).  
Tilt/Swivel Base.

## HIGH RESOLUTION MONOCHROME MONITORS HR 39 (Green) HR 134 (Amber)

Plugs Into The IBM Monochrome  
or Compatible Adapter.  
720 x 350 Resolution.  
12" Diagonal Screen.  
Super Crisp Text Capability.  
High Resolution TTL.  
Tilt/Swivel Base.



## PC KEYBOARD BT5151 AT KEYBOARD BT5161

Solid State Capacitive  
Key Switches.  
3-Position Height Adjustment.  
Keys In Standard Type-  
writer Positions.  
Separate Cursor Control  
and Numeric Keypads.  
Easy-To-Read Key Legends  
LED Indicators For All Lock Keys.

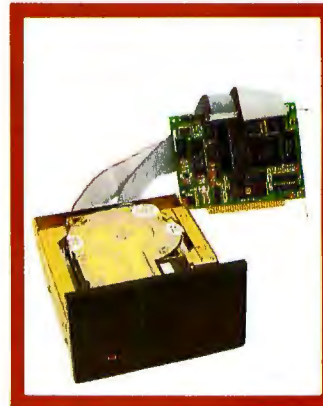

## PC HARD DISK SUBSYSTEMS BT20 (Internal) BT20E (External)

20 Megabyte Capacity.  
Boot From The Hard Disk--No  
Software Patches or Drivers.  
Runs All The Popular Software  
Designed For The XT.  
High Reliability and Durability--  
Specially Plated Drives.  
Includes 1dir "Visual Shell" and  
Xydex Software, Bezels.

## BACKUP POWER SOURCE AT800 XT300 SB200

Battery Powered Up To  
30 Minutes.  
Surge Suppression/  
Noise Filtering.  
Brownout Protection.  
800, 300, 200 Watt Models.



## MONOCHROME CARD HR720 COLOR CARD HR640

Complete IBM Compatibility.  
High Resolution Graphics  
Capabilities.

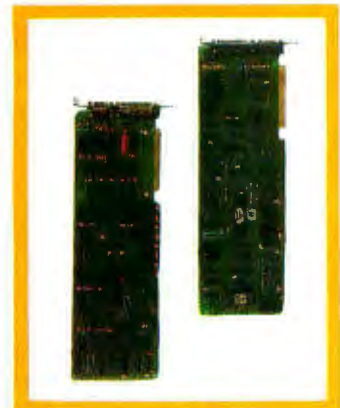



# T/Integrator Series



## PC MULTIFUNCTION CARD BT6Plus

Add 64K To 384K.  
Parallel Printer Port.  
Serial Communications Port.  
Clock/Calendar.  
BTPak Software--BTDrive  
(Electronic Disk Emulation) and  
BTSpool (Print Spooling)  
Optional Game Port



## AT MULTIFUNCTION CARD AT4X4Plus

Add 128K To 4 Mb.  
Double Split Memory Addressing.  
1 To 4 Serial Ports.  
Parallel Printer Port.  
Optional Game Port.

## EXTERNAL MODEM BT212A/1200E

Auto-dial, Auto-Answer.  
300/1200 Baud Operation.  
Runs All Hayes Compatible Soft-  
ware Like Crosstalk, Relay,  
Smartcom II, and Sidekick.  
RS-232C Compatible.  
Snap Hatch For Switch Access.  
Eight Status Indicator Lamps.  
External Volume Control Knob.



## INTERNAL MODEM PC212A/1200

Auto-dial, Auto-Answer.  
300/1200 Baud Operation.  
Runs All Hayes Compatible Soft-  
ware Like Crosstalk, Relay,  
Smartcom II, and Sidekick.  
Two Phone Jacks.  
Includes PC-TALK III Software,  
Modular Phone Cord.



## SPOOLING TAPE BACKUP BT/SP10E

10 Megabyte Capacity Reels.  
Backs Up 20 Megs In 30 Min.  
File By File Recovery.  
Uses Standard 1/4" Tape Reels.



## CARTRIDGE TAPE BACKUP BT60Streamr

60 Megabyte Capacity.  
Backs Up 20 Megs In 12 Min.  
Image Backup Capability.  
File By File Recovery.  
Uses 1/4" Data Cartridge.

## AT ENHANCEMENT KIT-1 BT44 (44 Megabyte) BT70 (70 Megabyte)

Combined With The  
AT4X4Plus-512K.  
No Other Chips Needed.  
Runs All The Popular Software  
Designed For The AT.  
High Reliability and Durability.  
Faster Access Time  
Than AT--30 msec.

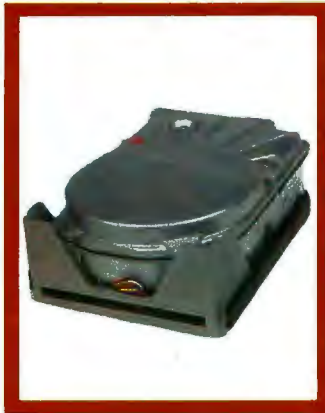

Peripherals designed to enhance systems and sales. Basic Time products are the latest technology and highest quality available today, at prices that will make you competitive. We only sell to VARs, VADs and integrators--end users, contact your dealer for more information.

3350 Scott Blvd., Bldg. 52  
Santa Clara, California 95054

Inside California  
(800) 841-2474

Outside California  
(800) 323-8437

# basic time



# We've Earned The Right To Be #1

## By Being First So Often

When it comes to being **FIRST** with technology-leading products **Advanced Digital** wears its #1 button with pride. We were **FIRST** to introduce an 8-Bit, single board S-100 computer... We were **FIRST** to introduce a 6MHz, 128KByte single board computer... We were **FIRST** to introduce a 6MHz, 128KByte Slave Processor board. Our record of **FIRSTS** continues with...

- The introduction of **MULTI SLAVE** – a 3 USER, 8MHz SLAVE card for the S-100 Bus systems running Turbo-Dos™ or NETWORK/O/S.™
- The introduction of **HDC-2001**, the all new hard disk controller for the S-100 BUS.
- The introduction of **SUPER 16**, a 16-Bit, S-100 Slave card for use with Turbo-Dos or NETWORK O/S.
- The introduction of our new **SUPER 186** – the **FIRST** 16-Bit, single board S-100 computer that performs at twice the speed of older technologies. Loaded with features such as on-board floppy disk controller and up to 1MByte of RAM, the SUPER 186 is designed to function as a bus Slave or Master. Advanced Digital's SUPER 186 permits you to take advantage of vast libraries of sophisticated applications software.

Again, we were #1 with...

- The introduction of **PC-SLAVE**, an IBM PC Multiuser card with 8088 (8MHz) CPU and 256-768K RAM on board.



When it comes to selecting your S-100 boards, go with **Advanced Digital** – the recognized industry leader.

See your local computer dealer or contact **Advanced Digital** today for more information on the new **PC-SLAVE**, and the complete line of S-100 single board computers and multiuser systems.

**ADVANCED  
DIGITAL  
CORPORATION**

Leading  
the Microcomputer  
Technology

**Advanced Digital** • 5432 Production Drive, Huntington Beach, CA 92649 • Tel. (714) 891-4004 • Telex 183210 **ADVANCED HTBH**  
**Advanced Digital U.K. Ltd.** • 27 Princes St., Hanover Square • London W1R8NQ • United Kingdom • (01) 409-0077 • (01) 409-3351 • Telex 265840 **FINEST**



SEE  
US AT  
LAS VEGAS  
COMDEX  
'85

**1**  
ADVANCED  
DIGITAL  
CORPORATION

FIRST  
PLACE

• Network O/S is a trademark of CBIS  
 • CP/M is a trademark of Digital Research  
 • TurboDOS is a trademark of Software 2000



## FIRST LOOK

### Application Environment for Apple IIe

The SwyftCard from Information Appliance Inc. is a text-oriented data-handling product based in ROM that comes as an add-in card for the Apple IIe. The brainchild of Jef Raskin, former head of the Apple Macintosh development team, the card offers word-processing, information-retrieval, program-development, calculation, and telecommunications capabilities in an integrated package.

The SwyftCard environment is designed for speed. Because the program resides in firmware, there is no need to access a disk for program information. All data manipulation occurs in memory, roughly 40K bytes on a 64K-byte Apple IIe. The SwyftCard uses a disk format that equates one disk to that 40K-byte figure; this wastes some disk capacity, but the only times the program really has to use the disk drive are at the beginning of a work session (retrieving data) and at the end (saving it).

The program is available directly from the card's firmware when you turn on the computer. Since the SwyftCard serves as its own operating system, you need a single disk only to store data. Thus you can use the card with a minimal hardware setup: an 80-column 64K-byte Apple IIe, a monochrome monitor, and one disk drive. The SwyftCard does not interfere with other

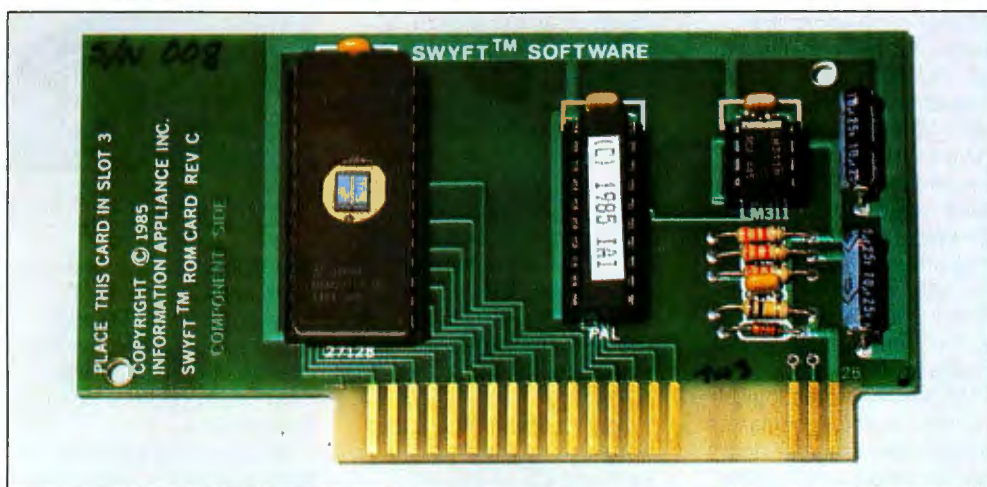

The SwyftCard add-in for Apple IIe computers.

Apple software; if you place a program disk in the drive, one keystroke removes the SwyftCard system and loads the new program.

The environment is essentially a continuous scroll of text divided only by page breaks. You enter data as with any word processor, and the SwyftCard provides all standard word-processing functions. There are no files as such; if you wish to print a section of the scroll, you mark the top and bottom of the region and send the block to the printer. Formatting for printing is automatic, although you can change parameters when you want. Rapid movement through the text scroll is provided by a search algorithm that takes advantage of a peculiarity of the Apple IIe keyboard—two keys with apple symbols on either side of the space bar. Depressing one of those keys initiates a search for the next letter or combination of letters entered; you can abort the search by typing a

short string of gibberish. The right key searches forward; the left one moves backward.

The SwyftCard interfaces smoothly to the IIe's AppleSoft BASIC interpreter. You enter programs as raw text. You highlight the program text as you would for any word-processing block operation, press one command key, and the program executes. BASIC can also be used as a shortcut for some text manipulations. For example, you can store boilerplate phrases or paragraphs as string variables. Typing the variable name, marking it, and executing it recalls the stored text; retyping or complex copying operations are replaced by a few keystrokes. You follow similar mark-and-execute procedures for calculating numeric expressions in text and for setting printer and tele-

communications parameters.

You do the same to dial the modem. Once you are connected, the text of your on-line session is incorporated into the scroll. If the modem is set to auto-answer, the SwyftCard will act as a rudimentary bulletin board—it will accept an incoming text stream. If you are at the keyboard, the card stores the message without interrupting your work.

Priced at \$89.95, the SwyftCard package contains the card itself, self-adhesive labels for the nine command keys, a manual, a schematic diagram and theory of operation, a tutorial disk, and a utility to convert SwyftCard files to Apple ProDOS format.

Contact Information Appliance Inc., 530 University Ave., Palo Alto, CA 94301, (415) 328-5160.

—Ezra Shapiro

Inquiry 600.

(continued)



## Spreadsheet Bridges 1-2-3, dBASE

**V**P-Planner from Paperback Software is an integrated spreadsheet/database manager for the IBM PC and compatible computers. Its basic command set, macro capability, and data structure are compatible with Lotus 1-2-3; VP-Planner can process files prepared with 1-2-3 and make use of spreadsheet templates developed for that program. VP-Planner can also import or export data as dBASE II or dBASE III files without any special conversion.

VP-Planner stores logical operations and formulas as spreadsheet macros—data can be saved by choosing the most efficient format. The program uses sparse matrix technology to optimize memory use (empty cells or data fields are essentially ignored; only active cells require full space in memory).

VP-Planner can organize data and logic from either database or spreadsheet files (or a combination) into what is called a multidimensional database. Up to five dimensions are supported. The spreadsheet acts as a window into two dimensions of the five. Thus, VP-Planner can perform complex sorts based on multiple criteria and can construct fully relational database joins.

The primary user interface is that of a spreadsheet. However, the grid can be used for entering, viewing, and editing database information (either multidimensional or dBASE) in a table format.

Written in FORTH, VP-Planner also features automatic recognition and use of 8087 and 80287 math coprocessors, a "learn" func-

tion that records keystrokes into macros, background printing of worksheets, zero-width columns, and password protection of databases.

Suggested retail price for VP-Planner will be \$99.95, which does not include a graphics print program. No price has been announced for VP-Graphics, a companion product that will answer that need. According to the company, VP-Planner will be available in late September; release of VP-Graphics will follow shortly thereafter. [Editor's note: This item was based on prerelease software and preliminary documentation. Final product specifications are subject to change.]

Contact Paperback Software, 2612 Eighth St., Berkeley, CA 94710, (415) 644-2116. Inquiry **601**.

## Corvus Cheetah Uses 68010

**C**orvus Systems' Cheetah workstation uses a 10-MHz Motorola 68010 processor and includes a 15-inch monitor with a resolution of 800 by 620 pixels and a 1-to-1 aspect ratio. Designed for computer-aided design, engineering, and electronic publishing applications, the Cheetah also features a 20-megabyte hard-disk drive, one 640K-byte floppy-disk drive, 1 megabyte of RAM, four RS-232C ports, one RS-422 port, and an Omninet local-area network port.

Standard software includes the UNIX System V operating system, a C compiler, a window display manager,

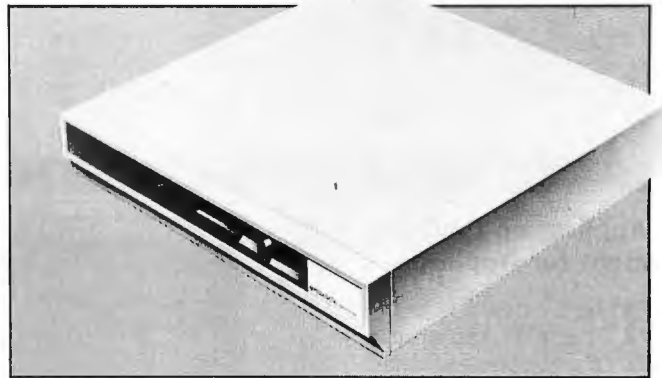

Megadata's Model Seven UNIX system.

and Corvus Connection network software. Up to 4 megabytes of RAM, additional mass-storage devices, and an optional floating-point math coprocessor can be added.

With the 20-megabyte hard disk and 1 megabyte of RAM, the Cheetah is priced at \$9995. For additional information, contact Corvus Systems Inc., 2100 Corvus Dr., San Jose, CA 95124, (408) 559-7000. Inquiry **602**.

## 8300 Model Seven UNIX Processor

**M**egadata's 8300 Model Seven uses the 68000 16-/32-bit microprocessor. The basic system features UNIX System V, 1 megabyte of RAM, a 26-megabyte Winchester disk, a 1-megabyte floppy-disk drive, and two RS-232C ports. This desktop computer is transportable.

An expansion board provides eight RS-232C ports and an additional 512K bytes or 1 megabyte of RAM for a maximum of 2 megabytes of system memory and eight users. Other options include increased disk capacity and streaming-tape backup.

The Model Seven sells for \$4399. The expansion board

adds from \$650 to \$990 to the basic system price, depending on amount of memory. Contact Megadata Corp., 35 Orville Dr., Bohemia, NY 11716, (516) 589-6800. Inquiry **603**.

## HP Disks

**H**ewlett-Packard has introduced 10- and 20-megabyte hard-disk subsystems and a ¼-inch streaming-tape backup designed for IBM microcomputers and close compatibles as well as HP's own personal computers.

The HP 9154A 10-megabyte hard-disk drive stands 4½ inches high, runs 3½-inch platters, and has an average access time of 75 milliseconds. In addition, the drive has been modified to withstand shock and vibration, head and bearing assemblies have been redesigned, and the platter has been coated with a layer of sputtered carbon for added surface protection and lubrication. The HP 9134H 20-megabyte hard-disk drive stands 5½ inches high, runs 5¼-inch platters, and has an average access time of 85 milliseconds.

(continued)



# Borland's SideKick™ Will Clear Your Desk In 30 Minutes And Increase Your Productivity By 50%

SideKick is a combination of seven desktop accessories, which makes SideKick the single most effective business tool. Just a keystroke suspends your application program, giving you a window into SideKick. Another keystroke brings you back to where you were. Instantly. It's that easy.

**A FULL-SCREEN WORDSTAR™-LIKE EDITOR**

You may jot down notes and edit files up to 25 pages long.

**AN ASCII TABLE** for easy reference.

**AN AUTODIALER** for all your phone calls. It will look up and dial telephone numbers for you. (A modem is required to use this function.)

**A PHONE DIRECTORY** for your names, addresses and telephone numbers. Finding a name or a number becomes a snap.

**A MONTHLY CALENDAR** functional from year 1901 through year 2099.

**A DATEBOOK** to remind you of important meetings and appointments.

**A FULL-FEATURED CALCULATOR** ideal for business use. It also performs decimal to hexadecimal to binary conversions.

COPY-PROTECTED **\$54.95**

NOT COPY-PROTECTED **\$84.95**

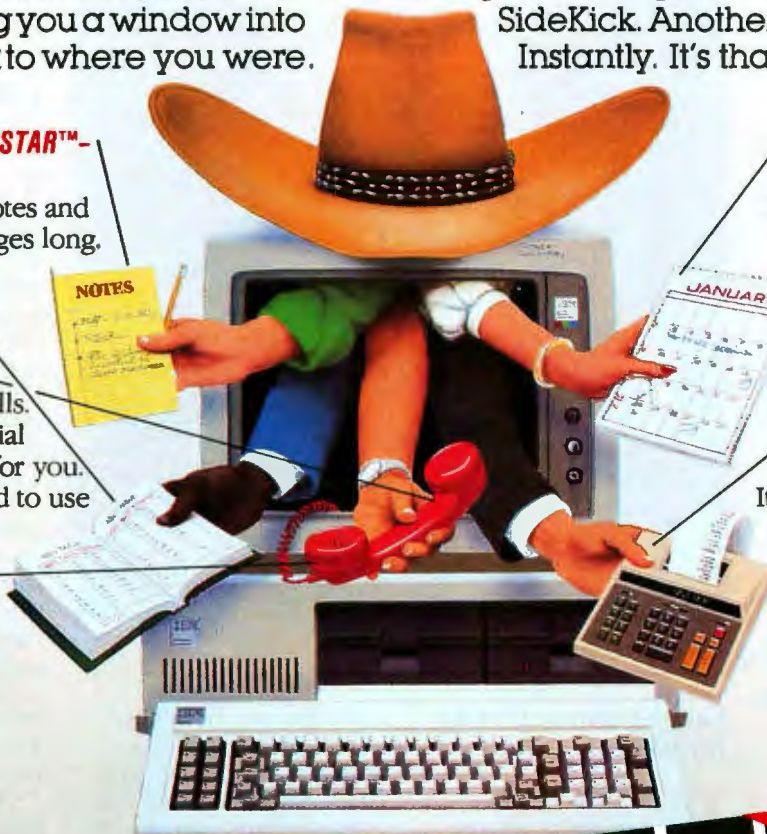

**THE CRITICS' CHOICE**

"SIDEKICK deserves a place in every PC." **Garry Ray, PC WEEK**  
 "If you use a PC, get SIDEKICK. You'll soon become dependent on it." **Jerry Pournelle, BYTE**  
 "SIDEKICK is by far the best we've seen. It is also the least expensive." **Ron Mansfield, ENTREPRENEUR**  
 "In a simple, beautiful implementation of WordStar's™ block copy commands, SIDEKICK can transport all or any part of the display screen (even an area overlaid by the notepad display) to the notepad." **Charles Patzold, PC MAGAZINE**



4585 Scotts Valley Drive, Scotts Valley CA 95066  
 Phone (408) 438-8400 Telex 172373

Copyright 1985 Borland International BI-1008A  
 SideKick is a trademark of Borland International, Inc.  
 IBM and PC-DOS are registered trademarks of International Business Machines Corp.  
 Infoworld is a trademark of Popular Computing, Inc. a subsidiary of CW Communications, Inc.  
 WordStar is a registered trademark of Micropro International Corp.

Inquiry 37 for End-Users. Inquiry 38 for DEALERS ONLY.

## SIDEKICK

**NOT COPY-PROTECTED**

Available at better dealers nationwide. Call (800) 556-2283 for the dealer nearest you. To order by Credit Card call (800) 255-8008, CA (800) 742-1133

Yes, I want the Best.  
 Please send me SideKick!

Copy-Protected **\$54.95**  
 (CA res. add \$3.30 tax per copy)  
 Quantity: \_\_\_\_\_ at \$54.95

Not Copy-Protected **\$84.95**  
 (CA res. add \$5.10 tax per copy)  
 Quantity: \_\_\_\_\_ at \$84.95



Software for your IBM®PC, XT, AT, jr. and true compatibles.

PCjr requires not copy-protected version

These prices include shipping to all US cities. All foreign orders add \$10 per product ordered.

Amount: (CA 6% tax) \_\_\_\_\_  
 Payment: VISA MC BankDraft Check  
 Credit Card Expir. Date: \_\_\_\_\_ / \_\_\_\_\_  
 Card #: \_\_\_\_\_  
 Name: \_\_\_\_\_  
 Shipping Address: \_\_\_\_\_  
 City: \_\_\_\_\_  
 State: \_\_\_\_\_ Zip: \_\_\_\_\_  
 Telephone: \_\_\_\_\_

COD's and Purchase Orders WILL NOT be accepted by Borland. California residents: add 6% sales tax. Outside USA: add \$10 and make payment by bank draft, payable in US dollars drawn on a US bank.



The HP 9142A ¼-inch streaming-tape backup uses standard 15- and 60-megabyte cartridges, storing 2 megabytes of data per minute. The 15-megabyte cartridge has an average access time of 15 seconds; the 60-megabyte cartridge averages 45 seconds.

The PC/T format (Personal Computer/Tape, a registered trademark of Tallgrass Technologies Corporation) that HP has chosen is compatible with PC-DOS 2.0, 2.1, and 3.0, and MS-DOS 2.11. This lets you address files on tape with DOS commands. It also means that the backup unit can emulate a hard disk. In fact, you can boot DOS from the tape. Other PC/T features include selective backup and restore, off-line tape formatting, a media monitor that counts the number of times the tape is used, and the ability to partition a cartridge into one, two, or four volumes, each accessible by its own directory.

The drives can be hooked up to IBM personal computers and close compatibles via the HP 88500A interface kit. The kit includes a short-slot card, cables, and disk-utility software that can support up to seven hard disks and one tape backup.

The HP 9154A 10-megabyte drive is priced at \$1690, the 9134H 20-megabyte drive is \$2390, and the 9142A cartridge-tape backup is \$1690. The 88500A interface kit is \$199. Contact Inquiries Manager, Hewlett-Packard Co., 1820 Embarcadero Rd., Palo Alto, CA 94303 or your local Hewlett-Packard dealer.  
Inquiry 604.

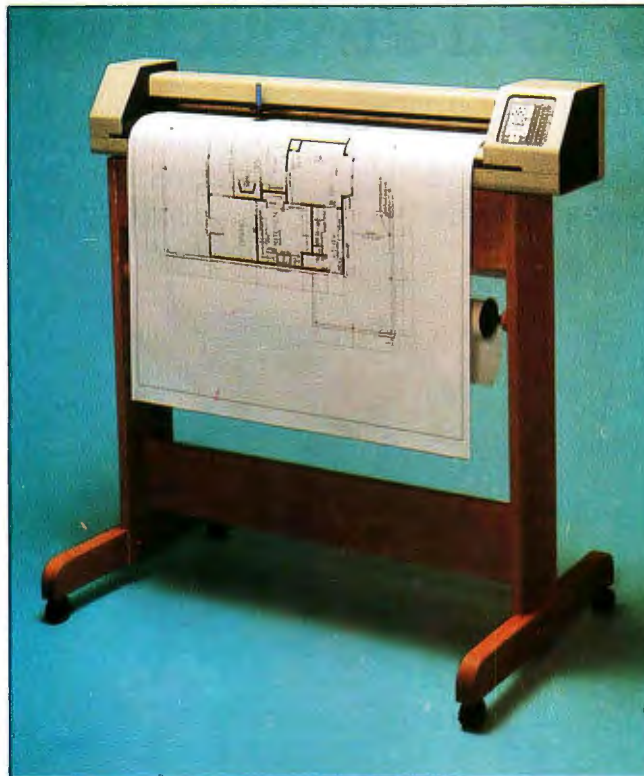

The LP3700 large-format plotter.

### Large-Format Plotter for Micros

IOLine Corporation's LP3700 Plotter, a large-format \$4995 plotter, has twin RS-232C ports that let you use it in most micro-computer-based CAD/CAE environments. It can draw on any size media, continuously adjustable to full-size "E" (i.e., 36- by 48-inch) drawings.

Axial plotting is performed at 10 inches per second; diagonal plotting speed is 14 inches per second (maximum). Addressable resolution is 0.001 inch, 0.0025 inch, 0.1 mm, and 0.005 inch; mechanical resolution is 0.0025 inch. Repeatability is 0.0025 inch, or, with a pen change, 0.010 inch. The LP3700's buffer can accommodate 14,000 bytes (i.e., approximately 1500 vectors).

Operator controls include eight pen-move directions,

selectable pen-move rates, chart-hold actuation, pen speed, chart size, and plot limits. Among the keyboard indicators are diagnostic test codes, plot out of limits, command error, and view-ing/pause.

The LP3700's ASCII character set is resident within the plotter. Its parameters are 8 bits, no parity, and 2 stop bits at 300 to 9600 bps. Since the LP3700 emulates Houston Instrument's DMPL, it can be used with a wide variety of available software. It can use both cut-sheet and roll-stock paper, vellum, matte polyester, mylar, or acetate film. The LP3700 can use such pens as Hewlett-Packard-compatible liquid inks, disposable fiber-tip pens, or roller balls. You can obtain custom pen adapters.

Oak and metal plotter stands are available. Contact IOLine Corp., Suite DI, 19417 36th Ave. W, Lynnwood, WA 98036. (206) 775-7861.  
Inquiry 605.

### LISP Interpreter and Compiler

Levien Instrument Company has introduced a LISP interpreter, BYSO LISP 1.17, and a LISP compiler, BYSO LISP 2.17. The interpreter uses lexical binding, and the compiler supports both lexical and dynamic binding. All the features of version 1.17 are supported by 2.17.

BYSO LISP 1.17 features a full-screen editor, a structure editor that displays programs in graphics format, and six prettyprinting styles. Among its file- and library-management capabilities are open, close, define and save a library, read and write random-access files, read and write sequential characters, atoms, lists, and strings.

Data types include integers, multidimensional arrays, structures, and oblist. Such list-manipulation conventions as car, append, map functions, intersect, and remove are standard. Some of the control structures are cond, if, or, prog, return, let\*, and apply.

BYSO LISP is compatible with LISP 1.5, MacLISP, and Common LISP. It's designed for the IBM PC and true work-alikes equipped with 256K bytes of memory.

BYSO LISP 1.17 is \$150. Version 2.17 is \$395. An upgrade for 1.17 is offered. Shipping and handling is \$5 within the U.S. and \$15 overseas. Contact Levien Instrument Co., Sittlington Hill, Box 31, McDowell, VA 24458.

Inquiry 606.

(continued)



ATTENTION SIDEKICK™ USERS: SUPERKEY IS  
SIDEKICK'S BEST COMPANION. GET SUPERKEY TODAY!

# Borland's SuperKey™ lets one powerful keystroke do the work of hundreds and helps keep your confidential files . . . confidential!

**SUPERKEY TURNS 1,000 INTO 1!** Yes, SuperKey can record lengthy keystroke sequences and play them back at the touch of a single key. Instantly. Like Magic. Say, for example, you want to add a column of figures in 1-2-3. Without SuperKey you'd have to type seven keystrokes just to get started. ["shift-@-s-u-m-shift-(")]. With SuperKey you can turn those 7 keystrokes into 1.

**SUPERKEY HELPS PROTECT YOUR CAPITAL INVESTMENT.** SuperKey, at your convenience, will make your screen go blank after a predetermined time of screen/keyboard inactivity. You've paid hard-earned money for your PC. SuperKey will protect your monitor's precious phosphor . . . and your investment. This feature alone justifies your SuperKey purchase!



**SUPERKEY KEEPS YOUR 'CONFIDENTIAL' FILES . . . CONFIDENTIAL!** Time after time you've experienced it: anyone can walk up to your PC, and read your confidential files (tax returns, business plans, customer lists, personal letters . . .). With SuperKey you can encrypt any file, even while running another program. As long as you keep the password secret, only YOU can decode your file. SuperKey implements the U.S. government Data Encryption Standard (DES).

**SUPERKEY PROTECTS YOUR WORK FROM INTRUDERS WHILE YOU TAKE A BREAK.** Now you can lock your keyboard at any time. Prevent anyone from changing hours of work. Type in your secret password and everything comes back to life . . . just as you left it.

### THE CRITICS' CHOICE

*"It's unquestionably the best new program I've seen since Borland's SideKick."*

*Stephen Manes, PC Magazine*

*"The encryption features were extremely easy to use because of some elegant incorporation of pull-down menus and clear prompts . . ."*

*SuperKey is a large amount of functionality in a small amount of code at a low price."*

*Victor Mansfield, PC Tech Journal*



4585 Scotts Valley Drive, Scotts Valley CA 95066  
Phone (408) 438-8400 Telex 172373  
Compuserve - GO BOR

Copyright 1985 Borland International BI-1009B

SuperKey and SideKick are trademarks of Borland International, Inc.  
1-2-3 is a trademark of Lotus Development Corp.  
IBM is a registered trademark of International Business Machines Corp.

Inquiry 39 for End-Users. Inquiry 40 for DEALERS ONLY.

**NOT COPY-PROTECTED**

# SuperKey

Get your IBM PC or compatible a SuperKey today.

**\$69<sup>95</sup>**

This price includes shipping to all U.S. Cities ONLY. All Canadian orders add \$10 per item ordered. Outside U.S.A. and Canada: see below.

**60 DAY MONEY-BACK GUARANTEE**

YES! Please rush SuperKey to me. Send me \_\_\_\_\_ copies.

Subtotal: \_\_\_\_\_  
(CA res. add 4.20 tax per copy)

Amount Enclosed: \_\_\_\_\_  
Payment VISA MC BankDraft Check

Credit Card Exp. Date \_\_\_\_\_  
Card # \_\_\_\_\_

Name: \_\_\_\_\_  
Shipping Address: \_\_\_\_\_  
City: \_\_\_\_\_  
State: \_\_\_\_\_ Zip: \_\_\_\_\_  
Telephone: \_\_\_\_\_

CGO's and Purchase Orders, UNLESS PREPAID, WILL NOT be accepted by Borland. California residents: add 6% sales tax. Canadian orders: add \$10 per item and make payment by bank draft, payable in US dollars drawn on a US bank. Outside USA and Canada: due to US restrictions on export of technology, purchase of SuperKey (without DES) can only be made through authorized distributors. Contact distributors in your area to obtain SuperKey.

K15



## Modem Adapts to Phone Quality

**D**igital Communications Associates (DCA) and Telebit recently announced Irma's Fastlink, an intelligent, high-speed, packetized modem that transmits and receives data over ordinary dial-up phone lines at up to 10,000 bps. Telebit of Cupertino, CA, developed the patented technology for high-speed, error-free data communications using the concepts of packet switching, dynamic multicarrier modulation, and digital signal processing. DCA, an Alpharetta, GA, company that produces the Irma line of micro-to-mainframe communications devices, is marketing and distributing the modem; Telebit is manufacturing it.

The modem is available in two versions. As a plug-in board for the IBM PC, XT, AT, and compatibles, it costs \$1995 and comes with Crosstalk-Fast from Microstuf. A stand-alone model is priced at \$2395; Crosstalk-Fast is optional.

Both versions provide asynchronous, dial-up connection; automatic error detection and correction; automatic speed selection at time of connection; 300-bps and 1200-bps full-duplex modes for Bell 103 and 212A compatibility; real-time line analysis and adaptation; Adaptive Duplex for maximized throughput; self-test; call progress monitoring and reporting; auto-dial and auto-answer; and a superset of the Hayes command language.

When a Fastlink modem calls a standard 300- or 1200-bps modem, it adjusts to that speed and behaves as a like device. However, Telebit's Packetized Ensemble Protocol (PEP) allows two Fastlink modems (or other PEP devices) to com-

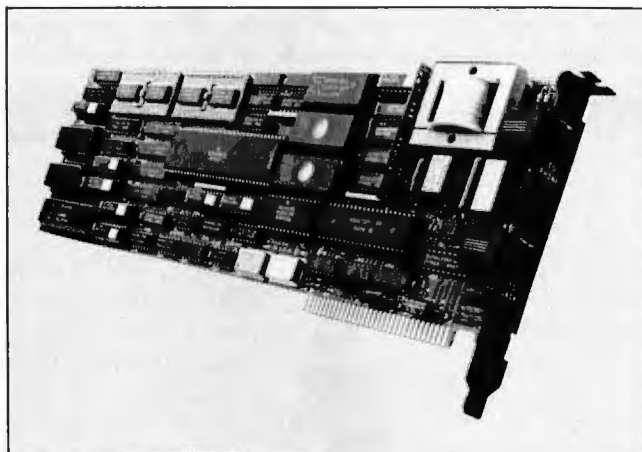

The Fastlink plug-in board for the IBM PC and compatibles.



The stand-alone version of the Fastlink modem.

municate at speeds of 10,000 bps. When one Fastlink calls another, it analyzes phone-line quality to determine the maximum transmission speed.

Fastlink works with a maximum of 512 carriers (every 8 Hz from 8 to 4000 Hz). The phone-line analysis tells which of those carriers is useful at any given time. Three modulation schemes are used to encode data. The lowest density is for low-quality carriers, and the highest density is for carriers with a high signal-to-noise ratio.

All of the hundreds of tones are then generated at the same time, converted

through an inverse fast Fourier transform into a complex waveform, and sent as a packet to the other Fastlink. The packet is accompanied by a 16-bit cyclical redundancy check. If any error is detected, the packet is resent.

After each packet, the Fastlink again analyzes the signal-to-noise ratios on the carriers and reassesses the maximum transmission speed. The previous speed is set back or increased by between 50 and 100 bps.

Fastlink depends on 70,000 lines of code, a 10-MHz 68000, and a Texas Instruments TMS32010 digital signal processor for its processing speed and execution of PEP.

Crosstalk-Fast is a special version of Crosstalk-XVI. Besides high-speed file-transfer capability, it includes terminal-emulation features and access to Fastlink's phone-line analysis characteristics. Telebit has no plans to license PEP.

Contact DCA Inc., 1000 Alderman Dr., Alpharetta, GA 30201, (404) 442-4000. Inquiry **607**.

## Interactive Satellite Dish

**E**quatorial Communications Company is offering the C-200, a small satellite dish designed specifically for personal computers and terminals. The C-200 dish, which measures 4 feet in diameter, can send and receive information at up to 19,200 bps; the dish connects to a personal computer through a standard RS-232C cable.

The C-200 transmits information over the weather-tolerant microwave band C to Equatorial Communications' transponders on the Westar IV and Galaxy III satellites. The information is then sent back to one of Equatorial's 36-foot dish receivers, processed on a mainframe computer, and retransmitted via satellite to another C-200.

The approximate cost for a C-200 setup is \$6000, or about \$225 per month, including charges for Equatorial's network services. The C-200 is designed primarily for large companies that use leased telephone lines. The minimum order is approximately 100 units. Contact Equatorial Communications Co., 300 Ferguson Dr., Mountain View, CA 94043, (415) 969-9500. Inquiry **608**.

(continued on page 431)



# Borland Introduces the Laws of *TURBO DYNAMICS*<sup>TM</sup>

**Laws That Work Like Magic.** Whether considering technological excellence, or innovation in areas such as pricing, not copy-protection, licensing agreements, site licenses, 60 day money-back guarantee — Borland is clearly recognized as the software industry leader. The following three laws of "Turbo Dynamics"<sup>TM</sup> exemplify our pledge for excellence.



**Turbo Dynamics Applies to Turbo Pascal.**  
Borland's Pascal family of products is growing by leaps and bounds. You can now join hundreds of thousands of users and enter the world of Turbo Pascal programming. And remember, all three laws of Turbo Dynamics apply to all Borland products.

## TURBO PASCAL<sup>TM</sup> \$69.95

**The industry standard.** With more than 350,000 users worldwide Turbo Pascal is the industry's de facto standard. Turbo Pascal is praised by more engineers, hobbyists, students and professional programmers than any other development environment in the history of microcomputing. And yet, Turbo Pascal is simple and fun to use. **Free spreadsheet** included on every Turbo disk with ready-to-compile source code. **Options:** We offer the exciting Binary Coded Decimal (BCD) option for your business applications as well as an 8087 option for your number-crunching applications at a very low charge. Please refer to the coupon. **Portability.** Turbo Pascal is available today for most computers running PC-DOS, MS-DOS, CP/M-80 or CP/M-86. **Jeff Duntmann, PC Magazine:** "In its simplicity it achieves an elegance that no other language compiler has ever displayed."



## TURBO GRAPHIX TOOLBOX<sup>TM</sup> \$54.95

**High resolution monochrome graphics for the IBM PC.**  
The Turbo Graphix Toolbox will give even a beginning programmer the expert's edge. It's a complete library of Pascal procedures and functions. Tools that will allow you to draw and hatch pie charts, bar charts, circles, rectangles and a full range of geometric shapes. Procedures that will save and restore graphic images to and from disk. And much, much, more. You may incorporate part or all of these tools in your programs and yet we won't charge you any royalties. Best of all, these functions and procedures come complete with commented source code on disk ready to compile.



## TURBO TUTOR<sup>TM</sup> \$34.95

**From start to finish in 300 pages.** Turbo Tutor is for everyone from novice to expert. Even if you've never programmed before Turbo Tutor will get you started right away. **A must.** You'll find the source code for all the examples in the book on the accompanying disk ready to compile. Turbo Tutor might be the only reference on Pascal and programming you'll ever need.



## TURBO DATABASE TOOLBOX<sup>TM</sup> \$54.95

**The Turbo Database Toolbox is the perfect complement to Turbo Pascal.** It contains a complete library of Pascal procedures that allows you to sort and search your data and build powerful applications. It's another Borland set of tools that will give the beginning programmer the expert's edge. **Get started right away: free database!**  
Included on every Toolbox disk is the source code to a working data base which demonstrates how powerful and easy to use our search system, Turbo-Access, really is. Modify it to suit your individual needs or just compile it and run. **Remember, no royalties!**



4585 Scotts Valley Drive, Scotts Valley CA 95066  
Phone (408) 438-8400 Telex 172373

Copyright 1985 Borland International BI-1011

Turbo Pascal, Turbo Database Toolbox, Turbo Graphix Toolbox, Turbo Tutor and Turbo Dynamics are trademarks of Borland International, Inc.

Inquiry 41 for End-Users. Inquiry 42 for DEALERS ONLY.

**TURBO PASCAL FAMILY**

NOT COPY-PROTECTED

Available at better dealers nationwide. Call (800) 556-2283 for the dealer nearest you. To order by Credit Card call (800) 255-8008, CA (800) 742-1133

<p>Carefully Describe your Computer System!</p> <p>Mine is: <input type="checkbox"/> 8 bit <input type="checkbox"/> 16 bit</p> <p>I Use: <input type="checkbox"/> PC-DOS <input type="checkbox"/> MS-DOS</p> <p style="padding-left: 20px;"><input type="checkbox"/> CP/M 80 <input type="checkbox"/> CP/M 86</p> <p>My computers' name/model is: _____</p> <p>The disk size I use is:</p> <p><input type="checkbox"/> 3 1/2" <input type="checkbox"/> 5 1/4" <input type="checkbox"/> 8"</p> <p>Name: _____</p> <p>Shipping Address: _____</p> <p>City: _____</p> <p>State: _____ Zip: _____</p> <p>Telephone: _____</p>	<table style="width: 100%; border-collapse: collapse;"> <tr> <td>Pascal 3.0</td> <td>\$ 69.95</td> </tr> <tr> <td>Pascal w/8087</td> <td>\$109.90</td> </tr> <tr> <td>Pascal w/BCD</td> <td>\$109.90</td> </tr> <tr> <td>Pascal w/8087 &amp; BCD</td> <td>\$124.95</td> </tr> <tr> <td>Turbo Database Toolbox</td> <td>\$ 54.95</td> </tr> <tr> <td>Turbo Graphix</td> <td>\$ 54.95</td> </tr> <tr> <td>Turbo Tutor</td> <td>\$ 34.95</td> </tr> </table> <p>*These prices include shipping to all U.S. cities. All foreign orders add \$10 per product ordered.</p> <p>Amount: (CA 6% tax) _____</p> <p>Payment: <input type="checkbox"/> VISA <input type="checkbox"/> MC <input type="checkbox"/> BankDraft <input type="checkbox"/> Check</p> <p>Credit Card Expir. Date: _____</p> <p>Card #: _____</p>	Pascal 3.0	\$ 69.95	Pascal w/8087	\$109.90	Pascal w/BCD	\$109.90	Pascal w/8087 & BCD	\$124.95	Turbo Database Toolbox	\$ 54.95	Turbo Graphix	\$ 54.95	Turbo Tutor	\$ 34.95
Pascal 3.0	\$ 69.95														
Pascal w/8087	\$109.90														
Pascal w/BCD	\$109.90														
Pascal w/8087 & BCD	\$124.95														
Turbo Database Toolbox	\$ 54.95														
Turbo Graphix	\$ 54.95														
Turbo Tutor	\$ 34.95														

60 DAY MONEY-BACK GUARANTEE

F15

COD's and Purchase Orders WILL NOT be accepted by Borland. California residents add 6% sales tax. Outside USA: add \$10 and make payment by bank draft, payable in US dollars drawn on a US bank.



## Conducted by Steve Ciarcia

### IN A CONSTELLATION FAR AWAY...

Dear Steve,

The reason I am writing to you is because for the last three years a friend of mine and I have been designing the plans for the most elaborate starship ever built. To give you an example of the immenseness of this ship, here are a few of its dimensions:

- length: 2 miles
- height: 1 mile
- width: 1/2 mile
- gross deadweight in metric tonnage: 1,500,000-2,000,000
- number of main engines: six ion drives
- backup: four cyclotron drives
- impulse: 12 matter/antimatter drives
- auxiliary power: 1500 fuel cells
- number of decks: 373, from 0 (deck observation) to 372 (laser weaponry)

Our problem is that we are going to build our own computer and electrical

layout of the ship. I have enclosed a block diagram of the computer as we need it (see figure 1). If you could give us any help, advice, or steer us to either books or people who could assist us, it would be greatly appreciated.

SEAN F. MCCARTNEY  
Newton, KS

*Your starship plans are very impressive. I congratulate you and your friend on your ambitions. Ad astra per aspera.* [Editor's note: For those of you whose knowledge of Latin is as nonexistent as mine, that translates as "to the stars by hard ways," and it is the motto of Kansas.]

*On a less grand scale than yours, some people have already projected some of the computing needs of an old-style starship like the USS Enterprise. Check out the December 1977 BYTE for an article called "The Computer of Star Trek" by Kurt J. Schmucker and Robert M. Tarr (page 12).*

*Any contracts that I may or may not have with certain unnamed agencies for which I consult may expressly forbid me to pass along any specific information regarding starship computer systems on which I may or may not be working. However, I would not be forbidden to point out some general considerations that may be of interest to you.*

*While a centralized computer system has advantages in coordinating information from all over the ship, some serious problems must be overcome. Due to the ship's size, information from a sensor (or another computer) may have to travel up to two miles to reach the main computer. Even if transmission efficiency were 100 percent—operating at the speed of light—a signal would take from 5 to 10 microseconds to make the journey in one direction.*

*Commercial microprocessors now operate at a 10-MHz clock speed, so perhaps we could surmise that seventh-*

*(continued)*

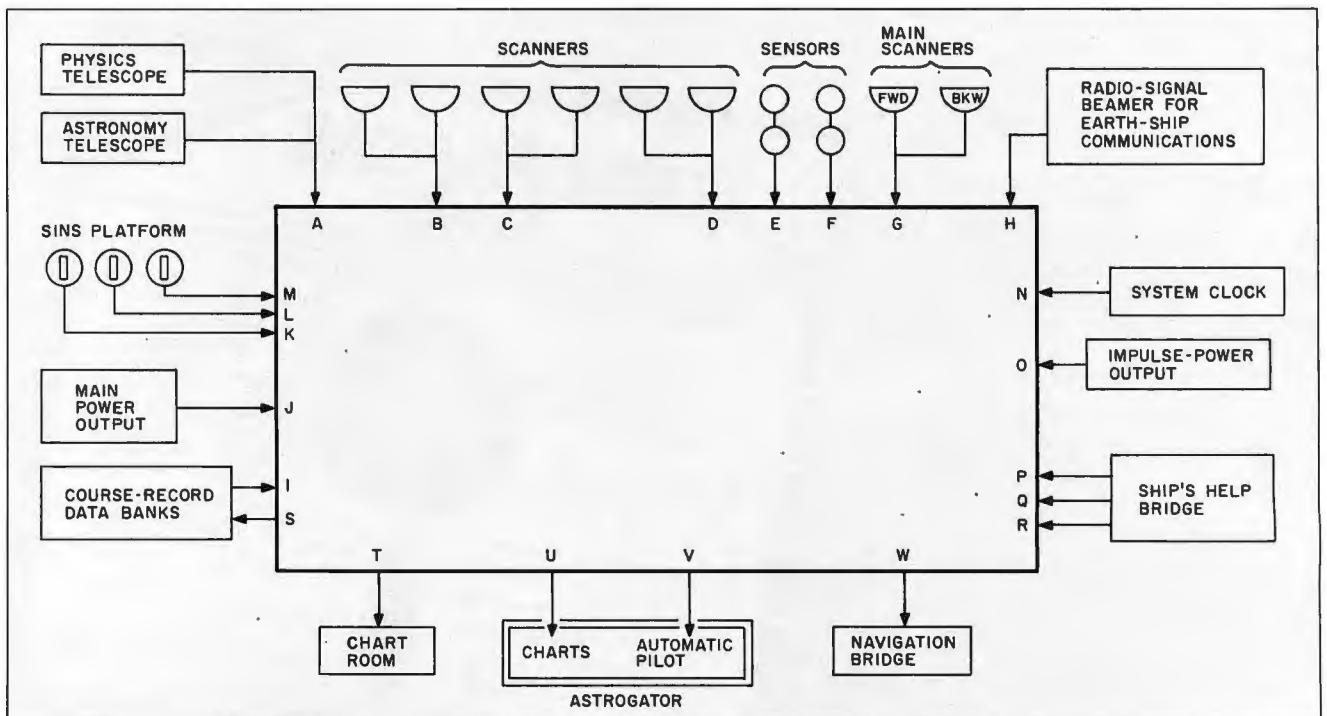
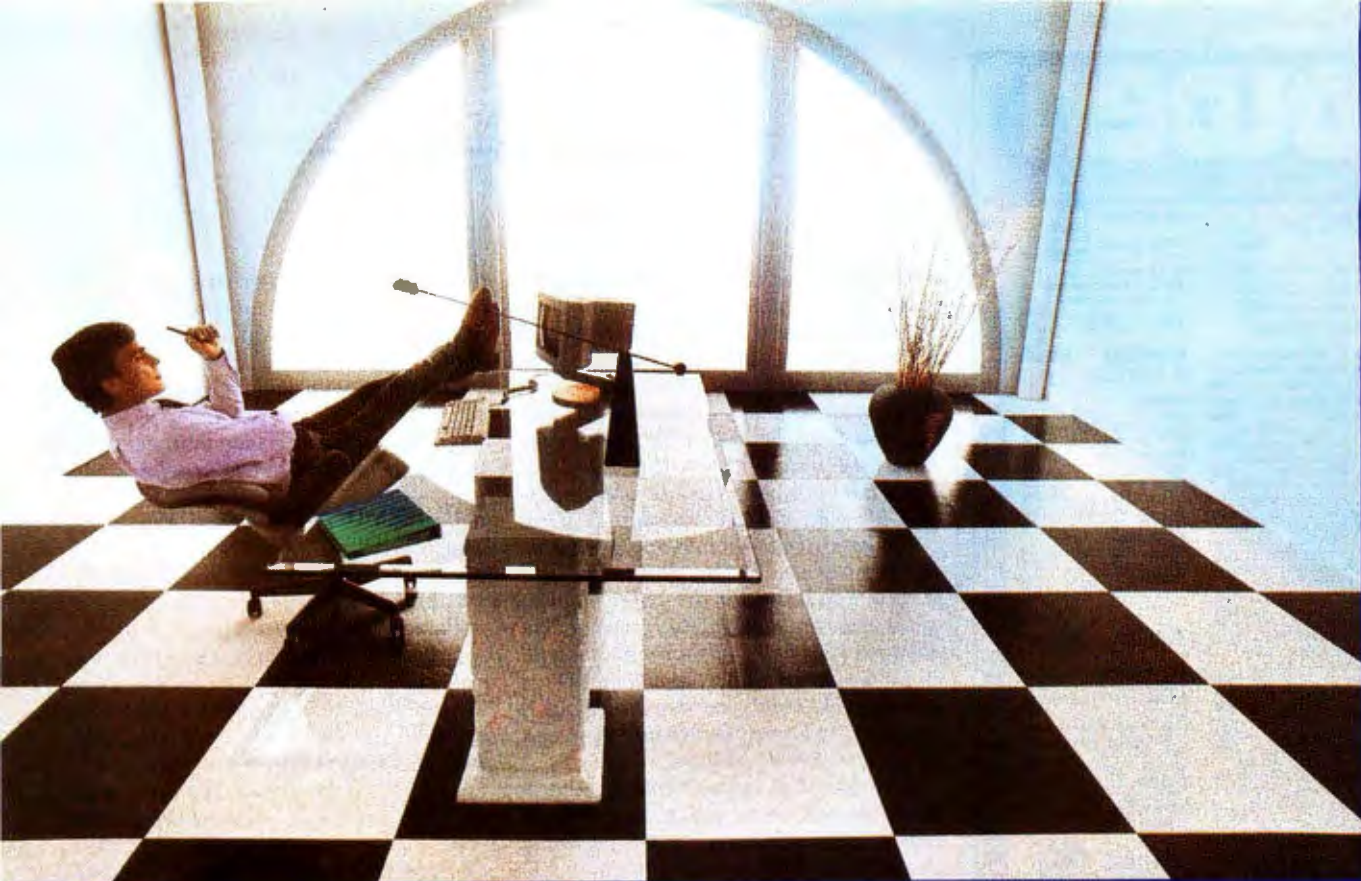

Figure 1: A block diagram of Sean F. McCartney's computer for his proposed starship.





## *Clipper gives dBASE III™ users more time to do more. Or less.*

Clipper™ allows you to run all dBASE III™ programs 2 to 20 times faster than they do with the standard dBASE interpreter.

That frees up extra time you're wasting if you're running dBASE III programs without Clipper.

Extra time to think. To create. To produce. To use as you choose.

You see, Clipper is the first true compiler for dBASE III. Clipper eliminates the time-consuming translation which the dBASE interpreter performs line after line whenever a program is run.

With Clipper, once you've debugged your source code, it's compiled into more efficient machine code.

And Clipper compiles all your dBASE III programs. The ones you have today. The ones you'll have tomorrow. But don't wait until tomorrow to order Clipper.

Today, Clipper has already been purchased to speed up dBASE run time at 3M and Touche Ross. At Exxon and NASA. In

the Harvard Physics Department. For the State of Arizona and TRW.

And that's just a few of the installations worldwide. From Greece to Venezuela to Canada to Europe.

So stop wasting time.

Call our toll-free 800 number and get Clipper.

You'll spend less time running dBASE III and more time running the rest of your life.

 **Nantucket™**  
Inquiry 266 for End-Users. Inquiry 267 for DEALERS ONLY.



# OLDEN

FOR EXPERT ADVICE • LOW PRICES • QUICK SERVICE

CALL (212) 725-1234 FOR ORDERS (800) 223-6312

---

## IBM PC

Bonus: Buy any IBM PC or PC Compatible and Receive a FREE Software Package

IBM PC w/2360k Disk Drives, 640k RAM, Mon. Printer Adapter, ZENITH 124 Mon. .... \$2099

IBM PC As Above Except w/RGB Color Monitor ..... \$1990

IBM PC 256k w/1) 360k Drive and 10Mb Hard Disk ..... \$2195

IBM PC 256k w/1) 360k Drive and 20Mb Hard Disk ..... \$2495

IBM PC 256k w/1) 360k Drive, and 12 Mb at Type Drive w/Contoller ..... \$1995

IBM PC 256k w/1) 360k Drive, and 12 Mo Floppy AT Type Drive and 10Mb Hard Disk Drive... \$2695

COMPAQ PORTABLE w/256k, (2) 360 disc drives, DOS & basic..... \$1949

COMPAQ PLUS ..... \$2995

COMPAQ Desk Pros ..... Call

LEADING EDGE "D" ..... In Stock

LEADING EDGE PC w/256k (2) 360 disc drives, monitor & adapter, basic, DOS 2.11..... \$1999

LEADING EDGE PC w/256k ss above but RGB color ..... \$1895

LEADING EDGE 10Mb hard disc system..... \$2395

SANYO MBC 555 2 ..... \$789

ZENITH 250 w/2) 360k disc drives, 128k RAM, IBM compail die, writes Microsoft Word & free Microsoft Multiplan & Color graphics card ..... \$1999

ZENITH ZW 151 as above but w/color monitor & 10Mb hard disc system..... \$2395

---

## LAP COMPUTERS

MORROW PIVOT, 256k, (2) 514" Disk Drives, 25 Line x 80 Col Display SPECIAL ..... \$1995

Above w/modem

And RGB Card ..... Call

---

## HARD DISK DRIVES

AMPEX MEGASTORE 20Mb Hard Disk w/ape Back up ..... \$795

Benkwalli Box 20Mb w/2) Cartridges ..... \$450

GENOA 10Mb External w/Power Supply Controller Card & Cables \$899

---

## SOFTWARE /IBM

Nutshell ..... \$89

PFS File ..... \$84

Wordstar 2000 ..... \$249

X Y Write Plus II ..... \$229

Word Perfect 4.0 ..... \$239

Volkmaster Deluxe w/RTI ..... \$169

Samna Plus ..... \$299

Multimate ..... \$244

Leading Edge Word w/SPELL ..... \$189

Smart System ..... Call

Framework ..... \$349

Enable ..... Call

Sagekick ..... \$29

Norton 3D ..... \$83

Managing Your Money ..... \$99

Dollar & Sense ..... \$109

Think Tank ..... \$99

Superkey ..... \$45

Flight Simulator ..... \$99

Sargon III ..... \$34

PFS Write ..... \$39

Multiplan ..... \$124

Run "C" ..... \$119

Microsoft "C" ..... \$279

Turbo Pascal 3D ..... \$99

PC Paintbrush ..... \$69

Harvard Total Project Mgr ..... \$249

---

## IBM PC DREAM SYSTEM

W640k RAM, (1) 360k Drive, (1) 10Mb Hard Disk, Zenith Amber TTL, Monitor, Monitor Adapter ..... \$2695

---

## ZENITH Z 150

W/2) 360k Drives, Color Graphics Card, Printer Port, DOS, RGB Color Monitor ..... \$1899

---

## LEADING EDGE PC

W/128k Leading Edge Monitor, Keyboard, Monitor & Printer Adapter ..... \$1399

---

## SANYO 775 Portable

(2) Drives, 256k, RGB Color Monitor, Dual Speed Processor ..... \$1539

---

## OLYMPIA RO

Daisy Wheel Letter Quality, 14 Cps w/Parallel & Serial Ports w/Built In Tractor Feed, 3 Pich ONLY! ..... \$319

---

## COMPAQ

Portable W/12) 360k Disc Drives, DOS & Basic Keyboard ..... \$1949

COMPAQ Plus W/Hard Disc ..... \$2995

---

1265 Broadway at 32nd Street New York 10001

Corporate Accounts w/COMI

TELEX #421887 SPWNY

Visa, MasterCard, American Express

Same Price Mail Order Only

We Reserve the Right to Limit Quantities and Price for Wholesale

Minimum Shipping \$20.00

35.00 Svc Charge to Orders Under \$50.00

Minimum \$54.00

We Are Not Responsible for Errors

Manufacturers Price Changes

Price Subject to Change

## ASK BYTE

and eighth-generation computers (we are just designing fifth-generation computers now) would have a clock speed of 100 MHz or greater with parallel processors. This would mean that the central computer was capable of operating so fast that the 5-10-μs delay would be a very long time indeed. Even if it could act upon the information in a picosecond or two, it would still face the same 5-10-μs propagation delay in responding. It is as if you put your hand on a hot stove, and it took 5 minutes for the pain signal to get to your brain. Your brain could decide to move your hand in less than a second, but it would take another 5 minutes for the signal to reach your hand and pull it away. By that time, you would have been in trouble for 10 minutes!

It would thus appear that a central computer system would demand that all high-priority operation systems be within reasonable proximity—no more than 100 feet. Another alternative would be to have local computers in control of their own systems but also be in a local-area network (star topology preferred) in order to receive less time-critical information from other, farther-away, computers.

One other possibility comes to mind. About 30 years ago, Isaac Asimov wrote a paper titled "The Endochronic Properties of Resublimated Thiotimoline," in which he described a chemical compound that dissolved a fraction of a second before it was added to water. This was due to one of the chemical bonds being in the fourth dimension, giving temporal instability to the compound. If thiotimoline can be made to act as a semiconductor, the propagation-delay problem would be solved. It would then be possible for the central computer to be synchronized to its peripheral units no matter how close or far away they were. By cascading several thiotimoline-based circuits in series, you could effectively reduce the propagation delay to zero and have the central computer act upon the virtual information sent from the peripheral device immediately. When the actual signal was received 5-10 μs later, it could be relegated to the bit bucket because the central computer would already have responded! Naturally, the same circuitry would be used in the opposite direction as well.

Of course, all this hinges upon making semiconductor devices from thiotimoline. As I recall, Dr. Asimov had some reservations about the use of this compound, and he is the only chemist I know of who

has synthesized it. Perhaps you could contact him and find out what the status of thiotimoline is. If you find out, let me know.

Good luck with your project.—Steve

PS. I checked again to see that you were writing to me and not Pournelle.

## S-100 EMULATOR BOARDS

Dear Steve,

It seems that many types of add-on boards for Apple and IBM computers are available. I was wondering if any of these boards allow S-100 bus computers to run Apple and IBM software?

I would like such boards for my CompuPro 8/16, since I would like to try many programs for the Apple and IBM.

LEE SIDDOWNAY  
Kure, Japan

I agree with you that S-100 Apple and IBM cards are a good idea. Unfortunately, up to now no one has offered them. There have been S-100 boards that use the 6502 processor (as does the Apple) but without the necessary video or disk-controller circuitry to emulate the Apple. No one currently manufactures an S-100 Apple board as far as I know.

Fortunately for you, Viasyn will soon be releasing an S-100 board to allow your CompuPro 8/16 to look more like an IBM, run PC-DOS, and read PC-DOS disks. Check with your local dealer or write Viasyn directly. Again, no other manufacturer I know has plans for an IBM S-100 card.—Steve

## RADIO SHACK PC-3

Dear Steve,

I recently purchased a Radio Shack PC-3 pocket computer. Because I want to program it in machine language, I would like to know what microprocessor it has and where I can find information about it.

The PC-3's BASIC has the PEEK and POKE commands, but it is missing the USR function necessary to run a machine-language program. How could I get around this problem?

Also, the computer has a dot-matrix printer. Is it possible to write a machine-language program to produce graphics on the printer?

RALF-ERIC PIEPER  
Santo Domingo, Dominican Republic

Sharp Corporation has chosen to keep the technical specifications of its PC-1250 pocket computer (the same as the Radio

(continued)



# Lots of dollars.

# Lots of sense.

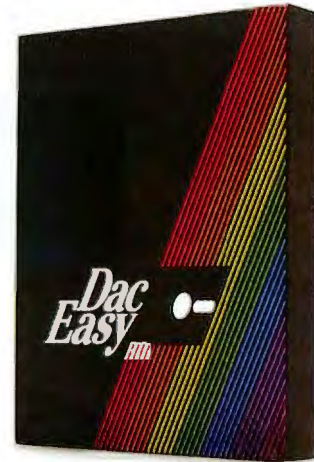

**\$69.95**

They've been doing it for years. Selling you accounting software module by module, till before you know it you've paid up to five thousand dollars for a complete system. That's a lot of dollars... which doesn't make good business sense. Now, there's a better alternative. Dac Easy Accounting. For only \$69.95, Dac Easy is a fully integrated accounting package offering instant access to General Ledger, Accounts Receivable, Accounts Payable, Inventory, Purchase Order, Billing and Forecasting. And Dac Easy has the flexibility to manage either product or service oriented businesses.

It's not just the price that makes Dac Easy better. Only Dac Easy saves three years of history in all files, making automatic forecasting easier and more accurate. Plus, you can generate any of 300 different reports for instant access to the exact information you need.

Dac Easy is menu-driven for ease-of-use, and comes with easy-to-understand documentation inside a handsome slip-case binder. It's also non-copy-protected. Listen to what experts are saying:

*"Dac Easy Accounting is remarkable, amazing, revolutionary, sensational..."*  
**Computer Buyer's Guide & Handbook, September 1985**

Find out for yourself why Dac Easy is the fastest selling accounting package in history. Compare Dac Easy's range of features against systems costing thousands more. You'll see how Dac Easy can save you lots of dollars. Which makes a lot of sense.

**PARTIAL LIST OF FEATURES**

**General Information**

- Menu driven
- Password protection
- File capacity limited only by disk space
- Support contract available

**General Ledger**

- Unlimited multi-level accounts
- Three-year account history for CRT inquiry
- Pencil and pen feature to correct mistakes
- Unique budgeting routine
- CRT transaction inquiry
- Activity report, trial balance, financial statements, unlimited departments and journals

**Accounts Receivable**

- Open invoice or balance forward
- Customized aging report
- Unlimited number of customers
- Flexible mailing labels and directories
- Supports partial payments & finance charges
- Three-year customer history for number of invoices, sales, costs, and profits

**Accounts Payable**

- Check printing with multiple invoices and cash available routines
- Aging reports with seven customized columns
- Unlimited number of vendors
- Flexible mailing labels and directories
- Three year vendor history
- Unlimited allocations per invoice

**Inventory**

- Supports average, last purchase, and standard costing methods
- Powerful physical inventory routines
- Accepts any unit of measure
- Three-year product history in units, dollars, cost, and profits
- Automatic forecast of product sales
- Automatic pricing assignments
- Alert and activity reports with 11 sorts
- CRT shows on-hand on-order committed/sales cost/profit/turns GROI

**Purchase Order**

- Inventory and non-inventory items
- Allows up to 99 lines per P.O.
- Per line discount in %
- P.O. accepts generic discounts/freight/taxes/insurance
- P.O. accepts back orders and returns
- Purchase journal

**Billing**

- Service or Inventory invoicing on plain or preprinted forms with remarks
- Prints sales journal
- Allows return credit memo

**Forecasting**

- Unique program that automatically forecasts using your three-year history:
- Revenue and expense accounts
- Vendor purchases
- Customer sales, cost, and profit
- Inventory item usage
- Forecast by same as last year, or % base from last year, or trend, or least square trend line analysis method

**Dac Easy Accounting**

To Order Call Toll Free

**1-800-992-7779**

Ask For Operator 19

For More Information Or In Texas Call

**214-458-0038**

☎ dac software, inc 4801 Spring Valley, Building 110-B, Dallas, TX 75244

Send in this coupon with your credit card number, money order or check for \$69.95 plus \$7.50 for postage and handling. In Texas, add 6¼% sales tax (\$4.28). Outside U.S., add \$17.50 for postage and handling. No C.O.D.

CHECK  MONEY ORDER  
 AMEX  VISA  MASTERCARD Expires \_\_\_\_\_

Account No. \_\_\_\_\_

Name \_\_\_\_\_

Company Name \_\_\_\_\_

Address \_\_\_\_\_

City \_\_\_\_\_ State \_\_\_\_\_ Zip \_\_\_\_\_

Phone \_\_\_\_\_

Signature \_\_\_\_\_

30-Day Money Back Guarantee: dac software, inc. provides a 30-day money back guarantee that all claims and features listed in this ad are true.

Minimum Hardware Requirements: IBM (PCjr, PC, XT, or AT)<sup>1</sup> or other compatibles. 128K memory, one 5¼ DSDD floppy disk, 132 column printer in compressed mode, 80X24 CRT, MS-DOS<sup>2</sup>, PC DOS<sup>1</sup> 2.0 or later.

<sup>1</sup>Trademarks of International Business Machines Corporation.  
<sup>2</sup>Trademark of Microsoft Corporation.

**Dac Easy Accounting**



# Brainy Buffer.

**Do you press print and wait? And wait? And wait?**

Your waiting is over with the Universal Data Buffer — it frees your computer in seconds while it handles the printing of your file.

And the Universal Data Buffer from HanZon is smarter than the average buffer. For one thing it has two inputs—one serial and one parallel, and two outputs—one serial and one parallel. Since all the ports are active, it means the Universal Data Buffer can interface between serial and parallel devices — even at different speeds and protocols. All that is a bonus to

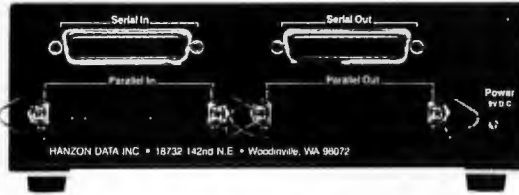

its standard function — as a 64K buffer expandable to 256K. The buffer also has operator controls for selecting additional copies, and pausing.

Call HanZon today for your nearest dealer: (206) 487-1717.



HANZON DATA INC. • 18732 142nd Ave NE • Woodinville, WA 98072

Suggested Retail Price: \$385 - 64K Buffer  
\$59 - 64K Expansion Module

*Shack PC-3) unpublished, and to date there has been no mention of the information that you requested. These machines were designed to use the BASIC language and may not allow access to machine-language programming.*

*You may be able to obtain some additional information from Sharp, 10 Sharp Plaza, Paramus, NJ 07652, Attn: Product Information.—Steve*

## MEMORY EXPANSION

Dear Steve,

I have two questions that may also be of interest to many of your readers. First, do you know of any memory-expansion device of at least 16K bytes that will plug into my TRS-80 PC-2? Second, what would be the best way for me to increase the memory of my TI-99/4A from 16K to 64K bytes now that no TI factory expansion devices are available?

ED ROCKWOOD  
Portland, OR

*The Radio Shack catalog no longer lists the memory-expansion devices for the TRS-80 PC-2. However, some stores in your area may still have them in stock. If not, the memory-expansion units for the Sharp PC-1500A are identical. Both the 8K- and 16K-byte versions can be ordered from Computer Mail Order, 477 East Third St., Williamsport, PA 17701, (800) 233-8950.*

*Two possible sources for the memory-expansion units for your TI-99/4A are*

Multicom Inc.  
POB 1693  
Sandy, UT 84091

M. W. S. Computers  
22 East Tioga St.  
Tunkhannock, PA 18657

—Steve

## DATA ACQUISITION

Dear Steve,

I am a research fellow in biochemistry. Although I have programmed microcomputers, I have done little hardware design work. Now I would like to design an 8085-based data-acquisition board that communicates with an IBM PC through an RS-232C port.

I am planning to use the 8237 DMA controller, an 8251 UART, and the 8155 and 8255 chips. I would also like to have a 12-bit A/D converter and a couple of

(continued)

- IBM color printer & IBM graphics printer compatibility standard.
- Multiple color, high resolution raster and bit image graphics.
- 200 cps data processing mode.
- 110 cps text quality mode.
- 35 cps letter quality mode.
- 10 ips graphics print speed.
- Centronics parallel interface.
- 5000-byte buffer.



**IBM Users...**

**Color your graphics with the Dataproducts 8052. For sale, lease or rent from MTI.**

The Dataproducts Model 8052 printer is one of the most economical yet highly versatile IBM-compatible color printers available for use in today's microcomputer applications environment.

MTI is an authorized distributor for Dataproducts, so we can meet your requirements with professionalism and in a timely fashion.

Whether you buy, rent or lease, MTI is the one source for all computer printers. And our prices are hard to beat. Call MTI and save.



A Subsidiary of Ducommun Incorporated

**Computer & Data Communications Equipment Sales / Leasing / Service / Systems Integration**

Digital Equipment Corp., Intel, Texas Instruments, AT&T, ADDS, Qume, HP\* Dataproducts, Diablo, Epson, Lear Siegler, Esprit, Wyse, Link, C.Itoh, PCI Racal-Vadic, MICOM, Ven-Tel, Develcon, Control Data, Emulex, U.S.Design

New York: 212/226-2337 516/621-6200 518/449-5959	New Jersey: 201/227-5552 Pennsylvania: 412/931-9351	California: 818/883-7633 714/220-6487 *Franchised areas only.	Ohio: 216/464-6688 Kentucky: 502/449-6656
---	--	--	--

**Or call 800/645-6530**

IBM is a registered trademark of International Business Machines.



# Circuit-Board-Artwork Software for the Design Engineer in a Hurry

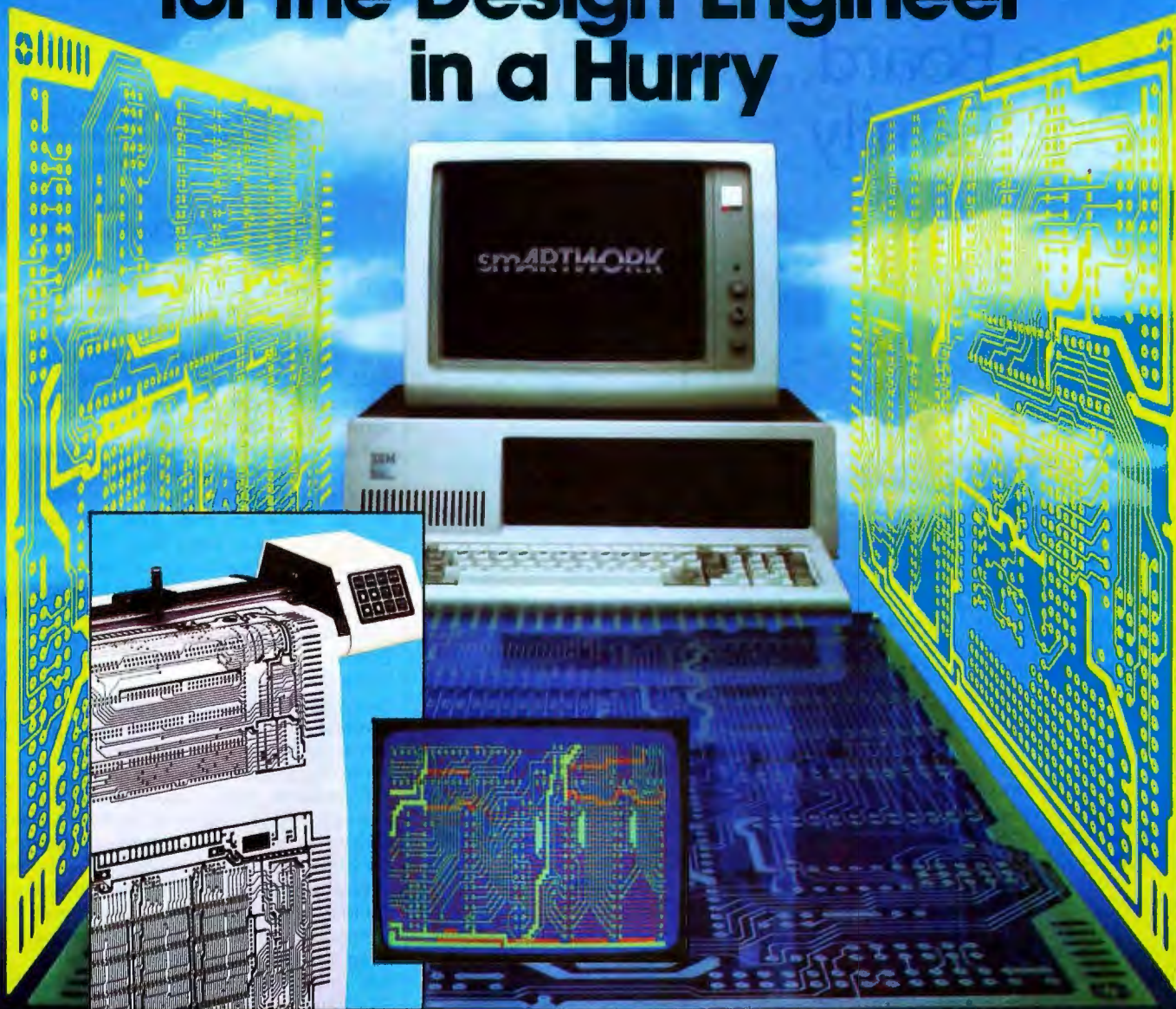

For only \$895, smARTWORK® lets the design engineer create and revise printed-circuit-board artwork on the IBM Personal Computer. You keep complete control over your circuit-board artwork — from start to finish.

Forget the tedium of taping it yourself or waiting for a technician, draftsman, or the CAD department to get to your project.

smARTWORK® is the only low-cost printed-circuit-board artwork editor with all these advantages:

- Complete interactive control over placement and routing
- Quick correction and revision
- Production-quality 2X artwork from a pen-and-ink plotter
- Prototype-quality 2X artwork from a dot-matrix printer

- Easy to learn and operate, yet capable of sophisticated layouts
- Single-sided and double-sided printed circuit boards up to 10 x 16 inches
- Multicolor or black-and-white display

#### System Requirements:

- IBM Personal Computer, XT, or AT with 256K RAM, 2 disk drives, and DOS Version 2.0 or later
- IBM Color/Graphics Adapter with RGB color or black-and-white monitor
- IBM Graphics Printer or Epson FX/MX/RX series dot-matrix printer
- Houston Instrument DMP-41 pen-and-ink plotter
- Optional Microsoft Mouse

#### The Smart Buy

At \$895, smARTWORK® is proven, convenient, fast, and a sound value. Call us today. And put it to work for yourself next week.



Wintek Corporation Inquiry 391  
1801 South Street  
Lafayette, IN 47904-2993  
Telephone: (317) 742-8428  
Telex: 70-9079 WINTERK CORP UD

In Europe contact: RIVA Terminals Limited,  
Woking, Surrey GU21 5JY ENGLAND,  
Telephone: 04862-71001, Telex: 859502

smARTWORK®, Wintek and the Wintek logo are registered trademarks of Wintek Corporation.



# One Board... One Family

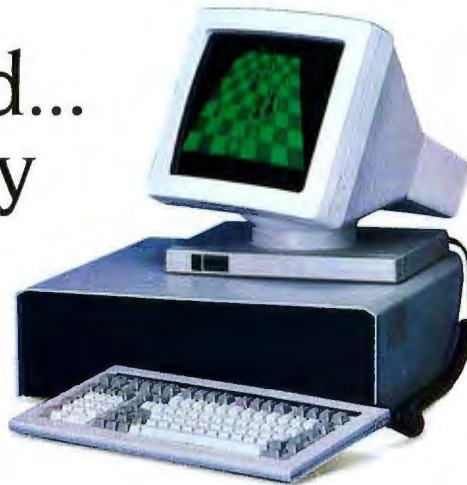

At the heart of every Stride 400 Series microcomputer, from the floppy-based 420 to the 448M byte 460, is an identical CPU board. This guarantees compatibility throughout the entire product family. And it means, our CPU board was designed with standard features that are either options or simply unavailable on other microcomputers:

- 68000 microprocessor (10 MHz with no wait states)
- VMEbus
- 256K bytes RAM
- 5¼" 640K byte floppy
- Battery-backed real time clock
- 4K CMOS RAM
- Four RS-232C serial ports (Stride multiuser BIOS)
- Centronics bi-directional parallel port
- Omninet Local Area Network (Liaison LAN software)

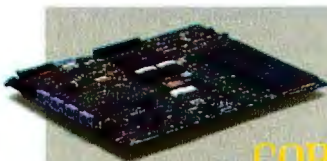

**COBOL**  
**Modula-2**  
**Pascal** **FORTRAN**  
**RM/COS** **Lisp**  
**UNIX** **CBASIC**  
**Cp-System**  
**CP/M68K**

All this, and still the best price/performance ratios in the industry: from \$2900 to over \$60,000. But it begins with the powerful Stride CPU board, a standard feature of every 400 series system. It's what we call "Performance By Design."

With this basic design, Stride is able to explore the full range of 68000 applications from an advanced multiuser, multi tasking BIOS to built-in local area networking. No other microcomputer offers the flexibility to run over a dozen different operating systems and more than 30 languages/compiler.

The basic design is backed by a rich option list:

- 12 MHz 68000 processor
- VMEbus (Eurocard) cage
- Low cost, high speed graphics
- NOD™ cursor control
- 12M bytes of RAM
- 448M bytes of hard disk storage
- 22 serial ports
- Floating point processor (NS16081)
- Cartridge streaming tape backup
- Memory Management Unit



**STRIDE**  
MICRO

Formerly Sage Computer

For more information on Stride or the location of the nearest Stride Dealer call or write us today. We'll also send you a free copy of our 32 page product catalog.

Corporate Offices:  
4905 Energy Way  
Reno, NV 89502  
(702) 322-6868

Regional Offices:  
Boston: (617) 229-6868  
Dallas: (214) 392-7070

## ASK BYTE

EPROMs for software.

Could you please point me in the direction of some reference materials that I could study, especially some information on the 8237?

JAY SHREE  
Cambridge, MA

*The hardest part of any hardware design is developing the logic necessary to execute each function. The next step is to select the chips that will accomplish each function. It's then just a matter of connecting these chips together with some TTL "glue."*

*It appears that you have already gone through these steps, as you have already selected your ICs for the project. Since all the chips are from Intel, its data catalog will be of great help. The Intel data catalog gives complete chip specifications and pin-outs and shows sample circuits. Contact Intel Corporation, Literature Department SV3-3, 3065 Bowers Ave., Santa Clara, CA 95051.*

*The Intel catalog also contains a good description of the operation of the 8237 DMA controller, which will show you how it is used in a circuit with the 8085.*

*You can obtain information about your A/D converter from its manufacturer. For example, Micro Networks makes A/D converters and has a catalog of data-conversion products that contains an excellent section called "Tutorial: Understanding Data Converters." This should give you most of the information you need to use A/D converters. You can obtain this catalog from Micro Networks, 324 Clark St., Worcester, MA 01606.*

*For a more detailed discussion of both A/D and D/A converters, read my article "Analog Interfacing in the Real World" (January 1982, page 72).—Steve ■*

IN ASK BYTE, Steve Ciarcia answers questions on any area of microcomputing. The most representative questions received each month will be answered and published. Do you have a nagging problem? Send your inquiry to

Ask BYTE  
c/o Steve Ciarcia  
POB 582  
Glastonbury, CT 06033

*Due to the high volume of inquiries, personal replies cannot be given. All letters and photographs become the property of Steve Ciarcia and cannot be returned. Be sure to include "Ask BYTE" in the address.*

*The Ask BYTE staff includes manager Harv Weiner and researchers Larry Bregoli, Bill Curlew, Jeannette Dojan, Roger James, Frank Kuechmann, Dick Sawyer, and Robert Stek.*



# When designing and building the Stride 400 microcomputers, why did you select the MC68000 Motorola processor over the newer Intel iAPX 286?

[This is one of a series of design philosophy discussions with Rod Coleman, President of Stride Micro (formerly Sage Computer).]

**RC:** With the introduction of the IBM AT, many people have been spending a lot of time comparing the 286 with the 68000. We also

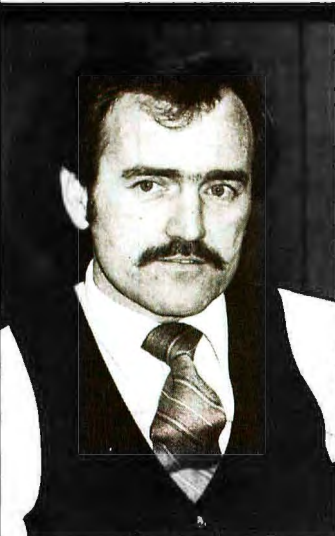

**"... the 68000 is at least one generation ahead of the 286 in terms of microprocessor design."**

surveyed the marketplace closely when we decided to build a second generation of our successful Sage computer, but came to a quick conclusion: the 68000 is at least one generation ahead of the 286 in terms of microprocessor design. Admittedly, the Intel microprocessor was a newer chip, and it had an impressive pedigree from the popularity of the 8088. But, in my view, the 286 was so steeped in its own history that the architecture suffered critically. In reality, today's 286 is little more than an 8086 with a memory management unit tacked on.

**Q:** What's wrong with that?

**RC:** Well, it certainly maintains compatibility with the Intel chip family, but it's not the way to design a state-of-the-art microprocessor. I like to use the example of a remodeled house. As your needs grow, you can build a new front porch, attach a garage, remodel the kitchen, and add a few bedrooms. But the end result never ends up as efficient as a larger house built from scratch. The halls are often too narrow and full of annoying twists and turns. The folks at Motorola apparently felt the same way, because they started with a clean sheet of paper when they designed their 32-bit architecture with no concessions to an 8-bit past.

**Q:** Can you give us an example?

**RC:** Just look at the registers and addressing modes. They are much larger and far more flexible in the 68000 than in the 286. The 8086 design was based on the 8080, which was an extension of the world's first 8-bit processor, the 8008. Strange as it may seem, the brand-new 286 has, as a subset, the registers from a processor designed back in 1972. Intel's motive was compatibility with current software; Motorola simply wanted to build the best possible chip. By creating a totally new design with the 68000, they were also able to apply several new concepts undeveloped in '72. The 68000 was designed from the ground up to execute high-level languages, as opposed to the 8008's roots as a simple industrial controller. Motorola provides 16 general purpose 32-bit registers to give greater flexibility and a clean orthogonal design. Thus, it efficiently and directly

addresses 16 megabytes with no preferred boundaries. The 286, by contrast, has only special purpose registers which can address just 64 kilobytes. It must use a segment register to exceed those boundaries, just as the earlier 8088 did.

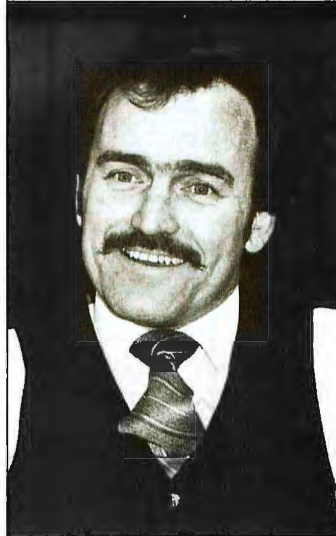

**"Sooner or later, even IBM will be forced to build a PC using a processor with a large regular addressing architecture."**

**Q:** Are there other critical differences?

**RC:** Yes. There's also the question of access. For a given generation of silicon design and feature size, any two contemporary processors should be able to do about the same number of instructions per second. Unfortunately, the 286 has a bottleneck where it forces single pins into double duty. It shares the use of its address and data bus which means that, for a given bus

bandwidth, its transfer rate will always be less than a non-multiplexed processor. The 68000 escapes the problem by dedicating a single pin for each function.

**Q:** What does it really mean to those on the software application level?

**RC:** As micros move into the late 80's, software will have to lead the way by becoming more functional and less complicated to use. Ironically, software that's easier to use actually has to be larger and more complex internally. It simply cannot be written when stifled by artificial hardware constraints like 64K byte boundaries. It's like building a new car with a one quart gas tank. Sooner or later, even IBM will be forced to build a PC using a processor with a large regular addressing architecture. But don't hold your breath; we got tired of waiting back in 1981. Apparently so did several thousand others; they have been buying our machines for four years.



**STRIDE**  
MICRO

Formerly Sage Computer

For more information on Stride or the location of the nearest Stride Dealer call or write us today. We'll also send you a free copy of our 32 page product catalog.

**Corporate Offices:**

4905 Energy Way  
Reno, NV 89502  
(702) 322-6868

**Regional Offices:**

Boston: (617) 229-6868  
Dallas: (214) 392-7070







**Commodore® Accessories**



**RS232 Adapter for VIC-20 and Commodore 64**

The JE232CM allows connection of standard serial RS232 printers, modems, etc. to your VIC-20 and C-64. A 4-pole switch allows the inversion of the 4 control lines. Complete installation and operation instructions included.

- Plugs into User Port • Provides Standard RS232 signal levels • Uses 6 signals (Transmit, Receive, Clear to Send, Request to Send, Data Terminal Ready, Data Set Ready).

**JE232CM . . . . . \$39.95**

**VOICE SYNTHESIZER FOR COMMODORE VIC-20 AND C-64**  
Plug-In - Talking in Minutes!  
**JE520CM. . . . . \$99.95**

**TRS-80 Accessories**



**MPI 5 1/4" DISK DRIVE**  
• Use as a second disk drive • Single-sided • Single/double density • Full-height drive • 48 TPI • Documentation included • Weight: 3.7 lbs.

**MPI51S. . . . . \$89.95**

**EXPAND TRS-80 MEMORY TRS-80 MODEL I, III**

Each Kit comes complete with eight MM5290 (UP0416/116) 16K Dynamic RAMs and documentation for conversion. Model I: 16K equipped with Expansion Interface can be expanded to 48K with 2 Kits. Model III: Can be expanded from 16K to 48K using 2 Kits. Each Kit will expand computer by 16K increments.

**TRS-16K3 200ns (Model III). . . . . \$6.29**  
**TRS-16K4 250ns (Model I). . . . . \$5.49**

**TRS-80 COLOR AND COLOR II**

Easy to install Kit comes complete with 8 each 4164N-20 (200ns) 64K Dynamic RAMs and documentation for conversion. Converts TRS-80 Color Computers with D, E, F and NC circuit boards to 32K. Also converts TRS-80 Color Computer II to 64K. Flux DDS or OS-9 required to utilize full 64K RAM on all computers.

**TRS-64K-2. . . . . \$11.95**

**Update! TRS-80 MODEL IV, 4P Update!**  
Easy to install Kits come complete with TRS-64K-2 (8 ea. 4164N-20 (200ns) 64K Dynamic RAMs), TRS-64K-2PAL (8 ea. 4164's plus PAL chip) and documentation for conversion.

**TRS-64K-2** Expands Model IV from 16K-64K or Model IV 4P from 64K-128K (w/ram, Disk). . . . . \$11.95  
**TRS-64K-2PAL** Expands Model IV (w/Black & White Monitors only) from 64K to 128K. . . . . \$29.95

**TRS-80 MODEL 100 • NEC • Olivetti**  
Easy to install module plugs right into the socket increasing memory in 8K increments. Complete with module and documentation for installation.

**M1008K (TRS-80 Model 100 Expansion). . . . . \$39.95 ea. or 3 for \$99.95**  
**NEC8KR (NEC PC-8201A & Olivetti M10). . . . . \$39.95 ea. or 3 for \$99.95**

**NEW! NEW! TANDY 200 NEW! NEW!**  
Easy to install module plugs right into the socket increasing memory in 24K increments. Complete with module & documentation for installation.  
**M200R (Tandy 200 Expansion). . . . . \$149.95 ea. or 2 for \$274.95**

**PROMETHEUS MODEMS**



**Intelligent 300/1200 Baud Modem with Real Time Clock/Calendar**

The ProModem™ is a Bell 212A (300/1200) intelligent stand-alone modem • Hayes command set compatible plus an additional extended command set • Shown with alphanumeric display option.

**PM1200 RS-232 Stand-Alone Unit. . . . . \$299.95**

**OPTIONS FOR ProModem 1200**

**PM-COM (ProCom Communication Software). . . . . \$79.95**  
Please specify Operating System.  
**PM-OP (Options Processor). . . . . \$79.95**  
**PMO-64K (Options Processor Memory - 64K). . . . . \$ 9.49**  
**PM-ALP (Alphanumeric Display). . . . . \$79.95**

(Incl. Options Processor, 64K Memory and Alphanumeric Display). . . . . **\$149.95**

**DATA BOOKS**



**30009 Intell Data Book (1984). . . . . \$9.95**  
Complete Line (965 pages).  
**30013 Zilog Data Book (1984). . . . . \$9.95**  
Microprocessors and Support Chips (849 pages).  
**210830 Intel Memory Components Hndbk. (1983/84). . . . . \$14.95**  
Contains all Applications Notes, Article Reprints, Data Sheet and other design information on Intel's RAMs, DRAMs, EPROMs, EIPROMs and Bubble Memories (880 pages).  
**230843 Intel Microsystem Components Hndbk. (1983/84) \$19.95**  
Contains Data Sheets on all of Intel's microprocessors & peripherals - 2 volumes (2575 pages).  
**30022 National Logic Data Book Set (1984). . . . . \$24.95**  
Volumes I & II (3485 pages).  
Contains information on National's TTL product line and CD4000 family. This includes 7400, 741, S, AS, LS and ALS Series devices, and MM54NC1, 74NC1, 54NC1, 74NC1, 54NC1 High Speed Micro CMOS family, MM54C 74AC family, and CMOS LS1 / VLSI.

**Muffin-Style and Sprite-Style Fans**  
**MUF60 (SPN3-15-2482)**  
Howard Industries (4.65" sq, 60cfm). . . . . \$9.95  
**SLIC7 Reverses Flow**  
EG&G Rotron (3.125" sq, 32cfm). . . . . \$9.95

\*\*\*\*\* **APPLE® Accessories** \*\*\*\*\*

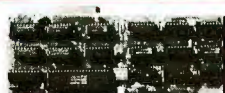

**APPLE\* Compatible CARDS**

Key: a = Apple II or II+  
b = Apple IIe

**16K RAM Card (Language Card)**

The ARC-16K RAM Card allows the Apple® II and II+ computers to expand from 48K to 64K. Complete with instructions. Key: (a)

**ARC-16K. . . . . \$39.95**

**Z-80 CP/M Card**

The AZ80-1 is Soft-card compatible. Used with CP/M related programs. Software not included. Key: (a,b)

**AZ80-1. . . . . \$49.95**

**EPROM Burner Card**

The AEB-2 allows user to program and work with standard EPROMs (2716, 2732 & 2764). Easy to use, on-board firmware. Menu contains the following options: Write, Read, Copy, Compare, Blank-Check and Monitor. Complete with instructions. Key: (a,b)

**AEB-2. . . . . \$69.95**

**80-Column Card w/Soft Switch**

The A80-C is an 80-column card designed for the Apple® II and II+ computers. The card is equipped with a soft switch which allows easy hookup for any monitor. The A80-C also features Inverse video capabilities. This card is similar to the Videx™ 80 column card. Complete with instructions. Key: (a)

**A80-C. . . . . \$74.95**

**Super Serial Card**

The ASSC-P is a serial card with a printer mode. It generates standard RS-232C signals and is similar to the Apple® Super Serial Card. Complete with instructions. Key: (a,b)

**ASSC-P. . . . . \$99.95**

**Parallel Graphics Printer Card w/64K Buffer**

The APC-64K is a parallel graphics printer card with a 64K buffer and graphic dump capabilities. Complete with instructions. Key: (a,b)

**APC-64K. . . . . \$129.95**

**80-Column/64K RAM Card**

Extended 80-Column/64K RAM Card expands memory by 64K to give 128K when used with programs like VisiCalc™. Complete with instructions. Key: (b)

**JE864. . . . . \$79.95**

\*APPLE, APPLE II, II+, IIe, IIC and Macintosh are registered trademarks of APPLE Computers.  
\*\*VisiCalc is a registered trademark of Visi-Corp. Inc.

**APPLE™ Compatible 5 1/4" Half-Height Disk Drive**



**ONLY \$129.95**

• Uses Chinon Pinch-type mechanisms • 143K formatted storage • 35 tracks • Super quiet • Works with Apple Controllers or other compatibles (ACC-1) right in. Complete with connector - just plug into your controller.  
• Size: 5 1/4" W x 1 1/4" H x 8" D • Wt.: 4 lbs. Key: (a,b)

**ADD-12. . . . . \$129.95**

**APPLE™ Compatible 5 1/4" Disk Drive & Controller Card**

• Uses Shugart SA39D mechanisms • 143K formatted storage • Color matches Apple Computer • Works with Apple Controller or other Apple-compatible controllers (ACC-1) • Complete with connector - just plug into your disk controller card • 35 tracks • Size: 5 1/4" W x 8-9/16" D • Wt.: 4 1/4 lbs. Key: (a,b)

**ADD-514 (Disk Drive). . . . . \$149.95**

**ACC-1 (Controller Card). . . . . \$ 49.95**

**APPLE™ IIC Compatible 5 1/4" Half-Height Disk Drive**

• Same specs as ADD-12 (left) except no controller necessary.

**ADD-IIC. . . . . \$129.95**

**Additional Apple\* Compatible Products**

**APF-1 Cooling Fan with surge protection • Key: (a,b). . . . . \$ 39.95**  
**JE614 Numeric/Aux. Keypad-23 accessible functions • Key: (b). . . . . \$ 49.95**  
**EAE-1 Expanded Apple Enclosure Case only • Key: (a). . . . . \$ 49.95**  
**KHP4007 Switching Power Supply • Key: (a). . . . . \$ 59.95**  
**KB-A68 68-Key Apple Keyboard only • Key: (a). . . . . \$ 69.95**  
**MON-12G 12" Green Monitor with swivel stand • Key: (a, b & I/C). . . . . \$ 79.95**  
**JE520AP Voice Synthesizer - Plug-in, User Ready • Key: (a,b). . . . . \$119.95**  
**KB-EA1 Apple Keyboard and Case • Key: (a). . . . . \$119.95**  
**PM1200A Prometheus Internal Modem - 2 cards • Key: (a,b). . . . . \$299.95**  
**PM1200M Prometheus Macintosh Ext. Modem • Key: (Macintosh). . . . . \$369.95**

**General Application Power Supplies**

**Power/Mate Corp. REGULATED POWER SUPPLY**  
• Input: 105-125/210-250VAC @ 47-63Hz • Line regulation: ±0.05% • Three mounting surfaces • Overvoltage protection • UL recognized • CSA certified

Part No.	Output	Size	Weight	Price
EMA5/6B	5V @ 3A/6V @ 2.5A	4 1/4" L x 4 1/4" W x 2 1/8" H	2 lbs.	\$29.95
EMA5/6C	5V @ 6A/6V @ 5A	5 1/4" L x 4 1/4" W x 2 1/8" H	4 lbs.	\$39.95

**KEPCO/TDK 4-OUTPUT SWITCHING POWER SUPPLY**  
• Ideal for disk drive needs of CRT terminals, microcomputers and video games • Input: 115/230VAC, 50/60Hz • Output: +5V @ 5A, +12V @ 1.8A, +12V @ 2A, -12V @ 0.5A • UL recognized • CSA certified • Size: 7 3/8" L x 6-3/16" W x 1 1/8" H • Weight: 2 lbs.  
**MRM 174KF. . . . . \$39.95**

**Congratulations BYTE On Your 10th Anniversary!**  
**IT'S JAMECO'S 12th!**  
**Working Together Serving the Electronics Industry**

\$10 Minimum Order - U.S. Funds Only CA Residents: Add 6 1/2% Sales Tax Spec Sheets - 30¢ each Shipping: Add 5% plus \$1.50 Insurance - Send \$1 Postage for FREE 1985 Jameco Catalog Prices Subject to Change and stamped, self-addressed envelope to receive a Monthly Sales Flyer - FREE!

MasterCard **Jameco ELECTRONICS** VISA

1355 SHOREWAY ROAD, BELMONT, CA 94002  
9/85 PHONE ORDERS WELCOME - (415) 592-8097 - Telex: 176043

**IBM® Accessories**

**IBM PC/XT Compatible Keyboard**

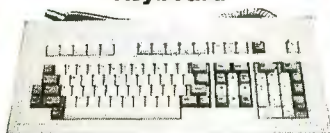

**IBM-5151 (Equivalent to Keytronic's® 5151). . . . . \$129.95**

**Additional Add-Ons Available!**

**MEMORY EXPANSION KITS**

**IBM PC, PC XT and Compatibles**  
The IBM64K Kit will increase memory in 64K byte increments. The Kit is simple to install - just insert the 9-64K RAM chips in the provided sockets and set the 2 groups of switches. Conversion documentation included.  
**IBM64K (Nine 200ns 64K RAMs). . . . . \$9.95**

**IBM PC AT**  
Each kit comes complete with nine 128K dynamic RAMs and documentation for conversion.  
**IBM128K (Nine 250ns 128K RAMs). . . . . \$79.95**

**IBM PCXT Equivalent 130 Watt Power Supply**  
**UPGRADE YOUR PCI**

• Input: 110V @ 60Hz • Output: +5VDC @ 15A - 5VDC @ 0.5A, +12VDC @ 4.2A, -12VDC @ 0.5A • Plug compatible connectors • Fits into IBM PC • Weight: 6 lbs.  
**IBM-PS. . . . . \$119.95**

**Prometheus Modems**

The ProModem 1200B/BS is a 1200/300 baud modem card which plugs into IBM PC or XT. Provides a third serial comport. Two versions available: 1200B (without software) and 1200BS (with software). The PM1200BS is supplied with powerful MITE communications software from Mycroft labs.

**PM1200B (without Software). . . . . \$239.95**  
**PM1200BS (with MITE Software). . . . . \$274.95**

**IBM Compatible! DISK DRIVES**



**Documentation Included**  
**RFD480 (Remex 5 1/4" DS full-ht.). . . . . \$ 79.95**  
**FD55B (Teac 5 1/4" DS half-ht.). . . . . \$119.95**  
**SA455 (Shugart 5 1/4" DS half-ht.). . . . . \$109.95**  
**TM100-2 (Tandon 5 1/4" DS full-ht.). . . . . \$129.95**

**5 1/4" DISK DRIVE ENCLOSURES**

Complete with power supply, switch, power cord, fuserholder and connectors  
**DDE-1FH (Houses 1 full-ht. 5 1/4" floppy drive). . . . . \$ 69.95**  
**DDE-2HH (Houses 2 half-ht. 5 1/4" floppy drives - vertical). . . . . \$ 79.95**  
**HDDE-1FH (Houses 1 hard drive). . . . . \$219.95**

**General Application Keyboards**

**Mitsumi 54-Key Unencoded All-Purpose Keyboard**

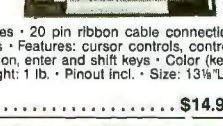

• SPST keyswitches • 20 pin ribbon cable connection • Low profile keys • Features: cursor controls, control, caps (lock), function, enter and shift keys • Color (key-caps): grey • Weight: 1 lb. • Pinout incl. • Size: 13 1/2" L x 4 1/4" W x 3/4" H  
**KB54. . . . . \$14.95**

**74-Key ASCII Cherry Keyboard**

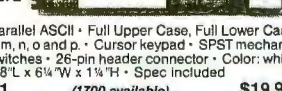

• 7-bit parallel ASCII • Full Upper Case, Full Lower Case except l, m, n, o and p • Cursor keypad • SPST mechanical keyswitches • 26-pin header connector • Color: white • Size: 18" L x 6 1/4" W x 1 1/4" H • Spec included  
**KB8201. . . . . (1700 available). . . . . \$19.95**

**UV-EPROM ERASER**

**8 Chips - 21 Minutes**  
**1 Chip - 15 Minutes**

Erases all EPROMs. Erases up to 8 chips within 21 minutes (1 chip in 15 minutes). Maintains constant exposure distance of one inch. Special conductive foam liner eliminates static build-up. Built-in safety lock to prevent UV exposure. Compact - only 9.00" L x 3.70" W x 2.60" H. Complete with holding tray for 8 chips.  
**DE-4 UV-EPROM Eraser. . . . . \$74.95**  
**UVS-11EL Replacement Bulb. . . . . \$19.95**



# IBM SHOP

**\*\* BACK TO SCHOOL SPECIAL \*\***

PANASONIC 1091 Printer 120cps NLQ ..... \$249.95

STAR MICRONICS SG-10 120cps NLQ ..... 249.95

**714/840-2406****\* SYSTEMS \*****ITT EXTRA PC-256K**Two 1.2 Ht. 360K Dr's, Monochrome Board, 12" Amber/Green Monochrome Monitor, Serial & Parallel Port, DOS 2.1 ..... **\$1,495.95****IBM XT 256K**One IBM 360K Floppy Dr., One 10 Meg Hard Disk, Monochrome Board, Amber/Green Monochrome Monitor, DOS 2.1 **ONLY** ..... **\$2,895.95****IBM PC-256K**Two TEAC 360K Dr's., Color/Monochrome Graphics Board, Parallel Printer Port, Monochrome Display, DOS 2.1 **ONLY** ..... **\$2,045.95****IBM PC AT 512K**1.2 Meg Floppy, 20 Meg Hard Disk, Amber/Green Monochrome Display, AST Advantage Board (Printer Port, Serial Port, Clock Calendar, Print Buffering, Etc.) **ONLY** ..... **\$4,995.95****10 MEG** Hard Disk Upgrade ..... **\$575.95****20 MEG** Hard Disk Upgrade ..... **\$775.95****\* TOP TEN SOFTWARE \*****dBASE III IBM** ..... **\$369.95****BPI Accounting Modules** ..... **325.95****PEACHTREE Accounting Modules** ..... **295.95**Managing Your Money **IBM/APPLE** ..... **115.95**Dollars & Sense **IBM** ..... **113.95**Norton Utilities 3.0 **IBM** ..... **59.95****PFS Write/File/Report** ..... **85.95****SIDEWAYS IBM/APPLE** ..... **39.95**Multimate **IBM** ..... **269.95**Crosstalk **IBM** ..... **104.95**Microsoft Word **IBM** ..... **249.95****\* HARDWARE \*****AST Six Pack Plus 64K** ..... **\$259.95****STB Rio Plus II 64K** ..... **249.95****PARADISE 5-Pack 64K** ..... **179.95****QUADRAM Quadboard 64K** ..... **249.95**Monochrome Graphics Card ..... **199.95**Monochrome Board With Parallel Port ..... **159.95****HERCULES Monochrome Graphics** ..... **329.95****HERCULES Color Card** ..... **179.95****\* PRINTERS DOT MATRIX \*****PANASONIC 1090 80CPS** ..... **\$189.95****PANASONIC 1092 180CPS/NLQ 33CPS** ..... **379.95****EPSON FX-80+ 160CPS** ..... **389.95****EPSON FX-100+ 160CPS** ..... **644.95****OKIDATA 92P 160CPS** ..... **389.95****BROTHER 2024L 200CPS/NLQ 96CPS** ..... **995.95****\* PRINTERS LETTER QUALITY \*****BROTHER HR-15 17CPS** ..... **\$369.95****BROTHER HR-25 24CPS** ..... **519.95****BROTHER HR-35 36CPS** ..... **729.95****DIABLO Advantage 25CPS** ..... **589.95****JUKI 6100 20CPS** ..... **399.95****JUKI 6300 40CPS** ..... **759.95****\* MODEMS \*****HAYES 1200B Internal w/Smartcomm 2** ..... **\$369.95****HAYES Micromodem IIe** ..... **219.95****HAYES 2400** ..... **649.95****ANCHOR Volkemodem 1200** ..... **199.95****U.S. ROBOTICS 2400** ..... **475.95****\* MACINTOSH/APPLE \*****MACINTOSH 128K w/Macdraw** ..... **\$1,699.95****MACINTOSH 512K w/Macpaint** ..... **2,145.95****IMAGEWRITER Printer** ..... **495.95****MACINTOSH 2nd Drive** ..... **269.95****MICROSOFT Chart** ..... **79.95****MICROSOFT Multiplan** ..... **119.95****ENSEMBLE** ..... **189.95****HELIX** ..... **239.95****VIDEX UltraTerm** ..... **189.95****MICROSCI A2 Drive** ..... **169.95**THOUSANDS OF ITEMS AVAILABLE.  
CALL FOR COMPLETE PRICING.

## CALIFORNIA MICRO HOUSE

16835 Algonquin St., Huntington Beach, CA 92649  
TELEX # 5101011798 CAL MICRO

Corporate accounts welcomed, purchase orders accepted with net 15 day terms, subject to credit approval. To expedite shipping of purchase orders, please use telex #. Also, use telex # for price quotations. All prices represent cash, prepaid discount. All items shipped next day in factory sealed packages. We guarantee all items for 30 days. California residents please add 6% sales tax. Prices subject to change without notice.

# C·L·U·B·S & N·E·W·S·L·E·T·T·E·R·S

**CHAPTER XI OSBORNE USERS' GROUP**, Charles M. Greene, 18799 Rio Vista Dr., Tequesta, FL 33458. Monthly meetings, newsletter.

**FORT McMURRAY BBS**, Peter Steeper, Brick Shirthouse, 226 Gregoire Dr., Fort McMurray, Alberta T9H 4K6, Canada, (403) 791-9388. Public-domain software BBS at (403) 791-9367.

**LOGIC**, Department B, Box 696, Station B, Willowdale, Ontario M2K 2P9, Canada. For Apple users. SIGs, technical assistance, public-domain software library, monthly magazine, and 300-bps BBS at (416) 445-5192.

**PIONEER VALLEY PC USERS GROUP (PVPCUG)**, Jeff Kane, POB H, North Amherst, MA 01059, (413) 549-4930. Monthly meetings for personal computer users between Springfield, MA, and Brattleboro, VT. Affiliated with the Boston Computer Society.

**LATHAM/ALBANY/TROY KAYPRO USERS GROUP (LATKUG)**, Paul Spannauer, 16 Maple St., Latham, NY 12110. Monthly meetings and newsletter, public-domain software library.

**IN TOUCH**, 3632 CTH I, Saukville, WI 53080. Bimonthly newsletter listing user-written software and used hardware. Annual subscription: \$2.

**TRS-80 COMPUTER SOCIETY OF DIABLO VALLEY**, Susan Copeland, POB 23438, Pleasant Hill, CA 94523, (415) 372-7003. Monthly meetings in Concord, CA, BBS, bulletin, and library. Annual dues: \$20; three-month trial: \$5.

**SCIENCENET**, Omnet Inc., 70 Tonawanda St., Boston, MA 02124, (617) 265-9230. An electronic mail service for research groups. Subscription to bimonthly newsletter free to potential users.

**LOS ANGELES MORROW USERS GROUP**, Seymour Saks, 1072 Stearns Dr., Los Angeles, CA 90035, (213) 939-3482. Monthly newsletter and meetings, public-domain software library.

**TRULY PORTABLE**, POB 1169, Berkeley, CA 94701, (415) 658-1889. Newsletter for NEC PC-8201A, Radio Shack Model 100, Epson Geneva, HP 110, and other portables. Subscription: \$16 for 10 issues; \$28 overseas; sample issue, \$2.50.

**MACINTOSH COMPUTER USERS GROUP OF THE SANGAMON VALLEY**, Mark Pence, 1540 West Cook St., Springfield, IL 62704, (217) 546-2782. Informal monthly meetings to discuss the Macintosh.

**GREATER COLUMBIA AREA XEROX USER GROUP**, Ed Bachman, HCFA, 2F3 Meadows East Building, 6300 Security Blvd., Baltimore, MD 21235, (301) 597-3069; Joan McGuire, (301) 594-0128. For users of Xerox 860, 820, 16/8, and Ethernet.

**JACKSONVILLE ATARI COMPUTER ENTHUSIASTS (JACE)**, 1187 Dunbar Court, Orange Park, FL 32073. Monthly meetings and demonstrations, newsletter, disk and cassette software library, 24-hour BBS at (904) 733-4515. Annual dues: \$10.

**FUTURE GENERATIONS COMPUTER SYSTEMS**, Karin van Schouten, North-Holland, P.O. Box 1991, 1000 BZ Amsterdam, The Netherlands. Journal for scientists, managers, and policymakers in the information industry. Subscription: \$156.30. For a free copy, write Elsevier Science Publishing Co. Inc., POB 1663, Grand Central Station, New York, NY 10163.

**GRAND RAPIDS IBM PC USERS GROUP**, Steve Hickel, 6441 28th St. SE, Grand Rapids, MI 49506, (616) 972-2178. Monthly meetings and newsletter. BBS, discounts on disks. Annual fee: \$20.

**NORTH STAR BBS**, Brian Holmes, POB 292, Lynwood, CA 90262. 24-hour, 300/1200-bps BBS in Downey, CA, on CP/M public-domain software, at (213) 861-2313. ■

*CLUBS & NEWSLETTERS is an acknowledgment of new clubs and newsletters received at BYTE. Please allow at least four months for your club's mention to appear. Send information to BYTE, Clubs & Newsletters, POB 372, Hancock, NH 03449.*





# The C for Microcomputers

PC-DOS, MS-DOS, CP/M-86, Macintosh, Amiga, Apple II, CP/M-80, Radio Shack, Commodore, XENIX, ROM, and Cross Development systems

## MS-DOS, PC-DOS, CP/M-86, XENIX, 8086/80x86 ROM

### Manx Aztec C86

"A compiler that has many strengths... quite valuable for serious work"

Computer Language review, February 1985

**Great Code:** Manx Aztec C86 generates fast executing compact code. The benchmark results below are from a study conducted by Manx. The Dhrystone benchmark (CACM 10/84 27:10 p1018) measures performance for a systems software instruction mix. The results are without register variables. With register variables, Manx, Microsoft, and Mark Williams run proportionately faster. Lattice and Computer Innovations show no improvement.

	Execution Time	Code Size	Compile/Link Time
<b>Dhrystone Benchmark</b>			
Manx Aztec C86 3.3	34 secs	5,760	93 secs
Microsoft C 3.0	34 secs	7,146	119 secs
Optimized C86 2.20J	53 secs	11,009	172 secs
Mark Williams 2.0	56 secs	12,980	113 secs
Lattice 2.14	89 secs	20,404	117 secs

**Great Features:** Manx Aztec C86 is bundled with a powerful array of well documented productivity tools, library routines and features.

Optimized C compiler	Symbolic Debugger
AS86 Macro Assembler	LN86 Overlay Linker
80186/80286 Support	Librarian
8087/80287 Sensing Lib	Profiler
Extensive UNIX Library	DOS, Screen, & Graphics Lib
Large Memory Model	Intel Object Option
Z (vi) Source Editor -c	CP/M-86 Library -c
ROM Support Package -c	INTEL HEX Utility -c
Library Source Code -c	Mixed memory models -c
MAKE, DIFF, and GREP -c	Source Debugger -c
One year of updates -c	CP/M-86 Library -c

Manx offers two commercial development systems, Aztec C86-c and Aztec C86-d. Items marked -c are special features of the Aztec C86-c system.

<b>Aztec C86-c Commercial System</b>	<b>\$499</b>
<b>Aztec C86-d Developer's System</b>	<b>\$299</b>
<b>Aztec C86-p Personal System</b>	<b>\$199</b>
<b>Aztec C86-a Apprentice System</b>	<b>\$49</b>

All systems are upgradable by paying the difference in price plus \$10.

**Third Party Software:** There are a number of high quality support packages for Manx Aztec C86 for screen management, graphics, database management, and software development.

<b>C-tree \$395</b>	<b>Greenleaf \$185</b>
<b>PHACT \$250</b>	<b>PC-lint \$98</b>
<b>HALO \$250</b>	<b>Amber Windows \$59</b>
<b>PRE-C \$395</b>	<b>Windows for C \$195</b>
<b>WindScreen \$149</b>	<b>FirsTime \$295</b>
<b>SunScreen \$99</b>	<b>C Util Lib \$185</b>
<b>PANEL \$295</b>	<b>Plink-86 \$395</b>

## MACINTOSH, AMIGA, XENIX, CP/M-68K, 68k ROM

### Manx Aztec C68k

"Library handling is very flexible... documentation is excellent... the shell a pleasure to work in... blows away the competition for pure compile speed... an excellent effort."

Computer Language review, April 1985

Aztec C68k is the most widely used commercial C compiler for the Macintosh. Its quality, performance, and completeness place Manx Aztec C68k in a position beyond comparison. It is available in several upgradable versions.

Optimized C Macro Assembler	Creates Clickable Applications
Overlay Linker	Mouse Enhanced SHELL
Resource Compiler	Easy Access to Mac Toolbox
Debuggers	UNIX Library Functions
Librarian	Terminal Emulator (Source)
Source Editor	Clear Detailed Documentation
MacRam Disk -c	C-Stuff Library
Library Source -c	UniTools (vi,make,diff,grep) -c
	One Year of Updates -c

Items marked -c are available only in the Manx Aztec C86-c system. Other features are in both the Aztec C86-d and Aztec C86-c systems.

<b>Aztec C68k-c Commercial System</b>	<b>\$499</b>
<b>Aztec C68d-d Developer's System</b>	<b>\$299</b>
<b>Aztec C68k-p Personal System</b>	<b>\$199</b>
<b>C-tree database (source)</b>	<b>\$399</b>
<b>AMIGA, CP/M-68k, 68k UNIX</b>	<b>call</b>

## Apple II, Commodore, 65xx, 65C02 ROM

### Manx Aztec C65

"The AZTEC C system is one of the finest software packages I have seen"

NIBBLE review, July 1984

A vast amount of business, consumer, and educational software is implemented in Manx Aztec C65. The quality and comprehensiveness of this system is competitive with 16 bit C systems. The system includes a full optimized C compiler, 6502 assembler, linkage editor, UNIX library, screen and graphics libraries, shell, and much more. The Apple II version runs under DOS 3.3, and ProDOS, Cross versions are available.

The Aztec C65-c/128 Commodore system runs under the C128 CP/M environment and generates programs for the C64, C128, and CP/M environments. Call for prices and availability of Apprentice, Personal and Developer versions for the Commodore 64 and 128 machines.

<b>Aztec C65-c ProDOS &amp; DOS 3.3</b>	<b>\$399</b>
<b>Aztec C65-d Apple DOS 3.3</b>	<b>\$199</b>
<b>Aztec C65-p Apple Personal system</b>	<b>\$99</b>
<b>Aztec C65-a for learning C</b>	<b>\$49</b>
<b>Aztec C65-c/128 C64, C128, CP/M</b>	<b>\$399</b>

### Distribution of Manx Aztec C

In the USA, Manx Software Systems is the sole and exclusive distributor of Aztec C. Any telephone or mail order sales other than through Manx are unauthorized.

## Manx Cross Development Systems

Cross developed programs are edited, compiled, assembled, and linked on one machine (the HOST) and transferred to another machine (the TARGET) for execution. This method is useful where the target machine is slower or more limited than the HOST. Manx cross compilers are used heavily to develop software for business, consumer, scientific, industrial, research, and educational applications.

**HOSTS:** VAX UNIX (\$3000), PDP-11 UNIX (\$2000), MS-DOS (\$750), CP/M (\$750), MACINTOSH (\$750), CP/M-68k (\$750), XENIX (\$750).

**TARGETS:** MS-DOS, CP/M-86, Macintosh, CP/M-68k, CP/M-80, TRS-80 3 & 4, Apple II, Commodore C64, 8086/80x86 ROM, 68xxx ROM, 8080/8085/Z80 ROM, 65xx ROM.

The first TARGET is included in the price of the HOST system. Additional TARGETS are \$300 to \$500 (non VAX) or \$1000 (VAX).

Call Manx for information on cross development to the 68000, 65816, Amiga, C128, CP/M-68k, VRTX, and others.

## CP/M, Radio Shack, 8080/8085/Z80 ROM

### Manx Aztec CII

"I've had a lot of experience with different C compilers, but the Aztec C80 Compiler and Professional Development System is the best I've seen."

80-Micro, December, 1984, John B. Harrell III

<b>Aztec C II-c (CP/M &amp; ROM)</b>	<b>\$349</b>
<b>Aztec C II-d (CP/M)</b>	<b>\$199</b>
<b>C-tree database (source)</b>	<b>\$399</b>
<b>Aztec C80-c (TRS-80 3 &amp; 4)</b>	<b>\$299</b>
<b>Aztec C80-d (TRS-80 3 &amp; 4)</b>	<b>\$199</b>

### How To Become an Aztec C User

To become an Aztec C user call 1-800-221-0440 or call 1-800-832-9273 (800TEC WARE). In NJ or outside the USA call 201-530-7997. Orders can also be telexed to 4995812.

Payment can be by check, COD, American Express, VISA, Master Card, or Net 30 to qualified customers.

Orders can also be mailed to Manx Software Systems, Box 55, Shrewsbury, NJ 07701.

### How To Get More Information

To get more information on Manx Aztec C and related products, call 1-800-221-0440, or 201-530-7997, or write to Manx Software Systems.

### 30 Day Guarantee

Any Manx Aztec C development system can be returned within 30 days for a refund if it fails to meet your needs. The only restrictions are that the original purchase must be directly from Manx, shipped within the USA, and the package must be in resalable condition. Returned items must be received by Manx within 30 days. A small restocking fee may be required.

### Discounts

There are special discounts available to professors, students, and consultants. A discount is also available on a "trade in" basis for users of competing systems. Call for information.

Inquiry 229

# MANX

To order or for information call:

## 800-221-0440



# EVEREX EVER FOR EXCELLENCE



LOTUS 1-2-3 132 COLUMNS



PC PAINT



PC PAINTBRUSH 720x348



SYMPHONY HIGH RESOLUTION



PC PAINT

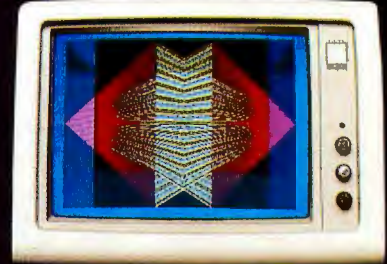

16 COLORS, 320x200

The Edge



The Plain Facts:

EVEREX THE EDGE	Everex The Edge	Paradise Modular Graphics Card	Tecmar Graphics Master	Tseng Lab Ultra Pak	Persyst Bob	Hercules Graphics Card
• IBM Monochrome Compatible, 720x348, High Resolution	/		/	/		/
• Runs Lotus 1-2-3™ and Symphony™ in high resolution monochrome:	/		/			/
– 132 columnsx25 rows	/			/		
– 132 columnsx44 rows	/			/		
• PC Paintbrush in monochrome	/		/	/		/
• 16 shades of green on the IBM monochrome monitor	/	/				
• Runs color software on the IBM monochrome monitor, full screen:	/	/				
– Flight Simulator	/	/				
– PC Paintbrush	/	/				
– PC Paint	/	/				
– PC Tutor	/	/				
– Pinball	/	/				
– Without software patch needed	/	/				
• Automatic Boot-up without software patch needed	/		/	/	/	/
• Runs Lotus 1-2-3™ and Symphony™ in high resolution color:	/		/			
– 16 colors, 320x200	/		/			
– 4 colors, 640x200	/		/			
• Printer port (standard)	/		/		/	/
• Software switchable among color, monochrome and 132 columns mode	/		/			
• Price	\$399	\$395	\$695	\$680	\$595	\$499

Excellence is the standard at Everex—it's in our name, our products, in everything we do. When you look for the best for your computer—you'll find Everex products.

Visit your local Everex dealer today and ask to see Everex products in action. For the name of your nearest Everex dealer, please call (415) 498-1111.

Registered Trademarks: Paradise Modular Graphics Card—Paradise Systems, Inc.; Hercules Graphics Card—Hercules Computer Technology; Lotus 1-2-3—Lotus Development Corporation; PC Paint—Mouse Systems Corporation; Tecmar Graphics Master—Tecmar Inc.; Persyst Bob—Persyst Products; Ultra Pak—Tseng Lab.; The Edge—Everex Systems Inc.; IBM, PC Tutorial—International Business Machines Corporation; Flight Simulator—Microsoft Corporation.

Dealer Hotline: (800) 821-0808. In CA (800) 821-0807.

Imaging Engineering Ultimo, Australia TLX: 74349 IMAGIN AA  
Microage Distribution Ltd. London, England TLX: 881 3241 WONGS G  
Feeder Paris, France TLX: 4413241 FEEDER  
Automated Office Systems Hout Bay, South Africa 2721-70-8091  
Survex, 1027 Speers Road, Oakville, Ontario Canada L6L-2X5, 416-842-6093  
Pride Computers, 102-8187 Main Street, Vancouver, British Columbia, V5X 3L2, 604-321-5690

**EVEREX**  
EVER for EXcellence

Address: 47777 Warm Springs Blvd., Fremont, CA 94539 (415) 498-1111.



# B·O·O·K R·E·V·I·E·W·S

A COMPUTER & COMMUNICATIONS NETWORK PERFORMANCE ANALYSIS PRIMER  
B. W. Stuck  
and E. Arthurs  
Prentice-Hall  
Englewood Cliffs, NJ: 1985  
624 pages, \$38.95

APPLIED PROGRAMMING TECHNIQUES IN C  
Terry A. Ward  
Scott, Foresman and Co.  
Glenview, IL: 1985  
268 pages, \$19.95

DIAGRAMMING TECHNIQUES FOR ANALYSTS AND PROGRAMMERS  
James Martin  
and Carma McClure  
Prentice-Hall  
Englewood Cliffs, NJ: 1985  
416 pages, \$40

INTRODUCTION TO COMPUTER ENGINEERING  
Franco P. Preparata  
Harper & Row  
New York: 1985  
336 pages, \$37.95

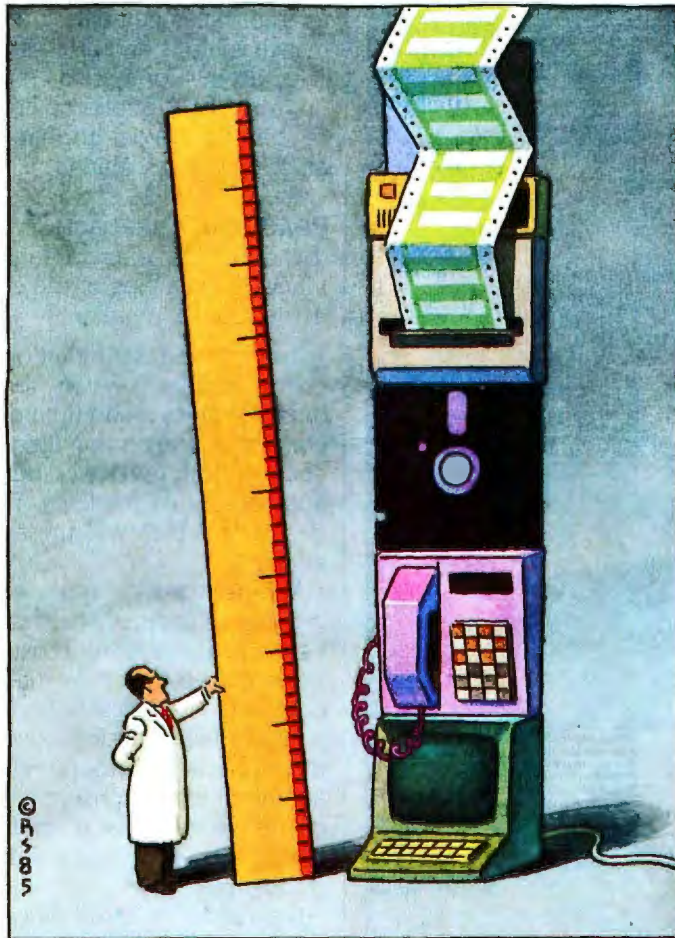

who built from scratch a 68000 system as relaxation from his daytime job on a huge SNA (IBM's Systems Network Architecture) network; another computes for fun on an Apple II at home but his vocation is designing on-line transaction-processing systems for a worldwide airline. One of my jobs as system administrator for the two UNIX-based computers that host the BYTE Information Exchange (BIX) was to help find the right mix of port assignments (hard-wired, local network, public-switched network, leased lines, Tymnet) to optimize access and response and minimize cost.

A book that will appeal to many BYTE readers is *A Computer & Communications Network Performance Analysis Primer* by B. W. Stuck and E. Arthurs, both computer scientists at Bell Laboratories. It is a guide to attacking performance-analysis problems in these and other

A COMPUTER & COMMUNICATIONS NETWORK PERFORMANCE ANALYSIS PRIMER  
Reviewed by Mark Klein

Many of us have struggled with performance problems in computer systems. When CP/M version 2 arrived, we worked to find the optimal sector size to use when formatting disks. Today we worry about effective throughput in local-area networks (LANs) as a function of variables such as transmission speed, message size, or network topology. In making these design decisions, many of us have often relied on an intuition developed by experience.

Of course, performance-analysis problems are not limited to the microcomputer world. I met a BYTE reader

types of systems. The book is not easy reading. It was written from material used to teach a graduate-level computer science course within Bell Labs. The authors assume that you have basic math skills such as linear programming and calculus, that you understand what operating systems are supposed to do, and that you don't blink at terms such as Poisson statistics, packet switching, link-level flow control, blocking, and queueing networks.

But it would be a mistake for a reader to think that this important material is inaccessible just because the book is full of equations and strange terms. A manager without a technical background shouldn't expect to find out from this book whether the planned order-entry system for a company needs a microcomputer or a superminicomputer. Someone else working for that company, however,

(continued)



DISK/COVERS  
\$100  
MAIN/FRAMES  
SINGLE BOARD

8" & 5"  
WINCHESTER  
& FLOPPY

**C  
H  
A  
S  
S  
I  
S  
L  
A  
N  
D  
/  
U  
S  
A**

100  
STANDARD  
MODELS

CUSTOM  
TOOL

DON'T  
SEE  
WHAT  
YOU NEED?  
CALL  
&  
ASK

**FROM  
\$100  
INCLUDING  
POWER SUPPLY**

32 Page  
Free Fakt  
Pakt Catalog

**BUILT LIKE  
A TANK —  
WON'T  
BREAK  
THE BANK!**

\* 1 Piece: Prices lower in quantity.

**3310**  
5" Floppy &  
Winchester  
4 Cards \$100  
**\$387\***



**3307**  
8" Floppy  
& 5" Winchester  
7 Cards \$100  
**\$494\***

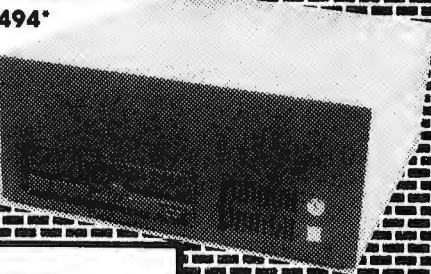

**3002T**  
5" Floppy  
& Winchester  
10 Cards \$100  
**\$565\***

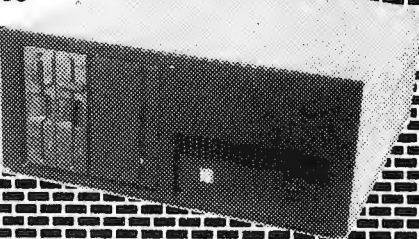

(Disk drives and computer cards not included.)

Write or call for our brochure which includes our application note: "Making micros, better than any 'ol box computer."

**INTEGRAND**

RESEARCH CORPORATION

8620 Roosevelt Ave./Visalia, CA 93291  
209/651-1203

We accept BankAmericard/Visa and MasterCard

## BOOK REVIEWS

could use the book to assess the resource needs and offer detailed quantitative support for a decision to buy, say, a VAX-11/780 instead of an 11/750.

Stuck and Arthurs take an engineer's approach. The book is, as the title claims, a primer. The authors teach by example and case study. They describe a computer communications system using flow diagrams and system data (and they don't split hairs on what is computer and what is communications). They quantify performance with a list of measurements, present the results of a performance analysis, and discuss the significance of the results. They do this for systems ranging from secretaries lining up to use a photocopier to an on-line transaction-processing system to handle telephone repairs. The analyses are fascinating.

### PRACTICAL APPROACH

To indicate the concrete, engineer's approach of this book, I include examples of the types of problems Stuck and Arthurs pose.

—The writers describe an on-line point-of-sale computer communications system for a widget retailer, down to details such as mean time per disk access, what files are created and when (log files, credit-check files, inventory-control files), processor busy time per transaction, and number of disk spindles. The question follows: "Is this design feasible? Will the system meet its performance goals?"

—Another transaction-processing problem begins by suggesting alternative hardware configurations: a high-performance system costing \$200,000 and a low-performance system at half that cost. After two more pages of system description, including possible combinations of the two basic hardware configurations that divide the application programs and operating-system code among different subsystems, the reader is asked to "calculate the total cost to operate each [of four] configuration[s] for five years, and the ratio of cost divided by throughput."

—The reader is asked to compare performance of two systems. In the first system, one secretary is assigned to 10 professionals and handles all document-preparation needs. In the second system, a text-processing center is set up.

—Another problem deals with insurance agents who dial up through a voice telephone network to a central computer and then use a terminal connected to a modem to query about different types of policies for potential customers. After considerable details, the reader is asked to figure out "how many modems are needed if the fraction of queries blocked due to no modem being available is no more than one query in ten."

Stuck and Arthurs subject packet-switching systems and local-area networks to this kind of nitty-gritty analysis throughout the book. Several aspects of these systems are

(continued)



Available  
for IBM PC

# What C did for Programming

## Mark Williams has done for C Programming

### The C Programming System from Mark Williams

MWC86 gets your C programs running faster and uses less memory space than any other compiler on the market. Then *csd*, Mark Williams' revolutionary C Source Debugger, helps you debug faster. That's The C Programming System from Mark Williams Company.

### MWC86

MWC86 is the most highly optimized C compiler available anywhere for the DOS and 8086 environment. The benchmarks prove it! They show MWC86 is unmatched in speed and code density.

MWC86 supports large and small models of compilation, the 8087 math coprocessor and DOS 2.0 pathnames. The compiler features common code elimination, peephole optimization and register variables. It includes the most complete libraries. Unlike its competition, MWC86 supports the full C language including recent extensions such as the Berkeley structure rules, voids, enumerated data types, UNIX\* I/O calls and structure assignments.

Quality is why Intel, DEC and Wang chose to distribute MWC86. These industry leaders looked and compared and found Mark Williams to be best.

### User Friendly

MWC86 is the easiest to use of all compilers. One command runs all phases from pre-processor to assembler and linker. MWC86 eliminates the need to search for error messages in the back of a manual. All error messages appear on the screen in English.

A recent review of MWC86 in *PC World*, June, 1984, summed it up:

*"Of all the compilers reviewed, MWC86 would be my first choice for product development. It compiles quickly, produces superior error messages, and generates quick, compact object code. The library is small and fast and closely follows the industry standard for C libraries."*

### *csd* C Source Debugger

Mark Williams was not content to write the best C compiler on the market. To advance the state of the art in software development, Mark Williams wrote *csd*.

*csd* C Source Debugger serves as a microscope on the program. Any C expression can be entered and evaluated. With *csd* a programmer can set tracepoints on variables and expressions with full history capability and can single step a program to find bugs. The debugger does not affect either code size or execution time. *csd* features online help instructions; the ability to walk through the stack; the debugging of graphics programs without disturb-

ing the program under test; and evaluation, source, program and history windows.

*csd* eases the most difficult part of development — debugging. Because *csd* debugs in C, not assembler, a programmer no longer has to rely on old-fashioned assembler tools, but can work as if using a C interpreter — in real time.

### The C Programming System from Mark Williams now supports the following third party software:

Windows for C, Halo, PHACT, The Greenleaf Functions, Btrieve, Panel, Plink 86, cView, C Utility Library, C Tree, The Application Programmer's Tool Kit, C Power Packs, PCLOCATE, Super C Index System, Opt-Tech Sort, Safe C Interpreter, C-terp, ProScreen, BRIEF, C Helper.

### The C Programming System from Mark Williams

The C Programming System from Mark Williams delivers not only the best C compiler for the 8086 but also the revolutionary *csd* C source level debugger. That's why it does for C programming what C did for programming. The Mark Williams C Programming System gives the programmer the MWC86 C compiler and the *csd* C Source Debugger for only \$495.

Order today by calling 1-800-MWC-1700. Major credit cards accepted.

Technical support for The Mark Williams C Programming System is provided free of charge by the team that developed it.

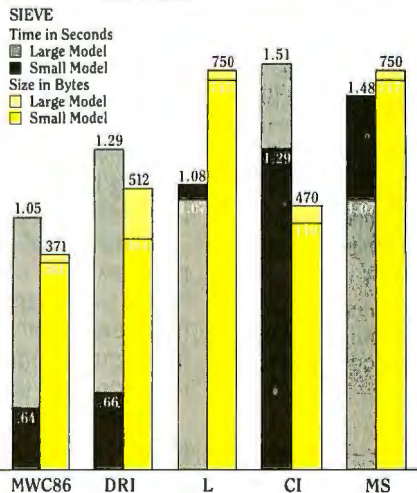

\*Unix is a Trademark of Bell Laboratories.



Mark Williams Company  
1430 W. Wrightwood Ave.  
Chicago, IL 60614



**For All IBM PC & XT & Compatibles . . .  
ELIMINATE NUM-LOCK!**



**KEYPATCH™ -10** - A full travel mini-keyboard. Plugs between keyboard connector and CPU. Automatically activates NUM-LOCK placing your IBM™ keyboard into the number pad mode while **KEYPATCH™ -10** provides separate cursor and screen control functions without the use of the NUM-LOCK key. Saves time — eliminates errors. **KEYPATCH™ -10** requires no software. A must for spread sheets; word processing; graphics; etc.

For Immediate Shipment

**Genest Technologies, Inc.**

1331 E. Edinger Ave.  
Santa Ana, Calif. 92705

**(714) 547-0880**

\*Patents Pending  
KEYPATCH™ is a trademark of Genest Technologies, Inc.  
IBM™ is a trademark of International Business Machines Corp.

**IBM PC/XT . . . . . \$84.95**

**Compatibles\* . . . . . \$89.95**

\*Zenith - ITT - Columbia - NCR  
Leading Edge - Sperry - Desk Pro  
— PLEASE SPECIFY SYSTEM —  
(Cal. Res. Add 6% Sales Tax)  
Visa, Master Card, Check, Money Order  
Plus \$2<sup>00</sup> Shipping

**BOOK REVIEWS**

studied. The last chapter is devoted to an in-depth, use-all-the-tools analysis of LANs,

**OFFICE COMMUNICATIONS**

One particularly relevant and readable chapter covers office communications. The premise to this section is that "the fundamental idea in office automation is to move ideas or information to people and not vice versa." For openers, there is a quantitative analysis of telephone tag; the frightening conclusion is that when "the mean number of tags increases to three, then the maximum mean throughput rate (completed calls) drops to one call lasting ten minutes every 203.5 minutes!" For comparison, the authors cover a voice-storage system.

Other topics in this chapter include copying and reproduction, document preparation, LANs, workstation productivity gains, and the interaction between secretaries and managers. Discussion of a sophisticated model of an automated office system is accompanied by relevant graphs of document-completion rate versus number of secretaries, questions pertaining to how many secretaries can be active inside a document-preparation system before congestion becomes unacceptable, and an analysis of the minimum set of numbers needed to say anything pertinent about these kinds of systems.

**BOTTLENECK DESIGN**

Office communications is just one of many systems to which the authors apply their ideas about bottlenecks. Early on, the reader is cautioned to remember that there will always be (by definition) some bottleneck; however, "the design problem is to choose where the bottleneck should be." For example, in their analysis of potential productivity gains that might be achieved in an automated office by giving workstations to professionals, Stuck and Arthurs quantitatively examine the effect of voice and electronic mail on three alternative bottlenecks: meetings, telephone calls, and documentation (filing, gaining access to reports, etc.).

Later they study a proposal to add an LAN to an office system currently running from a central processor. Potential bottlenecks are the clerks (who might not generate enough load to keep the system busy), terminals, central processing unit, disk system, printer, or terminal controller. Putting in the numbers for this particular example shows that the disk is the bottleneck. The authors conclude that "adding a local area network will not significantly improve performance, because the terminal controller [does not] reach complete utilization first." Of course, different numbers might lead to a different conclusion; the authors frequently suggest plugging in the numbers for the reader's own situation.

It is this kind of practical, quantitative analysis that makes the book so valuable. Many computer systems, large and small, are configured according to what feels right to the system designer. Stuck and Arthurs give us some sub-

(continued)

**The Ultimate Cable Assembly**

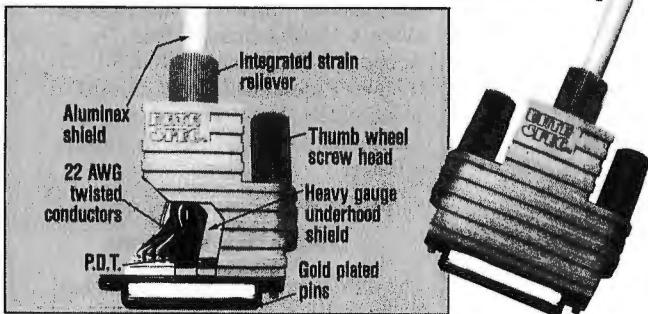

**Inside and Out**

You've never seen a cable that looks or works quite like this. The result of extensive research into functional design, the DATA SPEC cable assembly not only visually enhances your computer equipment, but provides superior quality with the following features:

- Full shielding (Exceeds F.C.C. EMI/RFI emission requirements)
- Positive strain relief
- Large convenient thumbscrews
- Gold plated pins
- Exclusive P.D.T. underhood for maximum integrity
- Lifetime warranty

DATA SPEC makes cable assemblies for all your interface needs: printers, modems, disk drives and monitors. For your IBM, Apple, AT&T and other popular PC's. Ask for DATA SPEC cables at your nearest authorized DATA SPEC dealer.

**DATA SPEC®**

FROM ALLIANCE RESEARCH CORPORATION  
20120 Plummer Street • Chatsworth, CA 91311 • 1-818-993-1202

IBM, Apple and AT&T are registered trademarks respectively of International Business Machines Corp., Apple Computer Inc. and AT&T Information Systems. Patent PND. ©Copyright 1985 Alliance Research Corporation



# Mark Williams

Now the biggest name  
in C compilers comes in a size  
everybody can afford.  
**Let's C.™**

**Introducing Mark Williams' \$75 C compiler.** Want to explore C programming for the first time? Or just on your own time? Now you can do it in a big way without spending that way. With Let's C.

This is no little beginner's model. Let's C is a powerful programming tool, packed with all the essentials of the famous Mark Williams C Programming System. The one chosen by Intel, DEC, Wang and thousands of professional programmers. The one that wins the benchmarks and the reviewers' praise:

**Mark Williams Let's C**

- For the IBM-PC and MS-DOS
- Fast compact code plus register variables
- Full Kernighan & Ritchie C and extensions
- Full UNIX compatibility and complete libraries
- Small memory model
- Many powerful utilities including linker, assembler, archiver, cc one-step compiling, egrep, pr, tail, wc
- MicroEMACS full screen editor with source
- Supported by dozens of third party libraries
- Upgradeable to C Programming System for large scale applications development

**Let's C Benchmark Done on an IBM-PC/XT, no 8087.**  
Program: Floating Point from BYTE, August, 1983.

Exec Time in Seconds

Let's C	134.20
MS 3.0	347.45

*"(This compiler) has the most professional feel of any package we tested..."—BYTE*  
*"Of all the compilers reviewed, (it) would be my first choice for product development."—David Wilson, PC WORLD*

And now for more big news. Get our revolutionary csd C Source

Debugger for just \$75, too. You can breeze through debugging at the C source level ignoring clunky assembler code.

Affordable, powerful, debuggable. Mark Williams Let's C is the big name C compiler at a price you can handle. Get your hands on it now.

Use this coupon or charge by calling toll-free:  
1-800-MWC-1700. In Ill. call 312-472-6659.

Mark Williams Let's C

**\$75**

Please send me:

\_\_\_\_\_ copies of Let's C and \_\_\_\_\_ copies of csd (C Source Debugger) at \$75 each. (Ill. residents add 7% sales tax.)

Check    Money Order    Visa, MasterCard or American Express

Name \_\_\_\_\_

Address \_\_\_\_\_

City \_\_\_\_\_ State \_\_\_\_\_ Zip \_\_\_\_\_

Card # \_\_\_\_\_ Exp. Date \_\_\_\_\_

Signature \_\_\_\_\_



**Mark Williams Company**

1430 West Wrightwood  
Chicago, Illinois 60614

Inquiry 231



# FASTEST SERVICE IN THE INDUSTRY

## IT'S OUR REPUTATION

### Standard Forms Shipped From Our Plant To You...In 3 Days!

Standard computer forms compatible with over 400 software programs can be shipped from our plant to you...in just 3 days! That's fast. Even our custom service is fast. Most custom orders are shipped in 5 to 10 days. Service this fast means no unnecessary delay. You are guaranteed what you want — when you want it!



### FREE CATALOG and COMPATIBILITY GUIDE . . .

Request your FREE 32 page catalog complete with a software/forms Compatibility Guide. Call Toll Free: 1-800-328-5727, Ext. 516 In Minnesota, 1-800-742-5685



**DELUXE**

COMPUTER FORMS

7763

A DIVISION OF DELUXE CHECK PRINTERS, INC.

## BOOK REVIEWS

stance on which to base systems decisions. Even more, for someone willing to read the text and work the problems, they offer a path to developing the intuition that is such a crucial part of system design.

Mark Klein (8 Bay Rd., Newmarket, NH 03857) has been involved with the BYTE Information Exchange (BIX) since its inception. He is BYTE's contributing editor on communications. His consulting firm, Channel Computing, specializes in communications technology.

### APPLIED PROGRAMMING TECHNIQUES IN C

Reviewed by Phil Hughes

Terry A. Ward's new book on the C language, *Applied Programming Techniques in C*, provides examples of real, useful programs written in C. It does not try to teach you the C language. The people who might be interested in this type of text are those with a basic knowledge of C who want to see some extensive programs written in that language. Another group is composed of owners of CP/M or MS-DOS systems who want to add some UNIX-like utility programs at little cost.

The first chapter presents basic information on operating systems and covers selection of a programming language. Ward limits his discussion of operating systems to Apple DOS, MS-DOS, and CP/M. I was disappointed to see UNIX ignored at this point in the book. The conclusion is as expected—use C—but Ward goes through the paces discussing APL, FORTRAN, Pascal, PL/I, and, of course, BASIC. I take exception to several comments about FORTRAN and Pascal. In particular, Ward claims that few new applications are being written in FORTRAN. This may be the case in the microcomputer world but is certainly not the case in advanced engineering work.

In the next chapter Ward presents a very condensed description of C. This description and the remainder of the book talk about BD Software's version of C (BDS C). This section is poorly written and has quite a few errors. For example, the first program will not compile because there are two statements in the wrong order. The fifth line consisting of a left brace should be moved up before line 3 to correct this error. Another example is on page 23. There is no such operator as the Unary Plus. Also, the descriptions of increment and decrement operators are misleading. When referring to pointers, these operators modify the value of the pointer by the size of the datum pointed to.

Even for the experienced C programmer, these errors detract from the value of the book; it remains difficult to separate errors from dialect differences between C and BDS C.

### PROGRAMMING TOOLS

In the remaining chapters, the author presents various programming tools. He explains each program and docu-

(continued)



**YOU'VE GOT THE BEST PASCAL COMPILER!**

**NOW — GET THE BEST UTILITY!**

# TURBO SCREEN™

**\$49.95**



**NEVER AGAIN WRITE SOURCE CODE FOR SCREEN DISPLAYS!**

*If you LIKE Turbo Pascal\*, you'll LOVE TURBO SCREEN™!*

Tired of writing line after line of source code just to create effective screen displays and error-proof data handling? Then use TURBO SCREEN's Editor to create the screens, the Collator to define a list of screens... and then relax for a few seconds while the Generator writes the code!

## TURBO SCREEN™

- 100 Fields per screen, and up to 80 screens in your application.
- One screen or eighty, the size of your program doesn't change.
- I/O field types of:
  - Real, Integer, String, Character, Boolean.
- "Bullet-proof" data entry.
- Create Window-Style overlays or Full-screen pictures in CP/M\*, MS-DOS\*, or PC-DOS.
- Supports video attributes for your terminal. And YES, if you have an RGB monitor, you can create screens in COLOR on your IBM PC or true compatible.
- A SINGLE LINE of source code invoking TURBO SCREEN'S "display" procedure controls:
  - picture selection
  - output to screen, printer, or disk
  - I/O field update
- TURBO SCREEN™ is completely menu-driven and includes a built-in Screen Editor, Collator, and Generator, each called up with a single keystroke!
- ADVANCED EDITOR:
  - Turbo Pascal\*—like commands include:
    - Block commands for copy, fill, exchange, erase.
    - Draw lines in any direction with any character.
    - Supports IBM color monitor and graphics characters.
- FAST—Generates code for 20 screens in about 60 seconds!
- DISK UTILITIES built-in:
  - directories
  - erase files
- REQUIRES:
  - Turbo Pascal any version
  - 80x24 or larger video screen
- AVOID software "bottlenecks!"

## PASCOM COMPUTING

23611 Chagrin Blvd., Suite 101  
Cleveland, Ohio 44122

Check \_\_\_\_\_ TURBO SCREEN™  
 Money Order \_\_\_\_\_ package \$49.95  
 Plus Shp. (UPS) 5.00  
 Visa \_\_\_\_\_ Total \$54.95  
 Master Card \_\_\_\_\_  
 Card # \_\_\_\_\_  
 Exp. Date: \_\_\_\_\_

Start letting TURBO SCREEN™ write your I/O source code today!



ONLY — Call TOLL-FREE: 1-800-243-1849

Inside Ohio call 1-216-292-8745 (Lines Open 24 hours, 7 days)

Computer System: \_\_\_\_\_ 8-bit \_\_\_\_\_ 16-bit  
 Operating System: \_\_\_\_\_ CP/M80 \_\_\_\_\_ PC-DOS  
 \_\_\_\_\_ CP/M86 \_\_\_\_\_ MS-DOS  
 Computer Model: \_\_\_\_\_ Disk Format: \_\_\_\_\_  
 Name: \_\_\_\_\_  
 Address: \_\_\_\_\_  
 City: \_\_\_\_\_ State \_\_\_\_\_ Zip \_\_\_\_\_  
 Telephone: \_\_\_\_\_

Ohio residents add 6½% sales tax. Outside U.S.A. add \$20.00

U.S. Dealer Inquiries Welcome.

\*Turbo Pascal is a trademark of Borland International. IBM is a trademark of International Business Machines. MS-DOS is a trademark of Microsoft. CP/M is a trademark of Digital Research.



ORDERS ONLY

# 1-800-241-8149. TWO NUMBERS YO

Locally or across the nation, you're only a phone call away from the best advice, information, sales and service for all your computer needs.

At Micro Mart. A name you can trust.

We're proud to offer the widest range of computer products anywhere. At very competitive prices. With innovative financing options like the Micro Mart Blue Chip Credit Card.

When we say a product is available today, we mean today. Our Micro-to-Mainframe inventory system keeps our products current. And our customers satisfied. We deliver quickly because we're geared to ship hundreds of products daily to customers all over the world.

But we don't stop there. Micro Mart offers a comprehensive range of Technical Support and Customer Service after-the-sale. We're on-site with hundreds of service locations nationwide. And our National Service Center is one of the fastest depot services in the USA.

Call Micro Mart today. You'll meet people who back up price, availability and service with performance. You can count on it.

## COMPUTERS

AT&T Color and Mono Systems in stock \_\_\_\_\_ Start at \$1995  
**COMPUTER SPECIAL OF THE MONTH** Call for details! \_\_\_\_\_

## NETWORKING/ PROTOCOL CONVERSION

SNA & BISYNC 3780, 5251.  
Mod 11 & 12, 3274, 3278 \_\_\_\_\_  
PC TURBO 186 by ORCHID,  
80186 coprocessor board \$599  
IRMA Complete line \_\_\_\_\_  
From \$829

## PRINTERS & PLOTTERS

We have thousands in stock.  
**PRINTER SPECIAL OF THE MONTH** Call for details!  
HOUSTON INSTRUMENTS Plotters and Digitizers in stock \_\_\_\_\_  
DOT MATRIX

EPSON FX85/185 \_\_\_\_\_ NEW!  
EPSON LX80/100, LQ1500 \_\_\_\_\_  
COMREX 420, Epson compatible, 400cps \_\_\_\_\_ \$1695  
OKIDATA 192 & 193, ML84, Pacemark 2410 \_\_\_\_\_  
OKIDATA Color printers, complete line \_\_\_\_\_  
TOSHIBA P-351 & 1340 \_\_\_\_\_  
New Low Prices!  
TEXAS INSTRUMENTS 855 \_\_\_\_\_  
From \$729  
LETTER QUALITY  
NEC Spinwriters 2050, 3550, 8850 \_\_\_\_\_ New Low Prices!  
COMREX CR II E, CR III & CR IV \_\_\_\_\_ Start at \$369

We carry a full range of form handling options.

## FLOPPY DISK DRIVES

TANDON TM 100-2, DD/DS, 360K \_\_\_\_\_ New low, low price!  
1/2 HEIGHT Disk Drives from Shugart, Mitsubishi & TEAC. PC, XT & AT Compatible \$115  
**SPECIAL!** Two 1/2 Height Drives, "Y" cables & brackets. \_\_\_\_\_ \$219

## HARD DISCS

Micro Mart carries many of the major brands. If you don't see it—ask for it.  
PEACHTREE TECHNOLOGIES P-10, & 20, int. & ext. \_\_\_\_\_ From \$595  
SEAGATE Fast 20 Meg. int. for AT \_\_\_\_\_ From \$675  
PEACHTREE TECHNOLOGY New 1/2 Height Tape and Winchester back-up system \_\_\_\_\_ \$1395  
SYSGEN 10 & 20 Meg. w/streamer tape \_\_\_\_\_  
New Models—Call!

SYSGEN Image & Quickfile, Streamer tape for XT/AT \_\_\_\_\_  
New Price!  
BERNOULLI TECHNOLOGY Hard Disc Subsystems \_\_\_\_\_ \$2595

## CHIPS

All our chips are tested and priced for quick sale. Call us!  
INTEL 8087, 80287, high speed coproc. \_\_\_\_\_ \$125  
64K—256K RAMCHIPS \_\_\_\_\_  
Call for Market Price.  
128K Piggy-back chips for your AT \_\_\_\_\_ Call for Market Price.

## MULTIFUNCTION BOARDS

We have a complete line of Multifunction Boards compatible with the Portable, XT/AT.  
**THE BOARD SPECIAL OF THE MONTH** \_\_\_\_\_ Call for details!  
SIX PAK 64-384K, multifunc. \_\_\_\_\_  
MPIO RAMboards for PC's & compatibles \_\_\_\_\_  
I/O MINNIE I/O shortboard for Portable & AT \_\_\_\_\_

ADVANTAGE 128K-3Mb, expansion for AT \_\_\_\_\_  
QUADRAM QUADBOARD, 64-384K, multifunc. \_\_\_\_\_ \$239  
TECMAR CAPTAIN, 0-384K, multifunc. \_\_\_\_\_ \$185  
TALLTREE J-RAM II \_\_\_\_\_  
New Low Price!

## GRAPHIC CARDS

PREVIEW Mono Graphics/Hercules look-alike \_\_\_\_\_ \$269  
HERCULES Mono & Color Graphics cards New Low Prices!  
TECMAR Graphics Master, HiRes Color & Mono supports Lotus \_\_\_\_\_ \$449  
QUADRAM Quadcolor I & II color cards \_\_\_\_\_  
PARADISE Multi-display or modular graphics cards \_\_\_\_\_  
From \$199  
STB Chauffeur & Colorific \_\_\_\_\_ \$289 & \$189  
SIGMA Color 400 for PGS SR-12 \_\_\_\_\_ New Low Price!





# (404) 449-8089. INFORMATION

# U CAN COUNT ON.

## SOFTWARE

**SOFTWARE SPECIAL OF THE MONTH.** Call for details!

**ACCOUNTING**  
SORCIM/IUS Complete line including Windows From \$289/each

**SPREADSHEETS & INTEGRATED PACKAGES**  
MICROSOFT MultiPlan, w/templates

SORCIM SuperCalc 3, vers. 2.0 New Low Price!

**ENHANCEMENTS & UTILITIES**

FOX & GELLER Complete line for dBase II/III, Rbase 4000  
NORTON Utilities 3.0 \$69  
ROSESOFT ProKey 3.0 \$89

**CENTRAL POINT SOFTWARE**  
Copy II PC \$35

SOFTSTYLE Set FX+ and Printworks, printer control

**SIDEWAYS** Inverts printout

**BORLAND** SideKick and SuperKey From \$35

**LIVING VIDEO TEXT** Think Tank \$125

**COMPILERS & LANGUAGE TOOLS**

LATTICE C-Compilers \$299  
MICROSOFT Complete line

BORLAND Turbo Pascal, Turbo Toolbox & more

From \$35/each

**GRAPHICS & CAD**  
Micro Mart carries many of the major CAD packages. Call if you don't see it listed.

Z-SOFT PC Paintbrush, mouse graphics \$75

**DECISION RESOURCES**  
ChartMaster Latest version \$239

MICROPRO ChartStar  
MICROSOFT Chart \$169

**COMMUNICATIONS**  
MICROSTUF Crosstalk XVI. Latest version \$99

HAYES Smartcom II \$85

**WORD PROCESSORS**  
MULTIMATE w/spelling checker & tutorial New Low Price!

SAMNA +  
MICROSOFT Word. New version New Low Price!

LIFETREE Volkswriter Deluxe \$169

SSI WordPerfect, version 4.0 \$269

MICROPRO WordStar Professional series New Low Price!

**OFFICE & PROJECT PLANNING**

HARVARD Total Project Manager \$299

SORCIM/IUS Super Project  
MICROSOFT Project \$175

**DATA BASE MANAGERS**  
Call for unadvertised Data

Base Managers.  
MICRORIM 4000 or 5000, Report Writer & Clout

New Low Price!

WARNER SOFTWARE The Desk Organizer \$145

MICROSTUF Infoscope \$149

**MODEMS**

HAYES Smartmodem 300, 1200, 1200B & 2400. We have the best stock in the USA. Call!

VEN-TEL 1200 Baud Half Card w/Crosstalk \$419

POPCOM Int. & ext. w/voice & data

AST Reach Modems  
Special Introductory Price!

**MISCELLANEOUS**

DYSAN Diskettes at the lowest price in the USA. Call!

MOUSE SYSTEMS PC Mouse, optical w/software \$139

MICROSOFT Mouse, bus or serial mechanical

KEYTRONICS 5151 & 5152 keyboards From \$149

KENSINGTON MICROWARE MasterPiece \$99

CURTIS Accessories, Pedestals, cables, etc.

HAYES Mach II & Mach III Joysticks \$39/\$45

QUADRAM Microfazer print buffer 8-128K From \$129

TRIPPELITE ISOBAR surge protectors, 4 & 8 plug From \$49

POLAROID Palette \$1195

PTI Back-up power supplies New Low Prices!

**MONITORS AND CRT'S**

PGS Max 12 (E) amber, HX12, HX12 (E), & SR-12

New Low Prices!

QUADRAM Quadchrome, 690 dot RGB \$429

AMDEK Color 300, 500, 600, 700, 710, 725

AMDEK 300A/300G/310A \$129/\$119/\$165

©1985 Micro Mart, Inc.

Technology Corporate Campus 3159 Campus Drive

Norcross, Georgia 30071



# THE COMPUTER TELEMART

# MICRO MART™

Inquiry 242







## Inside Every PC-SHADOW™ Is a Network Solution

Increasingly, companies are taking a bottom-line approach to purchasing PCs. Everyone seems to wish that they could purchase an IBM PC with a built-in network for under \$1,000. Effectively, now you can...by combining the useability of PC-Shadow™ Workstations with the power of MultiLink Advanced!™

**PC-Shadow™...More Than Just a Terminal, It's a PC-Workstation.** If you know how to use an IBM PC, you already know how to use our PC-Workstation. Every key that's on a PC's keyboard is located in the same place on a PC-Shadow!™

Just like the PC, PC-Shadow!™ has an easy-to-read 25 line screen which supports all graphics characters and attributes that are on the IBM Monochrome Display.

Best of all, when you attach a printer to PC-Shadow's™ auxiliary port, you're able to get complete printouts of reports and analyses...not just a "print screen!"

**PC-DOS Networking Power At Your Fingertips.** PC-Shadow!™ was designed expressly to work with MultiLink Advanced!™ our software-driven, departmental networking solution. It transforms ONE IBM PC/XT or AT into the CPU of a multi-user, multi-tasking system.

Up to eight PC-Shadows!™ can be connected to a single computer sharing printers, hard disks, programs, and files.

100% compatibility with LANLink!™ our company-wide local area network, makes it possible for your PC-Shadow!™ network to grow with you.

**Net More by Spending Less.** At \$795 per workstation, PC-Shadows!™ represent the most cost-effective networking solution available. For complete details and the dealer nearest you, call The Software Link TODAY. VISA, MC, AMEX accepted.

# PC-SHADOW™



**THE SOFTWARE LINK, INC.**

**Developers of LANLink!™ and MultiLink Advanced!™**

8601 Dunwoody Place, Suite 632, Atlanta, GA 30338  
Telex 4996147 SWLINK

CALL: 404/998-0700  
Dealer Inquiries Invited

**THE SOFTWARE LINK, INC./CANADA**  
400 Esna Park Drive, Suite 18  
Toronto (Markham), Ont. L3R 3K2  
CALL: 416/477-5480

LANLink!™ MultiLink Advanced!™ and PC-Shadow!™  
are trademarks of The Software Link, Inc.  
IBM PC, XT, AT & PC-DDS are trademarks of IBM Corp



BOOK REVIEWS

ments the functions within programs. The first programs are simple utilities such as ones that handle word counting and file comparison.

When I started reading the section on text compression, I thought we were going to get into a meaty program. As Ward suggests, if you want a real text-compression program, you should get it from a CP/M users group. He then goes on with a set of programs to replace spaces with tabs and vice versa.

More than 100 pages are dedicated to a text editor, written by Ed Ream, called ed2. I have used a derivative of this editor and found it to be fast and reliable. But to avoid typing more than 50 pages of source code, you can either purchase it for almost nothing from the C Users' Group (POB 97, McPherson, KS 67460, (316) 241-1065) or buy the fancy, updated version called RED (for a reasonable price of \$95) directly from Edward K. Ream at 1850 Summit Ave., Madison, WI 53705, (608) 231-2952.

Other areas Ward covers include text formatting, telecommunications, sorting, and the Othello game. My biggest negative comment on the listings is that each program is written in the style of the author of the program. For example, some listings use the brace matching conventions of Kernighan and Ritchie, while others use the matching indentation styles more common in newer C books. Ward could have used these differences to his advantage by discussing the issue of style, but instead he ignored them. I expect this inconsistency will confuse the beginner.

The appendixes are extensive and provide sources for books, periodicals, C compilers, and public-domain software. There is even a cross-reference for articles written about C.

Ward offers notes on converting programs to and from BDS C. Unfortunately, some of them are wrong. For example, he claims that BDS C supports multiline comments and standard C does not support multiline comments. I suspect he confused this with nested comments. I can assure you that at least the C compilers that have a traceable parentage to Bell Laboratories support multiline comments.

*Applied Programming Techniques in C* is a disappointment. The appendixes that show sources of software and articles are the best part. It looks like Ward did a lot of research but then ran into a deadline and couldn't get the rest of the book together. For the newcomer to C who wants to look at some code, Ward presents a lot of it. There are things to be learned from the book. For the person who wants to get some tools up and running on a CP/M or MS-DOS system, I suggest they purchase the software from the sources of public-domain programs listed in the appendixes.

Phil Hughes (c/o Specialized Systems Consultants, POB 55549, Seattle, WA 98155) is a computer scientist who has worked with UNIX and C for more than five years.

(continued)

**FREE CATALOG**

## More Space Saving Products From LinTek Computer Accessories



Monitor Mover (Adjusts 4 ways) .....	\$149.95
Space Saver Arm (Adjusts 3 ways) .....	89.00
Dust Cover/Copy Holder (for IBM-PC) .....	24.95
Keyboard Drawer (25" x 15½" x 3½") .....	84.95
Medium Tilt & Turn (11" x 10" x 2½") .....	27.95
Large Tilt & Turn (14" x 14" x 2½") .....	34.95
PC Printer Stand (Fits all printers) .....	19.95
System Floor Stand (For IBM-PC) .....	23.95

\*\*\* SEND FOR FREE CATALOG \*\*\*

**LinTek**   
Computer Accessories

Dealer inquiries welcome.

P.O. Box 8056, Grand Rapids, MI 49508 (616) 241-4040



## SPECIAL DISKETTE OFFER

Dysan diskettes are the ultimate in quality flexible recording media for flexible disk drives. They are certified to be 100% error free on-track and between tracks. Diskettes are tested on-track as well as between tracks for missing pulse, extra pulse, and modulation. Quality is built into each diskette from the inside out. The ultra smooth disc surface is burnished on both sides to promote longer media life, longer head and load pad life, as well as better recording and playback performance. And to help introduce you to the Dysan quality standard we're running a special on their diskette product line.

**PLUS!** If you call, write, or utilize reader service in response to this ad—we'll send you our full-range catalog of computer supplies with Special Offers good for further savings on Dysan diskettes and many other quality products. **Dysan. The Finest Quality Diskettes Available.**

**LYBEN** Simply #1 in Service and Reliability.  
COMPUTER SYSTEMS

1050 E. Maple Rd.  
Troy, MI 48083  
Phone (313) 589-3440



# NOVA PC/XT

THE TOP OF THE LINE IBM COMPATIBLE  
SUMMER SPECIALS

**FEATURES:**

- Affordably priced PC/XT Computer
- Runs PC, MS-DOS, CPM/86
- Of course, this versatile computer runs Flight simulator, Lotus 1-2-3, Symphony, Framework, Peachtree, D base II & III, PC Paint, Auto C.A.D., and tons of software.
- We have a demo system available for your testing.



**COMPUTER SYSTEMS**

NOVA AT Entry Model .....\$2695  
NOVA AT 640K mother board, Intel #80286 CPU (Option 8MHz), 195W P.S. Tpac 1.2MB floppy dr., DTC hard disk/floppy controller.

NOVA AT Enhance Model.....\$3995  
NOVA AT 1MB mother board, Intel #80286 CPU (Option 8MHz), 195W power supply, Tpac 1.2MB floppy dr., 20MB hard disk, 2 Serial/1 parallel card, keyboard.

NOVA PC Bare Bone .....\$695  
64K mother board, case, 130W power supply, floppy controller, keyboard.

NOVA PC 256K .....\$1295  
256K mother board, case, 130W power supply, 2 1/4 ht. drive, 8 pack compatible multifunction, color graphic card, 4-drive controller card.

NOVA XT 256K .....\$1895  
256K mother board, case, 130W power supply, 2 1/4 ht. drive, 8 pack compatible multifunction card, 10MB hard disk, DTC H.D. controller color graphic, 4-dr controller

**UPGRADE KIT for PC to XT**

Internal, Tpac 10MB H.D.+DTC controller...\$595  
Internal, Microscience 20MB+DTC controller \$695  
Internal, Irwin 10MB Tape back up with cartridge and cable, free installation ..... \$695  
High quality XT 130W power supply ..... \$130

NOVA external, 10MB, 20MB, 10MB Tape back up system from ..... \$850  
NOVA external case with 50W power supply for H.D. & tape backup ..... \$17

**DISK DRIVE and MONITOR and ACCESSORIES**

Tpac 5 1/4 1/4 ht. 300KB floppy drive ..... \$105  
Microscience 10MB, 20MB.....(Lowest price)  
Miniscribe or Tpac 10MB hard disk ..... \$420  
Keytronics compatible #6151 keyboard ..... \$130  
Hitec keyboard (made in U.S.A.) ..... \$130  
Amdtek 310A amber monitor ..... \$147  
Amdtek color IV (720x240) ..... \$385

**NOVA Series Add On Board**

NOVA bare board w/installation manual .....\$79  
NOVA 6-function board w/64K (AST 6 pack compatible).....\$185  
Mono-graphic card (Hercules compatible).....\$170  
Floppy controller with cable.....\$90  
High quality XT 130W power supply ..... \$130

DEALER INQUIRIES WELCOME. -- NOVA PC/XT KITS AVAILABLE  
**COMPUTRADE COMPANY** (in Koll Commercial Center)  
780 Trimble Road, Suite 605, San Jose, CA 95131  
Tel. (408) 946-2442, Telex: 171605  
Hours: Mon-Fri 9:00 a.m.-6:00 p.m.

## BOOK REVIEWS

### DIAGRAMMING TECHNIQUES FOR ANALYSTS AND PROGRAMMERS

Reviewed by Bonnie L. Walker

**D** *Diagramming Techniques for Analysts and Programmers* is written not only for the people mentioned in the title but also for data-processing (DP) executives to help prepare them for the latest revolution in the industry: computer-aided systems analysis (CASA) and computer-aided programming (CAP).

When several people work on a system or program, a formal diagramming technique is essential so they can exchange ideas, make components fit together, and maintain the system. Diagramming standards, according to authors James Martin and Carma McClure, are even more important today because the job of systems analysts and programmers is evolving from paper and pencil to CAP techniques. While diagramming on a computer screen speeds up the process considerably, it also enforces standards, automates documentation, permits cross-checking, and facilitates revision.

### A REVOLUTION

DP installations should be prepared for the CASA/CAP revolution. This requires identifying a diagramming approach that can be integrated with fourth-generation computer languages to generate code. The approach should communicate easily with end users as well as DP professionals. To this purpose, the authors review many techniques, including decomposition, dependency, and data-flow diagrams; three species of functional decomposition; structure and Nassi-Schneiderman charts; structured English and pseudocode; decision trees and decision tables; and compound data accesses.

*Diagramming Techniques* is not for beginners; it is for professionals with an understanding of standard flowcharting symbols and techniques as well as structured programming concepts. Martin and McClure review in depth the diagramming techniques in common use, describe them tutorially, and set them into perspective. Numerous illustrations are included. The authors compare techniques, pointing out the applications of each and the similarities and differences among them. They describe an integrated approach that they say is necessary for the most effective computer-aided design. There is very little specific information on fourth-generation (CASA/CAP) software that is available on the market today, which I found disappointing.

Structured programming and a standard diagramming technique in an organization seem obviously beneficial to anyone who has worked on system design. A major difficulty I had with the book was the lengthy and often repetitious reasoning with which the authors try to convince the reader how important it is to adopt a standard procedure for diagramming. It seems obvious to me that a systems analyst or programmer would be convinced by

(continued)

## TURBO-MEGA-BOARD

Complete Single Board 80186 Computer

**\$695**

Labels on the board: Battery Backed Real Time Clock, SASI Hard Disk Interface, I/O Expansion Port, Centronics Port, Serial Ports 50-38.4K Baud, 32K EPROM, Reset, 5 1/4 and 8" Floppy Disk Interface, 256K RAM Expandable to 1 MB, 80186-10MHz (no wait states), 2 DMA Channels and 3 Counter Timers.

**25% faster and double** the RAM capacity of other 80186 boards make the **Turbo-Mega-board** the best value in single board computers at **\$695**. Fully assembled and tested, the **Turbo-Mega-Board** runs Turbo-DOS, CP/M-86 and MS-DOS. The advanced hardware and firmware features allow easy integration of a complete and powerful single or multi-user system. For more details call:

**CARINT** Limited  
957-R Industrial Road  
San Carlos, California 94070  
Telex: 756224 CARINT RWC

**(415) 595-4333**





## Feel right at home with the stock market.

Now you can use your personal computer and modem to help make investment decisions with confidence. Right in your own home.

Dow Jones News/Retrieval® is the surprisingly affordable, online financial news resource with exclusive electronic access to *The Wall Street Journal*. The combination of News/Retrieval and Dow Jones™ Software makes personal investment decisions easier by giving you a clear, organized picture of the facts.

Use News/Retrieval to check on your stocks or read up on companies and industries that interest you. Get tomorrow's business news today—90 seconds after it appears on the Dow Jones News Service® (the broadtape). See what impact government or world news is having on the marketplace.

Measure stock performance—past and present—with Dow Jones Quotes. And to round out the picture, review economic and earnings forecasts or SEC, Merrill Lynch and Standard & Poor's reports. It's all here in one place.

Then use Dow Jones Software to display trends, organize your portfolio and give you the entire picture in clear graphics.

After you've checked your investments, the whole family can use News/Retrieval to get hot sports news, shop at home, look up articles in the encyclopedia and much, much more.

For more information on how Dow Jones News/Retrieval can help *you* feel at home with the stock market, call **800-345-8500 Ext. 144\***.

## Dow Jones News/Retrieval & Software

*Keeping you a step ahead.*

\*Alaska, Hawaii and foreign, call 1-215-789-7008 Ext. 144.

© 1985 Dow Jones & Company, Inc. All rights reserved. Dow Jones News/Retrieval and Dow Jones News Service are registered service marks of Dow Jones & Company, Inc. Dow Jones is a trademark of Dow Jones & Company, Inc.



# 64K S100 STATIC RAM

**\$139<sup>00</sup>**  
KIT

**NEW!**

LOW POWER!

150 NS ADD \$10

**BLANK PC BOARD  
WITH DOCUMENTATION**  
\$49.95

**SUPPORT ICs + CAPS**  
\$17.50

**FULL SOCKET SET**  
\$14.50

**FULLY SUPPORTS THE  
NEW IEEE 696 S100  
STANDARD  
(AS PROPOSED)**

**FOR 56K KIT \$125**

**ASSEMBLED AND  
TESTED ADD \$50**

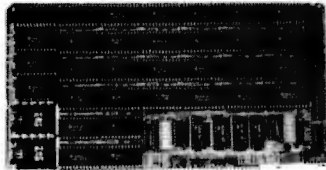

## FEATURES: **PRICE CUT!**

- Uses new 2K x 8 (TMM 2016 or HM 6116) RAMs.
- Fully supports IEEE 696 24 BIT Extended Addressing.
- 64K draws only approximately 500 MA.
- 200 NS RAMs are standard. (TOSHIBA makes TMM 2016s as fast as 100 NS. FOR YOUR HIGH SPEED APPLICATIONS.)
- SUPPORTS PHANTOM (BOTH LOWER 32K AND ENTIRE BOARD).
- 2716 EPROMs may be installed in any of top 48K.
- Any of the top 8K (E000 H AND ABOVE) may be disabled to provide windows to eliminate any possible conflicts with your system monitor, disk controller, etc.
- Perfect for small systems since BOTH RAM and EPROM may co-exist on the same board.
- BOARD may be partially populated as 56K.

## 256K S-100 SOLID STATE DISK SIMULATOR! WE CALL THIS BOARD THE "LIGHT-SPEED-100" BECAUSE IT OFFERS AN ASTOUNDING INCREASE IN YOUR COMPUTER'S PERFORMANCE WHEN COMPARED TO A MECHANICAL FLOPPY DISK DRIVE.

### PRICE CUT!

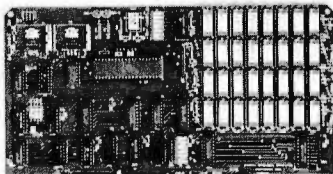

**BLANK PCB  
(WITH CP/M\* 2.2  
PATCHES AND INSTALL  
PROGRAM ON DISKETTE)**  
**\$69.95**  
(8203-1 INTEL \$29.95)

#### FEATURES:

- 256K on board, using + 5V 64K DRAMS.
- Uses new Intel 8203-1 LSI Memory Controller.
- Requires only 4 Dip Switch Selectable I/O Ports.
- Runs on 8080 or Z80 S100 machines.
- Up to 8 LS-100 boards can be run together for 2 Meg. of On Line Solid State Disk Storage.
- Provisions for Battery back-up.
- Software to mate the LS-100 to your CP/M\* 2.2 DOS is supplied.
- The LS-100 provides an increase in speed of up to 7 to 10 times on Disk Intensive Software.
- Compare our price! You could pay up to 3 times as much for similar boards.

#LS-100 **\$169<sup>00</sup>**  
(FULL 256K KIT) **(ADD \$50 FOR A&T)**

## THE NEW ZRT-80 CRT TERMINAL BOARD!

A LOW COST Z-80 BASED SINGLE BOARD THAT ONLY NEEDS AN ASCII KEYBOARD, POWER SUPPLY, AND VIDEO MONITOR TO MAKE A COMPLETE CRT TERMINAL. USE AS A COMPUTER CONSOLE, OR WITH A MODEM FOR USE WITH ANY OF THE PHONE-LINE COMPUTER SERVICES.

#### FEATURES:

- Uses a Z80A and 6845 CRT Controller for powerful video capabilities.
- RS232 at 16 BAUD Rates from 75 to 19,200.
- 24 x 80 standard format (60 Hz).
- Optional formats from 24 x 80 (50 Hz) to 64 lines x 96 characters (60 Hz).
- Higher density formats require up to 3 additional 2K x 8 6116 RAMS.
- Uses N.S. INS 8250 BAUD Rate Gen. and USART combo IC.
- 3 Terminal Emulation Modes which are Dip Switch selectable. These include the LSI-ADM3A, the Heath H-19, and the Beehive.
- Composite or Split Video.
- Any polarity of video or sync.
- Inverse Video Capability.
- Small Size: 6.5 x 9 Inches.
- Upper & lower case with descenders.
- 7 x 9 Character Matrix.
- Requires PAR. ASCII keyboard.

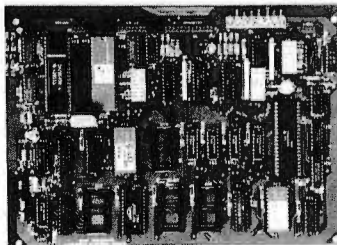

**\$89.95** #ZRT-80  
(COMPLETE KIT, 2K VIDEO RAM)

BLANK PCB WITH 2716  
CHAR. ROM. 2732 MON. ROM  
**\$49.95**

SOURCE DISKETTE - ADD \$10  
SET OF 2 CRYSTALS - ADD \$7.50

## Digital Research Computers

P.O. BOX 461565 • GARLAND, TEXAS 75046 • (214) 225-2309

Call or write for a free catalog on Z-80 or 6809 Single Board Computers, SS-50 Boards, and other S-100 products.

TERMS: Add \$3.00 postage. We pay balance. Orders under \$15 add 75¢ handling. No C.O.D. We accept Visa and MasterCard. Texas Res. add 5-1/8% Tax. Foreign orders (except Canada) add 20% P & H. Orders over \$50 add 85¢ for insurance.

## BOOK REVIEWS

personal experience. I think, however, that much of the text is too technical for the majority of end users or for any DP managers who have not been involved in systems analysis or programming. It has been my experience that the latter is common because many managers who have become involved in DP operations do not have formal DP backgrounds. Also, there are probably many people in the business (like me) who became involved in systems analysis and programming without a history of flowcharting and DP courses. For me, the text required careful attention to follow the tutorials relating to each technique.

### DOES IT HELP?

I approached *Diagramming Techniques* with this question: Can it assist an individual or group with a design background to actually use one of the methodologies? This approach led me to try the action-diagramming method (one the authors highly recommend) for a complex project involving the design of a computer-managed instructional system for a large training project. Before selecting a method, I thoroughly analyzed the type of system we were developing. We needed a method that could lead to computer-generated code, one that could depict a highly complex system, and perhaps most of all, a technique that could communicate this system to managers and end users with little or no programming or computer experience. We also needed a methodology that could be quickly understood by other programmers.

The authors point out that some diagramming techniques are good for presenting the "overview" of program structure, while others are good for describing the "detailed" program logic. The low level (details) should be a natural extension of the high level (overview); action diagrams achieve this. My team found that the instructions in the text were sufficiently clear to adopt this methodology. Action diagrams were quick and easy to draw. It helped greatly that they could be linked to a database. Although our experience with action diagrams has been brief, we are satisfied with both the technique and the instruction provided by Martin and McClure.

The topics addressed in *Diagramming Techniques* are complex. A quick read-through is not sufficient to get any benefit. The book is not intended as a general introduction to the field, despite the lengthy introductory chapters that cover a rationale for selecting a standard method of diagramming. Because of the depth of detail, this text is also not very good for presenting an overview of each of the techniques discussed. What this book is most useful for is presenting a complex analysis of the methods commonly used in the field and helping the serious systems analyst or programmer prepare for the CASA/CAP revolution.

Bonnie L. Walker (4101 Woodhaven Lane, Bowie, MD 20715) is a systems analyst/programmer and a consultant in telecommunications and computer-based training.

(continued)

ALL SALES SUBJECT TO THE TERMS OF OUR 90 DAY LIMITED WARRANTY. FREE COPY UPON REQUEST.



The future... a little sooner than you expected.™



**ACHIEVE THE POWER  
AND SPEED OF TOMORROW'S  
TECHNOLOGY. TODAY.**

**INTRODUCING  
THE EXEC. PARTNER™ FROM  
PANASONIC.®**

The Panasonic Exec. Partner. What makes it an executive? The 7.16 Mhz 8086-2 microprocessor for high-speed processing. So you can do more in less time.

What makes it your partner? Like all ambitious achievers the Panasonic Exec. Partner gets along with others. Namely, IBM hardware and software.

You'll also accomplish more with the new high-resolution plasma display. It lasts four times longer, offers clearer definition and is easier to read than an ordinary screen.

The Exec. Partner's built-in dual mode printer will help

you make a good impression. From silent, draft-quality mode to correspondence quality.

The 256K internal memory has built-in expandability to 640K. So the Exec. Partner will run the most sophisticated data base management programs. And its expansion slot allows you to fulfill the needs of specific applications like telecommunications and Local Area Networks.

Tomorrow's technology for today's executives. The new Panasonic Exec. Partner. **Panasonic Industrial Company**





# CONROY

TELEX 910 380 3980

ALL MAIL: 12060 SW Garden Place, Portland, OR 97223

## FOR YOUR APPLE



### MACINTOSH

	LIST PRICE	CONROY PRICE
AEGIS, Challenger or Pyramid, ea.	\$ 50	\$ 33
ASSIMILATION, Turbo Touch	\$ 129	\$ 89
BLUECHIP, Millstream, Barton, Tyson, ea.	\$ 80	\$ 37
CENTRAL POINT, Copy II Mac	\$ 40	\$ 24
CONROY-LA POINTE, Diskettes	SEE BELOW	
CONTINENTAL, Home Accountant	\$ 190	\$ 85
CREATIVE SOLUTIONS, MacForth Level I	\$ 149	\$ 95
CREIGHTON, Home Pak or Mac Office, ea.	\$ 39	\$ 26
Mac Spell+	\$ 39	\$ 62
Mac Lion	\$ 379	\$ 239
DOW JONES, Market Manager Plus	\$ 249	\$ 159
EXPERTTELLIGENCE, ExpertLogo	\$ 180	\$ 95
FIRST BYTE, Smooth Talker	\$ 150	\$ 86
FORETHOUGHT, Fact Finder	\$ 150	\$ 86
HABA, Ext. Disk Drive, 400K	\$ 550	\$ 335
HAYDEN, Sargon III	\$ 50	\$ 31
HIPPOTAMUS, Hippo C, Level I	\$ 150	\$ 90
HUMANOUS, Mind Prober	\$ 65	\$ 29
INFOCOM, Hitchhiker's Guide	\$ 40	\$ 25
KOALA, Mac Vision	\$ 400	\$ 229
LIVING VIDEOTEXT, Think Tank	\$ 145	\$ 83
LOTUS, Jazz	\$ 595	\$ 368
MANHATTAN, ReadySetGo	\$ 125	\$ 89
MEGAHAUS, Megalord	\$ 295	\$ 189
MICROSOFT, Business Pak	\$ 395	\$ 258
Exec	\$ 395	\$ 258
Multiplex, Word or File, each	\$ 185	\$ 125
MILES, Mac the Knife, v. 1	\$ 35	\$ 25
MONOGRAM, Dollars & Sense	\$ 150	\$ 89
NOVATION, Smartest Plus Modem w/Software	\$ 499	\$ 349
ODESTA, Hawk	\$ 385	\$ 249
PROVUE, Overvue	\$ 295	\$ 185
SIMON & SCHUSTER, Typing Tutor III	\$ 65	\$ 37
SOFTV. PUBL., PFS: File & Report Combo	\$ 175	\$ 105
SOFTWARE ARTS, Trk Solver	\$ 249	\$ 159
STATE OF THE ART, Electronic Checkbook	\$ 80	\$ 50
STONEWARE, Ctl Master	\$ 195	\$ 125
TELOS, Visa Visitor	\$ 195	\$ 115
VIDEX, MacCalendar	\$ 89	\$ 49
WARNER, Desk Organizer	\$ 145	\$ 99

### COMPUTERS



#### FLOPPY DISK DRIVES

It's, It's, Mac	LIST PRICE	CONROY PRICE
MICRO-SCI, A2 Disk Drive, 143K	\$ 295	\$ 159
A2 Controller Card	\$ 100	\$ 60
Half Height Drive for II+/Ile	\$ 295	\$ 159
Half Height Drive for IIc	\$ 295	\$ 159
TEAC, T40 Half Hl. 103K, Direct Controller Card for T40 by ComX	\$ 79	\$ 45

#### HARD DISKS

	LIST PRICE	CONROY PRICE
IOmega, 5 meg Bernoulli Box (iMac)	\$1995	\$1595
QUARK, QC10 for iMac/IIx/MAC	\$1995	\$1095

#### OTHER HARDWARE

	LIST PRICE	CONROY PRICE
APPLE, Mouse for file	\$ 150	CALL
APPLIED ENGINEERING, Ram Works, B&K	\$ 170	\$ 139
CCS, 7711 or 7710-A Interface, ea.	\$ 115	\$ 95
CP/SMARTSIDE, Wis Card II (copier, +) 140	\$ 140	\$ 79
COMK, 16K RAM Card (II+), 1 yr wdy	\$ 119	\$ 39
HAYES, Mach II, IIc, IIx, IIcx (II+ & IIc)	CALL	
KENSINGTON, System Saver Fan	\$ 80	\$ 65
KEY TRONIC, KB200 Keyboard (+)	\$ 269	\$ 179
KOALA, Muppet Keys	\$ 80	\$ 44
Touch Tablet w/Micro Illustrator (+) 150	\$ 75	
KRAFT, Joystick (II+ & IIc)	\$ 30	\$ 35
MICRO-SCI, M0 Co. Card + 84K RAM Card (IIc)	\$ 179	\$ 79
MICROSOFT, Premium Softcard (Ile)	\$ 265	\$ 275
Z80 Softcard II, 64K	\$ 425	\$ 285
ORANGE MICRO, Buffered Super Plus 1M	\$ 209	\$ 159
16K Buffer Board for Grappler (IIc)	\$ 99	\$ 59
Hot Link, S-P cable for IIc	\$ 70	\$ 44
TITAN, Accelerator I/c	\$ 319	\$ 219
128K RAM Card (II+)	\$ 329	\$ 149
TRACKHOUSE, Numeric Key Pad (Ile)	\$ 100	\$ 75
VIDEO 7, V Color 7 RGB Card	\$ 150	\$ 99
V Color IIc	\$ 150	\$ 89
V Color I/c	\$ 250	\$ 189
VIDEX, UltraTerm (II+ & IIc)	\$ 299	\$ 189
VideoTerm 60 Col. Card (II+ & IIc)	\$ 279	\$ 175
WICO, Smartcard (spec. III+ & IIc)	\$ 199	\$ 159

### BUSINESS SOFTWARE

	LIST PRICE	CONROY PRICE
ALS, Word or List Handler, ea.	\$ 80	\$ 36
Handler Pak (Word/List/Spell)	\$ 170	\$ 73
APPLE, Appleworks	\$ 250	\$ 215
ASHTON-TATE, dBase II (Req CPM 80)	\$ 495	\$ 289
BPI, AR, AP, PR or INV, each	\$ 395	\$ 240
BRODERBUND, Print Shop	\$ 65	\$ 39
Print Shop & Refill	\$ 65	\$ 39
Bank St. Writer or Speller, ea	\$ 70	\$ 45
Bank St. Combo (Writer & Speller)	\$ 140	\$ 85
DATA TRANS, Fontrix	\$ 95	\$ 80
DOW JONES, Market Manager	\$ 249	\$ 159
Market Analyzer or Microscope, ea.	\$ 349	\$ 219
HOWARD SOFT, Tax Preparer '85	\$ 250	\$ 159
HUMAN EDGE, Sales or Mgmt Edge, ea.	\$ 250	\$ 165
LIVING VIDEOTEXT, Think Tank	\$ 145	\$ 89
MECA, Managing Your Money	\$ 199	\$ 125
MEGAHAUS, Megaworks	\$ 125	\$ 79
MICRO PRO, WordStar (req. CPM)	\$ 350	\$ 189
WordStar w/Starcard	\$ 495	\$ 265
WordStar Professional, 4 Pak	\$ 495	\$ 265
MallMerge, SpellStar, or StarIndex, ea	\$ 99	\$ 54
InfoStar and StarCard Combo	\$ 595	\$ 295
MICROSOFT, Multi-Plan (Ap DOS)	\$ 85	\$ 82
QUARK, Word Juggler & Lexicheck (Ile/Ic)	\$ 189	\$ 129
SENSIBLE, Sensible Speller	\$ 125	\$ 79
SIERRA/ON-LINE, Screen Writer II	\$ 130	\$ 79
SOFTWARE PUBL., PFS:File or Write, each	\$ 125	\$ 79
PFS:Graph or Report, each	\$ 125	\$ 79
PFS:Access	\$ 70	\$ 43
SPRINGBOARD, Newroom	\$ 50	\$ 32
STONEWARE, DB Master, v. 4+	\$ 350	\$ 225

### UTILITIES SOFTWARE

	LIST PRICE	CONROY PRICE
EPSON, Graphics Dump	\$ 15	\$ 7
FUNK, Sideways	\$ 80	\$ 37
HAYES, Terminal Prog. for Smartmodem	\$ 99	\$ 65
MICROSOFT, Full Line IN STOCK	CALL	
OMEGA, Locksmith	\$ 100	\$ 73
PENGUIN, Complete Graphics System II	\$ 80	\$ 49
Graphics Magician	\$ 80	\$ 40
QUALITY, Bag of Tricks	\$ 40	\$ 29
UNITED SWI, ASCII Express-Pro DOS	\$ 130	\$ 82
UTILICO, Essential Data Duplicator III	\$ 80	\$ 48

### HOME & EDUCATIONAL

	LIST PRICE	CONROY PRICE
BEAGLE BROS., Full Line IN STOCK	CALL	
BRODERBUND, Print Shop	\$ 50	\$ 29
CONTINENTAL, Home Accountant	\$ 75	\$ 43
KOALA, Full Line IN STOCK	CALL	
MICROSOFT, Typing Tutor II	\$ 25	\$ 17
MONOGRAM, Dollars & Sense (II+ & IIc)	\$ 100	\$ 59
Dollars & Sense (Ic/Ile 128K)	\$ 120	\$ 65
Forecast	\$ 80	\$ 38
SCARBOROUGH, Mastertyp	\$ 40	\$ 25
Build-A-Book	\$ 40	\$ 25
Your Personal Net Worth	\$ 80	\$ 50
SIERRA/ON-LINE, Homework	\$ 70	\$ 45
SIMON & SCHUSTER, Typing Tutor III	\$ 50	\$ 33
PLUS: BARRONS, CBS, DAVIDSON, EDU-WARE, HARDCOURT, LEARNING CO., TERRAPIN		

### RECREATIONAL SOFTWARE

	LIST PRICE	CONROY PRICE
BLUECHIP, Millionaire or Barron, ea.	\$ 50	\$ 32
DATASOFT, Aztec or Zaxxon, each	\$ 40	\$ 27
ELECTRON, ARTS, Sky Fox & others, ea.	\$ 40	\$ 28
HAYDEN, Sargon III (Chess)	\$ 50	\$ 30
INFOCOM, Zork I, II, or III, ea	\$ 40	\$ 25
ORIGIN, Ultima III	\$ 80	\$ 37
PENGUIN, Transylvania	\$ 35	\$ 24
SPECTRUM HOLOBYTE, Gato	\$ 40	\$ 25
SPINNAKER, Full Line IN STOCK	CALL	
SW LOGIC, Flight Simulator II	\$ 50	\$ 30
PLUS: BRODERBUND, DATAMOST, MUSE, SIR-TECH		

### UTILITIES SOFTWARE

	LIST PRICE	CONROY PRICE
BEAGLE, GP/LE or Alpha Plot, ea.	\$ 50	\$ 27
Pronto DOS, Disk Quick, Ap. Mech. or I/O. Silver, ea	\$ 30	\$ 19
Full Line IN STOCK	CALL	
BOHLAND, Turbo Pascal (req. CPM)	\$ 70	\$ 33
CENTRAL POINT Copy II Plus (hit copier)	\$ 40	\$ 23

### DISKETTES

★ CONROY-LAPOINTE™ DISKETTES ★  
We guarantee these top quality products with our name. 5 YEAR LIMITED WARRANTY.

10 ea. SS/SD, (Apple, etc) 35 Trk. W/FLIP BOX	\$ 12
100 ea. SS/SD, (Apple, etc) 35 Trk	\$ 89
100 ea. SS/SD, (Apple, etc) 35 Trk	\$ 840
10 ea. DS/DD, (IBM, H/P) 40 Trk. W/FLIP BOX	\$ 15
100 ea. DS/DD, (IBM, H/P) 40 Trk	\$ 119
100 ea. DS/DD, (IBM, H/P) 40 Trk	\$ 859
10 ea. SS/DD, 3 1/4" (MAC, H/P)	\$ 25
50 ea. SS/DD, 3 1/4" (MAC, H/P)	\$ 115
100 ea. SS/DD, 3 1/4" (MAC, H/P)	\$ 229

CONROY-LAPOINTE™ IBM PRE-FORMATTED  
10 ea. DS/DD, 40 Trk W/FLIP BOX \$ 19  
100 ea. DS/DD, 40 Trk \$ 149  
1000 ea. DS/DD, 40 Trk \$ 959

#### SINGLE-SIDED, DOUBLE DENSITY

	LIST PRICE	CONROY PRICE
CDC, 10 ea. SS/DD, 40 Trk (Apple, etc)	\$ 45	\$ 19
DYSAN, 10 ea. SS/DD, (Apple, etc.)	\$ 40	\$ 27
MAXELL, 10 ea. SS/DD, MD1 (Apple)	\$ 47	\$ 19
VERBATIM, 10 ea. SS/DD, MD515-01 (Apple)	\$ 49	\$ 19

#### DOUBLE-SIDED, DOUBLE DENSITY

CDC, 10 ea. DS/DD, 40 Trk (IBM, H/P)	\$ 59	\$ 23
DYSAN, 10 ea. DS/DD, (IBM, H/P)	\$ 69	\$ 35
MAXELL, 10 ea. DS/DD, MD2 (IBM)	\$ 65	\$ 26
VERBATIM, 10 ea. DS/DD, MD34 (IBM)	\$ 75	\$ 24

#### 3 1/4" MICRO DISKETTES

MAXELL, 10 ea. SS/DD (MAC, H/P)	\$ 55	\$ 35
MEMOREX, 10 ea. SS/DD (MAC, H/P)	\$ 60	\$ 33
VERBATIM, 10 ea. SS/DD (MAC, H/P)	\$ 65	\$ 32

#### HIGH DENSITY DISKETTES FOR IBM-AT

MAXELL, 10 ea. DS/HD (IBM-AT)	\$ 75	\$ 49
MEMOREX, 10 ea. DS/HD (IBM-AT)	\$ 84	\$ 49

#### ★ GENERIK DISKETTES ★

Top quality, w/labels, no labels. Quantity discounts. 90 day "NO FEAR" MONEY BACK GUARANTEE.

100 ea. SS/SD, 35 Trk (Apple, etc)	\$ 80
100 ea. DS/DD, 40 Trk (IBM, H/P)	\$ 85

with credit card convenience, \$40 Minimum initial purchase.

### MODEMS

	LIST PRICE	CONROY PRICE
ANCHOR, Signalmen Mark XII	\$ 399	\$ 259
HAYES, 2400 External Modem	\$ 660	CALL
Smartmodem 1200B (IBM)	\$ 549	\$ 359
Smartcom II Software (IBM or MAC)	\$ 149	\$ 107
Smartmodem 1200 (External)	\$ 599	\$ 419
Micromodem IIe w/Smartcom (AP)	\$ 189	\$ 139
Transit 1000 - 128K	\$ 399	\$ 309
NOVATION, Apple Cat II 300 Baud (AP)	\$ 359	\$ 219
212 Apple Cat, 1200 Baud (AP)	\$ 595	\$ 409
SmartCat Plus w/Software (MAC)	\$ 489	\$ 349
ACCESS 1-3-3 Modem + DataKit (IBM)	\$ 595	\$ 369
PROMETHEUS, 1200 Standard Modem	\$ 495	\$ 345
ProModem 1200 w/Software (MAC)	\$ 549	\$ 389
ProModem 1200A (AP)	\$ 449	\$ 319
ProModem 1200B (IBM)	\$ 390	\$ 285
VENTEL, PC Halfcard (IBM)	\$ 549	\$ 359

### MONITORS

AMDEK, Color 300 - Comp/Audio	\$ 349	\$ 249
Color 500 - Comp/VCR/RGB/Audio	\$ 525	\$ 319
Color 600 - Hi Res/RGB/Audio	\$ 599	\$ 389
300A - 12" Amber/Comp	\$ 199	\$ 119
300G - 12" Green/Comp	\$ 179	\$ 115
310A, 12" Amber (IBM)	\$ 230	\$ 149
PRINCETON, HX-12 - Hi Res/RGB	\$ 795	\$ 489
HX-12x - Hi Res/RGB/Bit/IBM-EGA	\$ 795	\$ 559
SR-12 - Hi Res/RGB	\$ 799	\$ 599
MAX-12 - Amber (IBM)	\$ 249	\$ 179
QUADRAM, Amberchrome, 12"	\$ 250	\$ 159
ZENITH, ZVM122 - 12" Amber	\$ 150	\$ 89
ZVM123 - 12" Green	\$ 149	\$ 85
ZVM124 & ZVM 135	29-30% OFF	

### CABLES

ARBO, IBM-PC to Modem Cable	\$ 31	\$ 19
ASTAR, RF Modulator for T.V. (Apple)	\$ 35	\$ 20
COMPUGABE, Mac/Apple Smartmodem Cable	\$ 32	\$ 18
CURTIS, Monitor Extension Cable (IBM)	\$ 50	\$ 32
3 1/4" Keyboard Extens. Cable (IBM)	\$ 40	\$ 26
RCA, Monitor Cable	\$ 15	\$ 8

### PRINTERS

#### DOT MATRIX:

	LIST PRICE	CONROY PRICE
APPLE, Laserwriter	\$8995	\$8500
EPSON, FX Series - IN STOCK	CALL	
LX80 - 100 cps DQ/18 cps NLQ	\$ 299	CALL
LQ1500 - 200 cps DQ/87 cps NLQ	\$1285	CALL
HEWLETT-PACKARD, Laserjet	\$3495	CALL
Thinkjet - 150 cps Inkjet	\$ 485	CALL
OKIDATA, Okimate 20 - Color, Hi Res	\$ 289	\$ 208
182 - 120 cps/80 col	\$ 299	\$ 239
192 - 180 cps/130 col/para.	\$ 499	\$ 349
93 - 180 cps/130 col/para.	\$ 799	\$ 589
210 Pacemark - 350 cps/para.	\$2895	\$1949
PANASONIC, P1090 - 60 cps/10" P1092 - 180 cps/10"	\$ 349	\$ 249
\$ 599	\$ 459	
QUADRAM, Quadjet-Inkjet Color	\$ 895	\$ 395
STAR MICRO, S910 - 120 cps DQ/20 cps NLQ	\$ 289	\$ 249
SG15 - 120 cps DQ, 30 cps NLQ, 18K	\$ 499	\$ 419
SO10 - 180 cps OQ, 40 cps NLQ	\$ 449	\$ 379
SD15 - 180 cps DQ, 40 cps NLQ, 18K	\$ 599	\$ 509
SR10 - 200 cps DQ, 50 cps NLQ	\$ 649	\$ 549
SR15 - 200 cps DQ, 50 cps NLQ, 18K	\$ 799	\$ 679
TEXAS INSTRUMENTS, 855 - 150 cps	\$ 895	\$ 795
TOSHIBA, 351		



# -LA POINTE INC. SM

#B25

©1984 by Conroy-LaPointe, Inc. All Rights Reserved

LOW PRICES TO PROFESSIONALS WHO KNOW WHAT THEY WANT AND KNOW HOW TO USE IT!

**TO ORDER, CALL (800) 547-1289**

FOR YOUR IBM-PC, XT, AT or JR



**STOP WAITING**  
ALL ORDERS ARE NOW SHIPPED **2nd DAY AIR** VIA **EMERY WORLDWIDE**

**COMPUTER SYSTEMS**

— Call for Details —

**256K IBM-PC** SM

**360K Disk Drives by CDC**

90 Day Limited Warranty By Us

**COMPAQ Computers**  
Desktop and 256K Portable

CALL

**OTHER HARDWARE**

**MAYNARD, (Cont'd.)**

Floppy Cont. Card (accepts 3 modules)	\$ 285	\$ 195
Hard Disk I/F Module	\$ 495	\$ 359
Serial Port Module	\$ 95	\$ 79
Para or Clock Cal. Module, ea.	\$ 59	\$ 49
MICROSOFT, Mouse (for PC)	\$ 195	\$ 125
Serial Mouse	\$ 125	\$ 135
MOUSE SYSTEMS, PC Mouse & Paint	\$ 220	\$ 135
PARADISE, Modular Graphics Card	\$ 395	\$ 285
Parallel or Serial Port, ea.	\$ 95	\$ 85
256K Module w/clock	\$ 195	\$ 150
PERSYST, PC/Mono Board, w/para	\$ 250	\$ 195
PC/Color Graphics Board	\$ 244	\$ 176
QUADRAM, Quadboard, no RAM, to 384K	\$ 295	\$ 195
Quadboard 64K, to 384K, S/P/CC/G	\$ 395	\$ 239
Quadboard 256K, to 384K, S/P/CC	\$ 875	\$ 269
Quadboard, 384K (full), S/P/CC/G	\$ 795	\$ 295
Quadboard II, no RAM, to 256K	\$ 295	\$ 215
Quadboard II, 64K, to 256K, 2S/CC	\$ 395	\$ 265
Quadboard II, 256K, 2S/CC	\$ 595	\$ 395
Quad 512 + 64K w/serial port	\$ 325	\$ 245
Quadcolor I, board, 4 colors	\$ 295	\$ 195
Upgrade Quadcolor I to II kit	\$ 275	\$ 199
Quadvus, board, Mono, S/P/CC	\$ 345	\$ 269
Quad 3278	\$ 1195	\$ 1050
Quadnet VI	\$ 1965	\$ 1545
Quadnet IX	\$ 2295	\$ 1745
Quadlink	\$ 495	\$ 385
Quadprint	\$ 645	\$ 495
TALLTREE, J RAM II Board	\$ 219	\$ 165
TECMAR, Maestro, 128K to 384K, S/P for AT	\$ 589	\$ 419
TG PRODUCTS, Joystick	\$ 30	\$ 22
TITAN, 128K PC Accelerator	\$ 795	\$ 595
WOC, Smartboard Keyboard	\$ 400	\$ 279

**256K CHIP KIT \$49**  
9 each, 4256 chips  
150 ns

**64K CHIP KIT \$10**  
10 or more - \$8

**128K CHIP KIT \$75**  
9 each, 4128 chips  
Piggyback for AT

90 Day Warranty by us

CALL FOR QUANTITY PRICES

**OTHER HARDWARE**

AST, SixPak Plus, 64K	\$ 395	\$ 259
SixPak Plus, 256K, S/P/CC + S/W	\$ 895	\$ 295
SixPak Plus, 384K, S/P/CC + S/W	\$ 895	\$ 329
Preview™ Graphics Card w/para, 64K	\$ 399	\$ 299
Advantage™ Multif. Bd. for AT, 128K	\$ 595	\$ 445
I/O Plus II, S/P/CC	\$ 215	\$ 169
I/O Plus II, S/P/CC/G	\$ 285	\$ 225
Port Kits - ser, para, or game, ea.	\$ 50	\$ 35
COMX, 130 Watt Power Supply	\$ 179	\$ 93
HAUPPAGE (HCW), 8087 Chip	\$ 175	\$ 126
8087 Math Pak (Chip & softw.)	\$ 295	\$ 235
HAYES, Mach II Joystick	\$ 45	\$ 29
Mach III (PC or Jr.)	\$ 55	\$ 35
HERCULES, Color Card w/para.	\$ 245	\$ 159
Mono Graphics Card	\$ 499	\$ 309
KENSINGTON, Masterpiece™	\$ 140	\$ 95
KEY TRONIC, KB5151, Std. Keyboard	\$ 255	\$ 179
KB 5153 Keyboard w/Touch Tab	\$ 400	\$ 325
KOALA, Speed Key Software	\$ 100	\$ 63
Speed Key System (Tab w/ softw.)	\$ 200	\$ 115
Koala Pad w/PC Design	\$ 150	\$ 85
MAYNARD, SAND STAR SERIES		
Full Line IN STOCK	CALL	
Multifunction (6) Card	\$ 89	\$ 79
Memory Card no RAM	\$ 199	\$ 139

**★ ★ ★ FOR YOUR PC-JR ★ ★ ★**

KEY TRONIC, KB5151 Jr. Keyboard	\$ 255	\$ 179
Numeric Keypad	\$ 100	\$ 77
KOALA, Touch Tablet for Jr.	\$ 125	\$ 75
MICROSOFT, Bocoat 128K w/Mouse	\$ 265	\$ 195
MOUSE SYSTEMS, Mouse w/softw.	\$ 195	\$ 125
QUADRAM, Expansion Chassis	\$ 895	\$ 540
Memory Expansion Board 128K	\$ 275	\$ 215
RACORE, Expansion Chassis	\$ 875	\$ 449
128K Expansion Board	\$ 275	\$ 169
TECMAR, Jr. Captain	\$ 395	\$ 295

**DISK DRIVES & TAPE BACKUP**

**CDC, 360K DS/DD DISK DRIVE**

Limited 30 day warranty  
Call for quantity prices

Full Height **\$109**  
Half Height **\$ 89**

CDC, Internal 20 meg kit for AT \$1695 \$1195  
Internal 30 meg kit for AT \$1895 \$1325  
IRWIN, 10 meg Tape Backup \$ 795 \$ 569  
KAMERMAN, Internal 10 meg kit \$ 895 \$ 649  
External 10 meg kit w/power \$1295 \$ 949  
MF-10/10, H Disk, tape back, cont, power \$2895 \$2095  
MICRO SCIENCE, 10 meg w/controller \$ 795 \$ 675  
20 meg w/controller \$1095 \$ 735  
TALLGRASS, 24 meg disk, 80 meg tape, inf. \$3495 \$2695

Go ahead . . .  
**TAKE THE CREDIT**

**CONROY-LA POINTE INC.**

National Toll Free Sales (800) 547-1289

**Get Your CONROY-LA POINTE CREDIT CARD**  
Call for an application & details  
(503) 684-1232

## SOFTWARE FOR YOUR IBM-PC, XT, AT or JR

BUSINESS	
LIST PRICE	CONROY PRICE
ANALYTICA, Reflex	\$ 495 \$ 315
ASHTON-TATE, Framework	\$ 895 \$ 359
dBase III	\$ 895 \$ 389
dBase II, (req. PC-DOS & 128K)	\$ 495 \$ 279
ATI, PC DOS 2.1 Training	\$ 40 \$ 28
BPI, General Acctg. AR, AP, or PR, ea.	\$ 595 \$ 365
BRODERBUND, Bank St. Writer (PC or Jr.)	\$ 80 \$ 49
CDEX, Advanced Training for Lotus 1-2-3	\$ 70 \$ 45
CONTINENTAL, Ultralife	\$ 195 \$ 115
Tax Advantage	\$ 70 \$ 40
Property Management	\$ 495 \$ 295
DATA TRANS., Fontrix	\$ 155 \$ 99
Font Packs, each	\$ 20 \$ 12
DOW JONES, Market Manager Plus	\$ 249 \$ 159
Market Analyzer or Market Microscope	\$ 349 \$ 219
Spread Sheet Link	\$ 249 \$ 169
FOX & GELLER, QuickCode III	\$ 295 \$ 185
HARVARD, Total Project Manager	\$ 495 \$ 275
HOWARDSON, Tax Preparer '85	\$ 295 \$ 195
HUMAN EDGE, Mind Prober (PC or Jr.)	\$ 50 \$ 29
Sales Edge or Management Edge, ea.	\$ 250 \$ 159
Negotiation Edge	\$ 295 \$ 185
IBM, Topview	\$ 395 \$ 385
INFOCOM, Cornerstone	\$ 495 \$ 319
KENSINGTON, Easy Unk Mail Manager	\$ 95 \$ 59
LIFETREE, Volkswriter Deluxe	\$ 295 \$ 159
LIVING VIDEOTEXT, Think Tank	\$ 195 \$ 95
LOTUS, 1-2-3	\$ 495 \$ 309
Symphony	\$ 895 \$ 449
MDBS, Knowledgegan	\$ 500 \$ 275
MECA, Managing Your Money (PC)	\$ 199 \$ 105
Managing Your Money Cartridge (Jr)	\$ 199 \$ 179

BUSINESS	
LIST PRICE	CONROY PRICE
MICROPRO, WordStar (PC)	\$ 350 \$ 189
WordStar (Jr)	\$ 195 \$ 109
WordStar 2000 (copiable)	\$ 495 \$ 285
WordStar 2000 Plus (copiable)	\$ 595 \$ 295
WordStar Professional, 4 Pak	\$ 495 \$ 285
MailMerge, SpellStar or StarIndex, ea.	\$ 98 \$ 54
InfoStar Plus (+ Starburst)	\$ 595 \$ 315
Correct Star	\$ 145 \$ 77
MICROIM, R:Base Series 5000	\$ 695 \$ 369
Upgrade 4000 to 5000	\$ 245 \$ 135
R:Base 4000	\$ 495 \$ 255
R:Base Clout	\$ 249 \$ 129
Extended Report Writer	\$ 150 \$ 85
MICROSOFT, Spell	\$ 50 \$ 32
Multiplan (PC or Jr)	\$ 195 \$ 125
Chart or Project, each	\$ 250 \$ 159
Word	\$ 375 \$ 235
MOBAC, Twin	\$ 145 \$ 75
MULTIMATE, Multimate Ver. 3.3	\$ 495 \$ 229
PEACHTREE, Back to Basics	\$ 395 \$ 239
Peach Pak (GL/AR/AP)	\$ 395 \$ 219
QUE, Using 1-2-3 (book)	\$ 18 \$ 14
1-2-3 for Business (book)	\$ 17 \$ 13
Using Symphony (book)	\$ 20 \$ 15
SAMNA, Word Plus	\$ 695 \$ 349
Word III	\$ 550 \$ 276
SATELLITE, WordPerfect (PC)	\$ 495 \$ 209
WordPerfect (Jr)	\$ 89 \$ 39
SOFTW. ARTS, Spotlight	\$ 150 \$ 85
T/K Solver (specify DOS)	\$ 399 \$ 289
SOFTWARE GROUP, Enable	\$ 695 \$ 385

BUSINESS	
LIST PRICE	CONROY PRICE
SOFTWARE PUBL. PFS:Report	\$ 125 \$ 75
PFS:Write, File or Graph, each	\$ 140 \$ 82
PFS:Plan or Access, each	\$ 140 \$ 82
PFS:Proof	\$ 95 \$ 57
SORCHIM, SuperCalc III	\$ 385 \$ 245
SPRINGBOARD, Newsroom	\$ 50 \$ 37
THORN EM, Perfect Pak (Jr) (Write/Spell/Thesaur)	\$ 139 \$ 89
UNISON, Print Master	\$ 60 \$ 35
WARNER, Desk Organizer (PC or Jr)	\$ 99 \$ 63
XANARO, Ability	\$ 485 \$ 299

UTILITIES	
LIST PRICE	CONROY PRICE
BORLAND, Sidekick	\$ 55 \$ 29
Turbo Pascal or Super Keys, ea.	\$ 70 \$ 36
Turbo Pascal w/8087 or BCD, ea.	\$ 110 \$ 58
Turbo Pascal w/8087 & BCD	\$ 125 \$ 69
Toolbox or Turbo Graphics, ea.	\$ 55 \$ 28
Tutor Tutor	\$ 35 \$ 19
CENTRAL POINT, Copy II PC	\$ 40 \$ 23
COMX, Fastrak™, RAM/Disk & spooler.	\$ 100 \$ 39
DIGITAL RES., Gem Draw	\$ 160 \$ 95
Gem Desktop	\$ 50 \$ 32
CP/M-86™ (PC/XT)	\$ 100 \$ 64
DR LOGO-86 (CP/M-86)	\$ 150 \$ 99
FUNK SOFTWARE, Sideways	\$ 60 \$ 37
IMSI, CP Paintbrush	\$ 139 \$ 85
LIFEBOAT, Lattice C	\$ 500 \$ 289
Dr. Halo	\$ 100 \$ 56
MICROSOFT, Macro Assembler	\$ 150 \$ 99
BASIC Compiler or C Compiler, ea.	\$ 385 \$ 259
Business BASIC Compiler	\$ 450 \$ 295
COBOL Compiler	\$ 700 \$ 459
FORTRAN Compiler	\$ 350 \$ 229
PASCAL Compiler	\$ 300 \$ 199

UTILITIES	
LIST PRICE	CONROY PRICE
MICROSTUF, Crosstalk XVI (PC or Jr)	\$ 195 \$ 109
MOUSE SYSTEMS, PC Paint	\$ 99 \$ 69
NORTON, Utilities (14 prgms) v 3.0	\$ 100 \$ 58
ROBESOFF, Prokey	\$ 130 \$ 79
WESTERN UNION, Easy Link Mail Mngr	\$ 95 \$ 59

HOME & EDUCATIONAL	
LIST PRICE	CONROY PRICE
BPI, Personal Accounting	\$ 99 \$ 63
CONTINENTAL, Home Accountant (Jr)	\$ 75 \$ 45
Home Accountant Plus (PC)	\$ 150 \$ 90
DOW JONES, Home Budget	\$ 139 \$ 92
ELECTRONIC ARTS, Get Organized	\$ 95 \$ 75
MONOGRAM, Dollars & Sense w/forecast	\$ 180 \$ 99
SCARBOROUGH, MasterType (PC or Jr)	\$ 40 \$ 25
Your Personal Net Worth	\$ 100 \$ 63
SIMON & SCHUSTER, Typing Tutor III	\$ 50 \$ 33

RECREATIONAL	
LIST PRICE	CONROY PRICE
BLUECHIP, Millionaire, Barron, Tycoon, ea.	\$ 60 \$ 38
BRODERBUND, Large Inventory in Stock	CALL
ELECTRONIC ARTS, Large Inventory in Stock	CALL
HAYDEN, Sargon III (Chess)	\$ 50 \$ 34
INFOCOM, Hitchhiker's Guide or Zork I, ea.	\$ 40 \$ 25
Zork II or III, each	\$ 45 \$ 29
MICROSOFT, Flight Simulator (PC or Jr)	\$ 50 \$ 33
ORIGIN, Ultima III (PC or Jr)	\$ 60 \$ 39
SIERRA/ON-LINE, Ultima II (PC or Jr.)	\$ 60 \$ 40
SPECTRUM HOLOBYTE, Gate	\$ 40 \$ 25
SPINNAKER, President's Choice, Amazon	
Fahrenheit, Rendezvous, Dragon, each	\$ 40 \$ 25

**CASH-N-CARRY COMPUTER STORES, INC.**  
Retail Sales only. Store prices may vary.

**SAN FRANCISCO** — 550 Washington Street (at Montgomery, opposite the Pyramid). Interstate 80 to Highway 480; take Washington Street Exit. CALL (415) 982-6212.

**PORTLAND, OREGON** — At Park 217, Tigard at Intersection of Highways 217 and 99W. CALL (503) 620-5595.

**SEATTLE, WASH.** — NEW LOCATION! 1105 Bellevue Way N.E. in Belgate Plaza, 2 blocks north of Bellevue Square. CALL (206) 641-4736.



**OUR REFERENCES:**

We have been in computers and electronics since 1958, a computer dealer since 1980. Banks: 1st Interstate Bank, (503) 843-4878. We belong to the Chamber of Commerce (503) 228-9411, and Direct Marketing Association; call Dun and Bradstreet if you are a subscriber. Recipient of OREGON BUSINESS MAGAZINE's 1984 Enterprise Award.

MasterCard VISA

CONROY-LA POINTE CARD

NO SALES TAX

**CALL (800) 547-1289**  
In Oregon: (800) 451-5151  
Portland & Porland Residents Call (503) 620-9877

**QUESTIONS**  
(503) 620-9878  
9:00 AM - 5:00 PM (PDT)  
Weekdays Only

**ORDER DESK HOURS**  
Mon-Fri 8am to 6pm (PDT)  
Saturday 10am to 4pm (PDT)  
(6 am here is 9 am in New York)



# Call Kustom's hotline for hard facts about hard disks.

## 1-800-445-DISK.



**SUNFLOWER™**  
Hard Disk Backup Systems  
as low as

**\$1,895**

Selecting a microcomputer backup system is a confusing chore. Pitfalls are numerous. There are more systems on the market today than a porcupine has quills. And, for sure you don't want to get stuck with yesterday's technology.

That's why Kustom has established the "Sunflower Hard Disk Hotline." This toll-free link will put you in touch with backup experts. People who know all backup systems — hard disk, floppy disk and tape. People who will provide all the information you need to make an intelligent investment decision.

Once you have all the facts, you'll choose a Sunflower removable, hard disk system, **the technology of today.** Technology backed by Kustom's 20 years of electronics innovation. Units are available for **immediate shipment, low as \$1,895 direct from us to you.**

Call us today. Talk backup with people who know backup. You'll get no hard-sell pitch. We'll simply present the facts, then you decide.

**Sunflower Hard Disk Hotline 1-800-445-DISK. In Kansas call 1-913-492-1400.**



For backup that won't back down, hard disk is the only choice.

### BENEFITS OF INVESTING IN SUNFLOWER.

- A complete removable, hard disk system — controller boards, interface cables and power supply are included. One free removable media also included.
- Compatible with IBM PC and other major microcomputers. PC-DOS and MS-DOS compatible.
- On-line, rapid access. Automatic boot from disk.
- Limitless capacity. All models upgradable.
- Fast, accurate, easy to install and use.
- Available units include 10Mb removable; 10 Mb fixed/5Mb removable, 20/10, 30/10; 10/10 both removable and 30/30 both fixed.
- One year warranty.
- Modular design makes servicing easy. Overnight shipment of replacement modules guaranteed.
- All systems completely formatted and tested before shipment.
- Ongoing system support via "Sunflower Hard Disk Hotline."

When you buy Kustom, you invest in quality.

**KE KUSTOM ELECTRONICS INC.**

8320 Nieman Road  
Lenexa, KS 66214  
(913) 492-1400  
Telex WUD(0)437437



## BOOK REVIEWS

INTRODUCTION TO COMPUTER ENGINEERING  
Reviewed by Brian Edginton

In the preface to *Introduction to Computer Engineering*, Franco P. Preparata describes his book as a "first course text." The book is much more involved than that. Practicing engineers and advanced students could find it helpful for study and review. Used by a competent instructor, it could serve as a good introduction, even though at times its speed and intensity are overpowering.

Each of the book's three parts has distinctly different goals. The first is an overview of information processing, taking the reader from the representation of information through several number bases and base conversions. This presentation requires more mathematical background than most first-year students would normally possess.

Early in the text Preparata introduces binary-coded decimal (BCD) codes, the Gray code, and parity-check codes. Though he mentions error-correction schemes at this point, he never elaborates upon them. The rest of the first part introduces a computer model called the Simplistic Educational Computer (SEC). A description of this machine's logical and functional organization is followed by its basic instruction set and examples of how a microprocessor is programmed for problem solving in assembly or mnemonic-type language. Some readers might consider this approach to be a rather rapid immersion into the complex realm of computer science; without adequate mathematical background or experience with computers, it might well be.

The author provides well-designed problems to explore the concepts he discusses and to encourage thinking about logical solutions using the machine language of the SEC.

### BOOLEAN ALGEBRA

The second part of the book is dedicated to one of the subsets of Boolean algebra, switching algebra, and its application to hardware and circuit design. This section is well presented and requires little or no knowledge of algebra. Preparata begins by defining the two values in Boolean math, 1 and 0, and logically develops the principles and rules used to define logic equations. These equations are used to develop combinational networks, groups of gates and switches that make up the basis of computer systems. All the truth tables in this chapter are presented in both standard conventions, allowing the reader to see the same rules in two different lights.

Next Preparata covers analysis and design of combinational networks. If the material he has presented previously has not been understood, the rest may be incomprehensible. Although the text is developed well and takes a logical approach to teaching a complicated subject, it is not for the lightweight.

Again in this section the author seems to have forgotten that his purpose was to write an introductory text. The

(continued)



COMPUTERBANC

# BANC \$AFE

**Back to school! Purchase 2 or more of any separate item and get 5% off regular price. Call for complete pricing.**

<p><b>IBM PC AT</b> \$4895 20MB Hard Drive 512K Ram 1.2 MB Floppy Monitor PAA/SEA</p>	<p><b>IBM PC</b> Monitor/2 dr \$1950 <b>CALL</b> Monitor/2 dr <b>IBM PC 20MB</b></p>	<p><b>IBM PC Compatible</b> <b>1 TT XTAR</b> \$1599 2 dr, 256K Monitor, SEA/PAA</p>
---	--	---

\$ HARD DISK DRIVES	10 meg 489/475	20 meg 619/599	Quantity 1/10	\$ HARD DISK DRIVES
<b>IBM SOFTWARE</b>				
SORCIM SUPERCALC III	235.00	CALL	JC 1215 Composite Color w/audio	215.00
LOTUS 123	CALL	CALL	PRINCETON GRAPHICS HX-12	469.00
SYMPHONY	CALL	CALL	SA-12	685.00
ENABLE	399.00	CALL	MAX-12	179.00
ASHTON TATE Framework	399.00	CALL	TAXAN 121/122	149.00
dBASE II	289.00	CALL	420 (RGB)	439.00
dBASE III	399.00	CALL	415 (RGB)	489.00
MULTIMATE	269.00	CALL	PANASONIC DT-5101 Color	179.00
MICROSOFT Multiplan	125.00	CALL	DT-H103 10" High Res RGB	499.00
Word	229.00	CALL	DT = D1300D 13" RGB Color	279.00
Project	139.00	CALL	DT-M140 14" RGB Color	439.00
FOX & GELLER Quickcode	139.00	CALL	<b>PRINTERS</b>	
ASCI PRO Comm Software	99.00	CALL	BROTHER HA-10	CALL
In-House Accountant	99.00	CALL	HA-15	345.00
Word Perfect	285.00	CALL	HA-25	499.00
MICROPRO WordStar	249.00	CALL	HA-35	699.00
WordStar 2000	285.00	CALL	2024 LQ	879.00
SAMRA WORD III	279.00	CALL	Twinwriter	815.00
ALSO HAYDEN, MONOGRAM, EPI, MICROCOM, NORTON AND MANY MANY MORE			EPSON LX-80 F/T	CALL
<b>IBM HARDWARE</b>			FX-80 +	359.00
AST Six Pack Plus 64K	259.00	CALL	FX-100 +	CALL
MegaPlus II	269.00	CALL	LQ1500	CALL
HERCULES Mono Graphics	316.00	CALL	OKIDATA ML 182P	227.00
Color Card	159.00	CALL	ML192P	373.00
ORCHID Turbo 186	659.00	CALL	ML193P	535.00
Pc Net Starter Kit	CALL	CALL	PANASONIC 1091	229.00
Blossom ok-384k 5 Function	189.00	CALL	TOSHIBA 1340	575.00
QUADRAM Quadboard O-H	219.00	CALL	STAR MIRONICS SG-10	229.00
TECHMAR Captain 64K	199.00	CALL	CITIZEN	CALL
STB Rio plus 64K 5 Function	189.00	CALL	NEC 2050	CALL
Rio Grande 3 function for AT	209.00	CALL	<b>APPLE PRODUCTS</b>	
Graphix + II	210.00	CALL	AST Multi I/O	CALL
High Res 400	369.00	CALL	APPLIED ENGR Mega Ram	CALL
Chaffeur monographics NEW	235.00	CALL	MICRO SCI A2 Drive Ite	169.00
TALGARRS W/Tape	CALL	CALL	IIc drive	169.00
BERNOULLI 20MB	CALL	CALL	APPLE Compatible Drive	119.00
IRWIN 20 MB Tape Backup	CALL	CALL	REMINGTON RAND MAC DRIVE	289.00
IRWIN 10MB Tape Backup	499.00	CALL	HABA Mac drive	CALL
RODYNE 20MB DRIVE	CALL	CALL	MAC Compatible 3 1/2 drive	279.00
TANDON TM 100-2	105.00	CALL	BERNOULLI 5MB MAC drive	CALL
TEAC 55B	99.00	CALL	MACINTOSH Harddrive	CALL
IBM 1.2MB FLOPPY	CALL	CALL	MACINTOSH Software Jazz	CALL
MOUSE SYSTEMS Mouse	169.00	CALL	MICROSOFT Macenhancer	189.00
ALSO — PEASYST, PARADISE, TECHMAR, TITAN AND OTHERS			Softcord II	249.00
<b>MODEMS</b>			Multi-plan // e G Mac	189.00
ANCHOR Mark X	109.00	CALL	Basic (Mac)	109.00
Mark XII	239.00	CALL	ASCII EXPRESS (communications)	69.00
Volkmodem 1200 (5 yr wrnty)	169.95	CALL	THE DESK ORGANIZER (Mac)	133.00
HAYES 1200	379.00	CALL	APPLE MOUSE II	129.00
1200B	345.00	CALL	HAYES Mach III Joystick	39.00
2400	699.00	CALL	SYSTEM SERVER Fan	69.00
PROMETHEUS Promodem 1200	293.00	CALL	VIDEO 7 V-color 7	105.00
Promodem 1200A	289.00	CALL	V-color IIc	105.00
Promodem Mac Pac Kit	329.00	CALL	Mousestick (Mac)	46.00
<b>MONITORS</b>			Titan Accelerator	229.00
AMD6X 300	129.00	CALL	VIDEX Ultraterm	179.00
300A	145.00	CALL	APRICOAN (Lifetime Warranty)	
310A Hi-Res Amber	149.00	CALL	Super Serial Imager	79.00
NEC 1201 Hi Res Green	105.00	CALL	Serial Interface	59.00
1260 Green	75.00	CALL	Graphics Interface	69.00
			80 Column/64H	69.00
			Extend II 64H	59.00
			Apricord IIc	59.00
			WE SUPPORT THESE FINE SYSTEMS:	
			APPLE, IBM, COMPAQ, ITT, AND MANY MORE	

TELEX #550757/ANSWER BACK—COMPUTERBANC UD



Orders Only

800/332-BANC

OUTSIDE CALIFORNIA

COMPUTERBANC

16783 Beach Blvd., Huntington Beach, CA 92647

714/841-6160

Cash prices indicated. All products are in factory sealed packages. We guarantee all items for 30 days. Within this period, defective merchandise returns must be accompanied by RMA number. All other returns will be subject to a 10% restocking fee. For prepaid orders, there will be a 3% shipping charge; 5% for UPS Blue Label; \$5.00 minimum; all orders outside U.S.A. at 15% shipping. California residents add 6% sales tax. Prices subject to change without notice.

©Copyright 1985 COMPUTERBANC. All Rights Reserved



# TOTAL CONTROL with LMI FORTH™



## For Programming Professionals: an expanding family of compatible, high-performance, Forth-83 Standard compilers for microcomputers

### For Development:

#### Interactive Forth-83 Interpreter/Compilers

- 16-bit and 32-bit implementations
- Full screen editor and assembler
- Uses standard operating system files
- 400 page manual written in plain English
- Options include software floating point, arithmetic coprocessor support, symbolic debugger, native code compilers, and graphics support

### For Applications: Forth-83 Metacompiler

- Unique table-driven multi-pass Forth compiler
- Compiles compact ROMable or disk-based applications
- Excellent error handling
- Produces headerless code, compiles from intermediate states, and performs conditional compilation
- Cross-compiles to 8080, Z-80, 8086, 68000, and 6502
- No license fee or royalty for compiled applications

### Support Services for registered users:

- Technical Assistance Hotline
- Periodic newsletters and low-cost updates
- Bulletin Board System

**Call or write for detailed product information and prices. Consulting and Educational Services available by special arrangement.**

**LMI** Laboratory Microsystems Incorporated  
Post Office Box 10430, Marina del Rey, CA 90295  
Phone credit card orders to: (213) 306-7412

#### Overseas Distributors.

Germany: Forth-Systeme Angelika Flesch, D-7820 Titisee-Neustadt  
UK: System Science Ltd., London EC1A 9JX  
France: Micro-Sigma S.A.R.L., 75008 Paris  
Japan: Southern Pacific Ltd., Yokohama 220  
Australia: Wave-onic Associates, 6107 Wilson, W.A.

## BOOK REVIEWS

science of designing combinational and sequential networks is difficult to cover in 200 pages. The information is presented tersely and, if the reader lacks substantial background in networks, can be hard to comprehend.

The next part concerns itself with minimization techniques, the reduction of Boolean equations to their simplest of forms, and Karnaugh mapping and a tabular technique (Quine-McCluskey). These are principles needed in circuit design, but they require more than a chapter to be fully understood and used efficiently. Although the information is not very simple, it is accurate.

The balance of this section develops the basic building blocks of networks and designing with modules. Preparata discusses sequential networks, constructions that require action in preceding sections to cause a predefined chain of events to take place. These are the real techniques necessary in the decision-making circuits that make up present-day computers. Preparata does a very good job of covering this subject matter.

### SYSTEM PLAN

The third and last part of the book describes how to put together all of the information and circuit types that have been described previously. Here is where the reader builds his own SEC and learns how to write programs for it. I like the idea of using a model for learning because it allows me to grasp the concept of microprocessors or computers without the bias or commercial influence of using existing products. However, the problem with this teaching method is the same as writing a trilogy: All the parts have to be consistent and well developed or they lose credibility. The author has succeeded. In fact, this section is where the book excels as an introduction to computer engineering. Although Preparata here has a tendency to overwhelm the reader with mathematics at first, he soon settles into a comfortable description and analysis of a processing system. The programming language is expanded, and the processor (SEC) is developed to the point of actual implementation, with the registers and memory map being explained and documented as well as most real products.

This part contains one of the most straightforward and simple explanations of adders and look-ahead systems that I have come across. The author explains how an arithmetic-logic unit is designed and how it functions. He then develops the CPU and demonstrates its use of register transfers and memory.

The SEC's architecture is a good example of current processor technology. It can serve as a good basis for learning and using the microprocessors available on the market today as well as those we will see in the future.

*Introduction to Computer Engineering* is well written and well documented, but it is not suited for an introductory course. It would serve better at a second-year level or as a review for people already working in the engineering field. ■

Brian Edginton (551 Ramona Ave., Salt Lake City, UT 84105) is a consultant specializing in multiuser business systems.



# ABSOLUTELY MORE!

MORE THAN JUST PRICE! WE WON'T BE UNDERSOLD!



### AB Computers' Own PC

- 100% IBM Compatible
- 256K RAM
- 2-DS DD 380K Disk Drives
- Serial & Parallel Ports
- Choice 20 MHz Amber or Green Monitor
- Pearl Database Free w/System
- Lotus 123 only \$250 w/System

**\$1,475**

Ask about Free Software



### ZENITH data systems

More than IBM Compatible

- 2-DS DD 360K Disk Drives
- 320K RAM
- Amber 20 MHz Monitor - P3
- Pearl Database w/System

**152-C \$1,850**

Ask about Free Software Package

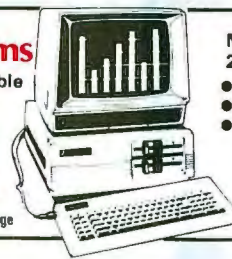

### More than IBM Compatible 20 Mg Hard Disk System

- 320 RAM
- 360K Drive (ds/dd)
- 20 Mg Winchester Hard Disk
- Green 12" Monitor
- Serial/Parallel
- Lotus 123 Only \$250 w/System

We will put the 20Mg hard disk drive (system compatible) in for you at no additional cost. Ask about free software package

**\$2,595**

Increase the Power of your P.C.

#### POWER PACK I

Quadram (384K) . 325.  
or  
AST Six Pack  
(384K) . . . . . 414  
Includes: Double DOS

#### POWER PACK II

Quadram (384K) 469.  
or  
AST Six Pack  
(384K) . . . . . 595  
Includes: Double DOS  
Volkmodem 1200

#### POWER PACK III

Quadram (384K) . 710.  
or  
AST Six Pack  
(384K) . . . . . 839.  
Includes: Double DOS  
Hayes 1200B Modem

#### Move up to Networking

If you currently have 3 IBM or Comp. PC's, package includes: PC Net Software  
One - Master Board (for server)  
Two - Slave Boards (for IBM Comp.)  
One - 20 Mg Hard Disk Add-In (for your server)  
Special . . . . . \$2,169  
Optional - Novelle Oper. Sys. \$1,199

#### HARD DISKS

10 Mg Add-in . . . . . 829  
20 Mg Add-in . . . . . 795  
53 Mg AT Kit . . . . . Call  
33 Mg . . . . . 1,550

#### TEAC

DS 00 Disk Drive . . . . . Call

#### POWER PACK IV

Color Monitor  
(BMC-Composit)  
Plus Color Card (Paradise)  
Plus Cable . . . . . 355

#### POWER PACK V

RGB Monitor (Zenith 133)  
Plus Color Card (Quadram)  
Plus Cable . . . . . 785

#### POWER PACK VI

20 Mg Hand Disk Drive Plus  
Controller Card . . . . . 745.

#### Move up to Networking

If you currently have 1 IBM or Comp. PC, package includes: PC Net Software  
One - Master Board (for server)  
Two - Slave Brds (inst in Clones)  
Two - IBM Clone 2/256K,  
Monochrome Monitor, Keyboard,  
and two 260K Drives  
One 20 Mg Hard Disk Add-In  
Special . . . . . \$5,287  
Optional - Novelle Oper. Sys. \$1,199

#### ADD-ON BOARDS

QUADRAM Hercules  
AST PARADISE

#### MODEMS

Hayes ANCHOR  
. . . . . Call

RAM Riot - 4/64 - \$9.00/Set 4/256 \$42.90/Set

#### AMDEK

300 Green/Amber . . . . . 129/149  
300 Color/Audio. . . . . 259  
310 Amber IBM-Plug . . . . . 189  
Color 500 Composite/RGB . . . . . 389  
Color 600 Hi-Res(840x240) . . . . . 439  
Color 700 Hi-Res(720x240) . . . . . 499  
Color 710 Long Phosphor. . . . . 579

#### USI

Hi Res. Metal Cabinet  
1-9 . . . . . 79  
10-19 . . . . . 70  
20 up . . . . . 86  
Large Quantity . . . . . Call

#### TAXAN

115/118 12" Gm.Amb.Mono 99  
121 Green TTL . . . . . 139  
122 Amber TTL . . . . . 149  
210 Color RGB . . . . . 239  
400 Med-Res RGB . . . . . 319  
415 Hi-Res RGB . . . . . 399  
420 Hi-Res RGB (IBM) . . . . . 429  
440 Ultra Hi-Res RGB . . . . . 589

#### Macintosh Software

Typing Tutor III. . . . . 40  
Multiplan. . . . . 129  
MacVegas. . . . . Call

#### ZENITH

ZVM 122/123 Amb. Grn. . . . . 89  
ZVM 124 IBM Amber. . . . . 149  
ZVM 131 Color. . . . . 299  
ZVM 133 RGB . . . . . 429  
ZVM 135 RGB/Color . . . . . 459  
ZVM 138 RGB/Color . . . . . 829

#### BMC

9191U Color . . . . . 199

#### Apple Software

Sideways . . . . . Call  
Word Attack . . . . . Call  
PFS Write/File/Graph/Plan . . . . . Call  
Copy II . . . . . 35  
Hitchhikers Guide to Galaxy . . . . . 28

#### IBM Software

dBaselll . . . . . 458  
Lotus 123 . . . . . Call  
Sideways . . . . . Call  
PFS Write/File/Graph/Plan . . . . . Call

#### DISK RIOT

DS/DD AS LOW AS

3M 1.52  
maxell 1.67  
MEMOREX 1.42

Nobody Beats our Price on Disks!

AB DISKETTES  
with Media Mate  
30 - 3.5" . . . . . 100  
100 - 5" DS/DD . . . . . 140

#### Amaray Disk Library

Media Mate . . . . . 8.95  
Flip N File/25 . . . . . 18.50  
Flip N File/50 . . . . . 22.95

#### Panasonic

With IBM Cable and Software disk to change type size & style

1090 80 cps . . . . . 219  
1091 120 cps . . . . . 299  
Specify computer

#### OKIDATA

82, 83, 84, 92, 93, 182, 2350, 2410.  
Okimate-20 . . . . . Call  
Dkimate (Specify C84 or Atari) . . . . . 199

#### EPSON

RX-80, FX-80+, LX-80, JX-80+ . . . . . Call  
FX-100+, RX-100, LD1500 . . . . . Call  
Homewriter 10 . . . . . Call

#### PAPER

9 1/2" x 11" Keen Edge . . . . . 29  
9 1/2" x 11" Standard . . . . . 27  
14 1/2" x 11" Standard . . . . . 38  
20 lb - other weights available  
2700 sheets per case

#### CITOH

Prowriter 7500 . . . . . 219  
Prowriter 8510P . . . . . 299  
Prowriter 1550P . . . . . 489  
Son of Starwriter A10P . . . . . 459  
Hot Dot Matrix . . . . . 459  
F10-40P Starwriter . . . . . 899  
F10-55 Printmaster . . . . . 1,049

#### CABLES

Parallel Cable (36 pin/36 pin) . . . . . 23  
RS232 Male to Male 8' . . . . . 17  
RS232 Male to Female 8' . . . . . 18  
Parallel Cable for Columbia. . . . . 25  
IBM Cable. . . . . 19

ORDERING INFORMATION: Order by check, Mastercard or VISA. Personal checks take 15 days to clear, no working on certified checks or money orders. Add 3% shipping and handling on all orders (minimum \$2.00) Min. APO/FPO. Air may require additional charges. PA residents add 6% sales tax. MA residents add 5%. All items subject to availability. Prices subject to change. Additional discounts available to qualified educational institutions. Requests for bid on volume requirements invited.

#### AB SATISFACTION GUARANTEE

Every product sold by AB Computers is factory packed and comes with the manufacturer's warranty. However, if an item is defective when received, you may return it to us within 15 days for repair, adjustment or replacement at our option. Returns must be accompanied with copy of your invoice, letter detailing defect, Mark warranty card and all original factory packing. To expedite handling, please call for return authorization number. (Sorry, no return on computer software once opened.)

Use our TOLL FREE Order Line Mon-Fri 9am-6pm EST

**800-822-1211**

In PA: 215-822-7727

252 BETHLEHEM PIKE, COLMAR, PENNSYLVANIA 18915

We support Apple, Macintosh, Commodore, IBM & compatibles



Customer Service 215-822-7727





# Helps simple tension.

We can't do anything about mergers. Takeovers. Or elevators that stick.

But we can do something about the nail-biting suspense of faulty floppy disks:

Make a diskette that's certified 100% error-free and guaranteed for life. Which we conservatively estimate to be 200 years at the rate of one read/write pass on

every track, every hour of every day.

A little overkill, but nowadays, you can't be too careful.

That's why every 3M diskette must live up to 327 of the most



# relieve nervous

demanding standards ever devised. Standards that even reject a floppy if the label's a little crooked.

Which means when a floppy leaves here,

we know it won't flop.

So you can find relief from nervous tension due to faulty floppies.

One less thing to worry about.

Inquiry 367



**3M**  
diskettes



# E·V·E·N·T Q·U·E·U·E

## September 1985

**AI AND EXPERT SYSTEMS SEMINARS.** Glasgow, Scotland. The Turing Institute, George House, 36 North Hanover St., Glasgow G1 2AD, Scotland. *September–November*

**DATA COMMUNICATIONS WORKSHOPS,** various sites throughout the U.S. and Canada. Intel Corp., Westford Corporate Center, Three Carlisle Rd., Westford, MA 01880, (617) 256-1374. *September–December*

**C LANGUAGE SEMINAR AND WORKSHOP,** Sheraton-Commander Hotel, Cambridge, MA. The fee is \$695. Beatrice Blatteis, CL Publications, 131 Townsend St., San Francisco, CA 94107, (415) 957-9353. *September 16–18*

**THE FOURTH ANNUAL DATA STORAGE INTERNATIONAL FORUM.** Red Lion Inn, San Jose, CA. Carlidge & Associates Inc., Suite M259, 1101 South Winchester Blvd., San Jose, CA 95128, (408) 554-6644. *September 16–18*

**THE SIXTEENTH CONVENTION INFORMATIQUE,** Palais des Congres, Paris, France. Convention Informatique, 4 Place de Valois, 75001, Paris, France; tel: (1) 261 52 42; Telex: 212 597 F. *September 16–20*

**THE SIXTH ANNUAL SOFTWARE/EXPO,** Infomart, Dallas, TX. Professional Exposition Management Co. Inc., Suite 205, 2400 East Devon Ave., Des Plaines, IL 60018, (800) 323-5155; in Illinois, (312) 299-3131. *September 17–19*

**UNIX EXPO: THE UNIX OPERATING SYSTEM EXPOSITION AND CONFERENCE,** New York Hilton and Sheraton Centre Hotels, New York City. Robert P. Birkfeld, National Expositions Co. Inc., 14 West 40th St., New York, NY 10018, (212) 391-9111. *September 18–20*

**EASTERN COMPUTER MANUFACTURING EXPO,** Charlotte, NC. Great Southern Shows, POB 655, Jacksonville, FL 32201, (904) 743-8000. *September 19–21*

**THE SEVENTH ANNUAL FORTH CONVENTION AND BANQUET,** Hyatt Rickey's, Palo Alto, CA. FORTH Interest Group, POB 8231, San Jose, CA 95155, (408) 277-0668. *September 20–21*

**THE TIDEWATER TENTH ANNUAL COMPUTER FAIR,** Radio Amateur Hamfest—Electronic Flea Market, Virginia Beach Pavilion, VA. Advance tickets are \$5 for both days or \$6 at the door. Jim Harrison, Tidewater Radio Conventions Inc., 1234 Little Bay Ave., Norfolk, VA 23503, (804) 587-1695. *September 21–22*

**SPACE TECH '85 CONFERENCE AND EXPOSITION,** Disneyland Hotel, Anaheim, CA. Society of Manufacturing Engineers, One SME Dr., POB 930, Dearborn, MI 48121, (313) 271-1500. *September 23–25*

**THE EIGHTH NORTHEAST COMPUTER FAIRE,** Bayside Exposition Center, Boston,

MA. Computer Faire Inc., 181 Wells Ave, Newton, MA 02159, (617) 965-8350. *September 26–29*

## October 1985

**UNIX SYSTEMS EXPO/85-FALL,** Bayside Exposition Center, Boston, MA. Computer Faire Inc., 181 Wells Ave., Newton, MA 02159, (617) 965-8350. *October 3–5*

**THE FIFTH ANNUAL SYMPOSIUM ON SMALL COMPUTERS IN THE ARTS,** Hilton of Philadelphia, Philadelphia, PA. Small Computers in the Arts Network, Symposium, POB 1954, Philadelphia, PA 19105. *October 5–8*

**THE SIXTH ANNUAL MEETING OF THE AMERICAN SOCIETY FOR ENGINEERING MANAGEMENT,** Portland, OR. American Society for Engineering Management, 301 Harris Hall, University of Missouri-Rolla, Rolla, MO 65401-0249, (314) 341-4560. *October 6–8*

**THE FIFTH ANNUAL EDUCATIONAL COMPUTER FAIR,** Cleveland, OH. Educational Computer Consortium of Ohio, Teacher Center 271, 1123 S.O.M. Center Rd., Cleveland, OH 44124, (216) 461-0800. *October 11–12*

**THE 1985 ASSOCIATION FOR COMPUTING MACHINERY ANNUAL CONFERENCE,** Denver Hilton Hotel, Denver, CO. ACM, 11 West 42nd St., New York, NY 10036, (212) 869-7440. *October 14–16*

**COMPUTERS AND THE DISABLED CONFERENCE,** California State University, Northridge. Dr. Harry J. Murphy, Conference Coordinator, Office of Disabled Student Services, 18111 Nordhoff St., Northridge, CA 91330, (818) 885-2578. *October 17–19*

**COMPUTERS IN EDUCATION,** Sheraton Centre Hotel, New York, NY. Carole Dornblaser, Conference Management Corp., 17 Washington St., Norwalk, CT 06854, (203) 852-0500. *October 18–20*

**NORTHCON/85 AND MINI-MICRO NORTHWEST-85,** Memorial Coliseum, Portland, OR. Electronic Conventions Management, 8110 Airport Blvd., Los Angeles, CA 90045, (213) 772-2965. *October 22–24*

**THE FIRST ANNUAL OPTICAL DISC/READ-ONLY MEMORY FORUM,** Pentagon Quality Inn, Arlington, VA. Learning Technology Institute, 50 Culpeper St., Warrenton, VA 22186, (703) 347-0055. *October 23–25*

**THE SIXTH ANNUAL FEDERAL OFFICE AUTOMATION CONFERENCE,** Convention Center, Washington, DC. Federal Office Automation Conference, POB N, Wayland, MA 01778, (617) 358-5356. *October 29–31*

**COMPUTER TECHNOLOGY FOR THE HANDICAPPED,** Radisson South Hotel, Minneapolis, MN. Closing the Gap, POB 68, Henderson, MN 56044, (612) 248-3294; in Minneapolis/St. Paul, 341-8299. *October 30–November 2* ■

IF YOU WANT *your organization's public activities listed in BYTE's Event Queue, we need to know about them at least four months in advance. Send information about computer conferences, seminars, workshops, and courses to* **BYTE, Event Queue, POB 372, Hancock, NH 03449.**



# THE PROFESSIONAL'S CHOICE

Lotus 1-2-3 <b>\$309</b>	Lotus Symphony <b>\$429</b>	dBase III <b>\$369</b>	FrameWork <b>\$369</b>	MultiMate <b>\$249</b>	Word Perfect <b>\$209</b>
--------------------------------	-----------------------------------	---------------------------	---------------------------	---------------------------	---------------------------------

## Software

### Word Processing Editors

FANCY FONT	\$139
FINAL WORD	\$189
MICROSOFT WORD	\$229
MULTIMATE	\$249
OFFICE WRITER/ SPELLER	\$259
PFS: WRITE	\$95
SAMNA WORD III	\$259
VOLKSWRITER	\$159
DELUXE	\$159
VOLKSWRITER SCIENTIFIC	\$279
THE WORD PLUS (OASIS)	\$105
WORD PERFECT	\$209
WORDSTAR	\$189
WORDSTAR 2000	\$259
WORDSTAR 2000+	\$299
WORDSTAR PRO XYWRITE II+	\$259
	\$199

### Spreadsheets/ Integrated Packages

ELECTRIC DESK	\$209
ENABLE	\$359
FRAMEWORK	\$399
JAZZ	\$399
LOTUS 1-2-3	\$309
MULTIPLAN	\$135
OPEN ACCESS	\$359
SAMNA PLUS	\$379
SMART SYSTEM	\$559
SPREADSHEET AUDITOR	\$109
SUPERCALC 3	\$179
SYMPHONY	\$429

### Accounting

BPI	\$319
GREAT PLAINS	\$479
IUS EASYBUSINESS	\$279
ONE WRITE PLUS	\$179
OPEN SYSTEMS	\$369
PEACHTREE	\$299
REAL WORLD	\$369
STATE OF THE ART STAR ACCOUNTING PARTNER	\$249
STAR ACCOUNTING PARTNER II	\$549

### Desktop Environments

DESK ORGANIZER	\$ 79
GEM DESKTOP	\$ 45
SIDEKICK	\$ 45

### Database Systems

ALPHA DATA BASE MANAGER II	\$179
CLIPPER	\$499
CLOUT V 2.0	\$139
CONDOR III	\$299
CORNERSTONE	\$289
DBASE II	\$299
DBASE II	\$369
KNOWLEDGEMAN	\$269
PFS: FILE/PFS: REPORT	\$169
POWERBASE	\$319
QUICKCODE III	\$169
QUICKREPORT	\$169
R BASE 4000	\$249
R BASE 5000	\$359
REFLEX	\$329
REVELATION	\$729

### Languages/Utilities

CONCURRENT DOS	\$189
C86 C COMPILER	\$299
DIGITAL RESEARCH C COMPILER	\$219
DR FORTRAN 77	\$219
LATTICE C COMPILER	\$299
MICROSOFT C COMPILER	\$249
MS BASIC COMPILER	\$249
MS FORTRAN	\$239
NORTON UTILITIES	\$ 89
TURBO PASCAL	\$ 59
XENIX	\$Call

### Project Management

HARVARD PROJECT MANAGER	\$209
HARVARD TOTAL PROJECT MANAGER	\$259
MICROSOFT PROJECT	\$159
PERTMASTER	\$549
SCITOR PROJECT	\$251
5000 W/GRAPHICS	\$189
SUPERPROJECT	\$249
TIME LINE	\$249

### Communications/ Productivity Tools

CROSSTALK	\$105
PROKEY	\$ 89
RELAY	\$ 99
REMOTE	\$119
SMARTCOM II	\$109
SUPERKEY	\$ 55

### Graphics/Statistics

ABSTAT	\$279
AUTOCAD	\$Call
BPS BUSINESS GRAPHICS	\$229
CHARTMASTER	\$229
CHARTSTAR	\$189
ENERGRAPHICS	\$199
EXECUVISION	\$259
GEM DRAW	\$ 89
GRAPHWRITER	\$359
COMBO	\$159
MS CHART	\$159
OVERHEAD EXPRESS	\$109
PC DRAW	\$249
PC PAINTBRUSH	\$ 89
PC PAINT	\$ 79
PFS: GRAPH	\$ 95
SIGNMASTER	\$185
STATGRAPHICS	\$595
STATPAK-NWA	\$329
STATPAC-	\$349
WALONICK	\$349
SYSTAT	\$419

### Professional Development

EXPERTEDGE	\$Call
LIGHTYEAR	\$329
MANAGEMENT EDGE	\$159
SALES EDGE	\$159
THINK TANK	\$119

### Personal Finance

DOLLARS AND SENSE	\$119
HOWARD TAX PREPARER 85	\$195
MANAGING YOUR MONEY	\$119

## Hardware\*

### Accessories

CURTIS SURGE PROTECTORS	\$Call
DATASHIELD BACKUP POWER	\$Call
GILTRONIX A/B SWITCH	\$Call
MICROBUFFER INLINE (84K)	\$Call
MICROFAZER INLINE (84K)	\$219
258K RAM SET	\$ 49
8087 MATH CHIP	\$125

### Multifunction Boards

AST ADVANTAGE	\$389
AST 6 PAK PLUS (84K)	\$259
AST 6 PAK PLUS (384K)	\$289
ORCHID BLOSSOM (0K)	\$209
ORCHID BLOSSOM (384K)	\$269
ORCHID PC TURBO	\$699
PERSYST TIME SPECTRUM (0K)	\$209
PERSYST TIME SPECTRUM (384K)	\$269
QUADBOARD (0K)	\$229
QUADBOARD (384K)	\$269
TECMAR CAPTAIN (0K)	\$189
TECMAR CAPTAIN (384K)	\$269
TECMAR JR CAPTAIN (128K)	\$329
TECMAR JR WAVE (84K)	\$249
TECMAR MAESTRO	\$429
TECMAR WAVE (84K)	\$209

### Display Boards

EVEREX GRAPHICS EDGE	\$329
HERCULES GRAPHICS CARD	\$299
HERCULES COLOR CARD	\$159
PARADISE MODULAR GRAPHICS	\$275
PARADISE MULTIDISPLAY CARD	\$295
PERSYST BOB	\$429
PRINCETON SCAN DOUBLER	\$199
SIGMA COLOR 400	\$529
STB CHAUFFER	\$289
STB GRAPHICS PLUS II	\$309
TECMAR GRAPHICS MASTER	\$489
TSENG ULTRA PAK	\$399
TSENG ULTRA PAK-S	\$349

### Emulation Boards

AST	\$Call
CXI 3278/9 Plus	\$959
IRMA	\$799
IRMALINE	\$999
IRMAPRINT	\$Call

### Networks

AST PC NET	\$Call
CORVUS NET	\$Call
ORCHID PC NET	\$Call
3 COM	\$Call

### Displays

AMDEK 310A	\$169
PRINCETON HX-12	\$459
PRINCETON MAX-12E	\$179
PRINCETON SR-12	\$589
PRINCETON HX-12E	\$Call
PRINCETON HX-9	\$Call
QUADRAM AMBERCHROME	\$179
TAXAN 122 AMBER	\$159
TAXAN 420/440	\$399/599
ZENITH 124 AMBER	\$145
ZENITH 135 COLOR	\$Call

### Modems

AST REACH 1200	\$389
HAYES 1200	\$389
HAYES 1200B	\$365
HAYES 2400	\$639
VENTEL 1200 HALF CARD	\$389

### Mass Storage/Backup

ALLOY MT25 TAPE (EXT)	\$895
CORE 56MB (AT)	\$3595
OMEGA BERNOULLI BOX	\$2595
IRWIN 310A 10MB TAPE (EXT)	\$850
SYSGEN IMAGE	\$850
TALLGARSS TG5025	\$2845
TECMAR QIC-60H TAPE (EXT)	\$1499
TECMAR QIC-60AT TAPE (INT)	\$1199

### Printers/Plotters

C. ITOH	\$Call
DIABLO	\$Call
EPSON FX-80+	\$349
EPSON FX-100+	\$499
EPSON LQ-1500	\$999
HP 7475A PLOTTER	\$Call
JUKI 6100	\$419
NEC P3	\$799
NEC 3550	\$1139
OKIDATA	\$Call
PANASONIC	\$Call
QUME SPRINT 1155	\$1589
TOSHIBA P1340	\$829
TOSHIBA P351	\$1279

### Input Devices

KEYTRONIC 5151	\$179
KOALA	\$Call
MICROSOFT MOUSE	\$139
PC MOUSE W PAINT	\$159

\*CALL FOR SHIPPING COSTS

Harvard HTPM <b>\$259</b>	Chart-Master <b>\$229</b>	Quadboard 384K <b>\$269</b>	Tseng Ultra Pak <b>\$399</b>	Smartmodem 1200B <b>\$365</b>	Smartmodem 2400 <b>\$639</b>
---------------------------------	------------------------------	-----------------------------------	------------------------------------	-------------------------------------	------------------------------------



**LOWEST PRICE GUARANTEE!!**  
We will match current nationally advertised prices on most products. Call and compare.



**1-800-221-1260**  
In New York State call (718) 438-6057

TERMS:  
Checks—allow 14 days to clear. Credit processing—add 3%. COD orders—cash, M.O or certified check—add \$3.00. Shipping and handling UPS surface—add \$3.00 per item (UPS Blue \$6.00 per item). NY State Residents—add applicable sales tax. All prices subject to change.

MasterCard VISA  
MON.-THURS. 9:00 AM-8:00 PM  
SUN. & FRI. 9:00 AM-4:00 PM

**Softline**  
Softline Corporation  
P.O. Box 729, Brooklyn, N.Y. 11230  
TELEX: 421047 ATLN UI



COMPAQ could have stopped here

---





...but we didn't.

## Introducing the new COMPAQ PORTABLE 286™ More features, more speed...more useful.

Most people think the IBM® Personal Computer-AT™ can do more than any other personal computer. But now COMPAQ offers a personal computer that does more in a package *half* the size, complete with a handle.

### Incredibly fast

Most computer companies would consider it a breakthrough to make a computer with the power and speed of the IBM PC-AT. But not COMPAQ. The new COMPAQ PORTABLE 286 runs all the popular programs 30% *faster*.

And no doubt most would have been elated to put 20 Megabytes of fixed disk storage in a portable computer. But we didn't stop there. We designed the COMPAQ PORTABLE 286 to accept an internal fixed disk drive back-up system as well. It protects your data on pocket-sized tape cartridges, something not even the IBM PC-AT can do.

### Room to grow

Once we got started, it was hard to stop. There's room for up to three internal storage devices. Choose from 1.2-Megabyte or 360-K byte diskette

drives, the fixed disk drive and fixed disk drive back-up.

Add up to 640-K bytes of memory on the main board. Then add up to 2 more Megabytes using an expansion board. That gives you more memory than most desktop computers.

For displaying your work, a built-in monitor shows high-resolution text *and* graphics. A second monitor isn't necessary.

### Does more—anywhere

Together, all these features add up to our fastest, most powerful portable computer. It helps you do more, in more places.

Of course, if you need a computer with even more power, we designed a model that stays in one place.

The new COMPAQ DESKPRO 286™. With up to 8.2 Megabytes of memory and 70 Megabytes of storage, it can take you beyond today's limits of desktop personal computing.

COMPAQ offers personal computers beyond compare. Because we make them without compromise.

For a free brochure or the location of your nearest Authorized COMPAQ Computer Dealer, call toll-free 1-800-231-0900 and ask for operator 6.



It simply works better.

**COMPAQ**  
**PORTABLE 286™**





HOMEBREW  
BYTE 1975-1985

FOLD  
ALONG  
DOTTED  
LINES

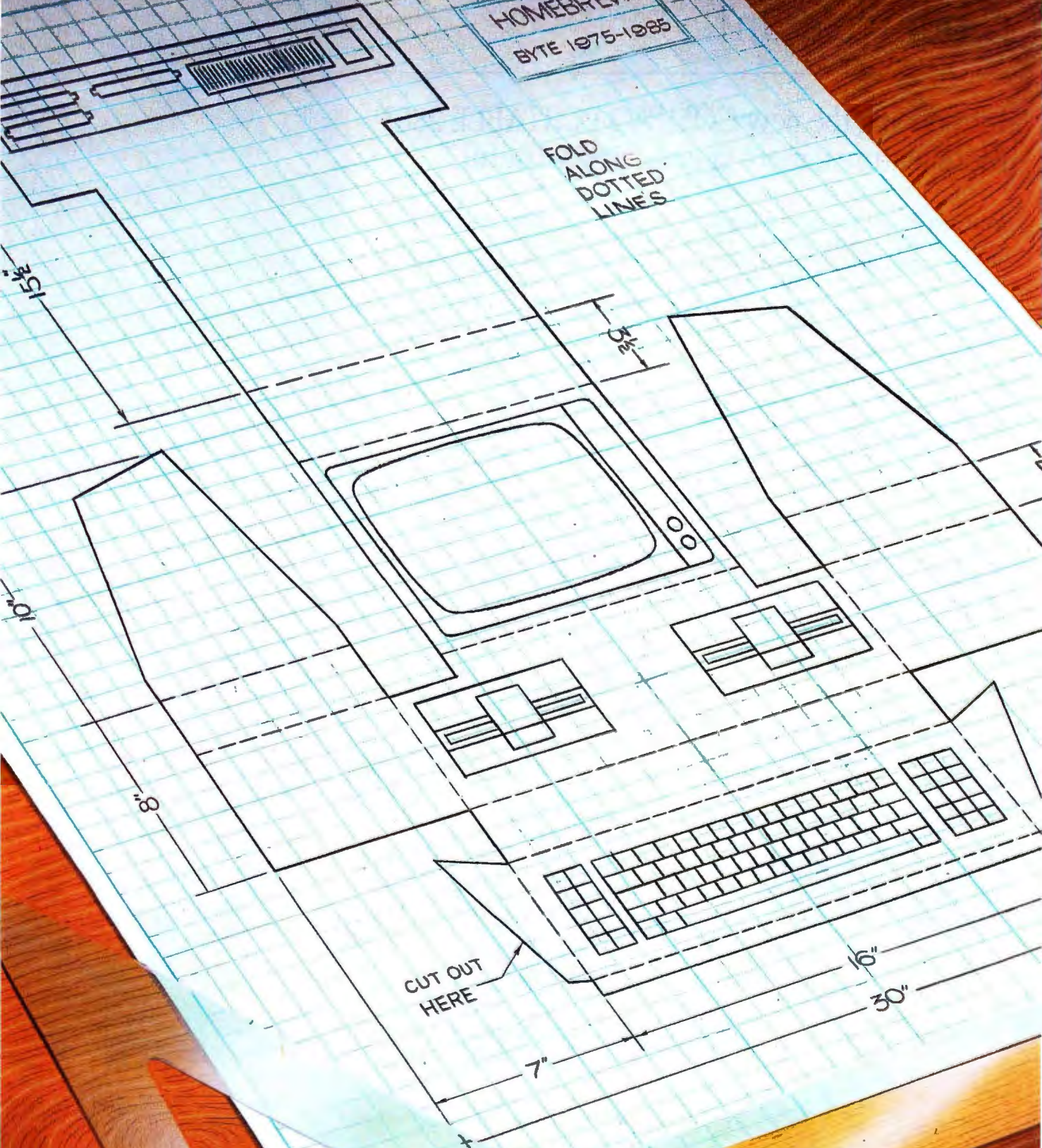

CUT OUT  
HERE

ROBERT  
STINNEY



# Features

---

<b>CIARCIA'S CIRCUIT CELLAR: BUILD THE SB180 SINGLE-BOARD COMPUTER, PART 1: THE HARDWARE</b> <i>by Steve Ciarcia</i> .....	<b>86</b>
<b>PROGRAMMING PROJECT: AN ANALYSIS OF SORTS</b> <i>by Jonathan Amsterdam</i> .....	<b>104</b>
<b>THE DSI-32 COPROCESSOR BOARD, PART 2: THE SOFTWARE</b> <i>by Trevor G. Marshall, George Scolaro, David L. Rand, Tom King, and Vincent P. Williams</i> .....	<b>116</b>
<b>AN ALGORITHM FOR DISK CACHING WITH LIMITED MEMORY</b> <i>by Brian McKeon</i> .....	<b>129</b>
<b>ASTROPHYSICAL NUMBER CRUNCHING</b> <i>by A. G. W. Cameron</i> .....	<b>141</b>
<b>TWO GENERALIZED FLOATING-POINT REPRESENTATIONS</b> <i>by David Salomon</i> .....	<b>154</b>
<b>TURBO PASCAL DRIVES THE MOUSE</b> <i>by John Figueras</i> .....	<b>161</b>
<b>IBM COMPATIBILITY FOR THE NEC APC III</b> <i>by Herbert Stein</i> .....	<b>171</b>
<b>PROGRAMMING INSIGHT: BUILD A TRAVESTY TREE</b> <i>by Peter Wayner</i> .....	<b>183</b>
<b>PROGRAMMING INSIGHT: PRINTING PASCAL GRAPHICS</b> <i>by Kelly W. Davis</i> .....	<b>193</b>

---

THE CIRCUIT CELLAR project this month is the innovative SB180 single-board computer. Steve says that the SB180 reasserts 8-bit computing in a 16-bit world. This first part of a two-part article describes the HD64180 chip used, gives an overview of the evolution of CP/M, and describes the design of the computer.

In this month's Programming Project, Jonathan Amsterdam discusses sorting in the context of three different algorithms: Selection Sort, for small lists, Quicksort, for larger lists, and Mergesort, for lists so large they can't fit into memory all at once.

This month we have part 2 of a two-part series describing Definicon Systems Inc.'s DSI-32 32032 coprocessor board for the IBM PC. This part focuses on the software available for the board.

"An Algorithm for Disk Caching with Limited Memory" by Brian McKeon presents a set of C functions that use a small amount of memory to store copies of disk sectors and improve floppy-disk performance. This algorithm is especially helpful when memory space is at a minimum.

Harvard astronomy professor A. G. W. Cameron describes his experiences with number crunching on a progression of computers—beginning in the mid-1950s, when he was working with an IBM 602A, to the present, with PC XT clones—in "Astrophysical Number Crunching."

"Two Generalized Floating-Point Representations" by David Salomon offers two designs, partitioned and variable-based, for support devices that handle floating-point numbers in formats other than the traditional *S E F*.

In "Turbo Pascal Drives the Mouse," John Figueras details a procedure that accesses MS-DOS functions and interrupts and interfaces the Microsoft Mouse with Pascal.

Herbert Stein made some changes to his APC III and ended up with what he considers the fastest low-cost IBM PC clone currently available. His operating-system patch and other upgrades are described in "IBM Compatibility for the NEC APC III."

This month we have another follow-up to last November's "Travesty Generator for Micros" by Hugh Kenner and Joseph O'Rourke. In "Build a Travesty Tree," Peter Wayner explains that tree data structures handle large problems much faster than the method described in the original article.

"Printing Pascal Graphics" by Kelly W. Davis presents a screen-dump program that simplifies graphics creation in Apple Pascal with any MX-series printer from Epson.



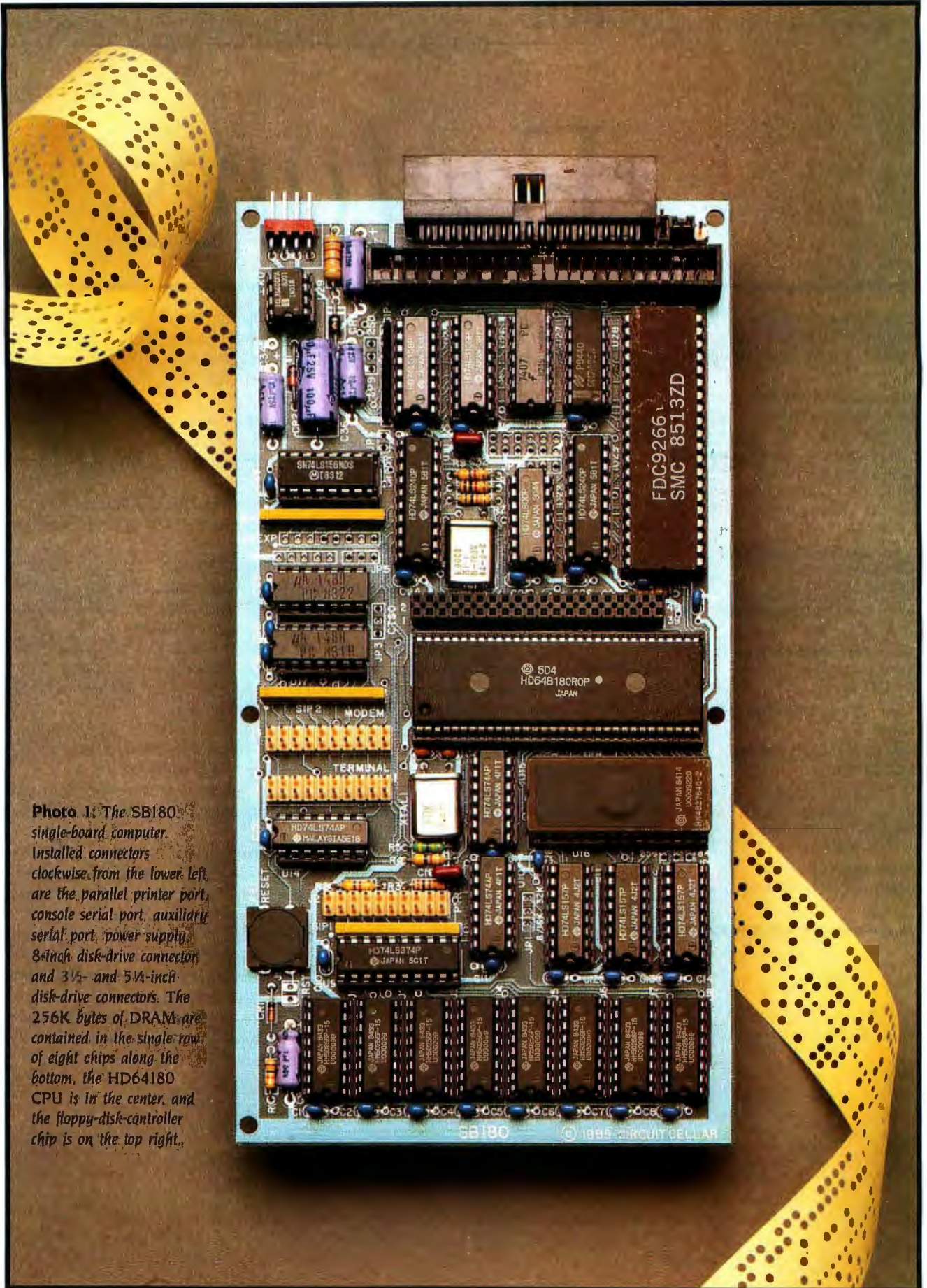

**Photo 1:** The SB180 single-board computer. Installed connectors clockwise from the lower left are the parallel printer port, console serial port, auxiliary serial port, power supply, 8-inch disk-drive connector, and 3 1/2- and 5 1/4-inch disk-drive connectors. The 256K bytes of DRAM are contained in the single row of eight chips along the bottom, the HD64180 CPU is in the center, and the floppy-disk-controller chip is on the top right.



# BUILD THE SB180 SINGLE-BOARD COMPUTER

## PART 1: THE HARDWARE

BY STEVE CIARCIA

*This computer reasserts 8-bit computing  
in a 16-bit world*



Newer, faster, better. These words are screamed at you in ads and reviews of virtually every new computer that comes to market. Unfortunately, many of the proponents of this rhetoric are going on hearsay evidence. While advertising hype has its place in our culture, a more thorough investigation may lead you to alternative conclusions.

Generally speaking, quotes of increased performance are basically comparisons of CPU (central processing unit) instruction times rarely involving the operating system. The 68000 is indeed a more capable processor than the 6502, but that doesn't necessarily mean that commercial application programs always run faster because the CPU has more capability. People owning 128K-byte Macintoshes have discovered this.

The bus size of the processor is only one factor in the performance of a computer system. Operating-system design and programming styles contribute much more to the overall throughput of a computer. It is not enough to simply compare 8 to 16 bits or 16 to 32 bits. For example, the Sieve of Eratosthenes prime-number benchmark runs faster in BASIC on the 8-bit 8052-based controller board presented in last month's

Circuit Cellar than it does on a 16-bit IBM PC.

The ultimate performance of a computer is the sum of its subsystem interaction times and not just the CPU execution speed. Using a simple database-management program involves interaction among the user input device, operating system, disk drives, firmware, system memory, and user output devices. Slow communication or a bottleneck between any two of these subsystems can degrade the performance of the entire computer.

In my opinion, the processor/operating system connection contributes most to user satisfaction. In the days before the IBM PC, the de facto computer standard was the 8080/Z80 and CP/M 2.2. Unfortunately, software developers considered it difficult to use, especially in turnkey applications. The frustration of having to warm-boot the system merely to change disks and the lack of a PATH command created many ready-and-willing PC-DOS customers. If only there were an 8-bit operating system with the capabilities and friendliness of MS-DOS.

*(continued)*

*Steve Ciarcia (pronounced "see-ARE-see-ah") is an electronics engineer and computer consultant with experience in process control, digital design, nuclear instrumentation, and product development. He is the author of several books about electronics. You can write to him at POB 582, Glastonbury, CT 06033.*



The Z80 is still considered a high-performance CPU. In reality, the 8-bit processor is a cost-effective and efficient choice for personal computers and industrial controllers. (Remember that peripheral support chips such as PIAs [peripheral interface adapters] and floppy-disk controllers are 8-bit devices, as are many memory chips.) One problem is that the Z80 has an address limitation of 64K bytes, which discourages the use of 50K-byte BASIC interpreters and 100K-byte integrated spreadsheet programs common to IBM PC users. While additional memory has been added through hardware bank switching, it has never been properly integrated into the CP/M operating system, and its function is kludgy. If only someone would design a Z80 chip that directly addresses more than 64K bytes.

### THE CIRCUIT CELLAR SB180

Hitachi has recently developed a CMOS (complementary metal-oxide semiconductor) Z80-code-compatible processor, designated the HD64180, that directly addresses 512K bytes. Echelon Systems has developed an operating system for the processor that is an amalgam of CP/M, MS-DOS,

and UNIX. This operating system is called the Z-System. Using the HD64180 and the Z-System, I have produced a computer that reasserts 8-bit computing in a 16-bit world and outperforms a standard IBM PC by 20 to 100 percent.

In this two-part article, I take a look at the Hitachi HD64180 and the evolution of CP/M as embodied in the Z-System. The hardware project is a single-board computer (4 by 7½ inches) called the SB180, which is the 29-chip equivalent of a large S-100 system (see photos 1 and 2). Refer to figure 1 for a block diagram of the SB180 board.

The Circuit Cellar SB180 has the following capabilities:

- 256K-byte on-board RAM (random-access read/write memory), which can be partitioned as 64K-byte system memory and 192K-byte RAM disk or as paged system memory
- 32K-byte EPROM (erasable programmable read-only memory)
- full ROM-based monitor with system-disk boot
- two RS-232C serial ports, one with automatic data-transmission-rate detection

- a Centronics parallel printer port
- single/double-density programmable floppy-disk controller capable of handling a mix of up to four 3½-, 5¼-, or 8-inch drives; different-size drives can run concurrently
- requires only +5 volts (V) and +12 V for operation (+12 V only for RS-232C)
- I/O (input/output) expansion bus
- fits on a 4- by 7½-inch board that mounts directly to a 5¼- or 3½-inch floppy-disk drive

Disk-based software includes the Z-System DOS (disk operating system), a debugger, and HD64180 assembler.

While this is in fact a hardware project, true functionality would be an exercise left to you readers were it not for the operating system and BIOS (basic input/output system) specifically written and adapted to the SB180. The combination of the HD64180 and Z-System is what gives this tiny computer so much power. Much of the project description therefore has to be the software that uniquely sets performance levels far above traditional 8-bit computer designs. I don't want to diminish the significance of the hardware, but I am a realist.

This month, I'd like to describe the HD64180 chip and give an overview of the changing evolution of CP/M as it pertains to this project. After that, I'll describe the design of the SB180. Next month will be dedicated to the operating-system software and BIOS.

### CP/M AND BEYOND

Anyone who has been involved with microcomputers for more than two years acknowledges the tremendous impact of CP/M upon the history of personal computing. While hobbyists were still debating whether the "standard" tape format should be Kansas City CUTS (cassette user tape system) or Tarbell, Gary Kildall made CP/M available at a reasonable price. It quickly became the de facto standard DOS for 8080- and Z80-based microcomputers. With a "standard" operating system and a "standard" 8-inch disk format, entrepreneurial program-

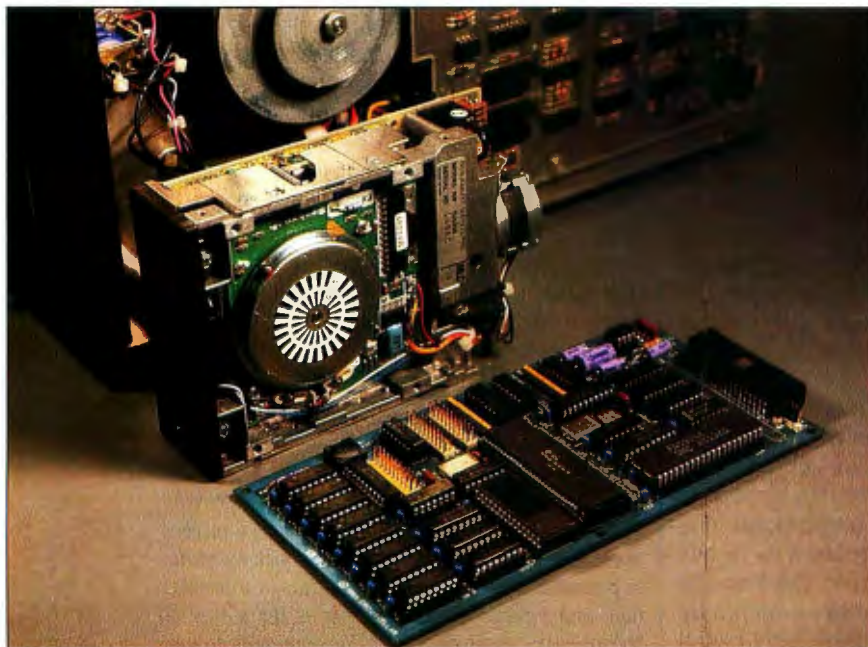

Photo 2: The SB180 shown beside a 3½-inch disk drive and an 8-inch disk drive.



mers saw the opportunity to write serious business applications that needed disk capability to be viable and that could be sold to thousands of CP/M machine owners.

The first major commercial release of CP/M was version 1.4. In an effort to fix some bugs and improve its file-handling capabilities and limits, it was upgraded first to version 2.0 and quickly to version 2.2. Version 2.2 has been a stable product that is familiar to most readers of *BYTE*. Version 3.0, or CP/M Plus, has been available for about two years, but it hasn't matched the popularity of version 2.2. While CP/M Plus does offer some advanced features, it is not significantly better than version 2.2.

CP/M has many quirks and shortcomings. Having to warm-boot the system when changing disks is a major inconvenience, and named directories would be more convenient than trying to remember disk designators and user-area numbers. Almost no file or system security is provided. CP/M 2.2 does not support redirection of I/O devices, as MS-DOS and UNIX do. Even the MS-DOS batch facility beats CP/M's more primitive Submit and XSUB two ways from Sunday; CP/M lacks conditional testing at the command level.

Many system integrators decry CP/M's lack of a good menu utility to integrate stand-alone, executable programs. Command-line editing is primitive, and multiple commands on one line would be appreciated; creating a single-name "alias" for multiple commands would be even better. Since CP/M has no search path (à la PC-DOS and UNIX), you must either keep multiple copies of often-used programs in many different user areas (wasting disk space) or patch CP/M with a software kludge to make user area 0 accessible from all user areas (even that doesn't help if you need to access a file from user area 3 while you are in user area 7). Many CP/M users supplement their system utilities with more useful public-domain programs like XDIR, DU, CRC, Help, Unerase, and Diff. It's too bad that CP/M wasn't upgraded more

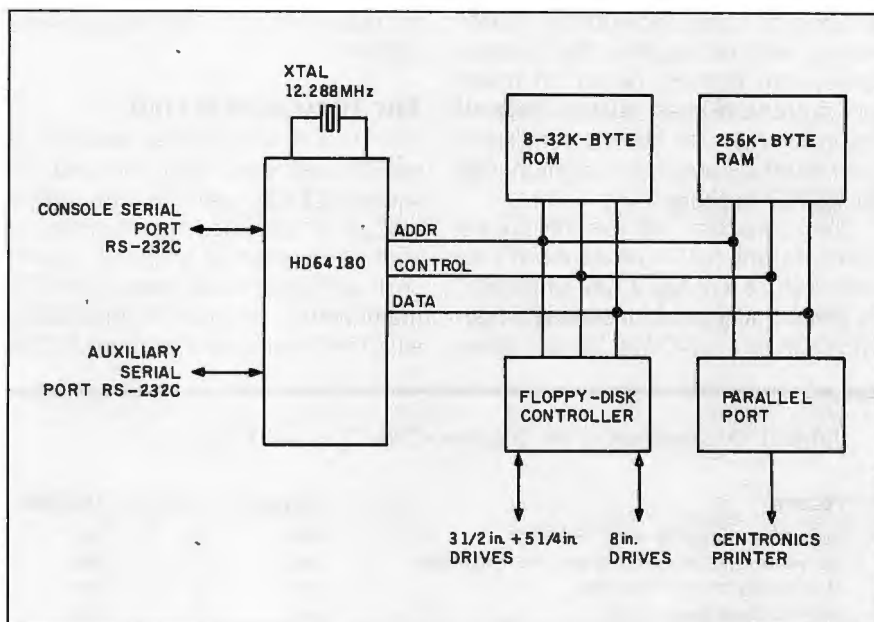

Figure 1: Block diagram of the SB180 single-board computer.

regularly so that it could have evolved into a more mature product.

These observations are certainly not unique. When millions of people use a computer and its operating system in an attempt to become more productive in some way, obstacles to efficiency and productivity are bound to show up. Computer users who have had experience with many different operating systems will miss certain features to which they had become accustomed. And creative individuals of all types always can think of a "better way" to perform some function already provided.

One of the best-known attempts to improve CP/M was ZCPR (Z80 command processor replacement), developed under the direction of Rick Conn. ZCPR was written to replace the console command processor (CCP) supplied with CP/M. This public-domain software featured scaled-down features of UNIX appropriate for a single-user CP/M system. However, since it was designed to fit into the same 2K-byte space as the CCP, it was limited in what it could offer. It did make user area 0 "public" so that executable programs there could be invoked from other user areas. It also changed the prompt so that it in-

dicated the user area as well as the drive currently logged in. As a result of user feedback, ZCPR2 evolved as an extended version of ZCPR. However, it required much more technical sophistication to install it into a CP/M system, and it started patching into and replacing parts of CP/M itself.

Within the past year, Echelon Inc. released ZCPR3, a much-improved version of ZCPR2, which provides solutions to all the problems with CP/M 2.2 and adds more features. Echelon has also developed a complete replacement for CP/M 2.2 in the form of the Z-System. It is composed of two major sections: ZCPR3 and ZRDOS. ZRDOS completely replaces CP/M's BDOS (basic disk operating system).

Written entirely in Z80 assembly language, the Z-System offers the benefits derived from the expanded Z80 instruction set (CP/M is 8080 code only) and from fixing bugs in CP/M 2.2 itself. It is downward-compatible with all CP/M software and takes advantage not only of the Z80 instruction set but of the Hitachi HD64180 CPU as well. Echelon provides both the operating system and a macro-relocating assembly lan-

(continued)



guage with linker and librarian, translators, and debuggers. The operating-system utilities, based on many good public-domain utilities, have all been rewritten to have a consistent user interface and make optimum use of ZCPR3 facilities.

The Z-System will be discussed more completely in next month's article. Suffice it to say, it has significantly greater utility and functionality than MS-DOS or plain CP/M. Table 1 gives

a comparison of the three operating systems.

**THE HITACHI HD64180**

The Hitachi HD64180 is based on a microcoded execution unit and advanced CMOS manufacturing technology. It provides the benefits of high performance, reduced system cost, and low-power operation while maintaining complete compatibility with the large base of standard CP/M

software. The HD64180 can be combined with CMOS VLSI (very-large-scale integration) memories and peripheral devices to form the basis for process-control applications requiring high performance, battery-power operation, and standard software compatibility.

Performance is derived from a high clock speed (6 MHz now, 9 MHz in the near future), instruction speedup, and an integrated memory-management unit (MMU) with 512K bytes of memory address space. The instruction set is a superset of the Z80 instruction set; 12 new instructions include hardware multiply, DMA (direct memory access), I/O, TEST, and a SLEEP instruction for low-power operation.

The HD64180 requires operation at specific frequencies in order to generate standard data-transmission rates. The standard operating frequency for the SB180 is 6.144 MHz (12.288-MHz crystal). Other frequencies that maintain standard data-transmission rates are 3.072 MHz, 4.608 MHz, and (later) 9.216 MHz.

System costs are reduced because many key system functions have been included on this 64-pin chip. Table 2 compares the HD64180 with other 8-bit processors.

The block diagram in figure 2 shows that the HD64180 CPU is composed of five functional blocks:

- Central processing unit: The CPU is microcoded to implement an upward-compatible superset of the Z80 instruction set. Besides the 12 new instructions, many instructions execute in fewer clock cycles than on a standard Z80.

- Clock generator: This generates the system clock from an external crystal or external clock input. The clock is programmably prescaled to generate timing for the on-chip I/O and system-support devices.

- Bus-state controller: This controller performs all status/control bus activity, including external bus-cycle wait-state timing, RESET, DRAM (dynamic RAM) refresh, and master DMA bus exchange. It generates "dual-bus" control signals for compatibility with

Table 1: A comparison of the Z-System, CP/M 2.2, and MS-DOS.

Feature	Z-System	CP/M 2.2	MS-DOS
Software-compatible with CP/M 2.2	yes	yes	no
No warm boot required when changing disks	yes	no	yes
Multiple commands per line	yes	no	no
Named directories	yes	no	yes
Password protection for directories	yes	no	no
Dynamically variable user privilege levels for commands	yes	no	no
Searching of alternate directories for invoked programs and files	yes	no	partial
Terminal-independent video capabilities	yes	no	no
Input/output redirection	yes	no	yes
Conditional testing and execution at the operating-system level (IF/ELSE/ENDIF)	yes	no	no
Shells and menu generators with shell variables	yes	no	no
Tree-structured on-line help and documentation subsystem	yes	no	no
512-megabyte file sizes, 8-gigabyte disks	yes	no	no
Complete error trapping with recovery, customizable messages, and prompts	yes	no	no
Screen-oriented file manipulation and automatic archiving and backup	yes	no	no
Full-screen command-line editing with previous-command recall and execution	yes	no	no

Table 2: A comparison of some 8-bit processors.

	HD64180	8080/85/Z80	NSC800	Z800	80188
Process	CMOS	NMOS	CMOS	NMOS	NMOS
Power	100 mW	1 W	100 mW	2 W	2 W
Maximum clock	10 MHz	8 MHz	4 MHz	10 MHz	8 MHz
Address space	512K bytes	64K bytes	64K bytes	512K bytes	1 megabyte
UARTs	2-ch.	no	no	1-ch.	no
DMAC	2-ch.	no	no	4-ch.	2-ch.
Timers	2-ch.	no	no	4-ch.	2-ch.
Clocked SI/O	yes	no	no	no	no
CS/wait logic	yes	no	no	yes	yes
DRAM refresh	yes	yes (Z80)	no	yes	no

Note: The availability of the Ziog Z800 is unknown, and specifications on it are subject to change.



# CIRCUIT CELLAR

both 68xx and 80xx family devices.

- **Interrupt controller:** The interrupt controller monitors and gives priorities to the four external and eight internal interrupt sources. A variety of interrupt-response modes are programmable.
- **Memory-management unit:** The MMU maps the CPU's 64K-byte logical-

memory address space into a 512K-byte physical-memory address space. The MMU organization preserves software object-code compatibility while providing extended memory access and uses an efficient common area/bank area scheme. I/O accesses (64K bytes of I/O address space) bypass the MMU.

The integrated I/O resources comprise the remaining four functional blocks:

- **Direct-memory-access controller (DMAC):** The two-channel DMAC provides high-speed memory-to-memory, memory-to-I/O, and memory-to-mem-

*(continued)*

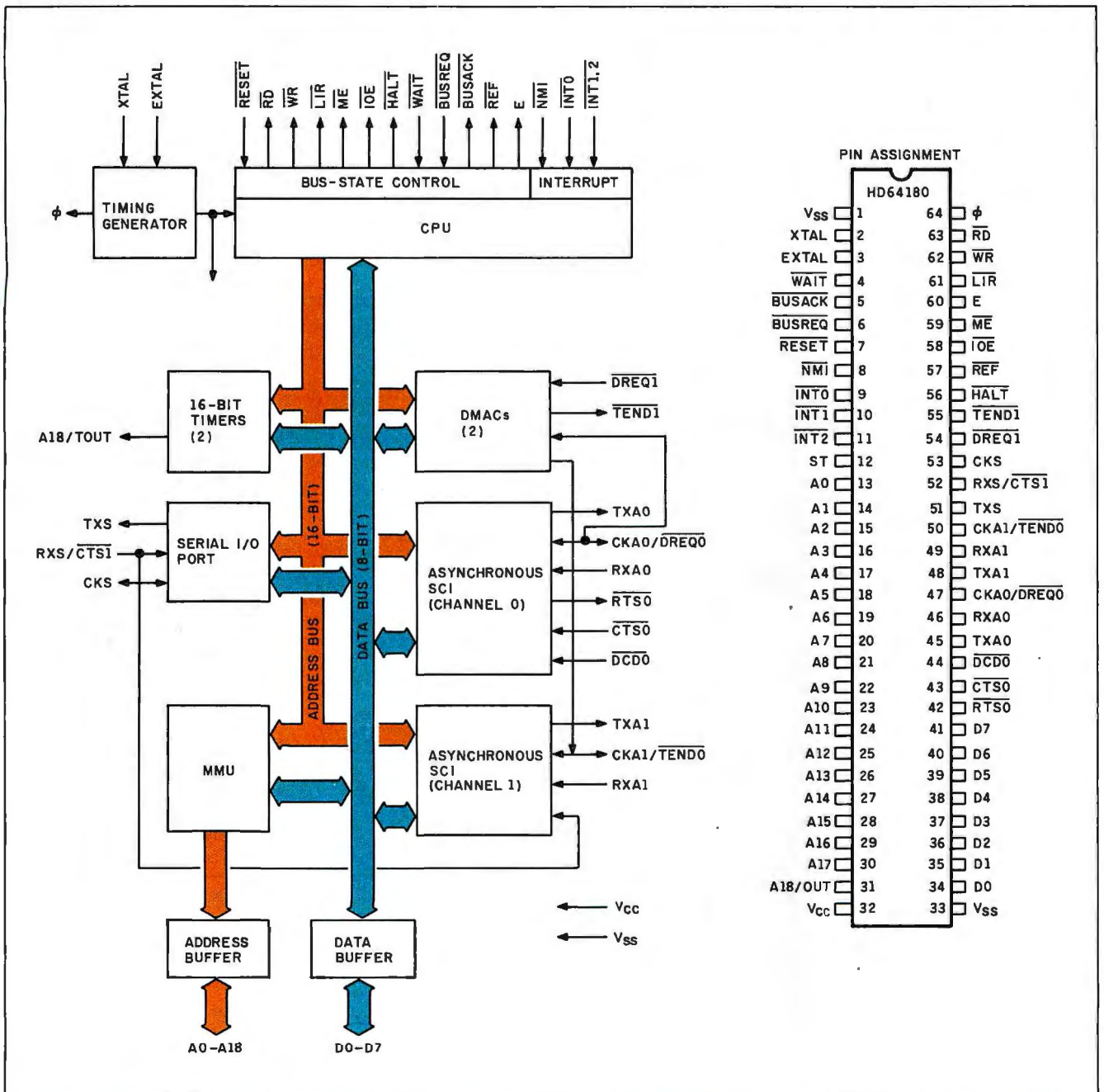

Figure 2: Block diagram and pin-out of the Hitachi HD64180.



ory-mapped-I/O transfer. The DMAC features edge or level sense-request input, address increment/decrement/no change, and (for memory-to-memory transfer) programmable-burst or cycle-steal transfer. In addition, the DMAC can directly access the full 512K bytes of physical-memory address space (the MMU is bypassed during DMA) and transfers (up to 64K bytes in length) can cross 64K-byte boundaries. At 6 MHz, DMA is 1 megabyte per second.

• Asynchronous serial communication interface (ASCI): The ASCI provides two full-duplex UARTs (universal asynchronous receiver/transmitters) and includes a programmable data-transmission-rate generator, modem-control signals, and a multiprocessor communication format. The ASCI can

use the DMAC for high-speed serial data transfer, reducing CPU overhead.

• Clocked serial I/O port (CSI/O): The CSI/O provides a half-duplex clocked serial transmitter and receiver. This can be used for high-speed connection to another microcomputer.

• Programmable reload timer (PRT): The PRT contains two separate channels, each consisting of 16-bit timer data and 16-bit timer-reload registers. The time base is divided by 20 from the system clock, and one PRT channel has an optional output allowing waveform generation.

**SB180 DESIGN CRITERIA**

With all this functionality on one chip, you can see why so few additional chips are needed to implement a truly sophisticated 8-bit single-board com-

puter in such a small space (less than 30 square inches). In terms of the original Altair microcomputer of 10 years ago, the functionally equivalent machine would have taken about 35 S-100 boards for a total of 1750 square inches (and that's using 8K-byte memory boards!).

In order to reduce chip count further, I decided to use an enhanced floppy-disk-controller chip (FDC) from Standard Microsystems Corporation, the 9266 (see figure 3). This 40-pin DIP (dual in-line package) chip is software-compatible with the industry-standard NEC 765A FDC and is actually an integrated combination of SMC's 9229 digital data separator and an NEC 765A FDC. It is compatible with single- and double-sided 3½-, 5¼- (40- and 80-track), and 8-inch

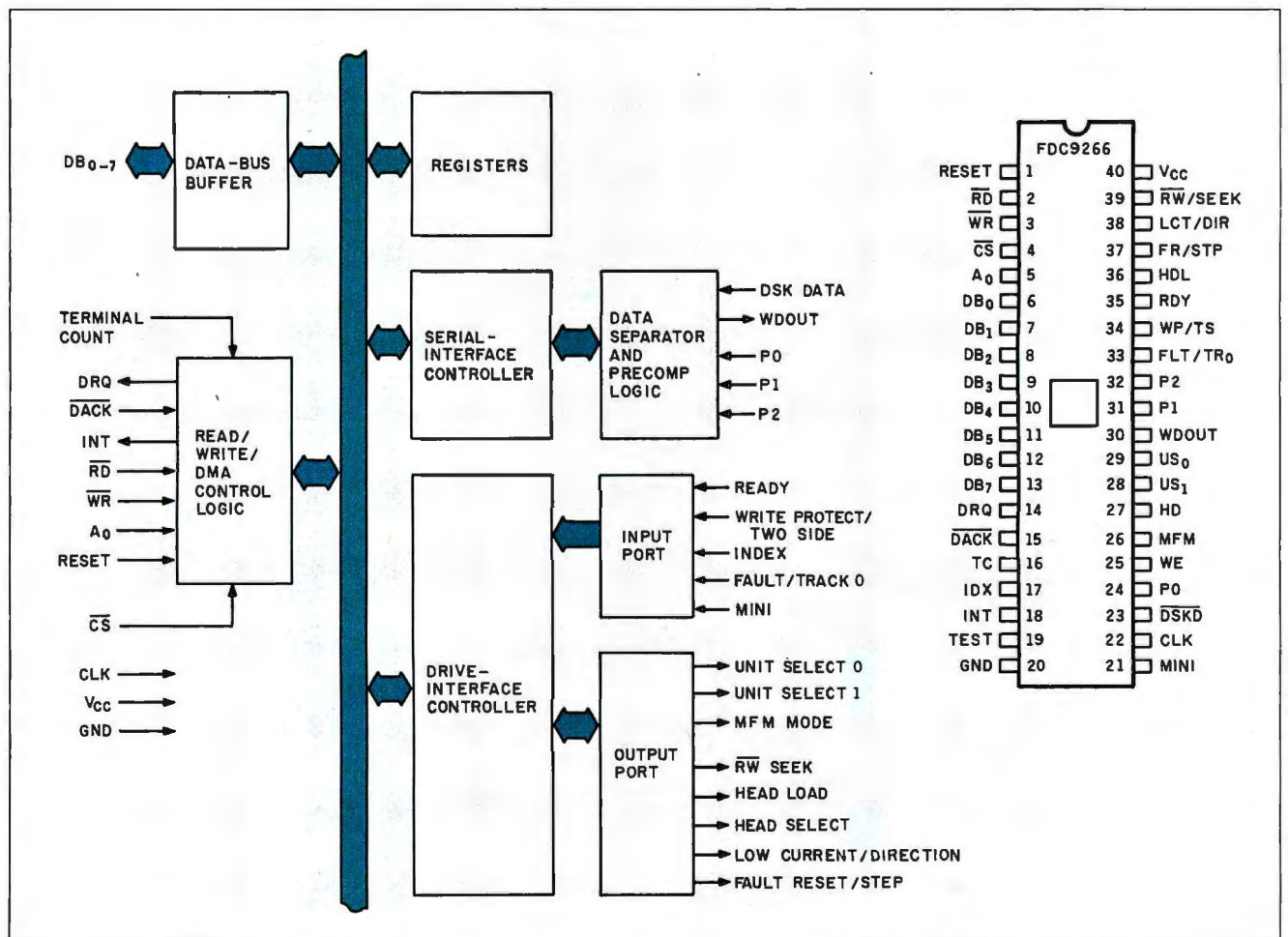

Figure 3: Block diagram and pin-out of SMC's 9266.



drives; the data separator handles both single- and double-density data. This means that it can be programmed to read and write most soft-sectored CP/M disk formats.

With the HD64180's two-channel ASCII built in, two serial ports were included in the design automatically. Provision was made for a Centronics parallel printer port as well. Since 256K-bit DRAM chips are now plentiful and inexpensive, eight were used for memory (64K-bit DRAMs can also be used). Because only 64K bytes is used for the logical-memory address space, you can optionally designate the other 192K bytes as a RAM disk in the operating system, or you may prefer to use if for other purposes (such as implementing banked memory for CP/M Plus).

### THE SB180 HARDWARE

Figure 4 is the schematic diagram of the SB180 computer. Its design is primarily characterized by the high-performance, high-density MOS (metal-oxide semiconductor) devices, including 256K-bit DRAMs.

In addition to the CPU elements previously discussed, the SB180 system design implements the following functional blocks: RS-232C interface, memory interface, Centronics printer interface, floppy-disk interface, XBUS expansion bus, and power supply.

### RS-232C INTERFACE

The HD64180 ASCII two-channel UART is connected to 1488/1489 RS-232C line drivers/receivers to provide two separate ports. ASCII channel 1 is used for the console; ASCII channel 0 is used for auxiliary RS-232C devices like printers, plotters, and modems. This distinction is made because modems require the extra handshake signals that are available with ASCII channel 0, while terminals do not. All primary RS-232C parameters (data-transmission rate, handshaking, data format, interrupts) are software-programmable.

### MEMORY INTERFACE

The SB180 incorporates a 28-pin boot-ROM socket that can be

jumpered to hold 8K by 8-bit, 16K by 8-bit, and 32K by 8-bit memory devices. The boot ROM (contains disk boot and ROM monitor) occupies the bottom 256K bytes of the HD64180 physical-memory address space since it is selected whenever A18/TOUT is low. (Note: The TOUT timer output function is not used.) Thus, the boot-ROM contents (whatever the size) are simply repeated in the lower 256K bytes. The boot-ROM output ( $\overline{OE}$ ) is enabled by the HD64180  $\overline{ME}$  (memory enable) signal. (As configured, the maximum RAM on the SB180 is 256K bytes. To support larger memories, additional address decoding would be required to designate RAM and ROM areas in the current 256K-byte boot-ROM space.)

ROMs of 200 nanoseconds (and, marginally, 250 ns) can operate with one wait state.

At  $\overline{RESET}$ , the HD64180 begins execution at physical address 00000, the start of the boot ROM. [Editor's note: All addresses are in hexadecimal.]

### 256K-BIT DYNAMIC RAM

Standard 256K-bit 150-ns DRAMs, requiring 256 refresh cycles (8-bit refresh address) every 4 milliseconds (ms) are used. These DRAMs occupy the top 256K bytes of the HD64180 512K-byte physical-memory address space.

The interface is quite straightforward. Complete DRAM refresh control is provided by the HD64180 in conjunction with control logic IC14 and IC22 and address multiplexers IC11, IC12, and IC13.

The HD64180  $\overline{WR}$  output directly generates DRAM  $\overline{WE}$ . The HD64180  $\overline{ME}$  output directly generates  $\overline{RAS}$ . During normal read/write cycles (A18 high, REF high), CAS goes low at the next rising edge of  $\phi$  following the rising edge of E (enable). This provides plenty of setup time for the address multiplexers since the rising edge of E switches the address multiplexers from row to column addresses.

$\overline{RAS}$ -only refresh is used. The HD64180 generates the refresh addresses. During refresh cycles ( $\overline{REF}$  low),  $\overline{ME}$  generates  $\overline{RAS}$ , while  $\overline{CAS}$  is

suppressed at IC22.

The HD64180 can be programmed to generate refresh cycles every 10, 20, 40, or 80  $\phi$  cycles as well as selecting a refresh every two or three clock cycles. Since the DRAM requires a refresh cycle every 15.625 microseconds ( $\mu$ s) (4 ms/256), the HD64180 is programmed for 80-cycle refresh request since  $80 \times (1/6.144 \text{ MHz}) = 13.02 \mu$ s. Two-cycle refresh is also programmed. Thus, refresh overhead is only 2.5 percent (2 cycles every 80 cycles).

### CENTRONICS PRINTER INTERFACE

The Centronics printer interface is composed of the 8-bit latch IC9 and flip/flop IC10. The Centronics port is decoded at I/O address 0C0 by IC26. To write to the printer, the following sequence is used:

Write data to port 0C1

This sets up the data to the printer and asserts  $\overline{STB}$  low. The following sequence:

Write data to port 0C0

deasserts the printer  $\overline{STB}$  signal high.

When the printer has processed the data, it will return the  $\overline{ACK}$  signal, which generates an external interrupt ( $\overline{INT 1}$ ) to the HD64180. The interrupt handler clears the interrupt by performing a dummy output to port 0C0. This clears the  $\overline{INT 1}$  interrupt request.

The printer interface is not buffered, so compatibility with all printer/cable setups cannot be guaranteed. In practice, however, problems should be rare since the software scheme provides adequate data-setup and -hold times. Also, note that this printer interface is interrupt-driven, which allows high-performance operation. In a more primitive polling design, excessive overhead limits acceptable performance in applications like background print spooling.

### FLOPPY-DISK INTERFACE

SMC's 9266 FDC manages almost all details of the drive interface, including data separation and (with external logic IC22 and IC23) programmable

(continued)



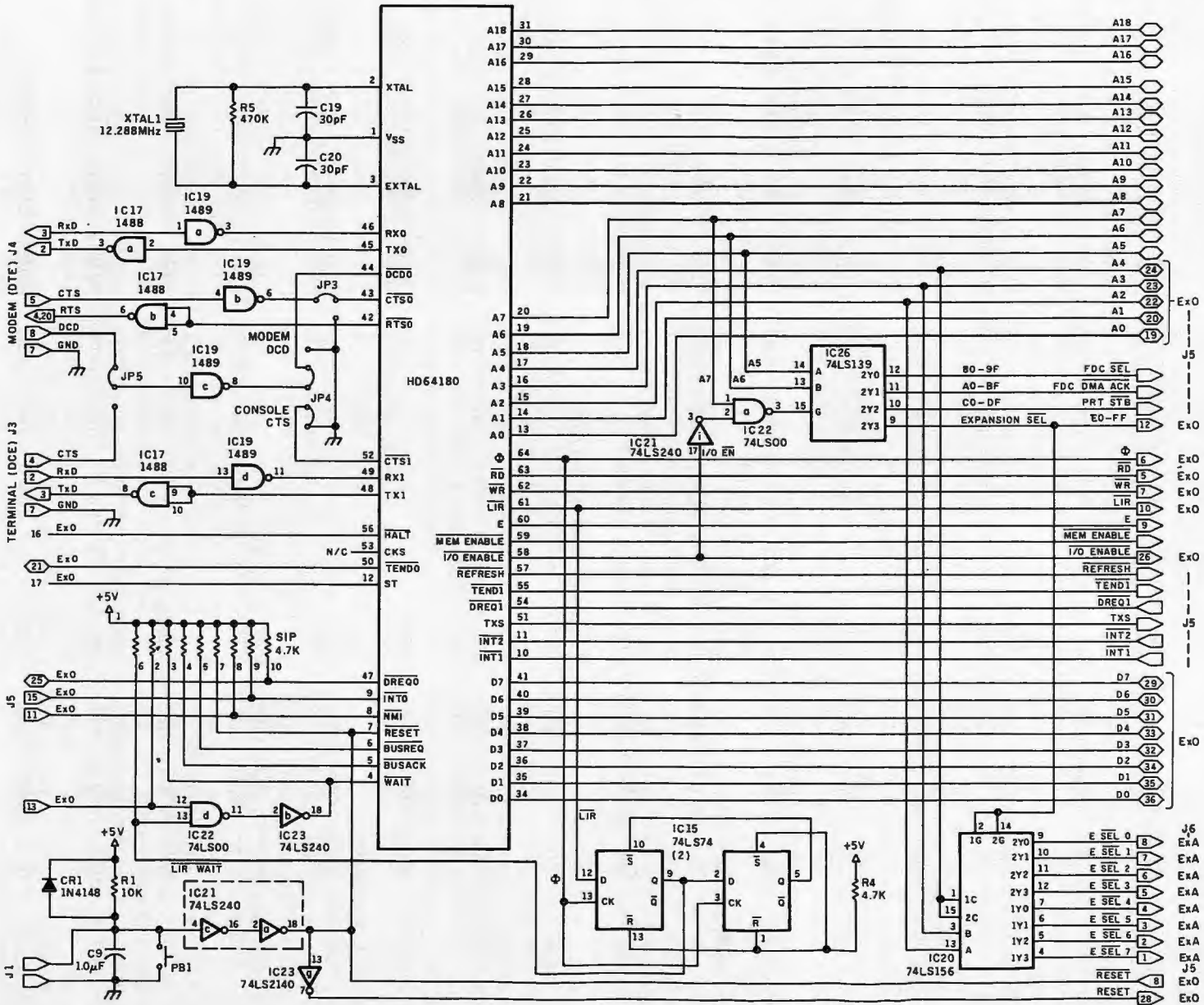

Figure 4: Schematic diagram of the SB180 computer.



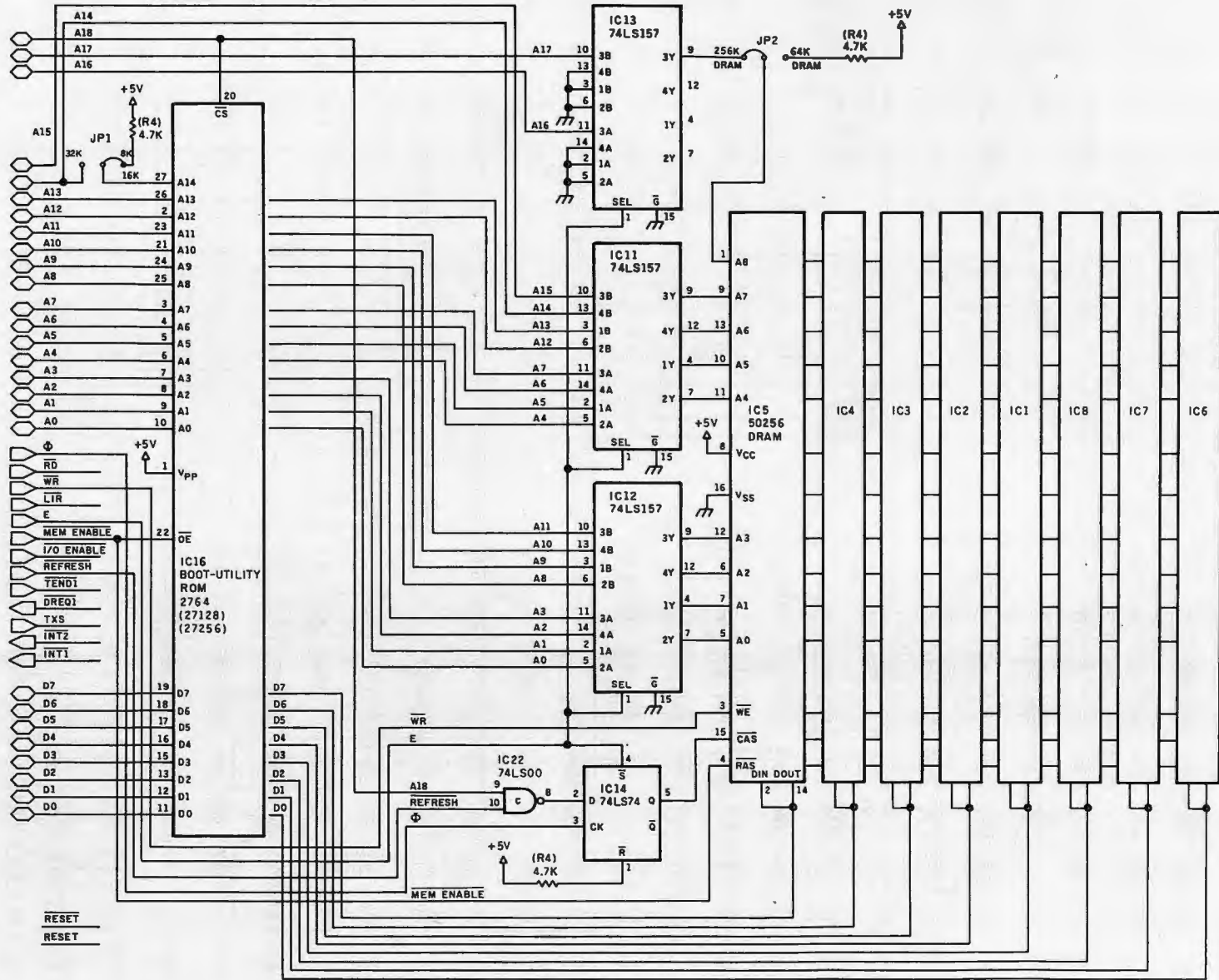

Figure 4 continued on page 96



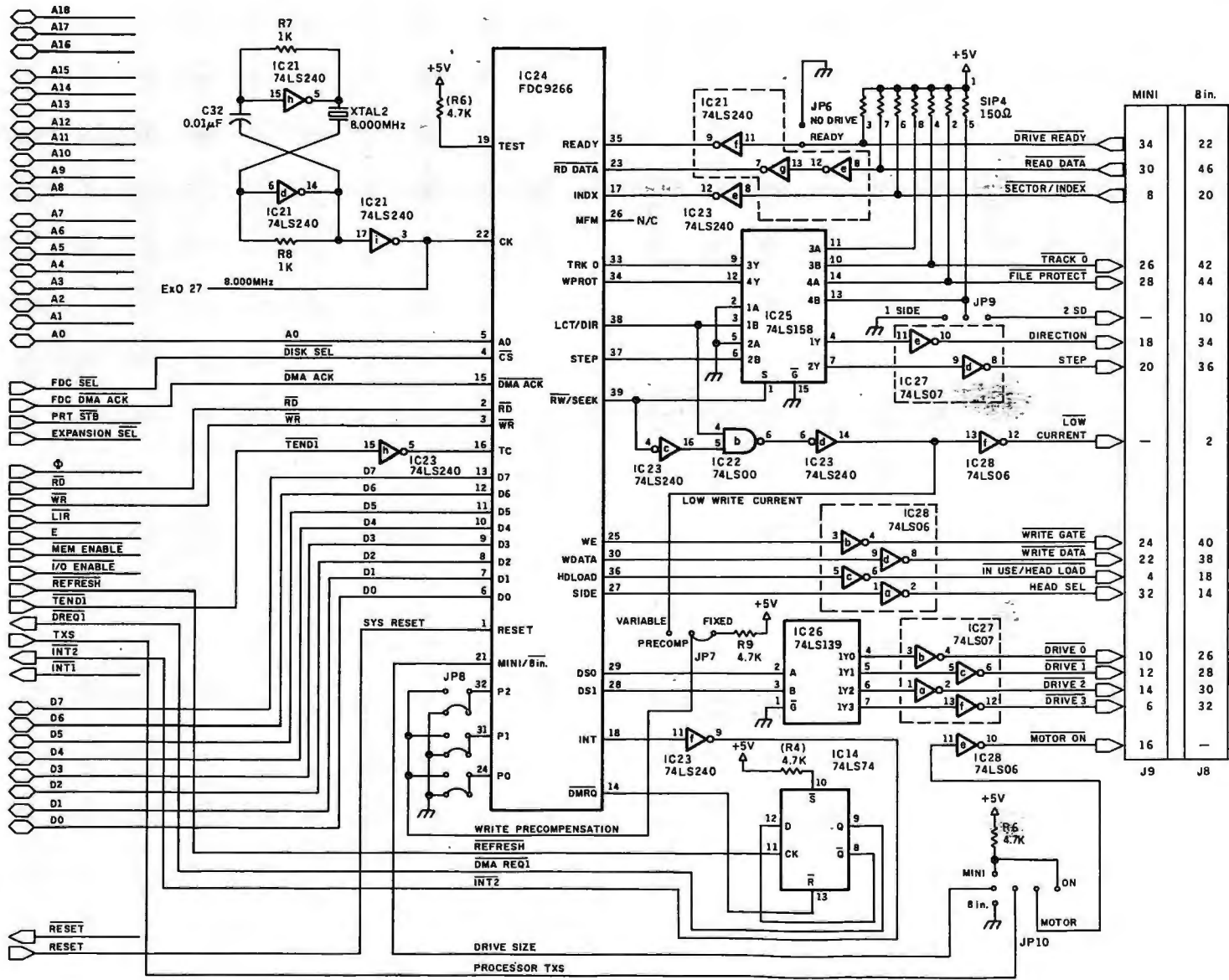
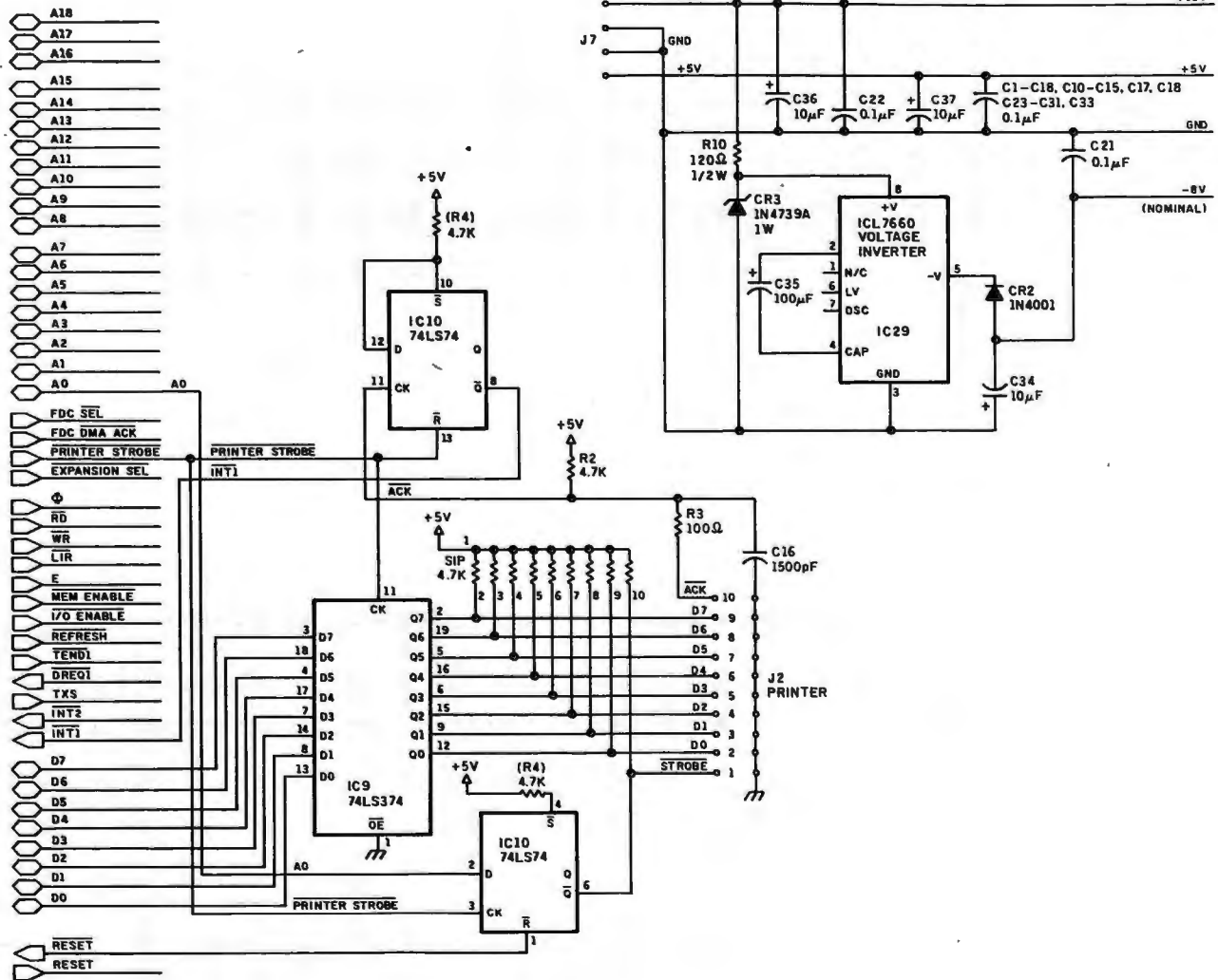

Figure 4 continued





CIRCUIT CELLAR



write precompensation. The 9266, as mentioned earlier, combines the NEC 765A/Intel 8272 FDC with SMC's 9229 digital data separator. Thus, from the host CPU side, the 9266 looks just like these devices, including hardware and software compatibility.

The 9266 clock is generated by an 8-MHz oscillator composed of a crystal and IC21. Jumpers are provided to select write precompensa-

tion and allow 8-inch floppy-disk drives to be interfaced.

On the CPU side, the key requirements are interfacing the 9266 with both programmed I/O ( $\overline{CS}$ ), for things like initialization and status check, and with DMA (DRQ,  $\overline{DACK}$ ), for data transfer.

Programmed I/O is straightforward, with  $\overline{CS}$  generated for I/O address 80, and  $\overline{RD}$  and  $\overline{WR}$  directly generated by

the HD64180. This is the same scheme used to interface with other 80xx family peripheral devices.

DMA is a little more involved. First, DMAC channel 1 is used for the FDC since dedicated handshaking lines ( $\overline{DREQI}$ ,  $\overline{TENDI}$ ) are provided on the HD64180. Since DMAC channel 0 control lines are multiplexed (with ASCII clocks), DMAC channel 0 is used for memory-memory DMA. This means that the ASCII clock functions are available, although they are not currently used in this design.

For disk DMA, the 9266 asserts DRQ, which in turn causes HD64180  $\overline{DREQI}$  assertion. The HD64180 performs DMA reads/writes to I/O address 0A0, which causes the 9266  $\overline{DACK}$  to be asserted, completing the transfer cycle. After the DMAC's programmed number of reads/writes has completed, the HD64180  $\overline{TENDI}$  output is asserted and, after inversion, causes the 9266 TC (terminal count) input to be asserted, completing the DMA operation. This is typically followed by the 9266 generating an HD64180  $\overline{INT 2}$  external interrupt. This interrupt-service routine can read the 9266's status to determine if errors occurred, etc.

However, one "gotcha" fixed by flip/flop IC14, conditions the 9266 DRQ output. It turns out that if 9266 DRQ directly generates HD64180  $\overline{DREQI}$ , the HD64180 may respond too quickly. This is because HD64180  $\overline{DREQ}$  input logic was designed to minimize latency, and  $\overline{DREQ}$  can thus be recognized at a machine-cycle breakpoint. Unfortunately, the 9266 requires that at least 800 ns elapse from the time it asserts DRQ before the DMA transfer ( $\overline{DACK}$ ) actually occurs. In other words, when the 9266 "asks" for service, it really doesn't want it . . . yet! To prevent accessing the 9266 too quickly after DRQ, DRQ from the 9266 is delayed at IC14 before issuing the  $\overline{DREQI}$  to the HD64180. DRQ is delayed by one  $\overline{REF}$  cycle time.

Minifloppy double-density data transfers occur at a 250-kilohertz (kHz) data rate. Thus, each byte must be read within 32  $\mu$ s. The disk-driver software reprograms the refresh-

Table 3: Power connections for figure 4.

		+5 V	GND	+12 V	-8 V
IC1	50256 DRAM 150 ns	8	16	—	—
IC2	50256 DRAM 150 ns	8	16	—	—
IC3	50256 DRAM 150 ns	8	16	—	—
IC4	50256 DRAM 150 ns	8	16	—	—
IC5	50256 DRAM 150 ns	8	16	—	—
IC6	50256 DRAM 150 ns	8	16	—	—
IC7	50256 DRAM 150 ns	8	16	—	—
IC8	50256 DRAM 150 ns	8	16	—	—
IC9	74LS374	16	8	—	—
IC10	74LS74	14	7	—	—
IC11	74LS157	16	8	—	—
IC12	74LS157	16	8	—	—
IC13	74LS157	16	8	—	—
IC14	74LS74	14	7	—	—
IC15	74LS74	14	7	—	—
IC16	2764 monitor ROM 200 ns	28	14	—	—
IC17	1488	—	7	14	1
IC18	HD64180	32	1,33	—	—
IC19	1489	14	7	—	—
IC20	(74LS156) optional	16	8	—	—
IC21	74LS240	20	10	—	—
IC22	74LS00	14	7	—	—
IC23	74LS240	20	10	—	—
IC24	FDC 9266	40	20	—	—
IC25	74LS158	16	8	—	—
IC26	74LS139	16	8	—	—
IC27	7407	14	7	—	—
IC28	7406	14	7	—	—
IC29	7660 regulator	—	3	—	—

Jumpers

JP1	(1x3)	ROM size
JP2	(1x3)	RAM size
JP3	(1x3)	CTS0 disable
JP4	(1x5)	RS-232C gate output
JP5	(1x3)	RS-232C gate input
JP6	(1x2)	Drive without ready
JP7	(1x3)	Write precomp mode
JP8	(2x6)	Write precomp value
JP9	(1x3)	Single-/double-sided drive
JP10	2 - 1x3	TXS function/drive size



request rate from every 80  $\phi$  cycles to every 40  $\phi$  cycles prior to disk DMA and reassigns it back to 80  $\phi$  cycles after the disk DMA is completed. The 9266 DRQ is delayed from between 40  $\phi$  cycles to 79  $\phi$  cycles. This is about 6 to 14  $\mu$ s. Therefore, the 800-ns delay and 32- $\mu$ s data-transfer constraint are both met. Note that 8-inch floppy double-density data transfer is twice as fast (500 kHz) and requires a refresh-rate increase to every 20  $\phi$  cycles.

### EXPANSION BUS

The spare  $\overline{CS}$  from address decoder IC26 (I/O addresses 0E0 to 0FF) and all major buses (address, data, control) are routed to the expansion bus. This allows an I/O expansion-board capability. The full complement of HD64180 control signals ( $\overline{IOE}$ ,  $\overline{E}$ ,  $\overline{RD}$ ,  $\overline{WR}$ , etc.) allows easy interface to all standard peripheral LSI (large-scale integration) devices, including the 80xx, 68xx, and 65xx families. Example expansion boards could include a hard-disk controller, 1200-bits-per-second (bps) modem, or LAN (local-area network) interface.

### POWER SUPPLY

The SB180 requires +5-V and +12-V power. A negative voltage is generated on board, which is used only by the RS-232C driver. The negative voltage is obtained by using a Zener diode to obtain +9 V from +12 V, which is then inverted using an Intersil 7660 converter. The +12-V power is used only for the RS-232C driver. Thus, the SB180 uses only significant power from the +5-V supply. Typically, this may be from 0.3 to 0.6 ampere (A) (depending on the proportion of the TTL [transistor-transistor logic] and memory devices that are CMOS)—about the same as a 5¼-inch floppy disk.

### THE SB180 ROM MONITOR

While my initial discussion espoused the merits of the Z-System, every good single-board computer needs a ROM monitor that should be more useful than just booting the operating system from a floppy disk. The SB180

- A ASCII table: Prints an ASCII table
- B Bank select: Selects a 64K-byte memory bank
- C Copy disk: Systems with 256K bytes of RAM can perform single-drive copies
- D Display memory: Displays memory in hexadecimal and ASCII
- E Emulate terminal: Console keyboard is echoed to the auxiliary RS-232C output, and the RS-232C input is echoed on the console display
- F Fill memory: Any portion of memory is filled with a data byte
- G Go to program: Starts program execution at specified address and optionally includes a breakpoint
- H Hexmath: Prints the 20-bit sum and difference and 32-bit product of the two arguments
- I Input port: Prints the 8-bit data input from specified port
- K Klean disk: Formats a specified drive
- M Move memory: Moves a block of memory
- N New command: Enables new commands from extended ROM space
- O Output port: Byte is output to specified port address
- P Printer select: Toggles printer selection between the Centronics parallel port and the auxiliary RS-232C port
- Q Query memory: Searches memory for pattern of 1 to 4 bytes
- R Read disk: Reads specified sectors from drive into memory
- S Set memory: Displays memory contents and allows new data to be entered
- T Test system: Tests various system devices
- U Upload hexadecimal file: Uploads Intel hexadecimal file from auxiliary or console serial port
- V Verify memory: Compares two blocks of memory
- W Write disk: Writes specified sectors to disk from memory
- X eXamine CPU registers: Displays main and alternate CPU registers and prompts for modification of main registers
- Y Yank I/O registers: Displays the HD64180 on-chip I/O registers
- Z Z-System boot: Boots the Z-System from disk

Figure 5: A list of the monitor commands.

8K-byte ROM monitor includes commands for everything you need—from A to Z. It is supplied on an 8K-byte EPROM. (The SB180 also supports 16K- and 32K-byte ROMs, so additional commands or application programs can be supported.)

The SB180 ROM monitor provides commands to assist the design and debugging of SB180-related hardware and software. Also, it serves as a stand-alone training vehicle for the HD64180 CPU.

The monitor supports the following I/O devices:

CON: Console RS-232C serial port  
 AUX: Auxiliary RS-232C serial port  
 CEN: Centronics parallel printer port

DSK: Floppy-disk storage devices

The monitor supports one to four 5¼-inch, 48- or 96-tpi (tracks per inch), 40- or 80-track, double-sided double-density disk drives. During initial system checkout, such a drive should be connected to verify operation of the disk interface.

At RESET, the monitor first checks for fatal RAM failure. If the RAM is bad, the monitor waits for a carriage return to be typed on the console in order to determine the console data-transmission rate and then prints 8 binary digits—each corresponding to one DRAM chip. A chip associated with a 1 is faulty. The RAM-check se-

(continued)



quence is repeated each time a carriage return is typed.

If the RAM is okay, the stack is set up, and the monitor checks to see if a disk is loaded in drive #0. If so, the DOS boot-load sequence (same as the Z command) is started.

The monitor commands are shown in figure 5.

### THE LUNCHBOX COMPUTER

The only things you need to turn the SB180 into a full-fledged stand-alone microcomputer are a +5-V and +12-V

power supply (or a 12-V battery and 5-V regulator), at least one 5¼-inch floppy-disk drive (initially), and a serial terminal.

You can mount such a small computer in many ways (see photos 3 and 4). If you use a half-height drive, the SB180 will fit on top of the drive inside a single full-height disk-drive chassis including power supply! Since the console serial port can automatically detect the terminal's data-transmission rate, you can carry your SB180 with you and connect it to any terminal (or computer emulating a terminal) running at 300, 1200, 9600, or 19,200 bps (other rates are optionally selected).

It is possible to fit the SB180, power supply, and two 3½-inch floppies into a lunchbox. If you want to get fancy, you could fit the SB180, power supply, one or two half-height floppies, the Micromint Term-Mite terminal board, and a keyboard into a small attaché case. Use any handy video monitor, and . . . voilà! You have just out-  
Osborned Adam Osborne!

I can imagine many unusual ways to package the SB180. When good LCDs (liquid-crystal displays) come down in price a bit more, I think the SB180 can form the basis of a functional notebook computer. The SB180 makes minimal use of the +12-V supply (and only for RS-232C operation) and can use less than 1 A at +5 V, so battery power is a real possibility. With just one floppy disk, the SB180 can become a super data logger. While my Z8 BASIC or FORTH single-board computer might ordinarily be used for such an application, not everyone likes to program in FORTH or BASIC. With a CP/M-compatible computer, a developer can now choose Pascal, C, FORTRAN, or even PL/I for applications. Since the data is already in CP/M format, it makes data analysis convenient.

The Z-System is provided with the complete SB180 board and software package. While it comes with a utility to read several other common 5¼-inch formats (like Kaypro and Osborne), its native format is identical to the well-optimized 386K-byte



Photo 3: The SB180 can be packaged in many off-the-shelf enclosures advertised in BYTE. It fits comfortably to the left of a pair of half-height 5¼-inch disk drives in a case available from Disk Plus. This enclosure also includes the power supply.



Photo 4: The enclosure from photo 3 is shown with the cover on. The only additional hardware necessary to use the system is a serial terminal.



## CIRCUIT CELLAR

double-sided double-density format of the Little Board from Ampro Inc. Provisions have been made to support 8-inch drives as well. Of course, it is possible to implement CP/M 2.2, CP/M Plus, MP/M II, TurboDOS, or Oasis if you prefer.

Although simple benchmarks are not to be taken as the last word in describing a computer's performance, I did run the BYTE Sieve of Eratosthenes prime-number program on the SB180 and the MPX-16 (8088-based with a 4.77-MHz clock, same as the IBM PC) using appropriate versions of Microsoft BASIC. For one iteration, the MPX using GW-BASIC took 203 seconds, while the SB180 using MS-BASIC took 147 seconds. An empty FOR . . . NEXT loop with 20,000 iterations took 27 seconds on the MPX and only 18 seconds on the SB180. Don't forget that these results are based on the 6-MHz implementation of the HD64180; with a 9-MHz clock, the results will be spectacular—not quite the speed of an IBM PC AT, but close!

### EXPERIMENTERS

As always, I try to support the computer experimenter by rewarding diligence. If you build the SB180 from scratch, send me a picture, and I'll send you a copy of the BIOS and ROM monitor on disk (SB180 format, double-sided double-density) at no charge, provided it is for your personal use. A printed listing is available for a modest charge.

If you build, buy, or otherwise assemble an SB180 system, I would like to know about it. I will be designing expansion boards for the SB180 and can notify you of them in advance of publication. In addition, having your name will greatly simplify the organization of any users groups that might arise.

### CIRCUIT CELLAR FEEDBACK

This month's Circuit Cellar Feedback is on page 416.

### NEXT MONTH

In part 2 of this article, I'll describe the software for the SB180. ■

*Special thanks to Tom Cantrell, Merrill Lathers, and Bob Stek for their contributions to this project.*

The following items are available from

The Micromint Inc.  
25 Terrace Dr.  
Vernon, CT 06066  
(800) 635-3355 for orders  
(203) 871-6170 for information

1. SB180 computer board with 256K bytes of RAM. Complete with user's manual and ROM monitor.  
assembled and tested. . . SB180-1, \$369  
complete kit. . . . . SB180-2, \$349
2. SB180 boot disk. Z-System DOS with limited utilities and BIOS. Provided on one 5¼-inch SB180 format double-sided double-density disk. . . . . SB180-10, \$49
3. Z-System, including ZRDOS, ZCPR3, an editor and utilities, ZAS assembler, BIOS source, and ZDM debugger. Complete with manuals. Provided on four 5¼-inch SB180 format double-sided double-density disks . . . . . SB180-20, \$190
4. HD64B180 chip (6 MHz) with data manual and 12.288-MHz XTAL. . . . . \$50
5. BYTE readers' special. Complete SB180 computer board with 256K bytes of RAM, user's manual, ROM monitor, and all the software listed in item 3. (Available through December 31, 1985.)  
assembled and tested. SB180-1-20, \$499  
complete kit. . . . . SB180-2-20, \$479

All boards are complete with the exception of the 50-pin, 8-inch drive and 44-pin expansion headers, which are not populated. They are optionally available. Printer, power, disk, and terminal cables are available separately. Call for pricing.

Please include \$10 (\$7 less on item 4) for shipping and handling in the continental United States, \$18 elsewhere. Connecticut residents please include 7.5 percent sales tax.

**Editor's Note:** Steve often refers to previous Circuit Cellar articles. Most of these past articles are available in book form from BYTE Books, McGraw-Hill Book Company, POB 400, Hightstown, NJ 08250.

*Ciarcia's Circuit Cellar, Volume I* covers articles in BYTE from September 1977 through November 1978. *Volume II* covers December 1978 through June 1980. *Volume III* covers July 1980 through December 1981. *Volume IV* covers January 1982 through June 1983.

To receive a complete list of Ciarcia's Circuit Cellar project kits, circle 100 on the reader-service inquiry card at the back of the magazine.

# GEMINI

THE AUTONOMOUS ROBOT

IS NOW PRICED FOR EVERYONE!



Buy each subassembly as a kit or factory assembled and create your own GEMINI Robot.

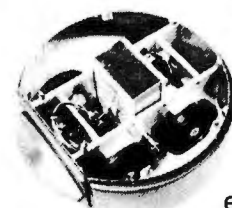

Or, for convenience, start with **GEMINEX**, our starter kit, and expand to **GEMINI**

later with upgrade kits.



Either way, **Buy a piece of tomorrow TODAY!**

**CALL or WRITE For Our FREE Brochure.**

**arctec systems**

9104 Red Branch Road  
Columbia, Maryland 21045  
(301) 730-1237  
Telex 87-781



# HOMEBASE ... TH

From the desk  
of **Alex Morton**,  
VP Marketing & Sales  
Amber Systems

*Here's what noted  
science fiction writer  
David Gerrold wrote  
about Homebase!  
A.M.*

You asked for my reactions to the latest version of Homebase. Ok, here goes. But I'm afraid I can't give you too many suggestions on how to improve it. It's great!

Look, all I expected was a simple little calendar-calculator-notepad utility, and I would have been satisfied with that. What I found instead, is that Homebase is very much more. It has quickly become the single most indispensable piece of software that I own. It is easy to use and powerful without being intimidating. It is definitely one of those "how did I ever get along without this?" programs.

I use the calendar and address-book functions constantly, both at home and in my Kaypro 2000 when I'm travelling. It's like taking my whole office with me, but without the problems of dragging it around the airport, or trying to get it through customs.

The notepad functions are especially useful. What I like the best is that I can just open up a window and go to work without having to first learn a whole new language. My ideas are always close at hand and I can get to my notes quickly. PLUS I can pull out notes on any specific topic that I need. (Translation: It's a whole database system, without all the big words. I like this a lot.)

There are a lot of nifty little surprises here, too. There's a terrific alarm clock, a set of DOS Services that makes most of my utility programs obsolete, and a calculator that does everything but reheat my coffee. (Do you accept trade-ins of hand held calculators?)

The built-in terminal program ought to be called "an Excedrin Option" because it makes the headaches of using a modem disappear. I like the ease with which I can configure the system and store specific configurations. And I really like the background electronic mail; I didn't know it could be this easy or convenient. I also like being able to just open a small window to listen in on the CompuServe CB simulation while keeping my other work on screen.

I'm sorry that I haven't used the cut and paste function enough to rave about it. Who knows? Maybe this is the part of the program that I'll hate. So what. I still got my money's worth. I hope you sell a zillion copies. And you should because the price is unbelievable. As far as I'm concerned, you've set a new standard for others to try to match. At \$49.95, the program is certainly worth it, ten times over.

Sincerely,



David Gerrold

David Gerrold is the award winning author of:

*The World of Star Trek, The Trouble with Tribbles, A Matter for Men, A Day for Damnation*, the classic novel of artificial intelligence: *When Harlie was One*, and a frequent contributor to computer magazines.

*HOMEBASE is designed to allow you to add additional tools, as your demands require them. That's why we've even made it ProKey compatible.*

**WE'VE BUILT A PROGRAM TO PROVIDE FOR YOUR FUTURE NEEDS AS WELL AS YOUR PRESENT ONES.**



# NEXT GENERATION

**HOMEbase™ BREAKS THE SOFTWARE BARRIER BY COMBINING ALL THE RESIDENT PROGRAMS YOU'VE ALWAYS WANTED ... INTO ONE SOLID PIECE OF SOFTWARE THAT LIVES IN YOUR COMPUTER ALONGSIDE WORDSTAR, LOTUS OR WHATEVER ELSE YOU HAPPEN TO BE RUNNING.**



**"We like HomeBase. It comes from the next generation of resident utilities."**

**Paul Freiberger  
& Phillip Robinson**  
Software Review  
San Jose Mercury News  
7/21/85

**\$49.95**

(not copy protected)

## FEATURES

- **Notepads**—you can have a single, simple notepad, or use HOMEbase's full power to have a series of notepads; indexed, cross-referenced and fully searchable and sortable.
- **Calculator**—designed for simple calculations and complex formulaic work as well.
- **DOS Services**—you can open multiple directories onscreen, move copy, view and even edit files from this powerful feature. And you can get a beginner up and running with MSDOS in just minutes.
- **Instant Databases**—just hit the hotkey to freeze whatever software you're working in, and you're ready to find, insert or manipulate data. Hit it again, and you're back working in your original software without skipping a beat.
- **Auto Dialer**—stores configuration data for each name ... even the window size you choose for that particular communication.
- **Alarm**—a window opens containing your appointment information, and the alarm first ticks, then rings.
- **Multiple Phone/Address Directories**—create as many as you like.
- **Rolodex™ Card Printer**—prints your HOMEbase address book directly onto continuous form Rolodex cards.
- **Template Maker**—create instant entry forms for your HOMEbase Databases.
- **Cut & Paste**—from anywhere to anywhere! You can even cut columns of numbers and paste them directly into your HOMEbase Calculator for instant addition!
- **Programmable Hotkeys**—you can choose the hotkeys you want to take you into HOMEbase's features.
- **Multiple Phone Message Pads**—a secretary can keep a separate message pad system for each of a number of people. Fully searchable and sortable, too!
- **Time & Expense Diary**—the easy way to keep out of trouble with the IRS.
- **To-do List**—with roll forward
- **Background Electronic Mail**—your electronic mail arrives and files itself while you're working in another piece of software!
- **Quickterm Terminal**—instant communications, available at the touch of a hotkey.
- **Mailing Label Printer**—print labels from your address book in just seconds.
- **Screen Saver**—automatically turns off your screen when you haven't hit the keyboard for a while. To turn it back on again, just hit any key. Prevents image burn-in.
- **Type Ahead Keyboard Buffer**
- **On-screen clock**—just hit the hotkey.
- **Multiple Calendars**—HOMEbase allows the user to keep track of numerous appointment books. And to search across one or all of them. Imagine how valuable this can be for a central secretary or receptionist!
- **New Easy Installation**—NOW HOMEbase can easily be installed by everyone!

**ORDER YOUR COPY OF HOMEbase TODAY!**

(NOW . . . ALL ORDERS SHIPPED WITHIN 48 HRS.!!)

For Visa, American Express and MasterCard Orders Call Toll Free **1-800-538-8157 ext. 824** California **800-672-3470 ext. 824** (Lines open 24 hours a day, 7 days a week) Or fill in this ORDER FORM enclose check, money order or Visa, American Express and MasterCard number. HOMEbase is available for the IBM PC, AT, XT and True Compatibles. Requires at least 256K (320K or more is recommended) so that it can reside in memory at the same time you're running other programs.

**HOMEbase \$49.95 + \$5 for shipping and handling\***

check  money order  VISA  MasterCard  American Express  Card # \_\_\_\_\_ Exp. Date \_\_\_\_\_

Name \_\_\_\_\_

Title \_\_\_\_\_

Company Name \_\_\_\_\_

Address \_\_\_\_\_

City \_\_\_\_\_ State \_\_\_\_\_ Zip \_\_\_\_\_

Home Phone ( ) \_\_\_\_\_ Work Phone ( ) \_\_\_\_\_

\*California residents add 6% sales tax. Outside U.S. please add \$15. Checks must be on a U.S. bank and in U.S. dollars. Sorry, no C.O.D. or purchase orders.

For dealer and site license information, call 408 996-1883.

**YES! Site licenses are available for companies . . . large and small. For further information on site licenses call 408-996-1883.**

Keypro is a trademark of Kaypro Corp. Wordstar is a trademark of MicroPro. ProKey is a trademark of RoseSoft. Rolodex is a trademark of Rolodex Corp. Lotus 1-2-3 is a trademark of Lotus Development Corp.

SEND TO:

**AMBER**

Amber Systems  
1171 S. Saratoga-Sunnyvale Road  
San Jose, CA 95129

B



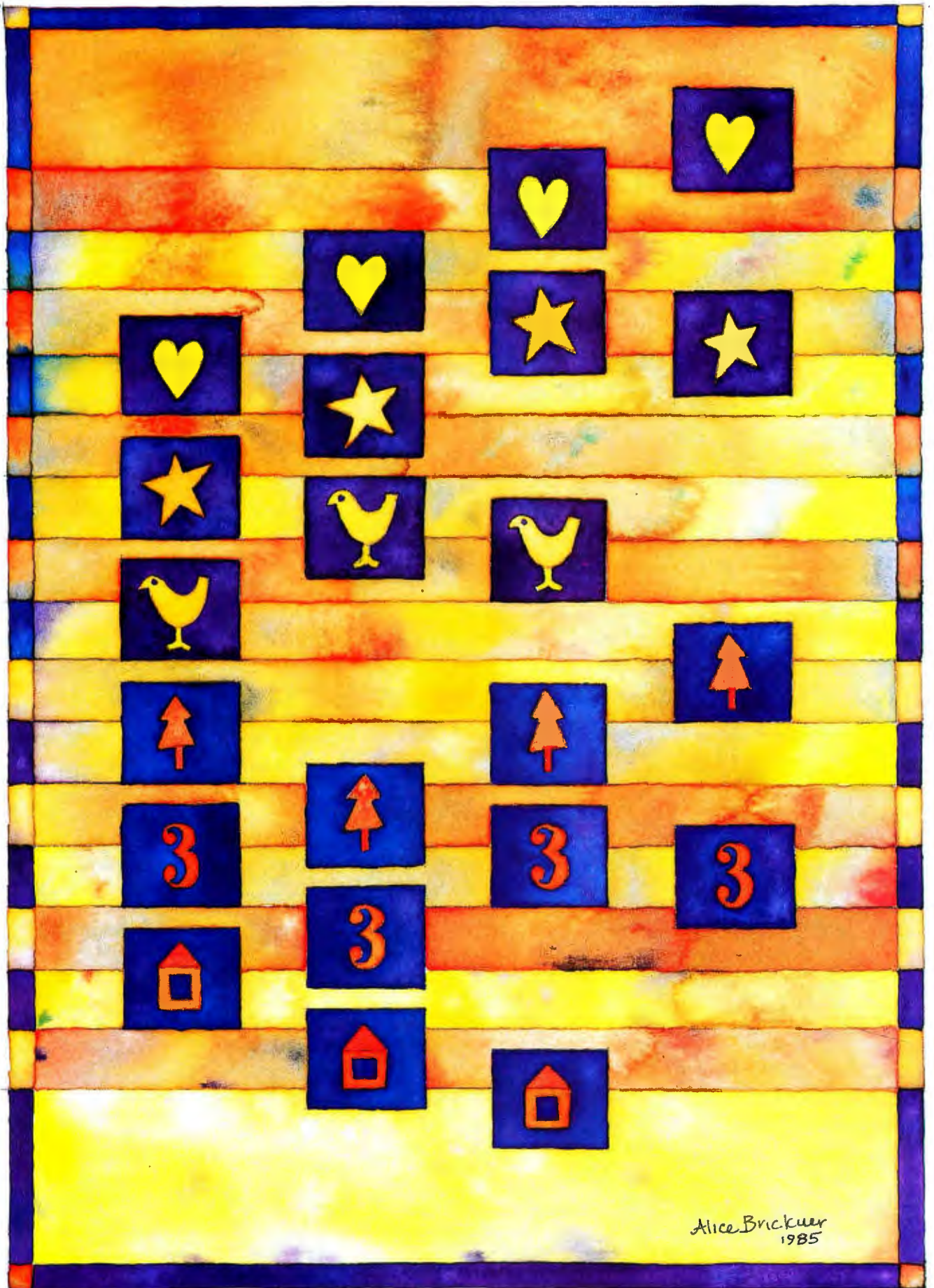

Alice Brickner  
1985



# AN ANALYSIS OF SORTS

BY JONATHAN AMSTERDAM

*How to choose  
one sorting algorithm over another*

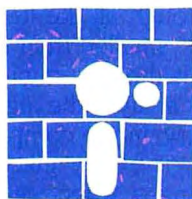

A friend told me recently that 90 percent of all the computer programs in the world sort. I can believe it. Our society's passion for organization has elevated the simple

task of putting things in order to a position of major importance. And who better to carry out the job than those informational beasts of burden—computers?

Because of their significance, sorting algorithms have been thoroughly studied. Some are slow and some are fast. Some sort a few items and some sort millions of items. Here I want to discuss sorting in the context of three different algorithms: Selection Sort, for small lists, Quicksort, for larger lists, and Mergesort, for lists of a size so monstrous they can't fit into memory all at once. But first we will need to develop some simple tools to help us with our analysis of these algorithms.

## **ANALYSIS**

Our goal is to understand the efficiency of some sorting algorithms. But we are immediately faced with a problem: How can we study an algorithm in the abstract without considering the language it's written in or the machine it's running on? For example, any algorithm written in a high-level language will run faster when written in

assembly language. And any program running on a microcomputer would run faster on a mainframe. We want to abstract away from these facts, to talk about an algorithm's running time independent of machine or language.

Computer scientists have come up with some simple rules that make this possible. The first is to measure running time by the number of key operations used in the algorithm rather than by actual speed on some computer or by number of instructions executed. For example, in sorting, the two key operations are comparing two items and swapping their positions. The idea behind this rule is that any program that implements the algorithm, regardless of what language it's written in or what computer it's running on, will have to do the same number of key operations. The number of comparisons is usually a better indication of the running time because there will almost always be more comparisons than swaps in a sorting algorithm.

The second important rule is to measure an algorithm's speed in terms of the size of its input. In a way, this is just common sense; we wouldn't want to compare the

*(continued)*

*Jonathan Amsterdam is a graduate student at the Massachusetts Institute of Technology Artificial Intelligence Laboratory. He can be reached at 1643 Cambridge St. #34, Cambridge, MA 02138.*



running time of an algorithm sorting 10 things to another sorting 100 things. More likely, we would have some kind of table that compared the algorithms' times on lists of 10, 100, 1000, or more things.

But we'd actually want something more than a table. Ideally, we want a function that tells us, for any size input, what the running time will be. Then we can compare the rate of the functions' growth to see which does better in the long run. For example, the function  $f(n) = n^2$  will "grow faster" than  $g(n) = 100n$ . That is, for sufficiently large values of  $n$ —in this case, when  $n$  is greater than 100— $f$  will be larger than  $g$ . Comparing rates of growth is made easier by looking at a graph, such as the one shown in figure 1. It displays the graphs of several common functions, including those we will be discussing here.

This idea of the size of a function in the long run—the so-called asymptotic rate of growth—is central to the analysis of algorithms. When we compare two algorithms, we usually don't care how well they do on small problems because small problems are easy. We want to know if they can maintain their good performance when the problems start getting large. Sorting a list of 10 items is going to take practically no time regardless of which sorting algorithm we choose. But as the lists get bigger, it becomes clear that the inherently slower algorithms are inferior.

To analyze an algorithm, then, we can derive the function that relates the key operations of the algorithm to the size of the input and obtain its asymptotic rate of growth. But often even this level of abstraction is too detailed. After all, it hardly matters on big problems if a sorting algorithm takes  $37n + 4$  comparisons or  $24n - 6$ . The important point is that the number of comparisons is directly proportional to the size of the input; that is, both functions have an asymptotic growth rate on the order of  $n$ . We will rarely go astray in our analysis of algorithms if we ignore additive and multiplicative constants and use order-of-magnitude estimates. In fact,

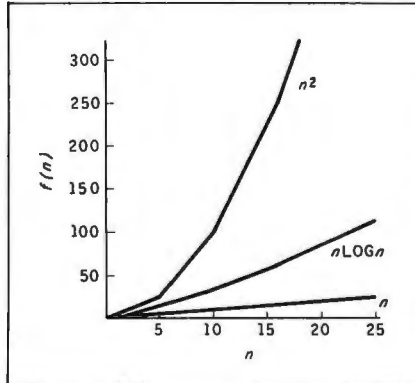

Figure 1: Rates of growth of some common functions.

**Listing 1: The algorithm for Selection Sort.**

```

Selection Sort.
Input: an array, A, and its size, n.
Output: the same array A, in sorted
        order.
begin
  for i := 1 to n do begin
    m := i;
    for j := i+1 to n do
      compare A[j] to A[m], making j
      the new m if it is less;
    swap A[i] and A[m];
  end
end.
    
```

there is a common and convenient notation for this: Write " $f = O(n)$ " (or "function  $f$  is order  $n$ ") if the growth rate of  $f$  is on the order of  $n$ . This so-called "Big O" notation has a more rigorous definition, which goes as follows:

If  $f$  and  $g$  are two functions, then  $f = O(g)$  if and only if there are two constants,  $c$  and  $k$ , such that  $f <= cg + k$ .

For example, if  $f$  is the function  $37n + 4$ , then  $f = O(n)$ , because we can choose  $c$  to be 37 and  $k$  to be 4, so that  $37n + 4$  is equal to  $37n + 4$ . To take a less obvious example, the function  $150n^2 + 97n - 34$  is  $O(n^2)$ . In this case, we could choose  $c$  to be 200 and  $k$  to be 13; many other choices are also possible.

Big O notation has several advantages. It eliminates the distracting clutter of constants and slow-growing

terms in our functions, making it easier to compare them. It abstracts away from unimportant details, allowing us to study an algorithm in its simplest form. And it simplifies our analysis by freeing us from the tedium of exact counting. To the trained eye, the "Big O" running time of an algorithm is often visible at a glance.

**SELECTION SORT**

Let's look at the algorithm for Selection Sort (see listing 1). Given a list of items to sort in ascending order, the idea is to find the smallest item and swap it with the item at the top of the list. Then the next time around we don't have to consider the first item again; instead, we find the minimum of items 2 through  $n$  and swap it with the second item. Finding the minimum is done as follows: Start with the minimum set to the first item, go through all the items, and if any one is smaller than the minimum, make it the new minimum.

Let's analyze the algorithm by seeing how many comparisons it performs. The only place we do comparisons is when we find the minimum. We do one comparison for each of the possible values of  $i$  and  $j$ . When  $i$  is 1,  $j$  ranges from 2 to  $n$ , for a total of  $n-1$  values, hence  $n-1$  comparisons; when  $i$  is 2,  $j$  ranges from 3 to  $n$ , or  $n-2$  comparisons; when  $i$  equals  $n-1$ ,  $j$  only covers one value; and finally, when  $i$  equals  $n$ , we don't execute the  $j$  loop at all. The total number of comparisons, then, is  $(n-1) + (n-2) + (n-3) + \dots + 1$ .

It is not hard to show that this sum equals

$$\frac{n(n-1)}{2} \text{ or } (\frac{1}{2})(n^2-n)$$

From our discussion of Big O notation, this is  $O(n^2)$ . So the Selection Sort is an order  $n^2$  sort. That is, for a list of size  $n$ , Selection Sort will do on the order of  $n^2$  comparisons. By the way, the famous Bubblesort algorithm is also  $O(n^2)$ .

**BEATING  $n^2$ : MERGESORT**

Can we do better than  $O(n^2)$ ? Yes, and the algorithm that does it, Mergesort,



uses the technique of divide-and-conquer to solve a large problem: Divide it into smaller problems of the same type, and solve the smaller problems the same way.

Mergesort takes two sorted lists, A and B, and merges them into a single sorted list, C. We start by comparing the first items of the lists. Since the lists are sorted, the smaller of the first items will be the smallest item overall. Say the first item of list A is smaller. We put this item at the start of C, then compare the next item of A with the first of B. Again, we put the smaller on the C list. We continue in this way until we've gone through both A and B. At the end, C will contain all the items of A and B in sorted order.

Given that we can merge two sorted lists, here's how we sort: If the list to be sorted is longer than one item, we split it in half (or as near as possible) and call Mergesort to sort the two halves. Then we merge the two sorted halves together. Listing 2 shows the algorithm for Mergesort. If the list to be sorted is one item long, then there's nothing to do; it's already sorted.

It is harder to analyze Mergesort than it is to analyze Selection Sort because Mergesort is recursive. First, look at the merge part of the algorithm. It takes at most  $n$  comparisons to merge two sorted lists each of size  $n/2$  into a single list of size  $n$ . To see this, note that every time we do a comparison we add an item to our final list, so we can't do more comparisons than there are items. The merge phase, then, is  $O(n)$ .

What about the rest of the algorithm? In a sense, there really is no "rest of the algorithm"—the only time any real work (i.e., comparison) gets done is in the merge phase. So the questions are, how often do we merge, and how much do we merge each time?

The best way to view Mergesort is as a binary tree (see figure 2). Each node represents a call on the Mergesort procedure. The top (root) of the tree represents the initial call of the procedure with a list of size  $n$ . Mergesort is then called recursively

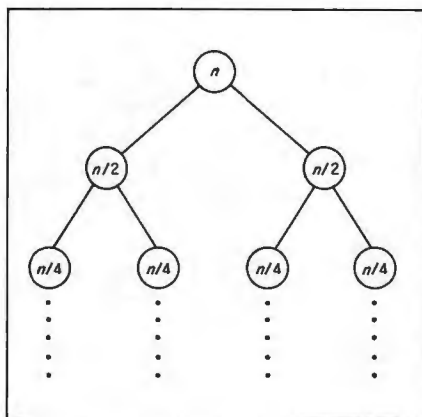

Figure 2: The Mergesort tree.

Listing 2: The algorithm for Mergesort.

```
Mergesort.
Input: a list, L.
Output: a sorted list, S.
begin
  If L is one item long, then S := L.
  Otherwise,
    split L into two lists L1 and L2,
      each about half as big.
    Mergesort L1 into S1.
    Mergesort L2 into S2.
    merge S1 and S2 into S.
end.
```

twice, each time with a list of size  $n/2$ . Each of these invocations of the procedure makes two other recursive calls, until finally we reach lists one item long.

At each level of the Mergesort tree, we do  $O(n)$  comparisons. At the top level of the tree, the only comparisons occur when we merge two lists of size  $n/2$  into a list of size  $n$ ; this operation takes at most  $n$  comparisons. At the next level, there are two merges, each creating a list of size  $n/2$ . Since each of these merges takes  $n/2$  comparisons and there are two of them, we again have  $n$  comparisons. At the third level, there are four merges of  $n/4$  comparisons each, and the same thing happens for the fourth level of the tree, etc.

We can now state that the running time of Mergesort is  $O(nk)$ , where  $k$  is the number of levels of the Mergesort

tree. We can express  $k$  in terms of  $n$  by noting that the number of levels of the tree is just the number of times you can divide a list of size  $n$  in half repeatedly until you get a list of size 1. That's the same as the number of times we can divide the number  $n$  by 2 until you reach 1; it happens to be about  $\log_2 n$  (by which I mean the logarithm to the base 2 of  $n$ ). We can convince ourselves of this easily if we choose  $n$  to be a power of 2. For instance,  $2^2$  equals 4; 4 divided by 2 is 2, and 2 divided by 2 is 1.

Armed with this fact, we can conclude that Mergesort is an  $O(n \log n)$  algorithm— $\log n$  levels of the tree with  $n$  comparisons at each level. That's better than  $O(n^2)$ , and the larger  $n$  is, the better it is. A glance at figure 1 will help you see that the function  $n^2$  grows much faster than  $n \log n$ . It also helps to look at some numbers: For  $n = 8$ ,  $n^2$  is 64 while  $n \log n$  is 24—not much of a difference. But for  $n = 256$ ,  $n^2$  is over 65,000, whereas  $n \log n$  is just over 2000.

Again, the obvious question is: Can we do better than Mergesort? If we know beforehand that the values to be sorted are in a limited range—say, the integers between 1 and 100—then it's possible to sort in  $O(n)$  time, and furthermore, we never have to compare the items we're sorting. But if we have no special information about the values to be sorted, then we can only use comparisons to sort them. It can be shown that if sorting is done by comparisons only, then  $O(n \log n)$  comparisons is the optimum. The proof is beyond the scope of this article, but it is contained in the book *Data Structures and Algorithms* by Aho, Hopcroft, and Ullman (Reading, MA: Addison-Wesley, 1983, page 282). The most thorough treatment of sorting algorithms is contained in Donald E. Knuth's *Art of Computer Programming, Volume 3: Sorting and Searching* (Reading, MA: Addison-Wesley, 1973).

While Mergesort is theoretically as good as possible, if we were to actually implement it, we would discover that it has some hidden costs that slow it down (particularly its need for

(continued)



an extra array in the merge phase). There is an algorithm that, like Mergesort, is  $O(n \log n)$ , but it will nonetheless run faster by a constant factor on all present-day computers. (Remember:  $2n \log n$  and  $1000n \log n$  are both  $O(n \log n)$ .) The algorithm, called Quicksort, is the fastest known comparison-based sorting technique.

**QUICKSORT**

Quicksort works like this: If the list to be sorted has only one item, we do nothing. Otherwise, we pick an item from the list and call it the pivot. Now we partition the list into two halves—items less than or equal to the pivot and items greater than it. Then we sort the two halves. We don't have to do anything after sorting the two halves, since the partitioning has already made sure that all the small things are at the beginning and all the large ones at the end.

Quicksort is similar to Mergesort and, in fact, was inspired by it. The key difference is that instead of a merge phase after the recursive sort, Quicksort has a partitioning phase before the recursion. What makes Quicksort more efficient than Mergesort is that, like Selection Sort, all the work can be done in place; that is, we only have to manipulate the original array. Listing 3 shows the Quicksort algorithm.

We partition an array as follows. We start by pointing to the beginning and end of the list to be partitioned. Say, for example,  $i$  points to the beginning and  $j$  to the end. Move  $i$  forward in the list until we reach an element larger than the pivot. Move  $j$  backward until it reaches an element smaller than the pivot. Then swap the item  $i$  points to with the one  $j$  points to. Repeat this until  $i$  meets  $j$  and then the list will be partitioned. Figure 3 shows how a list with five items would be partitioned by this method.

The analysis for Quicksort is similar to that for Mergesort. The partitioning phase takes  $O(n)$  comparisons, and if the list is partitioned into two almost equal halves, then the Quicksort tree will have  $\log n$  levels. So Quicksort is  $O(n \log n)$ , right? Well,

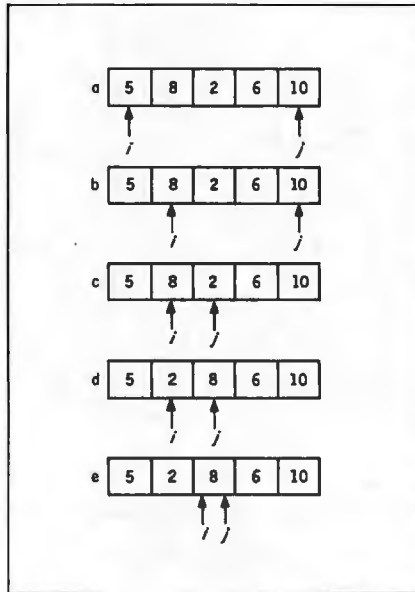

**Figure 3:** Partitioning of an array segment in Quicksort. In line a,  $i$  and  $j$  point to the beginning and end of the array, respectively. The pivot is taken to be the first element, here 5. In line b,  $i$  moves forward until the element it points to is greater than the pivot. In line c,  $j$  then moves down until it reaches an element less than or equal to the pivot. In line d, the two elements pointed to by  $i$  and  $j$  are swapped. And in line e,  $i$  then moves up again, becoming equal to  $j$ . This terminates the partitioning phase.

**Listing 3: The algorithm for Quicksort.**

```

Quicksort.
Input: an array A, with items from
1 to n.
Output: the same array, sorted.
begin
  choose a pivot;
  partition the list so that all
  items <= pivot are < i;
  Quicksort A from 1 to i-1;
  Quicksort A from i to n;
end.
    
```

almost. Our analysis depends on the fact that the list will be split nearly in half. That, in turn, depends on how we choose the pivot. Say we always choose the first element as the pivot. Now, if we assume a random distribution of lists, then on the average the first item will be somewhere comfortably between the largest and the smallest, so the list will be partitioned nearly in half. So, on the average, Quicksort is  $O(n \log n)$ .

But let's look at the worst case: Say we always manage to choose for our pivot the largest (or smallest) item in the list. Then we will partition the list into two parts, one of size 1 and the other of size  $n-1$ . We would then partition the second of those into lists of size 1 and  $n-2$ , etc.—a total of  $n$  partitions that take times  $n-1$ ,  $n-2$ , and so on. The analysis looks similar to that for Selection Sort, and indeed the result is the same. So the worst-case time for Quicksort is  $O(n^2)$ .

It should be clear now that the choice of pivot is very important. If we choose it wisely, we can decrease our chances of ending up with a slow sort. There are lots of ways to choose pivots cleverly. For instance, we might choose three items at random and use the median (middle item) of the three as the pivot. This would improve Quicksort's chances of running in  $O(n \log n)$  time without slowing it down too much. However, in my implementation, I simply choose the first element as a pivot every time. This strategy will give worst-case behavior when the list is in either sorted or reverse-sorted order, so if you expect to be sorting a lot of nearly sorted lists, you should choose your pivot more cleverly.

There is another problem with Quicksort that has to do with the amount of space it takes. We haven't considered space utilization until now, but it can be important. Selection Sort uses a small amount of space and, more importantly, the space it uses is independent of the size of the array. But because Quicksort is recursive, every time the procedure is invoked, some information is placed on the

(continued)



# Now there's a Mouse that flies.



*Introducing the View Control System.™ Ultrasonic technology that moves your cursor at the speed of sight.*

Your relationship with your Mac is about to change. Dramatically. Because now the View Control System™ (or VCS) from Personics gives you a powerful new way to control the cursor. Fast. Direct. Intuitive. It's the best thing since the Mouse. In fact, it's better.

## Move the Cursor Where You Look On the Screen

A lightweight headset translates natural head movement into cursor movement. Look to the right and the cursor moves right. Look down and left and the cursor moves accordingly. No exaggerated head motion is required, just subtle, natural rotation.



## Look Ma, Both Hands!

Now you don't have to take your hand off the keyboard to reach for the Mouse. A unique button pad clips on your keyboard just below the space bar. One button activates the headset. Use the second button for clicking and dragging. No more reach, grab, roll, click, return.

## Faster than a Speeding Mouse

Since you can look much faster than you can reach and roll, the VCS is faster than a mouse. And because your hands stay on the keyboard you maintain continuity and concentration. Expect a real boost in productivity.

## Reclaim Your Desktop

The VCS flies above the ordinary mouse, leaving more space on your desktop. Now you have room for books, papers and your favorite coffee cup. If you want, connect both your mouse and your VCS to the Mac and use them interchangeably.

## State-of-the-art Technology

The VCS uses a proprietary ultrasonic technology to measure subtle changes in the rotation and angle of your head.\* These changes are then translated into electrical signals just like those produced by the Mouse. The amount of cursor motion produced by a given amount of head motion depends on the *rate* your head moves. By monitoring this rate, the VCS can tell whether you are scanning across the screen or zeroing in on a small target. Then, it automatically adjusts to give you the right amount of head-to-cursor translation. Zip from corner to corner, or point to a tiny target with ease, even an individual pixel!

\*Patent Pending.  
IBM PC and Apple II versions available soon.

## Get Acquainted in 15 Minutes

A few minutes of experience will put you in command of the VCS. Before long, moving the cursor will feel like a natural extension



of vision. You'll simply look and click. The VCS headset accommodates eyeglasses and won't muss up your hair. And since it doesn't rest on your ears, you're free to use the phone. The VCS works with any 128K or 512K Mac. No hardware or software modifications are required.

Just \$199.00  
and Easy to Order

The VCS is available right now, directly from Personics. Call us toll free. A member of our sales staff will be happy to answer your questions. If you're ready to order, please have your major credit card at hand when you call. When your VCS arrives, try it for 30 days. If you're not completely satisfied, return it and we will swiftly refund your money. And we back the VCS with a full one year warranty. Satisfaction guaranteed.

CALL TOLL FREE . . . .800-445-3311  
In Massachusetts . . . .800-447-1196

The VCS. A simple and direct link between man and computer. Try it, and watch your ideas take off.



# VCS™

Personics Corporation  
2352 Main Street, Building 2, Concord, MA 01742

SEPTEMBER 1985 • BYTE 109



*Many Hard-to-Find Formats  
No Lower Prices Anywhere!  
No Hidden Charges*



*Many Years of Experience  
Specializing in Corporate and  
Educational Accounts*

**Software HOT LIST Sale Price**

WORDSTAR PROPAK	238
SYMPHONY	419
SIDEKICK (C.P.)	29
SUPERCALC 3	164
WORD PERFECT	235
LOTUS 1-2-3	299
DATA BASE MGR 2	169
DBASE 3	365
FRAMEWORK	365
TURBO PASCAL	52
SUPERKEY	49
HARVARD TOTAL PROJ. MGR	275
RBASE 5000	385
MULTIMATE	231
MULTIPLAN	138
CROSSTALK	98
WORDSTAR 2000	235
THINKTANK	99
SIDWAYS	39
ENERGRAPHICS	239
HOME ACCOUNTANT PLUS	89
BPI GENERAL ACCT.	348

Over 500  
Software Products Available

**HARDWARE**

AMDEK	HAYES
AST	HERCULES
PARADISE	STB

TO ORDER CALL TOLL-FREE:  
(800) 235-3020 (USA)  
(800) 235-3021 (CA)  
(415) 382-9085

448 IGNACIO BLVD., STE. 332  
NOVATO, CA 94947

**TERMS:**

- Call for shipping charges and support policies
- Full guarantee against manufacturers defects
- Allow 3 weeks for checks to clear
- Prices may change
- Call for availability
- No cash refunds! Due to our low prices, all sales final.
- CALL FOR OUR FREE CATALOG
- SAME DAY SHIPMENT ON MOST ORDERS
- Prompt UPS service
- Authorized purchase orders accepted
- Dealer, institutional and quantity discounts available
- No surcharge for credit care purchases
- VISA & Mastercard accepted
- COD

**PROGRAMMING PROJECT**

run-time stack. In the worst case, Quicksort can call itself recursively  $n$  times, so the stack will take up  $O(n)$  space. There is a clever way around the problem that will guarantee that the program uses no more than  $O(\log n)$  stack space. The trick involves making the first recursive call on the smaller of the two partitions and eliminating the second recursive call altogether by incorporating it into a loop. It's a bit messy and probably not worth it unless you're really worried about the space.

**SOME REAL DATA**

While the order-of-magnitude estimates of running times are useful, it's often nice to have some real data as well. With that in mind, I ran Selection Sort and Quicksort on integer arrays of various sizes with items chosen randomly. The results are shown in table 1. As you can see, the difference on small lists is negligible, but on large lists it becomes enormous. The programs I used were written in MacPascal on a Macintosh computer. (They are available for downloading via BYTEnet Listings at (617) 861-9774.)

**SORTING BIG**

Both Selection Sort and Quicksort suffer from a serious flaw. They both work best as internal sorts. That is, in both cases we assumed that we could fit the entire list of items to be sorted into an array, which presumably would be held in RAM (random-access read/write memory), and that the time required to examine and change elements of an array is small, which indeed it is if the array is entirely in main memory. But what do

we do when you have to sort so many items they cannot all fit into memory at once?

We need an algorithm to handle this external sorting problem. For example, say we have a file of a million records on disk. Now, we could treat this file as an array and run Quicksort much as it is, but we would have an incredibly slow algorithm. The reason is that accessing information from a disk is slower than accessing main memory. What we would like to do is to take advantage of the fact that reading a lot of information from a disk takes almost the same amount of time as reading a little, if the information is stored consecutively on the disk. That's because most of our time is spent finding the information on the disk, and only a small fraction of time is spent actually reading it. The same goes for writing. All operating systems use this fact; when asked to read a byte from the disk, they read in a block of bytes containing the one byte desired. Then if the next byte requested is within the block that was just read in, it will already be in memory and a disk access can be saved. When asked to write a byte to the disk, the operating system uses the same trick.

We want an algorithm that exploits these facts about disks. The problem with Quicksort is that it swaps items that are distant from each other in memory, so it doesn't exploit the sequential organization of disk memory. Mergesort, however, reads and writes the files in order, thus taking advantage of the disk buffering done by the operating system. Recall that the merge phase expects two sorted lists

*(continued)*

**Table 1: A comparison of running times (given as minutes:seconds) of Selection Sort and Quicksort.**

List Size	Selection Sort	Quicksort
10	<0:01	<0:01
50	0:05	0:05
100	0:20	0:09
500	7:49	1:02
1000	31:01	2:10



**\$14.95**  
SUGGESTED  
RETAIL PRICE

A NEW SOLUTION from  
MicroComputer Accessories, Inc.

# OPEN AND SHUT CASE.



**LOCKING  
50 DISK  
+ 4 FILE** Holmes, it's criminal—these "sloppy disks" all over the desk! How can we keep them secure and dust-free and still have access to the active ones?

Mystery solved, Watson. This new 50 + 4 Locking Disk File provides a locking, smoked plastic enclosure for up to 50 5¼" diskettes, *plus* an open, up-front, instant access, swap-rack for 4 diskettes. Let me call your attention to the built-in handle, and the adjustable dividers with adhesive labels. Note the rear storage pocket for extra labels.

By Jove, Holmes, open and shut simultaneously! It's perfect for those powerful integrated, multi-disks systems—and no one's thought of it before! Holmes, you never cease to amaze me.

Elementary, my dear Watson.

MicroComputer Accessories, Inc. 



Open—swap-rack for 4



Shut—lock for storage for 50



Built-in carry handle

USA: P.O. Box 3725, Culver City, CA 90231. Telephone 213/641-1800. EUROPE: Rue de Florence 37, 1050 Bruxelles, Belgique. Telephone 02/538.61.73.

Inquiry 246 for End-Users. Inquiry 247 for DEALERS ONLY.

SEPTEMBER 1985 • BYTE 111



*Mergesort reads and writes the files in order, thus taking advantage of the disk buffering done by the operating system.*

and produces another list. It does this by scanning the two sorted lists in order, choosing the smallest item each time. If the lists are files, then we have a good way to merge two sorted files into a larger sorted file. We will need to modify the merging algorithm slightly for our purposes, though. Instead of taking two sorted files, it will

take two files, each of which contains some number of sorted runs of items. For instance, one file might contain the items 1, 3, 4, 2, 6, 5, 6, 8, 9. While the whole file isn't sorted, it does consist of three groups of items, each of which is sorted: 1, 3, 4; 2, 6; and 5, 6, 8, 9. The merge phase will output two files, each with half the number of runs of either of the input files. We then feed these two files back into the merge algorithm and get two more files again. Eventually, the two files will each consist of only one run, and when we merge them we will have a completely sorted file. The merge algorithm needs to be modified only slightly to accommodate these changes. It merges items onto one output file as usual until it notices that an item is not in sorted order, then it writes the remainder of the other run onto the first output file and switches to the second one. (The program for

sorting a file with Mergesort [written in MacPascal] is included in the listings that can be downloaded from BYTEnet Listings.)

In analyzing the merging, we want to consider the number of times we have to read through the files, since that is the bottleneck of the procedure. If we begin with a total of  $n$  runs, then we have to do  $O(\log n)$  merges. The analysis is basically the same as that for Mergesort and Quicksort: Each merge cuts the number of runs in half, and we can divide a number in half only  $\log n$  times before we get to 1. Each merge reads the files once, therefore the total number of file passes is  $O(\log n)$ . Since a single merge takes  $O(n)$  comparisons, the algorithm is, like our internal version of Mergesort,  $O(n \log n)$ .

Only one problem remains: How do we get the files into lists of sorted runs in the first place? Actually, we don't have to. We could just take the original file, split it in half, and start merging, because the merge algorithm will work even if the runs are only one item long. But we can actually do much better, although only by a constant factor—the algorithm still takes  $O(\log n)$  passes through the files.

The idea is to combine internal sorting with external sorting. We read in as much of the original file as we can into memory, sort it using a fast internal sort like Quicksort, then write it out to one of two output files. Then we read in the next chunk of the original file, sort it, and write it to the other output file. We continue in this way until we've gone through the entire file. Now we're left with two files of sorted runs, ripe for merging.

Even though this is only a constant factor better than the straight merge algorithm, the constant is enormous—all of memory. For example, say we have a million-item file to sort. The merge algorithm alone would take 20 passes in the worst case, but if we can sort 10,000 items at a time in memory, then in one pass we can break the file up into 100 runs, which we can merge together into a single sorted file in another seven passes. ■

# Free Catalog!

*Your 80-page guide to computer supplies and accessories—including complete new product descriptions.*



- Packed with over 1600 products for microcomputers, minicomputers, and word processors — many available nowhere else.
- Big special section devoted to new supplies and accessories.
- Comprehensive product descriptions — including more than 475 full-color photos — clearly explain features and benefits.
- Easy-to-use cross reference guides to magnetic media, ribbons, and more—along with the industry's most complete cable guide.
- Helpful suggestions and tips, ranging from flexible disk care to proper ribbon selection to useful application ideas.

*Phone toll-free 1-800-547-5444*

**inmac™**

*Phone toll-free 1-800-547-5444 or send coupon today.*

Inmac Catalog Dept.  
2465 Augustine Drive  
Santa Clara, CA 95054

Please rush my free copy of the Inmac Catalog. I understand there is no obligation whatsoever.

NAME \_\_\_\_\_  
 COMPANY \_\_\_\_\_  
 ADDRESS \_\_\_\_\_  
 CITY \_\_\_\_\_  
 STATE \_\_\_\_\_ ZIP \_\_\_\_\_ PHONE \_\_\_\_\_

107152



## Pascal<sup>®</sup> power booster.

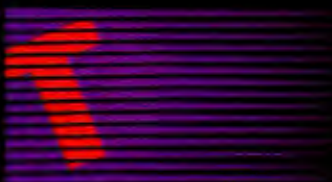

### Turbo-Plus™ (Version 3)

Turbo-Plus™ is a library of procedures crafted in assembly language and is designed to enhance Turbo Pascal<sup>®</sup> versions 2.0 and 3.0. No royalties are required for applications developed using Turbo-Plus™. These procedures are extremely fast and combine automatically with your programs. The benefit to you is rapid development turn around time and smaller, faster application programs. Turbo-Plus™ includes:

- Display Map Generator
- Pop-up Turbo Reference Guide
- Instant Text Display
- Advanced Keyboard Control
- Instant Text Retrieval
- RamWindow
- Screen Snapshot
- Enhanced Disk Input/Output Facility
- Enlarged Graphics Character Display
- Snow Removal
- Sample Programs with Source Code
- Printed Turbo-Plus Reference Guide

Version 3.0 update policy: Receive full credit (\$34.95) toward the purchase of Version 3.0 upon return of prior version's original diskette.

**\$59.95** Non-copy protected

## Run Lotus™ 1-2-3, Symphony™ and Sidekick™ without the floppy disk hassle.



### HardRunner™

Run Lotus™ 1-2-3, Symphony™ and Sidekick™ directly from your hard disk without your system diskette in drive A.

Join thousands of satisfied customers who use this product and no longer worry about losing or destroying their system program diskettes.

We guarantee that HardRunner™ makes absolutely no alterations to your Lotus™, Symphony™ or Sidekick™ programs. HardRunner™ actually copy protects them on the hard diskette. HardRunner™ requires less than 800 bytes of memory. (For the IBM PC/XT/AT/3270, true compatibles, and TI Pro. DOS 2.0 or higher is required.)

**\$39.95**  
**\$69.95** Non-copy protected

Lotus 1-2-3 and Symphony are trademarks of Lotus Development Corp. IBM is a registered trademark of International Business Machines Corp. Turbo Pascal and Sidekick are copyright products of Borland International Corp.

## Creative cursor control.



### NoBlink / Accelerator™

A key stroke initiated at any time pops up a window containing a wide range of NoBlink™ cursors and cursor speeds to choose from, including the standard blinking cursor or standard cursor movement speed.

The NoBlink™ cursors reduce eye fatigue and eliminates the distraction of a blinking cursor.

Choosing a faster cursor speed will surprise you. It's a great time saver because it lets you move faster within your word processor or spreadsheet.

Like the blinking cursor, NoBlink™ is disabled in graphic modes. (For the IBM PC/XT/AT/3270/Jr. and true compatibles like Compaq and AT&T 6300.)

**\$39.95**  
**\$69.95** Non-copy protected

To order, call or write:

**Nostradamus, Inc.**  
5320 South 900 East, Suite 110  
Salt Lake City, Utah 84117  
Telephone (801) 261-0769

Dealer and corporate inquiries welcome

Inquiry 274

# Nostradamus Inc. Software sourcery

#### Please send me:

- Hard Runner **\$39.95**
- Hard Runner **\$69.95**  
(Non-copy protected)
- NoBlink **\$39.95**
- NoBlink **\$69.95**  
(Non-copy protected)
- Turbo-Plus **\$59.95**  
(Non-copy protected)

U.S. shipping and handling included.  
Outside U.S., add \$10.00 per item.



#### Total amount enclosed \$ \_\_\_\_\_

- Check  Money Order
- Visa/MasterCard/Amex  
No. \_\_\_\_\_

City/State/Zip \_\_\_\_\_

\_\_\_\_\_

Expiration Date \_\_\_\_\_

Name \_\_\_\_\_

Address \_\_\_\_\_

\_\_\_\_\_

City/State/Zip \_\_\_\_\_

\_\_\_\_\_

**Nostradamus Inc.**  
5320 South 900 East, Suite 110  
Salt Lake City, Utah 84117  
Telephone (801) 261-0769



# THE AMERICAN BUS NEVER LOOK

SONY BRINGS THE BRILLIANCE OF TRINITRON® TO COMPUTER MONITORS.

From now on, business people all across America can enjoy all their favorite programs on a Sony Trinitron.

Because Sony proudly unveils the first computer monitors in the world endowed with Trinitron technology. RGB monitors which, in the laudatory words of Computer Buyer's Guide and Handbook, give you "crisp, brilliant, utterly flicker-free images that take the eyestrain and headaches out of both color graphics and text or data processing."

We've achieved this through technological breakthroughs that literally divide the computer-monitor world in half: Sony's, and all the others'.

First, the patented one-gun, one-lens Trinitron system itself, with a picture so vivid, so critically lifelike, it's become a legend.

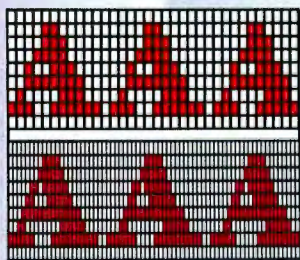

Typical coarse dot pitch vs. Sony Trinitron super-fine dot pitch.

Second, Sony Trinitron's exclusive Super Fine Pitch™ Aperture Grille. It dramatically increases the number of red, green and blue electrons reaching your screen.

Which dramatically increases the vibrance and brightness of the colors reaching your eyes.

And third, a dot pitch so fine, the horizontal resolution of a Sony is not only the highest in its class, but "close to that of models costing twice as much" (Computer Buyer's Guide and Handbook).

You can enjoy this extraordinary picture quality on screens ranging from 9"—the first ultracompact monitor in the business capable of displaying 2,000 characters of text—to 13"—a model that lets you switch from software to

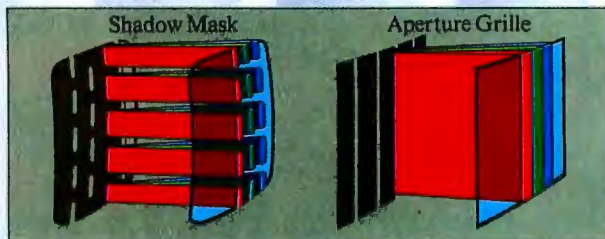

With a Fine Pitch Aperture Grille, Trinitron monitors give you dramatically brighter colors than the conventional shadow mask.

soaps at will by merging a computer monitor and full-feature TV into a single unit.

They're all compatible\* with the IBM®PC, Portable PC, PC/XT and PC/AT through built-in RGB circuitry. And compatible with most Apple® and other personal computers through optional accessories.

So call Sony for further information at 1-800-222-0878 (In New Jersey, 1-800-222-0879).

Because there's no longer any reason to view your technologically-advanced computer through a technologically-deprived monitor.

**SONY®**  
Information Products

registered trademarks, and Super Fine Pitch a compatibility: The microcomputer industry lacks its monitors will be compatible with any combination's compatibility in any particular instance.

Inquiry 345



©1985 Sony Corporation of America. Sony Information Products Division, Sony Drive, Park Ridge, NJ 07656. Sony and Trinitron are trademarks of Sony Corp. IBM PC is a registered trademark of IBM Corp. Apple is a registered trademark of Apple Computer. \*Computer standards. Software packages and add-on hardware options vary tremendously. For these reasons, Sony cannot and does not represent that a nation of non-Sony products you choose to connect to it. While your Sony dealer may be able to help, you must determine for yourself if the



# FINEST PICTURE HAS BEEN BRIGHTER.

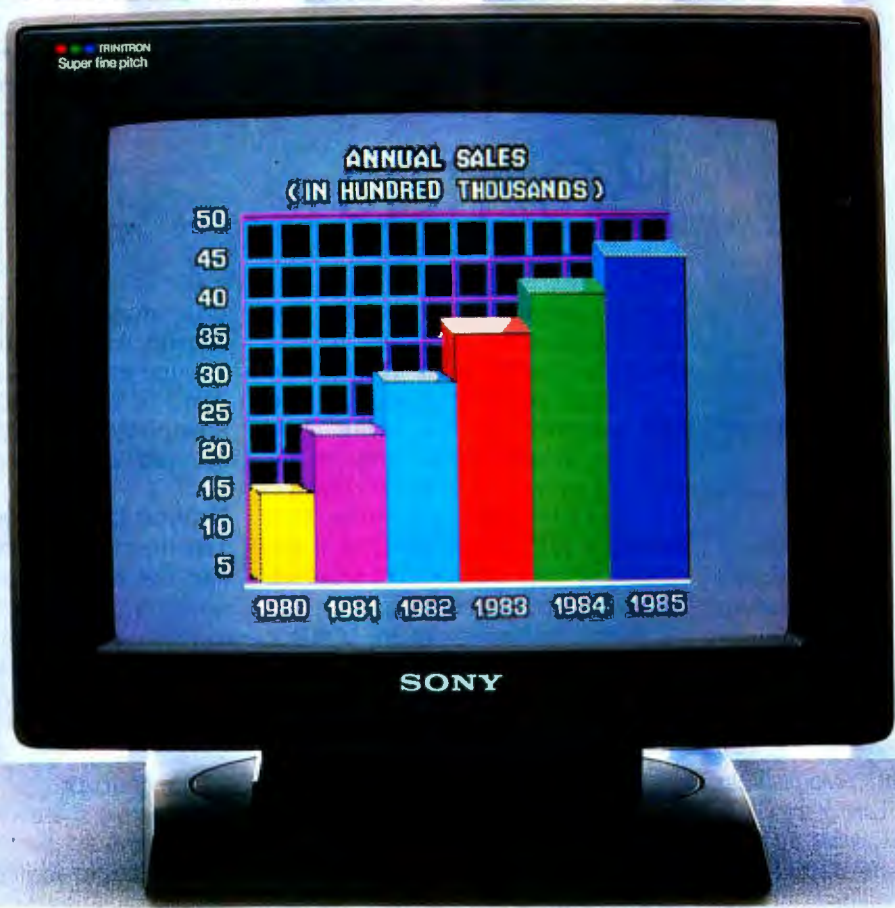



# THE DSI-32 COPROCESSOR BOARD

### *Plug a 32-bit microcomputer into your IBM PC*

---

*Editor's note: This is part 2 of a two-part series describing Definicon Systems Inc.'s DSI-32 32032 coprocessor board for the IBM Personal Computer (PC). Part 1 included a description of the hardware, and part 2 will focus on the software available for the board. If you are interested in a closer look at National Semiconductor's 32000 series, refer to "The National Semiconductor NS16000 Microprocessor Family" by Glenn Leedy, April 1983 BYTE, page 53. You should keep in mind that the 32000-series chips are direct descendants of the 16000-series chips, and that the design philosophies and internal operation of both families are identical.*

**D**efinicon has developed an unusual software interface for the DSI-32. The traditional software environment for a 32-bit computer has been some version of UNIX; instead, Definicon opted for a "shell" program and compilers that emulated the important UNIX calls. This lets the DSI-32 run both UNIX applications and existing MS-DOS applications. An additional advantage is that the 32032 I/O (input/output) operations are off-loaded to the 8088, which performs the file and I/O processing concurrently.

This interface consists of two pro-

grams running in tandem. On the 32032 side is a small operating system called 32IO. On the 8088 side is a program called LOADER, and the two programs talk via an interprocessor communications area in the DSI-32's memory (see figure 1). When the DSI-32 first starts, bootstrap code executes 32IO, which waits until the 8088 has loaded the 32032 program into the DSI-32's memory. Once the program load is complete, LOADER tells 32IO to execute the loaded program. Thereafter, if the 32032 program needs to open a file, write a character to the screen, or perform any other I/O operation, it passes that request to 32IO, which in turn passes it to the 8088.

The software interface uses the features of both the 8088 and 32032 environments. LOADER, written in C, runs under MS-DOS (or Concurrent PC DOS). Since it manages most of the file I/O, it is relatively complex (about 35K bytes of code). The 32IO module handles most of the computationally intensive tasks. Together they form the interface detailed in table 1.

A program running on the DSI-32 makes I/O requests to the 32IO program via the 32032's SVC (supervisor call) instruction. When an SVC instruction is executed, it initiates a supervisor call trap. This causes the 32032 to vector to a known location; it acts like a shorthand subroutine call. (The SVC instruction is directly analogous to the INT software interrupt instruction on the 8088/8086 processors.) To execute any of the 32IO program's service requests (as shown in table 1),

you simply load the 32032's R0 register with a request number and execute an SVC instruction. (See the April 1983 article mentioned previously for more information on the 32032's components.)

#### **DEVICE DRIVERS AND HANDLES**

The interaction between the 32032 and the 8088 occurs at two levels. Some primitive 8088 functions, such as reading and writing blocks of memory or reading and writing I/O ports, have been made available to 32032 programs, but the majority of the interface uses the MS-DOS device-driver concept.

Most users are familiar with MS-DOS devices such as CON: and COM1:, but in addition to these basic system facilities, MS-DOS allows the installation of special device drivers, such as .SYS files, at boot time. For example, if a GPIB (general-purpose interface bus) card has been installed in this way, a user program could define a driver for a device called GPIB:, open it in the same way as opening any other file, and access the GPIB card without any need to know about special memory locations, I/O ports, or other system-dependent parameters. UNIX goes a step further,



treating even CON: as the standard input device, which is labeled <STDIN>, so that all computer interfaces are accessed through the common file system. The Definicon MS-DOS interface has been designed to be similar to UNIX in this respect. The supervisor request to open a file (see request 5, table 1) opens the device whose name has been passed to it and returns a "handle," which is a 16-bit number assigned by the MS-DOS operating system to every file or device that a program has opened. Subsequently, when the program performs an I/O operation, the program informs the operating system where that I/O is to occur by passing it a handle. Detailed descriptions of handles can be found in most technical reference manuals for MS-DOS version 2.xx or higher.

Some handles are predefined and you need not explicitly open them to use them. For example, the handle for <STDIN>, which is usually the keyboard, is 0. The handle for the standard output device, <STDOUT>, usually the CRT (cathode-ray tube), is 1, and the standard error device, <STDERR>, is 2. You may redirect all these channels if you desire.

Thus, to write a character to the CRT using the interface, you would write in C

```
putc(char)
```

or in assembly language

(continued)

Trevor G. Marshall, George Scolaro, David L. Rand, and Tom King are engineers with Definicon Systems Inc. Vincent P. Williams is president of Definicon. They can be contacted at 21042 Vintage St., Chatsworth, CA 91311.

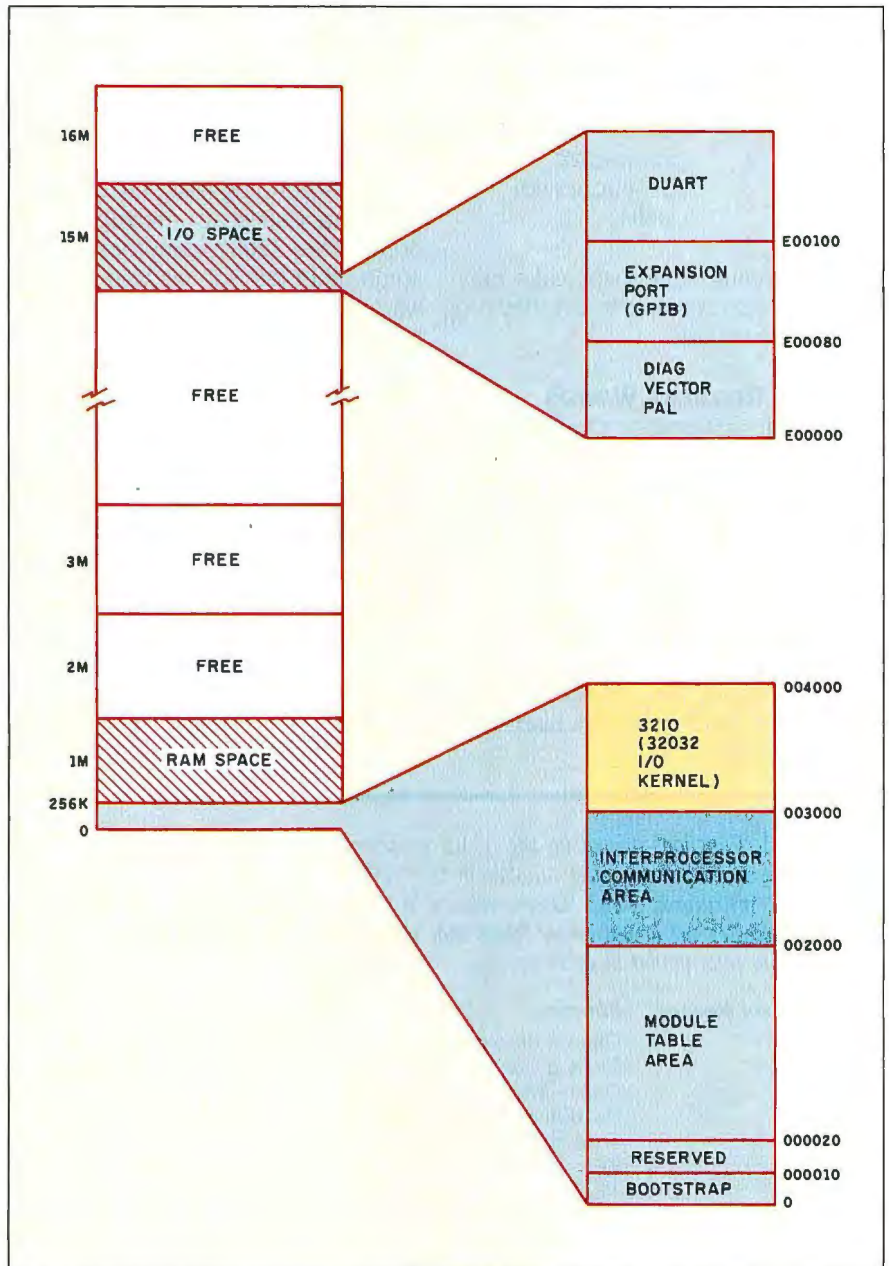

Figure 1: The DSI-32's memory map. 32IO is the I/O kernel that resides between locations 3000 and 4000. All addresses are in hexadecimal.



MOVB 9,R0 ;Supervisor request  
 9, write to device  
 MOVW 1,R1 ;Handle of  
 <STDOUT> is 1  
 ADDR char,R2;Point at char to  
 "put"  
 MOVW 1,R3 ;Output only 1  
 character  
 SVC ;Do supervisor  
 call

There is a 32032 SRW and an 8088 SRW. As shown in figure 3, these words act as mailboxes, holding messages that the two processors send to one another. For example, when the 32032 wants input from the keyboard, it first checks the 8088 SRW. If the SRW is clear—meaning no action is pending—the 32032 sets it to 1 and issues an interrupt to the 8088. The 32032 can then go do some other task, or just wait in a software loop for the 8088 to service the keyboard-input request.

The remaining supervisor calls may require fewer parameters, but they are accessed similarly.

**SERVICE REQUEST WORDS**

All interfacing between the 8088 and 32032 takes place in the first page of memory, or physical address 002000 through 0F2000 (hexadecimal) as seen by the 32032. [Editor's note: All addresses appear in hexadecimal unless specified otherwise.] Figure 2 lists the significant locations within that memory area. Two important communications areas in figure 2 are the service request word (SRW), and disk service request word (DSRW).

The 8088, upon getting the 32032's interrupt, checks its own SRW and discovers that it has been set to 1. The 8088 then places the next character typed at the keyboard into the keyboard queue, sets the 32032 SRW to 1, clears its own SRW, and sends an interrupt back to the 32032. When the 32032 processes this interrupt, it clears the 32032 SRW, fetches the character from the keyboard queue, and continues with the main program. (Normally, the 8088 puts all characters in the keyboard queue anyway, even

if the 32032 does not specifically ask for them.)

There is only one DSRW, and it is a little more complicated than the SRWs (see figure 4). Basically, it holds a code number corresponding to the particular I/O operation that the 32032 needs the 8088 to perform on a handle, which typically corresponds to a disk file.

**SUPPORT FOR IBM BIT-MAPPED GRAPHICS**

System call 17 (see table 1) moves memory from the 32032 to the IBM. This allows you to set up single or multiple 16K-byte graphics screen images in the 32032's memory space and swap them into the IBM PC's screen memory. It takes only a few tens of milliseconds to totally replace a PC's screen in this way. Thus, an application that, for example, requires animation, can use the 32032 to set up successive backgrounds in its own memory space, swapping only those portions of the screen memory actually necessary to update the foreground motion. When a background change is needed, it can be transferred to the display in a fraction of a second. Note that it would be possible to set up a large background space from which the 16K-byte screen display could be "zoomed," using the 32-bit integer manipulation capability of the 32032. Applications that have already been written (in a high-level language) can perform bit-mapped graphics with nearly identical code in the DSI-32 environment.

**HIGH-LEVEL LANGUAGE COMPILERS**

Early in the DSI-32 design, Definicon benchmarked a variety of hardware/software combinations. These benchmarks revealed huge speed variations that could only be attributed to compiler efficiency. For example, there was a large speed difference between the various implementations of the UNIX portable compilers, a difference that seemed to depend on the porting efficiency that the particular company was able to achieve.

Table 1: Functions offered by the 32IO program. Each supervisor request is called by placing the request number in the 32032's R0 register and executing an SVC instruction. 32IO passes requests to LOADer (running on the 8088), which accesses the actual device. Note that many supervisor requests require additional information in other registers.

Supervisor Request	Function
5	Open a file or device for I/O
6	Close a file or device
7	Create a file
8	Read from a file or device (up to 65536 bytes)
9	Write to a file or device (up to 65536 bytes)
10	Erase a file
11	Rename a file
12	Seek to a byte in a file (The offset to seek to can be from beginning of file, current position in file, or end of file.)
13	Return current position in file
14	Get command-line arguments
15	Terminate 32032 execution
16	Move data from IBM to DSI-32 (up to 65536 bytes)
17	Move data from DSI-32 to IBM (up to 65536 bytes)
18	Input from port on IBM
19	Output to port on IBM
20	Execute a software interrupt on the IBM

(continued)



32032-8088 Interface	
Memory	Contents
2000	Service request word (SRW) indicates what 8088 wants
2002	8088 completion status
2004	Request word indicates what 32032 wants
2006	32032 completion status
2008	8088 queue pointer (- >2050)      Keyboard queue
200A	32032 queue pointer (- >2050)
200C	8088 queue pointer      Video queue
200E	32032 queue pointer
2010	8088 queue pointer      Printer queue
2012	32032 queue pointer
2014	Disk service request word (DSRW)
2016	Current handle
2018	Number of bytes to transfer
201A	DWORD (double word) pointer to DTA (disk transfer area)
201E	Disk completion status
2020	Heap low address
2024	Heap high address
2028	Stack low address
202C	Stack high address
2030...	Reserved for expansion
204F	Reserved for expansion (32 bytes)
2050	64-byte keyboard buffer
2090	2048-byte video buffer
2890	1024-byte printer buffer
2C90...	Reserved for expansion
2FFF	Reserved for expansion (880 bytes)
3000	Start of free memory

Figure 2: Memory on the DSI-32 can be accessed by either the on-board 32032 or the PC's 8088, and the two processors use the memory for communication with one another. Some of the more important locations used are shown above.

Service Request Word (SRW) Definitions	
SRW	Action
1	Keyboard input
2	Video output
3	Printer output
4	Disk operation requested
5	Argument request (get command-line values)
7	Task completed normally
FFFF	Abnormal task completion, see completion byte for details

Figure 3: Possible values for the service request word and their meanings. Each value corresponds to a specific request made by one processor to the other.

# SAVE MONEY

with Flexforms.

Flexforms are pre-written, ready to use contracts, agreements and letters designed to save your company time and money. Flexforms work with any word processor. You literally "fill in the blanks" and create customized, professional and legally-binding documents for every situation.

Each of the forms can be quickly tailored to suit your individual needs without wading through confusing manuals.

Flexforms help protect your legal rights, avoid tax problems, dramatically improve efficiency, increase profits and eliminate costly misunderstandings.

Four Popular Series:

## BUSINESS

Ideal for expanding businesses:

Employee Agreements & Letters, Credit & Collection Letters, Subcontractor Agreements, Lease Forms & Amendments, Buying & Selling Forms, Credit Forms & Applications, Guaranties, Loan & Debt Notices & Letters, Assignments & Transfers, Affidavits & Notices, Promissory Notes & 83 more!

## REAL ESTATE

Designed for investors, developers, and property managers:

Residential & Commercial Forms, Purchase & Sales Forms, Broker & Agent Contracts & Forms, Partnership Agreements, Rental Forms, Lease Forms, Tenancy Agreements & Applications, Illegal Detainer Forms, Loan Agreements, Financing Agreements, Exchange Forms & Contracts, Disclaimers & Disclosures, Contractor Agreements and 75 more!

## CORPORATE

Exceeds State and Federal Corporate Law requirements:

Articles of Incorporation, Shareholder & Director Meeting Minutes, Corporate By-Laws, By-Law Amendments, Shareholder & Director Resolutions, Merger Resolutions, Compensation Resolutions, Dividend Resolutions, Loan Resolutions, Fringe Benefit Resolutions, Employee Benefit Resolutions and 86 more!

## PERSONNEL

Created for growing organizations:

Personnel Policy Manual, Employee Safety Manual, Employment Agreements & Applications, Secrecy & Invention Forms, Confidentiality Agreements, Non-Compete Agreements, 25 Job Descriptions, Consultant Agreements, Agency Agreements, Personnel Letters, Performance Reviews and 25 more!

Flexforms have been prepared under legal counsel. Unlike forms written by lawyers for lawyers, they are concise and easy to understand without needless legalese. Available in IBM and Apple disk formats.

Each series only

# \$49.95

(plus \$5 shipping), includes hard copy. All four for \$175 and we pay the shipping! Visa and Mastercard accepted. Inquiry 28

Atkins Associates  
P.O. Box 781 • Santa Cruz, CA 95061  
(408) 426-7638



## THE 32000 AND HIGH-LEVEL LANGUAGES

The NS32000 instruction set eases the task of writing efficient compilers. As an example, let's look at a simple subroutine in C that normalizes the size of a positive floating-point number to be between 0.5 and 1 and returns the corresponding scaling exponent such that

input argument = normalized result \*  $2^{\text{exponent}}$

This subroutine, in C, might be written as shown in listing A.

A more efficient means of performing this function is to examine the way in which the IEEE (Institute of Electrical and Electronics Engineers) standard specifies a floating-point number (see figure A). The number is made up of a sign bit, an 11-bit exponent, and a 52-bit mantissa. We can write figure A as a structure in C (using bit fields):

```
typedef struct {
    unsigned mantissa 1 : 32 ;
    unsigned mantissa 2 : 20 ;
    unsigned exponent  : 11 ;
    unsigned sign      : 1 ;
} double__precision__ieee;
```

When the Normalize subroutine is called, this number will have been pushed onto the stack by the calling routine. All the Green Hills compilers use identical calling procedures, so the code and subroutines from each can be intermixed. Using this new structure, we could rewrite the subroutine as shown in listing B.

The Green Hills C compiler generated the 32032 machine code in listing C.

We leave it to you to check the assembler code your favorite compiler generates with this routine. With our 8088 and Digital Research C, this source code generated about 22 lines of assembler, plus a call to a library function.

**Listing A:** A sample C program to normalize a floating-point number to between 0.5 and 1.

```
double normalize(y,exp)
double y;
int *exp;
int scaler = 0;
{
    if ( y > 1.0)
        while(y>1.0) {scaler = scaler + 1; y=y/2.0; }
    else if (y<0.5)
        while (y<0.5) {scaler = scaler - 1; y=y*2.0; }
    *exp = scaler;
    return(y);
}
```

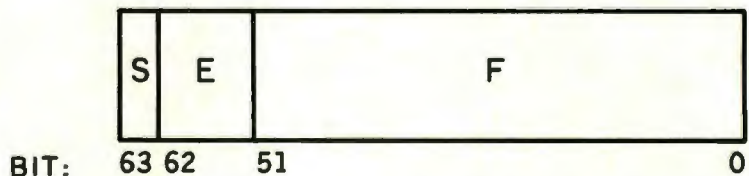

$$\text{NUMBER} = (-1)^S \times 2^{(E-1023)} \times 1.F_2$$

**Figure A:** IEEE standard for 64-bit floating-point number. The S bit indicates the number's sign—0 is positive and 1 is negative. The E or exponent field is in excess-1023 form (subtract 1023 from the value in the E field to get the actual exponent). The F field holds the fractional portion of the number.



Listing B: A modified version of listing A, using a C data structure.

```

double normalize(y,exp)
double y;
int *exp;
2
    /* create a pointer to the argument passed on the stack */
    register double__precision__ieee *pointer = &y ;

    /* calculate an exponent value by subtracting 1023 (all */
    /* ones) from the argument's exponent value */
    *exp = pointer -> exponent - 1023;

    /* and normalize the argument's exponent to all ones */
    pointer -> exponent = 1023;
    /* return the modified number (and of course, the exponent)*/
    return(y);
}

```

Listing C: 32032 machine code generated by the Green Hills C compiler for the program shown in listing B.

```

.module normalize.c
.program
__normalize: -
    addrd    8(sp),r1      ;first line of C code done
    extsd   6(r1),r0,4,11 ;EXTRACT Short Double
                                ;from bit one, length of 11
                                ;from the 32-bit word at (R1)+6
                                ;put them into bits 0-10 of R0
    subd    1023,r0       ;next line of C code
    movd   r0,0(16,sp))  ;put it onto the stack for return
    inssd   1023,6(r1),4,11 ;INSert Short Double
                                ;syntax similar to above extsd
                                ;except that an immediate field
                                ;inserted
    movl    8(sp),f0      ;get Y to F0, the return code
                                ;for the calling program
    rpx     0
    :__pointer r1        local      ;the compiler tells us where
    :__y 8(sp)         local      ;it put the variables
    :__exp 6(sp)       local
.endseg

```

To better evaluate compiler efficiency, Definicon examined the intermediate assembler source-code outputs and was able to divide the differences into the following two categories:

- degradations in floating-point performance due to a compiler's inability to produce in-line source code
- degradations due to the inability of the compiler to optimize its output code

Lack of in-line code often leads to a call to a subroutine every time a mathematical operation is performed. With in-line code, the compiler produces code to perform a mathematical operation—such as multiplication—every time it scans the operation. With the compact instruction set of the 32000 series, this reduces several lines of code to just one or two.

Lack of optimization is easily recognized. For instance, when compiling a benchmark that Definicon had devised to test floating-point operations, the UNIX portable C compiler produced the following code within the  $Z = Y * X$  execution loop:

```

MOVf __X,F0 ;get X from memory
              to floating register
              0
MULF __Y,F0 ;multiply it by Y
MOVf F0,__Z ;store the result in
              Z (in memory)

```

The Green Hills compilers shifted X and Y into floating-point registers outside the loop and then performed the much faster

```

MULF F0,F2 ;multiply where it
              stored X and Y
MOVf F2,F4 ;and store it where
              it wants Z

```

(It was interesting to note that the VAX compiler optimizers were so efficient that they removed any operations that produced results that were not used later in the program. This caused a great deal of trouble until Definicon devised benchmarks to force the generation of real code.)

Several other differences between

(continued)



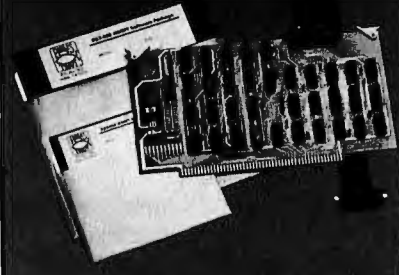

**The Most Powerful  
S-100/IEEE 488  
Interface  
Available**

The P&T 488 Interface Package turns an S-100 computer into an easily-used, versatile, and inexpensive 488 controller. It includes everything you need: a board, a cable, and extensive software. You can

- use any one of 8 operating systems (e.g. MSDOS<sup>®</sup>, CPM<sup>®</sup>, and ZDOS<sup>®</sup>)
- program in Fortran, Basic, C, Pascal, or assembly
- use P&T's sample and diagnostic programs to install 488 equipment quickly and easily
- control up to 15 IEEE 488 devices
- expect trouble-free service (less than 1/2% field failure rate)

Just compare these features. Nobody else offers this kind of versatility and reliability. And it only costs \$450 (plus shipping). So why settle for less? Call or write today for a detailed brochure.



**Pickles & Trout<sup>®</sup>**  
P.O. Box 1206  
Goleta, CA 93116  
**(805) 685-4641**

CP/M<sup>®</sup> Digital Research • ZDOS<sup>®</sup> Zenith Corp. • MSDOS<sup>®</sup> Microsoft, Inc.

**DSI COPROCESSOR**

compilers were also evident. The 32032 has a "move quick" instruction for immediate operators in the range of +8 to -7. For example:

```
MOVQD 6,R0
```

is only a 2-byte instruction that moves 6 into register R0 as a 32-bit ("double") quantity. If the operand is out of this range, most other compilers generate:

```
MOVD 34,R0,
```

which takes longer to execute than the previous instruction because the 34 is stored as a 32-bit, immediate double word.

The Green Hills compilers, however, generate

```
ADDR @34,R0,
```

which tells the CPU (central-processing unit) to calculate the effective address of 34, which is of course 34, and place the resulting 32 bits in R0. This construct requires only a 1-byte field for the immediate value and therefore executes faster.

Consequently, Definicon selected the Green Hills C, Pascal, and FORTRAN compilers for the DSI-32. Since these compilers were written in Pascal, Definicon attempted to port them by compiling them in an 8088 Pascal. This did not work because of segmentation constraints on the 8088 (see the text box "The Need for Speed" on page 124), so Definicon wrote an interface package that was used to port the Pascal compiler to the DSI-32. When Pascal was running successfully on the board, it was used to bring up the C and FORTRAN compilers.

**FORTH**

FORTH-83 defines integers and addresses clearly as 16-bit words. This severely limits FORTH's usefulness in a full 32-bit environment. Because each memory access on the DSI-32 (including, of course, stack accesses) is 32 bits wide, it makes no sense for a 32032 FORTH implementation to observe these restrictions.

*(continued)*

**Disk Service Request Word (DSRW) Definitions**

DSRW	Action
1	Open a file, returning a handle of 1-0xFFFF, or 0 if not found. The filename desired will be in the DTA, with the number of bytes count set to the length of the filename. Note that the DTA is a DWORD pointer, and thus the DTA may be anywhere in the 32032 address space.
2	Make a file, returning a handle of 1-0xFFFF, or 0 if the disk system is full. Same notes as 1, except that if the file exists, it is truncated to a length of zero.
3	Close a handle, returning the filename in the DTA, with the number of bytes count set to the length of the filename. If an error occurs, then a completion status will be nonzero.
4	Rename a handle. The new name is in the DTA, with length set as above. An error is shown by a nonzero completion status.
5	Read data from a handle. Data is read into the DTA, for a count of <i>n</i> bytes. Errors are returned as nonzero completion status.
6	Write data to a handle. Data is written from the DTA, for <i>n</i> bytes count. Errors are returned as nonzero completion status.
7	Seek to location. The current handle file pointer is moved to the location specified by the value in the DWORD DTA pointer. This allows 2 <sup>31</sup> file size.
8	Tell current location. The current handle's file pointer location is returned in the DTA pointer.
9	Delete a file. The DTA points to a valid filename. Status is returned in the handle.

Figure 4: Values for the disk service request word and their meanings.



When you're building a new company, every penny is important. So, when we were evaluating PC's and I recommended the new high-performance Olivetti M24, my boss thought high-performance meant added expense. I explained that while the new M24 is faster than the new IBM PC, it costs about the same.

When I told him the M24 is fully compatible with IBM and comes from Olivetti, a world leader in high technology, I knew I had won his approval. But, my boss' eyes really lit up when I told him about all the important features that come with Olivetti's M24 ... features we need, but he'd pay extra for with IBM — like the super high-resolution monitor, a graphics adapter, parallel and serial ports, and a perpetual clock calendar.

My M24 also has 7 expansion slots, not just 5! You'd use all those IBM slots just adding on the features our M24 came with! Now we have a PC that can grow and expand along with our company.

Fact is, my boss was so impressed with the M24, he said I deserve a raise. I didn't get one ... he just said I deserve one.



**olivetti**

Inquiry 122

Technology that makes a world of difference.



**“My boss never budgets for extras.  
But all the extras I need are already  
built into the new Olivetti M24 PC.”**

For the Olivetti dealer nearest you, call **1-800-447-4700.**

Olivetti products are marketed in the U.S.A. by Docutel/Olivetti Corporation, P.O. Box 660203, Dallas, Texas 75266-0203.



## THE NEED FOR SPEED

Early in 1984, Definicon Systems Inc. developed an advanced algorithm for spectral decomposition and performed most of the development work on a VAX-11/780. When that became too expensive, Definicon turned to an HP9000 32-bit supermicrocomputer. After a few months Definicon realized that owning an IBM PC clone would be much cheaper than leasing the HP9000.

Before deciding to go with the IBM PC architecture, Definicon performed benchmarks on a range of machines, from the VAX minicomputer, through 68000 UNIX-based machines, to PCs. The benchmark programs included the prime-number sieve, as well as a program devised specifically to test the arithmetic processing unit's speed. The early results indicated that an IBM PC clone was capable of providing about the same performance as the more expensive machines. So Definicon bought an Eagle Turbo, which had about twice the measured speed of a basic IBM PC XT.

When Definicon converted the algorithms to Microsoft FORTRAN, they were unpleasantly surprised to find that the benchmarking had been misleading. The algorithms took about 90 minutes to run on the 8086—about 5 times longer than the benchmarks had indicated. It took Definicon several months to find the problem.

The prime-number benchmark—the popular "Sieve of Eratosthenes" (see "Eratosthenes Revisited: Once More through the Sieve" by Jim Gilbreath and Gary Gilbreath, January 1983 BYTE, page 283)—initializes a Boolean (byte) array to logical TRUE then blanks out the nonprime numbers one by one, leaving only the primes unmarked.

For several reasons, the Sieve of Eratosthenes turns out to be a particularly bad indicator of advanced processor performance. For one thing, the usual array size is 8191 numbers, a value that exercises only the 16-bit arithmetic capabilities of the CPU. In addition, the array is Boolean, a byte array that means the 32-bit processors

usually discard 3 of the 4 bytes they fetch at each memory access.

The true measure of CPU performance, however, can be glimpsed when the array grows. When we try to find the primes in the first 40,000 numbers, for instance, a different picture emerges. The IBM PC AT (and the XT) drops to about 1/8 the performance of the 32- and 64-bit machines when 32-bit arithmetic has to be used (numbers are larger than 32,767).

A fundamental limit of the segmented architecture (found in the 8088/8086/80286 CPUs of the IBM PCs) is reached when the array extends to 65,536 numbers. Definicon could not find a compiler for the 8088/8086 that could deal with arrays with more than  $2^{16}$  elements.

Another major limitation of the segmented architecture, however, is not shown by the Sieve. The 8088/8086 and 80286 have a data space that only spans 64K bytes at a time. To handle data structures larger than 64K bytes, these CPUs must employ lengthy tests whenever a data byte is fetched. These tests check to see if the byte is from the current data segment and, if not, must switch the processor to the needed segment.

Although Definicon was interested primarily in scientific applications, the performance conclusions generally apply to many business software applications. In particular, spreadsheets and database managers are slowed considerably by the 64K segmentation overhead.

The 32032 architecture avoids the segmentation delays. Every module of code written for the 32032 has a module table. Each module table has four entries: static base, link table base, code base, and one reserved entry. The 32032 supports a "call external procedure" mechanism that uses the module table for a fast context change. A routine may also access an external variable if it knows both the module in which the variable is declared and the offset (to the variable location) at which the required data is stored.

A 32032 FORTH is available for the DSI-32 board from Symbolic Processing Systems of Orange, California. Symbolic Processing Systems' FORTH defines all integers and addresses as 32 bits wide. In addition, the storage order of bytes in memory has been changed to match that of the 32032. [Editor's note: The 32032 stores all multi-byte quantities with the least significant byte at the lowest address.] This version includes the FORTH editor, string and file support, together with all float-point operations.

Serious FORTH programmers will be interested in the upgraded FORTH package, complete with an assembler, debugging aids, the metacompiler, and FORTH source screens. The metacompiler allows recreation of a customized FORTH from its source screens. The debugging tools, including TRACE and VIEW facilities and a decompiler, provide a full-featured 32-bit FORTH programming environment. In addition, this FORTH is multi-tasking, with the number of tasks limited only by the available memory space. (See the text box on page 134 of the August BYTE for price information.)

Additionally, a small LISP interpreter and a small BASIC compiler, both written in FORTH, are available for the DSI-32.

### CONCLUSION

Coupled with the UNIX-like shell and high-level language compilers, the DSI-32 board performs on a level previously occupied by expensive minicomputers. It offers IBM PC owners 32-bit computing—an upgrade that doesn't cause the usual problem of equipment obsolescence.

A FORTH interpreter is available for \$299 from Symbolic Processing Systems, 501 West Maple, Orange, CA 92668, (714) 637-4298. ■

### ACKNOWLEDGMENTS

The authors are indebted to Martin A. Lewis of Cambrian Consultants Inc. of Calabasas, California, for his help and guidance, and to Les Wilson, an applications engineer at National Semiconductor, for his untiring assistance.



# DATAEASE™

## The Corporate Database Standard.

### DATAEASE

#1 with Corporate users.

Thousands of businesses, both large and small, use DATAEASE to solve their needs. Because DATAEASE, with its ideal combination of power and ease-of-use, allows you to gather, link, calculate and report information key to decision making — all without programming skills.

"We chose DATAEASE over dBASEII™ and Lotus 1-2-3™ because most of the programming was already done."

**Joe Dane, Human Resources Director**  
MCI Telecommunications Corporation

"Office staff members with little to no computer experience are actively using DATAEASE to improve productivity in handling large amounts of information."

**Louis M. Brigando, Senior VP,**  
MetPath, Inc.

"We switched from a \$250,000 mini system to a \$15,000 system of IBM PC's and DATAEASE. Now orders, inventory, sales . . . everything is easier. All without the help of a programmer."

**J.A. Fulmer  
Robinson  
Foundry, Inc.**

### DATAEASE

#1 with Reviewers

"I was very impressed with its overall performance and features."

**Bill Jacobson**  
BYTE, October 1984

"DATAEASE is a true winner."

**Business Computer Systems**  
April 1984

DATAEASE was rated good or excellent in performance, documentation, ease-of-use, error handling, support...In all areas.

**InfoWorld**  
March 25, 1985

"DATAEASE is perhaps the most effective blend of ease-of-use and performance available for PC users to date."

**Data Decisions**  
January 1985

For information or the dealer nearest you call:

**800-243-5123**

### DATAEASE

#1 in Corporate sales.

According to several recent best seller lists, DATAEASE is now the industry standard for corporate users who want a database that doesn't require programming:

DATAEASE tops dBASEII, R:BASE™ in Corporate Software sales.

**Infosystems, March 1985**  
Corporate Best Seller List

DATAEASE outsold all other database management systems — ahead of dBASEIII™, Symphony™ Framework™ and R:BASE 4000.

**MIS, Inc., September 1984**  
A leading supplier to Corporate America

DATAEASE ranked #3 on best sellers list; outselling Lotus 1-2-3™, R:BASE and Powerbase™

**Software News, March 1985**  
Corporate Best Sellers List

Why settle for less? Contact Software Solutions, Inc. for more information on DATAEASE, the #1 choice of Corporate America.

**Software Solutions, Inc.**

305 Bic Drive, Milford, CT 06460

203-877-9268

Telex: 703972

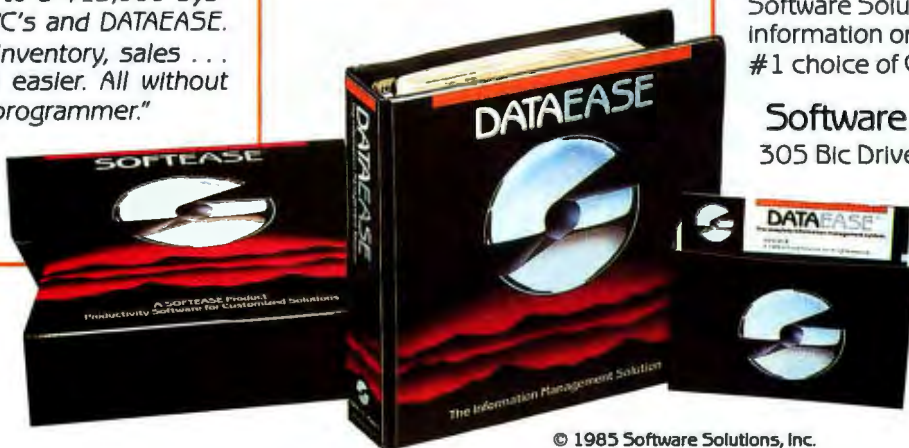

© 1985 Software Solutions, Inc.

Scandinavia  
West Soft A/S, Alesund, Norway; (47) 71-41141

United Kingdom  
Sapphire Systems, Essex; 01-554-0582

South Africa  
Dataflex, Craighill; 11724-6355

West Germany, Austria  
M&T Software Verlag, Munich; 089-4613-0

Switzerland, France  
Softsource, S&A 1222 Vesenz, Switzerland; 022-5518-55



**Introducing  
The Single  
Solution To  
Many Problems  
That Can  
Tie Up Your  
Personal  
Computer.**





# Transet 1000™. The print buffer, communications buffer, port expander, printer sharer and I/O switcher. All in one.

Anyone with a personal computer and one or more peripherals has faced the all-too-familiar dilemma. You need your computer to do an important job. But you're forced to wait for the system to finish one job (printing, communicating, whatever) before you can go on to the next one. Or you need to stop what you're doing to switch cables when you want to use another peripheral.

Wait no more. Now Hayes introduces an innovative new device that lets you perform many jobs—at the same time—independent of your computer. Transet 1000. It works with a wide range of systems and configurations. And it allows you to continually expand your system as your needs grow.

Transet 1000 frees your computer from waiting on your printer or modem—so you and your computer can go on to another task. It even lets you print out documents in pre-set formats without having to go back into your computer. At the same time, Transet 1000 can operate unattended mailbox communications—24 hours a day—even if your computer is turned off.



In addition, Transet 1000 is a port expander and software-controlled I/O switcher. Now files can be easily directed and redirected to different peripherals, without physically changing cable connections.

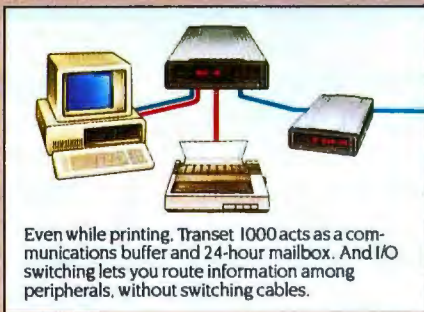

Transet 1000 contains a stand-alone microprocessor, and comes with 128K of memory. It operates with any RS-232 interface computer, and has optional accessory kits available for the IBM® PC and PC XT, Macintosh™ and Apple® IIc. Kits contain the necessary host cable, a user guide and menu-driven software that lets you graphically set up or customize port

parameters and printing formats. Cables available for IBM PC AT, other computers and peripherals.

Like all Hayes products, Transet 1000 combines sophisticated capabilities with easy operation. Just as Hayes set the standard in personal computer communications, now Hayes is taking the lead in computer task management.

Contact your authorized Hayes dealer to see how Transet 1000 can help you get a lot more productivity

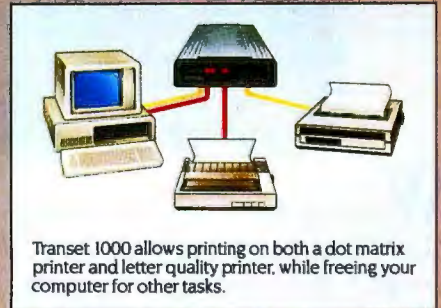

out of your computer system—without tying up your computer or you.

**Hayes Microcomputer Products, Inc.**, P.O. Box 105203  
Atlanta, Georgia 30348  
404/441-1617



# Hayes® Transet 1000

Innovative products for enterprising people



# CORVUS INTRODUCES SHARED STORAGE. FOR THE REST OF THE OFFICE.



**W**ithout mass storage that every Macintosh can access, your networked office won't have a prayer.

Because you'll still have to share data by swapping floppies.

And just consider how fast a floppy disk fills up with an entire workgroup compiling data. To share information, you have to get those floppies neatly stacked, sorted and cataloged.

Something your computer should do for you.

Which is why we've introduced OmniTalk software. It lets you network your Macintosh Office and LaserWriter printer with an OmniDrive hard disk. So you can store all your files in one place. And share information whenever you want, with whomever you want.

Without turning your floppies into little frisbees. Several people can even access the same information at once—something

a floppy could never do. With OmniDrive and OmniTalk, your Macintosh Office has faster access to software and data, greater storage capacity, even easier back-up

capability. Plus, you get three levels of protection to keep your files safe. And with the Corvus 126MB hard disk, it all costs less per megabyte than any other system. You see, Corvus has more experience networking than anyone else. No one offers more, because no one can.

So take it from us. If you're going to add people to your new Macintosh Office, add the mass storage system that everyone can use. OmniDrive from Corvus. Then your Macintoshes can really start talkin' business.

For more information, call (800) 4-CORVUS.



Macintosh is a trademark licensed to Apple Computer, Inc.  
LaserWriter is a trademark of Apple Computer, Inc. OmniDrive and OmniTalk are trademarks of Corvus Inc.

**CORVUS**



# AN ALGORITHM FOR DISK CACHING WITH LIMITED MEMORY

## *Efficient disk buffering for a small system*

**R**eading and writing to floppy disks is often time-consuming on microcomputers. The increased use of 16-bit microprocessors has caused floppy-disk delays to become a significant bottleneck in many programs for these processors. One solution to this problem is to add a RAM (random-access read/write memory) disk, but this is an expensive answer. This article presents a set of C functions that use a small amount of memory to store (cache) copies of certain disk sectors and improve the performance of floppy-disk systems. The algorithms used in these functions are suitable for any situation in which only a small amount of memory can be allocated as a cache.

The routines were developed as part of a multiprocessing operating system, now dubbed "Tonto," for the 8088/86 processor (see listing 1). The goal was to have multiprocessing and UNIX-like behavior on a system with floppy-disk drives and 128K bytes of memory. Originally I added caching to read or alter single bytes in a disk block (sector) without having to be concerned with reading and writing the whole block. Later, I improved the performance of the operating system significantly by the caching algorithm that I will describe in this article.

Disk-block caching is a technique

whereby copies of a number of disk blocks are kept in memory. If any requests are made to read from or alter the blocks that are cached, then the disk need not be accessed and the transfers are so fast that they approach memory-disk performance.

When designing a caching system you have to decide how much memory, or number of buffers, will be allocated for disk-block copies. Decisions behind caching with large

amounts of memory allocated for the cache (256K bytes is typical) were discussed in "Maximizing Hard-Disk Performance" by Roy Chaney and

*(continued)*

Brian McKeon is an Australian with a Ph.D. in medicine. He recently completed two years of research at MIT supported by a grant from the National Health and Medical Research Council of Australia. He can be contacted at 1-18 Manion Ave., Rose Bay, Sydney, Australia.





Listing 1: Routines for buffer manipulation, buffered block, and character I/O.

```

/*
Buffer manipulation, buffered block, and character I/O routines.
*/
#include      "xdefs.h"      /* system-wide definitions */
#define BLKSIZ 512          /* disk-block size */
#define NBUF 18             /* number of block
                           buffers in cache */

#define XBFLGS 0           /* flags for a buffer */
#define XBDEV 1            /* device and block of which */
#define XBBLK 2            /* this buffer is a copy */
#define XBAGE 3            /* "time" of last access */
#define XBFREQ 4           /* frequency-of-access parameter */
#define XBUF 5             /* start of actual buffer */

#define XBFREAD 01         /* buffer header bit flags */
#define XBFWRIT 02

#define XBUFSIZ (XBUF + (BLKSIZ/2)) /* buffer plus header size */
#define MINRDBUF (NBUF/3) /* cache flush threshold */
extern int traceflg, /* debug tracing flag */
          *sysproc; /* ptr to system process descriptor */
int *freebuf, /* free buffer list pointer */
    bufpool[NBUF*XBUFSIZ], /* pool of buffers and headers for each */
    devioage; /* counter of calls to buffered I/O func */

/*
Initialization of buffer management.
'freebuf' is a pointer to the first free buffer on the free list.
If the free list is empty, 'freebuf' will be 0.
*/
bufinit()
{
    int k, *ip;
    printf("buffer pool at %d/n", bufpool);
    freebuf = 0; /* freebuf == 0 will indicate end of free list */
    ip = bufpool + XBUF; /* point at start of first buffer */
    for(k = 0; k < NBUF; k++)
        {
            buffree(ip); /* and free up all buffers */
            ip = ip + XBUFSIZ;
        }
}

/*
Return a buffer to the pool.
Range checking has been removed
as this function is only called by the system.
*/
buffree(buf)
int *buf; /* note usage as array of int for correct pointer maths */
{
    buf = buf - XBUF; /* back up to address
                     of buffer header */
    buf[XBFLGS] = 0; /* clear all flags */
    buf[XBFLGS + 1] = freebuf; /* link onto free list */
    freebuf = buf;
}

/*
Allocate a buffer from the pool.
Look for the buffer with the lowest frequency of use and,
if more that one with the same value, choose the least
recently used (LRU) one.

```

(continued)

## Random replacement, FIFO, and LRU are decision algorithms for copy displacement.

Brian Johnson (May 1984 BYTE, page 307). In the case of the Tonto operating system, a large process and a couple of smaller processes left little room for a large cache and forced an 18-block (9K-byte) cache size. This restriction of a small cache is typical of many other applications where caching is implemented as part of a program, for example, programs for CP/M on 64K-byte machines.

The next design question—which copy should be displaced—arises when all cache buffers contain copies of disk blocks and a request is made for a block that is not in the cache. The decision algorithms in common use are random replacement, first-in/first-out (FIFO), and least recently used (LRU). Chaney and Johnson didn't find much difference in performance with large caches; however, the algorithm becomes very important when small caches are involved. To see why, we can look at typical activity in a large cache.

Much operating-system disk activity is concerned with opening, reading or writing, and closing files. It is obvious that a lot of this activity will involve reading and writing to directory blocks; therefore, it is desirable to try to keep copies of these blocks in the cache. After opening a file, the cache will contain copies of directory blocks. Reading a file will cause copies of its blocks to displace other copies in the cache. With large caches, the size is larger than most files and, when it comes time to open another file, the copies of directory blocks will probably still be in the cache. This will apply to any blocks that are accessed often; the chance of finding them in the cache will be higher than for other blocks that are used less.

(continued)



# Non-stop flights to XENIX.

The XENIX® market is taking off. To keep up you've got to convert your MS-DOS® software to run on the new, faster 80286 machines. Quickly. Efficiently.

Nobody makes porting software to the XENIX environment as easy as Microsoft; you simply recompile the original source code.

Our full-featured XENIX languages use commands and syntax identical to their MS-DOS siblings. So you don't have to rewrite your program to move it.

Whether your applications are written in Microsoft **MICROSOFT**® The High Performance Software™ versions of Pascal, BASIC, COBOL or FORTRAN, we have the solution to your transportation problems.

For the name of your nearest

Microsoft dealer call (800) 426-9400. In Washington State, Alaska, Hawaii and Canada, call (206) 828-8088.

## Overall features of XENIX Languages

- Shell support of synchronous and asynchronous tasks.
- Support of pipes for interprocess communication as a generalized I/O device.
- Record and file locking:
  - For sequential, random, dynamic and ISAM files.
  - Blocked or unblocked file reads.
  - Deny access, deny read and deny write lock levels.
  - Automatic or manual record and file locking of ISAM files.

## Microsoft FORTRAN Compiler

- Based on ANSI 77 (x3.9-1978) standard.
- Single and double-precision for both real and complex data types.
- Math packages: 287 support, alternative fast math and BCD decimal math.
- Large program support.

## Microsoft COBOL Compiler

- High Level 2 ANSI 74 standard features.
- Multi-key ISAM with split keys, alternate keys and duplicate keys.
- Interactive extended screen section.

## Microsoft BASIC Interpreter

- Standard Microsoft BASIC.
- Supports trace, single step and immediate execution.
- Supports random, dynamic, ISAM and sequential file I/O.

## Microsoft Pascal Compiler

- ANSI and ISO standard with extensions.
- Math packages: 287 support, alternative fast math and BCD decimal math.
- Large program support.



**MICRO  
SOFT**



```

If the number of read-type buffers is below the minimum,
flush any write buffers.
*/
bufalloc()
{
    int *ptr, *ip, k, age, oldest, freq, nrdbuf, nflush;
    if(!freebuf) /* any buffers on free list? */
    {
        ptr = freebuf; /* point free-list pointer to next on list */
        freebuf = freebuf[XBFLGS + 1];
        fillw(ptr + XBUF, SYSDSEG, 0, BLKSIZ/2); /* fill with null */
        return (ptr + XBUF);
    }

    ptr = bufpool; /* otherwise look for a 'READ' buffer */
    nrdbuf = 0; /* counter of number of 'READ'
                buffers found */
    ip = 0; /* 'ip' will be nonzero if a 'READ'
            buffer found */
    freq = 32767; /* hunt for XBFREQ less than this (a big
                 number) */
    oldest = 0; /* hunt for a buffer older than this */
    for(k = 0; k < NBUF; k++)
    {
        if(ptr[XBFLGS] & XBFREAD) /* a READ-type buffer */
        {
            nrdbuf++;
            if(ptr[XBFREQ] <= freq)
            {
                freq = ptr[XBFREQ];
                age = devioage - ptr[XBAGE];
                if(age > oldest)
                {
                    oldest = age;
                    ip = ptr; /* save it */
                }
            }
            ptr = ptr + XBUFSIZ;
        }
    }
    if(nrdbuf < MINNRDBUF)
        nflush = buf flush(); /* record number flushed */
    if(ip) /* was a READ buffer found? */
    {
        buf free(ip + XBUF); /* free it up */
        return bufalloc(); /* and try again */
    }
    else if(!nflush) /* were any write buffers flushed? */
        return bufalloc();
    else
        stop("bufalloc/problems");
}

/*
Buffered block I/O function.
Give device, read/write, desired block, address of data, and ID
of process requesting I/O.
Returns number of bytes transferred.
*/
bufdevio(dev, rwn, blk, addr, proc)
int *dev, rwn, blk, addr, *proc;
{
    int *ip;
    return cbufdevio(dev, rwn, blk, 0, BLKSIZ, addr, proc);
}

/*

```

(continued)

With small caches the reading of most files will displace any block copies that were in the cache before the file was read. This problem can be avoided for copies of directory blocks by having a separate cache for that information. Instead I have developed a more general scheme that responds to frequent demand for any blocks. The key to a better technique is to measure the frequency of access to a block copy and use this information when deciding which copy to displace. The LRU and FIFO algorithms are based on frequency of access, but they are approximations of frequency of access and they break down with small cache sizes. I will describe a simple technique that is more applicable in these situations.

#### ALGORITHM AND IMPLEMENTATION

Figure 1 shows the data structure of the cache used in the listing. The C compiler used to develop the routines is a much-modified version of a public-domain program ("A Small-C Compiler" by Ron Cain, *Dr. Dobbs Journal*, May 1980, page 176), which has been tailored for the 8088/86 processor. It does not recognize structure syntax, so the buffers and their headers are declared as integer arrays in the listing.

Each buffer in the cache has associated information that specifies the block and device from which it has been copied. In addition, flags are included to indicate if the buffer copy has been altered and not yet written to disk. The other parameters, XBFREQ and XBAGE, are used when deciding which copy to displace when the cache is full and a buffer is requested.

Whenever a block copy is found in the cache (a "hit"), the frequency-of-use parameter (XBFREQ) is increased. When a block copy is not in the cache (a "miss") and no buffers are free, the cache is scanned to find the block copy with lowest frequency of use (lowest XBFREQ) and this copy is displaced. If multiple copies with same lowest frequency of use are

(continued)





*Leaders have always recognized good advice...*

## Bring your company's presentation graphics into the computer age with the best recommendation you can make: Hewlett-Packard.



**H**ewlett-Packard's Graphics Plotters introduce *professional-quality* graphs and charts to the office... quality that, quite frankly, makes the competition look stone-age by comparison.

Combine our brilliant color capability, precise line quality, and proven reliability—and HP becomes the obvious choice for your presentation graphics needs. When it comes to plotters, it's easy to see why HP has become the world's Number One recommendation.

### Compare the quality of an HP Plotter...

Before making *your* graphics plotter recommendation, find out how HP stacks up against the competition. Here's a quick checklist:

Are the lines sharp and bold? Do they meet precisely? Are the diagonal lines smooth? Is the text easy to read?

In a chart, is the area fill uniform? With HP, the answer is always yes, yes, and...yes.

Runs with leading PC's and software packages.

HP Graphics Plotters are compatible with most of the personal computers in your office, including IBM, Compaq, and AT&T—as well as a host of HP computers. You even have a choice of many off-the-shelf software packages, such as Lotus 1-2-3™ and Symphony™,\* that give you "first-day" productivity.

Send today for your **FREE** sample plots—and see exactly what we mean.

Return the coupon—or call us toll-free at (800) FOR-HPPC. We'll send you a detailed brochure, a list of available software, plus sample plots from both an HP Graphics Plotter and a leading printer. Don't resort to stone-age methods before seeing the difference an HP Graphics Plotter can make. Call Hewlett-Packard *today*.

\*1-2-3 and Symphony are trademarks of Lotus Development Corporation.

*Leadership in Business Graphics.  
For Leaders in Business.*



**HEWLETT  
PACKARD**

Inquiry 172



1201502

**YES,** I'd like to make the most informed business graphics recommendation I can. Please send me your detailed brochure, plus sample plots so I can see exactly what my company's presentations have been missing. I understand I will receive this information without cost or obligation.

Name \_\_\_\_\_

Title \_\_\_\_\_

Company \_\_\_\_\_

Address \_\_\_\_\_

City \_\_\_\_\_

State \_\_\_\_\_

Zip \_\_\_\_\_

Mail to: Hewlett-Packard, 16399 W. Bernardo Dr.  
San Diego, CA 92127-1899.

Attn: Marketing Communications.

11502 BT9



Buffered character I/O function.

Give: device, read/write, desired block, offset in block at which transfer is to occur, number of bytes to transfer, address of data, and ID of process requesting I/O.

Returns number of bytes transferred.

```

*/
cbufdevio(dev, rwn, blk, offset, nbytes, addr, proc)
int *dev, rwn, blk, offset, nbytes, addr, *proc;
{
    int *ip, *buf, k, c_locn;
    if(traceflg > 2)
        printf("cbufdevio(%d, %d, %d, %d, %d, %d, %d)\n",
            dev, rwn, blk, offset, nbytes, addr, proc);
    if((offset < 0) | (nbytes < 0)) /* check for bad arguments */
        stop("bufdevio negative arg");
    if((offset + nbytes) > BLKSIZ)
        stop("bufdevio request too big");
    if(nbytes == 0)
        return 0;
    devioage++; /* bump access counter */
    if((devioage & 017) == 0) /* i.e., every 16 times called */
        { /* 'decay' all XBFREQ values by one half (rotate) */
            ip = bufpool;
            for(k = 0; k < NBUF; k++)
                if(ip[XBFLGS] & XBFREAD) /* a READ-type buffer */
                    ip[XBFREQ] = ip[XBFREQ] >> 1; /* halve */
        }
    if(ip = findblk(blk, dev)) /* this device block in a buffer? */
        {
            /*
            increase frequency of access count and
            reset time last accessed
            */
            ip[XBFREQ] = ip[XBFREQ] + 128;
            ip[XBAGE] = devioage;
            c_locn = ip + XBUF; /* get address of start of buffer */
            c_locn = c_locn + offset; /* and transfer address */
            if(rwn == RDFN) /* transfer from buffer */
                {
                    movsb(c_locn, SYSDSEG, addr, proc[PRDSEG], nbytes);
                    return nbytes;
                }
            if(rwn == WTFN) /* transfer to buffer and mark as WRITE */
                {
                    movsb(addr, proc[PRDSEG], c_locn, SYSDSEG, nbytes);
                    ip[XBFLGS] = (ip[XBFLGS] & (~XBFREAD)) | XBFWRIT;
                    return nbytes;
                }
        }
    /*
    the device block is not in the pool,
    allocate a buffer and read the block
    and do the requested transfer
    */
    buf = ip = bufalloc();
    ip = ip - XBUF; /* back up to start of buffer header */
    ip[XBDEV] = dev; /* set up header except for flags */
    ip[XBBLK] = blk;
    ip[XBAGE] = devioage;
    ip[XBFREQ] = 0;
    /*
    if a full block is to be written then
    it is not necessary to read the old block
    contents into the buffer

```

(continued)

## Copies that stay in the cache have a better chance of being hits.

found, then the copy that has not been used for the largest amount of time is displaced. This latter decision is made using the XBAGE parameter.

It's obvious that copies that stay in the cache have a better chance of being hits and, therefore, the XBFREQ parameters of these buffers will continue to increase. This parameter is "decayed" over time, otherwise some block copies would become locked into the cache. The method used to perform this decay is to halve the XBFREQ parameter of all buffers after every 16 calls to the buffered input/output (I/O) routine. Both halving and testing for every 16th call are implemented by rotates and masking for speed reasons. To gain better resolution in the selection of which buffer to displace, the XBFREQ parameter of a buffer is increased by 128 with each hit.

If, for other applications, you alter any of these values, then see if overflow of the XBFREQ parameter can occur. This parameter cannot overflow with the given values even if the same block is accessed repeatedly. (The maximum value that XBFREQ can attain is  $16 \cdot 128 + 0.5 \cdot 16 \cdot 128 + 0.5 \cdot 0.5 \cdot 16 \cdot 128 \dots$ , which approaches  $2 \cdot 16 \cdot 128$ , a safe limit.)

The algorithm is best illustrated by an example: With the Tonto operating system, when a file is opened, a directory block will be accessed typically 32 times as the directory entries in that block are scanned. In the worst case, this block would not have been in the cache and would start with XBFREQ zero. After the 32 accesses, XBFREQ would be  $24 \cdot 128$  ( $(16 + 0.5 \cdot 16) \cdot 128$ ) and subsequent file reading will halve XBFREQ for every 16 blocks read from a file. When the

(continued)



# Now! Tek quality and expert advice are just a free phone call away!

**The industry standard in CRT performance.** Crisp, easy-to-read, bright CRT; 14kV accelerating potential, provides high writing rate and small spot size. Full size 8x10 cm display for measurement accuracy.

**Display controls are flexible and easy to use.** Separate intensity controls reduce blooming in alternate sweep mode. Focus tracking minimizes control adjustment and BEAM FIND eliminates confusion.

**Vertical system provides measurement assurance.** Flat transient response and high accuracy ensures true reproduction of your signals. Fast risetime and high bandwidth is well suited for a variety of measurement.

**Perform delayed sweep measurements accurately and easily.** Both sweeps can be displayed alternately making differential measurements easy and accurate (1%). An interlocking SEC/DIV control simplifies set-up.

**Stable hands-off triggering.** P-P AUTO detects signal peaks, then sets the trigger level for you. Display asynchronous signals using VERT MODE triggering. Independent TV field and line selection.

**Front panel laid out by function for ease of use.** Color coding aids the user in operation. Functions and modes are placed logically. All nomenclature is clearly labeled, and protected behind a scratchless Lexan surface.



1-800-426-2200

**Our direct order line gets you the industry's leading price/performance portables... and fast answers from experts!**

The 60 MHz single time base delay 2213A, the 60 MHz dual time base 2215A and the 100 MHz dual time base 2235 offer unprecedented reliability and affordability, plus the industry's first 3-year warranty\* on labor and parts, CRT included.

**The cost: just \$1275 for the 2213A, \$1525 for the 2215A, \$1750 for the 2235.**† Even at these low prices, there's no scrimping on performance. You

have the bandwidth for digital and analog circuits. The sensitivity for low signal measurements. The sweep speeds for fast logic families. And delayed sweep for fast, accurate timing measurements. All scopes are UL Listed and CSA approved.

**You can order, or obtain literature, through the Tek National Marketing Center.** Technical personnel, expert in scope applications, will answer your questions and expedite delivery. Direct orders include comprehensive 3-year warranty\*, operator's

manual, two 10X probes, 15-day return policy and worldwide service backup.

**Order toll free: 1-800-426-2200, Ask for Rick.**

In Oregon, call collect: (503) 627-9000. Or write Tektronix, Inc. P.O. Box 1700 Beaverton, OR 97075

**Tektronix®**  
COMMITTED TO EXCELLENCE



## DISK CACHING

```

*/
if((nbytes == BLKSIZ) & (rwn == WTFN)) /* write full block? */
{
    movsw(addr, proc[PRDSEG], buf, SYSDSEG, BLKSIZ/2);
    ip[XBFLGS] = XBFWRIT; /* mark as WRITE */
    k = BLKSIZ; /* return value */
}
else /* fetch physical block for reading or updating */
{
    if(devio (dev, RDFN, blk, buf, sysproc) == ERROR)
    {
        buffree(buf);
        k = 0;
    }
    else
    {
        ip[XBFLGS] = XBFREAD;
        k = cbufdevio(dev, rwn, blk, offset,
            nbytes, addr, proc);
    }
}
return k;
}
/*
If a device block is in the buffer pool, return
the address of the buffer, else 0.
*/
findblk(blk, dev)
int blk, dev;
{
    register int *ip;
    int k;
    ip = bufpool;
    for(k = 0; k < NBUF ; k++)
    {
        if(ip[XBFLGS]&(XBFREAD | XBFWRIT)) /* a device-block image */
            if(ip[XBBLK] == blk) /* do more rare test first */
                if(ip[XBDEV] == dev)
                    return ip; /* a hit */
        ip = ip + XBUFSIZ;
    }
    return 0; /* a miss */
}
/*
Flush all pending writes in the buffer pool
and convert write status to read.
Return the number of buffers so changed.
Writing of buffers is performed in order to
minimize head movement across the disk.
Sectors on the same track will also be written
in order.
The order is from highest device ID to lowest
and lowest block number to highest.
*/
bufsflush()
{
    int *ip, nwrt;
    nwrt = 0; /* counter of buffers flushed */
    while(ip = buf_w__next()) /* find next in order */
    {
        devio(ip[XBDEV], WTFN, ip[XBBLK], ip + XBUF, sysproc);
        ip[XBFLGS] = (ip[XBFLGS] & (~XBFWRIT)) | XBFREAD;
        nwrt++;
    }
}

```

(continued)

XBFREQ parameter of the directory block falls below 128, that block copy will be displaced in favor of block copies that have been accessed only once (XBFREQ = 128). This will not occur until XBFREQ of the directory block has been halved 5 times, which happens after 80 (5\*16) file blocks have been read. This is a distinct improvement over simpler techniques where the copy of the directory block would be lost after only 18 blocks (9K-byte cache) had been read. If another file is opened before the copy of the directory block has been displaced, then the directory block's XBFREQ parameter will be refreshed. Alternatively, if some file blocks see a lot of accesses (e.g., parts of an editing program's temporary file), then the cache will try to hold onto the copies of these blocks and it will displace the directory block copy.

If, in other applications, the size of the cache is increased, then the cache should respond more slowly to changes in demand and the decay should be decreased. One way to achieve this is to halve the XBFREQ parameters less often (e.g., every 32 or 64 accesses).

Another aspect of this caching system that leads to a dramatic speed improvement is the way altered block copies are written to disk. Many programs are concerned with the reading of one file and the writing of another. The ideal method to maximize speed is to have programs read and write in large chunks. In any multiprocessing system, this solution is inefficient, as all such programs would have large I/O buffers built in and would require more memory to operate. It is more memory-efficient to centralize the buffering in the operating-system cache. (This has the added benefit that all processes "see" the same disk image; this would not be true if each process had a separate buffer.) In the caching system described in this article, writing or "flushing" occurs when a buffer is requested and the number of altered buffers is found to exceed a predetermined threshold. (It is also good practice to flush the cache

(continued)



# DECLARE YOUR DATA INDEPENDENCE.

THE NEW STANDARD OF  
MODERN OFFICE DATA STORAGE.



Free yourself  
from the limi-  
tations of

shared and finite hard disk storage. Your dynamic and expanding business data needs demand a more versatile way to deal with critical information.

The Bernoulli Box,<sup>™</sup> with its totally interchangeable 5- and 10-megabyte cartridges, lets you manage data the way you manage your business—directly, efficiently, by job function and application. You create, update, store, and back up

software and data bases on individual cartridges. You expand your capacity infinitely, by adding more cartridges, not more disk drives. You enjoy the convenience of taking or mailing cartridges anywhere—and the security of putting them under lock and key.

The Bernoulli Box works with the IBM PC, XT, AT, most compatibles, and the Macintosh.<sup>™</sup> For your nearest dealer, call 1-800-556-1234 ext. 215. In California, call 1-800-441-2345 ext. 215.



**Ω-MEGA**

ΩMEGA Corporation  
1821 West 4000 South  
Roy, Utah 84067

# BERNOULLI BOX<sup>™</sup>



```

    }
    return  nwrt; /* number of buffers written */
}
/*
Scan the buffer pool for buffers marked as WRITE
and return the address of the one with greatest device ID
and lowest block number. If none found, return 0.
*/
buf_w_next()
{
    register int    *ip, k;
    int             *devmax, blkmin, rval;
    devmax = 0;      /* a small, impossible, ID number */
    blkmin = 32767;  /* the biggest block number */
    rval = 0;        /* default return value */
    ip = bufpool;
    for(k = 0; k < NBUF; k++)
        {
            if(ip[XBFLGS] & XBFWRIT) /* a WRITE buffer ? */
                {
                    if(devmax < ip[XBDEV]) /* larger device ID? */
                        {
                            devmax = ip[XBDEV];
                            blkmin = ip[XBBLK];
                            rval = ip; /* save it */
                        }
                    else /* same device, smaller block number? */
                        if(devmax == ip[XBDEV])
                            if(blkmin > ip[XBBLK])
                                {
                                    blkmin = ip[XBBLK];
                                    rval = ip;
                                }
                }
            ip = ip + XBUFSIZ;
        }
    return  rval; /* zero or ptr to next block/dev buffer */
}

```

```

struct xbuf /* a cache buffer */
{
    int    xbflgs; /* buffer flags */
    int    xbdev; /* device block of which the buffer is a copy */
    int    xblk;
    int    xbfreq; /* parameter for frequency of use algorithm */
    int    xbage; /* parameter for LRU algorithm */
    char   buf[BLKSIZ]; /* buffer proper */
}
bufpool[NBUF]; /* the cache of 'NBUF' buffers */

```

Figure 1: Structure of the cache area.

periodically.) The cache is scanned and all altered buffers are written in order from lowest block number to highest. This minimizes head movement of the disk drive—a slow operation. To the disk drive it appears as if the operating system is reading

large chunks from some files and writing large chunks to others, the idealized arrangement mentioned earlier.

There is a penalty when writing in this manner: Disk-write errors can occur long after a program has per-

formed the write request. The disk-driver function `devio` goes to extremes in the correction of write errors but for other applications this may not be possible, and thus only block-read caching would be appropriate.

The listing should be largely self-explanatory except for three external functions. One is `movsb`; this is a call to a machine-language function that transfers a number of bytes from one address and segment (8088/86) to another address and segment. A second function is `devio`; it transfers a block to/from a floppy-disk device from/to a given address and segment. The passed-process descriptor is used to determine the transfer segment as for the `movsb` function. All of the process/segment parameters and even the `movsb` function could be eliminated when using these routines in many applications. A third function is `stop`; an error message is passed to it and it prints this message before halting.

## CONCLUSION

This caching algorithm has proven successful on a small multiprocessing operating system. It can be applied when caching is desirable and memory space is at a minimum, such as intelligent line buffering within editors and record buffering in database managers.

The routines help to illustrate a general point that has been made by many authors: The use of a high-level language enables the easy development of fast algorithms, often producing an end product that has equal, if not better, performance than routines written in assembly language.

The full source code of the Tonto operating system (over 100K bytes) and various utilities (over 200K bytes) including file-system checker and file-system debugger are available in bootable IBM Personal Computer (PC) or Sanyo MBC 55X form (three double-sided double-density floppy disks) for \$60. For further information, write to Brian McKeon, 1-18 Manion Ave., Rose Bay, Sydney, Australia. ■





# THE WORLD OF PC UPGRADES

## PC HARD DISKS

- |       |   |
|-------|---|
| IS10  | 10 Mbyte Hard Disk with Controller      |
| IS10R | 10 Mbyte Removable Hard Disk/Controller |
| IS20  | 20 Mbyte Hard Disk with Controller      |
| IS30  | 30 Mbyte Hard Disk with Controller      |

*All the above available for the Tandy 1000*

## TAPE BACKUP

- |      |  |
|------|--|
| MT10 | 10 Mbyte Micro Tape Backup "works like a floppy" |
| MT45 | 45 Mbyte Streaming Tape Backup                   |

## AT HARD DISKS

- |       |                     |
|-------|---------------------|
| AT20  | 20 Mbyte Hard Disk  |
| AT33  | 33 Mbyte Hard Disk  |
| AT120 | 120 Mbyte Hard Disk |

## SPECIAL SOFTWARE

- |                |   |
|----------------|---|
| COMMAND/ASSIST | DOS MANUAL ON DISK  |
| CACHE/ASSIST   | SPEED UP DISK ACCESS  |
| FREE/ASSIST    | *FREE SOFTWARE WITH ANY PC HARD DISK<br>(COMES ON YOUR HARD DISK) |

## AND OTHER PC ACCESSORIES

- |      |                      |
|------|----------------------|
| FS20 | FILE SERVER NETWORK: |
|------|----------------------|

- \$ 525
- \$ 1295
- \$ 625
- \$ 995

- \$ 425
- \$ 1195

- \$ 695
- \$ 995
- CALL

- \$49.95
- \$49.95
- FREE

CALL

"WITH THE PURCHASE OF ANY PC HARD DISK"

**\*FREE**

**SOFTWARE  
5 MEGA BYTES**

### PROGRAMS INCLUDE:

- 100 GENERAL PURPOSE
- 100 DATA BASE II
- 20 PASCAL PROGRAMS
- 80 "C" PROGRAMS
- ACCOUNTING PACKAGES
- FINANCIAL PROGRAMS
- WORD PROCESSOR
- VT100 EMULATOR
- AND FOR CHILDREN:**
- 90 GAMES
- I.Q. BUILDER
- WORD PROCESSING
- MATH

— AND —  
**MUCH, MUCH MORE**

ORDER LINE  
OUTSIDE FLORIDA

# 1-800-228-0891

1 YEAR WARRANTY, 30 DAY MONEY BACK GUARANTEE ON ALL OUR PRODUCTS

VISA  
MASTERCARD

## Micro Design International Inc.

6566 University Boulevard, Winter Park, Florida 32792 (305) 677-8333 TELEX 3382559 MDII OAL UD

Inquiry 241

IBM is a Registered Trademark





# Now you can build the Enhanced IBM PC-AT that IBM didn't.



## Internal medicine.

Begin with the readily available PC-AT basic model. Simply open the cabinet, plug in the RAM chips, slide the drive into place, and plug in the data cables. The result is a superior IBM PC-AT Enhanced Model. Even track access times are up to 30% faster. Everything is supplied. The cable, the AT mounting rails, the 256KB (150NS) Memory Chips and of course, CORE's high-performance INTERNAL hard disk subsystem.

## Homing heads always head for home.

Unlike the IBM/CMI AT drive and most others, our drive heads ALWAYS seek their dedicated landing-zone. They automatically go there and lock each time you shut off the computer. No more worry about the risk of head crashes and lost data. The CORE/CDC Drive parks and locks. Every time. And without calling special utilities.

## The shocking truth.

Most other drives can't meet our tough specifications. We allow only one bad sector per megabyte for our recording media. This means our recording surfaces are 99.95% error-free or better. The CORE/CDC Hard Disk Drive is fully shock-mounted, the kind you would specify if you were building a PORTABLE computer. We think your data deserves a smoother road to success.

**CORE**  
INTERNATIONAL

**GD**  
CONTROL  
DATA

# ATplus

Up to 144 MB inside the box.

The CORE/CDC ATplus Upgrade offers not ONE, but FIVE high performance internal hard disk drives for the AT . . . immediately available in 20, 30, 40, 56, and 72 megabyte capacities. Mix or match, the AT actually has space for ANOTHER CORE/CDC drive. So capacity can be as much as 144 MB of internal on-line hard disk storage. Not just the 41.2 MB IBM says you can have, but from 20 to 144 MB all INSIDE THE BOX. Best of all, these drives are 100% hardware and DOS compatible. And they're so reliable, your purchase is backed by a comprehensive parts and labor warranty, for one full year.

**Accept no substitutes.  
Because there aren't any.**

CORE/CDC hard disk drives are manufactured specially for CORE by Control Data Corporation. The ATplus Upgrade Kits are available exclusively from CORE INTERNATIONAL. Authorized IBM Dealers, VADs, VARs, and independent dealers are invited to contact CORE directly. End-users should see their local dealers.

542 S.E. 5th Avenue • Delray Beach, Florida 33444 • 305/276-3929

© CORE INTERNATIONAL, INC. 1985

Inquiry 92



# ASTROPHYSICAL NUMBER CRUNCHING

*My experiences with  
a progression of  
"personal" computers  
across the years*

I have used personal computers to do number crunching for my work in theoretical astrophysics for rather a long time. It is only in recent years that I have used the term "personal computers" to describe the machines I used, but they had many of the attributes of personal computers. The principal difference was that the earlier machines were not dedicated to only one user. However, in general, only one or two people could use one of these machines at any one time.

## THE FIFTIES

In the early days of computing you didn't have the option of using a computer like today's mainframes because such machines did not exist. In the middle and late 1950s, I was working at the Canadian Atomic Energy Project at Chalk River, Ontario. We started using the IBM 602A accounting machines for calculations. These were mechanical devices with relays, counters, and registers; they used a plugboard in which you inserted wires to direct the operations to be per-

formed on the cards passing through the machine—at a rate of about six cards per minute. One of my colleagues converted these machines into card-programmed calculators by placing germanium diodes in the wires. The machines then read their instructions from the cards themselves. I would do calculations with several trays of cards. Apart from very limited storage space, the principal difficulty was the lack of any IF . . . THEN . . . ELSE capability.

Nevertheless, we did useful work. I remember exploring the properties of helium thermonuclear reactions at that time. At a somewhat advanced stage in the evolution of a star, the helium in the interior burns into carbon, oxygen, and small amounts of

neon. This gives three simple but nonlinear differential equations to be integrated simultaneously. I did these on the computer for a variety of cases that spanned the range of uncertainties in the parameters' values.

In 1958 we got a Datatron 205, one of the new "small" computers that came out at that time; it was similar to, but better than, the IBM 650, which was then popular. The Datatron 205 was an electronic-tube machine

*(continued)*

A. G. W. Cameron (Harvard College Observatory, 60 Garden St., Cambridge, MA 02138) is a professor of astronomy at Harvard University and a member of the Harvard-Smithsonian Center for Astrophysics. He received his Ph.D. from the University of Saskatchewan in Canada.





*For the first year we had the Datatron 205, not very many people knew what to do with the computer.*

with 4000 words of storage on a rotating mechanical drum; its speed was similar to that of a modern micro-computer using interpreted BASIC. You programmed it in machine code, which wasn't too bad because everything was in decimal. It was a one-user-at-a-time machine, and you debugged your programs at the console, using absolute addresses. It was substantially interactive, since you could pause it at any time to examine the contents of any address locations and output that information on an attached printer.

For the first year we had it, not very many people knew what to do with the computer, so I had it to myself many nights and most weekends. I would come in to check on things on Saturday and Sunday, and if the machine was down I could generally get it back up with a kick or by swapping out an electronic-tube module that showed an invalid combination of lights. In 1959 I went away for a year, and when I came back everything had changed. People then knew what to do with computers, and it was very hard to get substantial access time.

The first year we had the Datatron 205 was incredibly productive for me scientifically. I explored the stages of nuclear burning beyond the helium stage (carbon, oxygen, neon, magnesium, and silicon burning) in the interior of a massive star. This involved the simultaneous integration of substantial numbers of differential equations for large numbers of nuclear species, as the temperature in the stellar interior rose and new sources of thermonuclear reactions became active. By numerical integra-

tion I evaluated the rates of those nuclear reactions that take place under conditions of very high density rather than high temperature—pynuclear reactions.

I also began experimenting with models of neutron stars; this involved integrating two simultaneous differential equations of stellar structure with an auxiliary equation for the relation between pressure and density—the equation of state. This work thoroughly convinced me of the advantages of an interactive computing environment where you can see what's going on as your calculation progresses.

**THE SIXTIES**

During the next period of my life I did relatively little computing, and none of it "personal." This was the era of the mainframe with its accompanying crew of "high priests." I was at the NASA Goddard Institute for Space Studies in New York. At first we had an IBM 7094, and later an IBM 360/95. All our computing was batch processing using FORTRAN. I found this environment so "unfriendly"—a term not used at the time—that I preferred to accomplish my projects through the students and postdoctoral research associates who were working with me.

**THE EARLY SEVENTIES**

In 1973 I came to Harvard University. The Center for Astrophysics was being established at this time to coordinate the research activities of the Harvard College Observatory and the Smithsonian Astrophysical Observatory. Our computing was still in batch mode on a CDC (Control Data Corporation) 6400 mainframe, which was located about a mile away from us. But the era of the small computer was at hand. I obtained a Hewlett-Packard 9830 programmable desktop calculator with an attached 5-megabyte hard disk. I have often wondered why histories of personal computing ignore this machine and others like it. It used interpreted BASIC in ROM (read-only memory) and had 16K bytes of available user memory.

Shades of the old Datatron 205—but better—and all to myself! It was quite a while before the better-known hobby machines, starting with the Altair, could match the capabilities of the HP 9830.

By this time, using computers in theoretical astrophysics was commonplace. My interests had shifted into investigations about the origin of the solar system. This is a complicated interdisciplinary subject dealing with a complex physical and chemical scenario, and much of the work in it involves computational simulations of system structures and their evolution across time. These systems include the sun and planetary bodies and the hypothetical solar nebula from which we believe they were formed.

The following are among the problems I remember working on with the HP 9830:

- A series of Monte Carlo calculations of collisions between small solid particles (originally interstellar grains). The purpose was to see how the particle sizes vary due to coagulation and disruption during the collisions. This involves storing the abundance (amount of material present) of particles of a given size in bins and moving those abundances between the bins as particles grow or are shattered.
- Calculations of the periods of radial and nonradial oscillations of hot-white dwarf stars. For a star of given mass and for a given class of oscillations, the frequency of oscillation must be varied in small steps so that you can determine when the center and surface boundary conditions of the oscillations are satisfied. For the nonradial oscillations this involves the simultaneous solution of five differential equations.
- The structure and evolution of the primitive solar nebula. In this problem you must determine the structure in the radial direction (along the radius) and, for each of a series of radial steps, in the vertical direction. Mass, angular momentum, and energy are transported in the radial direction as

*(continued)*



For those of you that mistook me for Bill Gates from Microsoft, let me clarify things. I'm Dave Carlin of PS Computers in Palm Springs, California. The differences are pretty basic. Bill reads the Wall Street Journal, wears glasses and writes great software. I read USA Today, wear soft contacts and build great hardware.

Now that you know who I am, or at least who I am not, let's get to the point.

**Problem.** Since I got into computers two years ago they have been a constant source of fascination and frustration.

Fascination due to the immense power and control that the personal computer has allowed me over my daily business activities; frustration due to the hundreds of hours I've spent making hardware and software cooperate with one another.

No doubt about it, once you get all the pieces put together correctly you have at your command an incredible tool. There is absolutely no limit to the number and type of tasks that you can accomplish with greater speed, better accuracy and stronger impact; all with far less effort. The trade off however has been the time, energy and uncertainty involved in finding the best buy on the right equipment, then getting all the parts to function as one.

Because I have personally gone through hours of long distance phone calls to hardware manufacturers and waited days for call backs that never happened. Because I have found myself so many times in front of a screen filled with meaningless greek characters at 2 AM unable to get the computer to print a simple business letter. Because I would not wish this type of agony on anyone. This is why I have put together the PS Turbo 640.

**Solution.** What happened was... a few months ago I discovered a source of computer mother boards that run IBM type software faster than the IBM PC. They're a genuine product of Taiwan and they are beautiful. I bought cases, keyboards, cables and disk drives; built the Turbo 640 and put it to work. Right now I have three PS Turbo 640s linked as a network running Dbase III and Lotus day in and day out in my business. The PS Turbo 640 works, it works well and it works faster than the IBM PC.

An oral surgeon friend saw my network and asked me to build one up for him. One of the Turbo 640's on the network is in his operating. It runs a program I wrote in Turbo Pascal for his anesthesia records - not a single glitch. (The 640 seems totally immune to the effects of Nitrous Oxide.)

**More than compatible.** Though I have a private pilot's license and quite a few hours flying high performance aircraft, I've never taken the time to learn to use the Flight Simulator program from Microsoft. Some of my friends have and it runs beautifully on the 640.

The phrase "IBM compatibility" is an understatement with my computers; the PS Turbo 640 is just flat out a better machine.

Peter Norton publishes a program that rates computers as to speed and compatibility with the IBM PC. In the normal mode of operation the PS Turbo 640 rates a 1.0 which indicates a 1 to 1 equivalency. In the high speed mode (selected with two keystrokes, no switches or rebooting) the 640 scores a 1.4; that's 40% faster than an IBM PC.

**The specs.** 640 K of memory (the maximum contiguous memory that the PC can address - and they're all 150 nanosecond chips). A keyboard that is very similar to the Key Tronic KB5151 (yes all the horror stories about the keyboards that come stock with IBM PCs are true). Two serial ports, a parallel printer port and a game port (you can't beat that). Battery powered clock (keeps track of the time and date while the computer is off). A video card that gives you crisp monochrome text and also displays color/graphic software on a monochrome monitor as sixteen shades of grey (amber). An amber monitor (very chic). Two 360 K disk drives (AKA Half Height DSDD). Two front panel LEDs (one to indicate that you left the computer on from the night before [it's ok, that doesn't hurt it] and the other to tell you if the processor is in the high speed mode or just going IBM speed). Eight expansion slots (two are used by the multifunction card and monitor card, four full sized and two short slots are available) Five available ROM sockets and two buss connection points (load programs stored on your own ROMs). 135 watt power supply (ready for upgrading to a hard disk). User's book and complete technical information (the user's part is easy - the tech part is very technical).

A computer without software is basically a solid state boat anchor and a rather poor one at that. When you buy the Turbo 640 I want you to be able to start using it the moment you take it out of the box.

**All this and software too.** First there's PC DOS 2.10. DOS is the program that brings the computer to life. Typically some version of it is run on all IBM PCs prior to running application programs. "And it came to pass that this was called booting the computer". I'm not crazy about the term, but everyone does it. The full DOS manual is included.

There is complete software for the multifunction card that allows you to partition the 640's memory into RAM disks and a printer buffer.

Perhaps you've heard about Sidekick from Philippe Kahn at Borand. InfoWorld voted it the Software Product of the Year. Well it's good code but I'm not including it with the Turbo 640. What I am including is a product that I like better, has essentially the same functions but in my opinion is easier to use - PopUps from Bellsoft. Regardless of how deep into your spreadsheet, database or master's thesis (revisions) you might be, two key strokes will put a notepad, calculator or any of 5 other utilities on your screen. Make notes, perform calculations, set an alarm, check your calendar or perform DOS functions. When you're finished just hit the escape key; the PopUps disappear from the screen and you're back into your program. This is the PopUp Deskset from Bellsoft, it's potent software and it's part of the PS Turbo 640 system.

**Don't wait.** If you're ready for this kind of computing then the PS Turbo 640 is the machine you need. Call me with your American Express Card account number or mail me a cashier's check. I will personally see to it that a Turbo 640 is shipped to you via UPS the next business day. Open the box, plug the monitor and the keyboard into the computer then plug the computer into the wall socket. Turn the computer and monitor on, stick in any software designed to run on the IBM PC and go to work. No chips to put in backwards, no little multicolored wires to push onto the wrong connector and no switches to set.

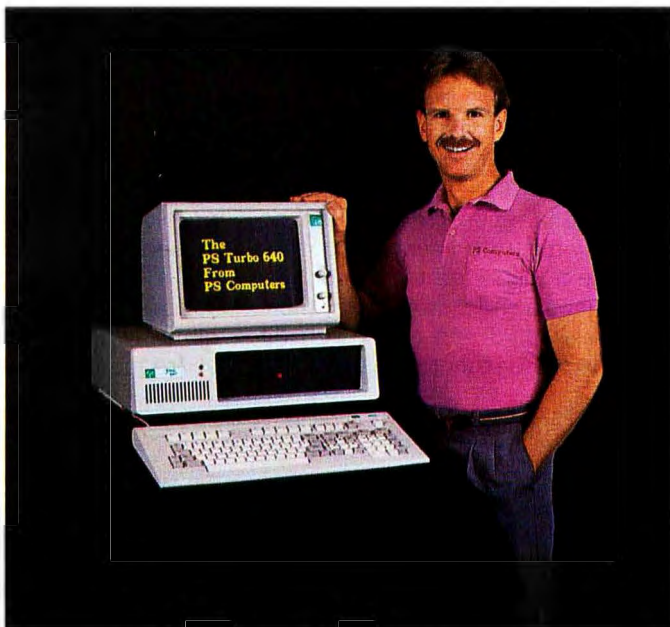

**Money back.** If the PS Turbo 640 doesn't perform like I've said then return it to me. Just put one copy of your invoice in the box and send it back. I will make sure that credit is issued on your credit card or a cashier's check is mailed out to you, the same business day that we receive the unit.

I've told you quite a bit about what you get when you buy the Turbo 640; now let me tell about something you won't get. You won't get up on hold if you have occasion to call the technical support division number. That's because there isn't a technical support number. Once the machine is on it looks like, acts like and runs like a properly configured IBM PC, just a little faster.

This is the part where I have to get a little tough. I've sold you what I feel is the ideal configuration of an IBM type PC. You have gotten the absolute best buy for your money on earth. I can not however, learn how to use it for you. Follow the directions in the book, remember that no matter how much you pay for your software it's probably not perfect, and most of all don't give up - whatever time it takes to get proficient at your particular software application will ultimately be all worthwhile.

If you have questions concerning operation (that aren't answered by the manual), you have three options:

One, write me a card or letter. All correspondence is answered the same day as received via MCI Mail. Two, sign onto the PS Computer 24 hour bulletin board, post your message and then sign on later for the answer. (admittedly hard to do if you didn't decide to get a modem or the computer I sold you broke [see option one]) Or three, find out where I live (probably the least convenient for both of us).

**Warranty.** The warranty on the Turbo 640 is simple. If anything goes wrong in the first six months, send it back. The unit will be repaired and shipped back to you two days after we receive it. After six months? Same thing, small charge.

**Placing your order.** The 800 number puts you in touch with an operator here at PS Computers whose function is to take the necessary information, quickly and accurately, period. I've given you the highlights of the system in this ad. If you need to know more about specific features drop me a line. Sure it seems like it might be a bit more trouble than calling; but you won't be reaching a busy signal and your answer will be in writing.

You have my word that the PS Turbo 640 has been accurately represented on this page and is in fact the absolute best buy for your dollars. If for any reason you don't like the 640 then you also have my word that upon our receiving the system, those dollars will be returned to you, immediately.

**Safe bet.** If you want to know for sure if the 640 is the computer for you, buy it. The local book is 100 to one that after you use the PS Turbo 640, you'll never part with it.

**PS Turbo 640 System**  
**\$1,700**

**PS Turbo 640 System**  
**with 10 Meg Internal Hard Disk**  
**\$2,200**



The (really) fine print. Flight Simulator is a trademark of Microsoft Corporation. Lotus is a trademark of Lotus Development Corporation. Dbase III is a trademark of Ashton-Tate. Turbo Pascal and Sidekick are trademarks of Borland International. The PopUp series of software are trademarks of Bellsoft. Key Tronic Corporation is the manufacturer of the KB 5151 keyboard; our keyboard is similar but is manufactured abroad. IBM is a trademark of a company called International Business Machines. InfoWorld, The Wall Street Journal and USA Today are nationally distributed publications.



## PS Computers

200 W. San Rafael Road  
Palm Springs, CA 92262

Canada & Export Line  
619-325-4856

Modem Line 300/1200  
619-323-4962

National Order Line  
800-654-7650

California Order Line  
800-231-8701

Inquiry 302



a result of friction due to turbulent viscosity in the nebula, and, depending on the rates of these transport phenomena, energy dissipation occurs in which the energy deposited must be transported to the surfaces of the nebula and radiated away there. We ran a half-dozen cases with different input parameter values.

The last problem took more than half a year to run. I developed a technique for starting and stopping a problem. The HP 9830 had an attached thermal printer, so that I could get a printout of the run status at various intervals; the current values of all the variables were stored to disk at frequent intervals also. Thus, if a

problem stopped, either by a deliberate action or by a power failure or whatever, it was a simple matter to restart it from the last disk-storage event. In fact, a problem's initial conditions were usually stored in an appropriate disk file where the main program could read them as it began.

**THE LATE SEVENTIES**

Nevertheless, the third problem ran along interminably; we needed a much faster machine—a minicomputer. In 1976 we upgraded to a Data General Nova 3/D computer. In its final configuration the Nova 3/D had 256K bytes of memory and ran a decent version of a FORTRAN compiler. It supported up to two users, each using one "ground" (foreground or background). After excluding the operating system, each user had an average of 110K bytes of RAM (random-access read/write memory) using memory-mapping techniques. This was not quite as "personal" as some of the other machines I used.

Later we added a Data General Nova 4/X computer. Dual ports connected both of these computers to two hard disks. By this time, the Center for Astrophysics was running a Digital Equipment Corporation VAX-11/780. Our benchmarks showed the Nova 3/D to run a number-crunching problem typically at 25 percent of VAX speed and the Nova 4/X at 45 percent, each running with only one ground. When both grounds were active, a given ground ran more slowly, but the total throughput was about 50 percent higher.

Our work was supported by government grants. On a given grant the best you could expect to have approved was a few thousand dollars—at the most about \$10,000—for computing time to be purchased from the central university computer. I have always felt that I can get much more computing per dollar by using small machines like personal computers; therefore, if I have to put up with certain inconveniences in order to do so, I will. For example, note from the speeds outlined above that if all four

(continued)



**Sweet deals on memory and logic programmers**

Stand-alone, intelligent RS-232 units compatible with most computers or terminals; minimal or no interfacing

**PROMPRO-8™**...Programs virtually all +5V EPROMs, single-chip micros, and emulates EPROMs. ONLY \$689.00 (128K RAM version)

**GANGPRO-8™**...Programs 8 EE/EPROMs at once (supports most EPROMs.) ONLY \$995.00

**UV ERASERS** ...Start at \$49.95, and \$97.50 for timer versions. Production model \$149.95 **AND MORE!** ...Call for more info on PALPRO, SHOOTER, PP7, XP, and required options. Detailed literature and spec sheets available. IBM PC, Apple and other popular PCs support.

PAL is a registered trademark of MMI.

**TOLL-FREE 1-800-EE1-PROM**

**It's only Logical.**

**LOGICAL DEVICES, INC.**

1321 N.W. 65th Place • Fort Lauderdale, FL 33309 • (305) 974-0967 • TELEX: 383142





# OEM & OWN BRAND COMPOSITE & TTL COMPATIBLE COLOR & MONO MONITOR TERMINAL



TERMINAL; SD-M1201

SM-12SF 31A6; APPLE COMPATIBLE  
SM-12SF 39A7; IBM COMPATIBLE



OEM BRAND; SM-12CL 31A1



SM-CL401 SNS; 8 COLORS  
SM-C1402 SNS; 16 COLORS  
IBM COMPATIBLE



#### SEOUL OFFICE

6~8TH FL, THE JOONG-ANG DAILY  
NEWS BLDG., 7 SOONHWA-DONG,  
CHUNG-KU, SEOUL, KOREA  
TEL: 7516-955/7, 7516-959/961  
TLX: STARNEC K22596  
CABLE: "STARNEC" SEOUL  
TEL

#### LONDON OFFICE

6TH FLOOR, VICTORIA HOUSE  
SOUTHAMPTON ROW W.C.  
1 LONDON, ENGLAND  
TEL: (01) 831-6951/5  
TLX: 264606 STARS LG  
FAX: (01) 430-0096

#### SANTA CLARA OFFICE

3003 BUNKER HILL LANE,  
SUITE 201 SANTA CLARA,  
CAL. 95050, U.S.A.  
TEL: (408) 986-8473  
TLX: 171685 SAMSUNG SNTA

#### TOKYO OFFICE

KASUMIGASEKI BLDG., 2522  
KASUMIGASEKI 3-2-5 CHIYOTA-KU  
TOKYO, JAPAN  
TEL: (03) 581-5804, (03) 581-9521-4  
TLX: 228009 SANSEI



grounds are used very efficiently, we can get a throughput comparable to that of our central VAX. The computing budget for our central computing facility a few years ago, when these comparisons were made, was about \$600,000 per year and often more. This was financed by user charges. Thus, we could claim that we

had the potential of doing the equivalent of \$600,000 worth of computing per year. In fact, we were rarely that efficient. It is probably closer to the truth to say that we got about \$200,000 to \$300,000 worth of computing per year at a real cost equal to a tiny fraction of this. (Many other installations have operated their

VAXes at much lower costs. Often they do not include depreciation of the original purchase in the running charges and use few if any hired operations personnel.)

The Novas were 16-bit machines, and the techniques of using memory mapping were anything but transparent to the user. Fortunately, the operating system was not included in user address space, but code and data did have to fit into 64K bytes. There were various ways of doing this for a large program. You could divide the code into overlays and explicitly load each overlay segment as needed; often the overlay scheme became very complicated. You could keep the data in extended, or virtual, memory and access it by moving a window around via calls to special FORTRAN subroutines and functions. You could write (or read) the entire virtual memory to (or from) disk. We quickly learned the value of making programs restartable in case someone or something crashed the system.

Despite these inconveniences, we did a lot of sophisticated programming. The following are some of the major programs we ran on the Novas:

- Neutron-capture nucleosynthesis on a rapid time scale. We investigated whether this process, which takes place somewhere in stellar systems, could be taking place through the production of neutrons by helium thermonuclear reactions, either in the helium zones of supernova explosions or deep in the helium cores of stars in an advanced stage of evolution. Our conclusion was that it was not. We needed to solve a very large number of differential equations simultaneously, since nuclear transformations interconnect more than 6000 nuclear species, and we had to evolve their abundances forward in time.
- Stellar evolution. Here a stellar model is divided into concentric spherical zones, and the four simultaneous differential equations of stellar structure are rewritten as difference equations applied to the zone boundaries. In effect, this produces

(continued)

## OUR CUSTOMERS HAVE COME FORTH...



SEE US AT  
7th ANNUAL FORTH  
CONVENTION  
SEPT. 20-21, 1985  
PALO ALTO, CALIFORNIA

## BUT THEY STILL WON'T TALK!

Software developers throughout the world have discovered FORTH, and are happy they did. Unfortunately, they're not spreading the word. Fortunately, we know why they won't talk. polyFORTH® from FORTH, Inc. has become their competitive edge—their secret weapon.

polyFORTH is more than a programming language. It is a fully integrated software environment that supports multi-tasking and multiple users for real-time applications. The system maximizes the programmer's efficiency and uses available hardware in the most effective way. The results are shortened program development times, and in turn, achievable product development deadlines.

polyFORTH products are available as high-performance native systems for the IBM-PC,-XT and AT; the Intel 8086/8088 SBC's; the DEC PDP-11 and LSI-11; the Motorola 6809 EXORset and

68000; and the RCA 1802 and 1805. Availability also includes OS-resident systems like MS-DOS, RSX/VMS, CP/M-80, and CP/M-86.

Our customers make polyFORTH the "language of choice" for such diverse real-time uses as process control, robotics, manufacturing control, image processing, data acquisition and analysis, plus scientific and medical instrumentation.

Discover polyFORTH and its unique approach to real-time applications. Let yourself in on the big secret. The secret that will help you maintain that competitive edge. Your secret has come . . . FORTH. It's polyFORTH from FORTH, Inc.

**FORTH, Inc.**   
2309 Pacific Coast Highway  
Hermosa Beach, California 90254  
(213) 372-8493 • TELEX (RCA)275182



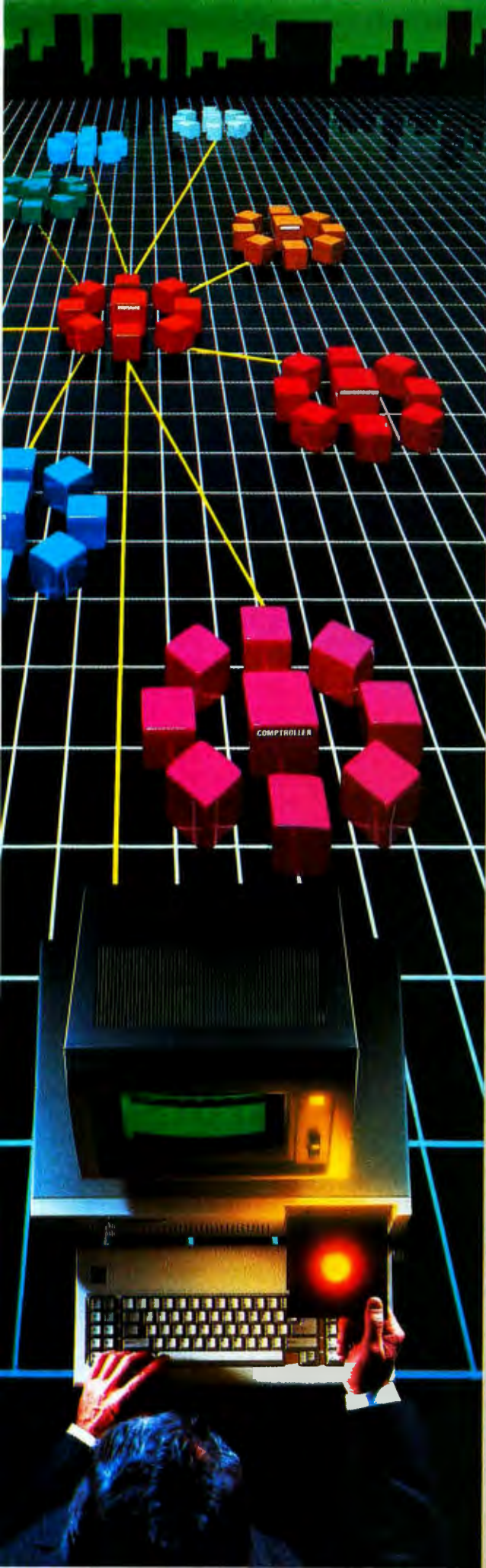

# We've Put a Local Area Network on a Disk

Corporate Information Sharing. It's been described as the key to increasing a company's productivity. It's also why large networks of PC's are becoming more and more common in the workplace...in spite of the fact that they're costly, difficult to install, and incompatible with much existing software.

Finally, there's a solution to this corporate dilemma. Its name is LANLink™

**A Software-Driven LAN That Uses Standard, RS-232 Ports.** A major breakthrough in local area networks, LANLink™ uses your computers' existing serial ports and runs under PC-DOS.

Because all of the intelligence the network requires is on the server and satellite diskettes, expensive network interface boards aren't required.

**A Powerful Network That's Cost-Conscious.** If you've been pricing board-driven LAN's, you already know that they can cost over \$1,000 per workstation.

LANLink™ is different.

Boasting a data transfer rate in excess of 100,000 BPS, LANLink™ is compatible with a wide range of programs. And because special boards aren't required, installation costs are one-third that of a traditional network.

**A Network Designed the Way Business Works.** With LANLink™ you're able to customize your network along departmental lines using a data-sharing hierarchy and password-protected access.

**Get Started With LANLink™ TODAY.** Call The Software Link TODAY for complete details and the authorized dealer nearest you. The LANLink™ Starter Kit, priced at \$495, comes complete with network software for both a server and a satellite computer. For a limited time, 50 feet of RS-232 cable will be included free of charge.

LANLink™ is immediately available and comes with a money-back guarantee. VISA, MC, AMEX accepted.

# LANLink™



THE SOFTWARE LINK, INC.

Developers of MultiLink™ and MultiLink Advanced™

8601 Dunwoody Place, Suite 632, Atlanta, GA 30338 Telex 4996147 SWLINK

CALL: 404/998-0700

Dealer Inquiries Invited

THE SOFTWARE LINK, INC./CANADA

400 Esna Park Drive, Suite 18, Toronto (Markham), Ont. L3R 3K2 CALL: 416/477-5480

MultiLink, MultiLink Advanced & LANLink are trademarks of The Software Link, Inc. PC-DOS is a trademark of IBM Corp.



four such equations per zone; we could handle up to 200 zones. We obtained a satisfactory solution for a stellar model by iterating changes in the conditions at the zone boundaries and computing additional models as the star evolved in time. If we had used realistic input for the physical quantities in this problem, the time required to compute, for example, the equation of state or the radiative opacity literally millions of times would have been too demanding. So we put these quantities into two tables on disk, each some 5 megabytes long, and read the records into windows in memory so we could interpolate it. We also ran a similar kind of program to study the evolution of giant gaseous planets.

- Astrophysical hydrodynamics. The stellar-evolution program just described is an example of hydrostatics; when velocities and accelerations in the system become important, then we have hydrodynamics. The hydrodynamics of a spherically symmetric case are similar to those of stellar evolution, except that the differential equations have more terms. (We have studied stellar oscillations this way.) However, we have run problems in cylindrical geometry that are somewhat more demanding. In such a problem conditions along the cylindrical axis differ from those perpendicular to that axis, so that you must set up a mesh of points representing a grid laid out along the axis and representing concentric circles in planes perpendicular to that axis. In a typical case we used a mesh of 32 by 64—a total of 2048 mesh points. Again, you must solve differential equations at each of the mesh points. We typically used this code to study the flow of gas past a star, as when a supernova goes off in a binary system or a star is immersed in a dense gas cloud in a galactic center. We have also used a different kind of hydrodynamic representation more suited to intrinsically three-dimensional motions. Here the available space is divided into cells, and the motions of test particles are followed through these cells (hence, this method is called the

"particle-in-cell" method).

- Structure and evolution of the primitive solar nebula. This is essentially the same problem I described earlier, but with the Data General Novas we could do it with improved physics and in much greater detail.

### THE EARLY EIGHTIES

With programs like these running, frequently for weeks on end, and with demands on the Novas for word processing, graphics, and other program development, it had become difficult to get computing time by 1982. At that time Data General modified the operating system for the Novas to allow RAM to be expanded to 512K bytes. Although we would clearly have benefited by adding the extra memory, I decided not to. That marked the beginning of our transition to microcomputers. The memory addition for the Nova 3/D would have cost \$3000, and for the Nova 4/X, \$5000. But 256K bytes of microcomputer memory cost only a small fraction of those amounts at that time. (Today it would cost less than \$100.) For a price comparable to either of these memory additions, I could buy an entire microcomputer. So I started in that direction, first with Otrona Attaches running CP/M.

We did not intend to use the microcomputers for serious number crunching at that time, but rather to off-load non-number-crunching tasks from the Novas. Foremost among these tasks was word processing; it was surprising how much time the preparation of scientific papers was taking on the Novas. The benefits of the off-loading were immediate. It became possible to run one or both of the Novas with a single ground most of the time; thus, we received nearly the same benefit that we would have gotten from the memory expansion. The Novas had essentially become personal computers. And we could use Microsoft CP/M FORTRAN to do small problems or program development, tasks where speed of execution was not significant, on the Otronas.

The introduction of the IBM PC

did not affect us at first. But later, with the availability of the Intel 8087 chip and the introduction of Microsoft FORTRAN-77 for MS-DOS, which generated in-line code for the chip, it became very advantageous to move to MS-DOS machines. We upgraded our Otronas to their dual-processor configurations and added some hard disks. Our benchmarks showed the IBM PC with an 8087 chip to run at 10 percent of the speed of the VAX, and the Otronas with their 8086/8087 combinations to run at 12 or 13 percent. (Due to the lack of 8-MHz 8087s, we had to install 5-MHz chips in the Otronas.) The Otronas had a limit of 256K bytes, but with IBM PCs we could go to 640K bytes. The speeds were significantly less than we got with the Novas, but it became very economically attractive to switch our number crunching to IBM PCs or compatibles. The price is right: Today it is possible to get IBM PC XT equivalents in the range of \$2000 to \$3000, including 640K bytes of RAM and the 8087 chip.

Due to the Novas' memory limitations, any problem that we could do with them, we can now do with XT equivalents. We can trade memory for speed in some instances; we are unlikely to need overlays unless our problems become much larger than they have so far; and accessing large amounts of memory in arrays is essentially now transparent to the user. We can also add additional RAM to be used as disk equivalents, thus speeding up access to large stored tables and cutting down on the waiting time for FORTRAN compilations.

Even the speed deficiency will disappear with time. I was looking forward with keen anticipation to the arrival of the IBM AT with the 80286 and 80287 chips, expecting that the performance for number-crunching problems would rise to 25 percent or more of that of a VAX. Alas! That proved not to be true; benchmark tests have shown that the AT runs at the same speed as the XT for problems that spend most of their time in the 8087 or 80287.

(continued)





## You know that choosing the right software is serious business. So does WATCOM.

So before you make any decisions about your software needs, talk to WATCOM—the people major software users around the world have trusted for years. WATCOM has the products you need to get the job done right. Proven performers like WATFOR\*, WATFIV\*, WATBOL\*, and SCRIPT. Plus new leaders in software for PC workstations and micro-to-mainframe communications. Networks, language interpreters and compilers. Text preparation and data management. All WATCOM products are human engineered to provide the optimum in people efficiency and productivity. And they're designed to run compatibly on IBM mainframes and PC's, Digital main-

frames and micros, and Commodore micros. Whatever you need is backed up by WATCOM's innovative maintenance and support services. You'll be kept up to date with the latest in product enhancements and information. And our publications and seminars will help you get the most out of your software investment. WATCOM. Quality products. Professional service. And a reputation built on more than 150,000 licensed mainframe and micro software programs throughout the world. So talk to us before you decide. After all, choosing the right software is serious business. For you. And for WATCOM.

### Make the right choice: Watfile Data Management

Data management for non-technical people that's easy to learn and easy to use makes WATFILE the right choice.

WATFILE'S intuitive command orientation requires only a few commands to complete most functions. Management and clerical people can easily solve their data problems without programmer assistance—and without a major investment in training.

Analyze data, create files, and produce reports. Manage inventories and payrolls. Print mailing lists.

WATFILE is human-engineered to do all this and more. WATFILE is available for IBM VM/CMS, IBM PC/DOS, and DEC VAX/VMS.

Make the right choice. Call or write WATCOM today and we'll tell you all about WATFILE or any of WATCOM's other people-efficient products.

# WATCOM

The right choice in software.

Inquiry 388

Yes! I want to make the right choice in software. Send me more information on:  WATFILE  WATCOM Software Catalogue

Name: \_\_\_\_\_

Company: \_\_\_\_\_

Title: \_\_\_\_\_

Address: \_\_\_\_\_

City: \_\_\_\_\_ State: \_\_\_\_\_ Zip: \_\_\_\_\_

#### WATCOM PRODUCTS INC.

415 Phillip Street  
Waterloo, Ontario, Canada  
N2L 3X2

(519) 886-3700

Telex 06-955458

BYT-4

\* WATFOR, WATFIV, AND WATBOL are registered trademarks of the University of Waterloo.

\* IBM PC and VM/SP CMS are registered trademarks of International Business Machines Corporation.

\* DEC VAX/VMS is a registered trademark of Digital Equipment Corporation.



Therefore, I invested in a Number Smasher board from Microway for installation in our PC XT equivalent instead (actually, it is a PC with a third-party hard disk). This board contains an 8086 and an 8087 running at 9.54 MHz. Benchmarks have shown that this board operates typically at a factor of 2.2 to 2.8 times as fast as the IBM PC, depending on application. In general, in our tests the board ran at approximately 25 percent of the

VAX's speed, equivalent to our Nova 3/D in the single-user mode.

**TODAY AND TOMORROW**

I don't know whether the faster performance of the future will come from chips in the Intel family, retaining PC compatibility, or from chip families from other manufacturers. Some people at the Center for Astrophysics are enthusiastic at the prospect of the Motorola 68000 series with either the

Weitek or the Motorola numeric coprocessors, which are predicted to outperform the VAX.

We are now using PC XT equivalents for most of our work, and the Novas will be shut down soon. I have transferred the more interesting software to PC floppy disks, and I am bringing up parts of it on the micros as needed for research. All of this should be very helpful to our scientific productivity. ■

**A PROTOTYPE FOR YOUR PROTOTYPES**



**METHODS BY DIGITALK. A SMALLTALK PROGRAM DEVELOPMENT ENVIRONMENT FOR THE IBM PC. AN OBJECT-ORIENTED SPEED DEMON. AN EXCITING WAY TO PROGRAM.**

Think about your problem. Browse the Methods Smalltalk source code. Select some building blocks like pop-up menus, windows, text-editors and dictionaries. Put them together. Try it. Oops, Methods tells you something is missing. No problem. Continue thinking, changing and trying. Now you're prototyping! Try out new ideas. Redefine your problem. And you don't have to throw this prototype away. Refine it until you like the finished product.

Methods by Digitalk. A new way to develop software for the PC. Use it for windowing, simulation and artificial intelligence applications. Use it by prototyping.

Methods is Smalltalk-80™ language compatible. It includes its own Smalltalk source code. You can extend it in Smalltalk and assembly language.

Methods operates on IBM PCs with 512K bytes RAM using MS-DOS or PC-DOS. Color and monochrome monitors are supported. No mouse is required. A Smalltalk language manual and an environment guide are included.



Available from Digitalk for \$250. Outside U.S. add \$15.00 for shipping and handling. California residents add 6% sales tax. Visa and MasterCard accepted. Educational and Dealer Discounts Available.

**DIGITALK, INC.**

5200 West Century Boulevard  
Los Angeles, California 90045  
(213) 645-1082

Smalltalk-80™ is a trademark of Xerox Corporation. IBM is a registered trademark of International Business Machines Corporation. MS is a trademark of Microsoft Corporation.



# Meet The Princeton Graphic Systems Family.

**The right monitor at the right price.** Princeton Graphic Systems offers you a complete family of high performance personal computer monitors. Monitors that deliver the compatibility, resolution, and reliability you need for any application and any budget: from word processing to sophisticated business graphics.



**HX-12E.** High resolution RGB monitor 640x350 lines noninterlaced - .28 mm dot pitch -Compatible with IBM Enhanced Graphics Adapter -Nonglare screen -**\$785**



**MAX-12.** Amber monochrome -720 x 350 lines -Enhanced to interface with IBM color or monochrome adapter card -Nonglare screen -Can display 16 shades of amber -**\$249**

**HX-12.** High resolution RGB monitor -640 x 200 lines noninterlaced -.31 mm dot pitch tube-Nonglare screen -**\$695**



**HX-9/9E.** Nine inch, high resolution RGB monitor non-interlaced -.28mm dot pitch tube -9E compatible with IBM Enhanced Graphics Adapter -Nonglare screen -Green/amber switch -Apple/IBM colors - Etched dark glass screen -**\$650/\$750 (9E)**



**SR-12P.** PGS's top of the line RGB monitor 640x480 lines noninterlaced - .26 mm dot pitch - Analog input allows for the display of 4,096 possible colors -Compatible with IBM Professional Graphics Adapter -Nonglare screen -**\$999**



**SR-12.** Super-high resolution RGB monitor -640 x 400 lines noninterlaced -.31 mm dot pitch tube - Nonglare screen - Requires interface card -**\$799**



**Princeton accessory product line.** Undergraduate tilt/swivel monitor base, ColorView card, Green/Amber switch, RGB-80 card and Scan Doubler card.

## Princeton Graphic Systems. The only real choice.

For office or home use, Princeton Graphic Systems has a monitor that's right for you. Inquire at your local computer store about our complete line of high resolution color and monochrome monitors; monitors that live up to the Princeton Graphic Systems' tradition of quality, performance, and value. **Princeton Graphic Systems.** 601 Ewing Street, Bldg. A, Princeton, N.J. 08540. (609) 683-1660 Telex: 821402PGSPRIN (800) 221-1490. Ext. 304.

**PRINCETON™**  
GRAPHIC SYSTEMS  
AN INTELLIGENT SYSTEMS COMPANY

IBM IBM Enhanced Graphics Adapter, and IBM Professional Graphics Adapter are trademarks of International Business Machines, Inc. Compaq is a trademark of Compaq Computer Corp. Corona is a trademark of Corona Data Systems, Inc. Apple is a trademark of Apple Computer Corp. PC World is a trademark of CW Communications Inc. SR-12 screen courtesy of Mouse Systems, Inc.



"Symphony 1.1 now makes translating data from and to other programs push-button simple. It is the first program I've seen that is actually fun to install."

*Bob Harris, Deputy Assistant Director For Budget Analysis,  
Congressional Budget Office.*

"I'm thoroughly impressed by Symphony 1.1 and glad to have it. You're going to have to use dynamite to get it out of my machine. It's almost my whole wish list in one."

*Dwight Alton, Assistant V.P., Internal Reporting,  
American Medical Int'l, Beverly Hills, CA*

"In our work in financial planning and analysis we have found that Symphony 1.1 does two things. First, it allows us to build spreadsheets which are a little bit bigger than would otherwise fit in the computer...Second, in doing a spreadsheet layout design, we now have greater flexibility because of the new memory allocation."

*Ron Diderich, Manager, Financial Planning and Analysis Consulting,  
Ernst & Whinney, Cleveland, OH*

# LOTUS PRESENTS SYMPHONY 1.

It was a sneak preview.

We gave advance copies of Symphony™ release 1.1—the new version of the popular live-function PC software—to some of the most sophisticated software experts. The reaction was overwhelmingly enthusiastic. Here's why:

1. **NEW EXPANDED MEMORY.** Symphony release 1.1 works with the new expanded memory boards to provide a solution to the "big data" issue, allowing users to store formulas, labels, and floating point numbers in up to 4MB RAM.

2. **NEW MEMORY ALLOCATION SCHEME.** The new

sparse matrix scheme provides greater flexibility and eliminates the need to arrange worksheets to conserve memory.

3. **MACRO LIBRARY MANAGER.** This permits the creation of libraries of macros that can be accessed from any worksheet and allows the development of multiple worksheet applications.

4. **8087/80287 SUPPORT.** Symphony release 1.1 can take advantage of 8087/80287 math co-processor chips, increasing calculation speed by up to 60 times.

5. **1-2-3 COMPATIBILITY.** New Symphony supports file translations between Symphony, 1-2-3® release 1/A and



"With Symphony 1.1, Lotus has again set the industry standards so high that they'll force the rest of the industry to shoot for the same."

*R. L. Martin, Manager, Decision Support Systems  
Eaton Corporation, Cleveland, OH*

"I am very excited about the memory feature. It's a breakthrough for Symphony in that it significantly broadens the universe of Symphony users."

*Robert Schultze, V.P., Computer Systems (Corporate Finance)  
Bankers Trust Co., New York, NY*

"The Macro Library function is great. Symphony's strength lies in its command language."

*Sally Nager, Senior Information Systems Analyst  
Acropet Electronic Systems Co., Azusa, CA*

## THE TOUGHEST CRITICS RAVE.

Jazz.<sup>™</sup> This fall, Symphony and a new version of 1-2-3 will have compatible spreadsheets, allowing the sharing of data files with no need for translation.

The critics have already acclaimed the programming potential found in Symphony's Command Language—with its conditional statements, branching and parameter passing—the Lotus<sup>®</sup> File Format and Add-In Tools. And they've praised Symphony Link<sup>™</sup>—the micro-to-mainframe Add-In. All of which makes Symphony one of the most powerful PC application development tools around.



And now Symphony is easier to learn, with a new install program and new documentation.

For your own private performance, visit your authorized Lotus dealer today.

If you already own Symphony, call 1-800-TRADE UP (in Canada 1-800-447-4700) and we'll tell you how to get your upgrade kit.

**Symphony**<sup>™</sup>  
**Lotus**<sup>®</sup>



# TWO GENERALIZED FLOATING-POINT REPRESENTATIONS

## Dynamic allocation of range and precision fields in FP numbers

**T**wo generalized floating-point representations are described, analyzed, and compared in this article. One is a partitioned representation allowing a trade-off between range and precision. The other is a variable-base representation that achieves a larger range but has fixed accuracy. Floating-point (FP) representations have not changed much since they were first introduced in the early 1950s. The common floating-point representation consists of a fixed-point fraction  $F$  that determines the accuracy (the significant digits) of the number and an exponent  $E$  that determines the range of the number. The number is defined as  $F \times 2^E$  or, more generally,  $F \times B^E$ , for some base  $B$ . If the signed exponent  $E$  is  $e$  bits long, it uses an excess  $B^E$  representation (a format in which the highest bit designates the sign of the exponent). This, combined with an  $SEF$  format (where  $S$  is the sign of the floating-point number), makes it possible to compare two floating-point numbers by comparing corresponding bits from left to right. A zero floating-point number is defined as all zeros, which makes it equal to an integer zero so the two can be used interchangeably. Notice that this convention makes the

sign of the exponent for zero negative to preserve the compatibility with integer format. These two features are useful and should, in my opinion, be preserved in any modification or generalization of floating-point representations.

In the past, alternative floating-point representations were not practical because of the complex hardware necessary. Today, however, it is not only possible but practical to design and build a support device to handle floating-point numbers in formats other than  $SEF$ . Such a device should be able to

- Accept two floating-point numbers, compare them, or perform any of the four arithmetic operations on them
- Accept one floating-point number and normalize it (set  $E$  to the value that accommodates the maximum number of significant figures for  $F$ ), convert it to integer, or test it for overflow/underflow (if those values exist in the representation used)
- Accept an integer and convert it to a normalized floating-point number

Another way of implementing the design I will propose here is by microprogramming it. Microprogramming is being used more and more, even on large, fast machines.

### PARTITIONED FLOATING-POINT REPRESENTATION

Morris has suggested a three-field floating-point format  $GEF$  in which  $G, E, F$  are the values of the field and  $g=3, e, f$  are their respective lengths (in bits) (see reference 1). Denoting the total length  $n$ , his definition was  $e=G+1$ , which implies  $f=n-3-e=n-G-4$ .

The fixed-length  $G$  field thus divides

the rest of the number into an  $e$ -bit signed exponent and an  $f$ -bit signed fraction. This format is flexible, achieving a trade-off between range (the range of values of  $2^E$ ) and accuracy (which is determined by the length  $f$  of the fraction). However, it has the following drawbacks:

- When  $G$  is small ( $G < 4$ ), the  $G$  field itself uses less than 3 bits. The unused bits could, in principle, be used to increase the effective size of the exponent  $E$ , thus increasing the range.
- The exponent ranges for different values of  $G$  overlap. Thus the two numbers  $010\ 011\ x \dots x$  ( $G=2, E=3$ ) and  $011\ 0011\ x \dots x$  ( $G=3, E=4$ ) have the same exponent. To achieve a unique representation (important for floating-point comparisons), the exponent has to be normalized by shifting it to the left and decreasing  $G$ .
- The sign of the entire number is part of the  $F$  field and, therefore, is not the most significant bit of the floating-point number. This complicates comparisons again since, when comparing  $G_1\ E_1\ F_1$  and  $G_2\ E_2\ F_2$ , verifying that  $G_1 > G_2$  and  $E_1 > E_2$  does not guarantee that the first number is the greater of the two. Every comparison must include  $F_1\ F_2$ , and a simple bit-by-bit comparison from left to right (integer comparison) would not work.



- A hidden bit is not used.

The modification proposed here eliminates all these drawbacks except the first one. The proposed format is  $S S_e G E F$ , where  $S$  is the sign of the fraction, and  $S_e$  is the exponent sign (using a sign convention of 0 for negative and 1 for nonnegative exponents).  $G$  is a  $g$ -bit field defining the length  $e$  of the exponent as  $e=G+1$ .  $E$  is the two's-complement exponent field, and the effective value of the exponent is defined as  $E+(2^e-2)$  when  $S_e=1$  (nonnegative exponents), and  $E-(2^e-2)$  when  $S_e=0$  (negative exponents).  $F$  is a two's-complement, normalized-fraction field, using a hidden bit. The advantages are

- Since  $e=G+1$ , the effective value of the exponent is determined by both  $G$  and  $E$ .
- This definition removes the overlapping in ranges of the exponent for different values of  $G$ . For example,  $G=1$  implies  $e=G+1=2$ . Thus  $e$  is a 2-bit field ranging in value from  $-4$  to  $3$ . The effective value of the exponent is thus  $E+(2^e-2) = (0:3)+(2^2-2) = 2:5$  for nonnegative exponents and  $E-(2^e-2) = (-4:1)-(2^2-2) = -6:-3$  for negative exponents.

These ranges do not overlap with the ranges for  $G=0$  or  $G=2$  (see table 3). In general, a given  $e$  results in the two ranges  $-(2^{e+1}-2):-(2^e-1)$  for negative exponents and  $(2^e-2):(2^{e+1}-3)$  for nonnegative ones.

- The fraction  $F$  is  $n-e-5 = n-G-6$

(continued)

David Salomon is a professor of computer science at California State University, Long Beach. He received a Ph.D. in physics from Hebrew University (Israel). He can be contacted at California State University, Department of Computer Science and Engineering, Long Beach, CA 90840.

Table 1: Ranges of floating-point number representations on some computers.

Computer	$n$	Approximate range
PDP-11	32 or 64	$10^{-38.6} 10^{38.2}$
IBM 7000 series	36	$10^{-38.6} 10^{38.2}$
IBM 360, 370	32 or 64	$10^{-78.3} 10^{78.9}$
CDC Cyber	60	$10^{-308} 10^{308}$
Cray-1	64	$10^{-2467} 10^{2467}$

Table 2: Representations of some floating-point numbers in the proposed system.

$S$	$S_e$	$G$	$E$	Value	Notes
0	1	000	1	$2^{-1} \times 2^1 = 1$	1
0	1	001	00	$2^{-1} \times 2^2 = 2$	
0	1	001	01	$2^{-1} \times 2^2 = 4$	
0	1	010	000	$2^{-1} \times 2^3 = 32$	
0	0	000	0	$2^{-1} \times 2^{-2} = 0.125$	2
0	0	000	1	$2^{-1} \times 2^{-1} = 0.25$	2

$S$	$S_e$	$G$	$E$	Value	Notes
0	0	001	00	$2^{-1} \times 2^{-6}$	2
0	0	001	01	$2^{-1} \times 2^{-6}$	2
1	1	000	0	$-2^{-1} \times 2^0$	3
1	1	000	1	$-2^{-1} \times 2^1$	3
1	0	000	0	$-2^{-1} \times 2^{-2}$	2,3
1	0	000	1	$-2^{-1} \times 2^{-1}$	2,3

Notes:

1. The fraction  $F$  in all the examples is all zeros and, therefore, is equal to 0.5
2. Negative exponent
3. Negative fraction

Table 3: Ranges for Morris and for the proposed system with different values of the  $G$  field.

$G$	$e$	$E$ (Morris)	$\bar{E} - (2^e - 2)$	$E + (2^e - 2)$
0	1	-2:1	-2:-1	0:1
1	2	-4:3	-6:-3	2:5
2	3	-8:7	-14:-7	6:13
3	4	-16:15	-30:-15	14:29
4	5	-32:31	-62:-31	30:61
5	6	-64:63	-126:-63	62:125
6	7	-128:127	-254:-127	126:253
7	8	-256:255	-510:-255	254:509



# THE DISTRIBUTION OF LEADING DIGITS

In base  $B$ , a normalized fraction has a leading digit in the range 1 to  $B-1$ . One might think that those values occur with equal probability. However, it was observed long ago that this is not the case. In 1881, the American astronomer Simon Newcomb noticed that the beginning pages of books of logarithms were the most worn. He interpreted this as an indication that people were looking up more logarithms of numbers starting with 1 than any other number. Consequently, he concluded that numbers starting with 1 were used more than other numbers. Knuth (see reference 3) brings detailed arguments supporting the claim that the leading digit of a floating-point fraction is logarithmically distributed. The probability of the digit being  $i$  is  $p_i = \log_B(1 + 1/i) = \log_2(1 + 1/i) / \log_2(B) = \log_2(1 + 1/i) / b$ . Raimi's article (see reference 4) gives a comprehensive review of literature on the logarithmic law.

The worst case of normalization is where the binary representation of the leading digit has  $b-1$  leading zeros. This only occurs when the digit is equal to 1, and the probability of that case is  $p_1 = \log_2 2 / b = 1/b$ .

The next worst case, where the leading digit has  $b-2$  zeros, occurs when it is equal to 2 or to 3. The probability for that happening is  $p_2 + p_3 = [\log_2(3/2) + \log_2(4/3)] / b = (\log_2 4 - \log_2 2) / b = 1/b$ .

In the general case, the leading digit has  $k$  zeros and can have values

$$\begin{aligned} 0 \dots 010 \dots 00 &= 2^{b-k-1} \\ 0 \dots 010 \dots 10 &= 2^{b-k-1} + 2 \\ 0 \dots 011 \dots 11 &= 2^{b-k-1} + (2^{b-k-1} - 1) \\ &= 2^{b-k} - 1 \end{aligned}$$

Defining  $q = 2^{b-k-1}$ , the leading digit takes values  $q, q+1, \dots, 2q-1$ .

The probability of such a case is

$$\begin{aligned} &[\log_2(1 + \frac{1}{q}) + \log_2(1 + \frac{1}{q+1}) + \dots + \\ &\log_2(1 + \frac{1}{2q-1})] / b = [\log_2(\frac{q+1}{q}) \\ &+ \log_2(\frac{q+2}{q+1}) + \dots + \log_2(\frac{2q}{2q-1})] / b \\ &= [\log_2(2q) - \log_2(q)] / b = 1/b \end{aligned}$$

The probability does not depend on  $k$ . All probabilities for the location of the first nonzero bit are thus equal and have the value  $1/b$ . The average number of leading zero bits is therefore the straight average  $(b-1)/2 = (\log_2 B - 1)/2$ .

It is interesting to note that, assuming uniform distribution of the leading digit, the probability of having  $k$  leading zeros in the binary representation of the leading digit depends on  $k$ . There are  $2^{b-k-1}$  different numbers of the form

$$\begin{array}{c} \overline{\phantom{0\dots 01x\dots x}} \quad b \\ 0 \dots 01x \dots x \\ \underline{\phantom{0\dots 01x\dots x}} \quad k \end{array}$$

each occurring with probability  $1/(B-1)$ . The probability of having  $k$  leading zeros is thus  $2^{b-k-1}/(B-1)$ .

The average number of leading zeros in the case of uniform distribution is

therefore

$$\begin{aligned} \sum_{k=0}^{b-1} k \times p_k &= \frac{2^{b-1}}{b-1} \sum_{k=0}^{b-1} k \times 2^{-k} = \\ &= \frac{2^{b-1}}{b-1} (2 - \frac{b+1}{2^{b-1}}) = 1 - \frac{\log_2 B}{b-1} \end{aligned}$$

Figure A shows the average number of leading zeros as a function of the base  $B$  for both the uniform and the logarithmic distributions.

In the case of the uniform distribution, that average asymptotically approaches 1. This means that at most 1 bit is "lost" when a floating-point fraction is normalized, regardless of the base  $B$  used.

If one believes in logarithmic distribution, however, then the result is that the average number of bits lost after normalization is proportional to  $b = \log_2 B$ .

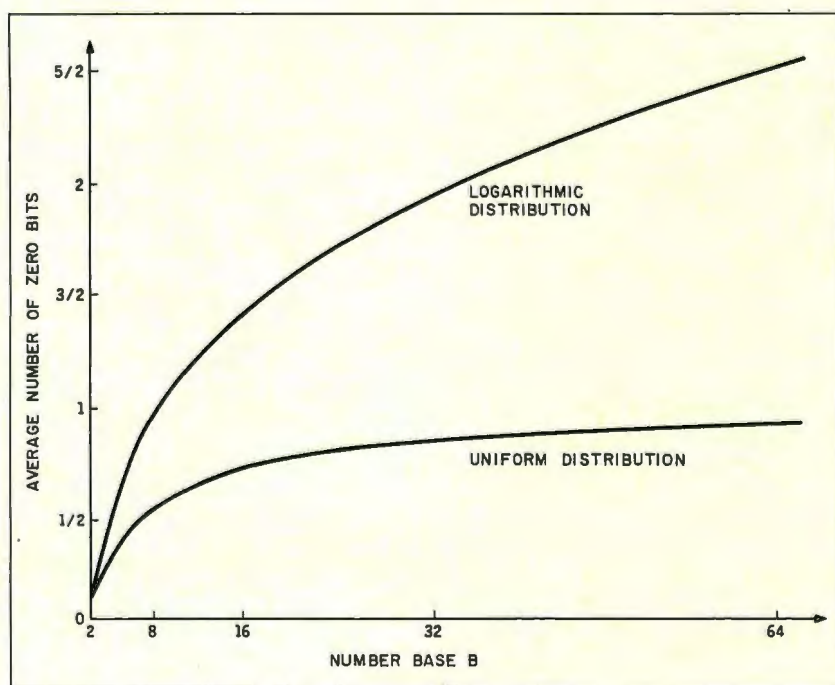

Figure A: The average number of leading zero bits in the fixed-point fraction assuming (a) uniform distribution of base  $B$  digits, and (b) logarithmic distribution of base  $B$  digits.



## FLOATING-POINT

bits long. Since the fraction is normalized and a hidden bit is used, the effective length of the fraction is  $n-G-5$  bits. The smallest fraction is always 0.5 and the largest one is  $1 - 2^{-(n-G-5)}$ . Since the extreme values of the exponent occur when  $G=7$ , the largest floating-point value possible in this representation is  $(1 - 2^{-(n-12)}) \times 2^{509} \approx 10^{153.3}$  and the smallest positive value is  $2^{-1} \times 2^{-510} \approx 10^{-153.9}$ . The range of negative values is similar. Table 1 gives the floating-point ranges for some existing computers.

Floating-point numbers on the Cray-1 computer far exceed the range that can be achieved in the proposed representation with  $g=3$ . This suggests that large, scientific machines use a 4-bit  $G$  field. For  $g=4$ , the maximum value of  $G$  is 15; thus  $e=16$ , the exponent range is  $-131070$  to  $131069$ , and the floating-point extreme values are  $(1 - 2^{-(n-20)}) \times 2^{131069} \approx 10^{39456}$  and  $2^{-1} \times 2^{-131070} \approx 10^{-39456}$

• Since both  $E$  and  $F$  are two's-complement numbers, comparisons can be done bit by bit from left to right (integer comparisons). Table 2 lists some floating-point values to illustrate this point.

### REPRESENTATION ERROR

The maximum error in a floating-point number is half of the least significant bit of the fraction or

$$\frac{1}{2} 2^{-f}$$

If the floating-point number  $\bar{x}$  represents the real number  $x$ , then the relative error of the representation is

$$\frac{|x-\bar{x}|}{\bar{x}}$$

$$\text{Since } |x-\bar{x}| \leq \frac{1}{2} 2^{-f} \times 2^{exp}$$

$$\text{we have } \frac{|x-\bar{x}|}{\bar{x}} \leq \frac{\frac{1}{2} 2^{-f} \times 2^{exp}}{\bar{x}} = \frac{\frac{1}{2} 2^{-f} \times 2^{exp}}{F \times 2^{exp}}$$

$$= \frac{\frac{1}{2} 2^{-f}}{F} \leq \frac{\frac{1}{2} 2^{-f}}{\frac{1}{2}} = 2^{-f}$$

The conclusion, therefore, is that

incrementing  $G$  by 1 cuts the relative error in half (by decreasing  $f$ ) while doubling the range (table 3).

### VARIABLE-BASE FLOATING-POINT REPRESENTATION

The definition of a floating-point value is  $F \times B^E$  where the base  $B$  is usually 2. To explore the possibilities of different bases, we can again use a floating-point format with fields  $S, S_e, G, E, F$  and define the base  $B$  as  $B=2^{G-1}$ . The  $G$  field now determines the base  $B$  and not the exponent size. The above definition allows for bases that are powers of 2, from 2 to 256. There is little practical need, if any, for bases such as 8, 32, or 64, and I will show that such a format is not as flexible as the one previously mentioned.

The main advantage of such a design is large range. The largest base is  $B=2^{7+1}=256$ , yielding a floating-point number in the range of  $256^{-2^e}$  to  $256^{2^e-1}$ , where  $e$  is the length of exponent field  $E$ .

### EFFECT OF BASE SELECTION ON RANGE AND ACCURACY

In examining the effects of base selection, let us revert to the  $S E F$  form of floating-point representation. The problems associated with other bases are independent of the floating-point format, so we will allow ourselves the luxury of using the simplest representation. Selecting a base greater than 2 affects the floating-point number in two ways. It increases the range from  $2^{e-1}$  to  $B^{e-1}$ . However, if one wants to maintain the same range, the exponent field can be shortened to  $e'$  bits where  $2^{e'-1} = B^{e-1}$ . Defining  $b = \log_2 B$ , this implies  $2^e - 1 = (2^{e'} - 1) \log_2 B = (2^{e'} - 1) b$  and the reduction in exponent size is  $e - e' = \log_2 b$  bits. This gain of  $\log_2 b$  bits can be added to the fraction to increase the accuracy of the floating-point number.

Normalizing a floating-point number with base  $B$  is done by decrementing  $E$  by 1 and shifting  $F$  to the left  $b$  positions, repeating until the leftmost  $b$  bits of the fraction are non-zero. Up to  $b-1$  zero bits may thus be left unused in the fraction and, on the

(continued)

## Color Diskettes

BY CENTECH

The Colorful Solution to Data Organization™

### TIMELESS WARRANTY

SS-DD 89¢ 5 1/4" QTY. 60 BULK 99¢ DS-DD

\$119\* 5 1/4" QTY. 20 BOXED \$139\*

\$199\* 96 TPI QTY. 20 BOXED \$245\*

Color! High Density for IBM PC \$319\* DS-HD

Certified and tested 100% error-free beyond 75% clipping level. Available in 13 useful assorted colors. Includes Tyvek sleeves, user ID labels, write/protect tabs and reinforced hub rings. For every order of 10-pack boxed diskettes, get one of the best Plastic Library Case/12. A \$4.95 value ..... FREE!!!

\*Free Flip'n'File/15  
\*PLUS UP TO \$30  
Cash Back from .....



### LIFETIME WARRANTY

SS-DD \$122\*\* DS-DD \$154\*\*

\$189\* 5 1/4" QTY. 20 96 TPI \$239\*

\$285 3-5" MICRO \$392

FDR IBM PC/DS-HD

\* Price After \$2.00 Cash Back From 3M  
3M Headcleaning Kit ..... \$6.95  
3M Data Cart. (DC300XL) ..... \$19.80  
DC600A ..... \$22.10

Best Price Ever on "Boxed Product"

## Nashua™ Diskettes

### LIFETIME WARRANTY

SS-DD 94¢ 5 1/4" QTY. 50 (5 BOXES) \$1.06 DS-DD

Factory fresh in boxes of 10 with Tyvek sleeves, user ID labels, write-protect tabs and reinforced hub ring.

ECONOMICAL PRICE American-Made EXCELLENT QUALITY

## BULK

DISKETTES

### LIFETIME WARRANTY

SS-DD 79¢ 5 1/4" QTY. 60 89¢ DS-DD

Includes white tyvek sleeves, user ID labels, write-protect tabs and reinforced hub ring. Certified 100% ERROR-FREE. Tested at 163% of industry standards to surpass the best the diskette world has to offer.

#### PRINTER RIBBONS

Epson MX 70/80 ..... \$3.55  
Epson MX-100 ..... \$4.30  
Okidata 80, 82, 83, 92, 93 ..... \$1.46  
Okidata 84 ..... \$3.60

#### DISK STORAGE

Amaray Media Mate 50 ..... \$8.75  
Disk Minder II-75 ..... \$10.95  
Micro Disk Minder-36 ..... \$7.75

PRICE PROMISE: We will better any lower delivered price on the same products and quantities advertised nationally.

TERMS: FREE USE OF VISA AND MASTERCARD. American Express also accepted. Shipping: Add \$3.00 per 100 diskettes or fraction thereof. Other items add \$3.00 for disk storage or headcleaning kit or dozen ribbons or C.O.D. orders. P.O. accepted from institutions and schools. Utah residents add 5 1/2% sales tax. Minimum order \$30.00

#### TOLL FREE ORDER LINE:

1-800-233-2477  
(1-800-AFFAIRS)

INFORMATION AND INQUIRIES:

1-801-942-6717

Computer Affairs, Inc.

2028 E. FT. UNION BLVD., #105  
SALT LAKE CITY, UTAH 84121  
CALL: 1-800-AFFAIRS  
HOURS: 9AM-5PM M-F (Min. Time)

Computer Affairs 1985



average,  $(b-1)/2$  zero bits will be left unused (see text box on page 164). This, added to the fact that a hidden bit can no longer be used, decreases the effective length of the fraction by  $1 + (b-1)/2$ .

We conclude, therefore, that selecting a base  $B > 2$ , while maintaining the same range, adds  $\log_2 b - (1 + (b-1)/2)$

bits to the effective length of the fraction. Since this quantity is always negative, accuracy is, in fact, decreased.

The main advantage of using a base  $B > 2$  is, therefore, the large range. Sweeney showed that a second advantage of using a base larger than 2 is that it simplifies alignment shifts in

floating-point addition (for more information, see reference 2).

**CONCLUSIONS**

The range and accuracy of floating-point numbers are important factors in considering the computing power of a computer. I have explained that either range or accuracy, but not both, can be considerably extended by the proposed partitioned representation.

Such a representation, if implemented in hardware, could increase the computing power of any computer. The main justification for such a representation may be the observation that in practical cases one is rarely concerned with both range and precision.

The partitioned representation should not be dismissed as just a storage-conserving scheme, made useless when storage costs are coming down. The method is insensitive to storage costs because (1) in existing computers the word length and the size of the address space are fixed regardless of cost, and (2) in future computers the word length and address-space size are likely to be determined more by factors such as speed, physical size, register size, and bus width, and less by storage cost. This implies that the art of packing more information into the same number of bits is not yet obsolete.

The variable-base format discussed is less flexible and does not seem to be as valuable in practical applications. ■

**ACKNOWLEDGMENT**

The author would like to thank Dr. Robert Henderson for his help in this research.

**REFERENCES**

1. Morris, R. "Tapered Floating Point: A New Floating-Point Representation." *IEEE Trans. Comp.* C-20, 1971, page 1578.
2. Sweeney, D. W. "An Analysis of Floating-Point Addition." *IBM Systems Journal* 4, 31, 1965.
3. Knuth, D. E. *The Art of Computer Programming*, vol. 2, 2nd ed., Reading, MA: Addison-Wesley Co., 1981, Sec. 4.2.4.
4. Raimi, R. A. "The First Digit Problem." *American Mathematical Monthly* 83, 1976, pages 521-538.

# Open the door to diskette compatibility with UniForm!

Just \$69.95 turns one of your floppy drives into a "look-alike" of most popular CP/M\* computers.

UniForm is the easy and inexpensive way to enable your CP/M computer to *directly* read, write and format diskettes from the most popular CP/M micros. This innovative program actually emulates the desired foreign drive. Files that were previously incompatible work flawlessly with your own software tools, such as word processors, database managers and spreadsheets. In addition, you can transfer files to or from MS-DOS.\*\*

Menu-driven UniForm is mastered in just minutes—simply load, select the proper diskette format and go! Operation of your software is unchanged. At just \$69.95, compatibility never cost so little!



UniForm is available from your local computer dealer or Micro Solutions.

For users of IBM PC, PC-XT, PC-AT or compatibles, UniForm-PC provides direct access to CP/M data diskettes. Also just \$69.95.

Trademarks:  
\*Digital Research  
\*\*Microsoft Corporation



**MicroSolutions**  
125 South Fourth St.  
DeKalb, IL 60115  
815-756-3411



# Technical Bulletin No. 2 in a series.



## SUBJECT: Engineering a LAN for Maximum Flexibility.

Quantum Software Systems Ltd. proudly announces QNX 2.0 — the Ultimate Distributed Network Operating System. QNX 2.0 is now available for the IBM-PC, IBM-AT, PC compatibles, DEC Rainbow and TANDY 2000. If you have been waiting for a Real-time Multi-tasking Multi-user Operating system with fourth generation LAN support, then QNX 2.0 can offer you today what the competition can't even begin to promise for the future.

QNX 2.0 integrates the Local Area Network architecture right into the heart of the operating system, at the fundamental level of intertask communication allowing tasks to communicate transparently with other tasks across the whole network. This means that any task (program/application) may access ANY serial port, ANY printer or ANY disk on the network. There are no artificial restrictions. Every PC with a disk is a potential file server. PCs without disks will automatically BOOT over the network.

### QNX on the IBM-PC AT:

QNX is the only Multi-tasking Multi-user Operating system available for the AT. It is available in both networked and single machine configurations. At about 2.5 times faster than the QNX 8088 PC based systems, and 10 times faster than other multi-tasking operating systems on the same processor, QNX is the ideal program development environment.

O/S	Computer	Processor	Measured time
QNX™	IBM-PC AT	80286	480 usec
XENIX™	Intel-286	80286	4,930 usec

### File Security:

Designed with extensive file security features, QNX 2.0 provides login protection with network wide file permission checking based on 255 groups of 255 users. In addition, each PC user may control network access to devices attached locally to their machine.

### Distributed Processing:

The QNX LAN supports distributed processing as well as distributed devices. Tasks may be executed on remote stations as easily as they may be executed on the local work station. This allows pure processing elements (PCs without keyboards or displays) to be plugged into the network to be used as an

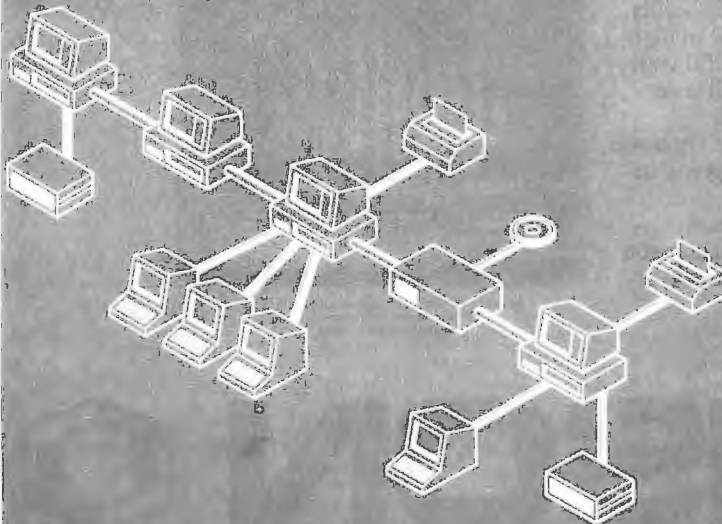

un-committed processing resource. This is ideal for real-time, process control, data acquisition and data communication applications.

### Global Communications:

QNX supports a full implementation of X.25 allowing connection to public networks such as Telenet and Datapac. This allows you to link geographically separate LANs together providing true global area networking.

### Cost Effective Growth and Flexible Solutions:

QNX is affordable, and will work with the PCs you use today and those you will use tomorrow. You may mix and match different brand PCs on the same QNX network with absolute ease. Multi-user expansion may be accomplished by adding terminals to PCs or PCs to the network. You can start your multi-user application on a single PC with 1 to 10 attached terminals. Once your single processor starts to show signs of degradation, add another PC and connect terminals to the new processor. If the disk becomes the major bottleneck, you may add hard disks to other attached PCs to distribute the processing. Applications which are very CPU intensive may wish to limit a single user to each processor and expand the system with low cost diskless PCs used as work stations. QNX does offer a truly cost effective and flexible solution to your applications needs.

### Portability:

QNX 2.0 is portable. The operating system is independent of the physical local area network. It is available in a form suitable for porting to other 8088/8086/80186/80286 computers in the consumer, educational and industrial market place. QNX is ROMable and can operate in as little as 128Kb RAM.

### DOS Compatibility:

PC-DOS version 2.1 can run as a task under the QNX 1.2 or 2.0 operating systems. QNX will also allow transparent access to the DOS file system partition and floppies.

### QNX Products:

QNX Kernel	Real Time Spelling Checker
Editor and Utilities	Electronic Mail
C Compiler & 8086 Assembler	Icon Menu Generator
Basic Compiler	Isam file utility
Cbot (dibol) Compiler	DOS Access Kit
Pascal Compiler	SoftPlan Spreadsheet
Full Screen Multi-terminal editor	Networking Board
Document Formatter	

### QNX Distributors:

Canada:	Quantum Software Systems (613) 726-1893
	Kanalek Micro (613) 726-1907
	Peripherals Plus Inc. (514) 364-5554
USA:	Micro Managers of Texas (512) 341-9544
Europe:	Xinit A.G. (Switzerland) (41) 57-311125
S. America	Analysis Sistemas (11) 280-6980



Moodie Drive, HiTech Park  
215 Stafford Rd., Unit 104  
Ottawa, Canada K2H 9C1 (613) 726-1893

QNX is a trademark of Quantum Software Systems Ltd. XENIX is a trademark of Microsoft Corp.



A

S I G H T

F O R

S O R E

E Y E S

T H O M S O N

To those of you who stare and stare—and stare at computers, blessed relief has arrived. Thomson™ monitors. We promise clearer, crisper resolution, remarkable colors and print-like text. Thomson builds a full line of monitors, from basic monochrome to high-resolution color models. All are designed to fulfill your needs today, and sophisticated enough to fulfill your needs in the future.

Thomson monitors are designed and built by Thomson, a \$6 billion international corporation. They're going to change the way America looks at computers.

Ask your local computer dealer for a Thomson monitor, or call 1-213-821-2995, ext. 34, for the Thomson dealer nearest you. Then take a stare at a Thomson monitor. It's a sight for sore eyes.™

Telex 3720233. Thomson is a trademark of Thomson S.A.

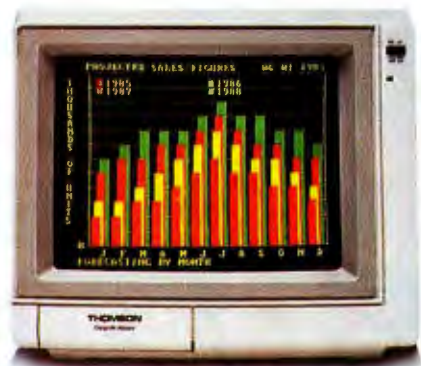

Model CM 3131SI. 12" diagonal, .31mm dot pitch RGBI color monitor with text switch and non-glare tinted screen.

**THOMSON**



©1985 Thomson Consumer Products Corporation



# TURBO PASCAL DRIVES THE MOUSE

## *A handy procedure to interface the Microsoft Mouse with Pascal*

**T**wo Turbo Pascal procedures for accessing the MS-DOS functions and MS-DOS interrupts, MsDOS and Intr, have simplified the task of interfacing the Microsoft Mouse with Pascal. It would have been much more onerous with expensive "full-scale" compilers. The two procedures are not well documented in the Turbo manual, but two .DOC files on the Turbo (version 2) disk, INTRPTCL and DOSFCALL, give examples of their use. Documentation for Intr is considerably improved in version 3.0 of Turbo Pascal, but not for MsDOS. This information, combined with that provided in the Microsoft Mouse manual (*Microsoft Mouse Installation and Operation Manual*, Microsoft Corporation, 1983), was adequate to devise simple Turbo Pascal routines that accomplish the same actions as the BASIC-callable mouse routines supplied by Microsoft.

Interrupt calls in machine language resemble ordinary procedure calls in higher-level languages. Certain values

must be placed in the 8088/8086 registers, and an interrupt procedure INT calls the desired procedure with a suitable code. The mouse uses INT 51 (or INT 33 hexadecimal), which with proper values in the registers provide particular Mouse functions. This is similar to passing a parameter to a function in Pascal or other higher-level languages. To program the mouse, the Microsoft Mouse manual requires the passing of the parameters M1%, M2%, M3%, and M4% to 8088/86 registers ax, bx, cx, and dx, respectively, before issuing the INT 51. BASIC ordinarily uses CALL MOUSE (M1%,M2%,M3%,M4%). For example, if I want function

number 1 to show the cursor in BASIC, I would set M1% to 1 and issue a CALL MOUSE (M1%, M2%, M3%,M4%); in machine language, I would load the value 1 into register ax and call INT 51.

Turbo Pascal's function Intr (P1, P2) takes two parameters. The first parameter, P1, selects the required interrupt, INT (decimal 51 or 33 hexadecimal for

*(continued)*

Dr. John Figueras was a research chemist with Eastman Kodak for thirty years. He has a Ph.D. in organic chemistry from the University of Illinois. Now retired, he is a part-time instructor of computer science at State University of New York at Geneseo. He can be reached at 65 Steele Rd., Victor, NY 14564.





the mouse); the second parameter, P2, is a Pascal variable of record type that references all of the registers and flags in the 8088/86 microprocessor. In listing 1, this record variable is called `recpack` and is given the type `regset`, which comprises the registers introduced above. To access a given mouse function out of Turbo Pascal,

therefore, you must load suitable values of the mouse parameters into the fields of the record variable and then pass this record to the function `Intr`. Values are inserted into the record `recpack` using either the Pascal with construct or qualified labels (dot notation). Listing 1, `MOUSE.PAS`, contains the Pascal

equivalents for seven mouse functions (see table 1). [Editor's note: Listings 1 and 2 are available for downloading from BYTEnet Listings, (617) 861-9774.]

The program `MTRIAL` (see listing 2) is a simple example of mouse programming in Pascal. The program uses the graphics routines supplied in version 2 of Turbo Pascal. It puts a box-shaped mouse cursor on the high-resolution screen and uses two accesses to draw a line on the screen: the first with the left button and the second with the right button. A repeat . . . until loop monitors the mouse. The loop keeps an eye on the status of the mouse button reported in the variable `mbt`, which is returned by the procedure `mpos`. When `mbt` has the correct value, `mpos` returns the coordinates of the mouse cursor at the time that the button was pushed.

Notice that whenever the procedure

(continued)

Table 1: Using listing 1, you can implement the functions below, listed according to their Microsoft function number, Pascal name, and action. If you need them, you should have no trouble implementing the other nine functions discussed in the Microsoft Mouse manual.

0	<code>mstatus</code>	initialize mouse
1	<code>mshow</code>	display mouse cursor
2	<code>mhide</code>	hide mouse cursor
3	<code>mpos</code>	get mouse position; return coordinates
4	<code>mput</code>	put the mouse at designated coordinates
8	<code>mvlimit</code>	limit mouse vertical position
9	<code>mshape</code>	assign a shape to the mouse cursor

## MULTILINGUAL WORD PROCESSING

### Multilingual Column Text

This is multilingual text.

**French:**  
La touche Alt est également utilisée avec les touches du clavier numérique pour entrer les caractères qui ne se trouvent pas sur les touches du clavier de type machine à écrire.

**Greek:**  
Το πληκτρολόγιο έχει μία μοναδική κλειδί με τον κέρσορα και ουσίως με τον κέρσορα στο κέντρο του πληκτρολόγιου.

**Japanese:**  
7 7 7 7 7 7 7 7 7 7  
5 5 5 5 5 5 5 5 5 5

**German:**  
Wenn Sie Ihren Text ohne "Papiervorschau" drucken, berichtigen oder abspeichern beachten brauchen Sie die Hilfe eines Textverarbeitungsprogramms.

### Graphics:



### Organization charts:

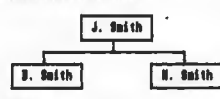

### Tables:

Date	Item number	Price
050585	310-0707-000	145.00
050585	545-0707-001	1000.00
050585	200-2000-000	45.87
000505	999-0000-000	1.00
100705	100-1000-100	1999.99

- Up to eight fonts on screen
- Graphics and character modes
- Image based Word processing
- Line graphics and bar charts
- Independent columns
- Real time text dragging
- Typewriter emulation
- Translation to and from ASCII
- Printing to printer or disk
- Comprehensive printer tables
- Numeric tabs and indents
- Headers and footers

- Color support
- Arithmetic calculations on text
- Integrated Communications
- Transmit and receive on disk
- Automatic hyphenation
- Document repagination
- Search and replace
- Context sensitive help
- Easy to use and learn
- In English, French, German
- In Dutch and Greek.
- IBM PC/XT/AT and Compatibles

Only \$250 Incl. Latin and Japanese/Greek font. Junior version \$49.95



### MICRO BUSINESS PRODUCTS

11E Avenue Observatoire  
Brussels, Belgium  
Tel: 375-0953 Tlx: 26340

P.O.Box 530  
Wayne, NJ 07470  
Tel: 201/684-4142



## NOW! 3.5 MB MEMORY ON A SINGLE BOARD FOR IBM AT AND AT COMPATIBLES

2 YEAR WARRANTY

### AT Smart Pack 2

### Multifunction Board

- Up to 3.5 MB of Memory Expansion
- 2 Serial Ports (1 optional)
- 1 Parallel Port
- Game Port (optional)
- Use with 256 K or 512 K populated CPU
- Easy Installation



Suggested Lists  
128K 1SP, 1PP... \$495.00  
512K 1SP, 1PP... \$595.00

### NOW AVAILABLE IN QUANTITIES Serial/Parallel Interface

- 1 Serial Port
- 1 Parallel Port
- Supports any RS 232 C Based Peripheral Device
- Supports Printer Plotter etc.
- Also compatible with IBM-PC

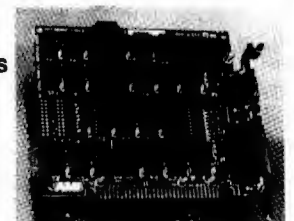

Suggested List \$129.00

Both Cards Fully Compatible to IBM AT

Boston	617-443-4818	AMERICAN MICRONICS INC.
Chicago	312-480-3575	17811 Skypark Circle, Suite H
Texas	713-495-5200	Irvine, CA 92714
Charlotte	704-525-4423	(714) 261-2428 Telex 314016
San Francisco	415-593-2324	

MADE IN USA

DEALER/DISTRIBUTOR/OEM DISCOUNTS AVAILABLE  
Smart Pack Trademark of American Microtronics, Inc. IBM & IBM PC AT  
Trademarks of International Business Machines Corp.



# ATTENTION: \$100 BUS USERS!

## LOMAS DATA PRODUCTS PRESENTS: IBM-PC COMPATIBILITY FOR ONLY

**\$ 1749\***

*\*User supplied keyboard and monitor required.*

LDP is offering a compatibility upgrade package to convert your current S100 BUS system quickly and easily to IBM-PC compatibility. This upgrade includes the high performance THUNDER 186 and COLOR MAGIC, IBM-PC compatible color graphics board. You get 10 Mhz 8086 performance, 256K bytes of no wait state RAM, two serial ports and a parallel printer port. No other S100 bus boards are required. Included with this set is the advanced CONCURRENT DOS operating system bringing PC-DOS compatibility and multitasking to the system. This board out performs the IBM-PC by a three to one margin. Gain IBM-PC compatibility without sacrificing S100 bus compatibility.

**THUNDER 186 / COLOR  
MAGIC SET . . . . . \$1749.00**



### IBM COMPATIBLE S100 BUS COLOR GRAPHICS

LOMAS DATA PRODUCTS presents COLOR MAGIC, the most complete compatibility solution for S100 bus computer products. COLOR MAGIC includes three major hardware sub-functions which allow it to emulate the IBM-PC: An entirely compatible video function, an IBM-PC keyboard interface and an IBM-PC compatible timer interface including IBM-PC sound compatibility. HOW COMPATIBLE IS IT? Currently we are running MICROSOFT's FLIGHT SIMULATOR recognized as one of the severest tests of compatibility. We can also directly boot PC-DOS for the IBM-PC with no alterations. Other programs which have been tested and function without problems are: LOTUS 1-2-3, DBASE III, WORDSTAR and VOLKSWRITER.  
**COLOR MAGIC (16K byte version) . . \$595.00**

■ **THUNDER 186** single board computer provides a high performance 16 bit computer all on one board. It is an ideal companion to the COLOR MAGIC to provide a low cost, high performance IBM-PC compatible system. The 8Mhz 80186 offers 10Mhz 8086 performance. THUNDER 186 provides all the components necessary to form a complete system including: 256K bytes of no wait-state RAM, 2 serial ports, a parallel printer port, high performance floppy disk controller controls both 5 1/4" and 8" drives simultaneously, full IEEE 696 (S100) bus

for system expansion. The COLOR MAGIC and THUNDER 186 combine to provide performance you won't find in other compatibles. The price includes the powerful Concurrent DOS operating system.

**THUNDER 186 . . . . . \$1195.00**

■ **NV-DISK** is a solid state memory with software to emulate a disk drive under MS-DOS, Concurrent DOS, and CP/M-86. NV-DISK is entirely COMPUPRO software compatible allowing COMPUPRO users to take advantage of the lower cost and battery protection support offered by NV-DISK. It offers the advantage of high speed access and no moving parts. It can be battery protected to allow data to stay even while powered down. The board is available in either 512K or 2 Megabyte configurations and multiple boards may be used to create disk drives with up to 16 Megabytes of storage.  
**NV-DISK 512K, \$595.00 2 MBYTE, \$1695.00**

■ **MEGARAM** is a high density, high performance dynamic RAM board with up to two Megabytes of storage. Megaram offers no wait state performance in 8086 systems with up to 10 Mhz processors at a fraction of the cost of comparable performance static RAM.  
**MEGARAM . . . . . 1/4 MBYTE, \$595.00  
1/2 MBYTE, \$749.00 . . . . . 1 MBYTE, \$1095.00  
2 MBYTE, \$1795.00**

### IBM-PC COMPATIBLE S100-BUS SYSTEM

LOMAS DATA PRODUCTS offers IBM-PC compatible systems with performance far exceeding that available from IBM. You can purchase systems offering performance of an eight Mhz 8086 or up the performance of an 8Mhz 80286. Each system is capable of supporting 8Mhz math coprocessors. Our 8Mhz 80286 system offers IBM-PC compatibility while offering up to 2 times the performance of the IBM-PC-AT. For applications where PC compatibility is desirable but higher performance is a benefit or requirement LDP offers the only viable solution.

### WHO IS LOMAS DATA PRODUCTS...

LOMAS DATA PRODUCTS has been shipping 16 bit microprocessor S100 bus products for five years. We have earned a strong reputation for reliability and performance over these five years. We were running MS-DOS (SCP-DOS/PC-DOS) before IBM knew the operating system existed. We offer a wide range of 16 bit operating systems including MS-DOS, CP/M-86, CONCURRENT CP/M-86 and CONCURRENT DOS. All our products are backed by a one year guarantee. We offer no 8 bit products and concentrate entirely on high performance 16 bit systems. *If you are looking for the highest performance possible on the S100 bus, you can be sure LOMAS DATA PRODUCTS offers it.*

MS-DOS, trademark of Microsoft  
PC-DOS, trademark of IBM  
Concurrent CP/M-86, concurrent DOS, trademark of Digital Research

Dealer inquiries invited.

## LOMAS DATA PRODUCTS, INC.



182 CEDAR HILL ROAD, MARLBORO, MASSACHUSETTS 01752 □ TELEPHONE: (617) 460-0333 □ TELEX: 4996272

For orders outside the U.S., contact our exclusive dealers: □ **Australia** - LAMRON PTY. LTD., (02) 808-3666 □ **Malaysia** - EXA COMPUTER (m) SENDIRIAN BERHAD, 795284 □ **England** - RATIONAL SYSTEMS, 0908-613209 or 0908-611349; SHARPBORN LTD., 018764559.

Inquiry 222



# The Ultimate Cable Assembly

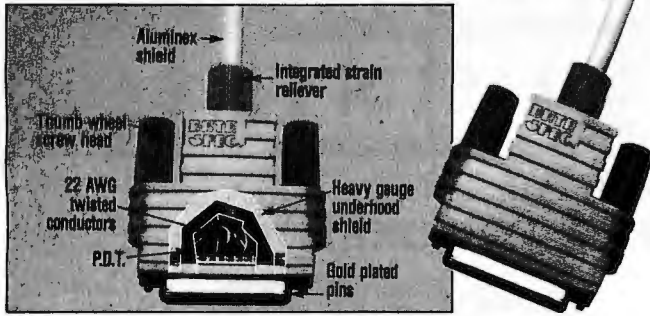

## Inside and Out

You've never seen a cable that looks or works quite like this. The result of extensive research into functional design, the DATA SPEC cable assembly not only visually enhances your computer equipment, but provides superior quality with the following features:

- Full shielding (Exceeds F.C.C. EMI/RFI emission requirements)
- Positive strain relief
- Large convenient thumbscrews
- Gold plated pins
- Exclusive P.D.T. underhood for maximum integrity
- Lifetime warranty

DATA SPEC makes cable assemblies for all your interface needs: printers, modems, disk drives and monitors. For your IBM, Apple, AT&T and other popular PC's. Ask for DATA SPEC cables at your nearest authorized DATA SPEC dealer.

### DATA SPEC®

FROM ALLIANCE RESEARCH CORPORATION  
20120 Plummer Street • Chatsworth, CA 91311 • 1-818-993-1202

IBM, Apple and AT&T are registered trademarks respectively of International Business Machines Corp., Apple Computer Inc. and AT&T Information Systems. Patent PND. © Copyright 1985 Alliance Research Corporation

## TURBO MOUSE

### Listing 1: Turbo Pascal mouse procedures.

```
procedure mshape(xhot, yhot : integer; var cursor : curarray);
{ xhot and yhot pixel designations for the cursor hot spot.
  cursor is the array containing the cursor shape. curarray
  is array type defined as ARRAY[0..31] OF INTEGER }
```

```
type
  regset = record
    ax,bx,cx,dx,bp,di,si,ds,es,flags : integer
  end;
var recpack : regset;
```

```
begin
  with recpack do
  begin
    ax := 9;
    bx := xhot;
    cx := yhot;
    dx := Ofc(cursor[0]);
    es := Seg(cursor[0])
  end;
  intr($33, recpack)
end;
```

```
procedure mstatus(var mstat, nbuttons : integer);
{ returns mouse status and resets mouse parameters.
  mstat = 0 if mouse is not installed. -1 otherwise.
  nbuttons is number of buttons enabled, = 2 }
```

```
type
  regset = record
    ax,bx,cx,dx,bp,di,si,ds,es,flags : integer
  end;
var recpack : regset;
```

```
begin
  recpack.ax := 0;
  intr($33, recpack);
  with recpack do
  begin
    mstat := ax;
    nbuttons := bx
  end
end;
```

```
procedure mshow;
{ show mouse cursor }
```

```
type
  regset = record
    ax,bx,cx,dx,bp,di,si,ds,es,flags : integer
  end;
var recpack : regset;
```

```
begin
  recpack.ax := 1;
  intr($33, recpack)
end;
```

```
procedure mhide;
{ hide mouse cursor }
```

```
type
  regset = record
```

(continued)

When You Want The Best, Call...

# nbs inc.

National Business Software and Supplies

**ORDER LINE 800-225-8800**

### SOFTWARE

JAZZ	<b>CALL</b>	SUPERCALC III	<b>\$215</b>
LEADING EDGE W.P.	<b>65</b>	WORD PERFECT 4.0	<b>229</b>
NUTSHELL	<b>99</b>	ELECTRIC DESK	<b>189</b>
ABILITY	<b>295</b>	R BASE 5000	<b>369</b>
TURBO PASCAL 3.0	<b>39</b>	NORTON UTILITIES	<b>59</b>
WORDSTAR 2000 +	<b>CALL</b>	SMART SOFTWARE SYS	<b>549</b>
MULTIPLAN	<b>118</b>	SUPER KEY	<b>39</b>

### PRINTERS

STAR MICRONICS	<b>CALL</b>	NEC 2050	<b>\$666</b>
EPSON	<b>CALL</b>	TOSHIBA 1340	<b>\$559</b>

### MISC.

AST 6 PAK + 64 K	<b>\$259</b>	CHIPS 64 K SET	<b>\$20</b>
TEAC 55-B DRIVE	<b>\$109</b>	MAXELL MD-2HD DISKS	<b>40</b>
HAYES 1200 B	<b>\$359</b>	MAXELL MF-2DD 3.5	<b>42</b>

### TWO LOCATIONS:

500 W. Broadway, Suite 116  
Tempe, AZ 85282  
(602) 966-8005

P.O. Box 23,  
Painesville, OH 44077  
(216) 352-1262

Monday-Friday 8am-5pm VISA & MasterCard Welcome

Shipping & handling add \$5 per order (printers \$10 per order). VISA & M/C add 3%. AZ residents add 8%. Allow two weeks for personal or company checks to clear. Returns subject to 15% restocking fee. All items are new with manufacturer's warranty. Machine compatibility not guaranteed. Prices subject to change, product subject to availability.

8/85



# Innovation

A system that keeps  
your private computer files  
from becoming public.



## GTX-100. Computer security so advanced, it could even keep secrets from Mata Hari.

Does your computer talk to strangers? Before you answer no, remember, today's computer intruders are very skillful.

In fact, even a famous spy like Mata Hari would be hard pressed to match their inventiveness. With one deft phone call, these electronic trespassers can tamper with such secret items as privileged customer reports, confidential correspondence, and marketing intelligence.

Inquiry 217

Data thieves can steal information like that. Or erase it. Or alter it to their advantage.

That's why your computer needs the protection of GTX-100. It's a new kind of security subsystem developed from Lockheed's years of experience with high technology and strict security.

GTX-100 puts an electronic wall around your sensitive computer files and keeps your private data private.

Use the coupon to get a GTX-100 brochure plus the name of your nearest sales office. They'll show you how GTX-100 can guard your secrets the next time a stranger comes calling.



© Lockheed-GETEX 1985

### Mail to:

Lockheed-GETEX, Suite 945,  
1100 Circle 75 Parkway, Atlanta,  
GA 30339. (404) 951-0878.

### Please send me:

- GTX-100 brochure.
- The name of my nearest sales office.

Name \_\_\_\_\_

Title \_\_\_\_\_

Company Name \_\_\_\_\_

Address \_\_\_\_\_

City \_\_\_\_\_

State \_\_\_\_\_

Zip \_\_\_\_\_

 **Lockheed-GETEX**  
Giving shape to imagination.

SEPTEMBER 1985 • BYTE 165



**"Switch boxes are sold by many suppliers, but by far the two best values are from MFJ Enterprises."**



**"The MFJ RS-232 Transfer Switch. Buy it before the manufacturer comes to his senses!"**

Joe Campbell, *The RS-232 Solution*  
Sybex Computer Books

Now you can have *reliable and affordable* port expansion. Don't keep plugging and unplugging cables. You can easily switch your computer to your high-speed printer, letter-quality printer, modem, terminal - any RS-232 peripheral device. MFJ's range of Transfer Switches includes one to fit your needs at a price you can afford. Look at these choices; then look at these prices. Compare others at any price! Then ask them for their reviews. When they won't show you, call MFJ...

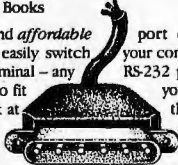

**When you need to switch between two peripherals... or you need to have two computers sharing the same peripheral... Model 1240/\$79.95**

Never unplug a cable again. Now, with the push of a button you can go from dot matrix to letter-quality printing, or go from your printer to your modem. MFJ's Model 1240 Transfer Switch features a built-in transmit/receive switch allowing you two-way information flow. LEDs monitor important data lines while a built-in surge protector guards them. The 1240 also acts as a null modem. All this for just \$79.95. No wonder its MFJ's No. 1 seller!

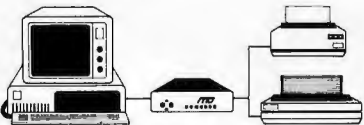

**When you need 1-to-4 computers to share one peripheral or 1-to-4 peripherals to share a common computer... Model 1243/\$119.95**

The perfect office Transfer Switch. Don't buy multiple printers or modems. Just buy MFJ's Model 1243. Then you can connect one or all your computers to a *single* printer or modem. Or let your one computer share up to *four* peripherals. Think of the money you'll save. LEDs monitor important data lines while a built-in surge protector guards them. Two-way communication is allowed with *no complicated software to learn: just push a button!*

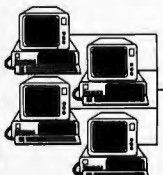

Seven additional models to choose from. Each unit's casing is constructed from high-quality aluminum. Printed circuit boards assure maximum reliability by eliminating crosstalk, line interference and any need for wiring. *All MFJ switches have LEDs to monitor data lines and MOV surge protectors.* Enhance the investment you've already made in your computer by choosing from the finest line of Transfer Switches on the market, including MFJ's IBM & Centronics Parallel Switches.

**You've got a lot of money tied up in your computer. Don't blow it!**

Your valuable computer and peripheral equipment can be damaged by electrical surges *much smaller than you've been led to believe.* Far more likely to happen is having your important data wiped out. These disasters, and others, can be prevented with **MFJ's Power Centers.** Relay latches power off during power dropouts (Model 1108). *Multi-filters* isolate equipment, eliminate interaction, noise and hash. *MOVs* suppress spikes and surges. **MFJ's Power Centers** also have 3 isolated, switched socketpairs, with at least one unswitched socket (so you can add a clock, etc.), lighted power switch, fast-acting fuse, 3-wire, 6-foot cords; 15A, 125V, and 1875 watts. Although each model is attractively housed in a protective aluminum casing, *these are heavy-duty, commercial-quality power centers.*

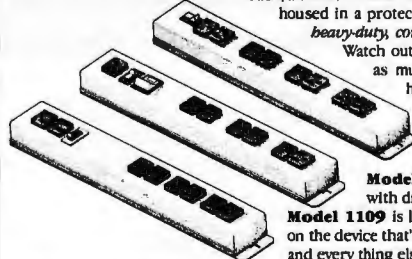

Watch out for fancy names that cost twice as much, last half as long, and have half the features of **MFJ's Power Centers.**

- Model 1107** 8 sockets, 2 unswitched; **\$79.95**
- Model 1108** 7 sockets, 1 unswitched; with dropout relay; **\$99.95**
- Model 1109** is like 1107 but intelligent (switch on the device that's plugged into the control socket and every thing else comes on). **\$129.95**

There are other **RS-232 Switches, Power Centers, and Computer Peripheral Products** available from MFJ. Call and talk with us about all your computing needs, and when you do, ask for our latest catalog. **Both the call and the catalog are free.**

**1-800-647-1800**

For technical/repair information, or in Mississippi, or outside the Continental United States, please telephone...

**1-(601)323-5869** or telex **53-4590 MFJSTKV**

All MFJ products come with a *double* guarantee we think is unmatched. Order from MFJ and try any product for 30 days. If it doesn't satisfy your needs, just return it for a *full refund*, less shipping. If you keep it you can be assured of continued service with our *One Year Unconditional Guarantee.*

Call toll-free 1-800-647-1800 and charge the products you need to your VISA or Master-Card, or send a check or money order, plus \$5.00 shipping, and our shipping department will promptly have your computer peripheral on its way to you.

**MFJ Enterprises Inc.**  
921 Louisville Road  
Starkville, MS 39759

**TURBO MOUSE**

```

ax,bx,cx,dx,bp,di,si,ds,es,flags : integer
end;
var recpack : regset;

begin
  recpack.ax := 2;
  intr($33, recpack)
end;

procedure mpos(var mbt, mx, my : integer);
{ returns position of mouse, coordinates mx,my.
  if mbt = 1, left button was pressed
  if mbt = 2, right button was pressed
  if mbt = 3, both buttons were pressed }

type
  regset = record
    ax,bx,cx,dx,bp,di,si,ds,es,flags : integer
  end;
var recpack : regset;

begin
  recpack.ax := 3;
  intr($33, recpack);
  with recpack do
    begin
      mbt := bx;
      mx := cx;
      my := dx
    end
  end;

procedure mput(mx,my : integer);
{ put the mouse cursor at coordinates mx,my.
  legal values must be supplied }

type
  regset = record
    ax,bx,cx,dx,bp,di,si,ds,es,flags : integer
  end;
var recpack : regset;

begin
  recpack.ax := 4;
  recpack.cx := mx;
  recpack.dx := my;
  intr($33, recpack)
end;

procedure mvlimit(minpos, maxpos : integer);
{ set min and max vertical limits for cursor positions }

type
  regset = record
    ax,bx,cx,dx,bp,di,si,ds,es,flags : integer
  end;
var recpack : regset;

begin
  recpack.ax := 8;
  recpack.cx := minpos;
  recpack.dx := maxpos;
  intr($33, recpack)
end;

```

(continued)



There's a good chance  
that a computer in  
your future will  
come with  
Microware software.

**People who can't wait for the  
future have Microware  
software now.**

Right now, many of the biggest names in the business have their next-generation personal computers on the drawing boards. These advanced systems will have capabilities that will go far beyond what's available today. Many of these exciting new products will feature high-performance system software by Microware.

Operating systems and programming languages are the foundations upon which all other applications are built. Microware's OS-9 operating system is the ideal base for innovative fourth-generation application packages. It provides many advanced capabilities including true multitasking, a universal file and I/O system, modular construction, powerful graphics, unlimited communications gateways, and real-time response. And it's so versatile it can be used on almost any size system — from inexpensive personal computers all the way up to large multiuser systems.

Microware also has outstanding versions of the most popular programming languages. For example, Microware's extended, structured Basic is friendlier than an interpreter, yet it runs as fast as a compiler. And it's so smart that it actually reports bugs as programs are typed in. Or consider Microware's full-feature C Compiler. It can recompile almost any Unix application program to be much smaller and faster than the Unix equivalent. You can also choose Fortran and Pascal compilers of equal calibre.

Software like this doesn't happen by accident. Microware software is specifically designed to unleash the full potential of the extraordinary

68000 and 6809 microprocessor families. Microware works in close cooperation with the people who actually design the systems and silicon in order to achieve maximum integration and performance. That's why Microware software has already made a big impact within the scientific, engineering, and industrial communities.

Affordable, powerful personal computers with Microware software are available *now* at most Tandy/Radio Shack retail locations, and through Fujitsu and Hitachi in Japan. Plus over a hundred innovative manufacturers worldwide offer a veritable banquet of professional systems and software for VME, Multibus, STD, and most other popular standard bus architectures. If you're technically oriented, you can even get a reasonably priced Microware PortPak™ and install OS-9 on your own custom 68000 system.

Some things change, others can't. Will Unix ever become affordable and understandable enough for you? How long can MS-DOS keep up with new technology? You can wait and find out, or you can step into the future today. Contact us today and we'll send you complete information.



**MICROWARE®**

MICROWARE SYSTEMS CORPORATION  
1866 N.W. 114th Street • Des Moines, Iowa 50322  
Phone 515-224-1929 • Telex 910-520-2535

MICROWARE JAPAN, LTD.  
41-19 Honcho 4-Chome, Funabashi City • Chiba 273,  
Japan • Phone 0474-22-1747 • Telex 298-3472

OS-9 is a trademark of Microware and Motorola. Unix is a trademark of Bell Laboratories. VAX is a trademark of Digital Equipment Corporation. Multibus is a trademark of Intel Corporation.



Listing 2: A demonstration of mouse programming in Pascal.  
 {\$I MOUSE.PAS} is a compiler directive to bring the procedures in listing 1 into a program for implementation.

```

program mtrial;
{ demonstration program. get two points with the mouse and
  connect them with a line }

type
  curarray = array[0..31] of INTEGER;

var
  cursor : curarray;
  i,nbut,mx,my,mbt,x,y : integer;
{$I MOUSE.PAS }

procedure bdraw;
begin
  gotoxy(1,2);
  write('Use left button for first point, right button for second point. ');
  mshow;
  repeat
    mpos(mbt,x,y)
  until mbt = 1;
  mhide;
  plot(x,y,1);
  mshow;
  repeat
    mpos(mbt,mx,my)
  until mbt = 2;
  mhide;
  draw (x,y,mx,my,1);
end;

begin
  {MTRIAL main line}
  for i := 0 to 3 do
    cursor[i] := $FFFF;
    {load cursor image in hexadecimal}
    {these values could be set up as typed constants}

  cursor[4] := $F00F;
  for i := 5 to 10 do
    cursor[i] := $F7EF;
  cursor[11] := $F00F;
  for i := 12 to 15 do
    cursor[i] := $FFFF;
  for i := 16 to 19 do
    cursor[i] := $0000;
  cursor[20] := $0FF0;
  for i := 21 to 26 do
    cursor[i] := $0810;
  cursor[27] := $0FF0;
  for i := 28 to 31 do
    cursor[i] := $0000;
  HiRes;
  HiResColor(10);
  mstatus(i,nbut);
  mshape(8,8,cursor);
  mshow;
  bdraw
  {set color green}
  {initialize mouse}
  {set cursor shape}
  {display cursor}
  {get 2 points and draw line}
end.
```

bdraw plots or draws, a call to the procedure mhide turns off the mouse cursor. With the Microsoft Mouse installed, the cursor will tend to interfere with plotting if the cursor is on when plotting. After the plotting has finished, the cursor can be moved freely over the plot without disrupting it. Therefore, hide the cursor during the plotting.

In addition, pay attention to the setting up of the cursor array and the passing of its location to the mouse routine mshape. When the mouse is programmed in BASIC, the screen and cursor masks are set up in a two-dimensional (16 by 2) integer cursor array (see the Microsoft Mouse manual for an example), and the location of this array in memory is passed to the cursor shape function (number 9) as a parameter with the value cursor(0,0), where cursor is the name of the cursor array. The Microsoft Mouse manual warns that in machine language, the masks that describe the cursor shape must be assigned to two contiguous arrays in memory, and the address of the first one goes in register dx. Therefore, in the Pascal program, the screen mask is placed in a single-dimensioned array, and the cursor mask is placed in the same array, directly following the first mask. This ensures that the two masks occur in contiguous arrays. In Turbo Pascal, the function ofs returns the starting address (offset) of the cursor array required in dx, and the Turbo function seg returns the segment part of that address.

To use the Mouse from Turbo Pascal, load the mouse files onto the Turbo disk and include Microsoft's MOUSE.COM in a boot-up AUTO-EXEC.BAT file, or MOUSE.SYS in a CONFIG.SYS file. Once these routines are loaded at boot-up, Turbo Pascal can access all mouse functions. The Pascal mouse procedures are stored as ASCII (American Standard Code for Information Interchange) source code in a file MOUSE.PAS (see listing 1); the compiler directive {\$I MOUSE.PAS} brings the procedures into a program for implementation. ■



# THE END OF SOFTWARE FREEBIES.



Finally there's a foolproof way to protect software against unauthorized duplication. And the technology is all on the disk itself.

The new Prolok™ disk doesn't need add-on hardware. Instead each diskette is marked with a unique, physical "fingerprint." No two are alike. A precise description of the individual print is encoded magnetically. The fingerprint AND the description must match exactly before the software is decrypted and released to the system. No match, no access.

Its genius is its simplicity and familiarity. Prolok looks like an unprotected disk, loads like an unprotected disk, works like an unprotected disk. The user feels immediately at home and in command. It's as easy as `A>PROLOK B: filename.`

Backups are easily made via normal system utilities. However, to be read they must be accompanied in the system by the original Prolok disk.

Prolok puts the casual copier—and even the deliberate pirate—out of business. It barely

increases the price of your product, yet it makes sure your customers don't buy one program and copy ten.

Several command line slash (/) options are built into Prolok diskettes for customized security, depending on your needs.

Software can be loaded easily onto Prolok diskettes using any system from a PC to commercial mass duplication equipment.

Prolok is an engineering breakthrough of Vault Corporation, which has been successfully safeguarding software since the inception of security disk technology. Over 2000 businesses and organizations protect their valuable programs with Prolok.

Simply contact Vault Corporation at 2649 Townsgate Road, Suite 500, Westlake Village, CA 91361. Or phone us at 800-445-0193 (U.S.) or 800-821-8638 (California). And find out why software freebies are becoming a thing of the past.



## PROLOK. SOFTWARE PROTECTION, RIGHT ON THE DISK.

Copyright © 1984 Vault Corporation. Prolok is a trademark of Vault Corporation



# The TeleVideo AT. The Performance AT.



The Performance AT™ is quite an appropriate name for TeleVideo's® new computer. Especially when you measure performance by what's most important—memory, flexibility and speed.

### 30% Faster.

The Performance AT is designed around the Intel 80286 running at 8Mhz—a third faster than the 6Mhz IBM® AT. A standard 640 Kbyte memory and eight expansion slots give you better configuration flexibility. And our AT has an edge with its 20 Mbyte hard disk and Personal Mini network compatibility.

You'll run the popular PC software library, as well

as hundreds of powerful mini computer and multi-user programs. And the TeleVideo AT offers standard graphics capability with remarkably enhanced 640 x 400 display resolution.

### Starts at \$3395.

Innovative design brings you these significant performance advantages at a price that's a good deal less than the IBM AT.

And this could be the least expensive AT-class computer to own. Because the quality of its components promises better reliability and less costly down time.

Should you need it, the Performance AT carries a complete warranty and easy TRW service around the world.

Call toll-free (800) 521-4897. Or, in California, (800) 821-3774. Ask to see the Performance AT. A computer with the power to save you hundreds of dollars.

IBM is a registered trademark of International Business Machines.



**Regional Sales Offices:** Northwest (408) 971-0255, Southwest (714) 476-0244, Southcentral (214) 258-6776, Midwest (312) 397-5400, Southeast (404) 447-1231, Mid-Atlantic (703) 556-7764, Northeast (617) 890-3282, East (516) 496-4777, Rocky Mountain (714) 476-0244.



# IBM COMPATIBILITY FOR THE NEC APC III

*This patch lets  
the APC III run  
IBM software*

**W**hen NEC announced its new APC III, it was difficult not to be impressed by the machine. The microprocessor, a 16-bit 8086 running at 8 MHz, has the support of two graphics controllers whose customized hardware environment works with a variety of screen formats. These graphics controllers let you create the best graphics I have seen on a microcomputer. (See "The NEC APC III" by John D. Unger, March BYTE, page 256, for a more in-depth look at the system.)

The problem with the APC III is that it is not compatible with the IBM Personal Computer (PC), although its disk format is. Aside from getting the APC III to read IBM PC files from IBM PC-formatted disks, I had little success getting it to do anything else. The system seemed to bomb out immediately after loading a program. According to the system manuals, NEC, not willing to produce another IBM PC clone, decided to give its APC all of the IBM PC display features but located the I/O (input/output) drivers (including the screen driver) at slightly different locations. Every call to display a character on the screen ended in an interrupt-return instruction. And, of course, with no driver

there was no screen output.

To work out the problem, I started to rearrange interrupt locations. After exploring the APC III's capabilities, I prepared an operating system patch (see listing 1) that gives some degree of IBM PC compatibility.

With this patch I ran standard IBM software (including Turbo Pascal [PC-DOS version 2.00], the Sanyo MBC 555 version of WordStar, and version 1.0 of Perfect Writer and of Perfect Speller) on the APC III without any problems. I was unable to use Lotus Development Corporation's 1-2-3.

At first I couldn't run version 3.3 of WordStar because this version writes video data directly to the hardware. However, the following patch will allow WordStar to revert to the more conventional I/O methods it used in the earlier versions, correcting the problem:

```
A> debug ws.com
-e 2aa 00
-e 2b0 00
-e 2b3 00
-w
Writing 5380 bytes (debug
  displays this message)
-q
A>
```

The software executed faster on the APC III than on the IBM PC. I measured Turbo Pascal directly with the Sieve of Eratosthenes benchmark [Editor's note: Turbo Pascal listings of these benchmarks are available for downloading via BYTE.net Listings. The telephone number is (617) 861-9774]. The APC III ran one iteration of the Sieve in 6.2 seconds,

while the IBM PC ran it in 12.6 seconds.

## MAKING THE INCOMPATIBLE COMPATIBLE

The compatibility problem involves more than reshuffling interrupt locations. The screen attributes of the APC III have nothing in common with standard IBM PC attributes. Therefore, the patch also includes an attribute-translation program, which occupies about 200 bytes of memory space.

It is necessary to install the patch in the interrupt table. The table, once set up, won't be overwritten by the operating system or a compiler and provides ample space for operating-system changes because the NEC microcomputer uses only 64 out of 255 interrupt vectors (see figure 1). The memory starting at address 10:0 (all addresses in this article are hexadecimal) up to the MS-DOS buffer area at 40:0 can hold a maximum program of 768 bytes. The tiny compatibility patch fits easily into this memory area.

The run-time module contains two procedures: The first memory segment (Copycode) contains the run-time environment for the screen driver; the second (Transfer) copies the first segment to address 100 and adds interrupt vectors to the NEC in-

(continued)

Herbert Stein (5/22 Hutton Ave., Ferntree Gully, Victoria 3156, Australia) is a member of the computer science staff at Telecom Australia Research Laboratories in Melbourne. His interests include writing computer books and restoring furniture.

**WHY WAIT FOR  
ANSWERS FROM YOUR  
IBM PC/AT/XT  
NOW THERE'S  
MEGA-MATH™**

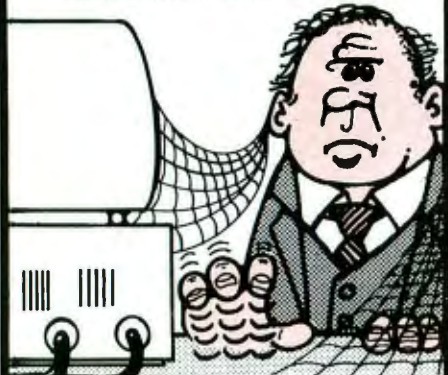

Engineers, scientists and statisticians are discovering the time saving capability of New "Mega Math" II. A library of over 45 assembly language subroutines for fast numeric calculations, up to 11 times faster than your present compiler.

The pretested routines use the 8087 or 80287 coprocessor for optimum performance. The routines reduce development time, code size and testing time.

"Mega Math" II Includes:

- MATRIX OPERATIONS**
- VECTOR OPERATIONS**
- VECTOR SCALAR OPERATIONS**
- STATISTICAL OPERATIONS**
- FAST FOURIER TRANSFORM**
- CONVOLUTION**
- SOLUTION OF LINEAR EQUATIONS**

The library is callable from Microsoft Fortran, Basic, "C" and Pascal compilers. Also IBM Professional Fortran and Macro Assembler.

Get "Mega Math" II Performance for only

**\$299.00 (U.S.)**

Also available is the "Mega Math" A.T. "Booster". A single PC board, designed to reduce execution time in numeric processing applications.

If your IBM AT is equipped with the 80287 coprocessor, the "Booster" will enhance its performance by up to 50%.

**PRICE \$349.00 (U.S.)**

For increased performance of Mega Math Routines, inquire about Micray's high performance floating point processor for the IBM AT or compatibles.

**MICRAY  
ELECTRONICS LTD.**

(403) 250-1437  
Bay 1, 4001A - 19 Street N.E.  
Calgary, Alberta, Canada T2E 6X8



DEARER INQUIRIES WELCOME

TRADEMARKS:  
(IBM, PC/XT/AT)  
INTERNATIONAL BUSINESS MACHINES  
(MICROSOFT) MICROSOFT CORPORATION  
(MEGA MATH) MICRAY

**NEC APC III PATCH**

Listing 1: To achieve IBM PC compatibility, this patch overlays the interrupt table of the NEC APC III. The program makes use of undefined interrupt locations and stores an attribute-translation subroutine at address (CS:IP) 10:0. The first part of this program, Copycode, accepts the IBM character attributes and translates them into NEC display standards. The second part of the program, Transfer, patches the interrupt locations to suit the IBM PC keyboard, disk, printer, and video drivers. Besides these connections, Transfer loads the IBM compatibility subroutine and, after the copy operation, returns to MS-DOS.

```

; ***** Standard NEC APC III BIOS calls won't be affected. ***** ;
;
;         assume cs:code
code     segment public 'code'
;
; COPYCODE — NEC APC III patch at address 10H:0H (CS:IP)
;
copycode proc
    cmp     ah,0           ; In case an application program sets
    jnz     nomode        ; a new video mode, the mode number must
    mov     cs:mode,al    ; be stored (CS:MODE) before
    db     0eah           ; the JMP to the NEC APC III interrupt
    dw     0f70h          ; subroutine can take place (F800H:0F70H).
    dw     0f800h         ;
nomode:  ;
    cmp     ah,0eh        ; Otherwise, the service requested (passed
    jz      breg           ; in register AH) indicates whether special
    cmp     ah,09h        ; action is necessary or not. The codes
    jz      breg           ; 06H, 07H (scroll page), 09H, 0AH (write
    cmp     ah,0ah        ; character), and 0EH (Teletype) require
    jz      breg           ; patching.
    cmp     ah,6          ; Both scroll operations pass the display
    jz      bhreg         ; attribute in register BH. All other
    cmp     ah,7          ; operations use register BL.
    jz      bhreg         ;
    db     0eah           ; All other codes are directly passed
    dw     0f70h          ; to the video-interrupt subroutine.
    dw     0f800h         ;
bhreg:  ;
    push   bx             ; In case BH contains the attribute, the
    mov    bl,bh          ; register is saved and BH copied into BL.
breg:   ;
    cmp    byte ptr cs:mode,4 ; Attributes are available only for
    jc     textmode       ; text modes (0, 1, 2, 3).
    mov    byte ptr cs:newattr,1 ; Text within a graphics mode (> 4)
    jmp    return         ; is displayed in one color only!
    ; ***** CURRENT B/W LIMITATION *****
textmode: ;
    mov    byte ptr cs:newattr,0 ; Within the text modes, bit 7 of
    test   bl,80h         ; BL specifies a blink bit, which
    jz     noblink        ; must be translated into the
    or     byte ptr cs:newattr,2 ; appropriate NEC attribute.
noblink: ;
    test   byte ptr cs:mode,1 ; Color modes are treated differently.
    jz     mono           ; The patch rotates the
    ror    bl,1           ; RGB information into the highest
    ror    bl,1           ; NEC attribute positions, clears
    ror    bl,1           ; remaining bits, and updates the
    and    bl,0e0h        ; NEC attribute.
    or     byte ptr cs:newattr,bl ;
    jmp    return         ;

```



## NEC APC III PATCH

```

mono:
    or    byte ptr cs:newattr,80h ; In monochrome mode, the intensity
                                     ; is initially set to half dim.
    test  bl,8
    jz   nointens
    or    byte ptr cs:newattr,0e0h ; Full intensity requires a change
                                     ; of the preset value.
nointens:
    and   bl,77h
    cmp   bl,0
    jnz  underlin
    and   byte ptr cs:newattr,1fh ; Having looked after blink and
                                     ; intensity, the patch can forget
    jmp   return
                                     ; about these bits.
                                     ; In case no other bits are set,
                                     ; the intensity bits are cleared to
                                     ; write black on black.
underlin:
    cmp   bl,1
    jnz  stdchar
    or    byte ptr cs:newattr,8h ; If an underline is requested, it
                                     ; must be translated into the
    jmp   return
                                     ; appropriate NEC code.
stdchar:
    cmp   bl,8
    jc   return
    cmp   bl,70h
    jnz  whitwhit
    or    byte ptr cs:newattr,4
    jmp   return
                                     ; Because the attributes are set, no
                                     ; action is required for normal characters.
                                     ; but the reverse attribute (70H)
                                     ; requires attention again and must
                                     ; be translated to suit the NEC.
whitwhit:
    or    byte ptr cs:newattr,0e4h ; Whatever else might come along
                                     ; is interpreted as writing characters
return:
    cmp   ah,8
    jnc  newbl
    pop  bx
    mov  bh,byte ptr cs:newattr
    jmp  video
                                     ; white on white.
                                     ; Finally, the services 06H and 07H
                                     ; require the new NEC attribute in
                                     ; register BH.
newbl:
    mov  bl,byte ptr cs:newattr
video:
    db   0eah
    dw   0f70h
    dw   0f800h
                                     ; All other services pass the
                                     ; display attribute in register
                                     ; BL.
mode   db   0
newattr db   0
copyend db 0
copycode  endp
                                     ; (Common NEC video interrupt at
                                     ; location CS = F800H, IP = 0F70H.)
                                     ;
                                     ; Current display mode.
                                     ; New attribute.
;
; TRANSFER the patch to the address 10H:0H
;
transfer  proc  far
start:
    xor  ax,ax
    mov  ds,ax
    mov  ax,34dah
    mov  bx,4ch
    mov  [bx],ax
    mov  ax,0a04h
    mov  bx,58h
    mov  [bx],ax
    mov  ax,2c5ch
    mov  bx,5ch
    mov  [bx],ax
    mov  ax,0
    mov  bx,40h
    mov  [bx],ax
    mov  ax,10h
    mov  bx,42h
    
```

(continued)

## Available, Reliable, Affordable Solutions for Computerization

**Little Board™/186 . . . \$499** with (128K)

Single Board 16-Bit Computer  
with SCSI/PLUS™ Bus

- Data and file compatible with IBM PC
- Three times the COMPUTING POWER of a PC
- Boots PC-DOS 2.10, 3.00
- Runs most MS-DOS generic software
- Mounts directly to a 5-1/4 inch disk drive
- Includes: 8 MHz 80186 CPU, 128K or 512K RAM, 16K-128K EPROM, 2 RS232C Serial Ports, Centronics Printer Port, Floppy Disk Controller, SCSI/PLUS™ Multi-Master bus for: hard disk / networking / I/O expansion
- Available with 512K RAM

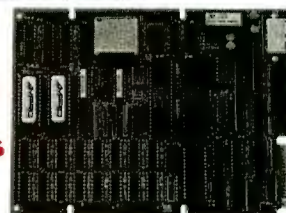

NEW  
for  
PC-DOS

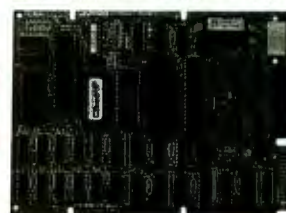

NEW  
for  
CP/M

**Little Board™/PLUS . . . \$349**

Single Board 64K CP/M Computer  
with SCSI/PLUS™ Bus

Same as Little Board/186 except:

- 4 MHz Z80A (8-bit) CPU
- 64K RAM, 4K to 16K EPROM
- CP/M 2.2 included

**Little Board™ (original) now \$289**

same as Little Board/PLUS  
except no SCSI, 4K EPROM

### Bookshelf™ Series

Cost Effective, Compact, Versatile  
computer systems

Choice of Little Board  
CPUs, 1 or 2 floppy drives  
(48 or 96 tpi); 10MB  
internal hard disk option.  
6 1/2" high, 7 1/4" wide,  
10 1/4" deep, 12 1/2 lbs.



### DISTRIBUTORS

- Argentina-Factorial, S.A. . . . . . 1-41-0018
- Australia-ASP Microcomputers . . . . . 613-500-0628
- Belgium-Centre Electronique Lempereur . . . . . 041-23-45-41
- Canada-Dynacomp . . . . . (604) 879-7737
- Denmark-Danbit . . . . . 03-66-20-20
- England-Quant Systems . . . . . 01-534-3158
- Finland-Symmetric OY . . . . . 358-0-585-392
- France-EGAL+ . . . . . 1-502-1800
- Israel-Alpha Terminals . . . . . 03-491695
- Spain-Xenios Informatica . . . . . 3-593-0822
- Sweden-AB AKTA . . . . . 08-54-20-20
- USA: . . . . . CALL AMPRO

IBM is a registered trademark of Intl. Bus. Mach.  
MS-DOS is a registered trademark of Microsoft.  
Z80A is a registered trademark of Zilog, Inc.  
CP/M is a registered trademark of Digital Research.

**AMPRO**  
COMPUTERS INCORPORATED  
67 East Evelyn Ave. • Mountain View, CA 94041  
(415) 962-0230 • TELEX 4940302

# NEC APC III PATCH

```

mov    [bx],ax      ;
mov    ax,10h      ; Prepare registers for a string
mov    es,ax       ; operation:
mov    ax,cs       ; ES — destination segment (= 10H)
mov    ds,ax       ; DS — source segment (= CS)
xor    ax,ax       ; DI — destination index (= 0)
mov    di,ax       ; SI — source index (= address COPYCODE)
mov    si,offset copycode ; CX — length of COPYCODE
mov    cx,offset copyend —
      offset copycode ;
repz   movsb       ; COPY THE WHOLE LOT!
mov    ax,4c00h    ;
mov    dx,2fh      ;
int    21h         ; and return to MS-DOS.

transfer endp

code ends
end start

```

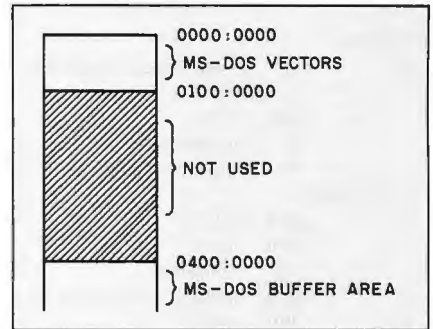

Figure 1: The patch program makes use of undefined interrupt locations and stores an attribute-translation subroutine at address 0010:0000 (all addresses in the figures are in hexadecimal notation).

LEVEL	NEC APC III	IBM PC	
0	DIVIDE BY ZERO		
1	SINGLE STEP		
2	NMI		
3	BREAKPOINT		
4	ARITHMETIC OVERFLOW		
5	CRT DUMP		
6	RESERVED		
7	RESERVED		
8	TIMER INTERRUPT		
9	KEYBOARD INTERRUPT		
A	EOI	RESERVED	
B	EOI	COMMUNICATIONS	
C	RS-232	COMMUNICATIONS	
D	EOI	DISK	
E	EOI	DISKETTE	
F	EOI	PRINTER	
10	EOI	CRT-I/O	NEC 19
11	EOI	EQUIPMENT CHECK	
12	DISKETTE	MEMORY SIZE	
13	EOI	DISK I/O	NEC 1D
14	EOI	RS-232C I/O	
15	EOI	CASSETTE	
16	8087-INTERRUPT	KEYBOARD I/O	NEC 18
17	EOI	PRINTER I/O	NEC 1B
18	KEYBOARD I/O	RESIDENT BASIC	
19	CRT I/O	BOOTSTRAP	
1A	RS-232C I/O	TIME OF DAY	
1B	PRINTER I/O	KEYBOARD BREAK	
1C	TIMER I/O	TIMER TICK	
1D	DISK I/O	VIDEO INIT	
1E	RESERVED	DISK PARAMETER	
1F	RESERVED	VIDEO-GRAPHICS CHAR	
20	MS-DOS INTERRUPTS		

EOI- END OF INTERRUPT

Figure 2: The interrupt tables of the NEC APC III and the IBM PC. Note that the APC III supports the 8087 with the IBM PC keyboard-interrupt vector; the patch therefore sacrifices the interface to the 8087.

errupt table. [Editor's note: The source code for the patch is also available for downloading via BYTEnet Listings.]

Figure 2 compares the interrupt tables of both NEC APC III and IBM PC and illustrates all of the needed changes. You have to modify the disk, printer, video, and keyboard vectors to obtain any sort of IBM PC compatibility. However, the disk, printer, and video interrupts will be fairly easy to modify because these vectors are not connected to existing interrupt programs. Rather, they address a common end-of-interrupt (EOI) service that can be replaced with an appropriate driver address. Patching the keyboard driver is more difficult because the APC III supports the number-cruncher 8087 with the IBM PC keyboard-interrupt vector. For now, achieving IBM PC compatibility means giving up the interface to the 8087.

Although there is little correlation between the IBM PC and the NEC APC III interrupt vectors, if you replace only the APC III's disk-, printer-, video-, and keyboard-driver addresses, you will be able to execute Turbo Pascal, WordStar, and the Perfect Software series. As I mentioned, the video interrupt requires that the patch translate all the IBM PC display attributes into their NEC equivalents. Therefore, the video-interrupt address, interrupt 10, refers to the patch program Copycode at ad-

(continued)



# COMPUTER WAREHOUSE

CALL TOLL FREE **1-800-528-1054**

**FREE FEDERAL EXPRESS**

**Air Express Shipping**

See Details Below

## HARDWARE

### PRINTERS

Anadex All Models	Call
Brother All Models	Call
Canon LBP-8A1	Call
C-Itoh A-10-30	\$439
F-10 Parallel or Serial	\$869
55 CPS Serial or Parallel	\$1035
8510 Parallel (Prowriter)	\$295
8510 BPI	\$315
Citizen MSP-10	\$279
MSP-15 or MSP-20	\$409
MSP-25	\$535
Comrex CR-2E	\$309
CR-4	Call
420	\$1309
DaisyLaser PR101	Call
Datasouth DS180	\$1079
DS220	\$1299
DS-PP#1	\$449
DS-PP#2	\$629
Diablo D-25	\$549
830 API	\$1484
830 ECS/IBM	\$1659
Other Printer Models	Call
Epson All Printer Models	Call
Juki 5500	Call
6000	\$169
6100	\$355
6300	\$679
NEC 2010, 2015, 2050	\$619
3510, 3550	\$989
3515	\$1009
3530	\$935
8810, 8830, 8850	\$1379
P2, P3	Call
Elit 360	\$399
Elit 370	\$389
Okidata All Printer Models	Call
Panasonic 1090	\$175
1091	\$239
1092	\$349
1093	\$429
KXP3151	\$459
Siemens PT/88 InkJet	Call
PT/89 InkJet	Call
Star Micronics	Call
All Printer Models	Call

### PRINTERS

Silver Reed	Call
EXP400 Parallel	\$209
EXP500 Parallel or Serial	\$279
EXP550 Parallel or Serial	\$389
EXP770 Parallel or Serial	\$699
Texas Instruments	Call
850 & 860 Series	Call
Toshiba P1340 Parallel or Serial	\$529
P351 Parallel	\$1029

### PLOTTERS

Enter Sweet-P600	\$759
Epson HI-80	Call

### MONITORS

Amdex All Monitors	Call
Princeton Graphic HX-12	\$445
Samsung	Call
All Models	Call
Sanyo CRT-36	\$149
Taxan 121 Green	\$125
122 Amber	\$129
420 RGB	\$389
425 RGB/Green	\$410
440	\$545
Zenith ZVM-122 Amber	\$89
ZVM-123 Green	\$89
ZVM-124	\$119
ZVM-130	Call
ZVM-133 Color/RGB	\$409
ZVM-135 Color/RGB W/Audio	\$459
ZVM-136	\$575

### VIDEO TERMINALS

Altos Smart II	\$769
Qume QVT Green 101	\$289
QVT Amber 101	\$314
Televideo 921	\$445
922	\$599
955	\$459
Wyse 50	\$529
75	\$559
Wyse 85	\$579
Zenith Z-22	\$499
Z-29	\$625
Z-49	Call

### MODEMS

AT&T	Call
4000 External	\$319
Anchor Automation	Call
Anchor Express	\$259
Mark XII	\$229
Hayes Smartmodem 300 Baud	\$129
Smartmodem 1200 Baud	\$379
Smartmodem 1200B (IBM)	\$319
Smartmodem 2400 Baud	\$609
Micromodem IIE (Apple)	\$129
Novation Smart Cat Plus	\$279
Prometheus All Models	Call
Racal-Vadic All Models	Call
US Robotics Password 1200	\$195

### BOARDS

AST Six Pack Plus	\$249
Everex	Call
Graphic Edge Card	\$319
Edge Card Full Graphic	\$299
Hercules Color Card	\$145
Graphic Card	\$289
Paradise Modular Graphic 06-1	\$259
Five Pak	\$154
Quadram E-Ram 80	\$89
Stadlink	\$325
All Models	Call
Tec Mar Graphics Master	\$449
126K Dynamic Memory	\$225
256K Dynamic Memory	\$299
Captain No Memory	\$159

### DISKETTES

Maxell MD-1 (Qty 100)	\$149
MD-2 (Qty 100)	\$189

### KEYBOARDS

Keytronics 5151	\$169
5151 Jr	\$179

### COMPUTERS

NEC PC-8201 Computer	\$315
PC-8401A	Call
8201 & 8401 Accessories	Call
Sanyo MBC-775 Portable	\$189
Televideo PM 4T	\$589
PM 16T	Call
Wyse Wyse pc Dual	Call
Wyse pc 10 Meg	Call
Zenith	Call
Z-150 All Models	Call
Z-180 All Models	Call
Z-198	Call
Z-148	Call
Z-171	Call
Z-200	Call

### DISK DRIVES

Alpha Omega Turbo 10	\$599
Turbo 20	\$849
Turbo 30	\$1109
Everex	Call
10 Megabyte	\$549
20 Megabyte	\$689
60 Megabyte Tape	\$879
Haba Habadisk for Macintosh	\$329
Iomega Bernoulli Box for IBM	Call
10 Megabyte	Call
20 Megabyte	Call
20 Megabyte Plus	Call
5 Megabyte for Macintosh	Call
Rana Elite I	\$149
Controller (W/Drive Only)	\$65



**Canon «PC»**  
PERSONAL COPIERS

Canon PC-10	\$509
Canon PC-20	\$719
Canon PC-25	\$939

## SOFTWARE

Gem Desktop	Call
Gem Draw	Call

### LANGUAGES

C Compiler (Microsoft)	\$239
Fortran Compiler (Microsoft)	\$209
Macro Assembler	\$89
Pascal Compiler (Microsoft)	\$179
Turbo Pascal 3.0	\$36

### MONEY MANAGEMENT

Dollars & Sense w/Forecast	\$95
Tobias Managing Your Money	\$96

### PROJECT MANAGEMENT

Harvard Total Project Manager	\$245
Microsoft Project	\$149

### COMMUNICATIONS

CompuServe Starter Kit	\$18
Crosstalk XVI	\$95

## IBM PC and 100% Compatibles

### UTILITIES

1 DIR	\$52
Copy II PC	\$20
Norton Utilities 3.0	\$53
Sidekick	\$29
Sidekick (Unprotected)	\$45
Sideways	\$33
Superkey	\$36

### GRAPHICS

Charmaster	\$225
PC Paintbrush	\$75
Turbo Graphix Tool Box	\$30

Word Perfect (Ver.4.0)	\$209
Supercalc 3 (Ver.2)	\$159

### WORD PROCESSORS

Leading Edge Word Processor	\$59
Leading Edge W/P with Spell & Mail	\$139
Microsoft Word 2.0	\$225
Multimate 3.3	\$215
PFS: Write	\$79
Wordstar w/Tutor	\$169
Wordstar Pro Pack	\$239

### TRAINING

Flight Simulator	\$32
Typing Instructor	\$30
Typing Tutor III	\$30

Wordstar 2000	\$239
Wordstar 2000 Plus	\$289
R:Base 5000	\$345

### INTEGRATIVE SOFTWARE

Enable	\$329
Framework	Call
Smart Software System	\$459
Symphony	Call

### SPREADSHEETS

Lotus 1-2-3	Call
Multiplan	\$115
Spreadsheet Auditor 2.0	\$65

### DATA BASE MANAGEMENT

Cornerstone	\$269
dBase II	Call
dBase III	Call
Nutshell	Call
PFS: File	\$79
PFS: Report	\$71
Quickcode	\$139
QuickReport	\$139
Extended Report Writer	\$60
Think Tank	\$99

Many other titles available.

We do not guarantee computer compatibility.

Inquiry 83 for MS DOS Products. Inquiry 84 for all others.

# COMPUTER WAREHOUSE

Order Line: 1-800-528-1054  
Order Processing: 602-224-9345  
2222 E. Indian School Rd.  
Phoenix, Arizona 85016  
602-954-6109

Store Hours: Mon-Fri 10-5:30  
Saturday 9-1  
Order Line Hours: Mon-Fri 7-5:30  
Saturday 9-1  
Order Processing Hours: Mon-Fri 10-3

Prices reflect 3% to 5% cash discount. Product shipped in factory cartons with manufacturer's warranty. Please add \$9.00 per order for UPS ground shipping. Orders 10 lbs. and under you pay for ground service, receive air service at no extra charge. Available on orders 11-20 lbs. \$16 for air service. Orders 21-30 lbs. \$26 for air service. Prices & availability subject to change without notice. Send cashier's check or money order...all other checks will delay shipping two weeks.



CWF-785



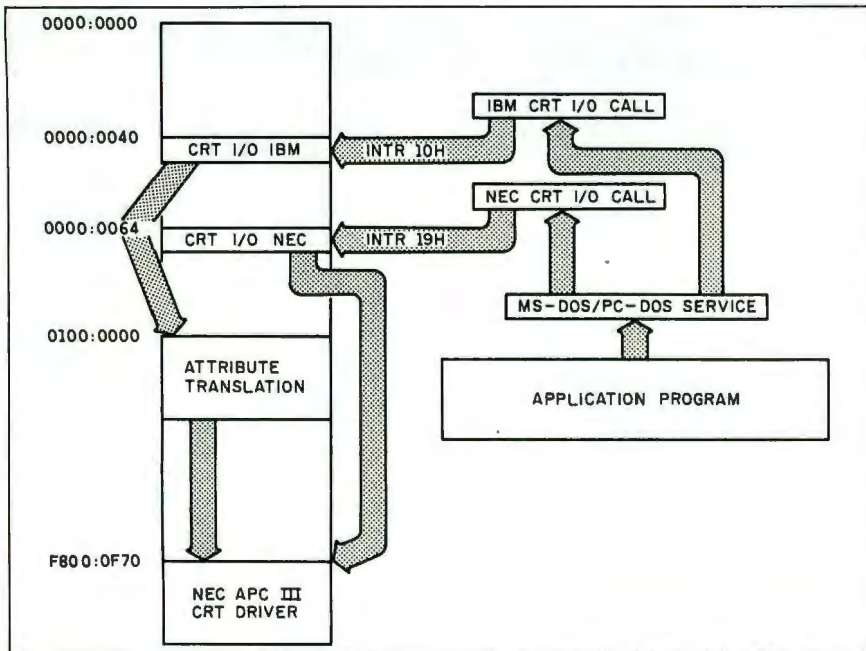

Figure 3: The program flow of the display I/O calls.

dress 10:0, which modifies the text attributes and, finally, passes control to the NEC screen driver (see figure 3).

Unfortunately, not all attributes have a matching equivalent because the display philosophy of the NEC micro-computer does not include background colors and is limited to eight foreground colors. To compensate, APC III programmers can use underlining, overlining, and reverse video in all eight colors. Figure 4 summarizes the attributes and the colors or gray shades available.

To modify an IBM PC attribute, the patch program has to recognize the display mode as well as the requested service. Only text modes (modes 0 to 3) and the selected services (06—scroll up screen, 07—scroll down screen, 09—write character and attribute, 0A—write character only, and 0E—write Teletype character) require

(continued)

# SLICER—THE SYSTEM THAT GROWS TO FIT YOUR NEEDS

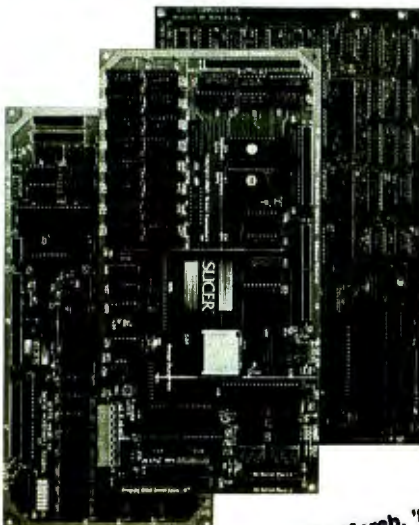

see BYTE, March, '85 page 193

## THE SLICER Real 16 Bit Power on a Single Board— Featuring the Intel 80186

- Complete 8 MHz 16-bit micro-processor on a 6" x 12" board
- 256K RAM, plus up to 64K EPROM
- SASI port for hard disk controller
- Two full function RS232C serial ports with individually programmed transmission rates—50 to 38.4K baud
- Software compatibility with the 8086 and 8088.
- 8K of EPROM contains drivers for peripherals, commands for hardware checkout and software testing
- Software supports most types and sizes of disk drives
- Source for monitor included on disk
- Bios supports Xebec 1410 and Western Digital WD 1002 SHD controller for hard disks

Fully assembled and tested only \$995  
Also available in several kit forms

## THE SLICER SYSTEM EXPANSION BOARD For expanded memory, additional ports, and real time clock

- Up to 256K additional dynamic RAM
- 2 RS232C asynchronous ports with baud rates to 38.4K for serial communication

- 2 additional serial ports for asynchronous RS232C or synchronous communication (Zilog 8530 SCC)
  - Real Time Clock with battery backup for continuous timekeeping
  - Centronics type parallel printer port
- Fully assembled and tested only \$750  
Available in several kit forms also

## THE SLICER PC EXPANSION BOARD Gives your Slicer high performance video capability

- IBM compatible monochrome video
  - Video memory provides 8 pages of text or special graphics capability
  - 2 IBM type card slots for color video, I/O expansion, etc.
  - IBM type keyboard port
- Fully assembled and tested only \$600  
Available in several kit forms also

Also available: The  $\mu$ SLICER 188 \$700; 8087 Math Co-Processor Bd. (call); 10 MB Hard Disk \$700; W.D. 1002-SHD H.D.C. Bd. \$200; Enclosures, Power Supply, and Support Hardware.

Operating systems are CP/M 86 by Digital Research, Inc. (\$85), and MS DOS by Microsoft Corporation (\$175).

MasterCard, Visa, Check, Money Order, or C.O.D. Allow four weeks for delivery. Prices subject to change without notice.

The SLICER Bulletin Board at 300/1200 Baud 612/788-5909



**SLICER™** Slicer Computers, Inc.  
2543 Marshall St. N.E., Minneapolis, MN 55418  
612/788-9481 • Telex 501357 SLICER UD





# BEST FRIEND

## Makes PC-DOS™ Easy to Use!

Best Friend™ rescues you from cryptic DOS commands. Menu driven with single key selections, Best Friend provides six easy to use functions; file services, disk services, Input/Output options, printer output redirection, typewriter, and a full-featured Scientific/Business Calculator. Always a keystroke away. Best Friend is there when you need it.

### Scientific/Business Calculator

- Over 40 math functions included
- Printable on-screen tape display
- Can be moved to reveal all screen areas
- Can return results to your program

### Electronic Typewriter

- Straight type-thru and line edit modes
- Automatic word wrap and margin controls
- Centering and underlining options

### Printer Output Redirection

Capture the printer output (even "Print Screen" data) from any program into a disk file. Great for creating custom reports that can be printed whenever desired.

### Pop-Back Feature

Use Best Friend even while running another program. "Pop-Back" to Best Friend from all your favorite programs including Wordstar™, dBASE™, Lotus 1-2-3™, BASIC, and many more. Return to your program just as you left it, or let Best Friend return a file name to your program.

### System Requirements

Best Friend can be obtained as one memory efficient program (uses 126K) or any one function may be obtained as a stand alone program. Best Friend and family will operate on an IBM-PC, XT, AT or true PC compatible. In addition, the File Services and Printer Output Redirection functions are available for most computers using CP/M-80™, CP/M-86™, and MS-DOS™

Best Friend is a TM of Elite Software Development, Inc. Wordstar is a TM of MicroPro corp. 1-2-3 is a TM of Lotus Development Co. IBM and PC-DOS are registered TM's of International Business Machines. dBASE is a TM of Ashton Tate. CP/M-80 and CP/M-86 are TM's of Digital Research. MS-DOS is a TM of Microsoft Corp.

**Elite Software Development, Inc.**  
**P.O. Drawer 1194 Bryan, TX 77806**

### File Services

- Copy, Delete, and Rename Files
- Find, View, and Print Files
- Change File Attributes (Make hidden files)
- Sort files using up to two keys
- Tag files for group copy and delete operations

### Disk Services

- Format and Copy Disks
- Make and Remove Sub-directories
- Change Disk Volume Label Names

### Input/Output Options

- Specify Printer to any Port
- Set Serial Port Parameters
- Specify one printer as the system printer and have a second printer "spool" files in the background.

## BEST FRIEND

Not Copy-Protected

Available at better dealers nationwide or call Elite Software at 1-800-648-9523, Texas 409-846-2340

<p>Carefully Describe your Computer System!</p> <p>Mine is: <input type="checkbox"/> 8 bit <input type="checkbox"/> 16 bit</p> <p>I Use: <input type="checkbox"/> PC-DOS <input type="checkbox"/> MS-DOS</p> <p style="padding-left: 20px;"><input type="checkbox"/> CP/M 80 <input type="checkbox"/> CP/M 86</p> <p>My computer's name/model is: _____</p> <p>The disk size I use is:</p> <p><input type="checkbox"/> 3 1/2" <input type="checkbox"/> 5 1/4" <input type="checkbox"/> 8"</p>	<table style="width: 100%; border-collapse: collapse;"> <tr> <td style="padding: 2px;">Best Friend (Full version)</td> <td style="text-align: right; padding: 2px;">\$84.95</td> </tr> <tr> <td style="padding: 2px;">Best Friend (Demo version)</td> <td style="text-align: right; padding: 2px;">\$14.95</td> </tr> <tr> <td colspan="2" style="padding: 2px;">(Functional, with limitations)</td> </tr> <tr> <td style="padding: 2px;">Typewriter only</td> <td style="text-align: right; padding: 2px;">\$39.95</td> </tr> <tr> <td style="padding: 2px;">Calculator only</td> <td style="text-align: right; padding: 2px;">\$39.95</td> </tr> <tr> <td style="padding: 2px;">File Services only</td> <td style="text-align: right; padding: 2px;">\$39.95</td> </tr> <tr> <td style="padding: 2px;">Printer Output Redir. Only</td> <td style="text-align: right; padding: 2px;">\$49.95</td> </tr> </table> <p style="font-size: small; margin-top: 5px;">*Add \$4 for shipping and handling to U.S. cities. Add \$10 per product for foreign orders</p>	Best Friend (Full version)	\$84.95	Best Friend (Demo version)	\$14.95	(Functional, with limitations)		Typewriter only	\$39.95	Calculator only	\$39.95	File Services only	\$39.95	Printer Output Redir. Only	\$49.95
Best Friend (Full version)	\$84.95														
Best Friend (Demo version)	\$14.95														
(Functional, with limitations)															
Typewriter only	\$39.95														
Calculator only	\$39.95														
File Services only	\$39.95														
Printer Output Redir. Only	\$49.95														

Name: \_\_\_\_\_

Shipping Address: \_\_\_\_\_

City: \_\_\_\_\_

State: \_\_\_\_\_ Zip \_\_\_\_\_

Telephone: \_\_\_\_\_

Amount: (TX 6% tax) \_\_\_\_\_

Payment: VISA MC BankDraft Check

Credit Card Exp. Date \_\_\_\_\_ / \_\_\_\_\_

Card #: \_\_\_\_\_

COD's and Purchase Orders WILL NOT be accepted by Elite Software. Texas residents add 6% sales tax. Outside USA: add \$10 and make payment by bank draft, payable in US dollars drawn on a US bank.

*If a color text mode has been specified at an earlier stage, Copycode cannot make use of the intensity flag or the IBM PC background color.*

program interaction. All other requests can be passed directly to the NEC CRT (cathode-ray tube), or display, I/O driver.

If a color text mode has been specified at an earlier stage, the program Copycode cannot make use of the intensity flag or the IBM PC background color. It generates the NEC attribute out of the remaining blink bit and the foreground RGB (red-green-blue) information (see figure 5).

In a monochrome mode, all IBM PC attributes can be displayed without problems. Figure 6 shows that the NEC APC III supports display features like overlining and vertical bars in addition to the IBM PC attributes.

The assembly-code listing provides a more detailed view of the attribute-translation process. Both program segments, Copycode and Transfer, are well documented and should provide sufficient information for future expansion.

You might have a problem with the missing link to the arithmetic coprocessor because the patch program overwrites the 8087 interrupt location. I would not regard this as serious because the 8-MHz version of the coprocessor is hard to obtain (few APC IIIs will come with the chip, and most users will probably find it too expensive). When the price comes down, however, the 8087 will be a must for a graphics environment, especially for rotation, scaling, shearing, and translation of two- and three-dimensional images.

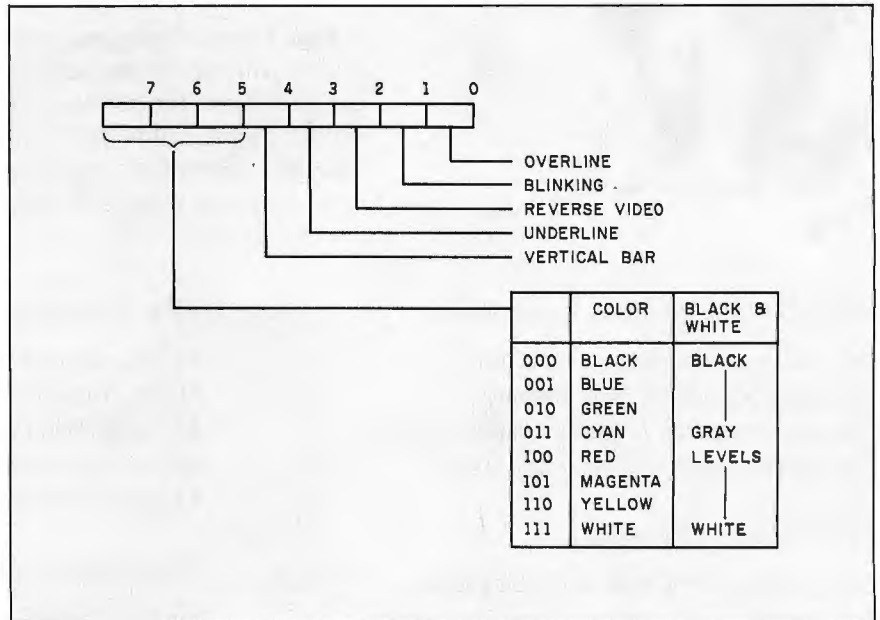

Figure 4: A summary of the NEC APC III display attributes and the available colors and shades of gray.

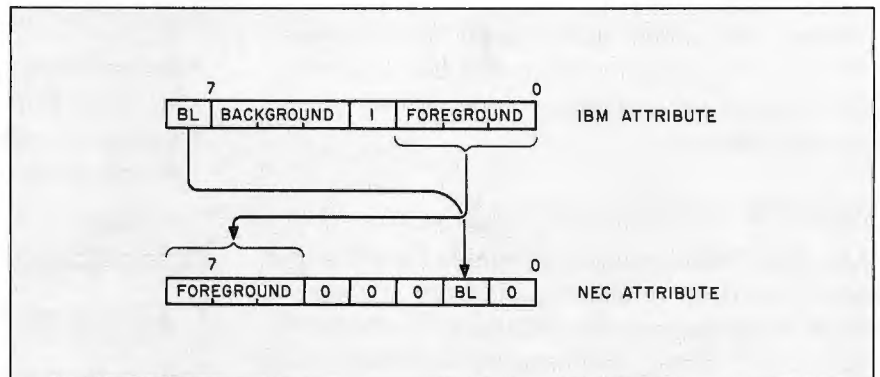

Figure 5: The translation of the color attributes. Note that the APC III cannot make use of the background color or the intensity flag.

BL	BACK	I	FORE									
				7	6	5	4	3	2	1	0	
000	000			NON-DISPLAY (BLACK ON BLACK)	0	0	0	0	0	0	X	0
000	001			NORMAL UNDERLINED CHAR	X	X	X	0	1	0	X	0
000	111			NORMAL CHAR	X	X	X	0	0	0	X	0
111	000			REVERSED CHAR	X	X	X	0	0	1	X	0
111	111			NON-DISPLAY (WHITE ON WHITE)	1	1	1	0	0	1	X	0

Figure 6: The translation of the monochrome attributes. In addition to the IBM PC attributes, the APC III supports additional features like overlining and vertical bars.



## NEC APC III PATCH

# GRAPHICS ENHANCEMENTS FOR THE NEC APC III

When the patch (see listing 1) executes, the NEC APC III will accept graphics commands and IBM screen configurations without any side effects. To increase speed, replace the Turbo Pascal graphics primitives with specific hardware drivers to handle directly the following interrupt services: draw line, draw rectangle, fill rectangle, and draw circle.

A hard Pascal interface will speed up image generation by about 20 times.

Both graphics controllers (text and graphics) and their customized hardware environment occupy roughly two-thirds of the main board and make the APC III superior to most other low-priced personal computers. The APC III can produce complex drawings or even animated graphics 40 times faster than the IBM PC. And, the APC III makes it possible to scroll quickly through WordStar text.

Another interesting aspect of the APC III's graphics support is the GSX (graphics system extension) kernel. This add-on to the operating system (MS-DOS 2.11) interfaces via interrupts to high-level languages and provides services similar to GKS (graphics kernel system) on a graphics workstation.

The basic system supplies two GSX disks. One contains the GSX kernel and mouse and NEC printer interfaces. The second keeps standard printer/plotter drivers. Unfortunately, NEC doesn't provide information about the GSX interface in the documentation; the company does discuss printers but not the programming interface. If the NEC does support the interface to either the GSX package or the NEC hardware,

non-hardware programmers should have no problem writing Pascal programs for animation or complex display applications. Many people working in our lab who were unfamiliar with Turbo Pascal and graphics hardware were able to put together animation programs in an hour or two.

For other graphics possibilities, Digital Research's DR Draw package gives you a menu-driven interface and eases the generation of graphics images. But again, the APC III manual does not explain how to interface the graphics files to a high-level language. Users unsatisfied with DR Draw might use GEM (Digital Research's Graphics Environment Manager), which provides presentation graphics and Macintosh fonts as well as free-form drawing. GEM will use the standard Macintosh-type pull-down menus, icons, and pointing devices. With GEM, the NEC APC III will be able to compete with the more expensive Macintosh computer without special print equipment.

### FUTURE ENHANCEMENTS

With its graphics hardware the APC III will challenge more computers than just the Macintosh or IBM PC. With the addition of communications software, the graphics capabilities of the APC III are sufficient to emulate graphics terminals. The operating system, which even provides an XON/XOFF protocol, will handle most of the communication interface. Standard communication packages are available, but you should evaluate them and, if necessary, change the patch program to suit the new application.

To increase the speed for trigonometric calculations without having to buy a special compiler, you will have to replace the standard keyboard driver of an IBM PC compiler with an additional keyboard-input subroutine. Then you will need to remove the keyboard-vector patch, leaving the 8087 interrupt unchanged. But losing the comfortable built-in keyboard inter-

rupt may be a reasonable sacrifice for much faster (20 to 50 times) and more accurate calculations.

With this optional chip and both graphics coprocessors, the NEC APC III seems to be the fastest low-cost IBM PC clone (with patch implemented, of course) on the market, at least until the next supermicrocomputer comes along. ■

## BUILD YOUR OWN IBM XT & IBM AT COMPATIBLE SYSTEMS

*Why Pay More—Build Your Own With Ease—Have Fun—Save A Fortune*  
**Introducing XT-16 Self-Assembly Kit**  
**At Super Low Cost**

- Including 256K XT-16 CPU Mother Board, Color Graphic Card, Floppy Controller, One DS/DD Slim Drive, Flip-Top Case, 135 W Power Supply, Keyboard, Assembly Instruction, and User's System Manual.

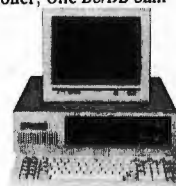

- **ONLY \$775.00**
- **AT-32 Self-Assembly Kit**
- **IBM PC/AT Fully Compatible \$Call**

### XT, AT CASE

- Same Dimension as IBM PC/AT
- For IBM PC/AT & Compatible Mother Boards \$Call
- Flip-Top For Easy & Quick Access to Inside
- IBM Style Slide-In Case Also Available \$79.00



### XT, AT POWER SUPPLY

- XT-135 W \$ 97.00 (Side Or Rear Switch)
- XT-150 W \$129.00
- AT-200 W \$Call

### XT, AT KEYBOARD

- XT—LED for Cap Lock & Num. Lock
- Big Return Key & Shift Key
- \$85**



- AT—Same Layout as IBM PC/AT
- \$Call**

### XT, AT MOTHER BOARD

#### XT-16 CPU MOTHER BOARD \$265

- IBM PC/XT Fully Compatible, Run All Popular IBM Softwares
- 8088 Microprocessor w/8087 Optional
- 8 I/O Slots
- Up to 640K Memory on Mother Board

#### AT-32 CPU Mother Board

- IBM PC/AT Fully Compatible
- 80286 Microprocessor w/80287 Optional
- 640K Standard, Upgradable to 1 MB on Board
- On Board Clock Calendar
- 8 I/O Slots **\$Call**

### PC/AT ADD-ON CARD

- AT-1 MB Memory Card ..... \$Call
- AT-1.5 MB Multifunction Card ..... \$Call
- AT-1.2 MB Floppy Disk Controller ..... \$Call

### PC/XT ADD-ON CARD

- PCP-128 Eprom Programmer ..... \$179.00
- Disk I/O Card (handle 2 Floppy Drive, Serial 2nd Optional), Parallel, Game, Clock w/cables & Software ..... \$169.00
- Color Graphic Card ..... \$109.00
- Floppy Disk controller (handle 4 drives) ..... \$ 75.00

- **OEM Dealers Welcome**
- **Please Call For Our Special Dealer Price**

## C.J. COMPUTERS CORP.

(Manufacturer & Distributor)

2424 W. Ball Road, STE B

Anaheim, CA 92804

Mail Order Hot Line: (714) 821-8922, (714) 821-8923

(IBM is a trademark of International Business Machines Corporation)

Contact us for other low prices on hardware and software.

Next Day Air Extra

# FREE SHIPPING NO SURCHARGE FOR OR

Call for latest prices.

## 10, 20, 33 and 44 MEG INTERNAL AND EXTERNAL HARD DISK SYSTEMS

Quantity 1 Quantity 10	10 MEG	20 MEG	33 MEG	44 MEG
Internal	<del>\$449</del> \$395	<del>\$549</del> \$509	\$929	\$1129
External	<del>\$599</del> \$545	<del>\$699</del> \$659	\$1029	\$1229

Externals mounted with independent power supply and fan. Fully DOS 2.X or 3.X compatible. Both Internals and Externals boot from Hard Disk. 33 and 44 Meg Internal Disks include extender power supply. The system comes complete and ready to install with the Hard Disk, Controller, Cables, Manual, Software, and Mounting Hardware. One Year Warranty.

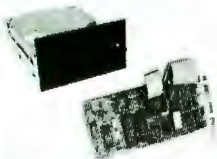

Half Height

**10, 20, and 33 Meg Hard Disks are available with combined Floppy/Hard Disk Controller Card for additional \$75.**

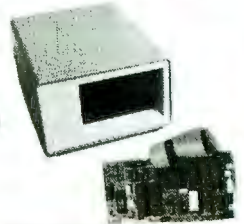

**COMPAQ®**

**CALL**

**DESKPRO 286™**

It simply works better.

**COMPAQ®**

256K, 1/360K drive,  
10 Meg Internal

Functional equivalent to a Compaq Plus.

**\$2549**

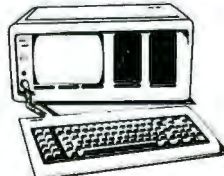

Now using 3 1/2" shock-mounted Winchester drives. The same as used in the Compaq Plus™. Also available with 2 half-height drives and 10 MEG HD- **\$2749**

Or upgrade your Compaq to a Compaq Plus™ equivalent with our 3 1/2" shock-mounted Winchester disk kit. Includes Hard Disk, Controller, Cables, Manual, software, and Mounting Hardware. One year warranty.

**\$549**

**IBM AT™**

**CALL**

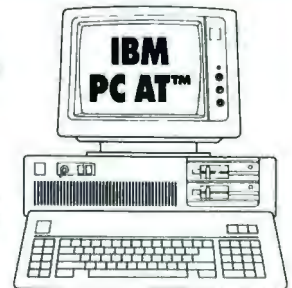

**IBM PC™**

**CALL**

IBM is a trademark of IBM Corp.



# DIAL 1-800-426-5150 FOR EASY ACCESS BARGAINS.

Call us for competitive prices on larger quantities of RAM chips.



## 64K RAM

Set of 9 chips, 200 or 150 Nanoseconds

# \$8

Quantities of 100 or more sets

# \$4<sup>50</sup>

per set.

## 256K RAM

Set of 9 chips

# \$39

Quantities of 50 or more sets.

# \$29

per set.

## AST SixPak Plus™



w/64K \$249  
w/384K \$289

One Year Warranty

- Upgradable to 384K
- Clock/Calendar
- Software included

## PC'S LIMITED Six Function Card



w/384K  
**\$197**

Two Year Warranty

- Parallel Port
- Serial Port
- Optional Game Port, \$25

## COMPAQ®

It simply works better:

## DESKPRO™

640K, One 360K Drive,  
One 10 Meg Internal Hard Drive  
Tape Backup Unit.

# \$3495

Includes Monitor



With 20 Meg Internal Hard Drive—\$3595  
With 33 Meg Internal Hard Drive—\$3975  
With 44 Meg Internal Hard Drive—\$4175

Compaq is a registered trademark and Compaq Plus and Compaq Deskpro are trademarks of Compaq Computer Corporation.

## Irwin Tape Backup System



# \$595

- Uses Floppy Controller Card
- 10.35 Meg Formatted Capacity
- Used in Compaq Deskpro.
- Half Height
- Low Power

## DISK DRIVES



MITSUBISHI

Half-Height, DS/DD

# \$85

TEAC

5.5-B, Half-Height, DS/DD

# \$95

## PARADISE™

*You can measure it.*

Paradise Modular Graphics Card™

\$269

Paradise Modular Graphics Card is a trademark of Paradise Systems Inc.

## INTEL 8087 Math Co-processor



# CALL

8087-2—CALL

80287—CALL

## SOLVE YOUR POWER PROBLEM.

## XT™ POWER 135W



# \$89

Fully XT™ compatible.  
One Year Warranty.  
Directly replaces power supply in PC.™

# 150W \$119

## IBM PC AT™ PRODUCTS



128K RAM Set \$49

20 MEG Internal Hard Disk \$559

32 MEG Internal Hard Disk \$729

Fully compatible with IBM PC AT™, Disk Controller DOS 3.0 or 3.1.

These are high-performance disk drives,

well-suited for the AT™.

IBM is a trademark of IBM Corp.

Items Due to our low prices and assurance that all our hardware is new, unused product, all sales are final. All technical support for return authorization number on all warranty repairs. Any unauthorized return subject to a 10% restocking fee. Prepaid checks, money orders, VISA, MasterCard, American Express, or approved company purchase orders are accepted. No exchange for VISA or MasterCard. 5% surcharge for American Express.

Compaq, TEAC, IBM, Irwin, and Intel are trademarks of their respective companies. All brand names are registered trademarks. We are an independent sales organization.

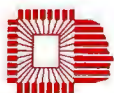

# PC'S LIMITED

OUTSIDE TEXAS, ORDERS ONLY, CALL 1-800-426-5150

7801 N. Lamar, #E-200, Austin, Texas 78752

All calls for technical support and inside Texas,  
call (512) 452-0323

Telex No. 9103808386 PC LTD

Try our own DS/DD Diskettes—  
1en for \$14 with any other purchase.



Ad number 409

# The First Idea-Processor For Programmers.

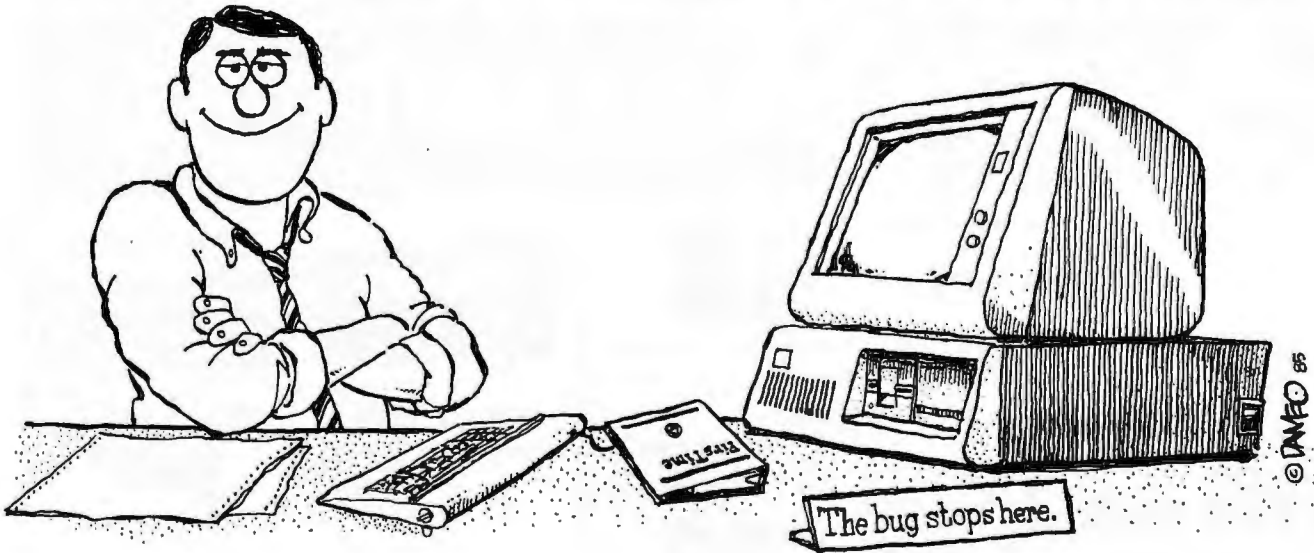

## FirsTime™

Has features no other editor has.

- Fast program entry through single keystroke statement generators.
- Fast editing through syntax oriented cursor movements.
- Dramatically reduced debugging time through immediate syntax checking.
- Fast development through unique programmer oriented features.
- Automatic program formatter.

### FirsTime is a True Syntax Directed Editor.

As the world's most advanced syntax-directed editor, FirsTime lets you work with ideas by taking care of the low-level syntax details of your program. For example, you can generate complete statement skeletons with one keystroke. Move the cursor from one procedure to the next with one keystroke. Type in code, and it's instantly formatted (you specify the rules). Type an error, and FirsTime warns you immediately. You can continue working if you wish. Later, you can use the search-for-error command to find the error and fix it.

### FirsTime Has Thorough Error Checking.

FirsTime not only checks your syntax, but also semantics. FirsTime identifies:

- Undefined variables, types and constants.
- Assignment statements with type mismatches.
- Errors in include files and macro expansions.

To Order Call: (201) 741-8188 or write:

## SPRUCE TECHNOLOGY CORPORATION

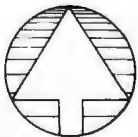

P.O. Box 7948  
Shrewsbury, NJ 07701

FirsTime is a trademark of Spruce Technology Corporation • MS-DOS is a trademark of Microsoft Corporation • IBM is a trademark of International Business Machines Inc. • Turbo Pascal is a trademark of Borland International • dBase III is a trademark of Ashton-Tate.

### FirsTime Lets You Work With Ideas.

The *Zoom command* gives you a top down view of your program logic.

The *View macro command* shows the expansions of a C macro while in the editor.

The *View include file command* instantly shows you the contents of an include file.

The *Transform command* allows you to change a statement to another similar statement, for example, a *FOR* to an equivalent *WHILE*.

The *Search for next error* command allows you to find errors throughout your program.

The *Cursor movement commands* let you traverse your program by logical elements, not just characters.

### FirsTime Works With Existing Files.

FirsTime works with standard ASCII files, so you can edit any existing source files.

FirsTime for Turbo Pascal	\$ 74.95
FirsTime for dBase III	\$125.00
FirsTime for MS-Pascal	\$245.00
FirsTime for C	\$295.00

In Germany, Austria and Switzerland contact:  
Markt & Technik Software Verlag  
Munchen, W. Germany  
(089) 4613-0



# BUILD A TRAVESTY TREE

BY PETER WAYNER

*A tree data structure improves search time  
for travesty generation*

THE TRAVESTY GENERATOR that was presented by Hugh Kenner and Joseph O'Rourke ("A Travesty Generator for Micros," November 1984 BYTE, page 129) works well for taking short initial texts, finding probabilities of various combinations, and generating a random output text. It illustrates the concept simply and uses hardly any memory, but since it checks the whole source text for each and every letter of output, the time that the program takes to finish the task depends mainly on the product of the lengths of the input string and the output string.

If a frequency table could be constructed, the output could be generated in a time that is proportional to the sum of the lengths. The time it takes to build the table would be dependent upon the length of the source, and the time to write the output would depend on the size desired. So, using a frequency table, the time to write 10,000 characters based upon a sample paragraph size of 20,000 characters would take about  $10,000a + 20,000b$  seconds where  $a$  and  $b$  are constants. The simpler version offered by Kenner and O'Rourke, which depends on the product of the

lengths, would take about  $10^{ac}$  seconds, where  $c$  is a constant. The linear behavior associated with frequency tables would be very desirable for large runs.

The problem with frequency tables is that they waste so much space. Combinations such as "qz" rarely (if ever) come up in English, but they still require space in the table. The memory that these combinations consume is immense. A paragraph of 1000 characters has at most 997 different combinations of four letters in a row, but a frequency table would take at least  $30^4$ , or 810,000, units to store this.

The best solution to this problem is to abandon the tables and replace them with a forest of 60 data trees. The root of each tree is either a punctuation mark or an upper- or lowercase letter. The branches that are attached to each root are the various combinations of letters that follow in the source string (see figure 1). In a fourth-order run of the program, each branch is four nodes long, and each node contains one combination of four letters that is found in the text. The leaf at the end of the branch contains the number of times the com-

ination is found. Given three letters, a new letter to follow it can be chosen by finding the three letters in the tree and then randomly selecting one of the twigs attached to it.

A TRS-80 Model 100 BASIC program that generates travesty text using the tree data structure described is shown in listing 1. It packs the information in one long, three-integer-wide array,  $M$ . The first number of the triplet of integers,  $M(n,1)$ , stores the letter of the branch in the form of a number that refers to the position of a letter in the string  $Q\$$ . The second number points to another branch on the same level, and the third points to the next node in the same branch of the tree. The program takes the sample text from an internal file, codes it into matrix  $T$ , and then builds the tree. Finally, it writes the output by examining the tree.

Since the Model 100 uses a BASIC interpreter, it runs much slower than Kenner and O'Rourke's Pascal program, but more abstract comparisons

*(continued)*

Peter C. Wayner is a senior majoring in math at Princeton University. He can be reached at the Department of Mathematics, Princeton University, Princeton, NJ 08544.

# DeSmet C

MACINTOSH™  
DEVELOPMENT PACKAGE \$150  
Includes Shipping

### Runs on 128K and 512K Macintosh

- Produces FINDER/SHELL applications
- Dynamic OVERLAY support

### Full K&R C Compiler

- Native Code Compiler
- In-line **asm** directive
- IEEE S/W Floating Point

### Assembler, Linker, and Librarian

### Machine Code Debugger

### Source Code Editor

### "SHELL" Interface

- Environmental Variables
- Wild-Card Expansion
- Many Built-in Functions
- Command History
- Runs Any Application

### >120 Function STDIO Library

### >450 Function Macintosh ROM Library

### 360 Page Manual

### RAM Disk

Macintosh is a trademark licensed to Apple Computer, Inc.

- Please Send Information.  
 Send Macintosh Development Package  
 Check # \_\_\_\_\_ Enclosed

SHIP TO:

ZIP

**CW A R E**  
CORPORATION

P.O. BOX C  
Sunnyvale, CA 94087  
(408) 720-9696

All orders shipped UPS surface. California residents add sales tax. Canada shipping add \$5, elsewhere add \$15. Checks must be on U.S. Bank and in U.S. Dollars. Call 9 a.m.-1 p.m. to CHARGE by VISA/MC/AMEX.

Street Address: 505 W. Olive, #767, Sunnyvale, CA 94086

## TRAVESTY TREE

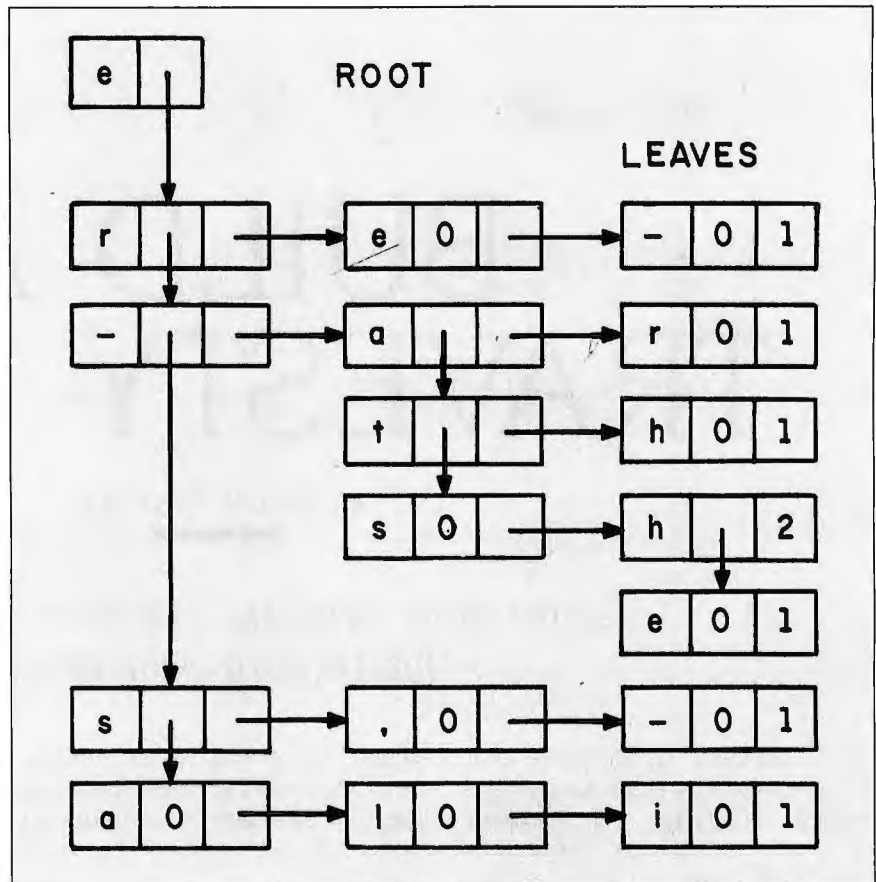

Figure 1: A diagram of the tree built for the letter "e" by the program when it processes the string "Here are the shoes, the ships, and the sealing wax." Each entry consists of one field that holds the character and two fields that hold pointers. (The root uses only one pointer field.) The last entry on a branch (its "leaf") uses the second pointer field to store frequency.

We can see from the tree that the only characters that immediately follow "e" are "r," "-", "s," and "a." The string "e\_a" is followed only by an "r," and this occurs only once. The string "e\_s" is followed by an "h" (occurs two times) and an "e" (occurs only once).

Listing 1: The TRS-80 Model 100 BASIC program that generates travesty text using the tree data structure described. The source code for this program is available for downloading via BYTEnet Listings under the name TRAV100.BAS. The telephone number is (617) 861-9774. A version of the program for the IBM PC is also available on BYTEnet under the name TRAVTREE.BAS.

```

10 REM A program to build a tree and then generate random text.
20 DEFINT T,M
30 DIM T(700),M(2000,3)
40 L=4
50 N=60
60 FOR X=1 TO N-1
65 M(X,1)=X
70 NEXT X
80 OPEN "ram:print.do" FOR OUTPUT AS 1
85 TIME$="00:00:00"

```

(continued)



**ORDER  
LINE  
800-354-7330**

# SILICON SPECIALTIES

**LOWEST PRICES  
NO SURCHARGE ON BANK CARDS**

## HARDWARE

### PRINTERS

Anadex All Models	Save
Brother All Models	Save
Canon LBP-8A1	Save
C-Itah A-10-30	\$439
F-10 Parallel or Serial	\$869
55 CPS Serial or Parallel	\$1035
8510 Parallel (Prowriter)	\$295
8510 BPI	\$315
Citizen MSP-10	\$279
MSP-15 or MSP-20	\$409
MSP-25	\$535
Comrex CR-2E	\$309
CR-4	Save
420	\$1309
DaisyLaser PR101	Save
Datsouth DS180	\$1079
DS220	\$1299
DS-PP#1	\$449
DS-PP#2	\$629
Diablo D-25	\$549
630API	\$1484
630 ECS/IBM	\$1659
Other Printer Models	Save
Epson All Printer Models	Save
Juki 5500	Save
6000	\$169
6100	\$355
6300	\$679
NEC 2010, 2015, 2050	\$619
3510, 3550	\$989
3515	\$1009
3530	\$935
8810, 8830, 8850	\$1379
P2, P3	Save
EP 360	\$399
EP 370	\$389
Okidata All Printer Models	Save
Panasonic 1090	\$175
1091	\$239
1092	\$349
1093	\$429
KXP3151	\$459
Siemens PT/88 Inkjet	Save
PT/89 Inkjet	Save
Star Micronics	Save
All Printer Models	Save
Silver Reed	Save
EXP400 Parallel	\$209
EXP400 Parallel or Serial	\$279
EXP550 Parallel or Serial	\$389
EXP770 Parallel or Serial	\$699
Texas Instruments	Save
850 & 860 Series	Save
Toahiba P1340 Parallel or Serial	\$529
P351 Parallel	\$1029

### MONITORS

Amdex All Monitors	Save
Princeton Graphic HX-12	\$445
Samsung	Save
All Models	Save
Sonya CRT-36	\$149
Taxan 121 Green	\$125
122 Amber	\$129
420 RGB	\$389
425 RGB/Green	\$410
440	\$545
Zenith ZVM-122 Amber	\$89
ZVM-123 Green	\$89
ZVM-124	\$119
ZVM-130	Save
ZVM-133 Color/RGB	\$409
ZVM-135 Color/RGB W/Audio	\$459
ZVM-136	\$575

### KEYBOARDS

Keytronics 5151	\$169
5151 Jr	\$179

### MODEMS

AT&T	Save
4000 External	\$319
Anchor Automation	Save
Anchor Express	\$259
Mark XII	\$229
Hayes Smartmodem 300 Baud	\$129
Smartmodem 1200 Baud	\$379
Smartmodem 1200B (IBM)	\$319
Smartmodem 2400 Baud	\$609
Micromodem 11E (Apple)	\$129
Novation Smart Cat Plus	\$279
Prometheus All Models	Save
Rascal-Vadic All Models	Save
US Robotics Password 1200	\$195

### BOARDS

AST Six Pack Plus	\$249
Everex	Save
Graphic Edge Card	\$319
Edge Card Full Graphic	\$299
Hercules Color Card	\$145
Graphic Card	\$289
Paradise Modular Graphic 06-1	\$259
Five Pak	\$154
Quadram E-Ram 80	\$89
Quadrant	\$325
STB	Save
All Models	Save
Tec Mar Graphics Master	\$449
126K Dynamic Memory	\$225
256K Dynamic Memory	\$299
Captain No Memory	\$159

### COMPUTERS

NEC PC-8201 Computer	\$315
PC-8401A	Save
8201 & 8401 Accessories	Save
Sonya MBC-775 Portable	\$1859
Televideo PM 4T	\$5089
PM 16T	Save
Wyse Wyse pc Dual	Save
Wyse pc 10 Meg	Save
Zenith	Save
Z-150 All Models	Save
Z-160 All Models	Save
Z-138	Save
Z-148	Save
Z-171	Save
Z-200	Save

### VIDEO TERMINALS

Alfas Smart II	\$769
Qume QVT Green 101	\$299
QVT Amber 101	\$314
Televideo 921	\$445
922	\$599
955	\$459
Wyse 50	\$429
75	\$559
Wyse 85	\$579
Zenith Z-22	\$499
Z-29	\$625
Z-49	Save

### DISK DRIVES

Alpha Omega Turbo 10	\$599
Turbo 20	\$849
Turbo 30	\$1109
Everex	Save
10 Megabyte	\$549
20 Megabyte	\$689
60 Megabyte Tape	\$879
Haba Habadisk for Macintosh	\$329
Imega Bernoulli Box for IBM	Save
10 Megabyte	Save
20 Megabyte	Save
20 Megabyte Plus	Save
5 Megabyte for Macintosh	Save
Rana Elite I	\$149
Controller (W/Drive Only)	\$65

### DISKETTES

Maxell MD-1 (Qty 100)	\$149
MD-2 (Qty 100)	\$189

### PLOTTERS

Enter Sweet-P600	\$759
Epson HI-80	Save

**ZENITH COMPUTERS**  
Always the lowest prices.  
Call us for a quote.

## SOFTWARE

### WORD PROCESSORS

Leading Edge Word Processor	\$59
Leading Edge W/P with Spell & Mail	\$139
Microsoft Word 2.0	\$225
Multimate 3.3	\$215
PFS:Write	\$79
Wordstar w/Editor	\$169
Wordstar Pro Pack	\$239

### UTILITIES

1 DIR	\$52
Copy II PC	\$20
Norton Utilities 3.0	\$53
Sidack (Unprotected)	\$45
Sideways	\$33
Superkey	\$36

### PROJECT MANAGEMENT

Harvard Total Project Manager	\$245
Microsoft Project	\$149

### GRAPHICS

Charmaster	\$225
PC Paintbrush	\$75
Turbo Graphics Tool Box	\$30

### COMMUNICATIONS

CompuServe Starter Kit	\$18
Crosstalk XVI	\$95

Word Perfect (Ver.4.0)	\$209
Supercalc 3 (Ver.2)	\$159

### LANGUAGES

C Compiler (Microsoft)	\$239
Fortran Compiler (Microsoft)	\$209
Macro Assembler	\$89
Pascal Compiler (Microsoft)	\$179
Turbo Pascal 3.0	\$36

### TRAINING

Flight Simulator	\$32
Typing Instructor	\$30
Typing Tutor III	\$30

Wordstar 2000	\$239
Wordstar 2000 Plus	\$289
R:Base 5000	\$345

### MONEY MANAGEMENT

Dollars & Sense w/Forecast	\$95
Tobias Managing Your Money	\$96

### INTEGRATIVE SOFTWARE

Enable	\$329
Framework	Save
Smart Software System	\$459
Symphony	Save

### SPREADSHEETS

Lotus 1-2-3	Save
Multiplan	\$115
Spreadsheet Auditor 2.0	\$85

### DATA BASE MANAGEMENT

Cornerstone	\$269
dBase II	Save
dBase III	Save
Nutshell	Save
PFS:File	\$79
PFS:Report	\$71
Quickcode	\$139
QuickReport	\$139
Extended Report Writer	\$80
Think Tank	\$99

Gem Desktop .. Save  
Gem Draw .. Save

**SILICON SPECIALTIES**  
2034 WEST SOUTHERN  
MESA, ARIZONA 85202  
602-969-0909  
CWSS-785

Inquiry 330 for MS-DOS Products. Inquiry 331 for all others.

Prices reflect 3% to 5% cash discount. Product shipped in factory cartons with manufacturer's warranty. Please add \$8.00 per order for UPS shipping. Prices & availability subject to change without notice. Send cashier's check or money order...all other checks will delay shipping two weeks.





Distributor  
Wanted!

## AI Language

Prolog-KABA IBM-PC  
version

Prolog-KABA is a high performance Prolog system for microcomputer developed by KABA (Kyoto Artificial Brain Associates) placing emphasis on user-friendly operation.

## FEATURES

## 1) Edinburgh DEC-10 Prolog syntax

The syntax and most of its built-in Predicates are based on Edinburgh DEC-10 Prolog which is regarded as standard Prolog system.

## 2) Screen Editor for easier modification of Prolog program

Prolog-KABA has its own screen editor 'Proedit' providing efficient editing of programs. 'Proedit' has the basic facilities of the EMACS screen editor which was developed at MIT.

## 3) High processing speed

'Prolog-KABA, written all in assembly language except for the screen editor, executes programs at a very fast speed.

Copyrighted by Kyoto Artificial Brain Associates  
Technically supported by ASTEC Inc.  
Distributed by BYNAS

Price: US \$ 400

## Common Lisp + CYKERNEL (GKS)

Common Lisp + CYKERNEL can be used as a powerful tool for development of AI application. The graphic facility provides an excellent means to interface the AI application and human.

- KCL (KYOTO COMMON LISP) can be used as common Lisp interface of CYKERNEL.
- Applicable machines: SUN 2, apollo, USTATION E15, VAX

LOVE ELECTRO LIFE  
**BYNAS**

BYNAS DIVISION, UNY CO., LTD.  
5F, DAI-NAGOYA BLDG., 28-12, 3-CHOME, MEIEKI,  
NAKAMURA-KU, NAGOYA, 450 JAPAN  
TELEPHONE: 052-581-7655 TELEX J59797 UNYHONSH

Prices are subject to change without notice.

JAPANESE QUALITY  
AT INCREDIBLE LOW PRICES

Fast delivery — We manufacture and control every stage of design and production. Many outstanding and unique products never shown before.



We are willing to take care of small orders, too.

## INQUIRE TODAY

## EAST DIGITAL CO., LTD.

2nd Fl., No. 432 Kuang-Fu S. Rd. Taipei, Taiwan, R.O.C. Tel: 703-2243, 703-2371  
Tlx: 10831 GEEMING, 20830 EDCLTD

## HONG KONG OFFICE

ATTN: MRS. CHEN Tel: 5-883-3201, 5-893-0888  
Tlx: 72400 UPTH1, 81283 1TCOY

## TRAVESTY TREE

```

90 PRINT #1, "Beginning time: "; TIMES
91 REM
92 REM Take the text from an internal file
93 REM and store it in array T.
94 REM This step can be eliminated if the
95 REM letters are processed
96 REM as they are read from the file.
97 REM
100 M = 1
110 OPEN "ram:input.do" FOR INPUT AS 2
120 A$ = INPUT$(1,2)
130 T(M) = ASC(A$) - 64
140 IF T(M) > 32 THEN T(M) = T(M) - 6
145 REM
146 REM These lines assign the appropriate
147 REM codes to punctuation.
148 REM
150 IF T(M) = -32 THEN T(M) = 53
160 IF T(M) = -20 THEN T(M) = 54
170 IF T(M) = -18 THEN T(M) = 55
172 IF T(M) = -5 THEN T(M) = 56
174 IF T(M) = -25 THEN T(M) = 57
180 IF T(M) < > 0 THEN M = M + 1: GOTO 120
182 REM
184 REM Finally a wraparound pad is added just like
186 REM the original Travesty program.
188 REM
190 FOR X = 1 TO L
192 T(M) = T(X)
194 M = M + 1
196 NEXT X
290 REM
291 REM Now build the tree using matrix M.
292 REM The letter at node n is stored in
293 REM M(n,1), the pointer to equal levels
294 REM is placed in M(n,2), and the pointer
295 REM to the next level down is M(n,3).
296 REM
300 FOR A = 1 TO M - L
310 D = 1
315 Y = M(T(A), 2)
320 IF Y = 0 THEN Y = T(A): GOTO 600
400 IF M(Y, 1) = T(A + D) THEN 500
410 IF M(Y, 2) = 0 THEN 600
420 Y = M(Y, 2)
430 GOTO 400
500 REM
505 REM If there is a match then look further until a set
506 REM of matches reaches down to the bottom level.
507 REM If not, add a branch.
508 REM
520 D = D + 1
530 IF D < L THEN Y = M(Y, 3): GOTO 400
540 M(Y, 3) = M(Y, 3) + 1
550 GOTO 999
600 REM
601 REM A subroutine to add a branch.
602 REM
610 P = L - D - 1
620 FOR X = 0 TO P
630 Z = N + X
640 M(Z, 1) = T(A + X + D)
650 M(Z, 2) = 0

```

(continued)



# MICRO CAP and MICRO LOGIC put your engineers on line... not in line.



## MY OWN WORKSTATION

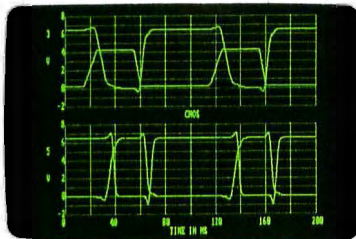

"Typical MICROCAP Transient Analysis"

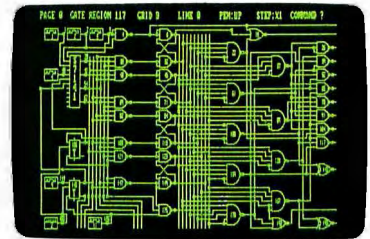

"Typical MICROLOGIC Diagram"

How many long unproductive hours have you spent "in line" for your simulation? Well, no more. MICROCAP and MICROLOGIC can put you on line by turning your PC into a productive and cost-effective engineering workstation.

Both of these sophisticated engineering tools provide you with quick and efficient solutions to your simulation problems. And here's how.

## MICROCAP: Your Analog Solution

MICROCAP is an interactive analog circuit drawing and simulation system. It allows you to sketch a circuit diagram right on the CRT screen, then run an AC, DC, or Transient analysis. While providing you with libraries for defined models of bipolar and MOS devices, Opamps, transformers, diodes, and much more, MICROCAP also includes features not even found in SPICE.

MICROCAP II lets you be even more productive. As an advanced version, it employs sparse matrix techniques for faster simulation speed and larger net-

works. In addition, you get even more advanced device models, worst case capabilities, temperature stepping, Fourier analysis, and macro capability.

## MICROLOGIC: Your Digital Solution

MICROLOGIC provides you with a similar interactive drawing and analysis environment for digital work. Using standard PC hardware, you can create logic diagrams of up to 9 pages with each containing up to 200 gates. The system automatically creates the netlist required for a timing simulation and will handle networks of up to 1800 gates. It provides you with libraries for 36 user-defined basic gate types, 36 data channels of 256 bits each, 10 user-defined clock waveforms, and up to 50 macros in each network. MICROLOGIC produces high-resolution timing diagrams showing selected waveforms and associated delays, glitches, and spikes—just like the real thing.

## Reviewers Love These Solutions

Regarding MICROCAP... "A highly recommended analog design program" (PC Tech Journal 3/84). "A valuable tool for circuit designers" (Personal Software Magazine 11/83).

Regarding MICROLOGIC... "An efficient design system that does what it is supposed to do at a reasonable price" (Byte 4/84).

MICROCAP and MICROLOGIC are available for the Apple II (64k), IBM PC (128k), and HP-150 computers and priced at \$475 and \$450 respectively. Demo versions are available for \$75.

MICROCAP II is available for the Macintosh, IBM PC (256k), and HP-150 systems and is priced at \$895. Demo versions are available for \$100.

Demo prices are credited to the purchase price of the actual system.

Now, to get on line, call or write today!

## Spectrum Software

1021 S. Wolfe Road, Dept. B  
Sunnyvale, CA 94087  
(408) 738-4387

# New 128K SBC with Hard Disk Controller



Only \$ **595.**

4" x 8"

- No Hard Disk Controller required
- No terminal required. Includes Video Controller and CP/M® 3.0
- ST-506 Interface on board
- Floppy Disk Controller runs any size floppy drive
- OEM Discounts Available

Other models include: CP/M® 2.2, 64K or 256K RAM, Time of Day Clock, EPROM, Peripheral Expansion & RGB Color Video Display

**128K SBC Includes:**

- 6 MHz Z80B®
- Video Controller
- 2 Serial Ports
- 4 Parallel Ports
- Source Code and Drivers
- I/O Expansion
- Floppy and Hard Disk Controllers
- CP/M® 3.0

To order or enquire, call us today. Megatel Computer Technologies Toronto Engineering Office (416) 745-7214. Or write our U.S. Sales Office 1051 Clinton St., Buffalo N.Y. 14206  
 CP/M is a registered trademark of Digital Research Inc.  
 Z80B is a registered trademark Zilog Inc.

**megatel**

## TRAVESTY TREE

```

660 M(Z,3)=Z+1
670 NEXT X
680 M(Y,2)=N
690 M(Z,3)=1
700 N=N+L-D
710 GOTO 999
990 REM
992 REM Close the loop and proceed on.
993 REM
999 NEXT A
1000 REM
1001 REM Generate a P-character-long text of order L,
1002 REM by searching the tree of (l-1)-tuples that match.
1004 REM Then choose one randomly.
1005 REM
1050 PRINT #1,"Time to form tree: ";TIMES$
1060 P=400
1100 PRINT #1,"M=number of seed letters=";M
1110 PRINT #1,"N=number of nodes used=";N
1120 PRINT #1,"L=depth=";L
1130 PRINT #1,"P=size of output=";P
1140 GOTO 1300
1145 REM
1150 REM A short section to print the tree if needed.
1160 REM
1200 FOR X=1 TO N
1210 PRINT #1,USING "####";X;
1220 PRINT #1,USING "####";M(X,1);
1230 PRINT #1,USING "####";M(X,2);
1240 PRINT #1,USING "####";M(X,3);
1250 NEXT X
1260 REM
1300 REM Begin the text generation using Q$
1301 REM whose i-th character corresponds
1302 REM with the tree code i.
1303 REM
1310 DIM Q$(60)
1320 Q$="ABCDEFGHIJKLMNOPQRSTUVWXYZ
abcdefghijklmnopqrstuvwxyz ,;"
1330 A=0
1331 REM
1332 REM Use array S for sliding storage of
1333 REM the last I characters printed. Use
1334 REM modulo arithmetic to keep track.
1335 REM
1340 DIM S(L)
1350 X=INT((M-L)*RND(1))
1360 FOR Z=1 TO L
1370 S(Z)=T(X+Z)
1380 NEXT Z
1390 REM
1391 REM A letter has been found. Go down
1392 REM one level on the tree.
1393 REM
1400 REM
1405 Y=M(S((A MOD L)+1),2)
1410 FOR X=1 TO L-2
1420 IF M(Y,1)=S(((A+X) MOD L)+1) THEN 1450
1430 Y=M(Y,2)
1440 GOTO 1420
1450 Y=M(Y,3)
1460 NEXT X
1500 IF M(Y,2)=0 THEN 1570
    
```

(continued)

# WORD FINDER™



## SYNONYM FINDER™

A Computerized Thesaurus  
 90,000 Synonyms For Over 9,000 Key Words

Improve your writing by finding the perfect word. Put your cursor on a word and pop up a window of words with similar meaning. Pick one, and voila, your new word replaces your old word. It's so fast and easy you'll use it all the time. Works right within WordStar (3.0, 3.3, 2000), Multi-mate, Word Perfect, MS Word, IBM Writing Ass't., and Pfs-Write. Specify word proc., computer, and operating system (MS/PC DOS or CP/M 80).  
 Name \_\_\_\_\_

"I recommend Word Finder from Abandon to Zeal.

- Peter McWilliams  
 Special introductory offer. only \$79.95! (Regularly \$124.95). Add \$2.50 shipping and NYS residents add sales tax.  
 Okay! My order is enclosed for

\$ \_\_\_\_\_ Check one:  
 Check  VISA  
 MC  COD

### Writing Consultants

A Division of Microlytics  
 Suite 410, 300 Main St., East Rochester, N.Y. 14445  
 Orders only: 800-828-6293 Info: 716-377-0130



# XEROX

## Three more firsts from the people who invented the wheel.

From day one, Xerox and Diablo have been known as the two best names in daisywheel printers. And now there are three more in the Xerox line to choose from.

The Xerox Advantage D-25 Diablo printer turns out letter quality documents quickly and quietly. And it does all that for the price of a dot matrix printer.

At 80 c.p.s., the D-80IF is the fastest daisywheel printer ever made by Xerox. It has a built-in double bin

sheet feeder. As well as the capacity to handle up to 16 computers at once.

Then there's the D-36. It's so reliable, it averages 4,000 hours of printing

between maintenance calls.

And each of these new printers is compatible with most computers on the

market, including the IBM-PC.

So if you're looking for the latest in daisywheel printing technology, call 1-800-833-2323, ext. 25, your local Xerox office, an authorized Diablo or Xerox dealer or send your business card to Xerox Corporation, Dept. 25192, P.O. Box 24; Rochester, NY 14692.



Xerox Advantage  
D-80IF Diablo Printer

Xerox Advantage  
D-36 Diablo Printer

Xerox Advantage  
D-25 Diablo Printer

For more information from Xerox, Circle 395 on the Reader Service Card.

XEROX®, Diablo® and the identifying numbers herein are trademarks of XEROX CORPORATION. IBM® is a registered trademark of International Business Machines Corporation.

```

1510 Y1 = Y
1515 Z = 0
1520 Z = Z + M(Y,3)
1530 Y = M(Y,2)
1535 IF Y > 0 THEN 1520
1540 Z = INT(Z * RND(1) + 1)
1545 Z = Z - M(Y1,3)
1550 IF Z > 0 THEN Y1 = M(Y1,2):GOTO 1545
1560 Y = Y1
1565 REM
1566 REM A letter is found. Print it and add it
1567 REM to the list.
1568 REM
1570 Z = M(Y,1)
1574 S(((A + L - 1) MOD L) + 1) = Z
1580 PRINT #1, MID$(Q$, Z, 1);
1590 A = A + 1
1600 IF A < P THEN 1400
1610 PRINT #1, " "
1620 PRINT #1, "Finishing time: "; TIME$
1630 PRINT #1, " "
1640 PRINT #1, " "
1650 END
    
```

can be made by looking at the increases in time the programs take to process larger input files. To do so, I took the opening paragraph of Vladimir Nabokov's *Pnin* and generated 500 characters of fourth-order text. Then I took 1741 letters of George Bernard Shaw's introduction to *Man and Superman* and produced a 10,000-character text.

Using the formula given by Kenner and O'Rourke for their Pascal program, the two runs would take  $0.8k$  and  $27.6k$  seconds, respectively. (Here,  $k$  is a system constant.) My program took 5.5 and 81.5 minutes, respectively. Consequently, while the second program would have taken 32 times longer than the first with the Kenner and O'Rourke program, it took only 14 times longer with mine. So as the problems get larger, the advantage of using a tree structure becomes apparent. ■

## Verbatim Datalife

Preserving your data is vitally important. Lose it and you've lost both time and money. That's why Verbatim Datalife Diskettes have 6 data-shielding improvements for greater disk durability and longer life. They come standard with the 5 year warranty that's 5 times longer than the industry standard—it guarantees trouble-free recording, storage, and retrieval. And to help introduce you to the Verbatim quality standard we're running a special offer on many of their products, including—Datalife and Verex Diskettes, Cleaning Kits, Disk Drive Analyzers.

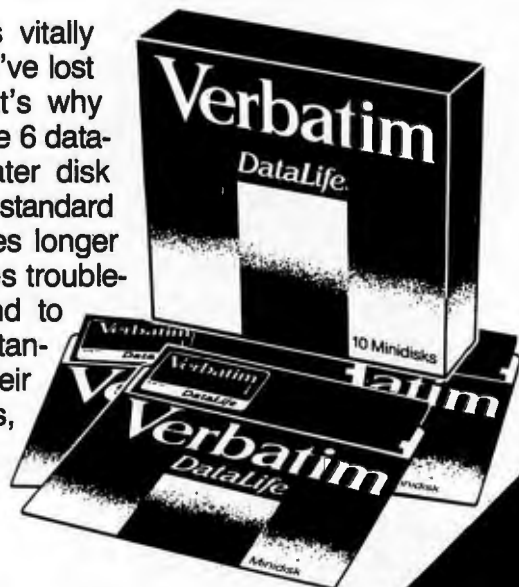

What separates us from our competition? Simply a combination of the best service in the industry, highly competitive pricing, and an ever widening range of products. Above all we care about our reputation and are willing to work on a lower margin while delivering what others only claim—and we do it all on a day-in day-out basis.

This fall 1/4 million subscribers to *Byte* magazine will be receiving our catalog with a special discount offer on the cover. We strongly feel that if you try us just once you'll join our list of satisfied confident customers. Lyben Computer Systems wants to be your source for computer supplies and accessories.

## Lyben Computer Systems

**WATCH  
FOR  
OUR  
FALL  
CATALOG**

1050 E. MAPLE RD. • TROY, MI 48083 • (313) 589-3440



# ITT INTRODUCES THE FASTEST PC IN THE WORLD. BECAUSE TIME IS MONEY.

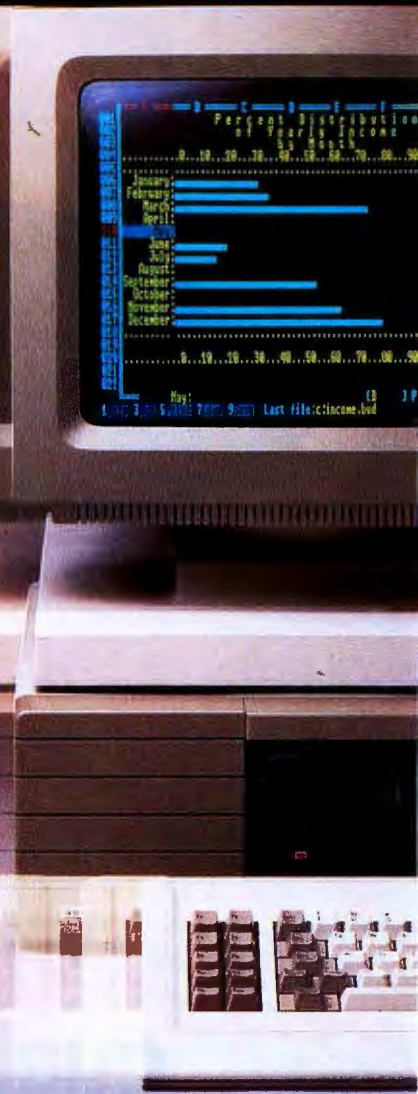

The faster you can do a job, the faster you can do another. And the more jobs you do, the more money you make.

A simple business principle around which we've craftily designed the ITT XTRA™ XP.

A personal computer bursting with the speed and power you need to move ahead and stay ahead. Over three and a half times faster and fully compatible with the IBM XT. Twenty-five percent faster than the AT. And twenty-five percent faster than the AT on a Lotus recomputation.

Example. A spreadsheet

that once took 32 seconds to compute now takes a mere 9 seconds.

Time savings for other business tasks are equally staggering.

Imagine all the extra muscle of the 80286 Intel microprocessing chip conveniently packaged in a very small space.

And imagine the very same tilt-and-swivel monitor, built-in telecommunications port, IBM compatibility and the host of other computer niceties that have made the whole family so successful.

Now stop imagining. And start dialing.

Call (800) 321-7661, or in California, (800) 368-7300 today.

We'll tell you your nearest ITT authorized dealer of the fastest PC in the known world. The ITT XTRA XP.

And call quickly. Before the rest of the business world passes you by.

Faster than you can imagine.

**ITT**  
PERSONAL COMPUTERS

## HELPING AMERICA WORK SMART.

© 1985, ITT Systems, Inc.  
IBM XT and AT are registered trademarks of International Business Machines. Intel 80286 is a registered trademark of Intel Corporation.  
The new ITT XTRA™ XP is scheduled to be available summer of 1985.





## You can still buy quality and dependability at a reasonable price.

That's exactly what we drive home at Viasyn. We offer you a whole line of CompuPro® IEEE 696/S-100 Bus boards. Along with single- and multi-user systems compatible with over 3,000 standard business applications, plus a wide variety of scientific and industrial programs. Each one's a value our competition finds hard to beat.

You can choose from a broad range of CPU boards, memory boards, disk controllers, network and interface boards, plus PC Video, in color or black and white. You can mix or match 8-bit and 16-bit software on the same machine or on different machines. And pick just the power and memory you need. Object: to grow and multiply in capabilities, at optimum cost efficiencies. Without sacrificing quality or dependability.

If that's what you're driving for, write us for our new short-form catalog or simply call our toll-free number.

# VIASYN™

The CompuPro People

## Where Computers Grow

26538 Danti Court, Hayward, CA 94545-3999  
Call 800/VIASYN-1. In CA, 800/VIASYN-2. TWX: 510-100-3288 VIASYN CORP

CompuPro is a registered trademark of Viasyn Corporation.



# PRINTING PASCAL GRAPHICS

BY KELLY W. DAVIS

*A simple subroutine dumps Apple Pascal graphics to any Epson MX-series printer*

I BOUGHT MY EPSON MX-80 printer and my Apple II computer with visions of graphics like the Mona Lisa dancing through my head. But I quickly discovered that Applesoft BASIC doesn't simplify graphics creativity. In fact, it forces any would-be da Vinci to delve into the mysterious realm of machine language. As everybody knows, machine language doesn't even make addition look easy, much less drawing complex pictures.

In desperation, I reverted to one of my favorite languages—Pascal. So far, Apple Pascal has met every creative expectation but one: It doesn't come with a screen-dump command. This might not seem like a big deal to a person who has never worked on more than one picture at a time. But after 30 or 40 graphics creations, a screen-dump routine comes in handy.

So I wrote one. *Screendump* (available for downloading from BYTEnet Listings at (617) 861-9774) takes whatever graphics are current-

*Kelly W. Davis (292 Howe Ave. Apt. G, Sacramento, CA 95825) works at McClellan Air Force Base as a field service engineer and is a part-time student, majoring in mathematics.*

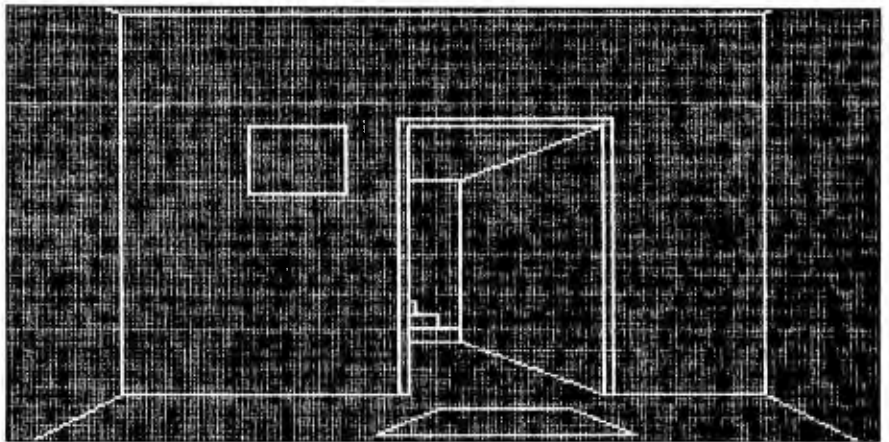

Figure 1: An example of a graphics screen printed by intrinsic unit *Screendump*.

ly on the screen and dumps them to any MX-series printer from Epson. I wrote *Screendump* as an intrinsic unit under Pascal and stored it in the library. I can call my routine in any program under the USES statement and after the TURTLEGRAPHICS declaration.

After I've programmed my graphics creation, I type PRINTGRAPH. *Screendump* scans the screen from top to bottom 29 times. Each time it looks at the Boolean equivalent of either 2 or 7 graphics screen bits, converting

them into their binary-coded equivalents. *Screendump* then stores them in a single-dimensional array (PRARRAY) 280 bytes deep, which is sent to the printer. *Screendump* takes about eight minutes. An example of the graphics screen printed by *Screendump* is shown in figure 1.

Dumping Apple Pascal graphics to a printer can be helpful if you need to develop many graphics screens, because instead of keeping them in your head, you can print each one out and enhance it individually. ■



## BUY HARDWARE AND SOFTWARE AT WHOLESALE + 8%, AND GET 14-30 DAY SOFTWARE RENTALS†...

Listed below are just a few of the over 20,000 products available at our EVERYDAY LOW PRICES! The Network carries products for Apple, IBM, CP/M and most other popular computer families.

### GAMES & EDUCATIONAL SOFTWARE FOR YOUR APPLE II & MACINTOSH

(Please add \$1 shipping and handling for each title ordered from below.)

Wholesale	Wholesale
Arrays Home Accountant-Mac Only \$65.00*	Miles Computing Mac Attack-Mac Only \$23.00*
Aston Art Portfolio & Card Shoppe 35.97*	Palatir Mac Type-Mac Only 24.50*
Bluechip Baron/Millionaire/Tycoon 28.25*	Penguin Graphics Magician 28.97*
Broderbund Loadrunner 19.75*	Penguin Pensate or Xyphus 20.50*
Broderbund Chopfitter 19.75*	Penguin Transylvania-Mac Only 20.97*
Broderbund Pmt Shop 28.75*	Professional Software Trivia Fever 22.00*
Broderbund Quiz & Draw 31.97*	Proyector Software Forbidden Quest 22.00*
CBS Mastering the GRE 53.50*	Scarborough Master Type 26.50*
CBS Murder by the Dozen 20.97*	Scarborough Run for the Money 27.00*
CBS Goren Bridge Made Easy 45.00*	Simon & Schuster Typing Tutor III 28.25*
Counterpoint The News Room 26.97*	Sir-Tech Wizardry 26.97*
Davidson Speed Reader II 37.97*	Sir-Tech Knight of Diamonds 18.97*
Davidson Math Blaster 29.97*	Sir-Tech Rescue Raiders 18.97*
Davidson Word Attack 29.97*	Sublogic Night Mission Pnball 20.30*
1st Byte Smooth Talker-Mac Only 47.00*	Spinmaker Alphabet Zoo, Face Maker 15.97*
Hayden DaVinci-House/Interiors/Landscapes 24.75*	Kindler Comp. Hey Diddle Diddle 15.97*
Hayden Sargon III 28.75*	Rhymes & Riddles, Story Machine 15.97*
Infocom Deadline or Suspended 27.00*	Spinmaker The Most Amazing Thing 20.77*
Infocom Enchanter Planetfall 20.50*	Spinmaker Delta Drawing 24.97*
Cuthroths, Witness or Zork I 22.00*	T/Maker Click Art-Mac Only 29.97*
Infocom Hitchhiker's Guide or Sealstalker 25.00*	Warner Desk Organizer 65.00*
Infocom Suspect, Sorcerer or Indiana 25.00*	Videx Fun Pack-Mac Only 19.77*
Infocom Zork II or III 23.50*	Videx Mac Checkers & Reversal 25.17*
Layared Front Desk-Mac Only 65.00*	Videx Mac Vegas-Mac Only 31.00*
Mirage Concepts Trivia 24.00*	Videx Mac Gannon & Crabbage-Mac Only 25.17*
Mark of the Unicorn Mouse Stampede 18.00*	Virtual Combinatics Micro Cookbook 21.00*

### BUSINESS SOFTWARE FOR YOUR APPLE II & MACINTOSH

(Please add \$2.50 shipping and handling for each title ordered from below.)

Apple Apple Works \$165.00*	Microsoft Word for Macintosh \$102.00*
Borland International Turbo Pascal 30.00*	Microsoft File for Macintosh 102.00*
BPI GL, AP, AR, PR, or INV 205.50*	Microsoft Multiplan for Macintosh 102.00*
Broderbund Bank Street Writer 40.00*	Microsoft Basic for Macintosh 79.00*
Central Point Copy II Plus or Copy II Mac 20.00*	Microsoft Chart for Macintosh 66.00*
Funk Software Sideways 34.00*	Monogram Dollars & Sense 52.00*
Funsort Macasm 60.00*	Monogram Dollars & Sense for Macintosh 89.98*
Haba Habadex 40.00*	Odessa Helix for Macintosh Reg's 512K 237.00*
Haba Habat 101.95*	Ontario Software Sensible Speller IV 67.50*
Haba Quartet 28.95*	Softcraft Fancy Fonts 125.00*
Harvard Mac Manager 25.50*	Software Arts TK Solver! for Mac 134.00*
Human Edge Mind Prober 110.00*	Software Publishing PFS File, Write, or Graph 68.00*
Human Edge Sales Edge 93.00*	Stevie Macintosh Numeric Keypad 74.00*
Human Edge Communication Edge 75.00*	Stevie Macintosh Numeric Keypad 74.00*
Living Videotext Think-Think-Mac Tool 85.00*	Prose Overview-Mac Only 135.00*
Main Street Inter-Mac Only 85.00*	Rio Grande Software Softmaker II 85.00*
MECA Managing your Money 105.50*	Telos Filenation for Mac 87.50*

### HARDWARE FOR YOUR APPLE II & MACINTOSH

(Please add shipping and handling charges found in Italics next to price.)

#### DISK DRIVES

Alps AP-100A Dual Apple Drives in One Case \$309.00* (7 00)
Alps AP-100C Slimline Drive in Case 159.00* (14 00)
Apple MAC 400KB External Drive 349.95* (7 50)
Haba MAC 800KB Double sided Drive 315.00* (7 00)
Twice the Capacity-Reads Standard Disks! Micro Sci A2 143KB Drive 165.00* (5 00)
Just like Apple's Own Micro Sci Floppy Controller 55.00* (2 50)
PC Network 140K External Air Drive for Apple IIC 95.00* (2 50)
Rana Elite I 163K Drive 225.00* (5 00)
Rana Elite II 326K Drive 320.00* (7 00)
Rana Elite III 652K Drive 398.99* (10 00)
Tecmar 5MB Removable Drive for MAC 1,350.00* (29 16)
Tecmar 10MB MAC Drive 1,350.00* (29 16)
Tecmar 5MB MAC Drive Upgrade 1,295.00* (27 97)

#### BOARDS AND BUFFERS

ALS 2-Engine \$129.00* (2 50)
AST Multi II/2 -2 serial/CLK 155.00* (2 50)
Microsoft Premium Softcard IIC 243.67* (2 50)
Microtek Dumping/GX 55.00* (2 50)
Orange Micro Grappler + 90.00* (2 50)
Orange Micro Serial Grappler 78.00* (2 50)
PC Network Z80 Card 35.00* (2 50)
Quadram APIC/G Graphics Interface 62.00* (2 50)
Quadram e-RAM-80 88.00* (2 50)
Quadram Multicolor -1 Parallel/1 Serial 140.00* (2 50)
Clock Expandable to 256K Thunderware Thunderclock 104.00* (2 50)

#### MODEMS

Hayes Macromodem II w/Smartcom \$125.00* (2 50)
Novation Applecote II 174.45* (3 50)
Prometheus 1200 A Low Cost 1200 Baud Internal Modem for Apple II 276.00* (6 00)
Zoom Zoom/Modem Ite 90.00* (2 50)
Macromodem Compatible-Free Dow Jones

#### ACCESSORIES

Apple Macintosh Carrying Case \$74.00* (1 50)
Apple Macintosh Security Kit 37.00* (1 50)
Stevie Macintosh Numeric Keypad 74.00* (2 50)
Hayes Mach III Joystick w/Fire Button for IIC 31.00* (1 50)
Kensington Disk Case 20.00* (1 50)
Kensington Dust Cover for MAC or imagewriter 8.25* (1 50)
Kensington Starter Pack 54.00* (3 00)
Kensington Surge Protector 33.47* (2 50)
Kensington Swivel 21.00* (2 50)
Kensington System Saver Fan 56.97* (1 50)
Kosala MacVision 203.00* (3 00)
Kosala Keypad Touch Tablet 78.00* (1 50)
M&R Sup-R-Mod RF Modulation 44.00* (1 50)
PC Network Cooling Fan with Surge Protector & Dual Outlets 25.00* (2 50)
PC Network SSD Diskettes (Box of 10) 9.00* (1 00)
PC Network Macintosh Diskettes 21.95* (1 50)
Includes Free Flip & File Case
These Diskettes are Guaranteed for Life! No Generics! 24.50* (1 50)
Some MAC Diskettes (Box of 10)

### MEMORY CHIPS

(All Memory Chips Guaranteed for Life!)

64K Memory Upgrade Kits (9 Chips) \$6.75* (1 00)
Quantity Discounts Available!
64K Dynamic Ram Chips (Each) .75* (1 00)
256K Dynamic Ram Chips (Each) 4.35* (1 00)
128K IBM AT Piggyback Chips (Each) 7.50* (1 00)

### EXTERNAL MODEMS

Anchor Mark XII \$230.00* (5 00)
Hayes Smartmodem 300 125.00* (5 00)
Hayes Smartmodem 1200 355.00* (5 00)
Hayes Smartmodem 2400 568.00* (5 00)
Prometheus Promodem 1200 276.00* (6 00)
External 100's Hayes Compatible
U.S. Robotics Courier 2400BPS Modem 450.00* (5 00)
U.S. Robotics Password 195.00* (4 00)
LOWEST PRICE 1200BPS Modem!

### MONITORS

Amdel Video 300G Composite Green \$110.00* (3 00)
Amdel Video 300A Composite Amber 120.00* (3 00)
Amdel Video 310A IBM Type Amber 130.00* (3 00)
Amdel Color 300-Composite 215.00* (4 64)
Amdel Color 600-High Res RGB 355.00* (7 88)
Amdel Color 700-Ultra High Res 455.00* (9 83)
Amdel Color 710-700 w/Non Glare Long Phosphor 475.99* (10 48)
Princeton HX-12 RGB Monitor CALL
Princeton MAX-12e CALL
Work with Color or Mono Card! Quadram Quadchrome II New 370.00* (8 21)
640X200 RGB w/14" Screen Black Phosphor Mask/IBM Case
Samsung 12" T1 IBM Type Amber 89.50* (5 00)
A great looking/performing monochrome from the manufacturer of IBM's own color monitor
Zenith ZVM-123 Green high res 76.00* (2 50)

### TERMS & CONDITIONS

\*PC Network - Members pay just 8% above the wholesale price, plus shipping. All prices reflect a 3% cash discount. Minimum shipping \$2.50 per order. International orders call for shipping & handling charges. Personal checks please allow 10 working days to clear.

†RENT BEFORE YOU BUY - Members are eligible to join the NETWORK's Business and Game Software Rental Club and evaluate products for a full 14 (Regular) or 30 (VIP) days to see if it meets your needs. And THE NETWORK's rental charges are far less than other software rental services - just 20% OF THE MEMBER WHOLESALERE PRICE. Rental titles available in IBM/Apple/IMAC and CP/M Formats. Hardware prices highlighted by \* reflect recent major price reductions.

### GAMES & EDUCATIONAL SOFTWARE FOR YOUR IBM

(Please add \$1 shipping and handling for each title ordered from below.)

Wholesale	Wholesale
ATI How to use Multimate \$42.00*	Infocom Zork I or Witness \$20.50*
ATI Intro to DOS Vol 1 & II 23.00*	Infocom Deadline, or Suspended 27.00*
ATI Intro to BASIC 23.00*	Microsoft Flight Simulator 27.00*
Bluechip Chess (Your Toughest Opponent) 34.50*	Mouse Systems PC Paint-Turn your PC into a Color Master! 59.95*
Bluechip Millenaria/Cl Baron or Tycoon 28.25*	Scarborough MasterType 27.00*
Broderbund Lode Runner 19.75*	Sierra On-Line King's Quest 27.00*
CBS Goren-Bridge Made Easy 45.00*	Sierra On-Line Crossfire 18.00*
CBS Mastering the SAT 81.00*	Sublogic Night Mission Pnball 20.00*
CDEX Training for Word Star 37.25*	Spinmaker Alphabet Zoo, Kinder Comp. 15.97*
Comprehensive Intro to Personal Computing 32.00*	Story Machine. Face Maker. Hey Diddle. Diddle. rhymes & Riddles 36.50*
Davidson Math Blaster. Word Attack! 26.50*	Spinmaker Delta Drawing 24.97*
Davidson Speed Reader II 36.50*	Spinmaker Most Amazing Thing 20.77*
Hayden Sargon III 26.97*	Virtual Combinatics Micro Cookbook 21.00*
Individual Professor DOS 32.50*	
Individual The Instructor 24.50*	

### BUSINESS SOFTWARE FOR YOUR IBM

(Please add \$2.50 shipping and handling for each title ordered from below.)

Ashton-Tate DBase III \$310.00*	Micro Pro Wordstar 2000- 5262.00*
Ashton-Tate Framework 310.00*	MicroRim Clout 110.00*
Borland Turbo Pascal 25.75*	MicroRim RBase 5000 325.00*
Borland Side Kick (Protected) 26.00*	Microsoft C Compiler 275.00*
Borland Turbo Pascal 8087 48.75*	Microsoft Word - Latest Version 2.0 205.00*
Borland Superkey 34.75*	Microsoft Multiplan 105.00*
BPI G/ A/R or A/P 305.00*	Microsoft Mouse 107.00*
BPI Aura 265.00*	Monogram Dollars & Sense 102.00*
BPI Personal Accounting 48.00*	Multimate Multimate (Latest Version) 200.00*
Central Point Copy II PC 20.00*	Norton Norton Utilities 3.0 46.00*
Conceptual Instruments Desk Organizer 157.00*	Oasis The Word Plus 90.00*
Digital Research CP/M-86 33.00*	Open Systems P/O Sales A/R INV GL A/P Team Mgr 325.00*
Digital Research DR Logo 57.00*	Power Base Power Base 222.00*
Digital Research Gem Desktop 73.00*	Real World GL A/P A/R or OE/INV 345.00*
Enertronics Energraphics with Plotter Option 235.00*	Rossoft ProKey Version 3 74.00*
Funk Software Sideways 34.00*	Ryan MacFarland MR COBOL (Dev System) 570.00*
Harvard Harvard Project Manager 185.00*	Sanna Sanna II Word Processor 227.00*
Harvard Total Project Manager 240.00*	Sanna Word - 320.00*
Hayes Smartcom II - New V100 Emulator 68.00*	Satelite Software Word Perfect 195.00*
Human Edge The Management Edge 137.50*	Softcraft Fancy Fonts 125.00*
Human Edge The Sales Edge 110.00*	Softstyle SET - IV 35.00*
Human Edge Mind Prober 26.50*	Software Arts TK Solver 222.00*
Lifetime Volkswriter Deluxe 135.00*	Software Publishing PFS File, Write, Graph 68.00*
Lotus Development Lotus 1-2-3 265.00*	Software Publishing PFS Report 64.00*
MDBS KnowledgeMan 245.00*	Sorcim SuperCalc III 159.00*
Micro Pro Wordstar 2000 222.00*	Xanaro Ability 252.00*

### HARDWARE FOR YOUR IBM

(Please add shipping and handling charges found in Italics next to price.)

#### DISK DRIVES

Apparat 512K Memory Board with 64K I/Omega Bernoulli Box Dual \$132.00* (2 85)
2,275.00* (49 14)
IBM Drives
Maynard WS-1 10MB Internal Hard Disk 730.00* (15 77)
Maynard WS-2 same as WS-1 but with SandStar Floppy Controller (uses 1 slot) 930.00* (20 30)
PC Network 10MB INTERNAL Height Autoboot Drive - New lower price 385.00* (8 32)
PC Network 10MB Internal Tape Backup Same unit used in Compaq's DeskPro! 495.00* (10 26)
PC Network Half Height Drives Our Volume Lists us import these Brand Name Drives Direct from the Source
Tandon TM 100-2 Full Height DSDD Drives 93.00* (2 20)
Tandem 25MB E External Hard Disk with 60MB Tape Backup 2,375.00* (51 30)
Teac FD 55-B Half Height DSDD Drives 90.00* (1 94)
Teac I 2MB Half Height DSDD Drive for AT 110.00* (2 40)

#### MULTIFUNCTION CARDS

Apparat 256K Memory Board with 64K \$81.00* (1 75)
AST Six Pack Plus with 64K 222.00* (2 50)
AST Advantage for AT 120.00* (2 50)
Environ Magic Card/64K 375.00* (2 50)
ORCHID Blossom w/64K 200.00* (2 50)
Full Six Pack Features with Networking Capabilities
Quadram Improved Quadboard w/OK 170.00* (2 50)
Tecmar Caplan Multifunction Card w/OK 146.00* (2 50)

#### MODEMS

AST Sharp! Short Slot 1200 Baud Internal Modem \$345.00* (2 50)
Hayes Smartmodem 1200B with New Smartcom II V100 Emulator 317.00* (2 50)
Hayes Smartmodem 1200B Alone 265.00* (2 50)
Prometheus Promodem 1200B Internal Modem 225.00* (2 50)
Quadram Quadmodem II 1200 Baud Half Card w/Crossstalk XVI 275.00* (2 50)

#### VIDEO CARDS

Hercules Color Card w/Parallel Port \$142.00* (3 20)
Hercules Monochrome Graphics Card 273.00* (2 50)
Paradise Modular Graphics Card 244.00* (2 50)
Periyet Bob Card Ultra High Res Color 365.00* (2 50)
STB Graphics Plus II 235.00* (2 50)
(smultaneous Mono Graphics & Color)

#### ACCESSORIES

Brand Name DSDD Diskettes Guaranteed for Life! Not Generic! \$12.99* (1 00)
DSDD Bulk Rate Special .81* ea.
Packaged in 50 with sleeves and labels Guaranteed for Life!
PC Network Replacement 130 Watt IBM-PC Power Supply-Gives your PC the same Capacity as an XT Good for add in Tape Drives (without need for a piggyback unit) and large capacity disk drives
SMA PC Documents, Keyboard Templates for Lotus/DBase/Ultimate and others (Each) 9.99* (1 00)

### COMPLETE SYSTEMS

Apple Macintosh Base System AT&T 7300 Unix PC \$3,699.00* (79 90)	CALL	Columbia Desktop & Portable Systems CALL
TOMB Hard Disk/1 Floppy/512K	IBM PC Base System 20SDDD/FDC/256K \$1,495.02* (32 55)	IBM PC Professional Hard Disk 1,846.82* (40 75)
COMPAG Hard Disk Portable 1040/1040/1 Floppy/256K 2,285.00* (49 35)	IBM PC/AT Base System - 2MB Floppy/256K 1,349.00* (68 00)	Sanyo MBC 775 "Lowest Cost Compatible" 620.00* (13 33)
COMPAG Desk/Pro/Tape Backup System w/640K/1 Floppy/10MB Hard Disk/10MB Tape Drive/Monitor 3,018.14* (65 20)	Sanyo MBC 775 Color Portable IBM Clone 2 Drives/Color Monitor/256K 1,775.00* (38 00)	
Citizen MSP-10 NEW 1600CPS/80C/L/Fnc + Trac \$280.00* (6 05)		
Citizen MSP-15 NEW 1600CPS/132C/L/Fnc + Trac 410.00* (8 86)		
Citizen MSP-20 NEW 2000CPS/80C/L/Fnc + Trac 410.00* (8 86)		
Citizen MSP-25 NEW 2000CPS/132C/L/Fnc + Trac 530.00* (11 45)		
C. Hoh F1040 Stenwriter 40 CPS LQ 875.00* (18 90)		
C. Hoh Prowriter 8510 AP 825.00* (6 16)		
Epson LX-80 100CPS/80C/LQ Mode New Model! 205.00* (4 43)		
Epson FX-85 315.00* (6 85)		
Epson FX-185 440.00* (9 50)		
Epson LQ 1500 CALL		
NEC 2030 20CPS/LQ Parallel 605.00* (13 00)		
NEC 2050 20CPS Letter Quality Printer 605.00* (13 00)		
NEC 3530 33CPS/LQ Parallel 960.00* (20 74)		
NEC 3550 33CPS Letter Quality Printer 860.00* (20 74)		
NEC 8850 55CPS Printer 1,330.00* (28 73)		
Okidata M1 182 New 120CPS/LQ Model FRC/IBM Graphics + more 200.00* (4 34)		
Okidata M1 192 New Sleek Design! 160CPS/LQ Mode/Fnc/IBM Graphics 325.00* (7 35)		
Okidata NEW/Color 20 80CPS/100 + Color/1 Q Mode/IBM Graphics + More (Requires Interface) 109.00* (2 35)		
Okidata NEW/IBM Interface for Okidata Color 2 65.00* (1 50)		
Okidata M1 84P 200CPS 132C/LQ 599.00* (12 94)		
Okidata M1 93P 160CPS Wide Platen 533.00* (11 50)		
Okidata 2410P Facemarc 350CPS 1,620.00* (35 00)		
Qume Sprint 1140 40CPS Letter Quality 1,155.00* (24 00)		
Star Micros Power type 18CPS 300.00* (6 48)		
Letter Quality		
Toshiba P1340 80C/L/144CPS 530.00* (11 45)		
Toshiba P351 New! 288CPS/132C/L 1,110.00* (23 98)		



# COMPLETE SYSTEMS

(Local warranty service available in most major metro areas)

## IBM PC BASE SYSTEM

IBM PC w/256K  
Floppy Drive Controller  
2 Double Sided Double Density Disk Drives



**\$1,495.02\***

CALL FOR LATEST IBM ANNOUNCEMENTS

CUSTOM CONFIGURATIONS WELCOME

## IBM PC HARD DISK SYSTEM

IBM PC w/256K  
Floppy Drive Controller  
1 Double Sided Double Density Disk Drive  
Half Height 10MB Disk Subsystem

**\$1,886.62\***

# COMPAQ™

**PORTABLE HARD DISK SYSTEM**  
w/256K/1 Floppy/10MB Hard Disk



**\$2,285.00\***

**DESKPRO SYSTEM WITH TAPE BACKUP**  
640K CPU/1 Floppy/10MB Hard Disk  
10MB Tape Drive/Monitor



**\$3,018.14\***

APPLE IIc



MACINTOSH BASE SYSTEM



Prices Too Low To Print!!!

\*Members pay 8% above this wholesale price plus shipping.

## 64K IBM PC MEMORY EXPANSION KITS

Quantity Discounts Available.  
Guaranteed for Life!



Set of 9 Chips  
**\$6.75\***

## BRAND NAME DISKETTES Guaranteed for Life!

(Quantity Discounts Available.)

SS/DD For APPLE II & III Box of 10 ..... **\$9.00\***  
DS/DD Box of 10 ..... **12.99\***  
MACINTOSH Box of 10 Includes free Flip & File Case ..... **21.95\***

## 1/2 HEIGHT DS/DD DISK DRIVES



The Network buys direct and makes fantastic deals with manufacturers like MPI/Tandon/CDC/Shugart/Queme/TEAC and others to bring you fantastic prices on Name Brand drives for your PC/AT/XT/jr/or Compatible.

**\$77.50\***

## INTERNAL PC HARD DISK

Low Power/Automatic Boot. Works on standard PC's and Compatibles. Includes drive/controller/cables/mounting hardware and instructions.



Full one year warranty!

10MB  
**\$385.00\***

20MB  
**\$505.00\***

**Lotus™**  
**\$265.00\***

**MultiMate™**  
Professional Word Processor  
**\$200.00\***

orders and memberships only

CALL TOLL FREE 1-800-621-S-A-V-E

In Illinois call (312) 280-0002 Validation code: B395

Inquiry 286

TM & R—Registered trademark of IBM/COMPAQ/APPLE

# PC NETWORK

GET THE NETWORK ADVANTAGE!!!

SEE WHY OVER 70,000 HAVE JOINED MAKING US THE NATION'S #1 SOURCE FOR EVERYTHING IN COMPUTING...

- **Our 600 Page Wholesale Catalog**  
Over 20,000 products priced at Wholesale + 8%. Anything you will ever need at a Consistent low price...
- **Quarterly Catalog Updates**  
Your Catalog is never obsolete! Keep on top of the newest products and latest price changes.
- **The Printout**  
Our newsletter gives you fantastic specials along with unbiased analysis of new products and industry trends.
- **10 Day Returns on any Hardware!!**  
If you don't like any hardware product—for any reason—return it for a refund.
- **1000 + Title Rental Library**  
14 to 30 day rentals on over 1000 different titles. Try before you buy!!
- **Size-Strength and Stability**  
The Network has over 100 employees, 35,000 square feet of office and warehouse, inventory valued in excess of \$5,000,000 and is ranked the largest computer product supplier in the Nation!! Our commitment is to serve our customers and our 90% repeat business rate is proof!!

## CALL TOLL FREE 1-800-621-S-A-V-E

In Illinois call (312) 280-0002

Your Membership Validation Number: **B395**

You can validate your membership number and, if you wish, place your first money-saving order over the phone by using your VISA, MASTERCARD or AMERICAN EXPRESS. Our knowledgeable service consultants are on duty Mon-Fri 8 AM to 7 PM, SAT 9 AM to 5 PM CST.

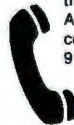

**PERSONAL COMPUTER NETWORK**  
320 West Ohio  
Chicago, Illinois 60610

Call now... Join the PC NETWORK and start saving today!



## PC NETWORK • MEMBERSHIP APPLICATION

**YES!** Please enroll me as a member in the PC NETWORK™ and rush my catalog featuring thousands of computer products, all at just 8% above DEALER WHOLESALER PRICES. I will also periodically receive "THE PRINTOUT", a special up-date on merchandise at prices BELOW even those in my wholesale catalog, and all the other exclusive, money-saving services available to Members.

**395**

I am under no obligation to buy anything. My complete satisfaction is guaranteed. Please check (✓) all boxes that apply:

### Basic Membership With 14 Days Rental

- One-year membership for \$8
- Two-year membership for \$15 (SAVE \$1)
- Business Software Rental Library for \$25 add'l. per year—with 14 day rentals
- Games Software Rental Library for \$10 add'l. per year

### Special V.I.P. Membership With 30 Days Rental

- One-year membership for \$15
- Two-year membership for \$25 (SAVE \$5)
- BOTH Business and Game Software Rental Libraries for \$30 add'l. per year—with 30 day rentals
- \*VIP members receive advance notice on limited quantity merchandise specials

Bill my credit card:  VISA  MasterCard  American Express

Account Number:

Exp. Date \_\_\_\_\_  
mo. year

Check or money order enclosed for \$ \_\_\_\_\_

Name \_\_\_\_\_

Address \_\_\_\_\_ Apt. No. \_\_\_\_\_

City \_\_\_\_\_ State \_\_\_\_\_ Zip \_\_\_\_\_

Telephone ( ) \_\_\_\_\_

My computer(s) is:  IBM PC  IBM-XT  IBM-AT  Apple II  
 Macintosh  Other \_\_\_\_\_

Signature \_\_\_\_\_

(Signature required to validate membership)

Copyright © 1984, PC NETWORK, INC.



# PERFORMANCE

THAT IS OUT OF THIS WORLD...



**\$389<sup>00</sup>**

**MODEL 2000 20MHz  
DUAL TRACE**

**\$549<sup>00</sup>**

**MODEL 3500 35MHz  
DUAL TRACE DELAYED SWEEP**

## ...AT A DOWN TO EARTH PRICE

At last! Truly affordable test equipment with no compromise in design, and features you would expect to find only on oscilloscopes costing hundreds of dollars more! JDR Instruments presents two, new, high-performance models backed by a two year warranty and technical support which is only a phone call away. Perfect for the technician or advanced hobbyist, both models feature Dual Trace capability and a variety of operating and triggering modes, including CH-B Subtract and X-Y operation.

MODEL 2000 has a 20 MHz bandwidth and 20 calibrated sweeps ranging from .2s to .2 $\mu$ s. A convenient built-in component tester provides additional diagnostic power.



INCLUDES TWO HIGH QUALITY  
1x, 10x TEST PROBES

MODEL 3500 features a 35 MHz bandwidth and exceptional 1mV/DIV sensitivity. Delayed sweep and variable holdoff allow stable viewing of complex waveforms.

**ORDER TOLL FREE  
800-538-5000  
800-662-6279 (CA)**



**JDR INSTRUMENTS**

1224 South Bascom Avenue  
San Jose, California 95128 (408) 995-5430

Inquiry 414

COPYRIGHT 1985 JDR INSTRUMENTS. EARTH PHOTO COURTESY OF NASA.  
THE JDR INSTRUMENTS LOGO IS A REGISTERED TRADEMARK OF JDR MICRODEVICES. JDR INSTRUMENTS IS A TRADEMARK OF JDR MICRODEVICES.



# 10 Years of **BYTE** Special Anniversary Supplement

NO CELEBRATION of BYTE's 10th anniversary would be complete without the acknowledgment of some of the events and contributions that helped to shape the magazine. In the too-few pages that follow, we tried to capture some of the flavor of the past 10 years.

Special thanks to all contributors and to the BYTE staff, especially Gregg Williams, who chaired the project, Richard Shuford, Rich Malloy, Mark Welch, and Stan Wszola.

#### A Microcomputing Timeline

compiled by Gregg Williams and Mark Welch.....	198
Notable Quotes.....	208
Evolution of the Microprocessor by Mark Garetz.....	209
Interview: Carl Helmers.....	216
Interview: Steve Ciarcia.....	217
Ciarcia's Prodigious Output.....	219
Interview: Robert Tinney.....	220
Tinney Favorites.....	221
Interview: Jerry Pournelle.....	222

TIME  
MACHINE

ROBERT  
BINNEY



# A MICROCOMPUTING TIMELINE

**PHOTOGRAPHED  
BY PAUL AVIS**

What follows is a modest and, we hope, correct timeline of personal computing. If the number of entries per year is any indication, then the most active years of personal computing were 1975, 1976, and 1977 and 1982, 1983, and 1984.

Although the roots of personal computing go back further, the excitement really started in January 1975, with the publication of Popular Electronics' cover story on the Altair 8800. A slogan printed on the cover of the first three issues of BYTE said it all: "Computers—The World's Greatest Toy." The slogan expressed the ideal that lured many, but few of us had the stamina and consuming fanaticism needed to make it happen; you had to design and build everything yourself, hardware and software. Most of you also had to learn electronics, mathematics, and the art of deciphering arcane, poorly written spec sheets—the phrase "by your bootstraps" took on new meaning.

By 1978, things were different; you could buy microcomputers and they would usually work, but it wasn't the same. Prior to 1978, the excitement was in saying "Look, my design works!" But when you took it for granted that it worked, the question became "What can you do with it?"; however, the answer was "Not all that much." Most systems lacked a disk drive and had 32K bytes of memory or less. The years between 1978 and 1982 were slow, evolutionary years—not too exciting, but necessary.

By late 1981, the industry was poised for growth, and IBM's introduction into the marketplace catalyzed that growth into a bumpy, breathtaking ride that shows no signs of slowing (though it did take about a year to get started, that is, to produce a significant number of IBM-related products). Personal computers finally could perform and were affordable enough to be used by people who weren't just hobbyists; that progress continues to build as computers become simultaneously cheaper and more capable.

BYTE has kept a close watch on the computer industry's growth, and we felt the need to annotate this timeline. When dates have been difficult to pinpoint, we've approximated them. In general, it has been an active and interesting first ten years.

—Gregg Williams and Mark Welch

**JULY 1974 RADIO-ELECTRONICS'  
COVER STORY IS ON THE MARK-8.**

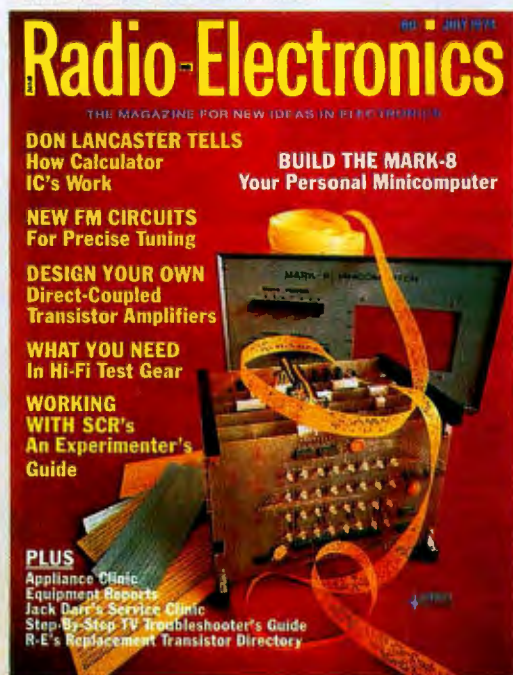



UPI/BETTANN NEWSPHOTOS

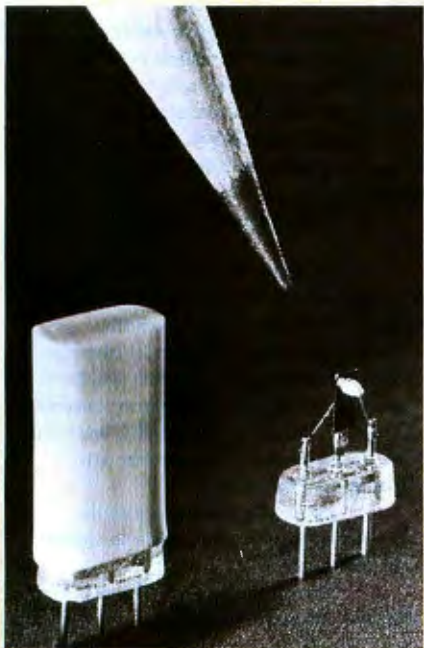

**1948 THE TRANSISTOR IS INVENTED AT BELL LABORATORIES.**

# Pre-1975

- 1948** John Bardeen, Walter Brattain, and William Shockley of Bell Laboratories invent the transistor.
- 1959** Texas Instruments unveils the first integrated circuit.
- 1964** John G. Kemeny and Thomas E. Kurtz develop the BASIC programming language at Dartmouth College.
- Digital Equipment Corp. advertises the PDP-8 minicomputer, which, at \$16,200, is "a full, general-purpose computer that scientists can afford—but it gets personal."
- 1970** OCTOBER *Scientific American* publishes Martin Gardner's first "Mathematical Recreations" column on John Conway's game of Life.
- 1971** Intel Corp. puts the 4-bit 4004 microprocessor on a single chip. Its initial price is \$200.
- 1972** NOVEMBER Intel Corp. introduces the 8008, their first 8-bit microprocessor.

- Nolan Bushnell founds Atari and ships the Pong video game.
- 1973** Scelbi Computer Consulting offers the 8008-based Scelbi-8H computer kit (\$565 with 1K byte of memory).
- FALL** Intel Corp. announces the improved 8080 8-bit microprocessor.
- SEPTEMBER** *Radio-Electronics* magazine publishes Don Lancaster's TVT-1 computer terminal project.
- 1974** Brian W. Kernighan and Dennis M. Ritchie develop the C programming language.
- SUMMER** Gary Kildall develops the CP/M operating system.
- JULY** *Radio-Electronics'* cover story is "Build the Mark-8: Your Personal Minicomputer."
- SEPTEMBER** *Creative Computing* magazine founded.

## Announcing a new era of integrated electronics

### A micro-programmable computer on a chip!

Intel introduces an integrated CPU complete with a 4-bit parallel adder, sixteen 8-bit registers, an accumulator and a push-down stack on one chip. It is one of a family of four new ICs which comprise the MCS-4 micro computer system—the first system to bring you the power and flexibility of a dedicated general-purpose computer at the cost no less than that of a single package.

MCS-4 systems provide complete computing and control functions for data systems, data terminals, testing machines, measuring systems, numeric control systems and process control systems.

The heart of any MCS-4 system is a Type 4004 CPU, which includes a sophisticated set of 45 instructions. Adding one or more Type 4001 ROMs for program storage and 4002 RAMs for rapid access memory and Type 4002 I/Os to expand the output ports.

Using no more than 16 ICs from this family of four, you can create a system with 4096 bit types of ROM storage and 5120 bits of RAM storage. When you require more than 4096 bits of RAM storage, you can use more than 16 ICs from this family of four systems. Intel's 4-bit adder and programmable ROM, Type 4001, may be substituted for the Type 4001 mask-programmed ROM.

MCS-4 systems interface easily with switches, tape, boards, displays, multiplexers, printers, readers, A-D converters and other popular peripherals.

The MCS-4 family is now in stock at Intel's Santa Clara headquarters and at our other regional offices in Europe and Japan. In the U.S., contact your local Intel representative for technical information and literature. In Europe, contact Intel at Avenue Louise 118, B-1050 Brussels, Belgium. Phone 478000. In Japan, contact Intel Japan Co., Ltd. at 1-1-1, Nishi-Shinjyuku, Shinjyuku-ku, Tokyo 163. In Singapore, contact Intel Singapore Pte. Ltd. at 111, North Bridge Road, Singapore. In Hong Kong, contact Intel Hong Kong Pte. Ltd. at 111, North Bridge Road, Hong Kong. In India, contact Intel India Pte. Ltd. at 111, North Bridge Road, New Delhi, India. In the Philippines, contact Intel Philippines Pte. Ltd. at 111, North Bridge Road, Manila, Philippines. In South Africa, contact Intel South Africa Pte. Ltd. at 111, North Bridge Road, Johannesburg, South Africa. Phone 011-264-7151.

**intel**  
delivers.

**NOVEMBER 1971 INTEL'S FIRST AD FOR THE 4004 MICROPROCESSOR IN ELECTRONIC NEWS.**



## 1975

**WINTER** Zilog Inc. develops the Z80 microprocessor, whose instruction set is a superset of the 8080's.

**JANUARY** Carl Helmers founds *Experimenters' Computer System* (ECS), which lasts for five issues before he moves to BYTE.

**JANUARY** *Popular Electronics'* cover story is "World's First Minicomputer Kit to Rival Commercial Models...Altair 8800." The Altair 8800 kit, with an Intel 8080 microprocessor, 256 bytes of memory, and a toggle-switch-and-LED front panel, sells for \$395.

**MARCH** Homebrew Computer Club founded.

**MAY** Amateur Computer Group of New Jersey founded.

**SUMMER** IMS International announces the IMSAI computer, which is essentially an improved clone of the Altair 8800.

**SUMMER** MOS Technology announces the MC6501 at \$20 and the MC6502 at \$25; at this point, the 8080 costs about \$150.

**FALL** MITS (the company that sells the Altair 8800) announces 4K-byte and 8K-byte BASIC (from Microsoft's founders Bill Gates and Paul Allen) for \$350 and \$500, respectively (\$60 and \$75 for purchasers of complete Altair systems).

**FALL** Dennis Allison publishes *Tiny BASIC*—later enhanced by many, including Tom Pittman and Li-Chen Wang.

**FALL** Sphere Corp. offers the Sphere I computer kit (6800, 4K bytes of RAM, ROM monitor, keyboard, video interface, for \$650).

**FALL** MOS Technology announces the KIM-1 microcomputer, an assembled single-board computer (6502, 1K byte of RAM, 2K-byte monitor in ROM, keypad, LED readout, cassette and serial interfaces, for \$245).

**SEPTEMBER** IBM announces the IBM 5100, the first briefcase-size computer (with BASIC, 16K bytes, and a tape cartridge storage system, for about \$9000).

**SEPTEMBER** BYTE publishes its first issue.

**SEPTEMBER** Godbout advertises the Pace kit in BYTE with "7 segment readouts for easy octal debugging."

**NOVEMBER** Southwest Technical Products Co. advertises the M6800 computer kit (6800, serial interface to terminal, monitor in ROM, for \$450). Unlike the Altair, it has no front-panel switches!

**DECEMBER** MITS unveils the Altair 680 kit (6800, 1K byte of RAM, serial interface, for \$293).

**DECEMBER** Microcomputer Associates Inc. offers the JOLT kit (6502, 512 bytes of RAM, serial interface to terminal, monitor in ROM, for \$249).

**DECEMBER** Robert Tinney's first BYTE cover.

## 1976

**JANUARY** *Dr. Dobb's Journal of Computer Calisthenics and Orthodontia* (*Running Light Without Overbyte*), a homebrew hardware and software magazine, publishes its first issue.

**MARCH** David Bunnell of MITS organizes the First World Altair Computer Convention in Albuquerque, New Mexico.

**SPRING** Texas Instruments announces its TMS9000, the first 16-bit microprocessor.

**APRIL** Apple Computer Inc. formed.

**APRIL** Cromemco Inc. advertises the Dazzler TV interface board—the first color display for a microcomputer.

**SUMMER** Keuffel and Esser (K&E) ceases its production of slide rules and donates its last one to the Smithsonian.

**JUNE** SwTPC M6800 ad promises "SOFTWARE—The flood is near. Editor and assembler now available. BASIC and more games right away. Yours for the cost of copying. WE DON'T SELL SOFTWARE—WE GIVE IT TO YOU. ENJOY IT, COPY IT, WE WON'T COMPLAIN..."

**JUNE** Scelbi releases SCALBAL, a BASIC-like language for \$49 (includes source); it runs in 8K bytes of memory or more.

**AUGUST** First floppy-disk-drive ad in BYTE (iCOM Frugal Floppy, 8-inch, for \$1195 [single quantity]).

**AUGUST** John Dilkes organizes the Personal Computing Festival in Atlantic City; it is the first microcomputer show of national scope.

**AUGUST** First portable computer: STM Systems' "BABY!" (6502, 2K bytes of RAM, bootstrap program in ROM, system software on tape, for \$850 assembled).

**FALL** Steve Wozniak proposes that Hewlett-Packard Co. create a personal computer; Steve Jobs proposes the same to Atari—both are rejected.

**SEPTEMBER** Ohio Scientific Instruments advertises OSI 400 (6502, 6572, or 6800, parallel and serial ports, 1K byte of RAM, 512 bytes of PROM, kit prices—\$140 and up).

**OCTOBER** Cromemco Inc. offers 4-MHz Z80 board for Altairs and other S-100 systems (\$395 kit, with a monitor program on paper tape).

**OCTOBER** PolyMorphic Systems advertises the S-100—based POLY 88 (8080A, 512 bytes of RAM, video/keyboard interface board, 1K bytes of ROM, cassette interface, for \$685 in kit form).

**NOVEMBER** Steve Ciarcia's first article (not Circuit Cellar).

**DECEMBER** Processor Technology advertises the Sol computer (8080, S-100 bus, 1K byte of RAM, 1K byte of PROM, 1K byte of video RAM, keyboard, cassette, serial, and parallel interfaces, BASIC-5 on cassette—kit, \$995; with dual 8-inch drives and operating system, \$1895; an assembly-language TREK-80 game, PT 8K BASIC, and 8080 FOCAL are also available). The machine was invented by Lee Felsenstein.

**DECEMBER** Michael Shrayner writes *Electric Pencil*, the first popular word-processing program for microcomputers.

**DECEMBER** Shugart announces its 5 1/4-inch "minifloppy" disk drive for \$390.



FALL 1975 THE SPHERE 1 COMPUTER KIT













**JUNE 1979 THE TI-99/4A**



**DECEMBER 1978 THE EPSON MX-80**



**JUNE 1977 THE FIRST COMPUTER CAMP**



**DECEMBER 1978 THE ATARI 800**



**DECEMBER 1978 THE ATARI 400**



**APRIL 1978 THE BYTEMASTER**



**AUGUST 1977 THE TRS-80 MODEL I**



**APRIL 1977 THE COMMODORE PET**



# 1980

**FEBRUARY** InfoWorld publishes its first issue.

**FEBRUARY** Sinclair Research announces its ZX80 computer (Z80A, 1K bytes of RAM, 4K integer BASIC in ROM, plastic membrane keyboard, \$199). Its successor, the ZX81, was later marketed by Timex for under \$100 before Timex left the microcomputer market.

**MARCH** Microsoft Corp. shows its first hardware product, the Z80 SoftCard for the Apple II at the 5th West Coast Computer Faire. The sudden availability of CP/M business software for the Apple contributes greatly to Apple Computer Inc.'s success.

**MAY** Apple Computer Inc. announces the Apple III, which is delivered a year late and has, at first, a high failure rate. The machine never becomes the replacement for the Apple II that Apple Computer wanted it to be.

**JUNE** Shugart begins selling 5¼-inch Winchester hard-disk drives.

**JUNE** Commodore Business Machines unveils the VIC-20 (6502A, 5K bytes of RAM, BASIC in ROM, serial, cassette, and modem interfaces, ROM cartridge slot, color display, for \$299).

**SUMMER** Radio Shack announces its TRS-80 Color Computer (6809E, "chicklet"-style keyboard, 4K bytes of RAM, BASIC in ROM, color display, serial and cassette interfaces, for \$399). They also announce the TRS-80 Model III, which replaced and improved their original Model I.

**SUMMER** "Zork, the Great Underground Empire" is first distributed by Personal Software Co. and later by Infocom, its creators. Infocom changed the nature of adventure games by allowing full-sentence input.

**JULY** Jerry Pournelle's "The User's Column" begins in BYTE.



**FEBRUARY 1980 THE SINCLAIR ZX80**



**MAY 1980 THE APPLE III**



**NOVEMBER 1981 THE EPSON HX-20**



**JUNE 1980 THE COMMODORE VIC-20**



**AUGUST 1981 THE IBM PC**

**APRIL 1981 THE OSBORNE I**



**SUMMER 1981 THE HAYES SMARTMODEM 300**



**SUMMER 1980 ZORK—AN EARLY ADVENTURE GAME**



# 1981

**WINTER** Tracy Kidder's *The Soul of a New Machine* (New York: Avon Books) glorifies the inner workings of the computer industry and becomes a national bestseller.

**FEBRUARY** Steve Wozniak, principal designer of the Apple II, crashes the airplane he was flying. After recovering from injuries and amnesia, he moves to non-Apple tasks such as returning to the University of California at Berkeley for his undergraduate degree and (in September of 1982 and 1983) sponsoring music/technology weekends called US Festivals.

**APRIL** Adam Osborne, publisher of microprocessor books, surprises the industry with the \$1795 portable Osborne 1 (Z80, 5-inch display, 64K bytes of RAM, keyboard and keypad, two serial interfaces, and two 5¼-inch disk drives). He also includes an impressive collection of bundled software whose list prices total more than the cost of the machine. The Osborne 1 had some flaws—low-density disk drives and a kludgy 52-character display—but it was a good machine for the money, and it caused competitors to produce similar computers at a lower cost than was common at the time.

**MAY** Xerox Corp. unveils the Star (later called the 8010). This is Xerox's first commercial product derived from over a decade of work at Xerox PARC (Palo Alto Research Center). Costing over \$50,000 for the smallest usable configuration, the

computer has little direct effect; however, its use of icons, the "desktop metaphor," and the mouse pointing device begin to influence the microcomputer market in 1983 (with Apple Computer Inc.'s announcement of the Lisa computer).

**SUMMER** Hayes Microcomputer Products Inc. advertises the Smartmodem 300, which becomes the industry standard.

**AUGUST** IBM introduces the IBM Personal Computer (PC) (8088, 64K bytes of RAM, 40K bytes of ROM, one 5¼-inch disk drive, \$3005), which legitimized the microcomputer industry to the rest of the world and established the preeminence of the Intel 8086-family processor and the Microsoft MS-DOS operating system.

**SEPTEMBER** BYTE publishes "A High-Level Language Benchmark" by Jim Gilbreath. This article makes the Sieve of Eratosthenes benchmark program infamous; it is later used to test hundreds of computer/language combinations.

**NOVEMBER** Epson America Inc. shows the HX-20, the first laptop computer, at COMDEX. The unit weighs less than 3 pounds and runs a CMOS (complementary metal-oxide semiconductor) equivalent of the 6801 and 16K bytes of RAM on internal batteries. Its 20-character by 4-line display, however, reduces its usefulness.

# 1982

**JANUARY** Radio Shack announces the TRS-80 Model 16 (68000 and Z80, 128K bytes of RAM, one 8-inch disk drive, for \$4999).

**APRIL** BYTE's Famous Programmer's School ad.

**APRIL** Non-Linear Systems (later named Kaypro Corp.) announces the Kaycomp II (later named Kaypro II), a portable computer with a full 9-inch screen and considerable bundled software, meant to compete with the Osborne at \$1795.

**APRIL** GRIID Systems announces the Compass, a futuristic briefcase-size portable computer with an electroluminescent display, for \$8150. Despite

several price cuts and feature changes, the computer never becomes popular. (GRIID was to announce a new product line in the summer of 1985.)

**APRIL** Xedex Corp. builds the Baby Blue card (a Z80 coprocessor card) to ease the lack of software for the 9-month-old IBM PC.

**SPRING** Franklin Computer Corp. unveils the Ace 100, the first legal Apple II clone.

**JUNE** Columbia Data Products Inc. advertises the MPC, the first IBM PC clone. Compaq Computer Corp. follows in November, and IBM PC cloning and claimed compatibility become a way of life in the industry.

**SUMMER** Commodore Business Machines Inc. announces the Commodore 64 (6510, 64K bytes of RAM, 20K bytes of ROM [including Microsoft BASIC], custom sound chip, color graphics, serial interface, for \$595). During 1983, its price drops to around \$200 and it eventually takes the market away from the Atari 800-series computers.

**SUMMER** The Logo programming language becomes readily available for several computers, most notably the Apple II and the TI-99/4A.

**JULY** Motorola Inc. and Hitachi America Ltd. release preliminary specifications for 256K-bit chips (they become available in late 1983).

**JULY** Intel Corp. announces the 80186 and 80286, more powerful processors that are compatible with the 8086 and 8088.

**FALL** U.S. Customs refuses to allow the custom chess-playing computer Belle to be taken to Moscow to play in exhibition. Ken Thompson, its inventor, notes that the only way it might be used as a weapon would be "to drop it out of an airplane. You might kill somebody that way."

**OCTOBER** Lotus Development Corp. announces 1-2-3, a fast spreadsheet/graphing program with some list-handling capability for the IBM PC. Its speed and capabilities allow it to replace VisiCalc as the industry standard, and its combination of several functions into one program starts the "integrated software" movement in microcomputers.

**DECEMBER** Volition Systems announces the first implementation of the Modula-2 language. It runs on an Apple II under the Softech p-System.



**SUMMER 1982 THE COMMODORE 64**



# 1983

**JANUARY** Commodore Business Machines Inc. sells its one-millionth VIC-20.

**JANUARY** Ill-fated computers: Atari unveils the 1200XL, and Mattel belatedly announces the Aquarius. Both are later discontinued, and Mattel gets out of electronic products entirely.

**JANUARY** Time magazine selects the Computer as its "Man" of the Year.

**JANUARY** Apple Computer Inc. unveils the Lisa computer at its annual stockholders' meeting. The machine is slow but innovative. It originally costs \$9995, but its price goes as low as \$4495 (with a 5-megabyte hard disk). By this time, however, the Macintosh is in the news.

**FEBRUARY** IBM announces the IBM PC XT. It adds a 10-megabyte hard disk, three extra slots, and a serial interface to the basic IBM PC design. With 128K bytes of RAM and one disk drive, it costs \$4995.

**MARCH** Radio Shack announces the TRS-80 Model 100, its first laptop. The unit weighs almost 4 pounds and has an 40-character by 8-line LCD (liquid-crystal display). It becomes very popular with journalists and businesspeople because of its built-in text editor and modem.

**APRIL** Microsoft Corp. announces Multi-Tool Word (later shortened to "Word").

**MAY** AT&T Information Systems announces the UNIX System V operating system.

**JUNE** Microsoft Corp. and numerous Japanese companies announce the MSX standard for low-cost Z80-based computers. It enjoys considerable success in Japan but none in the U.S..

**JUNE** Coleco announces the Adam, a Z80-based computer with a daisy-wheel printer, 64K bytes of RAM, and a tape-cartridge mass-storage device, for \$600. Coleco delivers late, raises the system's price, repairs many defective units, and discontinues the product by the end of 1984.

**JUNE** Apple Computer Inc. ships its one-millionth computer.

**SEPTEMBER** Hewlett-Packard Company announces the HP 150, later renamed the Touchscreen.

**SEPTEMBER** Osborne Computer Corp. files for protection from creditors under Chapter 11.

**OCTOBER** IBM announces the IBM PCjr. The 128K-byte floppy-disk version first sold for \$1269 and was crippled by lack of expansion and a cheap "chicklet"-style keyboard. Though these problems were fixed, IBM discontinued the PCjr in March 1985.



**AUGUST 1984 THE IBM PC AT**



**JANUARY 1983 THE LISA**



**JANUARY 1984 THE MACINTOSH**



**OCTOBER 1983 THE IBM PCJR**



**MARCH 1984 THE AT&T 3B2/300**

**SEPTEMBER 1983 THE HP 150**



**MAY 1984 THE HP 110**







JANUARY 1983 TIME'S MAN OF THE YEAR

**OCTOBER** Western Design Center introduces the 65802 and the 65816, both 16-bit versions of the popular 6502 chip. These chips were still not available in early 1985.

**OCTOBER** Shugart Corp. announces a \$7600 1-gigabyte write-once optical-disc drive.

**OCTOBER** In Japan, Canon displays an under-\$2000 300-dot-per-inch laser printer for OEM (original equipment manufacturer) use.

**OCTOBER** Borland International Inc. advertises Turbo Pascal for CP/M and 8086-based computers. Its quality, speed, and low price make it a de facto standard, especially in the IBM PC world.

**OCTOBER** Ovation Technologies announces Ovation, an ambitious integrated IBM PC software package that gets shown at several conventions but never gets shipped—the term “vaporware” is coined to describe it and similar products.

**NOVEMBER** Microsoft Corp. announces Windows, its multiple-window software product for the IBM PC, a package that became available in summer of 1985.

**DECEMBER** Tandy (Radio Shack's parent) announces the Tandy Model 2000, a \$2999 IBM PC clone with enhanced features and an 80186 processor.

## 1984

**JANUARY** Apple Computer Inc. introduces the Macintosh. At \$2495 for a computer that needs considerable expansion for many applications, it's hardly “the computer for the rest of us,” but its innovations (which draw considerably from its ancestors, the Xerox 8010 and the Apple Lisa) continue to influence many other microcomputer products.

**JANUARY** Seiko Instruments U.S.A. Inc. displays the first wristwatch computer; it has a 10-character by 4-line LCD, 2K bytes of CMOS RAM, and 6K bytes of ROM.

**JANUARY** Sinclair Research announces the Sinclair QL (68008, 128K bytes of RAM, two cassette-loop mass-storage drives, bundled software, and other features) for £399 in the U.K. The computer is not made available in the U.S.

**FEBRUARY** Lotus announces Symphony, its \$695 spreadsheet-oriented integrated package whose complexity limits its success.

**MARCH** AT&T unveils its 3B2/300 UNIX-based supermicrocomputer for \$9950; the computer uses the Western Electric 32000 CMOS processor.

**MARCH** Ashton-Tate announces Framework, its word-processor-oriented \$695 competitor to Symphony.

**APRIL** Mindset Corp. announces the Mindset PC, a graphics-oriented microcomputer with custom graphics chips and some IBM PC compatibility. Although its enclosure won a design award that put it in the Museum of Modern Art's design collection, the microcomputer market in 1984 was not able to support a new computer.

**MAY** Apple Computer Inc. unveils the Apple IIc with a morning-to-night publicity extravaganza that sets a new standard for such things in the industry.

**MAY** Hewlett-Packard Co. announces the HP 110, a 9-pound \$2995 portable that includes Lotus's 1-2-3 in ROM.

**JUNE** Motorola Inc. adds the 68020 32-bit processor to its 68000 family.

**JUNE** Tom Jennings releases the Fido computerized bulletin-board system, which runs on many MS-DOS microcomputers, into the public domain. By 1985 there are over 300 Fido “nodes” in the U.S.

**JULY** Jack Tramiel (formerly head of Commodore Business Machines Inc.) buys Atari from Warner Communications.

**AUGUST** Commodore Business Machines Inc. buys Amiga Corp. and its graphics-intensive 68000 computer design.

**AUGUST** IBM announces the IBM PC AT (80286, 256K bytes of RAM, one 1.2-megabyte floppy-disk drive, and other items—minimum working system, \$5469) and its PC Network local-area network.

**FALL** Digital Research Inc. announces its GEM icon/desktop user interface for 8086-based computers. (GEM is later used by Atari in its \$395 68000-based “Jackintosh.”)

**OCTOBER** Data General Corp. announces the DG/One, a 10-pound, \$2895 battery-powered portable computer with most of the features of a fully configured IBM PC. The machine is criticized for an LCD that is hard to read, a point that DG corrects to some extent in a later model.

**DECEMBER** IBM acquires Rolm Corp., a communications equipment company; this gives IBM a competitive edge against AT&T, which has entered the computer market.

**DECEMBER** Osborne Computer Corp. emerges from bankruptcy proceedings with the Vixen, a \$1298 Z80-based, two-drive portable with bundled software.



## NOTABLE QUOTES

*"What peripheral device most often describes the home hacker's ultimate system? It is, of course, the floppy disk."*

—Ira Rampil, December 1977 BYTE

*"In less than eight months, more than five thousand people have proudly purchased WordStar. . . ."*

—a MicroPro ad, April 1980 BYTE

*"The sin of inefficiency is venial compared to the mortal sin of "user-unfriendliness." I'd buy an operating system any day that takes a long time to run a given program but which makes me more productive by communicating with me in useful ways."*

—Chris Morgan, June 1981 BYTE

*"The current personal computer market is about the same size as the total potato-chip market. Next*

*year it will be about half the size of the pet-food market and is fast approaching the total worldwide sales of panty hose."*

—James Finke, President, Commodore International Ltd., February 1982 BYTE

*"CP/M 2.2. is extremely important, and the Z80 chip will live forever because of it."*

—Portia Isaacson, Future Computing Inc., May 1982 BYTE

*"To be a real hacker means to dedicate a substantial part of your life to the advancement of some application of a technology. It means going behind the backs of stuffed-shirt administrators who think that, despite their inability to do the technical work, they have royal prerogatives to push the technologists this way and that to satisfy obscure, largely symbolic organizational needs.*

*"To be a real hacker means to make a magnificent obsession of creating some effect previously unknown, especially when others say you cannot or may not do it. You will impoverish yourself, devote your whole being to the task, and go far beyond the limits that reasonable people place on unremunerative effort."*

—Lee Felsenstein, 1985



A decade of personal computer development displayed at The Computer Museum in Boston.



# EVOLUTION OF THE MICROPROCESSOR

*An informal history*



BY MARK GARETZ

*Author's note: The evolution of the microprocessor has followed a complex and twisted path. To those of you who were actually involved in some of the following history, I apologize if my version is not exactly like yours. The opinions expressed in this article are my own and may or may not represent reality as someone else perceives it.*

THE TRANSISTOR, developed at Bell Laboratories in 1947, was designed to replace the vacuum tube, to switch electronic signals on and off. (Although, at the time, vacuum tubes were used mainly as amplifiers, they were also used as switches.) The advent of the transistor made possible a digital computer that didn't require an entire room full of vacuum tubes, relays, and special air conditioning. Now a computer would take up only *half* a room and operate much more quickly.

It was not until 1959 that engineers at Texas Instruments figured out how to put more than one transistor on the same material (called the substrate) and connect them together without wires. Thus was born the integrated circuit, or IC. Today these thin flat pieces of silicon can contain millions of transistors, and we call them chips.

Integrated circuits may range from SSI (small-scale integration, contain-



ing relatively few transistors), through MSI (medium-scale integration, around 50 or more transistors), LSI (large-scale integration, with thousands of transistors), to VLSI (very-large-scale integration, which can contain millions of transistors).

In 1969, a year-old company named Intel announced a 1K-bit RAM chip. There were not yet any microcomputer chips to hook it to, but there

were many other applications for the new memory chip, which was significantly larger than any that had been produced before.

About this time, the summer of 1969, Intel was approached by the Japanese calculator manufacturer Busicom to produce a set of custom chips designed by Busicom engineers for the Japanese company's new line of calculators. The calculators would have several chips, each of which would contain 3000 to 5000 transistors.

Intel designer Marcian (Ted) Hoff was assigned to assist the team of Busicom engineers that had taken up residence at Intel. Hoff looked at the Busicom design and decided it was too complex to be cost-effective. He had worked before with Digital Equipment Corporation's PDP-8 mini-computer, which had a very small instruction set.

He reasoned that much of the calculator's complexity could be reduced if they used a small general-

*(continued)*

Mark Garetz (Viasyn Corporation, 26538 Danti Court, Hayward, CA 94545) is director of advanced projects at Viasyn. He has been a computer hobbyist since 1974, he designed CompuPro's 8085/8088 computer, and he is chairperson of the IEEE 696 Committee.



purpose processor. Such a design, using software rather than electronics to do the calculating, would greatly increase the memory requirements of the calculator—but then, Intel was in the memory business. Hoff also realized that this processor could be put to other applications and he sold the idea to Intel management.

The Busicom engineers were still pursuing their original design when Hoff and his group started work on their alternative design. And although the Busicom engineers had simplified their design, each chip still had over 2000 transistors, and it would take 12 chips to make a working calculator. Hoff's team figured it would take 1900 transistors to build their processor.

Hoff's general-purpose processor design was chosen over the Busicom design, and Intel got a contract from Busicom to produce the chip that later became known as the 4004.

Actually making the chip proved to be difficult until Federico Faggin (who later founded Zilog) joined Intel in early 1970. He took the chip from concept to silicon in just nine months. At first Intel sold the 4004 exclusively to Busicom, but in the summer of 1971, it gained the right to sell the chip set to other manufacturers.

In November 1971 Intel advertised the 4004 as a four-bit processor that performed 60,000 operations per second. By February 1972 Intel had sold \$85,000 worth of chip sets.

### THE BIRTH OF 8-BITS

At the same time the 4004 was being developed, CTC (Computer Technology Corporation, now Datapoint) asked both Intel and Texas Instruments to design LSI chips for a new intelligent terminal. Both companies proposed an 8-bit general-purpose processor. Note the pattern developing: 4-bits for calculators because they work in BCD (binary-coded decimal) and 8-bits for terminals because they deal with ASCII characters.

Interestingly, CTC chose neither solution; it built its terminal with standard logic ICs. But TI and Intel went ahead with their projects anyway. TI eventually got a patent on its chip

design and the project at Intel gave birth to the 8008.

The 8008, introduced in April 1972, was the first 8-bit microprocessor on the market. It required at least 20 support chips, but it had 45 instructions that it executed at 300,000 instructions per second, and it addressed a whopping 16K bytes of memory. That was a lot of memory then, and the 8008 was a considerable upgrade of the 4004.

The documentation for the 4004 and 8008 was cryptic (at least it seemed so to me; I didn't have a computer background at the time). The documentation assumed that you knew what everything was before you started reading it (a still-common failing of technical literature).

Intel's primary goal with the 4004 and 8008 was to replace "random logic"—another way of saying "lots of SSI and MSI wired together." Few people thought that these chips were suitable for general-purpose computing. But a few visionaries were intrigued by the possibility of owning a computer that could actually *do* something. True, computer kits had been offered previously, but they were more useful for demonstrating computer principles than for doing computing tasks. The availability of the 8008 changed all that.

In 1973 Scelbi Computer Consulting Inc. announced the first general-purpose microcomputer based on the 8008. This was followed by the RGS-008 from RGS Electronics. Then, in July 1974, *Radio-Electronics* magazine introduced Jonathan Titus's Mark-8 in a series of construction articles.

Until then, all computer articles and ads had been confined to amateur-radio publications. The Mark-8 was the first computer to hit a general-interest electronics magazine. These early microcomputers were still more demonstration tools than useful, but the small-computer revolution had begun.

### THE MIGHTY 8080

In April 1974 Intel changed the way we think about computers forever. They announced the 8080, a signif-

icant upgrade to the 8008 that required only six support chips, had 75 instructions and a tenfold increase in throughput over the 8008, and addressed 64K bytes of memory. (No program, most people thought, could ever be *that* large!)

The 8080 design was proposed by Faggin, but the design team was headed by Masatoshi Shima, a young engineer Intel had wooed away from Busicom. Having learned from the limitations of the 4004 and 8008, the designers made improvements to make their new chip a truly useful computing engine. The 8080, the first microprocessor not aimed at logic replacement, looked much more like a computer than anything that had come before it, and it was much easier to use from a hardware standpoint.

The January 1975 *Popular Electronics* magazine featured the first in a series of construction articles on the Altair 8800, a so-called "minicomputer" based on the 8080. The Altair was designed by MITS (Micro Instrumentation and Telemetry Systems), which was founded by Ed Roberts as a vehicle for supporting his experiments in electronics. The whole Altair kit, including the 8080 processor, motherboard, power supply, front panel with lots of lights, and 256 bytes (*not* 256K bytes) of memory sold for \$395.

People thought it was a misprint. The 8080 chip, introduced just nine months before, had been selling for \$360 all by itself. But MITS had made a special deal with Intel, and the price of the Altair was real. MITS sold more computers in the first day than it had hoped to sell during the whole life of the product.

The Altair played a significant role in the success of the 8080, largely because programmers now had a reason (and a good excuse) to write software for a microcomputer chip. Also, the Altair's open bus architecture (an improved version of which later became the S-100/IEEE 696 bus) allowed people to begin making peripherals for the computer.

One such peripheral was a disk controller from Digital Microsystems that featured the use of a new operating



system for the 8080 called CP/M (Control Program for Microcomputers.) CP/M, brainchild of Naval Post-graduate School instructor Gary Kildall, sold for \$70 and played a major role in the success of the 8080 and its architecture. As a result, a large portion of the microcomputer software in use today either runs on the 8080 instruction set or is a direct upgrade of a product that did.

### THE MOTOROLA FAMILY

In response to the 8080's success, Motorola began work on the 6800, which was designed by Chuck Peddle. Motorola was the first company to introduce a line of peripheral chips designed specifically to go with its microprocessor. These chips included parallel (6820) and serial (6850) I/O functions and made the integration of these functions into a system simple for system designers.

Motorola produced one other significant "peripheral": a huge microprocessor applications manual, bigger than all other microprocessor documentation put together. And it was almost readable! Hackers and system designers like myself rushed out and bought them at \$25 each. True, the manual was still oriented toward logic replacement, and you needed a mini-computer and expensive cross-assemblers to write software. No one had yet written anything that really explained these new chips to people who had no idea what they really were inside, or who had no computer experience. But we read the Motorola manual anyway. . . it was all we had.

Chuck Peddle left Motorola to join MOS Technology (not to be confused with Mostek, the subsidiary of United Technologies), a leader in the scientific-calculator-chip field. In June

or July 1975, MOS Technology ads appeared in the electronics trade journals claiming that the company would be introducing and delivering a \$20 microprocessor at the WESCON show that September. The so-called 6501 was to be pin-for-pin plug-compatible with the Motorola 6800—you could unplug the 6800 from a circuit board and plug the 6501 right into the same socket and it would work—although the software would also need changing because of differences in the architecture and instruction set. MOS was also planning a version of the chip with the complex clock circuitry required by other microprocessors built in. This would be the 6502 and would cost \$25.

The industry went into an uproar. At this time, Intel's 8080 and Motorola's

6800 were both selling for \$179 in single-piece quantity. I remember standing in the lobby (actually a living room) of E-Mu Systems with Scott Wedge and Dave Rossum, who had just designed some 8080s into their synthesizers. We were talking with an Intel salesperson who dismissed the ad as a hoax. He said Intel had assured him that MOS couldn't possibly do it at that price, and that either the ad was a publicity stunt or MOS Technology was quoting the million-piece price. I said that there was no reason that microprocessor chips wouldn't go the same way as scientific calculator chips had—originally hundreds of dollars, now just a few dollars. He said that the chips would never go below \$100.

The salesperson's attitude was nearly universal in Silicon Valley—but MOS Technology was on the East Coast. I called them up, and they insisted that they were serious and that yes, that was the single-piece price. I, and the rest of the valley,

would have to wait for WESCON to find out.

WESCON finally came and there was the MOS Technology booth—but no chips. The company had discovered when it got there that exhibitors weren't allowed to sell anything on the show floor. The chips, company representatives said, were available in their hospitality suite in a nearby hotel.

I went to the suite that evening, and it was packed. The chips were in two large fishbowls. MOS also had hardware and software manuals available for \$5 each. Ray Stevens, who owned RGS Electronics and had designed the RGS-008, was tending bar. Steve Wozniak was there, along with a lot of other people including Chuck Peddle.

(continued)

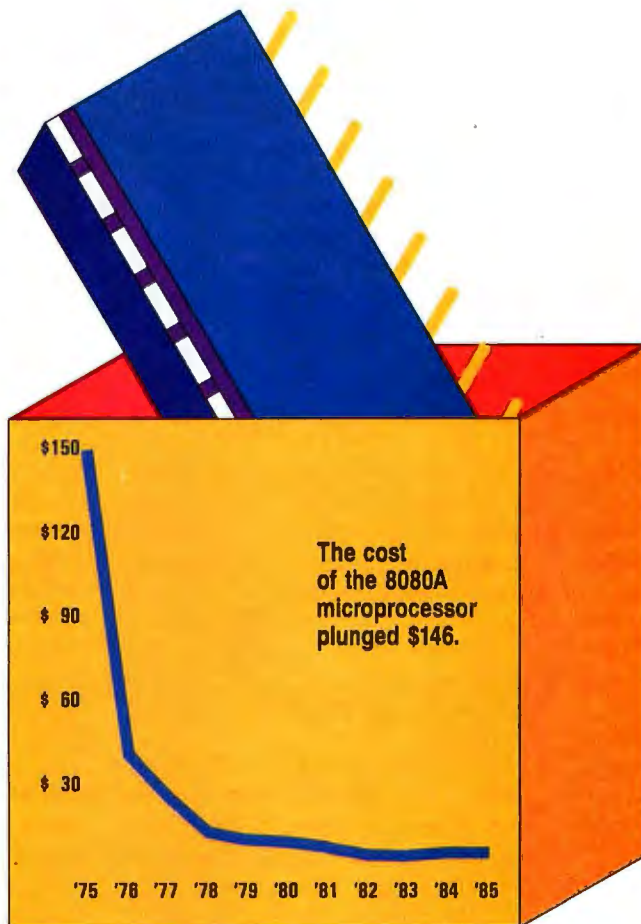

The cost of the popular 8080A microprocessor from 1975 to 1985. Note that in 1975 only the 8080 microprocessor was available.



who was happy to talk about his new processors.

I sat down on the couch and looked at the two manuals. They were written in English and they made sense!

MOS was also showing one more innovation in the suite that night—the first multifunction peripheral chips. The company had put RAM, ROM, timer, and I/O on one chip. One version was called the TIM (terminal-interface monitor) chip and contained a complete monitor for talking to a serial terminal. The other was the KIM (keyboard-input monitor) chip, and it was designed into a microcomputer board that had a keyboard, central processor, display, ROM, RAM, and parallel I/O, and sold for \$245. It was a complete system. No other microprocessor vendor had done anything like this before. It was impressive.

I went home that evening clutching my \$25 6502 microprocessor and two manuals. At the time I didn't realize I would spend another \$300 to make a working system, not counting the ASR-33 Teletype I used as a terminal.

That first day of WESCON, Intel and Motorola lowered the price on their chips to \$69.95. The revolution was in full swing. The industry would never be the same.

The 6501 was short-lived. Motorola sued MOS Technology charging that Chuck Peddle had stolen the technology from Motorola and that the 6501 infringed because it was plug-compatible. MOS Technology agreed to drop the 6501.

However, the many computers that were developed around the 6502 are now legend: MOS Technology's own KIM-1, the Apple I and II, the Atari models, and the Commodore PET and VIC-20, among others. Actually, the future of the 6502 was still questionable when fledgling Apple Computer Inc. produced the Apple I. Steve Wozniak put in a jumper connection that could be changed to allow the 6800 to be used instead of the 6502.

### ENTER THE Z80

Sometime in late 1975 or early 1976, Federico Faggin left Intel and formed

his own company, Zilog Inc. He took Masatoshi Shima with him. Their goal was to build a super 8080.

In 1976, Zilog announced the Z80, a significantly enhanced 8080 that ran almost all of the programs written for the 8080. The company claimed it would have parts that ran at 4 MHz, twice as fast as the 8080. In addition it had many more powerful instructions—a total of 176. It sounded too good to be true; the Z80 was treated with the same skepticism as the 6502 had been.

But, the Z80 turned out to be real, and there actually were some 4-MHz parts available. The early ones said "Engineering Sample" on them and were manufactured in Dallas, not in Silicon Valley. Mostek, a Z80 second source, was actually building the chips for Zilog. Nobody minded because everybody wanted one for their own computer.

Several Z80 cards for the S-100 bus were on the market shortly after the chip became available, and everybody had to have one. But even though the Z80 was a much more powerful chip than the 8080 in terms of its instruction set, very few people were writing software to take advantage of the Z80's extra instructions. The reason was simple: The majority of the machines installed at that time were 8080-based, and if you wrote code that only ran on a Z80, your market would be considerably smaller. This problem plagues the Z80 even today.

However, designers stopped using the 8080 in new computers. The Z80 was a far easier chip to use, requiring no support ICs and only a single-voltage power supply. And it was much faster, even if you didn't use the extra instructions.

The Z80 introduced one other new concept to microcomputer chips: built-in support for refreshing dynamic RAMs. Dynamic RAMs have always cost about four times less per bit than their static counterparts, and that made them very attractive to use. However, because you have to refresh them (or else they forget their data), they are extremely difficult to use, and early system designers viewed them

with some distrust. The Z80 gave the designer 90 percent of the solution and made it possible to build systems that were significantly cheaper than before. Computers such as Radio Shack's original TRS-80, designed by Steve Leininger, took advantage of this fact.

### INTEL STRIKES BACK

Meanwhile, Intel had realized that the 8080 needed upgrading. In 1976 Intel announced the 8085. It had all the 8080 instructions, plus a few more. But Zilog had taken Intel by surprise. The enhancements that the 8085 had over the 8080 were nowhere near as extensive as those of the Z80. From a purely hardware standpoint, the 8085 was a much nicer chip than the Z80, but the Z80 had mass appeal because it was faster. When introduced, the 8085 ran at 3 MHz, as opposed to the 4-MHz chip that Zilog was already shipping. Intel had to come up with something else—a 16-bit processor seemed like the answer.

Sixteen-bit processors had been tried before. National Semiconductor had started work on the IMP-16 chip set as early as 1972. The company reduced it to one chip called the Pace, and Bill Godbout Electronics announced a Pace-based computer, designed by George Morrow, in mid-1975. The unnamed system, a full-blown 16-bit computer with RAM and a built-in cassette interface, was advertised in the first issue of BYTE. They actually built one, but it never got to market. Bill Godbout said that the market wasn't ready for a 16-bit computer, and he was probably right. After all, the Altair was only a few months old itself. Neither the Pace chip nor the computer was ever a hit.

Other 16-bit chips included General Automation's LSI-16, a microprocessor version of its SPC-16 minicomputer; DEC's LSI-11, which was manufactured by Western Digital and included the PDP-11 instruction set; Western Digital's own WD-11, which was only one instruction different from the LSI-11; General Instrument's CP1600; and Texas Instruments'

TMS9900, which went into their home computer, making it the first mass-market 16-bit computer.

Interestingly, the first literature released by MOS Technology on the 6502 showed some little dashed lines where the 16-bit extensions to their registers would go in their 16-bit version of the 6502, the 6516. But the 6516 was never marketed, and the little dashed lines soon disappeared. The existence of such a part was rumored for years, but it never surfaced. Not until December 1983 did the Western Design Center (not the same as Western Digital) announce a 16-bit version of the 6502.

Again, Intel needed something to compete with the Z80. The company figured that most previous 16-bit designs were flops because they had no existing software base that could easily be migrated to it—they were all the first microprocessor offerings from their respective companies.

But Intel had an edge: the growing base of 8080 software. The company decided that its 16-bit processor would be a direct enhancement of the 8080. In 1976 Intel started work on the 8086. Unfortunately, the designers did not preserve direct compatibility with 8080 code, but at least each 8080 register had its 8086 counterpart, which made 8080-to-8086 code translators possible and gave programmers a familiar starting point. This was a big factor in the success of the 8086, which was announced to the world in 1978.

Then someone at Intel had an inspiration. Why not make the hardware almost as easy to migrate as the software? Thus was born the 8088. The 8088 is an 8086 on the inside but has

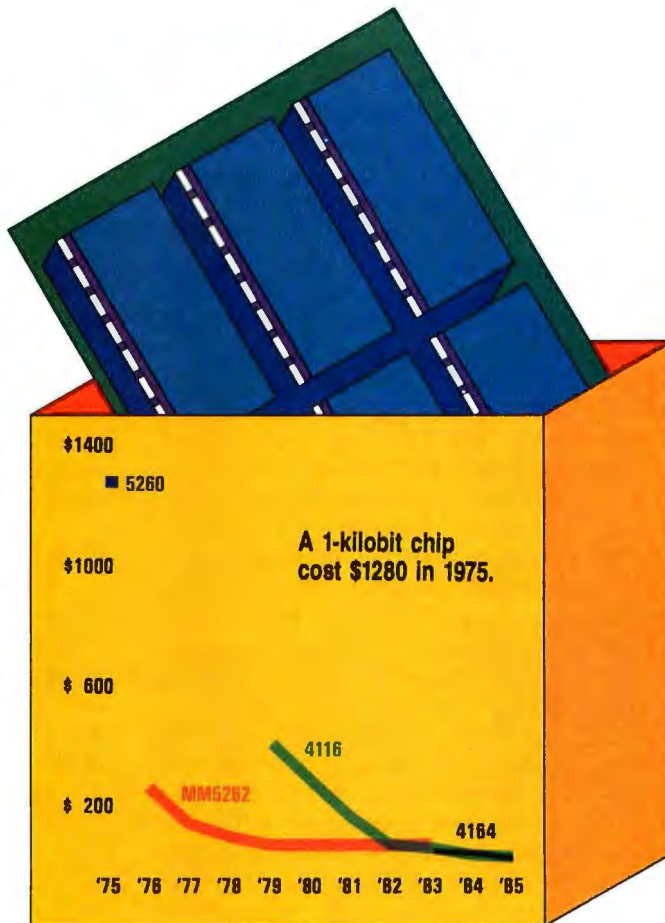

The cost of 64K bytes of RAM from 1975 to 1985, as found on the pages of BYTE magazines. Prices shown are for 512 of the 1-kilobit 5260 chip, 256 of the 2-kilobit MM5262 chip, 32 of the 2K-byte 4116 chip, and 8 of the 8K-byte 4164 chip.

an 8-bit data bus on the outside. When the processor wants to fetch 16 bits of data, it first gets 1 byte, then the second. The programmer doesn't have to worry about it, it all happens automatically in the hardware. The actual signals coming out of the 8088 look similar to the 8085, a chip that designers were already familiar with. Thus, it was easy to upgrade an existing 8-bit design to 16 bits.

You might think that by doing this the processor would run at half its potential. But Intel had been clever when they designed the 8086. Internally it consisted of two different but linked processors. One was the execution unit, the part that actually pro-

cesses the data or executes the instructions. The other was called the bus-interface unit (BIU). The BIU handles all communications with the outside world and is in charge of generating addresses and storing and retrieving data from the system. Inside the BIU is a queue. While the execution unit is busy crunching data, the BIU is out on the bus getting the next instruction and putting it in the queue. The 8086 BIU can stay up to 6 bytes ahead of the execution unit by keeping those bytes in its queue. Because of the queue, the 8088 performance only suffers an average of 20 percent compared to an 8086. (See "Benchmarking the Intel 8086 and 8088" by Gregg Williams, July 1983 BYTE, page 147.) The 8086/8088 processors were the first to use a queue mechanism.

Intel also introduced another new concept with its 8086 family—coprocessing. The idea was to hang another processor right on the bus of the main processor to extend its functions. The most significant of these coprocessors was the 8087, a math coprocessor that added a whole set of floating-point instructions to the 8086/8088. Since the 8087 was built solely to do math, it could do so very quickly.

### THE MC68000

In 1977, designers at Motorola were working on a new processor for the 16-bit market but vowing to keep it 32 bits internally. They also wanted to eliminate any special-purpose instructions and allow the processor to perform all operations, on all registers, on all data types, and in all addressing modes. This is called *orthogonality*. Programmers like

(continued)



orthogonality because it means they don't have to memorize a bunch of exceptions to the instruction set. The fruit of Motorola's effort was the 1979 release of the MC68000.

The MC68000 is one of those chips that some people love and others hate. There is very little middle ground. Compared to the 8086/8088, it required a massive software effort to get it to do anything. But UNIX was becoming popular, and the 68000 looked like a good UNIX machine. A number of 68000-based UNIX machines were announced, although hardly any of them were successful.

Motorola also announced the 68008, an 8-bit-bus version of the 68000, similar in concept to the 8088. However, the 68000 had no real queuing, and that meant that the 68008 ran half as fast as the 68000. Unfortunately, this made the 8088 look even better.

Internally, the 68000 was a micro-coded chip, which means that internal functional elements are general-purpose. A ROM (which contains the microcode) controls what the chip does. The processor's response to each instruction is controlled by the ROM. If an instruction doesn't do the right thing, you can usually fix it in the ROM and, within limits, you can even change the instruction set of the microprocessor if you want to. (IBM's add-in processor for the XT/370 is essentially a 68000 with custom microcode.)

Up until this time, all other processors were generally random-logic designs that had a little bit of circuitry to perform each specialized function within the central processor. There are advantages and disadvantages to both types of microprocessor design—microcoding offers flexibility at the expense of speed, while a random-logic design offers speed at the expense of flexibility. It is also difficult to fix errors in a random-logic design—especially when the designer of the chip leaves the company.

At Zilog, for example, Masatoshi Shima had begun work on a 16-bit processor, the Z8000, using random logic. Random logic worked fine for

the 8080 and Z80 but, in hindsight, it is unfortunate that Shima designed the Z8000 that way. After the first Z8000 silicon was produced, but before his team had had worked all the bugs out of the chip, Shima left Zilog to return to Intel. Zilog never did get all the bugs out of the Z8000. In addition, Zilog had set a standard by allowing the Z80 to run all the software for the previous-generation 8080. Unfortunately, the company didn't follow its own standard and made the Z8000 completely different from the Z80. Zilog was trying to put a minicomputer on a chip and, unfortunately, it didn't do a very good job of it. The Z8000's lack of a similar instruction set to the Z80, its built-in bugs, and its sacrifice in instruction power due to its random-logic nature all played a great role in keeping the Z8000 from becoming successful.

In 1981, National Semiconductor made a second attempt at the 16-bit market with the 16032. The 16032 was to be a 32-bit (internal data bus) microprocessor with a 16-bit external bus. Since Motorola had never been able to produce their promised math coprocessor, and Intel's 8087 so far couldn't break the 5-MHz speed barrier, everyone was impressed when National announced its math coprocessor, which would run at 10 MHz, giving it twice the performance of Intel's 8087.

Unfortunately, National became the first microprocessor company to ship all its peripheral chips 100 percent functional before the processor was available. Today the 16032 still has a few bugs in it. But programmers like its instruction set, which reminds them of a VAX (a series of high-performance DEC superminicomputers). Because the VAX has been so successful as an engine for running UNIX, the 16032 may be a natural successor as the base for a UNIX computer. There may be some life left in it yet.

In 1982, Intel one-upped the semiconductor industry again. They announced the iAPX 286. This new product was a vastly upgraded 8086 architecture that included built-in vir-

tual memory management and many other features designed expressly for supporting a multitasking, multiuser environment. It has a mode that runs all 8086 code directly, and Intel has significantly sped up its throughput. Also, true built-in memory management is something that no other microprocessor has to this day. The main advantage to having memory management built in is that it can work much faster than processors that require external memory managers. The IBM PC AT's use of the 80286 has ensured the success of this processor for at least the next few years.

### 32-BIT CHIPS

In spite of problems with the 16032, National Semiconductor was the first company to announce and ship a full-blown 32-bit microprocessor. The 32032, which used to be the 16032, is code-compatible with the 32016. It's still early to tell how the 32032 will fare, but the popularity of UNIX will probably be a major factor in its success, if indeed all the projections of the 32000 family being the ideal UNIX engine are true.

Motorola is now sampling its full 32-bit extension to the 68000, the 68020, which looks promising. It has one new feature that will probably get it into lots of designs early. Remember that the 8088 was successful because it allowed an easy migration path due to its 8-bit external data bus. The 68020 lets you dynamically choose the bus size you want—8, 16, or 32 bits. Supposedly, it is able to run all 68000 code, and it's fast. One of the things that gives it great speed is its cache—the logical extension of the queue used in the 8086/8088/80286 processors.

The cache in the 68020 is 256 bytes deep and works a little differently from a queue. If a jump occurs to a point in the queue, the queue is flushed and reloaded. But the cache looks just like memory, so a jump to a point in the cache would not cause the cache to be dumped and reloaded. If loops are small enough, they can execute directly from the cache. The advantage is that the pro-

cessor can access the cache much faster than it can access external memory, so programs run faster if they stay mostly in the cache. As with the 32032, it's still early to tell what the eventual success of the 68020 will be.

National has also announced the 32132 (not yet available), which is to have multiple caches and something the company calls a look-aside buffer.

Zilog had announced a product called the Z800, a 16-bit upgrade to the Z80 that was to be code-compatible with it. The company was never able to produce working silicon, however. Instead, it is trying to get the Z80 to work at 10 MHz. Zilog has also announced the Z80000, a 32-bit version of the Z8000 that I call the "kitchen-sink processor" because it will have everything, including code compatibility with the Z8000, which is the right idea but the wrong processor.

Intel has been talking for some time about the coming 80386, its 32-bit version of the 80286, but to date it hasn't released any hard data on it. Intel said it will be 80286-compatible, and that probably means IBM will use it.

### FASTER OR SMARTER?

I can't end my discussion of microprocessors without mentioning a few bizarre approaches. There is still a debate raging on whether microprocessor instruction sets should evolve toward more complex and high-level instructions, or whether they should be getting much simpler but much faster. So far, high-level instruction sets have not been winners. One ill-fated attempt was Western Digital's Pascal Microengine, which executed Pascal pseudocode (the output of all loyal Pascal compilers), directly.

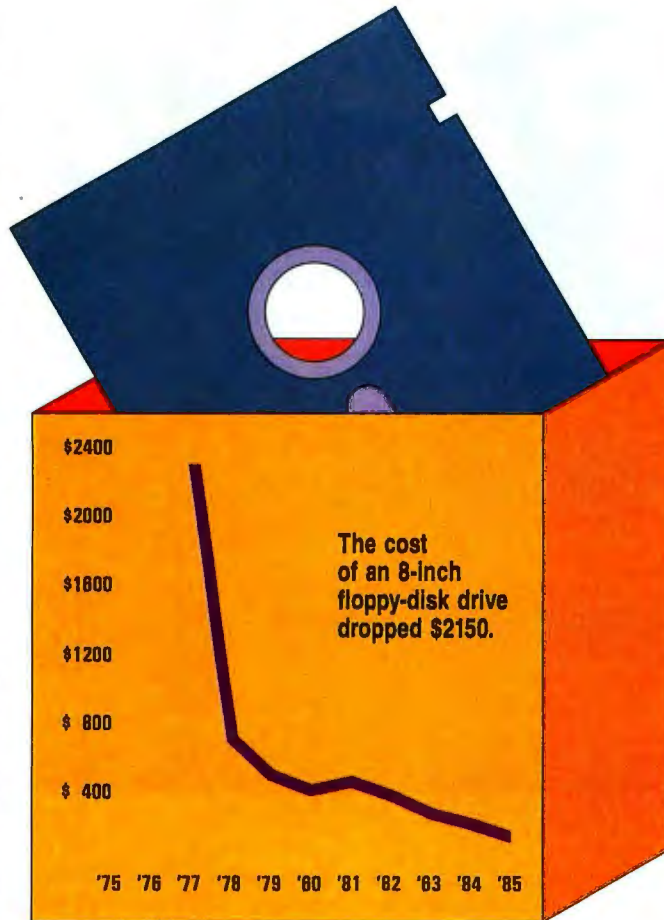

**The cost of an 8-inch single-sided double-density floppy-disk drive from 1977 to 1985. Note that such drives were not available in 1975 and 1976.**

Unfortunately, Pascal compilers that put out native 8080 code beat it handily.

Similar in concept is the new FORTH processor from Novix, developed under the direction of FORTH inventor Charles Moore. Instead of executing the output of a compiler directly, this FORTH chip runs threaded FORTH code directly—its instruction set is FORTH. It's supposed to be very fast, and if you like FORTH it's great.

The FORTH engine is a custom version of a chip from National Cash Register called the NCR 32. It is a microcode-executing 32-bit engine on two chips; a third chip is required to contain the microcode. Essentially you can "roll your own" instruction

set, which is what the developers of the FORTH engine did. This technique opens up a whole realm of possibilities, such as being able to emulate different computers on the fly by downloading different instruction sets. The speed at which this will be accomplished, however, will be limited by the fact that microcoding is hard work.

The Intel iAPX 432, probably the first 32-bit microprocessor available, was designed with very-high-level instructions to support the U.S. Department of Defense's Ada language.

Opposite the high-level instructions' team are those who think that a small set of simple but extremely fast instructions can outperform large and complex (slow) instructions. Such are the RISC (reduced instruction set computer) fans. A RISC machine was successfully implemented in silicon at Berkeley, amazingly on the first pass. They are currently working on speeding up the chip, which has a 32-bit architecture. Hewlett-Packard is also rumored to

be working on several RISC machines.

Last is a unique device just about to be sampled from INMOS called the Transputer (see "The Transputer" by Paul Walker, May BYTE, page 219). It is designed to perform parallel processing. It will take many more years of software development and sophistication to take full advantage of the Transputer, but the possibilities are fascinating.

Meanwhile, a 4004 microprocessor still controls a traffic light near my office. It tends to put all the whizzy new things in perspective, doesn't it? ■

### ACKNOWLEDGMENTS

I would like to thank Rebecca Wallo of Intel and Jim Farrell of Motorola for providing facts and figures for this article.



INTERVIEW: *Carl S. Helmers*

C

arl Helmers's interest in electronics began early. An amateur radio operator in high school, he put himself through the University of Rochester by learning FORTRAN, COBOL, and PL/I (among other things), and writing programs for various companies. After graduating with a physics degree, Carl went to work for an aerospace company called Intermetrics and became a frequent traveler to NASA's Johnson Space Center in Houston. At BYTE, Carl introduced many outstanding writers to the BYTE readership, including Steve Ciarcia and Jerry Pournelle. Following his BYTE experience, Carl founded North American Technology Inc., which publishes Bar Code News, Robotics Age, and Sensors magazines in Peterborough, New Hampshire. He talked recently with BYTE editors Richard Shuford and Gregg Williams about how his interest and involvement with microcomputers developed.

BYTE: How did you get started in microcomputing?

Helmers: In January of 1972 there was a presentation given in Houston by the executives of a new company in California called Intel. So I went and sat through a presentation about this wonderful thing called a microprocessor.

BYTE: Was this the 4004?

Helmers: The 4004 and the 8008. Actually, the 8008 was barely discussed, but it was the thing I zeroed in on. I knew that was going to be my computer. You see I had tried to design my own, but I had a problem deciding what the instructions were to be. Along came Intel with this little box and the company was going to hand me the instructions.

BYTE: How did you get into publishing?

Helmers: I sold 100 copies of a book on wire-wrapping. Then I started adding to my library publications of things that I could offer for sale. The longest was the ECS Computer publication, which was about a central processor based on the 8008. I published the 300 copies of the 72-page book in September 1974, and then I did it once a month thereafter. Since I was doing it once a month, I said, "Gee, this is a magazine, isn't it?" So I started calling it ECS Magazine in January of 1975.

BYTE: How did BYTE come about?

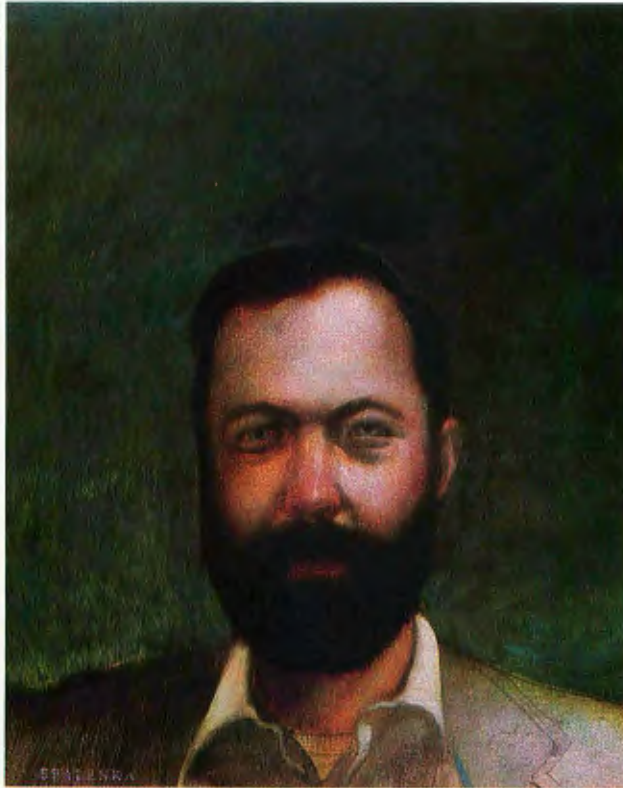

Helmers: Various people in Peterborough found out what I was doing. So I made a couple of trips to Peterborough in May 1975. We made the decision to publish BYTE at a meeting on May 25, 1975. That is the real birthdate of BYTE. Within a year and a half we had 50,000 subscribers.

BYTE: What kind of magazine did you conceive BYTE to be?

Helmers: I knew that I wanted a magazine that was the *Scientific American* of computer science with a vastly expanded amateur scientist section. That was my original conception, and the early years of BYTE were very much like that.

BYTE: How did you find authors in those early days?

Helmers: By publishing the magazine. For the first couple of issues I roped in acquaintances at Intermetrics, and I got my friends to write for us.

BYTE: When did Robert Tinney enter the scene?

Helmers: Robert is an old friend from my Houston days in the early 1970s. He did his first BYTE cover in December 1975. At the time he was constrained by our poverty to not using full color.

BYTE: A number of projects stood out in the early days of BYTE; the "LIFE Line" series was one, the other was the infamous kludge harp.

Helmers: The kludge harp was nothing more than a program to play music.

BYTE: It was different in that, at the time, most people were looking at computers as blinking lights, at the very most. You had a peripheral, simple as it was, that allowed you to play music.

Helmers: Actually, the reason I did that second 6800 system was to develop a 6800 that would control a music synthesizer. The other thing I did a lot of engineering on, early in BYTE, was this slow biphased Manchester-code audio-tape interface.

BYTE: Are there any pioneers you'd particularly like to remember here?

Helmers: Steve Jobs and Steve Wozniak. I think they are neat from several points of view. One is the naiveté they exhibited toward meeting magazines.

BYTE: Is there anyone who has not received recognition that you think should have it?

Helmers: Nat Wadsworth, a Scelbi computer consultant, who had the absolute first 8008 personal computer, and Lee Felsenstein, who started the Homebrew Computer Club. Then there are hundreds of authors who wrote for BYTE and other magazines. ■



INTERVIEW: *Steven A. Ciarcia*

B

YTE: Steve, you are known for designing electronic and computer construction projects and writing about them. How did you get your start in this?

Ciarcia: As far as electronics goes, I was just like any kid. When you're at a certain age, you find an electronic gadget and you want to see what's inside the box. So for years I had electronic parts lying all over the place at home. I never actually could afford to own a lot of equipment when I was a kid, so I had to build a lot of it.

Anyway, when I went to the University of Connecticut, I studied electrical engineering and came out with a BSEE. Then I worked in several engineering jobs.

In the early 1970s, while I was working for Control Data, I happened to see a construction article in *Radio Electronics* magazine about a thing called a "TV Typewriter," Don Lancaster's TVT-1. So I built that, and then I had the problem of "What do you do with this thing once you've got it?" Then a few months later, *Radio Electronics* ran another article, this one about building a small computer.

The project computer in the article was called the Mark 8. Jonathan Titus had designed it around the Intel 8008 microprocessor. I didn't want to build a Mark 8 because I felt its physical construction was hobby-grade. Having been involved in the electronics industry I knew what it took to make a computer stay reliable.

So I started hunting around for some other small computer that was also built around the Intel 8008. I found an outfit called Scelbi [pronounced "sell-bee"] Computer Consulting in Milford, Connecticut, that also made an 8008-based computer. I went down and saw Nat Wadsworth, the head of the company, and talked him into selling me his boards. I bought five blank circuit boards at \$125 per board and populated them with my own chips. I ended up buying my 8008 for \$120.

So after a while I had the Scelbi computer with the TVT-1 terminal tied onto it, a cassette recorder, a printer, a paper-tape reader—everything you could imagine back then. I homebrewed the cassette interface because Scelbi was using just paper-tape readers. By the time I retired the system a year and a half later, it had all of 4K bytes of memory in it and 4K bytes of EPROM. That was the first and last computer I wrote my own operating system for.

Next I got into graphics. I had bought a surplus Sanders



Associates 708 terminal. This was actually built as an alpha-numeric terminal, but it formed its characters by drawing vectors on the screen. I designed an interface and D/A converter driver to change the scanning so it would be a vector-graphics display, and I attached it to my 8008 system.

Having put together what I thought was a pretty neat graphics system, I thought somebody else might be interested in it, too. BYTE had been out for a couple of months by then, so I looked on the masthead and called up the editor, Carl Helmers. He liked the idea for an article. When the piece came out in November 1976, it got a very good response from the readers.

I then wrote a series of three articles that appeared in three consecutive months in 1977. After it turned out that these, too, were well received, I said to Carl, "Suppose I do articles regularly?" Carl still

wasn't sure he could find anyone who could write for him on a deadline and instead asked me if I would be an editor and work for him on the magazine.

I didn't think I could do it. At the time I was working as a consultant to Pratt & Whitney in Hartford, where we built a computerized casting facility for jet-engine turbine blades. One of the Pratt people who worked with me was a guy who could write well and played the accordion. I told him about Carl's offer, and he went up to New Hampshire and took the job. That's how Chris Morgan, who later became editor in chief, came to BYTE.

I continued to do projects in my spare time and write them up for the magazine. From November 1977 to date, I've done an article a month.

BYTE: How do you work on your projects?

Ciarcia: There are two classes of projects, long-term and short-term, so there are two kinds of schedules.

To keep myself interested in the magazine articles, I have to do some really way-out projects each year. But I try to balance them by putting together some lower-level projects for those people who aren't ready for the big time.

A long-term project is essentially a significant computer product or system; like the home-control system I've been working on for about six months. [See Ciarcia's Circuit Cellar, April, May, and June.] Or I should say "we've been working on." On these big projects I have to have help. For instance, I have people who lay out printed-circuit boards for me. For anything that needs more than 100 lines of code, I hire a programmer to write it—that's the only

(continued)



way I can get it done. But that doesn't make me hate programmers. It's just that somebody else can do it faster and better than I can. I think people should do what they are best at.

While all these people are working on a major project, I sometimes work on a short-term project. I'll say, "Okay, what's in my junk box that looks good?" Then I'll do an article that's mostly tutorial in nature or is about a smaller project that doesn't require an elaborate circuit-board layout and is easy to put together.

**BYTE:** *What's a good example of a short-term project?*

**Ciarcia:** The Whimsi-Bell from July 1984, which took about five days from conception to finishing the article. I stock common components in the Cellar so that if at 2 o'clock in the morning I get an idea about a good circuit I can just go build it. The inventory costs a lot, but it allows me to live by my own schedule.

**BYTE:** *Do people from semiconductor companies call you up and say, "Hey, I've got a wonderful new chip. Would you like to play with it?"*

**Ciarcia:** Yes and no. Most semiconductor houses don't have any way to get to me directly, so they don't. I purposely do that because I don't want anybody sending me samples of their products and giving me engineering advice, and then expecting something in return. Sometimes at the last minute I decide not to do a particular project because I don't see that the company that I have been dealing with is going to support the BYTE reader, who maybe wants to buy just one chip to build a project.

There are a few companies I work with all the time. They understand what I'm doing and they also understand their own business—companies like Zilog, Analog Devices, or Texas Instruments.

**BYTE:** *How do you handle working on many things at once?*

**Ciarcia:** You can't put together any kind of major project on a regular basis without having two or three running simultaneously.

Sometimes readers ask me why my construction designs show up on the market as commercial products. One reason is that it takes the resources only a company can provide to make the projects as useful as possible. Take the home-control system I wrote about for the April, May, and June issues this year. That had to be tested for radio-frequency interference by an independent lab to satisfy the FCC. Just that testing cost \$5000. So by letting the system be put on the market, I enabled my readers to build a legal kit. And the companies can provide continuing support better than I can alone.

**BYTE:** *With that in mind, how do you regard your projects?*

**Ciarcia:** I think of them as what I personally want for toys, or to use myself.

There is one thing I want to make clear: My chief interest is in *designing* computers. If I have a special task for a computer to perform, I build a specialized system for it. I don't take one computer and try to do everything with it. For instance, the home-control system. I didn't take an IBM PC and write a 25,000-line program to make it control my home. I use an off-the-shelf computer only the way an average businessman would use it—for word processing, spreadsheets, and some other little stuff.

I designed the Trump Card because I didn't want to learn C or Pascal or mess around with assembly language. I knew BASIC. But BASIC was too slow—so I built a faster BASIC engine.

**BYTE:** *Do you think that reading about your projects, like the home-control*

*series, becomes a kind of wish-fulfillment for people who tinker with electronics?*  
**Ciarcia:** I'm sure there are many vicarious builders, but the couple of hundred letters I get every month indicate that there are more people building this stuff than you might think. There are a great many technicians and software guys out there that just want to break in a little bit on building hardware but don't want to scrounge parts. They are 75 percent of the people who put my projects together.

When I started on the recent home-control project, it was because I was tired of changing BASIC statements in the existing system every time I needed to turn on a light. I wanted a closed-loop system, triggered by sensor inputs, and money was no object. The motion sensors, in particular, cost a lot. But I ended up putting them all over the house, except in places where I didn't need them.

**BYTE:** *Have you had any project ideas that you haven't been able to complete?*

**Ciarcia:** Yes. I'd like to build a 1200-bit-per-second modem. And a lot of my readers would like to see me do that, too. The problem is that the technology of modems is changing so fast. It could be done now, but not in the way I'd want to do it. Even if I did find a good cheap modem chip, I'd want to have good software to drive it. I'd also want to get the modem FCC-tested—I'm tired of projects that you have to connect to a telephone line through an unregistered data-access arrangement. It's the difference between hobby-grade and professional-grade stuff.

Most BYTE readers today are not hobbyists—I know that from my mail.

**BYTE:** *You attend computer shows and conventions. Do the questions you get at conventions differ from what you get in letters?*

**Ciarcia:** I get more hobbyists at conventions, often high school students who are working on a science-fair project. The letters are frequently from business people or engineers.

I get between 200 and 250 letters every month. The majority of these are legitimate questions, and, unfortunately, it can take hours of research to find out the answers. I've had to hire seven people to help me answer letters. Even then we don't get to them all. We do try because the thousands of people whose letters we have answered over the years have become the greatest supporters of the Circuit Cellar. I've got hundreds of pictures from readers showing the projects they have built.

**BYTE:** *Do you think BYTE has had much effect on the development of personal computers?*

**Ciarcia:** BYTE was significant in being *essentially* the first in its field—I know you can argue about that—and in the formative years it stood out in its journalistic integrity: It supported the experimenter. It supported the new industry without trying to exaggerate its own value. It didn't work out any deals to trade advertising or good reviews for computer equipment. I picked up that same attitude when I began to write for BYTE.

**BYTE:** *Do you know of anybody who has picked up one of your ideas and made a successful commercial product out of it?*

**Ciarcia:** At the West Coast Computer Faire this spring, I found an exhibitor that had put together a computerized telephone message system, using the ADPCM (adaptive differential pulse-code modulation) speech-digitization scheme I described in June 1983. And there are a lot of my Z8 control computers out in the world that have been built into OEM products. ■



## CIARCIA'S PRODIGIOUS OUTPUT

## 1976

Nov Make Your Next Peripheral a Real Eye Opener (vector graphics)

## 1977

Mar Try This Computer on for Size (review of Digital Group 8080A)  
Apr Having a "Private Affair" with Your Computer (humor)  
May Come Upstairs and Be Respectable (terminal communication)  
Sep Control the World! (Or at Least a Few Analog Points)

## CIRCUIT CELLAR SERIES

## 1977

Nov Memory-Mapped I/O  
Dec On a Test-Equipment Diet? Try an 8-Channel DVM Cocktail

## 1978

Jan Add More Zing to the Cocktail  
Feb A Penny-Pinching Address-State Analyzer  
Mar Program Your Next EROM in BASIC  
Apr Tune In and Turn On, Part 1:  
A Computerized Wireless AC Control System  
May Tune In and Turn On, Part 2: An AC Wireless Remote-Control System  
June Talk to Me: Add a Voice to Your Computer for \$35  
July Build a Keyboard Function Decoder  
Aug Let Your Fingers Do the Talking: Add a Noncontact Touch Scanner  
Sep Let Your Fingers Do the Talking: Scanner Applications  
Oct No Power for Your Interfaces? Build a 5-watt DC-to-DC Converter  
Nov I've Got You in My Scanner! (light-source tracking)  
Dec Build an Octal/Hexadecimal Output Display

## 1979

Jan Build a Computer-Controlled Security System for Your Home, Part 1  
Feb Build a Computer-Controlled Security System for Your Home, Part 2  
Mar Build a Computer-Controlled Security System for Your Home, Part 3  
Apr The Toy Store Begins at Home (Milton Bradley Simon game)  
May Communicate on a Light Beam  
June Mind Over Matter: Add Biofeedback Input to Your Computer  
July Sound Off! (SN76477 and AY-3-8910 sound effects)  
Aug Anyone Know the Real Time? (MM5312)  
Sep Joystick Interfaces  
Oct Self-Refreshing LED Graphics Display  
Nov The Intel 8086  
Dec Add Nonvolatile Memory to Your Computer (EAROM)

## 1980

Jan Computerize a Home (BSR X-10 controller, the Busy Box)  
Feb A Computer-Controlled Wood Stove  
Mar Ease into 16-Bit Computing, Part 1:  
Get 16-Bit Performance from an 8-Bit Computer  
Apr Ease into 16-Bit Computing, Part 2:  
Examining a Small Multi-User System  
May I/O Expansion for the Radio Shack TRS-80, Part 1 (parallel ports)  
June I/O Expansion for the Radio Shack TRS-80, Part 2 (serial ports)  
July Handheld Remote Control for Your Computerized Home  
Aug A Build-It-Yourself Modem for Under \$50  
Sep Build a Low-Cost, Remote Data-Entry Terminal  
Oct Make Liquid-Crystal Displays Work for You  
Nov Home In on the Range! An Ultrasonic Ranging System  
Dec Computerized Testing

## 1981

Jan Electromagnetic Interference  
Feb A Computer-Controlled Tank (Milton Bradley Big Trak toy)  
Mar Build the Disk-80: Memory Expansion and Floppy-Disk Control  
Apr Build a Low-Cost Logic Analyzer  
May DC Motor Controls: Build a Motorized Platform  
June Build a Low-Cost Speech-Synthesizer Interface (Micromouth)  
July Build a Z8-Based Control Computer with BASIC, Part 1  
Aug Build a Z8-Based Control Computer with BASIC, Part 2  
Sep Build an Unlimited-Vocabulary Speech Synthesizer (SweetTalker)  
Oct Build an Intelligent EPROM Programmer  
Nov Switching Power Supplies: An Introduction  
Dec Build a Touch-Tone Decoder for Remote Control (ITT MSD3210)

## 1982

Jan Analog Interfacing in the Real World (A/D conversion)  
Feb Build a Computerized Weather Station  
Mar Use Voiceprints to Analyze Speech  
Apr Use Infrared Communication for Remote Control  
May Everyone Can Know the Real Time (MM58167A)  
June Build an Interactive-Videodisc Controller  
July Add Programmable Sound Effects to Your Computer (SN76489A)  
Aug High-Resolution Sprite-Oriented Color Graphics (TMS9918)  
Sep Build the Microvox Text-to-Speech Synthesizer, Part 1: Hardware  
Oct Build the Microvox Text-to-Speech Synthesizer, Part 2: Software  
Nov Build the Circuit Cellar MPX-16 Computer System, Part 1  
Dec Build the Circuit Cellar MPX-16 Computer System, Part 2

## 1983

Jan Build the Circuit Cellar MPX-16 Computer System, Part 3  
Feb Build a Hand-held LCD Terminal  
Mar Build the ECM-103, an Originate/Answer Modem  
Apr Build an RS-232C Breakout Box  
May Build an RS-232C Code-Activated Switch  
June Use ADPCM for Highly Intelligible Speech Synthesis  
July Build the RTC-4 Real-Time Controller  
Aug Build a Power-Line Carrier-Current Modem  
Sep Build the Micro D-Cam Solid-State Video Camera, Part 1  
Oct Build the Micro D-Cam Solid-State Video Camera, Part 2  
Nov Build the H-Com Handicapped Communicator  
Dec Keep Power-Line Pollution Out of Your Computer

## 1984

Jan Build the Term-Mite ST Smart Terminal, Part 1 (NS455)  
Feb Build the Term-Mite ST Smart Terminal, Part 2  
Mar Build a Third-Generation Phonetic Speech Synthesizer (SS1263)  
Apr Build a Scrolling Alphanumeric LED Display  
May Trump Card, Part 1: Hardware (Z8000 coprocessor for IBM PC)  
June Trump Card, Part 2: Software  
July A Musical Telephone Bell (AY-3-1350)  
Aug Circuit Cellar Feedback  
Sep Build the AC Power Monitor  
Oct An Ultrasonic Ranging System (SN28827)  
Nov The Lis'ner 1000 (SP1000 speech recognition)  
Dec Build the Power I/O System

## 1985

Jan Understanding Linear Power Supplies  
Feb Build a Serial EPROM Programmer  
Mar Build the Touch-Tone Interactive Message System  
Apr Build the Home Run Control System, Part 1: Introduction  
May Build the Home Run Control System, Part 2: The Hardware  
June Build the Home Run Control System, Part 3: The Software  
July Living in a Sensible Environment  
Aug Build the BASIC-52 Computer/Controller



INTERVIEW: *Robert J. Tinney*

**A**rtist Robert Tinney has provided most of the illustrations that have appeared on the cover of *BYTE* during the past 10 years.

Robert studied advertising art at Louisiana Tech and then began working in Houston, Texas, drawing and illustrating for various publishers and advertisers. A mutual friend introduced him to Carl Helmers, who at the time was working on software for NASA's space shuttle. The two became friends, and when Carl began at *BYTE* he called on Robert for illustrations.

Robert moonlighted on the *BYTE* covers for the first few years, but in 1978 he moved to Baton Rouge, Louisiana, and began his computer-related illustrating full-time.

*BYTE* editors Richard Shuford and Gregg Williams talked with Robert about his 10-year association with the magazine and his thoughts about the future.

**BYTE:** How do you work with the *BYTE* editorial staff to develop ideas for cover art?

**Tinney:** We almost always have an issue theme—a programming language, computer graphics, or whatever. We start with that. I try to get as much input from the editors as possible; many times they will have visual ideas. After that phase, I do several sketches and send them to *BYTE*. Sometimes the editors like a sketch immediately. If they don't, they make suggestions and I try again.

We start with the concepts and look for visual symbols to represent the concepts. Often the editors suggest these. To get the best effect you have to position or relate the symbols in unexpected, humorous ways.

**BYTE:** Do you sometimes wish that computers and their parts looked more interesting?

**Tinney:** Because computers mostly look like boxes with wires, I try to draw concepts rather than technical facts. I always try to create a separate three-dimensional reality that the reader feels drawn into. It may be a three-dimensional space that exists on one small part of a circuit board somewhere, or it may be floating in infinite space, but it still has three dimensions.

I want the person viewing the cover to be imagining himself doing whatever the activity is in the scene. I don't often show people on the cover having a third-person experience. I like to draw the reader into the experience.



**BYTE:** What are you especially proud of?

**Tinney:** I really liked the concept behind the February 1985 "Computing and the Sciences" cover, which had the ribbon cable and double-helix effect. There are other paintings, like the April 1984 issue, the "Real-World Interfacing" theme, which showed all the world spinning under control of a hand-held computer. Some readers didn't like that one, probably because its appeal was more visual than conceptual.

**BYTE:** Do you personally own a computer?

**Tinney:** It has been about a year and a half now since I got my first computer, a Morrow Micro Decision. It's very useful and I love it. It came with some bundled software. I use WordStar to do all my business correspondence. And I use Personal Pearl to keep track of a database of customers who have ordered *BYTE* cover reprints.

**BYTE:** Can you tell us something about your explorations into computer-assisted drawing?

**Tinney:** So far I've not used computer graphics for any cover work, but I hope to get into it because it's obviously going to be important.

**BYTE:** Are you saying that as an illustrator or are you saying that as an illustrator who does computer-related themes?

**Tinney:** Absolutely as an illustrator. Even as they stand today, computer graphics systems are to an artist what a word processor is to a novelist.

I'm sure that in the future a computer is going to be able to mimic a paintbrush, a pencil, charcoal, or pen and ink. It will be easier, better, and more expressive to use a digitizing tablet and pen than it will be to actually use a pencil or a paintbrush. The hardware and software have a long way to go before they get to the point that I am describing, but I believe that these capabilities are bound to come.

**BYTE:** What computer graphics equipment have you used?

**Tinney:** I've had very limited hands-on experience with a Time Arts Lumena system and an Artronics Artron Studio Computer. These might be described as mid-range systems, yet I was just amazed at their capabilities. They have reached the point where you can get one for what you would pay for an expensive automobile.

**BYTE:** *BYTE* readers will be looking forward to seeing your work on the cover for years to come. ■



TINNEY FAVORITES

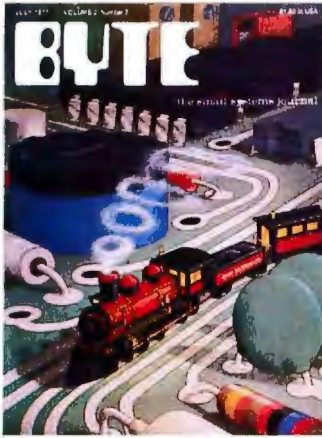

July 1977  
*Computer Engineering*



October 1978  
*Computer Chess*



March 1980  
*Computers in the Laboratory*



April 1981  
*Future Computers?*



May 1981  
*Software Piracy*



September 1982  
*Computers and the Handicapped*



March 1983  
*The Stacks*



June 1984  
*Graduation Memories*



April 1985  
*Recursive Hands*



## INTERVIEW:

YTE: Jerry, how did you first get involved with personal computers?

Pournelle: Back in 1976 my mad friend Dan MacLean was given a computer kit by someone who couldn't get it to work. The machine had about 1K byte of memory and you programmed it by endlessly throwing switches on the front panel. It took me about 10 seconds to decide I wanted nothing to do with that thing.

Months later, though, I saw a demonstration at a company called Computer Power and Light. Their machine was running Electric Pencil, the first true full-screen text editor. It was love at first sight: I realized instantly that

I could do all the revisions I wanted and never retype a page of text again. By then MacLean had got his old IMSAI working properly. MacLean and a Caltech graduate student named Tony Pietsch put together Ezekial, my friend who happened to be a Z80 computer. I've been writing my books with computers ever since.

BYTE: How did you get involved with BYTE?

Pournelle: Personal computers didn't work very well in the early days. The machines were wonderful, they'd do things I never thought possible, but they weren't very easy to use. In those times you couldn't just go to a store and buy a computer to take home. You got components and you tried to get them all to talk to each other, but they seldom did. The software situation was pretty grim, too.

The situation changed fast, though. If you wanted to keep up—and anyone who had a computer in those days *certainly* wanted to keep up—you had to read the magazines. There were a number of them, and I subscribed to all of them. I particularly recall one called ROM, the "Read-Only Magazine." It didn't survive.

One of the first magazines I subscribed to was BYTE—"The Small Systems Journal." I particularly liked the What's New section. I also read BYTE for the ads. Sometimes the magazine would drive me nuts, though, because I knew I wanted to learn what the article was saying, but I couldn't understand it even after reading it three times.

My oldest boy was in high school then and he was as interested in computers as I was. Sometime in the 1970s, after Ezekial came to live with me, my son Alex and I went to a computer show.

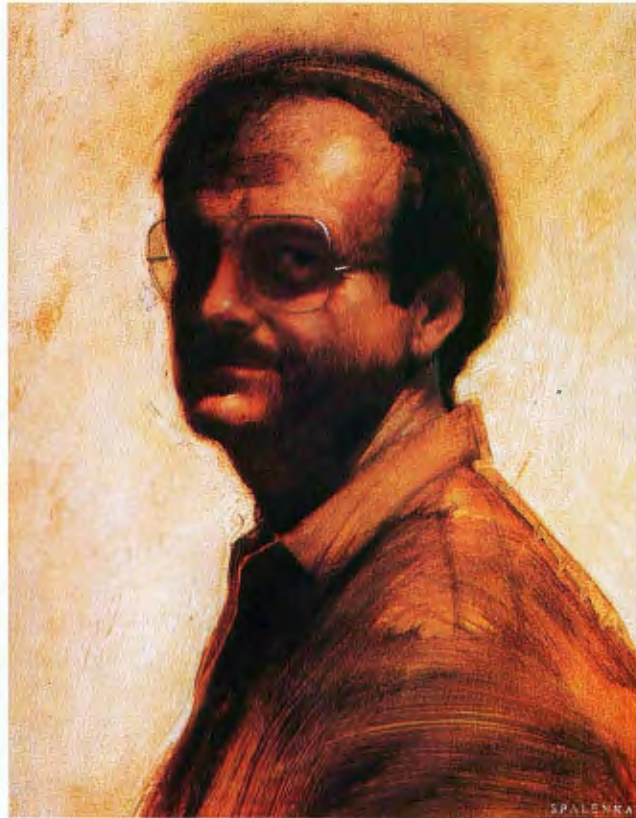

I was talking to someone when Alex came over to grab me and said, "You have to come meet the fabulous Carl Helmers."

It turned out that Carl had read some of my science fiction, so we got along fine.

Carl and I discussed the possibility of my doing some articles for BYTE, but we left it pretty loose. Later I got to thinking about it. I didn't know very much about computers, but I did use them: Anything I wrote would have to be user-oriented. I sent a column in. The readers liked it. At first I just sent in columns when I felt like it, but one day Chris Morgan [then managing editor] called and said, "Your column is due next week." After that The User's Column became a regular feature in BYTE.

BYTE: What milestones stand out in the history of the personal computer?

Pournelle: Oh, let's see—Bill Gates's BASIC. Before that we

didn't have any decent way to program small computers.

Then there was CP/M from Digital Research. Before CP/M none of our machines could talk to each other.

The Osborne computer was terribly important. You could just buy it and take it home and plug it in. More important, Osborne bundled in software.

dBASE II was the first really powerful database that ordinary people could learn to use on normal microcomputers. VisiCalc turned the Apple II into a viable business machine and introduced small computers into the business community.

The IBM PC changed everything, of course. Before the IBM PC, there was a definite microcomputer community. Before the IBM PC there were "hackers" and "users," and I wrote "the user's column"; but "users" in those days were still curious about their machines, what could be done with them, and where the microcomputer revolution was going. Many people who got computers after the IBM PC revolution were just users who didn't know or care that they were part of a revolution.

BYTE: How has that changed your column?

Pournelle: I'm still writing for the microcomputer user who's seriously interested in learning more about his or her machine. I guess my column is a little broader now: There's less out there for the real hacker, so I try to include something for the hacker community; and there are more occasional users, so I try to include something for them. Mostly, though, I write for the middle ground. I guess the column is a bit less technical than it used to be, which is strange, since The User's Column was supposed to be a nontechnical column in the first place. ■





## MAKE THE CONNECTION . . .

Our **Connection** systems will solve your problem of trying to read and write diskettes or tapes from almost any computer system using your PC.

The **Diskette Connection** is a hardware system that enables the IBM PC or compatible to read and write most 8 inch, 5¼ inch, or 3½ inch diskettes.

With our **File Connection** software programs you can transfer data files between most computer systems, including CP/M, DEC, Honeywell, Univac, IBM 3740, S/1, S/3, S/23, S/32, S/34, S/36, and S/38.

Our **Word and Typesetting Connection** programs use IBM standard Document Content Architecture (DCA-RFT) to transfer document files between most word processing and typesetting systems, including Compugraphic MCS, CPT, Displaywriter, OS/6, Multiset, NBI, Quadex, Xerox, and Wang.

Our **Tape Connection** system will read and write IBM or ANSI standard ½ inch 1600 BPI magnetic tape. A full size 2400 foot tape can store a 45 MByte file and be written in 6 minutes.

Since 1982, we have supplied thousands of systems to customers around the world, including IBM, NASA, AT&T, Kodak, and General Motors.

Our specialty is conversion systems and we can provide a solution to your problem. Call us today to discuss your requirements.

*This ad is one of a series featuring NASA missions. For a free poster, send us your written request.*

**Box 1970 Flagstaff, AZ 86002  
(602) 774-5187 Telex 705609**

Inquiry 145 for End-Users, Inquiry 146 for DEALERS ONLY.

## . . . FLAGSTAFF ENGINEERING



# **C** *Low power* Complete hard disk kit \$395

Comes complete with virtually the identical controller that's in the IBM® XT, and Xerox® warranties the hard disk for one year

## **G**uaranteed 100 percent IBM PC compatible

How can we offer this fantastic price? Simple. We buy in such volume that even the most avaricious hard disk businessmen understand they have to give us the best price possible. We could pocket the difference, but we don't.

Instead, we put the extra profit into our testing facilities. That's why Xerox guarantees our \$395 10 megabyte hard disk for one year.

Xerox knows, as our customers know, that we have an extensive testing program. Here is what we contribute toward giving you the maximum hard disk performance.

### **Best Drives Available**

First, we buy the best drives available. Sounds trite, doesn't it? I mean, a drive's a drive—right? Hardly. You should see some of the junk we get in our labs. Some have such high failure rates that we even questioned our own \$10,000 hard disk tester. But when we tested other manufacturers' drives we were assured that our equipment was fine, which just confirmed that the bad hard disks were not only bad—they were real bad.

But that's just the weeding out process. We then take each drive that we've put through our tester and test it again with the controller you've requested. We call this a "tested pair."

### **DOS Doesn't Do It**

In case you're thinking that all

this is an unnecessary duplication of what DOS does for you, let me explain the disk facts of life.

If DOS did what you may think it is supposed to do when you format the disk, DOS would map around these bad areas. Unfortunately, DOS doesn't do this.

DOS 2.0 and 2.1 can't enter the bad tracks. DOS 3.0 can, but only on the IBM AT. Unfortunately, as the press has so well documented, the AT's hard disk develops bad tracks later on.

### **We do what DOS can't**

We believe the problem is so bad, we use a software program that performs a powerful test of your disk drive on all of the IBM or IBM compatible computers—PCs, XTs, and ATs. Our format takes hours to analyze the disk. But when we finish, you know that the bad tracks are really mapped out so you won't write good data that will disappear into a black hole. We even send you a printed statement of our test results.

Our software allows you to type in the bad track locations from the list supplied by the manufacturers, so you'll never write good data to them—even if DOS didn't identify them as bad. The software even lets you save the location of these bad sections to a file, so that you can reformat your disk without spending hours retesting.

We even include a program that will give you continuous comments on the status of your hard disk. No more waiting for that catastrophic failure.

### **Average Access Time**

As you might suspect, some hard disks are faster than others in their ability to move from one track of data to another. The time it takes the hard disk to move one-half way between the beginning of the disk to the end is called the "average access time."

The first generation of 10 megabyte hard disks had average access times of 80-85 milliseconds (msec). But computer users love speed, and guess what—the average access time for the new 20 megabyte hard disk in the IBM AT is only 40 msec. (We sell an AT equivalent with only 30 msec access time!)

There are some legitimate reasons for the shorter access time. It's particularly helpful when there are multiple users on the same hard disk. It's also important when running a compiler. But remember, before you get too wrapped up in the access speed, there's always that ST 506 interface which won't let data transfer from the hard disk to the computer any faster than 5 megabits/second. We've bypassed that choke hole, too. If you want the functional equivalent of a Ferrari with a turbocharger, order our 10 Mbit per second 100

megabyte hard disk with 18 msec of average access speed.

### **Compatibility**

To be sure that your hard disk is 100 percent compatible with the IBM XT you don't need to buy the same hard disk that's in the XT. You can't even be sure what brand hard disk it is because IBM, like Express Systems, goes into the marketplace and buys hard disks from several vendors. However, they buy their XT hard disk controller from only one vendor—the same one we do.

You can buy the IBM XT controller from IBM for \$495 or you can buy from us, the functional equivalent, manufactured by the same company that makes it for IBM for only \$195. Is it the exactly identical IBM XT controller? No, it's better. First, it takes less power, and secondly, it can control from 5 to 32 megabytes—the IBM controller can work with only 10 megabytes. It is 100 percent IBM XT compatible, and 100 percent is 100 percent. If you want to save a slot, we carry a version that lets you operate two hard disks and two floppy disk drives.

### **More than 32 Megabytes**

You can operate with more than 32 megabytes (the limit of DOS) through the use of "device drivers." Express Systems can supply you with device drivers for our hard disks for over 32 megabytes formatted. But, if you don't have individual files, or databases that are large, you might want to consider one of our controllers that can divide our 65 megabyte (formatted) hard disk into two equal volumes of 32 megabytes each.

### **Reliability**

We offer you a choice between iron oxide and plated media—the stuff that covers the hard disk and gives it its magnetic properties. Iron oxide is, well, it's rust. If you inadvertently jost your disk, you may cause the low flying head to dig out some iron oxide. A little rust flake can ruin your whole day. Plated media is more resistant to damage, and if it happens, less data is lost.

We offer both types of hard disks. The iron oxide is older





technology, and quite frankly, manufacturers understand it better. Their better understanding, combined with some of the special head locking mechanisms, gives us peace of mind when we sell you one.

### Power

Hard disks consume power. Our small, half-high hard disks consume so little power that you can use them with your existing IBM PC power supply. If you plan to use lots of slots, you'll want to increase your power supply to be safe. We offer the same amount of power for your PC that comes in the XT.

### Our Customers

Some folks just never feel comfortable buying mail order. They forget that Sears began as a mail order house or that IBM is now into mail order. But, if it helps, here is a *partial* list of customers who have felt comfortable to buy from us.

- |                  |           |
|------------------|-----------|
| IBM              | Sears     |
| American Express | Honeywell |
| U.S. Army        | MIT       |
| AT&T (Bell Labs) | RCA       |
| Bausch & Lomb    | Lockheed  |
| Xerox            | Sperry    |

### Easy to Install

If you're like most of us, raised on the boob tube rather than the Great Books, you'd rather see the movie than read the book. Well, now you can choose to read our installation manual or for only \$9.95 more, you can get a VHS or Beta video cassette showing the simple steps for installation.



### Warranty

We offer you a one year warranty on our hard disks—the same as IBM on the AT and 90 days on the tape drives. (It's all the manufacturer gives us.) All



### Complete Hard Disk Kits

Formatted MB	Height	Plated Media	Average Access	Transfer Rate	PC or PC/XT	AT
10	1/2	no	85 msec	5 Mbits/s	\$ 395	\$ N/A
10	1/2	yes	85 msec	5 Mbits/s	\$ 495	\$ N/A
21	1/2	yes	85 msec	5 Mbits/s	\$ 795	\$ 595
21	Full	no	30 msec	5 Mbits/s	\$ 1,535	\$ 1,340
32	1/2	yes	85 msec	5 Mbits/s	\$ 995	\$ 795
32	Full	no	30 msec	5 Mbits/s	\$ 1,775	\$ 1,575
65	Full	no	30 msec	5 Mbits/s	\$ 2,295	\$ 2,070
100	Full	yes	18 msec	10 Mbits/s	\$ 4,995	\$ 4,995

### Removable Hard Disk

10	1/2	no	90 msec	5 Mbits/s	\$ 1,095	N/A
----	-----	----	---------	-----------	----------	-----

### Tape Systems and Subsystems

Formatted Storage Capacity	Height	Data Transfer Rate (k/sec)	PC or PC/XT	AT
60 Mbytes	1/2	88	\$ 995	\$ 995
60 Mbytes Subsystem		88	\$ 1,295	\$ 1,295
21 Mbytes (unformatted) Start/stop Subsystem		24	\$ 595	\$ 595
26 Mbytes Floppy Tape® Subsystem		31	\$ 749	\$ 749

### Controllers

All of our hard disk and tape controllers are available separately. Please call for prices.

### Subsystem Chassis

Any of our disk or tape units are available in an external subsystem for an additional \$250.00. You can mix & match any of our 1/2 high hard disks or tape drives together or add any single full height hard disk.

### Tape Cartridges

Express Certified 555 foot 310 Hci 1/4-inch Data Cartridge **\$35.00**

### Power Supply

130 Watt Power supply **\$75.00\***  
150 Watt Power supply **\$125.00**

\*with the purchase of any drive

anything goes wrong with your tape or disk drive or hard disk, send it back in the box it came in. However, we have found that we can usually solve the problem over the phone. So call first for a return authorization number because we can't accept any returns without it.

### Comes complete

All Express Systems products come complete with the appropriate software, tape and/or hard disk controllers, and cables where required. Hard disks are formatted and tested with the PC DOS of your choice. All drive sizes are formatted capacities.

If your application requires a stacking kit, power splitter cables, daisy chain cable, or some other variation, we'll supply these items at a nominal charge. We even ship our hard disks with Command Assist™ an on-line DOS-like manual to give you help with your DOS commands.

### More questions?

Because we spend so much attention on the front end with ensuring that our disks will arrive in working order, we have a customer service department that, unlike many of our competitors, has little to do. When you need us, you won't get a constant busy signal.

Call our friendly, knowledgeable customer service staff to get answers to your questions—before or after the sale. Our people, who know the PC, can talk you through the sticky parts, and they'll respond to you quickly. Just call us.

### How to order

Pick up the telephone and call 1-800-341-7549, to order. We accept Master Card, VISA, American Express and Diners Club. Or send a cashier's check or

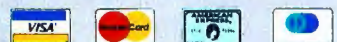

money order (We'll take a check, but you'll have to wait for it to clear) and tell us if you want one of our recommended configurations or you want to mix and match yourself. Corporations with a DUNS number may send purchase orders for quantities over five.



**Call Toll Free 1-800-341-7549 Ext. 1400**  
**In Illinois call (312) 882-7733 Ext. 1400**

Express Systems, Inc., 1254 Remington, Schaumburg, IL 60195

Inquiry 142

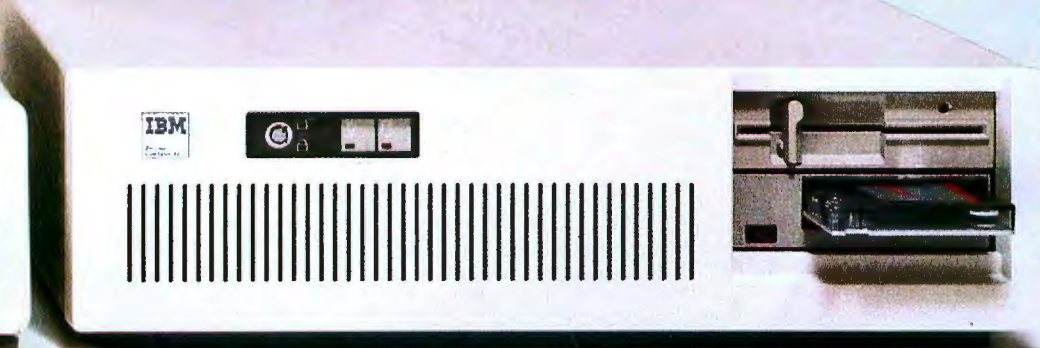



HOMEBREW  
BYTE 1975-1985

FOLD  
ALONG  
DOTTED  
LINES

CUT OUT  
HERE

8

7

16

30

ROBERT  
STINNEY

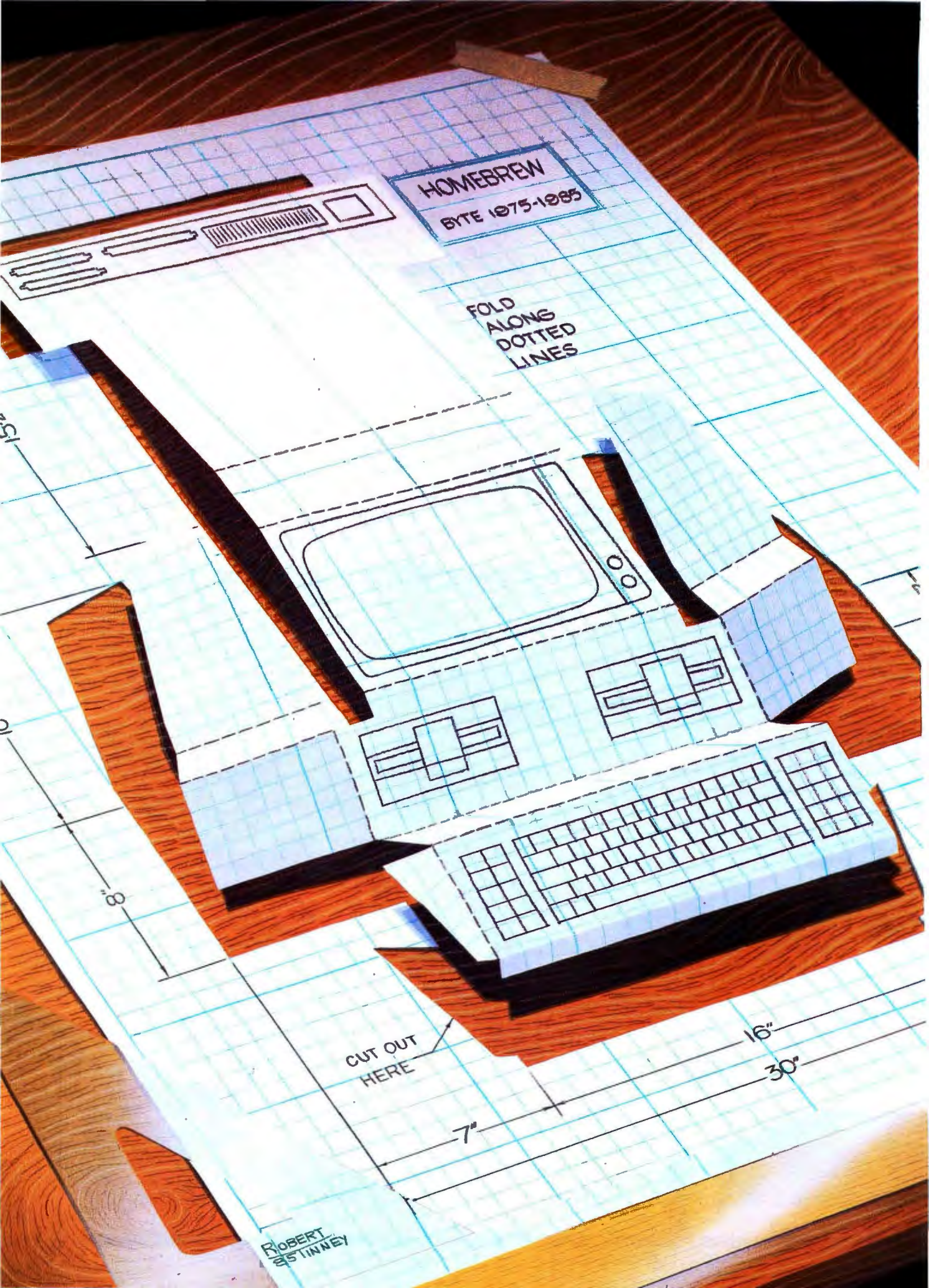



# Homebrewing

---

<b>EGO: A HOMEBUILT CPU, PART I: THE SOFTWARE</b> <i>by Clifford Kelley</i> . . . . .	<b>229</b>
<b>THE QUARTER-MEG ATARI 800XL</b> <i>by Claus Buchholz</i> . . . . .	<b>247</b>
<b>A PARALLEL-TO-SERIAL PRINTER PORT ADAPTER</b> <i>by Howard Austerlitz</i> . . . . .	<b>257</b>
<b>ADD FUNCTION KEYS TO YOUR MICROCOMPUTER</b> <i>by Mark Hanslip</i> . . . . .	<b>263</b>

---

IN THE PAST, THE ONLY WAY you could get hardware for your computer system was to build it yourself. Today, you can get almost anything you might want for your computer, but for a price. Many people are interested in hardware projects not only because they are an inexpensive source of extensions to their systems but also because of the experience they gain by building these projects.

We have several construction projects this month, ranging from the simple to the complex. In his article "The Quarter-Meg Atari 800XL," Claus Buchholz details how to upgrade your Atari 800XL memory to 512K bytes and promises to free users from the slow Atari disk-drive access time by providing software for implementing a fast RAM disk that uses all the extra memory.

Today, many computers have a Centronics parallel printer port as standard equipment. If you happen to have a serial printer, your parallel port may go unused. Howard Austerlitz presents an inexpensive parallel-to-serial printer port adapter that will help you take advantage of your parallel ports.

Often, the main thing separating an \$8000 commercial word processor from a word-processing program on a microcomputer is the presence of predefined keys for special functions on the dedicated systems. While most newer microcomputers have 10 or 12 programmable function keys, many older machines don't. Mark Hanslip has designed a project that enables you to add up to 40 function keys to any microcomputer with a parallel-encoded keyboard.

And for the ambitious builder, Clifford Kelley's two-part article "EGO: A Homebuilt CPU" (to be continued next month) delves into the complexities of building your own microprocessor: designing the instruction set, system architecture, and system hardware. While you may not want to build your own microprocessor, you'll probably be interested in the considerations that go into designing such a complex system.

Finally, be sure to check out Ciarcia's Circuit Cellar this month. Steve presents the SB180, a high-performance, HD64180-based, Z80-compatible single-board computer kit with 256K bytes of memory; floppy-disk controller; one I/O, one parallel, and two serial ports; and a lot of software. Don't let its 8-bit microprocessor fool you; the 6-MHz SB180 turns in some impressive benchmarks.



# Golden Common LISP

## Gold Hill Computers brings the language of Artificial Intelligence to Your Personal Computer.

### Why every Computer Professional should know COMMON LISP.

You know how frustrating it is to deal with programs that are stupid and inflexible like those buried inside automated bank teller machines and airline reservation systems. You also know how frustrating it is to engineer solutions to today's information-processing problems with languages designed mainly for number crunching. *It doesn't have to be this way.*

Programs based on the ideas of Artificial Intelligence and implemented in COMMON LISP can be intelligent, flexible, and human-like. When you use COMMON LISP in combination with artificial intelligence techniques, you will be able to *solve problems you could never solve before*. You will be able to write powerful programs that can accommodate naive computer users who want intelligible answers to questions quickly.

The best way to get started is to buy GOLDEN COMMON LISP™, the first COMMON LISP for personal computers.

### GOLDEN COMMON LISP: The AI Tutor

GOLDEN COMMON LISP makes it easy for you to learn to use COMMON LISP, on your personal computer, by yourself, at your own pace. The San Marco LISP Explorer™, a 1000-frame interactive software slide show developed by Patrick H. Winston and San Marco Associates, takes you through COMMON LISP and exciting *artificial intelligence applications* like expert systems, intelligent data-access systems, and natural language interfaces.

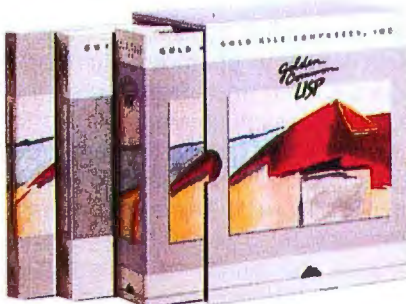

### GOLDEN COMMON LISP: The Complete LISP Environment

The GOLDEN COMMON LISP package includes:

- the GCLISP interpreter
- the GMACS editor
- the San Marco LISP Explorer
- the On-line Help system
- LISP, 2nd edition by Winston and Horn
- the *COMMON LISP Reference Manual* by Steele
- the GOLDEN COMMON LISP User's Manual

### GOLDEN COMMON LISP: The Powertool for Personal Computing

GOLDEN COMMON LISP is an extensive subset of COMMON LISP, supporting more than *400 LISP primitives*. Advanced features of GOLDEN COMMON LISP include co-routines for multi-tasking, macros for code clarity, streams for I/O, closures for object-centered programming, and multiple-value-returning functions for efficiency.

GOLDEN COMMON LISP requires an IBM, PC XT, PC AT, or 100% IBM PC compatible computer with 512K bytes of memory and PC-DOS 2.0 or higher. More memory is recommended for applications development.

ORDER GCLISP TODAY using the coupon below. Or call our Sales Department at:

**617-492-2071**

Gold Hill Computers		B1-85	
163 Harvard Street Cambridge, MA 02139			
Name _____			
Title _____			
Department _____			
Organization _____			
Address _____			
Phone _____		Today's Date _____	
Type of computer _____			
<input type="checkbox"/> Enclosed is a check to Gold Hill Computers for GCLISP.			
<input type="checkbox"/> Please bill my <input type="checkbox"/> MasterCard <input type="checkbox"/> VISA card.			
Card # _____		Expiration Date _____	
Signature _____			
Quantity	Description	Unit Price	Total Price
	GOLDEN COMMON LISP	\$495	
Subtotal			
MA residents add 5% Sales Tax			
Total Amount			
We welcome inquiries about volume discounts, dealer discounts, and educational discounts for university-affiliated purchasers.			
<input type="checkbox"/> Please send me more information.			

G O L D H I L L C O M P U T E R S

163 Harvard Street, Cambridge, Massachusetts 02139

Inquiry 158

GOLDEN COMMON LISP and GCLISP are trademarks of Gold Hill Computers. The San Marco LISP Explorer is a trademark of San Marco Associates. LISP is copyrighted by Addison-Wesley Publishing Company, Inc. The *COMMON LISP Reference Manual* is copyrighted by Digital Equipment Corporation. IBM PC, PC XT, PC AT, and PC-DOS are trademarks of International Business Machines.



# EGO: A HOMEBUILT CPU

## PART 1: THE SOFTWARE

BY CLIFFORD KELLEY

*This homemade CPU  
sports a clever instruction set*

*Editor's note: Part 1 of this two-part series covers the instruction set and software aspects of the EGO computer. Next month the author will examine the EGO computer's hardware.*

IT IS DIFFICULT TO JUSTIFY building a custom CPU (central processing unit). It won't cost less than an available microcomputer; it will take many hours to design, build, and debug; and, most important, no software will be available for it. However, there are the advantages of being able to incorporate features not found on commercial processors, not to mention the education you would derive from undertaking such a project.

For many years I toyed with the idea of building a CPU. I studied the subject briefly, but reality intruded and I soon forgot it. Then, a few years ago, I took some digital design courses that finally gave me the confidence to determine what my budget could take and to get on with it.

First, I set about defining the requirements. There were only two: Make it simple and make it powerful enough to be useful. These are somewhat contradictory, but in the end I believe EGO fulfilled both.

### THE INSTRUCTION SET

The most important part of designing a computer is devising the instruction set. It is the major determinant of the system architecture. As I said, I wanted EGO to be simple yet useful. My definition of useful is the ability to do floating-point operations efficiently. Thus, defining the ALU (arithmetic logic unit) operations was my first step. I wanted the ALU to be able to load, shift, rotate, increment, decrement, add, and subtract at the very least. These, combined with some simple logic operations like AND,

OR, and exclusive-OR, gave me a list of 14 instructions. The 74381 4-bit ALU seemed the perfect device. I could use it for the logic and arithmetic instructions. This left me with 16 basic instructions taking up 4 bits of instruction space.

Next came the instruction types. These determine how an instruction defines where the data used by the ALU comes from and where the results will be stored. In order to keep the instruction set simple, I decided to keep all EGO's registers general-purpose. Consequently, there are no restrictions on which registers can be used in what instructions, and the only special-purpose register is register 0, which is used as the program counter. Although I could have constructed an instruction set that loaded data directly to and from memory locations (known on most processors as direct addressing), I felt this would slow down the computer and corner me into including two or three memory-pointing registers (like the HL register pair on the 8080 or the SI and DI registers on the 8088/86) manipulated by a number of special instructions. The only reasonable solution was a large number of general-purpose registers that programmers could dedicate as their needs required. This also forced me to design EGO so that registers could be used for direct addressing (in which the register holds the actual data) as well as indirect addressing (in which the register holds the address of the data).

I decided that EGO would have four different instruc-

*(continued)*

Clifford Kelley has a B.S. in physics and mathematics from Marquette University. He currently works on missile simulation systems at Rockwell International. He can be contacted at 4127½ Maybank, Lakewood, CA 90712.



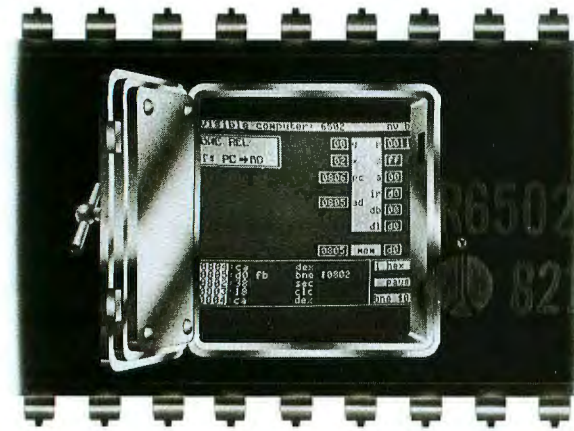

# UNLOCK THE SECRETS OF MACHINE LANGUAGE.

Our Visible Computer teaching systems do more than tell you about machine language, they show you — by turning your computer into an animated simulation of its micro-processor chip. You'll actually see the registers change as the processor executes instructions; you'll see how instructions are executed, not just the result.

The extensive manual may just be the clearest tutorial on machine language ever written. You'll work "hands-on-keyboard," at your own pace, as you progress through 30 demonstration programs stored on disk.

Apple II version: \$49.95. Commodore 64 version: \$39.95  
**NEW!** The Visible Computer: 8088 (IBM PC): \$69.95. At better software dealers or direct from Software Masters, P.O. Box 3638, Bryan, TX 77805. (409) 822-9490. MC/Visa accepted. Mail orders enclose \$3.00 shipping.

**Software Masters™**

## EGO

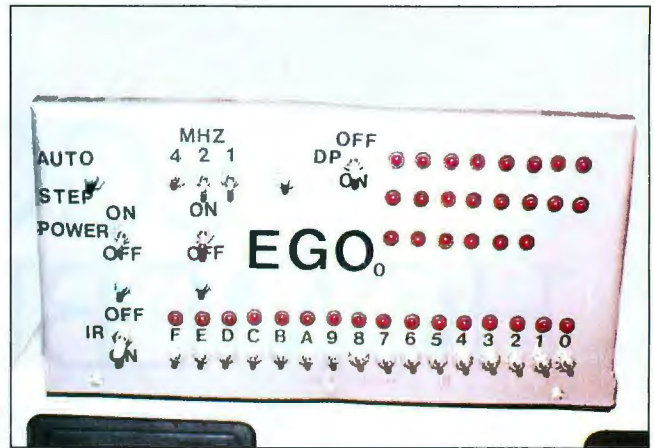

Photo 1: EGO, the author's homemade CPU, sits atop a Tandy 2000 that is used for uploading and downloading programs. The switch in the upper left corner allows the author to run EGO in single-step mode, and the row of LEDs along the bottom can be used to read either EGO's data bus or the CPU's instruction register.

tion types: data, register, indirect operand, and indirect result. The data instruction type (often referred to on other processors as the "immediate" instruction type) is composed of two words; the first word holds the instruction, and the second is data. The operation is performed using the data word and the contents of a register, and the result is returned to the register.

All other instruction types require only one word. In the register instruction type, the operands are the contents of two registers, and the result is stored in one of the registers. Indirect operand instructions use the contents of a register as one operand, use the contents of another register as a memory address where the other operand is stored, and leave the result in a register. Finally, the indirect result instruction type functions like the indirect operand type, except that the result is returned to the memory address of the second operand.

The last major decision was how long the instruction word and address lengths would be. Actually, it was an easy decision. To be useful, EGO had to be able to address a large amount of memory; to keep the registers truly general, the instruction length must be the same as the address length. For the address length, I felt the standard 16 bits would be more than adequate. Since EGO would be addressing words, this would give me a total of 64K words, or 128K bytes of memory—twice that available on 8-bit microprocessors. The instruction length is also a multiple of 4, which would make the circuits easier to build and allow 10 bits for register addressing. I felt that a two-address instruction set was a minimum for keeping the instructions general. I would have preferred a three-address instruction set, but that would have left me with only enough bits in the instruction to address eight reg-

(continued)

### HARMONY VIDEO & COMPUTERS

2357 CONEY ISLAND AVE., BROOKLYN, NY 11223  
 800-VIDEO84 OR 800-441-1144 OR 718-627-1000



**IBM PC 256K**  
**\$1309.95**  
**STAR SG 10**  
**\$207.50**

**PANASONIC 1091**  
**\$221.95**  
**APPLE 2E w/DRIVE**  
**\$779.95**

#### "PRINTER SPECIALS"

Brother HR15 XL	328	NEC 2050	593	Panasonic KXP 1093	411
Brother HR 35	678	NEC 3550	931	Panasonic KXP 3151	379
Citizen MSP 10	268	NEC850	1317	Powertype	275
Citizen MSP 15	408	NEC p3 or p2	558	Star SG10	208
Corona Laser	244	Okidata 192	328	Star SG15	338
Daisywriter	718	Okidata 183	510	Star SD10	308
Epson LX80	210	Okidata 182	219	Star SD15	404
Epson RX100	369	Okimate 10	119	Star SR10	436
Epson FX80+	321	Olympal Compact 2	312	Star SR15	543
Epson JX80	548	Olympal ro	250	Star SB10	671
Epson FX 185 +	473	Panasonic KXP 1091	222	Silver Reed Exp 550	384
Epson LQ 1500	910	Panasonic KXP 1090	161	Silver Reed Exp 500	208
HP Laser Jet	2704	Panasonic KXP 1092	331	Silver Reed Exp 770	850
Juki 6100	345			Toshiba 1340	515
Mannesman Spirit 100	187			Toshiba 351	984

# WOW! WOW! WOW!

IBM	APPLE	MONITORS
AT Enhanced	2E w/Disk Drive	Amdek 300 Green
AT Unenhanced	Apple 2C	Amdek 300 Amber
IBM Monitor	Imagewriter	310 Amber
PC 256K	Add. Drives	Color 300
PC XT	Orange Interface	Color 500
IBM Drive		Color 800
AST Six Pack		Color 700
Tallgrass 25 Meg		Color 710
Quad Board	130 XE	Princeton HX12
Keytronics	800 XL	Princeton Max 12
Handi 1	1027 Printer	Taxan 122A
Hercules Color	1050 Drive	Taxan 420
Hercules Monochrome	Indus. Drive	
Mitsuba Monochrome	1025 Printer	
Paradise Graphics	Koala Pad	
Paradise Multi Display		
STB Graphics + 2'		
Tecmar Graphics		
Tecmar Captain		
Persyst Monocard		
Bernoulli Box		
10 Mag Drive		
Joystick		

800-441-1144



# AMAZING DAISY

NOW! FULL SIZE, FULL FEATURE, LETTER QUALITY AT ONLY \$353

If you have been searching for a letter quality printer you have probably found the flood of claims and counterclaims to be a real roadblock in your search. Not long ago we were in the same position. We tried to determine which daisy wheel printer had all the features our customers wanted, yet would not set them back a month's salary. Recently several manufacturers have introduced machines that had features we were searching for. After a thorough assessment, we eliminated one model after the other for lack of one feature or another until we only had one left.

## THE RESULTS ARE IN

We found the printer which has all the features anyone could want. The winner is the Arotek Daisy 1120, a real heavy-duty workhorse printing at 20 characters per second. The manufacturer is Olympic Co. Ltd., a highly respected Japanese firm.

## FEATURES GALORE

This printer has it all. To start with, it has a front panel Pitch Selector button with indicators which allows 10, 12, 15 characters per inch (CPI) or Proportional Spacing. There is a Select (Online) button (with indicator) and a Line Feed button. You can also set Top-of-Form or Form Feed with the touch of the TOF button. Other front panel indicators include Power and Alarm.

To load a sheet of paper, simply place it in the feed slot and pull the paper bail lever. PRESTO! The paper feeds automatically to a 1 inch top margin and the carriage aligns to the selected left margin. In this manner, each page can have identical margins automatically. You can continue to compute while the Daisy 1120 is

printing. The built in 2K buffer frees up your computer while printing a page or two allowing you to go to your next job.

To really put your printer to work, the Cut Sheet Feeder option is great for automatic printing of those long jobs. Also available is the adjustable Tractor Feed option. Compare our option prices! Best of all the Daisy 1120 is quiet: only 57 dB-A (compare with an average of 62-65 dB-A for others).

## COMPLETE COMPATIBILITY

The Daisy 1120 uses industry standard Diablo® compatible printwheels. Scores of typeface styles are available at most computer or stationary stores. You can pop in a 10, 12, 15 pitch or proportional printwheel and use paper as wide as 14". At 15 CPI you can print 165 columns—great for spreadsheets.

The Daisy 1120 uses the Diablo Hytype II® standard ribbon cartridges. Again universally available.

Not only is the hardware completely compatible, the control codes recognized by the Daisy 1120 are Diablo 630® compatible (industry standard). You can take advantage of all the great features of word processing packages like Wordstar®, pfs: Write®, Microsoft Word® and most others which allow you to automatically use superscripts, subscripts, automatic underlining, bold-face (shadow printing) and doublestrike.

The printer has a set of rear switches which allow the use of standard ASCII as well as foreign character printwheels. Page length can be set to 8, 11, 12, or 15". The Daisy 1120 can also be switched to add automatic line feed if required.

## THE BEST PART

When shopping for a daisy wheel printer with all these features (if you could find one), you could expect to pay \$600 or \$700 dollars. The options would add much more. *Not now!* We have done our homework. We can now offer this printer for only \$353. Order yours today!

## NO RISK OFFER

Try the Daisy 1120 for 2 weeks. If you are not satisfied for ANY reason we will refund the full price—promptly. A full 1-year parts and labor warranty is included.

## THE BOTTOM LINE

Arotek Daisy 1120 (Order#1120) \$353 w/standard Centronics parallel interface and 2K buffer.

## Options

Auto Cut Sheet Feeder (#1110) \$188

Tractor Feed (#1112) \$77

## Accessories

8' Cable for IBM PC® and compatibles (#1103) \$26

Interface with cable: •TI-99/4A (#106) \$66

•Apple II or IIe (#1104) \$76

•All Commodore (except Pet) (#1105) \$44

•All Atari (#1107) \$66

Shipping is \$11—UPS continental USA. If you are in a hurry, UPS Blue or Air Parcel Post (second day air) is \$25. Canada, Alaska, Mexico and Hawaii are \$30 (air). Other foreign is \$60 (air). California residents add 6% tax. Prices are cash prices—VISA and M/C add 3% to total. We ship promptly on money orders, cashier's checks, and charge cards. Allow 14-day clearing for checks. No C.O.D.'s. Payment in US dollars only.

TO ORDER ONLY CALL TOLL FREE

(800) 962-5800 USA (8-8 PST)

(800) 962-3800 CALIF.

Or send payment to address below:

Technical Information & Customer Service: (805) 987-2454 (8-5 PST)

Dealer Inquiries Invited

©1985 APROTEK. All rights reserved.  
Trademarks: Diablo, Hytype II, 630-Xerox Corp.; Wordstar-Micropro Corp.; PPS-Software Publishing Corp.; Microsoft Word-Microsoft Corp.; Apple, II, IIe-Apple Computer, Inc.; IBM PC-IBM Corp.; PET-CBM.



 **APROTEK**

1071-A Avenida Acaso, Camarillo, CA 93010



DYNAMIC RAMS				STATIC RAMS			
41256	256K x 1	120 ns \$ 3.65 150 ns \$ 2.75	6264LP	8K x 8	120 ns \$ 5.50 150 ns \$ 4.50		
4164	64K x 1	120 ns \$ 0.90 150 ns \$ 0.75 200 ns \$ 0.75	6116P	2K x 8	120 ns \$ 2.15 150 ns \$ 1.95 200 ns \$ 3.95		
E. PROMS				8000's			
27256	32K x 8	250 ns \$ 7.25	7201	\$ 7.25	8253-5	\$ 3.75	
27128	16K x 8	250 ns \$ 2.95	765A	\$ 7.25	8255A-5	\$ 3.75	
27C64	8K x 8	200 ns \$ 4.50	8085A	\$ 3.95	8748	\$ 9.00	
2764	8K x 8	200 ns \$ 2.75	8088	\$ 8.75	8749HD	\$ 12.00	
		450 ns \$ 1.75	8155	\$ 3.25	8755A	\$ 16.75	
2732A	4K x 8	200 ns \$ 2.95 250 ns \$ 1.80	8251A	\$ 3.50	*For more parts not listed here. Please call		
● SPECIAL ITEMS							
2732	4K x 8	450 ns \$ 2.85	8087-2		\$ 105.00		
2532	4K x 8	450 ns \$ 4.95	8087-3		\$ 115.00		
2716	2K x 8	450 ns \$ 2.15	80287-3		\$ 195.00		
PRINTERS AND KEYBOARDS							
*Made in Japan, high quality product with one year warrantee.							
SX-100 cps	PRINTER				\$ 189.00		
SX-130 cps	PRINTER (IBM Compatible)				\$ 199.00		
SFK-201B	KEYBOARD (IBM Compatible • Capacity Type)				\$ 119.00		
I.C. EXPRESS							
15358 Valley Boulevard, City of Industry, CA 91746 Phone: 818-369-2688 (Mon-Fri • 8-5)							
ORDER TOLL FREE <b>800-892-8889 • 800-882-8181</b>							
EXCEPT FROM CALIFORNIA CALIFORNIA RESIDENTS ONLY							
Call for current prices & volume discounts. Prices are subject to change. TERMS: Minimum order \$10.00, California residents must add 6.5% sales tax. Shipping & Handling: UPS Ground \$3.00, UPS Air \$5.00 (under 1 lb.) ALL MERCHANDISE IS 100% GUARANTEED.							



**MAX. IBM® AT COMPATIBILITY AVAILABLE NOW!**

Made in USA

**\$1995**

IBS AT-7000 Mother Board from 512K-1 Megabyte

**AT/TURBO (6 MHz/8 MHz) System 30% Faster than IBM® PC-AT**

AT-7000/BASIC or ENHANCED Systems

XT-2001 Complete System **\$1695 (Dealers at Quantity 2)**

PC-2001 Complete System **\$995 (Dealers at Quantity 2)**

OEM BASIC System **\$555 (Minimum Order 10 Units)**

**AT-7000/Turbo/XT-2001/PC-2001 Options and Components:**

- 8 Expansion Slot Mother Board (AT-7000 is upgradable to 1 MB on board) • 380/1.2 MB TEAC Drive • 10/20/32 MB Hard Disk • Floppy Drive and Hard Disk Controller(s) • Multi-Function Card • Serial and Parallel Card • Tape Back-Up • Mono/Color Monitors

**\* DEALERS/OEMS PLEASE CALL FOR DETAILS (714) 579-0691 579-0692 579-0693**

PLEASE CALL FOR DEALER NEAREST YOU

AT-7000/TURBO NOT SHOWN BELOW

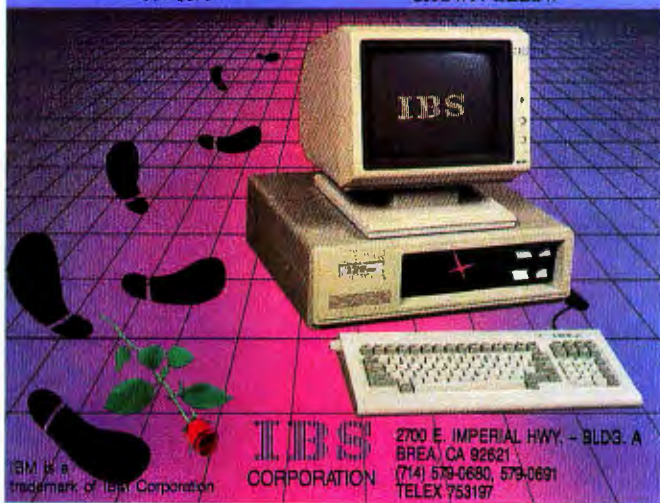

**IBS CORPORATION**  
2700 E. IMPERIAL HWY. - BLDG. A  
BREA, CA 92621  
(714) 579-0690, 579-0691  
TELEX 753197

EGO

### EGO Instruction Set

15 14 13 12 11 10 9 8 7 6 5 4 3 2 1 0 bit number

: 0 : 0 : Op Code : 1 : Condition : S2 : Word 1

---

15 0 bit number

: Data : Word 2

The condition bits refer to the four condition flags that are stored after every ALU operation:

Bit #	Flag	Set condition
8	Z	ALU result is zero
7	N	ALU result is negative
6	P	ALU result is positive
5	C	ALU result overflows ( carry )

Operation Code	Operation	Mnemonic
0 0 0 0	S2 = Data	LD S2,#Data ****
0 0 0 1	S2 = Data + 1	INC S2,#Data ****
0 0 1 0	S2 = S2 - Data	SUB S2,#Data ****
0 0 1 1	S2 = S2 - Data - $\overline{cy}$	SBC S2,#Data ****
0 1 0 0	S2 = Data - S2	NAD S2,#Data ****
0 1 0 1	S2 = Data - S2 - $\overline{cy}$	NCA S2,#Data ****
0 1 1 0	S2 = Data + S2	ADD S2,#Data ****
0 1 1 1	S2 = Data + S2 + cy	ADC S2,#Data ****
1 0 0 0	S2 = Data xor S2	XOR S2,#Data ****
1 0 0 1	S2 = Data left shift	SL S2,#Data ****
1 0 1 0	S2 = Data or S2	OR S2,#Data ****
1 0 1 1	S2 = Data left rotate	RL S2,#Data ****
1 1 0 0	S2 = Data and S2	AND S2,#Data ****
1 1 0 1	S2 = Data - 1	DEC S2,#Data ****
1 1 1 0	S2 = Data right shift	SR S2,#Data ****
1 1 1 1	S2 = Data right rotate	RR S2,#Data ****

The \*\*\*\* is space for the condition mnemonic code.

Figure 1: Data instruction types. These are the two-word instructions; all other instructions take only one word.

isters—not enough registers to allow for both dedicated uses and scratch-pad space for floating-point operations. A two-address instruction set allowed 5 bits to address a register, for a total of 32 registers, which appeared to be more than enough to do the job.

Inevitably, I had to make some compromises in the design of the instruction set. The data instruction type was necessary to load constants into registers. Since I made the program counter part of the general register set and was able to set aside 4 bits in the data type instruction word for condition testing, EGO could perform conditional jumps. This was in keeping with the general ALU structure I had chosen, but some miscellaneous instructions.

(continued)



# Introducing the Most Powerful Business Software Ever!

TRS-80™ (Model I, II, III, or 16) • APPLE™ • IBM™ • OSBORNE™ • CP/M™ • XEROX™

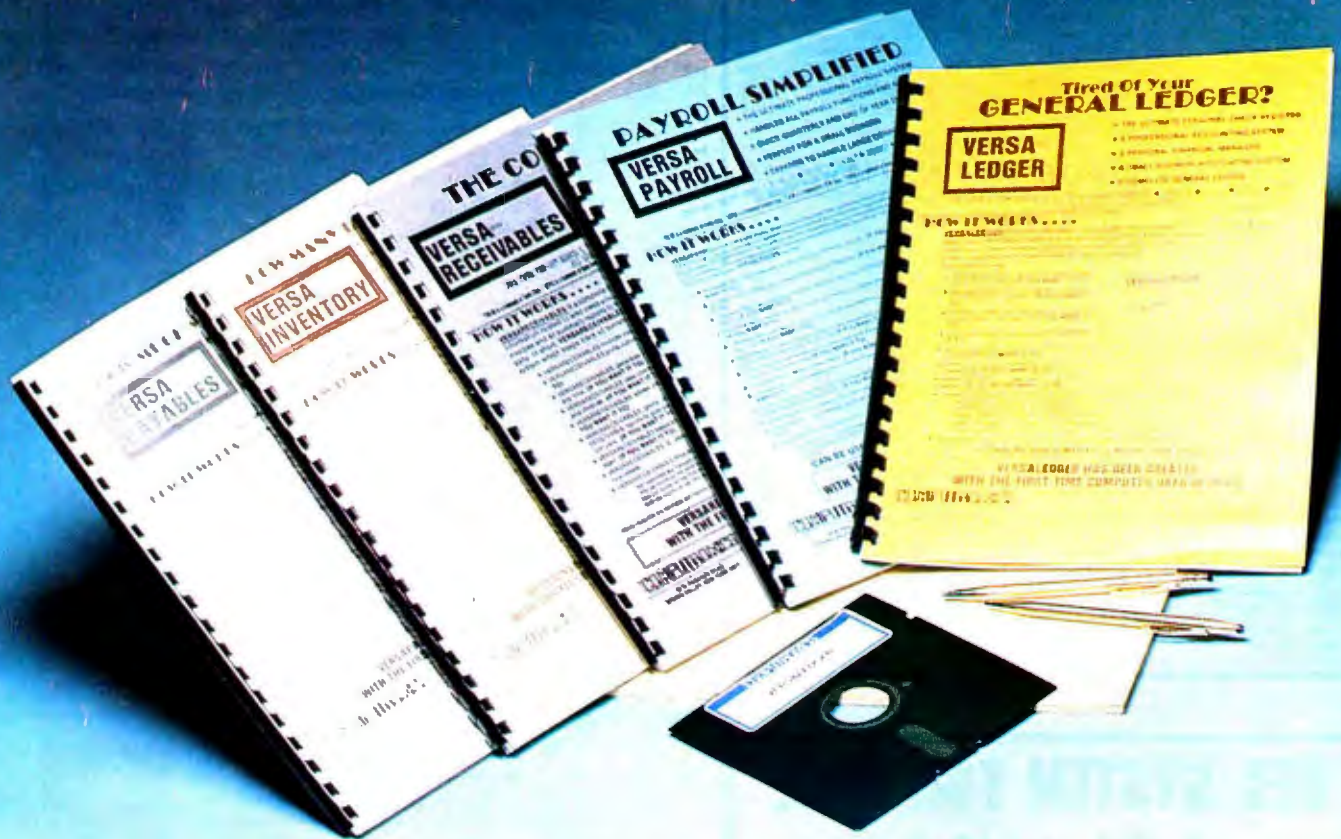

## The VERSABUSINESS™ Series

Each VERSABUSINESS module can be purchased and used independently, or can be linked in any combination to form a complete, coordinated business system.

**VERSA RECEIVABLES™** \$99.95  
 VERSARECEIVABLES™ is a complete menu-driven accounts receivable, invoicing, and monthly statement-generating system. It keeps track of all information related to who owes you or your company money, and can provide automatic billing for past due accounts. VERSARECEIVABLES™ prints all necessary statements, invoices, and summary reports and can be linked with VERSALEDGER II™ and VERSAINVENTORY™.

**VERSA PAYABLES™** \$99.95  
 VERSAPAYABLES™ is designed to keep track of current and aged payables, keeping you in touch with all information regarding how much money your company owes, and to whom. VERSAPAYABLES™ maintains a complete record on each vendor, prints checks, check registers, vouchers, transaction reports, aged payables reports, vendor reports, and more. With VERSAPAYABLES™, you can even let your computer automatically select which vouchers are to be paid.

**VERSA PAYROLL™** \$99.95  
 VERSAPAYROLL™ is a powerful and sophisticated, but easy to use payroll system that keeps track of all government-required payroll information. Complete employee records are maintained, and all necessary payroll calculations are performed automatically, with totals displayed on screen for operator approval. A payroll can be run totally, automatically, or the operator can intervene to prevent a check from being printed, or to alter information on it. If desired, totals may be posted to the VERSALEDGER II™ system.

**VERSA INVENTORY™** \$99.95  
 VERSAINVENTORY™ is a complete inventory control system that gives you instant access to data on any item. VERSAINVENTORY™ keeps track of all information related to what items are in stock, out of stock, on backorder, etc., stores sales and pricing data, alerts you when an item falls below a preset reorder point, and allows you to enter and print invoices directly or to link with the VERSARECEIVABLES™ system. VERSAINVENTORY™ prints all needed inventory listings, reports of items below reorder point, inventory value reports, period and year-to-date sales reports, price lists, inventory checklists, etc.

**VERSA LEDGER II™** \$149.95  
 VERSALEDGER II™ is a complete accounting system that grows as your business grows. VERSALEDGER II™ can be used as a simple personal checkbook register, expanded to a small business bookkeeping system or developed into a large corporate general ledger system **without any additional software.**

- VERSALEDGER II™ gives you almost unlimited storage capacity (300 to 10,000 entries per month, depending on the system),
- stores all check and general ledger information forever,
- prints tractor-feed checks,
- handles multiple checkbooks and general ledgers,
- prints 17 customized accounting reports including check registers, balance sheets, income statements, transaction reports, account listings, etc.

VERSA LEDGER II™ comes with a professionally-written 160 page manual designed for first-time users. The VERSALEDGER II™ manual will help you become quickly familiar with VERSALEDGER II™, using complete sample data files supplied on diskette and more than 50 pages of sample printouts.

### SATISFACTION GUARANTEED!

Every VERSABUSINESS™ module is guaranteed to outperform all other competitive systems, and at a fraction of their cost. If you are not satisfied with any VERSABUSINESS™ module, you may return it within 30 days for a refund. Manuals for any VERSABUSINESS™ module may be purchased for \$25 each, credited toward a later purchase of that module.

To Order: **Write or call Toll-free (800) 431-2818**  
 (N.Y.S. residents call 914-425-1535)

- \* add \$3 for shipping in UPS areas
- \* add \$4 for C.O.D. or non-UPS areas
- \* add \$5 to CANADA or MEXICO
- \* add proper postage elsewhere

Inquiry 161

DEALER INQUIRIES WELCOME

All prices and specifications subject to change / Delivery subject to availability.



# COMPUTRONICS

50 N. PASCACK ROAD, SPRING VALLEY, N.Y. 10977

\* TRS-80 is a trademark of the Radio Shack Division of Tandy Corp. • APPLE is a trademark of Apple Corp. • IBM is a trademark of IBM Corp. • OSBORNE is a trademark of Osborne Corp. • CP/M is a trademark of Digital Research • XEROX is a trademark of Xerox Corp.



## COMPETITIVE EDGE

P.O. Box 556 — Plymouth, MI 48170 — 313-451-0665

### Compupro®, LOMAS, EARTH, TELETEK S-100 CIRCUIT BOARDS

CompuPro 286 CPU**	\$695.	Lomas 286 8MHz	\$821.	Color Magic 32K	\$556.
CompuPro SPU Z** 8MHz	550.	Lomas 8086	420.	Lomas 10MHz 8086	520.
CompuPro 8085/88**	245.	Lomas Octaport** 8 Serial	320.	Lomas 4 serial	200.
CompuPro Disk 1A**	347.	Lomas LDP** 72	206.	Lomas Color Magic** 16K	476.
CompuPro Disk 3**	417.	Lomas 256K Dram	445.	Lomas MSDOS** 2.11	200.
CompuPro Ram 22**	795.	Lomas 512K Dram	562.	CompuPro MDrive H*512K	417.
CompuPro Ram 23**	240.	Lomas Ram 67**	625.	CompuPro I/O 3 8 port	347.
CompuPro Ram 23 128	415.	Lomas Hazitall**	244.	Teletek SBC 1 6MHz 128	899.
CompuPro CPU Z**	189.	Thunder 1 86**	895.	Turbodos* for Teletek	650.
CompuPro CCP/M*816*	250.	Lomas CCP/M*86**	280.	Lomas 2 Megabyte	
System Support One**	245.	CompuPro I/O 4	245.	Ram-(2048K)	just \$1495.
Teletek HD/	375.	Teletek SBC 1	525.		
Teletek Systemmaster*	557.	Systemmaster II*	899.		

**Earth Computer TURBO SLAVE 18MHz 128K \$395.**  
Turbo Slave I runs with Teletek, North Star Horizon, Advanced Digital and Others under Turbodos\*\*.

### SYSTEMS

CompuPro 85/88,256K,CDOS, SS1,I/O 4,2-96TPI DRS, 15 Slot	\$3095
CompuPro 85/88,256K,CDOS, SS1,I/O 4,1-96TPI,20MB, 15 Slot	\$4295
CompuPro 286, SPUZ, 40MB, SSI, I/3, CDOS, 15 Slot, 30 amp P/S	\$6995
286, 1024K, 20MB, AutoCad 2 System — Ready to Run	\$8395
Lomas 286,1024K,20MB HD,1-5",CDOS, 6 SERIAL, 2 Par, 15 Slot	\$4895
Lomas Thunder 186, 256K, 20 MB HD, 1-5", CDOS, 4 Slot	\$2895
Teletek 8MHz Master, 4-8MHz 128K SLVS, 1-5", 20 MB HD, TDOS	\$4995

### UPGRADE YOUR IBM® PC™ !!

MONITORS	GRAPHIC BOARDS	HARD DRIVE KITS
Amdax 310A	\$159 Hercules Monochrome	\$299 PC 10MB PC
Taxan Color 440	\$549 Hercules Color Card	\$169 PC 21MB PC
Pnncceton Color HR-12	\$469 Tecmar Graphics Master	\$449 AT 21MB AT
Pnncceton Color SR-12	\$649 Paradise Graphics	\$279 AT 36MB AT
286 ACCELERATOR	\$699 STB Graphix II	\$279 AT 70MB AT
Turbo Accel-286		\$2295 AT 80MB AT
MULTI-FUNCTION BOARDS	FLOPPY DRIVES	\$3995 AT 119MB AT
AST 6 Pak 64K	\$245 TEAC-1/2 HT FD55B	\$119
Quadram Expanded Quadboard 0K	\$219 Mitsubishi 96TPI	\$125
Tecmar Captain 64K	\$199 5" DSDO Color Diskettes	\$ 21

ALL PRICES SUBJECT TO CHANGE AND STOCK ON HAND

CompuPro is a Registered Trademark of Visayn, CPU Z, Disk 1A, Disk 3, Interfacar 3, Interfacar 4, CPU 286, CPU 8085/88, System Support 1, MDRIVE-H, Ram 22, Ram 23 are trademarks or registered trademarks of Visayn. CP/M 2.2, CCP/M, are registered trademarks of Digital Research Inc. MSDOS is a registered trademark of Microsoft, Systemmaster & Systemmaster II are registered trademarks of Teletek Enterprises. Turbodos is registered trademark of Software 2000. IBM is a registered trademark of International Business Machines. AutoCad 2 is a registered trademark of AutoDesk, Inc.

## DEC SYSTEM FOR SALE LSI 11/23

(OEMed by Ultimate Systems of NJ)  
(18 months old)

**256K memory**  
**2X processor**  
**66 MB hard disk (unformatted)**  
**1/2" 9 track 1600 bpi tape back up**  
**8 ports running, expandable to 12**  
**ports with current hardware**

7 Volker-Craig VC-4404 terminals,  
VT-52 compatible

Pick operating system with complete purchase order entry system

**New cost was over \$60,000.**

**Make me an offer.**  
**Call Jeannette at**  
**(203) 871-6170**

## EGO

### Condition Code

Condition Bits	Execution Condition	Mnemonic
0 0 0 0	Not carry	I
0 0 0 1	Carry	C
0 0 1 0	Greater than 0	P
0 0 1 1	Greater than 0 or carry	CP
0 1 0 0	Less than 0	N
0 1 0 1	Less than 0 or carry	CN
0 1 1 0	Not 0	PN
0 1 1 1	Not 0 or carry	CPN
1 0 0 0	Equal to 0	Z
1 0 0 1	Equal to 0 or carry	CZ
1 0 1 0	Greater than or equal to 0	PZ
1 0 1 1	Greater than or equal to 0 or carry	CPZ
1 1 0 0	Less than or equal to 0	ZN
1 1 0 1	Less than or equal to 0 or carry	CNZ
1 1 1 0	Unconditional	'blank'
1 1 1 1	Unconditional	'blank'

Figure 2: Bit settings for condition-flag testing. If the condition is not met, then execution continues with the instruction following the data word.

15 14 13 12 11 10 9 8 7 6 5 4 3 2 1 0 bit number  
: 0 : 0 : 0 : 0 : 0 : 0 : 0 : 0 : Operation Code :

Operation Code	Operation	Mnemonic
0 0 0 0 0 0 0 0 0 0	No operation	NOP
0 0 0 0 0 0 0 0 0 1	Set carry flag	SCF
0 0 0 0 0 0 0 0 1 0	Clear carry flag	CCF
0 0 0 0 0 0 0 0 1 1	Halt	HLT

Figure 3: EGO's miscellaneous instructions.

such as set carry, clear carry, halt, and no-operation, are also useful. Fortunately, there was 1 bit left to distinguish between data and miscellaneous instructions.

Thus the instruction set is small but very general. Figures 1 through 5 summarize the instruction set. Bits 15 and 14 hold the instruction type. Bits 13 through 10 determine the operation performed. The two-address instructions (figures 3, 4, and 5) allow one operand from S1 (source 1) and the other from S2 (source 2). It is assumed that the result will be sent to S2. When only one operand is required, S1 is the operand and S2 is the location in which the result is stored. Except for the data instructions, the last 10 bits are divided into two groups: bits 9 through 5 for S1 and bits 4 through 0 for S2.

The first and most complex of the instruction types is  
*(continued)*





## INPUT/OUTPUT TECHNOLOGY, INC.

25327 Avenue Stanford, Unit 113, Valencia, CA 91355 • [805] 257-1000

### Uncompromising Additions to your S-100/IEEE-696 BUS

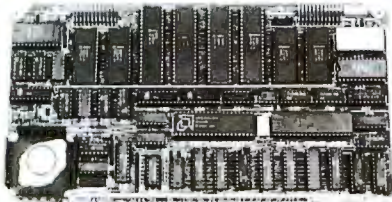

#### DUAL GPIB-488 INTERFACE BOARD

A Stand-Alone, Independently Controlled Dual Channel IEEE-488 I/O Processor. Interface Activity Modes for Controller-in-Charge, Controller Assigned or Terminal Bus Slave, and all Interface Functions are handled transparent to Host System CPU through an on-board CPU and DMA controller. User Friendly operation.

**A&T, P/N 52748-800-102**

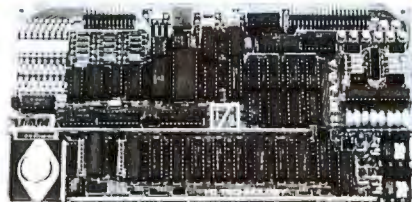

#### 12-BIT A-D-A CONVERTER BOARD

**8 Channel A-D:** 12 microsec. Conversion, 50KHz Sample Rate, Programmable Gains, Offset and Diff./Single Modes.

**8 Channel D-A:** 2 microsec. Settling, Bipolar V or Unipolar I Output. Programmable Reference levels, Dual-Ported Channel Refresh RAM. **16/8-Bit Data Transfers** via I/O or Memory Mapped

**A&T, P/N 52748-900-101**

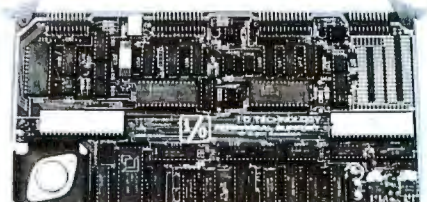

#### PERIPHERAL SUPPORT BOARD

Two Serial SYNC/ASYNCR Ports with RS-232, TTL or Current Loop Outputs, three 8-Bit Parallel Ports, three Timers, Real Time Clock/Calendar and Response Programmable Interrupt Controller. Small Proto Area with +5 and  $\pm 12v$ .

**A&T, P/N 52748-150-101**

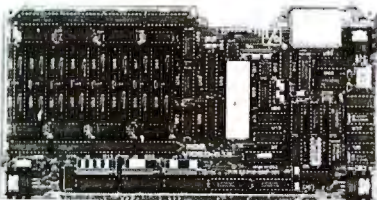

#### RGB COLOR GRAPHICS BOARD

Programmable resolution up to 512 x 512 pixels with 4 local video planes and on-board graphics processor. Color mapper allows 16 colors from a palette of 4096. Light pen input. Plus more ...

**A&T, P/N 52748-300-101**

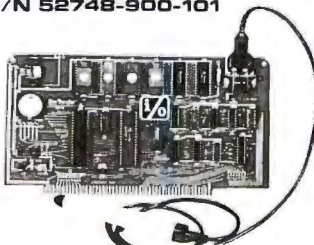

#### BAR CODE PROCESSOR BOARD

The BarTender is a stand-alone I/O Processor that reads and prints most common Bar Codes. Includes bi-directional reading, wand interface, clock/calendar with battery. Extensive documentation and software.

**A&T, 52748-500-101** Without Wand  
**A&T, 52748-500-201** With Wand

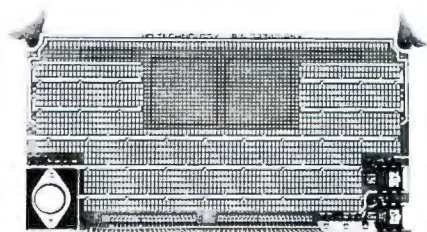

#### MULTI-PURPOSE PROTOTYPING KIT

Industrial Quality with Plated-Thru holes for Wire-Wrap or Solder projects. Complete with +5,  $\pm 12v$  Regulators, Bus Bar, Filter Capacitors, and Manual.

**P/N 52748-450** Inquiry 187

**ALSO AVAILABLE: MULTI-FUNCTION I/O BOARD, SMART PROTOTYPING KIT, 128Kx8/64Kx16 STATIC RAM MODULE**

SPECIFICATIONS SUBJECT TO CHANGE WITHOUT NOTICE.



# maxell Savings



5¼" DISKETTES	
MD-1 Sngl. Sided Dbl. Density . . . \$12.50 cellopak of ten (min. qty. 15 pkgs.) \$14.50 box of ten	
MD-2 Dbl. Sided Dbl. Density . . . \$17.50 cellopak of ten (min. qty. 15 pkgs.) \$19.50 box of ten.	
MD-2HD High Density . . . . . \$39.50 box of ten	
MD-1 (96 TPI) 5S Quad . . . . . \$22.50 box of ten	
MD-2 (96 TPI) DS Quad . . . . . \$28.50 box of ten	

3½" MICRO FLOPPY DISKS	
MF-1 5S Quad . . . . . \$26.50 box of ten	
MF-2 DS Quad . . . . . \$39.50 box of ten	

8" DISKETTES	
Single Sided . . . . . \$25.95 box of ten	
Double Sided . . . . . \$28.95 box of ten	

**TERMS:**  
 Visa/Mastercard — C.O.D. — Prepaid.  
 Allow 10 days for personal/ Company check to clear. Add \$3.00 Shipping. C.O.D. add \$2.00. Texas residents add 5.125% sales tax.



**Call for other Maxell Products**

**1-800-527-1814**  
 (in Texas 1-512-682-7774)  
 P.O. Box 3424—Edinburg, Texas 78540-3424

*the Disk Merchant*

Announcing the First

## OPTICAL DISC READ ONLY MEMORY FORUM

October 23-25, 1985  
 Pentagon City Quality Inn  
 Arlington, Virginia

**Presentations Cover:**

- Applications
- Market Potential/Investment Opportunities
- Computer Systems' Enhancement Potential
- Optical Disc-Read Only Memory Technology
- Standards & Specifications

**Pre-conference tutorials** are scheduled for October 22.  
**Exhibits** of representative technology will be available to conference registrants in an adjacent exhibit area.

For further information contact:  
**LEARNING TECHNOLOGY INSTITUTE**  
 50 Culpeper St., Dept. B  
 Warrenton, VA 22186 (703) 347-0055

### EGO

15 14 13 12 11 10 9 8 7 6 5 4 3 2 1 0	bit number	
: 0 : 1 : Op Code :	S1	S2

Operation Code	Operation	Mnemonic
0 0 0 0	S2 = S1	LD S2,S1
0 0 0 1	S2 = S1 + 1	INC S2,S1
0 0 1 0	S2 = S2 - S1	SUB S2,S1
0 0 1 1	S2 = S2 - S1 - $\overline{cy}$	SBC S2,S1
0 1 0 0	S2 = S1 - S2	NADS2,S1
0 1 0 1	S2 = S1 - S2 - $\overline{cy}$	NCA S2,S1
0 1 1 0	S2 = S1 + S2	ADD S2,S1
0 1 1 1	S2 = S1 + S2 + cy	ADC S2,S1
1 0 0 0	S2 = S1 xor S2	XOR S2,S1
1 0 0 1	S2 = S1 left shift	SL S2,S1
1 0 1 0	S2 = S1 or S2	OR S2,S1
1 0 1 1	S2 = S1 left rotate	RL S2,S1
1 1 0 0	S2 = S1 and S2	ANDS2,S1
1 1 0 1	S2 = S1 - 1	DEC S2,S1
1 1 1 0	S2 = S1 right shift	SR S2,S1
1 1 1 1	S2 = S1 right rotate	RR S2,S1

Figure 4: EGO's register instructions.

15 14 13 12 11 10 9 8 7 6 5 4 3 2 1 0	bit number	
: 1 : 0 : Op Code :	S1	S2

Operation Code	Operation	Mnemonic
0 0 0 0	S2 = (S1)	LD S2,(S1)
0 0 0 1	S2 = (S1) + 1	INC S2,(S1)
0 0 1 0	S2 = S2 - (S1)	SUB S2,(S1)
0 0 1 1	S2 = S2 - (S1) - $\overline{cy}$	SBC S2,(S1)
0 1 0 0	S2 = (S1) - S2	NADS2,(S1)
0 1 0 1	S2 = (S1) - S2 - $\overline{cy}$	NCA S2,(S1)
0 1 1 0	S2 = (S1) + S2	ADD S2,(S1)
0 1 1 1	S2 = (S1) + S2 + cy	ADC S2,(S1)
1 0 0 0	S2 = (S1) xor S2	XOR S2,(S1)
1 0 0 1	S2 = (S1) left shift	SL S2,(S1)
1 0 1 0	S2 = (S1) or S2	OR S2,(S1)
1 0 1 1	S2 = (S1) left rotate	RL S2,(S1)
1 1 0 0	S2 = (S1) and S2	ANDS2,(S1)
1 1 0 1	S2 = (S1) - 1	DEC S2,(S1)
1 1 1 0	S2 = (S1) right shift	SR S2,(S1)
1 1 1 1	S2 = (S1) right rotate	RR S2,(S1)

Figure 5: EGO's indirect operand instructions.

data (figure 1). Since only one register is referenced, there is room in the instruction for condition testing. Four condition flags are used to indicate the result of the previous ALU operation: zero, negative, positive, and carry (overflow). These can be tested in any combination, but you will notice that the "no flags" condition is used to test for "not carry" generated (see figure 2). If the condition is not met, the data instruction is ignored and execution con-

(continued)



# A FEW NEAT THINGS YOU CAN DO WITH KODAK'S CAT-QUICK INSTANT SLIDE-MAKERS...



*"Make your slides one by one, save on film and have some fun!"*

*"Correct mistakes, add new facts, give a show the punch it lacks."*

*"Take CRT data off the screen, edit freely in between."*

*"Mount your slides fast and clean—project bright hues on the screen."*

*"Meet tight deadlines, do a whole show, win new clients, hear 'bravo.'"*

*"Waste no money, waste no time, get results that are sublime."*



**"If you can't do without these cat-quick instant slide-makers another minute, contact your dealer in Kodak audiovisual products, listed in the Yellow Pages under 'AV Equipment and Supplies.' Or, phone 1 800 44KODAK, Ext 293 (1 800 445-6325, Ext 293). Tell 'em Slide Cat sent you!"**



The system includes KODAK INSTAGRAPHIC Copy Stand, KODAK INSTAGRAPHIC CRT Slide Imager and CRT Adapters, KODAK INSTAGRAPHIC Color Slide Film, and KODAK INSTAGRAPHIC Slide Mounter and Mounts.

© Eastman Kodak Company, 1985



PC/XT OWNERS,

# Replace Your Mother!



**Enjoy full XT hardware and software compatibility at PC/AT speeds with the BULLET-286 motherboard or get your money back\*.**

The Bullet-286 is a new motherboard for the IBM PC/XT built with Intel's 80286 cpu and packed with 640K on-board memory. Run your software up to 4 1/2 times faster. Recalculate a giant Lotus 1-2-3 spreadsheet 2 1/2 times faster. Norton's speed test ranks it 25% faster than the PC/AT!

Preserve your investment in the XT and its software in less than 10 minutes with just a screwdriver. And relax during our one year replacement warranty. Extended warranty available at additional cost.

Don't be fooled by add-ons or other boards that promise blinding speed, compromise compatibility, take up a slot, and have a token guarantee.

Remember, you can trust our mother.

Stop toiling away on a sluggish machine. Pick up some speed. Order the Wave Mate Bullet-286 today by calling Unisource Software Corp. at 617-491-1264.



71 Bent Street  
Cambridge, MA 02141  
(617) 491-1264

\*If any of your software doesn't run on the Bullet-286, we'll cheerfully refund your money within 30 days of purchase. The only condition: your software had to work on the original XT board and system, and not use IBM's ROM BASIC.

Lotus 1-2-3 is a trademark of Lotus Corporation  
Bullet-286 is a trademark of Wave Mate Corporation

## EGO

15 14 13 12 11 10 9 8 7 6 5 4 3 2 1 0 bit number

: 1 : 1 : Op Code : S1 : S2 :

Operation Code	Operation	Mnen
0 0 0 0	(S2)=S1	LD
0 0 0 1	(S2)=S1 + 1	INC
0 0 1 0	(S2)=(S2) - S1	SUB (S2),S1
0 0 1 1	(S2)=(S2) - S1 - cy	SBC (S2),S1
0 1 0 0	(S2)=S1 - (S2)	NAD (S2),S1
0 1 0 1	(S2)=S1 - (S2) - cy	NCA (S2),S1
0 1 1 0	(S2)=S1 + (S2)	ADD (S2),S1
0 1 1 1	(S2)=S1 + (S2) + cy	ADC (S2),S1
1 0 0 0	(S2)=S1 xor (S2)	XOR (S2),S1
1 0 0 1	(S2)=S1 left shift	SL (S2),S1
1 0 1 0	(S2)=S1 or (S2)	OR (S2),S1
1 0 1 1	(S2)=S1 left rotate	RL (S2),S1
1 1 0 0	(S2)=S1 and (S2)	AND (S2),S1
1 1 0 1	(S2)=S1 - 1	DEC (S2),S1
1 1 1 0	(S2)=S1 right shift	SR (S2),S1
1 1 1 1	(S2)=S1 right rotate	RR (S2),S1

Figure 6: EGO's indirect result instructions.

tinues. Also, when the data instruction is ignored, the ALU is not used, so the condition flags remain set at their previous values. This makes it easy to test and execute instructions for different conditions.

The miscellaneous instruction set is a subset of the data type. The instruction code is the same as the data instructions, except that bit 9 is zero. These instructions do not fit the general pattern of the rest of the instructions. The no operation, set carry flag, clear carry flag, and halt instructions are defined in figure 3.

The register, indirect operand, and indirect result instructions require only one word. For register instructions, S1 and S2 are direct operands, and the result is stored in register S2. For indirect operand instructions, S1 operand is indirect, S2 is direct, and the result is stored in register S2. For indirect result instructions, S1 operand is direct, S2 is indirect, and the result is sent to S2 indirectly.

The 16 ALU operations are pretty standard. They include the load, increment, subtract, subtract with carry, negate and add, negate and add with carry, add, add with carry, exclusive-OR, shift left, OR, rotate left, AND, decrement, shift right, and rotate right instructions. Although they're very basic, these instructions allow you to perform a number of powerful operations, especially when they're used with the program counter.

The instruction set takes some getting used to. Since I made the program counter a general-purpose register, data instructions can be used as direct or relative jumps. For example, the instruction LD0,#8 loads the program

(continued)



# Who Knows What Evil Lurks In The Lines Of Power?

Sahar Wilson

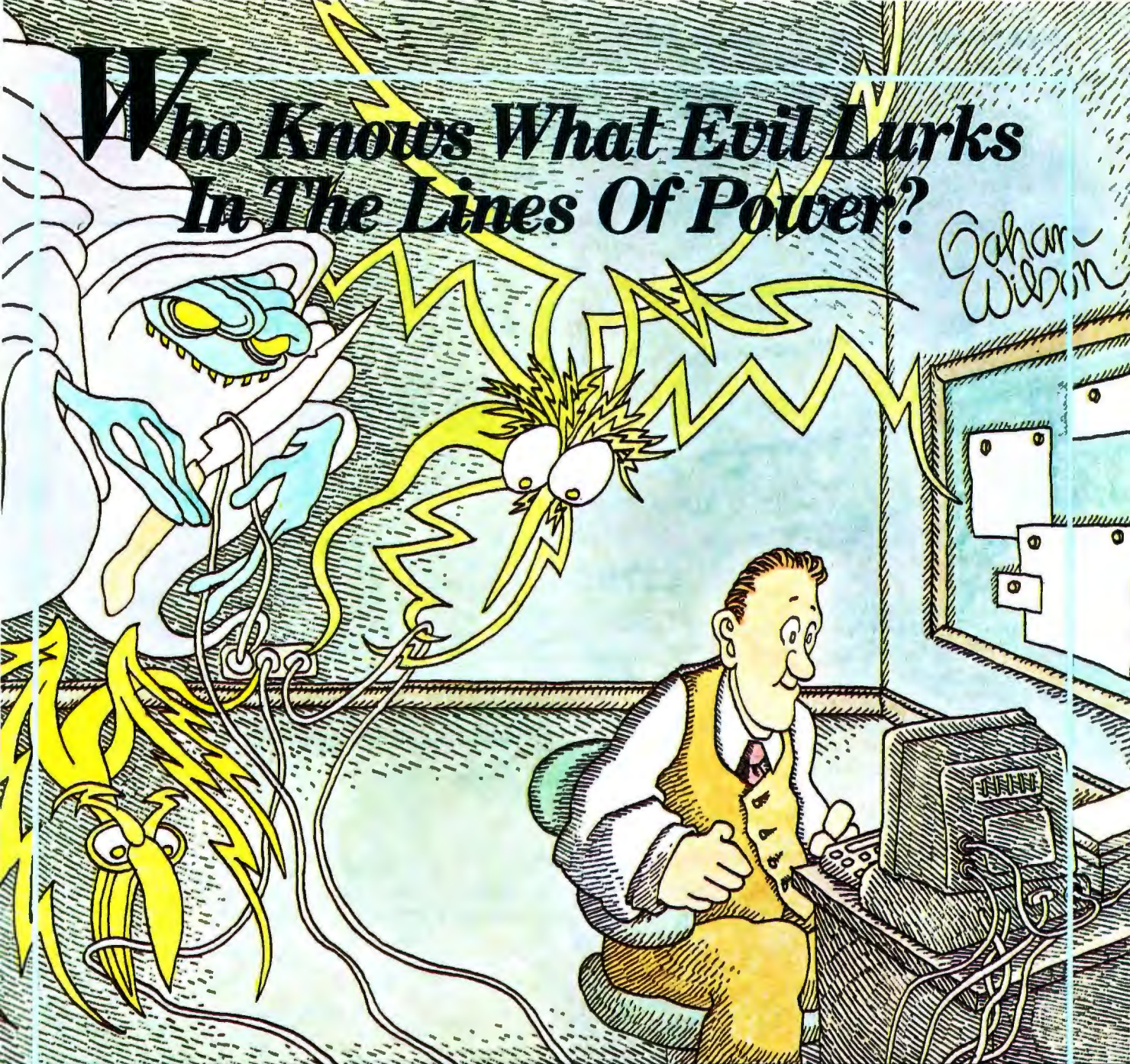

**DynaTech Knows.** This humorous illustration is no comfort to those who have experienced the frustration of losing hours of programming and data entry due to a power outage or surge. In addition to the inconvenience, such occurrences can mean lost programs and perhaps an expensive component destroyed.

DynaTech boasts 25 years of engineering experience in power and data line interference problems. We are one of the largest manufacturers of products solving these problems—and, without question, the engineering trendsetter in the industry.

The latest DynaTech trendsetter is our PowerHouse™ line of standby power supplies. Available in 300- and 500-watt models, PowerHouse protects your computer in two ways. First, should power fail, you instantaneously get clean, regulated power to your system, allowing for an orderly shutdown. Second, while on commercial power, our SurgeSentry™ circuitry protects your system from surges and other hazards.

To learn more about PowerHouse and other fine DynaTech products, call one of the dealers listed here or call us toll free for one near you: (800) 638-9098.



**DynaTech**  
Computer Power Inc.

4865 Scotts Valley Drive, Scotts Valley, CA 95066



# INTRODUCING THE **Western AT**

Newest Compatible in the Personal Computer Market!!! By the OEM Manufacturer of the Most Advanced IBM PC Compatible — The "Western PC Turbo."



## Some Outstanding Features of the "Western AT":

**\$2795.**

- 6MHz or Optional 8MHz CPU
- Up to 1MB RAM on the Mother Board
- 16MB in System Protected Virtual Address Mode.
- 8 I/O Expansion Slots
- On Board Battery Backed Clock-Calendar
- Socket for 80287 Math Co-Processor
- 20/40MB Winchester Disk Memory
- 2 Serial, 1 Parallel
- Optional 4 Serial, 1 Game Port
- 20-60MB Tape Streamer Back-Up



## Some Outstanding Features of the "Western PC Turbo":™

**\$1495.**

- Dual Clock Speed of 8MHz-4.77MHz Giving 65% Faster Operation.
- Up to 1MB RAM on the Mother Board. Optional RAM Disk Software to Address above 640K.
- 1 Serial, 1 Parallel Port on the Mother Board.
- Optional Clock Calendar and 1 Serial Port, 1 Parallel Port on Floppy Disk Controller.
- 10, 20, 40MB Internal Winchester Disk Capability.

IBM PC is a registered trademark of IBM Corp.  
Distributors, Dealers & OEM Welcome

**Western Computer**

1381 Warner Ave., Warner Corporate Park, Suite B  
Tustin, CA 92680  
(714) 544-4740, 544-4743, 544-4746  
TELEX 756731  
AnswerBack, Western Comp.

## EGO

Listing 1: EGO assembly-language code for direct and relative subroutine calls. Registers 30 and 31 had to be used to manage a software stack. The instruction DEC 0,#100 performs an unconditional jump to memory location 100.

### Direct Address Call and Return

Program

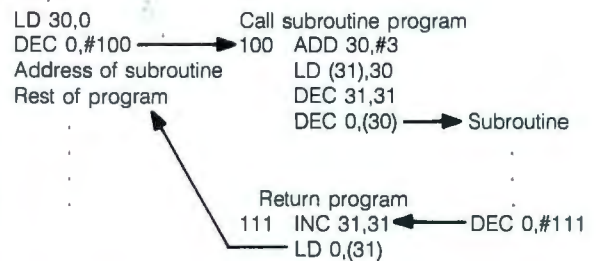

### Relative Subroutine Call and Return

Program

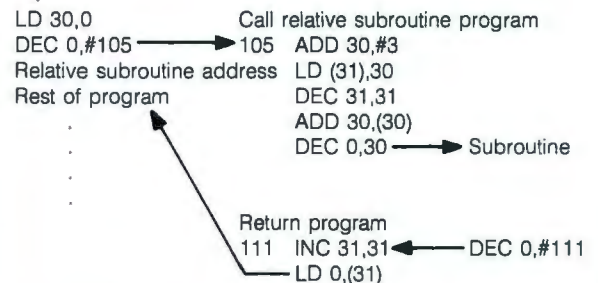

counter with the value 8, which is actually an unconditional jump to memory location 9 (since the program counter is automatically incremented at the end of every instruction). I can use any register as an index register. The simplicity gained by my instruction set resulted in a few strange-looking instructions. I have not yet found a use for some of the data instructions.

Since all of EGO's registers are general-purpose, it becomes the programmer's job to dedicate and keep track of any registers that may be needed for special purposes. Up to this point, I've dedicated only registers 30 and 31 for handling a stack. One of the most important groups of instructions a computer can provide is routine call and return instructions. EGO's flexible structure allows this, although it requires some extra code that most micropro-

(continued)



# PROUD.

To build a workstation good enough to put your name on, use the modular building blocks we put our name on. ACS, a company dedicated to the support of OEM's in pursuit of excellence.

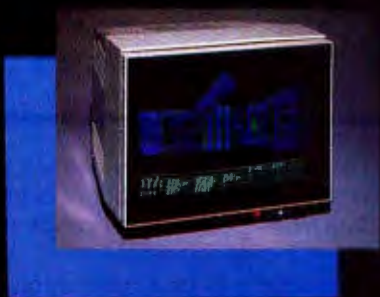
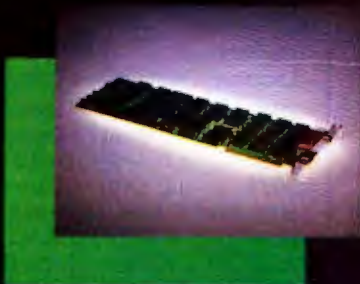

ACS-1000

**THE POWER** . . . a single board SuperComputer that is **100% IBM XT compatible** from its mounting holes to its memory mapping, but with more speed: **4.7 and 8 MHz**. Floppy controllers and network communications are built right onto the motherboard along with a SASI hard disk interface and as much as **1 Meg** of memory.

GraphiAx

**THE GLORY** . . . a graphics card (one card) with more than **20,000,000 pixels** of video memory powerfully arrayed in 5 planes (**32 Colors**). Driven by an on board graphics processor, this **2K x 2K** color card is compatible with most of the popular CAD/CAM packages . . . like AUTOCAD, PC Draft, GKS, and Tektronics Emulators . . . packages that run up to 5 times faster and virtually eliminate redraw by **zooming and panning** in memory instead of constantly recalculating.

Peacock

**AN IMPRESSIVE DISPLAY**  
The Peacock high resolution monitor will put all this technology up front where it counts. With a horizontal scanning frequency of **33.5 KHz** and a bandwidth of **40 MHz**, this RGB monitor gives you a **1K x 1K** window on the world with profitable OEM pricing.

1.2746, 2.6737

If you're going to build a workstation, you might as well build the best. The people at ACS are ready to help. For more information, call or write:

ACS International  
2105 Luna Rd. Suite 330  
Carrollton, Texas 75006  
214-247-5151  
TLX 709748 ACS UD

In Canada:  
Soltech Industries  
9274 194th St.  
Surrey, B.C. V2T4W2  
604-888-2606



Inquiry 7



**Listing 2:** EGO assembly-language code for the interface program.

Memory Location	Instruction	Comments
0	LD 3,#8188	Load interface address into R3
2	LD 2,(3)	Load instruction into R2
3	AND 2,#255	Use only lower order byte of R2
5	SL 2,2	Multiply R2 by 2
6	SL 1,2	Multiply R2 by 4
7	ADD 1,2	Add for multiply by 6
8	ADD 0,1	Add to PC for mem location
9	NOP	INST #0 NOP loop
10	NOP	
11	NOP	
12	NOP	
13	LD 0,#8	Go to start of NOP loop
15	LD 3,#8189	INST #1 Load address into R3
17	LD 4,(3)	Load data into R4 (address data)
18	LD 0,#8	Go to NOP loop
20	NOP	
21	LD 3,#8189	INST #2 Load address into R3
23	LD 3,(3)	Load data into R3
24	LD (4),3	Load data into (R4)
25	LD 0,#8	Go to NOP loop
27	LD 3,#8189	INST #3 Load address into R3
29	DEC 0,(3)	Go to (data)
30	LD 0,#8	Go to NOP loop
32	NOP	
33	LD 3,#8188	INST #4 Load address into R3
35	LD 2,(4)	Load (R4) into R2
36	LD (3),2	Load R2 into interface
37	LD 0,#8	Go to NOP loop

Memory location 8188 holds a number between 0 and 4. This number vectors execution to routines at locations 9, 15, 21, 27, or 33. The routine at location 9 executes NOP instructions. The routine at location 15 loads register 4 with the contents of register memory location 8189. The routine at location 21 stores the contents of memory location 8189 at the address pointed to by register 4. Location 27's routine transfers control to the program whose start address is stored in memory location 8189. Finally, location 33's routine moves the data at the memory location pointed to by register 4 into location 8188. By storing the proper information at locations 8188 and 8189, another processor connected to EGO's data bus can effectively move programs into EGO for execution and retrieve the results.

processors execute implicitly. Listing 1 shows the direct and indirect subroutine calls and the return routine.

**PROGRAMS AND BENCHMARKS**

Listings 2 and 3 are examples written in assembly language for EGO. Listing 2 is the source code for the interface program. It resides at the lowest part in memory so that on an interrupt, this program controls what occurs. The interface program allows a simple means of communicating with EGO using memory-mapped I/O (input/output). It recognizes five instructions: no operation, load ad-

**Listing 3:** EGO assembly-language code for an 8- by 8-bit multiply.

Memory Location	Instruction	Comments
2048	LD 5,4	Load first number into R5
2049	LD 0,#8	Return to no-op loop in interface program
2051	LD 6,#8	Load number of bits into R6
2053	LD 8,#0	Clear result register R8
2055 loop	RR 5,5	Rotate rightmost bit into carry flag
2056	ADD 0,#1	Jump to shift on no carry
2058	ADD 8,4	Add R4 to R8 to generate the result
2059 shift	SL 4,4	Shift R4 one bit left
2060	DEC 6,6	Decrement the bit count
2061	SUB 0,#8	If R6 is positive make another loop
2063	LD 3,#8188	Load address of interface into R3
2065	LD (3),8	Send result to interface
2066	LD 0,#8	Return to no-op loop in interface program

dress data, send data to memory defined by the address data, go to the address data location and run a program, and send data from the address location to the interface program.

Listing 3 is a simple 8- by 8-bit multiply program controlled by the interface program.

To get an idea of EGO's speed, I wrote a machine-language version of the Sieve of Eratosthenes program. Although EGO doesn't have enough memory to run the entire 16K-byte limit for primes, I ran it to 2K and extrapolated. Based on those calculations, it would take EGO about 3.6 seconds to do 10 iterations up to 16384. This is approximately one-half the time required for a Z80 to make the same calculation running at the same clock speed. With the 4-MHz clock and the average instruction taking between 6 and 9 clock periods, EGO can average about 0.5 million instructions per second.

Since I am interested in simulation and one of the purposes of EGO was to be useful, I wrote some integer and floating-point routines to start an operating system. The floating-point variables have a 32-bit signed mantissa and a 16-bit signed exponent. This provides about nine decimal places, or accuracy with an exponent greater than 9000. Benchmarks on these routines provided these results:

Multiply	0.575 ms
Divide	0.955 ms
Add	0.115 ms

It is interesting to note that while the hardware for EGO took only a few months to complete, the software has taken much longer. Presently, on the Tandy 2000 I have an assembler, an editor, a tiny FORTRAN-type language compiler, and a linker written in BASIC.

Next month I'll discuss the design details of EGO's hardware. We'll take a tour of a machine cycle and see how the hardware supports the EGO instruction set. ■





# The Computer Book Club®

Recognized as the authoritative source for micro users!

## Superior Performance, Practical Price!

More programs, projects, ways to use your micro for home, hobby, education, and business!

### Select 5 Books for Only \$2<sup>95</sup>

worth up to  
\$132<sup>75</sup>



1921  
List \$21.95

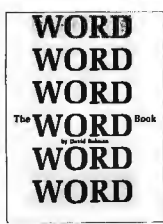

1958  
List \$24.95



1160  
List \$14.95



1205P  
List \$11.50 (paper)

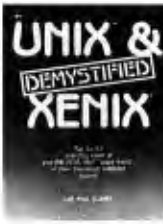

1874  
List \$21.95

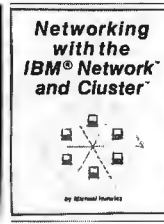

1929  
List \$29.95

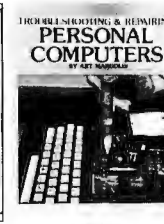

1539P  
List \$15.95 (paper)



1908  
List \$24.95



1501  
List \$21.95

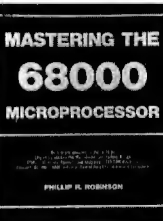

1886  
List \$22.95



1742  
List \$24.95



1884  
List \$24.95



1789  
List \$21.95



1389P  
List \$10.25 (paper)



1852  
List \$21.95



1948  
List \$22.95



1748P  
List \$10.95 (paper)

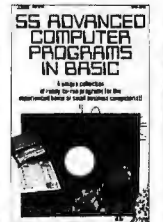

1295P  
List \$10.25 (paper)

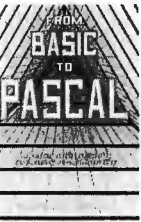

1486P  
List \$16.95



1556  
List \$21.95



1455P  
List \$10.95 (paper)



1821  
List \$15.95

### Free guide to BASIC Statements & Commands



## Plus FREE For Joining →

### 7 very good reasons to join The Computer Book Club®

- **Big Savings.** Save 20% to 75% on books sure to increase your computer know-how
- **No-Risk Guarantee.** All books returnable within 10 days without obligation
- **Club News Bulletins.** All about current selections—mains, alternates, extras—plus bonus offers. Comes 13 times a year with hundreds of up-to-the-minute titles to pick from
- **"Automatic Order."** Do nothing, and the Main selection will be shipped automatically! But . . . if you want an Alternate selection—or no books at all—we'll follow the instructions you give on the reply form provided with every News Bulletin
- **Bonus Books.** Immediately get a Dividend Certificate with every book purchased and qualify for big discounts of 60% to 80%.
- **Extra Bonuses.** Take advantage of added-value promotions, plus special discounts on software, games, and more
- **Exceptional Quality.** All books are first-rate publisher's editions selected by our Editorial Board and filled with useful, up-to-the-minute information

### The Computer Book Club®

P.O. Box 80, Blue Ridge Summit, PA 17214

Please accept my membership in The Computer Book Club® and send the 5 volumes circled below, plus my FREE copy of BASIC Statements, Commands and Functions, billing me only \$2.95 plus shipping and handling charges. If not satisfied, I may return the books within ten days without obligation and have my membership canceled. I agree to purchase 4 or more books at regular Club prices (plus shipping/handling) during the next 12 months, and may resign any time thereafter.

1160 1205P 1295P 1389P 1455P 1466 1501 1539P 1556  
1567 1710 1742 1748P 1789 1821 1852 1873 1874 1876  
1884 1886 1908 1921 1929 1939 1948 1958 1976

Name \_\_\_\_\_

Address \_\_\_\_\_

City \_\_\_\_\_

State \_\_\_\_\_ Zip \_\_\_\_\_ Phone \_\_\_\_\_

Valid for new members only. Foreign applicants will receive special ordering instructions. Canada must remit in U.S. Currency. This order subject to acceptance by The Computer Book Club®. BY-985



- Tougher*
- Quieter*
- Smarter*
- Thriftier*
- Easier*
- Quicker*
- Finer*
- Cleaner*
- Sharper*
- Sturdier*
- Abler*
- Prettier*
- Slimmer*
- Trimmer*
- Friendlier*



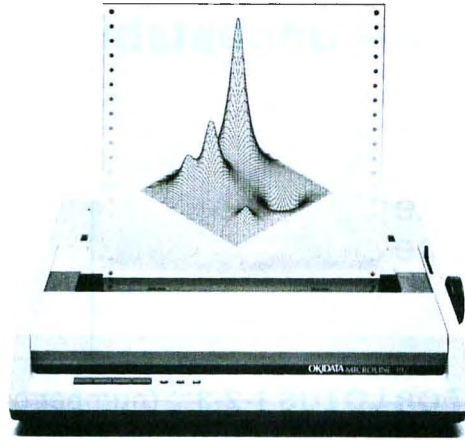

*and smaller.*

The new Okidata Microline 192 does everything the bigger, bulkier printers do. And more. But in a much smaller space.

It's easier to operate, too. With push-button menu select programming, so you never have to touch a DIP switch to set fonts, line widths, underlines and such.

It's compatible with your computer. Just plug it in and put it to work, without changing control codes. And, it's compatible with you. Long-life cartridge ribbons pop in and out without so much as smudging a finger.

Super-quiet operation and super-fast bidirectional throughput make the new Microline 192 one handy printer to own. All this, plus our full one-year warranty (try to find that on most printers), makes it the only one you should own.

The new Okidata 192 and the wide-column 193. Simply stated . . . better.

For more information, call toll free 1-800-OKIDATA.

**OKIDATA**  
an OKI AMERICA company  
Mt. Laurel, NJ 08054

We put business on paper.



# BUSINESS • SCIENCE • EDUCATION STATISTICAL PACKAGES

data-analysis software from:

## STATSOFT

— unbeatable power and flexibility  
for unbeatable prices!

We developed and distribute complete, high-performance statistical packages for all computers:

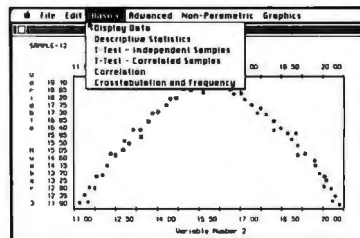

1. **STATISTICAL SUPPLEMENT FOR LOTUS 1-2-3™** (number one statistical add-on for LOTUS™ and Symphony™, also reads files from many other programs, can be used as a stand-alone statistical package, runs on IBM™ and all compatibles, 256k, 2dd, 8087 support) ..... **\$99**
2. **STATFAST** (the first stand-alone and still the most powerful statistical package developed for the Macintosh™ 128k or 512k, 1dd) ..... **\$99**
3. **APP-STAT** (a complete statistical package for the Apple II™ family of computers, 1dd) ..... **\$99**
4. **PSYCHOSTAT-3** (a complete statistical package, available for Kaypro™ and all CP/M™ computers, 1dd) ..... **\$99**

All of these statistical packages are user friendly and super-easy to use. They include the full range of basic statistical analyses (descriptive statistics, t-tests, correlations, cross-tabulations, nonparametric statistics, and more) and advanced multivariate statistics (multiple regression, multifactor analysis of variance and covariance, and more). All packages can handle data files of unlimited size, include flexible Data Editors, and can access data files from spreadsheets, databases, and mainframes.

We are committed to the distribution and support of high quality statistical software. Because we purchase large quantities of specialized programs (after a thorough evaluation of each program), we can pass on considerable savings.

5. **SPSS/PC:** for IBM/PC, XT, AT, and compatibles (320k, hard disk)  
Regular Price: \$795.00      OUR PRICE: ..... **\$695**
6. **SYSTAT:** for IBM/PC, XT, AT, and compatibles (256K); most CP/M systems (with 64k, incl. Apple II with CP/M)  
Regular Price: \$495.00      OUR PRICE: ..... **\$395**
7. **GANOVA:** Specialized designated general ANOVA/MANOVA program, up to 10 factors (between/within/mixed), for all IBMs and compatibles, most CP/M systems, Apple II  
Regular Price: \$100.00      OUR PRICE: ..... **\$ 80**

If you are interested in statistical analysis on micro computers, call us! Our technical staff can advise you and recommend the best program for your needs.



*All prices include shipping and handling. To place your order or talk to our technical staff for more information, call or write:*

**STATSOFT**

2831 EAST 10TH STREET, SUITE 3, TULSA, OK 74104  
(918) 583-4149



LOTUS 1-2-3, Symphony, IBM, Macintosh, Apple II, Kaypro, CP/M, SPSS/PC, SYSTAT, and GANOVA are registered trademarks of respective companies.



# THE QUARTER-MEG ATARI 800XL

BY CLAUS BUCHHOLZ

*Upgrade your 8-bit microprocessor to 256K bytes  
and add a RAM disk*

IT'S GETTING HARDER to find a microcomputer with less than 64K bytes of RAM (random-access read/write memory). A couple of years ago, the cost per bit of the 64K-bit RAM fell below its predecessor, the 16K-bit dynamic RAM, and the 64K-byte address space supplied by eight of the 64K-bit chips is ideal for the most common 8-bit microprocessors. Now, however, the cost per bit of the 256K-bit dynamic RAM is the lowest, and it is already common in powerful 16- and 32-bit microcomputer systems.

Since eight of these chips provide one-quarter of a megabyte and since they are so similar to their ancestors, it is tempting to upgrade an inexpensive 64K-byte micro to 256K bytes. Obviously, you can't fit 256K bytes of memory into the 64K-byte address space of a 6502 or Z80 all at once, but you can break it up into manageable chunks, called banks, and allow the processor to see one bank at a time. This method of interfacing RAM, called bank selection, requires some new hardware and software support.

This article describes the upgrade and presents a RAM-disk controller for the Atari 800XL. However, you can apply the basic idea to any micro that

uses 64K-bit RAMs—the Apple IIe, the Commodore 64, the MSX machines, and others.

## THE ATARI 800XL

The 800XL is a modern version of the popular Atari 800. [Editor's note: See Jon Edwards's "Atari 800XL" system review, *March BYTE*, page 267.] Introduced in 1979, the 800 was the first machine to use VLSI (very-large-scale integration) technology to bring advanced graphics and sound capabilities into the low-price market. It was also the first to include a full operating system in ROM (read-only memory) to support the versatile hardware. RAM consisted of up to three 16K-byte modules, each constructed around eight 16K-bit dynamic RAM chips.

In the 800, the 6502 processor shares the system with a programmable video DMA (direct memory access) controller, which halts the 6502 for one cycle of the 1.8-MHz clock when it needs to access a byte of screen memory. The 800XL incorporates the same VLSI hardware with newer, higher-density RAM and ROM. One 16K-byte ROM holds the entire operating system, and another 8K-byte ROM contains the BASIC lan-

guage. The RAM consists of eight 64K-bit dynamic RAM chips. Under BASIC, 40K bytes of RAM are usable. The ROMs, which occupy high memory space, can be disabled to gain access to the remaining RAM. The new design is smaller, cheaper, less power-hungry, and more attractive. The Atari is unquestionably a very fine machine.

## THE DYNAMIC RAM

The industry-standard dynamic RAM chip is itself an example of superb design. It is small, dense, adequately fast, and cheap. In the last decade, its memory capacity has doubled eight times without the chip outgrowing its 16-pin IC (integrated circuit) package. Each chip inputs or outputs one bit at a time, so each bit has a unique address.

For the 256K-bit chip, the address requires 18 bits. The chip has nine address inputs, each of which does

*(continued)*

Claus Buchholz (201C East Edgewood, Lansing, MI 48910) is a programmer for Meridian Instruments. He has a B.S. in astrophysics and computer science from Michigan State University. He uses an Atari 800 with a homebrew 192K-byte RAM and an ATR-8000.



double duty. During the first part of a memory access, half of the address bits are presented to the chip. This half is called the *row address*. Later in the access cycle, the chip receives the other half of the address, called the *column address*. The storage cells in the chip lie in a matrix, and the cell being addressed lies at the intersection of the row and column specified. To complete the access cycle, the chip reads or writes the selected bit.

The 800XL uses 64K-bit RAM chips, which have eight address inputs for an 8-bit row address and an 8-bit column address. This is fine for the 16-bit addresses the 6502 supplies. There are eight chips, and each contributes one bit to each byte of RAM.

The 256K-bit RAM is practically identical to the 64K-bit RAM except that it has one extra pin, #1 on the chip, to accommodate the two additional address bits it needs. Pin #1 on the 64K-bit chip has no function. The functions of all the other pins on both chips are identical. Therefore, our upgrade involves unplugging the eight 64K-bit RAMs and placing eight 256K-bit chips in their place. We must also add some circuitry to provide two extra address bits for pin #1.

The storage cells in dynamic RAM chips are actually microscopic capacitors, storing an amount of electric charge that represents a 0 or 1 bit. Since capacitors leak charge, they must be periodically recharged or refreshed. The chip refreshes one or two entire rows when accessed. Every row must be accessed frequently to keep the stored data accurate, but

normal operation of RAM can't guarantee that. The computer system must therefore provide special access cycles called *refresh cycles*, dummy read cycles in which refresh addresses are used as row addresses.

The 16K- and 64K-bit RAMs require 7-bit refresh addresses. The computer must provide all 128 possible refresh addresses every few thousandths of a second to keep the RAM refreshed. In the Atari, the video controller, which provides refresh cycles in addition to its screen-memory accesses, automatically provides 7 bits for the refresh address. The Atari, in fact, spends 8 percent of its time refreshing RAM.

One snag in designing the 256K-byte upgrade is that standard 256K-bit RAMs require an 8-bit refresh address. Older versions of the Atari video-controller chip provide only 7 bits of refresh address; newer versions provide all 8 bits. Therefore, I have designed two versions of the upgrade's interface circuit. The more complex one must add another bit to the Atari's refresh address. (See table 1 for a list of components.)

### BANK SELECTION

To fit 256K bytes into the 6502's 64K-byte memory space, you must divide it into banks. The upgrade uses eight 32K-byte banks, numbered 0 through 7 and selected by setting 3 bits in the Atari's memory-control register. Any one bank can appear in the lower half of the 6502's memory space. At power-up, bank #7 appears in the lower 32K bytes of RAM, bank #6 ap-

pears in the top 32K bytes, and the Atari acts as a normal 64K-byte machine. To access bytes in the other 192K, a program must select one of banks #0 through #5, which would then appear in place of bank #7. After accessing the bytes, the program could then switch bank #7 back in, restoring the normal configuration.

I used eight 32K-byte banks instead of four 64K-byte banks for three reasons. If a program in RAM were to replace the entire 64K bytes of RAM with another bank, it would cause itself to disappear, crashing the system. Moreover, the top 32K bytes of the address space is already cluttered with hardware addresses and ROMs that can be switched in and out. Finally, the screen RAM is usually in the top 32K; switching it out would cause glitches to appear on the screen.

Even with eight 32K-byte banks, we must be cautious. The operating system keeps important data in the lower part of RAM, and it expects the data to be there. Worse, interrupts frequently invoke routines that keep data in low RAM. Programs must therefore follow a strict rule: Keep bank #7 enabled as much as possible. If you select another bank, you must first disable all interrupts and not call the operating system until bank #7 is restored. One further consideration involves the 6502's stack, which is in low memory. The program should not use the stack when bank #7 is not selected, unless it takes great care to keep the stack valid.

### INTERFACING THE RAM

Figure 1 is a schematic diagram of the interface circuit for the 256K-byte RAM. It must be assembled on a small circuit board and installed inside the computer because the computer's expansion slot doesn't carry the signals we need. The circuit consists of two chips and replaces one of the chips on the motherboard. It also requires four jumper wires to various points on the motherboard.

The circuit plugs into the socket at position U27 on the motherboard. This gives it access to six important

(continued)

Table 1: The components you'll need to upgrade the Atari 800XL.

Quantity	Part Number	Description
8	41256	256K-bit dynamic RAM (200 ns or faster)
1	—	33-ohm, 1/4-watt resistor
(following part for circuit in figure 1 only)		
1	74LS153	Dual 4-to-1 multiplexer
(following parts for circuit in figure 2 only)		
1	74LS151	8-to-1 multiplexer
1	74LS393	Dual 4-bit counter
1	74LS00	Quad NAND gate



# Don't buy a disk/tape system that can't grow with you.



## Get the Sysgen<sup>™</sup> XL<sup>™</sup> *expandable* hard disk and tape back-up system.

Most popular disk/tape systems offer 20 Megabytes of hard disk, plus a 20-Megabyte tape back-up.

That may seem ample now, but do you know whether, a year down the road, 20 Megabytes will give you enough storage?

You don't. So it makes sense to get the *only* disk/tape system that gives you room for expansion later on.

And that doesn't cost you any more now.

The new Sysgen XL comes with 20 Megabytes of fast, reliable hard disk storage, a built-in 60-Megabyte tape for fast, reliable back-up, *plus* room for an additional hard disk drive.

### **What happens if you later need more hard disk storage?**

With the XL, you simply add a second 5¼" disk drive. It fits inside the cabinet, and plugs right into the XL controller.

You can add an additional 20 Megabytes, and back-up with a single pass of the 60-Megabyte tape.

Or add up to 100, and back-up with two tapes.

With the low cost of hard disk drives, expansion is *much*

more economical than buying a whole new \$3,000 system. Plus, you save desktop space by expanding *inside* the cabinet.

***The XL sells for \$3,295, including cabling, host adaptor, and utility software. You get everything you need.***

(Watch out. Some companies charge extra for cabling and the host adaptor.)

Installation? Just snap in the controller, plug in the system, install the system software, and you're running.

### **Compare before you buy.**

You'll find the XL to be the outstanding disk/tape system for your PC, XT, AT<sup>™</sup>, or compatible today. And the only system that can expand for your needs for tomorrow.

Trademarks: Sysgen, XL—Sysgen, Inc.; AT—International Business Machines, Inc.

**SYSGEN** 47853 Warm Springs Blvd.,  
Fremont, CA. 94539  
I N C O R P O R A T E D (415) 490-6770 Telex 4990843



# CopyWrite

## BACKS UP IBM PC SOFTWARE

Hundreds of the most popular copy-protected programs are copied readily. CopyWrite needs no complicated parameters. It needs an IBM Personal Computer, or an XT or an AT, 128k bytes of memory, and one diskette drive. CopyWrite will run faster with more memory or another drive.

CopyWrite is revised monthly to keep up with the latest in copy-protection. You may get a new edition at any time for a \$15 trade in fee.

CopyWrite makes back up copies to protect you against accidental loss of your software. It is not for producing copies for sale or trade, or for any other use that deprives the author of payment for his work.

To order CopyWrite, send a check for \$50 U.S., or call us with your credit card. We will ship the software within a day.



**Quaid Software Limited**

45 Charles Street East  
Third Floor  
Toronto, Ontario M4Y 1S2  
(416) 961-8243

Ask about ZeroDisk to run copy-protected software from a hard disk without floppies.

signals, including power and ground. The chip that was at U27 becomes IC1 in the circuit. As U27, this chip was one of the two responsible for selecting which 8 of the 16 address bits were passed to the 64K-bit RAMs at one time.

IC2 performs the bank selection by modifying one of the eight original address inputs to the RAMs and adding a ninth. The bank-selection circuitry needs three jumpers from the motherboard to carry 3 bits from the Atari's memory-control register. A fourth jumper carries the ninth address input to the RAMs.

Figure 2 shows the four-chip interface circuit necessary for machines containing the older version of the video controller. IC3, an 8-bit binary counter that counts the refresh cycles, supplies the eighth bit of the refresh address for the 256K-bit chips. The

refresh signal it uses comes through a jumper wire from the motherboard. Parts of IC1, IC2, and IC4 perform the bank selection in this circuit.

### PERFORMING THE UPGRADE

To disassemble the 800XL, remove the six screws on the underside and separate the top and bottom portions of the plastic case. Be careful of the flexible keyboard cable. Pull it straight up out of its socket on the motherboard. To detach the motherboard from the case bottom, remove three screws—one on the right side, one in the right rear corner, and one in the left rear. Gently pull the board free.

Next, remove the small nuts and bolts around the metal shielding that encases the motherboard. On the left side of the exposed motherboard, locate the row of eight 16-pin RAM chips. Just to their right is U27. Behind

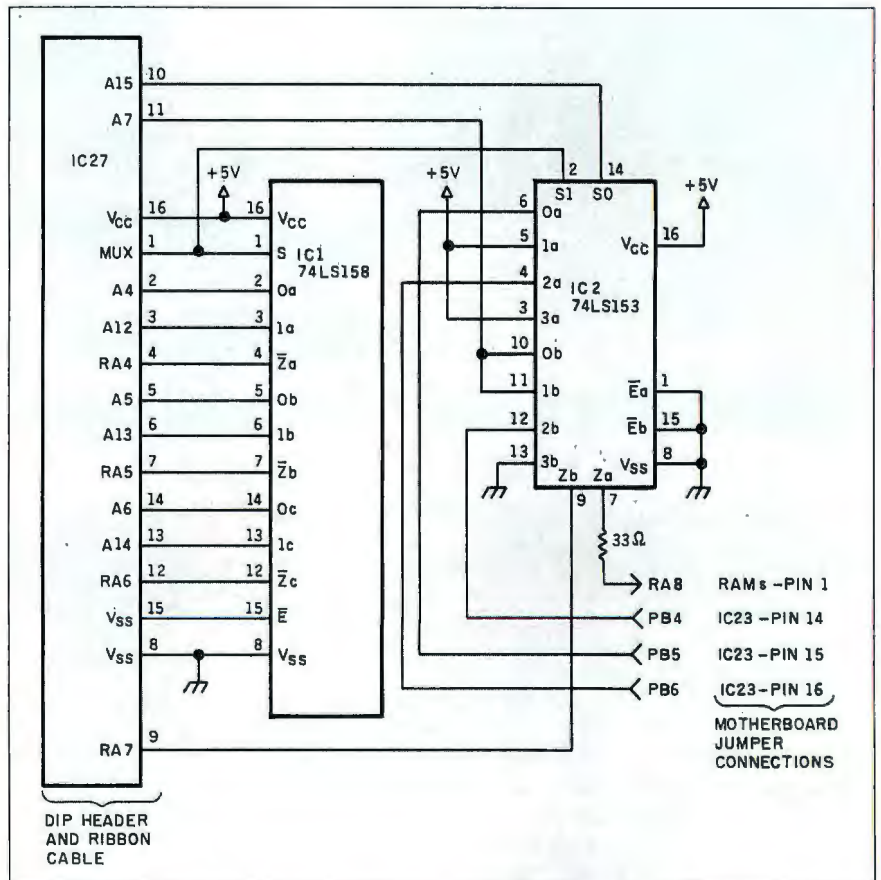

Figure 1: The schematic diagram of the interface circuit for the 256K-byte RAM. Use this circuit if the part number on the video controller is CO21697.



U27 is a 3-inch square area that fits inside the shielding. The circuit goes there because the shielding is highest toward the rear.

Replace the 64K-bit RAMs with the 256K-bit RAM chips. The new RAMs are very easily destroyed by static discharges, so extreme care is necessary in their handling. Lay aluminum foil on the work surface and keep the motherboard, RAM chips, tools, and your hands in contact with the foil at all times. This keeps everything at the same potential, decreasing the possibility of damage.

On the motherboard, locate the video controller, the 40-pin chip at U7. If the part number stamped on it reads "CO21697," you can use the simpler circuit shown in figure 1. If the number reads "CO12296," you must use the larger circuit.

Assemble the appropriate circuit on a 2- by 3-inch circuit board (Radio Shack's #276-150 is ideal). Use very low-profile sockets or no sockets at all because the shielding severely limits the height. If you do not use sockets, be careful not to apply heat to the IC pins for too long. Keep the wiring on the chip side of the board to conserve space. The wiring must be soldered because there is no room for wire-wrap posts.

The board plugs into the socket at U27 via a 16-pin DIP header and short ribbon cable. Finally, install the jumper wires. Find a resistor marked R32 immediately behind the row of RAM chips and remove it. A trace from one of the holes runs to pin 1 of the RAMs. Solder the first jumper to that hole. The next three jumpers run to a parallel port that the Atari uses to control ROM switching. We need pins 14 through 16, which are normally unused and not connected to any traces. Locate U23 and carefully pry the 40-pin chip from its socket. Bend up pins 14, 15, and 16 so that they point straight out. Reinsert the chip. Cut three adjacent pin positions from an IC socket and solder the three jumpers to them. Use this custom socket to connect the jumpers to the three protruding pins.

(continued)

# FREE high tech catalog

**Most accurate Clock**

**Computerized weather station**

**Low-noise audio spectrum analyzer**

**Ham radio gear of every type**

**HERO<sup>®</sup> robots and robotics training**

**Microprocessor trainer and courses**

**Professional test instruments**

**IBM-compatible computers, peripherals, software**

## A trustworthy guide to what's new in electronics and computers.

For many years the illustrated Heathkit Catalog has been a guide to new and exciting kit products for people like you to build. To enjoy and learn from them, while saving money in the process. What sets the Heathkit Catalog apart is its range of high quality products and accurate information to help make your buying decisions easy. If you've never tried kit-building, you have an absorbing new experience in store as you create products you'll take pride in.

**Send for free catalog** If coupon is missing, write Heath Company, Dept. 334-332 Benton Harbor, Michigan 49022



**Heathkit<sup>®</sup>**  
Heath  
Company

Mail to: Heath Company, Dept. 334-332  
Benton Harbor, Michigan 49022  
Please send me my FREE HEATHKIT CATALOG.

Name \_\_\_\_\_

Address \_\_\_\_\_

City \_\_\_\_\_ State \_\_\_\_\_ Zip \_\_\_\_\_

Heathkit products are also displayed, sold and serviced at 64 Heathkit Electronic Centers nationwide. Consult telephone directory white pages for location. Operated by Veritechnology Electronics Corporation, a wholly-owned subsidiary of Zenith Electronics Corporation. CL-778D



Cover the connector with electrical tape because the shielding is very low at this point.

If you are using the circuit of figure 2, you must install a fifth jumper. Locate a trace on the motherboard from pin 8 of the video controller, U7. Find a hole along the trace and solder the jumper there. Finally, insert a thin

piece of stiff cardboard or plastic under the small circuit board to avoid shorting the circuit. Refasten the shielding to the motherboard. If it doesn't fit over the circuit, carefully pound a dent out of the shielding with a hammer. Reassemble the computer. If all has gone well, the computer should power up normally and per-

form exactly as before, as long as the 3 bits in the memory-control register are left alone. The computer is ready to try some software that makes use of the large RAM space.

**THE RAM-DISK SOFTWARE**

Bank-selectable RAM is useless without software to control it. The software must obey strict rules as outlined above to work properly. The software must also be tailored to fit the application.

For example, you could store many graphics screens in the RAM and use page flipping to display them in quick succession for animation. Alternatively, the RAM could act as a print spooler. A word processor could print an entire document quickly into the RAM and go on to other jobs while the RAM emptied its contents slowly to a printer.

A more universal application is the RAM disk, a RAM-based disk-drive simulator. To DOS (disk operating system) and to the user's programs, the RAM disk appears to be just another disk drive, except that it is very fast. Application programs could then use standard DOS commands to access the large RAM space. The 192K bytes of available RAM hold more data than two Atari 810 drives or one double-density drive. I have written an assembly-language program that modifies the Atari's operating system to treat the RAM as either a single-density or double-density disk drive. The program is available for downloading as ATARIRAM.ASM on BYTENet Listings, (617) 861-9774. It works with Atari DOS 2.0, OS/A+ (versions through 2.xx) and compatible DOSes. Assemble the source code with any assembler that accepts the syntax of the Atari Assembler/Editor. Assembly produces an object file that performs several tasks as it loads. First, it copies the operating system from ROM into the underlying RAM. Next, the RAM-disk routines load into the RAM-based operating system, overwriting the international character set, a little-used feature of the 800XL. Finally, it

(continued)

**A new name for us, even better values for you.**

We've combined Silicon Valley Liquidators and Supply Line to increase our buying power — we pay less so you pay less.

**JANUS™ Diskettes**

One of the most respected names in the business, Janus disk is a SUPER VALUE!!

- **BOX** SS/DD **99¢**/DISK DS/DD **\$1<sup>09</sup>**/DISK  
(10 DISKS PER BOX)
- **BULK**  
SS/DD **69¢** EA DS/DD **79¢** EA

CALL FOR QUOTES ON LARGER VOLUMES.



---

**Verbatim** Probably the most well-known name in diskettes. We offer an alternative in buying them — OEM BULK packaging! Get the same top-quality, critically certified diskette that you get in the store.

Check out our **DYNAMITE PRICES**

- MD 525 SS/DD **89¢** EA (100 lot pricing)
- MD 550 DS/DD **\$1<sup>09</sup>** EA (100 lot pricing)

---

**Sentinel** With specs that exceed all others, Sentinel is a premium disk at a bargain price.

- **BOX** - SS/DD **\$1<sup>09</sup>**/DISK DS/DD **\$1<sup>19</sup>**/DISK (100 lot pricing)
- **BULK** - SS/DD **79¢** EA DS/DD **89¢** EA
- **COLOR BULK** - SS/DD **95¢** EA DS/DD **\$1<sup>09</sup>** EA

CALL FOR QUOTES ON LARGER VOLUMES.

---

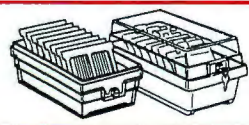

**DISK STORAGE BOXES**  
holds 100 disks - only **\$12<sup>95</sup>**  
— ALSO —  
**10-disk boxes** — low as **99¢** EA

---

**PRINTER RIBBONS** - for all makes and models — CALL!  
**PRINTWHEELS** - Camwill by FABER CASTELL — CALL!  
**DISKETTE ENVELOPES** - low as **5¢** ea. **DISKETTE MAILERS** - low as **32¢** ea.

P.O.'s accepted from recognized corporations, institutions and educational accounts. Please call for specific information before placing your order.

---

**Order Today!**



- Lifetime Guarantee
- 100 disk minimum order
- Orders shipped within 24 hrs of placement
- We accept A/E, VISA & MasterCard

---

**800/437-0900 • 800/435-9700 in CA**



# THE LEADER IN STATE-OF-THE-ART MEMORY

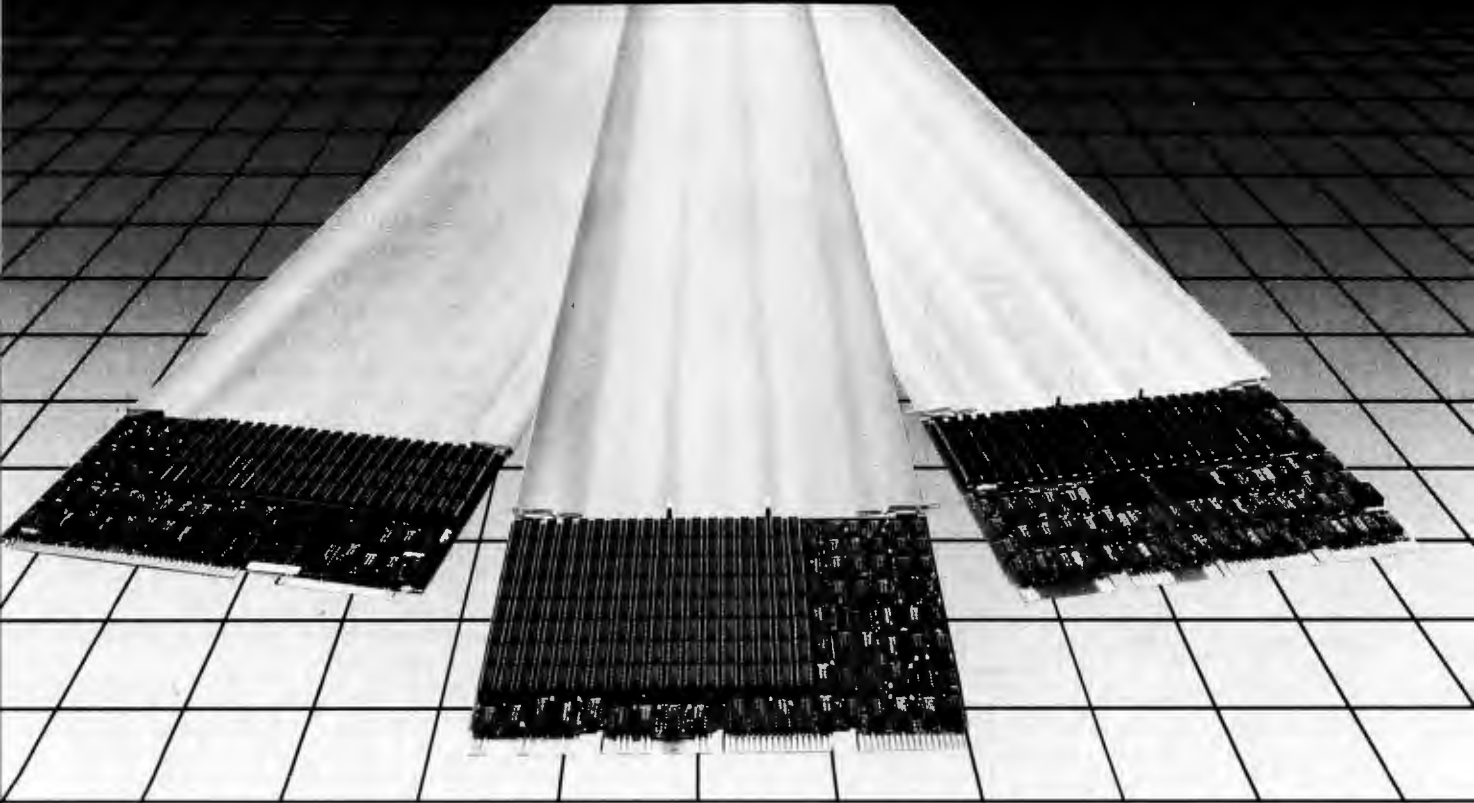

## MULTIBUS - MICROVAX II - VAX

Computer products are constantly being changed by Technological improvements. With Chrislin memory you can be assured that you are receiving state of the art technology. Features like Error Detection and Correction (EDC), fast access, lower pricing, 24 hour repair are just a few of the many attributes in Chrislin memory. Over a decade of leadership and experience make Chrislin a prime source for your procurements. Call today for more information.



COMPATIBILITY	MAXIMUM CAPACITIES	SPECIAL FEATURES
LSI-11, MICROVAX I	4MB & 2MB	BLOCK MODE/EDC
MICROVAX II	4MB	PARITY
VAX 730	1MB	ECC
VAX 750	1MB	ECC
ANY MULTIBUS	2MB	EDC

MULTIBUS is a trademark of Intel Corporation.  
MICROVAX, VAX, LSI-11 are trademarks of Digital Equipment Corporation.

**ALSO TRY OUR QBUS COMPATIBLE COMPUTER SYSTEMS AND SUBSYSTEMS . . .**



## **Chrislin Industries**

P.O. Box FF  
Canovanas, PR 00629  
Telex 345 4170 (CHRISLIN PD)  
(809) 876-6160

31352 Via Colinas  
Suite 101  
Westlake Village, CA 91362  
(818) 991-2254

1-800-468-0736 (est)

**AUTHORIZED DISTRIBUTORS:** Mississauga, Canada—Transduction Ltd (416) 625-1907;  
France—SNGA/Auctel (1)736.87.00, Peru—General Trading Corporation (51)-14-222506;  
W. Germany—Dema Computertechnik (089) 272 32 40



patches the operating system to install the RAM-disk program and calls DOS's initialization routine to let DOS recognize the new drive.

The source code provides two op-

tions: the drive number and the density. The RAM disk can act as any drive numbered 1 to 8. If you have one real drive, you might want the RAM disk to be drive number 2.

Remember that your DOS must be set up to look for the drive number chosen. See the DOS manual for instructions concerning drive numbers.

Like the Atari 810 disk drive, a single-density RAM disk has 720 sectors of 128 bytes each, for a total of 90K bytes. Like all double-density disk drives for the Atari, a double-density RAM disk has 720 sectors of 256 bytes, for a total capacity of 180K bytes. Atari DOS checks each drive in a system for its density and compensates. All DOS functions except duplicate disk operate with double-density drives. You obviously cannot duplicate a double-density disk to a single-density disk and vice versa.

Boot in the RAM-disk object file after DOS by renaming the object file AUTORUN.SYS. Once the file has loaded, you must format the RAM disk before use. You can do this manually from DOS, use the BASIC XIO command, use a call to CIO in machine code, or rely on an application program.

RESET and warm starts won't harm the contents of the RAM disk. If you reboot without powering down (through a POKE 580,1 and RESET, or by jumping to \$E477 in machine code), you must reload the RAM-disk program to access the data, which will remain unharmed in the RAM disk. The RAM-disk program, therefore, does not automatically format the RAM disk upon loading.

The major disadvantage of the RAM-disk approach is that all data is lost when the computer is turned off. You should therefore be sure to save important data to a real disk before ending. However, the speed, convenience, and versatility of the RAM disk outweigh its drawbacks.

**USES**

Assembly-language programmers, after studying the RAM-disk source code and heeding the rules above, can devise many practical uses for a quarter-megabyte of RAM. The large RAM space, joined with the Atari's versatile hardware and low price, provides a performance/price ratio that is unbeatable in today's market. ■

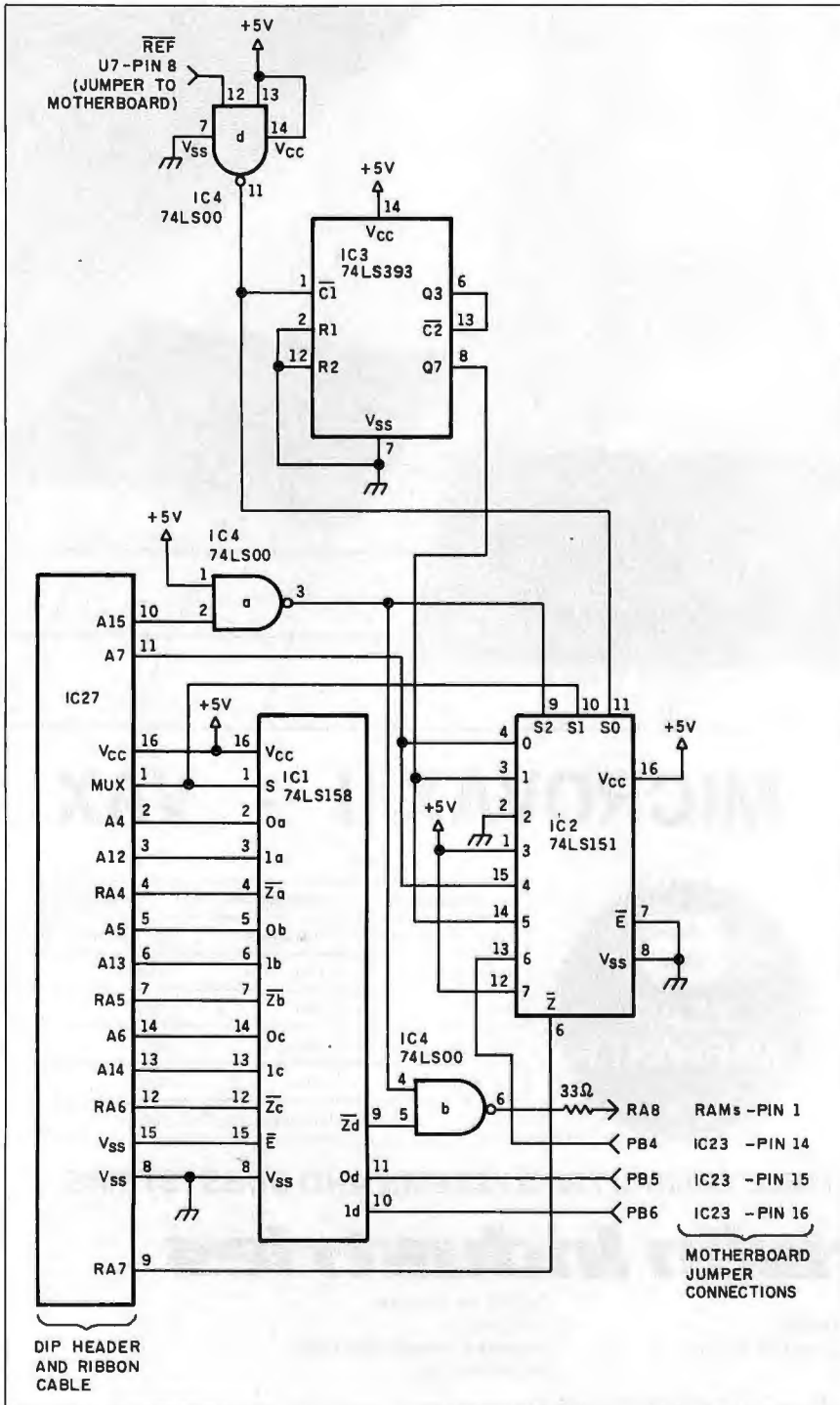
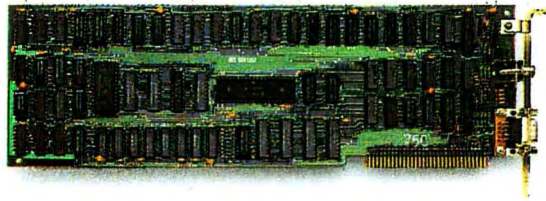

Figure 2: Use this circuit if the video controller part number reads CO12296.



# Compare the Hercules™ Color Card to IBM's.

Five reasons why the Hercules Color Card is better.



**IBM Color Adapter \$244**

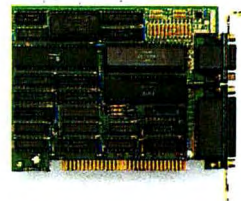

**Hercules Color Card \$245**

- |                  |  |   |
|------------------|--|---|
| 1. Compatibility | Runs hundreds of graphics programs.              | Runs the same hundreds of graphics programs. "The Hercules Color Card is so nearly identical to the IBM Color/ Graphics Card that it's almost uncanny." PC Mag. |
| 2. Printer port. | None.  | Standard. Our parallel port allows you to hook up to any IBM compatible printer.  |
| 3. Size.         | 13.25 inches. Limited to long slots.             | 5.25 inches. Fits in a long or short slot in a PC, XT, AT or <i>Portable</i> .  |
| 4. Flexibility.  | Can't always work with a Hercules Graphics Card. | Always works with a Hercules Graphics Card by means of a software switch.   |
| 5. Warranty.     | 90 days.   | Two years.  |

Any one of these five features is enough reason to buy a Hercules Color Card. But perhaps the most convincing reason of all is just how easy the Hercules Color Card is to use: "Right out of the box, the Hercules Color Card goes into an empty expansion slot, ready for you to plug in . . . and go to work—no jumpers, no software. For most applications, it's just that easy." PC Magazine.

Call 1-800-532-0600 Ext. 421 for the name of the Hercules dealer nearest you and we'll rush you our free info kit.

## Hercules.

**We're strong on graphics.**

Inquiry 168



INTRODUCING  
SOFTWARE  
WITH A MIND  
OF ITS OWN



**GURU™**

ARTIFICIAL INTELLIGENCE THAT MEANS BUSINESS.

For more information, write or call MDBS,  
P.O. Box 248, Lafayette, IN 47902. (317) 463-2581.



# A PARALLEL-TO-SERIAL PRINTER PORT ADAPTER

BY HOWARD AUSTERLITZ

*Build this \$35 adapter  
and use your parallel port for serial devices*

MOST PERSONAL COMPUTERS have at least one parallel (Centronics) printer port. But if your printer has a serial (RS-232C) interface, that parallel port is usually wasted. The adapter described here can be built for around \$35 and will convert the output of your computer's parallel port to serial form for driving a printer, plotter, or any read-only device.

The only limitation of this device is that it must use hardware as opposed to software (XON/XOFF) handshaking. However, software handshaking detection can be added. While the circuit shown in figure 1 was designed to work with the IBM Personal Computer and compatibles, it will also work with most other personal computers that have a Centronics-compatible printer port. Best of all, it requires no extra software. It looks just like a parallel printer to your computer.

## CIRCUIT OPERATION

The heart of the adapter is IC1, a UART (universal asynchronous receiver/transmitter) that converts the 8 parallel bits coming from the PC to a

serial bit stream driving the printer. The serial data rate out of the UART is determined by IC2, the clock generator, which is a 555 oscillator set at 16 times the desired data-transmission rate. Transmitter IC4 converts the UART's TTL (transistor-transistor logic) output to RS-232C levels.

Two control lines from the PC's parallel port are used— $\overline{\text{STROBE}}$  (output) and BUSY (input). At power-on, IC1 and IC5 are reset by R4, C3, and IC3c, initializing the BUSY line to low. After the PC has put valid data on the parallel port (output lines D0-D7), it sends a (low) pulse to  $\overline{\text{STROBE}}$ . This pulse loads the parallel data into IC1 and begins the serial data transmission by activating its DS (data strobe) line. It also sets the flip-flop IC5, keeping the PC's BUSY line active (high). The PC will not send another character until its BUSY line goes low again. When IC1 has finished the serial transmission, its EOC (end of character) line outputs a high pulse that resets IC5 and returns the PC's BUSY line low. Now another  $\overline{\text{STROBE}}$  pulse from the PC can begin the next character-transmission cycle. Switch S1 allows a

manual reset at any time to turn off BUSY.

Some serial printers have a hardware handshaking (output) line on their RS-232C interface to tell the computer if it is ready, busy, or has an error condition. This line, designated  $\overline{\text{READY/ERROR}}$ , is converted to TTL levels by the RS-232C receiver, IC6, and then applied as one input to OR gate IC7b along with the output of IC5 to drive the PC's BUSY input. This enables the printer to suspend the PC's output when needed. If your printer or plotter doesn't have a  $\overline{\text{READY/ERROR}}$  line, you can leave out IC6 and IC7b (connect IC5 pin 5 directly to CONN1 pin 11).

The adapter requires three power-supply voltages: +5 volts at 150 milliamps for most of the chips, and  $\pm 5$  V to  $\pm 15$  V at 20 mA for the RS-232C

*(continued)*

Howard Austerlitz is an instructor in the Department of Materials Science and Engineering at State University of New York at Stony Brook (Stony Brook, NY 11794) and a researcher interested in ultrasonics, signal analysis, and multiprocessor computer systems.



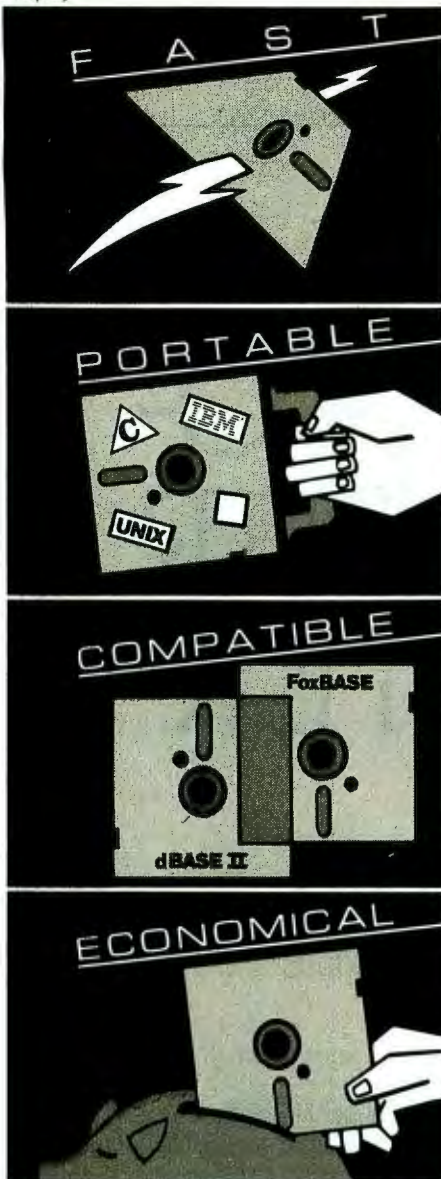

**At last, the breakthrough you've been seeking in a database management system.**

FoxBASE™ is more than just a relational database management system. Because it's written in C, FoxBASE is a highly portable, sophisticated interpreter/compiler that's ultraquick. Very economical. And dBASE II™ source compatible (including full macro usage).

FoxBASE emits compact object code and makes automatic use of an 8087 or 80287 chip to let you develop and run applications with unsurpassed speed.

And for as little as \$10 per license, you can distribute FoxBASE with your applications. FoxBASE even comes with a 30 day moneyback guarantee.

MS DOS \$395. ADS/VS \$995.

UNIX™ (priced according to host).

Don't be outfoxed by the others. Call or write Fox Software today.

dBASE II is a registered trademark of Ashton Tate.

**FOXBASE** 

from FOX SOFTWARE INC.

Developed by

**DACOR**

COMPUTER SYSTEMS

13330 Bishop Road, PO Box 269 Bowling Green, OH 43402  
419-354-3981/TWX 810-499-2989

## PRINTER PORT ADAPTER

*To set the data rate, connect a frequency counter or oscilloscope to the output of IC2 and adjust the trimmer potentiometer to obtain 16 times the desired data rate.*

transmitter, IC4. You can either use commercial power supplies or build the one shown in figure 2. This unit uses an inexpensive, unregulated wall transformer power supply, nominally +9 V at 250 mA, which is filtered for IC4's +9 V source and regulated by IC8 for the +5 V source. This +9 V also powers IC9, a negative voltage

converter, which produces the (nominal) -9 V for IC4. R6 and Zener diode D1 protect the input to IC9, which is rated at 10 V maximum.

### CONSTRUCTION

Figure 3 lists the parts necessary to build this parallel-to-serial adapter, and photo 1 shows a top view of the assembled adapter board. The construction method you use can be wire-wrap and/or point-to-point soldering. Use sockets for all ICs (except IC8, the +5 V regulator). You can wire the parallel-port connector (CONN1) to a DIP header via ribbon cable, but try to keep this cable as short as possible.

### SETUP

After wiring the adapter, test the power supply before you plug in any ICs. If +9 V is not present, neither will +5 V or -9 V be (if you use the supply from figure 2). LED1 ("Power") should light. Check for proper supply voltages at the IC sockets. Now turn off the power and plug in the ICs, but do not connect the PC or printer yet.

*(continued)*

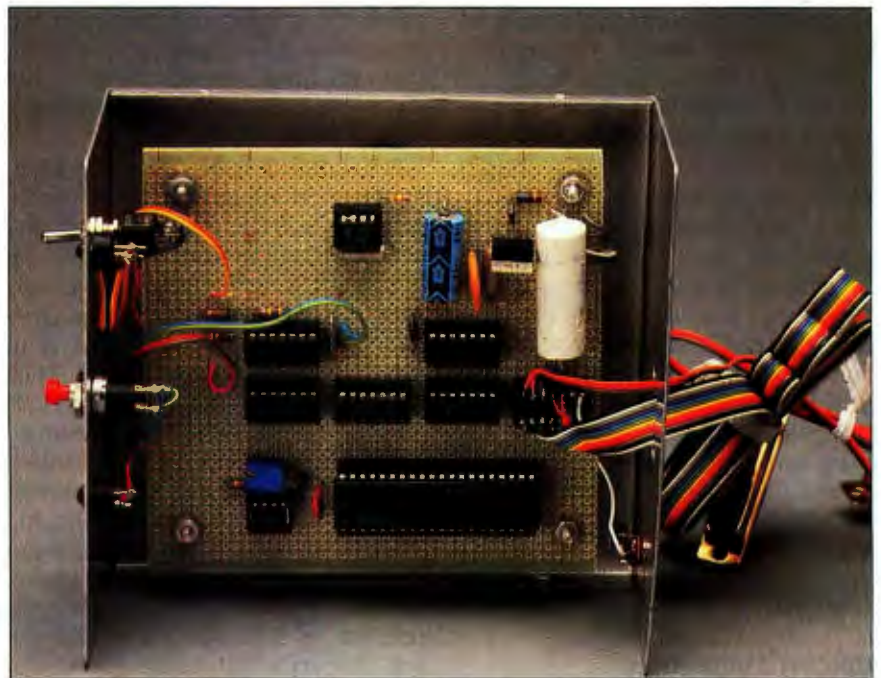

Photo 1: A top view of the parallel-to-serial printer port adapter. Notice the power toggle switch, reset button, and BUSY LED indicator on the left side of the case and the parallel cable and serial cable extending out the right.

# PRINTER PORT ADAPTER

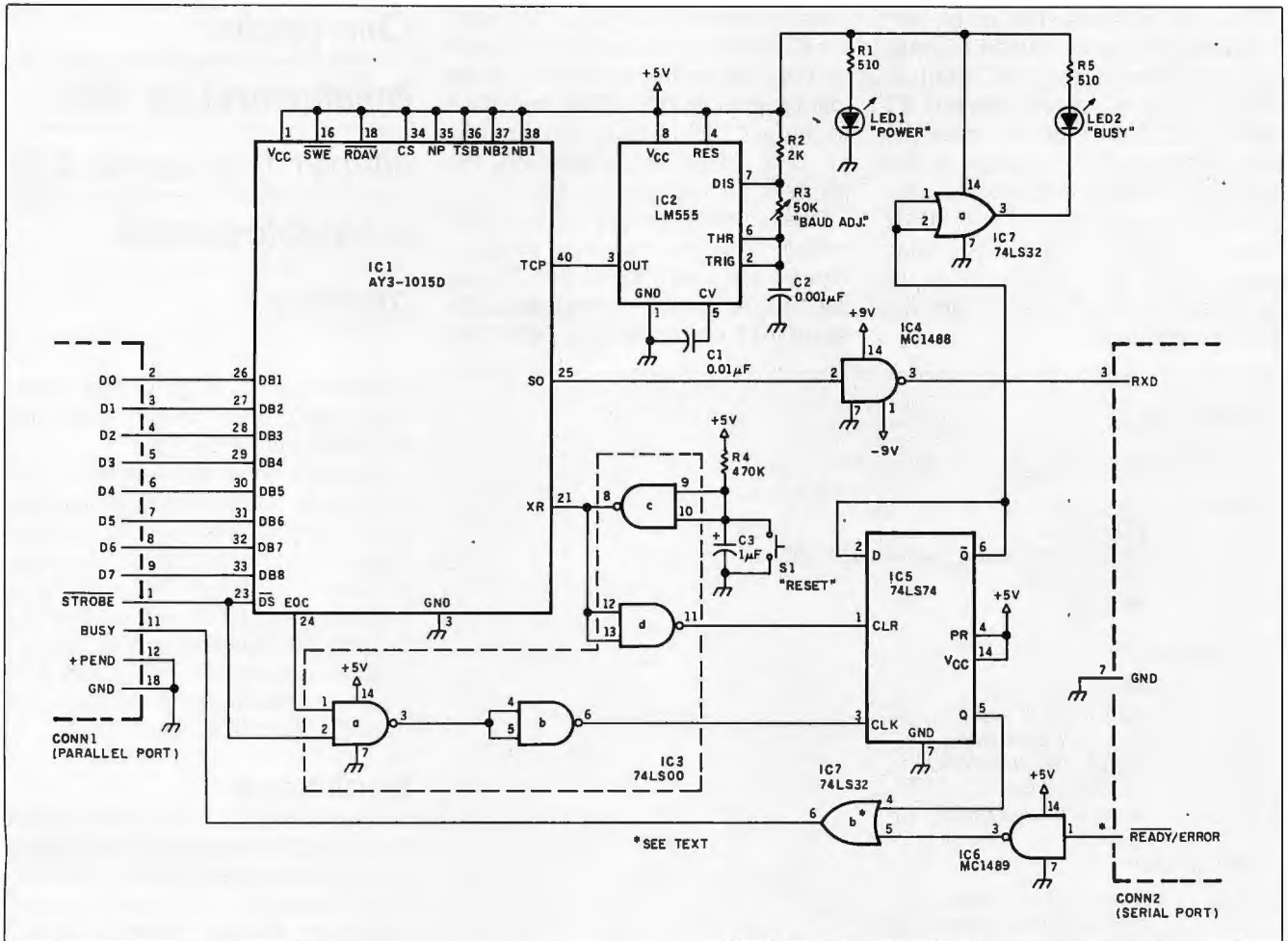

Figure 1: A schematic for the parallel-to-serial adapter. The UART (IC1) converts the 8 bits coming in at the parallel port

(CONN1) to a serial bit stream output at serial port CONN2 that can drive a read-only device with an RS-232C interface.

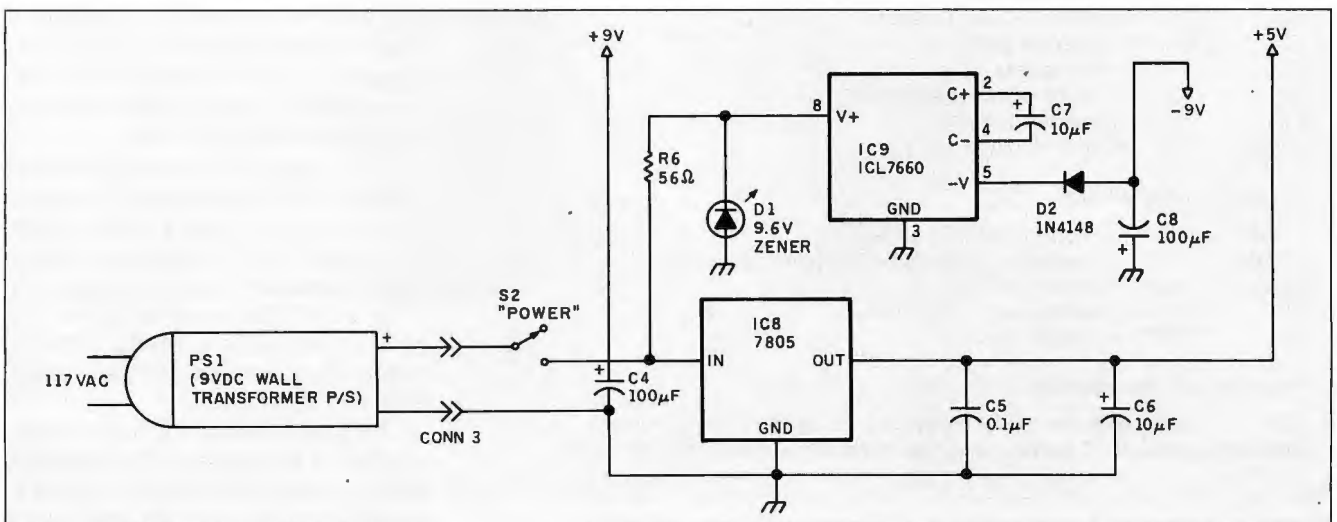

Figure 2: The power-supply adapter for the parallel-to-serial converter of figure 1.



First, the data rate has to be set. Connect a frequency counter or oscilloscope to the output of IC2 (pin 3). Adjust trimmer potentiometer R3 ("Baud Adj.") to obtain 16 times the desired data rate. For example, if you need 300 bits per second for your serial printer, adjust R3 for 4800 Hz (300×16). If you're running faster than about 2400 bps, you'll have to decrease the value of C2 to get the required frequency.

Next, wire in the RS-232C connector (CONN2). Check the user's manual on your printer for information on wiring its serial interface. You may have to jumper DTR (data terminal ready) to DSR (data set ready) on the printer's connector to enable it.

Finally, wire in the parallel port connector. The pin numbers given in figure 1 are strictly for an IBM PC that uses a DB-25 connector instead of the standard Centronics one. Note that

*One possible enhancement for this adapter is to couple it to a serial-to-parallel converter.*

+PEND (pin 12) is grounded to ensure that the PC doesn't think the printer is out of paper.

Normally, when the adapter is first turned on, LED2 (BUSY) should not light if the parallel port is inactive. Regardless, pressing switch S2 (Reset) will turn it off. When the printer port is being used, LED2 will be flashing on and off. Remember that it only gives an indication that the UART (IC1) is busy, not necessarily the printer (if the READY/ERROR line is used).

**OTHER NOTES**

Some personal computers have parallel ports that use a second input control line (besides BUSY), the ACK line. If required, a low pulse must be present on this line before the PC will send the next character (even if BUSY has been reset). Most PCs do not use ACK since BUSY provides all the required handshaking. However, if you need to use ACK, try adding a one-shot multivibrator (i.e., a 74LS123) triggered by the Q output of IC5. Set it to produce a 1-microsecond negative pulse on the ACK line.

If you need to support software (XON/XOFF) handshaking for a serial device, you can use the receiver half of the UART (IC1) to detect the handshake characters from the printer. The UART's DAV (data available) line can be used to toggle a flip-flop, whose output goes into an OR gate along with the BUSY line.

One possible enhancement for this adapter is to couple it to a serial-to-parallel converter. This will produce a parallel port extender for long hauls. Use your imagination and see what else you can come up with. ■

PARTS LIST	
Resistors (1/4-W, 10 percent)	
R1,R5	510 ohms
R2	2000 ohms
R3	50,000 ohms trimmer potentiometer—10 turn
R4	470,000 ohms
R6	56 ohms
Capacitors	
C1	0.01 μF, 50-V disc
C2	0.001 μF, 50-V metal film
C3	1 μF, 50-V electrolytic
C4,C8	100 μF, 35-V electrolytic
C5	0.1 μF, 50-V disc
C6,C7	10 μF, 35-V electrolytic
Semiconductors	
D1	9.6-V, 1-W Zener diode
D2	1N4148, general-purpose diode
IC1	AY3-1015D, UART
IC2	LM555, timer
IC3	74LS00, quad NAND gate
IC4	MC1488, quad RS-232C transmitter
IC5	74LS74, dual D flip-flop
IC6	MC1489, quad RS-232C receiver
IC7	74LS32, quad OR gate
IC8	7805, +5-V regulator
IC9	ICL7660, negative voltage converter
LED1	Green light-emitting diode
LED2	Red light-emitting diode
Connectors and Switches	
CONN1	DB-25P connector (for PC parallel port)
CONN2	DB-25 connector for printer (S or P depends on printer)
CONN3	Mating connector for PS1
S1	SPST momentary push-button switch
S2	SPDT mini toggle switch
Hardware and Miscellaneous	
PS1	Wall-transformer power supply, 9 V DC at 250 mA (minimum)
	Perfboard, wire-wrap IC sockets, wire, ribbon cable, case, mounting hardware

Figure 3: A parts list for the parallel-to-serial converter of figure 1 and the power-supply adapter of figure 2.

# THE FORTH SOURCE™

## MVP-FORTH

Stable - Transportable - Public Domain - Tools

You need two primary features in a software development package . . . a stable operating system and the ability to move programs easily and quickly to a variety of computers. MVP-FORTH gives you both these features and many extras. This public domain product includes an editor, FORTH assembler, tools, utilities and the vocabulary for the best selling book "Starting FORTH". The Programmer's Kit provides a complete FORTH for a variety of computers. Other MVP-FORTH products will simplify the development of your applications.

## MVP Books - A Series

- Vol. 1, *All about FORTH* by Haydon, MVP-FORTH glossary with cross references to fig-FORTH, *Starting FORTH*, and FORTH-79 Standard, 2nd Ed. \$25
- Vol. 2, *MVP-FORTH Assembly Source Code*. Includes IBM-PC®, CP/M®, and APPLE® listing for kernel \$20
- NEW** Vol. 3, *Floating Point Glossary* by Koopman \$25
- Vol. 4, *Expert System* with source code by Park \$15
- Vol. 5, *File Management System* with interrupt security by Moreton. \$25
- Vol. 6, *Expert Tutorial for Volume 4* by M & L Derick \$15
- NEW** Vol. 7, *FORTH GUIDE*, to MVP-FORTH by Haydon \$20

## MVP-FORTH Software - A Transportable FORTH

- MVP-FORTH Programmer's Kit including disk, documentation, Volumes 1, 2 & 7 of MVP Series, and Starting FORTH. CP/M. CP/M 86. Z100. Apple. STM PC. IBM PC/XT/AT & compatibles. PC/MS-DOS. Osborne. Kaypro. MicroDecisions. DEC Rainbow. NEC 8201. TRS-80/100 HP150  **NEW** **MACINTOSH MVP-FORTH** \$175
- NEW** MVP-FORTH Enhancement Package for IBM-PC/XT/AT Programmer's Kit. Includes full screen editor, MS-DOS file interface, disk, display and assembler operators. \$110
- MVP-FORTH Floating Point and Matrix Math for IBM PC/XT/AT with 8087 or Apple with Applesoft \$85
- MVP-FORTH Graphics Extension for IBM PC/XT/AT or Apple \$65
- MVP-FORTH Programming Aids for CP/M, IBM or APPLE Programmer's Kit. Extremely useful tool for decompiling, callfinding, translating, and debugging. \$200
- MVP-FORTH Cross Compiler for CP/M Programmer's Kit. Generates headerless code for ROM or target CPU. \$300
- MVP-FORTH Meta Compiler for CP/M Programmer's kit. Use for applications on CP/M based computer. Includes public domain source. \$150
- MVP-FORTH PADS (Professional Application Development System) for IBM PC/XT/AT or PCjr or Apple II, IIB or IIE. An integrated system for customizing your FORTH programs and applications. The editor includes a bi-directional string search and is a word processor specially designed for fast development. PADS has almost triple the compile speed of most FORTH's and provides fast debugging techniques. Minimum size target systems are easy with or without heads. Virtual overlays can be compiled in object code. PADS is a true professional development system. Specify Computer. \$500
- MVP-FORTH MS-DOS file interface for IBM PC PADS \$80
- MVP-FORTH Floating Point & Matrix Math see above \$85
- MVP-FORTH Graphics Extension see above \$65
- MVP-FORTH EXPERT-2 System for learning and developing knowledge based programs. Both IF-THEN procedures and analytical subroutines are available. Source code is provided. Specify Apple. IBM, or CP/M. Includes MVP Books, Vol. 4 & 6. \$100
- NEW** FORTH-Writer, A Word Processor for the IBM PC/XT/AT with 256K. MVP-FORTH compatible kernel with Files, Edit and Print systems. Includes Disk and Calculator systems and ability to compile additional FORTH words. \$150

## FORTH DISKS

- APPLE by MM \$125
- APPLE by MM,F, & G \$245
- ATARI® valFORTH \$60
- ATARI by PNS, F.G, & X \$90
- C64 by HES Commodore 64 cartridge \$40
- NEW** C64 with EXPERT-2 by PS. MVP,G,F & X \$99
- CP/M by MM \$125
- CP/M by MM, F \$160
- HP-75 by Cassidy \$150
- HP-85 by Lange \$90
- IBM-PC by LM \$100
- NEW** IBM-PC by MM \$125
- NEW** Macintosh by MM \$125
- Timex by HW, cassette \$25
- T/S 1000/ZX-81 \$25
- 2068 \$30
- Z80 by LM \$100
- 8086/88 by LM \$100
- 68000 by LM \$250
- VIC FORTH by HES, VIC20 Cartridge \$40
- Extensions for LM Specify IBM, Z80, or 8086
- Software Floating Point \$100
- 8087 Support (IBM-PC or 8086) \$100
- 9511 Support (Z80 or 8086) \$100
- Color Graphics (Z80 or 8086) \$100
- Data Base Management \$200

## Key to Vendors:

- HW Hawg Wild Software
- LM Laboratory Microsystems
- MM MicroMotion
- PNS Pink Noise Studio
- PS ParSec

## Codes:

- F - Floating Point
- G - Graphics
- T - Tutorial
- X - Other Extras

## FORTH MANUALS, GUIDES & DOCUMENTS

- Thinking FORTH by Leo Brodie, author of best selling "Starting FORTH" \$16
- ALL ABOUT FORTH by Haydon, MVP Glossary \$25
- FORTH Encyclopedia by Derick & Baker \$25
- NEW** FYS FORTH from the Netherlands  User Manual \$25  Source Listing \$25
- NEW** FORTH Tools and Applic. by Feierbach \$19
- NEW** The Complete FORTH by Winfield \$16
- NEW** Learning FORTH by Armstrong \$17
- NEW** Understanding FORTH by Reymann \$3
- NEW** FORTH, An Applications Approach by Toppen \$20
- NEW** FORTH Applications by Robens \$13
- Mastering FORTH by Anderson & Tracy \$18
- Beginning FORTH by Chirlian \$17
- FORTH Encycl. Pocket Guide \$7
- And So FORTH by Huang. A college level text. \$25
- FORTH Programming by Scanlon \$17
- STARTING FORTH by Brodie. Best instructional manual available. (soft cover) \$20
- 68000 fig-Forth with assembler \$25
- FORML Proceedings  1980  1981 Vol 1  1981 Vol 2  1982  1983  1984 each \$25
- NEW** 1981 Rochester Proceedings  1981  1982  1983  1984 each \$25
- Bibliography of FORTH \$17
- The Journal of FORTH Application & Research  Vol 1/1  Vol 1/2  Vol 2/1  Vol 2/2  Vol 2/3 each \$15
- META-FORTH by Cassidy \$30
- Threaded Interpretive Languages \$25
- Systems Guide to fig-FORTH by Ting \$25
- NEW** Inside F83 Manual by Ting \$25
- FORTH Notebook by Ting \$25
- Invitation to FORTH \$20
- PDP-11 User Man. \$20
- 6502 User's Manual by Rockwell Intl. \$10
- FORTH-83 Standard \$15
- FORTH-79 Standard \$15
- Installation Manual for fig-FORTH \$15
- Source Listings of fig-FORTH, Specify CPU or Computer \$15

**Ordering Information:** Check, Money Order (payable to MOUNTAIN VIEW PRESS, INC.), VISA, MasterCard, American Express. COD's \$5 extra. Minimum order \$15. No billing or unpaid PO's. California residents add sales tax. Shipping costs in US included in price. Foreign orders, pay in US funds on US bank, include for handling and shipping by Air \$5

for each item under \$25, \$10 for each item between \$25 and \$99 and \$20 for each item over \$100. All prices and products subject to change or withdrawal without notice. Single system and/or single user license agreement required on some products.

# MOUNTAIN VIEW PRESS, INC.

PO BOX 4656

MOUNTAIN VIEW, CA 94040

(415)961-4103



# Call for price, support, service...it's that simple



## PC PROGRAMMERS CORNER

**Borland**  
Turbo Pascal .... \$ 37  
**CompuView**  
Vedit ..... \$130  
Vedit+ ..... 179  
**Digital Research**  
Please call for prices  
and available products.  
**Emerging Technology**  
Edix (editor) .... \$139  
**Heritage**  
Smartkey II+ .... \$ 75  
**Morgan Computing**  
Prof Basic ..... \$ 79  
Trace 88 ..... 99  
**Peter Norton**  
Norton Util 3.0 ... \$ 59  
**Supersoft**  
Fortran ..... \$209

## IBM/PC SOFTWARE

**Anderson Bell**  
Abstat ..... \$289  
**Ashton-Tate**  
dBase II ..... Call  
dBase III (v. 1.1) ... Call  
Framework (v. 1.1) ... Call  
Friday ..... Call  
**Borland**  
Sidekick ..... \$ 37  
Turbo Pascal V 3 ... 45  
w/8087 ..... 75  
Super Key ..... 55  
**Central Point**  
Copy II PC ..... \$ 34  
**Connecticut Software**  
Printer Boss v. 5 ... \$ 99  
**Consumer Software, Inc.**  
Spread Sheet Audit. \$109  
**Dow Jones**  
Market Manager + . \$169  
**Enertronics**  
Energraphics ..... \$219  
w/Plotter Option ... 279  
**Fox & Geller**  
Quickcode (III or II) .. 159  
Quick Report ..... 159  
dUtil (III or II) ..... 58  
Quickcode ..... 159  
Quickreport ..... 159  
**Harvard Software**  
Total Project Mgr. ... \$279  
**Lifetree**  
Volkswriter Deluxe . \$155  
Volkswriter Scientific . 299

**MDBS**  
Knowledge Man ... \$275  
**Micropro**  
Wordstar ProPak ... \$255  
Wordstar 2000 ..... 255  
Wordstar 2000+ ... 295  
**Microrim**  
R-base 4000 ..... \$265  
R-base Clout (V 2.0) .. 159  
R-Writer ..... 95  
Prog Interface ..... 259  
R-base 5000 ..... 429  
**Microsoft**  
Flight Simulator ... \$ 39  
Word 1.15 ..... 229  
MuMath/MuSimp ... 179  
**Microstuf**  
Crosstalk ..... \$ 99  
**Open Systems**  
Acct'g Programs ea. \$379  
**Rosesoft**  
ProKey V 4.0 ..... \$ 89  
**Samma Corp.**  
Samma Word III ... \$329  
Samma + ..... 449  
**Sensible Designs**  
d Programmer ..... \$199

## APPLE SOFTWARE

**Alpha Software**  
Apple-IBM  
Connection ..... \$169  
**Dow Jones**  
Market Analyzer ... \$229  
Market Manager ... 189  
Spreadsheet Link ... 179  
Plus many more...  
PLEASE CALL!

## CP/M SOFTWARE

All prices below are for  
8" standard.  
**Ashton-Tate**  
dBase II ..... Call  
**Digital Research**  
Please call for prices  
and available products.  
**Infocom**  
All Games ..... Call  
**Micro Pro**  
Pro-Pak ..... \$359  
**Microstuf**  
Crosstalk ..... \$ 99  
**Northwest Analytical**  
Statpak ..... \$365  
**Supersoft**  
Disk Doctor ..... \$ 74

## APPLE BOARDS

**ALS**  
CP/M Card ..... \$269  
Smarterm II ..... 119  
Z-Engine ..... 139  
**CCS**  
7711 Asynch Serial . \$119  
**Microtek** ..... Call  
**Orange Micro**  
Grappler+ ..... \$119  
**Prometheus**  
Versacard ..... \$159

## IBM/PC BOARDS

Memory Chips ..... Call  
**AST Research**  
Six Pak + ..... \$265  
**Orchid Technology** . Call  
**Quadram**  
Quadboard 384K  
w/64K ..... \$226  
Other Products ..... Call  
**Tecmar** ..... Call

## MODEMS

**Hayes**  
Smartmodem 300 ... \$159  
Smartmodem 1200 ... 399  
Smartmodem 1200B ... 369  
Smartmodem 2400 ... Call  
**US Robotics**  
S-100 Modem ..... \$349  
Password M or F ... 325

## MONITORS

**Amdtek**  
300A Amber ..... \$149  
310A ..... Call  
**PGS**  
HX12 RGB Clr .... \$479  
MAX 12 ..... 179  
SR12 (690 x 480 Res) .. 639  
Doubler Card ..... 175  
**Quadram** ..... Call  
**Zenith** ..... Call

## PRINTERS

**C. Itoh Electronics, Inc.,**  
Diablo, Epson, NEC,  
Okidata, Quadram,  
Star Micronics ..... Call

## PC Jr ACCESSORIES

**KeyTronic**  
KB 5151 Jr. .... \$169  
KB 5149 (Numeric  
Keypad) ..... 89  
**Quadram**  
Quad Jr.  
Exp Chassis ..... \$479  
Quad Jr. Exp Mem  
(for Chassis) 128K . \$199  
**Tecmar**  
Jr. Captain ..... \$315

## MISC.

**Hauppauge**  
8087 w/o software .. \$149  
80287 AT Chip  
w/o ..... 269  
**Kensington**  
Masterpiece ..... \$109  
**Keytronic**  
KB 5150 ..... \$169  
KB 5151 ..... 189  
KB 5151 Dvorak ..... 173  
**Touchtone Technology**  
Touchtone II  
(PC Keypad) ..... \$169

## DISK DRIVES

**FULL HEIGHT —**  
CDC, Tandon  
HALF HIGH ..... Call  
**HARD DISK —**  
Corvus, Davong,  
I-Omega Bernoulli Box,  
Maynard Electronics,  
Mountain, Inc. .... Call

This is only a sample of the nearly  
10,000 products we carry. If you're  
interested in something that is not  
listed, PLEASE CALL!

# 1 800 826-1589

WITHIN WISCONSIN 1 800 472-3535

INT'L TELEX: 260181 ORYX SYS WAU

Technical Support/Order Status/Customer Service:  
Call (715) 848-1374.

## POLICY:

- ▶ Wisconsin residents add 5% for sales tax.
- ▶ Minimum \$4.00 for shipping, handling and insurance for orders to \$200.
- ▶ For orders over \$200, add 2½% for shipping, handling and insurance.
- ▶ For cash prepayment of orders \$200 or more, add ONLY 2% for shipping, handling and insurance.
- ▶ Prices are subject to change without notice.
- ▶ All items subject to availability.

## WE WELCOME:

BYAD0985

- ▶ Visa, MasterCharge and American Express. (No charge for credit cards.)
- ▶ Corporate, government, educational or volume purchasers, please ask for special accounts desk for additional discount.
- ▶ COD (Add \$2.00 per box/parcel. Cash or certified check required.)
- ▶ Checks. (Allow 1-2 weeks for clearing.)

## INTERNATIONAL POLICY:

We welcome foreign orders. Shipping and handling charges per order are actual shipping costs plus \$50. international handling fee. Canadian orders — please call. Telex: 260181 Oryx Sys Wau

## WORKING HOURS:

Monday-Friday 8:30-6:00 : Saturday 10:00-2:00 : Central Time



# Oryx Micro Supply

## CRAFTSMEN OF THE NEW TECHNOLOGY

425 First Street • P.O. Box 1961 • Wausau, Wisconsin 54401

# ADD FUNCTION KEYS TO YOUR MICROCOMPUTER

BY MARK HANSLIP

---

## *Expand your parallel keyboard*

MOST MICROCOMPUTERS now coming into the market have built-in software-programmable function keys. Many applications require the use of function keys, partly because they provide a consistent and quickly mastered user interface. Undoubtedly, many owners of older machines would also like some of that simplicity. For those whose machines did not come so equipped, the answer is a function-key generator.

I have designed a function-key-generator circuit that will produce up to 15 keystrokes with the push of one button. You can attach the circuit to the parallel-encoded keyboard of any microcomputer or word processor and use it with any operating system. The design allows 40 function keys and can be expanded to 60. You can also expand the 15-keystroke limit. The entire project involves two separate devices—a keyboard splitter and a function generator—and costs approximately \$20 to assemble.

### **KEYBOARD SPLITTER**

The keyboard splitter is a very simple device (see figure 1). Its function is

analogous to a coaxial antenna splitter; it combines two signals in one. When the keyboard splitter is connected, it allows the keyboard and the function-key generator to work without interfering with each other.

When both strobes are high, both 74LS244 buffers go into a high Z state. When either strobe is low, the data is passed through that specific buffer. The other buffer will still be in a high Z state and will not impair valid data. The pull-up resistor on the FKSTB (function-key strobe) line allows you to disconnect the function generator, so it will not trigger falsely. In an idle state, the strobes from your keyboard (STB) and FKSTB are both high, generating a low output at pin 6 of the 7400 NAND gate. When either strobe goes low, the output at pin 6 will go high until both strobes go high again. I have included another 7400 gate to provide an inverted strobe output (at CSTB) for those computers that require it. The function-key generator produces a high-going-low strobe. Some keyboards are low-going-high and some are the opposite. Determine which type you have before you

start. Check your computer's schematic or use a logic probe. For a high-going-low strobe from your keyboard, connect B to C and use output E to connect to your computer. For a low-going-high strobe, connect A to C and use output D.

The easiest method of construction is to use a small perf board. It should be large enough to hold all the sockets and the connector for the keyboard and the function generator. If your microcomputer has a keyboard connector (as the Apple does), it is best to use this connector so that the keyboard splitter can be removed later. Wire lengths are not critical, but it is best to keep them as short as possible.

### **FUNCTION-KEY GENERATOR**

The function-key generator's circuitry requires a minimum of discrete com-

*(continued)*

*Mark Hanslip is a systems analyst with NCR in Dayton, Ohio. He is a graduate of the University of Cincinnati and a past president of the Dayton Microcomputer Association. He can be contacted at 143 Schloss Lane, Dayton, OH 45418-2931.*





## ADDING FUNCTION KEYS

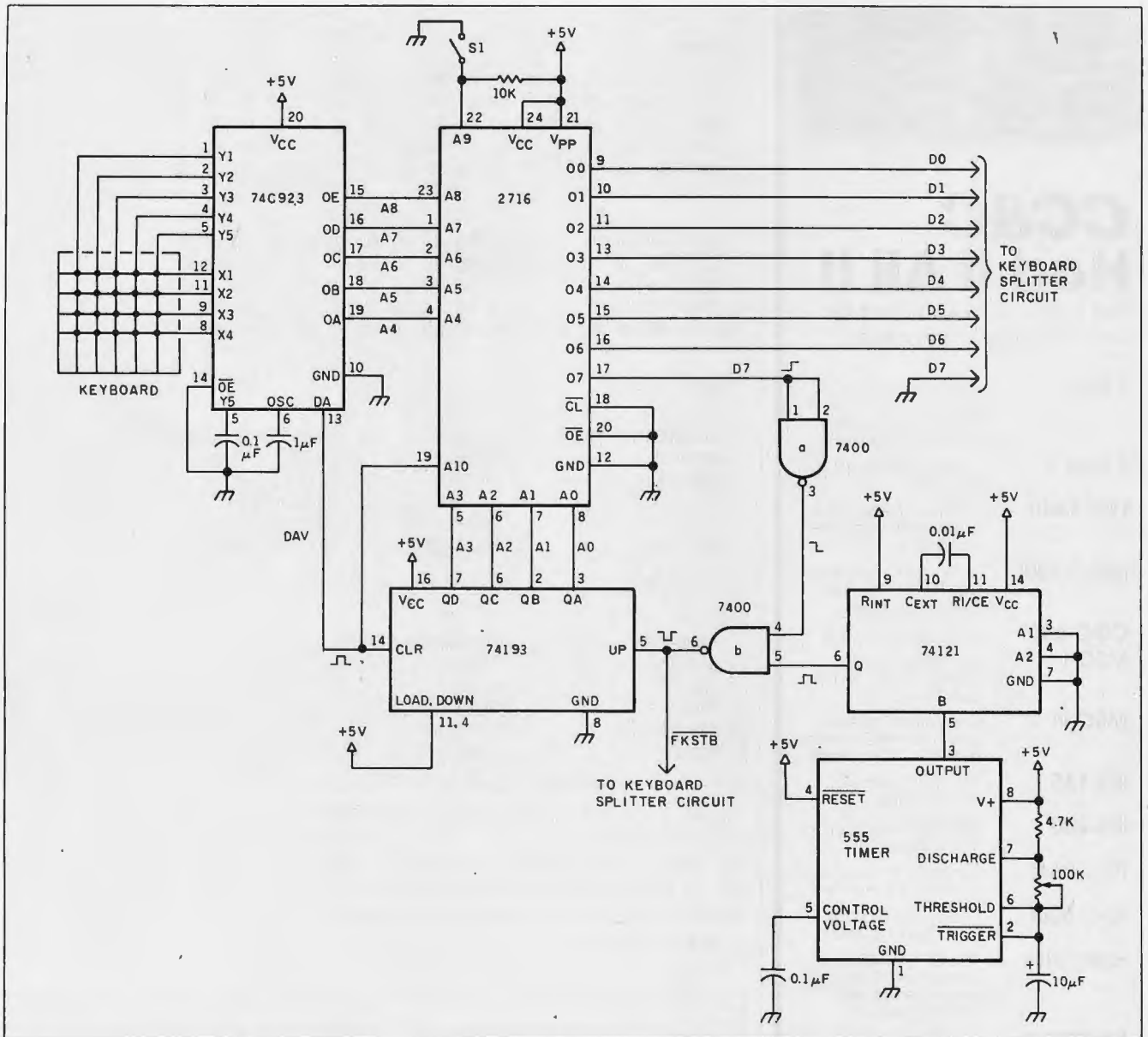

Figure 2: A schematic of the function-key-generator circuit.

keyboards. The keyboard should be wired in a 5-row by 4-column manner. Connect the keyboard to the 74C923 as listed in table 1.

Test the function-key generator very carefully. Turn the speed of the 555 down to very slow by adjusting the 100k-ohm variable resistor. Using a logic probe, make sure that pin 13 of the 74C923 goes from low to high when a key is pressed and returns to low when the key is released. Then check to see that pin 3 of the 74193

is changing state right after the key is released but eventually stops. Finally, verify that pin 17 of the 2716 goes high when the key is pressed and held, goes low for several counts when released, and then goes high and remains high. If your circuit fails to pass any of these tests, check for shorts, bad connections, and bad ICs.

### PROGRAMMING

When you program the codes in the EPROM, all you must remember are

a few simple guidelines. The function-key generator will not generate codes above decimal 127. This is not a problem for ASCII-encoded keyboards, but it can be for keyboards with special encoding. The function-key generator will produce as many as 15 keystrokes for any given key press. This includes spaces, punctuation, control codes, and carriage returns. Each set of codes must conclude with a hexadecimal 80 to shut off the counter.

*(continued)*



**ARC X turbo Board™**  
40 % Faster Than XT, 640K On Board

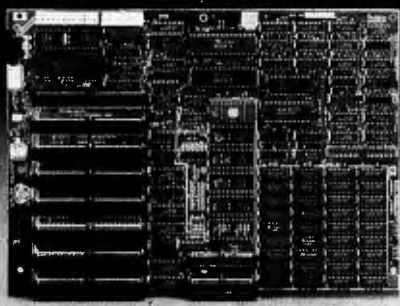

# CC&C Had it All !!

The Ultimate in Add-On's for your PC, Fully Comptible

- 7 Plus** Multifunction Card, 2 Serial, 1 Parallel Port, 4 Floppy Drives, Clock/Calendar, Game Port
- 8 Plus** Multifunction Card, (OK-384K)
- LDA-1440** High Resolution Letter Quality Monochrome Adapter
- MGC-720I** Monochrome Graphic Card Hercules Type, 1-2-3 Compatible
- CGC-640I** Color Graphic Card
- MSC-I** Computer Case Standard Size Heavy Duty Steel
- MSC-III** Computer Case excellent for ARC X turbo Board, 2 L.E.D. Indicator
- IPS-135** 135 Watt Switching Power Supply
- IPS-200** 200 Watt Switching Power Supply
- PBC-064I** Printer Buffer Card 64K, No software required
- FDC-500I** Floppy Disk Control Card, Up to 4 Drives
- Hard Disk** 10 MG Byte Microscience or 20 MG Byte Microscience With Control Card
- Keyboard** 5151 Compatible  
5150 Compatible
- Panasonic Floppy Drive** Half Height Floppy Disk Drive, \$105

Quality Enhancement to Rely On

**CALIFORNIA  
COMPUTER &  
COMPONENT, INC.**

2001 W. CHESTNUT STREET  
ALHAMBRA, CA 91803

Dealer, OEM Inquires Welcome  
Call (818)-576-1621

X turbo Board is the trademark of ARC.  
IBM PC/XT are registered trademarks of IBM Corp.

## ADDING FUNCTION KEYS

(3a)

```
000: 12 80 80 80 80 80 80 80 80 80 80 80 80 80 80 80
010: 03 80 80 80 80 80 80 80 80 80 80 80 80 80 80 80
020: 11 43 80 80 80 80 80 80 80 80 80 80 80 80 80 80
030: 11 52 80 80 80 80 80 80 80 80 80 80 80 80 80 80
040: 0F 53 80 80 80 80 80 80 80 80 80 80 80 80 80 80
```

```
200: 42 41 53 49 43 0D 80 80 80 80 80 80 80 80 80 80
210: 46 49 4C 45 53 0D 80 80 80 80 80 80 80 80 80 80
220: 46 49 4C 45 53 20 31 0D 80 80 80 80 80 80 80 80
230: 4C 49 4E 45 45 44 49 54 0D 80 80 80 80 80 80 80
240: 4D 4F 44 45 4D 50 0D 80 80 80 80 80 80 80 80 80 80
```

(3b)

ADDRESS	KEY	CODE	WORDSTAR COMMAND
000-00F	0	CNTRL-R	SCROLL DOWN
010-01F	1	CNTRL-C	SCROLL UP
020-02F	2	CNTRL-Q C	BOTTOM OF TEXT
030-03F	3	CNTRL-Q R	TOP OF TEXT
040-04F	4	CNTRL-O S	SET LINE SPACING

ADDRESS	KEY	COMMAND STRING
200-20F	0	BASIC
210-21F	1	FILES
220-22F	2	FILES 1
230-23F	3	LINEEDIT
240-24F	4	MODEMP

Figure 3: (a) A dump of a portion of the EPROM the author uses. Notice that each sequence starts on address xx0, continues to xxF, and is terminated by a hexadecimal 80. Although the EPROM actually holds sequences for two sets of function keys—the first set between 000 and 13F, the second between 200 and 33F—only the first five sequences of each set are shown here. (b) These two tables show what is actually stored in each key sequence.

QUANTITY	PART	QUANTITY	PART
1	74193	1	0.01 μF
1	74121	2	0.1 μF
2	74LS244	1	1 μF
1	74C923	1	10 μF 16V
1	2716	1	4.7k resistor
1	555	2	10k resistor
2	7400	1	100k potentiometer
1	24-pin IC socket	1	SPST toggle switch
3	20-pin IC socket	1	Project board
1	16-pin IC socket	1	20-key keyboard
3	14-pin IC socket	1	Enclosure
1	8-pin IC socket		Miscellaneous connectors

Figure 4: A parts list for the keyboard-splitter and function-key-generator circuits.

(continued)

# Now there is an even better structured, compiled programming environment than PROMAL. Introducing PROMAL 2.0 for the IBM PC, the Apple II, and the Commodore 64.

Until now, the best next language for the serious programmer was PROMAL™. Now, it's the new PROMAL—PROMAL 2.0.

PROMAL 2.0 provides the same sophisticated structured programming environment, the same fast one-pass compiler, the same speed of execution, the same powerful commands of the earlier release—plus a host of useful new features.

**Not just a language. A complete programming environment.**

PROMAL—the PROgrammer's Micro Application Language—provides you with a complete programming environment, including a structured, high level language, a powerful program Editor, and a compiler that quickly turns your source code into compact, rapidly executing object code. Plus a library of integrated machine-language subroutines for frequently used tasks. And for the Apple II and the Commodore 64, PROMAL provides a DOS-like operating system Executive.

**PROMAL 2.0—Even more of a good thing.**

In addition to all of the features that have made PROMAL users declare it "the best language I've ever used," PROMAL 2.0 provides:

- Overlays that can be compiled separately for modular programming.
- Program size greater than 64k. (IBM PC only).

## NEW for PROMAL The Graphics Toolbox\*

Twenty fast subroutines for creating sophisticated, high-resolution graphics, including windows, clipping, scaling, and text-on graphics using scaled, rotated, user-defined fonts. \$29.95.

\*Available for the Apple II and the Commodore 64

- True machine-to-machine portability.
- True 808X object code for the IBM PC.

**Let us prove that PROMAL is your best next language!**

Buy PROMAL 2.0 and try it for 15 days. If you don't believe it's your best next language, just return it for a full refund.

### PROMAL Features

- Structured language with indentation.
- Fast, one-pass compiler.
- Simplified syntax.
- No line numbers.
- Multi-dimensional arrays, strings and pointers.
- Long variable names.
- Global, Local variables.
- Byte, Word, Integer & Real types.
- Decimal or Hex numbers.
- Functions and procedures with passed arguments.
- Built-in I/O library.
- Control Statements: IF-ELSE, IF, WHILE, FOR, CHOOSE, BREAK, REPEAT, INCLUDE, etc.
- Compiler I/O from/to disk or memory.

### Executive\*

Command oriented with line editing.  
Allows multiple user programs in memory at once.  
Function key redefinition.  
Program abort or pause.

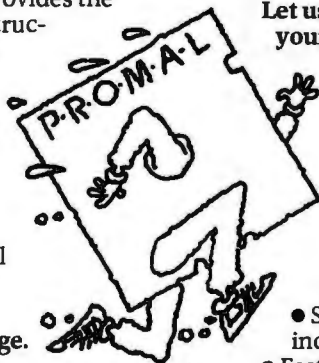

22 resident system commands.  
Unlimited user-defined commands.  
Prior command recall/edit.  
I/O redirection to disk or printer.  
Batch jobs.

### Editor

Full-screen, cursor driven.  
Function key controlled.  
Line insert, delete, search.  
String search and replace.  
Block copy/move/delete/read/write.  
Auto indent, unindent support.  
Edit after error.

### Library

50 machine language commands.  
Memory resident.  
Call by name with arguments.  
Formatted real output, string operations and much more.

\*Apple II and Commodore 64 only. Requires one disk drive and 80-column card for Apple (IIe, IIc only).

# 1-800-762-7874

In NC: 919-878-3600

Systems Management Associates  
3325 Executive Drive, Dept. PB-5  
Raleigh, North Carolina 27609



### Order Form

- My system is (check one)  
 IBM PC/100% compatibles     Apple IIc/IIe  
 Commodore 64/128
- Developer's Version—Compiler, Editor, Library, Demo disk, 280-page manual, (plus Executive for Apple and C-64) and stand-alone program generation.  
\$99.95 + 5.00 s/h.
- End-User System for Apple II and Commodore 64—all features of Developer's version except stand-alone program generation.  
\$49.95 + 5.00 s/h.
- Demo System—32-page "Meet PROMAL" manual and demonstration disk.  
\$10.00 + 2.50 s/h.
- Graphics Tool Box for PROMAL—Available for Apple and C-64 only. \$29.95 + 2.50 s/h.

- My check is enclosed.  
 Please charge to my  
 — Visa — Mastercard

Card Number \_\_\_\_\_ Expiration Date \_\_\_\_\_

Signature \_\_\_\_\_

Name \_\_\_\_\_

Address \_\_\_\_\_

City, State, Zip \_\_\_\_\_

NC residents add 4-1/2% sales tax.  
Foreign orders add \$15.00 additional s/h.



# WAREHOUSE DATA PRODUCTS

Se habla Español

Call for programs not listed

Technical & Other Information (602) 246-2222

TOLL FREE ORDER LINE 1-(800)-421-3135

## SOFTWARE SPECIALS

Authorized Sperry Dealer

Word Perfect .....	\$199	Supercalc III Ver. 2 ...	\$159	Crosstalk .....	\$95
Multimate .....	\$210	Nutshell .....	\$55	We stock over 300 IBM software programs - call for pricing	
Knowledgeman .....	\$225	R Base 5000 .....	\$339		

### FREE! PRINTER SET SOFTWARE

Purchase an Okidata, Epson, Citizen, Gemini or Toshiba printer and receive at no charge a menu driven program to set print characteristics or to make your computer function as a correcting typewriter. Retail value \$35. Available for most disk formats.

### --- PRINTERS ---

#### CITIZEN

MSP-10 ..... \$279  
MSP-15 ..... Call  
MSP-20 ..... 425

#### C-ITOH

F-10-55 ..... 1030  
8510 Parallel (Pro-writer) ..... 295  
8510SEP ..... 399

#### DAISYWRITER 2000

..... 795

#### EPSON - Call on all models

#### JUKI

Juki 6100 ..... 359  
Juki 6300 ..... 685  
Juki Tractors ..... 129

#### NEC

3550 ..... 1009  
8850 ..... 1349  
P2 Parallel ..... 525  
P3 Parallel ..... 725

#### OKIDATA - Call on all models

#### PANASONIC

1091 ..... 258  
1092 ..... Call  
1093 ..... 515  
KXP3151 ..... 455

#### SILVER REED

EXP 400P ..... 235  
EXP 500P ..... 289  
EXP 550P ..... 399  
EXP 770P ..... 699

#### STAR MICRONICS

SG-10 ..... 235  
SG-15 ..... 369

Call for prices on other models

#### TOSHIBA

1340 ..... 540  
P351 ..... 1065

#### AB PRINT SWITCH

..... 75

### --- COMPUTERS ---

#### IBM PC

..... Call

#### Sperry PC Mono

..... 1650

### --- MOUSE SYSTEMS ---

#### PC Mouse w/Paintbrush

..... 120

### --- TERMINALS ---

Qume QVT-102 Green ..... \$448  
WYSE 50 ..... 450

### --- MICROSOFT ---

Bus. Mouse ..... 110  
Serial Mouse ..... 129

### --- MODEMS ---

Hayes 1200 ..... Call  
Hayes 1200B ..... Call  
Hayes 2400 ..... 595  
Anchor Express 1200 Baud ..... 245  
Promodem 1200B ..... 265  
Promodem 1200 ..... 305

### --- RAM ---

64K 150NS Chips (set of 9) ..... 7.50  
256K Ram Chips (set of 9) ..... 39.50

### --- BOARDS ---

AST Six Pack Plus w/384K ..... 285  
AST Advantage ..... 395  
Hercules Color Card ..... 149  
Hercules Graphics Board ..... 295  
Paradise Graphics Board ..... 259  
Paradise Five Pak w/64K ..... 175  
Quadram Board ..... 199  
Quadcolor I ..... 179  
Sigma 384K Expansion Board  
w/64K and Clock ..... 145  
Sigma Maximizer w/64K ..... 169  
512K Expansion Board w/128K ..... 145  
STB Graphics Chauffeur Board ..... 255  
STB Mono Board ..... 155  
TEC Mar Graphics Master ..... 465

### --- DISK DRIVES ---

Iomega Bernoulli 20 mg ..... 2450  
Iomega Bernoulli Plus 20 mg ..... 2625  
10 mg External Hard Drive ..... 825  
33 mg External Hard Drive ..... 1625  
Teac 1/2 Ht. Drives ..... 99  
Turbo 10 Internal Drive ..... 625  
Turbo 20 Internal Drive ..... 1010

### --- MONITORS ---

AMDEK ..... Call for price  
Princeton HX-12 ..... 449  
Princeton Max 12E ..... 179  
Taxan 425 ..... 399  
Taxan 121 Green ..... 125  
Taxan 122 Amber ..... 134

### --- CP/M SOFTWARE ---

Call us for pricing on CP/M Software! Multiplan, Wordstar, Propack, Fortran, Move-It, Crosstalk and more. Most disk formats available.

## ADDING FUNCTION KEYS

The function-key  
generator will  
produce up to

15 keystrokes for  
any given key press.

Figure 3 is a hexadecimal dump of portions of the EPROM. My design uses S1 to switch between two different code sets. The first set of codes is stored between addresses 000 and 13F and consists of WordStar commands. The second set goes from 200 to 33F and contains CP/M and BASIC commands. In the lower address section, we see in line 020 an 11 43. This equates to a "Control-Q C," the WordStar command to move to the bottom of the file. In the upper address section, look at line 220 and you will see 46 49 4C 45 53 20 31 0D, which equates to "FILES 1 <CR>". Both sequences are generated by the same key, but with switch S1 set to a different position. It is a good idea to get an ASCII chart and make a list of the codes you want to use.

### CONCLUSION

You can expand the function-key generator. The design I have presented here uses 20 keys with two sets of codes for each, and each key generator provides up to 15 valid keystrokes (see figure 4 for a list of parts). By adding a second 74193, you can increase the number of keystrokes to 32, 64, or 128 per set. A 64-keystroke set would require 12 bits of address or a 2764 to hold all the output codes. Also, by using a three-position switch at S1, you could expand to three sets of codes per key. However, this would require a 2732 EPROM in place of the 2716.

The function-key generator is a very useful tool for almost any application, from word processing to general programming. In fact, I used it to help me write this article. ■

**TERMS:** Prices include 3% cash discount. Add 3% for charge orders. Shipping on most items \$5.00. AZ orders +6% Sales Tax. Personal check, allow ten (10) days to clear. Prices subject to change.

TOLL-FREE ORDER LINE 1-800-421-3135

WAREHOUSE DATA PRODUCTS

2701 West Glendale Ave., Suite 6  
Phoenix, AZ 85021





# THE ADVANTAGES OF BEING IN THE RED.

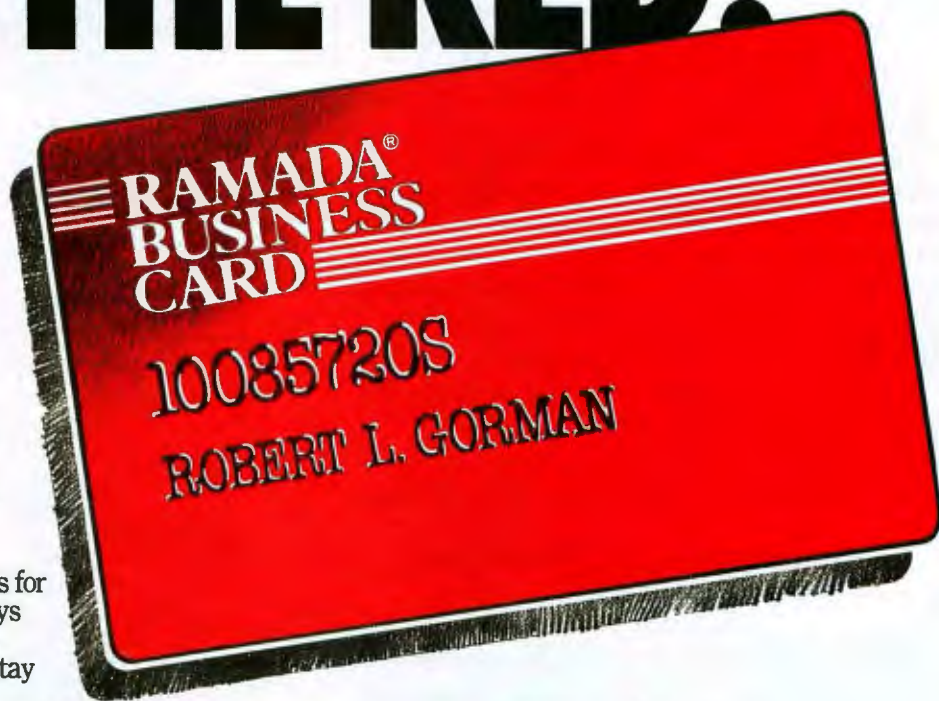

- Earn free airfare and lodging faster.
- Preferred room rates.
- Automatic upgrade when available.
- Bonus Dividend Points for Fri., Sat. and Sun. stays through August 25th.
- Spouse and children stay free in same room.
- 25% Bonus Dividend Points with Hertz.
- 25% Bonus Dividend Points with Eastern Airlines.
- Bonus Dividend Point for joining now.

No other preferred business traveler program gives you more. Membership begins immediately when you fill out an applica-

tion at any of over 500 Ramada locations. Or, if you prefer, simply send us your business card and we'll send you ours. Just mail to: Ramada Response Center, P.O. Box 4500, Woburn, MA 01888.

The Ramada Business Card. You'll come out ahead when you're in the red. Call 1-800-2-RAMADA for reservations.

**NEXT TIME, RAMADA**

Ramada Inns, Hotels and Renaissance Hotels 1-800-2-RAMADA

© Ramada Inns, Inc., 1985



# Discover the most powerful

---

## The IBM Personal Computer AT.

---

Hold on to your hat.

The IBM Personal Computer AT (for Advanced Technology) is based on the advanced 80286 16-bit microprocessor. This remarkable computer will run many of the programs written for the IBM PC, up to three times faster. You'll be able to recalculate large spreadsheets in seconds and retrieve files in a flash. And it's ideal for IBM TopView, the new kind of software program that lets you run and "window" several other programs at once.

The IBM Personal Computer AT has got the power (and price) to surprise you. In many ways.

---

### Compatibility, expandability, networking too.

---

With the IBM Disk Operating System, the IBM Personal Computer AT can use many programs from the fastest-growing library in the personal computer software industry.

The IBM Personal Computer AT is also available with up to 3 million bytes of user memory to run multiuser, multitasking operating systems such as XENIX™. Volume upon volume of information is available at your fingertips. You can customize your system to store up to 20,000 pages of information at one time. And its keyboard helps you use all of this computing power more easily.

This member of the IBM PC Family is a powerful stand-alone computer that can also be both the

primary file server and a station on your network. With the IBM PC Network (which is so easy to

#### IBM Personal Computer AT Specifications

<b>User Memory</b> 256KB-3MB*	<b>Diagnostics</b> Power-on self-testing* Parity checking* CMOS configuration table with battery backup*
<b>Microprocessor</b> 16/24-bit 80286*	<b>Languages</b> BASIC, Pascal, FORTRAN, APL, Macro Assembler, COBOL
Real and protected modes*	<b>Printers</b> Supports attachment of serial and parallel devices
<b>Auxiliary Memory</b> 1.2MB and 360KB diskette drives*	<b>Permanent Memory</b> (ROM) 64KB Clock/calendar with battery*
20MB fixed disk drive*	<b>Color/Graphics</b> Text Mode Graphics Mode
41.2MB maximum auxiliary memory*	<b>Communications</b> RS-232-C interface
<b>Keyboard</b> Enlarged enter and shift keys 84 keys 10-foot cord*	<b>Networking</b> High-performance, high-capacity station on the IBM PC Network*
Caps lock, num lock and scroll lock indicators	
<b>Display Screen</b> IBM Monochrome and Color Displays	
<b>Operating Systems</b> DOS 3.0, XENIX*, PC/IX 1.1	

\*Advanced Features for Personal Computers

---

connect you can do it yourself), the IBM Personal Computer AT can share information with IBM PCs, PC/XTs and IBM *Portable* PCs.

---

### Get a hands-on, hats-off demonstration.

---

The IBM Personal Computer AT has the power, compatibility and expandability many PC users need, at a very appealing price.

For more information contact your authorized IBM PC dealer, IBM Product Center or IBM marketing representative. For a store near you call 1-800-447-4700. In Alaska or Hawaii call 1-800-447-0890.

**IBM**®



personal computer IBM has ever made.



Little Tramp character licensed by Bubbles Inc., s.a.  
XENIX™ is a registered trademark of Microsoft Corporation.  
UNIX is a trademark of AT&T Bell Laboratories. PC/IX is based on UNIX System III, which is licensed to IBM by AT&T Technologies, Inc. Developed for IBM by INTERACTIVE Systems Corp.



HOMEBREW

15 1/2"

10"

8"

CUT OUT  
HERE

7"

16"

30"

ROBERT  
STINNEY

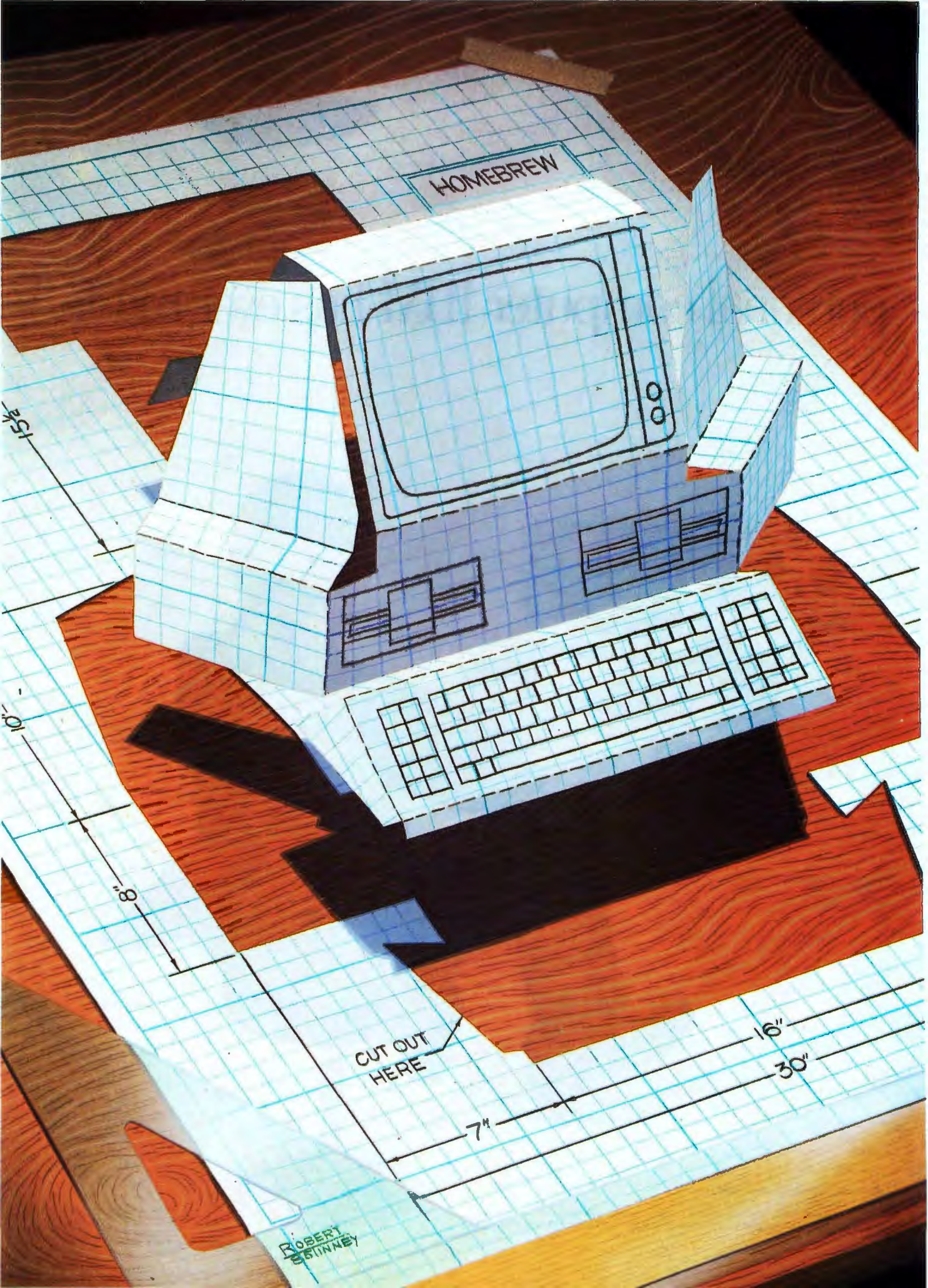



# Reviews

<b>REVIEWER'S NOTEBOOK</b>	
<i>by Glenn Hartwig</i> .....	275
<b>THE KAYPRO 16</b>	
<i>by Steve McMahon</i> .....	276
<b>THE OSBORNE 3</b>	
<i>by Donna Osgood</i> .....	284
<b>WORDSTAR 2000</b>	
<i>by Malcolm C. Rubel</i> .....	291
<b>XYWRITE II PLUS</b>	
<i>by Rubin Rabinovitz</i> .....	297
<b>FILEVISION</b>	
<i>by Scott L. Norman</i> .....	305
<b>DB MASTER FOR THE MACINTOSH</b>	
<i>by Jeffrey M. Jacques</i> .....	311
<b>PARADISE MODULAR GRAPHICS CARD</b>	
<i>by Harry Krause</i> .....	321
<b>THE RAMDISK-64</b>	
<i>by Warren Block</i> .....	325
<b>KEYPORT 717</b>	
<i>by David L. Salahi</i> .....	331
<b>REVIEW FEEDBACK</b> .....	335

TWO SYSTEM REVIEWS lead off this month's section. The transportable Kaypro 16 is IBM PC XT-compatible and has many standard features at a reasonable cost. Author Steve McMahon discusses this machine's strong and weak points. Associate Editor Donna Osgood reviews the Osborne 3, an IBM PC-compatible midsize portable system that doesn't include any extras.

WordStar 2000 is an enhanced version of the classic word processor. Malcolm C. Rubel explores its capabilities and concludes that it is easier to learn but more difficult to use than the original. Rubin Rabinovitz reviews a WordStar competitor, XyWrite II Plus. This package has some sophisticated features, including a redefinable keyboard, macro routines, and programming capability, but it might be a challenge for the less experienced user.

A pair of database managers for the Macintosh completes September's software reviews. Both programs take advantage of the Mac's pull-down menus, icons, fonts, and other novel characteristics. Scott L. Norman describes Filevision's unique emphasis on graphics in data management. Jeffrey M. Jacques's review of DB Master indicates that it is a straightforward, easy-to-use database manager; however, it needs several improvements to become excellent Macintosh software.

The Paradise Systems Modular Graphics Card gives the IBM PC user both monochrome and color capability in a single add-in product. It also lets you plug in several modules to support other functions, such as serial and parallel ports, a floppy-disk-drive controller, and extra RAM. Author Harry Krause has been using the card for months with very good results.

Commodore 64 user Warren Block reviews RAMDISK-64, an expandable 64K-byte RAM disk with a \$149 price tag. This product provides a considerable increase in speed over Commodore's 1541 disk drive.

In our final hardware review, David L. Salahi reports on the Keypoint 717 for the Apple II family of microcomputers. A programmable keyboard with 717 key locations, the Keypoint can greatly improve the Apple's user interface.





## 2400 bps modems: Do you Really need another speed?

- Is the shift from 300 to 1200 bps going to repeat itself at 2400 bps? The answer is both yes and no. There certainly are applications for 2400 bps asynch dial-up modems, but we shouldn't expect 1200 bps to die overnight.
- 2400 bps modems can improve throughput, thereby getting tasks done quicker and more economically. However, 1200 bps has become the virtual standard for professional dial-up communications, and most users are satisfied with it. So why consider a 2400 bps modem at all?
- One reason is flexibility. If the modem you select operates at all three speeds (300, 1200 & 2400) in accordance with accepted industry standards, it will serve virtually all dial-up applications now and in the foreseeable future.
- The modem you select should be the MultiModem224. It is Bell 212A and 103 compatible at 1200 and 300 bps, and CCITT V.22bis compatible at 2400. It is also 100% compatible with the Hayes command set, meaning that it will work with virtually all communications software packages, at all three speeds. Other features include both synchronous and asynchronous operation, full intelligence and a phone number memory.
- The MultiModem224 is available in both desktop and IBM PC™ internal card versions. (There is also a rack-mounted version for central sites.) And as a bonus, we provide free offers from ten of the most popular on-line information services, including CompuServe™, Dow Jones™ and The Source!™
- A 2400/1200/300 bps modem is just a plain good investment. Why not let the MultiModem224 provide your communications for both today and tomorrow?

Inquiry 262

**MultiTech**  
Systems 

*The right answer every time.*

82 Second Ave. S.E., New Brighton, MN 55112 (612) 631-3550, TWX: 910-563-3610

**MultiTech**  
Systems 

**MultiModem 224**  
2400/1200/300 BPS Intelligent Modem

1200  
300 Ans

# R·E·V·I·E·W·E·R'S N·O·T·E·B·O·O·K

**H**ewlett-Packard has come up with an interesting implementation of the less-is-more approach to product development with its Portable Plus, a new version of the HP 110. HP says it's like buying a stripped-down car and putting on the options you want instead of settling for the dealer's collection of prepackaged goodies.

The whole idea of custom configuration is near and dear to the hearts of most microcomputer users, and the more freedom the individual has, the better, but the Portable Plus's equation is somewhat complex. First of all, you get a fairly basic system (no applications software) for about the same price as the HP 110. All the features you might want to add will bring the cost up proportionately. This is not a way of getting the HP 110 of your dreams for the same price tag as on the model-year closeout.

On the other hand, the components of the basic system, as well as the available options, all indicate that a good deal of thought and preparation went into the design and choices. For example, you don't get a modem with the Portable Plus (you do with the HP 110). But if you decide you want this option, you get a 300/1200-bps Hayes-compatible modem and functional software instead of the 300-bps modem and cranky software included as part of the HP 110's standard equipment. If you want to write, you get Microsoft Word as an option instead of MemoMaker. I use both of these options, and they both represent a substantial improvement. I don't use spreadsheets much, so I don't have an opinion about Lotus 1-2-3 versus Multiplan.

The Portable Plus has 512K bytes of main memory. You configure it from a menu, so your ROM-based software has enough to run and you're left with

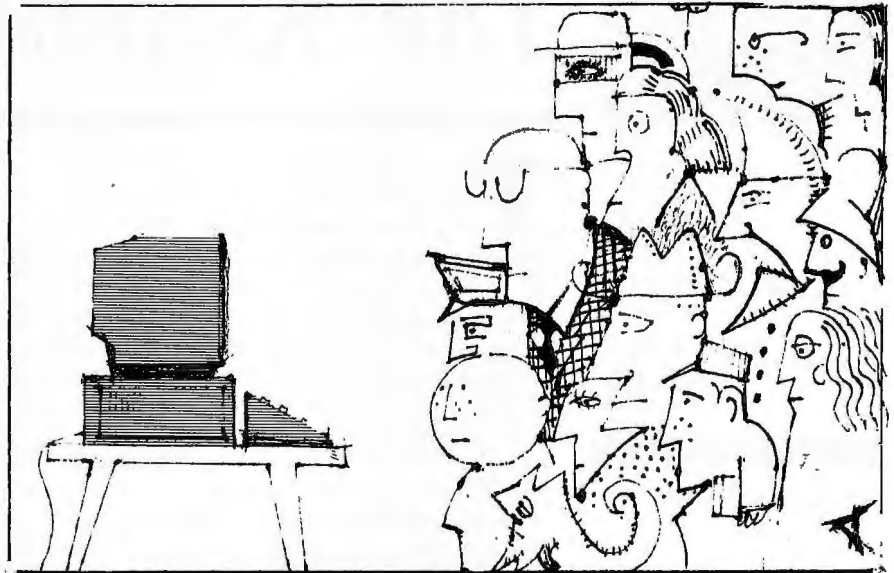

the remainder as work space. Microsoft Word for the Portable Plus takes up 140K bytes.

One thing that is both welcome and slightly ironic is the improvement in the documentation. Everything I have wanted to do with the portable machine was clearly and concisely spelled out. The irony is this: With the improved software and hardware, I needed to refer to the documentation less. All things considered, however, I'd much rather have good documentation that I needed to consult infrequently than an industry-standard cryptic manual that I needed to have grafted onto the side of my arm.

**L**ow-cost, high-volume mass storage is starting to take some interesting turns now that laser discs are being seen more often. At the National Computer Conference in Chicago, Optotech Inc. of Colorado Springs, Colorado, was showing to OEMs a write-once/read-forever 400-megabyte 5¼-inch unit integrated into an IBM Personal Computer. Dealers could get one for \$5000 "almost immediately." The normal small-quantity price was \$3000. Optotech said large-volume orders could bring the price down to less than

\$1000 per unit. National Memory Systems of Livermore, California, was reported to be the only customer as of mid-July.

What should be interesting to observe in the coming months is (1) whether or not laser discs with hundreds of megabytes of storage catch on with users, and (2) if they do, whether or not this further drops the price of magnetic hard disks. We've already seen and reported on 30-megabyte 5¼-inch hard disks that cost less than \$1000. If people can suddenly get 400 megabytes for the same price, it could increase their choices. One thing that might come between many users and the ability to take advantage of really high-volume mass storage could be the limitations of their machines.

Priam Corporation of San Jose, California, was showing to OEMs at NCC a 191-megabyte unformatted 5¼-inch hard disk. The company pointed out that an IBM PC AT could interface with the hard disk but couldn't address its entire capacity. If you happen to have a high-end CAD/CAM intelligent workstation, you're home free.

—Glenn Hartwig, Technical Editor, Reviews





# S·Y·S·T·E·M R·E·V·I·E·W

## The Kaypro 16

A low-cost  
portable  
compatible  
with the  
IBM PC

BY STEVE McMAHON

**T**he Kaypro 16 is an IBM PC-, PC XT-compatible computer packaged in a transportable box (see photo 1). The 16 comes complete with nearly all the components most computer users will need—two floppy-disk drives or one hard-disk and one floppy-disk drive, extensive software, communications and printer adapters, a video monitor, and 256K bytes of RAM (random-access read/write memory)—at a highly competitive price of \$2295 (\$3295 for a hard-disk system).

While comparing retail prices, you might discover that you can buy a hard-disk PC XT without software or a floppy-disk IBM PC with software for the price at which Kaypro provides both hard disk and software. Many users will appreciate the Kaypro 16's limited portability as a side benefit.

The Kaypro 16 (I reviewed the hard-disk model) comes in one package and is quite easy to set up. Its keyboard unlocks to reveal the built-in monitor and floppy-disk drive. Connect the keyboard to the back of the computer, prop the main unit up on its attached stand, plug it in, and it's ready to go.

Now the real fun begins: The 16 comes with a lifetime supply of gray paperback manuals (I counted 13). Fortunately, on its cover one of them bears the words "Read me first"; it contains setup information. Unfortunately, it's the worst manual of the lot. Some of the setup information was obviously written with a Kaypro computer other than the 16 in mind.

The 16 also comes with nine disks containing MS-DOS and the computer's extensive bundled software. When you place the first of these disks in the floppy-disk drive and turn the computer on, the Kaypro 16 formats the hard-disk drive and auto-loads the software bundle onto the hard disk, efficiently organizing the programs into several functionally defined subdirectories. This auto-load process prompts you to supply the appropriate disks and finishes by setting up the elaborate menu system to

automatically execute whenever you turn on the 16.

### MENUS

The hard-disk Kaypro 16 features a menu system that lets you use the machine's resources without immediately learning the complexities of the MS-DOS subdirectory system. The master menu, which appears when you first turn on the machine or restart it, presents you with a list of functionally organized submenus. When you select a submenu by positioning a reverse-video bar over it and hitting the return or right-arrow key, the computer displays the submenu's options beside the main menu, which is dimmed. On the right side of the screen, the system also presents helpful explanations of what each menu selection will do.

The hard-disk menu system allows access to word-processing and other applications, DOS utility programs, and a large collection of interactive tutorial programs from MicroPro. These tutorials cover everything from using the word processor and database programs included with the 16 to getting used to the computer and keyboard.

### COMPATIBILITY

I'm convinced that the Kaypro 16 is substantially compatible with the IBM PC. I had no problem running popular programs like Microsoft's Flight Simulator and Lotus 1-2-3, and such intimate DOS utilities as Borland International's SideKick, keyboard-redefinition programs, and RAM-disk software. The 16's BIOS (basic input/output system), designed by Phoenix and also used in IBM clones from Tandy and AT&T, appears to mimic the IBM PC's BIOS service for service.

As with any PC imitation, it is wise to check before you buy and make sure that any vital program you need to run will operate properly on the 16. Programs where problems are possible include those that are subtly copy-protected, that make direct use of the IBM BASIC read-only memory chip (usually graphics games), or

Steve McMahon (POB 3262, Berkeley, CA 94703) is an independent software developer specializing in systems for small newspapers.



that might depend on unique hardware characteristics of the IBM PC (such as a program that requires hardware or firmware modifications). The only program I couldn't run on the 16 was a copy-protected game that also does not run on several other compatibles.

### KEYBOARD

The Kaypro 16 has the IBM PC's unpopular keyboard layout (see photo 2). The return and left shift keys are small and placed differently than many touch-typists would expect. Typists with smaller hands might have to move their fingers away from the home keys to strike the return key.

The 16's keyboard offers an improvement over the PC and PC XT keyboards in another respect: Kaypro provides indicator lights for the Caps Lock and Num Lock keys. However, each light's status is apparently determined by the keyboard, rather than through software control by the BIOS. This means that it's possible to get the keyboard lights out of sync with the rest of the computer. Nonetheless, the indicator lights should prove convenient for most users.

The keys themselves have a very short throw and provide distinct tactile feedback. The noise they make is generally soft, with the exception of the space bar.

### VIDEO DISPLAY

The Kaypro 16's built-in green-phosphor display incorporates the strong and weak points of the IBM PC graphics standard. You can get medium-resolution (320 by 200 pixels) and high-resolution (640 by 200) graphics modes, and a tremendous collection of software is available for them.

However, as with the IBM PC graphics standard, the text this graphics monitor displays is comparatively poor (see photo 3). And when poorly defined characters are squeezed into a 9-inch display, as they are in the 16, the result is a screen that is close to unacceptable for long periods of text work. The 16's low-quality text display is

ironic: All Kaypro's other computers that are not IBM PC-compatible currently feature text displays that would be better for extended writing or editing sessions.

The 16's monitor shares another common deficiency of IBM PC-type graphics displays: It flickers when rapidly updated by software that directly manipulates the memory-mapped video. To avoid this problem, many programs slow down their video updating when they detect that an unimproved graphics monitor (as opposed to improved graphics monitors, such as Compaq's) is in use. The result of this slowdown is noticeable and can be annoying if you are accustomed to the high-performance scrolling and paging available on high-resolution monochrome monitors or improved graphics monitors.

Another drawback is the placement of the monitor's intensity control. Kaypro put this important control on the 16's back panel

*(continued)*



Photo 1: The Kaypro 16, an IBM PC- and XT-compatible featuring two floppy-disk drives or one floppy-disk and a 10-megabyte hard-disk drive (the latter combination is shown).



and then made matters worse by blocking it off with a plastic post (one of two meant to hold a cable when you transport the computer). In my experience, video intensity is not a control that you set once then forget about. I adjust it to different levels in the morning, afternoon, and night and nearly always prefer different brightness levels from others who work on the same machine. The Kaypro 16 makes such adjustments difficult.

A relatively minor problem is that

I could distinguish only about four different shades of video attributes on the green-phosphor screen. This meant that a couple of programs didn't look as good as usual. If you have an application requiring that more than a few video attributes be distinguishable, the 16's built-in monitor might not be satisfactory.

You can solve the problems with the Kaypro 16's small screen in a simple though expensive way. You can hook the unit to an external monitor

through the built-in RGB (red-green-blue) or composite-type video ports. On a larger monitor, the text resolution would not cause an eyestrain problem and, if you use an RGB color monitor, many more video attributes should be distinguishable. Presumably you could use the 16 with a larger, high-quality monitor at a home base, so you would have to use the built-in monitor only in the field. (Problems with flickering or slow video update do not go away with an external monitor; that's a fault of the video-board design, not the built-in monitor.)

**PORTABILITY**

You can prepare the Kaypro 16 for transport fairly easily. You put a transport card in the floppy-drive opening, lock the keyboard over the monitor and floppy drive, fold up the keyboard and power cables around posts at the rear of the computer. Plastic caps are included to cover the ends of the keyboard cable. You can carry the computer by the handle at its rear, and it will fit under many airline seats.

The problem is that the 16 is no lightweight. At 33 pounds, it's hard work to carry it anywhere. Also, the handle is nothing more than a flat metal strip with plastic around it. This type of handle wasn't much of a problem with the Kaypro 2, which weighed in at 26 pounds, but it is unsatisfactory on the heavier Kaypro 16.

Another transport problem arises from the fact that the 16 has two sets of vents that leave its interior vulnerable to moisture and dust. Also, the I/O (input/output) ports and reset switch on its side are completely unprotected. I suggest you budget in the cost of a good case if you intend to use the 16 as a portable.

The 16's optional, built-in, half-height, 5¼-inch Winchester hard-disk drive is double shock-mounted to withstand the bumps that inevitably come with transport. According to Kaypro, the 16 parks the read/write heads of the hard disk in a data-free landing zone whenever they're not in

(continued)



Photo 2: The Kaypro 16 keyboard with 83 keys, 10 IBM PC-compatible function keys, calculator keys, and Caps Lock and Num Lock indicator lights.

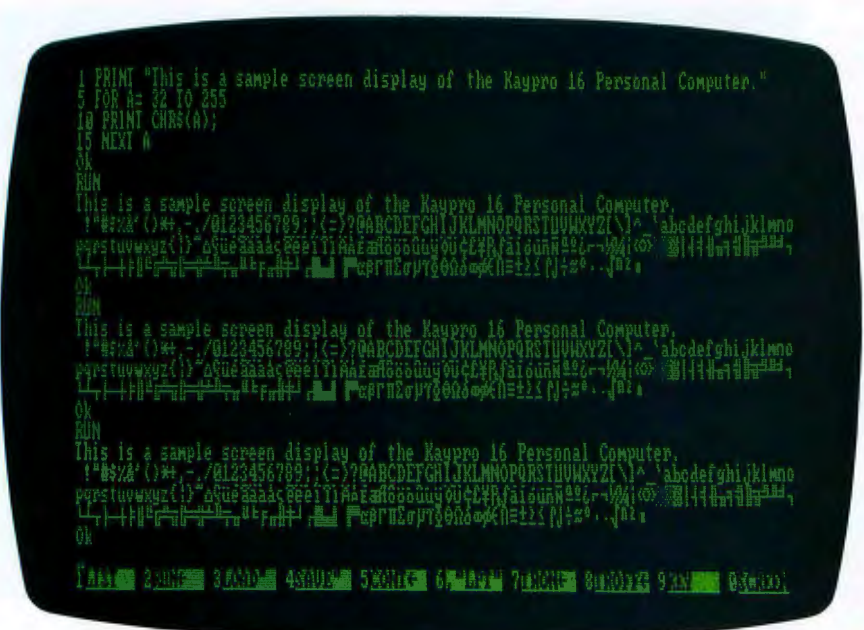

Photo 3: Text display on the Kaypro 16.



## AT A GLANCE

**Name**  
Kaypro 16

**Manufacturer**  
Kaypro Corp.  
533 Stevens Ave.  
Solano Beach, CA 92075  
(619) 481-4300

**Size**  
18 by 8 by 15 inches, 33½ pounds

### Components

**Processor:** Intel 8088  
**Memory:** 256K bytes standard, expandable to 640K bytes  
**Mass storage:** Two 360K-byte double-sided double-density 5¼-inch floppy-disk drives or one floppy drive and a built-in 10-megabyte hard-disk drive  
**Display:** 9-inch green phosphor, 80 characters by 25 lines, composite and RGB video output connectors  
**Keyboard:** Detached, 83 keys, 10 function keys, separate calculator keys, Caps Lock and Num Lock indicator lights  
**Expansion:** One available IBM PC-compatible slot  
**I/O interfaces:** Asynchronous serial and parallel printer ports

### Software

MS-DOS, WordStar, MailMerge, CalcStar, InfoStar+, MITE, GW-BASIC, and tutorials

### Documentation

69-page *Kaypro 16 User's Guide*, separate manuals for MS-DOS and each of the bundled software packages

### Price

Dual-floppy system	\$2295
10-megabyte hard-disk system	\$3295

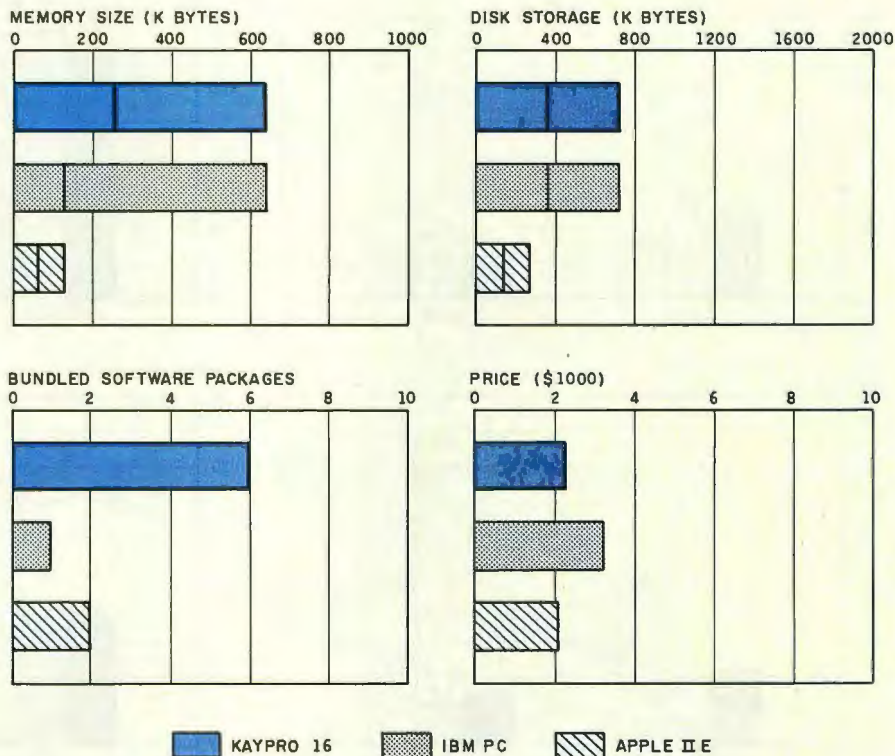

The Memory Size graph shows the standard and optional memory available for the computers under comparison. The Disk Storage graph shows the highest capacity for a single floppy-disk drive and the maximum capacity for each system. The Bundled Software Packages graph shows the number of software packages included with each system. The Price

graph shows the list price of a system with two floppy-disk drives, a monochrome monitor, graphics and color display capability, a printer port and a serial port, 256K bytes of memory (64K bytes for the Apple IIe), the standard operating systems for the computers under comparison, and the standard BASIC interpreter for each system.





On the back of the Kaypro 16 are the on/off switch, power supply, keyboard interface, and display brightness control. On the left side are the parallel, serial, RGB, and composite video outputs.

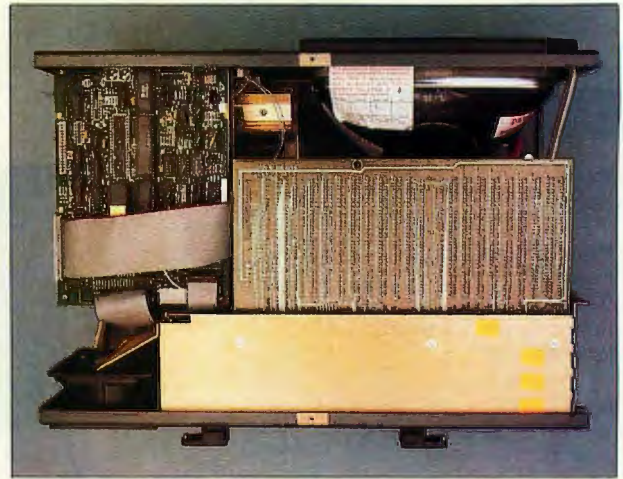

Removing the Kaypro 16 from its case reveals the expansion slot cage (bottom), the main memory board, and the hard-disk controller (left front).

DISK ACCESS IN BASIC (SEC)

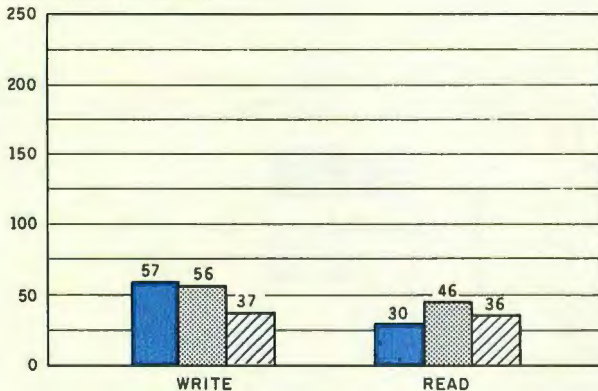

BASIC PERFORMANCE (SEC)

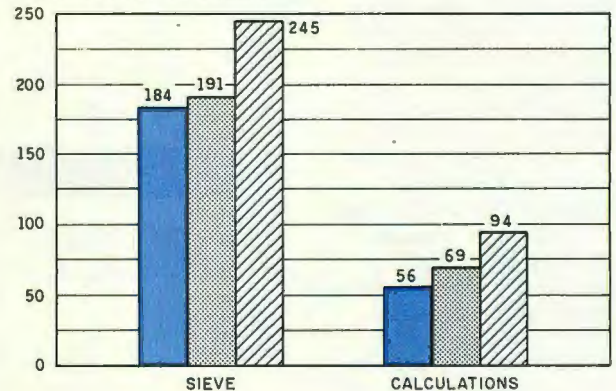

SYSTEM UTILITIES (SEC)

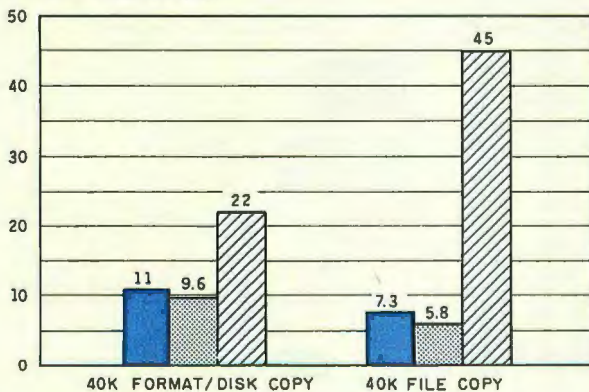

SPREADSHEET (SEC)

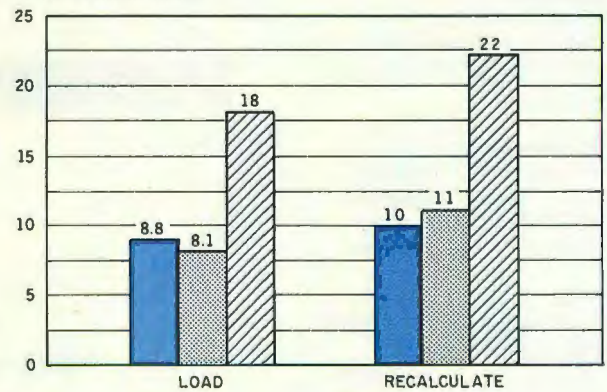

■ KAYPRO 16    ▨ IBM PC    ▩ APPLE II E

The graphs for Disk Access in BASIC show how long it takes to write and to read a 64K-byte sequential text file to a blank formatted floppy disk. (For the program listings, see June 1984 BYTE, page 327, and October 1984, page 33.) The Sieve columns in the BASIC Performance graph show how long it takes to run one iteration of the Sieve of Eratosthenes prime-number benchmark. The Calculations columns show how long it takes to do 10,000 multiplication and 10,000 division operations using single-precision numbers. The System Utilities graph shows how long it takes to format and to copy a disk

(adjusted time for 40K bytes of disk data) and to copy a 40K-byte file using the system utility programs. The Spreadsheet graph shows how long it takes to load and recalculate a 25- by 25-cell spreadsheet where each cell equals 1,001 times the cell to its left. Microsoft Multiplan was used on the IBM PC and Apple IIe; CalcStar was used on the Kaypro. Tests for the Apple IIe were done with the ProDOS operating system, except for the spreadsheet test, which was done with DOS 3.3. The IBM PC was tested running under PC-DOS 2.0, and the Kaypro 16 was tested running under MS-DOS 2.11.

use. If that's true, minor jiggles won't endanger data on the disk.

I'm still nervous about transporting a hard disk—the potential for expensive damage is great if anything goes wrong. The *Kaypro 16 User's Guide* offers no reassurance: It contains no information about preparing the 16 for transport, nor does it suggest what the machine should or should not be able to withstand.

**EXPANSION**

The 16's internal design is different from any other PC-compatible I've dismantled. The main board is upside down (chips down) at the top of the machine, with the expansion cage below it and toward the back of the computer (see photo on opposite page). The expansion cage and main board are held in place by four screws in the computer's back panel.

Another surprise is that the main board does not actually contain the heart of the computer. The 8088 microprocessor and nearly all of its support chips are on the board filling the first (rear-most) of the IBM PC-compatible expansion slots on the main board. It turns out that the motherboard contains very little but memory chips and slots, some hard-disk adapter circuitry, and the bus and expansion slots. Unfortunately, the most inaccessible of the 16's components are the ones you need to get at to expand its capacities.

The Kaypro 16 has one free expansion slot. (Three of four slots are occupied by the logic board, floppy-disk controller and serial/parallel I/O board, and video board.) Also, it has sockets for an additional 256K bytes of RAM on the main board and an 8087 numeric coprocessor chip on the logic board. To add either of these you must remove the entire main board and expansion-cage assembly and unplug seven cables.

This process is not documented in the *Kaypro 16 User's Guide*, nor does the guide contain instructions for setting the DIP (dual in-line package) switches on the logic board to let the computer know about the changes. Most users should not try expansion of the 16 on

their own but should reconcile themselves to paying a dealer to do it.

**SOFTWARE**

The 16's software bundle is extensive, including GW-BASIC and word-processing, spreadsheet, database, communications, and menu-construction packages. Unfortunately, the programs are of very uneven quality and might provide some unpleasant surprises. I liked only one program (MITE, the communications package) enough to consider using it regularly.

MicroPro's WordStar, the word processor, is a serviceable program that suffers only in comparison to the many editors available for PC-compatibles that are both more versatile and easier to use. Not so with CalcStar, the spreadsheet program: It is the slowest, clumsiest program of its type I've ever tried to use on an IBM PC-type computer. The principal deficiency of the bundled database program, InfoStar+, is its formidable—and, in my opinion, unwarranted—complexity. Its training and reference manuals run to hundreds of pages.

MITE's strong point is that it lets the user set up parameter files, each of which can contain information such as data-transmission characteristics, phone number to dial, log-on procedure, and number of times to retry if busy for each bulletin board or service you call regularly. The communications program's weak point is that Mycroft Labs has not yet adapted either the user interface or the manual sufficiently in transferring the program from CP/M to MS-DOS.

**USER'S GUIDE**

Most of the massive quantity of documentation provided with the Kaypro 16 is reprinted from the original MicroPro and Microsoft manuals for the bundled software. The only documentation items provided specifically for the 16 are the 69-page *Kaypro 16 User's Guide* and a stapled leaflet containing installation instructions for the MicroPro software.

I found the *User's Guide* grossly inadequate: It was poorly organized, omitted important subjects, and was

occasionally incorrect about what it did discuss. A section labeled "Maintenance" contained little more than instructions on how to clean the fan filter. Explanations of MS-DOS commands were brief, sometimes misleading, and in at least one case would result in a syntax error if followed precisely. Kaypro has received lots of criticism in the past concerning documentation; it's disappointing to see so little improvement.

**SOME KINKS**

One difficulty I had with the Kaypro 16 resulted from the fact that the 16's serial communications' port was a 9-pin female connector rather than the conventional 25-pin. This meant that not one cable out of my collection would connect my modem with the 16. Any modem with a built-in serial cable will need modification or an extra cable to work with the 16. The reason for this nonstandard connector is that the port shares external space with a 25-pin parallel connector, which leaves no room for the standard serial connector.

Perhaps a more serious complaint about the serial port is that it is positioned immediately next to the 16's RGB port, which is also a female 9-pin. Neither is labeled. Fortunately, Kaypro has stated that it is changing the connector to a 9-pin male, making it compatible with the 9-pin serial connector on the PC AT.

Another mild source of annoyance is the combination of a relatively loud fan and a quiet speaker, which makes it hard to hear the sounds that some programs generate.

**CONCLUSION**

The Kaypro is a serviceable and economical alternative to the IBM PC or PC XT, particularly if you can use the bundled software and you need limited portability. But the computer does have a variety of rough spots that should be weighed against its comparatively low price. Low text-display quality, limited expansion possibilities, uneven software quality, and poor documentation all deserve scrutiny from potential users. ■



I'm  
IBM  
Compatible



# Two-for-one special.

Tired of the perplexing decision about which desk-top computer to buy?

We don't blame you. Many people are familiar with the sophistication, power and advanced technology of the Macintosh. Others admire the IBM PC and its library of almost 10,000 software programs.

So which computer should you buy?

Well, now MacCharlie from Dayna Communications gives you an easy answer. Because with MacCharlie, your Macintosh becomes compatible with IBM PC software—and you benefit from the best of both worlds.

MacCharlie actually enhances IBM PC software. Your Macintosh

menu bar and window sizing are still active with the mouse. So now you have use of options like the clipboard, calculator and notepad with IBM PC software.

And through MacCharlie, you can link Macintosh to IBM serial networks and mainframes. Data files are also transferable from Macintosh to IBM and vice versa. Even if you have already taken the plunge into the IBM PC world, you now have the means to advance to Macintosh and still keep your software library intact.

So have your Macintosh and IBM PC software too, with MacCharlie, and enjoy the best of both worlds.

## MacCharlie™ by Dayna Communications

For more information, call Operator 14 toll-free, 1-800-531-0600.  
(In Utah, call 801-531-0600.)

MacCharlie is a product of Dayna Communications, 50 S. Main, Salt Lake City, Utah 84144

Apple is a trademark of Apple Computer, Inc. Macintosh is a trademark licensed to Apple Computer, Inc. IBM is a registered trademark of International Business Machines Corporation.





## The Osborne 3

A midsize,  
no-frills  
portable

BY DONNA OSGOOD

**T**he Osborne 3 is an IBM PC-compatible midsize portable computer based on the 80C86—a CMOS (complementary metal-oxide semiconductor) version of the 8086—running at 3.5 MHz. No applications software is bundled with the computer, nor is a battery included. Osborne ships the basic machine and expects value-added dealers to provide the battery, RAM upgrade to 512K bytes, modem, video cable, external monitor, applications software, and other things that make up a workable system.

The O3 has two 5¼-inch floppy-disk drives, 256K bytes of RAM (random-access read/write memory), and a liquid-crystal display (LCD) in a package that weighs less than 12 pounds (see photo 1).

### HARDWARE

At its weight and with the dimensions of 9½ by 13 by 5½ inches (closed), the O3 is in a class between transportables and briefcase computers. A removable shoulder strap fits into slots in the machine's sides. With the shoulder strap adjusted so that the slanted front panel fits over your hip, the O3 is very easy to carry, without the uncomfortable corners a square-profile machine has.

The front panel folds down to become the keyboard, revealing the screen embedded in the body of the computer. Two disk drives occupy the right side of the machine, and the battery slot, power jack, switch, and screen-contrast control are on the left. The rear panel contains the serial and parallel connectors.

The built-in screen is an 80-character by 16-line LCD with 480 by 128 addressable pixels (see photo 2). The character font is simple and readable, 5 by 7 pixels in a 6-by 8-pixel matrix, with true descenders. Under ordinary office lighting conditions (fluorescent light source from above), the screen is just readable. Sunlight coming from any direction washes it out completely, however. The screen is fixed; you can't

tilt it to suit your viewing angle. The contrast control provides some flexibility, but even at best the screen is a poor substitute for a CRT (cathode-ray tube) screen.

Osborne offers a partial solution: an external video adapter. The 1½-by 9½-by 6½-inch box includes a parallel port to replace the one it uses, so both a printer and an external monitor can be connected at the same time. On both monitors I tried, a Zenith monochrome and a USI Pi3, the picture was slightly larger than the screen, and a character or so was lost on each corner, even at optimum vertical and horizontal adjustment. This is not a problem on all monitors, but it is something to watch for.

The O3's keyboard (see photo 3) is a compressed and slightly rearranged version of the IBM PC's. Shift and Return keys, though small, are in the Selectric typewriter positions (with no annoying intervening keys). Scroll/Num Lock, Caps Lock, and Alt keys occupy the left side of the bottom row, with four cursor keys to the right of the space bar. The cursor keys serve as Home, End, Pg Up, and Pg Dn keys when used in combination with the Alt key. A calculator keypad is an overlay to alphanumeric keys on the right side of the keyboard, activated by the Num key. All alphanumeric keys repeat when held down.

Some of the IBM PC's keyboard problems are corrected in the Osborne. For example, the Prt Sc key, which causes a particularly frustrating delay when hit accidentally, is moved away from the home keys and works in combination with Alt.

A row of membrane keys above the keypad holds 10 function keys and 4 icon keys for the O3's built-in operations. Labels for the function keys appear on the screen when an application that supports them is running. This works well with the built-in applications, but function-key identifiers will not be visible when using a program such as WordStar, which puts them at the bottom of a 25-line screen. Shifting the screen back and forth from the top to the bottom

of the page is enough trouble to outweigh the convenience of the function-key identifiers.

The keyboard panel needs to be supported on a solid surface—it jiggles unacceptably if it extends beyond the edge of a table or desk. Even with the keyboard well supported, letters occasionally skipped on both machines I used while writing this review. The R key was a problem on both machines.

Sources at Osborne assured me that the O3's keyboard buffer is as large as the IBM PC's. However, when I use multiple-key-stroke commands, such as <Ctrl>|], which is NewWord's command to change the help level, the last letter is often not accepted. Occasionally, the lag between striking a key and seeing a letter on the screen is noticeable.

The O3 is shipped with 256K bytes of RAM, expandable to 512K bytes. The built-in calculator, scheduler, terminal emulator, and map-display programs use 16K bytes of ROM (read-only memory). To hold appointment notes, 4K bytes of nonvolatile RAM is assigned to the scheduler.

A 100/220-volt AC-to-DC adapter supplies 15 volts DC. A standard nicad video-camera battery fits the O3, but it is not included. A full charge on the nicad battery should run the machine for about five hours. A recharge takes about eight hours, though the battery will trickle-charge while in use with the AC-to-DC adapter.

The O3 uses two double-sided one-third-height 5¼-inch floppy-disk drives (see photo 4). The drive doors spring open to partially eject the disks when pressed and released. The doors cover the drive openings completely, keeping dust at bay. The openings are designed to guide disks into place without a struggle. I had no trouble inserting and removing disks from the side of the machine without peering around to see what I was doing. A red light glows when a drive is running.

The O3 has both a parallel and a serial

port. The RS-232C serial port uses the 8251, a CMOS chip manufactured by Oki, rather than the 8250 that is IBM's standard. A software front end in ROM makes the O3 compatible with CrossTalk, but some programs that talk directly to the serial port will not run.

The internal clock is backed by a battery and should keep time when the machine is unplugged. In one of the machines I used, however, the clock lost time when the machine had neither AC nor DC power turned on.

#### SOFTWARE

The only software bundled with the Osborne 3 is MS-DOS 2.11. BASIC is not included, nor are any applications programs. Three "executive productivity" programs are resident in ROM: an appointment book,

*(continued)*



Photo 1: The Osborne 3 with an 80-character by 16-line liquid-crystal display and two 5¼-inch floppy-disk drives.



a calculator, and a terminal emulator program.

**USING THE OSBORNE 3**

As the power comes on, the O3 displays a calendar, clock, and map of

the world. By pressing a function key at the map screen you can reach the menu from which you set time and date, printer and modem parameters, and screen type. Another function key (labeled on the screen) gives you the

appointment calendar (which can handle dates as far off as December 31, 2099). You can set an alarm (a flashing message and beep) to remind you of engagements.

To load a program from disk, you simply push the disk icon key. While you are using an application from disk, you can reach the O3's other built-in functions, like the calculator, terminal emulator, and calendar, by pushing their icon keys. When you have finished your digression, pressing the disk key returns the disk application to the screen.

**FLYING WITH THE OSBORNE 3**

If your reason for buying a portable computer involves travel, you will be concerned with the O3's performance on a plane. Its size and shape make it easy to stow under a seat. It fits well on a tray table and does not weigh enough to endanger the table's hinges. Be careful in the aisles, however. The O3 is no heavier than the average carry-on bag, but it is made of hard plastic with square corners, and it could do damage to someone if it slides around on your arm.

Airlines differ in their tolerance of portable computers on board, so check with your carrier before you plan to finish writing your big speech in the air. The O3 is rated with the FCC as a Class A machine, a rating that involves a less rigorous interference standard than Class B. Even so, using the computer in flight probably will not cause problems with the aircraft's equipment; Osborne reports that one airline pilot uses his O3 in the cockpit. On the other hand, if you wind up in Detroit when you were headed for Milwaukee, you might reconsider using your computer on planes.

**COMPATIBILITY**

The O3 is an IBM PC emulator. It uses a software front end to simulate the operation of an IBM PC. This means that no program that makes calls directly to hardware will work, which eliminates many copy-protected packages. The O3 doesn't have graphics capabilities, even when using an ex-

*(continued)*



Photo 2: Screen display of the Osborne 3 showing the world map and clock.



Photo 3: Close-up of the Osborne 3 keyboard shows the rows of special function and icon keys above the alphanumeric keys.



## AT A GLANCE

### Name

Osborne 3

### Type

Portable computer

### Manufacturer

Osborne Computer Corp.  
42680 Christy St.  
Fremont, CA 94538  
(415) 887-8080

### Size

9½ by 13 by 5½ inches  
closed; 11 pounds, 15 ounces  
without battery or AC adapter

### Components

Processor: 80C86 16-bit, 3.5  
MHz

Memory: 256K RAM  
(expandable to 512K using  
256K DRAMs), 16K ROM, 4K  
nonvolatile RAM

Disk storage: Two 360K  
5¼-inch floppy-disk drives

Display: 80-character by  
16-line LCD; 480 by 128  
addressable pixels with  
external video adapter

Keyboard: 63 keys, including  
4 cursor keys, 10 flat-  
membrane function keys, and  
4 icon keys

Power: 15-volt DC from a  
100/220-volt AC-to-DC  
adapter; can use standard  
nicad video-camera battery  
(not included)

### Software

MS-DOS 2.11; scheduler,  
calculator, and terminal  
emulator in ROM

### Documentation

User's guide, 57 pages;  
manual for appointment  
calendar, 22 pages; MS-DOS  
user's guide, 188 pages

### Price

\$1895 for two drives and  
256K RAM



MEMORY SIZE (K BYTES)  
0 200 400 600 800 1000

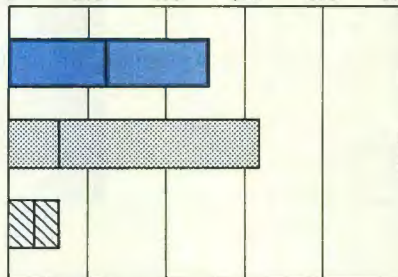

DISK STORAGE (K BYTES)  
0 400 800 1200 1600 2000

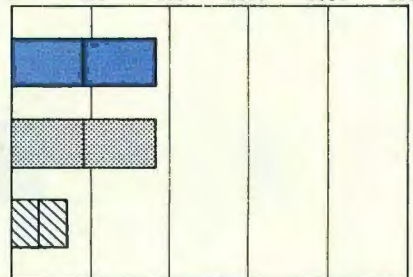

BUNDLED SOFTWARE PACKAGES  
0 2 4 6 8 10

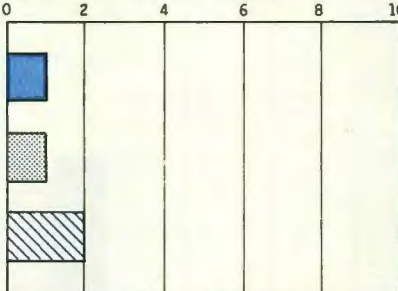

PRICE (\$ 1000)  
0 2 4 6 8 10

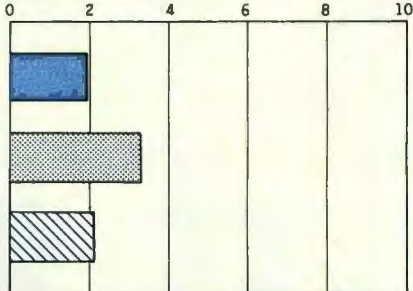

■ OSBORNE 3    ■ IBM PC    ■ APPLE IIe

The Memory Size graph shows the standard and optional memory available for the computers under comparison. The Disk Storage graph shows the highest capacity for one and two floppy-disk drives. The Bundled Software Packages graph shows the number of software packages included with each sys-

tem. The Price graph shows the list price of a system with two disk drives, a color-display adapter, a printer port and a serial port, 256K bytes of memory (64K bytes for 8-bit systems), and the standard operating system and BASIC interpreter for the computers under comparison.





The rear of the Osborne 3 holds the parallel and serial ports.

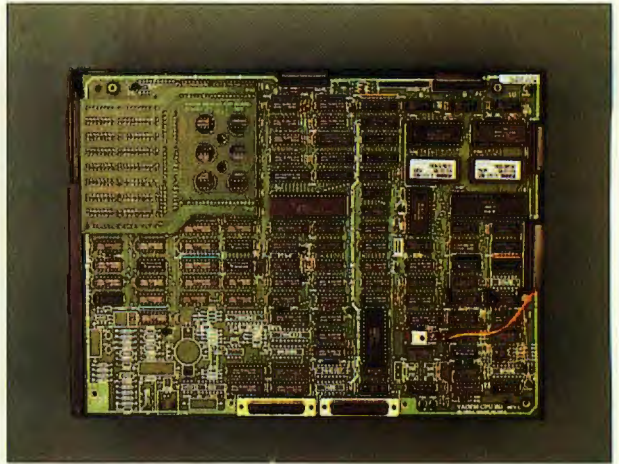

Inside the Osborne 3. Parallel and serial connectors are at the bottom.

DISK ACCESS IN BASIC (SEC)

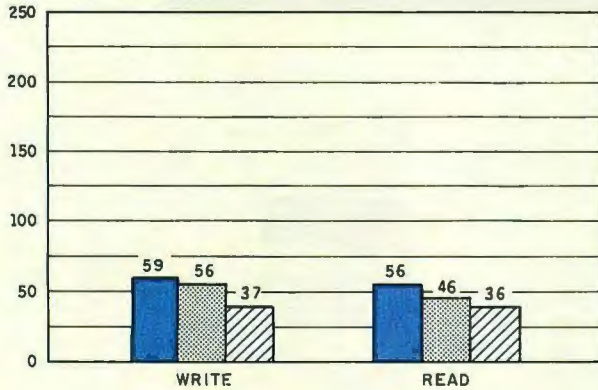

BASIC PERFORMANCE (SEC)

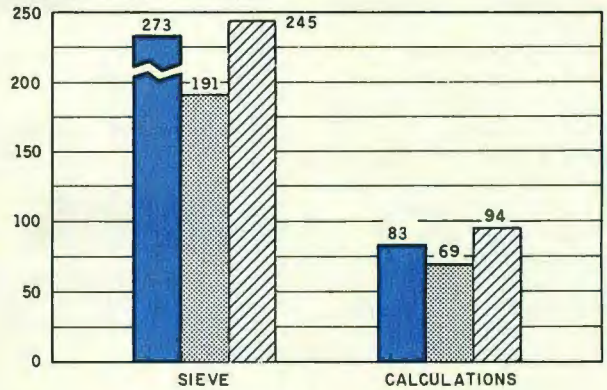

SYSTEM UTILITIES (SEC)

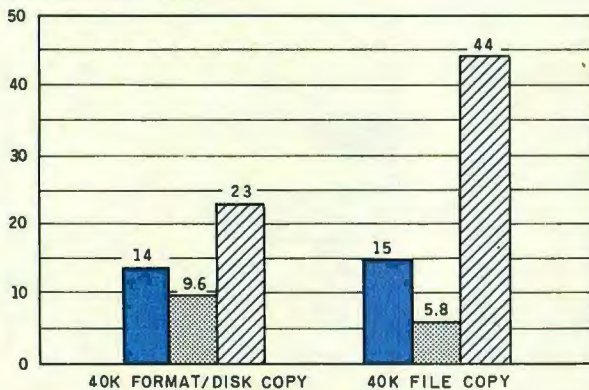

SPREADSHEET (SEC)

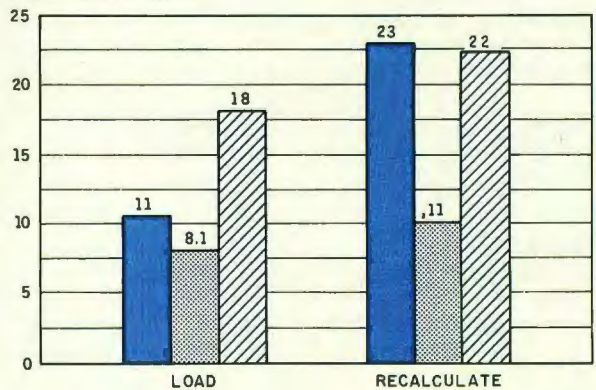

■ OSBORNE 3    ▨ IBM PC    ▩ APPLE II E

The graph for Disk Access in BASIC shows how long it takes to write and read a 64K-byte sequential text file to a blank formatted floppy disk. (For the program listings, see "The Chameleon Plus" by Rich Krajewski, June 1984 BYTE, page 327, and October 1984 BYTE, page 33.) The Sieve column in the BASIC Performance graph shows how long it takes to run one iteration of the Sieve of Eratosthenes prime-number benchmark. The Calculations column shows how long it takes to do 10,000 multiplication and 10,000 division operations using single-precision numbers. The System Utilities graph shows

how long it takes to format and to copy a standard text file to disk (adjusted time for 40K bytes of disk data) and to copy a 40K-byte file using the system utility programs. The Spreadsheet graph shows how long it takes to load and recalculate a 25- by 25-cell spreadsheet where each cell equals 1.001 times the cell to its left. Microsoft Multiplan was the spreadsheet used. The Osborne 3 used MS-DOS 2.11 and GW-BASIC. The IBM PC used PC-DOS 2.0 and BASICA. The Apple IIe used ProDOS, except for the spreadsheet test, which was done using DOS 3.3.





Photo 4: The right side of the Osborne 3 contains the two 5 1/4-inch floppy-disk drives.

ternal monitor, so only text-based programs and the text parts of integrated packages will run. In some cases, the graphics portions of programs confuse the machine; for example, loading a SuperCalc template that contains graphs crashes the system. The solution in this case is to load a partial file, large enough to contain only the spreadsheet.

While writing this review, I tried several versions of the Osborne machine, each with enhanced ROM chips and each running more IBM PC programs than the last. WordStar, Superwriter, PeachText, dBASE II, CrossTalk, Multiplan, and SuperCalc 3 worked without a hitch on the latest and, according to Osborne, final version. All O3s shipped to dealers will have the updated ROMs, and everyone who bought an earlier machine will receive the new chips, I was told.

Another potential compatibility barrier is memory size. A 256K-byte O3

has about 30K fewer bytes of usable memory than a 256K-byte IBM PC. The extra space is taken up in the memory-mapped video display, screen buffer, ROM working storage, and memory for the icon functions. This size difference can be critical for large programs such as ThinkTank, which gave me an "insufficient memory" message when I tried to run it on a 256K-byte O3. Other large programs, such as Framework and Symphony, may be restricted in file size.

#### DOCUMENTATION

Three manuals come with the O3: a user's guide for the computer, an MS-DOS guide, and a manual for the appointment calendar.

The user's guide covers the usual description of the case and keyboard, instructions for loading MS-DOS and making copies, and highlights of MS-DOS. It also has instructions for the nonexistent modem.

The MS-DOS guide includes a short section on using the operating system with the Osborne 3. Rather than lumping DOS commands into one alphabetical list, the guide breaks them into sections on handling disks, handling files, general commands, directories, and input/output.

The manual for the appointment calendar provides instructions for entering appointments, setting alarms, changing calendar entries, and keeping archives of appointments. It has a summary of commands and a glossary of error messages.

#### SUPPORT

Osborne has established a network of about 175 dealers across the country who will sell and service the O3. Two people in Osborne's offices will answer questions over the phone, though there is no toll-free number. The company encourages dealers and users groups to assume much of the burden of support.

#### CONCLUSION

Osborne and Morrow have built products around a computer designed by Vadem Inc. (Santa Clara, California). Morrow licensed the technology from Vadem and has since made its own modifications. Zenith, in turn, licensed the technology from Morrow and sells a similar machine. Osborne's relationship with Vadem involves manufacturing and system support. Vadem engineers have made extensive changes to the Osborne 3, mostly improving its IBM compatibility.

The O3 has two essential attributes of a truly useful portable computer: real portability and straightforward data storage. As long as your application does not involve graphics and you can live without slots, you would probably be satisfied with the O3. Its compatibility is not complete, and your software may find a loophole that the Osborne engineers did not close. Another consideration is speed; the O3 is slower than the IBM PC in all categories. Within those limitations, however, the Osborne 3 is a solid machine that provides the necessities in a very compact package. ■



# WordPerfect 4.0. Our highest marks yet.

InfoWorld					
REPORT CARD					
WORD PERFECT					
	<input type="radio"/> <input type="radio"/> <input type="radio"/> <input type="radio"/>	Poor	Fair	Good	Excellent
Performance	<input type="checkbox"/>	<input type="checkbox"/>	<input type="checkbox"/>	<input checked="" type="checkbox"/>	<input checked="" type="checkbox"/>
Documentation	<input type="checkbox"/>	<input type="checkbox"/>	<input type="checkbox"/>	<input checked="" type="checkbox"/>	<input checked="" type="checkbox"/>
Ease of Use	<input type="checkbox"/>	<input type="checkbox"/>	<input type="checkbox"/>	<input checked="" type="checkbox"/>	<input checked="" type="checkbox"/>
Error Handling	<input type="checkbox"/>	<input type="checkbox"/>	<input type="checkbox"/>	<input checked="" type="checkbox"/>	<input checked="" type="checkbox"/>
Support	<input type="checkbox"/>	<input type="checkbox"/>	<input type="checkbox"/>	<input checked="" type="checkbox"/>	<input checked="" type="checkbox"/>

Versions now available for  
**Novell Netware**  
and selected other  
Networks

**A** perfect report card. It wasn't necessarily our goal when we added the most recent enhancements to WordPerfect. We were more interested in responding to the suggestions of our users and dealers.

But a perfect report card is like icing on the cake. And it makes us more confident than ever that WordPerfect 4.0 is the most perfect WordPerfect, yet.

### Easier.

Most WordPerfect 4.0 functions require only one keystroke, a simple press of a finger. And new comprehensive documentation makes learning a breeze.

### Faster.

Document orientation means WordPerfect 4.0 never makes you

wait between pages. No matter how fast you type, WordPerfect won't slow you down.

### Better.

WordPerfect 4.0 includes several features not found on many word processors. Like a 100,000-word phonetic dictionary; multi-page footnoting capability; table of contents and index generation; automatic outlining and paragraph numbering;

and a 4.0 network version. Get the word processor that lives up to its name (and its report card):

InfoWorld  
WordPerfect 4.0. For more

information, see your dealer.  
Or call or write:

*new version lives up to its perfect billing.*

InfoWorld

SSI Software  
288 West Center Street  
Orem, Utah 84057  
Information: (801) 227-4020  
Order Desk: 1-800-321-4566,  
Toll-free



**SSI Software**  
Reaching for perfection.

*WordPerfect 4.0 represents a new standard of excellence*

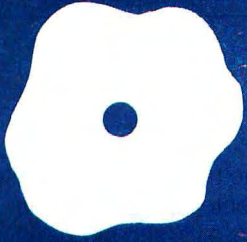

# WordStar 2000

**WordStar's  
first offspring  
is easy to use  
but somewhat  
slow**

BY MALCOLM C. RUBEL

**A**lthough WordStar was not the first word processor for microcomputers and some people argue that it is not the best, it is certainly the most successful. While hundreds of users wrote patches to help the program do more than it already could, the publisher of the package made few changes or improvements until now.

In response to a large number of competitors who claim that their word processors are easier to learn and use, MicroPro has released WordStar 2000 for the IBM PC and compatibles.

The new WordStar 2000 is available in the basic version and as WordStar 2000 Plus. The basic version contains MicroPro's spelling checker, CorrectStar, and retails for \$495. The Plus version includes MailMerge, StarIndex, and a new feature, TelMerge. WordStar 2000 Plus retails for \$595.

MicroPro has gone to considerable lengths to eliminate the difficulties that new users have encountered with WordStar. The product includes a new training guide of over 200 pages and a guide to the program's advanced features (it's 217 pages and included with WordStar 2000 Plus) giving further lessons for TelMerge, MailMerge, and StarIndex. Also included is a new series of interactive disk tutorials that will provide basic information for beginners.

WordStar 2000 is easier to learn than the original WordStar. For those with WordStar experience, the program will look familiar but the keystrokes will be different. MicroPro still uses control-key sequences to invoke commands, but these sequences have been changed to resemble the command a bit more closely. For example, Ctrl-C gives the choices for moving the cursor, Ctrl-P brings up print enhancements, and Ctrl-L is for locate. WordStar 2000 also uses Ctrl-G to call up context-sensitive help virtually anywhere in the program (Ctrl-H is the backspace code, not the help code).

MicroPro has also assigned many more commonly used commands to the function

keys (shifted and unshifted) and to the number keys at the top of the keyboard combined with Alt. The assignments made by MicroPro include some infrequently used commands such as Merge: Select Data File and Merge: Next Copy, but leave out such commonly used commands as Locate and Remove Block.

MicroPro lets you change the commands on the function and number keys in its installation program, but all the reference aids that the company provides have the basic assignments etched in plastic. When you make changes, the cards become much less useful.

Those commands in WordStar that were somewhat unusual have been straightened out and are easier to remember. Dot commands and format changes are no longer necessary. WordStar 2000 contains predetermined format lists that provide all the basic setups for the user. You simply specify which one you want to use when you create your document, and that format will be used each time you work with that file. You can also create your own format files.

Most of this is great, but what's the catch? Unfortunately, WordStar 2000 executes more slowly than its predecessor and, in some instances, has become less easy to use because it's become easier to learn.

## STARTING UP

WordStar 2000 requires version 2.0 or higher of MS-DOS or PC-DOS, two disk drives, and a minimum of 256K bytes of RAM (random-access read/write memory). More RAM can be assigned to buffers in the CONFIG.SYS file and speeds up execution considerably. Like WordStar, the new program makes heavy use of overlays.

The opening menu now takes up two screens; the user can toggle between them by using the space bar. WordStar's basic approach is still there but MicroPro has spread out the menu so individual entries are easier to see. You activate menu choices by

*(continued)*

Malcolm C. Rubel is president of Performance Dynamics Associates (305 Madison Ave., New York, NY 10165). He is coauthor of *The Performance Guides to Business Software, a series of books benchmarking word-processing, business-modeling, and database-management software.*



typing a one-key mnemonic.

To edit a document, you strike E and either type in the filename or move the cursor to it. If you are creating a new document, you are also asked which format file to use. As mentioned earlier, the format comes up with the file each time you call it, saving the initial formatting that was necessary with WordStar.

**TEXT ENTRY**

Once you choose the format, you are presented with the editing screen. The menu of the basic editing options takes up the top half of the screen, but you can set the program so only the submenus show after you strike the initial menu key or so that no menu shows at all.

Those familiar with WordStar will feel at home with the editing screen; it looks the same. Tabbing, which is set every *n* spaces in the format files, can be reset as you wish. Decimal tabbing is available with a choice of U.S. or European decimal points. You move the cursor either with the cursor keys or by using the traditional WordStar control-key cursor "diamond." You activate large cursor moves by using the Ctrl-C submenu of commands. The commands mirror those available with WordStar.

Unfortunately, moving through a WordStar 2000 file can be a slow process. In all comparative tests, I found a substantial reduction in performance. The most serious problem is the screen-rewrite time. It is so slow that when you hold the down-arrow key to scroll through the file, the

display goes blank as you move off the current screen. You must release the key for a few seconds to let the screen rewrite. In all cases, WordStar 2000's times were slower than WordStar's, even with a hard disk.

**TEXT EDITING**

You can delete text using the backspace key for delete left or the delete key for delete right. I found it unusual that the delete left command is an overlay; i.e., it is not always in memory. The first time you use it, the program has to load the code for this command from drive A. That process takes more than a second. Larger deletions, such as delete word, sentence, paragraph, etc., are included in the Ctrl-R (Remove) menu. The program also has an Undo command (Ctrl-U) that makes this function a powerful cut-and-paste option.

Block operations perform smoothly. Blocks can be either horizontal for normal text or vertical for tables. WordStar 2000 has also provided for block sorting (either numerically or alphabetically in ascending or descending order) for blocks up to 150 entries and block arithmetic (horizontally and vertically).

One feature most people will like about WordStar 2000 is its dynamic justification. As you insert and delete text, the paragraph remains justified, and if you change your margins, text will automatically be reformatted to your new margin settings. However, the reformatting is not instantaneous. If you reset the margins and then try to page through your file using the

PgDn key, the time it takes to write a new screen of text increases from 2.6 seconds to 6 or 7 seconds.

A second feature that will be useful to some users is the program's windowing capabilities. WordStar 2000 will open up three different windows to look at three different files. You can shift text from one file to another, making document assembly much easier. Window sizes are predetermined and cannot be changed.

Search and Replace operations are now included in a single command, Ctrl-L (for Locate). To search, you enter the string and strike several carriage returns to invoke. To replace text, you type R after entering the search string and then, when prompted, type in the replacement string. A large number of options are available, including whole-word search, case sensitivity, and wild cards. Unfortunately, the speed at which WordStar 2000 performs these operations is quite slow even with a hard-disk system. See the times in table 1.

**FORMATTING AND PRINTING**

WordStar 2000 provides for multiple-line headers and footers that you can alternate for right- and left-facing pages, separate print offset settings for right- and left-facing pages, flexible page-number placements, any number of different line lengths and tab settings in a document, and justified and nonjustified text included in a single file. You indicate line spacing by selecting different line heights. They allow for single, double, and triple spacing, as well as eight lines to an inch, but do not have the number of choices that were available with the WordStar Line-height command.

WordStar 2000 has improved WordStar's Hyphen-help function. The program has a function that will automatically insert hyphens where necessary as part of the dynamic justification process. Text looks better when you use the function. It works well, but I wish that MicroPro had given me the chance to define the decision criteria for applying hyphenation. The algorithm is not accessible to the user.

Table 1: A comparison of benchmarks obtained with WordStar 2000 and WordStar 3.3. All tests were done on an IBM PC with PC-DOS 2.1, and times are in seconds.

	WordStar 2000 (Floppy)	WordStar 2000 (Hard disk)	WordStar 3.3 (Floppy)
Load program	43.2	16.6	9.5
Load 4000-word file	14.4	11.7	9.9
Save 4000-word file	23.7	23.7	25
Move cursor down 40 lines	9.3	9.3	4.4
Go to end of file	73.1	67.3	9.9
Search	130	117	11
Replace string 400 times	217	204	34.7

## AT A GLANCE

### Name

WordStar 2000 and WordStar 2000 Plus

### Type

Word processor

### Manufacturer

MicroPro International  
33 San Pablo Ave.  
San Rafael, CA 94903  
(415) 499-1200

### Format

5¼-inch MS-DOS, six disks supplied, copy-protected

### Computer

IBM PC and compatibles,  
256K bytes of RAM

### Necessary Software

MS-DOS or PC-DOS version 2.0 or higher

### Documentation

Four manuals (five with WordStar 2000 Plus) covering installation, tutorials, reference, and advanced features

### Price

WordStar 2000	\$495
WordStar 2000 Plus	\$595

### Comments

WordStar 2000 is a full-function word processor that provides distinct improvements over WordStar. It is easier to learn and, in some respects, easier to use. However, the program is very large and slower than its predecessor.

LOAD (SEC)

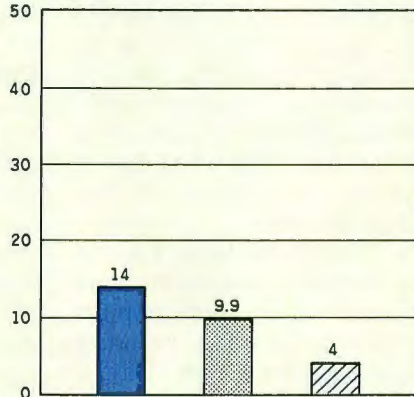

SAVE (SEC)

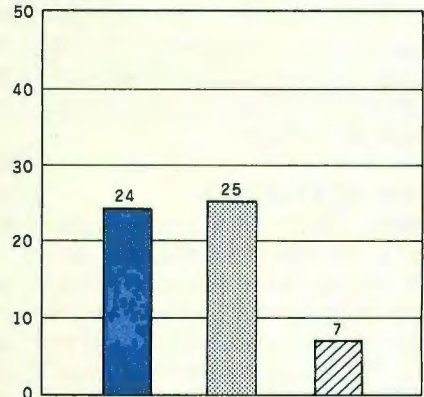

SEARCH (SEC)

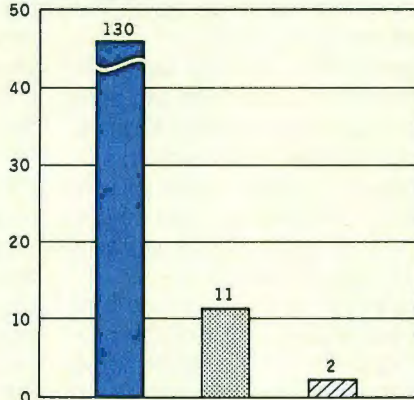

SCROLL (SEC)

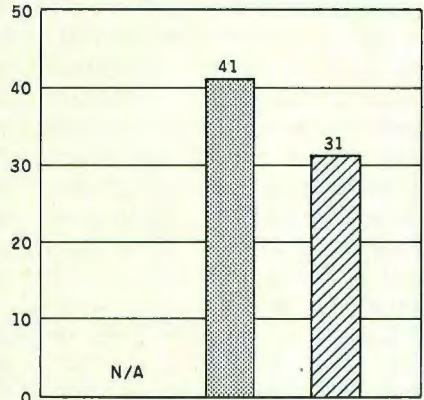

WORDSTAR 2000    WORDSTAR 3.3    XYWRITE II PLUS

A comparison of WordStar 2000 with WordStar 3.3 and XyWrite II Plus. The graphs show the results of performing various standard word-processing functions using a 4000-word text file. The Load graph shows the time required to load a file from disk to memory. The Save graph shows the time required to save the file on disk. The Search graph shows the timing

results for a search starting at the beginning of a file and looking for its last word. The Scroll graph illustrates the time required to scroll manually from the first line of the file to the last line. The manual scroll results for WordStar 2000 are not shown because the program uses a screen rewrite function instead of line-by-line scrolling.

WordStar 2000 supports everything from typewriter conversions to the HP LaserJet. It prints proportionally if the feature is supported on your printer, but instead of adding microspaces between the characters when performing right justification on my test printer (NEC 3550), it added microspaces between the words. Intercharacter microspacing gives a finished

document a better look.

WordStar 2000 supports chain and nested printing but, unlike WordStar 3.3, does not do background printing. WordStar 2000 has a function called Print and Resume Editing that prints a copy of the file to disk and then goes back to the opening menu. With a file of any size, the time you spend waiting is considerable. BYTE's

4000-word benchmark test file took 199 seconds to format on a floppy system and 168 seconds on a hard-disk system before bringing me back to the opening menu. You must also make sure you have enough space on your logged disk drive to accommodate the temporary print files because they take up more space

(continued)



than the document file does. If the logged drive does not have enough space, you will be presented with the message: "An unrecoverable error occurred while printing (filespec). Press ESCape to continue."

**ADVANCED FEATURES**

WordStar 2000 has a new function called a key directory that lets you store either word or command macros in any number of files that you desire. They are easy to set up and execute. You type in the command string under which the macro is stored and press Esc, and the macro will be executed. For repetitive procedures, this is a godsend.

The basic version of WordStar 2000 comes with CorrectStar, MicroPro's spelling checker. The program seemed to work well. You can create personal dictionaries to supplement the basic dictionary. This program is also slow, taking 305 seconds to make a single pass with no corrections through a 5000-word test file on the floppy system. When making corrections, CorrectStar ran even slower, requiring 17 to 30 seconds to read through 1 to 17 lines of text and highlight a mistake. Performance on a hard disk was not much better, although you do avoid changing disks. Unfor-

tunately WordStar 2000, like earlier versions of WordStar, changes bit 8 of the last character in each word, so many of the other spelling checkers will not work directly with its files.

WordStar 2000 Plus includes something completely new, TelMerge. It also includes new versions of MailMerge and StarIndex.

With a modem, TelMerge lets you use your computer as a terminal and call up several of the more popular on-line database systems, including The Source, CompuServe, Official Airline Guide, and others.

MicroPro has simplified MailMerge and put it into an easy-to-use format. The dot commands and bare file structure are gone. The entry format is predefined but has four variables for user-defined entries. You can print labels, but only in predefined formats. If you can change your needs to suit the program, it will be easy to use. WordStar's MailMerge was more powerful and flexible, but it was also more difficult to learn.

StarIndex too is easier to use but, as with MailMerge, some of the program's flexibility, and therefore some of its usefulness, has been sacrificed. With WordStar's StarIndex, you could either type in entries or identify them in the text being indexed. StarIndex

for WordStar 2000 requires that you type in each index entry.

**CONCLUSIONS**

People who are familiar with WordStar will find the transition to WordStar 2000 easy; its approach to word processing is similar to its predecessor's. For new users, the excellent tutorials supplied with the program make a big difference in how easy it is to learn.

There is not much that WordStar 2000 cannot do well. The problem is that it will do it slowly and sometimes with more intervention from prompts and confirmations than I would like. WordStar 2000 is written in C, which lets MicroPro transport it easily to other machines, but this results in slower program execution.

The program is so big that, like WordStar, it must continually access the program disks to overlay program code. With the original WordStar running in a 64K-byte environment, this problem was understandable. WordStar 2000, however, was designed in the 16-bit world. Its minimum memory requirement of 256K bytes should have improved this disk-access problem for program code and working file, but it has not. The program runs more slowly. If time is money, WordStar 2000 is an expensive program. ■

**Quality PC Products from MULTITECH**

- CPU board with 256K memory and up to 640K on board, serial, parallel ports, socket for 8087, 6 slots. Run MS DOS CPM/86. Complete documentation ..... **\$350**  
Power supply ..... **\$110**  
Case for the CPU board ..... **\$60**  
Keyboard ..... **\$70**
- Fully assembled IBM compatible PC with 256K, 1 serial, 1 parallel, color card, keyboard & 2(1/2) HT drives ..... **\$1100**  
*OEM and dealer discount available.*
- Multifunction board (64-384K) .. **\$130**  
1 parallel, 2 serial, clock/calendar, ramdisk, print spooler, & memory
- Color/graphic card ..... **\$110**
- Mono display adaptor with 1 printer port ..... **\$100**
- Mono/graphic card with 1 printer port (Hercules compatible, flicker free) ..... **\$150**
- Short expansion card  
Serial card (2 ports) ..... **\$50**  
Memory (0-576K) ..... **\$90**  
Floppy controller (2/4 drives) .... **\$60**  
Multi I/O (PC/XT/AT) ..... **\$140**

CALL TOLL FREE TO ORDER (800) 538-1542  
In California call (408) 730-1795      Technical Support Service (408) 773-8400

**U.S. SERVEX** 195 West El Camino Real  
Sunnyvale, California 94087

\* One-year warranty for all add-on cards!



## This will renew your trust in the phone company.

**A**nbody who's ever sent data over phone lines knows the problems it can present.

Information gets mumble-jumbled. \$4,000 invoices become \$40,000 invoices. And soon your company's lost a pretty penny over some modem foul-up.

Well, now you can say good-bye to all that.

™MNP is a trademark of Microcom, Inc.  
©Copyright 1985 Codex Corp.

See us at the TCA Show, September 17-19.

Because Codex just came out with a modem that overcomes the inadequacies of phone line performance.

(Codex, as your friends in data processing will tell you, is the industry's acknowledged leader in state-of-the-art products, in service, in just about everything that has to do with networking.)

The Codex error-correcting pc modem is a serious business modem.

It gives you data transmissions more than 10,000 times more reliable than most other modems. Over anybody's phone lines.

A sophisticated error-correction system called MNP™ detects breakdowns in phone line performance and retransmits data. And the beauty is all this happens without you ever knowing it.

Just think. Data you can trust.

Now don't you feel better about those crazy phone lines?

If you're a data

communications manager responsible for purchasing modems, call **800-426-1212. Extension 225.**

Or write Codex Corporation,  
Department  
707-225,  
20 Cabot  
Boulevard,  
Mansfield,  
MA 02048.



**codex**  
 **MOTOROLA**



# JUKI®



## AN EPIC ACHIEVEMENT— WITH A CAST OF THREE.

For an award-winning performance every time you print, bank on these three *letter-quality* printers from JUKI®. Stellar achievements in all the most-needed word-processing functions . . . and well within budget. Our three daisywheel stars are rapidly winning new fans all over the globe:

### JUKI 6100

18 cps—and *under \$600!* Prints graphics, 2K buffer memory (expandable to 8K), the small-office printer with big-office productivity!

### JUKI 6300

The big one. Handles spreadsheets and other documents up to 13 inches wide. 40 cps—for *under \$995!* Quiet, lightweight, and tough! 3K buffer memory (expandable to 15K).

### JUKI 6000

Ideal for home use. Prints 10 cps—costs *under \$300!* 13 lbs.—quiet—built to JUKI's acclaimed specifications, for reliable service.



## JUKI®

The workers.  
JUKI OFFICE MACHINE CORP.

New! One-Year Warranty!

#### EAST COAST:

299 Market St., Saddle Brook, NJ 07662  
(800) 932-0590

#### WEST COAST:

23844 Hawthorne Blvd., Suite 101, Torrance, CA 90505  
(800) 325-6134 • (800) 435-6315 (California)



# XyWrite II Plus

Word  
processing  
from the  
command  
line

BY RUBIN RABINOVITZ

**X**yQuest Inc.'s XyWrite II Plus is an innovative word-processing program for the IBM Personal Computer (PC) and compatibles. An advanced version of the entry-level XyWrite II, XyWrite II Plus is powerful and reasonably priced (\$295), and it has many attractive features. While XyWrite (pronounced *zye-write*) can run on computers with 128K bytes, it needs more memory if you plan to work on documents longer than, say, 30 to 40 pages. The program will make use of any extra memory beyond the minimum 128K bytes, up to 640K bytes.

XyWrite executes commands very quickly. The screen display can provide comprehensive format information or a version of your text that's close to the printed output. XyWrite also has some interesting advanced features, such as a redefinable keyboard, sophisticated macro routines, easy access to DOS (disk operating system) or another program, programming capability, and a facility for reconfiguring printer files.

The authors of XyWrite helped design Atex, a large multiterminal text-processing system with editing and typesetting capabilities. (Atex is used mainly by large firms—publishers, insurance companies, and law offices—that routinely print a great number of documents.) The two systems are in many ways similar, a factor that should make XyWrite especially attractive to Atex users.

## THE COMMAND LINE

The most distinctive characteristic of XyWrite is its reliance on a command line for initiating major operations. Let's say you've finished editing a file and want to save it. You move the cursor to a line reserved for entering commands at the top of the screen, type the command word for saving a file, and then press Return. Displaying another file or creating a new file involves different command words, but the rest of the procedure remains the same. Some XyWrite routines are initiated by the IBM PC's function keys (F1 through F10), but

where other programs typically offer menus or screen prompts, XyWrite makes use of the command line.

Most of XyWrite's commands have logical names, which helps when you're learning the program. For example, STORE lets you save a file, CALL displays an existing file, and NEW creates a file. Once you've learned the program you can save time by using abbreviations of these commands. In most cases, entering the first two letters of a XyWrite command word has the same effect as spelling it out; either ST or STORE is a legitimate command for saving a file.

XyWrite has more than a hundred commands of this sort. While this leads to flexibility in some of the program's advanced routines, it also introduces difficulties. Learning a great number of two-letter commands—as WordStar users know—can be time-consuming. Forgotten command words lead to annoying interruptions because you have to consult the manual. Typing mistakes force you to back up to revise the command entry. Such factors make working with a command line more demanding than choosing from options listed on the screen. If your favorite programs use menus extensively, you may not like this aspect of XyWrite.

A related problem has to do with the number of keystrokes required to complete command operations. In XyWrite the minimum number is usually four: one keystroke to move into the command line, two to enter the abbreviated form of the command, and one to execute the command. Comparable operations in other programs often involve fewer keystrokes.

However, once you've entered the commands they are executed very quickly; operations such as deletions, changes of format, and cursor movements occur almost instantaneously (see table 1). Such speed is possible because the program keeps your file in RAM (random-access read/write memory) until you decide to

(continued)

Rubin Rabinovitz (Department of English, Campus Box 226, University of Colorado, Boulder, CO 80309) is a professor of English. He received his doctorate at Columbia University and has reviewed books for the New York Times and New York magazine.



write it onto the disk. This, of course, makes your data vulnerable to loss in case of a power outage or a forgotten update command. But storing data is simple, and XyWrite has a trick that lets you keep updating your file easily. As long as you don't need the command line for another purpose, you can let the STORE command remain there; then, with one keystroke you can update your file. This principle applies to other XyWrite operations: Whatever you've entered in the command line remains there until you replace it, so you can easily keep repeating commands.

**LEARNING THE PROGRAM**

One flaw in a number of good programs is instructional material that looks as if it were written by someone whose native tongue is hexadecimal. While XyWrite's documentation isn't the worst I've ever seen, clarity is not its strong suit.

Some sections of the XyWrite on-line tutorial flash by too quickly, while others merely repeat material that appears in the printed version. The manual's instructions are often in-

complete, and at times it uses new names for familiar items (for example, the Backspace key is called the Rubout key). Another shortcoming is the manual's lack of illustrations and the absence of a printed keyboard chart (the only key-definition chart is on a help screen).

**GET THE UPDATE**

When I first began working with the program I discovered some errors in the manual, including misspelled command listings; I had been assuming that some mistake of mine was holding me up. I spoke about this with John Hild, one of the authors of XyWrite; he assured me that a new version of the program contained corrections. I duly tested this new version and found that the errors had been eliminated. In addition, although the texts of the original tutorial and manual have been retained, XyQuest has added a new tutorial booklet for beginners, entitled *XyWrite Level I Tutorial*. This booklet is clearly written and, unlike the manual, has easy directions for installing the program.

If you're planning to buy XyWrite, be

sure you're getting the updated program, which isn't as easy as it sounds—the earlier release and the update are both labeled version 1.00 on the opening screen and version 1.20 on the help screen, and neither designation appears on the manual's slipcase. In the newer version, however, the copyright year on the disk label is 1984 (versus 1983), and the aforementioned tutorial booklet is included with the program. If you bought the earlier version of the program and would like to have this booklet, XyQuest will sell you a copy for \$10.

**HELP FACILITIES**

XyWrite has only four help screens: one with general information, one with a keyboard chart, and two with listings for the major commands. The help screens are fairly elementary; displaying them is cumbersome. The help information fills the entire screen, so you can't see your file. Unlike many programs, XyWrite doesn't give you a specific message when you need to correct an error or complete a command sequence. Some commands are missing from the on-screen keyboard chart: XyQuest seems to have used the same help screens for XyWrite II Plus as it used for the entry-level version of the program.

You can create your own help screens, but this hardly makes up for the skimpiness of the ones provided. Asking users to write their own help screens seems a bit odd, something like telling a drowning man where he can get swimming lessons.

**CURSOR AND FUNCTION KEYS**

In general, XyWrite follows the IBM keyboard definitions; for complex cursor movements you use the cursor keys in combination with Ctrl and Alt. XyWrite doesn't provide as much cursor control as some other programs; you can't advance the cursor by sentence or paragraph or move from the middle of a line to the beginning of the next one with one keystroke. At the same time, three keys on the cur-

(continued)

Table 1: Benchmark results using XyWrite II Plus on the IBM PC (with 640K bytes and an adapter for a monochrome monitor) running a standard 4000-word document.

Test	Time (seconds)
Begin Program: time to load the XyWrite Editor program from the DOS A> prompt	4
Save Document: time to store the standard file on the disk	7
Recall Document: time to retrieve standard file from disk and display on screen	3.69
Search: time to find the last word (the 4000th) of the standard file	2
Scroll: time to scroll from the beginning to the end of the standard file	31
End of File: time to go to the end of the file and reset the page and line counter by pushing Ctrl-End	2.38
Delete: time to delete the first 5 words of a 100-word paragraph and reformat	immediate
Insert: time to restore the 5 deleted words and reformat	immediate
Format Changes: time to change spacing, margins, lines per page, margins, and pitch	immediate
Print File: time from entering the command to print a file to the start of printing	2.52

# AT A GLANCE

**Name**

XyWrite II Plus

**Type**

Word-processing package

**Manufacturer**

XyQuest Inc.  
POB 372  
Bedford, MA 01730  
(617) 275-4439

**Computer**

IBM PC, PC XT, PCjr, and compatibles with one disk drive and at least 128K memory; TI Professional, Hyperion, and DEC Rainbow

**Format**

One 5¼-inch double-sided floppy disk

**Language**

Assembly

**Documentation**

634-page indexed manual;  
71-page indexed beginner's manual

**Price**

IBM version, \$295 plus \$5 shipping  
TI and Hyperion versions, \$325 plus \$5  
DEC version, \$350 plus \$5 demonstration disk, \$7

**Audience**

Experienced users who want an advanced word-processing program

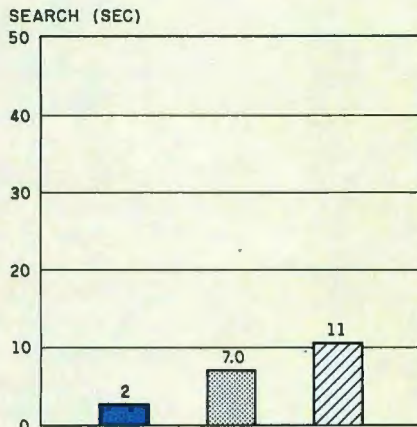
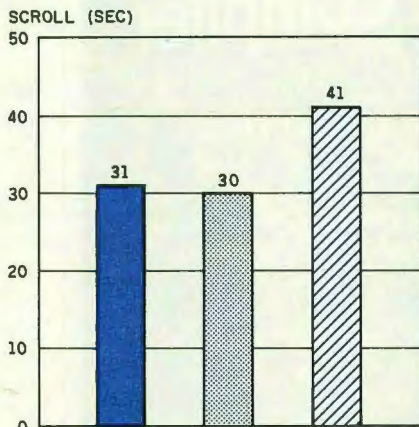
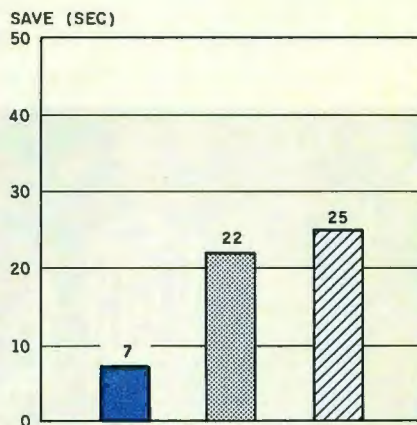
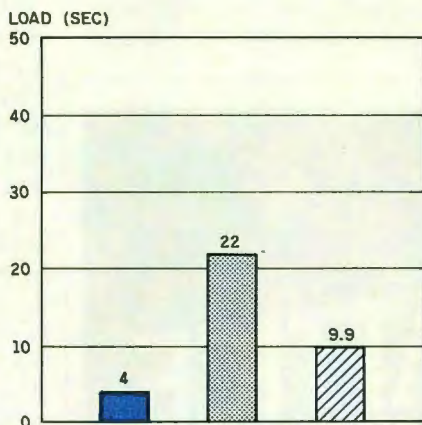

■ XYWRITE II PLUS    ▨ VOLKSWRITER DELUXE    ▩ WORDSTAR 3.3

A comparison of three word-processing programs—XyWrite II Plus, Volkswriter Deluxe, and WordStar 3.3. The graphs show the results of performing various functions using a 4000-word text file. The Load graph shows the time required to load the file from disk to

memory. The Save graph shows how long it takes to save the file to disk. The Scroll graph shows the time required to scroll through the file manually. The Search graph shows the time it takes to find the last word in the file, starting at the beginning.



sor pad (5, +, and -) aren't used for cursor movements. This is an inefficient arrangement. However, it seems from the reserved function calls listed in the manual that XyQuest may add some new cursor commands to future releases of XyWrite.

Normally, XyWrite operates in Insert mode. But the program also has an

Overstrike mode. You use the Insert key to toggle back and forth between modes, and the cursor changes from a box to a line to indicate that you've gone from Insert to Overstrike.

XyWrite's definition of the function keys is somewhat unconventional. While some keys have many functions, others are redundant; for example,

you can use either F5 or F6 to move the cursor to the command line. Given the frequent use of the command line, the authors of the program must have felt that this operation should be duplicated. But I didn't find this helpful; I always used F6 and never bothered with F5. In the same way, either F9 or the Return key can be used to execute commands.

XyWrite uses many of the other function keys for its Define procedure, which involves highlighting a block of text prior to performing some operation on it. Moving, copying, and deleting blocks are done entirely with the function keys, which means you don't have to go into the command line to perform these operations.

Assigning four operations to some function keys and only one to others makes it hard to remember some function definitions. Even so, being able to redefine the keyboard means that you can remedy such problems.

#### DISPLAY

XyWrite reserves three lines on the screen for program information. At the very top is the command line. Next is the prompt line; it contains information about modes of operation, such as the status of the Caps Lock and Num Lock keys. For the third line you have some choices: You can display a ruler with margin and tab information, a summary of the function key commands, or a straight line. The rest of the screen is reserved for your document.

XyWrite has three viewing modes, which permits you to look at text with or without control characters. Page Review mode shows you what the printed document will look like. Expanded Input mode displays all of the control-character information; this is the mode you'd use to make extensive format changes. Perhaps the most useful is the Formatted mode, a compromise between the other modes. In Formatted mode you see a bright triangle at each location where format information has been embedded. When you move the cursor under one of these triangles, the

(continued)



The advertisement features a dark, textured background with the Lattice logo (three overlapping squares) and the text "LATTICE C Compiler" in large, white, bold letters. Below this, the text "YOU GET MORE THAN LATTICE C FROM LATTICE, INC." is followed by a list of features and contact information. A vertical "LATTICE C Compiler" logo is also visible on the left side of the graphic.

**LATTICE C Compiler**

**YOU GET MORE THAN LATTICE C FROM LATTICE, INC.**

When you purchase a C Compiler from Lattice, you get the "complete" compiler chosen by more than 26,000 professional software developers world-wide for its:

- Fast compile time
- Compatibility with proposed ANSI C standard
- Extremely efficient code generation
- Seven iAPX 86 memory models
- Comprehensive XENIX and UNIX-compatible library
- High-quality documentation
- Free periodic updates during the warranty period
- Support by more than 50 compatible software libraries and tools
- Unconditional money-back guarantee
- Competent telephone support

Join the thousands of Lattice C users. Call Lattice today for complete information on the Lattice C Compiler, Lattice C Cross Compilers, C Function Libraries, and C Utilities!

**Ask about our "Trade Up To Lattice C" Policy!**

 Lattice, Inc.  
P.O. Box 3072, Glen Ellyn, IL 60138  
Phone: (312) 858-7950 TWX:910-291-2190

International Sales Offices:  
BENELUX: De Voeght, Phone (32)-2-720.91.28 ENGLAND: Roundhill, Phone (0672) 54675 JAPAN: Lifeboat, Inc. Phone (03) 293 4711



# Save

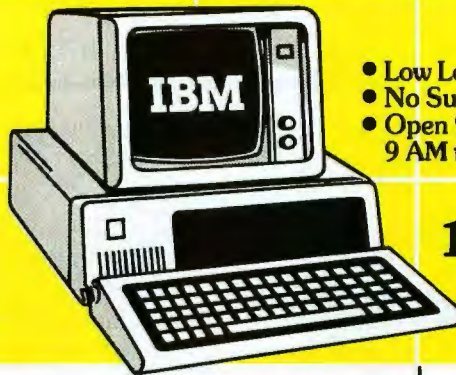

- Low Low Prices
- No Surcharge for MasterCard and VISA
- Open 9 AM to 7 PM Eastern (Mon-Fri)  
9 AM to 2 PM Eastern (Sat)

**1-800-237-4048**  
(ORDERS ONLY)

## COMPUTERS

IBM ENHANCED AT . . . .	5355
IBM ENTRY LEVEL AT ..	3647
IBM PC, 1 DSDD DR, 256K . . . . .	1559
IBM PC, 2 DSDD DR, 256K . . . . .	1669
IBM PC, NO DRIVES, 64K . . . . .	1293
IBM PC, 2 HALF/HYTES, 256K . . . . .	1637
IBM XT, 1DSDD DR/10MB, 256K . . . .	3355
IBM XT, 1DSDD DR/ TANDON HD, 256K . . . . .	2108
COMPAQ, 2 DSDD, 256K . . . . .	2153

## MONITORS

AMDEK 300G . . . . .	116
AMDEK 300A . . . . .	132
AMDEK 310A . . . . .	143
AMDEK 600 RGB COLOR . . . . .	407
AMDEK 710 SUPER HI RES COLOR . . . . .	523
IBM COLOR . . . . .	605
IBM MONOCHROME . . . .	231
PRINCETON MAX-12 . . . .	154
PRINCETON HX-12 RGB COLOR . . . . .	446
PRINCETON SR-12/SCAN DOUBLER . . . . .	572
QUADRAM AMBERCHROME . . . .	171
QUADRAM QUADCHROME II . . . .	438

## MISCELLANEOUS

MEMORY, 64K CHIPS . . . .	10
MEMORY, 256K CHIPS . . .	39
PRINTER CABLE . . . . .	13
MICROFAZER BUFFER, 8K . . . . .	131

MICROFAZER BUFFER, 64K . . . . .	212
VERBATIM, DSDD DISKS	20

## DISPLAY CARDS

STB SUPER HI RES 400 .	402
HERCULES COLOR . . . . .	145
IBM MONOCHROME . . . .	215
IBM COLOR . . . . .	226
EVEREX GRAPHICS EDGE . . . . .	325
GENOA SPECTRUM . . . .	295
TECMAR GRAPHICS MASTER . . . . .	459
PARADISE MODULAR GRAPHICS . . . . .	261

## BOARDS

AST SIX PACK PLUS, 64K . . . . .	248
AST MEGAPLUS, 64K . . .	281
AST MP-2, 64K . . . . .	228
AST ADVANTAGE, 128K .	384
AST I/O PLUS . . . . .	122
JRAM-2 . . . . .	169
QUADRAM QUADBOARD ØK . . . . .	240
QUADSPRINT . . . . .	418
TECMAR CAPTAIN, ØK . .	219
TECMAR FIRST MATE, ØK . . . . .	200
TECMAR WAVE XT, 64K .	187
TECMAR JR CAPTAIN, 128K . . . . .	295

## MODEMS

HAYES 2400 . . . . .	627
HAYES 300 . . . . .	138
HAYES 300/1200 . . . . .	407
HAYES 1200B w/ SOFTWARE . . . . .	380
HAYES 1200B . . . . .	351
VEN-TEL HALF CARD . . .	374
VEN-TEL 300/1200 INTERNAL . . . . .	341
AST REACH HALF CARD 1200 . . . . .	362

## PRINTERS

OKIDATA 83A, WIDE CARRIAGE . . . . .	545
OKIDATA 84P, WIDE CARRIAGE . . . . .	660
OKIDATA 92P . . . . .	385
OKIDATA 93P, WIDE CARRIAGE . . . . .	602
OKIDATA 2410P . . . . .	1782
OKIDATA 182 . . . . .	215
OKIDATA 192 . . . . .	363
OKIDATA 182S . . . . .	259
OKIDATA 184 . . . . .	660
EPSON FX-80, TRACTOR . . . . .	382
EPSON LX-80 . . . . .	248
EPSON RX-100, WIDE CARRIAGE . . . . .	417
EPSON FX-100, WIDE CARRIAGE . . . . .	531
EPSON JX-80 COLOR PRINTER . . . . .	531
EPSON LQ-1500 PARALLEL . . . . .	1042
NEC 2050 . . . . .	682
NEC 3550 . . . . .	1045
NEC 8850 . . . . .	1458
JUKI 6100 . . . . .	362
JUKI 6300 . . . . .	695

## ACCESSORIES

OKIDATA 82/92 TRACTOR . . . . .	44
NEC BI-DIRECTIONAL TRACTOR . . . . .	151
NEC CUT SHEET GUIDE .	63
JUKI 6100 BI-DIRECTIONAL TRACTOR . . . . .	105
JUKI 6300 BI-DIRECTIONAL TRACTOR . . . . .	124

**1-800-237-4048**



# COMPUTER MART

1901 S. TAMiami TRAIL, VENICE, FL 33595

Call for Non-Advertised and Lower Current Prices. IBM is a registered Trademark of International Business Machines. Prices subject to change. We accept MasterCard, VISA, American Express, Diners Club, Money Orders, certified and personal checks and COD shipments. Returns are subject to a 15% restocking fee.  
**IN FLORIDA CALL 813-493-2736**



*Word-processing programs seldom let you change their standard routines. XyWrite II Plus is an exception. You can easily enter the command words in executable files.*

relevant format information is given in the prompt line. This is a clever idea; the triangular markers take up very little space, yet the information they contain is readily available.

#### MAJOR FEATURES

XyWrite has many of the features found in sophisticated word-processing programs. These include search and replace, with uppercase and lowercase sensitivity, wild cards, and forward or backward search (because the working document is kept in RAM, search and replace routines are very fast); microjustification, which lets you adjust the spacing between letters; special character display, including boldface and reverse video; automatic footnotes, printed at either the bottom of a page or the end of a document; mail merge, including the capability to transfer a list created in another program (a database manager, for example) into XyWrite; two user-defined windows, either vertical or horizontal, and a whole-screen window that lets you toggle between pages from different files; extended ASCII (American Standard Code for Information Interchange) character sets, including foreign characters and scientific symbols; special keyboard layouts, either user-defined, Dvorak, or Spanish/Portuguese (included on the program disk, although there's nothing in the manual about these

keyboard files); 18 printer command files that support some 30 printers (if your printer isn't supported, you can create your own command file or send your printer manual and program disk to XyQuest and the company will write one for you); book-editing functions, including tables of contents and indexes, arranged alphabetically or in page order; and a math feature that lets you calculate and insert the results into text.

Though it can generate "soft hyphens" (hyphens that disappear when revisions make them unnecessary), XyWrite does not have an automatic hyphenation utility. XyQuest says it will include this feature in an update of XyWrite II Plus, to be released sometime this year.

The program also lacks a spelling checker, but since its files are written in ASCII, many of the spelling programs currently on the market are compatible with XyWrite. XyQuest recommends The Word Plus Spelling Checker (Oasis Systems) and Word Proof (IBM).

#### PROGRAMMING FEATURES

Word-processing programs, unlike many database-management packages, seldom give you opportunities to change their standard routines. XyWrite II Plus is an exception. Its use of a command line contributes to XyWrite's programming capability, since you can easily enter the command words in executable files.

The advanced features are not for novices; using them takes a certain amount of experience. Still, only a few routines require a knowledge of programming, and if you don't mind reading the manual and experimenting, you'll appreciate what you can accomplish with these utilities.

The save-and-get function, for example, lets you store a block of text (like a long book title or a boilerplate paragraph) and then insert it into the text by pressing Alt and an alphanumeric key. If you create a number of these save-and-get blocks, XyWrite can display a directory to remind you of their contents.

Another advanced feature permits

you to remap the keyboard. For example, if you own an IBM keyboard and are irritated by the placement of the Backslash key, you can transform it into a Shift key. You can also re-define keys so they perform command functions. These can be simple operations or fairly complex ones, where a short key sequence executes a file with many XyWrite letter commands. If you've used key-defining programs like ProKey, you'll be familiar with this routine. XyWrite also has a more complex macro function that lets you create executable files made up of a series of commands together with any data you may wish to enter.

XyWrite lets you use GoTo commands, variables, and command expressions like "if" and "greater than" in executable files. This adds up to real programming capability; You can create routines that the off-the-shelf version of XyWrite isn't capable of performing.

Finally, XyWrite lets you go into DOS without removing XyWrite from machine memory. You can perform functions in DOS and then return to the document you're editing—with the cursor in the same position as it was before you entered DOS. If your system has enough memory, you can even run another program (such as a spreadsheet or a database manager) together with XyWrite and move back and forth between them.

#### CONCLUSIONS

Some portions of XyWrite are very impressive; others need to be improved. Experienced PC users who can make use of its advanced capabilities, especially its programming features, will doubtless become XyWrite fans. Other people may be better off with a word-processing package that provides more user amenities.

In the world of word processors, XyWrite is like a sports car. It's fast; but the ride can be a bit rough, and to get it going properly you may have to do some tinkering. If you're not sure whether this much sportiness is for you, I recommend a trial spin with the XyWrite demonstration disk. ■

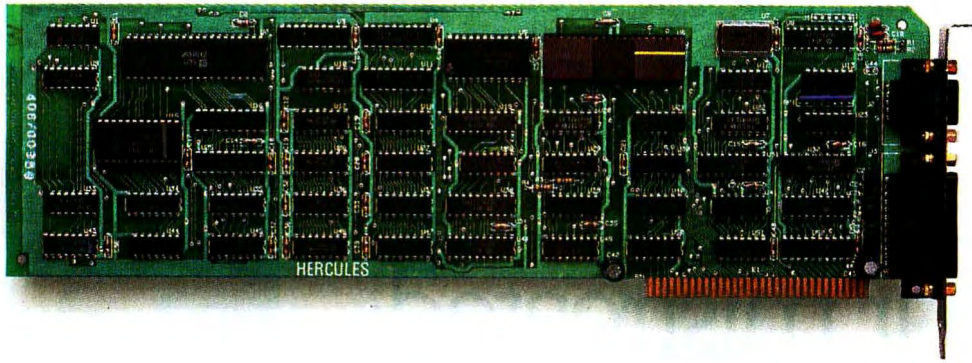

# The world's best selling monochrome graphics card for the IBM PC.

There are more Hercules™ Graphics Cards in more IBM® PCs, XT's and AT's than any other monochrome graphics card in the world.

Over a quarter of a million demanding users around the world use a Hercules Graphics Card to improve the performance of their software.

## The Lotus® 1-2-3® Booster.

Consider Lotus 1-2-3. Hercules gives an off-the-shelf copy of 1-2-3 the highest resolution possible on an IBM PC, XT or AT. More 1-2-3 users choose the Hercules Graphics Card to get crisper text and sharper graphics than any other monochrome graphics card.

And we bring the same performance to other integrated programs like Symphony™, Framework™, and SuperCalc®3.

But we don't stop there. The Hercules Graphics Card

improves all kinds of software.

Like Microsoft® Word, a word processor that enables you to display text with subscripts, superscripts and italics.

Or pfs:Graph, an easy-to-use business graphics program that converts your data into presentation quality graphs.

Or Microsoft® Flight Simulator, the high flying game for the overworked executive.

Or our own Graph X™, a library of graphics sub-routines that eases graphics programming.

Or AutoCAD™, a computer aided design program that offers features normally associated with expensive CAD systems.

And we supply free software with each card to do hi-res graphics using the PC's BASIC interpreter. **State-Of-The-Art Hardware.**

The Hercules Graphics Card gives you graphics resolution of 720h x 348v and a

parallel printer port. Our unique static RAM buffer provides sharp 9 x 14 characters and flicker-free scrolling. Our exclusive safety features help



prevent damage to your monitor.

State-of-the-art custom IC technology delivers unsurpassed reliability. Ordinary graphics cards use up to 30 ICs to do what one Hercules IC does. By using fewer parts, we reduce the possibility of component failure.

Which is one reason we warranty the Hercules Graphics Card for two years.

Unbeatable reliability. Advanced technology. Proven by over a quarter of a million users. Why settle for anything less than Hercules?

Call 1-800-532-0600 Ext 408 for the name of a Hercules dealer nearest you and we'll rush you our free info kit.

**Hercules.**  
**We're strong on graphics.**

Inquiry 169



# Give us your stained, your dog-eared, your filthy dirty, your mistreated:

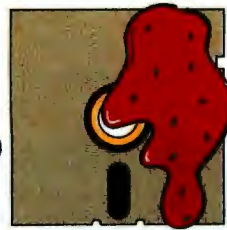

Aunt Molly's jam



Dog-eared jacket



Regular coffee, two lumps



Maria's liquid cover



Hot dog mustard



Dust (cough-cough)

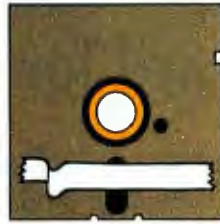

Tacky white tape



Boss's cigar ashes

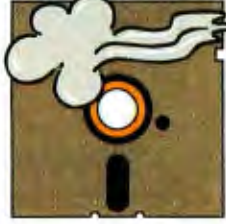

Clouds of smoke



Spilled milk



Potted plant—no pot



The big chill



Lunchcounter ketchup



Dry martini, one olive



Fizzy orange soda



Waterbased ink spots

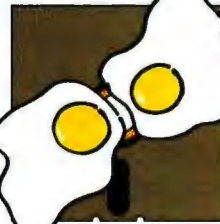

Sunny side up



English breakfast tea



Eraser bits



Chocolate fingerprints



Sudsy soap bubbles

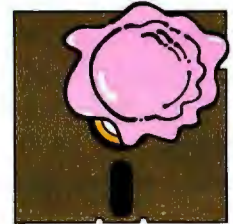

One scoop of ice cream



## If it's a Polaroid diskette, we'll fix it.

Accidents can be fatal to floppy disks. But now Polaroid introduces a free data recovery service.

So, if you spill coffee on a Polaroid Professional Quality Diskette, we can help recover your data. (And most other accidents, too.) Call 800-241-4403 and we will tell you how our service works.

These Polaroid Diskettes boast a 20-year guarantee and are certified 100% error-free. And only Polaroid offers a free data recovery service. Because accidents happen.

**Polaroid**

**PerfectData**

THE PROFESSIONAL QUALITY DISKETTE IN THE GRAY BOX.



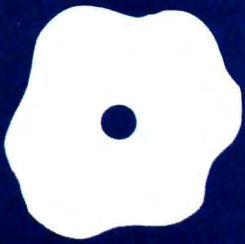

# Filevision

## A graphic example of data management on the Macintosh

BY SCOTT L. NORMAN

**T**elos Software's Filevision attempts to apply the Macintosh's novel features—the desktop metaphor, pull-down menus, and icons—to a common task: database management. Although limited in file size and reporting capability, Filevision might be the harbinger of a new generation of visually oriented software.

With Filevision you draw a picture, map, diagram, or other graphic image, then build a series of data files associated with various elements of the image. You can sort files and select items much as with conventional text-only database managers. You can highlight items meeting the current selection criteria on the pictorial display.

Filevision is not just another database manager with graphics tacked on as a gimmick. The program's authors take the viewpoint that the text-and-number files should support and elaborate on the picture rather than the reverse. As such, the program is unlikely to be a general-purpose data handler. I would not choose Filevision for managing a mailing list, and it would not do for keeping track of General Motors' parts inventory.

### DATA ORGANIZATION

The concept of a "type," or distinct class of object, is crucial to Filevision's method for organizing information. Every item in a Filevision drawing belongs to one type or another; even the background is assigned to the default type, called Background, when you begin to draw. You can design a different form, or "information record," on which you enter the data for each type, and you can specify "links," which are connections between an object in one drawing and an entirely different drawing file. Linked files are the key to storing multiple levels of detail, and you can use them to give visual expression to different ways of organizing information about a set of objects.

In Filevision, a field has essentially the same meaning as in more traditional database software: an individual piece of infor-

mation about a given object. With Filevision, you can add fields to or delete them from a form at any time.

Filevision has overlapping specifications for capacity. The manual indicates that a file can contain up to 999 objects that belong to as many as 16 different types. You can use up to 30 data fields to describe each type, and the limit on the text associated with a single object is 2000 characters. A 128K-byte Macintosh will not be able to reach all the limits that should be simultaneously attainable. A Telos customer-service representative told me that small-memory machines might run out of storage at 200 to 400 objects. This depends on the complexity of the file structure and arises from the fact that pointers to various objects are maintained in RAM (random-access read/write memory) where they consume storage space. Macintoshes with 512K bytes of RAM have no difficulty reaching the published limits. The vendor should have clarified this point.

### SETTING UP AN APPLICATION

The best way to get a feeling for the data-management problems Filevision can address is to work through an example. I set up a small group of files for this review: maps of the orbits of planets and some major asteroids in our solar system, supported by data sheets containing elementary facts and figures about the bodies. This application serves as a modest model for applying Filevision to teaching and also demonstrates how some of its features come into play as a result of graphics considerations.

Filevision is quite flexible concerning the order in which you perform the operations necessary to set up a database. One sensible approach is to specify the types of objects that will make up a file, define a data form for each, and then draw the objects and fill in the forms. Thus, a little pencil-and-paper planning is appropriate before ap-

(continued)

Scott L. Norman (8 Doris Rd., Framingham, MA 01701) is manager of the Solid State Science Department for GTE Laboratories.



## AT A GLANCE

### Name

Filevision

### Type

Pictorially oriented database manager

### Manufacturer

Telos Software Products  
3420 Ocean Park Blvd.  
Santa Monica, CA 90405  
(800) 554-2496;  
in California, (800) 368-3813

### Computer

Apple Macintosh

### Minimum Hardware

128K bytes of RAM, one disk drive

### Format

3½-inch floppy disk; working copies can be made, but original disk must be used for verification whenever a file is opened from the Finder

### Documentation

154-page manual with glossary and illustrated guide to all menus and commands; tutorial file on program disk

### Price

\$195 (backup master disk costs an additional \$15)

### Audience

Anyone who wants to keep track of data that can be conveniently expressed as parts of a drawing

### Comments

Filevision is an innovative approach to the management of facts and figures that adheres to conventions of the Macintosh user interface; it includes its own drawing program, which is less flexible than MacPaint, and its report-generation facilities are limited

proaching the keyboard, which is as true of Filevision as it is of any database manager.

This might make it seem as though the data forms have precedence over the imagery, and that need not be the case. You can draw a complete picture and then define object types and their associated data forms; you can readily change an object's type as you go along. Form layout is quick and painless and uses typical Macintosh click-and-drag operations to set the size and position of data fields.

You do not need to identify the type of information data fields will contain: string, integer, real number, and so on. This simplifies the process of setting up a form, although it ultimately restricts the program's ability to select objects from a file.

For my example, I drew a few background elements on the screen, defined data forms for the major types of objects, drew the objects themselves, and entered the relevant data. My view of our astronomical neigh-

borhood is shown in figure 1. I bundled the four inner and five outer planets into two members of a data type I called Planet\_\_type. At this level, I lumped all the asteroids into one type.

The three initial data forms—inner planets, outer planets, and asteroids—were quite skimpy. However, each was linked to another drawing, and the latter was backed up by considerably more detail: one record sheet for each planet and one for each major asteroid as in figure 2.

Why didn't I just define a nine-member data type called Planets and a six-member type called Asteroids and designate them as separate elements of one drawing? In best Filevision style, I made my choice based on graphics considerations. It is impractical to show all interplanetary distances to the same scale on one drawing; the solar system is too large. By using three subfiles, I could depict groups of orbit paths in something approaching true scale—although I

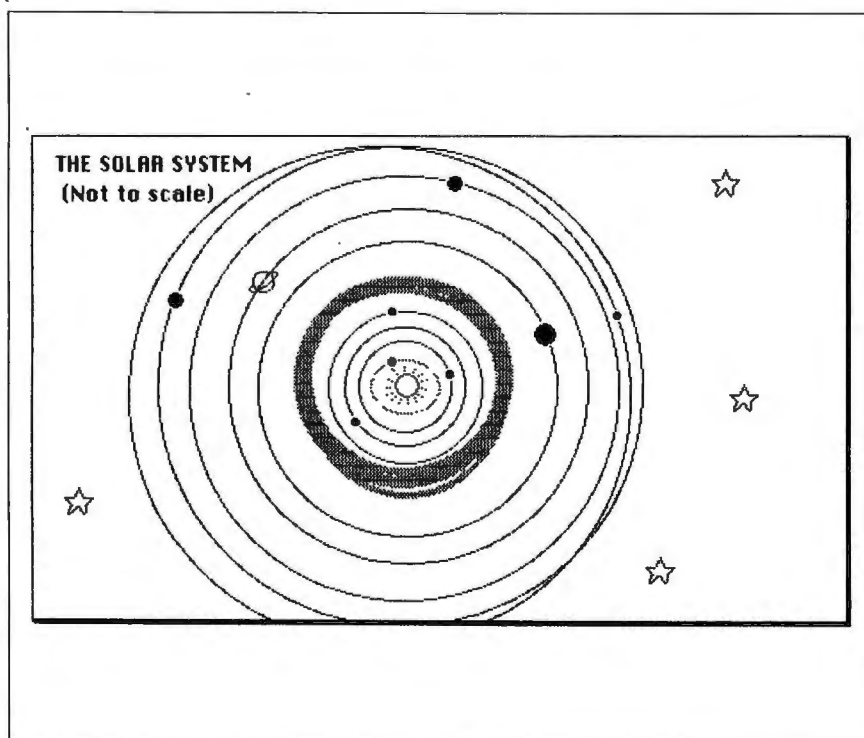

Figure 1: The solar system file. The four inner planets are lumped together as one member of the data type Planet\_\_type. The five outer planets constitute the other member, and the asteroids (symbolized by the broad gray band) form a second data type.

had to cheat on the sizes of the planets themselves.

**DRAWING WITH FILEVISION**

Filevision's drawing screen (see figure 3) bears a family resemblance to that of MacPaint, but there are important differences between the two. The kit of drawing tools is stripped down, as is the palette of fill-in patterns hidden under the Shades menu. Filevision doesn't have an eraser or Goodies menu, and hence no Fat Bits feature for touching up the fine points. However, Filevision gives you a selection of 20 preset symbols to use in a drawing (such as the little symbol of a man in figure 3), and you can edit these in a manner somewhat like MacPaint. You can delete items from this file and replace them with others of your own design.

You can also use pictures (or "glyphs") from some of the Mac's decorative fonts. The stars, sun, and ringed planet in figure 1 all came from the Cairo character set, and I entered them with the Text tool (the A).

Filevision has one drawing tool that I would like to see in MacPaint: a Reshape command that lets you add "handles" to any figure created free-hand or from straight line segments. You can use the handles to stretch the figure into a new shape; in figure 3, I used them to pull a freehand arc into a reasonable orbit for Jupiter. This figure also shows the optional grid used for alignment and scale setting. Note the typical distortion of video circles into ellipses caused by printing the screen with command-Shift-4. The distortion is rectified when you use Filevision's Print Display command to produce hard copy of an image.

Filevision normally treats every element added to a drawing as another example of whichever data type is active at the moment. For example, Filevision considers a planetary orbit and the corresponding symbol as two planets, unless you instruct the program that they represent the same object. In this case, you can use a special Bind command to link ele-

(continued)

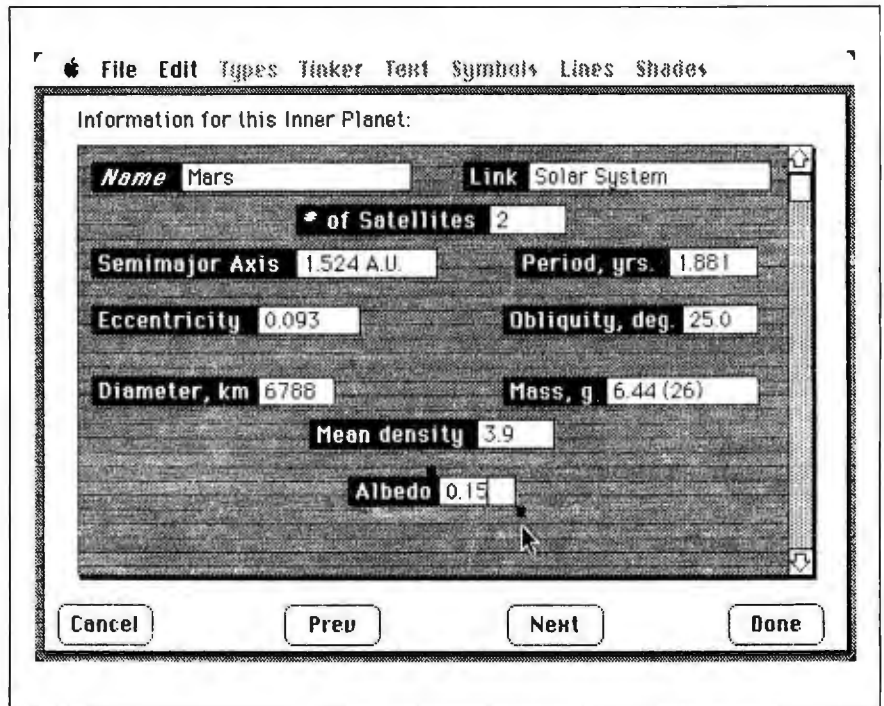

Figure 2: A full screen showing the data form for the Inner Planets data file. Note the Link box, which relates this file back to the Solar System file.

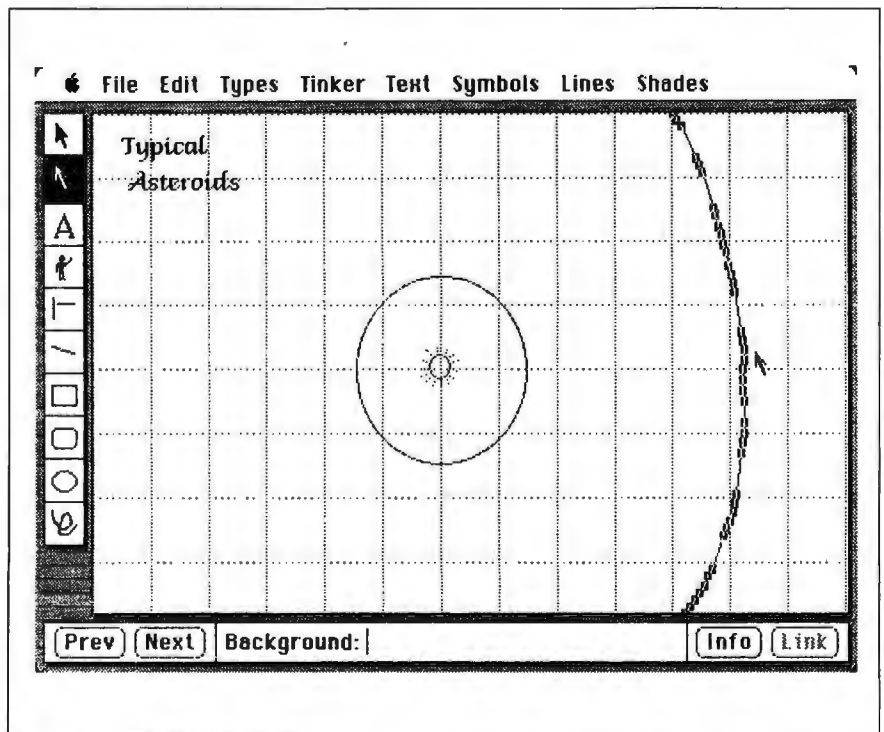

Figure 3: The Asteroids drawing taking shape on the Filevision screen. Mars's orbit and the sun have been entered, and a portion of Jupiter's orbit is being pulled into shape with the Reshape tool. Note the drawing tools, which will look familiar to MacPaint users.



Figure 4: Selecting fields and relationships for a Filevision report involves the point-and-click technique. You only need to type in numerical or text values for the comparisons. Objects meeting the two criteria shown here will be highlighted when the Done box is clicked.

Figure 5: The screen form used to design a Filevision List report. You use the Arrow box at the right of the "Order printing . . ." line to cycle through data fields until you find the one you want to use for organizing the report. A similar control appears at the bottom of the "Column layout" area, along with selectors for justifying entries in each column. You use the black squares on the Diameter box to stretch and pull that column into the desired position.

ments into a compound object so you can treat them logically.

#### FILE HANDLING AND REPORTING

It is simple to reorder a Filevision file, select a portion of it, and set up a report. You pay a price for this simplicity: Reports lack many features that users of more advanced database managers have come to expect.

You can select a single object by clicking on it in typical Macintosh fashion, but Filevision's Tinker menu must handle selecting groups of objects. Objects meeting the selection criteria can be highlighted on the screen; alternatively, either the selects or the rejects can be hidden from view. Selection operations only affect the object type that the Types menu currently specifies.

You set up selections on the special screen shown in figure 4 by using the point-and-click method. You can combine up to four criteria with the logical AND operation and specify a complete range of equality and inequality conditions (the special "--" symbol denotes the condition "between"). You cannot link conditions by OR.

A Filevision selection always compares a field's contents to a fixed numerical value or to a specified character string. Filevision allows wild-card characters. You cannot compare one field to another, which is probably a result of the program using untyped data fields; without this restriction, you might inadvertently try to compare a numerical field to text.

In addition to printing the screen, you can design three types of reports—Info, List, and Labels—on video worksheets and then print them; Filevision doesn't have a facility for routing a complete report to the screen. You can place objects selected for a report in ascending order according to the contents of any field.

A Print Info command produces hard copy of all the data for each object. Filevision positions all fields as they were on the original data form, but the absence of field titles might hamper interpreting the information. This is an informal report and the quickest way to get a record of every-

## REVIEW: FILEVISION

thing in a file. You can add page headers and footers.

A conventional columnar report is called a List in Filevision parlance. Although the Mac's click-and-drag technology makes report layout easy (see figure 5 for a sample screen), I wish the List option were more potent. For example, you cannot find the total of a numerical column, and multilevel sorts are out. It is also difficult to judge how much room you are allocating to a given column. You reserve space for a field by stretching a text box, and Filevision has no simple way to determine its width in characters until you release the mouse button and see how the title fits. Page space can become critical, since List reports devote only a single line to each object. The maximum width allotted to a printed List is 6½ inches.

The third kind of report, a Label, lets you print as many data fields as will fit into a space 5 inches wide and 2 inches high. This time, scales appear on the layout screen. Since this is the option you would choose if you were doing mailing labels, field titles are not printed.

It's good that Filevision makes setting up a report easy, because you cannot predefine several formats and save them under their own names. Although the manual makes no mention of the fact, Filevision saves your last Info, List, and Label formats when you quit the program, so people with modest reporting requirements might have no trouble. However, any selection criteria that might have preceded report generation are lost.

### CONCLUSIONS

Filevision is an easy program to work with provided your data-management chores have the proper graphics orientation. In most respects, the program adheres well to the Macintosh's user-interface conventions. You can perform many selection operations in two ways: by clicking on an object and then on a menu item or by double-clicking on the object. Picture elements and text boxes respond as expected to stretching and dragging, and anyone who has used MacWrite

*Filevision is easy  
to work with provided  
your database chores  
have the proper  
graphics orientation.*

will immediately feel comfortable with this program's text-editing features.

Nevertheless, Filevision differs from conventional Mac practice in a few areas. I was surprised to find that it doesn't have Save or Save As options on the File menu; you must select Quit to have the option of naming and saving a newly opened file. The active file is updated from time to time during a session, so the manual advises making a copy when you begin work to preserve the starting configuration.

It would help if Filevision could import a MacPaint image as a starting point, but it cannot. You can transfer images the other way, though; you can convert the Filevision screen to a MacPaint document with the command-Shift-3 "write to disk" key sequence. The images will appear on disk as Screen 0, Screen 1, and so on.

You can also select individual objects and store them in the Mac's scrapbook. And you can carry out cut-and-paste operations in the usual way, but the clipboard itself is not available for viewing from the Edit menu. Finally, Filevision cannot use the clipboard to transfer data from a text file or spreadsheet.

Despite its departures from the norm, Filevision is an exciting new approach to information management. In my first real application, I used the program's graphics to organize some laboratory data. Despite its lack of computational power, Filevision was a tremendous help. I deal with fairly small files and ask "What can you tell me about that?" questions. The "that" is often a piece of an image, so Filevision has found a home with me—even though it will not remain my only Macintosh database manager. ■

## Repair your own IBM PC® or APPLE®

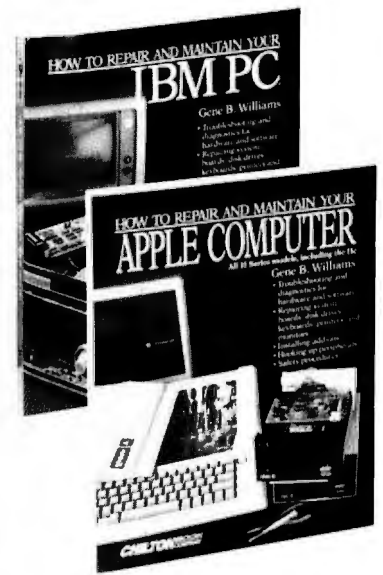

### These new guides make it easy.

If you can operate a computer, you can repair it. Ninety percent of all computer problems can be fixed with nothing more than a screwdriver and a multimeter. Chilton's Computer Repair Guides will show you how.

Each is filled with complete step-by-step diagnosis and repair instructions. They're easy to follow and fully illustrated with clear photos and helpful drawings.

Chilton's Computer Repair Guides cover most systems and components including disks, disk drives, power supplies, keyboards, printers and monitors.

Whether you own an IBM PC or any Apple Series II, one of these guides will help you save downtime and costly repair bills by repairing it yourself. Get the Chilton Computer Repair Guide for your computer today!

For a free Chilton Computer Book Catalog, write to our Marketing Department.

**CHILTON** BOOK COMPANY

RADNOR, PENNSYLVANIA 19089

800-345-1214



ONE OF THE ABC PUBLISHING COMPANIES



# Plotter graphics prevent boardroom boredom

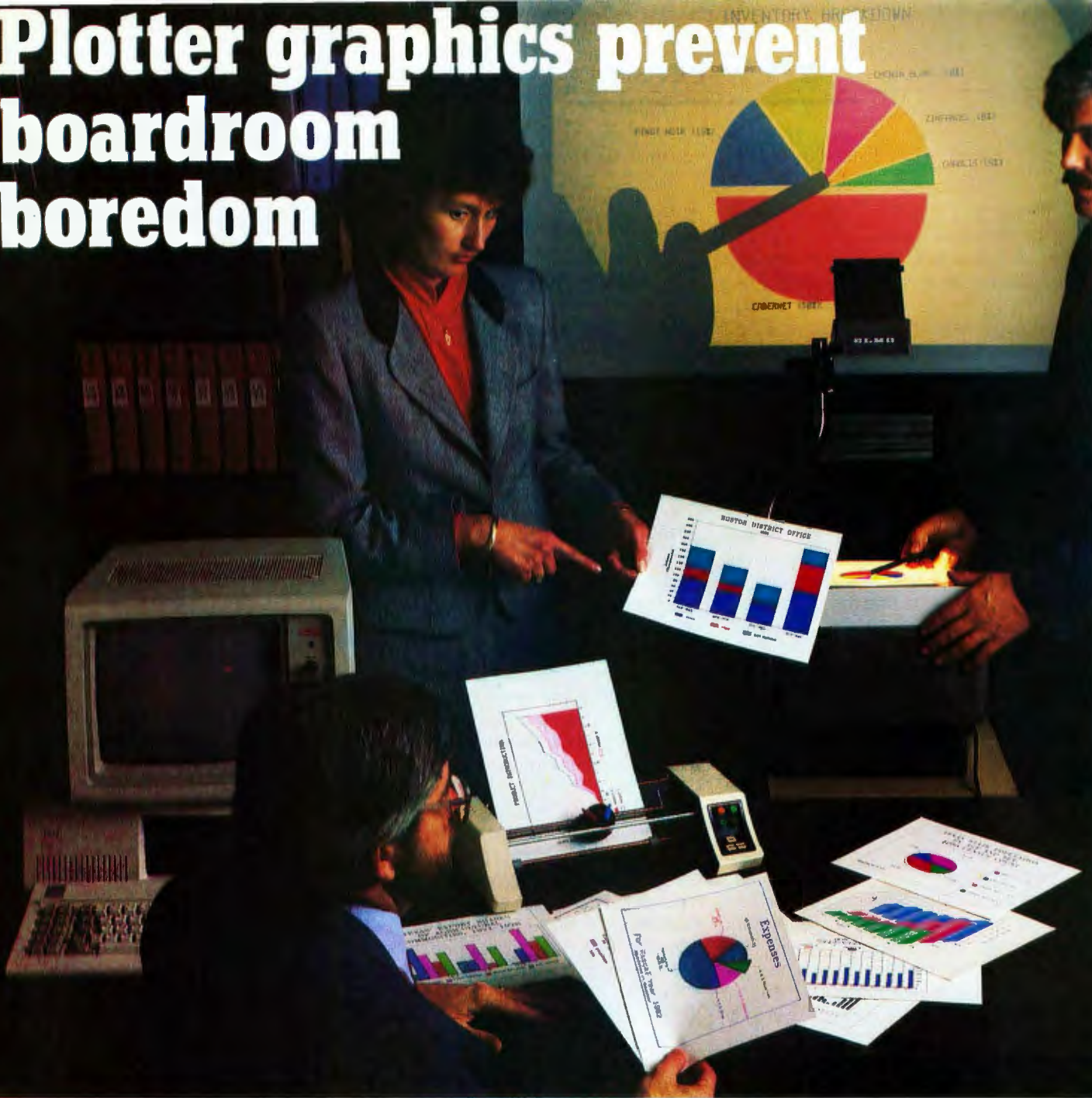

Crisp, clean, hardcopy graphics make dramatic impressions. Now, with Houston Instrument's PC Plotter, you have an affordable way to link the power of graphics to your personal computer. The PC Plotter produces quality graphics at a price you won't mind paying. It allows you to produce vibrant line, bar, and pie charts using eight different colors on either paper or overhead transparencies. And you can create either 8½" x 11" or 11" x 17" graphics.

Whether you're a computer wizard or novice, the PC Plotter is simple to operate and can be used with virtually any computer on the market today. Plus, your graphics software choices are unlimited. Houston Instrument products are supported by a versatile collection of more than 250 graphics software packages.

For example, just take a look at the above photo and you'll see plots created by PFS:® Graph, Lotus® 1-2-3,™ Peachtree Business Graphics System,™ Design Intelligence,™ Energraphics,™ and Smart Spreadsheet with Graphics.™

Make the most out of owning an IBM,® Apple® or other personal computer. Give it a PC Plotter. . . and give your presentations the visual advantage you need to win in business.

Visit your authorized Houston Instrument dealer or local computer store today and ask for a demonstration of the PC Plotter. For more information, call us at 800-531-5205. Texas residents may phone (512) 835-0900. Houston Instrument products are designed, marketed, and manufactured in Austin, Texas.

**houston  
instrument**

Inquiry 177

4P019





## DB Master for the Macintosh

An  
easy-to-use  
database  
manager  
with a  
few flaws

BY  
JEFFREY M. JACQUES

**S**toneware's Macintosh version of DB Master boasts easy access to the icon structure, pull-down menus, and a file size that any home or small-business user would be unlikely to outgrow—44 disks, or 20 megabytes on a hard-disk or cartridge system. Each record can handle as many as 100 fields, 3000 characters per record, and 20 complex computed fields that can include logical tests of other fields (IF . . . THEN type) and arithmetic functions such as SQRT, ABS, and RND. Stoneware's program costs \$195.

Upon booting, DB Master gives you two application options, Create File and Use File. Create File lets you define the field names, data types, formulas for computed fields, and so on. Use File lets you use a file that you have previously created. The program also comes with a test file, called Cities, with three dozen fields and records for 82 cities.

When you double-click the Create File application, DB Master explains that you can either design a new form for a file or redesign a previous form. The program then presents a gray screen with the title "Design Form" and several menu options.

To design a new form, you simply click the mouse anywhere within the screen and type in the name of your first field. The program allows both uppercase and lowercase characters, and you can change the way characters are displayed on the screen by pulling down a Print Style option from the menu. The program lets you display each of the field labels (or the data in the field) in any of seven Macintosh fonts, five sizes, and six styles. Using one font for field labels and a different font, size, or style for the data lets you clearly distinguish field labels from the data in that field. The program supports the various fonts in data entry, editing, and retrieval, but not in printing reports (more on that later). Each field label is limited to a maximum of 63 characters, and you are limited to a maximum of 100 fields in a form.

When you are done entering the label, you click the mouse in another part of the screen and DB Master automatically assigns a field number to the previous field. If you wish to move a field to another location on the screen, you can choose Cut and Paste commands from the menu.

You can also use pull-down menus to set field types (alphanumeric, numeric with up to two decimal places, or date) and field length (a maximum of 21 characters for a numeric field and about 3000 characters for a single alphanumeric entry). The more fields, the fewer the number of bytes possible for any other field since the maximum record length is 3000 bytes.

Another field option, Enter Formula, allows a field to get its value from computations based on another field or fields. For example, the value of Field 3, automatically computed by DB Master at the time of report generation, might be "Field 1 - Field 2." Each formula may be up to 240 characters long, and you can have up to 20 computed fields in a form.

You can define a key field or fields, the fields by which DB Master will automatically sort records as you enter them. The key may include as few as one field or as many fields as you wish, up to a total of 40 characters for the entire key. If you do not choose a key field, the program selects the first field as the key by default.

Once you have defined all the fields, the File menu lets you title and save your form. DB Master then takes you back to the Macintosh desktop, where you can begin using your newly created form. Unfortunately, the program doesn't *ask* you if you want to quit Create File when you save the form; it automatically takes you out to the desktop, which is inconvenient if you want to create more than one form at a time.

### USE FILE

When you double-click the Use File icon, DB Master presents a dialogue box with the

(continued)

Jeffrey M. Jacques is a sociology professor with extensive experience on mainframes, minicomputers, and microcomputers. He can be reached at the Department of Sociology, Florida A&M University, Tallahassee, FL 32307.



names of files available for you to use. (You can also double-click on the icon for a particular file, but the program still requires you to choose the file from the dialogue box, an annoying duplication of effort.) A menu selection called Record lets you add new records, set selection criteria for a retrieval, delete records, and so on. You may also use command-key combinations to select these functions from the keyboard.

Adding a new record is straightforward, although rather slow and sometimes tedious. When you select the Add New Records option, DB Master presents you with a copy of your form and white-boxed areas for data entry. You simply enter the essential information for each field and press Return or click the mouse on a new field to move on. You can shift back and forth between fields and edit the record at any time using keyboard commands or a pull-down Edit menu to cut, copy, paste, or erase text.

When you've finished entering all the data for the first record, DB Master accesses the disk, saves the data, and gives you another blank form to fill in.

To help with the drudgery of data

entry, you can select Set Field Defaults. For example, suppose you are developing a mailing list and many of the people on the list live in the same city and state; you can store the city and state names in the appropriate fields. When you ask to add another record, DB Master automatically fills in these fields with the specified text. (You can easily edit the fields when the default values are inappropriate.) This option can save considerable time.

**REPORT GENERATION**

DB Master lets you generate columnar reports with a wide variety of options (sort fields, column titles, tab distance between columns, etc.). The program makes it easy to select fields, organize them in order, title each field, compute sum totals and subtotals for numeric fields and counts/subcounts for alphanumeric fields, and select records based on one or several criteria.

DB Master lets you store more report formats than you are likely to ever use—255 in any file—and you may use up to 10 sort levels when creating a report. You may print reports to the screen, the printer, or

a disk file that you can edit with MacWrite or Microsoft Word.

**BYTE BENCHMARKS**

An important feature of any database system is how fast it can sort and retrieve stored information. The BYTE standard database benchmark consists of 1000 records, each with 100 characters divided into four fields. The first field in this test was a 4-character numeric field with values ranging from 1000 to 2000. This was the key field, and the program automatically indexed records according to this field when they were entered. Consequently, sorting and retrieving records with this field was very fast.

A more accurate test is to measure a nonindexed field. For this reason, the remaining 96 characters of each record were equally divided into three fields of 32 alphanumeric characters each. The first of these three fields had 32 haphazard values entered from the keyboard, and the benchmarks were conducted using this field.

BYTE's first benchmark measures sorting speed (see the graphs on the "At a Glance" page). DB Master's sorting speed is difficult to judge since the sorting routine is couched within the larger report routine. Therefore, the elapsed time included the amount of time DB Master spent writing the output to the screen or into a text file on disk. The program took 18 minutes to print the report to the screen and more than 12 minutes to print it into a text file.

When I sort a numeric field in ascending order, I expect the most extreme negative value to be listed first, followed by less extreme negative values, small positive values, and then large positive values. DB Master, however, sorts numeric data in ascending order by listing all the positive values first and the negative values next. The positive values are sorted as I would expect. However, small negative values (for example, -1, -5) are listed before the extreme negative values (-100, -500). Figure 1 shows a profit-and-loss report for a small company during a year, sorted according to the

(continued)

05-17-85	
Acme Widget	
889.79	01-29-84
910.44	09-29-84
951.10	06-29-84
1343.22	03-29-84
1347.18	10-29-84
-6.56	12-29-84
-8.95	11-29-84
-62.22	08-29-84
-90.00	02-29-84
-110.44	07-29-84
-878.21	05-29-84
-1166.84	04-29-84

Figure 1: When sorting numeric data, as in this profit-and-loss report, DB Master lists positive values first. Small negative values are listed before extreme negative values.

**Want to hear  
a demonstration of  
Hewlett-Packard's  
ThinkJet Printer?**



## AT A GLANCE

### Name

DB Master (Macintosh version)

### Type

Database manager

### Manufacturer

Stoneware Inc.  
50 Belvedere St.  
San Rafael, CA 94902  
(415) 454-6500

### Format

3 1/2-inch disk

### Computer

Apple Macintosh with 128K

### Language

Pascal

### Price

\$195

SORT (SEC)

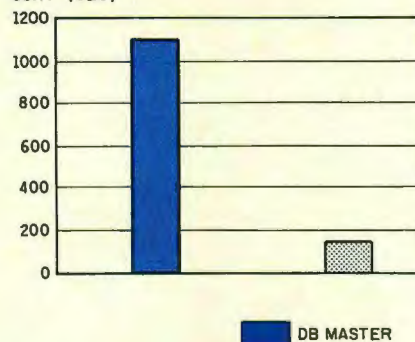

RECORD ACCESS (SEC)

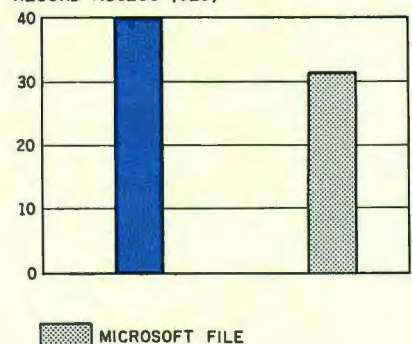

The graphs show the results of the BYTE benchmark tests on DB Master and Microsoft File, using a standard database of 1000 records, each with 100 characters. Tests were performed using the second field, a non-indexed, 32-character alphanumeric field. Sort

measures the time required to sort the records, and Record Access measures the time required to find the last record, both using the nonindexed field. Note that the Sort time for DB Master includes the time required to print the report to the screen.

numeric field \$ Profit/Loss. Not quite what I expected.

The second BYTE benchmark measures record accessing. This is more straightforward. It involves finding the last record in the file (using a nonindexed field), a task that took DB Master approximately 40 seconds. Retrievals are faster when you search using the key—just about instantaneous. That should not surprise anyone since the program uses ISAM (indexed sequential-access method) file structure. The actual elapsed time in retrieving a record has more to do with time spent accessing the disk than it has to do with the software. If you have a hard disk, you'll find it even faster.

DB Master lets you search for records using the logical operators =, <, >, ≤, ≥, and <>. You can also retrieve using multiple fields and link these fields using logical ANDs or ORs. You may enter up to 20 selection criteria for any retrieval.

### CLOSER EXAMINATION

While DB Master can do many things, there are several things it cannot do well, if at all. First, DB Master does not let you join files; that is, you cannot match records from different forms by

a specific key and then retrieve unique data from more than one file. Second, designing noncolumnar reports is awkward and time-consuming and requires considerable effort. For example, handling invoice reports when you have many different entries for products for some people and few for others, as well as the need to compute discounts, taxes, and totals across items, is not easy for a novice user. Furthermore, it is difficult to print the field names and the associated data for that field when designing a report. (You have to create a new field that houses the field name as an alphanumeric entry and then print both fields if you wish to include field labels.)

Producing standard mailing labels is not difficult. You just choose the appropriate fields from your larger file, indicate that you want to start a new line for street-address information, set the page length, number of blank lines, etc., and then print the report. But DB Master works only with single labels where each label is on a separate section of the pin-fed paper. It does not let you perform any string functions, so to sort on zip code or state, you'd have to have a separate field for each. Further, the program

lacks a mail-merge facility for matching names/addresses with a text or letter document.

Printed reports are strikingly limited in output styles. Your reports, if you use an Imagewriter, are limited to standard text output of pica, elite, condensed, and so on. All those fancy Macintosh fonts are visible only on the data-entry form, not on the printed report. Although DB Master supports a LaserWriter and provides a small set of additional print styles and sizes, it does not come near to using the Mac's printer capabilities. Rather, you have to dump the output to your word processor and use its editing and printing capabilities. Pretty shabby for Mac software.

One of my common tasks, creating annotated bibliographies, is difficult using DB Master. While I can define several fields as long alphanumeric data fields, thus allowing several lines of information for that field, editing facilities are incomplete. It is easy to add and delete information in fields where the number of characters is considerably below the field-length limit, but it's cumbersome to add information when the stored data is at the length limit. When I inserted ad-

(continued)



# Want to hear it again?

You made about as much noise turning the page as the ThinkJet Printer makes turning one out.

So it lets you do two things at once. Print. And think. Without sound hoods. Without remote printing stations. Without aspirin. (And without a lot of clutter. The only thing smaller than the ThinkJet Printer is its price: \$495\*.)

Better still, it works with just about every personal computer.

Hear the ThinkJet Printer sound off.

Call (800) FOR-HPCC, Dept. 276X, for the Hewlett-Packard dealer nearest you.



**HEWLETT  
PACKARD**

Inquiry 171



**HEWLETT  
PACKARD**

ThinkJet



ditional information in a field that had many characters, the data at the end of the field was dropped immediately. Even if I deleted some other characters, those dropped characters did not reappear. There's no temporary storage area that would have allowed me to modify the entry—enter the needed additional information, re-examine the entry, and then delete unneeded characters—the way I typically work.

These limitations may not be important to some of you, but I found other essential applications missing, too. Perhaps the most disappointing feature of this version of DB Master is that all data entry must be done from the keyboard. Currently there is no way to directly read data from another database-management system, nor is there any way to read DIF files from a spreadsheet program. The bottom line is this: If you have a new applica-

tion and have no other machine-readable data sources, then this package might make sense; otherwise, you're going to be reentering a lot of data.

#### DOCUMENTATION

The documentation provided with DB Master is easy reading, is generally straight to the point, and usually provides backup for what may not be apparent when using the software and the help screens. The documentation comes in two parts. The first, a 13-page document called *Getting Started*, covers the essentials of how to back up your program disk, retrieve information using the Cities file tutorial, and design, build, and retrieve data with your own form. The second and larger document, the user's guide, is good at providing worked examples and serving as an overall reference for creating a form and doing retrievals. It needs con-

siderable work (especially for the novice user) on designing reports, thinking through issues, and developing applications.

Along with the documentation, you get a single program disk. It is not copy-protected. You also get a single-machine license agreement, a registration card, and a telephone number to Stoneware's technical support personnel.

#### CONCLUSIONS

Although DB Master is easy to use and has some nice features, it does not meet my expectations for a database-management system on the Macintosh. The product has the basic code to be a good file-management system, but it needs better interfacing to other software, more regard for users and their needs, better report documentation, and better use of the Macintosh's printing potential. ■

# THE \$2995 I<sup>2</sup> DEVELOPMENT SYSTEM

Turns any personal computer into a complete, integrated microprocessor DEVELOPMENT SYSTEM. The control/display program runs under MS-DOS, CP/M, or ISIS, and controls the UDL via an RS-232 port.

ADAPTERS AVAILABLE FOR VAX, APPLE CP/M AND PDP-11



### IN-CIRCUIT EMULATOR

32K bytes of EMULATION ROM (128K max) allows you to make program patches instantly. You can stop the program at break-point, single-step, and display or change registers, ports and memory. The target processor stays in its socket for perfect transparency.

### BUS STATE ANALYZER

Features four-step sequential triggering, selective trace, and pass and delay counters. Symbolic trace disassemblers and debuggers are available for Z-80, NSC-800, 8048, 6301, R65, 6500, 6800, 6801, 6802, 6805, 6809, 8051, 8085, Z-8, 1802, 8088/80188, 8086/80186, and 68000/8.

### EPROM/EEPROM PROGRAMMER

Doubles as a stimulus generator during system checkout. Handles 24 and 28 pin devices up to 27256.

FOR FURTHER INFORMATION  
TELEPHONE JOHN STANLEY

**(415) 361-8883**

OR WRITE:

**ORION INSTRUMENTS, INC.** 702 MARSHALL STREET • SUITE 614 • REDWOOD CITY, CA 94064

**The next step  
for your PC  
isn't as big as  
you think.**





# Introducing the

## The best of both worlds.

For owners of IBM Personal Computers, combining personal productivity and business applications is now less of a leap than ever before.

There's a new IBM product that marries the IBM System/36 and the IBM Personal Computer to give you the best of both worlds.

### Meet the newest member of the System/36 Family.

It's called the IBM System/36 PC. Very small but it opens up new worlds for your personal computer. Very affordable with a price starting at \$5,995, yet capable of running System/36 programs that will help you run your business.

Even if you've never owned a computer before, this can be your first business system, instantly offering the capability of running your business right now and expanding it in the future.

### Multiuser system.

System/36 PC can be a standalone computer for small companies or a departmental system or even part of a distributed network for larger companies, providing multiuser access to data.

The System/36 PC is made up of a 5364 Processor attached to an IBM PC, PC XT or PC AT. And you can connect up to three more of these personal computers. Or you can connect terminals such as System/36 printers or displays.

### Flexibility.

Whether your business has two employees or more than 2,000, the System/36 PC can combine the personal productivity of your PC with the business applications of the System/36 Family.

The System/36 can handle all facets of your business—distribution, sales analysis and general ledger functions. Accounts payable, inventory control and payroll.



# IBM System/36 PC.

And you can get traditional PC functions such as spreadsheets and word processing.

Software for the System/36 has been developed over the years and has proven invaluable in all kinds of businesses of all sizes. And with the thousands of programs written for both IBM PC and System/36, the sky's the limit for business and planning applications.

The System/36 PC even provides you with data security features so that the right data gets into the right hands.

## Small yet powerful.

All of this processing power can sit right on a desk or under it—either horizontally or vertically. It measures a mere 21¼" x 16¾" x 6½"—about the size of a small suitcase.

Yet as small as it is, this little box has multiple processors, with main memory that can be dedicated to running your business functions. In plain English, this means you can get better response time. The System/36 PC comes with a 1.2 MB diskette drive and either 40 or 80 MB disk storage, depending on your information storage needs.



## Easy to use.

The System/36 PC is easy to learn and to use. If you need assistance, it has over 2,800 "help" screens that take you step-by-step through any rough spots. You can merge data you've generated on your PC with information that's on your System/36 PC. And you can share information that is stored in the System/36 PC with other attached IBM Personal Computers or System/36 terminals.

Compatibility is high so that you can keep on using many of the PC peripherals and programs you may already own.

## Easy growth.

What happens when your small office becomes bigger?

That's what the System/36 Family is all about. No matter what size your business, there's a member of the System/36 Family that can help you do whatever you do, better.

As your needs become greater, there's the mid-sized 5362 processor that offers greater performance and can handle up to 22 personal computers or System/36 terminals.



Then there's the original System/36—the 5360 processor—the largest member of the System/36 Family, which can handle up to 36 personal

computers or System/36 terminals.

Any one of these processors can function as the central processor in your office. Each can communicate with PCs or larger systems, giving communication and connectivity new meaning by allowing departments to share data.

So if your dreams are big but your office is small, the new System/36 PC is the perfect step for you to take. You not only get the best of both worlds, you also get IBM product reliability. And authorized IBM on-site service is available anywhere in the U.S.A.

For a free brochure on the IBM System/36 PC or for information on product availability from participating IBM Product Centers, Authorized PC Dealers or Value Added Dealers, call 1 800 IBM-2468, ext. 104, LL. Or call your IBM marketing representative.

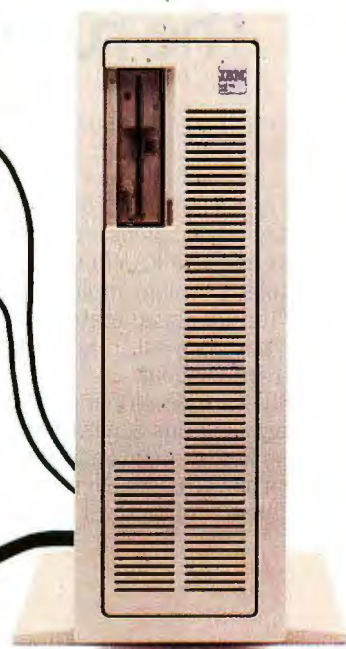





## The rush to Revelation<sup>®</sup> has just begun.

When ordinary database management software isn't enough, enlightened users are switching by leaps and bounds to Revelation, the complete database and applications environment.

That's because Revelation includes powerful tools to create applications in no time. Plus advanced features that help users get the most from their system day in and day out.

For software developers, there's a powerful applications generator that builds files, fields, menus and reports.

For corporate users, Network Revelation is already off and running on

both IBM's<sup>®</sup> PC Network and any hardware running Novell NetWare.<sup>™</sup>

For hard-core programmers, Revelation's R/BASIC procedural language combines the best of BASIC with the structure and logic of C.

And for everyone, there's an advanced query language and report writer that's fluent in everyday English and eager to learn new expressions.

The secret is incomparable technology: variable-length fields to conserve precious disk space; unlimited files, fields and records; data dictionaries that make it easy to change your

database when you change your mind; plus a high-speed compiler to accelerate program execution. And, of course, conversion utilities for dBase II<sup>®</sup> and Lotus 1-2-3<sup>™</sup> are included at no extra cost.

Revelation isn't for everyone. But if you're ready for a database management system you'll never outgrow, rush to your nearby dealer.

Ask for an unforgettable demonstration of Revelation's superior capabilities.

IBM is a registered trademark of International Business Machines. NetWare is a trademark of Novell, Inc. dBase II is a registered trademark of Ashton-Tate. 1-2-3 is a trademark of Lotus Development Corporation.

Cosmos, Inc., 19530 Pacific Highway S.

# COSMOS<sup>™</sup>

Seattle, WA 98188, (206) 824-9942





## Paradise Modular Graphics Card

A multi-  
function  
color/graphics  
card for the  
IBM PC

BY HARRY KRAUSE

**M**any owners of IBM Personal Computers (PCs) face the problem of wanting both the crisp display of a monochrome monitor for word processing and the color and graphics available with IBM's color/graphics-display adapter. An obvious, but expensive, solution is to have both the monochrome and color/graphics cards in your computer. A less expensive solution is to use the Paradise Systems Modular Graphics Card (see photo 1).

The Paradise card is functionally equivalent to both the IBM color/graphics card and the monochrome-display card together. It can display color on an RGB (red-green-blue) monitor and display graphics on a monochrome monitor. Paradise's card translates the 16 colors into levels of image intensity on a monochrome monitor.

The Modular Graphics Card lives up to its name by letting you plug in modules for serial and parallel ports, a game-control interface, a floppy-disk-drive controller, a clock/calendar, and additional RAM (random-access read/write memory).

I have worked with the card for several months and it has performed beautifully. Text-based programs are displayed with the same high quality I expect from a monochrome monitor, and full-size graphics automatically pop up on the same screen. The card will properly drive any kind of monitor used with IBM PCs: TTL (transistor-transistor logic) monochrome, composite monochrome, or RGB. There is no advantage, however, to using the card with either RGB or composite monitors because the display quality with these devices is no better than with the IBM color/graphics card.

### INSTALLATION

The full-length adapter card is packaged with a 60-page instruction manual and a software disk. Many PC users who buy a new card just pop it into their machines without reading the manual. I wouldn't recommend doing this with the Modular

Graphics Card. You have to check positions of several switches or jumpers on the card or in the PC before you do anything else. In fact, a headline on the first page of the manual warns: "If you read nothing else, read this!" The headline is followed by clearly worded instructions and an illustration of the card. Depending on the equipment you've got, some of the instructions will apply. First, you've got to let your PC know, by setting the proper DIP (dual in-line package) switch on its motherboard, that the Paradise card functions as a color/graphics adapter. Second, you must examine the Paradise card and move a jumper or two to let it know whether you're using an RGB or composite-video monitor or a TTL monochrome monitor.

Once you've set the switches and jumpers, you can insert the Paradise card into an empty slot in the PC.

For software installation, Paradise supplies a disk of files necessary to configure the graphics board to the system being used. You invoke most of these through an on-screen menu program called MGPREP. After providing instructions, MGPREP displays the main menu, which appears as a table of configuration data. You can select a monitor from a list of several selections, such as RGB/COMP, Taxan, Eagle/Amdek, and Princeton.

With the Mode option, you select the video-display mode. The list includes 80-column text, black-and-white monitor with 40-column display, and color monitor with 40-column display. The Mono Card selection is for cases where you also have IBM's monochrome-display adapter in the computer and want the machine to boot up using that card and the monochrome monitor.

The Centering menu selection lets you adjust the display for use with a television set, composite monitor, or RGB monitor. When invoked, the routine runs a centering pattern on the display. When the pattern is too

(continued)

Harry Krause (POB 596, Great Falls, VA 22066) is a marketing consultant who claims he got involved with microcomputers out of self-defense after seeing them pop up overnight on clients' desks



### AT A GLANCE

**Name**

Modular Graphics Card

**Type**

Display adapter for text and graphics

**Manufacturer**

Paradise Systems Inc.  
150 North Hill Dr.  
Brisbane, CA 94005  
(415) 468-6000

**Size**

Full-size PC card, 13 by 4 inches; occupies one slot

**Equipment Needed**

IBM PC or compatible with an available slot and one disk drive

**Features**

Invisible shifting between text and graphics modes on TTL monitors; modular construction to accommodate add-ons

**Options**

Add-on modules: parallel printer port (\$95), game port (\$95), serial port (\$95), clock/calendar and 256K RAM (\$275), 384K RAM (\$275), floppy-disk controller (\$275)

**Documentation**

60-page owner's manual

**Price**

\$395 for fully functional display adapter

**Warranty**

One year, limited

far to the right or to the left, you can tap the appropriate arrow keys on the computer's keyboard in order to center it.

When you are finished configuring, you can select the Install option and MGPREP will create an MGCCOM disk file incorporating your selections. MGPREP is clever enough to include another option that allows the MGCCOM file to be automatically inserted into your computer's AUTO-EXEC.BAT file. MGPREP's menu also lets you set parameters for many of

the options (additional memory, serial port, controller, etc.) available for the Paradise card.

**RESISTORS AND PIXELS**

At this point, I ought to mention an installation anomaly. I had no difficulties installing the Paradise card in an IBM PC with an IBM green-screen monitor. But I prefer amber displays, so I tried the card with an Amdek 310A. The program loaded properly, but the screen remained blank. I turned the monitor off and then

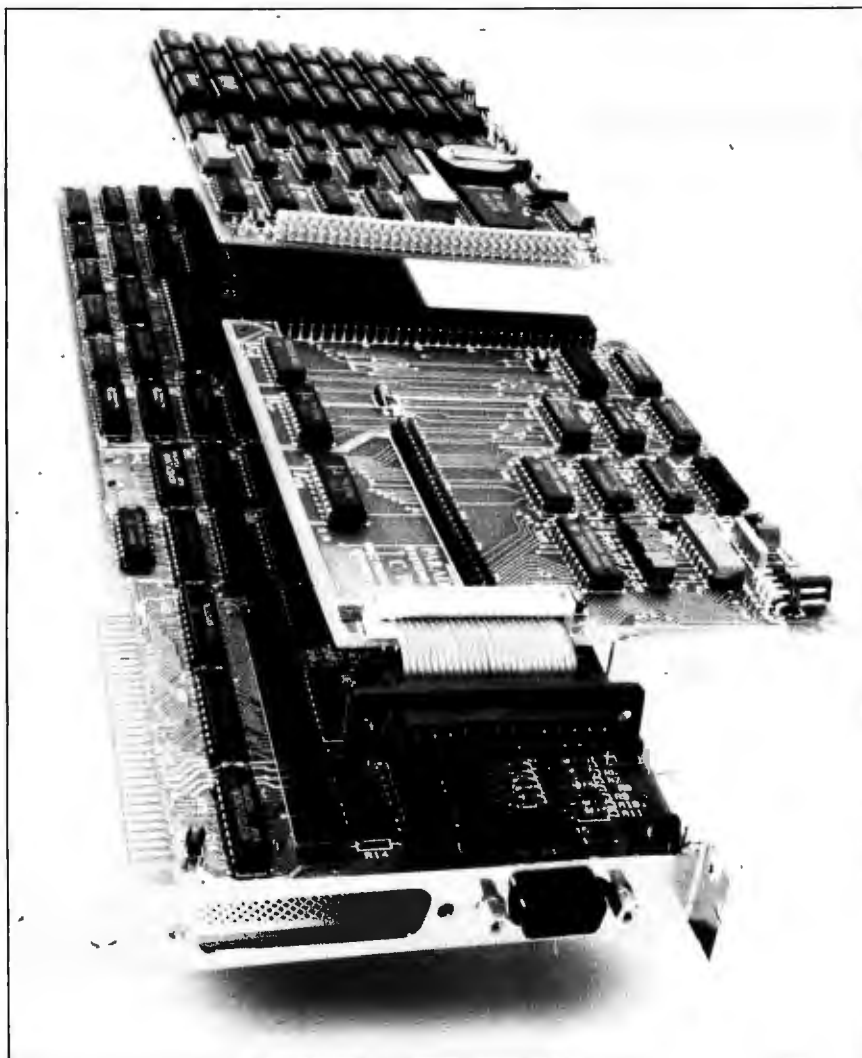

*Photo 1: Modular Graphics Card from Paradise Systems fits into any full-size slot in an IBM PC or compatible. The connector at the bottom right of the photo mates with a cable from a monochrome TTL monitor. Also shown are two of Paradise's optional add-on modules: at the top is a combination RAM/clock card, and below that, a serial adapter card.*

## REVIEW: PARADISE CARD

turned it on again—it worked fine. Puzzled, I called Paradise and spoke with a technical representative. Apparently, early versions of the Amdek 310A included a resistor-protective circuit that created a mode-shifting problem when used with boards like those built by Paradise Systems. The solution is to snip off one end of the offending resistor. Before hacking up my monitor, I verified the information with Amdek. Sure enough, Amdek had issued a service bulletin identifying the resistor as a special problem and recommended disabling it. I opened up the monitor, cut a lead off the offending resistor, and the problem disappeared. (The monitor is potentially the most dangerous peripheral because of high voltages. You might want to have a dealer make any modifications.)

My AUTOEXEC.BAT file sets several system parameters and leaves me at the operating-system prompt. Adding MGC.COM to the batch file did not seem to change anything. The characters on the display, however, were ever so slightly different than what I was used to seeing. They looked a little more squared off but were still very readable; when I scrolled through a display of my hard-disk directory, there was no flicker. Reading the Paradise instruction booklet, I discovered that, while the characters displayed in the nongraphics mode are the same size as with the IBM monochrome card (a 7 by 9 matrix of pixels), the character matrix—the matrix in which characters are formed—is 8 by 14, a tad smaller than the IBM's. The squared-off characters also appear with the Paradise card's graphics mode. The displayed characters aren't of a lesser quality than those generated by IBM equipment; they are just a little different.

I ran BASICA and then selected and invoked a couple of programs I hadn't been able to run before installing the new card. They use graphics that simply won't display on the monochrome adapter/TTL monitor combination. These are simple graphics demonstration programs I downloaded from IBM PC-oriented bulletin

boards. They run now on my Amdek just as I had seen them run on graphics monitors.

I had to slightly reconfigure some of my nongraphics programs to accommodate the new setup. For word processing, I use Volkswriter Deluxe, a program with an elaborate but easy-to-use setup file that allows it to be customized for an assortment of IBM PC-compatibles and peripherals. The program's configuration file asks you to specify what type of graphics card/monitor combination you're using. I had previously set a monochrome card/monochrome monitor combination. With the Paradise card installed, I had to reconfigure and tell the program I was now using a graphics card/monitor combination. Once Volkswriter Deluxe was reconfigured, it ran without a glitch. If you're familiar with Lotus 1-2-3, you know about the selection of monitor drivers. If you've been running 1-2-3 with a monochrome adapter/monitor combination and you install the Paradise, you'll have to use the Lotus configuration program to select another display driver. The benefit will be apparent; you will now be able to display the Lotus graphics that were previously unavailable.

### CONCLUSION

Between my software and that owned by my colleagues, I have access to hundreds of programs that run on IBM PCs and compatibles. I checked several dozen graphics-based programs with the Paradise and they all ran as they should; I actually did not come across a program that would not. To check on compatibility with lesser-known computers, I opened up an Eagle Turbo and popped in the Paradise card. It worked as it did on an IBM PC: beautifully.

In looking through my notes for ways in which Paradise could improve the product, I don't see much. If you follow the directions, the card is easy to install. And it performs exactly as advertised. Paradise Systems' Modular Graphics Card is one of the few products I've evaluated that I'd consider purchasing for my own system. ■

## C Programmers: Program three times faster with *Instant-C*<sup>™</sup>

*Instant-C*<sup>™</sup> is an optimizing interpreter for the C language that can make programming in C three or more times faster than using old-fashioned compilers and loaders. The interpreter environment makes C as easy to use as Basic. Yet *Instant-C*<sup>™</sup> is 20 to 50 times faster than interpreted Basic. This new interactive development environment gives you:

**Instant Editing.** The full-screen editor is built into *Instant-C*<sup>™</sup> for immediate use. You don't wait for a separate editor program to start up.

**Instant Error Correction.** You can check syntax in the editor. Each error message is displayed on the screen with the cursor set to the trouble spot, ready for your correction. Errors are reported clearly, by the editor, and only one at a time.

**Instant Execution.** *Instant-C*<sup>™</sup> uses no assembler or loader. You can execute your program as soon as you finish editing.

**Instant Testing.** You can immediately execute any C statement or function, set variables, or evaluate expressions. Your results are displayed automatically.

**Instant Symbolic Debugging.** Watch execution by single statement stepping. Debugging features are built-in; you don't need to recompile or reload using special options.

**Instant Loading.** Directly generates .EXE or .CMD files at your request to create stand-alone versions of your programs.

**Instant Floating Point.** Uses 8087\* co-processor if present.

**Instant Compatibility.** Follows K & R standards. Comprehensive standard library provided, with source code.

**Instant Satisfaction.** Guaranteed, or your money back. *Instant-C*<sup>™</sup> is available now, and works under PC-DOS, MS-DOS\*, and CP/M-86\*.

Find out how *Instant-C*<sup>™</sup> is changing the way that programming is done.

*Instant-C*<sup>™</sup> is \$495. Call or write for more information.

### Rational Systems, Inc.

(617) 653-6194

P.O. Box 480

Natick, Mass. 01760

Trademarks: MS-DOS (Microsoft Corp.), 8087 (Intel Corp.), CP/M-86 (Digital Research, Inc.), Instant-C (Rational Systems, Inc.)



• PLUS • PLUS • PLUS • PLUS •



• PLUS • PLUS • PLUS • PLUS

# PRODUCE STUDIO-QUALITY TRUE-COLOR PICTURES ON YOUR PC

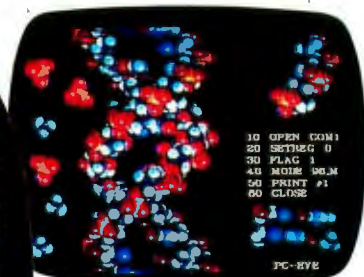

Now you can create and edit studio-quality pictures on your IBM\* PC or compatible computer with the IMiGIT PLUS™ color system.

Anything a video camera can see — people, products, scenery and artwork — can be computerized in 256 colors using the IMiGIT PLUS color system. Pictures are captured and displayed in their original “true color” so you do not have to spend hours recoloring to attain a “real-life look”. Images can be enhanced with text, line art and other graphics for business presentations, art studio, education, engineering, architecture and television applications.

### Professional Quality — Special Effects

Pictures are captured at a resolution of 512 x 512 x 256 colors selectable from a 16 million color palette. Captured images can be modified with editing tools such as: multi-font annotation, line and freehand drawing, filled and unfilled boxes and

circles, texturing, color fill, curve fitting and rubberstamping. A cut and paste feature allows “cut art”, previously saved to disk as picture sections, to be recalled and overlaid on the display. This editing sophistication lets you create complex graphics as well as dramatic and illusionary special effects.

### Designed for the User

The IMiGIT PLUS color system is easy-to-use and versatile. Completely icon-driven, you can quickly learn to master the powerful editing tools. Also, you can select the various editing commands using the keyboard, popular mouse devices or digitizing tablets. Captured color pictures can be displayed for editing, saved and retrieved from disk, printed, and recorded on 35mm slides for professional presentations.

IMiGIT PLUS is available as a hardware/software combination, an add-on system, and as a complete IBM AT graphic workstation. The software and PC-EYE color capture board are priced at \$1,295. The IMiGIT PLUS system includes a color camera, RGB monitor, graphics adapter, software/hardware package with expansion chassis priced at \$9,500. The workstation is priced at \$18,000 and includes an IBM AT with 20MB disk, IMiGIT PLUS software, PC-EYE™ capture board, Colorverter™, graphics display card, digitizing tablet, color camera/accessories, and a high resolution RGB analog monitor.

For more information on IMiGIT PLUS or our other imaging products for applications in data base management, communications and image capture, please write or call 1-800-OCHORUS or 603-424-2900.

Inquiry 62

TM: IMiGIT PLUS, Colorverter and PC-EYE are trademarks of Chorus Data Systems, Inc.

\*: IBM is a trademark of International Business Machines

# CHORUS





# The RAMDISK-64

Fast disk  
access on the  
Commodore  
64 at a  
reasonable  
price

BY WARREN BLOCK

**A**n alternative to Commodore's 1541 disk drive for the Commodore 64 is P Technologies' RAMDISK-64, which simulates a disk drive with dynamic RAM (random-access read/write memory) chips. Until now, most RAM disks that imitate small-capacity disk drives had at least 128K bytes of RAM and cost in the neighborhood of \$400. RAMDISK-64 has 64K bytes of RAM, is expandable to 256K bytes, and costs only \$149. RAMDISK-64 requires a motherboard expansion chassis for the Commodore 64's cartridge port. C-64s without the expansion will require an additional extender board (\$10). The RAMDISK-64 with 256K bytes costs \$350.

The RAMDISK-64 package includes the RAM disk itself (a rather small cartridge), a copyable disk containing the RAM disk's software, and a small user's manual. I also purchased the no-frills extender board.

First, I plugged the extender board into the cartridge port on the C-64. Then I plugged RAMDISK-64 into the extender board's socket. If you switch cartridges frequently, you should buy a motherboard with enable/disable switches for each cartridge; this makes life easier for you and your computer. The manual, which is clearly written and easy to follow, suggested that I load a test/diagnostics program from the disk. When I ran the utility, it printed RAMDISK-64 FUNCTIONAL!!! I then loaded the Fast-Drive program and ran it as instructed. Everything worked the first time through; the computer displayed RAMDISK-64's directory. In its 64K-byte configuration, the RAM drive has a capacity of 254 blocks, or about one-third that of a normal disk drive.

## COMPATIBILITY

I used a straightforward procedure to check compatibility with programs that alter the C-64's operating system. After loading the version of Fast-Drive that goes at the top of BASIC memory, I loaded and tried to execute such programs. Most worked without a hitch. However, my word processor,

SpeedScript, begins by clearing memory; it refused to work with the Fast-Drive software. The program worked as if RAMDISK-64 were not present. Supermon, a machine-language monitor, will not save files to RAMDISK-64. This is minor since sending object files from the assembler to the RAM drive is easier than saving them through Supermon.

In the most difficult test, I ran my assembler's initialization program, which loads the DOS Wedge, the Supermon monitor, and then an assembler. This is not a fair test because all three alter the C-64's operating system in different ways. Nonetheless, all executed perfectly, and I still had 28K bytes of BASIC memory left. This is sufficient space for an assembler development system. If you need more free memory, you can load a version of the Fast-Drive program into the 4K-byte block of free RAM at 49152 (C000 hexadecimal); this leaves the normal 38K bytes free for BASIC programming. I prefer to place Fast-Drive at the top of BASIC, keeping the 4K-byte block free for assembler programs.

## USING RAMDISK-64

The RAM drive is fairly simple to use. The Fast-Drive program installs the RAM drive as device number 15, making references very similar to those used for the "real" disk drive. For example, you can view RAMDISK-64's directory by typing LOAD "\$",15. Unlike the 1541, the directory is not actually loaded into program memory so it will not erase your program—one example of the forethought that P Technologies put into the product.

It is just as easy to load and save programs to the RAM drive. For example, to load the program Filename, you type only LOAD "FILENAME",15. As in the method for the 1541, you use the Open statement to scratch (delete) files. The Fast-Drive program recognizes "S:" to scratch a file and "C:" to change the RAM drive's device

(continued)

Warren Block is majoring in computers and mathematics at Chadron State College. He can be reached at 645 King St., Chadron, NE 69337.



**AT A GLANCE**

**Name**  
RAMDISK-64

**Type**  
64K-byte RAM disk for the Commodore 64

**Manufacturer**  
P Technologies  
1555 Riverpark Dr., Suite 206  
Sacramento, CA 95815  
(916) 920-3226

**Computer**  
Commodore 64 and 1541 disk drive

**Documentation**  
21-page user's manual

**Price**  
\$149  
Extender board \$10

**Audience**  
Programmers and software developers,  
home users

number. To scratch the file Filename, you type OPEN 1,15,0,"S:FILENAME". Typing OPEN 1,15,0,"C:20" changes the device number of the RAM drive to 20. Fast-Drive intercepts the Open statements before they get to the operating system; since they never actually open files, you don't need to close them.

The software also supports Commodore's "save with.replace" command. To save a new file over an old one, you use the conventional @: prefix before the filename. The method is easier than scratching an old file and saving its replacement.

Fast-Drive includes two useful commands that let you transfer programs and text files to or from RAMDISK-64 without going through program memory. These Load and Save operations are similar to the normal ones, except that they cite RAMDISK-64's device number at the end. For example, to

transfer a program called FILENAME.BAS to the RAM disk, you enter the command LOAD "FILENAME.BAS",8,15. Similarly, SAVE "FILENAME",8,15 saves the RAMDISK-64 contents of the Filename file to the disk in the 1541 drive.

RAMDISK-64's transfer commands let you copy text and object-code files without the usual hassle. Copying text files from disk to disk with a 1541 normally requires entering a utility program, and copying object-code files requires that you know their starting and ending addresses. RAMDISK-64 greatly simplifies the copying process. Even if you didn't know the length and starting and ending addresses of an object-code file on a disk in the 1541 drive, LOAD "FILENAME",8,15 would transfer it to the RAM drive. After you switch disks in the 1541, SAVE "FILENAME",8,15 will dupli-

(continued)

**A Full C Compiler  
For \$49.95**



**New Release 4.1**



The Ecosoft Eco-C88 compiler for the 8088 and MSDOS is going to set a new standard for price and performance. Consider the evidence:

Compiler	Eco-C88	Latice (1)	C86 (1)
Seive	13	11	13
Fib	44	58	46
Deref	13	13	-
Matrix	21	29	27
Price	\$49.95	\$500.00	\$395.00

(1) **Computer Language**, Feb., 1985, pp.73-102. Reprinted by permission. Eco-C88 Rel. 2.20, on IBM PC with 2 floppy disks, 256K. Benchmarks from Feb., 1985 **Computer Language**.

- Eco-C88 includes:
- \* All operators and data types (except bit fields)
  - \* Error messages in English with page numbers that reference the **C Programming Guide** - a real plus if you're just getting started in C.
  - \* Over 170 library functions, including color and transcendentals
  - \* New Library functions for treating memory as a file
  - \* User-selectable ASM or OBJ output (no assembler required)
  - \* 8087 support with 8087 sensed at *runtime*
  - \* cc and "mini-make" for easy compiles (with source)
  - \* Fast, efficient code for all IBM-PC, XT, AT and compatibles using MSDOS 2.1 or later.
  - \* Complete user's manual

If ordered with the compiler, the C library source code (excluding transcendentals) is \$10.00 and the ISAM file handler (as published in the **C Programmer's Library**, Que Corp) in OBJ format is an additional \$15.00. Please add \$4.00 for shipping and handling. To order, call or write:

**Ecosoft Inc.**  
6413 N. College Avenue  
Indianapolis, IN 46220  
(317) 255-6476 • 8:30-4:30

We've continually improved Microstat since it was introduced in 1978, and the latest release includes many new features you've wanted.

- |   |  |
|---|--|
| Interactive and Batch Processing                            | Data sets that can exceed memory             |
| Expanded Data Management Subsystem with New Data Transforms | Multiple Regression (including Stepwise)     |
| Reading data files created by other programs (e.g., Lotus)  | Scatterplots (including best fit regression) |
| 3 types of Analysis of Variance                             | Correlation Analysis                         |
| Time Series   | 12 Nonparametric tests                       |
| Crosstabs and Chi-Square                                    | 8 Probability Distributions                  |
| Factorials, Permutations, and Combinations                  | Descriptive Statistics                       |
| Hypothesis Tests  | Easy Installation                            |

Microstat's algorithms have been designed to prevent numeric overflow errors and yield unsurpassed accuracy. Microstat's price is \$375.00 including the user's manual and is available for the Z80, 8086, 8088 CPU's and CP/M80, CP/M86, MS-DOS, and PC-DOS. To order, call or write.



Trademarks: Eco-C88, Microstat (Ecosoft), CP/M (Digital Research), MSDOS (Microsoft), PC-DOS (IBM), Z80 (Zilog), 8086, 8087, 8088 (Intel).



# THE BETTER LETTER BOX

**Introducing EasyPlex™. The new, easy-to-use electronic mail system from CompuServe.**

Finally! Electronic Mail that's so easy to use you can start composing and sending messages the first time you get online.

Designed for various experience levels, EasyPlex has a menu mode with simple, easy-to-follow directions for beginners, and it lets experienced users save time by working in the prompt or command modes. With EasyPlex, you can compose, edit, send, file, and take advantage of sophisticated

options previously available only with more expensive services.

CompuServe's EasyPlex lets friends and relatives, associations and club members communicate any time of the day or night. And small business owners, real estate professionals, insurance agents, lawyers, writers, etc. can communicate quickly and simply—either interoffice or interstate. "It's Easy." "Just Plex it!"

Best of all, EasyPlex is available to all CompuServe subscribers. And, along with EasyPlex, you get hundreds of valuable and entertaining computing options. Plus the assurance of belonging to the largest, fastest

growing computer information service in the world and the premier supplier of business information to FORTUNE 500 companies.

Start communicating! To buy a CompuServe Subscription Kit, see your nearest computer dealer. To receive our informative brochure or to order direct, call or write:

**CompuServe®**

Information Services, P.O. Box 20212  
5000 Arlington Centre Blvd., Columbus, Ohio 43220

**800-848-8199**

In Ohio, call 614-457-0802

Inquiry 74

An H&R Block Company



cate the file on the new disk. Your program in memory will remain undisturbed.

The Fast-Drive system does have a

few problems. Apart from "S:" and "C:", RAMDISK-64 does not have any of the DOS commands available with a real disk drive. Moreover, the soft-

ware supports only 16 files in RAMDISK-64 at one time. With only 64K bytes, the limitation is not a problem, but a lot of space might be wasted if you add the 256K-byte expansion.

*Listing 1: The programs used to write (1a) and read (1b) the sequential text file. In both programs, line 110 was changed for RAMDISK-64 to read: 110 OPEN 1,15,2,"TEXTFILE". The Open statement used with RAMDISK-64 does not have the "S,R" or the "S,W" for read and write, respectively, because RAMDISK-64 is always open for both.*

```
(1a)
100 REM OPEN A SEQ FILE FOR WRITE
110 OPEN 1,8,2,"TEXTFILE,S,W"
120 REM WRITE 40,000 BYTES OF DATA
130 FOR L = 1 TO 1000
140 PRINT#1,"THIS IS A LINE OF TEXT USED AS A TEST..."
150 NEXT
160 CLOSE 1
```

```
(1b)
100 REM OPEN A SEQ FILE FOR READ
110 OPEN 1,8,2,"TEXTFILE,S,R"
120 REM READ 40,000 BYTES OF DATA
130 FOR L = 1 TO 1000
140 INPUT#1,A$
150 NEXT
160 CLOSE 1
```

*Table 1: Write and read times for the sequential file programs in listing 1. Times are in minutes and seconds.*

	1541 Drive	RAMDISK-64
Write	2:07	1:22
Read	1:54	1:24

*Table 2: Save and load times for two files. Times are in minutes and seconds.*

**17K-byte assembler source file in BASIC format**

	1541 Drive	RAMDISK-64
Save	0:46	0:02
Load	0:52	0:02

**34K-byte BASIC program**

	1541 Drive	RAMDISK-64
Save	1:28	0:03
Load	1:22	0:03

**PERFORMANCE**

RAMDISK-64 was quite impressive in the speed test. To be consistent, I ran all the benchmarks with RAMDISK-64 connected and Fast-Drive in memory. Listing 1 presents the programs used to write and then read the files. RAMDISK-64's performance with sequential text files was less than twice as fast as the 1541 drive (see table 1). This is peculiar, yet better than no increase at all.

Then I loaded and saved a 17K-byte BASIC program for my assembler and a 34K-byte BASIC program to both the 1541 and RAMDISK-64. The results were much more impressive (see table 2). Using RAMDISK-64, I could assemble my program to memory, test it, reload the source code, make changes, save the source code again, then reassemble without going to the "physical" disk drive. And, as the times demonstrate, loading and saving was very fast indeed.

**CONCLUSIONS**

RAMDISK-64 is a well-engineered module, and the manufacturer provides some software support. Still, P Technologies could improve the product by including a separate power supply to preserve RAMDISK-64's contents when the computer is off, a program to use part of RAMDISK-64 as a printer buffer/spooler, and a battery pack to allow using the RAMDISK-64 cartridge for file transfer between computers.

RAMDISK-64 has enhanced my programming environment by providing unusual speed on the Commodore 64. At last I can change and resave a program without the long wait for the 1541 drive. At the end of a session, I can transfer the work from RAMDISK-64 to an actual disk with little bother. RAMDISK-64 is a solid addition to the Commodore 64, and software writers will find it an indispensable aid. ■



# TIME & MONEY

SemiDisk is the disk emulator that saves you more of both.

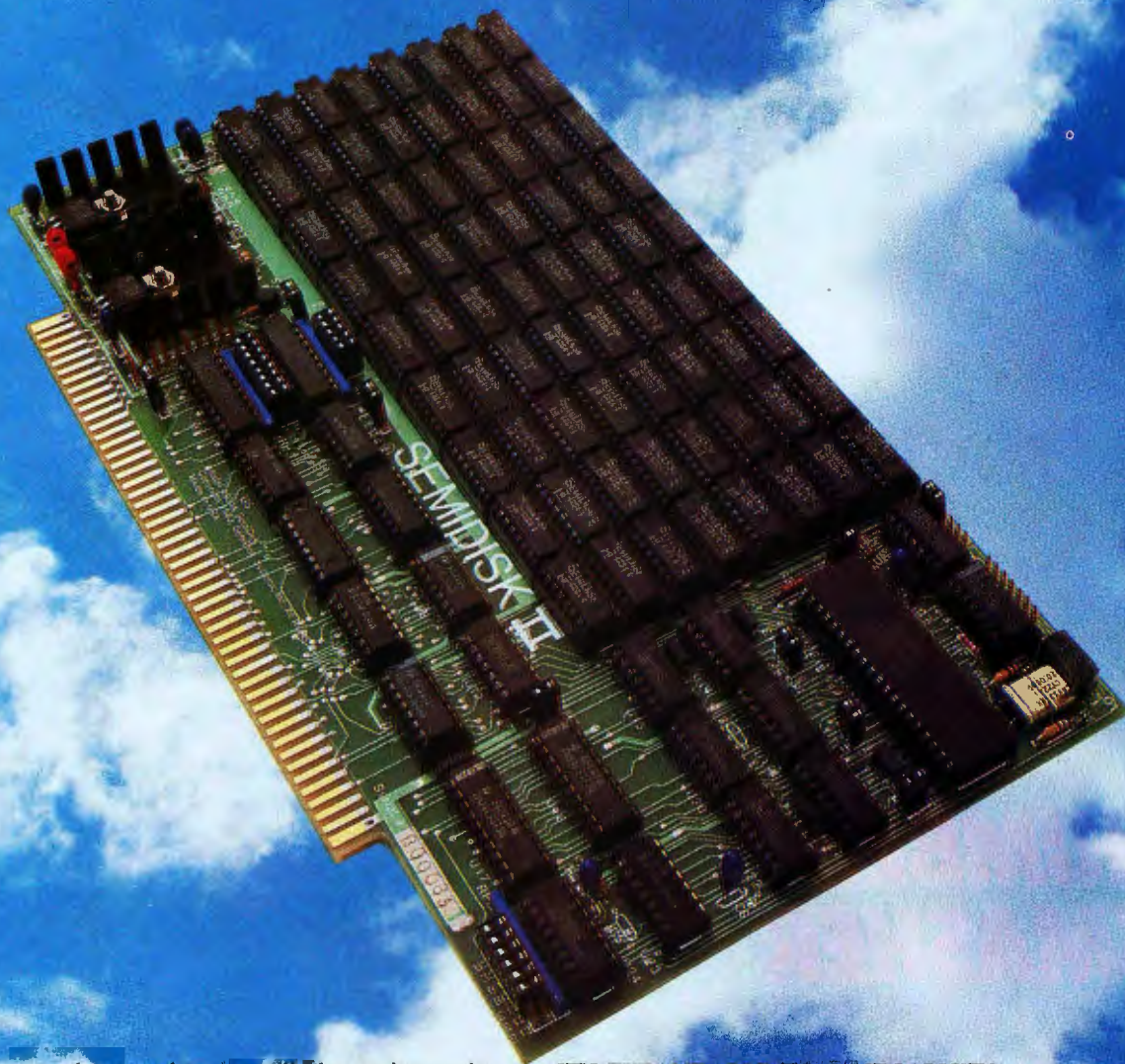

We've just done something we know you'll like. We've made the SemiDisk far more affordable than ever before. With price cuts over 25% for most of our product line. Even our new 2 megabyte units are included.

#### COMPARE WITH THE OTHERS.

SemiDisk Systems builds fast disk emulators for more microcomputers than anyone else. S-100, IBM PC, Epson QX-10, TRS-80 Models II, 12, and 16. Up to 2 megabytes per board, standard. Up to 8 megabytes per computer, using only four bus slots, max! Software drivers are available for CP/M 80, MS-DOS, ZDOS, TurboDOS, VALDOCS 2, and Cromix. SemiDisk turns good computers into great computers.

#### GREAT NEWS FOR IBM PC AT USERS.

New MS-DOS 3.0 software drives take full advantage of the 80286's expanded instruction set, moving data four times faster than can be done on PC or XT.

#### BATTERY BACKUP, TOO.

At 0.7 amps per 2 megabytes, SemiDisk consumes far less power than the competition. And you don't have to worry if the lights go out. The battery backup option gives you 5-10 hours of data protection during a blackout. Nobody else has this important feature. Why risk valuable data?

#### IT'S EXPANDABLE TO 8 MEGABYTES.

You can start with as little as 512K bytes, and later upgrade to 2 megabytes per board. At your own pace, as your needs expand.

In an IBM PC, XT, and AT you can have multiple drives on a single system. And the SemiDisk gives you mainframe performance on the top of your desk.

#### AND THE BEST NEWS IS SAVED FOR LAST:

	512K	1Mbyte	2Mbyte
SemiDisk I, S-100	\$695	\$1395	
SemiDisk II, S-100	\$995		\$1995
IBM PC, XT, AT	\$695		\$1795
QX-10	\$595		\$1795
TRS-80 II, 12, 16	\$695		\$1795
Battery Backup Unit	\$150	\$150	\$150

## SEMIDISK

SemiDisk Systems, Inc.

P.O. Box GG, Beaverton, Oregon 97075

503-642-3100

Inquiry 328







# NUMBER SMASHER

## Speeds Up Everything...Especially 1-2-3™!

The MicroWay NUMBER SMASHER triples the speed of all cpu bound software while doubling the speed of 8087 bound software. When combined with MicroWay's FASTBREAK™ it results in an increase in the speed of 1-2-3™ of up to 80 to 1! If you're tired of WAITing, the SMASHER is the card for you!

The heart of the NUMBER SMASHER is a 9.54 mhz 8086 working with a matched high speed 8087. The card comes standard with 512K of 16 bit RAM and can be expanded to 640K. It triples the throughput of your original 8088 by doubling the system clock speed and quadrupling the data bus bandwidth.

Software compatibility is guaranteed by the nature of our card. It does not augment the 8088, but replaces it with a special 8086 that runs as a true 16-bit processor in the first 640K of ram and as an 8-bit processor everywhere else.

Examples of software which show dramatic speed-ups include AUTOCAD, 1-2-3™ worksheets which depend heavily on financial or transcendental functions, and multi-user operating systems. Any program written with an MS-DOS compiler that supports the 8087, such as MS-FORTRAN or 87BASIC, will run on the NUMBER SMASHER at least a factor of 2.5 times faster! Software that comes with the card also increases the throughput of I/O bound programs and includes a disk cache routine, ram disk and print spooler.

The NUMBER SMASHER is an upgrade product for 8088 based PCs and compatibles. It works on the IBM-PC and XT, the COMPAQ and compatibles manufactured to the IBM-PC hardware standard. Contact MicroWay or your local MicroWay Installation Center for technical specifications and supporting benchmarks.

**Micro  
Way**

*The World Leader in 8087 Support*

P.O. Box 79, Kingston, Mass. 02364 USA (617) 746-7341

NUMBER SMASHER and FASTBREAK are trademarks of MicroWay, Inc. LOTUS and 1-2-3 are trademarks of Lotus Development Corp.





## Keyport 717

### An alternative to the standard Apple keyboard

BY DAVID L. SALAHI

**T**he Keyport 717 from Polytel Computer Products is a touch-sensitive membrane keyboard that you can use as an alternate input device to the normal Apple keyboard. It has 717 key locations that you can program to mean anything you desire. By using a plastic overlay, you can develop custom applications so you can execute functions by simply pressing the appropriate spot on the keyboard (see photo 1).

I don't expect any single application would ever use all 717 keys; that would be too confusing. Rather, you would leave blank space between some keys and make other keys "larger" by grouping two, three, or more locations together.

Using the Keyport 717 as an input device lets you avoid using the regular computer keyboard; non-typists can approach the computer much more easily. Also, with so many keys, you have that many more options available all at once. This reduces the need to traverse through menus or memorize command sequences. In addition, you can label the keys with the actual function, obviating the need to remember that D is for delete and L is for list. By grouping the keys in a logical fashion and appropriately using color and shape, you have the potential to develop a user interface far superior to anything currently available.

#### DESCRIPTION

Physically, the Keyport 717 is a plastic box measuring 26 inches wide by 13 inches deep by 2½ inches high at the back, sloping to 1½ inches high at the front. It plugs into the Apple's game connector so it does not take up a slot. The connecting cable is only about four feet long, however, and this limits the Keyport's placement. Since I wanted to place it on the left side of my desk and since the cord was connected to the opposite end of the Keyport, its placement was severely restricted. I would have welcomed another two or three feet, particularly when I wanted to remove it from

my desk to use the standard keyboard.

Also, the Keyport's active area is only 9 by 22 inches. This amounts to about 40 percent of the top surface area that is essentially wasted space. If the unit could be repackaged without this excess, it would be much easier to fit onto a desk or other working area.

The key locations themselves are about ⅜ inch square and seem to be about the right size. In the front middle of the Keyport is a section devoted to a QWERTY keyboard so you can do all your work from it. Several plastic overlay templates define the keys with the desired meanings for various applications.

Since it is a membrane keyboard, the Keyport has no actual up-and-down key motion, so it has no "feel." This is a distinct disadvantage that I will discuss in more detail below. The manual warns that the surface is sensitive and cautions users not to place heavy objects, such as books, on it. If a heavy object is left on the unit for several days, a short or open circuit could occur and lead to malfunction. This characteristic of the unit excludes it from use in any environment where the risk of mistreatment exists (such as schools).

The Keyport works with the Apple II, II+, or IIe. I tried mine on a Franklin Ace and it seemed to work, although I had trouble running the Safari game. The Keyport does not work with 80-column cards or with lowercase.

For those who are not interested in programming new applications, the Keyport supports several prepackaged ones. These include templates for VisiCalc, Applesoft BASIC, and a new one for Apple Writer IIe. Also, two educational games for children called Safari and Farm even feature on-screen graphics and sound.

#### BASIC INTERFACE

The BASIC Interface is a prepackaged application with an overlay that lets you enter

*(continued)*

*David L. Salahi is a programmer with eight years of experience in civil engineering applications and an A.A. degree in computer science. He can be reached at 90 Streamwood, Irvine, CA 92714.*



**AT A GLANCE**

**Name**

Keyport 717

**Type**

A 717-key programmable membrane keyboard that attaches to an Apple II, II+, or IIe through the joystick port

**Manufacturer**

Polytel Computer Products Corp.  
2121 South Columbia, Suite 550  
Tulsa, OK 74114  
(800) 245-6655

**Size**

26 inches wide, 13 inches deep, 2½ inches high in back, sloping to 1½ inches high in front

**Options**

VisiCalc Interface	\$39.95
Farm (educational game) Interface	\$29.95
Farm Interface for ECHO II speech synthesizer	\$39.95
Safari (educational game) Interface	\$29.95
Safari Interface for ECHO II speech synthesizer	\$39.95

**Documentation**

30-page manual

**Price**

Keyport 717 with BASIC overlay and disk with configuration programs \$179

BASIC commands by pressing a key on the Keyport (reducing entire words to a single keystroke). All the standard commands are available on the Keyport and are grouped logically together into attractive color-coded areas. Areas are provided for low-resolution and high-resolution graphics, text display and printing, string functions such as LEN and MID\$, arithmetic functions, disk utilities, and disk-access commands. A nice convenience is an area called Operators that contains all the keys you must normally shift (!, @, #, \$, %, and so on) that can be obtained from the Keyport without shifting.

To use the BASIC Interface, you boot DOS and then boot the BASIC Interface disk supplied with the unit. At this point, you may enter any BASIC command by selecting it from the Keyport. For example, to set a color in low-resolution graphics, instead of coding a statement such as COLOR = 3, you press the purple button on the BASIC overlay. The phrase COLOR = 3 automatically appears on the screen. To code a FOR loop, press the button corresponding to FOR and the word appears. At the end of the loop, press the word NEXT and it appears.

Some useful command sequences are programmed into the BASIC Interface, such as TEXT : HOME : LIST, making graphics programming much easier. Also provided are 16 additional undefined keys that let you

define your favorite command sequences.

A tutorial program on the disk walks you through the construction of a program using the Keyport BASIC Interface. The tutorial is very well done, and by the end of it I found it simple to construct programs using the device.

The drawbacks to programming with the Keyport have to do with two features inherent in its design. One is the keyboard's lack of feel. Since there is no key motion, you are sometimes not sure whether you have actually pressed a key. Fortunately the Apple's speaker is used as a key click. Still, the lack of feel limits the speed with which you can press the keys, making the Keyport less comfortable than a conventional keyboard.

The lack of feel is compensated for in large part by the reduction of many keystrokes to one or two for BASIC commands. However, you will still have to enter a fair amount of text with the regular keyboard or the QWERTY keyboard on the Keyport. It's just not practical to switch between the Keyport and the Apple's keyboard unless you enter large portions of text relatively infrequently. This means that to enter little bits of often occurring text, you must use the QWERTY keyboard on the Keyport. For this purpose, the Keyport's membrane keyboard is very slow and unwieldy. However, the user of an application program designed for the



Photo 1: The Keyport 717 with the BASIC programmer's overlay.

## REVIEW: KEYPORT

Keypoint would primarily be selecting functions. The entry of text would be less and the Keypoint's use would be more feasible.

The other drawback to the Keypoint is its large size. It is about as large as an entire Apple computer and it's not easy to find room on the average desk for a device this size. This is especially true if you want it to be in a position suited to comfortably viewing the monitor.

### BOARD DEFINITION PROGRAM

Developing a program that uses the Keypoint as an input device involves three steps. First you must design an overlay with the positions of the various functions located on the surface. For this purpose, two clear plastic overlay sheets are provided that you can write on with a felt-tip pen to lay out the positions of function buttons.

Once you have designed the overlay, you create a Key Data Table to let the Keypoint monitor know what functions you have placed at what positions on the keyboard. You may assign a function number and a string of up to 250 characters to each key position. These two items will be returned to the application program whenever you press a key. Each key may have both a shifted and an unshifted code. Key Data Tables are created by running a Board Definition program. This program is very straightforward; you press each key you wish to define and enter the associated function number and string. When all the keys are defined, the table is saved on disk.

Several tables may be stored on a disk. The Hello program specifies which one is to be used when you boot the disk. It is a simple matter to create a modified copy of the Hello program that you can run at any time to load in a new data table.

Once the Key Data Table and the Keypoint Monitor have been loaded from disk, an application program may access the Keypoint either by using a Get or Input statement or by calling an assembly-language routine provided. Once a key has been pressed, the key number, its function

*The Keypoint is about  
as large as an entire  
Apple computer and  
it's not easy to find  
room on the average  
desk for a device  
this size.*

number, and its associated string may be accessed. These parameters, as well as the type of key (Keypoint or keyboard), are retrieved by a series of PEEKs.

### DOCUMENTATION

The small programmer's reference manual is not at all clear on exactly how to make use of the Keypoint's functions. It seems to be disorganized so you have to keep flipping back and forth. Also, you have to read between the lines; some of the information is not explicitly stated. A novice programmer would have a difficult time trying to use this manual.

A good working knowledge of the Apple is helpful and, in fact, some assembly-language experience would be useful. For example, when the manual tells you to PEEK(513), PEEK(514), . . . , to get the string corresponding to the pressed key, it makes more sense if you know that these locations are the keyboard input buffer.

### CONCLUSIONS

The Keypoint 717 is an interesting concept with great potential for improving the human-machine interface. However, the execution of the concept leaves something to be desired, chiefly in the areas of keyboard feel, unit size, and ruggedness. With these caveats in mind, I recommend it for those who are looking for an alternative to the standard typewriter-style keyboard as an input device. ■

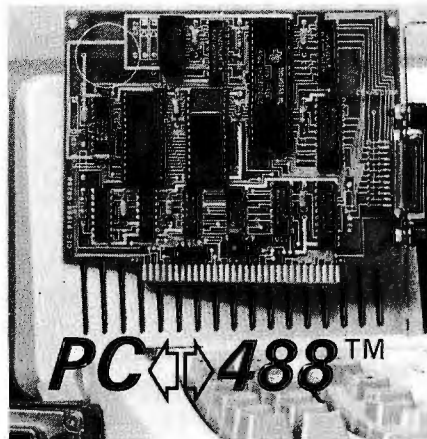

**An IEEE-488 interface for all  
IBM-PC's and COMPATIBLES**

### VERSATILE

Easy-to-use commands for all IEEE-488 (GP-IB, HP-IB) functions.

Resident firmware supports **BASIC, Pascal, C, and FORTRAN.**

Emulates Hewlett-Packard controller functions and graphics language statements.

Supports Tektronix® Standard Codes and Formats.

Print listings, plot graphs, and use **Lotus 123™** with IEEE-488 peripherals.

### FAST

Direct memory transfer rates to 800K bytes/second.

### PROFESSIONAL

Clear and concise documentation includes a complete tutorial; programming examples, and application programs.

**\$395.00 complete.** There are no additional software charges.

Find out why **PC488** is the first choice of over 500 companies.



**CAPITAL EQUIPMENT CORP.**

10 Evergreen Avenue  
Burlington, MA. 01803  
(617) 273-1818

IBM is a trademark of International Business Machines Corp.  
Lotus 123 is a trademark of Lotus Development.  
Tektronix is a trademark of Tektronix, Inc.



# SAM 3001<sup>®</sup>, THE ALTERNATIVE!

Smart institutional buyers throughout the world have been choosing us as their primary supplier of microcomputers since 1982. That's because here at HiTech, we offer our customers mainframe consideration on a micro budget.

Now, we are teaming up with SAMSUNG, the 7 billion-strong Korean giant, to form a unique marketing/manufacturing combination which will make HiTech the forerunner when others have already vanished. Backed by SAMSUNG's stability and the confidence built upon us, we now introduce the SAM 3001 AT.

Whether you are a corporation for profit or otherwise, a VAR, OEM or a Systems House, we are equipped to back you with the support you require. Call us to discover the HiTech frontier. We are ready to be your partner for the new beginning.

## STANDARD FEATURES ON SAM 3001

- Genuine IBM AT compatibility
- 80286 CPU with optional 80287 co-processor
- 8 Expansion Slots, 640K to 1MB RAM on Board
- 1.2MB floppy disk drive
- 30MB voice coil hard disk drive
- Mono-graphics board with optional RGB
- 1 parallel and 2 serial ports
- Optional LAN and multi-user interface, and tape back-up
- 1 year warranty



Amsterdam O20 84 31 38  
Dusseldorf O211 395094  
London O524 381 423  
Paris (1) 597 45 29



**HiTech**  
International, Inc.

1180-M Miraloma Way  
Sunnyvale, CA 94086  
(408) 738-0601, TLX 501422HIT

IBM is a trademark of IBM.  
SAMSUNG is a trademark of Samsung Group.  
SAM 3001 is a trademark of HiTech International, Inc.

## SIDEKICK COMMENTARY

Mark J. Welch's "Convenience Software" review (June, page 353) contained many serious errors regarding SideKick.

First, SideKick is available in two versions, unprotected (\$84.95) and protected (\$54.95). There are currently more than 300,000 SideKick users worldwide. The article's statement that SideKick "appears to be designed for programmers" is inaccurate. We are second in business software on the Softsel Hot List.

The ASCII table in SideKick hardly relegates the product's usefulness to the domain of programmers. Many of our customers use the extended ASCII character set for graphics purposes. You can draw boxes, bar charts, and the like for memos and other basic reports by marking the displayed symbols in the chart and importing them into SideKick's notepad. The Ctrl-Q-G command in the notepad will do the rest.

SideKick's auto-dial facility does not require resetting DIP switches (this change was made in September 1984). The telephone dialer in the package actually picks numbers off the screen, beginning at the top and then scanning the screen. The right-arrow key allows scrolling through numbers, and the space bar automatically brings up the Rolodex. The Rolodex functions like a free-form database and stores up to 1500 entries in any format. Addresses and comments can have any format whatsoever and take as many lines as you want. These entries can be retrieved by a keyword or string. With the current version of SideKick (1.5) you can also use the Rolodex with or without a modem.

SideKick does use many WordStar commands. However, you can redefine those commands through the installation program to look like your favorite word-processing programs.

In addition, SideKick provides two ways to print out information: Ctrl-K-P will print a marked block or the entire page if no block has been marked and Ctrl-K-W lets you write a block to any file or logical device including a printer.

SideKick's window management is more powerful than that of most products in the desktop category. With SideKick, users can shrink or expand windows and move

windows around the screen. In addition, the program's main menu will appear on the screen if a hesitant user presses the Alt key without an identifier. In other words, SideKick "senses" that the user is unsure which window he or she wishes to invoke and provides the main menu to assist the user in choosing. And at any point, the user can press F1 and get the on-line help window relative to the current active window.

SideKick 1.5 contains many new features, including automatic word wrap, setting of right margin for word wrap, and reformatting paragraphs. You can also export data from the notepad into other applications in use for true cut-and-paste capability and use the Rolodex with or without a modem hookup. SideKick 1.5 supports more modems, including AT&T, VOAD keyboard phone, PCjr internal modem, and all Hayes-compatible modems. SideKick recognizes a system with two active monitors, even if one is color and one monochrome, and no reinstallation is required. You can specify a hot key to activate SideKick. Finally, this package is compatible with SuperKey and can be called from SuperKey, making SideKick a programmable desktop manager and providing you with RAM-resident macro definition and encryption capability.

PHILIPPE KAHN  
Borland International  
Scotts Valley, CA

*As Mr. Kahn notes, the prices for both versions of SideKick were raised early this year.*

*I can't dispute SideKick's phenomenal commercial success, but I stand by my opinion that it was designed for programmers.*

*The version of SideKick I reviewed (1.10C) required that I reset the DIP switches on the modem. I'm glad this is not required in later versions. As noted in the review, I was unable to auto-dial a number picked out from another task; I assume I will be able to use this feature in the current version. I can't agree with Mr. Kahn that the standard text file used in the auto-dialer is best described as a free-form database, although he correctly points out that you can search the file for*

*text strings. While you can use multiple lines for an entry, you can only auto-dial a number on the current line.*

*SideKick's notepad can print files. I'm not sure why I believed that it could not do so, but both the manual and help files explain that Ctrl-K-P will print the current block or file. I apologize for the error.*

*Mr. Kahn is correct in noting that you can use SideKick's installation utility program to reconfigure the word-processor commands; however, the product is shipped using the standard WordStar command set.*

*I'm glad SideKick has been upgraded to version 1.5 and look forward to seeing the new version.*

—MARK J. WELCH  
Staff Writer

As a SideKick aficionado, I enjoyed the "Convenience Software" review. Mr. Welch states that SideKick's notepad cannot paste or feed information into an application. I share his disappointment. When I began using SideKick, I searched the manual for the documentation on this feature I knew had to be there. It wasn't.

As for printing, if you wish to print only part of the notepad file, you can use the WordStar block commands Ctrl-K-B and Ctrl-K-K to mark the beginning and end of what you want to print. Then press Ctrl-K-P to print. Be sure to include the carriage return at the end as part of the block. If you fail to do so, your printer might not print the last line of the block and the tabulation of the first line of the next printed block will be wrong.

Mr. Welch states that SideKick required him to reset the DIP switches on his modem and he could not get the auto-dial feature to work. Without resetting the DIP switches on a Hayes Smartmodem, I had no problem with the auto-dialer after I inserted a "P" (for pulse dialing) before each of the phone numbers in my directory. However, after SideKick begins dialing a number, it says, "Pick up phone and press space." If you pick up the phone before the dialing sequence is completed, the call will be aborted.

I found the copy-protected version of SideKick quite cumbersome. I quickly

(continued)



traded up to the unprotected version so I could copy SideKick and an AUTO-EXEC.BAT file onto each of my software disks. Loading SideKick from a second disk is too much bother.

To invoke SideKick, you press the Ctrl and Alt keys simultaneously or press both shift keys. The first method is adequate. The second is a nuisance. More than a few times I have typed a series of capital let-

ters and found that I had activated SideKick inadvertently when moving back and forth between the two shift keys.

I look forward to the promised release of SideKick Plus, an extended SideKick that is supposed to offer multiple notepads, a window manager, a business calculator, an IRS log system, DOS filers, built-in telecommunications, and true text reformatting and blocking capabilities. Given

SideKick's current capabilities, SideKick Plus might provide users more conveniences than the long-awaited IBM TopView and Microsoft Windows.

JEFFREY S. ROYER  
Burke, VA

**THE MINDSET PC**

I would like to correct a misleading impression left by Tom Wadlow's recent review "The Mindset Personal Computer" (June, page 324). Limicon's \$500 ProDraw graphics software is the basis of the new television game show "Catch Phrase," not Lumena and GW-BASIC. In "Catch Phrase," the contestants must guess the phrase suggested by a short ProDraw "cartoon" containing a visual pun. Each day "Catch Phrase" will need 25 completely new, high-quality, animated puzzles. Only ProDraw gave the show's producers the ability to turn their idea into a television show.

A single studio technician uses other Limicon software to control the various puzzles and special effects in response to the contestants' puzzle selections and answers. The Mindset is being used on "Catch Phrase" because ProDraw graphics look better on it than on the IBM PC and because it has a good NTSC video signal.

HOWARD GOODMAN  
Limicon Inc.  
Toronto, Ontario, Canada

Thank you for your review of the Mindset PC. It presented a good introduction to one of the best-kept secrets in computerdom.

I purchased a Mindset nearly a year ago, largely on the strength of BYTE's product preview (April 1984, page 270). I was looking for a machine that provided a standard video output, a fast true 16-bit processor, and 16 colors in medium resolution. I planned to use the system to produce animated software tutorials on video cassettes. I looked at many other systems, but not one met all my criteria in the form of a single off-the-shelf package like the Mindset.

This machine has far exceeded my expectations. In addition to giving me everything I needed, it gave me a much-enhanced version of MS-DOS with built-in graphics primitives and animation functions, and graphics hardware features that include double-frame buffering and a graphics coprocessor that is unmatched in any other machine in the same price range. In spite of the many new graphics products that have come to market since I got my machine, the Mindset is still a

(continued)

# GIVE YOUR PC THE GIFT OF SIGHT.

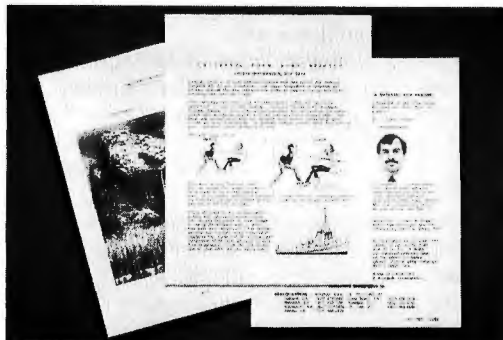

Once installed, our electronic digitizing scanner allows you to capture images in high resolution. These can then be manipulated, stored, retrieved, and even printed.

But what's truly amazing is the range of applications for the Datacopy 700. Such as generating complex documents including text, drawings and pictures.

Until now, your PC was telling only half the story. Because no matter how you look at it, words and numbers are simply that: words and numbers.

But the Datacopy 700 changes all that. **TURN YOUR WORD PROCESSOR INTO AN IMAGE PROCESSOR.**

This remarkable peripheral enables you to combine photos, diagrams, even 3-D objects with word processing, data base, CAD and communications applications using standard software.

All you need to get the picture is an IBM XT, AT, or compatible. Our friendly, yet powerful, Word Image Processing System™ software is included in your purchase.

Technical manuals. Catalogs. Personnel or document files. Or what ever you decide.

The result is a visionary achievement: the power to give words and numbers far more meaning. To publish information, not just data. And to extend the possibilities of your PC. All for a surprisingly low cost.

For more details, call toll-free 1-800-821-2898 or in California 415-965-7900. Or write to Datacopy Corporation, 1215

Terra Bella Avenue,  
Mountain View,  
CA 94043. Telex:  
701994 DATA-  
COPY UD.



**DATACOPY**  
The Eye of the Computer

For fastest response, call 1-800-556-1234 or in California 1-800-441-2345. Ask for extension 96.

# GET THE KNOW-HOW TO REPAIR EVERY COMPUTER ON THIS PAGE.

## Learn the Basics the NRI Way—and Earn Good Money Troubleshooting Any Brand of Computer

The biggest growth in jobs between now and 1995, according to Department of Labor estimates, will occur in the computer service and repair business, where demand for trained technicians will actually double.

You can cash in on this opportunity—either as a fulltime corporate technician or an independent serviceperson—once you've learned all the basics of computers the NRI way. NRI's practical combination of "reason-why" theory and "hands-on" building skills starts you with the fundamentals of electronics, then guides you through advanced electronic circuitry and on into computer electronics. You also learn to program in BASIC and machine language, the essential languages for troubleshooting and repair.

## You Build—and Keep—a Sanyo MBC-550-2

The vital core of your training is the step-by-step building of the 16-bit Sanyo MBC-550-2 computer. Once you've mastered the details of this state-of-the-art machine, you'll be qualified to service and repair virtually every major brand of computer, plus many popular peripheral and accessory devices.

With NRI training, you learn at your own convenience, in your own home. You set the pace—without classroom pressures, rigid night-school schedules, or wasted time. You build the Sanyo MBC-550-2 from the keyboard up, with your own personal



IBM is a Registered Trademark of International Business Machine Corporation.

Epson is a Registered Trademark of Epson America, Inc.

Apple and the Apple logo are Registered Trademarks of Apple Computer, Inc.

Compaq is a Registered Trademark of COMPAQ Computer Corporation.

© 1984 AT&T Technologies, Inc.

using machine language. You'll also prepare the interfaces for future peripherals such as printers and joysticks.

## 100-Page Free Catalog Tells More

Send the postage-paid reply card today for NRI's big 100-page color catalog on NRI's electronics training, which gives you all the facts about NRI

courses in Micro-computers, Robotics, Data Communications, TV/Video/Audio Servicing, and other growing high-tech career fields. If the reply card is missing, write to the address below.

# AND MORE.

NRI instructor and the complete NRI technical staff ready to answer your questions or give you guidance and special help whenever you need it.

Praised by critics as the "most intriguing" of all the IBM-PC compatible computers, the new Sanyo uses the same 8088 microprocessor as the IBM-PC and features the MS/DOS operating system. As a result, you'll have a choice of thousands of off-the-shelf software programs to run on your completed Sanyo.

Your NRI course includes installation and troubleshooting of the "intelligent" keyboard, power supply, and disk drive, plus you'll check out the 8088 microprocessor functions,



Your NRI course includes the Sanyo MBC-550-2 Computer with 128K RAM, monitor, disk drive, and "intelligent" keyboard; the NRI Discovery Lab®, teaching circuit design and operations; a Digital Multimeter; Bundled Spread Sheet and Word Processing Software worth \$1500 at retail—and more.

**NRI** SCHOOLS  
McGraw-Hill Continuing Education Center  
3939 Wisconsin Avenue, NW  
Washington, DC 20016



We'll Give You Tomorrow.



For IBM-PC Add-On Users

# In A Pinch? Give QIC The Inch

**We Have the Right Products ... at the Right Prices  
... Right Now!**

Mass Storage at  
Massive Savings

**QIC-01 10, 20, 32 MB Internal  
Hard Disk Subsystem**



10MB \$545  
20MB \$695

This low power Microscience sub-system comes complete with controller, cables, drive, easy instructions. Fits inside your floppy slot. Compatible with DOS 2.0, 2.1, and 3.0 without any patches. 32 MB half-height w/controller, \$1,295 ... 20 MB Drive for the PC AT, \$895. Mounting hardware for Compaq is available. External 10 MB \$695, external 20 MB \$895.

**QIC-03 300/1200 Baud  
Modems**

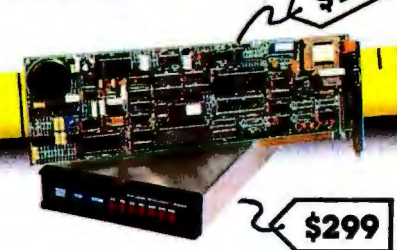

\$199

\$299

Our modems are fully Hayes compatible with features such as low heat dissipation, low power consumption, software volume control for the speaker, and large-scale-integration "Modem on a chip" for high reliability. It also comes with communications software which lets you emulate VT100 or IBM 3101. Half-size Internal \$299.

More Functions ...  
Less Cost

**QIC-05 Multi-Function Card**

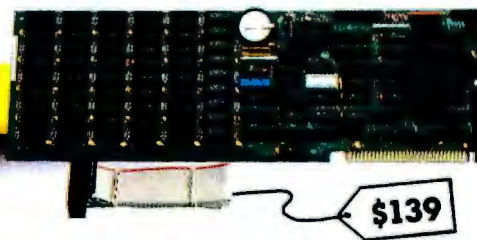

\$139

It gives you more than just added memory. It gives you reliable memory expansion (up to 384K), a serial port, a parallel port, a game port, and a battery back-up clock calendar. Includes RAM disk print spooler, and clock utilities. (The 64K RAM set is only \$15.) With 2 serial ports \$175.

**QIC-20 External Hard Disk  
with Tape Backup.**



\$1955

20 MB hard disk with a 20 MB tape backup unit in a chassis with two extra I/O slots. Comes with cable and a half size host adapter card. 20 MB hard disk with 60 MB tape is only \$2450.

**QIC-02 10, 20, 60 MB  
Half-Height Tape  
Back-up Systems**

Out of slot? On budget? Our 1/2 height tape back-up unit plugs into the back of your floppy controller. It works like a floppy disk so you can use all the DOS file commands such as COPY or DIR. Back-up 10 MB in 15 minutes. Our

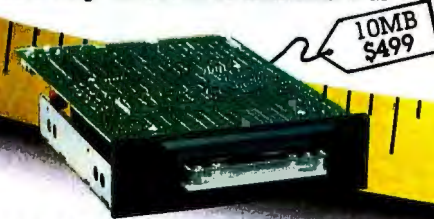

10MB \$499

20 MB cassette and 60 MB cartridge back-up systems come with controller, cables and drive. Back-up 20 MB in 6 minutes. You can even do fast Image back-up and then file-by-file retrieval. Works on IBM PC, XT or AT. Internal 10 MB \$499, 20 MB \$699, 60 MB \$899. External 10 MB \$675, 20 MB \$875, 60 MB \$995.

### Graphics Boards

- Hercules, Color ..... \$185
- Hercules Compatible, Mono \$199
- Color Graphics Card ..... \$125
- Everex Graphics Edge ..... \$295

### Half Size Cards

- Memory card with
  - ØK ..... \$ 99
  - 384K ..... \$175
  - 576K ..... \$225

- I/O card with 2 serial ports,  
1 parallel port,  
clock/calendar ..... \$125

- Internal Power Supply
  - 135 Watt ..... \$ 99
  - 150 Watt ..... \$115

- Expansion Chassis with  
I/O Slots ..... \$695
- IBM PC, 256K, 2 Drives ..... \$1499

### We Guarantee Satisfaction!

No Risk. All our products carry the manufacturer's warranty. And remember, if for any reason, you are not completely satisfied within 30 days, you can return it for a full refund.

**Call Us Today!**  
**(408) 942-8086**

Telex: 5101002379 QICRCH

**QIC RESEARCH**  
INCORPORATED  
Inquiry 303  
489 Valley Way  
Milpitas, Ca 95035  
QIC-405

leader, and it's getting better all the time.

Mindset has recently released several new products that were not mentioned in your review. They include a 128K-byte memory-expansion module, a 10-mega-byte external hard disk, an analog RGB interface, and a real-time color video-image digitizer.

Mindset is now marketing to video and graphics professionals and other people who realize that there is life after MacPaint. It is doing much better for the change in focus. These are people who need a system like the Mindset and can appreciate its unique capabilities.

TIM NEGRIS  
First Mindset Users Group  
Walnut Creek, CA

Tom Wadlow's system review of the Mindset Personal Computer contained many errors. Mr. Wadlow states that only a mouse was available for review. He neglected to say that it was his fault and not Mindset's. I own a joystick along with the mouse and so know that joysticks are available.

The BASIC Performance test states that the Sieve takes 301 seconds to calculate prime numbers. I used BYTE's corrected version of the Sieve and it ran in 191 seconds—the same as the IBM PC. How could this discrepancy occur? A reader would conclude that the Mindset was almost 20 percent slower than an Apple IIe.

Next, the reviewer announces the Mindset's failure to run Microsoft's Flight Simulator. Had he reviewed Mindset's compatibility chart, he would have realized that this software would not work on the machine. Most of today's better software addresses ROM, but Flight Simulator directly addresses the hardware, making it impossible for the program to run on anything but an IBM clone, which, fortunately, the Mindset is not.

In the text box, Rich Malloy states that "consumer-oriented software such as games has not been developed." Vyper from Synapse Software is an outstanding example of the Mindset's graphics capabilities and it uses a joystick. Odesta has a chess game with three-dimensional graphics.

In the "At a Glance" section, the optional software includes only MS-DOS, BASIC, and Lumena. Over 160 of the most popular PC titles run on the Mindset as well as graphics programs such as 4-Point Graphics Plus (stores images and plays them back sequentially), CADDraft (engi-

neering and architectural scaled drawings with overlays), and Designer (roughly similar to PC Paintbrush). Also, the Price section incorrectly states that a monochrome display is part of the usual configuration.

In the future, please make sure that your reviews have been well researched and provide accurate and reasonably complete coverage of the product. I own a

Mindset, and I wouldn't want to own an IBM clone at half the price.

MARK JOHNSON  
Bryan, TX

*Mark Johnson raises some points that I feel I should address. First, authors do not deal directly with the company involved in a review. All equipment is sent*  
(continued)

# POWER PROBLEMS?



## POWERTRAC™ COMPUTERIZED POWERLINE MONITOR

Powertrac now allows you to troubleshoot your computer's power problems.

Powertrac easily monitors, analyzes and records the power that feeds your sensitive computer.

Powertrac, a state-of-the-art combination of hardware and software that monitors your power while you work and displays your precise problem at a glance. Includes audible power alarm.

Powertrac allows you to do some simple inexpensive diagnostic testing before you order expensive power equipment.

Available for IBM PC and Apple II.

ONLY \$99<sup>95</sup>

Plus \$4.50 shipping & handling. (CA res. add sales tax.)

**vertex**  
systems inc.

6022 W. Pico Blvd.  
Los Angeles, CA 90035

(213) 938-0857

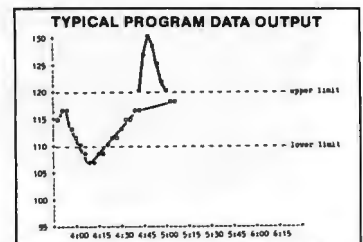

IBM PC is a registered trademark of International Business Machines Corporation.

APPLE is a registered trademark.



directly to BYTE and then shipped to the author writing the review. When I review a product, I can judge it only on the components that were shipped to BYTE. Mindset chose not to include a joystick in the review package. The best I could do was mention the existence of such a device.

Mr. Johnson and I agree that it is unfortunate that Microsoft's Flight

Simulator does not run on the Mindset, although Mr. Johnson seems annoyed that I chose to point this out. I did not expect Flight Simulator to run. In fact, I expected it to fail for the reasons that Mr. Johnson points out. Nonetheless, I tried it, rather than assuming it would fail, and reported the results. In the first paragraph on page 329 of my article, I point out that a great deal of IBM soft-

ware runs directly on the Mindset with no problems.

Mr. Johnson also correctly points out that 301 seconds is far too long for the Sieve of Eratosthenes. However, 3 minutes and 1 second (181 seconds), which is the number I measured, is much more realistic. I apologize for the error, which occurred during the editorial process.

I am pleased that Mr. Johnson enjoys the machine he chose to buy. I am sorry he found so much to disagree with in a review that basically echoes his feelings on the Mindset PC.

—TOM WADLOW  
Livermore, CA

# E-Z-DOS-IT™

gives you  
concurrent processing  
in only 8K of RAM.



Unique, E-Z-DOS-IT™ Concurrent Processing Software lets your PC wear several different hats *at the same time*—and it operates in only 8K of RAM.

With E-Z-DOS-IT, your IBM PC, PC/XT, or PC/AT can run your choice of background tasks while you continue to work at the screen. No waiting, because your single-tasking PC now behaves like two or more PCs. And E-Z-DOS-IT is compatible with the most popular software and hardware on the market today.

To find out more about E-Z-DOS-IT, or to order directly, call toll-free:

**800/228-9602**

In California, call 800/423-5592

Ask for operator #10.



Redefining Your PC Productivity.

Hammer Computer Systems, Inc.  
900 Larkspur Landing Circle, Suite 250  
Larkspur, CA 94939. 415/461-7633

E-Z-DOS-IT is a trademark of Hammer Computer Systems, Inc.

The following registered trademarks are acknowledged: IBM PC, PC/XT, and PC/AT — International Business Machines; Lotus 1-2-3 and Symphony — Lotus Development Corp.; dBase II and Framework — Ashton-Tate; Wordstar — Micro Pro International; PFS:File — Software Publishing; Multi-Plan — Microsoft Corp.; Crosstalk — Microsoft, Inc.

## THE COMPAQ DESKPRO

I paid \$2370 for my Compaq Deskpro Model 2 (two 360K-byte drives, 256K bytes of memory) from a full-service dealer, and it was a better buy than an IBM Personal Computer comparably equipped at almost any price. The engineering thoughtfulness of the Deskpro speaks as loudly as its performance. I thought that reviewer Jerry Grady gave a fair assessment of it (May, page 260). However, I would like to emphasize some grievances for the benefit of potential Deskpro buyers.

Foremost, while the machine documentation is pretty, it is nearly useless. There is no technical manual and Compaq refuses to make one available. An example of frustration: The manual gives not a clue as to how to set the configuration switches for a third disk drive (e.g., RAM disk) and implies that such a configuration is not possible.

The keyboard is cheap-looking plastic that actually rattles when it is moved. The keys are so difficult to use (especially the space bar) that a touch-typist will certainly have to replace it. The green monitor had such a long-persistence phosphor that screen-update ghosts made word processing impossible. A second green monitor was the same. I finally switched to amber, which is satisfactory. A Hercules high-resolution graphics card will not run on the Compaq Deskpro because of an addressing conflict. Other graphics boards will run.

I have had significant problems running large complex dBASE II programs on the Compaq Deskpro. Even in its retarded 8088 mode, the machine seems to confuse dBASE on deeply nested procedure calls and on rapid screen updates. The programs run fine on an IBM PC and a Zenith 150. I have been unable to get

(continued)

# You were smart to buy Turbo Pascal™ back then. Now you'd be smart to sell it.

**AND HERE'S YOUR CHANCE. TRADE IN YOUR TURBO PASCAL AND GET THE MODULA-2 SOFTWARE DEVELOPMENT SYSTEM (M2SDS) FOR JUST \$50.88.**

How can you get the latest in programming efficiency? Simple. Just send us your Turbo Pascal diskette\*—whether it's IBM format or not—and we'll send you M2SDS for just \$50.88. That's \$30 off the regular price.

Why switch? Because Modula-2 was specifically designed by the developer of Pascal, to replace the Pascal language. So you already know the language basics that will help you start programming right away.

And when you combine the power of Modula-2 with all the features of M2SDS, you'll be programming faster than ever—in virtually no time at all.

Just look at all the extras M2SDS includes. And how it outperforms Turbo Pascal in independent studies.

So now that you're wise to Turbo Pascal, why not trade it in? And trade up to the programming efficiency of the future. Get M2SDS for just \$50.88 when you send us your Turbo Pascal diskette. Or, order M2SDS for just \$80.88 without the trade.

Either way, it's one of the smartest moves you can make in programming. And now, it's the best deal going.

*Turbo Pascal is a trademark of Borland International.*

*\*Diskette will be destroyed immediately upon receipt, so that your Borland license agreement is not violated.*

	M2SDS	TURBO 3.0
<b>COMPILE SPEED (MIN:SEC)</b>		
30 LINES	0:09.00	0:02.00
360 LINES	0:25.00	0:05.00
<b>EXECUTION SPEED (MIN:SEC)</b>		
SIEVE	0:13.92	0:15.26
FIBONACCI	0:53.49	1:49.74
30X30 MATRIX (8087)	0:08.84	0:19.28
FP OPERATIONS	0:52.12	0:31.75
FP OPERATIONS (8087)	0:01.97	0:06.21
SYNTAX CHECKING EDITOR	YES	NO
MULTIPLE WINDOW EDITING	YES	NO
EDITOR FILESIZE LIMIT	MEMORY SIZE	64K
COMPILE ERROR CALLS EDITOR	YES	YES
LINKER	YES	NO
PRODUCES .EXE FILES	YES	NO
EXECUTABLE CODE SIZE LIMIT	DISK SPACE	64K
DOS ACCESS FROM EDITOR	YES	NO
DOS ACCESS FROM PROGRAMS	YES	LIMITED
8087 SUPPORT STANDARD	YES	NO
COPY-PROTECTED DISK	NO	NO
COST WITH 8087 SUPPORT	\$80.88	\$109.90

Trade in your Turbo Pascal for M2SDS today. Or, order your copy by completing this coupon.

Enclosed is my Turbo Pascal diskette and a check for \$50.88, plus \$4 shipping and handling.

Enclosed is my Turbo Pascal diskette. Apply charges to the credit card indicated below.

Please send me M2SDS for \$80.88, plus \$4 shipping and handling. My check is enclosed.

Please send me M2SDS for \$80.88. Apply charges to the credit card indicated below.

VISA/MasterCard/AmericanExpress.  
(Circle One)

Credit card # \_\_\_\_\_

Expiration Date \_\_\_\_\_

Name \_\_\_\_\_  
(Signature required for credit card orders.)

Address \_\_\_\_\_

City \_\_\_\_\_

State/Zip \_\_\_\_\_

Price does not include shipping and handling. Texas residents add 6.125% sales tax. International orders add \$30.

INTERFACE TECHNOLOGIES CORPORATION  
3336 Richmond, Suite 200 Houston, TX 77098

Source: Software Resources, Inc.

Sieve program from BYTE, January 1983.

Fibonacci program from Dr. Dobb's Journal, February 1985.

Matrix program from BYTE, October, 1982.

FP Operations program from BYTE, May 1985.

Turbo Pascal without 8087 uses only 6-byte accuracy for type REAL; M2SDS with or without 8087 uses 8-byte accuracy.

Programs compiled with all checking options on. All tests conducted on a standard IBM-PC/XT with 512K of memory and an 8087 math coprocessor.

 **INTERFACE TECHNOLOGIES**

3336 Richmond Ave., Suite 200  
Houston, Texas 77098

**1-800-922-9049**

(In Texas, call 713/523-8422) Telex: 322127

Modula-2 Bulletin Board: 713/523-7255



Listing 1: A self-timing version of the Sieve of Eratosthenes benchmark.

```

2 REM: "SIEVE"
5 CLS:CLS:COLOR 15,1,1:WIDTH 40
6 KEY OFF:CLS
10 PRINT;TAB(4);"The Sieve of Eratosthenes Benchmark":PRINT
20 SIZE = 7000
30 DIM FLAGS(7001)
40 PRINT "Start one iteration":PRINT:PRINT TAB(4);TIMES$
50 COUNT = 0
60 FOR I = 0 TO SIZE
70 FLAGS(I) = 1
80 NEXT I
90 FOR I = 0 TO SIZE
100 IF FLAGS(I) = 0 THEN 180
110 PRIME = I + I + 3
120 K = I + PRIME
130 IF K > SIZE THEN 170
140 FLAGS(K) = 0
150 K = K + PRIME
160 GOTO 130
170 COUNT = COUNT + 1
180 NEXT I
190 BEEP:PRINT:PRINT "Done: ";COUNT;" Primes found":PRINT:PRINT TAB(4);
    TIMES$
    
```

Microsoft Word to use the 9 by 14 high-resolution character set, and the 8 by 8 set that Word wants to use is intolerable. Word uses the 9 by 14 character set on the Zenith 150.

Despite these problems, I can endorse the Deskpro. Having graphics on the monochrome or color monitor is great and compatibility is 99 percent. The machine is fast, quiet, well crafted, and not from IBM.

WILLIAM A. ADAMS  
Seattle, WA

### ANOTHER SIEVE

Listing 1 is a small variation on the Sieve of Eratosthenes benchmark. I feel that any self-respecting benchmark should at least be self-timing.

L. CRAIG REDMOND  
Chicago, IL ■

REVIEW FEEDBACK is a column of readers' letters. We welcome responses that support or challenge BYTE reviews. Send letters to Review Feedback, BYTE Publications, POB 372, Hancock, NH 03449. Name and address must be on all letters.

## Subscription Problems?

We want to help!

*If you have a problem with your BYTE subscription, write us with the details. We'll do our best to set it right. But we must have the name, address, and zip of the subscription (new and old address, if it's a change of address). If the problem involves a payment, be sure to include copies of the credit card statement, or front and back of cancelled checks. Include a "business hours" phone number if possible.*



# BYTE

Subscriber Service  
P.O. Box 328  
Hancock, NH 03458



# *Presenting* JC + PC NETWORK



## WHAT YOU SHOULD, WHAT YOU SHOULD NOT, NOW AND LATER

You don't want to buy a multi-user system without a PC file server capability. You don't want to buy a PC file server without a multi-user capability. The Multi-User File Server (MUFS) is what compliments your needs in performance, growth, and cost.

Selecting the right computer system is the most crucial requirement for your company



growth, because of ever-increasing demand in computer performance and capacity. The computer you purchase now should not be a bottleneck later.

JC Multi-User, Multi-Processor, File Server is the only computer system you can afford to speculate. And Nothing else. . .

Inquiry 199



**JC INFORMATION SYSTEMS**

469 Valley Way  
Milpitas, CA 95035

408 / 945-0318 TLX: 910-381-7041

In Australia: Synax Systems, Ctr. Pacific Hwy & Beaconsfield, Lindfield N.S.W. Australia 2070, Tel: 467-1166 TLX: (790)25468  
In The United Kingdom: Interam Corporation 62 Weir Road Wimbledon, London SW19 8UG, England, Tel: 879-1888 TLX: (851)8954072  
In Europe: COSTEC GmbH Hollandische Strasse 19, 3500 Kassel, West Germany, Tel: 56147268 TLX: (841)99695  
ARECTA System AB Ekensbergsvagen 117, S-171 41 Solna, Sweden, Tel 898-6790 TLX: (854)08986790



HOMEBREW

BYTE 1975-1985

CIC

CUT OUT  
HERE

8

7"

16"

30"

ROBERT  
STINNEY

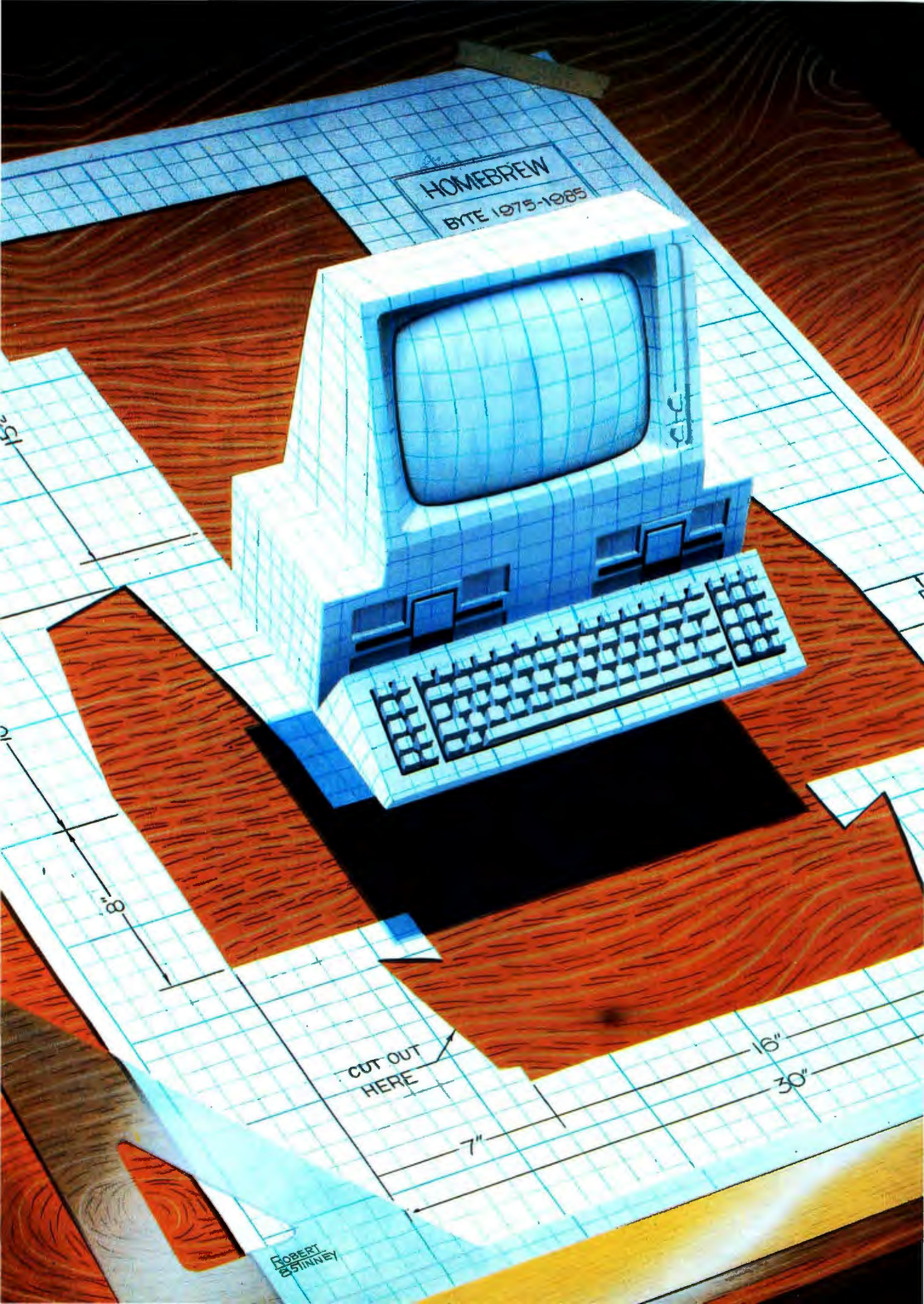

# Kernel

---

**COMPUTING AT CHAOS MANOR:  
PCs, PERIPHERALS, PROGRAMS,  
AND PEOPLE**  
*by Jerry Pournelle* . . . . . **347**

**CHAOS MANOR MAIL**  
*conducted by Jerry Pournelle* . . . . . **382**

**BYTE U.K.: SEVENTH ANNIVERSARY  
OF MICROCOMPUTING**  
*by Dick Pountain* . . . . . **385**

**BYTE JAPAN: A HISTORY OF JAPAN'S  
MICROCOMPUTERS**  
*by William M. Raike* . . . . . **395**

**ACCORDING TO WEBSTER: WEST COAST  
FAIRE, MAC STUFF, AND THE AMIGA**  
*by Bruce Webster* . . . . . **401**

**MATHEMATICAL RECREATIONS:  
 $\pi$ ,  $e$ , AND ALL THAT**  
*by Robert T. Kurosaka* . . . . . **409**

**CIRCUIT CELLAR FEEDBACK**  
*conducted by Steve Ciarcia* . . . . . **416**

**BYTELINES**  
*conducted by Sol Libes* . . . . . **418**

---

The ongoing construction work at Chaos Manor made it desirable for Jerry to escape yet again. He attended a joint press conference held by Microsoft and Apple in New York. The product introduced at the conference, Excel, is a spreadsheet for the Macintosh. Comments made at the press conference caused Jerry to put down some thoughts on software integration and whether or not we need it. He also looked at several new products, including a new version of BASIC from the inventors of the language.

This being our anniversary issue, Dick Pountain brings us a condensed history of personal computing in Great Britain. He also introduces us to a rugged new lap-held portable, the Husky Hunter.

From Japan, Bill Raike sends us an abbreviated history of that country's microcomputers and also discusses an innovative new product from Brother Industries—the SV-2000 Software Vending System.

In this month's According to Webster, Bruce describes his experiences at the West Coast Computer Faire. He discovered that it isn't as much fun as it used to be, but he found some interesting products on display. He also discusses Apple's plans for the Macintosh, predicts success for the Amiga, and looks forward to testing a host of new products.

Bob Kurosaka discusses the world of transcendental numbers in Mathematical Recreations. Some of them are familiar to us, such as  $e$ , the base of natural logarithms, and  $\pi$ . He looks at some hiding places for these two numbers and some ways to approximate their values.



# SuperSoft Languages When Performance Counts

## SuperSoft BASIC 3.0

### The Interpreter Compatible Compiler

Now you can use the superior BASIC compiler for improved performance. SUPERSOFT BASIC. Compatible with the most commonly used interpreter, it compiles larger programs than competing compilers. It comes complete with:

- **Full 8087 Support** – for lightning fast math operations
- **IEEE floating point** – for fast, precise scientific calculations
- **BCD math** – for exact decimal numbers in business applications
- **Fully implemented double precision** – for unbeatable math accuracy
- **Precise error messages/codes and sub-codes** – for simplified debugging

SuperSoft BASIC is highly compatible with Microsoft's BASIC interpreter. For example, it supports the CHAIN with COMMON, COMMON, INPUT, INPUT#, and DEF FN statements in a compatible fashion. IBM's doesn't. It also contains critical features which the IBM BASIC compiler does not:

IMPLEMENTED FEATURES	SUPERSOFT BASIC COMPILER	IBM BASIC COMPILER
8087 Support	✓	
True IEEE Floating Point	✓	
BCD Math Option	✓	
True Double Precision	✓	
Dynamic loop nesting	✓	
CHAIN ALL, CHAIN line number	✓	
RUN, TRON, TROFF, ERASE, CLEAR	✓	

And, to top it off, SuperSoft BASIC:

- Allows easy interface to C and Assembly code.
- Allows 32,767 bytes per record and 65,535 records per random file.
- And requires no run-time license fee for distribution of your compiled code.

SuperSoft BASIC (PC-DOS, MS-DOS, CP/M-86): \$300

## SuperSoft C

SuperSoft's C compilers and C cross compilers are designed to meet the highest standards of quality, reliability, and performance.

- **Over 200 library functions provided in source code form** – for full control over your libraries



- **Full overlay support** – for extremely large application programs
- **Inline assembly code interface** – for easy insertion of assembly code
- **BCD math** – for full decimal accuracy
- **Fully ROMable assembly code output** – for use with the Z80, 8080, 8086, 8088, Z8001, Z8002, and others
- **General compatibility with UNIX version 7 C** – for standard C programming

Available on the most popular operating systems, these features make SuperSoft C your best choice for a professional quality compiler.

SuperSoft C (PC-DOS, MS-DOS, CP/M-80, CP/M-86): \$350

## SuperSoft FORTRAN

For years, serious developers have been using SuperSoft FORTRAN to bring their large applications down to micro-computers. Why? Because SuperSoft FORTRAN offers major advantages over other FORTRAN compilers.

- **For compiling extremely large programs** – extended code and data space (under PC & MS-DOS) plus overlay support
- **For faster math operations** – optional 8087 support
- **For mainframe compatibility** – full ANSI '66 FORTRAN
- **For structured programming techniques** – optional RATFOR preprocessor
- **For those without unlimited memory** – only 128K of memory required
- **For unbeatable math accuracy** – double precision and complex numbers using IEEE floating point
- **For fast, compact code** – buy SuperSoft FORTRAN

SuperSoft FORTRAN

(PC-DOS, MS-DOS, CP/M-86, CP/M-80): \$325

## Outstanding Support Services

SuperSoft's commitment to product excellence and service is unrivaled in the industry. Our technical hotline is staffed by programming professionals to provide prompt, expert assistance. We offer free update notification. And, we customize products to meet your needs.

SuperSoft FORTRAN was developed by Small Systems Services, Urbana, IL.

Japanese Distributor: ASR Corporation International, TBL Building, 7th Floor, 1-19-9 Toranomon, Minato-Ku, Tokyo 105, Japan Tel. 03-05025550 Telex 222-5850 ASRTYO J

# SuperSoft

SuperSoft, Inc., P.O. BOX 1628  
Champaign, IL 61820 Telex 270365

To order, call: 800-762-6629

In Illinois call: 217-359-2112

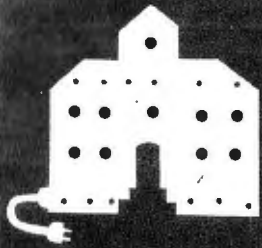

# C·O·M·P·U·T·I·N·G A·T· C·H·A·O·S M·A·N·O·R

## PCs, Peripherals, Programs, and People

Excel

Switcher

Integrated Software

Write-Hand-Man

GRAF 2.0

True BASIC

Gato

Zenith Advanced PC

Omni-Reader

Squire

Incunabula

By Fire and Sword

BY JERRY POURNELLE

**M**ore years ago than I care to remember, "Everything takes longer and costs more" was known in the aerospace industry as Pournelle's Law of Costs and Schedules. (Poul Anderson claims independent discovery.) I've since seen it stated as Cheops' Law, and on reflection I'm willing to concede that since the old pharaoh had to deal with architects and contractors, he probably was aware of it.

In other words, I'm still not in my new offices. I've moved upstairs, but everything—including me—is crammed into the storage room. It's frustrating. Tony Pietsch has my new PC Video board, Concurrent DOS, and even an experimental UNIX for my CompuPro. A new Hewlett-Packard machine and ThinkJet, the AT&T 3B2/300, and the Eagle Turbo PC all sit in my electronics room—but the room is so filled with boxes of books that I can't get into it. Two Macintoshes, one with HyperDrive, the other with MegaMac and a Corvus hard disk, sit in one corner of this room, while on shelves above them is arrayed a vast quantity of new and wonderful MacSoftware—but I can't get to the machines. Sigh. At least I don't have to put up with raspberry carpets.

There's not even an end in sight. The only thing left to do is the floor, but with the new parquet floor partially in place problems developed, and they may have to take it up and start over. Meanwhile, new crews show up on weekends without appointments. I'm fighting to stay sane. I really am.

### QUEST FOR CAFFEINE

Time was that computer companies made their major announcements at the West Coast Computer Faire or the National Computer Conference (NCC). When COMDEX got bigger than both NCC and the Faire, it became the place to show new wares. Lately I've noticed a new trend: companies hold their own press parties, sometimes in San Francisco, often in New York.

I seldom go to these things, which gen-

erally turn out to be long on hype and short on information. However, when Microsoft and Apple announced a New York joint press conference to be attended by Apple's Steve Jobs and Microsoft's William Gates, I was a bit intrigued. I was going to Atlanta for COMDEX three days later anyway. A week before the press conference, Pam Edstrom of the Waggener Group PR firm called to ask if I'd be coming. Just as I picked up the phone, a carpenter began hammering. The monitor screen flickered as someone else turned on a buzz saw. Suddenly it seemed like an excellent idea to be somewhere else.

The conference started at 10:30 a.m. in the Tavern on the Green in New York's Central Park. By my internal clock 10:30 was 7:30, a ghastly hour under any circumstances. Naturally I overslept. The front desk of the New York Athletic Club informed me that New York's taxi drivers were putting on a demonstration, and there were no cabs to be had. I'd have to walk to the conference, and there'd be no time for coffee or breakfast.

That didn't seem important. This was a press conference, right? The first rule for dealing with the press, particularly out-of-town press people, is to have lots of strong coffee. I walked briskly to the Tavern, arriving at 10:15—and found to my horror that although the PR staff had coffee, there wasn't any for the guests. There wouldn't be until after the press conference, at which time there would be an open bar and a free lunch.

I didn't think I'd live that long. As Barry Workman says, "The first cup of coffee recapitulates phylogeny." The prospect of listening to speeches without that first cup was more than I could bear. Fortunately, I found a sympathetic headwaiter, else I'd have nothing to report.

The moral ought to be clear: they can skip the open bar and free lunch, but it's cruel and unusual punishment to invite people to

(continued)

*Jerry Pournelle holds a doctorate in psychology and is a science-fiction writer who also earns a comfortable living writing about computers present and future.*



# Program Editing with

# BRIEF™

**is More Productive and Less Frustrating**  
because it will work YOUR way; BRIEF elegantly integrates:

- A high-level, readable **Macro Programming Language** - allows customization for programming languages . . . Complete, unlimited variables, etc.
- Edit **multiple files of unlimited size** (2 Meg is OK)
- Multiple **Windows** on screen with different or same file, fragments, etc.
- A bona-fide **UNDO** stack (up to 300) of **all operations**: deletions, reading files, search, translate, more
- Full "**regular expression search**" - wild cards, complex patterns
- A completely **reconfigurable keyboard**
- **Keystroke macros** - for common typing sequences
- Suspend BRIEF to execute, **exit to DOS** - run another program (like a compiler, dir, XREF, DIFF, or DEBUG) then resume BRIEF session
- **Compiler-specific** support like auto indent, syntax check, compile within BRIEF  
For PC, AT, and compatibles.

**FREE WITH ORDER:** Best of BRIEF Macros" — includes Fortran, C, Calculator. Call before 11/30/85.

Only \$195

Full Refund if not satisfied in 30 days.  
CALL 800-821-2492.

335-B Washington St., Norwell, MA 02061  
617-659-1571

**Solution  
Systems**

## CHAOS MANOR

listen to any kind of speeches in the morning without plenty of coffee.

### LOOK OUT, LOTUS

The conference began with a fair amount of hype. My notebook says: "Claims they will set new standards. Most advanced product available. Most etc. 'We sell lots of stuff. We're going to sell even more.' Ten minutes of snow. I still don't know what the product is. More snow. Does he really believe anyone is interested? YE GODS!!!" Of course, it's possible that I wasn't yet fully awake.

Eventually we were told what we were going to see: Excel, a new spreadsheet for the Macintosh. Microsoft President John Shirley said it would be "the world's best spreadsheet." Somehow his saying that didn't surprise me.

In the midst of all the superlatives, Shirley showed an interesting chart. It didn't stay up long enough for me to copy it; I wish it had, because with it came the most interesting remark of the press conference. "Excel," Shirley said, "is an example of our new policy of producing appropriately integrated products." The accompanying chart contrasted Excel with fully integrated programs like Symphony and Ovation.

Next up was Microsoft's founder William Gates. "Why not do all-in-one fully integrated programs? Because there are limits," he began. "Hardware has improved wonderfully, but if you try to do everything at once you soon run up against the limits. We've found that what users really want are a common user interface so that the same command philosophy works with a variety of different kinds of programs; the ability to interchange data between programs; and the ability to run several programs at the same time."

"Yeah, something like Concurrent DOS," I thought to myself. But he was certainly correct.

"Instead of trying to do it all in one program, we're using the new Macintosh Switcher program, which will be bundled with Excel," Gates continued.

"Switcher's not released, except to

(continued)

# PROLOG-86™

## Become Familiar in One Evening

Thorough tutorials are designed to help learn the PROLOG language quickly. The interactive PROLOG-86 Interpreter gives immediate feedback. In a few hours you will begin to feel comfortable with it. In a few days you are likely to know enough to modify some of the more sophisticated sample programs.

### Sample Programs are Included like:

- an **EXPERT SYSTEM**
- a **NATURAL LANGUAGE INTERFACE**  
(it generates a dBASEII "DISPLAY" command)
- a **GAME** (it takes less than 1 page of PROLOG-86)

### PROTOTYPE Ideas and Applications QUICKLY

Serious development of experimental systems and prototypes is practical with the full syntax of PROLOG-86. 1 or 2 pages of PROLOG is often like 10 pages in "C".

**Programming Experience is not required** but a logical mind is. PROLOG-86 supports the de facto STANDARD.

**RECENT IMPROVEMENTS:** Access to MSDOS, on-line help, load Editor.

**AVAILABILITY:** All MSDOS, PCDOS systems.

**FREE** with order: "Best of Prolog-86 Programs"—contest entries include: a primate expert system, an automobile expert system, a blocks world natural language system, etc. Call before November 30.

Only

\$125.

Full refund if not  
satisfied during  
first 30 days.

**Solution  
Systems**

335-B Washington St.,  
Norwell, Mass. 02061  
617-659-1571  
800-821-2492

# THE PROGRAMMER'S SHOP™

helps save time, money and cut frustrations. Compare, evaluate, and find products.

## SERVICES

- Programmer's Referral List
- Compare Products
- Help find a Publisher
- Evaluation Literature free
- BULLETIN BOARD - 7 PM to 7 AM 617-826-4066
- Dealer's Inquire
- Newsletter
- Rush Order
- Over 700 products

## Free Literature - Compare Products

Evaluate products Compare competitors Learn about new alternatives. One free call brings information on just about any programming need. Ask for any "Packet" or "Addon Packet"  ADA, Modula  "AI"  BASIC  "C"  COBOL  Editors  FORTH  FORTRAN  PASCAL  UNIX/PC or  Debuggers, Linkers, etc.

## RECENT DISCOVERIES

LISP-86 - "COMMON" subset, tutorial, editor, PP, trace. Best to learn. All MSDOS. **Only \$95**

## ARTIFICIAL INTELLIGENCE

- ARITY/PROLOG-full, debug, to ASM&C, 16 Meg use, windows, strings. With compiler \$1950. MSDOS \$495
- ExperEASE - Expert system tool. Develop by describing examples of how you decide. PCDOS \$625
- ExperLISP - Interpreter: Common LISP syntax, lexical scoping, toolbox, graphics. Compiler. 512K MAC \$465
- EXSYS - Expert System building tool. Full RAM, Probability. Why, serious, files PCDOS \$275
- GC LISP - "COMMON LISP", Help. tutorial, co-routines, compiled functions, thorough. PCDOS Call
- M Prolog - full, rich, separate work spaces. MSDOS \$725
- PROLOG-86 - Learn fast. Standard, tutorials, samples of Natural Language. Exp. Sys. MSDOS Call
- TLC LISP - "LISP-machine"-like. all RAM, classes, turtle graph., 8087, Compiler. CPM-86. MSDOS \$235
- WALTZ LISP - "FRANZ LISP" - like, 611 digits, debugger, large programs. CPM80 MSDOS \$159
- MicroProlog - improved MSDOS \$235

## BASIC

- ACTIVE TRACE, DEBUGGER - BASICA, MBASIC, interactive, well liked MSDOS \$ 79
- CADSAM FILE SYSTEM - full ISAM in MBASIC source. MSDOS \$150
- BASCOM-86 - Microsoft 8086 279
- CB-86 - DRI CPM86, MSDOS 419
- Data Manager - full source MSDOS 325
- InfoREPORTER - multiple PCDOS 115
- Prof. Basic - Interactive, debug PCDOS 89
- TRUE BASIC - ANSI PCDOS 125
- Ask about ISAM, other addons for BASIC

## EDITORS FOR PROGRAMMING

- BRIEF Programmer's Editor - undo, windows, reconfig. PCDOS Call
- FirsTime by Spruce - Improve productivity. Syntax directed for Pascal (\$235) or C (\$285).
- C Screen with source 86/80 75
- Epsilon - like EMACS PCDOS 195
- PMATE - powerful 8086 159
- VEDIT - well liked PCDOS 119
- XTC - multitasking PCDOS 95

## COBOL

Microsoft Version II - upgraded. Full Lev. II, native, screens. MSDOS \$500

- Dig Res-decent MSDOS 525
- Macintosh COBOL - Full. MAC 459
- MBP - Lev II, native, screen MSDOS 885
- MicroFocus Prof.-full PCDOS call
- Ryan McFarland-portable MSDOS 695

## C LANGUAGE

- C-terp Interpreter by Gimpel, full K&R, .OBJ and ASM interface. 8087 MSDOS \$255
- INSTANT C - Interactive development - Edit. Source Debug, run. Edit to Run - 3 Secs. MSDOS \$445
- "INTRODUCING C" - Interactive C to learn fast. 500 page tutorial. examples, graphics PCDOS Call
- Wizard C - Lattice C compatible, full sys. III syntax, lint included, fast, lib. source. MSDOS \$419
- MSDOS C86-8087, reliable call
- Lattice C - the standard call
- Microsoft C 3.0 - new 259
- RUN/C - interpreter 119
- Williams - debugger, fast call
- CPM80 - EcoPlus C-faster, SLR 275
- BDS C - solid value 125
- MEGAMAX C - native Macintosh has fast compile, tight code, K&R. toolkit, .OBJ, DisASM MAC \$249
- MACINTOSH Hippo Level 1 109
- Consulair's MAC C with toolkit 365
- Compare. evaluate. consider other Cs

## C ADDONS

- COMMUNICATIONS by Greenleaf (\$149) or Software horizons (\$139) includes Modem7, interrupts, etc. Source. Ask for Greenleaf demo.
- C SHARP Realtime Toolkit-well supported, thorough, portable, objects, state sys. Source MANY \$600
- CIndex + -full B+Tree, vari. length field. Source, no royal. MSDOS \$259
- dbVista FILE SYSTEM - full indexing, plus optional record types, pointers. Source, no royalties. MSDOS \$450
- Faster C Lattice & C86 users eliminate Link step. Normal 27 seconds. Faster C in 13 sec. MSDOS \$ 95
- PC Lint - full C program checking and big, small model. All C's. MSDOS \$95

- CHelper: DIFF, xref, more 86/80 135
- Ctree - source, no royalties ALL 345
- CURSES by Lattice PCDOS 110
- C Utilities by Essential MSDOS 149
- dBc ISAM by Lattice 8086 229
- Greenleaf-zu0+, fast. MSDOS 149
- PHACT-up under UNIX, addons MSDOS 225
- ProScreen - windows PCDOS 275
- Turbo B - Greenleaf C, fast PCDOS 159
- Windows for C - fast, reliable MSDOS 175

## FORTRAN LANGUAGE

- MacFORTRAN - full '77, '66 option. toolbox, debugger, 128K or 512K. ASM-out option MAC \$349
- RM/Fortran - Full '77. BIG ARRAYS. 8087, optimize, back trace, debug. MSDOS \$459
- MS FORTRAN-86 - Improved. MSDOS 239
- DR Fortran-86 - full '77 8086 249
- PolyFORTRAN-XREF, Xtract PCDOS 165

## LANGUAGE LIBRARIES

- MultiHALO Graphics-Multiple video boards, printers, rich. Animation, engineering business. ANY MS language, Lattice, C86 \$195, for Turbo \$95.
- Screen Sculptor - slick, thorough, fast, BASIC, PASCAL. PCDOS \$115
- GRAPHMATIC - 3D, FTN, PAS PCDOS 125
- File MGNT: Btrieve - all lang. MSDOS 209
- Micro: SUBMATH - FORTRAN full 86/80 250
- MetaWINDOW - icons, cup PCDOS 139
- PANEL - many lang., terminals MSDOS 239

## OTHER LANGUAGES

- ASSEMBLER-ask about Turbo ASM (\$95), ED/ASM (\$95) - both are fast, compatible. or MASM (\$125), improvements.
- BetterBASIC all RAM, modules. structure. BASICA - like PCDOS \$175
- SNOBOL4+ - great for strings, patterns. MSDOS \$ 85
- MacASM - full, fast, tools MAC 115
- Assembler & Tools - DRI 8086 149
- PC FORTH - well liked MSDOS 95

## SUPPORT PRODUCTS

- PLINK 86 - a program-independent overlay linker to 32 levels for all MS languages. C86 and Lattice. \$315
- Multilink - Multitasking PCDOS 265
- Pinish - Profile by routine MSDOS 345
- Polylibrarian - thorough MSDOS 95
- PolyMAKE PCDOS 95
- ZAP Communications - VT100, TEK 4010 emulation, full xfer. PCDOS 65

## DEBUGGERS

- Periscope Debugger - load after "bombs", symbolic, "Reset Box", 2 Screen, own 16K. PCDOS \$279
- Advanced Trace 86 Symbolic PCDOS 149
- Atron Debugger for Lattice, MSFTN PCDOS 369
- CI Probe for C86 MSDOS 200
- Pfix Plus Debugger MSDOS 315
- TRACE86 debugger ASM MSDOS 115

Note: All prices subject to change without notice. Mention this ad. Some prices are specials. Ask about COD and P.Os. All format's available. UNIX is a trademark of Bell Labs.

Call for a catalog, literature, and solid value

# 800-421-8006

## THE PROGRAMMER'S SHOP™

128-B Rockland Street, Hanover, MA 02339

Mass: 800-442-8070 or 617-826-7531 985



1	Exxon
2	General Motors
3	Mobil
4	Ford Motor
5	IBM
6	Texaco
7	E.I. du Pont
8	Standard Oil (Ind.)
9	Standard Oil of Cal.
10	General Electric
11	Gulf Oil
12	Atlantic Richfield
13	Shell Oil
14	Occidental Petroleum
15	U.S. Steel
16	Phillips Petroleum
17	Sun
18	United Technologies
19	Tenneco
20	ITT
21	Chrysler
22	Procter & Gamble
23	R.J. Reynolds Ind.
24	Getty Oil

25	Standard Oil (Ohio)
26	AT&T Technologies
27	Boeing
28	Dow Chemical
29	Allied
30	Eastman Kodak
31	Unocal
32	Goodyear
33	Dart & Kraft
34	Westinghouse Elec.
35	Philip Morris
36	Beatrice Foods
37	Union Carbide
38	Xerox
39	Amerada Hess
40	Union Pacific
41	General Foods
42	McDonnell Douglas
43	Rockwell Int.
44	PepsiCo
45	Ashland Oil
46	General Dynamics
47	3M
48	Coca-Cola

49	Consolidated Foods
50	Lockheed
51	Georgia-Pacific
52	Monsanto
53	W.R. Grace
54	Signal Companies
55	Anheuser-Busch
56	Nabisco Brands
57	Johnson & Johnson
58	Coastal
59	Raytheon
60	Honeywell
61	Charter
62	General Mills
63	TRW
64	Caterpillar Tractor
65	Aluminum Co. of Amer.
66	Sperry
67	Gulf & Western Ind.
68	Continental Group
69	Bethlehem Steel
70	Weyerhaeuser
71	Ralston Purina
72	Colgate-Palmolive

## CHAOS MANOR

some developers," thought I. Switcher—I haven't actually seen it operate yet—is said to do for the Macintosh what Concurrent DOS does for the PC, but do it smoother, and of course it employs "the Macintosh philosophy." Thinking about Switcher lost me a couple of Gates's sentences.

"...bringing out the world's best spreadsheet and bundling in the Macintosh Switcher program. That way users can run Excel and their favorite text editor, database, and communications program. They're not locked into one program," Gates was saying.

I glanced at my watch. Sixteen minutes since the conference started. I had a page of notes, but nothing worth writing about. Even the speakers sounded bored. Couldn't they see they were losing the audience? But of course they couldn't. Every 20 seconds a maniacal photographer with an incredibly noisy thyristor popped his flash; once I counted nine flashes in less than three minutes. I came to New York for this?

Then, suddenly, the Macintosh projector was fired up. "They've got a great projector," I wrote.

"Excel has 16,000 rows and 256 columns," Gates said. I perked up. There was an unmistakable change to his tone. He wasn't bored anymore.

Using a 512K-byte Macintosh and dual floppies, but no hard disk, Bill Gates put Excel through its paces. Numbers flashed up on the screen. Cells were recalculated. Now I was really interested. Those recalculations went *fast*. "The 68000 is fast," Gates said. "And Excel keeps track of the data structure so it recalculates only the relevant cells."

My next note says, "I guess I'm impressed."

I was, too. Do understand, I was watching a demonstration of a not-yet-released program running a live but well-rehearsed (there were photographs of the very same screens in the press kit) demonstration. The photographer maniac popped his flash so often that not only couldn't I reflect on what Gates was saying, I found it

(continued)

## 27 million Americans can't read. And guess who pays the price.

While American business is trying to stay competitive with foreign companies, it's paying an added penalty. The penalty of double-digit illiteracy.

Believe it or not, 27 million American adults can't read and write. Another 47 million are literate on only the most minimal level. That adds up to almost one third of our entire population... and probably a disturbing number of *your* employees.

What does illiteracy cost you? Get out your calculator. Illiterate adults make up 50%-75% of our unemployed. Every year they cost us an estimated \$237 billion in lost earnings. They swell our welfare costs by \$6 billion annually and diminish our tax revenues by \$8 billion.

Illiteracy costs you through your community, too. It robs the place where you work and live of its resources. It undermines the potential of the people who make your products and the people who buy them. No dollar figure can be assigned to this. But over the years, this may be the costliest loss of all.

What can your company do about this? It can join in local efforts to fight illiteracy. It can volunteer company dollars and facilities for better school and tutorial programs. It can invest in a more literate community.

The first step is to call the Coalition for Literacy at **1-800-228-8813** or fill out the coupon below. Do it today. You may find it's the greatest cost-saving measure your company has ever taken.

**A literate America is a good investment.**



Coalition for Literacy

- I want my company to join the fight against illiteracy. Please send brochure with additional information.
- We want to discuss funding the Coalition for Literacy. Please have a representative contact me.

Name \_\_\_\_\_

Title \_\_\_\_\_

Company \_\_\_\_\_

Address \_\_\_\_\_

City \_\_\_\_\_ State \_\_\_\_\_ Zip \_\_\_\_\_

Phone \_\_\_\_\_

Please return to: Coalition for Literacy  
Business Division  
P.O. Box 81826  
Lincoln, NE 68501-1826

# WE THOUGHT YOU SHOULD KNOW

FROM

# QUANTEK

You can now purchase a fully compatible IBM AT type system, fully enhanced, priced far below competition.

Here is what you get for under \$3,300.00

- Microprocessor 80286 ■ Memory 640Kb RAM
- Math co-processor socket for 80287
- System expansion eight I/O slots
- Hard disk drive 20 Mb (40 Mb optional)
- Floppy disk drive 1.2 Mb ■ Serial ports
- Parallel ports ■ Controller card
- Keyboard 84 keys
- Runs current IBM AT software packages

QUANTEK CORPORATION has earned one of the highest ratings in the industry. Our microprocessor boards are now receiving less than 1% rework. This track record permits us to give an unconditional six months warranty on the **QUANTEK 2000 AT** which is twice the competition.

Dealer and distributor inquiries invited.

Inquiry 307 for End-Users. Inquiry 308 for DEALERS ONLY.

QUANTEK CORPORATION  
17975 Main St.  
Irvine, CA 92714  
(714) 250-1909

IBM is the registered trademark of International Business Machines.



## Why I recommend Logitech's Modula-2

Logitech Modula-2™ combines many of the best features of both C and Pascal. My product Time Line™ contains over a million bytes of source code. It is fast and indisputably powerful. I estimate that it would have taken 20 to 50 percent more time to develop in C, and would not be as reliable. I anticipate half the maintenance costs using Logitech Modula-2. Six years ago I was recommending C for serious programming. Today, I recommend Logitech Modula-2.



Andrew Layman, San Francisco, Ca.  
Time Line, a project management Author of program.

### Further comments:

**Access to the machine:** Logitech Modula-2 gives you direct access to the hardware.

**Speed:** Logitech Modula-2 compiles to native machine code.

**Strong Typing:** Catches many programming errors that would slip past a C compiler.

**Modularity:** It is very easy to insulate one part of a program from changes in another.

**Debugging:** Logitech provides you with a runtime and a post-mortem debugger. Both are symbolic, and show source code, call chains, variables, modules, and raw memory.

**Overlays:** Your main program can bring overlays into memory. You do not even have to decide in advance which overlays or their order.

**Version Control:** The compiler, linker and loader all check that version of modules, programs and overlays are consistent.

**Good Library:** Includes modules for file I/O, string handling, real number math, operating system access, screen and keyboard, and you can substitute your own.

Modula-2 from Logitech is the proven, professionally supported native code compiler and cross compiler for VAX™ and PC systems. For more information, call Christopher Cale at Logitech, 805 Veterans Blvd., Redwood City, CA 94063, (415) 363-9852. In Europe, call (41) (21) 77 45 45.



Logitech Modula-2—Logitech, Inc.: Time Line—  
Breakthrough Software Corporation; VAX—Digital  
Equipment Corporation.

## CHAOS MANOR

hard to follow his talk. On the other hand, after the conference when everyone else headed for the bar, I found Jabe Blumenthal, the Excel program manager, and got my own demonstration on a machine that I know was a normal 512K-byte Mac with floppies; and I was still impressed.

Excel is fast, it's simple to use, it has really impressive automatic charting capabilities, and, best of all, it turns macro building from a chore into child's play. That is: a macro is a user-built procedure. Lotus 1-2-3's macro capability is one of its most powerful but, alas, most difficult-to-learn features. Excel does things differently. You can cause Excel to remember exactly what you're doing, including things like "increment date," and give that set of procedures a name. You have now built a macro. You can run the whole complex pattern again simply by invoking the name. The example Gates showed was updating monthly sales data: input the new data and invoke the macro. The months are incremented, everything is shifted over a column, charts are prepared, averages taken, etc. In my own private play with Jabe Blumenthal, I built a financially meaningless but highly complex macro involving extensive calculations. It worked fine.

Something else impressed me. Bill Gates likes the program, not because it's going to make him a lot of money (although I'm sure it will do that), but because it's a neat hack.

Excel may just do for the Macintosh what VisiCalc did for the Apple II. Assuming that it works as I saw it, Excel will certainly make the Mac into a serious business machine. Spreadsheets are important to business. I'm told that about half the IBM PCs are sold with a copy of Lotus 1-2-3. From everything I saw, I'd rather have Macintosh with Excel than the PC with Symphony. I'd even prefer it to my CompuPro with SuperCalc.

### WHAT DO WE WANT, ANYWAY?

I don't usually write so much about an unreleased product, but John Shirley's remark about "appropriate integration," followed by Gates's com-

ment on limits, set me to thinking. What do we—as users—really want out of these machines, and what limits our getting it? I've in no way reached any final conclusions, but I do have some thoughts.

I believe Bill Gates was right when he said that fully integrated software is a dead end. Even without machine limitations it's going to be difficult to sell full integration to users. There's just too much to learn. Old hands looking for an improved text editor may not care to change spreadsheets. Newcomers almost certainly won't want to learn about spreadsheets, databases, text editors, and communications all at once; heck, I'm reluctant to take on such a formidable task myself. It's better to learn by accretion.

When we look at the individual parts of integrated programs, the situation is even worse. Perhaps you could have "the world's best spreadsheet" in your integrated package; perhaps you could even add "the world's best communications program"; but what do you do about text editors and databases? You *can't* include "the world's best text editor" because there isn't one. World's best at *what*? I know of at least five text editors that could claim to be "world's best" for one or another use, and while WordStar isn't "world's best" on any one feature, it's on so many machines, and comes in second with so many features, that it's a contender overall. The same is true with database programs. Several are good enough, and a couple are superb in one way or another—Savvy, for example, is wonderful for people who can't spell and can't remember precisely how things were stored—but if there's one that deserves the title of "world's best" at every application, I don't know which one it is. How, then, can an integrated software package have the "best" when you can't define what "best" means?

So. Fully integrated software isn't the answer, because users want to be able to pick and choose programs according to their particular needs. On

(continued)

# EASY COME.



# EASY GO.



## THE VERSATILE ARK 24K Everything You Want in a Dial Modem

With a flash of its front panel control, the ARK 24K can make simultaneous transition from low-speed applications to 2400 bps. And it's the only full-duplex dial modem on the market with *separate* Synchronous and Asynchronous connectors.\* It's fast, versatile, easy to install, and very easy to use. ARK engineers designed the 24K to bridge the gap between yesterday's terminal requirements and the PC requirements of the future. The ARK 24K...we've got you covered coming and going!

- Complete front-panel operation with help commands, continuous visual and audible monitoring of call progress, command, and on-line modes of operation as well as complete terminal and front-panel monitoring of both local and remote modem status.

- Full menu of automated dial services including auto dial from front panel or terminal, telephone directory, and tandem dialing.
  - ARQ error-free transmission based on MNP\*\*.
  - Hayes™ "AT" Mode Compatible.
  - Universal Compatibility.
  - Stand alone or rack mount.
- Nationwide on-site service available.

**\$595**

Order today. Call toll free:  
**800-228-0914**

For free brochure, call (305) 724-5260, or write ARK Electronic Products, Inc., Dept. C, P.O. Box 2169, Melbourne, FL 32902-2169.

\*U.S. patent pending

\*\*MNP is a proprietary product of MICROCOM, Inc.

\*\*\*IBM is a registered trademark of International Business Machine Corp.

### THE FIRST FAMILY OF DIAL MODEMS





# SOLVE PROGRAMMING PROBLEMS THE WAY YOU THINK. PURE AND SYMBOL.



## APL★PLUS® PC IS THE ANSWER.

The shortest distance between two points is a straight line. But unfortunately, that's not the case in programming.

Most languages require you to go through an enormous number of steps before an idea becomes reality.

That's why the APL★PLUS PC System is such a dramatic and exciting software tool for serious PC programmers and application developers.

Instead of requiring you to learn—and write—long-winded and complicated programs, APL is based on your instinctive ability to deal in symbols. And once you

begin using APL's quick notations, you'll find it the ideal programming environment for all your application needs.

The incredible shortcuts you get with APL will let you spend less time on drudgery, and more time creating. Intricate calculations and modeling on PC's are a snap.

And only with APL★PLUS PC do you get:

- full-screen editing
- a built-in terminal emulator
- communications
- graphics primitives
- and report formatting.

Plus concise notation for programs like sorting, matrix inversions, string searching,

and more. And the complete package price is just \$595 with major credit cards accepted.

Act now, and we'll send you a free Convincer Kit. Contact your local dealer, or call **800-592-0050** (in Maryland, call **301-984-5123**) to order your system, or for more information about our other APL★PLUS products—from our UNIX™ version to the new streamlined Pocket APL™

Or write STSC, Inc., 2115 East Jefferson St., Rockville, MD 20852.

You'll see how symbol PLUS★WARE products are to use, the very first time you use them.



## Problem-solving at the speed of thought.™

**STSC**  
A Contel Company

APL★PLUS PC System requires 192K. A soft character set can be used for computers with IBM compatible graphics board. A character generator ROM or software is included for the IBM PC or selected compatibles. PLUS★WARE and Pocket APL are trademarks of STSC, Inc. APL★PLUS is a registered service mark and trademark of STSC, Inc. UNIX is a trademark of AT&T Bell Laboratories.

## CHAOS MANOR

the other hand, databases, text editors, spreadsheets, communications packages, and chart-making capabilities *are* interrelated. It makes little sense to have rudimentary capabilities for each function in each of five (or more) different programs, and it's sheer drudgery to learn how to do the same thing five different ways. Clearly, it would be better to have a good chart maker and pass it data from text editor, spreadsheet, or database; to use your favorite editor to write the text generated from a spreadsheet and be able to transfer both charts and spreadsheet calculations into the editor; and to be able to send the whole *fershlugginer* mess out through your favorite communications package. Full integration may be undesirable, but some measure of integration is still needed.

Second, it's still easier to learn by accretion. Sure, I managed to learn CP/M, WordStar, WRITE, dBASE II, SuperCalc, and a myriad of other programs, but then I'm a computer enthusiast. Moreover, having invested all that time and energy into learning to do things in certain ways, I'm reluctant to spend the time it takes to learn a lot of the new programs. Of course I eventually bite the bullet because I'm naturally curious, but I sure do get tired of learning new ways to do the same old things. If programs did most things with the same commands and in a logical and consistent manner, reserving novelty for the uniquely *new* things the program does, I'd be happier and so, I suspect, would everyone else.

Finally, most of us might like to work on one thing at a time, but in the real world we tend to be interrupt-driven systems. Sit down to write, and the phone rings: someone wants someone else's telephone number. Start to work on a spreadsheet, and you're sure to remember a phone call you ought to make. Begin one task, and you'll find a sheet of paper reminding you of something that has to be taken care of right now.

It isn't so much that we want to be able to run more than one program at a time, but that we want to go back

and forth among tasks without long waits and distractions. I don't like it much when the phone interrupts my writing, but it's sure a lot better for me—and thus for whomever has called me—if I can deal with the call quickly and easily without having to search for notepaper, address book, calendar, and the like.

Epson tried to integrate all those functions with Valdocs, and while the idea had merit, the execution was fatally flawed. It took too long to save off the last job and get to the next, and it wasn't easy to transfer data from one task to another. Even in Valdocs 2.0, they suggest that you integrate the chart maker with the text editor by means of scissors, paste, and a copy machine. Valdocs was an early attempt at integration. Even in conception it had one major flaw. If Valdocs couldn't do the job you wanted—and certainly it couldn't do everything—you had to exit the Valdocs environment and cope with an entirely different operating system unrelated to what you'd already learned.

Another approach is typified by Borland's SideKick: use your favorite programs in conjunction with a set of utilities resident in high memory. The utilities can be called into a "window" on screen at any time. The job you're doing is interrupted for the moment, but as soon as you exit SideKick you're right back where you were when you called it. SideKick does an excellent job of handling notebook, calculator, phone book, and schedule. It can even pass data around within its parts. The new version has a limited capability to pass data among "foreign" programs like Lotus 1-2-3 and WordStar. However, while SideKick's command structure is logical, it isn't necessarily related to the programs you want to use. I'd rather use SideKick, 1-2-3 or SuperCalc, XyWrite, dBASE II, and MITE than any of the integrated programs I've tried, but I really want a lot more integration than the combination gives me. The SideKick method is a good one, but it doesn't go far enough.

(continued)



### PROGRAMMER'S UTILITIES especially for Turbo Pascal on IBM PC/XT/AT and compatibles

**MORE POWERFUL THAN UNIX UTILITIES!!!**

These Ready-to-Use programs fully support Turbo Pascal versions 2.0 and 3.0, and PC DOS 2.X and 3.0. Here's what you get:

#### **Pretty Printer**

Standardize capitalization, indentation, and spacing of source code. Don't waste your own time! Several adjustable parameters to suit your tastes (works with any standard Pascal source).

#### **Program Structure Analyzer**

Find subtle problems the compiler doesn't: uninitialized and unused variables, modified value parameters, "sneaky" variable modification, redefined standard identifiers. Also generates a complete variable cross reference and an execution hierarchy diagram. Interactive or write to file (works with any standard Pascal source).

#### **Execution Timer**

Obtain a summary of time spent in each procedure and function of your program, accurate to within 200 microseconds. Also counts number of calls to each subprogram. Fully automatic.

#### **Execution Profiler**

Obtain a graphic profile of where your program spends its time. Interactive, easy-to-use. Identify weak code at the instruction level. (Profiler and Timer for Turbo Pascal Source code only.)

#### **Command Repeater**

Customize any operation by reading and parsing the standard input. Send up to 255 keystrokes to any executed program. Automatically generate DOS batch files.

#### **Pattern Replacer**

Find and REPLACE versatile regular expression patterns in any text file. Supports generalized wildcards, nesting, alternation, tagged words and more. Over a dozen programmer's applications included.

#### **Difference Finder**

Find differences between two text files, and optionally create an EDLIN script which rebuilds one from the other. Disregard white space, case, arbitrary characters and Pascal comments if desired.

#### **Super Directory**

Replace PC DOS DIR command with extended pattern matching, sort capability, hidden file display, date filtering, and more.

#### **File Finder**

Locate files anywhere in the subdirectory tree and access them with a single keystroke. Display the subdirectory tree graphically.

### AVAILABLE IN SOURCE AND EXECUTABLE FORMAT

**Executable: \$55 COMPLETE** including tax and shipping. Compiled and ready to run, includes 140-page printed user manual, reference card and one 5 1/4" OSDD disk. Ideal for programmers not using Turbo. NOT copy protected.

**Source: \$95 COMPLETE** including tax and shipping. Includes all of the above, and two additional OSDD disks. Disks include complete Turbo Pascal source code, detailed programmer's manual (on disk) and several bonus utilities. Requires Turbo Pascal 2.0 or 3.0.

Requirements: PC DOS 2.X or 3.0. 192K RAM — programs run in less RAM with reduced capacity. Two drives or hard disk recommended.

#### **TO ORDER:**

VISA/MasterCard orders, call 7 days toll-free 1-800-538-8157 x830. In California, call 1-800-672-3470 x830 any day. Or mail check/money order to:

TurboPower Software  
478 W. Hamilton Ave., Suite 196  
Campbell, CA 95008

For technical questions, call 408-378-3672



# Thinking of the C Language?

## THINK COMPUTER INNOVATIONS

**NEW!**

### C86 VERSION 2.3 with Source Level Debugging Support

The C language has rapidly become the development language of choice for applications ranging from Operating Systems to Accounting Packages. WHY? Its structured approach and extreme portability make it perfectly suited to today's fast-paced environment.

Of all the C Compilers available for PC/MSDOS, more programmers choose COMPUTER INNOVATIONS' C86. WHY? Because it's part of a **COMPREHENSIVE** family of C products with an unparalleled reputation for performance, reliability, and stability.

#### C86 2.3 C COMPILER

C for PC/MSDOS began with C86 and today it remains perhaps the most solid, stable C Compiler available. Even competitor's ads show C86 as a consistent top level performer in benchmark testing.

Version 2.3 offers a host of new features including source level debugging support and a 40% boost in compilation speed. Call for complete specifications.

**COST: \$395 UPDATE TO 2.3: \$35 w/old diskettes NOT COPY PROTECTED CALL ABOUT VOLUME DISCOUNTS**

#### LEARN C INTERACTIVELY WITH INTRODUCING C

Intimidated by rumors about the difficulty of learning C? Need to train your staff quickly? **INTRODUCING C** can help. **INTRODUCING C** combines a thorough, self-paced manual with a unique C interpreter to provide a fast, efficient method of learning C. Designed for both professional and casual programmers, it provides a comprehensive understanding of important C concepts such as standard K&R syntax and operators, full structures and unions, arrays, pointers, and data types. Requires IBM PC, XT, or AT with one disk drive and 192K bytes of memory.

**COST: \$125 - NOT COPY PROTECTED**

#### CI PROBE SOURCE DEBUGGER

Take advantage of C86 2.3 source level debugging support with **CI PROBE**. Cut down program development time and save money! **CI PROBE** is highly economical yet has the features of debuggers costing far more.

**COST: \$225 - NOT COPY PROTECTED**

#### C-TERP C86 COMPATIBLE INTERPRETER

The **C-TERP INTERPRETER** is a full K&R implementation that allows you to write code and execute it immediately without the compile and link steps. Once you have your program running with **C-TERP** you can compile the code (without alterations) with **C86** for fast, efficient executable files. **C-TERP** requires 256K, 512K is recommended.

**COST: C86 version - List Price: \$300, Special Computer Innovations Price \$250. Combined C86 & Lattice version - List Price: \$400, Special Computer Innovations Price \$350.**

#### Start With Us, Stay With Us

Computer Innovations offers a complete range of products that let you enter the C environment and create applications with the most advanced set of development tools available. Unparalleled tech support assures that you're always at the height of productivity.

To order call: **800-921-0169**

 **COMPUTER INNOVATIONS, INC.**

980 Shrewsbury Ave., Tinton Falls, NJ 07724 • (201) 542-5920

C-TERP is a trademark of Gimple Software. Prices and specifications subject to change without notice

It seems clear to me that the best approach is to integrate software through the operating system. It's hardly a new idea. UNIX allows pipes, in which the output of one program can become the input of another, and boasts a bewildering array of utilities that programmers can call. Alas, UNIX is big, slow, and cumbersome. It's hard to use. UNIX has so many adherents, particularly among hackers, that it can't be ignored, but I'll be much surprised if UNIX is the answer to software integration.

The Macintosh operating system started out in the right direction. It may even get there. The problem was that the 128K-byte Macintosh had a number of silly limitations that Apple tried to pass off as features, when it was plain to all that they were bugs. If they could try to make you believe that, what else were they doing to you?

The 512K-byte Macintosh, especially with hard disk, is a different proposition. There really is a lot to like about the Macintosh operating system. Not only is it easy to learn, it provides a unifying approach to the command structure of any application program. The Macintosh operating system has an automatic means for transferring data from one program to another. Given that the Switcher operates as advertised—and Microsoft seems satisfied that it does—then the Microsoft/Macintosh path to integration looks pretty good.

That's fine for Macintosh. Those who have IBM PCs and PClones haven't anything like the Macintosh operating system just yet, but there are plenty of developments. Microsoft promises the often-announced Windows integration Real Soon Now. There are new signs of life at Digital Research. I'm not convinced that making the PC into a Macintosh look-alike is the right way to go, but there's another. Concurrent DOS is reaching out to engulf PC-DOS. It will then spread even further to integrate with UNIX. If AT&T can really develop a standard UNIX business shell, the PCommunity will be ready.

(continued)



# The Source<sup>SM</sup> Is Friendly.

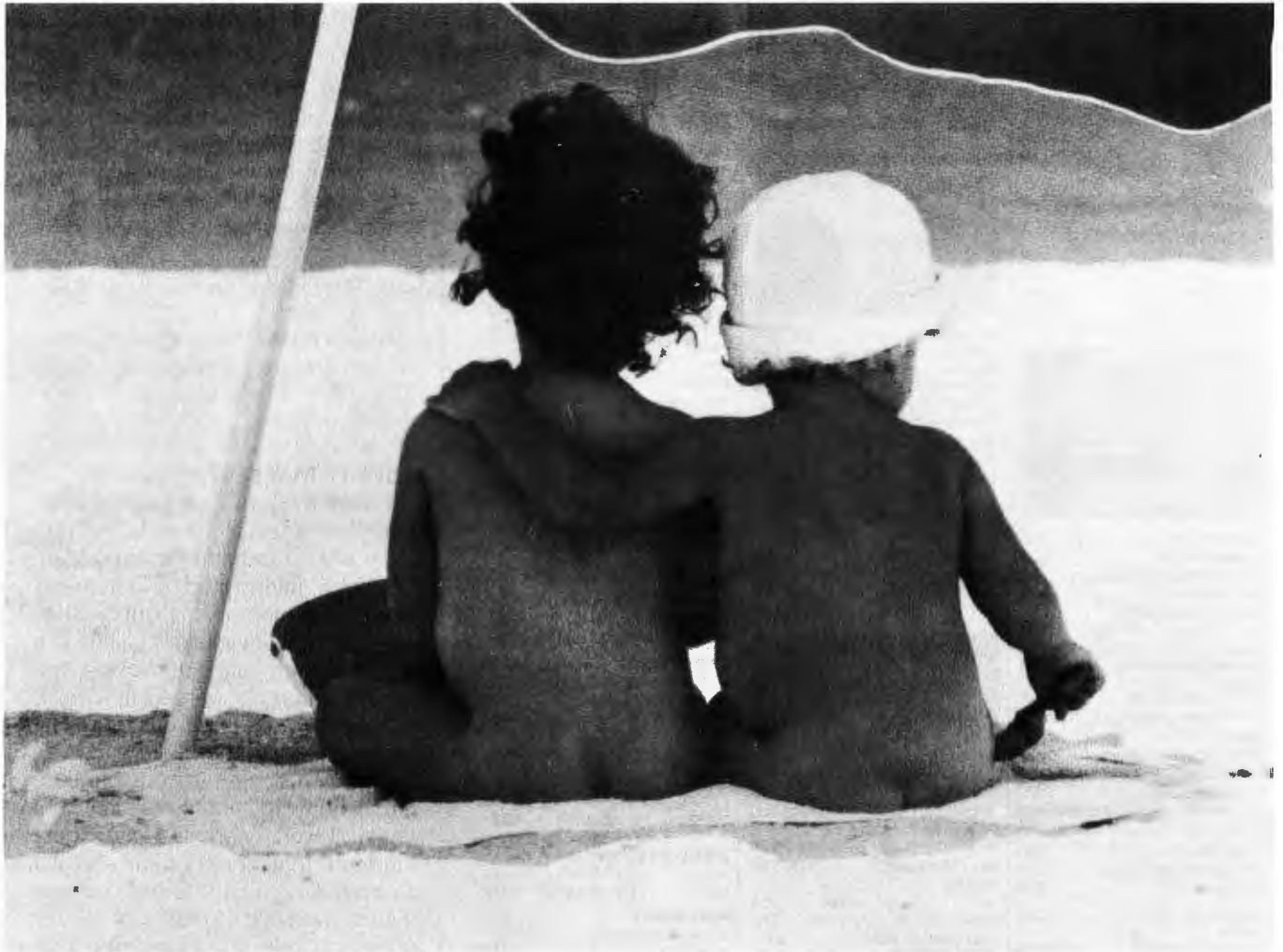

Many online information services claim to be "user friendly." But only one really lives up to that promise.

**The Source.**

You see, The Source is specifically designed to save you time online. With new, shorter menus. Simpler commands. And a user's manual so well-written and easy to understand, it's setting an industry standard.

The Source is also the only service that gives you introductory lessons and assistance, free of on-line charges. So you get up-to-speed on our dime, not yours.

You get to the information you need in record

The Source is a service mark of Source Telecomputing Corp., a subsidiary of The Reader's Digest Assn., Inc. © 1985 Source Telecomputing Corp.

time, without frustration. Everything from the hour's headlines to travel reservations. From special interest groups to online stock trading. So you don't waste your valuable time. Or money.

Call 1-800-336-3366, send the coupon, or visit your nearest computer dealer.

And make friends with America's friendliest online information network.



INFORMATION NETWORK  
**The Source<sup>SM</sup>**

The most powerful resource any personal computer can have.

I'd like to make friends with The Source.  
Please send more information to:

Name \_\_\_\_\_

7826315

Address \_\_\_\_\_

City, State \_\_\_\_\_

Zip \_\_\_\_\_

Mail to: Source Telecomputing Corporation,  
1616 Anderson Road, McLean, VA 22102



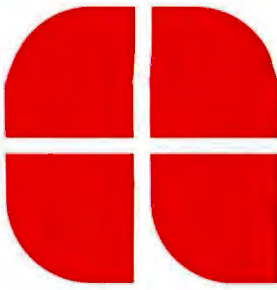

# GenTech

CHAOS MANOR

## COMPUTERS

### IBM SYSTEM SPECIALS

256K, 2 Drives . . . . .	\$Call
256K, 1 Drive & 10 MB Hard . . . . .	\$Call
IBM AT All Models . . . . .	\$Call
CORONA 400 Series . . . . .	\$Call
FUJITSU Micro 16s (8086/Z80A) . . . . .	\$1995



KAYPRO All Models . . . . .	\$Call
LEADING EDGE PC . . . . .	\$Call
MORROW DESIGNS All Models . . . . .	\$Call
NCR All Models . . . . .	\$Call
NEC APC-III PACKAGES	
w/2 Dr, Wordstar Pro Pk, 2050 . . . . .	\$2299
w/plotter, digitizer & AutoCAD . . . . .	\$Call
SEEQUA Chameleon/Plus . . . . .	\$Call
WANG	
PC/APC Up to 21% off! . . . . .	\$Call
Office Assistant w/printer . . . . .	\$Call
ZENITH	
ZF-151-52 w/Zenith Monitor . . . . .	\$Call
ZF-151-21 w/10 MB Hard Disk . . . . .	\$Call
ZF-161-52 (Portable, 2 Dr) . . . . .	\$1675

### FOR IBM PC/AT/JR & COMPAQ

BLUE LYNX 3278 . . . . .	\$Call
DCA Irma/Irmaline/IrmaKey . . . . .	\$Call
IDEAcomm 3278 . . . . .	\$Call
ANCHOR Mark XII . . . . .	\$239
HAYES	
Smartmodem 1200/2400 . . . . .	\$385/\$Call
1200B w/Smartcom II . . . . .	\$355
NOVATION SmartCat Plus . . . . .	\$329
PRENTICE POPCOM	
C100/X100 . . . . .	\$249/\$265
VEN-TEL 300/1200 Half Card . . . . .	\$409



AST RESEARCH INC.	
ADVANTAGE! (for AT) . . . . .	\$Call
SIX PACK PLUS w/64K . . . . .	\$Call
JrCOMBO (exp to 512K) . . . . .	\$Call
HERCULES Graphics Card . . . . .	\$299
Color Card (RGB/Comp/Par) . . . . .	\$155
PROMETHEUS Promodem External . . . . .	\$315
ORCHID PCTurbo 186 w/128K . . . . .	\$655
PARADISE SYSTEMS Multi-Display \$Call	
Modular Graphics Card . . . . .	\$269
EVEREX Graphics Edge . . . . .	\$Call
INTEL 8057/80287 . . . . .	\$Call
ABOVE Board (PC/AT) . . . . .	\$Call
QUADRAM	
EXPANDED QUADBOARD w/64K . . . . .	\$209
QUADMEG AT . . . . .	\$Call
SIGMA DESIGNS Color 400	
/Mouse . . . . .	\$499/\$575
STB SYSTEMS Graphix Plus II . . . . .	\$239
Super Rio w/64K . . . . .	\$279
TALL TREE JRAM-2 . . . . .	\$Call
TANDON TM-100-2 (DSD) . . . . .	\$129
TEAC FD-55B (Thinline DSD) . . . . .	\$109
TECMAR Graphics Master . . . . .	\$485
Captain w/OK . . . . .	\$179
JrCaptain w/128K . . . . .	\$309

## HARD DISK

### CORVUS

11.1 MB Omnidrive Starter Kit . . . . .	\$1649
45 MB Omnidrive . . . . .	\$4149
Trimline Combo (TLC) . . . . .	\$Call



INTERDYNE Tape Back Up . . . . .	\$Call
IRWIN Internal Tape Back Up . . . . .	\$549
IOMEGA Bernoulli 20 MB . . . . .	\$2499
SEAGATE/RODIME . . . . .	\$Call
MAYNARD ELECTRONICS . . . . .	\$Call
SYSGEN Archive . . . . .	\$Call
TALLGRASS	
TG-5025 I low low price I . . . . .	\$Call
TG-6180 (80 MB w/60 MB Tape) . . . . .	\$5949

## DOT MATRIX PRINTERS

C-ITOH All Models . . . . .	\$Call
CITIZEN	
MSP-10 . . . . .	\$329
MSP-15 . . . . .	\$489
MSP-20 . . . . .	\$Call
MSP-25 . . . . .	\$Call

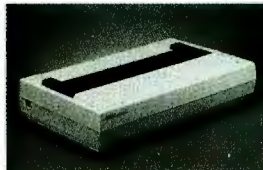

EPSON JX-80 Color . . . . .	\$489
LQ-1500 . . . . .	\$899
LX-80 . . . . .	\$229
FX-85 . . . . .	\$350
FX-185 . . . . .	\$490
NEC P2/P3 Pinwriters . . . . .	\$525/\$735
OKIDATA	
192 . . . . .	\$359
ML 84P . . . . .	\$Call
Dikimate 20 \$Call	Pacemark . . . . .
PANASONIC KX-P1091 . . . . .	\$249
STAR MICRONICS	
Gemini 15X . . . . .	\$345
SG-10 . . . . .	\$229
SD-10H5 . . . . .	\$Call
SR-15 . . . . .	\$619
TOSHIBA	
P1340 . . . . .	\$559
P351 . . . . .	\$1145

## LETTER QUALITY

BROTHER/DYNAX	
HR-15XL/HR-35 . . . . .	\$359/\$729
Twinriter 5 . . . . .	\$Call
HEWLETT-PACKARD Laser Jet . . . . .	\$Call
DIABLO 630 ECS/IBM . . . . .	\$1779
EPSON DX-10/SQ-2000 . . . . .	\$Call
JUKI 6100/6300 . . . . .	\$Call
NEC	
ELF 360 . . . . .	\$415
205D . . . . .	\$669
3550 . . . . .	\$1069
8850 . . . . .	\$1499
QUME Sprint 1140/1155/1190 . . . . .	\$Call
SILVER REED EXP 500/550 . . . . .	\$250/\$419
STAR MICRONICS Power Type . . . . .	\$415

## PLOTTERS & DIGITIZERS

GTCO All models . . . . .	\$Call
HITACHI Tiger Tablet II . . . . .	\$Call
ENTER COMPUTER Six Shooter . . . . .	\$779



HOUSTON INSTRUMENTS	
PC-695 . . . . .	\$645
DMP-41/42 . . . . .	\$2369
DMP-29 . . . . .	\$1799
DMP-51/52 . . . . .	\$3559
DT-11 Digitizer . . . . .	\$679
TAXAN 710S . . . . .	\$Call
ROLAND DXY-800/880 . . . . .	\$699/\$920
SUMMAGRAPHICS SummaSketch . . . . .	\$Call

## MONITORS & TERMINALS

### AMDEK

Video 300/300A/310A . . . . .	\$125/130/155
Color 500/710 . . . . .	\$319/\$539

PRINCETON GRAPHICS Max-12E . . . . .	\$175
HX-12/HX-12E/SR-12 . . . . .	\$469/519/599

QUME All Models . . . . .	\$Call
---------------------------	--------

### ROLAND

MB-122G . . . . .	\$155
MB-142 . . . . .	\$Call
CB-141 . . . . .	\$269
CC-141 . . . . .	\$559

### TAXAN

115 . . . . .	\$115
116 . . . . .	\$125
420/L . . . . .	\$Call
440 . . . . .	\$559

TELEVIDE All Models . . . . .	\$Call
-------------------------------	--------

### WYSE

WY-50 . . . . .	\$459
WY-350 . . . . .	\$Call

### ZENITH

ZVM-123A . . . . .	\$79
ZVM-124 . . . . .	\$Call
ZVM-135 . . . . .	\$439
ZVM-136 . . . . .	\$Call
Z-29A . . . . .	\$Call
Z-49 . . . . .	\$Call

## FOR APPLE II/IIe

ALS Smarter II (80 Col. Card) . . . . .	\$129
AST RESEARCH INC. Multi I/O . . . . .	\$Call
DIGITAL RESEARCH CP/M Gold Card \$289	
FOURTH DIMENSION 16K RAM Card . . . . .	\$55
80 Column Card (Ile) . . . . .	\$55

### HAYES

Micromodem IIe w/Smartcom I . . . . .	\$136
---------------------------------------	-------

MICROSOFT Softcard II . . . . .	\$339
---------------------------------	-------

MICROTEK Dumping GX . . . . .	\$69
-------------------------------	------

NOVATION Apple Cat II . . . . .	\$209
---------------------------------	-------

212 Apple Cat II (1200) . . . . .	\$389
-----------------------------------	-------

ORANGE MICRO Grappler+ . . . . .	\$79
----------------------------------	------

Buffered Grappler+ . . . . .	\$145
------------------------------	-------

PCPI Applicard 6 MHz . . . . .	\$Call
--------------------------------	--------

MACINTOSH DRIVEI . . . . .	CALL FOR \$\$
----------------------------	---------------

## MISCELLANEOUS

RAM CHIPS	
64K SET . . . . .	\$9
256K SET . . . . .	\$Call
call for quantity pricing	

DOUBLE-SIDED DISKETTES	
3M . . . . .	\$27
Dysan . . . . .	\$30
Maxell . . . . .	\$25
Wabash . . . . .	\$19

### PRINT BUFFERS

QUADRAM Microfazer	
Parallel/Parallel 16K . . . . .	\$139
64K . . . . .	\$185
128K . . . . .	\$239
Serial/Serial, Ser/Par, Par/Ser	
8K . . . . .	\$139
64K . . . . .	\$159
INT. STRUCT. ShuffleBuffer 32K . . . . .	\$269
ACT Printer Optimizer . . . . .	\$Call

SURGE PROTECTORS	
EPD/CURTIS All models . . . . .	\$Call
NETWORK Wire TrailPlus . . . . .	\$39/\$55
KENSINGTON Masterpiece . . . . .	\$Call

### EMERGENCY POWER SYSTEMS

SOLA Mini UPS . . . . .	\$Call
-------------------------	--------

TrippLite BC425-FC (425 Watts) . . . . .	\$375
--	-------

SWITCHBOXES	
DATASPEC All configurations . . . . .	\$Call

COMPUTER ACCESSORIES	
Data Directors (All Models) . . . . .	\$Call

## CUSTOMER SERVICE

**401-781-0020**

**800-843-4302**

217 Broadway, Suite 615, NY, NY 10007

HOURS 9-8 EST, MONDAY-SATURDAY  
Personal Ck (2 Weeks to Clear), Cashier's Ck,  
Money Order Accepted.

APD Orders Add 8% (minimum \$7). Add 3%  
For Net Terms. All Returned Non-Defective  
Merchandise Are Subject To A 20% Restocking  
Charge. GenTech Reserves the Right to Change  
Advertised Prices.

AMERICAN EXPRESS  
MasterCard  
VISA

There's another dark horse in the wings. The Modula-2 operating system, which grew from the same inspiration as Macintosh's operating system (namely, the work of Alan Kay at the Xerox Palo Alto Research Center), keeps popping up in unexpected places.

We don't as yet have an acceptable software-integrating operating system, but maybe we won't have to wait forever to get one.

## DOES IT MATTER?

One final thought. One way to "integrate" programs is not to bother: do you really care whether your program has been interrupted and remains resident in memory as opposed to saving your work on disk, calling in a new program, and reinvoking the original when it's wanted again? Or that in order to transfer data from one program to another, you must go through a disk file? Of course, we do care when disk access is slow; but what if it were nearly instantaneous?

Indeed, that's pretty nearly what I do now. Despite the advanced machines available, I still do all my writing on Zeke II, a CompuPro Z80. This is partly sloth but mostly my attachment to my (alas, no longer available) Archive Hall-effect keyboard and my memory-mapped video brought out on an ancient but incredibly reliable Hitachi 14-inch monitor. (It was a 15-inch monitor when I bought it, but the measurement standards seem to have changed.) I suppose that some day I'll change to another system, but so far I've no overwhelming temptation to do so.

What makes this ancient system tolerable is a megabyte of RAM (random-access read/write memory) disk. Mine happens to be CompuPro's M-Drive/H, but I've also used Semi-Disk without noticeable difference. The result is that I can save this entire column in about 2 seconds. It takes about 20 seconds to save the column, exit the editor, and bring in my address book or a small database. I've also written filter programs that convert one kind of file to another, so

(continued)





*"Put more performance in less space"*

### Look into the new Princeton HX-9 Series

See high-resolution RGB color with the Princeton HX-9 and HX-9E Color Monitors.

Observe exceptionally sharp high resolution graphics and text created by color phosphor dots which are within a mere .28mm of one another.

Enjoy Princeton performance on a 9-inch screen in less desk space than most any other monitor on the market today.

### Display images of clearly superior quality

Flicker-free technology enables you to view colorful images with clear, sharp definition. Dark-glass, non-glare screens further enhance viewing clarity.



A built-in green/amber switch allows you to switch from multi-color to either a green or amber mode. It's like owning both a color and a monochrome monitor.

The Princeton HX-9 Color Monitor is perfect for viewing up to 16 vivid colors with the IBM Color/Graphics Monitor Adapter (or equivalent).

And, the enhanced member of the HX-9 Series, the Princeton HX-9E Color Monitor, offers one big extra: It also allows you to use the IBM Enhanced Graphics Adapter (or equivalent) to view up to 64 brilliant colors.

What's more, they tilt. They swivel. Both have a built-in base to adjust your monitor to a comfortable viewing angle.

### Princeton quality is built in

Both monitors in the Princeton HX-9 Series are manufactured to provide years of reliable use. Verified by tough quality-control procedures. And backed by a full one-year warranty.

### Visit your local computer store today

See the HX-9 Series and all other products bearing the world-respected Princeton name. To find the Princeton dealer nearest you, call: **800-221-1490 (Extension 404)**, 609-683-1660 (NJ only), Telex: 821402 PGS PRIN.

Princeton Graphic Systems, 601 Ewing Street, Bldg. A, Princeton, NJ 08540.

# PRINCETON™

GRAPHIC SYSTEMS  
AN INTELLIGENT SYSTEMS COMPANY

IBM is a registered trademark of International Business Machines Corp.

Inquiry 298

SEPTEMBER 1985 • BYTE 359



that the output of one program can become the input for the next; by using the CP/M Submit utility I can do highly complex operations, and given the RAM disk they go fast. It's not integration or anything like it, and I do indeed miss the SideKick utilities; but the speed of the RAM disk takes a lot of the sting out of nonintegration.

The major problem with the RAM disk is that everything goes away during a power failure. However, memory isn't the only thing that's getting cheaper each year. So is the uninterruptible power supply (UPS); at COMDEX I saw more than one UPS that would be better than adequate to run Zeke II for half an hour or longer, plenty long enough to protect work in progress. There are still plenty of incentives for integration, but with a RAM disk and a UPS I can afford to sit back and wait until something really excellent comes along.

**POOR WHAT?**

While we're on the subject of integration, there is a program called Write-Hand-Man (WHM) from Poor Person's Software. The name is a play on SideKick, of course. WHM attempts to do for CP/M 2.2 systems what SideKick does for the IBM PC. The problem is that CP/M systems are already hurting for available memory; using up another 6K to 8K bytes for a resident demon can present problems. WordStar doesn't particularly notice the loss, but WRITE and other text editors that work only on text resident in

memory certainly do.

Another problem is the trigger character. Few CP/M keyboards can generate anything other than ASCII (American Standard Code for Information Interchange) characters 00 through 127, which means that only 32 control characters are available. Many of these, such as carriage return and horizontal tab, already have accepted meanings, leaving even fewer available characters to do special things, such as moving the cursor around. To use WHM, you must choose something your terminal can make that you won't normally use. Poor Person's Software suggests ASCII null (00), which is Control-@. Whatever you select can never be used for anything else while you're running WHM.

WHM gives you a notebook, a phone book, and a two-week appointment calendar. It also gives you the option of running any other program that you've written and assembled and left on the disk as a .REL file. If you want to write your own application programs, you'll need a relocating assembler like RMAC or M80. (If this means nothing to you, don't worry about it.)

WHM is ingenious and works as intended. The manual is only about eight pages long. Most of the information is more useful to hackers than to users. You have to read through all of it, then go back and start over, before you get all the information needed to install the program. Even so, I'd guess

that all but the most naive users would be able to get WHM installed provided they don't mind making a few mistakes and doing some experimentation.

There was a time when I would eagerly have welcomed WHM; but, in fact, I've found that the loss of memory when I'm writing is too high a price to pay for the limited convenience. It's possible that I'm spoiled. I also have plenty of RAM disk.

**TERMINAL ADVICE**

A book I wish I'd had years ago is David Stephens's *A Programmer's Guide to Video Display Terminals* (Atlantis Publishing Company, POB 56967, Dallas, TX 75220). It's priced a bit high at \$30, and it's hardly light reading; but if you need it, you need it bad.

The book is mostly tables of control codes. What sequence erases to end of line for the Teletype 5420 terminal? What homes the cursor? How do you clear the screen on the Ann Arbor Guru terminal? It's all here, page after page of information in readable form. Terminal manuals are notoriously poor, written by graduates of that secret school that teaches the black art of incomprehensible technical writing. This book tables the information in a sane and clear-cut way. It's even indexed several times in ways that bring together terminals with similar command structures.

You can also get the data in the book on disk; write Atlantis Publish-

(continued)

**GRAPHS WITHOUT GRAPHICS?**

SALES IN 1983

**No need for color monitor or graphics board.  
Make graphs on dot matrix printers.**

Easy to Use. No Programming.  
CP/M 2.2, 3, 80, or 86, MS-DOS or PC-DOS.  
Excellent Manual. Most disk formats.

**DataPlotter™**  
Line Graphs & Scatterplots . . . \$69  
Bar Graphs & Pie Charts . . . \$69  
Both for \$99  
*(Prices include manual)*  
Add \$3 shipping,  
\$8 outside US and Canada.  
Specify type of Printer.

**Lark Software™**  
131 N. Leverett Rd.  
Leverett, MA 01054 (413) 773-8687 Visa, M/C

Y-axis: D E P L A Y E M E N T  
X-axis: M I L L I S E C O N D S

— THEORETICAL  
xxx EMPIRICAL



# TYP-SET™

## The Ultimate Software Solution for Lettering

TYP-SET™ is the ultimate, easy-to-use, high resolution graphic arts quality lettering software for making presentation material. With an IBM PC or compatible microcomputer and almost any plotter, you can create beautiful graphics using different lettering styles, spacing and shading. By yourself, you can easily create report graphics, overhead projections and signs of almost any size on many kinds of materials.

**CAN YOUR LETTERING MACHINE CREATE CHARACTERS THIS BIG?**



TYP-SET™ generates graphic art quality lettering in many font styles.

TYP-SET's characters are designed mathematically to produce presentation quality lettering without distortion or loss of resolution.

Lettering can be produced in any size from .05 inches to 72 inches without any loss of aesthetic quality, spaced proportionally with automatic kerning or spaced for columnized alignment.



**QUICKLY PRODUCE AD LAYOUTS OR ART WORKUPS?**

Text can be mirrored and reversed with spacing controlled to create gapped or overlapped lettering.



**CREATE BUSINESS CHARTS THAT STILL LOOK GOOD ON THE SCREEN?**

All fonts can be presented as designed or in condensed, extended or italicized styles with concatenated text made up of mixed fonts.

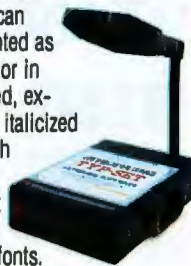

### TYP-SET™ FEATURES

- IBM compatible.
- Video or plotter output selectable.
- Interfaces to Sweet-P, Hewlett Packard and most popular plotters for hard copy output on paper or transparencies.
- Fully menu-driven for easy operation.
- High quality lettering from .05 inches to 72 inches without distortion or loss of aesthetic quality.
- Automatic or selectable line and character spacing.

- Allows 360° line rotation, right, left and center justification.
- INCLUDES SIX DIFFERENT FONTS.

**SGH01 HVL LIGHT**

**SGH55 DHD DUCK**

**SGH12 AGM MEDIUM**

**SGH121 GMB BOLD**

**SGH140 FMB BLACK**

**SGH145 LEM MEDIUM**

*Sweet-P*®

Enter Computer, Inc.  
6867 Nancy Ridge Drive  
San Diego, Ca. 92121  
(800) 227-4375  
(800) 227-4371 (CA)  
(619) 450-0601  
TLX-181740

\*Wordstar is a registered trademark of MicroPro International; Lotus, Lotus Development Corp; AutoCAD, Autodesk; TYP-SET Enter Computer, Inc.

**DISTRIBUTORS:** SOFTSEL COMPUTER PRODUCTS • EASTERN U.S. (800) 645-7779 (201) 575-5245 • CENTRAL U.S. (800) 645-7775 (312) 773-8888 • WESTERN U.S. (800) 645-7778 (213) 412-1700 • CANADA (800) 268-0460 (416) 629-2222 • GEORGIA PRYOR CORPORATION, DECATUR (404) 987-0300 • ILLINOIS PRYOR CORPORATION, CHICAGO (312) 736-0855 • PRYOR CORPORATION, PEORIA (309) 688-9585 • ZENITH DATA SYSTEMS, NORTHLAKE (312) 562-7300 • MARYLAND PRYOR CORPORATION, COLUMBIA (301) 992-0040 • NEW JERSEY PRYOR CORPORATION, EAST RUTHERFORD (201) 935-2525 • NORTH CAROLINA ALLISON-ERWIN, CHARLOTTE (704) 334-8621 • OHIO PRYOR CORPORATION, POWELL (614) 436-8281 • PENNSYLVANIA PRYOR CORPORATION, LEETSDALE (412) 741-2920 • TENNESSEE MULTI COMPUTER PRODUCTS, COOKVILLE (615) 528-7777 • TEXAS AMCAD, Inc., CARROLLTON (214) 323-0700 • WISCONSIN PRYOR CORPORATION, MADISON (608) 273-2050



ing for information. Anyone serious about writing install programs to put software on a variety of terminals can't afford to be without both book and disk. Highly recommended for programmers.

**CHEAP GRAPHICS**

Hackers are probably familiar with the public-domain program GRAF 1.0. For \$35 (well, it says \$29.95 + \$5 shipping and handling), Dr. Donald Brittain, who wrote the original GRAF, will sell you GRAF 2.0, which does considerably more. The GRAF programs plot bar and line graphs on Epson and Epson-compatible printers if you have one for a Z80 CP/M machine. GRAF 2.0 needs a full 64K bytes of memory. Time was when those were serious limitations, but no longer. However, it won't work on the older CompuPro 8/16 or the Zenith Z-100, which both use an 8085 rather than a Z80 for

their 8-bit processor. It seems to work fine with the new CompuPro 286 with the Z80 SPUZ slave board.

Printers supported include the Epson MX-80 with Graftrax, RX-80, and FX-80; the C.Itoh ProWriter (shades of the past!); and the Okidata with Plug 'n Play chips (but not unmodified Okidata). The version I have comes in the Kaypro 5¼-inch disk format; you can also get it on 8-inch IBM single-sided single-density disks. Specify printer and disk format when ordering (there's no install program).

Writing the above paragraph takes me back to the days when nothing was compatible with anything else, even though CP/M had become the standard operating system. Things are supposed to be much better now. I wonder.

Anyway, GRAF 2.0 is simple enough to use and produces charts and graphs that are good enough for

academic reports and the like. Dot matrix is dot matrix, of course; this isn't going to be print-quality work. It's more than good enough for term papers though.

GRAF 2.0 has a lot of convenient features, such as automatic scaling and labeling of graph axes, disk storage of graphs, overlay capability, and ways to take data from other programs. The manual is well written. This is one of those programs that does a job well without fuss or bother. If you need line or bar graphs and don't want to spend much money, this is the program to get. Recommended.

**BLINKERS**

Thanks. After my tirade about the Texas Instruments Professional's blinking cursor, I received more than 50 letters with fixes for it. Some of them got pretty elaborate, with full-screen

*(continued)*



**VT100**  
**\$150\***

\*plus your IBM PC

! Now with KERMIT !

Use your IBM PC jr/XT/AT, or compatible with ZSTEMpc-VT100 Smart Terminal Emulator.

Connect to PDP-11, DEC-10, VAX for on-line data input or editing. Use with ALL-IN-1, EDT, WORD-11, DEC CALC

Transfer files from your host for input to spreadsheet/word processing or local modification prior to transfer back to the host.

- 132-columns by windowing — no additional hardware •
  - Double High / Double Wide Characters •
- Complete VT100 line graphics • Smooth Scrolling •
  - International Font Support •
  - Full Keyboard softkey / MACROS •
  - Single Key DOS Access •
- Bidirectional file transfer — including XMODEM and KERMIT •
  - Baud rates to 38.4 KB with high throughput •
- Color/graphics, monochrome, and EGA adaptor support •

Call today: VISA and MasterCard accepted  
Quantity and dealer discounts available  
30 day money back guarantee  
AIR MAIL POSTAGE included for US & Canada

**KEA Systems Ltd.**

2150 West Broadway, Suite 412  
Vancouver, B.C. CANADA V6K 4L9  
Technical Support (604) 732-7411

**Order desk (800) 663-8702 Toll Free**  
TELEX 04-352848 VCR COMPUSERVE 72177, 506

Trademarks IBM PC jr, XT, AT — IBM Corporation, VT100, PDP DEC, VAX — Digital Equipment Corp. ZSTEMpc — KEA Systems Ltd.

**Computers For The Blind**

**Talking computers give blind and visually impaired people access to electronic information. The question is how and how much?**

**The answers can be found in "The Second Beginner's Guide to Personal Computers for the Blind and Visually Impaired" published by the National Braille Press. This comprehensive book contains a Buyer's Guide to talking microcomputers and large print display processors. More importantly it includes reviews, written by blind users, of software that works with speech.**

Send orders to:

**National Braille Press Inc.,  
88 St. Stephen Street, Boston, MA 02115  
(617) 266-6160**

*NBP is a nonprofit braille printing and publishing house.*

# Powerful MS-DOS™ Software.

For the IBM®-PC, XT, AT & compatibles with MS-DOS/PC-DOS 2.0 or higher.

Only **\$39.95** Each

## UTAH COBOL™

**ALL NEW!** We believe this is the fastest COBOL compiler on any micro; for example, we have compiled 4500 statements per minute on an IBM-AT. Utah COBOL is based on ANSI-74 standards with powerful level 2 features, including compound conditionals & full CALL CANCEL. Speed and simplicity are certain to make it a favorite in the classroom as well as with professional programmers. Package includes diskette, 165-page manual, many examples & 16 complete COBOL source code programs. **\$39.95.**

COBOL Application Package, Book 1: \$9.95.

## UTAH PASCAL™

Has many advanced features including: 14 digit precision, BCD math (no round-off errors), floating point +63 -64, TRACE debugging, Arrays up to 8 dimensions, 64K strings, External procedures & Dynamic Module loading. Package includes diskette & 134-page manual. **\$39.95.**

## UTAH PILOT™

Written by Prof. J. Starkweather, the language's creator, Utah PILOT exceeds all PILOT-73 standards. And it has an integrated full-screen text editor for easy program development. Ideal for classroom instruction, business training & home study. Package includes diskette, 129-page manual & 10 sample programs. **\$39.95.**

## UTAH EDIT™

A full-screen, video-display text editor designed specifically for computer program text preparation. Completely user-changeable, it can be configured to almost any terminal & takes only 12K disk space. Package includes diskette & 58-page manual. **\$39.95.**

UTAH **BASIC™** \$39.95  
Package includes diskette & 239-page manual.

**BIGPRINT™** DISKETTE \$19.95  
Great for making signs. Requires 132-position printer.

UTAH software requires 128K RAM (i.e., 90K user RAM) an IBM-PC, XT, AT, PCjr, or compatible (16-bit) microcomputer with MS-DOS or PC-DOS Operating System, Rev. 2.0 or higher. For 8-bit CP/M-80 systems, ask about our **NEVADA** Software Series.

MS is a trademark of Microsoft Corp. IBM is a registered trademark of International Business Machines, Corp. Utah COBOL, Utah BASIC, Utah PASCAL, Utah PILOT, Utah EDIT, BIGPRINT, & Ellis Computing, Inc. are trademarks of Ellis Computing, Inc. © 1985 Ellis Computing, Inc.

**SATISFACTION GUARANTEED.** If for any reason you're not completely satisfied, just return the Utah package within 15 days—in good condition, with the sealed diskette unopened—and we'll refund your money. **There's absolutely no risk to you, so why wait?—order today.**

### Please send me these UTAH Software packages

(IBM-PC diskette):

- |                                 |                                |                                   |
|---------------------------------|--------------------------------|-----------------------------------|
| <input type="checkbox"/> COBOL  | <input type="checkbox"/> BASIC | <input type="checkbox"/> EDIT     |
| <input type="checkbox"/> PASCAL | <input type="checkbox"/> PILOT | <input type="checkbox"/> BIGPRINT |

Send me \_\_\_\_ (how many) software packages: TOTAL \$ \_\_\_\_\_

Utah COBOL Application Book 1; BIGPRINT: \_\_\_\_\_

California residents add sales tax (6% or 6½%) \_\_\_\_\_

HANDLING/SHIPPING: no shipping charge within U.S.; Overseas add \$10 for first package, \$5 each additional. \_\_\_\_\_

- |                                |                               |                                     |
|--------------------------------|-------------------------------|-------------------------------------|
| <input type="checkbox"/> Check | <input type="checkbox"/> VISA | <input type="checkbox"/> MasterCard |
|--------------------------------|-------------------------------|-------------------------------------|

Checks must be in U.S. Dollars, drawn on a U.S. bank.



(Sorry, no C.O.D.s.)

Enclosed: TOTAL \$ \_\_\_\_\_

### Send my UTAH order to:

CARD NO. \_\_\_\_\_ EXP. \_\_\_\_\_

SIGNATURE \_\_\_\_\_

SHIP TO NAME \_\_\_\_\_

STREET \_\_\_\_\_

CITY/STATE/ZIP \_\_\_\_\_

COUNTRY \_\_\_\_\_

Order now from:

**ELLIS COMPUTING, INC.**  
3917 Noriega Street  
San Francisco, CA 94122

Phone **(415) 753-0186**



SINCE 1977

**ELLIS COMPUTING™**



# COMPUTER MAIL ORDER

## THE CMO ADVANTAGE

- ✓ THE BEST PRICES!
- ✓ Next day shipping on all in stock items.
- ✓ Free easy access order inquiry.
- ✓ Orders from outside Pennsylvania and Nevada save state sales tax.
- ✓ Free technical support with our factory trained technical staff.
- ✓ There is no limit and no deposit on C.O.D. orders.
- ✓ There's no extra charge for using your credit card. Your card is not charged until we ship.
- ✓ No waiting period for cashiers checks.
- ✓ We accept purchase orders from qualified corporations. Subject to approval.
- ✓ Educational discounts available to qualified institutions.
- ✓ FREE CATALOG MEMBERSHIP

### ORDER LINE

**1-800-233-8950**  
In PA 1-800-242-4215

**CUSTOMER SERVICE & TECH SUPPORT**  
1-717-327-1450

Dept. A109

### MAILING ADDRESS

Computer Mail Order  
Dept. A109  
477 East Third Street  
Williamsport, PA 17701



MEMBER DIRECT MARKETING ASSOCIATION

### CREDIT CARDS



Inquiry 79



### SHIPPING

Add 3%, minimum \$5.00 shipping and handling on all orders. Larger shipments may require additional charges.

All items subject to availability and price change.

Returned shipments may be subject to a restocking fee.

### CANADIAN ORDERS

**1-800-268-3974**  
Ontario/Quebec

**1-800-268-4559**  
Other Provinces

**1-416-828-0866**  
In Toronto

**TELEX: 06-218960**

2505 Dunwin Drive,  
Mississauga, Ontario  
Canada L5L1T1

All prices shown are for U.S.A. orders. Call The Canadian Office for Canadian prices.

## ATARI



### COMPUTERS

**130XE 128K.....CALL**  
**520ST 520K SystemCALL**  
**800XL 64K.....CALL**

850 Interface.....\$119.00  
1010 Recorder.....\$47.99  
1020 Color Printer.....\$69.99  
1025 Dot Matrix.....\$179.00  
1027 Letter Quality.....\$239.00  
1030 Direct Connect Modem\$59.99  
5049 Atari Visicalc.....\$45.99  
8036 Atari Writer.....\$24.99

### BOARDS FOR ATARI

Axlon 32K.....\$39.99  
Axlon 48K (400).....\$69.99  
Axlon 128K.....\$269.00  
Bit 3 Full View 80.....\$169.00

### SPECIALS

**Atari 800-48K \$69.99**

**Atari 835 Modem.....\$29.99**

**4011 Star Raiders.....\$5.99**

**4022 Pac Man.....\$5.99**

**8026 Dig Dug.....\$5.99**

**8030 Donkey Kong.....\$5.99**

**8044 Joust.....\$5.99**

**4013 Astroids.....\$5.99**

**8130 Caverns of Mars.....\$5.99**

**4020 Centipede.....\$5.99**

**4025 Defender.....\$5.99**

**8030 E.T.....\$5.99**

**8039 Eastern Front.....\$5.99**

## HOME COMPUTERS

### APPLE

APPLE IIe.....CALL  
APPLE IIc.....CALL  
MacINTOSH.....CALL  
IIC LCD Display.....CALL

### Macintosh Software

Lotus Jazz.....CALL  
Microsoft Excel.....CALL  
Microsoft Business Pak.....\$375.00  
Living Videotext  
ThinkTank 512.....\$159.00  
Manhattan Ready, Set, Go.....\$79.99  
Creighton Development  
Mac Spell.....\$69.99  
Monogram Dollars & Sense.....\$99.99  
Peachtree Back to Basics - GL\$109.00  
PFS File & Report (New Version)\$129.00  
Silicon Beach Airborn.....\$25.99

### Commodore

C128 Computer.....SNEW  
C1571 (Disk Drive for C128).....SNEW  
C1902 (RGB 13" Monitor for C128).....SNEW  
C1670 (Modem for C128).....SNEW

5X-64 Portable.....\$399.00  
Commodore Plus 4.....\$199.00  
CBM 64.....\$149.00  
C1541 Disk Drive.....\$199.00  
C1530 Datasette.....\$39.99  
M-801 Dot Matrix Printer.....\$169.00  
MCS 803 Dot Matrix.....\$179.00  
C1702 Color Monitor.....\$199.00  
C1660 Auto Modem.....\$59.99  
DPS 1101 Daisy Printer.....\$339.00

## PORTABLE COMPUTERS



41CV.....\$189.99  
41CX.....\$249.99  
HP 71B.....\$419.99  
HP 11C.....\$62.99  
HP 12C/15C/16C.....\$89.99  
HP 75D.....\$999.99  
HPIL Module.....\$98.99  
HPIL Cassette or Printer.....\$359.99  
Card Reader.....\$143.99  
Extended Function Module.....\$63.99  
Time Module.....\$63.99

We stock the full line of  
HP calculator products

### NEC

PC-8401.....CALL  
PC-8201 Portable Computer.....\$289.00  
PC-8231 Disk Drive.....\$599.00  
PC-8221A Thermal Printers.....\$149.00  
PC-8281A Data Recorder.....\$99.99  
PC-8201-06 8K RAM Chips.....\$105.00

### SHARP

PC-1350.....\$159.99  
PC-1261.....\$159.99  
PC-1260.....\$109.99  
PC-1500A.....\$165.99  
PC-1250A.....\$88.99  
CE-125 Printer/Cassette.....\$128.99  
CE-150 Color Printer Cassette.....\$171.99  
CE-161 16K RAM.....\$134.99

## DISKETTES

### maxell.

3 1/2" SS/DD.....\$39.99  
3 1/2" DS/DD.....\$54.99  
5 1/4" MD-1 w/Hardcase.....\$17.99  
5 1/4" MD-2 w/Hardcase.....\$23.99  
5 1/4" MD-2-HD for AT.....\$44.99

### Verbatim.

5 1/4" SS/DD.....\$21.99  
5 1/4" DS/DD.....\$29.99  
Disk Analyzer.....\$24.99

### Dennison

Elephant 5 1/4" SS/SD.....\$13.99  
Elephant 5 1/4" SS/DD.....\$15.99  
Elephant 5 1/4" DS/DD.....\$16.99  
Elephant Premium DS/DD.....\$23.99

IBM  
5 1/4" DS/DD Floppy Disks  
(Box of 10).....\$25.99

## DISK HOLDERS

### INNOVATIVE CONCEPTS

Flip-in-File 10.....\$3.99  
Flip-in-File 50.....\$17.99  
Flip-in-File 50 w/lock.....\$24.99  
Flip-in-File (400/800 ROM).....\$11.99

### AMARAY

50 Disk Tub 5 1/4".....\$9.99  
30 Disk Tub 3 1/2".....\$8.99

### SMITH & BELL KAS

Wood Disk Holders.....CALL

## MODEMS

### ANCHOR

Volksmodem.....\$59.99  
Volksmodem 300/1200.....\$189.99  
Mark XII (1200 Baud).....\$259.00  
Signalman Express.....\$299.00  
Lightning 2400 Baud.....\$399.00

### Hayes

Smartmodem 300.....\$139.00  
Smartmodem 1200.....\$389.00  
Smartmodem 1200B.....\$359.00  
Smartmodem 2400.....\$629.00  
Micromodem IIe.....\$249.00  
Smart Com II.....\$89.99  
Chronograph.....\$199.00  
Transet 1000.....CALL

### AST

Reach 1200 Baud Half Card.....\$399.00

### MPP MICROBITS

MPP-1000E AD/AA (Atari).....\$79.99  
MPP-1064 AD/AA (C-64).....\$69.99

### Novation

Smart Cat Plus.....\$319.00  
J-Cat.....\$99.99  
Novation 2400.....CALL  
Apple Cat II.....\$229.00  
212 Apple Cat II.....\$379.00  
Apple Cat 212 Upgrade.....\$229.00  
Macmodem.....\$319.00



Quadmodem II  
300/1200.....\$339.00  
300/1200/2400.....\$499.00

### TELELEARNING

C64 300 Baud.....(Closeout).....\$39.99

## GRAPHICS



IBM.....\$89.99  
Apple/Franklin.....\$79.99

### Polaroid

Palette.....\$1299.00

## DRIVES

### HARD

### ALLOY

PC Stor.....CALL

### IBEA Associates

5 meg Removable/Internal.....\$1399.00  
10 meg Fixed/Internal.....\$1249.00  
15 meg 5 Removable/10 Fixed\$2149.00  
25 meg 5 Removable/20 Fixed\$2499.00

### MEGA

10 Meg Bernoulli Box.....\$2099.00  
20 meg Bernoulli Box.....\$2599.00  
5 meg "MacNoulli".....\$1599.00



12, 25, 35, 50, 80 meg (PC)  
.....from \$1499.00

## FLOPPY

### INDUS

Apple GT.....\$209.00  
Atari GT.....\$239.00  
C-64 GT.....\$259.00

### μ-SCI

A1.5 Apple.....\$199.00  
A2 Apple.....\$199.00

### MSD

SD1 C-64 Single.....\$219.00  
SD2 C-64 Dual.....\$469.00

### Tandon

320K 5 1/4" (PC).....\$119.00

### TEAC

320K 5 1/4".....\$109.00

# CALL TOLL-FREE



**MONITORS**

**AMDEK**

300 Green.....	\$129.00
300 Amber.....	\$139.00
310 Amber IBM-Plug.....	\$169.00
Color 300 Composite.....	\$199.00
Color 500 Composite/RGB.....	\$389.00
Color 600 Hi-Res (640x240).....	\$399.00
Color 700 Hi-Res (720x240).....	\$499.00
Color 710 Long Phosphor.....	\$579.00



12" Amber/Green Composite.....	\$99.99
12" Amber/Green TTL.....(ea.)	\$119.00

**NEC**

JB 1260 Green.....	\$59.99
JB 1201/1205 (ea.).....	\$99.99
JB 1270 Green.....	\$139.00
JB 1275 Amber.....	\$149.00
JB 1280 G TTL/1285 A TTL.....	\$149.00
JC 1410 RGB.....	\$669.00

**PRINCETON**

MAX-12E Amber.....	\$189.00
HX-9 9" RGB.....	\$469.00
HX-9E Enhanced.....	\$519.00
HX-12 12" RGB.....	\$469.00
HX-12E Enhanced.....	\$559.00
SR-12 Hi-Res.....	\$599.00
SR-12 P Enhanced.....	\$649.00

**TAXAN**

115 12" Green Mono.....	\$118.00
116 12" Amber Mono.....	\$119.00
121 Green TTL.....	\$139.00
122 Amber TTL.....	\$149.00
420 Hi-Res RGB (IBM).....	\$429.00
440 Ultra Hi-Res RGB.....	\$559.00



8400 Quadchrome I.....	\$479.00
8410 Quadchrome II.....	\$429.00
8420 Amberchrome.....	\$179.00
8500 Quad Screen.....	\$1499.00



ZVM 1220/1230.....	\$99.99
ZVM 1240 IBM Amber.....	\$139.00
ZVM 130 Color.....	\$269.00
ZVM 131 Color.....	\$249.00
ZVM 133 RGB.....	\$429.00
ZVM 135 RGB/Color.....	\$459.00
ZVM 136 RGB/Color.....	\$599.00
1220, 1230, 1240.....	CALL

**INTERFACES**



Graphcard.....	\$79.99
Serial Card.....	\$99.99
Microbuffer II +.....	\$169.00
Microbuffer 32K.....	\$189.00



Microfazer.....	from \$139.00
Efazer (Epson).....	from \$79.99

**Orange Mikro**

Grappler CD (C64).....	\$99.99
Grappler + (Apple).....	\$89.99
Grappler 16K + (Apple).....	\$159.00

**DIGITAL DEVICES**

Ape Face (Atari).....	\$49.99
U-Print A (Atari).....	\$54.99
U-A16/Buffer (Atari).....	\$74.99
U-Call Interface (Atari).....	\$39.99
U-Print C (C64).....	\$49.99
P-16 Print Buffer.....	\$74.99
U-Print II Apple IIc.....	\$89.99

**mpe MICROBITS**

MPP-1150 Parallel (Atari).....	\$69.99
MP-1150XL (Atari 1200XL).....	\$69.99
MicroStuffer 64K Print Buffer.....	\$109.00

**PRINTERS**

**CANNON**

A40.....	CALL
LBP-8A1 Laser.....	CALL



MSP-10 (80 col.).....	\$349.00
MSP-15 (132 col.).....	\$499.00
MSP-20 (80 col.).....	\$489.00
MSP-25 (132 col.).....	\$679.00

**C. ITOH**

Prowriter 7500.....	\$219.00
Prowriter 8510P.....	\$299.00
Prowriter 8510 NLO.....	\$329.00
Prowriter 1550P.....	\$469.00
F10-40P Starwriter.....	\$869.00
F10-55 Printmaster.....	\$1049.00

**corona**

Lazer LP-300.....	\$2799.00
-------------------	-----------

**DIABLO**

D25 Daisywheel.....	\$599.00
630-109 Daisywheel.....	\$1749.00
D801F Daisywheel.....	CALL



2000.....	\$749.00
-----------	----------

**EPSON**

LX-80, LX-90, FX-85, FX-185	
JX-80, DX-10, DX-20, SQ 2000	
HS-80, Homewriter 10.....	CALL

**JIUKI**

6000 Letter Quality.....	CALL
6100 Letter Quality.....	CALL
6300 Letter Quality.....	CALL

**NEC**

8027 Transportable.....	\$299.00
2000 Series.....	\$699.00
3000 Series.....	\$1099.00
8000 Series.....	\$1449.00
ELF 360.....	\$449.00

**OKIDATA**

84, 182, 192, 193, 2410.....	CALL
Okimate 10 (Specify C64/Atari).....	\$169.00
Okimate 20 (IBM).....	CALL

**OLYMPIA**

Needlepoint Dot Matrix.....	\$299.00
Compact RO.....	\$339.00
Compact 2.....	\$369.00

**Panasonic**

KX1091.....	\$259.00
KX1092.....	\$389.00
KX1093.....	\$479.00



Quadjet.....	\$399.00
Quad Laser.....	CALL

**SILVER-REED**

500 Letter Quality.....	\$279.00
550 Letter Quality.....	\$419.00
770 Letter Quality.....	\$759.00



SG-10C (C64 Interface).\$NEW	
SB/SD/SG/SR Series.....	CALL
Powertype Letter Quality.....	CALL

**TEXAS INSTRUMENTS**

T1865.....	\$1049.00
------------	-----------

**TOSHIBA**

1340 (80 column).....	\$589.00
P351 (132 column).....	\$1169.00

**PC COMPATIBLES**

**IBM PC SYSTEMS**

**Configured to your specification. Call for Best Price!**

**IBM-PC, IBM-PC II, IBM-XT, IBM-AT**

**SOFTWARE FOR IBM**

**ALPHA**

Electric Desk IBM-PC.....	\$199.00
Framework.....	\$369.00
dBase III.....	\$369.00

**ASHTON-TATE**

Turbo Pascal 3.0.....	\$49.99
Sidekick.....	\$39.99

**BORLAND INTERNATIONAL**

Turbo Pascal 3.0.....	\$49.99
Sidekick.....	\$39.99

**CENTRAL POINT**

Copy II PC-Backup.....	\$29.99
------------------------	---------

**DECISION RESOURCES**

Chartmaster.....	\$259.00
Signmaster.....	\$179.00

**FOX & GELLER**

Quickcode III.....	\$169.00
--------------------	----------

**FUNK SOFTWARE**

Sideways.....	\$39.99
---------------	---------

**Harvard Software Inc.**

Harvard Project Manager.....	\$209.00
Total Project Manager.....	\$269.00

**Human Edge™**

Communication Edge.....	\$99.99
Management Edge.....	\$119.00
Negotiation Edge.....	\$139.00
Sales Edge.....	\$119.00

**LIFETREE**

Volkswriter Deluxe.....	\$159.00
-------------------------	----------

**LIVING VIDEOTEK**

Think Tank.....	\$109.00
-----------------	----------

**Lotus**

Symphony.....	\$439.00
1-2-3.....	\$309.00

**MECA SOFTWARE**

Managing Your Money.....	\$109.00
--------------------------	----------

**MICROSTUF**

Crosstalk XVI.....	\$89.99
Microstuf Remote.....	\$89.99

**MICRORIM**

R:Base 4000.....	\$259.00
R:Base 5000.....	\$399.00
Clout 2.0.....	\$129.00

**MicroPro**

WordStar 2000.....	\$249.00
WordStar 2000 +.....	\$309.00
WordStar Professional.....	\$299.00

**MICROSOFT**

Word.....	\$239.00
Mouse.....	\$139.00
Flight Simulator.....	\$39.99
MultiPlan.....	\$129.00

**MultiMate**

Multi Mate Word Proc.....	\$249.00
---------------------------	----------

**NOUMENON**

Intuit.....	\$69.99
-------------	---------

**NORTON**

Norton Utilities 3.0.....	\$59.99
---------------------------	---------

**Peachtree Software**

Peachtext 5000.....	\$189.00
PeachPack (GL/AP/AR).....	\$219.00

**psf: IBM/APPLE**

Access.....	\$54.99
Write/Graph/File/Plan..... (ea.)	\$79.99
Report.....	\$74.99
Proof.....	\$59.99

**Professional Software**

Wordplus-PC w/Boss.....	\$249.00
-------------------------	----------

**ROSESOFT**

Prokey.....	\$89.99
-------------	---------

**THE SOFTWARE GROUP**

Enable.....	\$339.00
-------------	----------

**SATELLITE SYSTEMS**

Word Perfect 4.0.....	\$219.00
-----------------------	----------

**SORCIM/IUS**

Accounting AP/AR/GL/INV/OE..... (ea.)	\$295.00
SuperCalc III.....	\$195.00
EasyWriter II System.....	\$195.00
Super Project.....	\$195.00

**SPI**

Open Access.....	\$379.00
------------------	----------

**THOUGHTWARE**

Trigger.....	\$289.00
Self, Sell, Sell Training.....	\$299.00
Application.....	\$179.00

**AT&T**

Safari (7300).....	CALL
8300.....	CALL

**corona**

PPC400 Dual Portable.....	\$1799.00
PPCXT 10 meg Portable.....	\$2399.00
PC40022 10 meg Desktop.....	\$1999.00

**ITT**

ITT X-TRA 256K, 2 Drive System.....	CALL
256K, 10 meg Hard Drive System.....	CALL

**SANYO**

MBC 550-2 Single Drive.....	\$699.00
MBC 555-2 Dual Drive.....	\$969.00
MBC 775 Portable.....	\$1599.00
MBC 511 10 meg.....	CALL
MBC 675 Portable.....	CALL
MBC 880 Desktop.....	CALL



PC-151-21 Single Desktop.....	CALL
PC-151-52 Dual Desktop.....	CALL
PC-151-53 10 meg Desktop.....	CALL
PC-161-21 Single Portable.....	CALL
PC-161-52 Dual Portable.....	CALL
Z-200 (AT).....	CALL
171 (Portable).....	CALL
138 (Transportable).....	CALL
148 (DeskTop).....	CALL

**MULTIFUNCTION CARDS**

**AST**

Six Pack Plus.....	\$239.00
Mega Plus II.....	\$269.00
I/O Plus II.....	\$139.00
Advantage-AT.....	\$399.00
Graph Pak.....	\$599.00
Monograph Plus.....	\$399.00
Preview Mono.....	\$299.00
PC Net Cards.....	\$379.00
5251/11 On-line.....	\$799.00
5251/12 Remote.....	\$579.00
3780 Emulation Card.....	\$639.00
BSC Bisynd.....	\$469.00

**dca**

IRMA 3270.....	\$879.00
IRMA Print.....	\$999.00

**EVEREX**

Color Card (Graphics Edge).....	\$299.00
Magic Card.....	\$199.00

**HERCULES**

Graphics.....	\$299.00
Color.....	\$159.00

**IBA Associates**

IDEAmax - ZPR, 64K, C, S, P.....	\$229.00
IDEAmini - YPR, C, S, P.....	\$189.00
IDEAminimax - MPR 128K.....	\$229.00
IDEAshare Software.....	\$219.00
IDEA 5251.....	\$699.00

**MYLEX**

The Chairman.....	\$489.00
-------------------	----------

**PARADISE**

Modular Graphics Card.....	\$274.00
Multi Display Card.....	\$289.00
Five Pack C, S.....	\$159.00

**PERSYST**

Bob Board.....	\$389.00
----------------	----------

**PLANTRONICS**

Color Plus.....	\$369.00
-----------------	----------

**LEGAR**

Captain - 64.....	\$239.00
Captain Jr. 128K.....	\$339.00
Graphics Master.....	\$469.00

**QUADRAM**

Quadport-AT.....	\$119.00
Quadmeg - AT (128K).....	\$349.00
The Gold Quadboard.....	\$449.00
The Silver Quadboard.....	\$239.00
Expanded Quadboard.....	\$219.00
Quad 512 +.....	\$229.00
Liberty.....	\$309.00
QuadSprint.....	\$499.00
QuadLink.....	\$399.00
Quadcolor 1.....	\$199.00
Quad Jr. Expansion Chassis.....	\$469.00
Expansion Chassis Memory.....	\$199.00
Quadmem. Jr.....	\$199.00
Chronograph.....	\$79.99
Parallel Interface Board.....	\$64.99

COMPUTER MAIL ORDER



Listing 1: A simple program to fix the TI Professional's blinking cursor.

```

CUR          SEGMENT          ;CURSE.COM
              ORG          100H ;THIS PROGRAM SETS THE CURSOR
              ASSUME      CS:CUR ;TO FULL NO BLINK AND CLEARS
              MOV         AX,0100H ;THE SCREEN. CONVERT AS FOLLOWS
              MOV         CX,000BH ;USING DEBUG:
              INT         49H      ; 1) RENAME FILE TO .COM
              MOV         0AH,13H ; 2) LOAD DEBUG WITH FILE
              INT         49H      ; 3) AT-TYPE M 400 500 100
              INT         20H      ; 4) MODIFY CX FOR SHORT LENGTH
              CUR          ENDS    ; AT-TYPE RCX AT : TYPE 120
              END          ; 5) ISSUE W THEN Q
    
```

control capabilities.

Bruce Neild of Cheshire, Connecticut, sent in the simplest cursor fixer (see listing 1). It's not fancy, but bound into a start-up batch file it will make the cursor bearable. Mr. Neild reports that he's happy with his TI PC, but "One is hard-pressed to find advertisements in today's magazines that

say they also have the TI PC format. Oh, well, it keeps one from frivolous software purchases."

We can hope that will change. TI does seem anxious to provide support for software developers, and as I reported last month, I'm impressed with the natural-language links. TI also has an artificial-intelligence-based

decision-function generator I hope to report on Real Soon Now.

**TRUE MADNESS**

I've just spent one of the most frustrating hours of my life. I tried to get the new True BASIC to do something useful. I didn't succeed. My usual result was to get cryptic error messages that are not indexed in the manuals: ask for HELP; get the message "Can't help with that. Try HELP TOPICS:"; type in HELP TOPICS; and again get the message "Can't help with that. Try HELP TOPICS:"

My first experiment was to try a simple program:

```

10 FOR I = 1 TO 128
20 PRINT I, CHR$(I)

30 NEXT
40 END
    
```

The result of that was "Illegal line number."

The index shows that line numbers are covered in the reference manual, not in the tutorial. Turning to the reference manual, I see that line numbers are said to be optional; I also see an example of a program that uses line numbers beginning with 100. Could that be it? I changed my little program's line numbers to 110, 120, etc. Ran program. Got "Illegal line number" message. Tried HELP. Got "Can't help with that. Try HELP TOPICS:" This was not a message I particularly wanted.

At this point I was in zugzwang, because True BASIC has windows, but there is no obvious way to get from the command window to the editing window. The index isn't helpful on that, either. By fighting my way about—True BASIC uses function keys, but Control-C and the other things normal BASIC users are accustomed to do not do anything like what you expect—I managed finally to get some familiarity with the command system. For example, there is a way to get back to the command window: it's F2, the "history-window" key. The manual calls it a command window, but what the hell.

(continued)

**IF POWER FAILS, DATASAVER® TAKES OVER!**

**PROTECTION** - saves data during power failures.  
 - saves hardware from overvoltage transients.

**PORTABILITY** - allows mobile or extended holdup time using auxiliary 12 volt battery.

**FEATURES** - internal battery provides 5 min. + operating time - AC line conditioning  
 - audible and visual alarms, interrupt signal - compact, desktop styling  
 - no installation required.

200 WATT - \$495 / 90 WATT - \$350  
 For special applications and product information, call 805-541-4160.

Instant power order line  
**805-541-4161**

**CUESTA SYSTEMS, INC.**  
 3440 Roberto Court, San Luis Obispo, California 93401

**INSTANT AC POWER**



# IT'S NICE TO HAVE A WORKAHOLIC PERSONALITY AROUND THE OFFICE.



## Relax.

When you need hard copy, leave the hard work to your office workaholic—a Datasouth printer. There's a high performance workaholic Datasouth for every hard copy job around your office.

Move mountains of words and data with a never-say-die DS 180 or a DS 220. Type out correspondence with a speedy DaisyWheel 36. Or get an all-purpose Personal Printer to work overtime next to your desktop PC.

And get personal support direct from Datasouth, toll-free.

Set up an interview with a high performance workaholic today. Call for the name of your nearest Datasouth distributor.



**datasouth**

H I G H P E R F O R M A N C E P R I N T E R S

AVAILABLE NATIONWIDE  
THROUGH OUR NETWORK OF  
SALES AND SERVICE DISTRIBUTORS

Datasouth Computer Corporation  
Box 240947 • Charlotte, NC 28224  
704/523-8500 • Tlx 6843018 DASOU UW

CALL TOLL FREE:

1-800-222-4528  
Ext. 504



Once I sort of figured out how to use the editor—most of the commands aren't particularly intuitive—I edited my little program to have no line numbers at all. Press F9, which is RUN. It didn't run, of course. I got the error message "Ending doesn't match beginning." After a moment's thought, I made 30 (well, the statement that

used to be 30) read NEXT I. That ran. Then I tried inserting some REMARK statements. They stopped the program. Try HELP. Couldn't help with that. Found out that True BASIC wants REM as the REMARK command. Incidentally, True BASIC doesn't recognize "?" as a synonym for PRINT. Anyway, I edited my REMARK to a

REM statement. Tried running the program. This stopped at the END statement with the message "Ending doesn't match beginning." No amount of spelunking in the indexes of the two manuals produced information useful in fixing the problem. Eventually I had to go to command level, type NEW, and begin all over again.

In other words, it doesn't matter whether or not you're familiar with BASIC on microcomputer systems; if you want to use True BASIC, you'll have to read, *systematically*, through the entire terminally chatty manual. Don't skip. Some important points are buried in casual paragraphs. Even then you won't discover everything, and some things it tells you aren't true. I never did find an explanation of why my END statement to a simple program produced "Ending doesn't match beginning."

I may have a broken version, but I don't think I do; once I figure out the syntax, the programs seem to run all right (except for line numbers, which I can't get it to accept at all). Broken or not, the editing features don't all work. The manual says that Backspace at a line marker will delete the line, but, in fact, I have found absolutely no way to delete lines. (I can delete all the text in a line with either Escape, to delete from cursor to line start, or Control-End, to delete from cursor to end of line; but the blank line marker remains no matter what I do. Goofy.) The manual says that the Delete key works. Mine doesn't, on either an IBM PC or a Zenith Z-160. The index is off by a page or so on most topics, too. You don't expect that sort of error in an Addison-Wesley publication.

True BASIC has about as dumb a licensing agreement as I've ever seen. The Addison-Wesley lawyers couldn't figure out whether they wanted to protect their product—product is a pretty apt name for this thing—by copyright law, contract law, or trade secret law; so they tried for all three. The resulting schizophrenia would be hilarious if they weren't so serious about it.

If you get True BASIC, be warned:

(continued)



## Dot Matrix Made Beautiful

All the type in this ad was printed on an inexpensive dot matrix printer with Fancy Font, the program that works with almost any word processor to produce high resolution, proportionally spaced, letter quality printing.

No special hardware or installation is required, so you'll be using Fancy Font as soon as you get it.

Fonts, including Roman, Sans Serif, Bold, Italic, Script, Old English and more, from 8 to 24 points come standard with Fancy Font.

**FLEXIBLE.** Fancy Font comes with a complete set of over 1500 mathematical, foreign language and other special symbols.

Hundreds of additional fonts in sizes from 6 to 72 points are available, at a nominal additional charge, from our growing font library.

You can edit any character and also create your own characters or logos, up to 1 inch by 1 inch.

Powerful formatting features let you center, justify, wordwrap and type flush left or right, with or without running headers and footers — even with different fonts and sizes on the same line.

**COST EFFECTIVE.** You buy Fancy Font from your local dealer or direct from us, the software developers, for only \$180.

You get near typeset quality at a small fraction of the time and cost of using art or typesetting services.

Fancy Font runs on PC DOS, MSDOS and CP/M systems with Epson, Toshiba and compatible dot matrix printers.

You'll be turning out great looking reports, newsletters, presentations, letters, mathematical texts, overheads or invitations after getting your copy of Fancy Font. The applications are limited only by your imagination.

Call or write now to order Fancy Font or ask for additional information including actual samples and independent reviews.

**CALL TODAY 1-800-351-0500** MasterCharge and Visa Accepted

**SoftCraft, Inc.**

222 State Street, Madison, WI 53703 (608) 257-3300

Fancy Font is a registered trademark of SoftCraft, Inc.



MASTER THE NEW ELECTRONICS WITH MCGRAW-HILL'S

# Contemporary Electronics Series

The fast, easy and low cost way to meet the challenges of today's electronic innovations. A unique learning series that's as innovative as the circuitry it explains, as fascinating as the experiments you build and explore.

From digital logic to the latest 32-bit microprocessor, the McGraw-Hill Contemporary Electronics Series puts you into the electronic picture one easy step at a time. Fifteen unique Concept Modules, sent to you one every 4-6 weeks, give you a handle on subjects like optoelectronics, robotics, integrated circuits, lasers, fiber optics and more.

Each Concept Module goes right to the heart of the matter. You waste no time on extraneous material or outdated history. It's a fast, efficient, and lively learning experience... a non-traditional approach to the most modern of subject matter.

### Unique Interactive Instruction

With each module, you receive a McGraw-Hill Action Audio Cassette. Each tape is a dynamic discussion that drives home the key facts about the subject. Your learning

With your first module, you get this solderless breadboarding system. You'll use it throughout the series to build electronic circuits and bring concepts to life.



experience is reinforced through interaction with vividly illustrated text, audio cassettes, and actual electronic experiments. Indexed binders preserve backup material, notes, and tapes for convenient referral.

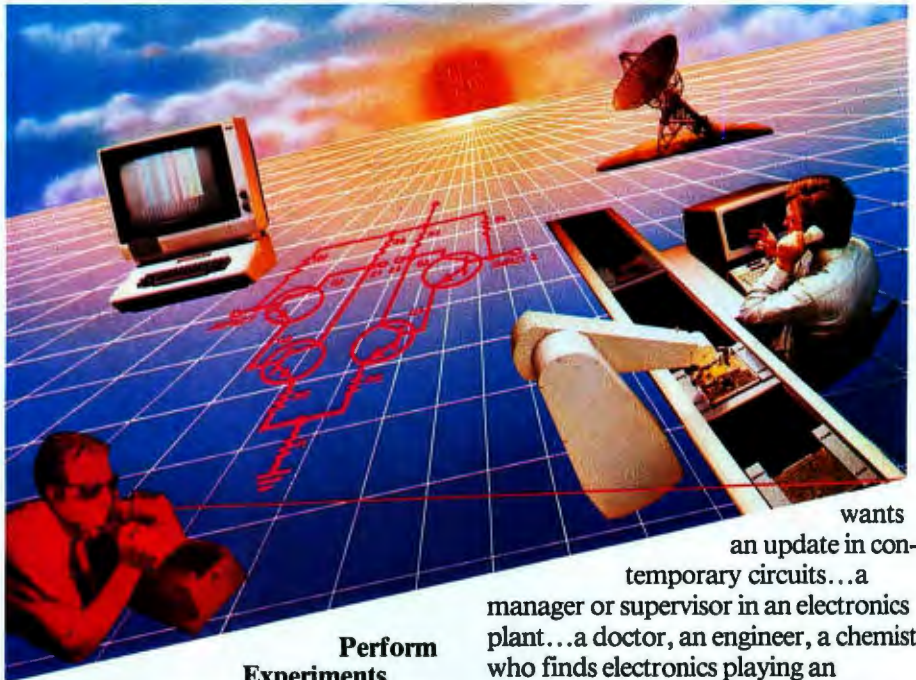

### Perform Experiments in Contemporary Electronics

Throughout your series, laboratory experiments reinforce every significant point. This essential experience... dynamic, hands-on demonstrations of theory in practice... will help you master principles that apply all the way up to tomorrow's latest VLSI (Very Large Scale Integrated) circuitry.

In your very first module, you'll use integrated circuits to build a digital oscillator, verifying its operation with a light emitting diode (LED). You'll learn to identify passive and active components, understand concepts common to all electronic circuits.

### For Anyone Interested in Electronics

The Contemporary Electronics Series is designed for anyone from hobbyist to professional. It's for you if you're looking for new fields of interest... if you're a teacher who

wants an update in contemporary circuits... a manager or supervisor in an electronics plant... a doctor, an engineer, a chemist who finds electronics playing an increasingly important role in your work. It's even for electronics engineers or technicians who feel their training needs freshening up. It's the quickest, most convenient, probably least expensive way to do it. And the only one that gives you hands-on experience.



### 15-Day No-Risk Trial

To order your first module without risk, send the postage-paid card today. Examine it for 15 days under the terms of the order form and see how the Contemporary Electronics Series gets you into today's electronics. If card has been used, write us for ordering information.



McGraw-Hill  
Continuing Education Center  
3939 Wisconsin Ave.  
Washington, D.C. 20016



# Introducing the first IBM™ AT Compatible Kit!

## Building your own AT is as easy as it looks.

Now, it's easy to have the IBM AT that you want by building your own from ADTEK's SERIES 286AT™ compatible, board-level kit. Choose from a complete kit (chassis, motherboard, cables, disk controller, keyboard and enhancement boards) and add your own monitor and disk drives. Or buy just the parts you need for your project. Either way, all series 286AT products are hardware and software AT compatible.

But you won't be on your own. The ADTEK SERIES 286AT comes with illustrated, step by step instructions that even a beginner can follow. (Some basic knowledge of electronics will be helpful.) With just a few simple household tools you can put your new computer together in a Saturday afternoon. And you'll feel confident about your SERIES 286AT because every ADTEK product is protected by a full, one year factory warranty.

## And amazingly frugal.

If you're ready for AT power and speed, but don't want to pay IBM's premium price, rest easy. A complete ADTEK SERIES 286AT kit is priced significantly less than a comparably assembled IBM AT. That's engineering excellence at a real bargain! Call or write today for a detailed brochure and price list on the SERIES 286AT and other fine ADTEK products.



Fully assembled SERIES 286AT



Fixed disk and floppy disk controller.



AT compatible, switchable power supply.



AT compatible keyboard. LED on cap, num and scroll lock keys.



80286 motherboard, 256K standard memory, upgradable to 1M. Clock upgradable to 8MHz.



Fully AT compatible chassis, optional lock. Mounts standard floppy and fixed disk drives.



User supplied disk drives. Kit supplied with list of compatible drive suppliers.



I/O expansion and user expandable memory cards.



User supplied monitor. Kit supplied with list of recommended CRTs.



Video display and printer adaptor boards are fully interfaced with SERIES 286AT system.

Manufacturers of Personal Computers, Peripherals, Accessories

3001 LBJ Freeway Suite 213 Dallas, Texas 75234

(214) 386-6554

ADTEK

IBM is a registered trademark of International Business Machines Corporation and SERIES 286AT is a registered trademark of ADTEK Corporation



in the unlikely event that you'd want to, you are not allowed to "reverse engineer, decompile, or disassemble the Software."

These are minor nits. The real question is: why do we need True BASIC at all?

True BASIC doesn't seem to do anything regular BASIC doesn't do, and what it does do isn't attacked in a logical or intuitive manner. Escape to delete to end of line? REM but never REMARK? And the most annoying misfeature of all: True BASIC produces no output at all if it encounters an error! If, for instance, you don't have an END statement, when you try to run the program, True BASIC thinks to itself for a while, produces no output at all, and finally the cursor appears at the end of the program with the message "No END statement." If you have syntax errors, the same thing happens. No output. Only error messages. No more hacking through by inserting print statements as diagnostics. True BASIC compiles to an intermediate code, similar to the public-domain EBASIC and the earliest versions of CBASIC. It then interprets the intermediate code line by line. The result is that it's not as fast as truly compiled code, yet you don't have the convenience of line-by-line interpretation when writing code.

There are vast differences between True BASIC and what we microcomputer people have learned. They're supposed to be features. After all, True BASIC conforms to the standards set by the American National Standards Institute (ANSI), and indeed the Addison-Wesley press release proclaims rather proudly that True BASIC is the *only* microcomputer BASIC to be "true" to the ANSI standard. Why a standards institute would set standards so at variance with the versions of BASIC that microcomputer people really *use* is not known to me. I don't even know whom ANSI consults when they decide to set "standards." They sure didn't talk to anyone I know. Maybe they spent all their time with mini and mainframe people.

What I do know is that Microsoft BASIC is the microcomputer user's

standard BASIC. If it hadn't been for Bill Gates and his early BASIC, there probably wouldn't have been a microcomputer user movement. Microcomputers might have been captured by the academicians and high priests, and we'd have no choice but to live with their "standards"; but that didn't happen. Microsoft BASIC and BASCOM are a powerful package. Alternatively, there's compiled CBASIC. Why learn yet another?

True BASIC has a few interesting features. There are MAT (matrix) operations; but since they're limited to add, subtract, and multiply, you'll have to write matrix-manipulation procedures before you can do any serious work with matrices. If you must write the more complex ones, it's no work to write the simple ones that come with True BASIC. Still, True BASIC does have MAT commands. Also, the graphics capabilities are good (or at

least the manual says they are; I got tired of fighting with True BASIC's "features" after a couple of hours).

According to the press release, the real attraction of True BASIC is its ability to do structured code. There are special features for this. All very well, but I don't see any control commands in True BASIC that we don't have in extended BASIC for microcomputers. In the old days of little machines with small memories, often without disk drives, there was a flurry of tiny BASICs and small, limited interpreters. There had to be; our early machines wouldn't run anything larger. Those were days when dialects of BASIC multiplied, and BASIC programs weren't transportable. Now, though, it's rare to find a BASIC that isn't an extended, disk version. BASIC programs aren't totally portable, but I've found that conversion is general-

(continued)

## Operate your office PC from home ...

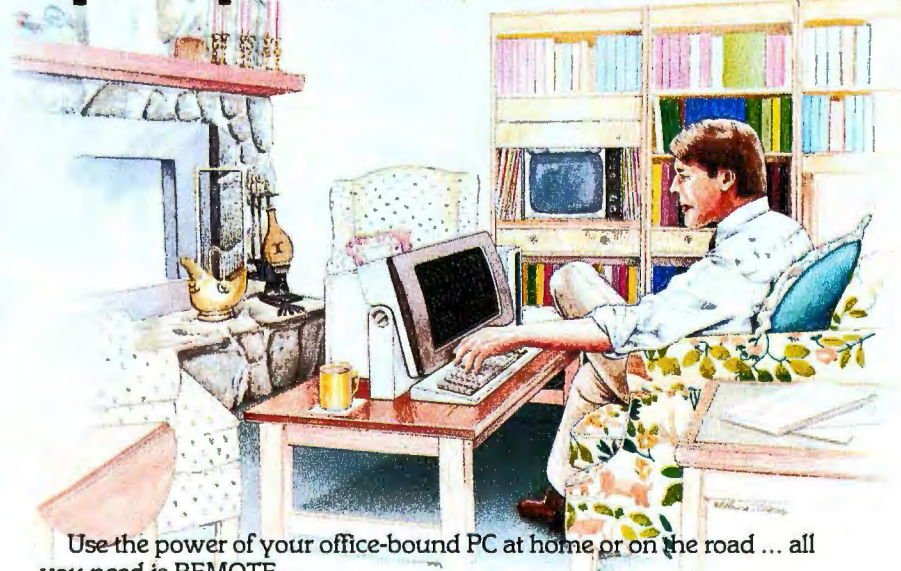

Use the power of your office-bound PC at home or on the road ... all you need is REMOTE.

Whatever PC power you may need, spreadsheet, DBMS, word processor, can be yours. All you need is a portable computer or terminal and a modem. REMOTE provides password protection for each user.

Leave your PC in the office ... but pack the power to go. REMOTE.

# REMOTE™

**MICROSTUF®**

1000 Holcomb Woods Parkway / Roswell, Georgia 30076





**20MB FULL HEIGHT DRIVE FOR IBM AT**  
 • Access time is 2 x's faster than any other 1/2 height drive  
 \$795



**MEMTEC 1/4" STREAMING TAPE** by WANGTEK  
 • Software includes image backup/restore and file copy file  
 Internal - \$865  
 External - \$965



**10/20 MB HARD DISK SUBSYSTEM** by MicroScience  
 • Half height  
 • Low power consumption  
 • Controller, software, cables included.  
 10MB \$535  
 20MB \$660



**20MB STREAMING TAPE DRIVE** by MEMTEC  
 • Backup 10MB in under 4 minutes  
 • Software included  
 \$725

**ALSO AVAILABLE**  
 • Mounting bracket for COMPAQ DESKPRO and IBM AT  
 • Data cable  
 • Y or power cable



**300/1200 MODEM**  
 • 100% Hayes Smart Modem and Bell 103/212 compatible  
 • Also supports COM 3 and COM 4  
 Internal - \$225  
 External - \$325



**COLOR/MONO GRAPHIC DISPLAY CARD**  
 • 720 x 350 resolution in monochrome  
 • 640 x 200 resolution in color  
 Color/Mono - \$280  
 Hercules Compatible Mono - \$255



**EXPANSION CHASSIS**  
 • Various I/O slots/models to choose  
 • Supports all IBM controllers and memory expansion  
 \$665

**10MB FLOPPY TAPE BACKUP**  
 • Uses regular floppy controller  
 • External unit also available.  
 Irwin - \$525  
 Interdyne - \$659



**MEMORY EXPANSION CARD**  
 • Serial, parallel game ports and clock/calendar  
 • Expansion capability to 384K  
 • Includes 64K memory Free  
 \$199



**HALF-HEIGHT FLOPPY DRIVE**  
 • 100% IBM compatible  
 • 360K byte capacity and 48 TPI  
 \$119



IBM, AT & T AND COMPAQ ARE REGISTERED TRADEMARKS.  
 VISA OR MC ADD 3% TO ALL PRICES

# It's Your Move To Improve!

For years we have been selling our products through distributors hoping that they will provide better technical support and services to our customers. Lately, we find that most of them are not really technical and sensitive enough to satisfy our customer needs. In order to provide quality products and services at factory prices, we have decided to sell to you direct by passing distributors. Each of our products comes standard with an easy do-it-yourself installation guide. If you still have problems, our highly trained technical staff is only a phone call away to answer any of your questions.

To further back up our commitment for high quality and better services, our policy is one year warranty and a 30-day no-questions-asked money back guarantee on most of our products.  
 Remember. No loss. No stalemate. Make your move to improve. Call us at our hotline.

**IN USA CALL: 800-JEDEN US**  
**IN CALIFORNIA CALL: 800-JEDEN CA**  
 For a free catalog, call 714-545-8108

**IN CANADA 416-842-3177**  
 912 Barton Street, East, Suite 26  
 Hamilton, Ontario, Canada L8L3C2  
 Inquiry 400

**JEDEN**  
 COMPUTER PERIPHERALS  
 1318 W. Sepulveda Blvd., Harbor City, CA 90710



ly pretty simple. As an example, it took me less than an afternoon to translate Jay Forrester's World Dynamics model into Microsoft BASIC.

The fact is that all modern microcomputer BASICs have IF... THEN... ELSE, WHILE, multiline functions, declarations, and a form of CASE statement. My mad friend used to hate BASIC because it made top-down code structures impossible; but before he died, even MacLean admitted that modern microcomputer BASICs were plenty good enough. He muttered that Microsoft had extended the language to the point that it wasn't really BASIC any longer; but he quit complaining about command structure.

True BASIC offers little that we don't already have (except matrix operations), but it does do things differently from the way microcomputer people have learned them. For example: there's a method for making variables truly local, which is no bad thing. True BASIC's method is similar to the method used by CBASIC—but with an important difference. In True BASIC, in order to have true local variables you must define your functions *outside* the program, after the program END statement. (Like CBASIC, True BASIC has no procedures, but functions can do just about everything a Pascal procedure can do.) I fail to see how this is superior to the CBASIC method: in CBASIC, variables declared inside a function definition are local to the function, and those declared outside it (or not declared at all) are global; what could be simpler? I suppose it's a matter of preference, but I prefer my functions to be inside my program; and if I'm going to use a compiled BASIC, I want one that compiles to native code, not to some intermediate code that it then interprets. It's probably all prejudice on my part.

BASIC was written 20 years ago by John Kemeny and Thomas Kurtz, the authors of True BASIC. Surely they ought to know what BASIC should look like? Moreover, Dr. Thomas Kurtz chairs the Dartmouth Graduate Program in Computer and Information

Sciences and heads the ANSI committee on standards for BASIC. Perhaps that tells us something about the motivation of the standards committee? In any event, we can see what its chairman thought.

In the introduction to True BASIC, Kemeny and Kurtz say, "Today's personal computers are large and powerful machines that allow the implementation of a full modern BASIC. Yet the versions most widely used are what are called in the trade 'Street BASIC'—a horrible dialect of a beautiful language. And since the authors of these languages violated the fundamental design principles of BASIC, 'Street BASIC' is heavily dependent on the hardware being used. The same BASIC program will not run on different personal computers; indeed, it typically does not run on two different models from the same manufacturer.

"The time has come to replace the

obsolete and often ugly implementation of BASIC with a well-designed, modern version."

In other words, little microcomputer user, you're terribly sick and don't even know it. Don't worry, though. The high priests are coming to save you.

It's funny that so few of us microcomputer users understand how badly we need help or how ugly our BASIC has become. Now we have The Word. Kemeny and Kurtz have called for "a rebirth known as True BASIC."

Perhaps they'll get it. Me, I think I'll pass up the opportunity to become a born-again True BASIC believer. I enjoy my Microsoft and CBASIC heresies.

**GATO!**

Years ago as a graduate student I worked on a U.S. Navy research proj-

(continued)

**PC power ... anywhere.**

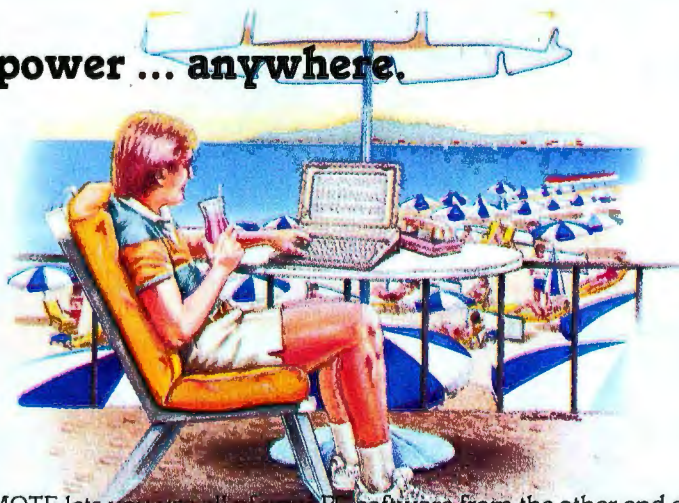

REMOTE lets you use all of your PC software from the other end of a telephone line ... wherever that might be!

All you need is a terminal or portable microcomputer, a modem, and a phone line. You can call into the host microcomputer, access it, and run most popular programs, including word processors, spreadsheets, and database managers. You'll see the program in operation just as if you were sitting in front of the host computer.

REMOTE's powerful electronic mail system rivals those found on mainframes, with full password protection. Why leave your PC power in the office ... when you can give it a call with REMOTE?

**REMOTE™**

**MICROSTUF®**

1000 Holcomb Woods Parkway / Roswell, Georgia 30076



# At NEC, monitors and printers are not peripheral issues.

All too often, brand-name CPUs are "bundled" with mediocre peripherals—a practice that makes for profitable sales, but does nothing for the system's performance.

In Japan, where most computer peripherals are actually built, NEC is the largest personal computer company—by far. And NEC didn't make it to first place by offering second rate peripherals.

## The monitors with the broadcast video heritage.

While dozens of companies market display monitors, only a handful possess the tube technology and manufacturing capability to actually build them. NEC is one of the few. In fact, NEC's complete line of color and monochrome monitors reflects the professional and broadcast video

expertise that twice earned NEC Emmy Awards from the National Academy of Television Arts & Sciences.

## Winning the printer race takes both speed and endurance.

Ask people who really know about printers, and they'll tell you that NEC builds the best. They may also point out that NEC builds printers for other computer companies. And if you ask them to choose one word to sum up what makes NEC printers stand out, it will probably be "reliable." This is why NEC has become the printer of choice for the most demanding installations.

So before you buy a peripheral from any name company, make sure the company puts more into the peripheral than just its name.

PC-PR105A IBM PC PLUG COMPATIBLE TRI-MODE DOT MATRIX PRINTER.



JB-1280DA IBM PC PLUG COMPATIBLE GREEN PHOSPHOR BLACK SCREEN MONITOR.



# NEC

NEC Home Electronics (U.S.A.) Inc.

Personal Computer Division  
1401 Estes Avenue  
Elk Grove Village, IL 60007  
1-800-447-4700

Inquiry 270

NEC Corporation, Tokyo, Japan



ect at the University of Washington. The principal investigator was Dr. Paul Horst, but our immediate superior was Dr. August Dvorak, professor of sociology, inventor of the Dvorak keyboard, and uncle of the columnist John Dvorak. Dr. Dvorak was a Naval Reserve captain and had been skipper of a Gato-class submarine in World War II.

I'd read *Run Silent, Run Deep* (and seen the movie), of course, but otherwise I knew nothing of submarines. When Dr. Dvorak was in a chatty mood, he tended to talk about his keyboard rather than telling war stories; but once in a while he'd spin a yarn. Submarine duty was pretty exciting in those days. I suppose it takes a special kind of sailor to go to sea in a ship *designed* to sink . . .

Anyway, that explains why I was interested when I saw a game simulation of World War II Gato-class submarine warfare.

My first reaction to Gato was dismay. When you start the game, things happen *fast*. "I'm a Star Fleet Admiral. I don't know anything about this wet Navy stuff," I protested, but it didn't do me any good. The enemy continued to move, and my ship was just sitting there. The enemy ships were moving *fast*.

Like many games of this type, Gato is a combination strategic and arcade game. You have to think up what to do while you're doing something else. This kind of game gives me mixed emotions. Compressing a four-hour battle into five minutes certainly puts you under considerable pressure, but it isn't very realistic. On the other hand, true realism would be boring; you don't want to spend hours on a single attack. I do wish I could slow the game down a bit. Even at the beginner level the action is a bit fast. You can stop the game for a while to plan things out, but if you do, you can't see any of the displays; as soon as you look at the chart, or your own speed and heading, or anything else, things start moving again. You get used to the command structure after a few plays, but it's still pretty hectic.

Don't get me wrong, though. I like

the game. I must. I've certainly wasted enough time with it. The PC version is in color. The Macintosh version is more fun. Maybe I'm getting used to the Mac? Recommended.

### SPRING COMDEX

Spring COMDEX in Atlanta this year was a mixed bag. I didn't find much to write about, but I did see a number of items that look pretty good. I use COMDEX as an opportunity to meet people, see interesting items, and look for things to review later.

One long-awaited item was a big display of new Atari computers. They look pretty good for the price, but Atari isn't shipping them yet, and I long ago gave up being much impressed by items on a showroom bench. Also, it's difficult to see how there's going to be much software for them, since Atari was charging pretty stiff prices for early development-sys-

tem copies of the machine. I'd have thought Atari would want to get a lot of those machines out in the hands of the hackers, but Atari's policy made venture capitalists out of the software developers.

Another hot item was the Zenith Advanced PC, an 80286-based IBM PC AT clone. (Alex promptly dubbed it the ZAT, a name that I suspect will stick despite all effort on Zenith's part.) I think I'm going to like the ZAT. I've been impressed with other Zenith equipment. We'll see when I get one here. By the time it comes, I ought to have the construction people out of my hair.

### READ THAT MANUSCRIPT

One of the more interesting items at COMDEX was the Omni-Reader by Oberon. This is a gizmo into which you can insert a page of typescript,

(continued)

## System service by REMOTE control.



System troubleshooting's enough of a headache without adding travel to it. REMOTE can cut your service travel ... to nothing flat.

REMOTE lets you access and operate a distant system via modem. You can troubleshoot the system from top to bottom, update or revise software and data files ... all without leaving your office!

Boost your system support efficiency and your bottom line ... all you need is REMOTE!

**REMOTE™**

**MICROSTUF®**

1000 Holcomb Woods Parkway / Roswell, Georgia 30076



# The fastest micro in the world



No micro in its right mind would want a showdown with Pinnacle.

Its awesome fire power is provided by the superb Motorola 68000 charging along at 12MHZ with no wait states (giving about 3MIPS).

And Pinnacle's ammo belt is just bristling with high powered options to give rapid fire to all seven users.

P-System, Unix,™ CP/M-68K,™ Mosys, BOS, Mirage, Tripas all obey instantly – along with their armies of applications.

Up to 8 Megabytes of directly addressable RAM and 110 Megabytes of Winchester storage dance when Pinnacle barks its sharp orders.

And that's just for starters. There's also the Pinnacle IX with TWO 68000's, DMA, and Memory Management hardware. Ideal for disk intensive operating systems like Unix™ and Pick.

And a Pinnacle LX expansion chassis allowing nine 68000 processors to network 56 users.

A micro's gotta do what a micro's gotta do.

And starting at under \$4000 Pinnacle's just the fastest there is.

## PINNACLE

The accessible peak of performance

US DISTRIBUTORS **Pinnacle Systems Inc.** 10410 Markinson Road, Dallas, Texas 75238. Tel. (214) 340-4941. Telex 88-8442

ELECTRONIC MANUFACTURING/SERVICE **Lamtech Electronics Corporation**, 620 Easy Street, Garland, Texas. Tel. (214) 272-3504

INTERNATIONAL SYSTEMS GROUP **ISG Pinnacle**, Dallas, Texas. Tel. (214) 340-4941. (Distributor enquiries invited).

VERTICAL MARKET SYSTEMS **VMS Pinnacle**, Dallas, Texas. Tel. (214) 340-4941.

EUROPEAN DISTRIBUTORS **TDI Pinnacle Ltd**, 29 Alma Vale Road, Bristol BS8 2HL, England. Tel. (0272) 742796. Telex 444653.

UNIX is a Registered Trade Mark of Bell Labs. CP/M-68K is a Registered Trade Mark of Digital Research.

then by drawing a mouse-like gadget across the paper line by line, get the text into machine-readable form. I wrote several books back before Ezekial, my friend who happened to be my first Z80, came into my life. It would be nice to get those books onto disk so they could be painlessly revised. The Omni-Reader looked like a godsend.

Alas, it's not quite that simple. The Omni-Reader accepts only certain typefaces. Fortunately, 12-pitch Letter Gothic from a Selectric is one of them, since that's what I wrote all my early books in. (I didn't then realize that it's better to use 10-pitch and save your editor's eyes than 12-pitch and save paper. Live and learn.) However, the Omni-Reader is a bit tricky. You have to move the reader across each line at a fairly constant speed; wait; try again if you went too fast; and in general deal with the text line by line. After a while it gets easier, because you get a feel for how fast to drag the reader and thus don't make as many mistakes.

After that it's faster than retyping. Not a lot faster, but enough so that it would probably be worth using to get my early books into machine-readable form—except that any editorial changes made in manuscript, and all rewrite in galley, would have to be entered by hand anyway. The Omni-Reader can't read the finished book because typesetters deliberately vary the spacing between characters, and this bothers the heck out of the Omni-Reader. By the time I've compared the typescript to the printed material, I've used up the time the Omni-Reader saved. Simpler to hire someone to type directly from the printed matter.

The result is that it's hard to see what to use the Omni-Reader for. One possibility would be in an office that has both typewriters and computers; letters written on a typewriter could later be read into the machine. I do wonder, though, if it wouldn't be better to write the letters on a computer to begin with. On the other hand, if you want to put letters that you've received from someone else into machine-readable form, Omni-Reader

would save you considerable time.

There are versions of Omni-Reader for both Macintosh and PC clones. The machine reads manuscripts written in Courier 10 and 12; Letter Gothic; and Prestige Elite. Oberon promises additional font selections on disk in the near future.

It's a neat gadget. I'm very fond of

the concept. It's well made. It's just that it's not that much faster than retyping, and after the novelty wears off—say, after about five pages—not much more fun. The Omni-Reader works as advertised, and Oberon has been very careful not to make unjustified claims for it. It's a pity that

(continued)

Here are 87 reasons to buy at Elek-Tek, not to mention the fastest delivery anywhere.

**MEGA BERNOULLI BOX**

1. 5 meg Drive for Macintosh . . . . . \$ 1375
2. Cartridges for above . . . . . 43
3. 10 meg Drive for IBM-PC/XT/AT & compatibles . . . . . 1790
4. 20 meg Drive for IBM-PC/XT/AT & compatibles . . . . . 2490
5. 10 meg Drive w/ Auto Boot for IBM-PC/XT & compatibles . . . 1890
6. 20 meg Drive w/ Auto Boot for IBM-PC/XT & compatibles . . . 2590
7. 10 meg cartridges for above (3 pak special) . . . . . 125

26. Amdek 310A Amber Monitor . . . . . \$ 150
- Other Amdek Monitors . . . . . CALL
27. Zenith Monitors . . . . . CALL
28. AST Six Pak + Multifunction Board, 64K . . . . . 249
29. AST Six Pak + (loaded) Multifunction Board, 384K . . . . . 309
30. AST Megapius II Multifunction Board, 64K . . . . . 270
31. Quadram Quadboard Multifunction Board, 0K . . . . . 195
32. Quadram Quadboard Multi- Board, 64K/384K . . . . . 210/267

Save 30% to 43% off Manufacturer Suggested Ret. prices on EPSON • Okidata • Star • DIABLO • TOSHIBA • COMREX •

- EPSON®**
8. LX 80 . . . . . \$ 230
  9. RX 100+ . . . . . 350
  10. FX 85 . . . . . 350
  11. FX 185 . . . . . 490
  12. LQ 1500 parallel . . . . . CALL
  13. DX10 Daisy Wheel 10CPS . . . . . 230
  14. DX20 Daisy Wheel 20CPS . . . . . CALL
  15. Comrex II Comriter . . . . . 269
- STAR**
16. SG 10 . . . . . 235
  17. SD 10/15 . . . . . CALL
  18. SR 10/15 . . . . . CALL
- OKI**
19. Oki 182 . . . . . CALL
  20. Oki 192/193 . . . . . CALL
  21. Oki 84 . . . . . CALL

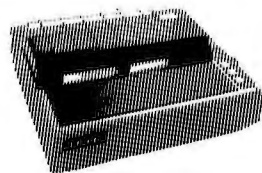

EPSON FX 65

**OTHER PRINTERS**

22. Olympia Compact 2 . . . . . \$ 350
23. Olympia Compact RO . . . . . CALL
24. Toshiba P351 . . . . . 1080
25. Toshiba P1340 . . . . . 560

**PRODUCTS FOR IBM-PC**

33. Generic Multi Multifunction Board, 64K . . . . . 150
34. Orchid Tech. PC Turbo 186 . . . . . CALL
35. Paradise Modular Graphics Card . . . . . 275
36. Hercules Monochrome Card . . . . . 329
37. Hercules Color Color Graphic Card . . . . . 170
38. Novation 4905911 Modem w/software . . . . . CALL
39. Novation 4905921 Internal Modem w/software . . . . . CALL
40. Hayes 1200B Internal modem w/software . . . . . 379
41. AT&T 4000 300/1200 Ext. Modem . . . . . 335
42. Hayes 1200 External modem . . . . . 399
43. Hayes 2400 External modem . . . . . 599
44. US Robotics Courier 2400 Ext. 2400B Smart Modem . . . . . 460
45. US Robotics Telpac Telecomm. Software . . . . . 74
46. TEAC FD55B 1/2 Ht. DSDD Disk Drive . . . . . 95
47. Prah Keyboard 13 prog. keys, heavy duty . . . . . 175

**DISKETTES**

	Dysan	maxell	3M	SONY	waback	MEMOREX
3 1/2" SSDD	28.00	25.00	25.00	25.00	—	—
DSDD	—	37.00	37.00	37.00	—	—
5 1/4" SSDD	17.00	14.00	14.50	13.00	11.50	11.50
DSDD	21.00	18.00	18.00	16.00	12.50	14.00
SSDD96TP1	28.00	24.00	24.00	—	—	—
DSDD96TP1	37.00	29.00	29.00	—	—	—
5 1/4" DSDDHD (For IBM AT)	45.00	39.00	40.00	—	—	—
8" SSDD**	25.00	29.00	25.00	—	—	—
8" DSDD**	29.00	32.00	29.00	—	—	—

Call for Quantity pricing for 10 boxes or more.

**3M DATA CARTRIDGES**

82. DC100A . . . . . \$ 14.00
83. DC300A . . . . . 18.00
84. DC300XL . . . . . \$ 21.00
85. DC300XL/P . . . . . 22.00
86. DC600A . . . . . \$ 23.50
87. DC1000 . . . . . 15.00

Call for Quantity pricing for 10 cartridges or more.

CALL TOLL FREE 800-621-1269 EXCEPT Illinois, Alaska

Corp. Accts. Invited. Min. Ord. \$15.00. Visa or MasterCard by Mail or Phone. Mail Cashier's Check, Mon. Ord., Personal Check (2 wks. to clear) Add \$4.00 1st item. (AK, HI, P.R., Canada add \$10.00 1st item) \$1.00 ea. add'l shipg. & handl. Shipments to IL address add 7% tax. Prices sub; to change, WRITE for free catalog. RETURN POLICY: Defective Only: Most products replaced within 30 days of purchase with identical merchandise only. Computer and large peripherals replaced only when defective on arrival (within 3 work days of delivery). Other problems covered by mfr. warranty. ALL ELEK-TEK MERCHANDISE IS BRAND NEW, FIRST QUALITY AND COMPLETE. Delivery subject to availability. DUNS #09-718-8517

**ELEK-TEK, inc.**

6557 N. Lincoln Ave., Chicago, IL 60645  
(312) 631 7800 (312) 677 7660



someone hasn't developed an easy way to scan books. Oh, well.

If you have a need for an optical encoder that reads typescript line by line, then this one certainly does the job.

### WINDING DOWN

I suppose one game of the month is Gato (although the boys continue to

rise through the ranks in Cygnus's Star Fleet I). The other game of the month isn't really a game. That is, Blue Chip Software, makers of the neat stock-market game Tycoon, have a financial-planning simulation called Squire that can teach some valuable lessons about retirement funds, tax shelters, and the like. The version I have is for MS-DOS; I expect there is, or shortly

will be, a Macintosh version as well. If you don't have a feel for compound interest and the effects of taxation on wealth accumulation, you owe it to yourself to get this one.

Two other interesting games for the IBM PC are Incunabula and By Fire and Sword, both from Avalon Hill. Both can be fun played solitaire but are really better if there are multiple players. Incunabula starts with clansmen struggling to build a civilization while avoiding destruction at the hands of nomads and raiders. Accumulate enough wealth and you can invest in various arcana such as architecture, mathematics, or music. By Fire and Sword is a game of medieval combined-arms armies, diplomacy, and treachery. Both of them snaffled off more of my time than I could afford.

The books of the month are *Stock Selection: Buying and Selling Stocks Using the IBM PC* by Jeremy C. Jenks and Robert W. Jenks (Wiley, 1984, \$17.95, \$67.90 with programs) and *The Serious Assembler* by Charles M. Crayne and Dian Girard (Baen Books, 1985). Fair warning: the latter book is a Pournelle Users Guide. It's also the best intermediate-level book on IBM PC assembly-language programming I've come across. If you're seriously thinking of doing such programming, look at this one. It has useful programs as examples. The Jenks book has a revealing discussion of the real world of Wall Street, as well as common sense on using computers and some good practical programs. Fair warning: if you buy the Jenks book and end up losing your shirt, it's not my fault.

With any luck, next month's column comes from my new office. I can dream, can't I? ■

## ITEMS DISCUSSED

BY FIRE AND SWORD.....\$25	Borland International
INCUNABULA ..... \$30	4585 Scotts Valley Dr.
Avalon Hill Company	Scotts Valley, CA 95066
4517 Harford Rd.	(408) 438-8400
Baltimore, MD 21214	
(301) 254-5300	
EXCEL (includes Apple's	SQUIRE ..... \$49.95
Switcher).....\$395	Blue Chip Software
Microsoft	6740 Eton Ave.
10700 Northrup Way	Canoga Park, CA 91303
POB 97200	(818) 346-0730
Bellevue, WA 98009	
(800) 426-9400	
GATO.....Price unavailable	STAR FLEET I.....\$49.95
Spectrum HoloByte Inc.	Cygnus
2006 Broadway, Suite 301	POB 57825
Boulder, CO 80302	Webster, TX 77598
(303) 433-0191	(800) 622-4070
	(credit card orders)
	(713) 486-4163
	(check or COD orders)
GRAF 2.0.....\$29.95	TRUE BASIC.....\$149.90
Microcomputer System Consultants	Addison-Wesley Publishing Company
301 North Harrison St.	Jacob Way
CN 5279, Suite 228	Reading, MA 01867
Princeton, NJ 08540	(617) 944-3700
MACINTOSH	VALDOCS 2.0
128K bytes.....\$2195	for OX-10 (OEM product)...\$49.95
512K bytes.....\$2795	Epson America Inc.
Apple Computer	2780 Lomita Blvd.
20525 Mariani Ave.	Torrance, CA 90505
Cupertino, CA 95014	(213) 539-9140
(408) 973-2222	
OMNI-READER ..... \$699	WRITE-HAND-MAN.....\$49.95
Oberon International	Poor Person's Software
5525 MacArthur Blvd.	3721 Starr King Circle
Suite 630, LB48	Palo Alto, CA 94306
Irving, TX 75038	(415) 493-3735
(214) 257-0097	
	ZENITH ADVANCED PC
SIDEKICK	(1.2 megabytes).....\$3999
copy-protected.....\$54.95	Zenith Data Systems
not copy-protected.....\$84.95	1000 Milwaukee Ave.
	Glenview, IL 60025
	(312) 391-7000

*Jerry Pournelle welcomes readers' comments and opinions. Send a self-addressed, stamped envelope to Jerry Pournelle, c/o BYTE Publications, POB 372, Hancock, NH 03449. Please put your address on the letter as well as on the envelope. Due to the high volume of letters, Jerry cannot guarantee a personal reply.*



**Kimtron**

# MULTI-USER SOLUTION for IBM PC, XT, AT

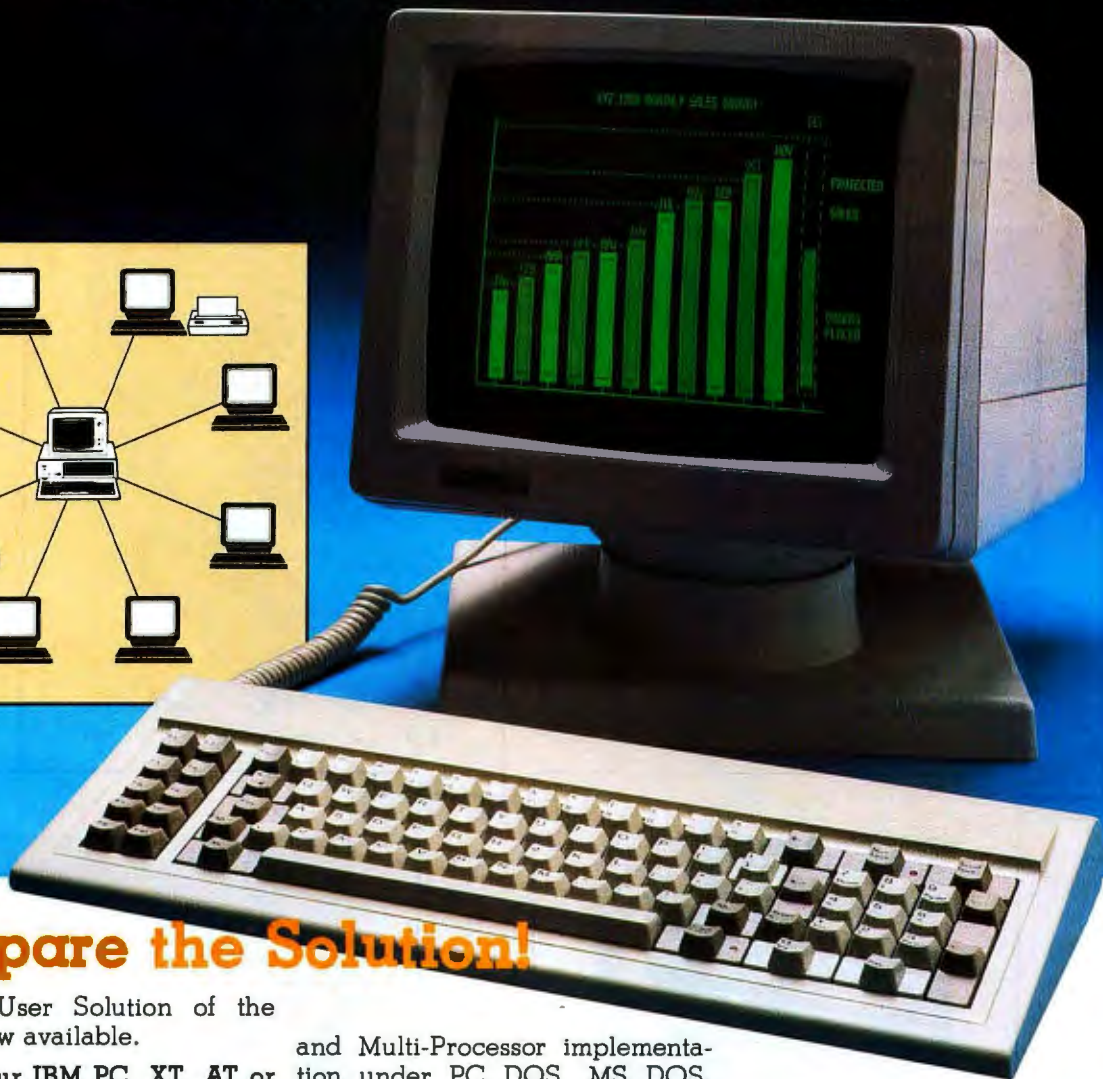
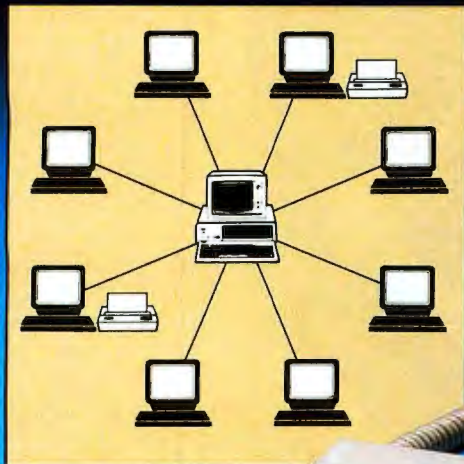

## Compare the Solution!

The Multi-User Solution of the future is now available.

Convert your IBM PC, XT, AT or Compatibles to a true multi-user system while maintaining display, keyboard and software compatibility.

Since the KT-7/PC display is the same as your PC monochrome monitor, with its look-alike keyboard, operators will feel they're using an IBM PC and can also use the same software manual. Kimtron's multi-user solution includes file and record locking, shared data access, and communication between users. It is the intelligent alternative.

The KT-7/PC supports Time Sharing, Enhanced Time Sharing

and Multi-Processor implementation under PC DOS, MS DOS, UNIX, XENIX, CPM 86, Multilink, Concurrent PC DOS, and other compatible multi-user operating systems.

Kimtron's multi-user solution may be tailored for cost effectiveness; as low as \$1095 for an additional user, and for speeds more than ten times faster than LAN. You can add one or as many as 31 additional users per PC. Kimtron delivers the future now by allowing an ever-widening network of multi-user PC's.

The KT-7/PC may be complemented with one (or more) I/O Card, Memory Card, 8086 Speed

Enhancer Card, 80286 AT Card, 8088 Multi-Processor Card, 80186 Speed Enhancer Card, 68000 Card, and related software.

For more information about Kimtron's Multi-User Solution, or general video data terminals for other mini or micro multi-user systems, call your local computer dealers, distributors or Kimtron Corporation Today!

**(408) 286-8790**  
**TWX 910-338-0237**



1705 Junction Court  
Building #160  
San Jose, CA 95112

**Kimtron**

NOTE: IBM PC, XT, AT, PC DOS, MS DOS, UNIX, XENIX, CPM 86, Multi-Link, Concurrent PC DOS are registered trademarks of IBM Corporation, Microsoft Corp., Bell Labs., Digital Research Inc., Software Link Inc. respectively.



# Announcing 4 New Collector Edition

# BYTE COVERS

The 4 Byte covers shown below are the newest additions to the Collector Edition Byte Cover series. Each full color print is 11" x 14", including a 1 1/2" border, and is part of an edition strictly limited to 500 prints. Each print is a faithful reproduction of the original Byte painting, printed on museum quality acid free paper, and is personally inspected, signed and numbered by the artist, Robert Tinney. A Certificate of Authenticity accompanies each print.

Collector Edition Prints are carefully packaged flat to avoid bending, and are shipped first class within one week of receipt of order. The price of each print is \$30. All 4 prints are available as a set (Set 21-24) for only \$100.

Other Collector Edition Byte Covers are also available from Robert Tinney Graphics. For a color brochure, or to order one or more of the prints shown, please check the appropriate box in the coupon below.



#21 The Wall Street Terminal \$30

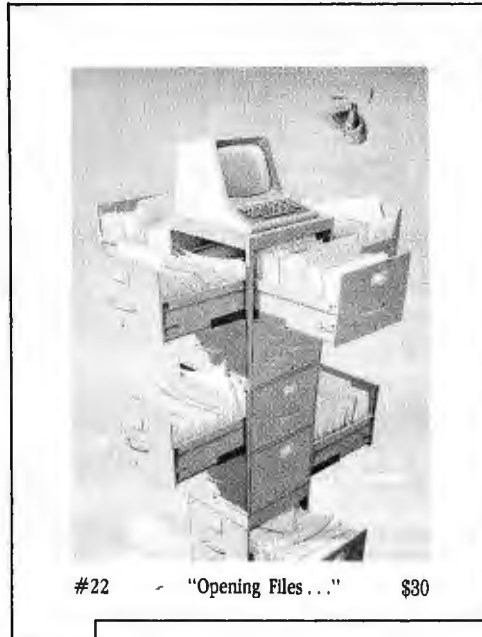

#22 "Opening Files..." \$30

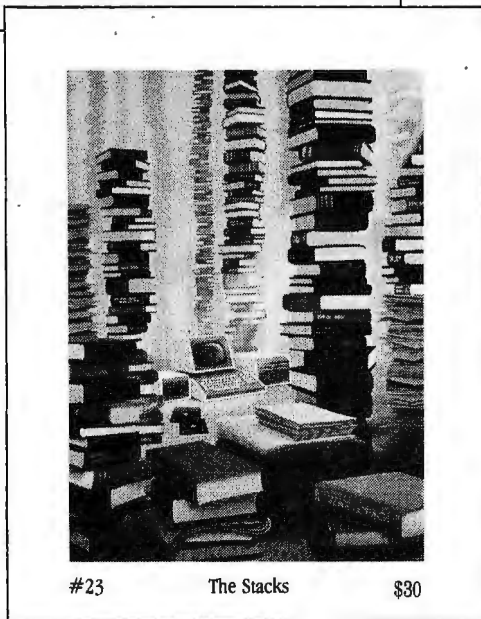

#23 The Stacks \$30



#24 Inside IBM \$30

Please send me the following Prints (\$30), or Sets (\$100).

I have enclosed check or money order.

QTY.	TITLE & PRINT NO.	AMOUNT
_____	_____	\$ _____
_____	_____	\$ _____
_____	_____	\$ _____
postage & handling \$3.00 (Overseas \$8.00)		\$ _____
<b>TOTAL</b>		<b>\$ _____</b>

Visa  MasterCard

Card No. \_\_\_\_\_

Exp. Date: \_\_\_\_\_

SHIP MY PRINTS (OR BROCHURE) TO:

Name: \_\_\_\_\_

Address: \_\_\_\_\_

City: \_\_\_\_\_

State: \_\_\_\_\_ Zip: \_\_\_\_\_

Mail this coupon to:

**robert tinney graphics**  
1864 N. Pamela Drive  
Baton Rouge, LA  
70815

**FOR VISA OR MASTERCARD ORDERS**  
or for more information  
**CALL 1-504-272-7266**  
Daytime or Evenings

Please send me your color brochure.

We specialize in Purchase Orders  
from Universities and  
Fortune 500 Companies.

## MODEMS

Hayes 2400 Baud	\$579.95
Hayes 1200	359.95
Hayes 1200 Internal PC	349.95
Micro Modem IIE or IIC	159.95
Promodem 1200B for PC	279.95
Promodem 1200 RS232	289.95
Promodem 1200 for MAC	339.95
Promodem 1200A for Apple	339.95
Options - each	74.95
US Robotics 2400 Baud	539.95

## MONITORS

Amdk 300G or 300A	\$134.95
Amdk 310A	144.95
PGS MAX-12	169.95
PGS HX-12, 640x280	439.95
PGS SR-12, 720x480	599.95
Scan Doubler	189.95

## TAXAN 425

RGB w/Color or Grn Screen, 640x280 **\$379.95**

Taxan 440, 720x400 **\$559.95**

## PRINTERS

### EPSON LX80

100 CPS with NLQ Mode **\$239.95**

Epson 185, 8K Buf., 15" Car. **\$469.95**  
Epson 85, 8K Buf., 160cps **349.95**

### OKIDATA ML192

160 CPS with NLQ Mode **\$369.95**

Okidata 182, Parallel **\$219.95**  
Okidata 193 **579.95**

## IBM COMPUTERS

### PC SYSTEM

256K Memory **\$1499.95**  
2 - 360K Drives

### PC-XT SYSTEM

256K Memory, 10Mb Hardisk, 1-360K Drive **\$2195.95**

### PC-AT SYSTEM

Unenhanced **\$3195.95**  
Enhanced by DG **\$3995.95**

**We Will Not Be Undersold!**

## IBM EXPANSION CARDS

### MULTIFUNCTION with 384K

On Card - Parallel Port, Serial Port, Gameport, 384K Installed, Software & AST Compatible **\$149.95**

### IBM VIDEO CARDS EXPANSION CARDS

Hercules Color	\$159.95	AST Sixpack w/84K	\$224.95
Hercules Graphic	299.95	AST Advantage 128K	379.95
DG Monochrome Card with Parallel Port	119.95	IBM Monochrome Adaptor	209.95
DG Color Graphics	99.95	IBM Disk Controller	99.95

## COMPAQ COMPUTERS

Portable 286	Call
Compaq 286 Deskpro	Call
Compaq Deskpro 1	1729.95
Compaq Deskpro 2	2149.95
Compaq Deskpro 3	3695.95
Portable, 2 Drives, 256K	1895.95
Compaq Plus	3395.95

With Over  
20 Years Experience  
in the Electronics Field

## MEMORY

4164, 150nS **\$.89ea.**  
41256, 200nS **4.89ea**

### PRIME 64K MEMORY SETS

1 Yr Guarantee, Set of Nine with Instructions **\$5.95**

8087-2 (8MHz) **\$109.95**  
8087-3 (5MHz) **99.95**

## ACCESSORIES

IBM PC Cable (6' Shielded) **\$17.95**  
RS232 Modem Cable **17.95**

### 5 1/4 DBL SIDE DISKS

Comes with Reinforced Hubs, 1 Yr Gar. & Sleeves. While supply lasts. **99¢ ea**

ISOBAR 4 Receptacle **\$49.95**  
ISOBAR 8 Receptacle **59.95**  
Switch Box, Parallel or Serial **59.95**

## DISK DRIVES

Apple 1/2 High, Ready To Go **\$109.95**  
Apple Full Ht, Ready To Go **119.95**

### TEAC 55B or TANDON TM100-2

360K IBM Compatible Incl. Manual & Mounting Instructions - Same Price **\$87.95**

10 Megabyte External HD **\$699.95**  
20 Mb Internal w/Contrl **599.95**  
For Tape Back-up **Call**

### 10 MEGABYTE HARD DISK SYS

Complete w/Manual, Controller Card, Mounting Bracket and 1 Yr Warranty. **\$429.95**

#### TERMS:

We accept P.O.'s, MC, VISA, AE (add 5%), COD and Prepay. Minimum shipping \$4.00.

## THE DIVERSIFIED GROUP

DIVISION OF CAL UNITED

Mail Orders To: 8726 S. Sepulveda, Suite A132, Los Angeles, CA 90045

TOLL FREE ORDER LINE  
**800-523-1041**  
INSIDE CALIFORNIA  
**213-416-9696**



*Editor's note: Due to space limitations, we are able to publish only a sampling of the great amount of mail Jerry receives each month.*

## WILL YOU STILL LOVE IT WHEN THE COMMODORE IS 64?

Dear Jerry,

I've been reading your column for several years. I'll agree wholeheartedly that anybody who writes every day needs a computer.

What I do question are your comments about "toy" computers. For what it's worth, I put out a 64-page quarterly magazine, a number of freelance articles a year, speeches, special pamphlets, and the equivalent of an average paperback book in other publications a year on a Commodore 64.

In fact, circulation, mailing lists, billing, payroll, bookkeeping, and a tournament record of about 500 competitors in 35 events is kept on the 64.

I've got a \$50 word processor that keeps up with my writing gusts and has more formatting potential than most "professional" programs and can even be used with 80-column software. (I'd love faster disk speed, but what's 5 extra minutes a day waiting for a disk compared to tripling the price of the hardware and quadrupling the cost of software?)

What's more, we have three workstations (C-64s) with disk drives, two printers, and interchangeable software and files. Anytime machines are run 8 to 10 hours a day they may go down—so we have backups on line all the time. I can replace any component other than printers for less than \$250.

Mouse technology? Icons? 80-column hardware and superfast disks? I'd love it. But I seriously question that it would be a significant enough increase in productivity to be as worthwhile as a printer buffer or two.

Yes, I think also that we're probably using the little Commodores to near potential. But until dollars justify changing and until Apples or Oranges or Big Blues can offer a better per-dollar value, we'll stick with what we have.

MILO DAILEY  
Memphis, TN

*I guess I both agree and disagree. It is possible to do productive work with primitive equipment, and indeed the worst computer system is likely to be better than the best nonelectronic typewriter. On the other hand, ballpoint pens are preferable to quill pens.*

*I can live without icons, but surely you do not mean that a writer will not be more productive when enduring less eye-strain? Or that writing time is less valuable than time spent waiting for disk access?*

*A penny saved is a penny earned; but those who save pennies seldom become wealthy. I'll bet you a fair amount that a few thousand spent on updating your equipment will make those three workstations as productive as six would be using what you have.*

*Stay well.—Jerry*

## TRANSFERRING FILES

Dear Jerry,

In reference to Mark E. Cornell's letter regarding use of the SAVE command to transfer files from the NEC PC-8201A ("NEC PC-8201A," February, page 359), I routinely use this command to transfer files from my NEC to an S-100 system running ASCOM. The form is SAVE COM:abcdef, where a is the data-transmission rate, b is the parity, etc. This method of transferring a BASIC program can save many minutes over the alternative of using Telcom.

The only trouble I have encountered was in transferring from the S-100 to the NEC at 19.2 kbps. In this case, I lose an occasional byte, even with XON/XOFF protocol.

I'm not sure what the source of the problem is for Mr. Cornell's application. Perhaps it is the form of the SAVE command that he used. I am not familiar with the one he gives in his letter. If the form I have given above still does not resolve the problem, I suggest that he check his cable grounds (pins 1 and 7) and make sure XON/XOFF protocol is activated on both the NEC and the Kaypro.

Incidentally, I give you an "F" on this one, Jerry—you didn't do your homework. The use of SAVE is documented in the NEC manual under SAVE and OPEN. Mr.

Cornell's letter deserved a few minutes of your time to consult the manual and suggest some alternatives a bit more meaningful than your response of "Alas, I think you have no choice but to save your programs in ASCII and use Telcom."

CORT COOPER  
Ponca City, OK

*Guilty as charged, but with an explanation: as I said, I don't use Percy, our NEC PC-8201A, except for writing while on trips; so I've not had reason to investigate some of his other capabilities.*

*Thanks.—Jerry*

## KEYBOARDS

Dear Jerry,

In reading your columns, which I enjoy greatly, I get the impression that you are not altogether satisfied with the IBM keyboard but that you are reluctant to switch to the Key Tronic 5151, despite its superior layout, because you dislike the light feel.

My 5151 was shipped with 1.5-ounce springs in the keys, although I have been told by the manufacturer that they have since switched to 2-ounce springs. In any event, it was a simple matter to remove the light springs and install a new set of 3-ounce springs supplied by the manufacturer, along with a tool for removing them.

As a result, the 5151 has an altogether different feel, much more like the IBM. As a professional writer, I can attest that the change has given me the best of both worlds.

ANDREW J. GLASS  
Washington, DC

*I'm glad to hear that Key Tronic has made some improvements. It turns out that I wasn't the only one who found that the original 5151 had a "dead" feeling.*

*Alas, for the moment the Wico Smartline Smartboard keyboard has made the question moot. Beyond the Wico is a new keyboard under development by Texas Instruments; if the production model is anywhere near as good as the prototype I've seen, nothing will be able to touch it. Of course, Key Tronic isn't going to sit still either.*

*Best.—Jerry ■*

*"Without question [NFL Challenge] is the finest computer game I've ever seen — but then I like football."  
John C. Dvorak San Francisco Examiner*



# Put the NFL at your fingertips.

Hands-on pro football excitement is as close as your keyboard with **NFL Challenge** from Xor. This is the officially licensed NFL action computer game with offensive plays and defensive sets based on the ones in NFL playbooks, plus complete updatable rosters for all 28 NFL teams. All impressively packaged.

Every game can be the Super Bowl when you take the field with Xor **NFL Challenge** software. Feel the pressure as you choose starting lineups, drive down-field against the clock, and go head-to-

head, down-by-down against the league's most innovative offenses and formidable defenses. It's the most intense computer simulation of the pro football experience ever devised.

Xor's **NFL Challenge** requires IBM® PC or PC/XT with DOS 2.0, 256K bytes of memory, monochrome monitor with IBM® monochrome card or RGB color monitor with IBM® color graphics adapter. Also runs on the IBM® PC/AT.

With **NFL Challenge** from Xor, you have 50-yard line seats for every game!

## Ordering Information

**NFL Challenge** will be in short supply. To kick off your NFL season, send us \$99.95, or if you're in a hurry-up offense, order by major credit card:

**1-800-NFL-CHAL**  
(in MN call (612) 938-0005)

ADD \$6.00 for shipping to all U.S. cities.  
Minnesota residents: add 6% sales tax.

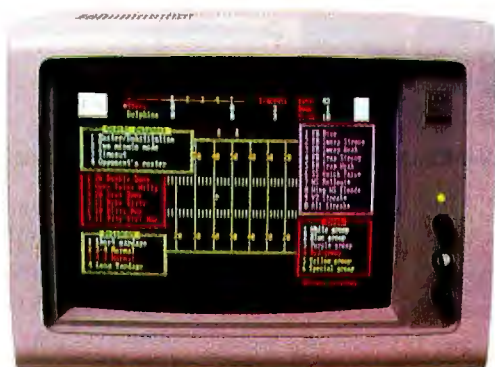

**XOR**™  
CORPORATION

5421 Opportunity Court  
Minnetonka, Minnesota 55343  
(612) 938-0005



IBM is a registered trademark of International Business Machines.  
NFL Challenge is a trademark of NFL Properties, Inc.  
© 1985. All rights reserved.

Inquiry 397





# The ARC turbo personal computer combines 8088-2 turbo speed and 640K memory to take you further, faster....

- ▶ The system's foundation is the four-layered 8088-2 X-turbo motherboard. It's processing speed is 50% faster than the PC's and with 640K on-board memory you get high speed and maximum memory on one board.
- ▶ More CPU speed means you can reduce the valuable time you now waste waiting for your PC to record, retrieve and process data.
- ▶ The 640K on-board memory makes it easier to design your own customized testing programs and eliminates all those time-consuming memory/diskette data transfers. Any excess memory can be used for RAMdisk or spool programs.
- ▶ The X-turbo was designed to be used in conjunction with all PC compatible software, which means access to nearly all the most popular software packages.
- ▶ The 7-Plus, multifunction card provides a complete solution to your most essential hardware add-on requirements. It includes a parallel printer port, a serial port a floppy disk controller and a fully system integratable clock/calendar. And even more. The RAMdisk Plus and Spool Plus software.

- ▶ The ARC turbo keyboard supports 100 full-function, finger-sized keys, a spacious display, a separate cursor control panel, and LED displays for power, turbo, caps and numeric.
- ▶ A monochrome or color/graphics card completes the system.
- ▶ The X-turbo itself is built around four layers instead of the standard two, making the board itself, and the system as a whole more stable and less susceptible to power loss. So along with the unsurpassed speed you get a quality you can always rely on. And our seal of confidence — a one year warranty.
- ▶ This system will give you more processing speed, memory, function concentration, and reliability than any comparable system. And cost you less. For more information on where to try out an ARC turbo, contact ARC at the address below.

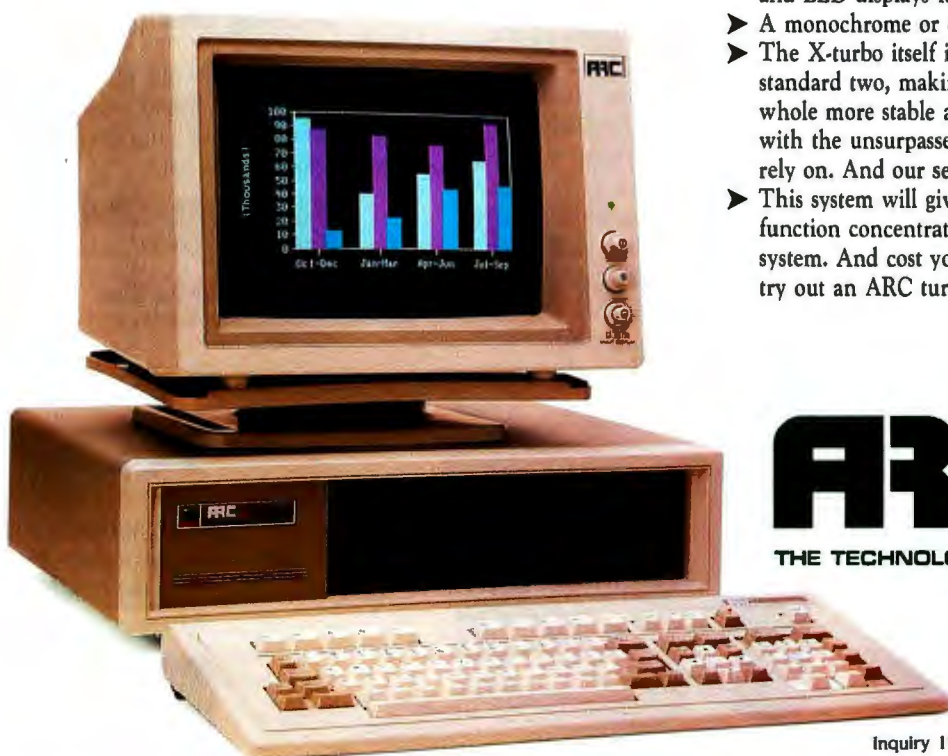

**ARC** American  
Research  
Corporation

THE TECHNOLOGICAL BRIDGE TO YOUR FUTURE

2001 W. CHESTNUT ST., ROOM  
103 ALHAMBRA, CA 91803  
TEL: (818) 289-8742  
TLX: 285653

Inquiry 17 for End-Users. Inquiry 18 for DEALERS ONLY.

# Seventh Anniversary of Microcomputing

A brief  
history  
of U.K.  
computing  
and a look  
at the Husky  
Hunter

BY DICK POUNTAIN

**T**his being the 10th anniversary issue of BYTE, I have been asked to offer a condensed history of personal computing in Britain.

I became involved with computers in 1977 when a friend, who was a mathematics teacher, told me that he'd just seen a demonstration of a "personal computer" (the Commodore PET) that fit on the top of a desk. I recall asking him "Why would anyone want a computer?" The answer became obvious to me a short while later when I purchased a programmable calculator (a Casio fx-201p) to help with print-costing computations. Within weeks I was addicted to programming, on a device with 127 bytes of memory and no editing facilities. I even wrote games for it.

Personal computing started in the U.K. about three years behind the U.S., so, strictly speaking, we can celebrate only our seventh anniversary. U.S. personal computers began to arrive in Britain in 1977, but those first machines (Altair, South West Technical Products, and Sol) were just too expensive to create a hobbyist following.

In 1978 the PET, the Apple II, the TRS-80 Model I, and the Exidy Sorcerer arrived, but at £500 and upward, they were still too expensive for the average hobbyist. Their entry prices had profound significance, though. At over £1000 the Apple II was so expensive that the cheaper, all-in-one PET became the dominant machine in Britain, Germany, and Scandinavia, keeping Commodore comfortably afloat during those lean years when Apple was cleaning up in the U.S.

The real pioneers of personal computing in the U.K. needed something much cheaper. The U.K. computer industry was born in the form of kit computers, such as the Nascom I, the Science of Cambridge Mk 14, and later the UK101, which sold for £200 and under. They were single-boards, with typically 2K to 4K bytes of RAM (random-access read/write memory), a hexadecimal keypad (the Nascom's ASCII

[American Standard Code for Information Interchange] keyboard was quite a luxury), and a machine-code monitor in ROM (read-only memory). Having built the kit, you then had to write the system software—starting with an assembler if you were feeling lazy.

To service those intrepid hackers, the first U.K. personal computing magazine, *Personal Computer World*, was published in 1978.

The first packaged U.K. home computers, the Acorn Atom and the Sinclair ZX80, arrived in 1980. Both were offered in kit or prebuilt form, had BASIC in ROM, and introduced a second generation of slightly less crazed hackers to computing.

The Atom was a 6502-based machine with 2K bytes of memory, expandable to 12K bytes, and monochrome output to a television set including "high-resolution" graphics. It grew out of a system of single-board modular computers that had launched Acorn into the industrial-controller market the previous year. The Atom's success put Acorn on the road to the BBC Micro.

Sinclair Research and its founder, Clive Sinclair (now Sir Clive Sinclair), were already known for dramatic interventions in the low-cost consumer-electronics market. Earlier products had included a £25 programmable calculator (when everyone else charged over £100), the infamous Black Watch digital-watch kits, and a range of miniature hi-fi equipment produced 15 years before the Japanese got there.

To the ZX80 fell the honor of breaking the magic £100 price barrier. This tiny sliver of white plastic contained a Z80 with 1K byte of RAM, integer BASIC, and television and cassette interfaces, and it hinted at the era of mass-market computers. A year later it was replaced by the ZX81 with floating-point BASIC and an astonishing price of just £70, or £50 if you wanted to solder it yourself. Inside the ZX81 were just 4 chips compared to 21 in the ZX80; the uncommitted logic array had arrived in the home.

(continued)

Dick Pountain is a technical author and software consultant living in London, England. He can be contacted c/o BYTE, POB 372, Hancock, NH 03449.



*This machine is  
designed to keep all  
data and programs in  
nonvolatile CMOS  
RAM and to download  
to a desk computer  
back at "base camp."*

Another year later Sinclair followed up with the 48K-byte color Spectrum at £125 and proceeded to multimillionaire-dom. The Spectrum (marketed for a while in the U.S. as the Timex Sinclair 2000) still dominates the games-playing home market in the U.K., with hundreds of thousands of sales. Only recently has the Commodore 64 come close to challenging it in sales and volume of software.

Meanwhile Acorn produced the BBC Micro to the BBC's (British Broadcasting Company's) specifications for a computer that could be used in conjunction with an educational television series. (The competition for that BBC contract had been bitter.) The BBC Micro, with its fast 2-MHz 6502 and fine color graphics, quickly became established as a favorite school and college computer. Despite its high price, it also became the machine that serious hobbyists aspired to, filling the slot left open by Apple's relative marketing failure in the U.K.

Unfortunately, Acorn rode that basic design too long. Announced enhancements were continually delayed, resulting in Acorn's near collapse and rescue in March of this year by Olivetti.

Another prominent U.K. manufacturer, ACT, started by selling PET software and importing the CompuThink Minimax CP/M machine. ACT then took the wind out of IBM's European sales by importing Chuck Peddle's Victor 9000 as the ACT Sirius, and

now manufactures and markets the Apricot range of microcomputers with considerable success.

The threatened Japanese invasion never quite happened in the U.K., though Sharp made some impact here in the early 1980s with its PET competitor, the MZ-80K. I did all my serious learning on a Sharp MZ-80B running CP/M 2.2; after all those quirky home computers with their proprietary operating systems (often incompatible between versions), it was a real liberation. Suddenly compilers for all the interesting languages (except Smalltalk) were within reach.

It seems only right to pay tribute to some of those who fell by the wayside. Quite a few interesting and some downright cranky machines have come and gone in our seven years of personal computing. There was the Newbrain, half the size of an NEC lap-held computer, with its built-in display and battery pack that never quite arrived. With a very advanced specification for its time (Z80, indefinitely expandable RAM and ROM, graphics), it was to be the BBC Micro until production difficulties decreed otherwise.

Then there was the Jupiter Ace, a tiny ZX80 look-alike with a rubber keyboard and FORTH instead of BASIC in ROM. The fact that FORTH is not a beginner's language killed it, though it still has its fans and bankrupt stock still surfaces occasionally for about £30.

There was the Dragon 32 with its estimable 6809 processor and an upgrade path to the OS-9 operating system. It was the best value for the money for six months in 1982. What about the Oric, whose very name was an invitation to prepare the headline "Alas, poor Oric . . ."? It became the most popular home microcomputer in France. And there was the Lynx, remembered chiefly as the first computer whose BASIC had floating-point line numbers.

**INDESTRUCTIBLE COMPUTING**

This condensed history of U.K. personal computing leads me rather nicely into my next topic. It is prob-

ably not well known that the first lap-held computer was made—and is indeed still made—in the U.K.

The reason that the machine, the Husky from Husky Computers Ltd., is not more widely known is that it's not aimed at the mass market. It is a *ruggedized* computer intended for military or outdoor scientific and engineering uses. It made quite an impression (literally) when Husky's representative hurled a Husky Hunter onto my floor to demonstrate its tolerance of abuse; I doubt that a Tandy or an NEC would appreciate such treatment.

The first Husky was manufactured in 1981 and captured some attention by virtue of the press photos of it being run over by an Army truck. Since then the design has been refined and diversified, though the basic elements remain the same. It is available in the U.S. from Sarasota Automation Inc. (1500 North Washington Blvd., Sarasota, FL 33577).

The Husky is driven by a CMOS (complementary metal-oxide semiconductor) Z80-compatible chip, the National Semiconductor C800, clocked at 4 MHz, and uses the CP/M operating system.

Husky's designer made a very important decision right from the beginning. For use in rough or hazardous environments, no mechanical mass-storage device is sufficiently robust or reliable. This machine is designed to keep all data and programs in nonvolatile CMOS RAM and to download to a desk computer back at "base camp" using a built-in serial link.

This decision required the provision of plenty of RAM; from the first, the Huskies had a paged-memory system of 144K bytes. In 1981 memory was considerably more expensive than it is now, and this guaranteed a high unit cost of over £1000.

Users who needed a machine of the Husky's ruggedized quality were not deterred by the price, and the orders rolled in from day one. Users include regional water authorities (for on-site reservoir-volume calculations), the Greater London Council (for welfare-benefit calculations), various airlines,

*(continued)*

# "Quick! Find the Accounts Receivable File."



## You just experienced one of the benefits of CenTech Color Diskettes.

### **They're easy to find.**

Now you can locate everything from Accounts Receivable to Payroll; and you can do it at the speed of color.

CenTech Color Diskettes are the logical solution to data organization. They come in 13 useful colors, to give you more color coding possibilities.

Designed, engineered, and manufactured in America to specifications and standards that exceed those developed by the industry. CenTech diskettes are exceptionally consistent in accepting and maintaining data.

CenTech is a registered name of Cenna Technology, Inc.

Every diskette is tested, certified, and warrantied to be 100% error free and free of manufacturing defects, or we will replace it at no charge.

Cost competitive, color diskettes by CenTech. Engineered to surpass the best the world has to offer.

Ask for CenTech Color Diskettes by name at your dealer, or become a

dealer yourself by calling toll free: (800) 255-3999, or write CenTech, 185 Cottage Avenue, Sandy, Utah 84070. Telex: 499-6093

## **CENTECH<sup>®</sup>**

The Colorful Solution to Data Organization™



© 1985 Cenna Technology, Inc.



the British Army, and a Canadian logging company that uses them for counting and cataloging trees.

**HUSKY HUNTER**

The latest model, which I borrowed for this article, is called the Husky Hunter (see photo 1).

The first feature you notice is its size; it's almost exactly half the size of a conventional A4-size lap-held microcomputer. This small format precludes the use of a full-size typewriter keyboard, so the Hunter is not a machine for portable word processing. Instead it has a calculator-style button keyboard, with an undersize, noncentral space bar.

The second thing you notice is its construction. Like all Huskies, the Hunter has a cast light-alloy casing of a thickness that would not be out of place in a hand grenade; the computer, nevertheless, weighs only 1.2 kilograms and can be easily held in one hand. The removable bottom of

the case is secured by 12 recessed Allen bolts and sealed with a rubber gasket, which makes the whole thing watertight.

While Husky does not recommend that you use the Hunter underwater, it will certainly stand up to being accidentally dropped into a tropical torrent. Another feature is an internal humidity indicator in the corner of the display. This warns you if moisture enters the case, which is normally kept dry by silica gel.

The battery compartment holds four AA penlight batteries (good for 50 hours) and is capped by a huge alloy screw plug with another rubber gasket. The removable batteries are backed up by an internal rechargeable battery that protects stored data in the event of a low-battery condition occurring in the field. The manual warns that power loss could be experienced in the proximity of "nuclear events;" but I feel that damage to the "warmware" would concern me more

in such circumstances.

Since the Hunter's case is hermetically sealed, Husky gives instructions for releasing over- or underpressure conditions, for instance, if you're in orbit, or in a diving bell, by momentarily loosening the battery plug.

A sturdy wrist strap for carrying the Hunter attaches to either side of the case by a swivel mounting. The case is not perforated by the various I/O (input/output) connectors found on ordinary computers. A single 25-pin male "D" connector for the serial link is recessed and sealed into the otherwise unbroken metal surface.

The 40-character by 8-line LCD (liquid-crystal display) lies beneath a flush plastic window that appears to be more than ¼ inch thick. The viewing angle can be adjusted from the keyboard, thus eliminating another source of holes in the case. This display provides a window onto a virtual 80-character by 24-line standard CP/M screen, but it can also present 240- by 64-dot high-resolution graphics from BASIC.

The Hunter contains 48K bytes of ROM firmware, including a text editor, communications program, BASIC interpreter, and the file manager DEMOS, which is fully compatible with CP/M 2.2 but works from a RAM-disk emulator instead of a floppy disk.

You select the ROM programs from the menu presented when you turn on the computer by pressing the number keys in conjunction with a function-shift key. The bottom line of the display shows you the function-key assignments. Ordinary CP/M programs are run from a ">" prompt as usual.

A 54K-byte transient program area is supported for CP/M programs, with the rest of the memory, up to 208K bytes, devoted in 48K-byte pages to virtual disk-file storage.

The BASIC, which looks much like a very extended Microsoft version 5, does *not* run under CP/M and therefore has the entire 54K bytes free for programs. It does, however, use the same file store as CP/M programs.

The text editor is a full-screen editor

*(continued)*



Photo 1: *The Husky Hunter.*



New from McGraw-Hill.

# X-VIEW 86™

Lets you observe the internal operations of DOS application software.

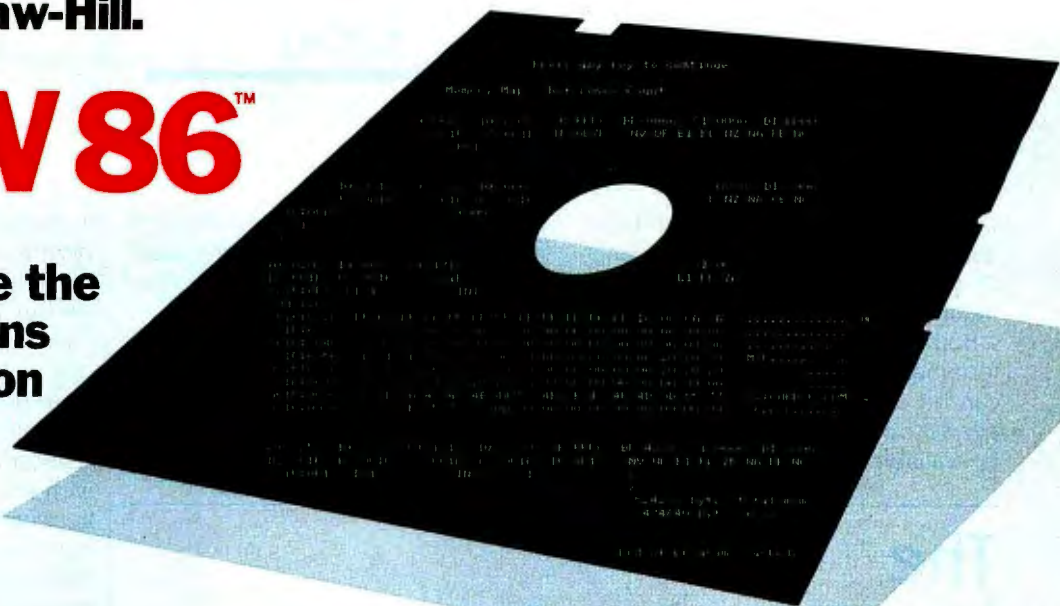

Maybe you've never put it into words. But you know the feeling. It's the frustration that gets you every time you analyze, debug, test, port, or convert DOS application software. To do the job right, you need something no one has invented.

You've got to see what's going on inside the software, how it's acting and reacting. You need something that gives you x-ray vision.

Now you've got it. X-VIEW 86™, new from McGraw-Hill, lets you observe the internal operations of DOS application software.

Developed, tested, and refined in the highly respected technical labs of Future Computing, it helps you generate a thorough, reliable technical analysis. Much faster than what you could produce on your own.

- The data X-VIEW 86 gathers will help you
- find code hotspots
  - improve program performance
  - discover and eliminate unwanted side-effects
  - find bugs in areas beyond DEBUG's reach
  - port or convert software

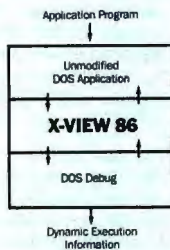

This powerful new tool — we call it a software analyzer — is an affordable \$59.95. It runs on any member of the IBM PC family — or any operationally compatible machine that has at least 64 Kbytes of memory. You use it with PC-DOS DEBUG 2.0 or 2.1.

- Single-stroke commands allow you to interrupt the application program
- on any processor I/O access
  - on any processor interrupt instruction
  - when its execution reaches a specified address
  - when it uses a specified memory location

- In addition, you can:
- automatically collect
    - memory map references
    - I/O space references
    - interrupt usage
    - instruction set usage
    - segment usage information
  - start execution at a specified address
  - display analysis results on screen
- X-VIEW 86™. A new kind of software. For developers and engineers with vision.

1-800-221-VIEW. Texas call 1-800-233-VIEW



Inquiry 151

Future Computing Incorporated is a unit of McGraw-Hill Information Systems Company.

IBM is a registered trademark and PC-DOS is a trademark of International Business Machines Corporation.

### Order Form

To order X-VIEW 86™ by credit card, call toll free 1-800-221-VIEW. In Texas call: 1-800-233-VIEW or send the coupon today.

Customer Service  
McGraw-Hill Inc.  
8111 LBJ Freeway  
Dallas, Texas 75251

### Fees & Payment Information

X-VIEW 86™ is \$59.95. All orders are subject to acceptance by McGraw-Hill Inc. Prices are subject to change without notice.

- Check enclosed (Make check payable to McGraw-Hill Inc. Orders paid by check are subject to delay.)
- A.E.  M.C.  VISA  D.C.

Name \_\_\_\_\_  
 Title \_\_\_\_\_  
 Company \_\_\_\_\_  
 Address \_\_\_\_\_  
 City \_\_\_\_\_ State \_\_\_\_\_ Zip \_\_\_\_\_  
 Phone ( \_\_\_\_\_ ) \_\_\_\_\_

Qty	\$59.95	Amt
_____	_____	_____
	Shipping (\$2.00 per copy)	_____
	Texas sales tax (\$3.67 per copy)	_____
	Total	_____

Signature \_\_\_\_\_  
 Name on card \_\_\_\_\_  
 Credit card no. \_\_\_\_\_ Expiration date \_\_\_\_\_



with simple functions such as FIND—quite adequate for small documents, though the keyboard militates against touch-typing.

Both file-transfer and asynchronous terminal programs are included and can be operated at up to 4800 bits per second. A special disk program is available to transfer data to and

from an IBM PC or a Sirius/Victor. A permanent clock/calendar is included, offering a typical accuracy within two seconds per day.

I found operating the Hunter to be just like using a full-size CP/M machine with a single drive. It ran standard dBASE II satisfactorily. The keyboard takes some getting used to because

it is small and requires very positive keypressing to work. The LCD quality is neither better nor worse than that on the Tandy Model 100.

Husky supplied me with a sample of a real application program that had been developed in BASIC for an overseas airline. It acts as a portable cash register for in-flight refreshment sales, with the unusual twist that it can accept payment in a mixture of different currencies. The Hunter has an auto-run feature that lets you set up such programs as turnkey applications. You can use the function keys to avoid typing commands on the small keyboard; 16 such functions are available.

**SPECIAL HUSKIES**

In addition to the Hunter, Husky manufactures several special-purpose variants based on the same architecture. Each of these is packaged in a somewhat larger case (still of thick cast alloy) with a membrane keyboard for complete sealing and lack of moving parts. Husky has discovered that such membrane keyboards are easier to operate when wearing protective gloves.

The Husky SP (Special Performance) has a larger memory (352K bytes) and twice the battery life of the Hunter. It's intended mainly for running expert-system programs with large RAM requirements.

The Husky IS (Intrinsically Safe) is certified to meet the stringent standards for electrical safety laid down in the U.K. for the petrochemical, gas, oil, and mining industries. It uses the RS-422 interface for serial communication, with lower voltages—hence less spark risk—than the RS-232C.

The Husky A/D (Analog/Digital) has eight channels of A/D conversion built in and is intended for data logging at remote sites. It also features auto-answer modem handling so that you can interrogate and control it over a telephone line.

The military-specification Husky M-208 claims to be the first general-purpose computer in the world to meet DEF-STAN 66-31/1 and 07-55 standards for resistance to vibration,

(continued)

# The Line Tamer™ UPS speaks for itself.

Its on-board micro and RS-232 port let it talk with your computer for power system monitoring and control. And its energy-efficient design slashes your operating cost.



A conventional UPS calls for the battery and inverter to run constantly, wasting up to 40% of the power used. The Line Tamer Uninterruptible Power System for microcomputers is up to 80% efficient because it bypasses the battery and inverter during normal operation. Its unique design will save you money without sacrificing the performance of an on-line UPS.

The built-in Line Tamer Power Conditioner cleans and regulates AC power, removing spikes, transients, noise, overvoltages and undervoltages. When a blackout occurs, or line frequency varies beyond specified tolerances, the battery and inverter activate in phase, with no break in the sine wave output to your equipment.

The on-board microprocessor and RS-232 port let the Line Tamer UPS alert you automatically in the event of a power emergency, so you can begin an orderly shutdown. Among the user-defined warning and alarm parameters are High or Low Battery Voltage, Over or Undervoltage, Over-temperature and Battery Capacity.

It also keeps you informed of System Status, including Number of Power Outages, Number of Minutes on Inverter, Number of Hours on System, Number of Overloads, and Battery Time Remaining.

The Line Tamer UPS also features five front panel LED's for System Ready, Inverter On, Charger On, AC Present and Alarm. An audible alarm backs up the LED and automatic interrupts.

The complete specifications for the Line Tamer UPS for microcomputers speak well, too. For your copy, call or write Shape Magnetronics today.

**SHAPE** THE CLEAN  
MAGNETRONICS, INC. POWER  
SOURCE

901 DuPage Avenue, Lombard, IL 60148  
Phone 1 312 620-8394 • TWX 910-991-2352

Line Tamer is a trademark of Shape Magnetronics, Inc.

# LASER WARS

Attention Earth. The BDS Laser invasion is proof that all 8-page/minute laser engines are not created equal. BDS Corporation is the planet's largest manufacturer of devices using the Dataproducts printer mechanisms. And now, at the risk of causing permanent brain damage to anyone with a large stock of ordinary laser or daisy wheel printers, we are proud to announce our first laserprinter, the BDS Laser 630/8.

## OFFICE-READY AT \$3495, BATTERIES NOT INCLUDED

As the designation "630/8" implies, the new BDS laserprinter is Diablo 630-compatible and operates at 8 pages per minute. At \$3495, this is exactly what you need for a clean landing in your office and word-processing environment. No software conversions. No retraining all the secretaries. No more cumbersome sound-proofing enclosures or long walks to the printing room (the BDS laserprinter is quiet enough to sit next to you in a public library). And no surprises. Like paying \$4750 by the time you add all the options you really need for your office.

Now, however, the distance between BDS and the other laser/daisy competition *really* starts opening up.

You'll start out using your standard word-processing software. Even before you teach people how to imbed typefont-changing codes into their text, they'll be able to customize documents via the intelligent control panel.

For example, they may want to change magnification factors. Like blowing up text size for speeches and overheads; reducing for text compaction, or printing sideways for spreadsheets. And the BDS laserprinter will remember these new settings even after a power failure (we don't even need batteries, because we use non-volatile memory!)

Nine typefonts are provided in the basic configuration. Complete, for \$3495. With optional font cartridges, up to sixteen typefonts may be simultaneously online for use in any document.

Competitive distance becomes parsecs with the BDS *open architecture*. One of the optional font cartridges allows custom or user-defined typefonts to be downloaded from the host computer. Which ought to create a brisk third-party business for suppliers of corporate logos, bar codes and special-purpose character sets.

The final leap into hyperspace, and ahead of the competition, is achieved with dual-porting. Two computers can connect to the laserprinter, via one parallel and one serial interface. Yep. \$3495.

For the office which hasn't yet standardized on a local area network, two independent workstations can be connected. Eventually, one of the laser ports can connect to a LAN printer server, while the other can connect to a Diablo-compatible host supermini or PC.

All of the above capabilities combine to open up vast possibilities. Both for today *and* tomorrow.

## TAKE THIS AD TO YOUR LEADER

If you're a Fortune 1000-size company, we can Federal Express your BDS Laser 630/8 the same day you call us with your purchase order number.\* If you're a smaller company, we'll launch a communication probe in your direction, that will give you the name of our nearest, authorized dealer.

Oh. We don't mind landing the BDS unit next to the other, inferior daisy wheels or lasers you may already have. Of course, after running them side by side, you may want to shoot your old printer straight out of (no pun intended) a cannon.

Inquiry 33



BDS  
Corporation  
800 Maude Ave.  
Mtn. View, CA 94043  
(415)964-2112

UK (734)730023 Australia (03)9961222

\*FOB Mountainview, CA. © by BDS Corp. Multiple-unit end-user discounts up to 32% and OEM discounts up to 36%. Artwork by Geoffrey Chandler. % Illuminarium Gallery, Larkspur, CA. Adv. by TRBA, 408/258-2708.



shock, and temperature, and its appearance suggests that it might be the only object to survive World War III. It uses a military-standard 19-way bayonet socket for serial communication; the British Army uses it to test guided-weapon systems in the field.

Although Husky emphasizes the use of RAM storage in the field, the company supplies both a disk drive and a digital-tape data recorder for backup and archiving data from the

computers. The disk unit uses 3-inch floppy disks.

**SUMMARY**

The Husky Hunter makes every other computer that I've handled feel quite flimsy. It isn't suitable for word processing, but is intended to run CP/M applications in outdoor or other hazardous environments that could quickly destroy a conventional plastic lap-held portable.

Huskies are not really computers for the office-bound. They go better with travel-stained jungle boots and a tin of mosquito repellent. Nevertheless, it amuses me to think that it might someday become chic to saunter around with a khaki M-208 on a shoulder strap.

In short, the Husky computers are serious tools; not everyone needs one, but if you do, you really need one. ■

**FREE SHIPPING ON ORDERS OVER \$100**

**HEWLETT-PACKARD**  
**10 Series**

HP-11C	Scientific	\$ 55.95
HP-12C	Financial	\$ 87.95
HP-15C	Scientific	\$ 87.95
HP-16C	Computer Science	\$ 87.95
Solutions Books		
HP-11C	Solutions	\$ 15.00
HP-12C	Real Estate	\$ 15.00
HP-12C	Leasing	\$ 15.00
HP-12C	Cash Flow Analyzer	\$ 32.95
HP-15C	Advanced Functions	\$ 45.00

**HEWLETT-PACKARD**  
**Thinkjet**

2225B	Thinkjet Printer	\$ 379.00
Accessories		
82199A	Battery Pack	\$ 39.95
92261A	Ink Cartridge	\$ 7.95
92261N	Fanfold Paper (2600)	\$ 44.95
92261S	Printer Stand	\$ 39.95
82167B	IL Cable (1 meter)	\$ 6.40

**EPSON**

LX-80	100cps & NLQ	\$ 239.00
LX-90	100cps & NLQ	CALL
HS-80	Inkjet	CALL
FX-85	160cps Dot Matrix	CALL
JX-80	Color Dot Matrix	\$ 469.00
RX-100	100cps Dot Matrix	\$ 369.00
FX-185	160cps Dot Matrix	CALL
LQ1500	NLQ Dot Matrix	\$ 895.00
HI-80	Plotter	\$ 369.00
DX-10	Daisywheel	CALL
DX-20	Daisywheel	CALL
QX-16	Computer	CALL

**HEWLETT-PACKARD**  
**40 Series**  
Free 12K Rom with HP-41CV/X

HP-41VC	Scientific	\$ 169.95
HP-41CX	Scientific	\$ 239.95
Accessories		
82059D	Battery Recharger	\$ 16.00
82104A	Card Reader	\$ 150.15
82120A	Battery Pac	\$ 28.00
82160A	HP-IL Interface	\$ 96.25
82181A	Extended Memory	\$ 60.00
92266A	Extended Use Battery	\$ 39.95
Software		
41-15002	Statistics	\$ 28.00
41-15003	Math	\$ 28.00
41-15004	Financial Decision	\$ 28.00
41-14005	Surveying	\$ 28.00
41-14006	Circuit Analysis	\$ 36.00
New	Advantage Rom	\$ 39.95

**HEWLETT-PACKARD**  
**Additional Items**

7470A	2-Pen Plotter	\$ 843.15
82143A	Thermal Printer	\$ 295.00
82161A	Cassette Drive	\$ 423.00
82164A	LRS-232 Interface	\$ 227.15
82166C	IL Interface Kit	\$ 304.15
82168A	Acoustic Coupler	\$ 389.95
9114A	710K Disc Drive	\$ 625.00
92192A	Box of 10 Discs	\$ 55.20
82162A	IL Printer	\$ 346.50

**PRINTERS**

**Diablo**

D-25	25 cps Daisywheel	\$ 550.00
D-80	80 cps Daisywheel	\$ 2195.00
630ESC	45 cps Daisywheel	\$ 1679.00

**Okidata**

ML182	120cps Dot Matrix	\$ 219.00
ML192	160cps Dot Matrix	\$ 359.00
Ok120	Color Dot Matrix	\$ 199.00
ML193	160cps Wide Carriage	\$ 499.00

**Brother**

HR-15XL	17cps Daisywheel	\$ 345.00
HR-35	36cps Daisywheel	\$ 689.00
2024L	200cps & NLQ	\$ 825.00
CF100	Sheet Feeder	\$ 199.00
Twinwriter 5	Daisywheel/Dot Matrix	CALL

**Panasonic**

KXP1090		\$ 185.00
KXP1091		\$ 255.00

**Citizen**

MSP-10	160cps Dot Matrix	\$ 299.00
MSP-15	160cps Wide Carriage	\$ 439.00
MSP-20	200cps Dot Matrix	\$ 439.00
MSP-25	200cps Wide Carriage	\$ 569.00

**HEWLETT-PACKARD**  
**70 Series**

HP-71B	Handheld Computer	\$ 389.95
HP-75D	Handheld Computer	\$ 858.75
Peripherals		
82400A	Card Reader	\$ 127.05
82401A	HP-IL Interface	\$ 96.25
82420A	4K Memory Module	\$ 60.00
82441A	FORTH Assembler	\$ 115.50
82483A	Surveying	\$ 115.50
82490A	41/21 Translator Pac	\$ 96.25
92198A	IL 80 Column Interf.	\$ 250.25
82489A	Statistics Pac	\$ 96.25

**TEXAS INSTRUMENT**

TI-3511	Scientific	\$ 15.79
TI-5511	Programmable Scien	\$ 32.95
BA-35	Student Financial	\$ 16.29
BA-11	Financial	\$ 32.95
TI-5310	Printing Financial	\$ 99.95



**CAPITAL MICRO**

7600 FLOWER AVENUE  
WASHINGTON, D.C. 20912

**(800) 544-4442**

Maryland  
Call Collect  
**(301) 565-3595**

**XEROX**

1020	Copier (11cpm)	\$ 1295.00
1025	Copier (21cpm)	\$ 1795.00
610	Memorywriter	\$ 750.00
620	Memorywriter	\$ 1195.00
640	Memorywriter	\$ 3675.00

**TERMS:**

- \*Free Shipping on orders over \$100.
- \*NO ADDITIONAL CHARGE for credit cards.
- \*MD residents add 5% sales tax.
- \*Credit references required for open account.
- \*Allow 2 weeks for personal checks.



An unbelievable number of software companies will try to tell you their word processors are easy to use. But one look at even the simplest command calls their bluff.

The boldface feature, for instance. This "simple" command can require up to six keystrokes on some systems. You could spend months learning to use them. And that's no exaggeration.

Boldfacing with our system requires only one keystroke: *b* to *boldface*. Just as *c* will *copy text*, *d* will *delete* it, and *e* will *end* the edit.

Our system is Final Draft. And we spent months designing it to be the best system on today's market. Best because our edit commands are alphabetically-assigned so that you can remember them easily. Best because we have only 35 commands, not 305. Best because you can learn our system the first day and master it the second.

But let's not distort the facts: Final Draft isn't just simple. It's powerful. Features like the thesaurus, floating footnotes, canned paragraphs and automatic

red-lining are no myth.

There's only one thing about Final Draft that's hard to believe: the price. It's \$395.

So if you're tired of hearing one boldface lie after another, just heed this simple truth: Final Draft is a great word processor.

### **FINAL DRAFT™**

The word processor from CYMA/McGraw-Hill. Call 800-292-CYMA.

Inquiry 98 for End-Users.  
Inquiry 99 for DEALERS ONLY.

# IT'S A BOLDFACE LIE





# HAYES...

The Future Of Telecommunications  
Atlanta or San Francisco

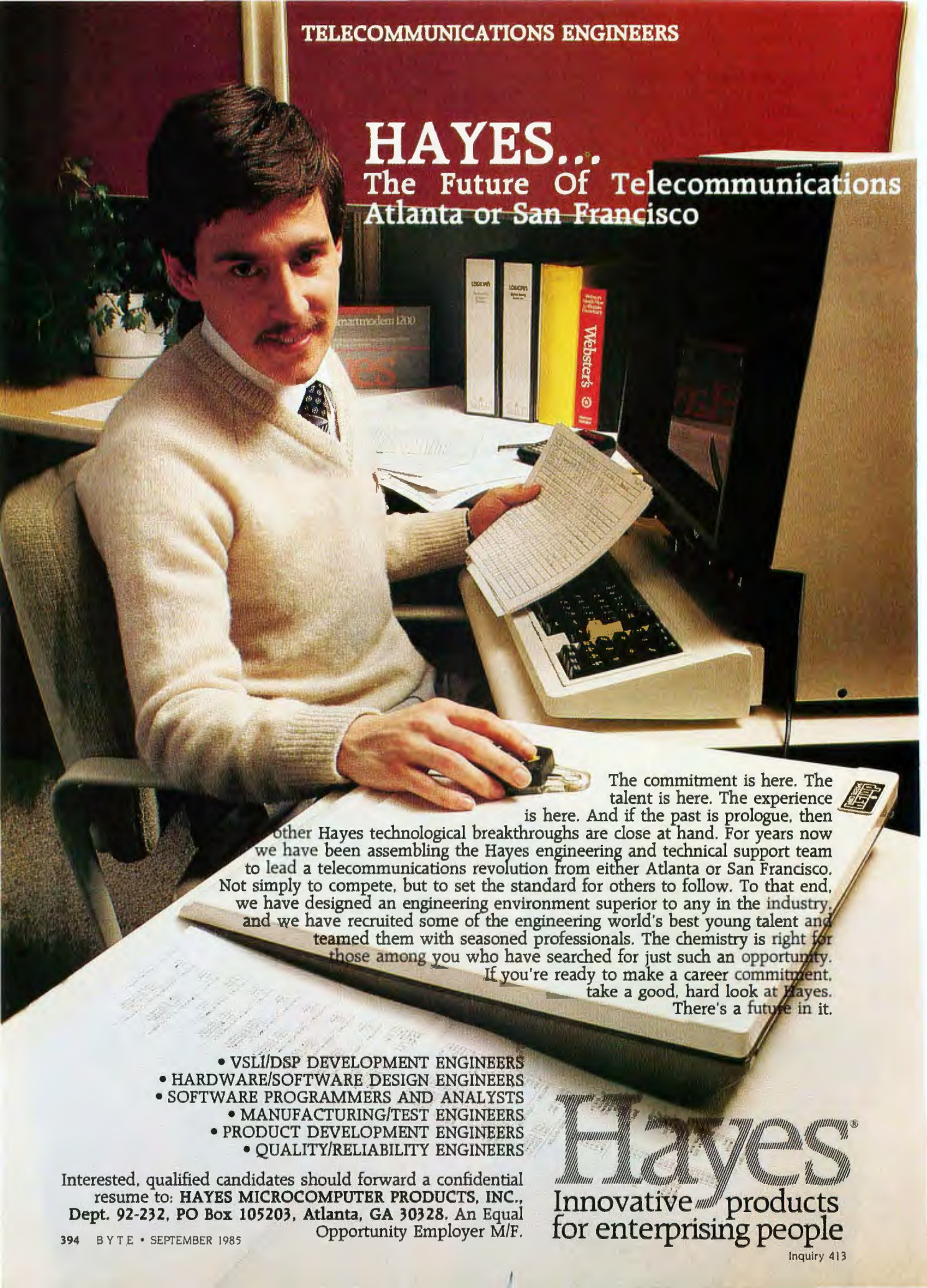

The commitment is here. The talent is here. The experience is here. And if the past is prologue, then other Hayes technological breakthroughs are close at hand. For years now we have been assembling the Hayes engineering and technical support team to lead a telecommunications revolution from either Atlanta or San Francisco. Not simply to compete, but to set the standard for others to follow. To that end, we have designed an engineering environment superior to any in the industry, and we have recruited some of the engineering world's best young talent and teamed them with seasoned professionals. The chemistry is right for those among you who have searched for just such an opportunity. If you're ready to make a career commitment, take a good, hard look at Hayes. There's a future in it.

- VSLI/DSP DEVELOPMENT ENGINEERS
- HARDWARE/SOFTWARE DESIGN ENGINEERS
- SOFTWARE PROGRAMMERS AND ANALYSTS
- MANUFACTURING/TEST ENGINEERS
- PRODUCT DEVELOPMENT ENGINEERS
- QUALITY/RELIABILITY ENGINEERS

Interested, qualified candidates should forward a confidential resume to: HAYES MICROCOMPUTER PRODUCTS, INC., Dept. 92-232, PO Box 105203, Atlanta, GA 30328. An Equal Opportunity Employer M/F.

**Hayes**<sup>®</sup>  
Innovative products  
for enterprising people



バイト

# A History of Japan's Microcomputers

TLCS-12

$\mu$ COM-4, -8, & -16

NEC 700

TK-80

MZ-80

PC-8001

And a new idea:  
A software  
vending machine

BY WILLIAM M. RAIKE

**W**hen Gregg Williams, a senior technical editor at BYTE, mentioned that the September BYTE was going to be the 10th anniversary issue and suggested that I devote this column to the history of microcomputers in Japan, my first reaction was "Great idea!" My next thought was "Where on earth can I find any information about that?" Luckily, thanks to Asao Ishizuka at BYTE's Japanese-language sister publication, *Nikkei BYTE*, I located a gold mine of computer-related reference material. It's a small, out-of-the-way library in Tokyo's Gotanda district that's operated as a public service by the Fujitsu people. Besides having all kinds of technical books and catalogs, the periodical files yielded just what I was looking for.

You can trace the ancestry of most of today's personal computers back to Intel's original 4-bit microprocessor, the 4004, which first appeared in November 1971. Intel's 8-bit 8008 microprocessor appeared the next year, followed by the landmark 8080 in 1973. In 1975, Zilog introduced the Z80, still in use today.

It didn't take the Japanese long to develop their own microprocessors. Toshiba developed Japan's first microprocessor chip, the TLCS-12. Announced in May 1973, only a year and a half after the Intel 4004 appeared in the U.S., the TLCS-12 was a 12-bit microprocessor that was intended primarily for industrial control applications. OEM (original equipment manufacturer) samples of the TLCS-12, including a circuit board in kit form, cost well over a thousand dollars. NEC announced its  $\mu$ COM-4 in September 1973, followed in late 1974 by the 8-bit  $\mu$ COM-8 and the 16-bit  $\mu$ COM-16. If you really want to be picky, though, you can call 1972 the year of the first Japanese microprocessor; in the spring of 1972 NEC started shipping its NEC 700 series to Japanese manufacturers. Although the 700 series consisted of a set of two special-purpose LSI (large-scale integration) chips instead of a one-chip microprocessor, the

two chips together were functionally equivalent to the Intel 4004.

Although other Japanese manufacturers introduced microprocessors of their own in the mid-1970s, NEC has consistently led the way in Japanese microcomputer technology. It started an intensive VLSI (very-large-scale integration) research program in 1975. In 1976, responding to the MITS Altair kit that appeared in the U.S. the previous year, NEC introduced a microcomputer kit for Japanese hobbyists, the TK-80.

In the late 1970s, as interest in microcomputers continued to grow everywhere, hobbyist-oriented microcomputer shows began to appear. In 1977 in Tokyo, 36 companies participated in what was apparently Japan's first microcomputer show. Although the featured products were mostly kits, chips, memories, interface boards, and the like, 35,000 people attended the show. During the same period, office computers began to appear at business shows, along with peripheral equipment like printers that could print Japanese characters.

Meanwhile, personal computers like the early TRS-80s, Apples, and PETs were being introduced in the U.S.—and marketed in Japan soon afterward. Predictably, after a lag of a year or two, the first Japanese personal computers appeared. In 1979 Sharp introduced the first machine in its MZ-80 series. Based on the Z80 processor, it was a single unit containing a keyboard, display, and cassette tape drive, and it came supplied with a version of BASIC. An external dual-floppy-disk-drive unit was available, but it cost about \$1200 extra. The same year, NEC introduced its PC-8001, the computer that was to begin its dominance of the Japanese personal computer market. Despite competition from its own newer models, NEC has continued to modernize the design of the PC-8001 and recently introduced the PC-8001 Mk II SR, which is software-compatible with the original machine. The original PC-8001, like its newer

(continued)

William M. Raikes, who has a Ph.D. in applied mathematics from Northwestern University, has taught operations research and computer science in Austin, Texas, and Monterey, California. He holds a patent on a voice scrambler and was formerly an officer of Cryptext Corporation in the United States. In 1980, he went to Japan looking for 64K-bit RAMs. He has been there ever since as a technical translator and a software developer. He can be contacted at BYTE, POB 372, Hancock, NH 03449.



cousin, has a separate display. Most people use cassette tapes for external storage, but you can buy external disk drives. It can even run the CP/M operating system.

Both the Sharp and NEC machines came with versions of BASIC, like Hitachi's ill-fated (and glacially slow) BASIC Master series. They were sold

mostly to technically oriented hobbyists, although games soon began to proliferate.

The Japanese-language display and processing capabilities of these early machines ranged from rudimentary to nonexistent. Perhaps mostly for that reason, the explosive growth in applications software that took place in

the U.S. in the early 1980s didn't happen in Japan. Hobbyist-oriented hardware has continued to dominate the Japanese personal computer scene. In the last two or three years the availability of fast, powerful, cheap hardware with extensive Japanese-language capability has begun to change that, and competition is now mushrooming in Japanese-language applications software. Some of it is home-grown and some, like dBASE II, Multiplan, SuperCalc, and others, is imported under license with Japanese-language features added.

I think that the most important aspect of Japanese microcomputer history is what *didn't* happen here in the early 1980s. As regular readers of BYTE Japan know, the powerful influence of the IBM Personal Computer (PC) and compatibles on the U.S. personal computer market has been absent in Japan. Although NEC is the leader in Japanese personal computers, largely as a result of the PC-9801 series, its leadership is not undisputed, and competitors choose to compete technologically rather than to imitate like the IBM PC clones—apologies to Apple and the Mac. There are two sides to this coin: The lack of hardware standardization makes it tougher for software vendors to develop third-party application-software packages (although computer manufacturers sometimes offer inducements to cooperating vendors), but, at the same time, consumers get the chance to buy much more powerful and up-to-date hardware at very low prices. When I visit the U.S., people are impressed when they hear, for example, that Japanese users can buy computers (such as the latest NEC or Fujitsu machines) that run two to four times faster than the IBM PC. These computers are based on the 8086-2 or 80186 microprocessors, have a half-megabyte of RAM (random-access read/write memory) and a couple of 1-megabyte floppy-disk drives, run MS-DOS or CP/M-86, support the full Japanese language, have impressive color graphics capabilities, and are available for about \$1300. A built-

(continued)

# You're in Good Company When You Program in BetterBASIC



All of these companies rely on BetterBASIC to write their software programs. They have found that BetterBASIC combines the features they need from BASIC, Pascal, C and Forth in one familiar environment. Some of these features include the following.

**640K** Now you can use the full memory of your PC to develop large programs.

**STRUCTURED** Create well organized programs using procedures and functions that are easily identified and understood and completely reusable in future programs.

**MODULAR** Use procedures and functions grouped together to form "library modules."

**INTERACTIVE** BetterBASIC acts like an interpreter, responding to the users' commands in an immediate mode. However, each statement is actually compiled as it is entered.

**EXTENSIBLE** Create your own BetterBASIC modules which contain BetterBASIC extensions (ideal for OEMs).

**COMPILED** Each line of the program is compiled as it is entered

**Better  
BASIC™**

ALSO AVAILABLE FOR THE TANDY 2000, 1200 AND 1000

into the computer's memory rather than interpreted at runtime. The optional Runtime System generates EXE files.

**BetterBASIC** Runs on IBM PC, IBM PC/XT and compatibles.

**CALL 1-800-225-5800** (In Canada: 416-469-5244) Order BetterBASIC now, or write Summit Software Technology, Inc.™, P.O. Box 99, Babson Park, Wellesley, MA 02157. Prices are listed below.

BetterBASIC: \$199 Runtime System: \$250  
8087 Math Module: \$99

Order the BetterBASIC sample disk which includes a demo, a tutorial, compatibility issues and more. Only \$10.

MasterCard, VISA, P.O. Checks, Money Order, C.O.D. accepted.

BetterBASIC is a registered trademark of Summit Software Technology, Inc.

IBM PC and IBM PC/XT are registered trademarks of International Business Machines Corp. Tandy is a registered trademark of Tandy Corp. Illustrated above are registered trademarks of the following companies: Mobil Oil Corp.; A T & T; General Electric Co.; Westinghouse Electric Corp.; TRW, Inc.



# Tools That Make Your Job Easier

For PC DOS/MSDOS (2.0 and above/128K) • IBM PC/Compatibles, PC Jr., Tandy 1000/1200/2000, & others  
For CPM80 2.2/3.0 (Z80 required/64K) • 8" SSSD, Kaypro 2/4, Osborne I SD/DD, Apple II, & others

## MIX EDITOR

Programmable, Full/Split  
Screen Text Processor

Introductory  
Offer

# 29<sup>95</sup>

### Great For All Languages

A general purpose text processor, the MIX Editor is packed with features that make it useful with any language. It has auto indent for structured languages like Pascal or C. It has automatic line numbering for BASIC (255 character lines). It even has fill and justify for English.

### Split Screen

You can split the screen horizontally or vertically and edit two files simultaneously.

### Custom Key Layouts

Commands are mapped to keys just like WordStar. If you don't like the WordStar layout, it's easy to change it. Any key can be mapped to any command. You can also define a key to generate a string of characters, great for entering keywords.

### Macro Commands

The MIX Editor allows a sequence of commands to be executed with a single keystroke. You can define a complete editing operation and perform it at the touch of a key.

### Custom Setup Files

Custom keyboard layouts and macro commands can be saved in setup files. You can create a different setup file for each language you use.

### MSDOS Features

Execute any DOS command or run another program from inside the editor. You can even enter DOS and then return to the editor by typing exit.

## MIX C COMPILER

Full K&R Standard C Language  
Unix Compatible Function Library

Introductory  
Offer

# 39<sup>95</sup>

### Complete & Standard

MIX C is a complete and standard implementation of C as defined by Kernighan and Ritchie. Coupled with a Unix compatible function library, it greatly enhances your ability to write portable programs.

### The Best C Manual

MIX C is complemented by a 400 page manual that includes a tutorial. It explains all the various features of the C language. You may find it more helpful than many of the books written about C.

### Fast Development

MIX C includes a fast single pass compiler and an equally fast linker. Both are executed with a simple one line command. Together they make program development a quick and easy process.

### Fast Execution

The programs developed with MIX C are fast. For example, the often quoted prime number benchmark executes in a very respectable 17 seconds on a standard IBM PC.

### Standard Functions

In addition to the functions described by K&R, MIX C includes the more exotic functions like *setjmp* and *longjmp*. Source code is also included.

### Special Functions

MIX C provides access to your machine's specific features through BDOS and BIOS functions. The CHAIN function lets you chain from one program to another. The MSDOS version even has one function that executes any DOS command string while another executes programs and returns.

### Language Features

- Data Types: char, short, int, unsigned, long, float, double (MSDOS version performs BCD arithmetic on float and double-no roundoff errors)
- Data Classes: auto, static, extern, register
- Struct, Union, Bit Fields (struct assignment supported)
- Typedef, Initialization
- All operators and macro commands are supported

### 30 DAY MONEY BACK GUARANTEE

Orders Only: Call Toll Free 1-800-523-9520, (Texas only 1-800-622-4070)

MIX Editor \_\_\_\_\_ \$29.95 + shipping (\$5 USA/\$10 Foreign) Texas residents add 6% sales tax

MIX C \_\_\_\_\_ \$39.95 + shipping (\$5 USA/\$25 Foreign) Texas residents add 6% sales tax

Visa \_\_\_\_\_ MasterCard \_\_\_\_\_ Card # \_\_\_\_\_ Exp. Date \_\_\_\_\_

COD \_\_\_\_\_ Check \_\_\_\_\_ Money Order \_\_\_\_\_ Disk Format \_\_\_\_\_

Computer \_\_\_\_\_ Operating System: MSDOS \_\_\_\_\_ PC DOS \_\_\_\_\_ CPM80 \_\_\_\_\_

Name \_\_\_\_\_

Street \_\_\_\_\_

City/State/Zip \_\_\_\_\_

Country \_\_\_\_\_

Phone \_\_\_\_\_

**MDX** 2116 E. Arapaho  
Suite 363  
Richardson, Tx 75081  
software  
Dealer Inquiries Welcome  
Call (214) 783-6001

MSDOS is a trademark of Microsoft PC DOS is a trademark of IBM CPM80 is a trademark of Digital Research WordStar is a trademark of MicroPro

**B**



in 10-megabyte hard-disk drive brings the price up to about \$2400.

**OH, BROTHER—**

**A SOFTWARE VENDING MACHINE**

Brother Industries makes some really neat products. My little EP-44 portable electronic typewriter/serial printer has worked perfectly since the day I bought it, and the newest model, the WP-600 portable word processor I wrote about last month, promises to be even better. This month I walked into the showroom lobby of Brother's headquarters in the Kyobashi district of Tokyo, near the Ginza, to get a look at Brother's latest brainchild, the SV-2000 Software Vending System. Brother has no plans to export it, but I think it's the most intriguing software marketing idea I've seen in a long time.

In Japan, when you want to buy a new computer game, you go to a

*Made of molded  
white plastic, the  
SV-2000 Software  
Vending System looks  
like a telephone booth  
without sides.*

computer-software store that has rack after rack displaying hundreds of cassettes and floppy disks, just like a record store. The stores have no way to demonstrate most of the games, and new games are being published constantly. Word of mouth and magazine reviews can popularize only a few products, so buying new games

can be an expensive gamble, even apart from the risk that the media you buy (the tapes or disks) might be defective.

Brother has come up with its SV-2000 Software Vending System as a new marketing approach. Made of molded white plastic, the SV-2000 looks like a telephone booth that has only a front, a back, a ceiling, and a floor—no sides. It reminds me of one of those arcade-type race-car driving games, except that you sort of slouch/stand against the back of the booth. The front of the booth has a display screen, a Start button, two cursor buttons, a Confirm button, a Cancel button, and slots for inserting coins, tape cassettes, floppy disks, and credit cards, as well as a printer slot. The booth works like a terminal: It's connected via telephone lines to a mainframe computer located somewhere else. The remote system controls the

# Last year the experts tested the top-of-the-line Toshiba 3-in-One™ printer. Here's what they said.

“When Toshiba America called to see if there were problems testing their printers, I responded, ‘You bet—I can’t get the P1351 off Bill Machrone’s desk long enough to get its picture taken!’ It’s that good.”

(Bill Machrone is the editor of PC Magazine.)

PC Magazine  
November 27, 1984

“It is setting new standards for quality and performance in the dot matrix arena.”

Computers & Electronics Magazine  
November 1984

interaction with the user, handles the financial transaction, and downloads selected software from its database onto the user's own tape or floppy disk inserted into the appropriate slot; the media (blank tapes or disks) are not sold through the SV-2000.

After pressing the Start button, a menu display asks you to specify which type of computer you own; you select a game from the next menu. Right now, the system covers only a handful of the NEC personal computer models. I would have thought it worthwhile to provide for the MSX computer family, in which there are dozens of models, all compatible with each other. Presumably, if the system is successful, Brother will extend it to additional types of computers.

After you pick a game, using the cursor buttons to select a title from the menu, the SV-2000 displays a demonstration screen from the ap-

*After you pick a game,  
the SV-2000 displays  
a demonstration  
screen to give you  
some idea of what  
the game is all about.*

propriate game to give you some idea of what the game is all about. If you want to buy the game, you press the Confirm button and follow the instructions for depositing money or a credit card and inserting your blank tape or disk into the appropriate slot. The SV-2000 prints the appropriate information onto a blank label you insert

into the printer slot and then downloads the game onto your tape or disk. Typically, it takes about 3 minutes to download the software.

So far, the only SV-2000 booths in existence are the ones in the Brother headquarters in Tokyo and in Nagoya, but since the booth is so compact and plugs into an ordinary power outlet, Brother hopes to arrange with software manufacturers to install them in computer-software shops and in videotape and record stores. Brother expects the booths to cost somewhere between \$8000 and \$12,000 each.

#### COMING UP

Next month I'll tell you about the Tokyo Microcomputer Show, where I had a chance to see the NEC PC-98XA and PC-9801U2, the 286 XENIX System V, and a new Hitachi drive. ■

“

”

## Imagine what they will say about its successor.

**The New Toshiba P351 3-in-One printer.** They could say that inside the sleek new Toshiba P351 you'll find the ultimate 3-in-One printer. Because it offers a combination of:

Letter-quality printing. Perfectly translated graphics. And speed. (100 cps letter. And draft speed improved to 288 cps.)

They could say you'll appreciate the 24-pin dot matrix head that gives the P351 its exemplary letter and graphic quality.

They could say the new P351 gives you an almost unlimited number of ways to express yourself. With both downloadable software fonts and new plug-in font cartridges.



And they could say the new P351 is not only the best looking printer in the \$1,000 to \$2,000 range. But also the most reliable.

Of course, we're not putting words in their mouths. Just the ultimate 3-in-One printer in their hands. And yours.

For complete information call 1-800-457-7777, Operator 32.

In Touch with Tomorrow

**TOSHIBA**

TOSHIBA AMERICA, INC. Information Systems Division



# Your System/Controller should fit you like a good suit.



## LET MICROMINT CUSTOM FIT YOU

Whether it's suits or system controllers, you can't buy off the rack when you need a custom fit.

That's why Micromint individualizes its system controllers to meet your particular needs and budget. What's most important to you? Software compatibility? Speed? Everything on one board? Economical computing power?

**#1: "I want software compatibility."**

### Solution:

#### THE SB180 COMPUTER/CONTROLLER

The SB180, only 4" by 7½", offers a Z80 compatible CPU running at 6MHz, 256K bytes of RAM, up to 32K bytes of ROM, two serial ports, a parallel port, Z80/6800 I/O expansion bus, and an industry standard 765A-compatible disk controller for up to four disk drives — any combinations of 3½", 5¼" or 8" drives. The SB180 is based on the Hitachi HD64180 CPU, a microcoded CMOS chip which provides high performance, reduced system cost, and low power operation while maintaining complete compatibility with the large base of standard CP/M software.

SB180-1 w/8K ROM monitor. . . \$369.00  
 SB180-5 w/8K ROM monitor, BIOS source and Z-system . . . . . \$418.00

**#2: "I need speed."**

### Solution:

#### THE Z8 FORTH SYSTEM/CONTROLLER

The Z8 FORTH System/Controller is only 4" by 4½" and includes a custom masked Z8 version of the FORTH

language with a full screen editor, cassette I/O driver primitives, EPROM programmer primitives, and other utility words. It also contains up to 4K bytes of RAM or EPROM, an RS-232 serial port with selectable baud rates, and two parallel ports. Additional Z8 peripheral boards include memory expansion, a smart terminal board, serial and parallel I/O, real time clock an A/D converter, and an EPROM programmer. It's perfect for data reduction and high speed control applications.

BCC21 w/utilities . . . \$225.00

**#3: "Let me have an entire development system on one board."**

### Solution:

#### THE BCC52 SYSTEM/CONTROLLER

The BCC52 is a new stand alone single board microcomputer which is bus compatible with the Micromint BCC11/BCC21 Z8 System/Controllers and expansion boards. The BCC52 features the Intel 8052AH-BASIC microprocessor which includes a ROM resident 8K byte floating point BASIC inter-



For a System Controller suited to your needs, give us a call.

preter with extensions for process control work. It contains sockets for up to 48K bytes of RAM/EPROM, an "intelligent" 2764/128 EPROM programmer, 3 parallel ports, a serial terminal port, and a serial printer port.

BCC52 . . . \$239.00

**#4: "Give me lots of economical computing power."**

### Solution:

#### THE BCC11 BASIC SYSTEM/CONTROLLER

The Z8 BASIC System/Controller is nearly identical to the FORTH System/Controller but contains a tiny BASIC interpreter, up to 6K bytes of RAM and EPROM, an RS-232 serial port with switch selectable baud rates, and two parallel ports. Add a power supply and terminal to start programming in BASIC or machine language. Programs can be transferred to 2732 EPROMS with the optional EPROM programmer for auto-start applications. It can also use any of the expansion boards mentioned under the Z8 FORTH System/Controller.

BCC11 . . . \$149.00

Additional information on peripheral boards and OEM pricing is available.

**Order Toll Free**  
**1-800-635-3355**  
 In Connecticut call: 1-871-6170



MICROMINT, INC.  
 25 Terrace Drive  
 Vernon, CT 06066



## A·C·C·O·R·D·I·N·G T·O· W·E·B·S·T·E·R

# West Coast Faire, Mac Stuff, and the Amiga

Computer Faire

Ericsson Portable

AT&T UNIX PC

Mac RAM Upgrades

BMUG

Apple

Amiga

TeamMate

BY BRUCE WEBSTER

**T**his month's column will include some commentary and have less of a product-review emphasis. Trips out of town have kept me away from the computers. Also, the pipeline of hardware and software dried up for a while, leaving me with little to talk about. However, Brenda McLaughlin of BYTE's West Coast office has worked hard to fill up the pipeline again, and I now have enough to keep me busy for some time. Look for lots of products to be covered during the next few months.

### WEST COAST COMPUTER FAIRE

I went up to San Francisco for the Tenth West Coast Computer Faire, now run by Prentice-Hall. Jim Warren sold it to that company two years ago. The Faire is legendary for the number of major firms that got their start there. Apple and Digital Research are a few of them. A friend of mine delights in telling of an experience at one of the first Faires. He bought an early copy of CP/M (for \$75) from a small booth staffed by Gary Kildall. (As far as I know, my friend still uses that version of CP/M on his IMSAI 8080.) This was my fourth Faire in a row, but it was my first as something other than an exhibitor, and I was looking forward to really enjoying it.

My impression after a day or so was that Warren sold out just in time. The Faire is shrinking. It may not be dying, but it is no longer the important trade show it was two short years ago. Without the giant booths from IBM, Apple, and AT&T, the Faire would have looked like any other small, local, end-user show. The move to the Moscone Center didn't help that impression; a large chunk of the main floor was unused, adding to the impression of the Faire's shrunken size.

Several reasons can be given for the Faire's diminishing stature, but they all sound like clichés: the rise of COMDEX, the invasion of microcomputers at NCC, the proliferation of specialized computer shows (like the Mac-World Expo), the maturing of the industry. A less-mentioned reason is that many exhibitors last year were outraged by high drayage fees

(the cost to move goods and equipment on and off the exhibit floor) and hostile behavior from members of the labor force. I know of several exhibitors who swore that they would not come back this year, and they didn't. The result is the same: The Faire—and the industry—just aren't as much fun as they used to be, at least for those directly involved.

End users, on the other hand, are still having a great time. Some terrific bargains were to be found at the Faire. I bought 128K bytes (18 64K-bit chips) of RAM (random-access read/write memory) for my SixPakPlus board for only \$21; 256K-bit chips were selling for as little as \$5.50 in quantity one. I drooled a long time over a 21-megabyte internal hard disk for my Compaq that was selling for just \$675 (with controller and cable). Complete computer systems were going at low prices. One example was a 512K-byte Macintosh with an external disk drive and an Imagewriter printer for \$2594. Modems, printers, monitors, and graphics cards were selling for no-margin prices. I'm not sure if the vendors made any money, but I saw a lot of happy buyers walking out with large boxes and bags.

Some interesting products were on display. Ericsson, a Swedish company specializing in ergonomic (body-friendly) IBM PC-compatibles, showed a portable compatible with one 5¼-inch disk drive, 256K bytes of RAM, parallel and serial ports, and a plasma display for just \$2995. If you're not aware of how expensive plasma displays usually are, here's one clue: IBM was showing one that hooks up to the IBM PC and that has about four times the resolution of the Ericsson (i.e., double the width and double the height). The IBM unit cost \$3000 by itself. Ericsson is supposed to be sending an evaluation unit; if and when it shows up, I'll let you know just how nice it is.

AT&T—which has generally failed to live up to anyone's expectations as to how it would do in the computer market—displayed the UNIX PC (formerly known as the 7300). This is a 68000-based box with windows, lots of

(continued)

Bruce Webster is a charter member of the PMS Commandos and a consulting editor for BYTE. He can be contacted c/o BYTE, 425 Battery St., San Francisco, CA 94111.



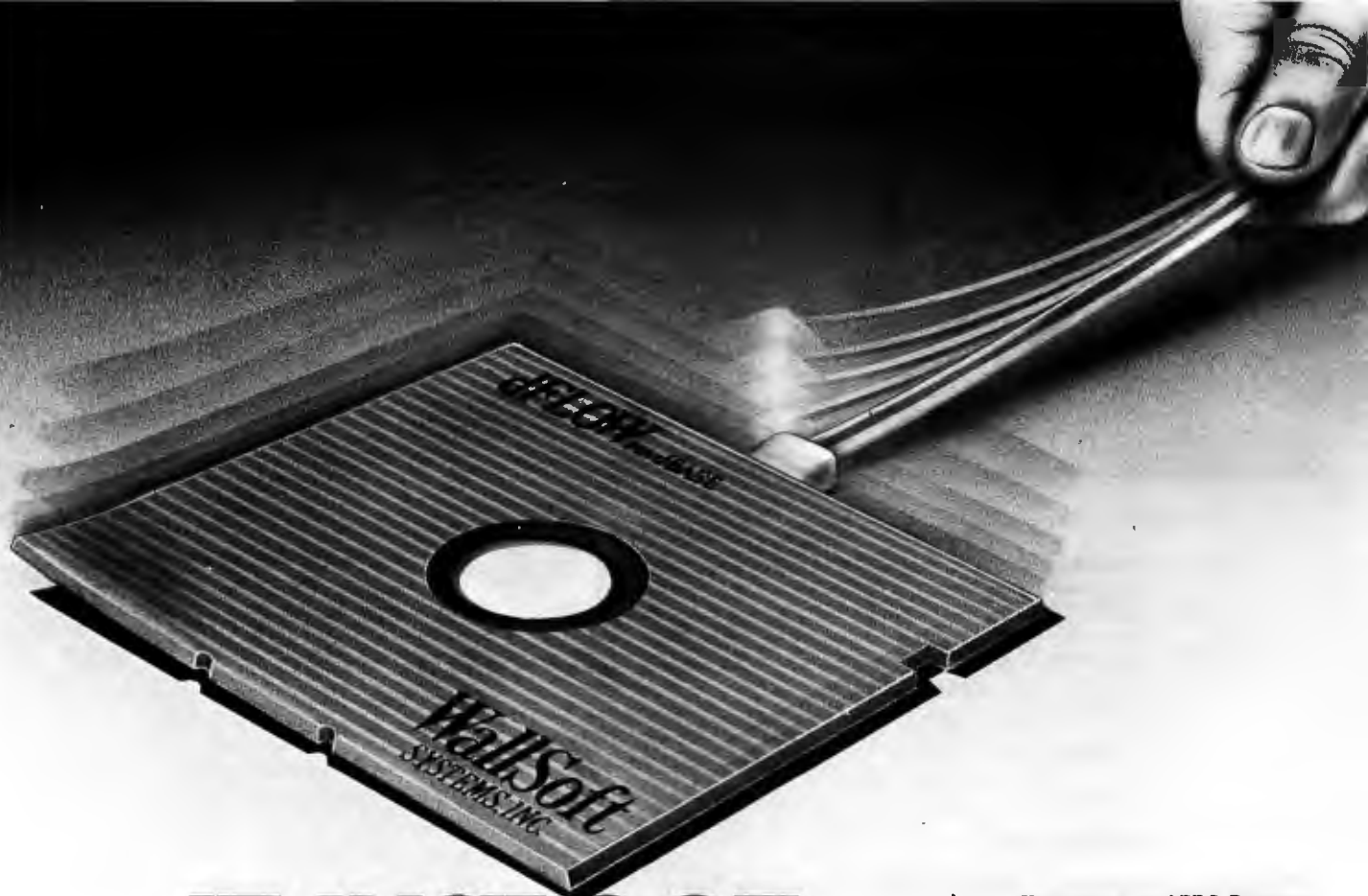

# IT JUST GOT TOUGHER TO BUG dBASE PROGRAMMERS

You wrote a good PRG. But now you're patching in the 23rd "exception," your indentation is shot and one little ENDIF is missing.

#### **dFLOW CAN HELP**

Ask dFLOW for a quick error check. Call up your PRG's control flow diagram, and watch that open IF statement stand out.

You've made the fix. Now have dFLOW re-indent your source and print a flow diagram. And if that isn't enough, dFLOW will cross-reference your full system and give you a variable concordance.

#### **SWATS BUGS FAST**

dFLOW is so fast that, from floppy, you can read and check a 100 line PRG in seven seconds plus 14 keystrokes—DOS to DOS. And it's menu driven, so there's no need to read the manual. Unless of course, you want to run dFLOW in batch.

dFLOW has a suggested retail price of \$129, and comes with a six-month, money back guarantee. Call for your free demo disk. (800) 23d-Flow. In New York, (212) 406-7026. Visa, MC, AE, DC.

dBASE is a registered trademark of Ashton-Tate.  
© 1985, WallSoft Systems, Inc., 233 Broadway, New York, NY 10279.

## WallSoft SYSTEMS, INC.

RAM, a hard disk, telecommunications hardware, and the UNIX operating system. The windows are an attempt to make UNIX palatable; however, without sufficient third-party software (ever UNIX's bane), there still won't be much demand for the machine. Again, an evaluation unit is supposed to arrive in a few months; I'll let you know more when I get it.

A number of interesting Macintosh products were there. Everyone and her sister seems to be offering RAM upgrades for the Macintosh, mostly because Apple still insists on charging the ridiculous amount of \$700 for its 512K-byte upgrade. Competition is heavy; most firms are charging about \$300, which is still high, given recent drops in 256K-bit chip prices. The current winner for biggest upgrade is Levco, which offers a 2-megabyte upgrade for less than \$1000; the actual cost is dependent upon current chip prices. A friend of mine sat down at one of the 2-megabyte Macs, set up a 1.4-megabyte RAM disk (with the Assimilation Process software), and still had a full 512K-byte workspace left over. Not too shabby. (However, some dark clouds are on the horizon for Mac owners using third-party or do-it-yourself upgrades; see the "Mac RAM Upgrade Alert" section below.)

A variation on the Mac RAM disk is available from Western Automation Laboratories. This company is producing the *external* DASCH (disk acceleration/storage control hardware) RAM disk, something the Mac could have used a year ago. Several sizes are available, ranging from 500K bytes to 2 megabytes; ironically, the low-end (500K-byte) \$500 drive is probably your best value, since you could buy a 10-megabyte hard disk for less than the price of the high-end RAM disk (\$2000 for 2 megabytes).

A large number of users groups had booths, another indication that the Faire had a hard time selling its floor space to dealers and manufacturers. I gladly joined the Berkeley Macintosh Users Group (BMUG) (1422A Walnut St., Suite 153, Berkeley, CA 94709, (415) 849-9114); for \$17, I got a 120-page "newsletter" (printed on a LaserWriter)

and a disk of public-domain software. Another users group—Atari—had probably the most crowded booth at the Faire. They had two Atari 520STs (the Jackintosh) up and running for hands-on demonstrations, one running GEM (Digital Research's Mac-like environment) and the other running FORTH, more evidence that the machine is for real.

This, of course, is the spot where I should stop and pontificate about the future of the West Coast Computer Faire. However, most of you can guess (and "guess" is the right word) just as well as I can where things are going, and with just as much validity, so I'll skip the dramatics and move on to the next topic.

**MAC RAM UPGRADE ALERT**

It is now late April, and I just found out that this column won't see print until September. I wish it were otherwise,

because I've recently come across some very disturbing news. A very reliable source has told me that a major ROM (read-only memory) upgrade for the Macintosh will happen this fall, about the time you read this. The new ROM will be 128K bytes (the current one is 64K bytes) and will incorporate fixes and changes to the operating system and Toolbox, support double-sided disks, and so on. This has been confirmed from other sources and is hardly disturbing news. However, this same source told me that Apple was instructing all its dealers *not* to perform the ROM upgrade on any Mac that has been upgraded or modified in any way other than the official Apple 512K-byte upgrade (board swap). In other words, if you were not willing to pay the \$700 Apple wanted, but instead have done it yourself or gone to a third party, you are out of luck.

(continued)

**FASTER**

USRobotics' swift new Courier 2400™ modem cuts data transmission time in half, decreasing phone costs and increasing productivity. The auto-dial, auto-answer Courier adjusts itself from 2400 to 1200 or 300 bps. And if you prefer an internal slot modem for IBM-PCs or compatible computers, the Microlink 2400™ gives you the same great features at the same great price. Courier and Microlink 2400 modems. They're going fast.

**courier 2400**  
**USRobotics™**

8100 McCormick Blvd., Skokie, IL 60076  
 Phone: (312) 733-0497  
 Outside Illinois: 1-800-Dial-USR



# MICROWAY'S 8087 RUNS 1-2-3™!

MicroWay is the world's leading retailer of 8087s and high performance PC upgrades. We stock a complete selection of 8087s that run at 5 and 8mhz. All of our coprocessors are shipped with a diagnostic disk and the best warranty in the business - one year! We also offer daughterboards for socketless computers such as the NEC PC and PCjr, and a board which increases the clock speed of the 80287 from 4 to 6 mhz. Our NUMBER SMASHER™ includes 512K ram. It will run the IBM PC at clock speeds up to 10mhz and achieves a throughput of .1 megaflops

with 87BASIC/INLINE, Intel Fortran, or Microsoft Fortran. Software reviewers consistently cite MicroWay software as the best in the industry! Our customers frequently write to thank us for recommending the correct software and hardware to meet their specific needs. They also thank us for our same day shipping! In addition to our own products which support the 8087 and 80287, we stock the largest supply of specialized software available anywhere. For information call us at

**617-746-7341**

## FASTBREAK™

MicroWay's software turns on your 8087 during 1-2-3™ execution. Recalculations run up to 36 times faster. When used with the NUMBER SMASHER™ it can provide a total increase in 1-2-3™ execution speed of up to 79 to 1. FASTBREAK provides you with the unique capability for running other programs on top of 1-2-3. These programs can be written in BASIC, PASCAL, Fortran or C and can access the current values in your 1-2-3 worksheet. .... \$149.

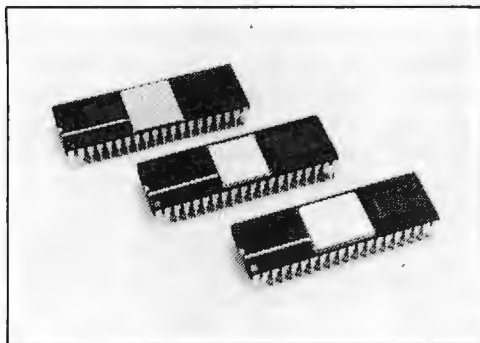

# MicroWay® 8087 Support

For the IBM PC, PC XT, PC AT and Compatibles.

**NUMBER SMASHER™** The World's Fastest Accelerator Card for the IBM PC, XT, and Compatibles! Includes an 8086 and 8087 pair tested to 10mhz, and 512K bytes of high speed ram. Compatible with all software, operating systems and hardware! Your program speed is increased by a factor of 2.5 to 4.0. Floating point programs run up to 2.8 times faster on the PC than on an 80287 equipped PC AT ..... \$1590

**MATRIXPAK™** manages a MEGABYTE! Written in assembly language, our runtime package accurately manipulates large matrices at very fast speeds. Includes matrix inversion and the solution of simultaneous linear equations. Callable from MS Fortran 3.3, 87MACRO, and 87BASIC/INLINE ..... each \$150

**87FFT™** Written in assembly language, performs Forward and Inverse FFTs on real and complex arrays which occupy up to 512K bytes of RAM. Also does convolutions, auto correlations, hamming, complex vector multiplication, and complex to radial conversions. Callable from MS Fortran, 87MACRO, C, TURBO PASCAL or 87BASIC/INLINE ..... \$200

**87FFT-2™** performs two-dimensional FFTs. Ideal for image processing. Requires 87FFT \$100

### GRAPHICS PACKAGES

Grafmatic for MS Fortran or Pascal ..... \$125  
Plotmatic for Grafmatic ..... \$125  
MultiHalo (one language) ..... \$189

**DFixer™** - Eliminates the AT hard disk problem! A disk which thoroughly checks PC or AT hard disks for bad sectors and updates the MS DOS file allocation table accordingly. .... \$149

**87DEBUG™** - a professional debugger with 8087 support, a sophisticated screen-oriented macro command processor, and trace features which include the ability to skip tracing through branches to calls and software and hardware interrupts. Breakpoints can be set in code or on guarded addresses in RAM ..... \$150

**87BASIC/INLINE™** converts the output of the IBM Basic Compiler into optimized 8087 inline code which executes up to seven times faster than 87BASIC. Supports separately compiled inline subroutines which are located in their own segments and can contain up to 64K bytes of code. This allows programs greater than 128K! Requires the IBM Basic Compiler and Macro Assembler. Includes 87BASIC ..... \$200

**87BASIC™** includes patches to the IBM Basic Compiler and both runtime libraries for USER TRANSPARENT 8087 support. Provides super fast performance for all numeric operations including trigonometrics, transcendental, addition, subtraction, multiplication, and division. .... \$150

**87MACRO™** - our complete 8087 software development package. It contains an object library of numeric functions including transcendental, trigonometrics, hyperbolics, encoding, decoding and conversions which take full advantage of the 8087's capabilities. 87MACRO will save you many years in development time! For the IBM or MS Macro Assembler, Version 1.0, 2.0, or 3.0 ..... \$150

**OBJ-ASM™** - a multipass object module translator and disassembler. Produces assembly language listings which include public symbols, external symbols, and labels commented with cross references. Ideal for understanding and patching object modules and libraries for which source is not available ..... \$200

**RTOS - REAL TIME OPERATING SYSTEM**  
RTOS is a multi-user, multi-tasking real time operating system. It includes a configured version of Intel's iRMX-86, LINK-86, LOC-86, LIB-86, OH-86, and MicroWay's 87DEBUG. Runs on the IBM-PC, XT, PC-AT and COMPAQ. .... \$400

### INTEL COMPILERS<sup>1</sup>

FORTAN-86 ..... \$750  
PASCAL-86 ..... \$750  
PL/M-86 ..... \$500  
ASM-86 ..... \$200

<sup>1</sup>Requires RTOS or iRMX-86. All Intel compiler names and iRMX-86 TM Intel Corp.

**8087 5mhz..... \$109**  
Including DIAGNOSTICS and one-year warranty For IBM PC and compatibles.

**8087-3 5mhz..... \$175**  
For the Tandy 1200.

**8087-2 8mhz..... \$175**  
For Wang, AT&T, DeskPro, NEC, Leading Edge.

**80287-3 5mhz..... \$199**  
For the IBM PC AT and Compaq DeskPro 286.

**287Turbo™ 6 mhz.... \$375**

**64K RAM Set..... \$7**

**256K RAM Set..... \$49**

**256K CMOS RAM Set... \$49**

**128K RAM Set PC AT... \$150**

**AST Advantage™..... \$439**

**JRAM-2™ (ØK)..... \$169**

**JRAM™ AT (ØK)..... \$229**

**MAYNSTREAM™ 60 meg..... \$1695**

### FORTAN, C and BASIC

Microsoft Fortran Version 3.3 ..... \$229  
IBM Professional Fortran ..... \$45  
Ryan-McFarland Fortran ..... \$399  
FORLIB+ or STRINGS and THINGS. .... \$65  
Lattice C ..... \$299  
Microsoft C Version 3.0 ..... \$299  
C86 ..... \$279  
FLOAT87 ..... \$150  
IBM Basic Compiler Version 2.0 ..... CALL  
87BASIC/INLINE ..... \$200  
Summit BetterBASIC™ ..... \$175  
Summit 8087 Module ..... \$87  
True Basic ..... \$105

### MACRO ASSEMBLERS

IBM Assembler with Librarian V. 2.0 ..... \$155

Microsoft Assembler Version 3.0 ..... \$125

### PASCAL and APL

Microsoft Pascal Version 3.3 ..... \$199  
Borland Turbo with 8087 Support ..... \$85

STSC APL★PLUS/PC ..... \$450

Pocket APL ..... \$85

COSMOS Revelation ..... \$750

SPSS/PC ..... \$595

FASTBREAK and NUMBER SMASHER are trademarks of MicroWay, Inc. Lotus and 1-2-3 are trademarks of Lotus Development Corp.

**MicroWay**

P.O. Box 79  
Kingston, Mass.  
02364 USA  
(617) 746-7341

**The World Leader  
in 8087 Support!**

I would like to dismiss this information as another crazy rumor, but I can't. First, my original source is someone who should know and claims to get this straight from Apple. Second, I have since heard the same news from two or three independent sources. Third, it fits in too well with other events at Apple, such as Steve Jobs forcing Frog Designs (the firm that did the IIc design) to stop all work on Steve Wozniak's new product, even though that product does not appear to be in any way competitive with Apple.

Apple shot itself in the foot last fall with the overpriced 512K-byte upgrade and has let the wound fester by keeping the price too high. This policy punished those who did the most to help the Mac succeed: Those who bought the Mac in its first few months, paying too much money for a machine with too little memory and almost no software. If Apple carries through on this latest plan, it will be hurting those same people again. What an irony! Apple (especially Steve Jobs) takes pains to paint itself as the "people's alternative" to IBM; yet IBM has shown more consideration for PCjr owners than Apple has for Mac owners.

All these problems and incidents make it appear as though Apple is in danger of self-destructing. I truly don't want that to happen; I prefer more competition in the field, not less. Besides that, I have a sentimental attachment to the company. The first computer I ever owned (though just for a few months) was an Apple II; the second was a Macintosh; and I bought a IIe late last year. So it saddens me to see the direction the company is going. Apple may have shot itself in the foot last year, but it now appears determined to shoot itself in the head.

#### AMIGA

Among its other faults, Apple has been shamelessly neglecting the Apple II family, and specifically the Apple IIe. When the IIc came out a year ago, Apple cut the price of the IIe and slowed production, figuring the machine would die of its own accord. Instead, IIe sales jumped dramatically, easily outselling the IIc. People would

see the IIc ads, come into the computer store, and walk out with a IIe. Why? Because the IIe had slots, while the IIc (like the Mac) was a closed machine. The IIe is a chameleon: With the right set of boards, you can make it look like and do just about anything. Case in point: The nicest development system I've ever used, including mainframes and minis, was an Apple IIe with 128K bytes of RAM, an Accelerator IIe card (3.5-megahertz 65C02), and two Axlon 320K-byte RAM disks (configured as four 160K-byte floppy disks). Apple's response to the increased IIe sales was to cut back on production and raise its price (while discounting the IIc). Even so, it wasn't until late 1984 that the IIc finally started outselling the IIe.

What does this have to do with the Amiga? Well, several machines are competing in the low-end market: the Atari 520ST, the Apple IIc, the Mac (to a lesser extent), and the Amiga. Guess

how many of these are easily expandable? Just one: the Amiga. Guess which machine will probably end up being the Apple II of the late eighties? I don't think the IIc will, nor the Mac, and the ST is a tightly closed, nonexpandable box. My vote is for the Amiga. From what I can see, the Amiga's graphics, sound, 68000 processor, memory map (allowing up to 8 megabytes of RAM), and expansion bus give it the potential of a long and successful life. There's always the chance that Apple will, indeed, come out with a souped-up Apple II next year, but even with the Western Design Center chips (65816, etc.) and the nifty 3½-inch Duodisk (1.6 megabytes of storage), it will probably be too little, too late.

#### UPDATES

I talked last month about TeamMate, the repackaged version of Jack2—a

(continued)

# SMARTER

USRobotics' new high-speed Courier 2400™ modem responds to the industry standard AT command set—so it works with any of today's popular telecom software, including our own Telpac™. Courier reports the length of each call, lets you automatically repeat a command, and provides an on-screen summary of its settings. Courier even adjusts to phone line conditions to assure nearly perfect performance on every call. This smarter modem is clearly a wise choice.



courier  
2400

HS AA CD QM RD SD TR MR AL

courier 2400  
**USRobotics™**

8100 McCormick Blvd., Skokie, IL 60076  
Phone: (312) 733-0497  
Outside Illinois: 1-800-Dial-USR



# YOU'LL FIND A LOT MORE THAN PROMISES BEHIND THE TDK NO-RISK™ DISK.



Think for a moment about all the floppy disk advertising that's trying to program your buying habits. You hear one promise after another. Well, at TDK, we also make a lot of promises. But we back them with far more than transparent conversation.

Take for instance our proud position as the world's largest manufacturer of magnetic media. Over the past fifty years, our technological superiority and innovativeness have spawned what is today's state-of-the-art audio and video recording tape.

And, as you can imagine, everything we've learned over the years about oxide formulations, film bases... etc., has been invaluable in helping us perfect our disk technology. In fact, all our disks are made with such a wealth of expertise that they meet or exceed the most rigid industry standards.

Whether you choose our 8-inch, 5.25-inch High Density, 5.25-inch standard or 3.5-inch floppy disks, you'll be assured of absolutely flawless performance no matter how often they're used. We also offer a lifetime replacement warranty—an added assurance you'll probably never need.

So, if you're looking for a disk that offers the utmost in reliability, make yourself a promise. Don't risk your valuable information with anything less than the TDK No-Risk Disk.

© 1985 TDK Electronics Corp.

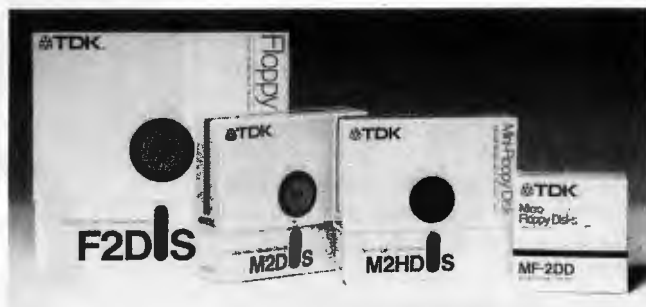

# THE NO-RISK™ DISK. TDK®

## ITEMS DISCUSSED

**AMIGA** ..... \$1295  
Commodore/Amiga  
983 University Ave.  
Los Gatos, CA 95030  
(408) 395-6616

**ATARI 520ST** ..... \$799  
Atari Inc.  
1265 Borregas Ave.  
POB 3427  
Sunnyvale, CA 94088  
(408) 748-2000

**AT&T UNIX PC**  
10-megabyte hard disk ..... \$5590  
20-megabyte hard disk ..... \$6590  
American Telephone and Telegraph  
1 Speedwell Ave.  
Morristown, NJ 07960  
(201) 898-2000

**DASCH MAC RAM DISK**  
500K bytes ..... \$495  
1 megabyte ..... \$975  
2 megabytes ..... \$1785  
Western Automation Laboratories  
POB 3438  
Boulder, CO 80307  
(303) 449-6400

**ERICSSON ERGO-SCREEN**  
**PORTABLE** ..... \$2995  
Ericsson  
Greenwich Office Park 1  
Greenwich, CT 06836  
(800) 367-3746

**MONSTER MAC UPGRADE**  
without RAM ..... \$499.95  
with 1 megabyte ..... \$624.95  
with 1.5 megabytes ..... \$749.95  
with 2 megabytes ..... \$874.95  
installation charge ..... \$100  
Levco Enterprises  
6160 Lusk Blvd., #C-203  
San Diego, CA 92121  
(619) 457-2011

**TEAMMATE** ..... \$69.95  
SofTech Microsystems  
16875 West Bernardo Dr.  
San Diego, CA 92127  
(617) 451-1230

\$500 product—released by SofTech Microsystems at \$69.95 for the IBM PC. Since then, I've had a chance to play with it. It has an easy-to-use, easy-to-grasp user interface and appears to be a truly integrated package, i.e., not just a few programs strung together by data-transfer modules. Unfortunately, I've never used Framework, Symphony, Jazz, Ovation (sorry, bad joke), or even (gasp!) Lotus 1-2-3, so I don't have much basis for comparison. On the other hand, at this low of a price you can hardly lose. I think it would be great for small businesses (or small departments in large businesses) that need a package to do invoices, financial reports, letters, and the like. All in all, it looks like a real bargain.

### IN THE QUEUE

As I said at the start, I've been receiving a steady stream of hardware and software from the San Francisco office.

A number of C compilers, for both the Mac and the IBM PC, have shown up, and my education in C is lurching forward. The GEM Programmer's Toolkit has come from Digital Research; maybe now my attendance at the GEM seminar will pay off. Sunol Systems has sent a disk-server network, with interfaces for the Compaq, Apple II, and Macintosh, but I haven't got it up and running yet. Two new languages for the Mac have arrived: ExperLisp, a compiling LISP from Expertelligence, and Rascal (real-time Pascal), an I/O-oriented language developed at Reed College. Several information-management packages for the Mac are showing up as well, including Filevision and TimeBase. And Brenda just informed me yesterday that more boxes are on the way. Getting through all this may kill me, but, hey, I knew the job was dangerous when I took it. Take care, and I'll see you on the bit stream. ■

# FRIENDLIER

USRobotics' new super-speed Courier 2400™ modem is designed to make things simple for you. The entire AT command set and S-register functions are displayed on "help screens" and summarized for you on the underside of the unit. Courier shows you the length of each call, and the status of a call in progress. And perhaps the friendliest thing of all is the \$699 price tag. How friendly can you get!

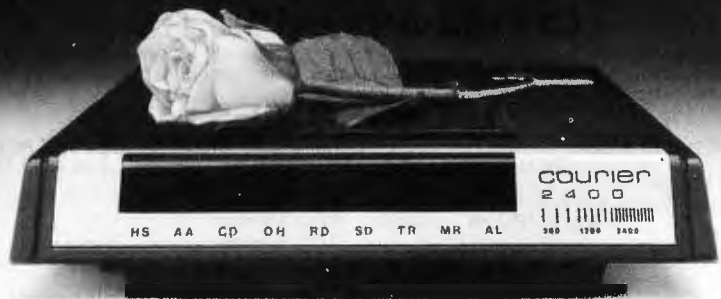

**courier 2400**  
**USRobotics™**

8100 McCormick Blvd., Skokie, IL 60076  
Phone: (312) 733-0497  
Outside Illinois: 1-800-Dial-USR



You would think when IBM needs EPROM Programmiers they would choose the best and the most expensive. They don't. They only choose the best. GTEK.



MODEL 7956 (w/RS-232 option) ..... \$1099  
 MODEL 7956 (stand alone) ..... \$ 979

GTEK's outstanding **Gang Programmer** with intelligent algorithm can copy 8 EPROMS at a time! Use the 7956 in a production environment when you need to program a large number of chips. Programs all popular chips through the 27512 EPROMS; supports CMOS EPROMS through the 27C256; supports EEPROMS through the X2864A; supports Intel's 2764A & 27128A chips. The 7956 will also program single chip processors.



MODEL 7324 ..... \$1499

The 7324 has a **built-in compiler**. It programs all MMI, National and TI 20 & 24 pin PALS. It has **non-volatile memory** and operates stand-alone or via RS-232.

MODEL 7322 ..... \$1249  
 Same as Model 7324 but operates only via RS-232.

MODEL 7316 ..... \$ 749  
 This PAL PROGRAMMER programs Series 20 PALS. It has a built-in PALASM compiler.

MODEL 7283 ..... \$1199  
 This BI-POLAR PROM PROGRAMMER programs all popular BI-POLAR PROMS. It operates stand-alone (for production) or RS-232 (for development).

MODEL 705 ..... \$ 299  
 68705V3, R3, P3 PROGRAMMER.

### EPROM, PROM & PAL PROGRAMMERS

— These features are standard from GTEK —

Compatible with all RS-232 serial interface ports • Auto select baud rate • With or without hand-shaking • Bidirectional Xon/Xoff • CTS/DTR supported • Read pin compatible ROMS • No personality modules • Intel, Motorola, MCS86 Hex formats • Split facility for 16 bit data paths • Read program, formatted list commands • Interrupt driven—program and verify real time while sending data • Program single byte block or whole EPROM • Intelligent diagnostics discern bad and/or unerased EPROM • Verify erasure and compare commands • Busy light • Complete with Textool zero insertion force socket and integral 120 VAC power (240 VAC/50Hz available) •

### UTILITY PACKAGES

GTEK's **PGX Utility Packages** will allow you to specify a range of addresses to send to the programmer, verify erasure and/or set the EPROM type. The PGX Utility Package includes GHGX, a utility used to generate an Intel HEX file.

PALX Utility Package—for use with GTEK's **Pal Programmiers**—allows transfer of PALASM\* source file or ASCII HEX object code file.

Both utility packages are available for CPM, MS-DOS, PC-DOS, ISIS\* and TRSDOS\* operating systems. Call for pricing.

### CROSS ASSEMBLERS

These assemblers are available to handle the 8748, 8751, Z8, 6502, 68X and other microprocessors. They are available for CPM and MS-DOS computers. When ordering, please specify processor and computer types.

### ACCESSORIES

Model 7128-L1,L2, L2A .....  
 (OEM Quantity) \$259.  
 Model 7128-24 ..... \$329.  
 Cross Assemblers CPM-80 ..... \$200.  
 MSDOS; CPM 86 ..... \$250.

Erasers ..... DE4 \$80; PE14T \$129  
 C25 \$349; C50 \$599  
 U/V Eraser DE-4 ..... \$ 80.  
 RS-232 Cables ..... \$ 30.  
 8751 Adapter ..... \$174.  
 8755 Adapter ..... \$135.  
 48 Family Adapter ..... \$ 98.

PGX Utilities ..... Call for pricing  
 PALX ..... Call for pricing



Development Hardware/Software  
 P.O. Box 289, Waveland, MS 39576  
 601/467-8048; telex 315-814 (GTEK UD)  
 , INC.

GTEK, PALASM, CPM, MS-DOS, PC-DOS, ISIS, TRSDOS, & CPEmulator are registered trademarks.

"All you CPM people who wanted to move to IBM, but couldn't... now you can — and bring your CPM software with you!"

From GTEK, the leader in development hardware and software, comes the CPM user's dream.

The majority of advances being made in the computer industry today are being made for PC-DOS and MS-DOS machines.

If you are a CPM user who wanted to convert to these operating systems but didn't because you had to abandon or rewrite your CPM programs, now you can make your move without losing or rewriting a single program!

The dream from GTEK is a package that makes your PC-DOS (IBM PC, XT, AT) or MS-DOS (IBM clones like COMPAQ, Leading Edge, Televideo) machines think they're being run by an 8080 or Z80 microprocessor with CPM!

The GTEK package contains a CPEmulator™ and CPM Conversion Utility that allows you to read and write popular CPM disk formats such as Kaypro and Osborne.

If you've been using CPM on any of these machines you can now move to PC-DOS or MS-DOS operating systems.

Kaypro • Osborne • Heath/Zenith • Radio Shack • Epson • DEC • IBM • Morrow • Xerox • HP • Sanyo • Intertec • Cromenco • Televideo • Compupro.

How easy is it to use? Two steps. (1) Use the Conversion Utility to copy the CPM program to an MS-DOS or PC-DOS diskette. (2) Use the Bind Utility to attach the CPEmulator to your program. And that's it. It's ready to run.

You won't see any difference when you run the CPM program! Now all the work you did in CPM is still valuable when you change to your PC-DOS or MS-DOS machine.

And here's the happy ending to the dream. The CPEmulator is just \$199.

Call GTEK's CPM Hotline...  
 1-601-467-9019

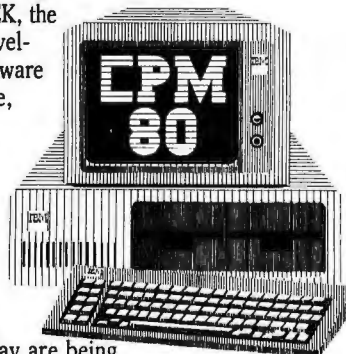



# M·A·T·H·E·M·A·T·I·C·A·L R·E·C·R·E·A·T·I·O·N·S

## $\pi$ , $e$ , and All That

### Sneaking up on transcendental numbers

BY ROBERT T. KUROSAKA

*God made integers, all else is the work of man.*  
—Kronecker

**T**his famous quote of Leopold Kronecker serves as the starting point for this month's column. The integers (the whole numbers) can be used to construct other numbers.

We can construct rational numbers by dividing one integer by another. When we do so, we get either a terminating decimal ( $1/4=0.25$ ) or a nonterminating, repeating decimal ( $7/18=0.388888 \dots$ ). Repeating, or cyclic, decimals are a fascinating study I may explore in a future column.

#### IRRATIONAL NUMBERS

We can also construct numbers that are both nonterminating and nonrepeating. It is a rather amazing notion that a string of digits may go on forever without having to establish a pattern. It's such an odd notion that the ancient Greeks originally did not believe it possible—or even imaginable. When it was established that the square root of 2 was such a number, the Greeks called this kind of number irrational. The root meaning of irrational is "without ratio," or unable to be expressed as a fraction. The Greeks found such numbers irrational not only in the sense of "non-ratio-able" but also in the sense of "nonsensical."

The differences between rational and irrational numbers are substantial. It can be shown that no more rational numbers exist than do whole numbers, but irrational numbers outnumber rational numbers. This fact, which is often presented as a paradox, is not especially surprising when you look at how we have constructed rational numbers. They are built up out of whole numbers and can be expressed as integer fractions. As I said above, irrational numbers cannot be so expressed.

#### TWO TYPES

There are two different kinds of irrational numbers. The first, like the square root of

2, is called an algebraic irrational number. In algebra, we are restricted to some basic operations: addition, subtraction, multiplication, division, raising to a power, and taking roots. An algebraic number is one that can be obtained by a finite number of algebraic operations.

An alternate definition states that an algebraic number is one that is a solution of a polynomial equation. By definition, a polynomial is an expression that has rational coefficients and integer exponents. For example, the square root of 2 is one of the solutions of  $x^2-2=0$ . Similarly,  $2+\sqrt{5}$  is a solution of the equation  $x^3-5x^2+3x+1=0$ . There are many algebraic numbers.

However, there exists a second class of irrational numbers that are not algebraic. They are not solutions of any polynomial equation, nor can they be calculated by a finite number of algebraic operations. These numbers, higher in the constructivist hierarchy of real numbers, are called transcendental numbers. Not only are you unable to write down the decimal value of a transcendental number, you are unable to explicitly write down how to calculate it. Oddly, some of these numbers are familiar to us. Among them can be found  $e$ , the base of natural logarithms, and  $\pi$ , or pi.

In this column, I'll look at some surprisingly ordinary hiding places for these extraordinary numbers. I'll also take a look at some ways of approximating the values of them. A well-known, but still amazing, equivalence is worth a quick mention. I have mentioned  $e$  and  $\pi$ . There is yet another number that is not irrational but imaginary (it's hard to keep your prejudices out of numbers). That number is, of course,  $i$ , the square root of  $-1$ , which stands at the door to complex numbers. Between  $\pi$ ,  $e$ , and  $i$ , we seem to have the numerical equivalent of a circus freak show. But put them all together in the form of  $e^{i\pi}$ , and you end up with the ordinary number  $-1$ !

Perhaps the most extraordinary aspect of

*(continued)*

Robert T. Kurosaka teaches mathematics in the Massachusetts State College system. He invites your correspondence to BYTE, POB 372, Hancock, NH 03449.



transcendental numbers is that, although there are infinitely many of them, only  $\pi$  and e are immediately recognized by most educated people as transcendental. What makes these two the celebrities of the transcendental set? We'll try to get a sense of that as we proceed.

**PI AND COFFEE**

Enough. On to the business at hand. The transcendental number  $\pi$  is equal to 3.1415926535... This value can be easily memorized by learning this exchange: "May I have a large container of coffee?" "Cream and sugar?" Count the number of letters in each word and get the sequence: 3, 1, 4, 1, 5, 9, 2, 6, 5, 3, 5.

Pi occurs in circles and circular figures—ellipses, cycloids, and so on—but it also turns up in highly improbable situations. For example, if we calculate the area between the curve  $y = 1/\sqrt{1-x^2}$  and the x-axis for  $x = -1$  to 1 (see figure 1), we find two surprises. First, the area is finite; second, the area is  $\pi$  square units.

If we consider the curve  $y = 1/x$  from  $x = 1$  to  $\infty$  (see figure 2a), we are not surprised to find that its length is infinite, nor that the area between the curve and the x-axis is infinite. If we revolve the curve about the x-axis, forming a long funnel (see figure 2b), its surface area is also infinite (ho hum!). However, we get a pi in the face

when we calculate the *volume* of this funnel: It is exactly  $\pi$  cubic units. The paradox is truly mind-boggling. We cannot paint the inner surface of the funnel—there isn't enough paint in the universe—but we can fill it!

**BUFFON'S PROBLEM**

In 1760, Comte Georges-Louis Leclerc de Buffon devised an empirical method for determining the value of  $\pi$ . Parallel lines, spaced equally at a distance  $d$ , are drawn on a sheet of paper. A needle of length  $l$ , where  $l$  is less than  $d$ , is tossed onto the paper. Now consider the probability of the needle crossing one of the parallel lines. The "Buffon needle theorem" assures us that this probability is  $2l/\pi d$ .

We can recreate this classic experiment by computer simulation. Using a needle exactly half the length of the distance between the lines ( $l = d/2$ ), the ratio of tosses to crosses should approach  $\pi$ .

I had hoped to tell you about an Italian mathematician, Lazzerini, who performed this experiment in 1901. I was disappointed to find that three books that discuss him give contradictory information and inaccurate arithmetic. One book gives 3400 tosses and 1082 crosses and notes that 3400/1082 differs from  $\pi$  by less than one-tenth of one percent. So far, so good. Another source gives 3407

tosses but not the number of crosses, yet it claims 3.1415929 as the ratio. (Can you find the number of crosses?) The third book gives 3408 tosses and 2169 crosses, using a needle equal in length to the distance between the lines. That author attains a certain measure of immortality by actually publishing the "fact" that  $(2 \times 3408 / 2169) = 3.1415929$ . Two of the authors hint broadly that Lazzerini's results have been looked upon with suspicion all these years—and small wonder!

You may already know that 355/113, or 3.1415929..., has been noted as the "best" rational approximation of  $\pi$  because it provides eight-digit accuracy using only three-digit numbers. The fraction is easily memorized once you note the pattern 113355. Its discovery is credited to a Chinese mathematician, Tsu Ch'ung-chih, about the year 480.

Back to Buffon. In figure 3, the lines are  $d$  units apart. The needle has length  $d/2$ ; the half-needle,  $d/4$ . When tossed at random, the needle will land with its midpoint a random distance  $x$  from the left-hand line and will make a random angle  $a$  with the horizontal. We want to know whether the left half of the needle crosses line 1 or the right half crosses line 2. We may therefore limit our attention to one-half of the needle,  $d/4$ , and ask whether the

*(continued)*

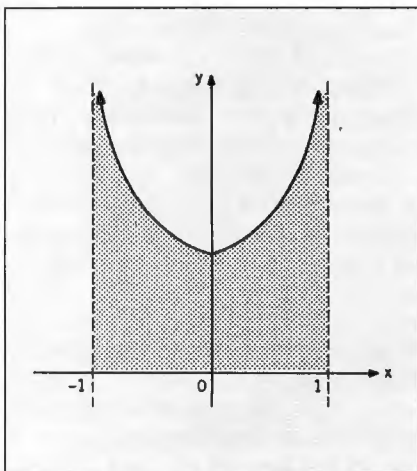

Figure 1: Area under  $y = \frac{1}{\sqrt{1-x^2}}$ .

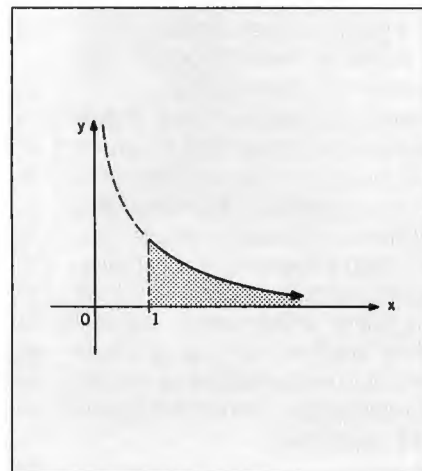

Figure 2a: Graph of  $y = \frac{1}{x}$  on  $[1, \infty)$ .

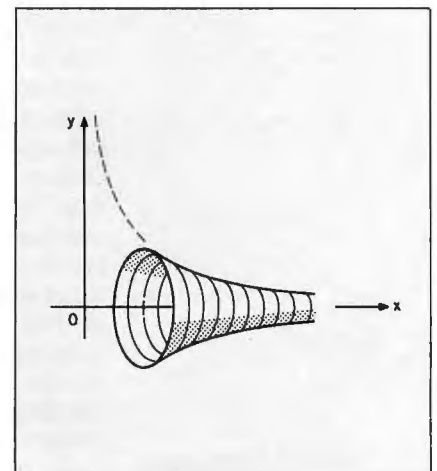

Figure 2b: The funnel formed by revolving 2a around the x-axis.

# BUY A 1200 BPS MODEM FOR UNDER \$200!

*Special Offer*

**INFOMATE 212PC \$149**

**FEATURES:**

- 1200/300/110 bps, full duplex
- Internal card for IBM PC/XT or compatibles
- Bell 212A and 103 compatible
- CROSSTALK software compatible
- MODEM-MATE software included
- Auto-dial, Auto-answer
- Tone or rotary dialing, auto-selected
- Call progress monitoring
- 8 diagnostic test modes
- Asynchronous data format
- 1 year limited warranty

The INFOMATE 212PC comes complete with MODEM-MATE software and will run other popular programs such as CROSSTALK and PC TALK III. The 212PC plugs into any of the computer's full size expansion slots and communicates with all commonly used 1200 or 300 bps modems.

Yes, it's true! Cermetek is selling your choice of two 1200 bps modems for under \$200. There's no catch! We want you to take advantage of this spectacular deal and find out what communications can do for your computer. It's as simple as that.

**CROSSTALK SOFTWARE ONLY \$95!**

Now you can purchase CROSSTALK software, with your INFOMATE modem, for \$100 under the retail value. This version of CROSSTALK will run on IBM PC's or compatibles with 96K of memory, 1 disk drive, and PC DOS 1.1 or 2.X. You may only purchase CROSSTALK software with one of the INFOMATE modems and this offer is limited to one software package per modem.

**ORDER TODAY!**

Offer expires 10/31/85. Offer is limited to quantities on hand.

**INFOMATE MODEMS**

by Cermetek Microelectronics  
1308 Borregas Avenue  
Sunnyvale, CA 94088-3565  
(800) 862-6271 (In California call 408/752-5000)

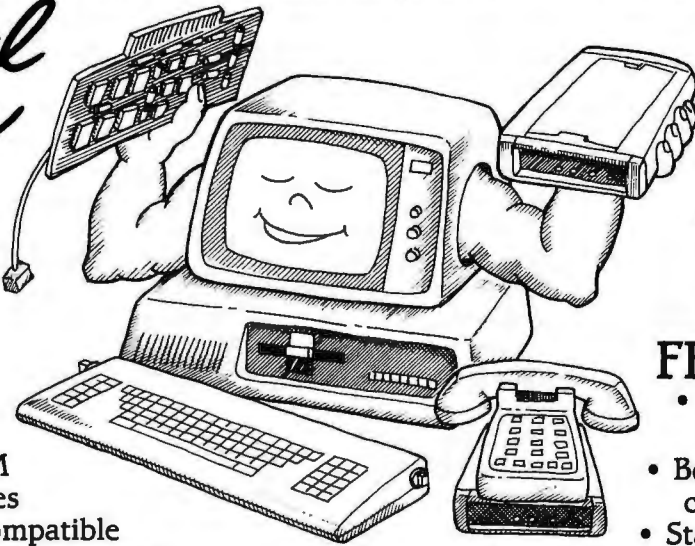

**INFOMATE 199SA \$199**

**FEATURES:**

- 1200/300/110 bps, full duplex
- Bell 212A and 103 compatible
- Stand alone modem

for use with any computer or terminal with and RS-232C port

- CROSSTALK software compatible
- Auto-dial, Auto-answer
- Auto-speed, Auto-parity selection
- Tone or rotary dialing
- Asynchronous or synchronous operation
- 1 year limited warranty

The INFOMATE 199SA is an intelligent stand alone modem, compatible with CROSSTALK software, and allows you to communicate with all commonly used 1200 or 300 bps modems.

This is a deal I can't pass up! I would like to order:

- The INFOMATE 212PC for \$149.00
- The INFOMATE 199SA for \$199.00
- CROSSTALK software for IBM PCs for \$95.00

Please send the above checked items to:

Name \_\_\_\_\_  
 Address \_\_\_\_\_  
 City \_\_\_\_\_ State \_\_\_\_\_ Zip \_\_\_\_\_  
 Daytime phone (\_\_\_\_) \_\_\_\_\_  
 My check is enclosed for \$ \_\_\_\_\_  
 Please charge my purchase on my:  
 VISA  MASTERCARD  
 Acct. No. \_\_\_\_\_  
 Signature \_\_\_\_\_  
 Exp. date \_\_\_\_\_

Calif. residents add 6½% sales tax. All orders must add \$4.00 per modem for shipping and handling. Please allow 4 weeks for delivery.



In Buffon's needle experiment, the transcendental number  $\pi$  emerges from operations involving only integers (tosses and crosses) and straight lines.

projection of  $d/4$  onto the  $x$ -axis is greater than or equal to  $x$  (in which case the left half of the needle intersects line 1) or is greater than or equal to  $d-x$  (in which case the right half of the needle intersects line 2). Listing 1 presents a program that performs the simulation for us. [Editor's note: The listings in this article are available for downloading via BYTEnet Listings. The telephone number is (617) 861-9774.]

I find something less than satisfying about this program. In Buffon's exper-

iment,  $\pi$  emerges from operations involving only integers (needle tosses and crosses) and straight lines. The pleasure we take in it is akin to that we get when a magician pulls a rabbit out of a hat. In our simulation program, however, we use the number 1.57079633 in generating our angle measurement. As you may have noticed, this is nothing other than  $\pi/2$  to nine-digit accuracy. In our program, we see the magician put the rabbit into the hat before the show begins.

GETTING TO FIRST BASE

Perhaps we can do better with e, the base of natural logarithms, which is equal to 2.718281828459045 . . . . This value can also be memorized. After mastering the initial 2.7, recite "Jackson, Jackson wore a pair of 45s until he was 90." Andrew Jackson was elected president of the United States in 1828; hence, two 1828s. Since he "wore a pair of 45s," the question arises, "Shouldn't the next digits be 454590?" The reply is, "He wouldn't wear both guns on one hip, would he?" This silly story was given to me by my good friend and colleague John C. Jacobs. As all good mnemonics do,

its sheer absurdity hard-wired the information into my brain.

CHECK YOUR EULER

The number e turns up unexpectedly in a classic problem called The Careless Hatcheck Girl. This absentminded woman checked  $n$  hats for  $n$  men during a banquet. At the end of the evening, she returned the hats randomly to the men. What is the probability that no man received his own hat?

This seems to be a problem in elementary probability. The hats can be distributed in  $n!$  ( $n$  factorial) ways. We must find the number of ways that  $n$  hats can be arranged so that no hat is given to its owner (the number of complete permutations). This is not an elementary task.

The derivation of the complete permutation formula is complicated and uses some rare and exciting techniques. I will make it available to interested readers on request. The formula is given here without proof. The probability of a complete permutation of  $n$  objects is

$1/2! - 1/3! + 1/4! - 1/5! + \dots + (-1)^n n/n!$

(continued)

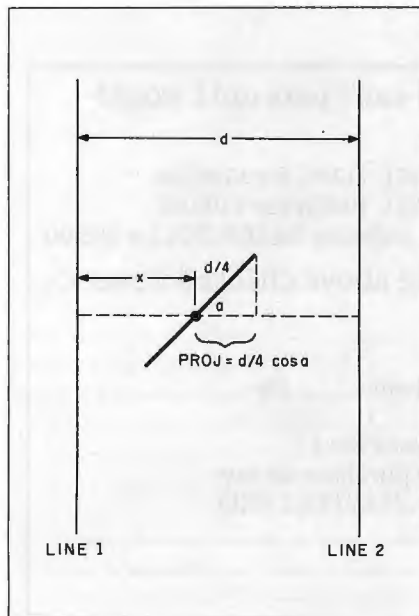

Figure 3: The geometry of the Buffon needle experiment.

Listing 1: The Buffon needle experiment in BASIC.

```
10 .....
20 '*          BUFFON'S NEEDLE EXPERIMENT          *
30 '*          BY BOB KUROSACA                      *
40 .....
50 CLS
60 PRINT "THIS PROGRAM APPROXIMATES THE NUMBER PI"
70 PRINT "BY SIMULATING BUFFON'S NEEDLE-DROPPING EXPERIMENT."
80 PRINT :PRINT
90 REM USE THE COMPUTER CLOCK TO SEED THE RANDOM-NUMBER
  GENERATOR.
100 SEED = VAL (RIGHT$(TIME$,2))
110 RANDOMIZE(SEED)
120 INPUT "NUMBER OF TRIALS";TRIALS
130 FOR I = 1 TO TRIALS
140   ANGLE = 1.57079633#*RND(1)
150   X = RND(1)
160   PROJ = .25*COS(ANGLE)
170   IF PROJ >= X OR PROJ >= 1 - X THEN CROSSES = CROSSES + 1
180 NEXT I
190 PRINT "NUMBER OF CROSSES:";CROSSES
200 PRINT "THE CALCULATED APPROXIMATION OF PI FROM THIS
  IS:";TRIALS/CROSSES
210 END
```

# PERFORMANCE PACKAGE

Blaise Computing Inc. introduces the PERFORMANCE PACKAGE™ for Turbo Pascal programmers.

# TURBO PASCAL

**Turbo ASYNCH™** With Turbo ASYNCH, you can be in constant touch with the world without ever leaving the console. Rapid transit at its best. Turbo ASYNCH is designed to let you incorporate asynchronous communication capabilities into your Turbo Pascal application programs, and it will drive any asynchronous device via the RS232 ports, like printers, plotters, modems or even other computers. Turbo ASYNCH is fast, accurate and lives up to its specs. Features include...

- ◆ Initialization of the COM ports allowing you to set all transmission options.
- ◆ Interrupt processing.
- ◆ Data transfer between circular queues and communications ports.
- ◆ Simultaneous buffered input and output to both COM ports.
- ◆ Transmission speeds up to 9600 Baud.
- ◆ Input and output queues as large as you wish.
- ◆ XON/XOFF protocol.

The underlying functions of Turbo ASYNCH are carefully crafted in assembler for efficiency, and drive the UART and programmable interrupt controller chips directly. These functions, installed as a runtime resident system, require just 3.2K bytes. The interface to the assembler routines is written in Turbo Pascal.

The Turbo Pascal PERFORMANCE PACKAGE™ is for the serious Turbo Pascal programmer who wants quality tools to develop applications. Every system comes with a comprehensive User Reference Manual, all source code and useful sample programs. They require an IBM PC or compatible, utilizing MS-DOS version 2.0 or later. There are no royalties for incorporating PERFORMANCE PACKAGE functions into your applications.

Turbo POWER TOOLS and Turbo ASYNCH sell for \$99.95 each, and they may be ordered directly from Blaise Computing, Inc. TO ORDER, call (415) 540-5441

**BLAISE COMPUTING INC.**

## NEW!

### Turbo POWER TOOLS™

Turbo POWER TOOLS is a sleek new series of procedures designed specifically to complement Turbo Pascal on IBM and compatible computers. Every component in Turbo POWER TOOLS is precision engineered to give you fluid and responsive handling, with all the options you need packed into its clean lines. High performance and full instrumentation, including...

- ◆ Extensive string handling to complement the powerful Turbo Pascal functions.
- ◆ Screen support and window management, giving you fast direct access to the screen without using BIOS calls.
- ◆ Access to BIOS and DOS services, including DOS 3.0 and the IBM AT.
- ◆ Full program control by allowing you to execute any other program from within your Turbo Pascal application.
- ◆ Interrupt service routines written entirely in Turbo Pascal. Assembly code is not required even to service hardware interrupts like the keyboard or clock.

Using Turbo POWER TOOLS, you can now "filter" the keyboard or even DOS, and create your own "sidekickable" applications.

YES, send me the Best for the Best! Enclosed is \_\_\_\_\_ for  
 Turbo ASYNCH     Turbo POWER TOOLS. (CA residents add 6½% Sales Tax. All orders add \$6.00 for shipping.)

Name: \_\_\_\_\_ Phone: \_\_\_\_\_  
 Shipping Address: \_\_\_\_\_ State: \_\_\_\_\_ Zip: \_\_\_\_\_  
 City: \_\_\_\_\_ Exp. Date: \_\_\_\_\_  
 VISA or MC #: \_\_\_\_\_

Turbo Pascal is a trademark of Borland International. Turbo POWER TOOLS, Turbo ASYNCH and PERFORMANCE PACKAGE are trademarks of Blaise Computing, Inc. IBM is a registered trademark of International Business Machines Corporation. MS-DOS is a trademark of Microsoft Corporation.

# BLAISE

*watch us!*

• 2034 BLAKE STREET  
 • BERKELEY, CA 94704  
 • (415) 540-5441



Many of you may recognize the pattern and rhythm of this formula—it is the first  $n$  terms of the Maclaurin series for  $e^x$ , where  $x=-1$ . That is, as the number of hats increases, the probability of a complete permutation approaches  $1/e$ .

In our program (see listing 2), we will simulate the permutations of  $n$  hats. For  $n=12$ , there are 176,214,841 complete permutations out of a possible 12!, or 479,001,600 permutations. The probability is 0.3678794413 . . . , and

its reciprocal is 2.7182818274 . . . , accurate to the eighth decimal place. As in Buffon's needle experiment, the program allows us to repeat the experiment any number of times. It will randomly permute the  $n$  hats and count the number of complete permutations that occur. Then it will print the results and the ratio of number of trials to number of complete permutations, which should approximate  $e$ . In this program, we have managed to effect our simulation without sneaking

*The transcendental numbers  $\pi$  and  $e$  seem to be woven into the very fabric of mathematics.*

the answer into the program beforehand.

**WINDING DOWN**

It is both amazing and amusing that  $\pi$ , which is found in that most symmetric figure, the circle, should be a nonterminating, nonrepeating decimal number—a most unattractive number. Yet  $\pi$  is somehow fundamental to mathematics. All angles are measured in radians ( $2\pi$  radians equal 360 degrees); otherwise, awkward adjustment factors must be introduced. The same holds true for  $e$ . As an undergraduate, I wondered what could possibly be "natural" about natural logarithms. Yet calculus demonstrated that  $e$  is the most convenient base of all. The symmetry of  $e$  is perhaps more abstract than that of  $\pi$ . For the curve defined by  $e^x$ , the slope of the tangent at the  $y$ -axis is 45 degrees. But this is also a fundamental kind of symmetry. All other bases would require adjustment factors.

It appears that  $\pi$  and  $e$  are constantly lurking in the shadows, snickering as we trip over them. More seriously, these two powerful numbers seem to be woven into the very fabric of mathematics.

In closing, I want to at least mention my favorite irrational number: the golden mean,  $\phi = (1 + \sqrt{5})/2 = 1.6180339887$  . . . . As you can see, it is an algebraic irrational number, not a transcendental number. But it also turns up in surprising places. One hiding place is the Fibonacci sequence: 1, 1, 2, 3, 5, 8, 13, 21, . . . , a purely additive sequence of integers. I leave you with the challenge of discovering  $\phi$  in that sequence. ■

Listing 2: The BASIC hatcheck girl simulator.

```
10 '*****
20 '*           THE TRANSCENDENTAL HATCHECK GIRL           *
30 '*                   BY BOB KUROSAKA                   *
40 '*****
50 CLS
60 PRINT "THIS PROGRAM APPROXIMATES THE NUMBER 'e' BY A MONTE
CARLO SIMULATION"
70 PRINT "OF A HATCHECK GIRL WHO RANDOMLY RETURNS HATS TO
CUSTOMERS."
80 PRINT :PRINT
90 INPUT "HOW MANY HATS SHOULD I USE";N:HATS
100 DIM HAT (N:HATS)
110 RANDOMIZE (VAL (RIGHT$(TIMES$,2)))
120 INPUT "NUMBER OF SIMULATIONS TO RUN";N:TRIALS
130 CLS
140 '
150 REM RUN THE SIMULATION N:TRIALS TIMES
160 '
170 FOR TRIAL = 1 TO N:TRIALS
180 '
190     REM ASSIGN THE HATS TO THEIR RIGHTFUL OWNERS
200 '
210     FOR OWNER = 1 TO N:HATS
220         HAT(OWNER) = OWNER
230     NEXT OWNER
240     OWNER = 1:FOUL.UP$ = "PERFECT"
250 '
260     REM RANDOMLY RETURN THE HATS. IF NO ONE GOT THE RIGHT
HAT, ADD ONE TO THE COMPLETE PERMUTATION COUNTER
(COMP.PERM).
270 '
280     WHILE OWNER <= N:HATS AND FOUL.UP$ = "PERFECT"
290         RECIPIENT = INT(RND(1)*N:HATS) + 1
300         IF HAT(RECIPIENT) < > 0 THEN HAT(RECIPIENT) = 0 ELSE 290
310         IF RECIPIENT = OWNER THEN FOUL.UP$ = "IMPERFECT"
320         OWNER = OWNER + 1
330     WEND
340     IF FOUL.UP$ = "PERFECT" THEN COMP.PERM = COMP.PERM + 1
350 NEXT TRIAL
360 PRINT "WITH A TOTAL OF";N:HATS;" HATS AND";N:TRIALS;"
SIMULATIONS;"
370 PRINT "THE HATCHECK GIRL GAVE EVERYONE THE WRONG
HAT";COMP.PERM;" TIMES"
380 PRINT "THE APPROXIMATION OF e THIS GIVES IS";N:TRIALS/COMP.PERM
390 END
```

# Store this in your memory: buy two packs of Xerox Floppy Diskettes and get one pack free.

It's true. When you buy two packs of our new 3½" micro diskettes or selected 5¼" diskettes, you'll receive an additional pack absolutely free.\* It's our way of introducing you to our superior new floppies.

Try them out on your IBM-PC, PC-AT, Macintosh, Compaq, AT&T, ITT, Olivetti, HP or on our own PC's and word processors. You'll see how superior they are, both in quality and performance. And they're packed in a durable library case as well.

To get your free diskettes (or for more information) simply call 1-800-822-2200 Dept. 20 and order any of the items specified below:

- 11R66003: 5¼" double-sided/double density diskettes (10 per pack) for your IBM-PC or IBM-compatible PC
- 8R2467: 5¼" high density diskettes (10 per pack) for your IBM-AT
- 8R2466: 3½" single-sided micro diskettes (5 per pack) for your Apple Macintosh



This offer ends December 31, 1985 and is limited to five free packs per customer.

So remember, call 1-800-822-2200 Dept. 20 and order your free diskettes today. That's a pretty memorable offer!

\*Your free pack will be of comparable or lesser value than the two you purchase. XEROX® is a trademark of XEROX CORPORATION.

For more information from Xerox, Circle 396 on the Reader Service card.





Conducted by Steve Ciarcia

## TI-99/4A MEMORY EXPANSION

Dear Steve,

I own a TI-99/4A home computer. I am presently using a cassette for additional storage. I would like to build my own memory-expansion board and/or floppy-controller board because the built-in 16K bytes of the 99/4A is too small for what I want to do.

I read your article "Build the Disk-80: Memory Expansion and Floppy-Disk Control" (March 1981, page 36). It seems the first thing I need to do is define the I/O pins on the edge connector. However, TI's documentation does not describe these pins in any way. I am reluctant to dismantle my computer, which would allow me to trace the 9900's I/O lines to the edge connector, because TI used a somewhat bizarre construction that shields the main PC board.

DAVID GEHLY  
Littleton, MA

*You're right about the bizarre construction of the TI-99/4A.*

*Before attempting any interfacing to the TI-99/4A, you should obtain a copy of the TI-99/4A Console Technical Data Manual. The manual describes the address locations to be used for memory and I/O additions. You can obtain this manual from Texas Instruments Inc., Dealer Parts Department, POB 53, Lubbock, TX 79408.*

*I am not aware of any articles on building a memory expansion or a floppy-disk interface for the TI-99/4A. However, a good source of information on the TI-99/4A is the series of articles being written for Computer Shopper magazine by Randy Holcomb called "Randy's Ravings." These articles cover many of the technical aspects of the TI-99/4A and the peripherals available for the system. You can probably obtain this type of information by writing to Randy Holcomb at Computer Shopper, 407 South Washington Ave., POB F, Titusville, FL 32781.—Steve*

## CALL-STATUS MONITORING

Dear Steve,

I have built a 6809 single-board computer to use as a household controller/

burglar alarm. The program flow follows your outline in "Build a Computer Controlled Security System for Your Home" (January through March 1979) exactly and runs like a charm.

Accessory boards add BSR lighting-system control and inputs for a wireless alarm receiver similar to the one you used in your articles. An SC-01 speech synthesizer will deliver a message upon acknowledgment of an alarm condition to any phone number(s) I choose.

The only problem I'm having is monitoring the status of a phone call from the computer. If the computer calls a number and it's busy, it will go ahead and deliver the message regardless. The same thing will happen if the call wasn't switched properly by the phone company and never gets through.

Your article in a recent BYTE detailed the frequencies of the tones to monitor (dial tone, busy, ringing). I haven't had any luck using NE567 tone decoders, possibly due to the slow response at lower frequencies.

Could you please tell me how to monitor the progress of these status tones? Does anyone make a chip that performs this function?

STEPHEN J. BLAIR  
APO San Francisco

*I am glad to hear that you are getting such good performance from my computer-controlled security system, and I hope the following information will help you in expanding the system.*

*Special chips are available that recognize dial tones, busy signals, ringing tones, and recorder tones (commonly known as call-progress tones). The January BYTE detailed the information that you are looking for in the Circuit Cellar Feedback column.*

*See "Do I Have Circuits?" on page 414 for complete information on the chips you need. Also see "Build the Touch-Tone Interactive Message System" (March, page 98).—Steve*

## SEARCHING FOR BOOKS

Dear Steve,

I want to build my own computer, but I need help in obtaining good books on the subject. You see, English books on

computers are rare here, must be ordered (which takes centuries!), and once ordered must be bought even if the book turns out to be a lemon.

I am interested in what operating systems I can run on a Z80, what software is available, and which controllers (for disk, video, etc.) I can interface to it. I would also appreciate any information on 16-bit computers, since I cannot go into my local bookstore and browse through books of this kind in English.

D. KOOHDOR  
Bern, Switzerland

*The books below should be helpful.*

*Practical Interfacing Techniques for Microprocessor Systems by James W. Coffron and William E. Long (Prentice-Hall, 1983). Written for the serious hobbyist who is exploring interfacing techniques for the first time, it is a very complete yet clear description of the requirements to interface memory and peripheral devices to a microprocessor.*

*Microprocessor Interfacing Techniques by Rodnay Zaks and Austin Lesea (Sybex, 1979). This book covers much of the same material as the above-mentioned book but complements it by extending the discussion to cassette tape recorders and floppy-disk drives.*

*A more advanced but clearly written book that covers many of the topics you mentioned is Microcomputer Interfacing by Harold S. Stone (Addison-Wesley, 1982). In addition to many practical examples, the book also features state-of-the-art information so that an appreciation of the sophistication of new devices can be obtained.—Steve ■*

*Over the years I have presented many different projects in BYTE. I know many of you have built them and are making use of them in many ways.*

*I am interested in hearing from any of you telling me what you've done with these projects or how you may have been influenced by the basic ideas. Write me at Circuit Cellar Feedback, POB 582, Glastonbury, CT 06033, and fill me in on your applications. All letters and photographs become the property of Steve Ciarcia and cannot be returned.*

# WE WROTE THE BOOK ON HIGH PERFORMANCE.



## VOLUME I

The Datasouth DS 180. The original high performance matrix printer. The printer that won international acclaim as the most rugged and dependable ever made.

And the printer made even better in the DS 180 Plus. Improved by enhancements like an 8-bit support capability and a new sound-dampening design.

The DS 180 Plus. The latest edition of the book we wrote on High Performance.

And that's only half the story.



## VOLUME II

The DS 220. The multi-mode matrix printer that brought Datasouth dependability to a variety of applications.

With servo-controlled logic and high speed tabbing to deliver faster data processing. Word processing copy to rival daisy-wheels. And high resolution dot addressable graphics.

The DS 220. The latest word in high performance multi-mode matrix printing.

From the company that wrote the whole book.

**south**

H I G H P E R F O R M A N C E P R I N T E R S

AVAILABLE NATIONWIDE  
THROUGH OUR NETWORK OF  
SALES AND SERVICE DISTRIBUTORS

Datasouth Computer Corporation  
Box 240947 • Charlotte, NC 28224  
704/523-8500 • Tlx 6843018 DASOU UW

CALL TOLL FREE:  
**1-800-222-4528**  
Ext. 505



## Conducted by Sol Libes

Verbatim recently demonstrated a prototype 3½-inch erasable optical disc to prospective OEMs. It stores 47 megabytes (unformatted). That's not much as optical-disc drives go, but the current opticals are all write-once, read-only. Verbatim is reportedly shooting for third-quarter 1987 production with an OEM price of \$300 and \$20 to \$30 for the removable discs.

OEM prices for 10-megabyte hard-disk drives are now well below \$200, with 20-megabyte drives below \$300. Prices are expected to go even lower in the next 12 months as Japanese and Korean makers start competing with U.S. vendors. Even prices on larger drives should be affected in what some feel will be a bloodbath for U.S. hard-drive makers. . . . Within two weeks of Lotus shipping Jazz, some West Coast dealers were advertising 40 percent discounts on the product. . . . Now that IBM is beginning to ship PC network systems, dealers are finding that many popular software products, such as Lotus 1-2-3, Framework, and dBASE, do not work properly in a network environment. No doubt these vendors will have to bring out special versions of their software for these system users. . . . Several Lotus 1-2-3 clones are shortly expected to hit the market and sell for a fraction of the cost of the real thing; expect Lotus to announce a new, greatly enhanced version. The question now is: Will users go for expensive bells and whistles or low-cost compatibility?

Experts are predicting that 1986 will be the year of the low-cost 3½-inch hard disk. Just as no manufacturer would think of introducing a computer without at least one floppy drive, all new systems will contain a hard-disk drive. The reason is that prices for 3½-inch drives should be far lower than the current 5¼-inch units. Using a small fraction of the parts employed in current hard-disk drives, occupying less than a third of the space (say goodbye to separate controller cards and expensive cabling) and less than a quarter of the weight, the smaller drives are expected to provide a greatly improved level of reliability.

Rumor has it that AT&T is getting ready to enter the optical-storage arena via a cheap wallet-size card holding 2 megabytes or more of data. The product is probably an option for AT&T's 6300 and 7300 desktop systems.

### THE TOP TEN

Do you know the top 10 microcomputer makers? Without looking at table 1, take paper and pencil and write their names. Now look at the list in table 1 compiled by *Datamation* magazine (June 1985, page 38).

### APPLE BYTES & PITS

Apple recently showed its first quarterly loss ever and is experiencing severe belt-tightening as it, and the industry as a whole, attempts to weather a slackening of growth in the personal computer industry. Apple laid off 1200 employees in June, only a month after laying off 1600 employees. It has trimmed about 40 percent of its staff, closed three plants, and consolidated operations.

Working on the cutting edge of technology, as Apple has traditionally done, is a good strategy in a young, rapidly growing market. As the personal computer industry matures and supply catches up with demand, marketing becomes more important than technology. The pioneers either reorient their efforts from product innovation to product selling or fail to compete. Apple now appears to be going through that transition and remolding its operation into the IBM-type marketing-oriented computer maker.

Apple is expected to introduce several new products that will upgrade the power of the venerable Apple II. Anticipated this fall are plug-in cards that can increase the unit's memory up to 1 megabyte in 256K-byte chunks and a 3½-inch disk drive that stores nearly a megabyte. Also expected early next year is the 16-bit microprocessor upgrade.

### IBM WATCHING

Even IBM is feeling the current recession in the computer business. IBM president John Akers recently said that business for the first nine months of 1985 will not measure up to the same period last year and profits for the year will be lower than last year.

Did you know that IBM has 394,930 employees and, according to *Datamation* (June 1985, page 42), the average revenue per employee was \$112,200 for last year? That makes IBM one of the most profitable computer companies in the world.

According to *PC Week* magazine (June 11, 1985, page 1), IBM's highly automated production line enables the company to make a 55 percent profit on each PC sold. A \$2520 PC with 256K bytes of RAM, a 360K-byte floppy drive, a disk controller, and a monochrome-display controller card costs IBM about \$700 to produce.

IBM is now marketing the JX in Australia. The JX is made in Japan and has been on sale there for almost a year. It runs MS-DOS; contains two 360K-byte 3½-inch floppies, 512K bytes of RAM, and a cartridge slot; and is not expandable. The unit is seen as a lower-cost, Japanese version of the PCjr. There are rumors that IBM is seriously considering marketing the unit in the U.S. (after selling out its current inventory of PCjrs).

Incidentally, after the recent backlash to

(continued)

BYTELINES, news and speculation about personal computing, is conducted by Sol Libes, the author of numerous books and articles on computers. He is the founder of the Amateur Computer Group of New Jersey and a coorganizer of the Trenton Computer Festival. He edits and publishes *Micro Systems Journal*, a bimonthly publication for system programmers and integrators. He can be contacted c/o BYTE, POB 372, Hancock, NH 03449.

Table 1: Top 10 microcomputer manufacturers as compiled by *Datamation* magazine. Revenues are for 1984, in millions of dollars.

1. IBM	\$4000.0
2. Apple Computer	1897.9
3. Commodore International	1129.5
4. Hewlett-Packard	510.0
5. Sperry	503.4
6. Tandy	402.8
7. Convergent Technologies	361.7
8. Compaq Computer	329.0
9. Ing. C. Olivetti	289.6
10. NEC	258.9

Multi-User  
Relational

# HARD-NOSED DATABASE \$99.

## If You Liked DBase III, You'll Flip Over TAS™

Hard-nosed business owners have been asking for the power of DBase III™ and RBase 5000™, but without the high price. That's why Business Tools, Inc. created TAS™.

Compare TAS with DBase III and RBase 5000. You'll see why we think TAS is a better "Hard-Nosed" value than DBase or RBase. TAS includes a data dictionary. TAS includes a true procedural language. TAS includes a run-time compiler. Plus TAS supports multi-user record and file locking.

TAS lets you to develop your own professional menu-driven business applications. And not just simple ones either. TAS applications can hold up to 17 million records. And because TAS compiles them, they run fast.

## But Why Is It Only \$99?

We could have priced TAS at \$695 like the other guys, it's well worth it. But we happen to believe "Hard-Nosed" business people are looking for real software value today, so that's what we've given you.

## Take It From Hard- Nosed Phil Mickelson

If anyone's "Hard-Nosed" about good software, it's Phil. In 1982, he created The Sensible Solution™.

**BUSINESS TOOLS™**



The following are registered trademarks of these companies: TAS, Accounting Solution, Business Tools Inc; RBase 5000, Microm Inc; DBase III, Ashton-Tate Inc; CP/M and MP/M, Digital Research Inc; IBM PC/XT/AT, International Business Machines Corp; Compaq, Compaq Computer Corp; AT&T 6300, AT&T Information Systems Inc; Tandy 1000, 1200, 2000, Tandy Corp; MS-DOS, Microsoft Corp; The Sensible Solution trademark rights are claimed by O'Hanlon Computer Systems Inc.

(relational database). Now he's taken the next big step by creating TAS, the affordable software for your business. And it's backed with Phil's reputation and personal service.

## TAS™ Runs On These CPUs

TAS is available for the IBM PC/XT/AT,™ Compaq,™ AT&T 6300,™ Tandy 1000, 1200, 2000™, and most MS-DOS,™ CP/M™ and MP/M™ systems.

## Get TAS™ Accounting Software for \$249

But why stop with just a database? For just \$249, you get TAS Relational Database/Language plus General Ledger, Accounts Receivable and Accounts Payable. And for \$399 you get all the above plus Inventory, Sales Order Entry, Purchase Order Entry, and Payroll.

Source code Included FREE! So you can even modify the accounting to fit your business.

	TAS™	DBASE III	RBASE 5000
Multi-User	Yes	No	Optional
Data Dictionary	Yes	No	Yes
Procedural Language	Yes	Yes	Yes
Compiler	Yes	No	Yes
Records Per File	Unlimited	Unlimited	Unlimited
Files Open	16	10	40
Fields Per File	Unlimited	128	400
File Size	Unlimited	Unlimited	Unlimited
Record Size (Fixed)	10,254	4,000	1,530
Field Size	254	254	1,530
Prices	\$99	\$696	\$700

## Call Today 1-800-648-6258

Call our Toll-Free Hotline. Use your VISA or MasterCard to order today. Outside Washington call 1-800-648-6258. Washington residents call 1-206-644-2015.

Dealer Inquiries Welcome.



# TAS™

"Affordable Software For Your Business Needs"

Describe your computer system:

- 8 bit  16 bit  
 PC-DOS  MS-DOS  
 CP/M, MP/M  CP/M-86  
 Disk size is:  5 1/4"  8"

Computer name/model is: \_\_\_\_\_

Name: \_\_\_\_\_

Street: \_\_\_\_\_

City: \_\_\_\_\_

State: \_\_\_\_\_

Phone: \_\_\_\_\_

Business Tools, Inc.  
4038-B 128th Ave. SE  
Bellevue, WA 98006

Quantity

- \_\_\_ TAS Database/Language—\$99  
 \_\_\_ Level 2 Accounting (TAS, GL, AR, AP)—\$249  
 \_\_\_ Level 3 Accounting (Level 2, SO, PO, INV, PAY)—\$399  
 Subtotal (WA add 7.8% tax) \_\_\_\_\_  
 Shipping (USA—\$4.00) \_\_\_\_\_  
 (Foreign—\$10.00) \_\_\_\_\_

Total Enclosed: \_\_\_\_\_

Payment:  VISA  MC  Bank Draft  Check  
 (All amounts are payable in U.S. funds only.)

Credit Card Expiration Date: \_\_\_\_\_

Card Number: \_\_\_\_\_

Signature: \_\_\_\_\_

NOT COPY-PROTECTED



IBM's announced cessation of PCjr production, IBM adopted the policy of not commenting as to whether any product is in production. It will only confirm whether or not the product is being shipped.

IBM is also rumored to be planning the introduction of several coprocessor-equipped ATs, in addition to the already-announced desktop 36. These are expected to include a UNIX (Berkeley 4.2)

unit based on the National Semiconductor 32032 32-bit microprocessor and an 801 unit for the scientific market. These machines would be sold by IBM's advanced dealer program available only to large chains.

**CONTINUOUS-SPEECH INPUT SYSTEM**  
Kurzweil Applied Intelligence Inc. (411 Waverly Oaks Rd., Waltham, MA 02154)

has introduced the first commercial voice input system capable of handling continuous speech. It can learn speech from many users in several languages with a 1000-word vocabulary (a 10,000-word beta-test unit is expected later this year). The company claims 100 percent accuracy. Units that are currently on the market work only with interrupted speech, have smaller vocabularies, and have far less accuracy.

The unit is a board-level product that will sell to OEMs for as low as \$3000 in quantity. PC, multibus, and RS-232C versions already exist in which the unit acts as a keyboard input device. The unit is speaker-adaptive and performs better the more it "talks" with the same user.

Called the KVS-3000, the unit comprises three boards, an input analog-to-digital converter with signal conditioning, an acoustic pattern processor recognizing 3000 utterances, and a speech processor (using a 68000) that assembles recognized strings of speech and handles I/O to the host system.

**CD-ROM UPDATE**

At the recent Consumer Electronics Show in Chicago in June, Activenture Inc. (Pacific Grove, CA) demonstrated the first compact disc containing the complete text for an encyclopedia. It used less than a quarter of the 550-megabyte storage capacity of the 4 3/4-inch-diameter disc (using the Sony/Philips standard). Activenture showed an improved retrieval system that allowed retrieval of data in less than 3 seconds. The technique employed an index file as large as the 60-megabyte data file.

And Reference Technology Inc. (Denver, CO) announced the availability of the first CD-ROM drive with an IBM PC interface and software driver. The unit lists for \$1535 plus \$100 for the software. National Decision Systems (Encinitas, CA) announced a 1-gigabyte disk for that drive that contains marketing and demographic databases previously stored on a large mini-computer.

Both Sony and Philips are shipping evaluation samples of the bare drives to OEM customers. It is believed that these include Atari, Commodore, IBM, and Apple. Atari is already promising such a unit for its new ST computers with an expected selling price of \$500.

**CREDIT-CARD SOFTWARE**

Mitsubishi Plastics Industries Ltd, in cooperation with Hudson Soft Ltd., both

(continued)

**YOU CAN'T TRANSFER  
FILES FROM APPLE  
TO IBM ...  
WRONG!**

A "wireless file transfer" package for the IBM PC® to Apple II and back, and back again. Turnover is a firmware board which fits into any slot in the IBM PC® or compatible, and software running under MS-DOS®. No modems, no serial links, no hassles, no problems. **TURNOVER™** will format Apple CP/M®, Apple DOS 3.3, Pro Dos, Apple III and P-System disks. Leave your IBM and Apple computers where they are. Put Your Apple Disk In Your IBM-PC and transfer your file to a PC-DOS disk. Allows for modifications to text and data files. It's a simple, inexpensive, fast high performance alternative to complicated serial links and modems.

**See your dealer or call for information. (213) 938-0857**



6022 W. Pico Blvd., Los Angeles, CA 90035

p-System is a trademark of SofTech Microsystems, Inc.  
APPLE is a registered trademark of APPLE Computers, Inc.

MS-DOS is a registered trademark of Microsoft Corporation.  
IBM PC & PC-DOS are registered trademarks of International Business Machines Corporation.

# Avocet turns an ordinary PC into an extraordinary development system. And saves you \$20,000 in the process.

Now, there's a way to see all your best microprocessor designs take root, easily and effectively. Avocet cross-assemblers, simulators,

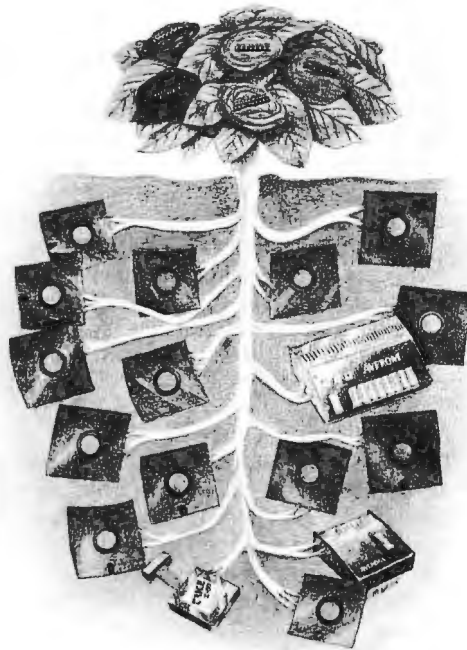

## THE AVOCET CROSS-ASSEMBLER FAMILY.

Avocet Cross-assembler	Target Micro-processor	CP/m*-80	CP/M-86 IBM PC, MSDOS**
XASM04	6804	\$250.00	\$250.00
XASM05	6805	200.00	250.00
XASM09	6809	200.00	250.00
XASM18	1802/1805	200.00	250.00
XASM48	8048/8041	200.00	250.00
XASM51	8051	200.00	250.00
XASM65	6502/65C02	200.00	250.00
XASM68	6800/01,6301	200.00	250.00
XASM75	NEC 7500	500.00	500.00
XASM85	8085	250.00	250.00
XASM400	COP400	300.00	300.00
XAMF8	F8/3870	300.00	300.00
XASMZ8	Z8	200.00	250.00
XASMZ80	Z80	250.00	250.00
<b>NEW!</b>			
XASM6811	68HC11	250.00	250.00
<b>NEW!</b>			
XASM180	HD64180	250.00	250.00
XMAC682	68200	595.00	595.00
XMAC68K	68000/68010	595.00	595.00

\*Trademark of Digital Research  
\*\*Trademark of Microsoft

emulators and EPROM programmers turn your personal computer into a sophisticated development system. No more waiting for the continually overloaded mainframe. Or, wondering how to pay for a \$20,000 dedicated development system. Avocet products save time and money, and provide the most flexible development system available.

Avocet allows you to develop software for practically any microprocessor without switching development systems. And equally important, Avocet development tools are easy to install and easy to use. We provide you with everything you need to develop microprocessor software, from data entry through assembly, debugging and final EPROMs.

## Now "debug" on your PC.

Avocet has realistic answers for users who want low cost debugging capability. Until now, engineers have been very much on their own in the area of testing. But now Avocet simulators and emulators virtually eliminate the frustrating and often costly "crash and burn" method.

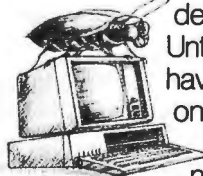

## New AVSIM family of full screen simulators.

Avocet's new software simulator/debuggers let you test your code in a crashproof, interactive environment, without additional hardware. Your PC's screen becomes a "window" into the simulated target CPU. Extensive break point, I/O, and interrupt facilities make AVSIM a truly useful development tool. Price \$299.

## New TRICE in-circuit emulator.

At last, an affordable in-circuit

emulator! With the self-powered TRICE, you can examine target memory and register, set break points, single-step, trace and more; TRICE recognizes 34 different commands. Its serial interface lets you control emulation and download code from your terminal or PC. Priced from \$498.

## AVPROM programmer works with any PC.

The AVPROM programs over 37 different devices, including EPROMs through 27512, CMOS and E<sup>2</sup> PROMS, and MPU/EPROM combos, using fast "adaptive" algorithms. Intelligent, self-contained units work with any personal computer, using Avocet's GDx driver software...from \$429. Gang programmers from \$979.

To find out more about Avocet software development tools and accessories, call us toll-free:

# 1-800-448-8500

(In the U.S. except Alaska and Hawaii.)

VISA and Mastercard accepted. Most popular disc formats now available—please specify. Shipping and handling additional—call for exact quotes. OEM INQUIRIES INVITED. Avocet Systems Inc., P.O. Box 490-B9, Rockport, Maine 04856, (207) 236-9055. Telex: 467210 AVOCET CI.

# AVOCET SYSTEMS INC.®



of Japan, has introduced a new way to distribute software. The software is contained in a plastic credit-card-like package about twice the thickness of a standard credit card. The card contains either a 1-megabyte masked ROM or a 256K-byte programmable ROM or EEPROM. The 32 plated traces at one end of the card form the edge-card connector. You can insert the card into your personal computer's interface adapter.

The first software card to be introduced contains a game and costs \$19.20. An adapter for MSX-based systems costs \$5. An adapter for Commodore 64 systems is expected shortly.

Matsushita Electric Works Ltd. (Osaka, Japan) has already constructed an experimental automatic blood-pressure measuring system that writes data to an EEPROM-type card. The card is then inserted into an interface adapter connected to a personal computer for read-out and analysis.

Hudson Soft is planning to install vending machines with cards that are programmed when a purchaser buys an item.

The purchaser will probably be able to use a credit card to buy the card.

**MICROCODE COPYRIGHT DISPUTE**

A court battle with far-reaching implications is in progress. Intel Corp. is suing NEC charging that NEC's new V series of microprocessors violates its microcode copyright. Microcode determines the fundamental instruction set for a processor.

NEC claims that it did not copy Intel's microcode for the 8086 16-bit microprocessor, that microcode is not protected anyway, and that Intel is harassing NEC's customers with this suit. A win for Intel will greatly strengthen the position of companies with proprietary computer architectures. A loss will let competitors freely emulate computer designs.

**MSX UPDATE**

Over one million Z80-based MSX systems were sold in the last 12 months in the Far East and Europe. Over a dozen companies manufacture consumer-oriented MSX computers.

Now the developers of MSX (Microsoft

and ASCII Japan) are promising to shortly release MSX-2, supporting 3½-inch floppies and a 512- by 512-pixel 256-color display, with a base price below \$400. Preproduction models are expected to be shown at the October Japan electronics show. And IBM is known to be taking a very close look at MSX.

As yet, MSX has not made any inroads in the U.S., primarily because of the high \$200 to \$300 retail price and lack of floppy disks.

**THE ONE-STOP SHOP**

Where else but in Silicon Valley can you make a quick trip to an all-night market for a quart of milk or loaf of bread and also pick up some EPROMs, a PC or two, some memory chips, or a copy of Lotus 1-2-3 at discount prices? If you are in Sunnyvale, California, head for Fry's Electronics, a part of the Fry's Food and Drug supermarket chain advertised as the place for "fast, one-stop shopping for the Silicon Valley professional," where you can get your three Cs: computers, components, and convenience foods. ■

# DISKETTES

CALL TOLL FREE → West of Rockies 1-800-621-6221  
Central & East 1-800-654-4058

<p><b>Dysan</b> 5¼" Disks S-SIDE 1695 D-DEN. 2195 D-SIDE 2895 S-SIDE 96TPI 3895 D-SIDE 96TPI 5195 HIGH DEN. 5195 8" Disks S-SIDE 2195 D-DEN. 2395 D-SIDE 2795</p>	<p><b>maxell</b> 5¼" Disks S-SIDE 1395 D-DEN. 1995 D-SIDE 1995 S-SIDE 96TPI 2495 D-SIDE 96TPI 3095 HIGH *DEN. 3995 3½" Disks S-SIDE 2895 D-SIDE 4295 8" Disks S-SIDE 2595 D-DEN. 2895</p>	<p><b>BONUS</b> Disks-10 pk \$9.95 per box SS DD Verbatim Kits 495 Refills 895 Media Mate 895 ea. *29¢ Shipping 100 Disk Bulk Pack 85.00 SS DD 97.00 DS DD</p>	<p><b>3M</b> 5¼" Disks S-SIDE 1495 D-DEN. 1995 D-SIDE 1995 S-SIDE 96TPI 2495 D-SIDE 96TPI 3095 3½" Disks S-SIDE 2895 D-SIDE 2895 8" Disks S-SIDE 1995 D-DEN. 2495 D-SIDE 2895</p>	<p><b>Verbatim Datalife</b> 5¼" Datalife S-SIDE 1495 D-DEN. 1995 D-SIDE 1995 S-SIDE 96TPI 2495 D-SIDE 96TPI 3095 3½" Datalife S-SIDE 2795 D-SIDE 2795 8" Datalife S-SIDE 1995 D-DEN. 2295 D-SIDE 2695</p>
---	---	--	---	---

**THE Diskette Connection**

1-800-621-6221 P.O. Box 1213 Boulder City, NV, 89005  
1-800-654-4058 P.O. Box 1674 Bethany, OK, 73008

**TERMS:** Minimum 20 disks or \$35.00 — VISA or MasterCard accepted  
C.O.D. orders add 2% for special handling. **SHIPPING:** 3½" & 5¼" Diskettes; Add 3% for every 100 Diskettes or any fraction thereof. 8" Diskettes; Add 4% for every 100 Diskettes or any fraction thereof. We ship UPS; orders requiring other delivery methods add shipping, plus 2% of total order.

## a message to our subscribers

From time to time we make the BYTE subscriber list available to other companies who wish to send our subscribers material about their products. We take great care to screen these companies, choosing only those who are reputable, and whose products, services, or information we feel would be of interest to you. Direct mail is an efficient medium for presenting the latest personal computer goods and services to our subscribers.

Many BYTE subscribers appreciate this controlled use of our mailing list, and look forward to finding information of interest to them in the mail. Used are our subscribers' names and addresses only (no other information we may have is ever given).

While we believe the distribution of this information is of benefit to our subscribers, we firmly respect the wishes of any subscriber who does not want to receive such promotional literature. Should you wish to restrict the use of your name, simply send your request to the following address.

BYTE Publications Inc.  
Attn: Circulation Department,  
70 Main St., Peterborough, NH 03458

# UP AND COMING VS. UP AND RUNNING

## OTHER COMPANIES PROMISE THE IDEAL LOCAL AREA NETWORK, BUT AT&T HAS IT TODAY.

If you're tired of waiting for a way to build your company's information network, AT&T offers a ready solution.

It's called AT&T Information Systems Network (ISN), the versatile, cost-effective local area network that's available now.

### RUN AS ONE.

Think of the time, effort and money you'll save as ISN links together terminals, workstations, personal computers, minicomputers, and mainframes to give your company a cohesive, efficient information network. And ISN links to your PBX as well. So your people can share information, resources, data bases and files with the efficiency of a single system. And be more productive by getting the information they need when they need it.

Also, ISN is easy to run. Its unique centralized administration and control capability lets you monitor network performance, pinpoint malfunctions, take corrective action, and prevent unauthorized access to information, all from one control console. And its open architecture gives you the flexibility to design a network that links AT&T's products and those from other manufacturers across any number of locations.

### THE FAST TRACK.

ISN not only puts your data on a fast track, it puts your business on one too. It's cost effective for as few as 50 connections, and can expand to several thousand. Easy and inexpensive to install, ISN uses optical fiber to move data fast. And with copper wire connections to your workstations, moves and changes are no longer a problem.

Add to this the fact that ISN is backed by the largest, most experienced sales and service force in the industry, and it's clear that the AT&T Information Systems Network is the right choice for your company.

It's the network that's up and running before some others even get started.

For more information, call your AT&T Information Systems Account Executive, or 1-800-247-1212, Ext. 191.



**AT&T**

The right choice.





(continued from page 32)

### DEFENDING THE MAC

The continuing saga of "The Macintosh Controversy" in your Letters column has become an interesting study in machine partisanship, arousing strong emotional responses in BYTE readers.

As an owner of both the Mac and the Tandy 1000, I can't resist joining the fray to add some opinions based on my own personal and professional experience. As a video/film producer, I can say that both systems are proving themselves increasingly useful in my profession, and for quite different reasons. The Tandy drives a video character generator and interfaces with an editing system, while the Mac does an outstanding job of creating images and text for preparing storyboards—and with Multiplan, it has no problem with complex cost-estimate spreadsheets. In short, both do their discrete jobs very well.

As for "arcane icons," anyone who travels overseas learns to appreciate them quickly—especially in the Orient. I have found the combination of icons, mouse, and keyboard on the Mac a joy to use. It's difficult to understand how an exhilarating experience like working the Mac can be called "an exercise in frustration," unless the reference is to the 128K-byte version. Mr. Monteith prefers the DeskMate word processor to MacWrite, he says (see "Iconoclasm and the Mac," June, page 16). That is truly baffling. DeskMate is okay for simple letters but suffers severe formatting limitations, while I have used MacWrite to design attractive advertisements and flyers ready for printing.

The Mac may never find its niche in the big-business environment—so much the worse for my 10 shares of Apple Computer stock—but it has earned my gratitude for being so innovative and remarkably versatile.

PAUL COHEN  
Westport, CT

### INSTALLING MICROS IN CHINA

While schoolchildren in America discuss the merits of the latest home computer improvements, business and government leaders in China are just beginning to learn about microcomputer technology. As China moves to develop its economy and embraces more Western-style business practices, its leaders are looking for ways to improve productivity. Microcomputer technology is one area they are exploring with great interest.

Several professors from Rensselaer Polytechnic Institute recently had the oppor-

tunity to establish the first microcomputer lab in China and to introduce approximately 180 Chinese middle-level managers, bureaucrats, and educators to the uses of microcomputers in management. We were part of a six-month, graduate-level management-education program sponsored by the National Center for Industrial Science and Technology Development at the Dalian Institute of Technology, Dalian, China. Its graduates are expected to return to their places of employment and lead others in implementing new technology and management methods.

By American standards, our lab was quite spartan. We had 20 IBM Personal Computers, along with printers and software, "installed" on benches in one of the classrooms. During scheduled lab times, three students had to share each workstation, and power outages took their toll on the amount of our productive computer time. Nevertheless, the computers—with their "Made in Taiwan" labels—were a constant source of discussion and excitement.

Although many of our students had had college-level scientific training, only about 4 percent used a computer regularly. Almost 75 percent had never used a computer before. We provided lectures (delivered by us in English with sequential translation into Chinese), computer lab exercise, and opportunities for students to use the lab on their own for additional hands-on experience.

By administering questionnaires both before and after the students used the PCs, we were able to get an indication of how their perceptions about microcomputers changed through actual exposure to them. Not surprisingly, those who used the PCs most often identified the most potential uses for them and were the most optimistic about when their organizations might adopt micros. We have no doubt that as microcomputers become more available in China, they will fuel their own development.

We were somewhat more surprised to discover that factors of age, prior experience with computers, and ability to understand English did not seem to influence their perceptions. Since the computer displays, manuals, and software were in English, we had expected language to present problems. On the contrary, we found that at least two-thirds of our students had a reading proficiency in English—often required by their jobs. Even those who were not proficient in English seemed to adapt to the computer quickly. While having computers with Chinese-

language support would probably enhance their attractiveness, from our experience it is not necessary to the adoption of microcomputer technology by the Chinese.

There are other barriers, however, such as the lack of trained personnel and an infrastructure to service the computers. In that regard, microcomputers have several distinct advantages over minicomputers and mainframe computers. They are comparatively inexpensive, giving an enterprise the potential to own more than one. They are small and easy to transport to the regional service centers that would be available first. And they are less complex, making it easier for Chinese personnel to learn to service and maintain them.

As China decides when and if it will adopt microcomputer technology, perhaps the most significant consideration will be the uses its leaders perceive for the micros. China has one-quarter of the world's population and a government policy of full employment, so the country's leaders may not be interested initially in many of the computer applications common to the West, such as automation of clerical tasks. They are more likely to be attracted by computer applications in complex planning tasks such as budgeting, forecasting, inventory control, production scheduling, and scientific research. Again, microcomputers have the advantage because many of these applications in Chinese enterprises are on a scale that could be handled by a personal computer with a hard disk.

By concentrating on the computer's ability to aid in management projections and decisions, we believe China could benefit enormously from an investment in microcomputers. The interest is there, the micros are affordable, and personal computers are simple enough to be put into use immediately, even as China develops its own infrastructure for computer service and technology.

DANIEL P. ORNE AND  
WILLIAM A. WALLACE  
Rensselaer Polytechnic Institute  
Troy, NY

### MORE MAC FEEDBACK

After reading Bruce Webster's review of "The Macintosh" (August 1984, page 238) and letters in BYTE, I went to a computer store for a test drive, all of which leads me to agree with those who say that the Macintosh is the computer "for the rest of them."

Two further points: The Mac's real in-

(continued)

FREE SHIPPING!

# PC SOURCE

No Credit Card Surcharge!

## AST SixPakPlus



w/384K

**\$269**

**AST Advantage!** W128K... **\$399**



PC's & AT's

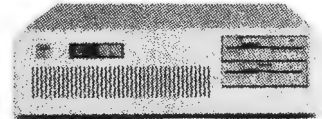

**Call For Current Prices...**

## Memory

### 64K Chip Set

9 chips per set, 1 year warranty... **\$8**

**256K Chip Set**  
9 chips per set, 1 year warranty... **\$39**

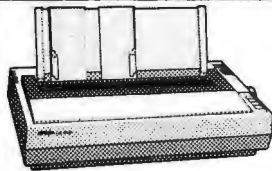

LX80... **\$229**

FX85... **\$379**

## EPSON



Number one. And built like it.

FX185... **\$499**

LQ1500... **\$929**

W/Parallel Interface

## Intel

Math Co-Processor

8087... **\$98**

80287 **\$219**

## Mercury Hard Disks for the IBM PC

- ✓ Complete Kits
- ✓ Full Instructions
- ✓ 1 Year Warranty

**\$395**  
10 MB

**\$495**  
20 MB

**\$795**  
30 MB

**COMPAG** 10 MB Hard Disk Kit... **\$475**

## PC Source

Add-on Boards for IBM PC

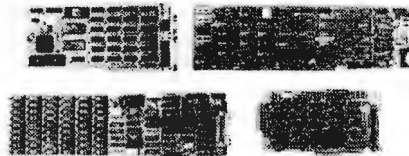

**Call For Details...**

## TEAC 55B



Half Height Double Sided

**\$99**

## MINUTEMAN™

Total Power Protection!

- Blackouts
- Interruptions
- Brownouts
- Surges
- Spikes
- EMI/RFI Noise

### Minuteman 250

250 watts output power capability... **\$339**

### Minuteman 500

500 watts output power capability... **\$549**

## 360K Floppy Drive for the IBM AT™

360 K



**\$119**

Qty. 5 \$99

## CORPORATE AND INSTITUTIONAL ACCOUNTS

Our national accounts division is dedicated to providing the prompt professional service required to keep your business running smoothly. We accept P.O.'s on a net terms basis, offer same day shipping, free fully insured UPS ground shipment. We offer a full-time technical staff to answer any questions that might arise and to make fast repairs if needed. Call our national accounts staff today. We make your job easier.

### OUR POLICY

We accept Mastercard & Visa (with no Surcharge!), money orders, certified checks, personal checks (allow 10 days for processing), COD, Company/Institutional P.O.'s and wire transfers. We do not charge your card until we ship. We pay shipping (UPS ground, fully insured) on orders delivered in continental U.S.A..

Add 6 1/8 sales tax if Texas resident. Prices are subject to change. All equipment carries a new factory warranty. Any return item must be accompanied by a return authorization number.

Call Toll Free (800) 643-0992

Within Texas (512) 331-6700

10904 Marhle Road Austin, TX 78750





novation is that it is not a computer! At least, most are not using it as one; it is an expensive drafting aid. Also, the degree of "proprietaryness" in the Mac (ROMs, custom chips, disk format) means that true clones will not appear to drive the price down and the performance up, as has happened with the IBM PC and the Apple II. The Mac will remain as limited and as expensive as it is today, and the Stride 420 will remain the best 68000 computer, as evidenced by the number of blatant clones emerging (not to be advertised by me). Please note I am not a Stride employee, just a satisfied and partisan customer.

P. MATSON  
Reno, NV

### MORE STRUCTURE, NOT LESS

From his letter, I fear that Erwin S. Strauss ("Toward a Less Structured Approach," May, page 458) has not fully understood structured programming. Structured programming has never been an attempt to have "fewer lines, fewer statements, fewer variables"; although he is correct that it is supposed to be easier to read and understand.

His examples are too small to say anything about structured programming. Any discipline, or no discipline, will work for sufficiently short programs; if you can hold the program in your head as you're writing it, you don't need any help. But if the program is too large to know entirely, if you're not the only person working on it, if you expect to change it three years from now to run on a different computer, you must be able to understand it from reading the code.

The essence of structured programming is that a program should be composed of small building blocks, each with some clear and understandable function, connected in an understandable way. Repeat this as often as you want: The building blocks of one level are themselves composed of smaller subprograms. The advantage of this is that you, the programmer, can understand the program (or any subprogram) on its own ground; you need to know what the subprograms do, but not how they do it.

Most languages have primitive operations, like input and output; would you want to have to know how your OPEN statement does disk accesses before you could use it? Probably not. The ideal structured program treats any complicated operation—the ones that you wrote yourself—the same way. You don't want to have to think about how your B-tree algorithm

works except during the algorithm; the rest of the program should treat it as a magical amulet that does disk lookups.

This has a number of advantages. It's easier to write programs. You can write the top level of a program as if in an ultrahigh-level language with commands that do precisely what you want. Then write each of those commands as a subroutine in a slightly lower-level language, and so on, until you're writing in the real computer language. For example, the top level of a spreadsheet might be

```
Initialize_Everything
LOOP
  Display_The_Changes_That_Affect_
  The_Screen
  Get_A_Command
  If The_Command_Is_Quit THEN
    EXIT
  ELSE
    Do_The_Command
  END_IF
END_LOOP
Finish_Up
```

That is the main routine.

It is also easier to debug programs. With a moderate amount of care, each of the commands is independent of all the others except those that it calls (strictly, that it or any of its callees, recursively, calls). If you want to rewrite your Get\_A\_Command, fixing bugs or adding features or moving it to another machine, you will *know* that your changes won't damage any of the rest of the program. You don't have that guarantee in a nonstructured program; it is quite likely that you will have to make changes in all the rest of the code.

Structured programming encourages modifying parts of the code to make them work better and be friendlier. When the details of entering a command can confound the screen-refresh routine, I'm going to hesitate a long time before I touch the command-reader. If they're separate, I won't worry. Also, when I change things in the command-reader, a lot of its subroutines will still be useful; I'll already have most of the tools I need.

In fact, structured programming is a way of avoiding discipline on a small scale. When I wrote the body of the spreadsheet, I didn't think in any especially structured way or make any particular attempt to make it easy to understand. It's only 11 lines of code and not very dense at that; there's not enough there to have trouble with.

If every routine is too small and too easy to understand to have trouble with, where

are you going to have trouble? (That's way, way oversimplified, but it has the right idea. You will still have bugs—there are always bugs—but they're easier to fix.)

I cannot understand Mr. Strauss's objection to structured programming from his letter. In one paragraph, he seems to think that "one of the costs of structure is insensitivity to the end user." In another, "structured programming is a fine thing in a production-type environment." This seems to imply that it is a fine thing for widely distributed programs to be insensitive to the end user, but local and temporary programs should be friendly. I rather doubt that he intended this. Saying that "debugging can come later" is rather peculiar; it is very easy to write a program that does great things—except that it doesn't work.

The quality of a program doesn't have anything to do with its programming discipline. Designing the program (especially the part the user sees) and writing it should be as separate as possible; in his example, the style of printing the index should have been chosen at leisure by the designer, not on the fly by the programmer. I guess that Wirth didn't do this; shame on him.

I suggest that anyone critiquing structured programming (or anything else) critique the discipline itself, rather than a vague impression of it.

BARD BLOOM  
Cambridge, MA

### CAN THIS PUZZLE BE SOLVED?

It certainly is no secret that this world contains more than its share of frustrations. However, I'd sooner take on writing a program in BASIC to calculate to the last digit of pi than try to solve the Rubik's Cube on the cover of your June issue. How can this puzzle be solved with two blue squares in the middle?

SUZIE R. MAGALLANES  
Scotts Valley, CA

*Gregg Williams replies:*  
Thanks for allowing me to say "I told you so." When Robert Tinney came up with his Rubik's Cube idea for the June BYTE cover (I was the theme editor), I told him he'd better base his painting on a real Rubik's Cube. Otherwise, I told him, there'd probably be some inconsistency in the image he came up with, and some BYTE reader would surely find it. When he declined to do so, I found a few edge- and corner-cube errors, but I completely overlooked the fact that each center

(continued)

# REAL-TIME INNOVATION



*Computer professionals work with advanced equipment and technologies at Northrop Advanced Systems Division.*

*Northrop Advanced Systems Division is advancing aviation into the 21st century by successfully interfacing human creativity with powerful sophisticated computer systems. Here, utilizing latest and often revolutionary equipment and techniques, our innovative Information Resource Management (IRM) organization attracts the nation's finest computer professionals. Join our team and work in one of the world's most advanced high technology environments.*

Our facilities are ideally situated midway between Los Angeles and Orange County in Southern California. We have immediate openings for the following:

- IBM Equipment Configuration Specialists
- Database Specialists
- IMS Systems Programmers
- MVS Systems Programmers
- Performance Specialists
- Scientific Programmers/Analysts (Engineering, Manufacturing and Logistics applications)
- Change Management
- Systems Analysts
- Network Design Specialists
- Sr. Communications Analysts
- Network Control Analysts
- Computer Aided Design (CAD) Specialists
- Data Control Systems Specialists

Relocation assistance is available.

Northrop provides our employees a competitive, comprehensive benefits package. Please send your resume to: Bill Hargen, Computer Systems Employment Office, Dept. B 686, P.O. Box 1138, Pico Rivera, CA 90660-9977.

**PROOF OF U.S. CITIZENSHIP REQUIRED.** Northrop is an Equal Opportunity Employer M/F/H/V.

## **NORTHROP**

**Advanced Systems Division**  
Aircraft Group

*We're within your reach.*



face must be a different color! Thanks for confirming my high opinion of the *BYTE* reader.

### PAYING EXTRA FOR MANUALS

Yesterday, the disk I use for word processing gave me a system error number 10. However, when I tried to find the English translation of this error message, I discovered that the manufacturer had not bothered to document any error messages, so as to "enhance" the user-friendliness of its manuals.

No, this was not some Japanese import. It was that bastion of user-friendliness, Apple Computer.

I later learned that Apple did in fact document the Macintosh system errors in a separate manual, which costs an additional \$100. No other personal computer company in the world would charge me for an essential reference manual after I'd spent \$4000 on a computer system. It appears that Apple should take some lessons from its more experienced competitor, IBM. IBM documented all possible error messages for the IBM PC in its standard manual and charges only \$39 for its technical reference manual for true hackers.

RICHARD SINGER  
Berkeley, CA

### YET ANOTHER GEM

I found "Public-Domain Gems" by John Markoff and Ezra Shapiro (March, page 207) to be both interesting and valuable, but I want to point out one gem that they overlooked.

No Visible Support Software (Box 1344, Berkeley, CA 94704) distributes a public-domain FORTH called F83 that fully observes the FORTH 83 standard. F83 was written by Henry Laxen and Michael Perry

and is available for a variety of microprocessors, including a version that runs under PC-DOS. (In the DOS version, all I/O goes through DOS, except cursor positioning and clear screen, which go through BIOS.)

F83 from No Visible Support costs \$25 for disk and handling (the software is free). The source disk sent to the purchaser is compacted by means of a Huffman code; the unpacking program is on the disk and produces two disks' worth of code. The code is also found on various bulletin boards; the most recent version of F83 is version 2.1.

Because F83 is an exceptionally clean and powerful implementation, it is becoming widely used as the basis for a variety of languages and products.

MICHAEL HAM  
Santa Cruz, CA

### COMPUTERS IN JAPAN

As far as I can tell from sources who are familiar with Japan, the personal computer boom has soured in Japan. While the major contenders try in vain to stir interest among buyers with new product offerings, NEC is still strengthening its "full nelson" on the market (nearing 70 percent share, with Fujitsu taking up second with some 20 percent).

The home/game market that the MSX technology was supposed to spark is stale; all the talk of "new media" and "INS" still seems to elude the family market. The remaining game machines are now in the \$45 range, rather than the \$360-to-\$450 range of the MSX machines.

Sord—Japan's Apple and crown prince of that country's fledgling venture business—is in deep trouble with a devastated earnings picture and deep internal rifts in management. Its proprietary PIPS operat-

ing system has been more or less abandoned. Sord's forthcoming \$600 large-screen LCD word-processing portable may be its last hurrah as a player in the export market.

Apple-Japan, along with its partner Canon Hanbai in Japan, has run into trouble with its attempts to develop functional kanji firmware for the Macintosh; attempts to generate kanji character sets on the Mac would end up entirely incompatible with the existing Mac operating system. The project seems to have been shelved, and Apple is resigned to marginal sales performance. But even the unmodified Macs were selling for astronomical prices—698,000 yen list (\$3150).

The Japanese have so far found computers best suited to the office environment (with suitable clerical staff to operate them). Their impact has unquestionably been solid and is still widening. If and when the Japanese "invasion" ever arrives in the U.S., it will be in integrated OA systems (word-processing, optical filing, facsimile). But even then, the software requirements for the U.S. and Japanese office environments are virtually incompatible. In the long run, we may see a strong presence in Japan only by IBM (with its successful 5550 series) and, conversely, in the U.S. only by the local subsidiaries of NEC and Fujitsu. The Sharps, Epsoms, Mitsubishi's, Sords, and Kay Nishis are not likely to remain as long-term competitors.

I may well be wrong on a number of counts, so I look forward to reading more updates in *BYTE* on the Japanese situation.

PETER E. FUCHS  
*The Program on U.S.-Japan Relations*  
*The Center for International Affairs*  
*Harvard University*  
Cambridge, MA ■

## MASTERBYTE.

Computer Consultants.

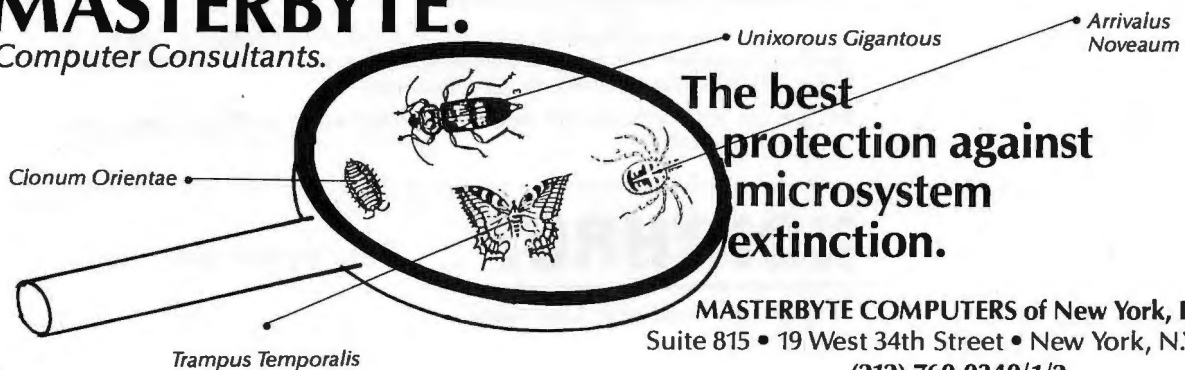

MASTERBYTE COMPUTERS of New York, Inc.  
Suite 815 • 19 West 34th Street • New York, N.Y. 10001  
(212) 760-0340/1/2

©1984

# LycO Computer Marketing & Consultants

LOWEST PRICES!

SUPER SAVINGS!

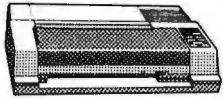

## SAVE ON THESE IN STOCK PRINTERS

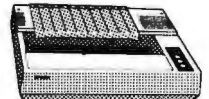

**AXIOM**

GP550AT (Atari).....	239
GP550CD (C-64).....	239
GP550PC (IBM).....	229
GP550AP (Apple).....	269
GP700AT (Atari).....	439
GP700AP (Apple).....	439
ELITE5CD (C-64).....	229
GP100AT (Atari).....	CALL

**C. ITOH**

PROWRITER 8510AP.....	279
8510AP+.....	299
8510BPI.....	309
8510SP.....	375
8510SR.....	425
8510SCP.....	449
8510SCR.....	469
7500AP.....	205
7500AR.....	245
1550P.....	439
1550AP+.....	459
1550BCP.....	469
A10-30P.....	445
F10-40P or S.....	859
F10-55P or S.....	1039
F10 Tractor.....	159
F10 Sheet Feeder.....	249

**CARDCO**

32K BUFFER..(C-64).....	59
-------------------------	----

**CITIZEN**

MSP-10.....	289
MSP-15.....	449
MSP-20.....	449
MSP-25.....	569
Sheetfdr (10/20).....	189
Sheetfdr (15/25).....	199

**CORONA**

LP300 Laser Printer.....	2699
200361 Toner Cartridge.....	89

**EPSON**

LX80 (NEW).....	225
FX80+.....	349
FX100+.....	479
JX80 Color.....	489
RX100.....	369
HOMEWRITER 10 (New).....	CALL
F10-40P.....	159
LQ1500 Par.....	999
LQ1500 Ser.....	1059
H180 Color Plotter.....	379

**JUKI**

Juki 6100.....	375
RS232 Serial Board.....	55
6100 Tractor.....	119
6100 Sheet Feeder.....	209
Juki 6300.....	765

**OKIDATA**

Okimate 10.....	CALL
Okimate 20.....	CALL
182.....	215
192.....	349
193.....	565
92P.....	349
93P.....	565
84P.....	645
92 Imagewriter.....	349
*IBM versions also	

**BROTHER**

HR-15XL-P.....	359
HR-15XL-S.....	359
HR-35P.....	839
HR-35S.....	839
2024L-P.....	949
M1009-P.....	189

**LEGEND**

880.....	199
1080.....	225
1380.....	265
1385.....	299

**DIGITAL DEVICES**

16K BUFFER.....	75
32K BUFFER.....	89
64K BUFFER.....	125

**TOSHIBA**

P13-10.....	559
P351.....	1289

**MICROBITS**

Microstuffer.....	99
-------------------	----

**DIABLO**

D25.....	549
630API.....	1599
630ECS.....	1759
D801F.....	2395
P32CQ1.....	699
P38.....	1749
C150.....	999

**PANASONIC**

1091.....	239
1090.....	185
1092.....	375
1093.....	429
3151 Letter.....	429
4K Buffer.....	65

**SILVER REED**

EXP400.....	249
EXP500.....	295
EXP550.....	409
EXP770.....	749

**STAR MICRONICS**

SG-10.....	215
SG-15.....	375
SD-10.....	339
SD-15.....	445
SR-10.....	485
SR-15.....	585
Powertype.....	305
SB-10.....	CALL
SG-10C-64 (NEW).....	CALL

## MONITORS

**SAKATA**

SG1000 12" Green.....	99
SA1000 12" Amber.....	109
SG1500 12" Green TTL.....	119
SA1500 12" Amber TTL.....	129
SC100 13" Color Comp.....	209
SC200 13" RGB.....	389
STSI Tilt Stand.....	29

**ZENITH**

ZVM 122A Amber.....	84
ZVM 123G Green.....	75
ZVM 124 Amber IBM.....	129
ZVM 131 Color.....	275
ZVM 133 RGB.....	389
ZVM 135 Composite.....	449
ZVM 136 Hi Res Color.....	589

**PANASONIC**

DT 1300 RG1 composite.....	299
----------------------------	-----

**NEC**

JB-1260 Green.....	95
JB-1201 Green.....	135
JC 1215 Color.....	235
JC 1216 RGB.....	375
JC1460 Color.....	265
JB-1205 Amber.....	139

**PRINCETON GRAPHICS**

MAX-12 Amber.....	189
HX-12 RGB.....	475
SR-12 RGB.....	599

**AMDEK**

300 Green.....	125
300 Amber.....	139
310 Amber IBM.....	155
Color 300 Audio.....	245
Color 500 Composite.....	369
Color 600 Composite.....	429
Color 700.....	495
Color 710.....	569

**X-TRON**

Comcolor I Composite Green.....	185
---------------------------------	-----

**TAXAN**

115 12" Green Composite.....	CALL
116 12" Amber Composite.....	CALL
121 12" Green TTL.....	135
122 12" Amber TTL.....	145
220 14" Color Composite.....	259
410 12" RGB Hi Res IBM.....	329
420 12" RGB Super Hi Res.....	409
440 12" RGB Ultra Hi Res.....	569
Tilt Stand.....	35

## MODEMS

**HAYES**

SMARTMODEM 300.....	139
SMARTMODEM 1200.....	379
SMARTMODEM 1200B.....	349
SMARTMODEM 2400.....	599
MICROMODEM IIE.....	135

**ANCHOR**

Volkmodem.....	55
Volkmodem 12.....	186
Mark 12.....	229

**NOVATION**

IBM-300/1200 MS-DOS ext.....	319
IBM-300/1200 CPM-86 ext.....	319
IBM 300/1200/2400 ext.....	529
IBM 300/1200/2400 MS-DOS.....	579
IBM MS-DOS int.....	325
IBM CPM-86 int.....	325
Macmodem 300/1200.....	315
Macmodem 300/1200/2400.....	585
Apple Cat II.....	219
Upgrade Apple Cat II.....	225
Cat 300 Acoustic.....	139
J-Cat RS232.....	89

**TELE LEARNING**

Total Telecommunications.....	29 95
IC-64.....	69 95
AP-250 (300 Baud Apple).....	69 95
IB-250 (300 Baud IBM).....	69 95

**WESTRIDGE MODEM (C-64).....59**

MITEY MO MODEM (C-64).....	69
Compuserve.....	19 85

## DISKETTES

**SKC (Box 10)**

(Qty)	10	100	500
5 1/4" SSDD.....	13 75	12 99	11 99
5 1/4" DSDD.....	15 75	14 99	14 25

**ELEPHANT (Box 10)**

5 1/4" SSDD.....	13 50	12 99	11 99
5 1/4" SSDD.....	14 99	13 99	12 99
5 1/4" DSDD.....	16 99	15 99	14 99
Premium SSDD.....	15 95	14 95	13 95
Premium DSDD.....	17 95	16 95	15 95

**MAXELL (Box 10)**

5 1/4" MD-1.....	16 75	15 75	14 75
5 1/4" MD-2.....	22 99	21 99	20 99

## DRIVES

**MSD**

SD1 Drive (C-64).....	229
SD2 Drive (C-64).....	469

**INDUS**

GT ATARI.....	215
GT COMMODORE.....	235

## IBM-PC COMPATIBLE

**PARADISE**

Multi-Display Card.....	289
Modular Graphics Card.....	275
Five-Oak.....	155

**\*LOTUS**

Lotus 1-2-3.....	309 00
Symphony.....	439 00

**Zenith**

Z-150.....	Call
------------	------

**Leading Edge**

PC Compatible.....	Call
--------------------	------

**OMEGA**

10 Meg Bernoulli Box (IBM).....	1899
5 Meg Bernoulli Box (MAC).....	1499

# TOLL FREE 1-800-233-8760



TO ORDER



CALL TOLL FREE

## 800-233-8760

or send order to  
LycO Computer  
P O Box 5088

Customer Service 1-717-327-1825 Jersey Shore PA 17740

### RISK FREE POLICY

In-stock items shipped within 24 hours of order. No deposit on C.O.D. orders. Free shipping on prepaid cash orders within the continental U.S. Volume discounts available. PA residents add sales tax. APO, FPO, and international orders add \$5.00 plus 3% for priority mail service. Advertised prices show 4% discount for cash, add 4% for MasterCard or Visa. Personal checks require 4 weeks' clearance before shipping. Ask about UPS Blue and Red label shipping. All merchandise carried under manufacturer's warranty. Free catalog with order. All items subject to change without notice.



# OK-WRITER™

LETTER QUALITY



Enhancement for  
Okidata ML824/783A  
Dot Matrix Printers

- Easy to install
- Plug-in module
- Letter Quality: 30 cps
- Draft Quality: 120 cps
- 10, 12, 17 cpi
- Full dot addressable graphics
- Front panel access to all features
- Proportional spacing, bold, double width, underlining, self-test, etc.
- Serial and parallel interfaces retained
- HEI mode; Diagnostic HEX dump
- And many other features

**RAINBOW** TECHNOLOGIES, INC.

17971-E Skypark Circle, Irvine, CA 92714  
(714) 261-0228 Telex 386078  
UK Distributor: X-DATA (0753) 72331

**SPECIAL OFFER**

## ON 3M DISKETTES

Everything that goes into a 3M diskette is manufactured and/or controlled by specifications set by 3M. And to help introduce you to the quality of 3M, we're running a special on their full range of information processing products including—

- 3M Diskettes
- 3M Mag Tape
- 3M Data Cartridges

**PLUS!** Specials on many other products in our full range discount catalog of computer supplies. Call, write, or utilize reader service to obtain your FREE catalog with special offer coupon enclosed. If it's worth remembering, it's worth 3M.

Simply #1 in Service & Reliability

**LYBEN**  
COMPUTER SYSTEMS

1050 E. Maple Rd.  
Troy, MI 48063  
(313) 589-3440

Serial ◀■■■■■■▶ Parallel



**Convert What You Have  
To What You Want!**

- RS232 Serial
- 8 Baud Rates
- Latched Outputs
- Centronics Parallel
- Handshake Signals
- Compact 3½ x 4¼ x 1½

No longer will your peripheral choices be limited by the type of port you have available! Our new High Performance 700 Series Converters provide the missing link. Based on the latest in CMOS technology, these units feature full baud rate selection to 19.2K, with handshake signals to maximize transfer efficiency. Detailed documentation allows simplified installation. Order the Model 770 (SerPar) or Model 775 (ParSer) Today!

Buffer Products  
Coming Soon!



only \$89.95

Connector Option \$10.00  
CA Residents 9% tax  
UPS Shipping \$3.00

CALL (805) 658-7466 or 658-7467  
For FAST Delivery

Inquiry 312

Inquiry 226

Inquiry 136

### Software for Engineers

#### Electronic Circuit Analysis

- Nonlinear transient, DC, AC analysis
  - Worst Case, Monte-Carlo
  - Frequency, time dependent parts
- \$450.

#### Logic Simulation System

- Full delay analysis (min, max, typical, load dependent)
  - Ability to save simulation results
- \$395.

Both have:

- Built in editor, fully interactive
- Macros (unlimited)
- Large circuits

For MS-DOS, 192k minimum

#### Tatum Labs

33 Main Street  
Newtown, CT 06470  
(203) 426-2184

**NOW INCLUDES  
TINY BASIC  
FORTH AVAILABLE**



## SIBEC 51 8051/52 DEVELOPMENT BOARD

8051-Based Single-Board Computer with  
Monitor/Debugger

- 4 28-pin byte-wide sockets; monitor will program EEPROMS.
- Perfect for System Development and Educational Applications

**\$335**



Binary Technology

P.O. BOX 87 • MERIDEN, NH 03770 • 603/469-3232

Inquiry 363

Inquiry 34

Inquiry 282

## 64K • 128K • 256K DRAMS

80287-3

8087-3

8087-2

BITTNER  
**BE**  
ELECTRONICS

899 SOUTH COAST HIGHWAY  
LAGUNA BEACH, CA 92651  
(714) 497-6200

Inquiry 35

## \$100 boards by S.C. Digital

model	description	price
• 256KB	256k Dynamic Ram with memory mapping, 8b data	\$325
• 256KM	512k Dynamic Ram, 8/16b data, parity, 8mhz operation	\$375
• 128KS	Static ram 128kb Eprom, -N with no ram	\$169
• FDC1	Floppy controller, 765, DMA, serial, moni/boot	\$325
• Support1	4serial, centronics, Sasi, interrupts, clocks	\$345
• 80286 CPU	8, 8mhz, fram	\$350
• 8086 CPU	8, 10mhz clock	\$325
• Z80 CPU	8, 8mhz, with memory mapping, addressable 4mbytes	\$249

DEALER PRICING AVAILABLE

### S.C. Digital, Inc.

1240 N. Highland Avenue, Suite 4  
Aurora, Illinois 60506  
312-897-7749

Inquiry 320

# Verbatim flexible disks

Call Free (800) 235-4137 for prices and information. Dealer inquiries invited. C.O.D. and charge cards accepted.

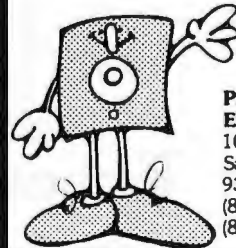

VISA

#### PACIFIC EXCHANGES

100 Foothill Blvd.  
San Luis Obispo, CA  
93401. In Cal. call  
(800) 592-5935 or  
(805) 543-1037.

Inquiry 282



## Sure it's insured?

SAFEWARE® Insurance provides full replacement of hardware, media and purchased software. As little as \$39/yr. covers:

- Fire • Theft • Power Surges
- Earthquake • Water Damage • Auto Accident

For information or immediate coverage call:  
**1-800-848-3469**

In Ohio call 1-614-262-0559



SAFEWARE, The Insurance Agency Inc.

Inquiry 324

## NEW SYSTEMS

**VersaBraille II**

**T**elesensory Systems has introduced the VersaBraille II system, a portable, disk-based electronic information processor for the blind. This braille computer lets you electronically store, process, and retrieve information. A special telephone modem can link VersaBraille II to other computers.

VersaBraille II consists of a standard 3½-inch micro-floppy-disk system and a braille display that substitutes for a video monitor. Its memory holds up to 30,000 characters; disk support boosts the unit's capacity to 77,000 characters. This is adequate for many word-processing procedures, such as formatting, high-speed searching, and inserting, deleting, and relocating text. The system can simultaneously output braille and print information.

VersaBraille II is fully programmable. Menus guide the user to each of the system's programs. The manufacturer provides special software that converts VersaBraille II into a four-function calculator with algebraic logic, floating decimal point, square root, and percent. Plans for other software packages include a 50,000-word spelling checker, a two-way braille translator, and a language interpreter.

The price of a VersaBraille II system is \$6995 plus shipping and handling. For more information, contact Telesensory Systems Inc., 455 North Bernardo Ave., POB 7455, Mountain View, CA 94039-7455, (415) 960-0920. Inquiry **615**.



HP's Series 300 technical workstation.

**Hewlett-Packard's Series 300**

**T**he Series 300 technical workstations from Hewlett-Packard expand the HP 9000 family. A modular design lets you choose the CPU, display, systems software, programming language, and peripherals.

For an entry-level to mid-range system, you can choose a 10-MHz Motorola 68010. If you require high-speed processor performance, a 32-bit 16.6-MHz 68020 is available. With both CPU configurations, you get 1 megabyte of RAM, expandable to 7½ megabytes.

Low-resolution display choices include two 12-inch monitors with 512 by 400 pixels in black and white or color. You can also choose a 19-inch color or 17-inch monochrome high-resolution monitor with a 1024- by 768-pixel display.

The Series 300 runs most Series 200 applications software. Packages are available for word processing, spread-

sheets, database management, project management, and graphics. You can choose an integrated word-processing/spreadsheet/database package or programs for electrical and mechanical engineering. BASIC 4.0, Pascal 3.1, and HP-UX are also available.

Peripheral options include digitizer tablets, mice, mass-storage subsystems, printers, and plotters. Two IEEE-802.3 standard cabling options allow linking up to 30 systems over a distance of 185 meters or up to 100 computers over a distance of 500 meters. Series 300 network software provides file transfer, file access, and directory access within the HP 9000 system.

Series 300 prices start at \$3500. A typical system ranges from \$5500 for an entry-level configuration to \$55,000 for a high-end system. Contact your local Hewlett-Packard sales office. Inquiry **616**.

**Micro Five AT-Compatible**

**M**icro Five's Series 5000 is compatible with the IBM PC AT. It features an 8-MHz 16-bit Intel 80286 and 150-nanosecond interleaved memory with no wait states. You can select 6- or 8-MHz 80286 operation. An optional 80287 numeric coprocessor is available.

DMA controllers let the hard-disk subsystem read and write a track of data on a single disk revolution. Average disk-access time is 30 milliseconds.

Available with the Series 5000 are MS-DOS 3.1 and XENIX 3.2, which supports up to 16 users. You can also get GW-BASIC 3.1 and a virtual-disk program.

The Series 5000 Model 100 has 512K bytes of memory, a 1.2-megabyte floppy-disk drive, an RS-232C serial port, a Centronics parallel printer port, a clock/calendar with battery backup, and an AT-compatible keyboard. The Model 200 has the same features plus a 27-megabyte formatted 5¼-inch hard disk. Both models have nine expansion slots.

Options include memory expansion to 2 megabytes on the motherboard and 15 megabytes for the system; disk-drive formatting capacities of 27, 45, 62, or 116 megabytes; 60-megabyte 5¼-inch streaming-tape backup; 360K-byte floppy-disk drive; and up to five three-port I/O cards.

Series 5000 list prices are \$3395 for the Model 100 and \$5215 for the Model 200. Contact Micro Five Corp., POB 5011, 3560 Hyland Ave., Costa Mesa, CA 92626, (714) 957-1517. Inquiry **617**.

(continued)



## ADD-INS

**FFT Coprocessor Card**

The Ariel PC FFT card performs fast Fourier transforms by executing a single program line in interpreted and compiled BASIC, IBM Pascal and FORTRAN, Lattice C, and Turbo Pascal. The card's disk-based assembly-language driver routines make the host/peripheral interface transparent to the user. PROM-resident algorithms include forward and inverse FFT, hamming window, and power spectral density.

The PC FFT transforms 16-bit integer data arrays of up to 2048 complex points in less than 20 milliseconds. The pipelined architecture lets you fit all the hardware necessary to perform complex signal-processing algorithms inside the computer. The PC FFT's low power consumption lets you install two or more FFT processors in a single host.

The PC FFT card plugs into the IBM PC, XT, AT, or compatible computers and costs \$1850. Contact Ariel Corp., Suite 84, 600 West 116th St., New York, NY 10027, (212) 662-7324. Inquiry **618**.

**Apple EPROM Programmer**

Apparat's Apple 28-pin Prom Blaster is a menu-driven EPROM programmer that will burn the following EPROMs: 2764, 2764A, 27128, 27128A, 27256, 27C256, and 27512.

The Prom Blaster has an edit function for the data buffer and can move system memory into the data buffer. It provides 12½- or

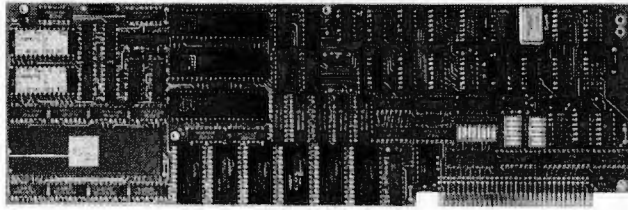

PC FFT coprocessor card from Ariel.

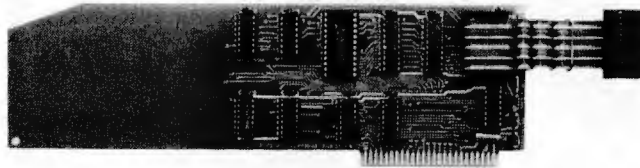

Writable ROM Board from Douglas Electronics.

21-volt programming voltage and +5 or +6 volts for  $V_{CC}$ .

The Apple 28-pin Prom Blaster is \$119. It requires 48K bytes of RAM and one floppy-disk drive. Contact Apparat Inc., 4401 South Tamarac Parkway, Denver, CO 80237, (800) 525-7674; in Colorado, (303) 741-1778. Inquiry **619**.

**Interface Breadboard for IBM, Commodore**

Group Technology has put together the BG-Board, an interface breadboard that lets you construct circuits and use BASIC programs to control the flow of information between a microcomputer and external devices. BG-Board provides access to your machine's data, control, and address buses so you can build interfaces for monitoring home appliances, analytical instruments, security systems, and so on.

Interface cards called CableCards let you use the BG-Board with an IBM PC, Commodore 64, or VIC-20. CableCards are also available for the TRS-80 Models

I, III, and 4 and the Apple II+ and IIe.

The BG-Board is buffered to protect the microcomputer if a wiring error occurs. It provides up to eight decoded address outputs in either the device- or the memory-addressing models. You can address up to 256 I/O devices by using BASIC software. A built-in logic probe permits detection of logic levels and pulse edges.

The Model BG-101A assembled interface breadboard for the IBM PC, Commodore 64, or VIC-20 sells for \$280; the Model BG-101K kit is \$205. For more information, contact Group Technology Ltd., POB 87, Route 1 Box 83, Check, VA 24072, (703) 651-3153. Inquiry **620**.

**Apple II Writable ROM**

The Writable ROM Board from Douglas Electronics lets an Apple II, II+, or IIe function as a 2K-byte

ROM. The board fits into an expansion slot on the Apple and connects to the ROM socket on a destination computer or device with a 12-inch 24-pin jumper cable.

To test a program, you use software to switch the WROM Board to its RAM mode, copy the program to the board, and switch the board back to ROM mode. The destination computer sees the program as on board in ROM. You execute the program by pressing the destination computer's reset button. For further editing, repeat the process. After you debug the program, a ROM is burned.

You can also use the WROM Board to program a 2816A EEPROM. When you program the EEPROM, you can place it in the destination computer's PROM socket, letting the remote machine function independently.

Model 5010-DE-12 Writable ROM Boards are \$95. Contact Douglas Electronics Inc., 718 Marina Blvd., San Leandro, CA 94577, (415) 483-8770. Inquiry **621**.

**Single-board 80286 Computer**

Transtec Technology's Hydra SBC is based on the Intel iAPX 286 microprocessor. It includes 1 megabyte of on-board RAM expandable to 4 megabytes, from 16K to 256K bytes of ROM, an on-board floppy-disk controller, an SCSI interface, four serial ports, and one bidirectional parallel port. An 80287 numeric coprocessor is optional.

Graphics resolution is as high as 1024 by 768 pixels. Graphics features include panning, smooth scrolling, and programmable character

ADD-INS

sizes or fonts. A 4-color display is standard; with an optional card, you can display 16 colors from a 4096-color palette.

The Hydra SBC's operating system is Concurrent DOS 3.3 with GSX. The board, with 512K bytes of memory and the operating system, sells for \$1500. Contact Transtec Technology, Unit 5, Ida Complex, Macken St.,

Dublin 2, Ireland; tel: 718521/719800. Inquiry 622.

**Videotaping Graphics Board**

**N**ew Media Graphics' PC-VideoGraph is an add-on board for the IBM PC, XT, and AT that allows videotaping of computer-gener-

ated graphics and text. The PC-VideoGraph has a 6845 microprocessor and 128K bytes of display memory. It runs IBM graphics and text-generation software and operates in a 640- by 400-pixel mode. The board can display 16 colors; with dithering, it can display up to 136 colors simultaneously.

Demonstration software and graphics libraries for

BASIC, Pascal, FORTRAN, and C are included. A light pen, mouse, touchscreen, and interactive paint and font software are among PC-VideoGraph's options.

Single-quantity price for PC-VideoGraph is \$695. Contact New Media Graphics Corp., 279 Cambridge St., Burlington, MA 01803, (617) 272-8844. Inquiry 623.

PERIPHERALS

**Bus and Modem Support for Integral PC**

**H**ewlett-Packard has introduced two options for its Integral PC: the HP 82904A bus expander and the HP 82915A 300/1200-bps modem.

The bus expander plugs into one of the Integral PC's two I/O ports with a 1-meter cable and expansion interfaces. It has its own power supply and provides five extra ports. Price for the bus expander is \$1295.

The serial modem is an asynchronous, full-duplex interface that features auto-dial and auto-answer modes. You install it in one of the Integral PC's I/O ports and can connect it to a telephone network with a standard modular jack. Built-in communications software lets you switch from 300 to 1200 bps, provides auto-dialing, and uses menu-driven configurations. The modem's protocol is UMODEM.

List price for the HP 82915A serial modem is \$595. Contact your local Hewlett-Packard dealer or sales office. Inquiry 624.

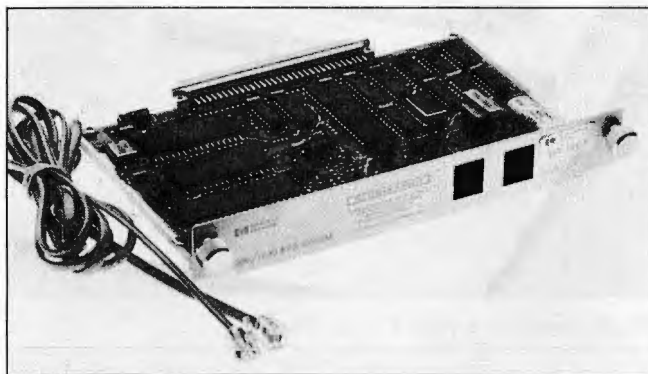

The HP 82915A modem for the Integral PC.

**MIDI Processor**

**H**inton Instruments' MIDIC is a MIDI processor that contains its own software in ROM. It has a MIDI 1.0 specified interface with an optoisolator for minimum data corruption and an RS-232C/423-compatible interface for connection to a computer. You can use the computer to select commands from a menu. MIDIC's expansion socket allows for software extensions or custom packages.

The MIDIC 1.1 software has two modes of operation. In the process mode, you can insert MIDIC in the data stream of a MIDI equipment setup and process the data as directed by the setups. All setups can be uploaded and down-

loaded between MIDIC and a host computer. In the interface mode, MIDIC can buffer and convert MIDI codes in 8-bit binary or ASCII hexadecimal format. Both modes permit automatic generation of active sensing clocks and MIDI timing clocks. Tempo is variable from 30 to 279 crotchets per minute.

MIDIC costs £300; with a battery backup, it is £350. For more information, contact Hinton Instruments, 168 Abingdon Rd., Oxford OX1 4RA, England; tel: Oxford (0865) 721731. Inquiry 625.

**Portable Battery and Case for Laptops**

**T**he Prairie Power portable battery system helps to extend continuous usage of laptop computers. LEDs on the charger indicate when the unit is charging and when the battery is full. The charging unit also allows for emergency power backup.

The battery is a sealed lead-acid unit that has Department of Transportation approval for air transport. Custom cables are included in the package.

Prairie Power's water-resistant carrying case (17 by 13 by 5 inches) features a removable insert panel that you can use as a laptop workstation. It holds the battery, charger, and computer, and it has a padded pocket with room for acoustic cups, cables, a small recorder, or 3½-inch disk drive.

The complete ensemble sells for \$169. Components are available separately. Contact Prairie Power Systems Inc., 768 Twelve Oaks Center, 15500 Wayzata Blvd., Wayzata, MN 55391, (800) 435-8721; in Minnesota, (612) 475-1793. Inquiry 626.

(continued)



## PERIPHERALS

**Interface for Home Control**

**X**-10's Powerhouse interface for the Apple IIe and IIc and the Commodore 64 provides automatic control of electrical devices in the home. It has its own 80C48 processor, on-board ROM, RAM chip, and real-time clock. Its battery backup can sustain the unit without AC power for more than 100 hours. X-10 Powerhouse sends signals over AC wiring to control up to 72 lights and appliances plugged into System X-10 modules, which are plugged into 120-volt outlets.

The interface comes with a home-control software package that uses a color-graphics interactive approach to programming. After you complete installation and programming, you can disconnect the Powerhouse from the computer. The interface will continue to run the control system according to the program.

The X-10 Powerhouse (interface, software, and connecting cable) retails for about \$120. Contact X-10 Inc., 185A Legrand Ave., Northvale, NJ 07647, (201) 784-9700. Inquiry 627.

**RS-232C to IEEE-488 Controller**

**T**he CmC RG interface lets any personal computer control the IEEE-488 bus. You can connect up to 15 IEEE-488 devices to one RS-232C port by using the interface. In the CmC RG's transparent mode, an IEEE-488 device looks like an RS-232C device to the computer.

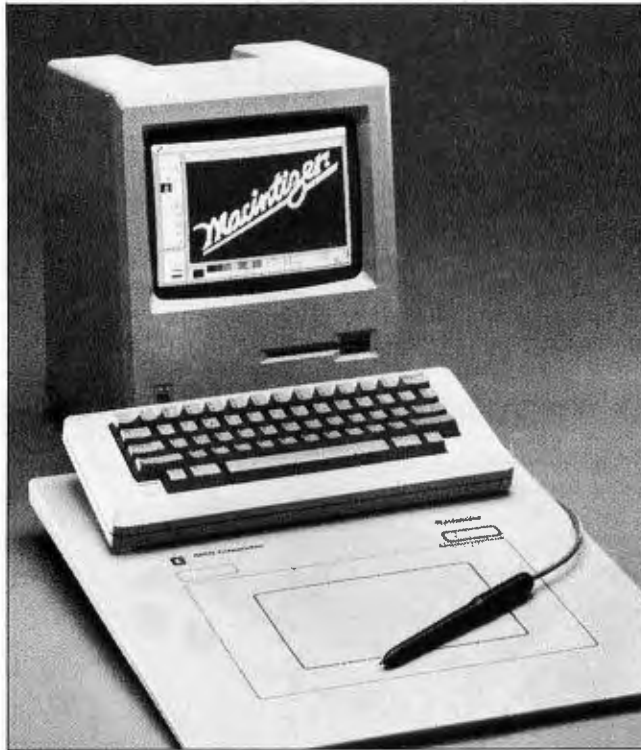

GTCO's Macintizer, a digitizer for the Mac.

You can configure this interface for talk and listen commands for all primary and secondary addresses. You can also use a talk-only mode with any listen-only device. The CmC RG understands simple ASCII commands and works with any computer language.

The CmC RG comes with case, power supply, and standard IEEE-488 and RS-232C connectors. The RG4 is for device number 4 only and costs \$495; the RGA supports devices 0 to 30 and costs \$695. Contact Connecticut microComputer, POB 186, Brookfield, CT 06804, (203) 354-9395. Inquiry 628.

**Macintosh Digitizer**

**T**he Macintizer from GTCO Corp. plugs directly into the Macintosh's mouse port and operates without any modification to the Mac's operating system or applications software. GTCO says this electromagnetic digitizer requires no preventive maintenance and will not skip (as a mouse can). It consists of an electronic work surface and a hand-held stylus.

The Macintizer works in an absolute coordinate mode, so pointing to the center of the tablet always puts the arrow in the center of the screen. You can use the digitizer to trace maps, drawings, and other non-metallic material. The Macintizer's surface has two work areas that provide a one-to-

one screen correspondence and a 33 percent reduction. An optional mouse cable is available.

The Macintizer sells for \$599. Contact GTCO Corp., 1055 First St., Rockville, MD 20850, (301) 279-9550. Inquiry 629.

**IBM PC Memory Machine**

**P**eachtree Technology's Memory Machine for the IBM PC is an external dual-drive subsystem that resides between the PC and its monitor. You can choose from several combinations of disk drives, including 5¼-inch Winchester drives, removable Winchester cartridge drives, and backup tape-drive systems. Various configurations provide up to 20 megabytes of fixed-drive and 60 megabytes of tape-drive capacity.

The Memory Machine contains a power supply, cooling fan, overload power-surge protector, and multi-function power director. Its five front-panel power switches and 15-amp three-prong connectors let you supply power to five other peripherals.

Sold as a kit, the Memory Machine's two drives, cables, and instructions cost \$3695. Contact Peachtree Technology Inc., 3020 Business Park Dr., Norcross, GA 30071, (404) 662-5158. Inquiry 630.

## Musical Speech System

The Voice Master is a digital speech/voice recognition system for the Apple II line, Commodore 64, or Commodore 128. But it's also a music-synthesis program that converts humming and whistling into a music score. The package consists of a hardware module, a headset/microphone, system software, and cables.

The system basically works as a digital tape machine, recording the user's voice as digital information and storing it in vocabulary files on a disk. Each file can contain up to 64 distinct words, sounds, or phrases. The user can control the recording rate, playback speed, and volume.

The accompanying Voice Harp program lets you compose music in real time by humming or whistling; it converts your vocal input into musical output. As you hum or whistle notes, they scroll by on the display in standard musical notation. In editing mode, you can play back and rearrange or change notes. In performance mode, you can change octaves and add chords. When you finish, you can save your composition and print out the score.

The Voice Master costs \$89.95. Sound Master, an optional plug-in card for the Apple II+ and IIe, provides three-part harmony and sound effects; it costs \$39.95. A Voice Master for the Atari 800XL, 65XE, and 130XE reportedly will be available soon. Contact Covox Inc., 675-D Conger St., Eugene, OR 97402, (503) 342-1271. Inquiry 631.

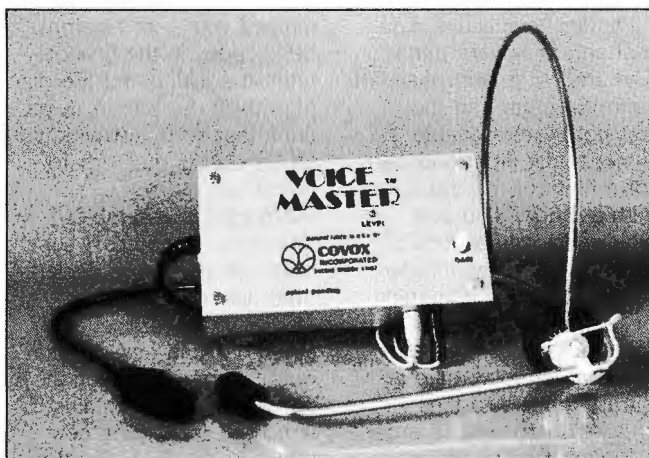

Covox's speech system for Apple IIs and Commodores.

## Knowledge Integration Toolkit

MacKIT Level 1, a program for the 512K-byte Macintosh, is designed to serve as an introduction to knowledge engineering and help you build expert systems. It features a backward-chaining inference engine, a production rule compiler, a question generator, and a graphics window.

You code your pertinent knowledge into production rules using English and a word processor (MacWrite will do). Employing a back-chaining method, MacKIT starts with conclusions, finds rules that support the conclusions, and tries to verify the premise by searching the knowledge base for relevant facts. The process continues until the conclusions are verified or disproved.

MacKIT is written in MacFORTH. It costs \$149. Contact Knowledge System Environments Inc., 201 South York Rd., Dillsburg, PA 17019, (717) 766-4496. Inquiry 632.

## Expert-Systems Building Tool for Mac

Expertelligence has developed a microcomputer version of OPS5, a tool for building expert systems. ExperOPS5 runs on the 512K-byte Macintosh and features a forward-chaining inference engine coupled with a pattern-matching algorithm. It also has an interface designed to provide complete access to ExperLisp, the vendor's LISP development environment for the Mac.

ExperOPS5 has a suggested retail price of \$325 and requires an add-on floppy-disk or hard-disk drive and ExperLisp software (\$495). Contact Expertelligence Inc., 559 San Ysidro Rd., Santa Barbara, CA 93108, (805) 969-7874. Inquiry 633.

## Mac Meets Juki

Juki's LetterPrint kit gives Macintosh users the option of sending output to Juki 6100 and 6300 letter-quality printers. The software is capable of driving MacWrite word-processing functions directly onto the Juki printer.

The kit contains a disk and instructions. It has a suggested retail price of \$75. A connector cable costs \$20 more. Contact Juki Office Machine Corp., Printer Division, 299 Market St., Saddle Brook, NJ 07662, (800) 932-0590; West Coast, (800) 325-6134; in California, (800) 435-6315. Inquiry 634.

## Alternatives for Iconoclasts

PBI Software's Icon Switcher lets you alter Macintosh icons or fashion ones of your own design. The program comes with 20 icons and a tutorial and has a suggested retail price of \$19.99.

PBI sells additional sets of icons at \$19.99 each. Icon Library #1 is a collection of business and utilities images. Icon Library #2 consists of "fun and games" icons. Icon Switcher can change the images in both libraries.

Contact PBI Software Inc., 1155B-H Chess Dr., Foster City, CA 94404, (415) 349-8765. Inquiry 635.

## Spelling Checker for Appleworks

Spellworks proofreads documents prepared with the Appleworks word-processing program. It has a 90,000-word dictionary and checks spelling at a rate of 10 words per second.

The spelling checker retails for \$49.95. Contact Advanced Logic Systems Inc., 1195 East Arques Ave., Sunnyvale, CA 94086, (408) 730-0306. Inquiry 636.

(continued)



## Scientific Subroutine Library

**W**iley Professional Software's BASICA Library consists of 114 pretested and precompiled mathematical and statistical subroutines. The subroutines perform tasks involving the most commonly used complex number operations in such areas as matrices with real or complex elements, polynomials, differential equations, analysis of variance, solution of equations, and general statistics.

BASICA Library comes on three disks containing source code, compressed source code, and test programs and results. System requirements are an IBM PC, XT, AT, or compatible with at least 128K bytes, a double-sided disk drive, and PC-DOS or MS-DOS 1.1 or later. The price is \$125. Contact Wiley Professional Software, John Wiley & Sons Inc., 605 Third Ave., New York, NY 10158, (212) 850-6788. Inquiry 637.

## Fourier Transforms with Graphics

**A**lligator Transforms has released a package that performs one- and two-dimensional Fourier transforms and displays the results graphically. Fourier Perspective can handle one-dimensional real or complex data sets up to 8192 points and two-dimensional arrays as large as 128 by 128. Reported typical times are 0.5 seconds for a 256-point 1-D transform and 11 seconds for a 64 by 64 2-D transform with an 8087 math coprocessor. The program can also plot individual rows.

Fourier Perspective plots real and imaginary parts. The amplitude and phase of both the input and the transform are available. Two-dimensional input and transform files can be displayed with a hidden line plot, which removes concealed segments, or a nonhidden line plot. No programming or compiling is necessary. The package contains utilities that let you create arbitrary input data files and checkerboard data in order to center the transforms in the frequency domain.

The software runs on the IBM PC, XT, AT, and compatibles and requires DOS 2.0 or later, at least 192K bytes of memory, two disk drives, and a graphics card. Options are a screen-dump utility and an 8087 math coprocessor. List price is \$99. Contact Alligator Transforms, POB 271505, Houston, TX 77277, (713) 665-3855. Inquiry 638.

## Table-based Cross-Assembler

**C**ross-8 from Universal Cross-Assemblers uses a flexible instruction-table structure to produce code for most microprocessors and microcontrollers with an 8-bit data word and an address word of 16 bits or less. You can specify the format of the hexadecimal machine-language file as Intel, Motorola, or Tektronix 8-bit format.

You can prepare the assembly-language source file using any ASCII text editor. Cross-8 ignores the most-significant bit of all ASCII characters. It selects the corresponding processor instruction file by using the CPU directive within the source code.

Assembly errors are

marked with 1 of 14 alphabetic codes in the first column of a listing and are displayed on the screen. A program that sorts instruction tables checks them for format errors.

Among the assembler directives that Cross-8 supports are processor declaration; define byte, data storage, and word; end of assembly; and hexadecimal output format declaration. A 30-page manual contains instructions for writing new tables or modifying existing ones.

Cross-8 is about 25K bytes long and requires 17 bytes per label and 35 bytes for each instruction in the table. For IBM PCs and compatibles with PC-DOS and MS-DOS 2.0 (or higher), at least 128K bytes of RAM is recommended; an Apple II+ or IIe with CP/M-80 needs at least 48K bytes. The program costs \$99.95 in U.S. funds and \$129.95 in Canadian. Contact Universal Cross-Assemblers, POB 384, Bedford, Nova Scotia B4A 2X3, Canada. Inquiry 639.

## Software Emulates Intel 8051 Family

**H**iTech Equipment's 8051SIM emulates Intel's 8051 family of microprocessors and provides some of the debug and test facilities of an in-circuit emulator. The menu-driven program accepts Intel .HEX files and features a "hex calculator" mode.

You initiate a typical session after the assembly of an 8051 program by invoking the emulator with the name of the object file. The display is formatted as several windows into the

central processor, and the main menu is displayed. You can single-step or trace (with breakpoints) your program while watching the effects on the screen.

The package is available for IBM PC XTs with PC-DOS and Z80 machines with CP/M for \$199. Contact HiTech Equipment Corp., 9560 Black Mountain Rd., San Diego, CA 92126, (619) 566-1892. Inquiry 640.

## BASIC Matrix Commands

**D**esigned to enhance BASIC on the IBM PC, Matrix 100 provides matrix-manipulation capabilities that you can call with a single statement for each operation. Besides the standard operations, the package has commands to invert matrices, solve equations, perform multiple regression, and obtain LU and QR factors.

Matrix 100 also has source code for an interactive linear programming package and an eigenvalue solver for real symmetric matrices.

According to Stanford Business Software, its program calculates up to 100 times faster than BASIC. In double precision, Matrix 100 with the optional 8087 support is reportedly 25 times faster than the standard package.

Matrix 100 runs on any IBM PC with BASIC or BASICA and at least 128K bytes of RAM (192K bytes is recommended). It costs \$80. With 8087 support, it costs \$125. Additional compiler support raises the price to \$250. Contact Stanford Business Software Inc., Suite 215, 4151 Middlefield Rd., Palo Alto, CA 94303, (415) 424-9499. Inquiry 641.

## SOFTWARE • OTHER COMPUTERS

**Locus of Root Solver**

**L**ocipro provides control-system and electronic engineers with a means of quickly determining closed-loop system stability from open-loop transfer functions. The stand-alone program solves the locus of roots for systems up to the 26th order and 10 loop elements.

Output data can be vectored to a line printer or to data files. All program inputs are free-format and menu-driven.

Locipro, priced at \$72.95, is available for PC-DOS, MS-DOS, CP/M-80, and TRSDOS machines in 121 different disk formats. Contact BV Engineering, Suite 207, 2200 Business Way, Riverside, CA 92501, (714) 781-0252. Inquiry **642**.

**Cross-Reference Generator**

**D**alsoft Engineering has developed a cross-reference generator that's designed to work with most programming languages. UCRF comes with configuration files for BASIC, C, Pascal, Modula-2, FORTRAN, COBOL, IBM Macro Assembler, and dBASE II. You can modify these files to accommodate specific language implementations or develop new files to support other languages.

UCRF accepts multiple input files from anywhere on disk and produces program and cross-reference listings with page numbers, user-defined title lines, and date and time stamp. Full directory and path support are provided for input and output.

The program can be operated either from the DOS

command line or activated from batch files to automate the compilation/assembly and listing of groups of program modules. UCRF handles symbol lengths of up to 128 characters and automatically folds long input lines.

Minimum system requirements are 128K bytes of RAM, one disk drive, and PC-DOS 2.0 or higher. UCRF costs \$39.95. Contact Dalsoft Engineering, 3565 High Vista, Dallas, TX 75234, (214) 247-7695. Inquiry **643**.

**Low-Cost Video Digitizer**

**A** video-digitizer system for the TRS-80 Color Computer and the Commodore 64 uses a composite standard NTSC video-input source—a video camera, video-cassette recorder, or videodisc player—to construct gray-level images in less than 5 seconds. The package, consisting of software, assembly plans, documentation, and a blank printed circuit board, costs \$39.95. You must supply the other components.

The Color Computer version provides a resolution of 256 by 192 pixels in selectable gray levels of three, five, or seven shades. The joystick and cassette ports are used for interfacing.

The Commodore 64 ver-

sion provides resolution of 160 by 200 pixels with gray levels of four, six, or eight shades. Interface is via the user I/O port.

Both versions are menu-driven. Brightness and contrast are adjustable.

Contact Kinney Software, Dept. B, 121 North Hampton Rd., Donnellsville, OH 45319, (513) 882-6527. Inquiry **644**.

**Design Tool for 68000, 68008**

**O** Orion Instruments has developed a disassembler/debugger program for products based on Motorola's 68000 and 68008. The package, called DDB68K, runs on Orion's Universal Development Laboratory (UDL).

UDL is a compact development system that integrates a 48-channel bus-state analyzer, an 8-bit and a 16-bit real-time emulator, an EPROM programmer, and a stimulus generator. The system interfaces with any MS-DOS or CP/M machine and enables software and hardware debugging of more than 30 processors.

DDB68K augments the trace-analyzer features of UDL with multiple breakpoints and single-step capabilities. Hexadecimal or binary files can be directly downloaded into the internal emulation memory of

UDL. The software permits the execution of a program from emulated memory or target-system memory (RAM or ROM) with the capability of memory patching.

The internal registers of a processor can be displayed or modified. A debugged program can be stored on disk or burned directly into an EPROM. The standard UDL supports operation of the 68000 up to 10 MHz; optionally, it can support up to 13 MHz.

DDB68K costs \$395. The standard UDL is \$2995. Contact Orion Instruments Inc., 6th Floor, 702 Marshall St., Redwood City, CA 94063, (415) 361-8883. Inquiry **645**.

**LISP Interpreter**

**C**LISP is a LISP interpreter written in C and running on MS-DOS systems. It has more than 40 built-in functions for list manipulation, arithmetic, and relational and Boolean operations. The package contains what Westcomp calls a "modest" library of LISP functions.

Complete source code for the interpreter is included (C86 by Computer Innovations was the compiler used). With the information in the manual, a user can add in almost any combination of functions, windows, graphics, and so on.

The package costs \$150 and consists of documentation, CLISP source code, run-time program, and LISP routines. Contact Westcomp, Suite 229, 517 North Mountain Ave., Upland, CA 91786-5016, (714) 982-1738. Inquiry **646**. ■

—Compiled by Dennis Barker and Lynne M. Nadeau

**WHERE DO NEW PRODUCT ITEMS COME FROM?**

*The new products listed in this section of BYTE are chosen from the thousands of press releases, letters, and telephone calls we receive each month from manufacturers, distributors, designers, and readers. The basic criteria for selection for publication are: (a) does a product match our readers' interests? and (b) is it new or is it simply a reintroduction of an old item? Because of the volume of submissions we must sort through every month, the items we publish are based on vendors' statements and are not individually verified. If you want your product to be considered for publication (at no charge), send full information about it, including its price and an address and telephone number where a reader can get further information, to New Products Editor, BYTE, 425 Battery St., San Francisco, CA 94111.*



# THE BUYER'S MART

## A Directory of Products and Services

THE BUYER'S MART is a new monthly advertising section which enables readers to easily locate suppliers by product category. As a unique feature, each BUYER'S MART ad includes a Reader Service number to assist interested readers in requesting information from participating advertisers.

**RATES:** 1x—\$350 3x—\$325 6x—\$300  
Prepayment must accompany each insertion.

**AD FORMAT:** Each ad will be designed and typeset by BYTE. Advertisers must

furnish typewritten copy. Ads can include headline (23 characters maximum), descriptive text (250 characters maximum), plus company name, address and telephone number. Do not send logos or camera-ready artwork.

**DEADLINE:** Ad copy is due 2 months prior to issue date. For example: December issue closes on October 1. Send your copy and payment to THE BUYER'S MART, BYTE magazine, 70 Main Street, Peterborough, NH 03458. For more information call Karen Burgess at BYTE 603-924-9281.

### ACCESSORIES

#### SOFTWARE PACKAGING, DISKS

Cloth binders & slips like IBM's. Vinyl binders, boxes, and folders—many sizes. Disk pages, envelopes, & labels. Low qty. imprinting. Bulk & branded disks. Much More! Low prices. Fast service. Call or write for FREE CATALOG.

**Anthropomorphic Systems Limited**  
376-B East St. Charles Road  
Lombard, IL 60148  
(312) 629-5160

Inquiry 702.

### ACCESSORIES

#### ADAPT-A-DISC \$19.95

With an ADAPT-A-DISC coupler, any economical disk drive compatible with the Apple II+ or IIe can be put to work as an EXTERNAL disk drive for the IIc.

**COMPUTER ACCENTS, INC.**  
P.O. Box 5307 / Kingwood, TX 77325  
(713) 664-9727

Inquiry 705.

### DISK CONVERSION

#### CONVERSION SERVICES

Convert any 9 track magnetic tape to or from over 200 formats including 3 1/2", 5 1/4", 8" disk formats & word processors. Disk to disk conversions also available. Call for more info. (312) 459-6010

**Pivar Computing Services, Inc.**  
★ ★ 47 W. Dundee Road ★ ★  
Wheeling, IL 60090

Inquiry 730.

### MAINTENANCE PRODUCTS

FOR THE MAINTENANCE & OPERATION OF COMPUTERS AND COMPUTER ROOM EQUIPMENT

CRT Cleaner • Hood Cleaner • Anti Static Keyboard Duster • Anti Glare • Print Off Internal Cleaner • Head & Disc Cleaner

**ROCKWELL CHEMICAL**  
22 JERICHO TURNPIKE — MINEOLA, N.Y. 11501  
516-742-0500

Inquiry 736.

### BOOKS / DISKS / VIDEOS

#### We Wrote THE BOOKS

"The Book of" series:  
The Book of KnowledgeMan (BK/DISK)  
The Book of KnowledgeMan vol. 2 (BK/DISK)  
The Book of R:base (BK/DISK)  
NEW! The Book of DOS-WINDOWS (disk only)  
-The best DOS manual, and its on disk!  
\$49.95 (+ 4 S&H + 2.50 in MA)  
VISA / MC / PO / CHK  
**ALL-HANDS-ON PRESS**  
3 Courthouse Lane — Chelmsford, MA 01824  
(617)-458-1130

Inquiry 734.

### CHANGING WORD PROCESSORS?

We convert to and from: XEROX, DEC, IBM, LANIER, WANG, PC-DOS, WORDSTAR, MULTIMATE, STRAIGHT ASCII, MICOM. Also most CP/M systems.

**LOWEST PRICE**  
**DATA CONVERSION INC.**  
6310 Caballero Blvd. • Buena Park, CA 90820  
(714) 522-7762 (800) 824-4851 in CA.

Inquiry 708.

### STANDS & COVERS

Quality, Selection & Low Prices

Acrylic Printer Stands 80/132 col T/B feed From \$29.95 + S&H  
Custom, Antistatic Vinyl PC & Printer Covers From \$10.95 + S&H

**SGW**  
P.O. Box 29249 San Diego, CA 92129  
619-755-8324

Inquiry 737.

### C LANGUAGE VIDEO

Want to learn the hottest new language? Use the best and most professional video training package! Complete 5 hour video production. Learn all aspects of C from basics through pointers.

**INTRO. OFFER \$495 (+ 12 S&H + 25 in MA)**  
(EXP. 9/6/85) VISA / MC / PO / CHK  
**ALL-HANDS-ON PRESS**  
3 Courthouse Lane — Chelmsford, MA 01824  
(617)-458-1130

Inquiry 735.

### DUPLICATING SERVICES

#### WESTERN TRANSDATA, INC.

Why risk duplicating your important programs on your computer, when our equipment is designed solely to duplicate disks & verify their perfection 100%? Over 600 formats. 3 1/2", 5 1/4" & 8". Plus serialization, copy protection, labeling, packaging, shrink-wrapping and fast, personalized service.

**WESTERN TRANSDATA, INC.**  
1701 E. Edinger Ave. A-7  
Santa Ana, CA 92705  
714/547-3383 (collect)

Inquiry 750.

### COMMUNICATION

#### BARR/HASP RJE ADD-ON BOARD

For use in IBM PC, PC XT, PC AT.  
Use as a 2400 LPM Printstation or 4800 BAUD Dial-Up Workstation.  
Supports MVS/SES, CDC/NOS, VM/RSCS.

**\$890**  
**BARR SYSTEMS, INC.**  
800-BARR-SYS or 904-371-3050

Inquiry 703.

### GRAPHICS SOFTWARE

#### ATTENTION ENGINEERS

Easy-to-use graphics software for the IBM PC, XT, AT, and compatibles. Full 2-D and 3-D screen graphing capabilities including contours. No programming needed! Interface to pen-plotter.

OMNILOT [S] ..... \$195  
OMNILOT [P] ..... \$195  
BOTH ..... \$295

**MICROCOMPATIBLES**  
301 Prelude Drive ★ Silver Spring, MD 20901  
(301) 593-0883

Inquiry 726.

### KEY TRONIC 5151 TEMPLATES

Keyboard overlays for the Key Tronic™ 5151 keyboard. A one-sided template with all the commands and functions controls to your favorite software like Lotus, WordPerfect 4.0, etc. Priced at \$14.20 each + \$1.80 shp/hdl

**INTERSTATE SOFTWARE, INC.**  
P.O. Box 40398 — Raleigh, NC 27629  
(919) 266-5608

Inquiry 718.

### CONTRACTS

#### FOR ENTREPRENEURS

Legal contracts for hardware/software developers. Employee agreement, non-disclosure form, contracts for sale (hardware and/or software), consulting, development, hardware & software maintenance, non-competition, project delivery & more.

**\$50** **Waters Publishing** **\$50**  
— 8235 Douglas — Suite 1000 —  
Dallas, TX 75225  
(214) 369-8108

Inquiry 748.

### BLANK FUNCTION KEY TEMPLATES

Write convenient commands next to your function keys on reversible plastic templates. Styles to fit IBM-PC, Compatibles, HP-150, Keytronic 5151, and others. Custom also available.

**\$4.95 Pkg. of 3 (Plus \$1 s&h)**  
**1-800-231-5413**  
In CA 1-800-523-5441

Free catalog of other helpful products available by circling number below on inquiry card.

Inquiry 707.

### THE DRAWING TABLET

Draw lines, circles, parallelograms, arcs. Paint with 100 different brush sizes in four shades. Block functions with the ability to replace, overlay, inlay. Save to disk or printer. Store symbols in libraries. Text capability. Only \$49.95 + 3.00 s&h.

**K SOFTWARE HOUSE**  
Rt. 2, Box 83B1 Unionville, TN 37180  
(615) 284-5090

Inquiry 720.

## GRAPHICS SOFTWARE

### GRAPHICS PRINTER SUPPORT

AT LAST! Use the PrtSc key to make quality scaled B&W or color reproductions of your display on any dot matrix, inkjet, or laser printer. GRAFPLUS supports all versions of PC or MS-DOS with IBM, Tecmar, and Hercules graphics boards. \$59.95

**Jewell Technologies, Inc.**  
4302 SW Alaska St., Suite 207  
Seattle, WA 98116  
(206) 937-1081

Inquiry 719

## HARDWARE

### POWERLINE GREMLINS?? POWER FAILURES??

The MEIRICK STANDBY POWER SYSTEM is the TOTAL SOLUTION to your powerline problems.  
240 watt system - \$365; 400 watt system - \$495;  
800 watt system - \$795

**MEIRICK Inc., POWER SYSTEMS DIV.**  
Box 298, Frisco, CO 80443 303-668-3251

Inquiry 725

## SOFTWARE

### RATS!

RATS is a fast, accurate & complete regression package with unsurpassed POWER. Has both time-series & cross section analysis. Includes Box-Jenkins, logit & probit. Spectral analysis & graphics also available. Requires 256K RAM, IBM PC or compatible. \$200. MC/Visa.

**VAR Econometrics**  
P.O. Box 19334, Minneapolis, MN 55419  
(612) 822-9690

Inquiry 747

## PLOTTER SOFTWARE

For the IBM PC or APPLE computer and the Hewlett-Packard or Houston Instrument plotter. The DGI Signmaker will make text slides for presentations. The DGI ORGANIZATION will graphically show your organization and quickly make updated charts.

**Decision Graphics, Inc.**  
P.O. Box 2776-B, Littleton, Colorado 80161  
Phone (303) 796-0341

Inquiry 709

## HARDWARE SECURITY

### SECURITY SAM

"BOLT-THROUGH-TABLE" LOCK SYSTEM provides high security for personal computers at low cost. Group keying, quantity and educational discounts available. Now for IBM PC, XT, AT, Apple II, & Zenith 150. Ideal for schools. Retail \$99.

**SAM SYSTEMS INC.**  
P.O. Box 2339 Hammond, Ind. 46323  
219-844-2327

Inquiry 738

## MY WORD!® is just \$35.00

Complete word processing plus sort, add rows & columns, mergeprint, quickprint, macros, math, micro-justify, use all 256 char. Source: add \$35. 150 page printed manual. **30-day money-back guarantee.** IBM PC or compatible, 128K, one drive, any printer.

**T.N.T. SOFTWARE, INC.**  
34069 Hainesville Road, Round Lake, IL 60073  
(312) 223-8595

Inquiry 745

## HARDWARE

### 1/2 IN. 9 TRACK COUPLER

READ and WRITE 1/2 in. magnetic tape with formatted 9 track drives. Runs all speeds and densities in PC, XT, & AT running MS-DOS or IBM XENIX. Data transfers up to 904K bytes/second. Couplers start at \$880. Complete sub-systems start at \$2995.

**Overland Data, Inc.**  
5644 Kearny Mesa Rd., Ste. A, San Diego, CA 92111  
(619)-571-5555 and TELEX 754923 OVERLAND

Inquiry 728

## SOFTWARE

### MILP88-MIXED INTEGER LP

A general-purpose system for solving mixed integer linear programs with up to 45 integers, 255 constraints 1255 variables. Solves problems by applying the branch and bound method. Menu-driven with many useful features similar to LP88. Requires 192K, \$99 with 8087 support, user's guide. VISA/MC.

(703) 549-5469  
**EASTERN SOFTWARE PRODUCTS, INC.**  
POB 15328, Alexandria, VA 22309

Inquiry 711

## PERSONAL RESEARCH STATISTICS

APPLE & IBM program will calculate totals, means (averages), standard deviations, medians, averages and much more. Calculates a least square linear regression when drawing scatter graphs. Data totals, displays, prints. \$198.00 VISA/MC/COD

CALL FOR FREE ELECTRONIC MAIL BOXES  
**SOFTWEST PROGRAMMING**  
4418 E. CHAPMAN - SUITE 155  
ORANGE, CALIFORNIA 92667  
TEL (714) 380-9437 • TELEX 6502502780 MCI • E-MAIL 250-2780

Inquiry 741

## ★ ★ MODEM SALE ★ ★

MAJOR BRANDS FOR IBM PC & APPLE IIe

Hayes compatible plug-ins:  
IBM 300/1200 baud ..... \$149 ..w/sw \$199  
APPLE 300 baud ..... \$ 79 ..w/sw \$109

### TRANSEND CORP.

For info: 408-435-0701  
To order: 1-800-227-2400 x959  
In CA: 1-800-772-2666 x959  
Credit cards accepted 30 day MONEY BACK GUARANTEE.

Inquiry 748

## LP88-Linear Programming

A powerful menu-driven system for solving linear programs w/ up to 255 constraints & 2255 variables. Features include interactive & batch operation, spreadsheet-style input & editing, storage of problems & bases, Simplex Algorithm restart, report generator, sensitivity analysis. Req. 192K. \$99 w/8087 support, user's guide. VISA/MC

**Eastern Software Products**  
P.O. Box 15328, Alexandria, VA 22309  
(703) 549-5469

Inquiry 712

## DATA REPORTER I

APPLE & IBM program can create any database. Manipulate data quickly and easily. No programming knowledge necessary. Data is processed in RAM and on disk. Sorts in less than 5 seconds. Search less than 3 seconds. \$99.00 VISA/MC/COD/CHECK

CALL FOR FREE ELECTRONIC MAIL BOXES  
**SOFTWEST PROGRAMMING**  
4418 E. CHAPMAN - SUITE 155  
ORANGE, CALIFORNIA 92667  
TEL (714) 380-9437 • TELEX 6502502780 MCI • E-MAIL 250-2780

Inquiry 742

## PROM/PAL BIPOLAR PROGRAMMER IBM PC

EPROM PROG—\$250, PAL OPTION—\$250,  
MP OPTION—\$100, BIPOLAR OPTION—\$350  
•MS-DOS, CPM-86 Software handles 2716 through 27256  
EPROM • 16, 20 and 24 pins BIPOLAR PROMS • From MMI,  
SIG. HAR. TI & AMD • 20 and 24 pins PAL from MMI, AMD,  
NAT & TI • Also 6741/48/49/51 MP

**Advanced Microcomputer Systems Inc.**  
2780 S.W. 14th St. • Pompano Beach, FL 33069  
(305) 975-9515

Inquiry 701

## ★ FORECASTING ★ MODELING ★ PLANNING ★

Compatible with IBM PC & Apple II  
**MICRO-BJ™** **NUAMETRICS™**  
• Box-Jenkins ARIMA • Econometrics package  
• Identify, estimate, forecast \$195.00  
\$295.00  
**XTRAPOLATOR™** **PROFESSIONALS CHOICE**  
• Automatic forecasting \$195.00 • Link to Lotus, Visicalc  
Multiple order discounts  
50% off Apple II orders

**STRATIX**  
P.O. Box 4413 • Burlingame, CA 94011  
(415) 697-0573 MC/VISA

Inquiry 743

## CP/M Calls from CB80

Access the FULL power of CP/M or MP/M direct from your CB80 prog. Execute BDOS or XDOS calls. Get such info as user or CP/M version number, time of day, directory, etc. BDOSMASTER consists of CB80 Basic code to be "INCLUDED" in your prog and a module for use by LK80. Complete package \$75.00.

**Practical Solutions, Inc.**  
134 S. Central Ave., Valley Stream, NY 11580  
FOR INFO. CALL 1-516-561-0566  
TO ORDER: 1-(800)-227-3800, ext. 983

Inquiry 732

## TURBOCHARGER FOR IBM

✓ Increases processing speed over 300%  
✓ Full software compatibility with PC and XT  
✓ Supports Intel 10 MHz 8087 coprocessor

**Everett/Charles® Marketing Services**  
6101 Cherry Avenue  
Fontana, CA 92335  
800-443-1860 Calif 800-821-0589

Inquiry 715

## TURN ON YOUR PRINTER

Eleven printer fonts and printer control menu. Includes Italics, Script, Correspondence. Optional Fonts Scientific, Russian, Greek and Hebrew (\$20 @). Okidata 92, 93, Epson FX80, 100, Star Micronics. MS-DOS, CPM-80. CUSTOM CHARACTER SET \$46.50

**WOODSMITH SOFTWARE**  
Rt. 3-Box 550A, Nashville, IN 47448  
(812) 988-2137

Inquiry 749

## PortaAPL

APL for the Macintosh is here!  
\$275 + \$10 S&H Demo \$10

**Portable Software**  
60 Aberdeen Ave. • Cambridge, MA 02138  
(617) 547-2918

Inquiry 731



# THE BUYER'S MART

## SOFTWARE

### CBTREE FOR C PROGRAMMERS

Provides enhanced file handling calls directly into C programs. Maintains balanced B-trees, supports unlimited number of keys, data records, and key lengths. Fast, Flexible, Efficient. No royalties. Source Code Included. **New Low Price: \$99**

#### PEACOCK SYSTEMS, INC.

2009 Hileman Road  
Falls Church, VA 22043  
(703) 893-0118

Inquiry 729.

## SOFTWARE

### FOOTNOTES FOR \$69<sup>95</sup>

Complete word processor for Apple II or IBM does automatic footnoting, alphabetical indexing, table of contents, etc. With optional spelling checker—\$99<sup>95</sup>. VISA or Mastercard. 15 day money-back guarantee.

#### SOF/SYS, Inc.

4308 Upton Ave. S., Minneapolis, MN 55410  
(612) 929-7104

Inquiry 740

## SOFTWARE

### ENHANCE YOUR PRINTER!!

Print in a variety of fonts and sizes with your Epson (or compatible) printer. Prints SIDEWAYS too. Great for letters, spreadsheets, . . . even signs and banners! Create your own fonts to print. DigiCon Print Package—\$49.95 (for IBM PC).

#### Digital Concepts, Inc.

P.O. Box 8345, Pittsburgh, PA 15218  
(412) 823-8314

Inquiry 710.

### Dr. HALO II \$139.00

Dr. HALO II, the paint program designed for business. Merge word processing files and graphics; draw, cut and paste, use 20 fonts to create your presentation/report. Runs on: IBM PCs, compatibles; most input devices, graphics cards and printers.

#### Media Cybernetics, Inc.

7050 Carroll Ave. • Takoma Park, MD 20912  
(301) 270-0240 (800) 446-HALO

Inquiry 724.

### HP-PC HYPER-CALCULATOR

MS-DOS emulation of HP-11C programmable scientific calculator available inside any program, permits data return. Program & data disk storage, indirect addressing, alpha prompts, printing, HELP, 100 registers, 1000 program steps, utility programs. \$39.95.

#### SUNDERLAND SOFTWARE ASSOCIATES

P.O. BOX 7000-64  
REDONDO BEACH, CA 90277  
(213) 540-2567

Inquiry 744.

### IBM DOS DEBUGGER WITH SOURCE

PC-Test Symbolic Debugger so friendly you hardly need the manual. Multi-window memory display, text file browse, port I/O, screen save, 16 breakpoints, loop breaker. With optional commented source novices can learn/developers can customize. \$39 or \$129 (w/SRC) + \$4 shipping.

#### AJM ASSOCIATES

10917 Northridge Square, Cupertino, CA 95014  
(408) 996-7249

Inquiry 700.

### dWINDOW for dBASE II

9K assembly language program adding windowing syntax to dBASE: create database windows—retrieve data full screen at a time—programmable window structure—256 character & color attributes—executable DOS commands under dBASE program control—\$185 + \$4 s&h.

#### LIBERTY BELL PUBLISHING

4640 SW Macadam Suite 150 Portland, OR 97201  
(503) 221-1806

Inquiry 723.

### PIK'r data editor

CONVERT Mainframe Reports! A very easy-to-use editor lets you scan ASCII report files and extract only the data you need. Data assembled and edited in full screen cut & paste environment, then written out for Lotus, dBASE, Multiplan, etc.

#### SAMKHYA Corp.

47 Sixth St., Suite 3  
P.O. Box 142, Petaluma, CA 94953  
(800) 442-0012 U.S. (800) 442-5544 CA

Inquiry 739

### PLEDGE REPORT for Churches/Fraternal Organizations

\* stores pledge amounts and payment increment \* calculates and prints a monthly delinquency list alphabetically \* maintains up to 20 separate accounts \* statements are formatted to a business-sized window envelope, ready for mailing \* statements may be cumulative or itemized, or any combination of both \* many more features \$495.00

DEMO PROGRAM—\$29.95 for more information write

#### CHILCOAT MICROWORKS

17813 Plumtree Lane, Yorba Linda, CA 92686  
(714) 528-5276

Inquiry 704.

### ► SCIENTIFIC CALCULATOR ◀

Pop-up emulation of the HP-11C plus direct insertion of results in foreground program, 17 digits, 512 program steps, number base conversions, and more. Mouse support included. 8087 or Standard versions \$49.95 + 3.00 s&h.

#### K SOFTWARE HOUSE

Rt. 2, Box 83B1 Unionville, TN 37180  
(615) 294-5090

Inquiry 721.

### PERSONAL FINANCIAL STATEMENT

THE PROGRAM'S UNIQUE FEATURE IS THE ABILITY TO USE THE PRINTOUT FOR LOAN APPLICATIONS. Use when submitting one's financial statement to a financial institution when applying for a mortgage loan, personal note, or installment loan. CPA Tested. IBM Version: \$88.00 Apple Version: \$68.00

#### KISS Computer Company

"Keep It Simple. . . Software™"  
P.O. Box 1341, Cape Coral, FL 33910  
813-481-2092

Inquiry 722.

## UTILITIES

### THE C UTILITY LIBRARY

Make C program development easy on PC & AT. 300 documented, tested functions: pop-up windows, fast graphics, data-entry, time/date math, much more. SOURCE (95% in C) included. NO ROYALTIES. Most compilers, memory models. \$185.

#### Essential Software, Inc.

P.O. Box 1003, Maplewood, N.J. 07040  
(914) 782-6605

Inquiry 714.

### THE GREENLEAF C FUNCTIONS

Library of over 200 C functions has every capability of the IBM PC for all popular C Compilers, all memory models. Strength in DOS, Disk, Printer, Color Text, Extended Keyboard, and Time/Date. Also has video effects, cursor, equipment interfaces, and serial I/O. \$185.

#### Greenleaf Software Inc.

1411 LaMay Drive, Suite 101, Dept. B, Carrollton, TX 75007  
(214) 446-8641

Inquiry 716.

### PC-Write™ Shareware

Fast, friendly, flexible word processor and text editor for IBM PC. Easy to use. Advanced features like macros, split screen, footnotes, mailmerge. Many good reviews, thousands sold. All software, manual on disk \$10. OK to copy! Register for full manual, support, source \$75.

Quicksoft (206) 282-0452 Visa/MC  
219 First N. #224J, Seattle, WA 98109

Inquiry 733.

### MEDIA MASTER PLUS

READ, WRITE, and FORMAT over 60 CP/M disks and run most CP/M-80 programs on your IBM PC! Two program package includes ZP/EM, a CP/M-80 emulator program that transforms your IBM PC into a 1-2 MHz CP/M 2.2 computer. \$59.95 + \$3.00 SH (CA 6%)

#### INTERSECTING CONCEPTS, INC.

4573 Heatherglen Ct. Ste. 10  
Moorpark, CA 93021  
(805) 529-5073

Inquiry 717.

### CROSS ASSEMBLERS with "UNIVERSAL" LINKER and POWERFUL LIBRARIANS for IBM PC MS-DOS

Full featured for most microprocessors

#### ENERTEC, INC.

BOX 1312, Lansdale, PA 19448  
215-362-0966

Inquiry 713.

### DATA ENTRY SYSTEM

Heads-down data entry with two-pass verification for the PC/XT/AT & compatibles. Loaded with features like: Auto dup & skip, verify bypass, range checks, & table lookups. Fully menu driven only \$395. Call for free 30 day trial period.

#### COMPUTER KEYES

6519 193 SW, Lynnwood WA 98036  
(206) 776-6443

Inquiry 706.

### UTILITIES

- Turbo-Plus™ (Version 3) \$59.95
- HardRunner™ \$39.95
- NoBlink/Accelerator™ \$39.95

TO FIND OUT MORE ABOUT OUR PRODUCTS  
SEE OUR ADD ON PAGE 113.

#### NOSTRADAMUS INC.

5320 South 900, East Salt Lake City, Utah 84117  
(801) 261-0769

Inquiry 727.

# What the world really needs is a 99 cent Double Sided, Double Density Diskette with a LIFETIME WARRANTY!

## And DISK WORLD! has it.

### Introducing Super Star Diskettes: the high quality diskette with the lowest price and the best LIFETIME WARRANTY!

In the course of selling more than a million diskettes every month, we've learned something: higher prices don't necessarily mean higher quality.

In fact, we've found that a good diskette manufacturer simply manufactures a good diskette...no matter what they charge for it. (By way of example, consider that none of the brands that we carry has a return rate of greater than 1/1,000th of 1 percent!)

In other words, when people buy a more expensive diskette, they aren't necessarily buying higher quality.

The extra money might be going toward flashier advertising, snazzier packaging or simply higher profits.

But the extra money in a higher price isn't buying better quality.

All of the good manufacturers put out a good diskette. Period.

#### How to cut diskette prices ...without cutting quality.

Now this discovery posed a dilemma: how to cut the price of diskettes without lowering the quality.

There are about 85 companies claiming to be "diskette" manufacturers.

Trouble is, most of them aren't manufacturers.

Rather they are fabricators or marketers, taking other company's components, possibly doing one or more steps of the processing themselves and pasting their labels on the finished product.

The new Eastman Kodak diskettes, for example, are one of these. So are IBM 5 1/4" diskettes. Same for DYSAN, Polaroid and many, many other familiar diskette brand names. Each of these diskettes is manufactured in whole or in part by another company!

So, we decided to act just like the big guys. That's how we would cut diskette prices...without lowering the quality.

We would go out and find smaller companies to manufacture a diskette to our specifications...specifications which are higher than most...and simply create our own "name brand" diskette.

Name brand diskettes that offered high quality at low prices.

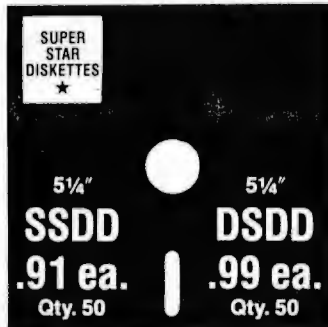

Super Star diskettes are sold in multiples of 50 only. Diskettes are shipped with white Tyvec sleeves, reinforced hubs, user ID labels and write-protect tabs.

**Boy, did we get lucky. Our Super Star Diskettes are the same ones you've been using for years...without knowing it.**

In our search for the low priced, high quality diskette of our dreams, we found something even more interesting.

We found that there are several manufacturers who don't give a hoot about the consumer market for their diskettes. They don't spend millions of dollars in advertising trying to get you, the computer user, to use their diskettes.

Instead, they concentrate their efforts on turning out the highest quality diskettes they can...because they sell them to the software publishers, computer manufacturers and other folks who (in turn) put their name on them...and sell them for much higher prices to you!

After all, when a software publisher or computer manufacturer or diskette marketer puts their name on a diskette, they want it to work time after time, everytime. (Especially software publishers who have the nasty habit of copy-protecting their originals!)

**Super Star Diskettes. You already know how good they are. Now you can buy them...cheap.**

Well, that's the story.

Super Star diskettes don't roll off the boat from Pago-Pago or emerge from a basement plant just east of Nowhere.

Super Star diskettes have been around for years...and you've used them for years as copy-protected software originals, unprotected originals. Sometimes, depending on which computer you own, the system master may have been on a Super Star diskette. And maybe more than once, you've bought a box or two or more of Super Star diskettes without knowing it. They just had some "big" company's name on them.

Super Star Diskettes are good. So good that a lot of major software publishers, computer manufacturers and other diskette marketers buy them in the tens or hundreds of thousands.

We buy them in the millions.

And then we sell them to you. Cheap.

**When every little bit counts,  
it's Super Star Diskettes.**

You've used them a hundred times...under different names.

Now, you can buy the real McCoy, the same diskette that major software publishers, computer manufacturers and diskette marketers buy...and call their own.

We simply charge less.

#### Super Special!

Order 50 Super Star Diskettes and we'll be happy to sell you an Amaray Media-Mate 50 for only \$8.75, shipping included...a lot less than the suggested retail price of \$15.95.

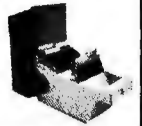

Regular DISK WORLD! price: \$9.69 ea.  
+ \$2.00 Shpng.

#### DISKETTE STORAGE CASES

##### DISK CADDIES

The original flip-up holder for 10 5 1/4" diskettes. Beige or Grey only.

\$1.65 ea. + .20 Shpng.

##### DISKETTE 70 STORAGE

Dust-free storage for 70 5 1/4" diskettes. Six dividers included. An excellent value.

\$11.95 ea. + \$3.00 Shpng.



#### HOURS:

Human: 8AM-6PM Central Time, Monday through Friday  
Answering Machine: 6PM-8AM, All Times  
MCI MAIL: 24 hours a day.

#### HOW TO ORDER:

##### ORDERS ONLY:

1-800-621-6827

(In Illinois: 1-312-256-7140)

##### INQUIRIES:

1-312-256-7140

**FOR FASTEST SERVICE, USE NO-COST MCI MAIL:** Our address is DISK WORLD!. It's a FREE MCI MAIL letter. No charge to you. (Situation permitting, we'll ship these orders in 24 hours or less.)

**SHIPPING:** 5 1/4" & 3 1/2" DISKETTES—Add \$3.00 per each 100 or fewer diskettes. **OTHER ITEMS:** Add shipping charges as shown in addition to other shipping charges. **PAYMENT:** VISA, MASTERCARD and Prepaid orders accepted. **COD ORDERS:** Add additional \$3.00 special handling charge. **APD, FPO, AK, HI & PR ORDERS:** Include shipping charges as shown and additional 5% of total order amount to cover PAL and insurance. We ship only to United States addresses, except for those listed above. **TAXES:** Illinois residents, add 8% sales tax.

**MINIMUM ORDER:** \$35.00 or 20 diskettes.

#### The Super Star LIFETIME WARRANTY!

Super Star Diskettes are unconditionally warranted against defects in original material and workmanship so long as owned by the original purchaser. Returns are simple: just send the defective diskettes with proof of purchase, postage-paid by you with a short explanation of the problem, and we'll send you the replacements. (Incidentally, coffee stained diskettes and diskettes with staples driven through them don't qualify as "defective".)

**WE WILL MEET OR BEAT ANY NATIONALLY ADVERTISED PRICE ON THE SAME PRODUCTS AND QUANTITIES SUBJECT TO THE SAME TERMS AND CONDITIONS.**

# DISK WORLD!, Inc.

629 Green Bay Road  
Wilmette, Illinois 60091



# CCT-4 SYSTEM SERIES

The latest CCT implementation of the new generation Intel 16-Bit Processor technology. This means extreme speed, unequalled power, and the ultimate in reliability, and of course, the innovators at CCT behind it.

This series in the CCT line exploits the speed and power of the Intel 80286 and Zilog Z-80H (8MHz), on the 286Z CPU board. This combination, along with CompuPro DMA controllers and I/O boards, yields a dramatic improvement in system throughput speeds, from basic CP/M operation, up to large powerful multi-user/multi-tasking machines. The CCT-4 represents the most advanced hardware presently available in a microcomputer to run the thousands of CP/M type software programs on the market, and with CONCURRENT DOS 8-16 and the CompuPro PC Graphics board (when available), all software written for the IBM PC machines. This series is for the serious business/scientific user.

**CCT-4A** State-of-the-art power in it's basic form. Consists of CCT-286Z CPU board and CCT-M256 (256K), along with CompuPro: Enclosure 2 Desk (21 slot MF), Disk 1A, System Support 1, Interfacer 4, the CCT-2.4 floppy drive system, and CP/M 80 and CP/M 86, and with SF-200 surge suppressor system. . . . . **\$5,495.00**

**CCT-4B** Single-user/hard disk power. As the 4A, except priced without the CCT-2.4, to add in your choice of CCT hard/floppy combination drive subsystem, at the published pricing. . . . . **\$4,375.00**  
 (Example: CCT-4B Mainframe with CCT-10/1 = \$6,548.00) Plus cost of selected drive subsystem

**CCT-4C** Multi-user/hard disk power. As the 4B, with the CCT-M512 (512K static RAM board) instead of M256; Interfacer 3 instead of Interfacer 4; SF-400 instead of SF-200, plus Concur. DOS 8-16 O.S. (6 user system) . . . . . **\$6,075.00**  
 (Example: CCT-4C Mainframe with CCT-40/1 = \$9,248.00) Plus cost of selected drive subsystem

**NEW RAM BOARD**

**Limited Time Offer - FREE Supercalc 86 with any CCT-4**

The above systems include all necessary cabling, assembly, testing, minimum 20 hour burn-in, and the CCT unconditional 12 month direct warranty.

**CCT-M512** CCT introduces it's 512K static RAM board. IEEE Standard 12MHz. 512K in one slot! **Introductory Price: \$1,799**  
**CCT-M256** 256K version of M512 upgradeable to full 512K. Perfect 256K RAM board for any CompuPro system . . . . . **\$949**

**CUSTOM COMPUTER TECHNOLOGY / BOX 4160 / SEDONA, ARIZONA 86340**  
**TOLL FREE ORDERING: 800-222-8686 / For technical support / service: 602-282-6299**



## SUNTRONICS CO., INC.

12603 Crenshaw Blvd., Hawthorne, CA 90250

1-800-421-5775 (Order Only)  
 (213) 644-1140 (CA Order & Int'l)  
 STORE HOURS  
 Mon - Fri 9 a.m. to 6 p.m.  
 Sat 10 a.m. to 5 p.m.

TERMS VISA MASTERCARD C.O.D. (Cash or Certified Check Required) Check (Allow 2-3 Weeks for Clearing) Shipping & H.C \$3.00 for 3 Lbs. plus 50c for each add'l Lb. Calif. residents add Calif. Sales Tax \$10.00 Minimum Order IBM and Apple are registered trade-marks of IBM & Apple

### SUN-XT COMPUTER (IBM PC/XT COMPATIBLE)



- RAM EXPANDABLE TO 640 K
- USES MS & PC-DOS OPERATING SYSTEMS
- RUN LOTUS 1-2-3, FLIGHT SIMULATOR, SYMPHONY, DBASE II & III, AUTO CAT, WORD STAR, MULTIPLAN . . . ETC.
- (DOES NOT RUN PROG. REQUIRE ROM BASIC.)

- CPU BOARD W/256 K RAM
- COMPUTER CABINET
- FULL FUNCTION KEYBOARD
- 135 W/POWER SUPPLY
- 2 DSDD DISK DRIVES
- FDC W/CABLE
- TTL MONITOR (AMBER OR GREEN)
- MONOCHROME GRAPHICS CARD W/PARALLEL PRINTER PORT. (IN KIT VERSION)

**ONLY \$959.00**

**DEALER & OEM INQUIRES INVITED!!**

**SUN-XT CPU**

- 8088 CPU (8087 OPTION)
- RAM EXPANDABLE TO 640K
- FULLY IBM COMPATIBLE
- DIMENSION SAME AS IBM PC/XT
- NO RAM INCLUDED

**\$195.00**

**FLOPPY DISK CONTROLLER**

- STANDARD DOUBLE SIDE DOUBLE DENSITY
- RUN 2 INTERNAL & 2 EXTERNAL
- WITH CABLE

**\$59.00**

**IBM STYLE CABINET**

- 8 SLOT BACK PANEL
- COMES WITH MOUNTING BRACKET & HARDWARE
- FITS IBM POWER SUPPLY

**\$59.00**

**COLOR GRAPHIC CARD**

- RGB & COMPOSITE VIDEO
- 640 x 200 HIGH-RES
- 320 x 200 LO-RES
- 80 x 25 TEXTMODE
- LIGHT PEN INTERFACE

**\$99.00**

**"SAM SUNG" MONOCHROME MONITOR**

- 12" AMBER OR GREEN
- 1000 LINES AT CENTER
- 20MHZ BAND WIDTH
- SEPARATE TTL SIGNAL INPUT
- DUAL INTENSITY SIGNAL LEVEL
- HIGH PERFORMANCE SHARP IMAGES

**\$105.00**

**MONOCHROME GRAPHIC CARD**

- HIGH-RES CHARACTER 720(H) x 348(V)
- 80 x 25 TEXT MODE
- RUN LOTUS 1-2-3 ETC.
- WITH PARALLEL PRINTER PORT

**\$149.00**

**MULTI-FUNCTION BOARD**

- RAM EXPANDABLE TO 384(0 K)
- SERIAL/PARALLEL PORT
- CLOCK CALENDAR W/BATTERY BACKUP
- GAME PORT
- SPOOL & RAM DISK

**\$159.00**

**MULTI-I/O BOARD**

- FLOPPY DISK DRIVE CONTROLLER
- PARALLEL PRINTER PORT
- SERIAL I/O PORT (OPTION: DUEL)
- CLOCK CALENDAR W/BATTERY BACKUP
- GAMEPORT

**\$169.00**

**RGB COLOR MONITOR**

- 14" DISPLAY 08-9 CONNECTOR
- 640 x 240 HIGH-RES
- 2500 CHARACTERS (80 x 32)
- RGB TTL LEVEL, INTENSITY SIGNAL
- 0.39 mm DOT PITCH
- H-SCANNING 14.5K-17.8KHZ

**\$365.00**

**FULL FUNCTION KEYBOARD**

- 83 KEY FULL FUNCTION
- POWER, CAPS, NUM LIGHT INDICATOR
- MECHANICAL TYPE SWITCH
- WITH CABLE

**\$79.00**

**135W POWER SUPPLY** **\$97.00**

**150W POWER SUPPLY** **\$119.00**

**MONO GRAPHIC (w/o PARALLEL P.P.)** **\$99.00**

**10MB HARD DISK w/CONT** **\$495.00**

**20MB HARD DISK w/CONT** **\$699.00**

**ABYNC RB232** **\$59.00**

**PARALLEL PRINTER CARD** **\$39.00**

**TEAC 55B DISK DRIVE** **\$89.00**

**HARD DISK DRIVE CONTROLLER (10MB OR 20MB)** **\$199.00**

**64K RAM KIT (9 EA)** **\$8.50/KIT**

**256K RAM KIT (9 EA)** **\$39.00/KIT**

**APPARAT EPROM BLASTER (FOR IBM)** **\$129.00**

**CITIZEN MSP-10 PRINTER** **\$319.00**

**TOHIBA 1340 PRINTER** **\$599.00**

**DSDD 5 1/4 DISKETTE** **\$13.95/per 10 ea**

**PARALLEL PRINTER CABLE** **\$15.00**

**TOLL-FREE  
ORDERING:  
800-222-8686**

# CCT<sup>®</sup> CUSTOM COMPUTER TECHNOLOGY

**FOR TECHNICAL SUPPORT/  
SERVICE / IN ARIZONA:  
602-282-6299**

**1 CCT PLAZA — P.O. BOX 4160 — SEDONA, ARIZONA 86340**

Purchase your Hardware and Software directly from an OEM / Systems Integrator. Take advantage of our buying power! We stock a full line of Board Level Components, Software and Peripherals. Call for your needs. We'll give you the Lowest Prices, and the Technical Support and Know-How we are quickly becoming well-known for. Satisfied Customers Nationwide. The Nation's Custom Systems House for Business, Education and Science. Call for a system quote. CCT implements tomorrow's technology today!

**• FOREMOST QUALITY • ADVANCED SUPPORT • REASONABLE COST •**



## \$ ACROSS THE BOARD PRICE REDUCTIONS \$

### INDUSTRIAL GRADE SUPERIOR QUALITY **CCT DISK DRIVE SYSTEMS** ROLLS ROYCES OF THE INDUSTRY

#### S-100 HARD DISK SUBSYSTEMS

Professionally engineered ST-506 type systems for the business market S-100 Computer user. Includes industry top quality drives, CompuPro Disk 3 DMA controller, all cabling, A&T, formatted, burned-in. Provisions for up to two hard disks in each system. We include operating system update. CP/M 80, CP/M 86, CP/M 8-16, MP/M 8-16, CP/M 68K. (1 Systems are CCT innovated hard/floppy combinations, with Mitsubishi DSDD 8" drive.) 12 month warranty.

CCT-10 (11 + MEG) .....	\$1499	CCT-10/1 .....	\$2049
CCT-20 (22 + MEG) .....	\$2019	CCT-20/1 .....	\$2569
CCT-40 (36 + MEG) .....	\$2499	CCT-40/1 .....	\$3049
CCT-60 (58 + MEG) (New) .....	\$3699	CCT-60/1 .....	\$4249
CCT-90 (87 + MEG) (New) .....	\$4909	CCT-90/1 .....	\$5459
CCT-125 (123 + MEG) (New) .....	\$6099	CCT-125/1 .....	\$6649

### **NEW** 10 MEG REMOVABLE CARTRIDGE DRIVE SYSTEM for hard disk back-up — DMA using Disk 3 controller. Super fast/Ultra reliable — Available April

**80286 NOW!**  
□ **CCT-286Z** is our model designation for the **MI-286** dual processor board from **Macrotech**. It features the super high speed combination of Z-80H and 80286, with provision for the 80287 math chip. Directly replaces 8085/88 and 8086 CPUs running CP/M, MP/M Concurrent DOS, and MS-DOS, at throughput increases of 3X to 5X!  
**SPECIAL PRICE-\$895**  
**80287 Option - Installed - \$250**

**SEE THE CCT-4 SERIES USING THIS BOARD DETAILED ON THE FACING PAGE**

**NEW—TRUE IBM PC INTERFACE ULTRA HI-RES GRAPHICS!**  
CCT S-100/PC is a break-through for the Science/Business user. Mini-enclosure accepts PC & compatible boards and directly connects to your S-100 system, running PC-DOS or Concurrent DOS. Hercules™ Graphics System—Coming this May!  
**!! THE BEST OF BOTH WORLDS !!**

**LIBERTY TERMINALS**  
• Superior Reliability •  
110-14" GREEN-80/132 Column .... \$499  
110-14" AMBER ..... \$519  
200-14" GREEN-80/132 Super Deluxe \$569  
200-14" AMBER ..... \$589

**OKIDATA PRINTERS - Top Quality**  
82 - 80 Col. .CALL 83 - 132 Col. .CALL  
92 - 80 Col. .CALL 93 - 132 Col. .CALL  
84 - 132 Col/200cps—Top of the line. .CALL  
For Serial Interfaces—Add.....CALL

**TOSHIBA P351 - 288 CPS/24 PIN - \$1499**  
**DIABLO — Letter Quality Series**  
Model 620 .. \$969 Model 630 .. \$1799  
**WE HAVE ALL SOFTWARE—CALL**

Prices & availability subject to change. All products new, and carry full manufacturer's warranties. Call for catalog. Free technical help to anyone. All products we sell are CCT individually tested and set up for your system - Plug-In & Go! Arizona residents add sales tax. CCT<sup>®</sup> Trademark — Custom Computer Technology; MS-DOS<sup>®</sup> Trademark — Microsoft; IBM<sup>®</sup> Trademark — International Business Machines; CompuPro<sup>®</sup> Trademark — W.J. Godbout; CP/M<sup>®</sup> MP/M<sup>®</sup> Trademarks — Digital Research; HERCULES<sup>™</sup> Trademark — Hercules Computer Technology

**FLOPPY SYSTEMS**  
**CCT-2.4 • Dual 8" DSDD**  
Mitsubishi 1.2 Megabyte in Extra Heavy horizontal enclosure, removable filter air system, all cabling, A&T, Burned in. The fastest system available: ..... \$1229  
**CCT-5 • 5 1/4" DSDD**  
IBM Compatible Tandon 320K. Extra Heavy Cabinet accommodates two drives, hard or floppy. All cabling, A&T, Burned-in. Perfect for our PC-DOS Package .... \$399  
**CCT-8/5 • FULL IBM COMPATIBILITY**  
One Mitsubishi 8" DSDD (1.2 Meg)/One 5-1/4" DSDD (360K) IBM Drive  
Both 3ms step rate — For Concurrent DOS and PC DOS ..... \$1029

**★ SUPER PRICES ★ COMPUPRO COMPONENTS ★ IN STOCK ★**  
CPU-Z - \$229 • Disk 1A - \$399 • Disk 1A w/CP/M - \$499 • CPU 8086/10 - \$359 • SPU-Z - ?  
CPU 8085/88 - \$229 • CPU 286 - \$849 • CPU 68K - 10Mhz - \$359  
PC Graphics - \$399 • Disk 3 - \$459 • RAM 22 (256K) - \$1179 • RAM 23/64K - \$279/128K - \$469  
**NEW → M-Drive/H - 512K - \$469 / 2 Meg - \$1989**  
Enclosure 2 Desk - \$699/Rack - \$749 • Interfacer 3 - \$409 • Interfacer 4 - \$289 • System Support 1 - \$299  
Concurrent DOS 8-16 (CCTCMX) - \$309 • CP/M 80 (CCTHMX) - \$125 • CP/M 86 (CCTTMX) - \$175  
CP/M 8-16 (CCTTMX) - \$199 • CP/M 68K (CCTCX) - \$279 • Operating System Updates/Remakes - \$30  
**16 Bit Upgrade Kit: CP/M 86, RAM 23, System Support 1, Cable \$729 □ CP/M 8-16 - Kit - \$753**

**CCT-1 — ENTRY LEVEL S-100 BUSINESS SYSTEM**  
• Enclosure 2-Desk-21 Slot Mainframe • • CCT-2.4-Dual 8" Mitsubishi  
• CPU 8085/88 - 6Mhz 8085/8Mhz 8088 • DSDD Drive System - 2.4 Megabytes •  
• Disk 1A - DMA Floppy Disk Controller • • CP/M 80 - 2.2 HMX - CCT Modified •  
• RAM 23 - 64K Static RAM - 12Mhz • • All Cabling, Complete CCT Assembly,  
• Interfacer 4 - 3 Serial/2 Parallel I/O • Testing, and Minimum 20 Hour Burn-in •  
**RUNS ALL STANDARD 8" CP/M SOFTWARE - INCLUDES OUR EXCLUSIVE 12 MONTH DIRECT WARRANTY**

**SPECIAL PRICE**  
**\$3,375**



# MEGA-BOARD™-XT

**#1 CHOICE OF MAJOR OEM MANUFACTURERS, UNIVERSITIES, RESEARCH LABS ETC.** A THOROUGHLY FIELD PROVEN DESIGN. HIGH VOLUME PRODUCTION ENGINEERED.

- **FULL IBM PC-XT\* COMPATIBILITY!**
- **FULL MEGA-BYTE RAM CAPACITY ON MOTHERBOARD!**

**THOUSANDS SOLD WORLD WIDE!**

**DEALERS AND OEM MANUFACTURERS QUANTITY DISCOUNTS AVAILABLE**

**Standard Keyboard Interface**  
(Full PC compatible)

**Hardware Reset**  
(Overcomes reset flaw in PC)

**Eight Compatible I/O Interface Connectors**  
(Full PC compatible)  
(compatible with all IBM-PC\* plug-in cards)

**Power Connector**  
(Full IBM\* pinout compatible)

**Special J1 Interface**  
(Allows horizontal mounting of compatible expansion cards for easy bus expansion and custom configuring) (Board has 62 pin gold plated compatible connector)

**8088 Processor**  
(Same as PC)

**8087 Numeric Processor**  
(Same as PC)

**Peripheral Support Circuits**  
(Same as PC)

**Extended ROM Capability**  
(Runs all compatible PC ROMS) (Jumper programmable to accommodate all popular 8K, 16K, 32K and 64K ROM chips and NEW EE ROMS! VPP power pin available for EP ROM burning!) (External VPP voltage required)

**Configuration Switches**  
(Same as PC)

**Speaker/Audio Port**  
(Same as PC)

**Wire Wrap Area**  
To facilitate special custom applications!

**Full Mega-Byte Ram Capacity! On board!**  
(With parity)  
 256K Bytes using 64K chips  
 1 Mega Bytes using 256K chips

**Only \$499.95**  
Fully Socketed and Assembled  
256k RAM

Mega-Board™ Triple-tested, fully socketed and assembled with IC's.

Includes highest quality PC board with gold plating, silk screen, solder mask

**Board Size** 10.5 inch X 13.5 inch

*MegaBoard Products On Display at the following locations:*

Hawaiian Industrial Instruments  
1154 Fort Street Mall, Suite 200  
Honolulu, Hawaii 96813  
808 533-4132  
Electronics Projects Inc.  
30 Airport Blvd  
Mobile, Alabama 36608

**FREE OFFER**

**FREE!** Displaytel™ Exclusive. Our Commitment to Microcomputer Education!

**FREE** Intel 8088 Data Book with each Mega-Board™ Order!

**ORDER NOW!!!** Fast, friendly service

**CALL: 214-607-1DTC**



**Immediate shipment!**  
Most instock items shipped same or next day!

10 Day money back guarantee if not completely satisfied!

**DTC™** DISPLAY TELECOMMUNICATIONS CORPORATION

InterFirst Place  
8445 Freeport Parkway, Suite 445  
P.O. Box 27  
Irving, Texas 75062  
(214) 607-1382  
Telex 510600176 DTC UD

\*IBM and IBM PC are trademarks of International Business Machines

©1984 Display Telecommunications Corporation

# 8051

# 8048

**SIMULATORS - CROSS ASSEMBLERS - PROGRAMMERS - SIM51 and SIM48** Software Simulators run on IBM-PC, CP/M-80, MS-DOS. Designed for validation & debugging application software. Simulation includes all on chip functions plus expansion chips. \$250, one year **FREE** updates. Formats: PC-DOS 2.x DSD, CP/M-80 8" SSSD, many 5 1/4" formats. Cross Assemblers and EPROM pgms also available. **Logical Systems Corp.** 6184 Teall Station, Syr., NY 13217. (315) 457-9416.

**Logical Systems**

Inquiry 221

## Advanced DOS Utilities

- PF - is an execution profiler/analyzer
- ATTRIB - status/set/reset file attributes
- CAP - "caps" a pipe (eg. sort < file-x ' cap file-x)
- DFREE - displays free disk space on current drive
- DUMP - is a hex dump utility (for printing, quickly)
- DKNUM - displays number of diskettes needed to 'hold' file(s)
- KEYBUF - expands keyboard buffer for type-ahead
- LOCATE - finds file(s) in file system
- MFREE - displays next available and total available memory
- MOVE - renames file(s) into another directory
- TAIL - displays last lines in file
- TD - displays current time and date (for .BAT files)
- TEE - "tees" a pipe (eg. sort < file-y : tee z > file-y)
- TREE - displays tree diagram below current directory
- WAIT - delays execution for specified interval
- XCOPY - is an advanced version of DOS copy (for archiving)

Most utilities are recursive. Each has been tested under DOS 2.x/3.x (including DOS 3.1) on the IBM\* PC/XT/AT

The price for all 16 utilities, postpaid, is **\$59 for unprotected binaries** (sources are available) **\$10 for manual only**

For quickest response, order with VISA/MC by calling

**800-621-2283 ext 912**

In TX: 800-442-5321 ext 912

Or send check/money order to address below.

TX orders add 6 1/8% sales tax

**PC Network Specialists, Inc.**

Dept. B59, 13109 Chandler Drive  
Dallas, TX 75243  
214-373-2386

Inquiry 287

## DISKETTE CONVERSION

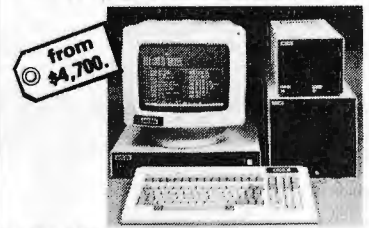

### DISCON

Solve your PC compatibility problems with DISCON, the complete turnkey system with CPU, software, terminal and four disc drives.

DISCON can format, read and write hundreds of MS-DOS and CP/M 8", 5 1/4" and 3 1/2" floppy diskette formats. Programs, data bases and documents can be transferred directly disc-to-disc.

Pacifica Technology  
11696 Sorrento Valley Rd., Suite A  
San Diego, CA 92121  
619-453-2945

Inquiry 283

## Fantastic Price! NASHUA DISKETTES

**FIVE YEAR WARRANTY**

# 75¢

each  
Qty. 100

5 1/4" SS/DD or DS/DD, your choice, with hub ring and Tyvek sleeve, bulk packaged, no labels. Shipping extra. For quantity 50, add 10¢ each.

**Get the same low price our high-volume duplication customers get!**

**CALL TOLL FREE  
1-800-321-4668**

in Colorado, 303-234-0871

ALF Products Inc. • Denver, CO

## "KING OF THE ELECTRONICS JUNGLE"



**LEO ELECTRONICS, INC.**  
P.O. Box 11307  
TORRANCE, CA 90510-1307  
PHONE 213/212-6133 or  
outside CA: 800/421-9565  
TLX: 281 985 LEO UR  
FAX: 213/212-8106

### WE WILL BEAT ANY PRICE ON MEMORY EXPANSION CHIPS

UPGRADE YOUR IBM OR OTHER PC WITH MORE RANDOM ACCESS MEMORY.

RAMS	EACH	SALE PRICING:
41256-150ns	4.25	If these prices are not the lowest in this publication, we will meet any legitimate* price. <small>*Confirmed prime chip pricing on quality merchandise</small>
4164-150ns	1.20	
4164-200ns	1.10	
4128-150ns (IBM/AT)*	6.75	
HM6116P-3	2.50	

EPROMS AND MATH CO-PROCESSOR CHIPS		WE NOW CARRY:		
2708	\$2.80	27128	\$4.50	Disk drives, power supplies, 384K Multifunction boards, Color/graphics boards, and more <b>CALL FOR BROCHURE</b>
2716	2.80	27256	8.00	
2732	3.00	8087	CALL	
2764	3.30	80287	CALL	

\*IBM - Trademark of International Business Machines  
We accept checks, VISA, MasterCard, PlusCard, Discover, from qualified banks, and credit cards. If it's finally called "Call for C.D. Cash/credit cards. 4825" in the shipping order, add \$5.00 for ground and \$5.00 for air. All major manufacturers. All parts 100% guaranteed. Pricing subject to change without notice.  
**CALL FOR LOWEST PRICING.**

Inquiry 215

## Robot Experimenter™

The only monthly magazine dedicated to designing, constructing, and using personal and educational robots.

Experimenter's will find all the diagrams and software necessary to construct their own robots.

Early issues contain articles on inexpensive infrared ranging systems, single-chip microcomputer controllers, simple pneumatic control systems, voice & vision systems, and AI program design techniques for microcomputers.

Subscribe now and receive our introductory rate of \$18 for 12 issues (offer good until 1 October 1985).

To subscribe, send name and address along with \$18 in check or money order. If you prefer to use MasterCard or Visa, include your card number and expiration date.

174 Concord St., Suite 31  
PO Box 458  
Peterborough, NH 03458-0458  
603/924-3B43

Inquiry 317

## SCIENTISTS! IBM PC & APPLE II USERS

Dramatic advances are being made in scientific tools for personal computers. Jandel Scientific specializes in software and peripherals for:

- Planimetry, digitizing
- Interactive Statistics
- Dynamic System Simulation
- Computer-generated lecture Slides
- And more...

Call us and let our technical advisors help you find the product you need. Or write or call for our **FREE** catalog.

**CALL TOLL-FREE 800-874-1888  
IN CALIF. CALL 415-331-3022**

**Jandel Scientific**  
2656 Bridgeway, Sausalito, CA 94965.

Inquiry 198

# DISKS

AS LOW AS **58¢** SS/DD BULK

Made by top USA makers, not "low-end" or "cut-rate". Our suppliers won't let us to reveal their names, but when you receive them you'll recognize them as premium disks that sell for much more! Certified, guaranteed 100% error free. **MONEY BACK GUARANTEE!** Lifetime replacement warranty! **FAST 48 HOUR SHIPPING!**

**BOXED WITH SLEEVE AND LABEL:**  
 5000 SS/DD-35K (Apple) 10/72¢ea, 100/70¢ea, 500/67¢ea  
 5000 SS/DD-Standard 10/74¢ea, 100/80¢ea, 500/77¢ea  
 5000 DS/DD (IBM, etc) 10/91¢ea, 100/83¢ea, 500/86¢ea

**BULK, NO SLEEVE/LABEL/BOX:**  
 5000 SS/DD-35K (Apple) 100/64¢ea, 500/61¢ea, 1000/58¢ea  
 5000 SS/DD-Standard 100/74¢ea, 500/71¢ea, 1000/68¢ea  
 5000 DS/DD-(IBM, etc) 100/83¢ea, 500/80¢ea, 1000/77¢ea

**IC SALE! 27128 \$3...4116-200 16/\$2...780A-P10, S101, 2 #2**

Pay by MC-Visa-Amex-ODD or send check with order. Include \$3 for shipping & handling +\$2 if COD. On ALL orders include daytime phone & street address. Minimum order \$15. Money-back 30 day satisfaction guarantee!

**TOLL FREE (800)343-0472** IN MASS: (617)UNI-TECH™  
**UNITECH** 208 HURLEY ST. CAMBRIDGE, MA 02141  
 Send for **FREE CATALOG** listing 1000's of items!

Inquiry 375

## PRINTER RIBBONS

Lowest Prices! Highest Quality! In Stock!

Ribbon Type (Prices are per Ribbon)	Qty 6*	Qty 12*
Apple Imagewriter & OMP	4.50 ea.	3.95 ea.
BMC-BX-80	6.50 ea.	5.95 ea.
C. Itoh Prowriter	4.50 ea.	3.95 ea.
Diablo Hytype II M/S	3.75 ea.	3.75 ea.
Diablo 630 M/S	3.75 ea.	3.75 ea.
Epson RX-FX-MX-80	3.50 ea.	3.50 ea.
Epson RX-FX-MX-100	5.50 ea.	4.95 ea.
Epson LQ 1500	7.75 ea.	6.95 ea.
Gemini 10-10X-15-15X	1.95 ea.	1.45 ea.
Nec 5500/7700 M/S	3.75 ea.	3.50 ea.
Nec 8023A	4.50 ea.	3.95 ea.
Okidata 80/82/83/92/93	1.95 ea.	1.45 ea.
Panasonic KXR-P1090/91/92	8.50 ea.	7.95 ea.
Radio Shack DMP-2100	6.95 ea.	6.50 ea.
Tally Spirit 80 M/S	6.50 ea.	5.95 ea.
Toshiba P1340/1350	6.95 ea.	6.50 ea.
Tritel	5.50 ea.	4.95 ea.

**FREE Shipping on orders \$50 + in Continental U.S.**  
(add 3.95 under \$50 order)

Visa M.C.

Order toll FREE 1-800-821-5339

**C.R.E. Wholesale**

P.O. Box 361 North Salt Lake, Utah 84054  
 (801) 531-7139

Inquiry 49



**PURCHASE ORDERS  
& BID REQUESTS  
WELCOME**

# Compu\$ave

**Call Toll Free: 1-800-624-8949**

**WE ACCEPT MAJOR  
CHARGE CARDS**



**ARIZONA RESIDENTS CALL (602) 967-3532**

## PRINTERS

<b>ABATI</b>	
LQ20 .....	215
All Other Models .....	CALL
<b>CITIZEN</b>	
MSP10 .....	250
MSP15 .....	365
All Other Models .....	CALL
<b>EPSON</b>	
LX80 .....	215
All Other Models .....	CALL
<b>JUKI</b>	
6100 .....	355
6300 .....	668
All Other Models .....	CALL
<b>PANASONIC</b>	
1090 .....	170
1091 .....	235
1092 .....	348
All Other Models .....	CALL
<b>SILVER-REED</b>	
EXP 400 .....	228
All Other Models .....	CALL

### CALL FOR PRICES

- ABATI
- AMDEX
- ANADEX
- CIE
- C. ITOH
- COMREX
- DATA PRODUCTS
- DIABLO
- NEC
- OKIDATA
- QUME
- STAR MICRONICS

**TRACTORS, SHEET FEEDERS,  
SWITCH BOXES, INTERFACES &  
BUFFERS ALSO AVAILABLE**

## MODEMS

<b>ANCHOR</b>	
Singleman Express .....	248
Volkmodem .....	CALL
<b>HAYES</b>	
1200/External .....	355
1200B/IBM (W/Software) .....	355
All Other Models .....	CALL
<b>PROMETHEUS</b>	
Promodem 1200/External .....	300
All Other Models .....	CALL
<b>CALL FOR PRICES</b>	
• AST	• QUBIE
• NOVATION	• RACAL-VADIC
• VEN-TEL	• US ROBOTICS

## SUPER SPECIAL

### TOSHIBA P351 DOT MATRIX PRINTER

- 288 cps
- 100 cps NLQ
- 4K Buffer
- IBM Compatible



**UNLIMITED SELECTION OF DOWNLOADABLE FONTS**

**Tractor and Sheet Feeder..... CALL**

## COMPUTERS

<b>ALTOS</b>	
586-40 Multiuser System .....	6295
All Other Models .....	CALL
<b>IBM</b>	
PC W/256K/1 Drive .....	1520
All Other Models .....	CALL
<b>WYSE</b>	
WY 1100-1 PC/2 Drives .....	1305
All Other Models .....	CALL
<b>CALL FOR PRICES</b>	
• APPLE	• TELEVIDEO
• COMPAQ	• ZENITH

## BOARDS

<b>AST</b>	
Six Pac Plus W/64K .....	219
Advantage W/128K .....	380
All Other Types .....	CALL
<b>HERCULES</b>	
Color Card .....	143
Monochrome Graphics Card .....	290
All Other Types .....	CALL
<b>ORANGE MICRO</b>	
Grappler + .....	70
All Other Types .....	CALL
<b>PARADISE</b>	
Multi Display Card .....	192
All Other Types .....	CALL
<b>QUADRAM</b>	
Quadboard W/OK .....	180
All Other Types .....	CALL

### CALL FOR PRICES

- ABM
- AMDEK
- CARDCO
- STB
- MICROTEx
- MPC
- PERSYST
- MICROSOFT

## TERMINALS

<b>ALTOS</b>	
AL II .....	759
AL III .....	590
<b>AMPEX</b>	
210 G .....	355
230 G .....	442
<b>QUME</b>	
QVT 101 G .....	293
QVT 102 G .....	413
All Other Models .....	CALL
<b>TELEVIDEO</b>	
914 .....	539
All Other Models .....	CALL
<b>WYSE</b>	
WY 50 .....	428
WY 75 .....	564
All Other Models .....	CALL

### CALL FOR PRICES

- ADDS
- ALLOY
- CIE
- C. ITOH
- DIGITAL
- HAZELTINE
- VISUAL
- ZENITH

## DISK DRIVES

<b>FLOPPY AND HARD DRIVES FOR APPLE, IBM AND COMPATIBLES</b>	
• ABATI	• MITSUBISHI
• NEC	• ALPHA OMEGA
• AMDEK	• QUADRAM
• APPLE	• QUBIE
• AST	• RANA
• RODINE	• CONTROL DATA
• CORVUS	• SEAGATE
• GAMMA	• TALLGRASS
• IOMEGA	• TANDON
• MICROSCI	• TEAC
<b>LOW PRICES..... CALL</b>	

## MONITORS

<b>AMDEK</b>	
300-G/Monochrome .....	116
310-A/Monochrome .....	142
Color 300/Composite .....	201
All Other Models .....	CALL
<b>PRINCETON</b>	
MAX-12/Monochrome .....	168
HX-12/RGB Color .....	448
All Other Models .....	CALL
<b>TAXAN</b>	
121-G/Monochrome .....	119
122-A/Monochrome .....	124
All Other Models .....	CALL

### CALL FOR PRICES

- APPLE
- COMREX
- IBM
- ZENITH
- SAMSUNG
- TELEVIDEO
- WYSE
- QUADRAM

## ACCESSORIES

<b>CABLES</b>	
Shielded Printer Cables .....	17
All Other Types .....	CALL
<b>DISKETTES</b>	
Bonus SS/DD (Qty 50) .....	45
Bonus DS/DD (Qty 50) .....	57
Verbatim SS/DD (Qty 50) .....	77
Verbatim DS/DD (Qty 50) .....	97
Maxell .....	CALL
IBM-AT, Apple Macintosh .....	CALL

## WE ALSO CARRY

- RAM And Coprocessor Chips
- Power Supplies And Backups
- Power Surge Protectors
- Houston And Other Plotters
- Kurta And Other Digitizers
- Key Tronic And other Keyboards
- Printer And Other Stands
- SOFTWARE-ALL TYPES**
- LOW PRICES..... CALL**

**ORDER LINE HOURS: MONDAY-FRIDAY, 8AM-6PM/SATURDAY 9AM-2PM**

Send Orders & Payments To: CompuSave, 3010 S. 48th Street, Suite 8, Phoenix, AZ 85040.

For Customer Service & Other Information Call Mon-Fri (602) 967-3533.

Prices reflect a cash discount of 3% to 5%. Prices and availability are subject to change without notice. Merchandise is shipped in factory cartons with manufacturer's warranty. Minimum shipping charge is \$4. Pay by wire, cashier's check, money order, or charge. Business or personal checks delay shipment 2 weeks. CompuSave is a Division of Adlanko Corporation. (85-9)

# ATTENTION BERNOULLI BOXERS

Give your IOMEGA a Boot!

**FIXT/B PLUS for  
IBM AT, XT, PC and compatibles**

FIXT/B PLUS gives you the utility of a bootable hard disk while preserving the performance of your Bernoulli Box. You can have it all with FIXT/B PLUS!

**Golden Bow Systems**

\$95-\$110  
Add \$3 for shipping/handling  
California residents add 6% sales tax



3386 Second Ave., Suite F  
San Diego, CA 92103  
(619) 298-9349

Inquiry 159

# NEC PRINTERS

Pinwriter P-2 (180 cps) .. \$ 485  
(w/Interface & Tractor)  
Pinwriter P-3 (180 cps) .. \$ 685  
(w/Interface & Tractor)  
Pinwriter P-5 (290 cps) .. \$ 925  
(w/Interface & Cut Sheet Guide)  
ELF 360 (16 cps) .. \$ 380  
2010/15/30/50 (20 cps) .. \$ 605  
3510/15/30/50 (35 cps) .. \$ 960  
8810/15/30/50 (55 cps) .. \$1365  
Optional Forms Handling  
Devices .. CALL

**QUALITY PRINTERS**  
8415 Cement City Rd.  
Brooklyn, Michigan 49230  
Phone: 517-592-3749

Inquiry 305

# TERMINAL EMULATION

**Softerm PC** emulates over 30 popular terminals including the:

- DEC VT102, VT220
- Data General D200, D410
- IBM 3101-20 (block mode)
- Hewlett-Packard 2622A
- Honeywell VIP7801, VIP7803

**Guaranteed Compatibility**

Call for free product brief  
\$195 MC-VISA-COD  
For the IBM PC/XT/AT, DG1, NEC,  
Wang PC, TI Pro, Gridcase, Tandy

## SEIFTRONICS

3639 New Getwell, Suite 10  
Memphis, TN 38118  
901-683-6850

Inquiry 336

## Use the Power of Your Computer

... to automatically look up city, state and county information based on zip code. Table of 48,000 zips allows significant savings on data entry, error corrections and file maintenance. This set of floppy disks, including easy instructions, is just \$149. Most popular 5 1/4" and 8" formats are available. Hard disk required. Call or write for free information.

### DCC Data Service

1990 M Street, N.W., Suite 610  
Washington, D.C. 20036  
202-452-1419

Inquiry 111

## EPROM PROGRAMMER



APROTEK 1000  
ONLY

**\$265.00**

COMPLETE WITH  
PERSONALITY  
MODULE

117 AC POWER-RS232  
-6 BAUD RATES - HANDSHAKE TO HOST  
**ALLOWS READ, WRITE, VERIFY & COPY**

Comes complete with CPM, IBM and Apple BASIC Driver Program Listings. Driver Programs on Disk only \$20.00.

Programs the following 5 Volt 24 or 28 pin devices: 2716 series through 27256, 25xx series, 68764 plus others. Please Specify Personality Module desired with order. Additional Personality Modules only \$15.00 ea. Full 1 year warranty.

TO ORDER: CALL 1-800/962-5800 OR WRITE

### APROTEK

1071-A AVENIDA ACASO  
CAMARILLO, CA 93010  
Info: (805) 987-2454

Add \$4.00 Shipping-USA  
VISA or MC Add 3%

Inquiry 23

## PC/TEK 4010

■ EM100-4010 for IBM PC, XT, AT

- Tektronix 4010 emulation
- VT102 emulation **\$249**
- Picture files
- High resolution hardcopy
- Supports IBM, IBM Enhanced, Hercules and Tecmar

■ EM100 for IBM PC, XT, AT

- VT102 emulation **\$149**
- File Transfer
- 132 Column modes
- Color Support

**FREE VT220 UPDATE**



**Diversified Computer  
Systems, Inc.**

3775 Iris Ave., Suite 1B  
Boulder, CO 80301  
(303) 447-9251

Trademarks: VT100 - Digital Equipment; IBM PC, XT - IBM Corp.

Inquiry 121

## RS-232 to RS-422A CONVERTER

For  
Under  
**\$50!**



- Allows your RS-232 Equipment to communicate with devices using RS-422A
- Two converters can extend RS-232 signals up to 4,000 ft.
- Bi-directional, uses 12 volts

ORDER NOW! Model 422C \$49.95  
Optional power supply \$14.95. Cash orders shipped postpaid. IL Res. add 6% sales tax. Visa and MasterCard accepted. Satisfaction Guaranteed. FREE fully illustrated newly revised catalog of interface & testing equipment. Phone: 815-434-0846

**B & B electronics**  
MANUFACTURING COMPANY  
P.O. Box 1008B, OTTAWA, IL 61350

Inquiry 31

## FINALLY! "No-Stretch" Viewing ANGLED PRINTER STAND

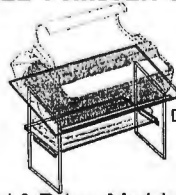

Deluxe Model

Standard & Deluxe Models available  
Deluxe fits over Disk Drive  
80/132 column available  
Priced from \$21.95

### COMPUTER MEDIA MARKETING

Dept. B-9 P.O. Box 614  
Katy, Texas 77492  
713/392-2385

Dealer Inquiries Welcome

Inquiry 81

## NEW AN I/O™ AP-8 Analog Interface for your APPLE II

**Versatile  
Accurate  
and Fast**



### FEATURES:

- Programmable 8-bit A/D conversion up to 50 KHz
- Programmable 8-bit D/A conversion up to 100 KHz
- Programmable 1-bit circuit or time output
- Variable input arrangement for AC coupled, DC coupled, or resistor scaled input
- Precision instrumentation amp with variable gain at input
- Precision sample and hold for A/D conversion
- Versatile five pole variable bandwidth filter for anti-aliasing input, and independent five pole variable bandwidth output filter for accurate waveform reconstruction
- Disk software with high speed IO routines, storage scope, FFT power spectrum, function generator, and more

### IDEAL for:

- Acoustic signal sampling and synthesis
- Educational tool for teaching digital signal processing and active filtering techniques
- Research in digital processing of speech, telecommunication, and bio-information studies
- And many other real-world interface needs for Apple II, II+, and IIC Computers

INTRODUCTORY OFFER  
**\$299.00**  
(including software)

FOR ORDER OR INFO  
Please Contact  
**CANETICS, Inc.**  
P.O. Box 70549  
Pasadena, CA 91107  
(818) 584 0438

Offer good until  
October 15, 1985 REG \$349.00

Inquiry 418



# DISK WORLD! is proud to introduce the lowest-priced, LIFETIME-WARRANTY diskettes ever!

## And they're BRAND NAME PRODUCT to boot!

### 5.25" SSDD → .79 ea. 5.25" DSDD → .89 ea.

### 5.25" DSDD-HD → \$2.35 ea.

### 3.50" SSDD → \$2.25 ea. 3.50" DSDD → \$2.65 ea.

Based on multiples of 100 each.  
Boxed in 10's with heavy-duty cardboard sleeves, user ID labels,  
reinforced hubs (where appropriate) and write-protect tabs.

#### Introducing Wabash Pinnacle Series Diskettes.

Two years ago, if you'd told me I'd be writing this ad, I would have laughed.

At that time, Wabash diskettes were synonymous with "s---t".

Just saying that quality control was poor would be charitable.

So much was wrong that DISK WORLD wouldn't sell them.

#### That was yesterday.

Kearney-National Inc., a \$202-million division of a much larger company, came into Wabash.

Out went the old management, the old methods, the old production techniques... and in went a lot of new people, ideas, production lines and some really imaginative thinking.

#### The end result.

Today, I'm proud to offer you the Wabash Pinnacle Series of diskettes at the prices shown.

This isn't evolution in diskette manufacturing: it's revolution.

#### Here's what you get.

- Wabash Pinnacle diskettes are
- ...certified 100% Error Free
- ...are covered by a LIFETIME WARRANTY
- ...meet or exceed all industry specifications (by quite some distance)
- ...and are simply the best value in diskettes available today.

#### The torture test.

Considering Wabash's earlier dubious reputation, I wasn't exactly a true believer when their Director of Marketing came into my office with samples.

So I took a box at random, selected a disk, bent the thing every which way and slipped it into my IBM-PC.

It formatted. It booted. It stored and retrieved data.

#### That wasn't enough.

I gave samples of the diskettes to Curt Rostenbach and, in turn, to Tom Streit, both hackers of long experience and members of the Waukegan (Illinois) Apple Users Group.

Tom really went at it.

He took a quartz-halogen lamp, aimed it at the diskette until it started to smoke (and melt)... and then formatted, booted the diskette and stored and retrieved data!

The same terribly (and intentionally) mutilated diskette ran on an ITT, Corona and IBM.

Curt was nicer.

He simply bent the diskette every which way... and it still formatted, booted and ran on his Apple.

#### The best buy I've ever seen.

DISK WORLD!, Inc. sells more flexible magnetic media by mail-order than anyone else in the world.

I, as President of the corporation, won't tolerate a product with a failure rate of more than 1/1000th of 1 percent.

I also don't like companies who try to milk a "quality" or "premium" image for a higher price like Dyan and Verbatim did... until they failed.

As President of DISK WORLD!, Inc., my motto is simple: "the best diskette for the least amount of money."

#### Wabash is it.

Right now, there is no better value than the Wabash Pinnacle Series of diskettes.

Granted, you have to buy a hundred at a time, but so what? Split the order with friends, relatives, co-workers or even your worst enemies.

The key thing is to get the most diskette for the money. And this is it.

(Incidentally, as a corporation, we put our money where our

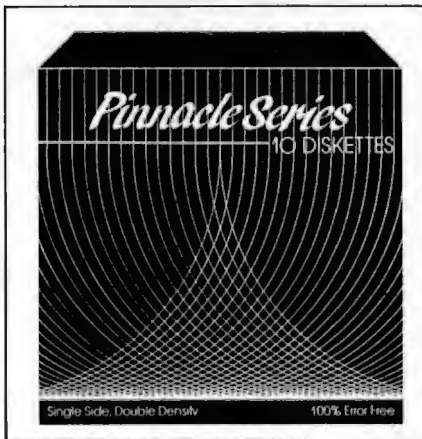

mouth is. Our first order for Wabash Pinnacle Diskettes was 1.5-million units.)

That's an awful lot of faith and confidence. But, then again, I have the diskette that Tom Streit literally melted... and kept on running.

#### The truth about \$1.00 or less diskettes.

More and more ads are popping up offering diskettes for \$1.00 or less.

By the same token, more and more people who were selling used cars a few months ago are now selling diskettes by mail.

We did a little survey of current ads for diskettes advertised for a dollar or less and did some analysis of the market and here's what we found as it applies to 5.25" DSDD diskettes "supposedly" selling for a dollar or less.

VENDOR:	ADVERTISED LOW PRICE:	ACTUAL PRICE PER 100:	ACTUAL MFGR.:
Unitech	.89 ea.	.92 ea.	Unspecified.
Datatech	.99 ea.	.99 ea.	Unspecified.
Computer Club	.95 ea.	.98 ea.	Unspecified.
	.99 ea.	1.02 ea.	Unspecified.
Communications & Electronics	.49 ea.	.80 ea.	Unspecified.
Precision Data	.89 ea.	.93 ea.	Unspecified.
Diskette Connec.	.93 ea.	.93 ea.	Unspecified.
Comp Soft Serv.	.77 ea.	.77 ea.	Unspecified.
		+ shpg.	
Computer/Computer	.99 ea.	.99 ea.	Unspecified.
DISK WORLD	.89 ea.	.92 ea.	Wabash Datatech

#### The real truth about \$1.00 or less diskettes.

It costs all diskette manufacturers about the same to produce a diskette. Some may charge more because they want to project a "premium quality" image, ala the late, lamented Dyan who bought their basic media from 3M.

Some charge less because they sell a sub-standard product... and we're not foolish enough to name names here.

But here's the truth about the \$1.00 or less diskette market.

It falls into four categories:

1. The DISK WORLD's of the universe who simply are so big that they can buy first quality product in massive quantities and choose to pass on the savings to you. (Precision Data and Diskette Connection on BRAND NAME products also fall into this category.)

2. The people who buy "cosmos"...stuff from major manufacturers that usually hits quality control standards, but is cosmetically blemished and thus can't be packaged and sold under the manufacturer's own name.

3. "Duplicator Quality": Uncertified media, usually below manufacturer's own standards and frequently below ANSI and IBM standards. Sold on an "as-is" basis with the understanding that the manufacturer's name will never be divulged. Usually about a 20% reject rate...as compared to DISK WORLD's standard of less than 1/1000th of 1% reject/return rate. Next to garbage, this is the source of most diskettes advertised at a dollar or less.

They may work... and then again they may not. (Frankly, the odds at the Blackjack table in Las Vegas are more in your favor.)

4. Garbage. Stuff that shouldn't be sold at all. But some manufacturers are hurting for cash, so they sell it anyway. (After all, they want to meet their payroll. Look what happens when you don't: you become a Dyan or Verbatim. Lots of history, but no money.) More and more garbage is being dumped into the market as manufacturers become pressed for cash and are motivated into selling anything and everything they can manufacture. (Read the article in FORBES about Verbatim and its "Bonus" brand.)

Finally, the Taiwanese counterfeiters are moving into the act. Perfect duplicates of the packaging of major manufacturers with one exception: the quality isn't there.

#### The Critical Factor.

Only DISK WORLD!, Inc. offers fully brand-identified, LIFETIME-WARRANTY product for less than a dollar.

Every one else offering 5.25" product for less than a buck doesn't tell you who makes it.

We do.

And that ought to tell you a lot right there.

### Ordering & Shipping Instructions

**SHIPPING:** Wabash Pinnacle Diskettes are sold in multiples of 100 only. Shipping charges are \$3.00 per 100, regardless of type or size.

**PAYMENT:** VISA, MASTERCARD and PREPAID orders accepted. Corporations rated 3A2 or better and government and quasi-government open accounts are accepted on a NET 15 basis.

C.O.D. orders are subject to a \$5.00 special handling charge. (Sorry for the increase, but too many people have been refusing C.O.D. orders or using bad checks. It's a classic example of a few "bad eggs" making life more expensive for everyone else.)

**APO, FPO, AK, HI & PR ORDERS:** Include shipping as shown and an additional 5% of the total amount of the order to cover PAL and insurance.

No other non-continental U.S. orders are accepted.

**TAXES:** Illinois residents only, add 7%.

All orders subject to acceptance.  
Not responsible for typographical errors.

**ORDERS ONLY:**  
1-800-621-6627

(In Illinois: 1-312-256-7140)

**INQUIRIES & INFORMATION**  
1-312-256-7140

**FOR FASTEST SERVICE,**  
**USE MCI MAIL:**

Just address "DISK WORLD"  
(24-hour shipping on any item in stock  
if you order via MCI MAIL.)

# DISK WORLD!, Inc.

629 Green Bay Road  
Wilmette, Illinois 60091

# maxell DISKS

LIFETIME WARRANTY

TIRED OF WAITING  
FOR SERVICE AND PRICE?  
9 out of 10 SURVEYED  
DISK BUYERS PREFERRED

**NORTH HILLS**  
**#1 IN SERVICE AND PRICE**  
**1-800-328-3472**

Formatted and hard sectored disks  
in stock-Dealer inquiries invited.  
COD, VISA, MASTERCARD  
All orders shipped within 24 hrs.



**NORTH HILLS CORP.**  
**INTERNATIONAL**  
3564 Rolling View Dr.  
White Bear Lake, MN. 55110  
MN. call collect—612-770-0485

## Get the Proportional Printing Program which Really Works!

Get type-set quality true proportional spaced printing from unmodified WordStar and NewWord document files. PropStar prints on most daisy-wheel printers with ps type-wheels including Diablo, Gume, NEC, Brother, Juki, S-R, C.Itoh and many others.

PropStar is a stand-alone program, not a patch to your w.p. program, it maintains correct letter spacing, never crowds capitals (even on short lines), gives higher quality print than modified WordStar. PropStar supports most of the common WordStar and NewWord print enhancements. No installation patching required. For CP/M-80 systems on 8" and 5-1/4" media, also for MS-DOS systems on 5-1/4" PC media. Only \$ 49.95, Visa & M/C o.k. Specify computer and printer. Dealers wanted.



**CIVIL  
COMPUTING  
CORPORATION**

2111 Research Drive, Suite 1  
Livermore, California 94550 (415) 455-8086

## MARYMAC INDUSTRIES INC.

800-231-3680

### Radio Shack TRS-80's Epson Printers

People you Trust to give you the very best!



• Lowest  
Discount  
Prices

• Reliable  
Service

• Quality  
Products



"World's largest independent authorized Tandy dealer!"

22511 Katy Fwy., Katy (Houston) Texas 77450  
(713) 392-0747 Telex 774132

Inquiry 64

## 9-TRACK MAG. TAPE SUBSYSTEM FOR THE IBM PC/XT/AT



\$4757

For information interchange, backup and archival storage, IBEX offers a 9-track, IBM format-compatible W\* magnetic tape subsystem for the IBM PC, featuring:

- 42 M-Bytes on a single reel.
- IBM format 1600 cpi.
- Software for PC-DOS, MS-DOS.

Write, phone or TWX for information

**IBEX**

**IBEX COMPUTER CORP.**  
20741 Merile St.  
Chattsworth, CA 91311  
(818) 709-8100  
TWX 910-483-2071

Inquiry 178

## PC/XT USERS!

- COGTREE Utilities by Cogitate ..... \$129.95
- LYNC by Norton-Lamber... \$199.95
- DATAFLEX by Data Access...Varies
- RM/COBOL by Ryan/McFarland.....Varies
- Universe by Omnitrend.....\$ 98.50
- Blue MacI by Cogitate.....\$599.00
- CadPower+ by Trilex.....\$995.00
- Softext Teaching Aids.....\$ 95.00
- PrintSet by Cogitate.....\$ 79.95
- CogITAPE by Cogitate.....CALL!!
- Anti-Static Products.....Varies
- Uninterruptible Power Backups.....Varies
- TeleVideo Software.....CALL!!

**COGITATE**

"A Higher Form of Software"  
24000 Telegraph Road  
Southfield, MI 48034  
(313) 352-2345/Telex 386551

VISA/MASTERCARD ACCEPTED  
Dealer Inquiries Welcomed

Inquiry 65

## The Statistician

CPM IBM-PC  
TRS-DOS XENIX

- \* Multiple Regression Stepwise Ridge All Subsets Backward Elimination
- \* Time Series Analysis
- \* Descriptive Statistics
- \* Transformations
- \* Survey Research
- \* Nonparametrics
- \* XY Plots
- \* ANOVA
- \* Random Samples
- \* Data Base
- \* Search & sort
- \* Hypothesis tests

Please call TOLL FREE

1-800-334-0854 (Ext. 814)



for more information  
or write:  
Quant Systems  
Box 628

Charleston, SC 29402  
VISA/M/C Accepted

Inquiry 306

## IBM Enhancements

- Monochrome/Graphic/Printer Card \$169.00 (runs Lotus 1-2-3, 64K, 720 x 348)
- 384K MultiFunction Card \$139.00 (Parallel/Serial/Game/Clock/Calendar/384K)
- Floppy Disk Controller Card (w/cable) \$69.00
- 384K RAM Card (w/64K) \$99.00

### Switching Power Supplies

192.5 w for IBM AT . . . . . Call

130 w for PC/XT . . . . . \$109.00

Internal replacement, 4 drive connectors, ETRI, fan

12V/4.5A 5V/15A 110V/220V

Case for AT . . . . . Call

Case for PC/XT (Flitpot or Slide) . . . . . \$64.00

Game Card (2 Joystick Ports) . . . . . \$39.00

5151 Compatible Keyboard . . . . . \$139.00



Distributors/Dealers/OEM Inquiries Invited

Call 408-249-4512 Telex 172412

**Supreme Company**

1101 S. Winchester Blvd., F166  
San Jose, CA 95128

Inquiry 358

## ROSE ELECTRONICS DATA SWITCHES



SHARE computers, printers, any parallel or serial device ELIMINATE cable swapping INEXPENSIVE way to network COMPATIBLE with all computers. Businesses, Schools, Homes

WE ALSO OFFER:  
Data Buffers, Line Drivers, Modems, Protocol Converters, Parallel - Serial Converters, Cables, Computers, Printers, Disk Drives, and more.

AUTOMATIC - CARETAKER is ideal for a business or school to share a printer or modem among many computers. Operation is fully automatic with no software required. Parallel or Serial 4 channels - \$295 8 channels - \$395

MANUAL - HARD SWITCH is operated with the flip of a switch. 2:2 and 2:4 models allow simultaneous communication.

Serial 1:2 - \$59 1:4 - \$ 99 2:2 - \$109 2:4 - \$189  
Parallel 1:2 - \$99 1:4 - \$159 2:2 - \$189 2:4 - \$279  
LED and spike protection on serial models add \$20.

CODE ACTIVATED - PORTER connects one computer to multiple peripherals. A software code selects the peripheral. Parallel or Serial 4 channels - \$295 5 channels - \$395 Buffer option 64K - \$100 256K - \$250

REMOTE - TELEPATH connects multiple computers to multiple peripherals. A selector at each computer or terminal chooses up to 4 peripherals and displays busy status. 4:4 - \$485 4:8 - \$795 selector - \$39.

Give a Rose to your computer

**ROSE ELECTRONICS** (713) 240-7673  
P.O. BOX 742571 MC & VISA Accepted  
HOUSTON, TX 77274 Dealer inquiries invited  
CALL US FOR ALL YOUR INTERFACE NEEDS

Inquiry 319

## DATA ACQUISITION TO GO INTERFACE FOR ANY COMPUTER



Connects via RS-232. Built-in BASIC. Stand alone capability. Expandable. Battery Option. Basic system: 16 ch. 12 bit A/D, 2 ch. D/A, 32 bit Digital I/O. Expansion boards available. Direct Bus units for many computers.

SPECIALISTS IN PORTABLE APPLICATIONS

(201) 299-1615

P.O. Box 246, Morris Plains, NJ 07950

**ELEXOR**

Inquiry 133





# FORTRON CORPORATION

3797 YALE WAY, FREMONT, CA 94538

INFORMATION & CALIF. RES. [415] 490-8171

FOR YOUR IBM PC, XT, AT OR COMPATIBLES

- Dealer & OEM Are Invited -

ORDER TOLL FREE:  
[800] 821-9771



## POWER SUPPLIES

### For PC/AT



169.00

#FC 5192,  
200 WATTS (max.)

- +5V/19.8A, +12V/7.3A -5V/1A, -12V/1A
- 110/230 VAC Switchable
- Come with 4 Drives Connector
- (U) Pending
- ONE YEAR WARRANTY
- Fully Tested in U.S.A.

#FC-130 40  
130 Watt power supply for PC/XT



119.00

- Fully Tested in U.S.A.
- Good for Faraday, DTC Megaboard, and other PC/XT compatibles
- Back side on-off switch
- Use cabinet FC 630
- 110/230 VAC convertible
- (U) Pending

140 W.(MAX)  
POWER SWITCHER

#FC 135-40

Fully Tested in U.S.A.

129.00

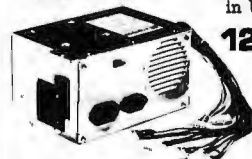

- Direct replacement to IBM PC power supply
- High air flow, low noise fan
- (U) Pending
- Outstanding quality, 1 yr. warranty

## KEYBOARD

#FC 527

- IBM® PC AT key layout
- Enlarge return & shift key
- Capacitance low profile key switch

PC/AT ..... 129.00

#FC 427

- IBM® PC/XT compatible
- Light on num. & caps lock keys

PCXT ..... 99.00

#FC 630 A-1

## COMPUTER CHASSIS

#FC-630 A-2

#FC-630 A



139.00

- IBM® PC/AT identical dimension
- Heavy duty metal frame & front plastic panel
- Completed hardware and accessories
- Use our power supply FC-5192 and keyboard FC 527

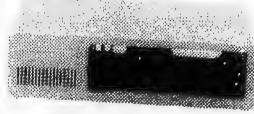

99.00

- IBM® PC/XT identical dimension
- Righthand side on-off switch position
- Hardwares included
- 7 & 8 slot rear panels. Good for 0.75" or 1" apart slot connectors
- Use FC 135 40 power supply

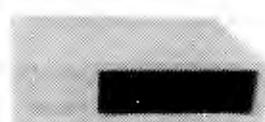

79.00

- Rear side on-off switch position
- Good for Faraday, DTC megaboard and other compatibles
- 6 or 8 slot on rear panel
- Use FC-130-40 power supply

## IBM PC, XT ADD-ON CARDS

### FC 230 Floppy Disk Controller

- Drives 4 x 5 1/4" FDD
- IBM fully compatible
- w/cable

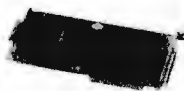

59.00

### DTC 5150 BX Hard Disk Controller

- Up to 2 Hard Disk Drives
- Fully Buffered I/O Bus
- Built-in ECC



199.00

### FC 530 Monochrome Controller w/Printer port

- 8 x 25 Screen
- 9 x 14 Character Box
- 7 x 9 Character
- TTL level of output

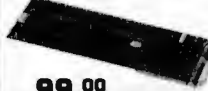

99.00

### FC 940 RS232C/ REAL TIME CLOCK

- To 9600 Baud
- Battery Back-up

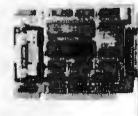

69.00 49.00  
Clock Only

## Get a Full Function PRINTER at 99.00

(Listed 199.00)

- Comes with:
- 25-36 pin cable adapter
  - 4 Batteries
  - 1 roll paper



- 11 1/4" x 4 1/4" x 1 1/4"
- 2.2 pounds weight

- Dot Matrix Thermal Printer
- 80 Standard Character/Line
- 40 cps (DC 6V) 50 cps (AC)
- Battery Back-up
- 55 db noise
- Centronic Type Parallel Interface

Limited Stock On Hand!

### I.C.

- 64K RAM (150 ns) ..... 8.00/9 pcs.
- Piggy back 128K RAM for PC/AT ..... 53.50/9 pcs.
- 256K RAM (150 ns) .... 44.00/9 pcs.
- 8237A-5 ..... 3.95/ea.
- 8284A ..... 1.80/ea.
- 2764 ..... 3.95/ea.

### TERMS:

- Minimum handling & shipping \$6.00
- 1. Please call for actual charges.
- 2. CA Res. add 6.5% tax
- 3. A RMA NO. is required for return merchandise, unauthorized return goods will be refused.
- 4. Restocking charge 15%
- 5. Prices subject to change without notice
- 6. Not responsible for typos

### Monochrome/Graphic with Printer Port, CT-6040

- 80 x 25 Text mode
- 720 x 348 Graphic mode
- Can run Lotus 1-2-3
- 64K Graphic Display memory
- Monitor & printer interface



149.00

### MORE. ....

- 384K Multifunction Card ..... 119.00
- RS232/Printer Card ..... 79.00
- Color Graphic Card with Printer Port ..... 159.00
- FC 830 (512K Memory Exp. .... 89.00 Card QK)

## MONITOR

Monochrome

109.00

- 12", TTL Level
- 1000/800 Lines
- 2000 (Characters)

## CABLES

- Hard Disc Drive Cable (34 pin-34 pin) ..... 19.95
- Floppy Drive Cable ..... 11.95
- 9 Pin D Type to 25 Pin D Type for PCAT ..... 29.00
- Printer Cable 25 Pin D Type to Centronics ..... 19.00
- RS232 to RS232 Cable ..... 19.00
- AC Input/Output Power Cord ..... 3.00

## DRIVES

5 1/4" FLOPPY

Teac/Panasonic DS/DD  
95.00  
(Drive Only)

10 MEG

Teac. 1/2 Height  
489.00  
(w/Cable Controller)

20 MEG

Teac. 1/2 Height  
659.00  
(w/Cable Controller)

# RS-422

Communications Board

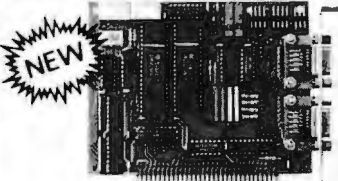

- For IBM-PC/AT/XT and compatibles
- Dual RS-422 serial interface
- Programmable to 56k baud
- Differential drivers to 4000 ft.

**\$345.00**  
**QUA TECH, INC.**

478 E. Exchange St. Akron OH 44304  
 (216) 434-3154 TLX: 5101012726

Inquiry 304

# NOW C HERE! CROSS SOFTWARE for the NS32000

Also Available for IBM PC

**INCLUDES:**

- \* Cross Assembler \*
- \* Cross Linker \*
- \* Debugger \*
- \* N.S. ISE Support \*
- \* Librarian \*
- \* Pascal Cross Compiler \*
- \* C Cross Compiler \*

U.S. prices start at \$500

## SOLUTIONWARE

1283 Mt. View-Alvino Rd.  
 Suite B

Sunnyvale, Calif. 94089  
 408/745-7818 • TLX 4984264

Inquiry 344

# DATA BROKERS 1-800-833-2600 in Ohio (513) 581-0099 FREE SHIPPING NO EXTRA CHARGES! MODEMS

Hayes Compatible

USR Courier 300/1200/2400 .....	\$469
USR Password 300/1200 .....	\$229
USR IBM 300/1200 IBM int. ....	\$299
Anchor Express 300/1200 .....	\$279
Anchor Volksmodem 12 300/1200 ...	\$179
Anchor Mark XII 300/1200 .....	\$220
Anchor Mark X 300 .....	\$ 99
Hayes 1200 The standard .....	\$399
Hayes 1200B IBM int. ....	\$379
Multitech MT 212AH2 300/1200 .....	\$349
Multitech MT 224AH 300/1200/2400 ..	\$559
Cermetek Security w/callback security	\$599
Cermetek 1200PC IBM int. ....	\$349

DATA BROKERS ..... THE MODEM EXPERTS  
 3535 Roundbottom Rd. Cinti., OH 45244

Inquiry 106

**NEW!**

**SafeSkin™**  
 KEYBOARD PROTECTOR

Remains in place during keyboard use. Prevents damage from liquid spills, dust, ashes, etc. Fits like a second skin, excellent feel. Available for: IBM-PC, AT, Apple (all), Compaq, Model 100, NEC 8201, C64, Zenith 150, DEC, Kaypro and many others, Send \$29.95, check, M.O., Visa & MC include exp. date. Specify computer type. Dealer inquiries invited. Free brochure avail.

**Merritt Computer Products, Inc.**  
 2925 LBJ Fwy. #180 / Dallas, Texas 75234  
 (214) 942-1142

Inquiry 237

**DOUBLE THE OPTION CAPACITY OF YOUR IBM PERSONAL COMPUTER**

## PC-XTRA

- DIRECT EXTENSION OF IBM PC BUS
- NO SOFTWARE CHANGES
- NO HARDWARE MODIFICATION
- STYLING CONSISTENT WITH IBM

Add all these special options that you've been wanting without worrying about filling your plug-in and back panel space

**DEALER INQUIRIES INVITED.**  
**\$549.00\*** F.O.B. SANTA ANA  
\*CALIFORNIA RESIDENTS ADD 6% SALES TAX

**P C HORIZONS, INC.**  
 1701 E. Edinger, Ste. A6, Santa Ana, CA 92680  
 (714) 953-5396

Inquiry 281

**AMX**  
 8080  
 Z80  
 6809

**Real-Time Multitasking Executive**

- No royalties
- Source code included
- Fault free operation
- Ideal for process control
- Timing control provided
- Low interrupt overhead
- Inter-task messages

- Language Interfaces:  
 C Pascal  
 PL/M Fortran
- DOS File Access:  
 CP/M-80  
 IBM PC DOS

Options:  
 ■ Resource Manager  
 ■ Buffer Manager  
 ■ Integer Math Library

AMX is the trademark of KADAK Products Ltd.  
 CPM-80 is the trademark of Digital Research Corp.  
 IBM PC DOS is the trademark of IBM Corp.

AMX for 8080	\$ 800 US
8088	950
8089	950
68000	1600

Manual (specify processor) 75

**KADAK Products Ltd.**  
 1804) 734-3796  
 Telex: 04-55670  
 206-1847 W. Broadway, Vancouver, B.C., Canada V6J 1Y5

Inquiry 206

## AMBER CRTs

- Eliminates strobe, flicker, and eye fatigue
- Made with Lead/Strontium impregnated glass that stops X-ray emission
- Available in slow decay green or medium decay "European Amber" (the standard in Europe)
- High-contrast double dark face glass that also cuts U.V. radiation
- Tube face is etched to stop glare

- Ideal for word processing and programming, yet fast enough for games and graphics
- Warranted for one full year against manufacturing defects or tube failure
- Comes with a 30-day money back guarantee
- Easily installed (comes with pre-mounted hardware)

Now, you can easily upgrade your monitor to exceed European standards for persistence and color with the installation of a Langley-St. Clair Soft-View™ CRT! Available for the TRS-80™, TeleVideo™, Kaypro™, Heath™, DEC™, Zenith™, IBM PC™, Apple III™ and a wide variety of other monitors.

Call now to order your Soft-View™ CRT from **Langley-St. Clair** — **\$99.95** Plus \$7 for packing and UPS Shipping (\$17 for Overseas, Parcel Post or UPS Blue Label). Add sales tax where applicable. Visa/MasterCard orders welcomed.

**Langley-St. Clair**  
 Instrumentation Systems, Inc.  
 132 W. 24th St.  
 New York, NY 10011  
 In New York call 212 989-6876

**TO ORDER:  
 CALL 800  
 221-7070**

Inquiry 268

## FREE SOFTWARE FROM THE PUBLIC DOMAIN

User Group Software isn't copyrighted, so no fees to pay! 1000's of CP/M and IBM software programs in COM and source code to copy yourself! Games, business, utilities! All FREE!

	Rent	Buy
IBMPC-SIG 1-370 Diskettes .....	400.	800.
IBMPC-BLUE 1-116 Diskettes .....	145.	375.
SIG/M UG 1-222 Diskettes .....	130.	625.
CP/M UG 1-92 Diskettes .....	45.	250.
PICO NET 1-34 Diskettes .....	25.	100.
KAYPRO UG 1-39 Diskettes .....	45.	90.
EPSON UG 1-39 Diskettes .....	45.	90.
Commodore CBM 1-28 Diskettes ..	25.	65.

Public Domain User Group Catalog Disk \$5 pp. (payment in advance, please)  
 Rental is for 7 days after receipt, 3 days grace to return. Use a credit card, no disk deposit.  
 Shipping, handling & insurance \$9.50 per library.  
 (619) 941-0925 Orders & Technical (9 to 5)  
 (619) 727-1015 24 Hr. 3 Min. Info Recording  
 Have your credit card ready!

**National Public Domain Software**  
 1533 Avohill Dr.  
 Vista, CA 92083

888

Inquiry 289

**Macintosh™**

**512K**  
 Includes drive.  
**\$1995**

Macintosh is a trademark licensed to Apple Computer, Inc.

Call for prices on other Macintosh products.

**PC'S LIMITED**  
 OUTSIDE TEXAS, ORDERS ONLY, CALL 1-800-426-5159.  
 7801 N. Lamar, #1-200, Austin, Texas 78752  
 All calls for technical support made inside Texas, call (512) 452-0223.  
 base the 913-852-8400 PC Co. Ad number 407 A

Call technical support for return authorization number on all warranty repairs. Any unreturned return subject to a 10% restocking fee. No exchange for Visa or MasterCard. 3% charge for American Express.

Inquiry 268



# 100% GUARANTEED ICs - MONEY BACK!

## 1-800-245-2235

### SPECIAL

#### 64K DRAM

4164 .45  
4416 .90

FULLY FUNCTIONAL  
WITH SLIGHTLY  
SHORTER LEADS  
200ns or FASTER

That's right... 100% money-back guaranteed ICs at prices never before possible! Krueger Technology's unique patented IC removal process is the key to our ability to sell so low. The fact is, it costs less to retrieve and refurbish an IC from an obsolete PC board than manufacture a new one. Since we maintain an inventory in excess of six million ICs and process over 100,000 ICs per day (over thirty million in the past ten years) we can supply you with most, if not all of your IC needs. Until this year our vast inventory of ICs was available to only manufacturers and distributors. The phenomenal growth of the catalog market has allowed us to open our inventory to you. You can now buy direct and cut out all middlemen.

Call today and discover what seven of the ten largest computer manufacturers already know... "The Krueger Alternative".

### SPECIALS

2114-300ns .50  
FDC1793 5.00  
74LS322 .50  
6116-120ns 1.75  
8080A .75  
Z80ASIO/O 3.75

#### MICROPROCESSORS

2901	3.00	8039	2.00
2903	5.00	8080A	.75
68000-8	18.00	8085	2.00
68008-8	18.00	8086	4.00
Z8001	7.50	8086-2	5.00
80186-3	15.00	8088	7.50
8031	5.00	8X300	6.00
8035	2.00	8741A	8.00

#### ADC/DAC

ADC08XX	3.50
DAC08XX	1.50
DAC80	8.00

#### CONTROLLERS/UARTS

1691	5.25	2661	4.00
1771	6.50	5027	3.00
1791	10.00	5037	5.00
1793	5.00	7201	4.50
1795	10.00	765	4.00
1797	10.00	COM8116	5.00
2651	4.00	3250	4.00

#### SOUND CHIPS

76477	2.00
AY3-8910	2.00
AY3-8912	2.00

#### 82XX PERIPHERALS

8202	14.00	8259	2.00
8212	1.00	8272	4.00
8216	1.00	8273	10.00
8224	3.00	8274	9.00
8228	3.00	8275	9.00
8237	3.00	8276	15.00
8237A-5	4.00	8279	3.50
8243	1.50	8281	7.50
8251	2.00	8283	5.50
8253	2.00	8284	2.00
8254	4.00	8288	4.00
8255	2.00	8291	20.00
8257	2.00	8292	21.00

#### TMS 9900 SERIES

9901	1.50
9918	20.00
9927	5.00
9980	10.00
ALL OTHER 99XX SERIES	3.00

#### DYNAMIC RAMS

4164-120ns	1.75
4164-150ns	.95
4164-200ns	.85
4164-250ns	.65
4416-150ns	1.50
4116-150ns	.75
4116-200ns	.35
4116-250ns	.25

#### STATIC RAMS

6264-150ns	6.00
6116-150ns	1.25
6116-200ns	.90
6116-250ns	.65
1420-55ns	2.00
2147, 2148, 2149	2.00
2114-300ns	.50
2114-FASTER	.80

## 1-800-245-2235

#### EPROMS

27128-250ns	5.00
27128-350ns	4.00
27128-450ns	3.00
2764, 2732, 2716	
250ns	3.50
300ns	3.00
350ns	2.75
450ns	2.25
650ns	1.75

1702	1.50
2708	2.00
68766	6.00
68708	4.00

CMOS version at double the above prices

25 Series EPROMS are the same price as 27 Series EPROMS

#### ECL

ANY 10K LOGIC	1.00
ANY ECL RAM	3.00
ANY 100K LOGIC	5.00

#### Z80 SERIES

2.5 MHZ	
CPU, CTC, PIO	1.00
DMA, DART, SIO	3.00
4.0 MHZ (A)	
CPU, CTC, PIO	2.00
DMA, DART, SIO	4.50
6.0 MHZ (B)	
CPU, CTC, PIO	3.00
DMA, DART, SIO	9.00

#### MISCELLANEOUS

0026	1.50
1488	.50
1489	.50
3232	1.00
3242	4.00
3470	1.50
3486	1.00
3487	1.50
CA3XXX	1.00
MC4024	2.00
MC4044	2.00
555	.35
75XXX	.50
8131	2.25
8136	4.00
8303	3.00
8304	1.75
88XX	.50
8TXX	.50
9602	.75
96LS02	1.50

#### 74 SERIES

74XX	.25	74SXX	.35
741XX	.35	74S1XX	.45
742XX	.50	74S2XX	.60
743XX	.50	74S3XX	.60
74LSXX	.25	74ALSXX	.35
74LS1XX	.35	74ALS1XX	.45
74LS2XX	.50	74ALS2XX	.60
74LS3XX	.50	74ALS3XX	.60

74FXX	.35
74F1XX	.45
74F2XX	.60
74F3XX	.60

#### CMOS

ANY 4000 SERIES	.25
ANY 4500 SERIES	.50

#### 6500/6800 SERIES

ANY 65XX	2.00
ANY 65XXA	2.50
ANY 65XXB	3.00
ANY 68XX	2.00
ANY 68AXX	2.50
ANY 68BXX	3.00
6810	.75

#### OUR POLICY

Delivery: Orders normally shipped within 2 business days. Add \$3 for UPS ground-5# & under; Add \$4 for UPS blue (air), 2# & under; for each additional air pound add \$1. Arizona residents add 6% sales tax.

Payment: Visa, MC, cashiers check, certified check, money order, personal check accepted (Allow 10 days for personal checks to clear). No surcharge on credit card orders. CODs welcome with cash, certified check, cashiers check or money order. Add \$3 COD handling charge.

Pricing: Prices subject to change without notice. All items limited to stock on hand. We reserve the right to limit quantities.

# KRUEGER Technology, Inc.

2219 South 48th Street • Tempe, AZ 85282

## 800-245-2235

In Arizona 602-438-1570

HOURS: 7 a.m. - 5:30 p.m.  
(MOUNTAIN TIME)  
Monday Thru Friday





**RS232C IBM PC Compatible  
Paper Tape Transmitter/Model 612**

Stops and starts on character at all speeds, uses manual control or X-on, X-off 90-260 volt, 50-60 Hz power. 50-9600 baud, up to 150 char/sec synchronous or asynchronous; gated internal or external clock, RS 232C, current loop or parallel output, reads 5-8 level tape, 7-11 frames per character, even or odd parity. Desk top or rack mount.

**Addmaster Corporation, 415 Junipero Serra Drive, San Gabriel, CA 91776, (818) 285-1121, Telex 674770 Addmaster SGAB**

Inquiry 8

**6800 Family Software**

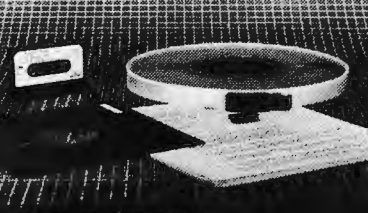

Software for 6800/01/05/09 microprocessors.  
**SOFTWARE:** C compiler, Pascal, multitasking DOS, macro-assemblers, FORTRAN, 16K BASIC  
**FIRMWARE:** Fanlom monitor/debugger, math library, 4K BASIC  
**CROSS-SOFTWARE:** Assemblers, PL/W Compilers, Linker, Simulators

**WINTeK** Wintek Corp  
1801 South Street  
Lafayette, IN 47904  
317-742-8428

Inquiry 392

**Universal Machine  
Independent Assembler**

**MOPI:**  
A unique software development system.

The only assembler capable of generating machine code for any 8- or 16-bit micro using; a universal set of instructions, including procedural, the manufacturer's or user defined instructions.

The first assembler to implement a proposed AL Standard, applicable to any computer; simplifies learning AL, reduces development time, offers limited portability.

Simple enough for a beginning programmer, sophisticated enough for experienced computer professionals.

For CP/M or PC-DOC - \$195



**VOCS**  
P.O. Box 3705  
Mpls., MN 55403

Inquiry 385

**SAVE TIME AND MONEY WITH  
LOW COST PI-SWITCH BOXES.**

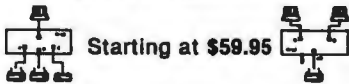

Starting at \$59.95

- Quickly shares your computer among multiple terminals, printers, modems, etc. with just a flick of the wrist.
- Compact black & beige aluminum enclosure features a high quality rotary switch with rear mounted connectors.
- Serial RS-232 Models have fem. 25-Pin Conn. (Lines 1-7 & 20)
- PI-02-S switches 2 to 1 ..... \$59.95
- PI-03-S switches 3 to 1 ..... \$79.95
- PI-05-S switches 5 to 1 ..... \$109.95
- Parallel models have fem. 36-Pin cent. conn.
- PI-02-P switches 2 to 1 ..... \$94.95
- PI-04-P switches 4 to 1 ..... \$154.95
- Dealers, schools & custom inquiries welcome.
- One Year Warrantee. COD, VISA, M/C.
- Shipping UPS \$2.00/ea. AIR \$4.00/ea.

**SAB LINK** 7301 NW 41 St.  
MIAMI, FL 33166  
(305) 592-6092

Inquiry 323

**Call For  
DEALER'S  
ADVANTAGE**

**Add-on Products for IBM PC®**

10 Mb Hard Disk Kit (with controller)	\$500.
20 Mb Hard Disk Kit (with controller)	\$650.
Floppy Controller Card	\$50.
Color Graphics Card (RGB and NTSC Comp.)	\$95.
Monochrome Graphics Card	\$100.
Memory Card with 256K	\$150.

**MINIMUM OF TEN BOARDS**

100 Bulk Diskette 05/DD ..... \$95.

® IBM is a registered trademark of International Business Machines, Inc.

**CRANE Associates, Inc**

3928 S. Sepulveda Blvd., Ste. 12  
Culver City, CA 90230  
(213) 390-9840

Inquiry 95

**DATA ACQUISITION  
and control for ANY computer**



The Model 1232 communicates via RS-232, and has 8 analog inputs ( $\pm 4$  VDC; 12 bits), 8 digital inputs and outputs, and a 2000 point buffer. Suitable for field data logging or lab use, the 1232 costs only \$690. The 8-bit system (0-5 VDC) is \$490. Detailed manual, \$6. Phone our applications engineer at 617-899-8629 or write:

**STARBUCK DATA COMPANY**

225 Crescent St., Waltham, MA 02154

Inquiry 348

**P.D.Q. CABLES**

3821 PURDUE ROAD  
DAYTON, OHIO 45428

No higher quality computer cables on the market today!!

**METALIZED HOODS  
FULLY SHIELDED  
POSITIVE STRAIN  
RELIEF  
100% GUARANTEED**

- IBM PARALLEL CENTRONICS-----\$25.00
- IBM SERIAL PRINTER CABLE-----\$19.00
- IBM SERIAL FOR MODEM-----\$19.00
- STRAIGHT PARALLEL CENTRONICS-----\$29.00
- RS232C-----\$19.00

IF THERE IS A CABLE NEEDED, P.D.Q. CAN CONSTRUCT AND GUARANTEE IT!

CALL (513) 254-8755

Inquiry 290

**ICs PROMPT DELIVERY!!!  
SAME DAY SHIPPING (USUALLY)**

OUTSIDE OKLAHOMA: NO SALES TAX

ADD \$40 (Kv) to PCXT 8-SLOT MOTHERBOARD  
CONSUME NO EXPANSION SLOTS: \$73.10

8087-3	MATH	\$125.00
8087-2	COPROCESSORS	150.00
<b>DYNAMIC RAM</b>		
256K	256Kx1 120 ns	\$ 4.49
256K	256Kx1 150 ns	2.95
64K	64Kx1 150 ns	1.10
<b>EPROM</b>		
27C256	32Kx8 250 ns	\$17.50
27256	32Kx8 250 ns	9.10
27128	16Kx8 250 ns	3.30
27C64	8Kx8 200 ns	5.25
2764	8Kx8 250 ns	2.95
2732A	4Kx8 250 ns	2.75
<b>STATIC RAM</b>		
6264LP-15	8Kx8 150 ns	\$4.75
6116LP-3	2Kx8 150 ns	1.95

QUANTITY ONE PRICES SHOWN

OPEN 7 DAYS WE CAN SHIP VIA FED-EX ON SAT

MasterCard/VISA or UPS CASH COD  
**Factory New, Prime Parts**  $\mu$ Proc  
MICROPROCESSORS UNLIMITED  
24,000 S. Florida Ave., (918) 267-4961  
BEGGS, OK, 74421

Prices shown above are for July 30, 1985  
Please call for current prices. Prices subject to change. Please expect higher or lower prices on some parts due to supply & demand and our changing costs. Shipping & insurance extra. Cash discount prices shown. Orders received by 4 PM CST can usually be delivered to you by the next morning, via Federal Express Standard Air @ \$8.00, or Priority One @ \$15.00!

Inquiry 249

**Crescent Com, Inc.**

**CONTACT US TODAY!**

**Remarkably  
LOW Prices—  
Very Competitive**

- IBM PC, XT, AT and peripherals
- ALL APPLES including "Fat" MAC and peripherals
- COMPAQ Computers
- Most Popular Software

**Call TOLL-FREE  
1-800-325-1287  
California Only  
1-800-492-3003  
Telex 855771**

**Crescent Com, Inc.**  
3517 Ryder Street  
Santa Clara, CA 95051  
408-738-2480



# IBM PC SPECIALS!

IBM PC, 256K, One Half Height 320K Disk Drive DS/DD, Persyst Color Card With Printer Port, Taxan Green Monitor, DOS 2.1, PLUS a 10MB Hard Disk Sub System All For:

**\$2599.**

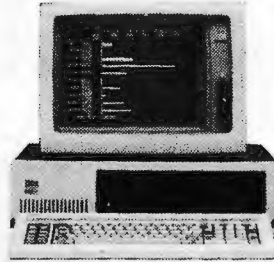

IBM PC, 256K, Two Half Height Drives DS/DD, Persyst Color Card With Printer Port, Taxan Green Monitor, DOS 2.1, 130 Watt Power Supply, 20MB Hard Disk Sub System All For:

**\$3299.**

IBM PC, 256K, Two Half Height Drives DS/DD, Persyst Color Card With Printer Port, Taxan Green Monitor, DOS 2.1, 130 Watt Power Supply, 10MB Hard Disk Sub System, PLUS 10MB Tape Back Up System All For:

**\$3499.**

IBM PC, 256K, Two Half Height Drives DS/DD, Persyst Color Card With Printer Port, Taxan Green Monitor, DOS 2.1, 130 Watt Power Supply PLUS a 10MB Hard Disk Sub System All For:

**\$2899.**

IBM PC, 256K, Two Half Height Drives DS/DD, Persyst Color Card With Printer Port, Taxan Green Monitor, DOS 2.1, 130 Watt Power Supply, 20MB Hard Disk Sub System, PLUS 10MB Tape Back Up System All For:

**\$3899.**

## MONITORS

AMDEK 300 Green	\$135.00
AMDEK 300 Amber	\$149.00
AMDEK 310 Amber W/TTL Plug	\$165.00
PGS HX-12	\$465.00
PGS MAX-12	\$185.00
PGS SR-12	\$625.00
TAXAN #115 Green Composit	\$125.00
TAXAN #116 Amber Composit	\$135.00
TAXAN #121 Green W/TTL Plug	\$149.00
TAXAN #122 Amber W/TTL Plug	\$159.00
TAXAN #425 COLOR MONITOR	\$449.00
TAXAN #440 COLOR MONITOR	\$569.00
IBM MONOCHROME DISPLAY	\$260.00
IBM COLOR DISPLAY	\$590.00

## PRINTERS

OKIDATA 182	\$235.00
OKIDATA 192	\$385.00
OKIDATA 193	\$599.00
OKIDATA 83A	\$555.00
OKIDATA 92P	\$385.00
OKIDATA 93P	\$599.00
OKIDATA 84P	\$725.00
OKIDATA 2350P	\$1925.00
OKIDATA 2410P	\$1899.00
NEC 3550	\$1550.00
NEC PINWRITER 80 Col.	\$699.00
NEC PINWRITER 130 Col.	\$899.00
EPSON LX 80	\$249.00
EPSON FX 80	\$399.00
EPSON FX 100	\$525.00
EPSON RX 100	\$399.00
EPSON JX 80	\$525.00
EPSON LQ 1500	\$925.00
COMREX CR 420	\$1895.00
TOSHIBA 351	\$1275.00
STAR MICRONICS SG 10	\$259.00
STAR MICRONICS SG 15	\$395.00
CITIZEN PRINTER MSP-10	\$375.00
CITIZEN PRINTER MSP-15	\$585.00
CITIZEN PRINTER MSP-20	\$545.00
CITIZEN PRINTER MSP-25	\$740.00
JUKI LQ 6100	\$425.00
JUKI LQ 6300	\$745.00
BROTHER HR-25	\$665.00
BROTHER HR-35	\$895.00
DYNAX DX 15XL	\$389.00

## MODEMS

HAYES SMART MODEM 1200	\$459.00
HAYES SMART MODEM 300	\$209.00
HAYES 1200B PLUG IN CARD	\$399.00
HAYES 2400 BAUD MODEM	\$714.00
POP COM 1200 EXTERNAL	\$375.00
AST REACH MODEM	\$389.00
QIC MODEM INTERNAL	\$275.00

## DRIVES

TANDON TM-100-2 DS/DD	\$155.00
TOSHIBA SLIMLINE DS/DD	\$139.00
TEAC SLIMLINE DS/DD	\$139.00

## HARD DISKS

10MB SUB SYSTEM INTERNAL	\$750.00
EXTERNAL	\$925.00
20MB SUB SYSTEM INTERNAL	\$975.00
EXTERNAL	\$1150.00
40MB SUB SYSTEM INTERNAL	\$1295.00
EXTERNAL	\$1475.00

## HARD DISKS & TAPE BACK-UP UNITS (EXTERNAL)

10MB HARD DISK W/10MB TAPE BACK UP	\$1250.00
20MB HARD DISK W/10MB TAPE BACK UP	\$1475.00
40MB HARD DISK W/10MB TAPE BACK UP	\$1795.00

## MULTIFUNCTION BOARDS

AST I/O MINI CARD, 1-SER.	\$150.00
AST SIX PACK 64K, 1-SER., 1-PAR.	\$265.00
AST PREVIEW	\$309.00
AST ADVANTAGE CARD 128K FOR AT	\$495.00
ALR CHALLENGER CARD 128K FOR AT	\$395.00
PERSYST COLOR PRINTER ADAPTER	\$179.00
PERSYST MONOCHROME PRINTER ADAPTER	\$199.00
PERSYST BOB CARD	\$395.00
HERCULES COLOR PRINTER ADAPTER	\$179.00
HERCULES GRAPHIC PRINTER ADAPTER	\$325.00
STB GRAPHIC PLUS II	\$325.00
IBM COLOR GRAPHIC ADAPTER	\$225.00
IBM MONO PRINTER ADAPTER	\$230.00
GENOA SPECTRUM GRAPHIC CARD	\$349.00
ORCHID TURBO-186, 128K	\$975.00
ORCHID DAUGHTER TURBO-186, 128K	\$219.00

## GENERAL

MAXELL DISKETTES MD2	\$35.00/box
MAXELL MD2-HDM FOR AT	\$65.00/box
CONTROL DATA DISKETTES	\$30.00/box
KEYTRONIC KEYBOARD KB 5151	\$189.00

Many other products available, Please call for Low, Low Prices!

*Microshop*  
COMPUTER PRODUCTS

**(714) 838-7530**

2640 Walnut Avenue, Unit K, Tustin, California 92680

Prices & availability subject to change without notice - IBM is a registered trademark of IBM Corporation

Get the **ProDOS™** advantage for  
+  
all your **Aztec C65™** programs

**VIX** is a UNIX like operating system designed to run Manx's Aztec C65 software under ProDOS. With VIX, programs running under the SHELL will run under ProDOS including c65, ccl, as65, asi, in, mklib and others. System includes:

- Standard utilities: cat, cp, date, l, mkdir, ren, rm and stty.
- An improved library written in 6502 assembly.
- A fast screen editor with undelete, auto-indent, work wrap and more.
- Source code to entire system except editor.

VIX - \$49.95 + \$3.50 shipping  
Balanced binary tree data base library- \$75  
b-tree with source-\$350

**Eclipse Systems**

223 Matthew Road  
Merion Station, Pa. 19066  
(215) 664-2419

Inquiry 130

## BAR CODE READER



- IBM PC/XT COMPATIBLE (AND MOST CLONES)
- CONNECTS BETWEEN KEYBOARD AND THE PC
- NO CARD SLOT REQUIRED/SIMPLE INTERCONNECT
- NO CUSTOM SOFTWARE DRIVERS REQUIRED
- HIGH FIRST READ RATE
- READS DOT MATRIX & PRINTED BAR CODE LABELS
- CODE 3 OF 9, INTERLEAVED 2 OF 5, UPC
- AUTOMATIC BAR CODE SELECTION
- AUDIO AND VISUAL INDICATORS
- READS HIGH, MED. AND LOW DENSITY LABELS
- SWITCH SELECTABLE OPTIONS
- SELF-TEST DIAGNOSTICS

**\$495 ea.**

PC/MS DOS BAR CODE PRINTING SOFTWARE \$79 ea.

**AMERICAN MICROSYSTEMS**  
P.O. BOX 830551, RICHARDSON, TX. 75080  
(817) 834-9889



MASTERCARD AND VISA ACCEPTED



Inquiry 16

## CONVERSE WITH YOUR COMPUTER

AT LAST! A FULL IMPLEMENTATION of the original ELIZA program is now available to run on your microcomputer!

Created at MIT in 1966, ELIZA has become the world's most celebrated artificial intelligence demonstration program. ELIZA is a non-directive psychoanalyst who analyzes each statement as you type it in and then responds with her own comment or question—and her remarks are often amazingly appropriate!

Designed to run on a large mainframe, ELIZA has never before been available to personal computer users except in greatly stripped down versions lacking the sophistication which made the original program so fascinating.

Now, our new microcomputer version possessing the FULL power and range of expression of the original is being offered at the introductory price of only \$25. And if you want to find out how she does it (or teach her to do more), we will include the complete SOURCE PROGRAM for only \$20 additional.

Order your copy of ELIZA today and you'll never again wonder how to respond when you hear someone say: "Okay, let's see what this computer of yours can actually do!"

ELIZA IS AVAILABLE IN THE FOLLOWING FORMATS:

- 1 5 1/4 inch disk for the 48K Apple II, II Plus, IIe or IIc \$25 for Protected Version—\$45 for Applesoft Source Version
- 2 5 1/4 inch disk for the 64K IBM Personal Computer \$25 for Protected Version—\$45 for IBM Disk BASIC Source Version
- 3 5 1/4 inch disk or tape cassette for the Commodore 64 (specify which) \$25 for Protected Version—\$45 for C-64 BASIC Source Version
- 4 Standard 8 inch single density disk for all CP/M based computers \$25 for ELIZA.COM—\$45 with Microsoft BASIC-80 Source
- 5 5 1/4 inch disk for most CP/M based computers (specify computer) \$25 for ELIZA.COM—\$45 with Microsoft BASIC-80 Source

Please add \$2.00 shipping and handling to all orders (California residents please add 8% sales tax)

**ARTIFICIAL INTELLIGENCE RESEARCH GROUP**



921 North La Jolla Avenue, Dept. B  
Los Angeles, CA 90048  
(213) 856-7368 (213) 854-2214  
MC, VISA and checks accepted



Inquiry 26

## PC EXPANSIONS

AST SixPakPlus (64k)	\$259
SixPakPlus (384k)	\$299
MegaPlus (64k)	\$269
Advantage (128k)	\$419
Advantage (1.5M)	\$679
I/O Plus	\$129
PCnet - starter kit	\$809
Quadboard (64k)	\$199
Quadboard (384k)	\$249
Quadmeg-AT (128k)	\$319
Quadmeg-AT (2M)	\$669
Quadport-AT	\$105
HERCULES graphics board	\$319
Color Card with PP	\$159
HAYES Modems: 2400	\$call
Smartmodem 1200	\$409
Smartmodem 1200B	\$379
Set of 9 chips (64k)	\$10
256k chips (each)	\$5
8087 chip	\$119
Maynard Disk Controller	\$100
Sandstar Series	\$call
Internal Hard Disks from	\$679
MaynStream tape backup from	\$979
Qume 142A	\$109
Teac FD55B	\$109
Tandon TM100-2	\$109
CDC 9409	\$119
Verbatim Datalife disks (10)	\$25

**VLM Computer Electronics**  
10 Park Place • Morristown, NJ 07960  
(201) 267-3268 Visa, MC, Check or COD.

Inquiry 66

## 3M Diskettes

### Lifetime Warranty

**TIRED OF WAITING  
FOR SERVICE AND PRICE?  
9 out of 10 SURVEYED  
DISK BUYERS PREFERRED**

**NORTH HILLS  
#1 IN SERVICE AND PRICE  
1-800-328-3472**

Formatted and hard sectored disks  
in stock-Dealer inquiries invited.  
COD, VISA, MASTERCARD  
All orders shipped within 24 hrs.



**NORTH HILLS CORP.  
INTERNATIONAL**  
3564 Rolling View Dr.  
White Bear Lake, MN. 55110  
MN. call collect—612-770-0485

Inquiry 16

controls up  
to 4 motors  
from any CRT,  
terminal or  
computer



**STEPPER  
MOTOR  
CONTROLLER**

- powerful 5 amps/ winding
- RS232 interface
- Standard Version with BASIC \$985
- 16K BASIC with Battery Backup \$1335
- CNC VERSION \$1950
- Stepping Motor Tips Cookbook \$8
- CNC Manual \$12

**CENTROID (814) 237-4535  
Box 739, State College, PA 16804**

Inquiry 58

## DATAFLEX™

- Multi-user Database!
  - Powerfull
  - Multiple Operating System Compatibility!
  - Attractive Dealer Pricing!
  - Full Dealer Support!
- Dataflex is a trademark of Data Access  
Dealer Inquiries Invited

**COGITATE**

24000 Telegraph Road  
Southfield, Michigan 48034 USA  
(313) 352-2345

Inquiry 66

## 5 1/4" BASF FLEXYDISKS

	10-90	100 +
SS / DD Soft	\$1.11 ea.	\$1.09 ea.
DS / DD Soft	\$1.29 ea.	\$1.25 ea.
High Density (IBM - AT)	\$3.15 ea.	\$3.05 ea.
3.5 / SS Micro	\$2.10 ea.	\$2.05 ea.

In Stock — Immediate Shipment.  
Mastercard, VISA, Check or Money Order.  
Add \$3.00 shipping charges per each 100 or part.  
Add \$2.50 additional for C.O.D. shipments.  
N.J. residents add 6% sales tax.

**Data Exchange**  
Dept. B, P.O. Box 993  
178 Route 206 South  
Somerville, N.J. 08876  
(201) 874-5050

Inquiry 101

## NEW LOCKIT II

- Password Protected Subdirectories
- Hides files-makes files Read-Only
- Runs on any PC or compatible with Hard Disk under DOS 2.0 or Higher—
- Easy to use - only \$79.95

### LOCKIT I

- Password Enabled Boot-up
- For IBM PC or PC/XT
- Optional Hard-Disk-Only Boot.
- Invulnerable! \$129.95

### PC RESET/QUICKON

- Reset without turning off power
- Eliminate turn-on & Reboot wait
- Saves time, frustration & damage to PC & PC/XT \$89.95

Specify PC or XT, MC/VISA

**SECURITY  
MICROSYSTEMS  
CONSULTANTS**

16 Flagg Place  
Suite 102B  
S.I., NY 10304

(718) 667-1019

Inquiry 327



# PRIORITY

# 1 ONE

# ELECTRONICS

**TANDON 55-2**  
**5 1/4" - 40 Track**  
**Double Sided**  
**1/2-Height Drive**

**\$79 EACH** **\$69 Each**  
 FOR 2 OR MORE  
 BUTND552 (Sh. wt. 3 lbs.)

**5 1/4" Floppy Disk**  
**Drive Cabinet**

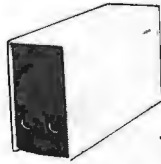

DRIVES  
 NOT  
 INCLUDED

Dual  
 1/2-Height

5V @ 1A 12V @ 1.5A  
 BUJMR2SV5 (7 lbs.)

**\$65**

**M DRIVE®/H™**

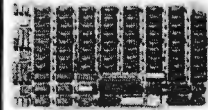

**VIASYN/  
 CompuPro**

- Increase System Speed 3500%!
- Auto Format • Auto Size
- IEEE 696/S-100

**\$499 Ea.** **\$450 Ea.**  
 FOR 2 OR MORE  
 BUGBTA072 List Price: \$695.00

**HERCULES Video**  
**Cards**

**High-Res Monochrome**  
**Graphics Card**  
 BUHECGC **\$399**

**NEW Color Graphics Card**  
**XT-Compatible!**  
**\$179** BUHECCOLOR

**20Mbyte Add-On Hard**  
**Disk For Your IBM PC**  
**and Compatibles**

Comes Complete With Half High  
 Disk Drive, Controller, & Cables

**INTERNAL EXTERNAL**

**\$599 \$799**

BUPRIPCSUB20I BUPRIPCSUB20X  
 Include \$5.00 (Internal), \$8.00 (External) for Shipping.



**S-100**  
**/PC**  
**Video**  
**Card**

**VIASYN/CompuPro**

- Bit-mapped graphics
- PC Compatible monochrome and RGB text graphics

BUGBTA356 **\$475**  
 List: \$495.00

**WYSE 50**



**\$499 Ea.** **\$479 Ea.**  
 FOR 2 OR MORE  
 BUWYS50 LIST PRICE: \$695.00  
 (Shipping weight 32 lbs.)

**25 Pin D Connectors**

<b>MALE</b>	<b>FEMALE</b>
BUGNDB25P	BUGNDB25S
50: <b>\$1</b> each	50: <b>\$1.50</b> each
100: <b>95¢</b> each	100: <b>\$1.25</b> each
1000: <b>90¢</b> each	1000: <b>\$1</b> each

**SHIELDED HOODS**

25 pcs	100 pcs	1000 pcs
<b>\$1.20</b>	<b>\$1.10</b>	<b>\$1.00</b>
each	each	each

BUGNDP25HS - Order in exact multiples of quantities shown

**VIASYN/CompuPro**



**INTELLIGENT DMA HARD DISK**  
**CONTROLLER FOR ST500-**  
**COMPATIBLE DRIVES**

**\$499**

BUGBTA087 Retail: \$595.00

**IRVINE**

18241 Mc Dermott,  
 Irvine, CA 92714  
 (714)660-1411



**PRIORITY**

**1  
ONE**

**ELECTRONICS**

Inquiry 299

**Mall Your Order To:**

9161 Deering Ave., Chatsworth, CA 91311

**INDUSTRIAL: (818)709-5111 RETAIL: (818)709-5464**



**SAN JOSE**

452 W. Trimble Rd.,  
 San Jose, CA 95131  
 (408)946-7010

MINIMUM PREPAID ORDER \$25.00. Terms U.S. VISA, MC, BAC, Check, Money Order, U.S. Funds ONLY. CA residents add 6%, 6 1/2%, or 7% Sales Tax, depending on your local rates. Include MINIMUM SHIPPING & HANDLING of \$3.00 for the first 3 lbs., plus 50¢ for each additional pound (25¢ if within Calif.) Plus 25¢ per \$100.00 value of your order for

insurance. Orders over 70 lbs. sent freight collect. Just in case, include your phone number. Prices subject to change without notice. We will do our best to maintain prices through September 1985. Credit card orders will be charged appropriate freight. We are not responsible for typographical errors.



**ORDER TOLL FREE (800)423-5922 (NOW IN CALIF. TOO!!)**

# MBASIC programmers

save Time & Money with  
Help Message System™  
B-Plus Tree Sub-System™  
Screen Builder System™  
EZ Screen™

Priced as low as \$59 each  
Money Back Guarantee  
Not Copy Protected  
No Royalty

**STERLING  
CASTLE**

702 Washington Street Suite 174  
Marina Del Rey, CA 90291  
(213)306-3020

Inquiry 351

# ROMDISK

## IBM PC\* COMPATIBLES AND APPLE IIe\*

ROMDISK is an EPROM diskette and  
disk drive emulator.

- Diskless control and communications systems
- Dedicated workstations for improved productivity
- Solid state reliability and performance
- Self contained control and EPROM program circuitry
- PC and MS DOS\* compatible

ROMDISK PC-1 (180K) \$495  
ROMDISK PC-2 (360K) \$595  
ROMDISK A for //e (144K) \$349



**CURTIS, INC. 22 Red Fox Road  
St. Paul, MN 55110 612/484-5064**

\*IBM PC and PC DOS is a registered trademark of IBM Corporation. MS DOS is a registered trademark of Microsoft Corporation. Apple //e is a registered trademark of Apple Computer Corporation.

Inquiry 97

## 6809-BASED SINGLE BOARD COMPUTER

The PT69, a powerful computer system on a single board, performs equal to larger and more expensive systems. It features:

- OS-9 L1 Operating System available (\$200)
- 2 RS232 Serial Ports (6850)
- 2 8-bit Parallel Ports (6821)
- Time-of-Day Clock (146818)
- 56K RAM; 4K EPROM (2732)
- DS/DD Floppy Controller Chip (2797)

**PRICE: \$289**

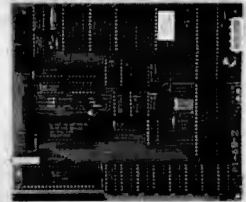

FLOPPY/HARD DISK SYSTEMS AVAILABLE!

**PERIPHERAL TECHNOLOGY**  
1480 Terrell Mill Rd., Suite 870  
Marietta, GA 30087

VISA/MasterCard/COD 404/973-0042

\*OS-9 is a trademark of Microware and Motorola.

Inquiry 291

## IBM AT 3Mb COMBO CARD WITH LIFETIME WARRANTY\*



The AT Multifunction Card that can give you up to  
3Mb of added memory plus added I/O features.

Expandable from 128K to 3Mb. Add memory as you need it. • IBM AT Compatible • Parallel Port • Serial Port • Spooler • Supports IBM VDISK • User Upgradeable • Parity Checking Standard • Split Memory Addressing.

Complete with 128K RAM, Serial and Parallel Port ..... \$299  
AT RAM Expansion Card (8K) ..... \$109  
Additional RAM available at our low prices. OTHER ADD ONS 384K  
RAM/ Clock, 512K RAM Card, Spoolers, RAM Cards for PPGs and more.

**Apparat, Inc.**  
ADD ON AND ON AND ON AND ON AND ON

4401 So. Yuma Parkway / Denver, CO 80237 / 303/741-1778

ORDERING AND DEALER INFORMATION  
800/525-7674

Stores in Denver & Chicago / \*On all cards sold after June 1, 1984

Inquiry 22

# uniforth™

## THE PROFESSIONAL

Now UNIFORTH is better than ever!

It's been upgraded to the FORTH-83 Standard and extended with lots of  
new programming tools that will save you time and frustration

- No vague error messages
- No jumping back and forth between UNIFORTH and your operating system

It's all there, in one comprehensive package

- Prioritized Multitasking
- Multi-file Video Editor
- Floating-Point Arithmetic
- Powerful String Package
- Text File Support

Plus, the ability to copy files, search directories, compile whatever!

The Professional comes with a unique 500-page Users/Programmers  
Guide that will lead you painlessly from the basics to the heart of FORTH.  
You'll find lots of examples and programming hints inside the ivory slip  
case

Need more? Some of the options we offer include:

- Telecommunications
- Graphics
- Cross-Compilers
- Star Catalogs

The UNIFORTH Professional is available for most  
personal computers and DEC mini-computers.  
Prices start at only \$195!

For more information, call or write for our free 16-page catalog. We  
guarantee that you'll enjoy using UNIFORTH, or your money back!

### UNIFIED SOFTWARE SYSTEMS

P.O. Box 2564, New Carrollton, MD 20784  
(301) 552-9590

Inquiry 374

## TRANSWEST COMPUTER PRODUCTS

PC/XT  
compatible  
to  
IBM  
\$1800.00

- 640K RAM
- 2 HH FDD/CTA
- game port
- case
- 130W Power Supply
- 2 parallel 2
- serial ports
- keyboard

- Clock calendar

- Options:
- 8087
  - color adaptor
  - HDD w/CTA card
  - 64K DRAM
  - 256K DRAM

(Dealer Inquiries Invited)

**(408) 292-4500**

Inquiry 369

## I.B.M. Compatible

Case	\$ 65.00
Motherboard (256K RAM space, RAM not included)	200.00
Color Graphic Adapter	150.00
Floppy Disk Driver Controller Card	65.00
Plotter (4 colors)	495.00
Computer (2 DD Drivers, Color Graphic Adapter, 256K RAM Case, Keyboard and 135 W Power Supply)	995.00
Keyboard	95.00

## APPLE Compatible

Z 80 Card	40.00
80 Column Card	45.00
I.C. Tester	75.00
Pal Writer Card	299.00
Graphic Pad Card (includes graphic program)	220.00

Prom 8200 Programmer (Fast Universal Type  
Eprom & Prom Programmer)  
For Eprom: 2716-27512; 2516-25512; (No Adapter Needed)  
For Prom: 63xx, 745xx, 145xx, 185xx, 245xx, 285xx,  
825xx, 875xx,

Include RS232 Interface IC's Available

CALL NOW (312) 280-7610  
Telex 280208 HFFM INT CGO

**DIST. WANTED**

**HOFFMAN INT'L**

600 N McCleary Ct. Ste. 309A  
Chicago, Illinois 60611

Inquiry 174

# American SEMICONDUCTOR

computers \* components \* hardware \* software

10 mb IBM Compatible  
Winchester  
HARD DRIVE **285.**

20 mb IBM Compatible  
HARD DRIVE **479.**

41256 MOS/OKI  
NAT/HIT **3.50**

1/2 HEIGHT Floppy Drives	89.
80287 FOR AT	175.
8087 Math Coprocessor	99.
AT TURBO KITS	CALL
Winchester Controller Card	175.
4164	799.
EPSON FX-100	499.
COLOR CARDS	130.
HAYES 1200B	350.
AT 360K 1/2 Height	109.

All new, proven parts. All merchandise guaranteed.

**1-800-237-5758**

Vander Line SALES EXT. 503  
813-948-3183

Inquiry 19

## RS-232 TO 9-TRACK TAPE ST-1 Streamer Interface for Streaming Tape Drives



Baud Rate to 19.2 KB  
ASCII or EBCDIC Code  
7 or 8 Level  
Block Length to 4096  
Read and Write

**Gentian Electronics Ltd.**  
1-613-836-3987

Inquiry 156



## Computer Systems

Please call w/ your System Requirements so that we may quote the configuration that best fits your needs.  
III XT-256 w/ Dual 1/4 HT DRVS, 256K, 8 slots, Mono. Monitor, PRT Ports. PC-DOS \$1,189  
INTERCONTINENTAL MICRO SYSTEMS CALL

## MORROW PIVOT II



**MORROW PIVOT I & II Portable** 11.5 Lb w/4 HR Battery IBM Compatibility, Expansion Capability, S/W & More Call For Our Dual Drive Lumicon Screen Special  
**MORROW MD3** MDT70 & HR15-XL Printer \$1,595  
**MORROW MD11** MDT70 & HR15-XL Printer \$2,295  
**ZENITH Z-158 PC-DESKTOP SYSTEM:** 2DRVS. 256K, S&P Ports, Includes MD-DOS, MS-WORD, MS-MULTIPLAN 5 & 8 MHz Switch \$1,849  
**640K RAM OPTION / 1/4 HT 10Mb TAPE** \$99/\$495  
**2 FLOPPY & 10Mb Drives / 20Mb Drives** \$2,449/\$2,589  
**VIASYN 816/286 w/ 40Mb & Tape** \$8,095  
**VIASYN 816/C-H40 w/ 5 1/4" & 8" FLPY'S** \$6,795  
**VIASYN 816/10-H40 w/ Two 5 1/4" FLPY'S** \$5,395  
CALL FOR OTHER SYSTEM CONFIGURATIONS

## S-100 Bus Boards

If you purchased before calling us, you probably paid too much! We stock **ACKERMAN DIGITAL, ADVANCED DIGITAL, CCS, VIASYN, CROMEMCO, DUAL, ELECTROLOGICS, INTERCONT. MICRO, KONAN, MULLEN, PICKLES & TROUT, SYNTech DATA, TARBELL, TECMAR, TRANSEND, VECTOR ELEC.**  
A few Of This Month's SPECIALS Are:  
**COMPUPRO/VIASYN RAM 22, 256K STATIC** \$779  
**COMPUPRO/VIASYN RAM 23, 128K STATIC** \$415  
**DUAL NEW BOARD SPECIALS** CALL  
**MACROTECH 256-ST / 512 Static VRAM** \$895/\$1,195  
**MACROTECH ADIT-4** Intelligent I/O \$699  
**MACROTECH MI-286 80286/Z80H DUAL PROC.** \$679  
**MACROTECH MSR-II 1Mb DYNAMIC RAM** \$999  
**VECTOR RAM 17 64K Static Ram (VIASYN)** \$319  
**VECTOR INTERFACER I** Dual Serial (VIASYN) \$209  
**VECTOR INTERFACER II** 3 Para., 1 Serial \$229

## Mainframe & Drive Enclosures

**INTEGRAND 1100 7** Slots and 2 X 8" Drives \$475  
**JMR POWER PLAY - Side by Side** 5 1/4" H.D. with Command Console & 6 Outlets Surge/Noise \$239  
**JMR 1 H5 5 1/4" H.D. PC Style Cabinet** \$189  
**MPS 6500 5 1/4" H.D. & 1/2 HT FLY OR TAPE** \$209  
**MICROWARE 521011** Dual Rom 1/2 Ht. 5 1/4" FLPY \$75  
**PARA DYNAMICS 3820S PRONTO** \$1,150

## Floppy Disk Drives

**MITSUBISHI 2894 STD./2896 1/2 HT. 8"** \$395/\$369  
**MITSUBISHI 4853 HALF HT. 5 1/4" 96TPI DSDD** \$139  
**TANDON 100-2A IBM-PC Compatible** \$109  
**TEAC FD55B/MITSUBISHI 4851/EPSON SD-521** \$95

## Hard Disk Subsystems

**PC-INSIDER/PC-OUTSIDER H.D. SERIES FOR IBM** 10 to 116 Formatted with Controller & All Cables, Hardware & P/S or PC Style Cabinet from \$529  
**WANGTEK 60Mb 1/2 HT Steering Tape in PC** \$2,200  
CALL For DLR &/or QTY. PRICES on HARD DISKS:

### MITSUBISHI Meggor RODIME

**MICROPOLIS QUANTUM Amcodyne**  
S-100 BUS SUBSYSTEMS Supporting Turbodos, Concur. Dos. CP/M 80 & 816 Operating Systems CALL  
**TAPE BACK-UP 10Mb 5 1/4" 1/2 HT** \$539

## PC-Slave Boards

**ADVANCED DIGITAL PC-SLAVE W/256K, 8 MHz 8088** CPU, 2 S Ports, RTNX S/W-For Multi-User PC \$865  
**ALLOY PC-SLAVE/16 256K to 768K RAM** \$759

## PC-Multifunction Boards

We have a Good Selection of Multifunction and Memory Boards for PC, XT, AT, JR, AT & T, and PC Portables  
**LASER DISK I/O FLPY CTRL, S, P & G Ports, CLK-CAL, Ram-Disk & Print Spool/MS-DOS** \$175/\$40  
**STB BIG BYTE 64K** \$155  
**STB GRANDE BYTE/PC-AT 128K** \$249  
**STB RIO GRANDE/PC-AT 128K 2 S, P, & G** \$330  
**STB RIO PLUS III/PC & XT 64K** \$240  
**TECMAR CAPTAIN UNPOP. w/ Treasure Chest** \$160  
**TECMAR JR. CAPTAIN 128K w/Treasure Chest** \$289  
**TECMAR EXPANSION CHASSIS With 8 Slots** \$675  
**TECMAR MAESTRO Unpopulated For PC/AT** \$335  
**TECMAR WAVE 64K Fits XT Short Slot** \$179

## PC-Video/Graphics Boards

**STB GRAPHICS PLUS II / MONO PLUS II** \$240/\$155  
**STB CHAUFFER** No Video Drivers Needed \$255  
**TECMAR GRAPHICS MASTER/TENDER** \$439/\$189

## Graphics & Cad

**PFS Graph** CALL  
**VECTRIX HIGHEST QUALITY FOR YOUR PC OR THROUGH SERIAL PORT.**  
**VECTRIX VX384A Stand Alone RS232 Co-proc.** CALL  
**VECTRIX VX1301 13" RGB Analog Monitor** CALL  
**VECTRIX VX1901 19" RGB Analog Monitor** CALL  
**VECTRIX VX/PCB 512 Col./Pall. of 16,800,000** CALL  
**VECTRIX VXTB 11"X11" Graphics Tablet** CALL

## PC-Scientific/Industrial Boards

**TECMAR BASE BOARD 96 Digital I/O Lines** \$219  
**TECMAR DADIO Data Up to 24 Devices** \$249  
**TECMAR IEEE-488 Board** \$249  
**TECMAR LABMASTER w/ TM40 PGL Option** \$865

## Monitors & Terminals

**LINK 125 WYSE 50 Compat. 14" GRN or AMB** \$449  
**LINK 125/PC w/ PC Emulating Video & Keybd** CALL  
**TATUNG CM-1322 640X200 RGB-SATISFACTION GUARANTEED. It Puts Competition to Shame!** \$395  
**TATUNG CM-1360 Like 1322 with Green & Amber Switch PLEASE ASK ABOUT OUR "HOT SPARES" LOANER POLICY** \$419  
**TATUNG CM-1370 720X480 RGB w/GRN Switch Long Persist Phos. Works w/ STB's SUPER RES 400** \$499  
**TATUNG MM-1222G/A Hi-Res 12" TTL(IBM)** \$119/\$125  
**TAXAN MONITORS** Call for Low Prices  
**TECMAR 640X480 RGB, GRN Switch Long Phos** \$519  
**ZENITH ZVM123A (Green) 122A (Amber)** \$85/\$89  
**ZENITH ZVM135 HI-RES RGB w/ Green Switch** \$449

## Printers & Plotters

**BROTHER HR-10 12CPS Daisy w/ TRAC., S&P** \$265  
**BROTHER HR-15-XL 17CPS Daisywheel S or P** \$359  
**BROTHER HR-35 36 CPS Daisywheel S or P** \$699  
**BROTHER TWINRITER Dot Matrix & Daisy** \$869  
**CITIZEN MSP-25 200/50 CPS 15" ULTRA QUIET** \$589  
**EPSON LX80, RX100+, FX80+, FX100+, LQ1500** CALL  
**HOUSTON INST. PLOTTERS & DIGITIZERS** CALL  
**OKIDATA New 182 Quiet 120 CPS & 60 CPS** CALL

## Networking & Switch Boxes

**GILTRONIX MANUAL AND AUTOMATIC SWITCHING UNITS** to Fit all of Your SHARED Printer, Terminal, Modem, and Other Peripheral Needs. From \$79  
**INTERCONT. MICRO LAN-PC/LANS-100** \$469/\$359  
**VIASYN NET II** for 816/10 SYS. \$425  
**VIASYN NET 101-96 for S-100 BUS** \$425

## Printer Buffers

**HANZON 12315 64-256K UDB S&P In&Out** from \$259  
**PRACTICAL PERIPH. MICROBUFFERS** CALL

## Modems

**HAYES SMART MODEM 1200 / 2400** \$425/\$639  
**PRENTICE POPCOM w/ PFS Access C150/X150** \$315  
**PROMETHEUS PROMODEM 1200** Hayes Compatible w/ Built-In PWR Supply-RS232 Stand Alone Unit \$289  
**OPTIONS FOR PROMODEM 1200 ARE:**  
**PROCESSOR/64K MEMORY/DISPLAY** \$75/\$35/\$79  
**PROMETHEUS 1200A / B / M** \$295/\$265/\$329  
**U.S. ROBOTICS COURIER / PASSWORD** \$499/\$209  
**U.S. ROBOTICS S-100 Board 300/1200** \$295  
**U.S. ROBOTICS PC MODEM w/ Teipac Software** \$249  
**U.S. ROBOTICS PC MULTI-MODEM** \$459

## Software

We have Access to all Well Known Brands - ORDER CORRECTLY - SOFTWARE IS NOT RETURNABLE!

## Accounting

**CORE SOFTWARE'S FASTRAK: A DATA FLEX** Application for all Your Accounting Needs Supporting All Networks & Operating Systems CALL

## Spreadsheets & Integrated Pkgs.

**ASHTON-TATE Framework** CALL  
**LOTUS 1-2-3/SYMPHONY** \$299/\$429  
**MDBS Knowledgegan** \$319  
**SORCIM Supercalc-3** Better Than 1-2-3!!! \$209

## Operating Systems & Utilities

**BORLAND SideKick Windows & Calculator** CALL  
**COMPUPRO/VIASYN CPM** at Affordable Prices  
**CROMEMCO COMPLETE LINE** GOOD ECONOMIES  
**DIGITAL RESEARCH Complete line** up to 35% Off

## Language And Tools

**BD SOFTWARE "C" Compiler 8" SS SD 8 BIT** \$95  
**COMPUTER INNOVATIONS C-86 "C" Compiler** \$299  
**COMPUVIEW VEDIT/VEDIT-PLUS** \$115/\$169  
**DIGITAL RESEARCH Most Products in Stock** CALL  
**LATTICE "C" Compiler (Ask About Options)** \$299  
**MICROSOFT Complete Line** CALL

## Data Base Managers

**ASHTON-TATE dBASE II & III** BEST PRICE  
**DATAFLEX FILE/RECORD Locking Multi-User** CALL  
**PFS FILE/REPORT** CALL

## Communications

**MYCROFT LABS MITE AND MITE PLUS** From \$79  
**MICROSTUF CROSS TALK XVI** \$96  
**PFS Access** CALL

## Word Processors

**MICROPRO WORDSTAR, Etc.** CALL  
**NEWSTAR NEWWORD w/ Money Back Guar.** \$129  
**OASIS THE WORD PLUS Spell Check, CP/M86** \$89  
**PFS WRITE/PROOF** CALL/CALL

## Diskettes & Cartridges

**3M TAPE CARTRIDGES 300XL & 800A In Stock** \$29.95  
**DYSAN DISKETTES** Low Prices From \$19.50  
**DYSAN Hard Disk Cartridges 5 1/4" & 8"** \$99/\$150  
**FUJI FILM FLOPPY DISKS** Low Prices From \$16.50

## Power Solutions

**FORTRON PC/XT Replacement P/S 140 Watt** \$149  
**SAFT SPS1000VA/SINE WAVE 1mSEC Switch** CALL  
**SOLA MINI UPS 750 Watt Sine Wave HIGH INRUSH (4500 Watt) 100% Batt. Op. w/o Switch-Over** CALL  
**TRIPPLITE BC-425-FC 425 Watts 15-20 Minutes** \$439  
**TRIPPLITE ISOBAR Line Suppressor-Filters** from \$40  
**TRIPPLITE SB-1000 Watt w/80 Amp/Hr. Battery** \$695

## Testing Devices & Software

**DATACOM TRI-STATE RS232 V.24 Breakout** \$199  
**DYSAN Floppy Analyzers** CALL  
**FLUKE 77 DVM w/ Hoister** \$119  
**RID-DYME FLPY DRV DIAGNOSTIC DISKETTE** \$30

## Chips

We Have Some of the LOWEST PRICES in the Nation!!  
**64K, 256K, 8087 & 80287** CALL

## Hobby Corner

**APPLE PASCAL** \$95  
**CCS 2810 280 CPU w/ Serial Port** \$209  
**DIGIAC 64K Dram w/o Ram. Works for N.S. Horiz** \$89  
**ITHACA BDS 64K, 6 SIO w/ I, XPU, Pascal** from \$100  
**MICROSOFT SOFTCARD APPLE II or II+ CP/M** \$85  
**MORROW A811 8" SSDD Add-On Drive** \$495  
**NORTHSTAR ADVANTAGE 8116 UPGD. w/ 64K** \$229  
**NORTHSTAR ADVANTAGE G/MSDOS w/ CP/M** \$195  
**PMMI MM-103 S-100 BD. 300-600 Baud Modem** \$149  
**S-100 EPROM BOARD 16K** \$89  
**SYNTech DATA PROM 100 KIT** \$89  
**TRANSEND VB3A (24) Kit Video Board** \$295



Incredible value!

# Nashua™ Diskettes

**LIFETIME WARRANTY!**

**97¢** ea. **\$107** ea.  
5 1/4" SSDD Qty. 50 5 1/4" DSDD Qty. 50

These are poly-bagged diskettes packaged with Tyvek sleeves, reinforced hubs, user identification labels and write-protect tabs. NASHUA Corporation is a half-billion dollar corporation and a recognized leader in magnetic media.

**SOFT SECTOR ONLY!** Sold in multiples of 50 only!

**FOR ORDERS ONLY:** 1-800-621-6827 (In Illinois: 1-312-256-7140)  
**INFORMATION & INQUIRIES:** 1-312-256-7140

HOURS: 8AM-5PM Central Time, Monday-Friday

**WE WILL BEAT ANY NATIONALLY ADVERTISED PRICE ON THE SAME PRODUCTS AND QUANTITIES!**

**DISK WORLD!, Inc.**

629 Green Bay Road • Wilmette, Illinois 60091

**DISK WORLD!**

Authorized Distributor **NASHUA MAGNETIC MEDIA**

## ATHANA DISKETTES

The great unknown!

**97¢** ea. **\$101** ea.  
5 1/4" SSDD Qty. 50 5 1/4" DSDD Qty. 50

You've used these diskettes hundreds of times...as copy-protected originals on some of the most popular software packages. They're packed in poly-bags of 25 with Tyvek sleeves, reinforced hubs, user identification labels and write-protect tabs.

**LIFETIME WARRANTY!**

**SOFT SECTOR ONLY!** Sold in multiples of 50 only.

**FOR ORDERS ONLY:** 1-800-621-6827 (In Illinois: 1-312-256-7140)  
**INFORMATION & INQUIRIES:** 1-312-256-7140

HOURS: 8AM-5PM Central Time, Monday-Friday

**WE WILL BEAT ANY NATIONALLY ADVERTISED PRICE ON THE SAME PRODUCTS AND QUANTITIES!**

**DISK WORLD!, Inc.**

629 Green Bay Road • Wilmette, Illinois 60091

**DISK WORLD!**

Authorized Distributor **ATHANA MAGNETIC MEDIA**

## DISKETTE STORAGE CASES

**AMARAY MEDIA-MATE 50: A REVOLUTION IN DISKETTE STORAGE**

Every once in a while, someone takes the simple and makes it elegant! This unit holds 50 5 1/4" diskettes, has grooves for easy stacking, inside nipples to keep diskettes from slipping and several other features. We like it!

**\$9.69** ea. + \$2.00 Shpg.

**DISKETTE 70 STORAGE: STILL A GREAT BUY.** Dust-free storage for 70 5 1/4" diskettes. Six dividers included. An excellent value.

**\$11.68** Shpg.

**DISK CADDIES \$1.65** ea. + 20¢ Shpg.  
The original flip-up holder for 10 5 1/4" diskettes. Beige or grey only.

**FOR ORDERS ONLY:** 1-800-621-6827 (In Illinois: 1-312-256-7140)  
**INFORMATION & INQUIRIES:** 1-312-256-7140

HOURS: 8AM-5PM Central Time, Monday-Friday

**WE WILL BEAT ANY NATIONALLY ADVERTISED PRICE ON THE SAME PRODUCTS AND QUANTITIES!**

**DISK WORLD!, Inc.**

629 Green Bay Road • Wilmette, Illinois 60091

**DISK WORLD!**

The value leader in Computer supplies And accessories.

FANTASTIC LOW PRICES ON

# BASF

## QUALIMETRIC DISKETTES!

**LIFETIME WARRANTY!**

**\$114** ea. **\$131** ea.  
5 1/4" SSDD Qty. 20 5 1/4" DSDD Qty. 20

5 1/4" SSDD-96TPI — \$1.46 ea. 5 1/4" DSDD-96TPI — \$1.75 ea.

**PACKED IN CARDBOARD CASES!**

BASF QUALIMETRIC DISKETTES have a LIFETIME WARRANTY with Tyvek sleeves, reinforced hubs, user identification labels and write-protect tabs.

**SOFT SECTOR ONLY! MINIMUM ORDER: 20 DISKETTES**

BASF 3.5" MICRO-FLOPPIES BASF 5 1/4" HIGH DENSITY

5SSDD-135 TPI — \$2.34 ea. DSDD-HD — \$3.14 ea.

**FOR ORDERS ONLY:** 1-800-621-6827 (In Illinois: 1-312-256-7140)  
**INFORMATION & INQUIRIES:** 1-312-256-7140

HOURS: 8AM-5PM Central Time, Monday-Friday

**WE WILL BEAT ANY NATIONALLY ADVERTISED PRICE ON THE SAME PRODUCTS AND QUANTITIES!**

**DISK WORLD!**

Authorized Reseller Information Processing **BASF** Media

## DISK WORLD! Ordering & Shipping Instructions

**Shipping:** 5 1/4" & 3.5" DISKETTES—Add \$3.00 per each 100 or fewer diskettes. **Other Items:** Add shipping charges as shown in addition to other shipping charges. **Payment:** VISA and MASTERCARD accepted. **COD Orders:** Add additional \$3.00 Special Handling charge. **APD, FPO, AK, HI & PR Orders:** Include shipping charges as shown and additional 5% of total order amount to cover PAL and insurance. **Taxes:** Illinois residents only, add 7% sales tax.

Prices subject to change without notice.  
This ad supercedes all other ads.  
Not responsible for typographical errors.  
MINIMUM TOTAL ORDER: \$35.00

**FOR ORDERS ONLY:** 1-800-621-6827 (In Illinois: 1-312-256-7140)  
**INFORMATION & INQUIRIES:** 1-312-256-7140

HOURS: 8AM-5PM Central Time Monday-Friday

**WE WILL BEAT ANY NATIONALLY ADVERTISED PRICE ON THE SAME PRODUCTS AND QUANTITIES!**

**DISK WORLD!, Inc.**

629 Green Bay Road • Wilmette, Illinois 60091

**DISK WORLD!**

## PRINTER RIBBONS:

### at extraordinary prices!

Brand new ribbons, manufactured to Original Equipment Manufacturer's specifications, in housings. (Not re-inked or spools only.)

**LIFETIME WARRANTY!**

**Epson MX-70/80** . . . \$3.58 ea. + 25¢ Shpg.  
**Epson MX-100** . . . \$4.95 ea. + 25¢ Shpg.  
**Okidata Micro83** . . . \$1.48 ea. + 25¢ Shpg.  
**Okidata Micro84** . . . \$3.66 ea. + 25¢ Shpg.

**FOR ORDERS ONLY:** 1-800-621-6827 (In Illinois: 1-312-256-7140)  
**INFORMATION & INQUIRIES:** 1-312-256-7140

HOURS: 8AM-5PM Central Time, Monday-Friday

**WE WILL BEAT ANY NATIONALLY ADVERTISED PRICE ON THE SAME PRODUCTS AND QUANTITIES!**

**DISK WORLD!, Inc.**

629 Green Bay Road • Wilmette, Illinois 60091

**DISK WORLD!**



Now, the lowest prices ever on

## 3M Scotch® DISKETTES

LIFETIME WARRANTY!

The best deal on 3M diskettes you've ever seen!

# FREE!

FLIP N' FILE 15 with every order for 5.25" SSDD and DSDD.



**\$1.42** ea. — 5.25" SSDD with FREE Flip n' File 15  
5.25" DSDD with FREE Flip n' File 15 — **\$1.74** ea.

### 100% LIFETIME WARRANTY

This is a Super Special promotion. It was supposed to end around the end of May.

But we decided to buy more than 1,000,000 3M diskettes packed in the FREE Flip n' File 15's...and give you the benefits of this terrific value.

One word of warning: **this offer is limited only to supplies on hand.** Once these supplies are used up, the prices stay the same...but there's no free Flip n' File.

The last time we ran an offer like this, everything was sold out in about six weeks.

So don't wait. Order now.

### Other 3M diskettes:

(Flip n' File offer does not apply.)

5.25" SSDD-96TPI . . . . . \$2.06 ea.  
5.25" DSDD-96TPI . . . . . \$2.57 ea.  
5.25" DSDD-HD for  
IBM PC/AT . . . . . \$3.93 ea.  
3.50" SSDD-135TPI for  
Apple Mac . . . . . \$2.86 ea.

### DATA CARTRIDGES

100% certified 3M data cartridges.

DC-1000 . . . . . \$13.90 ea.  
DC-300XLP . . . . . \$19.83 ea.  
DC-600A . . . . . \$22.13 ea.

Sold in cases of 10 only.  
Add \$5.00 shipping per 10.

**DISK WORLD!**

Authorized Distributor Information Processing Products





# DISK DRIVES

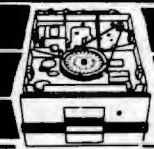

## Tandon TM 100-2

★ 360K  
★ Full Height  
**\$99**

### Apple Compatible Drives

#### Micro Sci

A-2 ..... \$ 159  
Controller ..... 60

#### CCU

FD525A Slimline for IIE ..... \$ 129  
FD525C for IIC ..... 139

**Hard Disk**  
10 Meg w/cont. & pwr supply ..... \$ 995

### 5 1/4" Disk Drives

#### Teac

FD55A, 160K ..... \$ 99  
FD55B, 360K ..... 99  
FD55F, Quad Density ..... 129

All Teac's are Half Heights

#### Tandon

TM100-2, 360K ..... \$ 99  
TM101-4, Quad Density ..... 2.69

#### Mitsubishi

4851, 360K 1/2 Height ..... \$ 129  
4853, Quad Den. 1/2 Height ..... 139

#### Hard Disk

10 Meg w/IBM Controller ..... \$ 499

#### Sanyo

1/2 Height 360K ..... \$ 89

### 8" Disk Drives

#### Siemens

FDD-100-8 Sgl Side ..... \$ 129  
FDD-200-8 Dbl Side ..... 189

#### Tandon

848-1E, Sgl Side, 1/2 Ht. .... \$ 279  
848-2E, Dbl Side, 1/2 Ht. .... 379

#### Mitsubishi

M2894-63, Dbl./Dbl. .... \$ 399  
M2896-63, Dbl./Dbl. 1/2 Ht. .... 399

### 5 1/4" & 8"

### Power Supply & Cabinets

#### JMR 5 1/4"

Single Cabinet w/pwr ..... \$ 79  
Dual Thinline Cab w/pwr ..... 89  
Dual Cabinet & Power ..... 89  
All have 6 month Warranty

#### JMR 8"

Sgl. Cabinet w/pwr & fan ..... \$ 229  
Dual w/pwr for 2 thinlines ..... 239  
Dual w/pwr & fan ..... 279

# PRINTERS

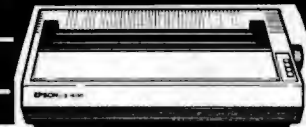

## Brother HR-15XL

★ 18cps  
★ Letter Quality  
**\$349**

#### Toshiba

P1340 ..... \$ 559  
P351 ..... 1095

#### Brother Dist. by Dynax

HR15XL, 12 cps ..... \$ 349  
HR25, 25 cps ..... 549  
HR35, 36 cps ..... 769

#### Epson

LX-80  
RX-100 +  
FX-80 +  
FX-185 +  
LQ1500  
JX-80

We Will  
Beat ALL Pricing

We are an Authorized Dealer

#### Okidata

OKI 182 ..... \$ 229  
OKI 83A ..... 535  
OKI 84P ..... 669  
OKI 84S ..... 749  
OKI 192 ..... 349  
OKI 193 ..... 585  
OKI MATE20 Color Printer ..... 199

Call for other Models

#### A B SWITCHBOX

Par. or Ser. .... \$ 69

### PRINTER INTERFACES

#### Fourth Dimension

Card & Cable (For Apple) ..... \$ 45

#### Microtek

Dumpling GX (Grappler Compatible) \$ 75  
Dumpling GX exp to 64K ..... 145  
Dumpling GX 16K w/16K exp to 64K ..... 160

#### Okidata Options

Tractor for 82 & 92 ..... \$ 59  
Serial Interface ..... 85

#### Orange Micro

Grappler + ..... \$ 84  
Grappler + w/16K ..... 149

#### Epson Accessories

Epson Serial Interface ..... \$ 99  
Letter Writer NLQ Kit ..... 59  
LX-80 or FX-80 Tractor ..... 39

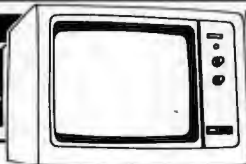

# MONITORS

## Taxan 425

★ Hi-Res Color  
★ IBM Compatible  
**\$389**

#### Amdek

300G, Hi-Res Green ..... \$ 125  
300A, Hi-Res Amber ..... 134  
310A, Monochrome Amber ..... 158  
300 Hi-Res Color Comp. .... 249  
500 RGB Composite ..... 399  
DVM Board for Apple RGB ..... 119

#### Taxan

425 Color RGB ..... \$ 389  
440 Ultra Hi-Res ..... 519

#### Stand

Tilt & Turn Stand ..... \$ 15

#### Princeton Graphics

MAX12, Monochrome Amber ..... \$ 169  
HX12, RGB Color ..... 459  
SR-12 w/Doubler Board ..... 799

#### IBM

Monochrome Green ..... \$ 249  
Color Hi-Res ..... 599

#### Zenith

ZVM122 ..... \$ 89  
ZVM123 ..... 89

# Computer Components Unlimited

Inquiry 68



No Surcharge for Credit Cards

All Prices Reflect a Cash,  
Pre-Paid Discount

This Ad Supersedes All Others

Customer Service & Technical

(213) 618-0487

Sales Desk

(800) 847-1718

Outside California

(213) 618-0477

Inside California

# SYSTEMS

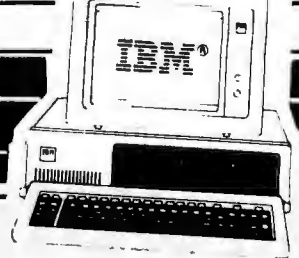

## IBM XT

- ★ One 360K Drive
- ★ One 10 Meg Hard Disk

**\$2495**

## IBM AT

- ★ Enhanced

**\$4295**

### Apple

IIE cpu	\$ 790
Macintosh	1895
IIC Portable	899

### Compaq

Portable (PC Compatible) 2, 360K Drives	\$1895
256K of Memory	3300
Compaq + w/10 Meg	1945
Deskpro 1	2250
Deskpro 2	2900
Deskpro 3	Call
Deskpro 4	Call

### IBM

PC 256K, 2 Drives	\$1499
XT w/10 Meg, 256K	2495
Additional Memory 64K	6.50
AT Standard Config.	Call
AT w/20 meg	Call
Add \$50 for Configurations & Testing	

# MODEMS

## Hayes 1200B

- ★ 1200 Baud
- ★ Internal for IBM
- ★ Hardware Only

**\$319**

### Hayes

Micro Modem IIE	\$ 169
300 Baud	169
1200B IBM Internal	349
1200	379
2400 Baud	599

### Anchor Automation

Mark XII, 1200 Baud	\$ 225
Mark X, 300 Baud Stand alone	149
Express 1200 Baud	269

### Prometheus

Promodem	\$ 299
Pro 1200A Apple Int w/sw	329
Pro 1200B IBM Int w/sw	299
Pro Mac w/cable & sw	379
No. C Cable	12
Alpha Disp.	89
Options Proc.	89

### U.S. Robotics

Password	\$ 219
Courier 2400 Baud	569

# IBM & APPLE ACCY'S

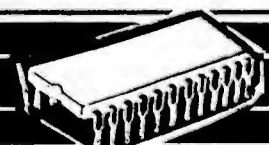

## 64K Upgrades

- ★ Nine 4164, 200ns
- ★ 1 Year Warranty
- ★ Nine to a Set

**\$6.50**

### APPLE EXTRAS

#### ALS

Z Engine	\$ 119
CPM 3.0 Card	240

#### CCU

RF Modulator	\$ 9
Fan w/Surge	34
16K Mem. Card 1 yr war.	45

#### Micro Max

Viewmax 80, 80 col. card	\$ 135
Viewmax 80E (F for IIE) 64K	120

#### Micro Soft

Premium Soft Card IIE	\$ 369
Soft Card (280) w/64K	279

#### Micro Tek

Serial Interface	\$ 89
------------------	-------

### IBM EXTRAS

#### Ast Research

Six Pack + w/384K	\$ 299
-------------------	--------

#### Hercules

Color Card	\$ 149
Graphics Card	304

#### Helix Technology

Memory Board 0-K to 512K	(0-K) \$ 119
--------------------------	--------------

#### IBM

Monochrome Adapter	\$ 219
Color Card	225

#### Paradise Systems

Multi-display Card	\$ 329
New Modular Card	260
5 Pack Multifunction	160

#### Quadram

Quadlink	\$ 349
----------	--------

#### 64K Upgrade AT Upgrade

64K of Mem. \$6.50 200ns	\$69
--------------------------	------

#### Ports

Parallel	\$ 79
Serial	79

#### CCU

Color Graphics Card	\$ 119
---------------------	--------

#### Everex

Graphics Edge	\$ 329
---------------	--------

### CCU Multifunction Card

Par. & Ser. Ports w/64K exp 384K	\$ 155
Clock, Calendar, Sftwr & Manuals	209

#### 8087's

8087-2	\$ 129
8087-3	115
8087-6	109

### 5 1/4" DISKETTES

#### CCU

Sgl/Dbi reinforced hub	\$11	100 for 100
Dbi/Dbi reinforced hub	13	100 for 110
Not Bulk Packed		

#### Dysan

Sgl/Dbi	\$33	100 for 300
Dbi/Dbi	39	100 for 370

#### Verbatim

Sgl/Dbi	\$26	100 for 240
Dbi/Dbi	36	100 for 340

### 8" Diskettes Available — Call

### DISK ACCESSORIES

#### Verbatim

8" or 5 1/4" Head Cleaning Kit	\$ 9
--------------------------------	------

#### Flip Tub

5 1/4" Holds 60 disks, plexiglass	\$ 9
-----------------------------------	------

Inquiry 68

### RETAIL STORES:

11976 Aviation Blvd  
Inglewood, CA 90304

16129 Hawthorne Blvd., Suite E  
Lawndale, CA 90260

### MAIL ORDER:

P.O. Box 1936  
Hawthorne, CA 90250

### Retail Hours:

10 a.m. - 6 p.m. Mon.-Fri.

10 a.m. - 3 p.m. Sat.

### Customer Service Hours:

10 a.m. - 4 p.m. Mon.-Fri.

John Aurentz

(213) 618-0487

### Mail Order Hours:

8 a.m. - 6 p.m. Mon.-Fri.

10 a.m. - 3 p.m. Sat.

(800) 847-1718 (213) 618-0477

(Outside California) (Inside California)

All merchandise new. We accept M.C. Visa. With Transfer. COD Call. Certified Check. Plus from qualified items. APO accepted. Shipping Minimum \$4.50 first 5 pounds. Tax: California Res. Only add 6% sales tax. All returns subject to 10% restocking charge. Advertised prices for Mail Order only. Retail prices slightly higher. Prices subject to change.



## MAJOR BRAND LIQUIDATION



Retail Value \$5000

Save up to 60%

**ACP PRICE  
NOW ONLY!**

**\$1985<sup>00</sup>**

*Color 14" RGB Included  
10 Mb Hard Disk*

ACP is proud to make this one-time special offer for a complete IBM PC™ Compatible Computer System. This is by far the most significant bargain that we at ACP have offered in our 10 year history. This

system was successfully designed and manufactured to exceed IBM's PC™ in terms of quality, expansion modularity and capability, aesthetic appearance, and performance.

The system design utilizes the latest in state-of-the-art technology including:

- VLSI - Large Scale Integration Circuit Design
- Ergonomic CRT Design with Tilt Screen
- Professional Molded Packaging and Design
- High Quality 100 Watt Switching Supply
- Complete Integrated System
- Microsoft Compatible Mouse Function

The system is not a Taiwan or Korean knock-off. Each component is specifically designed and specified to meet the highest performance and reliability standards in the industry. It represents the best that Japanese craftsmen have to offer and you will be equally proud to own one of your own. ACP has a limited quantity of these systems in several different configurations. IBM PC-DOS™ v1.1/2.1, MS-DOS™ v2.11 and Concurrent v3.1 compatible. We have found no known incompatibility with any IBM PC application. Our technical staff has 8.5 Megabytes of various MS-DOS software packages installed including Lotus 1-2-3 and Flight Simulator. Each system comes complete with a 90 day warranty.

### ACP Base System Consists of:

- (1) 360K DD/DS Floppy Disk Drive
- Mouse with Software
- 256K Memory Expandable to 640K on the Motherboard
- Deluxe Keyboard with LEDs
- Serial Port and Parallel Port
- Color or Monochrome Controller
- 4.77MHz, 8088 CPU
- 100 Watt Switching Supply w/Fan
- Three Expansion Slots
- Optional 6 Slot Expansion Chassis with Power Supply (add \$399)

	SYSTEM CONFIGURATION	Est IBM List*	Your Price
<b>SYSTEM A</b>	Base System (see left) PC with 360K Floppy, Keyboard & Mouse.	\$2100.00	<b>\$995.00</b>
<b>SYSTEM B</b>	Base System (see left) plus Add'l 360K Floppy Drive	\$2295.00	<b>\$1099.00</b>
<b>SYSTEM C</b>	Base System plus 12" Green Monitor with Detachable Tilt/Swivel Base.	\$2575.00	<b>\$1399.00</b>
<b>SYSTEM D</b>	Base System plus 12" Color Monitor with Detachable Tilt/Swivel Base.	\$2995.00	<b>\$1599.00</b>
<b>SYSTEM E</b>	Base System plus Cir Monitor, 10Mb Hard Disk and Boot Diagnostics.	\$5000.00	<b>\$1985.00</b>
<b>SYSTEM F</b>	Base System plus 80 Col. x 25 Line LCD Screen	N/A	<b>\$1299.00</b>

Base System A (as above) **\$995.00**

\*Assumes required add-in boards to provide same capacity

IBM PC is a trademark of IBM Corp.

**10 Mb \$449.00**  
**HARD DISK**  
w/Controller for IBM PC and Compatibles.  
At This Price, Supply Is Limited.

**PC UPGRADE SPECIAL**  
**\$10<sup>00</sup>** SET OF (9) 64K RAMS  
**\$45<sup>00</sup>** SET OF (9) 256K RAMS  
**\$5.95** 128K PIGGYBACKS

**IBM Brand ASYNCH**  
INTERFACE CARD  
List \$100 **ACP \$49.95**

**5 Mb EXTERNAL**  
Sharp IBM Look-a-like w/contr. for IBM PC. Sub-Sys Price: **\$429.00**  
External Enclosure Add **\$195.00**  
Internal w/controller  
Sub-System Price: **\$299.00**

### LQP PRINTER SPECIAL

Major Manufacturer  
Daisy Wheel Model 620  
Letter Quality Printer  
with Serial Interface.  
Perfect for IBM PC and Compatibles. Prints 25cps and comes with 90 day warranty.  
List \$1495  
**\$495<sup>00</sup>**

### DELUXE JOYSTICK

**\$11.95**  
Compatible w/Atari 2600, 400, 800, VIC-20/64 and Apple. Apple requires optional cable adapter. Add **\$2.95**

### APPLE DISK DRIVE

**\$115.00**  
High quality 1/2 high drive for Apple II, II+, IIe or IIc. Apple IIc requires optional cable adapter. Add **\$10.00**

Inquiry 12





# DoKay

COMPUTER  
PRODUCTS,  
Inc.

ORDER TOLL FREE

(800)  
**538-8800**  
(CALIFORNIA RESIDENTS)  
(800)  
**848-8008**



## STATIC RAMS

2101	256 x 4	450ns	1.90
2102	1K x 1	450ns	.79
2102L-4	1K x 1	450ns	.99
2102L-2	1K x 1	250ns	1.29
2111	256 x 4	450ns	2.29
2112	256 x 4	450ns	2.29
2114	1K x 4	450ns	.99
2114-25	1K x 4	250ns	1.10
2114L-4	1K x 4	450ns	1.20
2114L-3	1K x 4	300ns	1.20
2114L-2	1K x 4	200ns	1.40
2147	4K x 1	55ns	3.95
5101	256 x 4	450ns	CMOS 3.95
TM84044-4	4K x 1	450ns	2.95
TM84044-3	4K x 1	300ns	3.45
TM84044-2	4K x 1	200ns	3.95
MK4110	1K x 8	250ns	6.95
TM82010-20	2K x 8	200ns	2.49
TM82010-15	2K x 8	150ns	2.99
TM82010-10	2K x 8	100ns	4.49
HM8110-4	2K x 8	200ns	CMOS 2.49
HM8110-3	2K x 8	150ns	CMOS 2.99
HM8110-2	2K x 8	120ns	CMOS 5.40
HM8110U-4	2K x 8	200ns	CMOS 2.99
HM8110U-3	2K x 8	150ns	CMOS 3.49
HM8110U-2	2K x 8	120ns	CMOS 8.40
Z-6132	4K x 8	300ns	29.95
HM8204P-15	8K x 8	150ns	CMOS 5.95
HM8204LP-15	8K x 8	150ns	CMOS 6.95
HM8204LP-12	8K x 8	120ns	CMOS 8.95

## DYNAMIC RAMS

TM84027	4K x 1	250ns	1.45
UPD411	4K x 1	300ns	1.85
HM8280	4K x 1	300ns	1.95
MK4100	8K x 1	200ns	.49
HM8290	8K x 1	250ns	.49
4110-20	16K x 1	200ns	.79
4110-15	16K x 1	150ns	.99
4110-12	16K x 1	120ns	1.49
2110	16K x 1	150ns	3.95
4184-25	64K x 1	250ns	5v .59
4184-20	64K x 1	200ns	5v .59
4184-15	64K x 1	150ns	5v .79
41250-20	256 x 1	200ns	3.05
41250-15	256 x 1	150ns	3.05

## EPROMS

1702	256 x 8	1 us	3.95
2706	1K x 8	450ns	2.49
2766	1K x 8	450ns	5.90
2718	2K x 8	450ns	5v 3.95
2718-1	2K x 8	380ns	5v 3.95
TM82510	2K x 8	450ns	5v 3.95
TM82710	2K x 8	450ns	5v 6.95
TM82532	4K x 8	450ns	5v 3.95
2732	4K x 8	450ns	5v 2.95
2732 A-4	4K x 8	450ns	21v 2.95
2732 A-35	4K x 8	350ns	21v 3.95
2732 A	4K x 8	250ns	21v 5.95
2732 A-2	4K x 8	200ns	21v 8.95
2764	8K x 8	450ns	5v 3.95
2764-25	8K x 8	250ns	5v 4.95
2764-20	8K x 8	200ns	5v 5.95
TM82504	8K x 8	450ns	5v 9.95
MC808704	8K x 8	450ns	5v 17.95
MC808706	8K x 8	350ns	5v 19.95
27120-45	16K x 8	450ns	5v 5.90
27120-30	16K x 8	300ns	5v 5.50
27120-25	16K x 8	250ns	5v 6.90
27250-25	32K x 8	250ns	14v 9.95

## 74LS00

74LS00	.23	74LS125	.48	74LS200	.58
74LS01	.24	74LS126	.48	74LS201	.54
74LS02	.24	74LS132	.58	74LS273	1.45
74LS03	.24	74LS133	.58	74LS275	3.30
74LS04	.23	74LS138	.38	74LS279	.48
74LS05	.24	74LS137	.98	74LS280	1.95
74LS06	.27	74LS138	.54	74LS283	.88
74LS09	.20	74LS139	.54	74LS289	.88
74LS10	.24	74LS145	1.15	74LS293	.88
74LS11	.34	74LS147	2.45	74LS295	.98
74LS12	.34	74LS148	1.30	74LS298	.88
74LS13	.44	74LS151	.54	74LS299	1.70
74LS14	.58	74LS153	.54	74LS323	3.45
74LS15	.34	74LS154	1.85	74LS324	1.70
74LS20	.24	74LS155	.88	74LS352	1.25
74LS21	.28	74LS156	.88	74LS353	1.25
74LS22	.24	74LS157	.84	74LS363	1.30
74LS26	.28	74LS158	.58	74LS364	1.90
74LS27	.28	74LS160	.88	74LS365	.48
74LS28	.34	74LS161	.84	74LS366	.48
74LS30	.24	74LS162	.88	74LS367	.44
74LS32	.28	74LS163	.84	74LS368	.44
74LS33	.54	74LS164	.58	74LS373	1.35
74LS37	.34	74LS165	.94	74LS374	1.35
74LS38	.34	74LS166	1.90	74LS377	1.35
74LS40	.24	74LS168	1.70	74LS378	1.13
74LS42	.48	74LS169	1.70	74LS378	1.30
74LS47	.74	74LS170	1.45	74LS385	1.85
74LS48	.74	74LS173	.88	74LS386	1.45
74LS49	.74	74LS174	.54	74LS390	1.15
74LS51	.24	74LS175	.54	74LS393	1.15
74LS54	.28	74LS181	2.10	74LS395	1.15
74LS55	.28	74LS189	6.90	74LS399	1.45
74LS63	1.20	74LS190	.88	74LS424	2.90
74LS73	.38	74LS191	.88	74LS447	3.80
74LS74	.34	74LS192	.78	74LS480	1.90
74LS76	.38	74LS193	.78	74LS824	3.95
74LS78	.38	74LS194	.68	74LS840	2.15
74LS78	.48	74LS195	.68	74LS845	2.15
74LS83	.58	74LS196	.78	74LS868	1.55
74LS85	.58	74LS197	.78	74LS869	1.85
74LS86	.58	74LS221	.68	74LS870	1.45
74LS90	.54	74LS240	.94	74LS874	9.50
74LS91	.88	74LS241	.98	74LS892	3.15
74LS92	.54	74LS242	.98	74LS893	3.15
74LS93	.54	74LS243	.98	74LS894	3.15
74LS95	.74	74LS244	1.25	74LS895	3.15
74LS96	.88	74LS245	1.45	74LS898	2.35
74LS107	.38	74LS247	.74	74LS899	3.15
74LS109	.38	74LS248	.98	74LS973	23.95
74LS112	.38	74LS249	.98	81LS95	1.45
74LS113	.38	74LS251	.58	81LS96	1.45
74LS114	.38	74LS253	.58	81LS97	1.45
74LS122	.44	74LS257	.58	81LS98	1.45
74LS123	.78	74LS258	.58	25LS2521	2.75
74LS124	2.95	74LS259	2.70	25LS2589	4.20

We will try to BEAT  
All Competitor's Prices  
CALL for Quote!

## DISC CONTROLLERS

1801	.....	6.90	2795	.....	38.90
1771	.....	14.90	2797	.....	38.90
1791	.....	22.90	6843	.....	33.90
1793	.....	22.90	8272	.....	19.90
1795	.....	22.90	MB8876	.....	22.90
1797	.....	22.90	MB8877	.....	22.90
2143	.....	6.90	MC3470	.....	4.90
2701	.....	38.90	UPD785	.....	19.90
2793	.....	38.90			

## CRT CONTROLLERS

6845	.....	11.90	CRT5027	.....	18.90
6847	.....	10.90	CPD5037	.....	28.90
68047	.....	23.90	DP8350	.....	38.90
68845	.....	18.90	HD49505	.....	11.90
7220	.....	38.90	MC1372	.....	9.90
8275	.....	28.90	TM89818A	.....	38.90

## UV ERASERS

QUV-T8/1 \$49.95  
ECONOMY Model



- Erases 15 EPROMS in 20 minutes
- Plastic Enclosure

## 6500

6500	.....	4.90	6502A	.....	5.90
6504	.....	6.90	6520A	.....	5.90
6505	.....	8.90	6522A	.....	9.90
6507	.....	9.90	6532A	.....	10.90
6520	.....	4.30	6545A	.....	12.90
6522	.....	4.90	6551A	.....	10.90
6532	.....	9.90			
6545	.....	9.90			
6551	.....	9.90	6502B	.....	7.90

## 1 MHz

8800	.....	2.90			
8802	.....	7.90			
8803	.....	17.90			
8808	.....	12.90			
8809E	.....	6.90			
8809	.....	8.80			
8810	.....	2.90			
8820	.....	4.30			
8821	.....	2.90			
8828	.....	13.90			
8840	.....	11.90			
8843	.....	33.90			
8844	.....	24.90			
8845	.....	11.90			
8847	.....	10.90			
8850	.....	2.90			
8852	.....	5.90			
8860	.....	7.90			
8862	.....	10.90			
8875	.....	6.90			
8880	.....	1.90			
8883	.....	21.90			

## 8000

8031	.....	14.90	8253	.....	6.90
8035	.....	5.90	8253-5	.....	7.90
8039	.....	5.90	8255	.....	4.45
IM8-0060	.....	15.90	8255-5	.....	4.90
IM8-0073	.....	29.90	8257	.....	7.90
8080A	.....	3.90	8257-5	.....	8.90
8085	.....	4.90	8259	.....	5.90
8085A-2	.....	11.90	8259-5	.....	6.90
8088	.....	24.90	8271	.....	69.90
8087-3 (5 MHz)	.....	124.95	8272	.....	18.90
8087-2 (8MHz)	.....	190.95	8274	.....	28.90
8088	.....	19.90	8275	.....	28.90
8089	.....	59.90	8279	.....	8.90
			8279-5	.....	7.90
			8282	.....	6.45
			8283	.....	6.45
			8284	.....	4.90
			8286	.....	6.45
			8287	.....	6.45
			8288	.....	12.90
			8289	.....	44.90
			8292	.....	12.90

## 8100

8131	.....	2.90			
8155	.....	6.90			
8155-2	.....	7.90			
8156	.....	6.90			
8156-2	.....	38.90			

## 8200

8202	.....	23.90			
8203	.....	38.90			
8205	.....	2.90			
8212	.....	1.75			
8214	.....	3.75			
8218	.....	1.75			
8224	.....	2.20			
8228	.....	1.75			
8237	.....	3.45			
8237-5	.....	12.90			
8237-6	.....	14.90			
8238	.....	4.45			
8243	.....	4.45			
8950	.....	4.95			
8251	.....	3.95			
8251A	.....	4.60			

## 8300

8303	.....	2.90			
8304	.....	1.90			
8307	.....	2.90			
8308	.....	2.90			
8310	.....	3.90			



**EXTENDED 80-Column Card for APPLE IIe**  
 ● 64K to 128K Upgrade  
 ● 2-Year Warranty  
**\$69.95**

**Z-80 (CP/M) CARD APPLE II+, IIE**  
 ● Compatible w/all Apple CP/M  
 ● Lifetime Warranty  
**69.95**

**LOGICAL DEVICES, INC. LOGICAL**



**Low Cost EPROM Programmer The "SHOOTER" ... \$395.00**  
 ● 32K, upgradable to 128K bit memory  
 ● Built-in Serial RS232 port  
 ● Program and verify 2716 thru 27258  
 ● Intelligent, fast programming  
 ● Up/download Hex, Binary, ASCII etc.  
 ● Serial RS232 interface compatible



**PROMPRO-8 84K version ... \$689.00**  
 ● Powerful EPROM/Micro development programmer  
 ● Keypad simulations  
 ● 256K memory buffer option

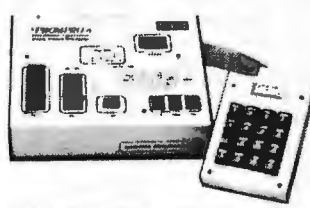

**LANGPRO-8™ ... \$995.00**  
 Sophisticated capability to program and verify 8 EPROMS or EEPROMS at once. Can be configured to program any of the standard single voltage 2K, 4K, 8K or 16K EPROMS or EEPROMS. Separate power circuitry for each of 8 ZIF sockets with isolation, over-voltage and overcurrent protection. 4-digit alpha-numeric display, self-contained with power supply.  
 ● High through-put  
 ● Reliable, user-friendly  
 ● Intelligent algorithm  
 ● Program and verify 2716 thru 27258  
 ● Stand alone (RS232 option \$185)

# APPLE & IBM ACCESSORIES

## APPLE ACCESSORIES

- Parallel Printer Card ..... 49.95
- 80-Col. card for Apple II+... 149.95
- 80-Col. card for Apple IIe... 129.95
- Checkmate 80-Column Card... 69.95
- Serial Card (communication)... 69.95
- Clock Calendar card..... 79.95
- Cooling Fan ..... 38.95
- Power Supply ..... 69.95
- Joystick ..... 29.95
- Joystick Adapter Apple IIe... 14.95
- RF Modulator ..... 13.95
- Disk Drive Full Height ..... 169.95
- Disk Drive 1/2 Height ..... 169.95
- Controller Card ..... 49.95
- Apple Paddles ..... 5.95
- 16K Card ..... 39.95
- 16K Bare Board ..... 13.95
- Extend-A-Slot ..... 34.95
- Paddle Adapple ..... 29.95
- Koala Touch Pad ..... 99.00
- Magic Touch Pad w/Joystick... 79.95
- Keytronic Keyboard..... 219.00
- Apple Keyboard (Taiwan).. 149.95



**VIEWMAX-80 149.95**

The right 80-column card for your Apple II+

- Soft video switch
- Built-in inverse video
- Shift key support
- 2 year parts & labor warranty



**VIEWMAX-80e 129.95**

Most advanced 80-column extended video card for Apple IIe

- Expands memory up to 192K
- Double high resolution
- 2 year parts & labor warranty



## DISK DRIVES Apple and IBM compatible

- Apple full height ..... 159.95
- Apple half height ..... 129.95
- Teac 558 ..... 115.95
- Tandon TM100-2..... 149.95

## APPLE or IBM JOYSTICK

**\$29.95**

Compatible for either:  
 APPLE II and APPLE IIe  
 OR  
 IBM-PC, JR., & IBM-XT  
**MULTIFUNCTION CARD**



- 64K to 384K RAM
- Parallel Port
- Serial Port
- Clock Calendar
- Software included
- 1-Year Warranty

**\$199.00**

## MEMORY CARD



- Expandable to 512K
- Fully compatible with IBM software
- Fully compatible w/IBM diagnostic utilities
- Serial Port Available
- 1-Year Warranty

**\$149.00**

## MEMORY EXPANSION KIT



**4164 200ns  
69¢ each!**

## 8087 MATH CO-PROCESSOR

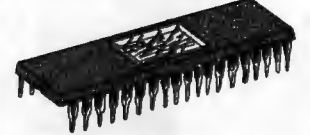

- 8087-3 (5 MHz) ..... 124.95
- 8087-2 (8 MHz) ..... 199.95

**NO LABEL:( SOFT SECTOR w/HUB RING )**  
 25 per package  
**SS/DD ... 24.75 or .99 ea.**  
**DS/DD ... 28.75 or 1.19 ea.**  
**2-YEAR WARRANTY ON ALL BULK DISKETTES**

## 1985 - THE IC MASTER -



Your ticket to fast and easy IC selections  
**\$89.95**

**DB25 Connectors**  
 MALE ..... 1.75  
 FEMALE..... 1.95

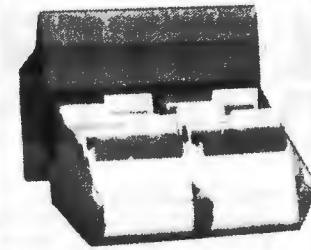

**The Flip Sort PLUS™**  
 The new Flip Sort PLUS™ adds new dimensions to storage. Its smoked acrylic elegance holds over 100 diskettes with all the features you expect from the Flip Sort Family—  
**\$24.95**

## CALL or WRITE for our FULL CATALOG

**TERMS:** Minimum order \$10.00  
 For shipping and handling include \$2.50 for UPS ground or \$3.50 for UPS Blue (air). For each additional air pound, add \$1.00. California residents must include 6% sales tax; L.A., S.F., S. Cruz & S. Mateo counties include 6.5% sales tax and Santa Clara include 7% sales tax. All items subject to availability and prices are subject to change. Typographical errors are not our responsibility.  
 No additional charge for Mastercard or Visa. We reserve the right to substitute manufacturer and to limit quantities.

**CALL for VOLUME Quotes**  
 NEW HOURS: M - F 7:30 am - 5:00 pm

VISIT OUR RETAIL STORE  
 2100 De La Cruz Blvd.  
 Santa Clara, CA 95050  
 (408) 988-0697

**ALL MERCHANDISE IS 100% GUARANTEED**

**Telex: 756440**

**DoKay**



# California Digital

17700 Figueroa Street • Carson, California 90248

## F10 DAISY WHEEL PRINTER

# \$499

## LETTER QUALITY

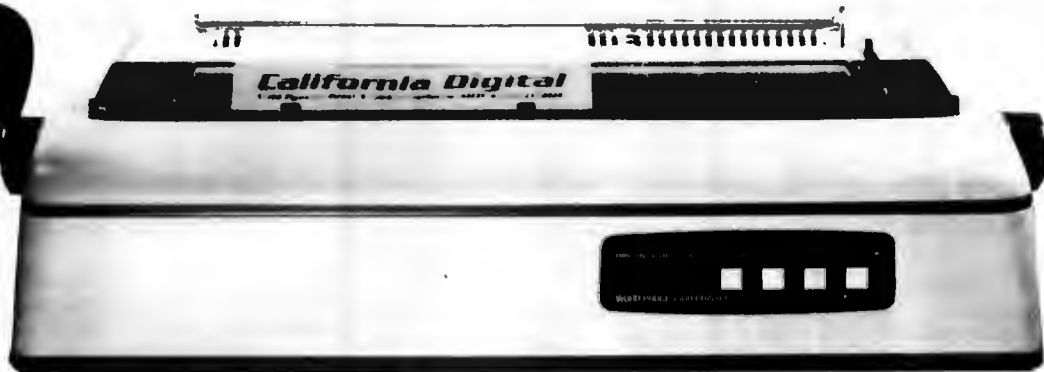

The TEC F-10 Daisy Wheel printer is the perfect answer to a reasonably priced 40 character word processing printer. While this printer is "extremely" similar to C.ltoh's F-10/40 Starwriter printer. Legal counsel for the C.ltoh Company have advised us that we should refrain from referring to the TEC printer as a Starwriter.

This 40 character per second printer auto installs with Wordstar and Perfect Writer. Features extensive built-in word processing functions that allow easy adaptability and reduced software complexity. Industry standard Centronics interface provides instant compatibil-

ity with all computers equipped with a parallel printer port. The TEC F-10 accepts paper up to 15 inches in width.

These printers were originally priced to sell at over \$1400. Through a special arrangement California Digital has purchase these units from a major computer manufacturer and is offering these printers at a fraction of their original cost.

Options available include tractor feed, buffered memory and an assortment of printer cables for a variety of computers.

### UltraLink 1200



\$159

The UltraLink is a Hayes compatible 300/1200 modem designed for the IBM/PC market place. The UltraLink adds a voice/data dimension to your PC. Manufacturers original suggested price on this modem is \$795. California Digital's price \$159.

### DUAL SHUGART SUBSYSTEM

\$239

The dual Shugart subsystem features two SA465 (96 tpi) 5 1/4" double sided disk drives. Also supplied within the subsystem is 50 watt power supply and a shielded signal cable.



\$99

### MEMORY

4164 DYNAMIC MEMORY 150ns

Quantity 100

\$ .99

#### DYNAMIC MEMORY

4164 150ns. 64K 128 refresh	1.31	32 +	100 +
41256 150ns. 256K	1.39	1.19	.99
4116 150ns. 16K	6.95	6.50	6.25
4116 200ns. 16K	1.75	1.85	1.45
4128 for IBM/AT	1.95	1.85	1.45
DP8408 dynamic controller	6.95	6.75	6.35
	39.00	35.00	29.00

#### STATIC MEMORY

21L02 300ns. 1K static	1.49	1.29	1.15
21L02 450ns. 1K static	1.29	1.15	.99
21L2 450ns. 2K static	2.99	2.85	2.75
21L4 300ns. 1K x 4	1.95	1.85	1.75
4044TMS 450ns. 4K x 1	3.49	3.25	2.99
5257 300ns. 4K x 1	2.50	2.25	1.99
6116 P4 200ns. 2K x 8	3.95	3.85	3.70
6116 P3 150ns. 2K x 8	4.55	4.35	4.15

#### EPROMS

2708 450ns. 1K x 8	4.95	4.75	4.55
2718 450ns. 2K x 8	4.50	4.25	3.97
2716TMS 450ns. Tri-voltage	7.95	7.85	7.25
2732 450ns. 4K x 8	8.50	8.25	8.55
2764 250ns. 8K x 8	5.95	5.75	6.25
27128 350ns. 16K x 8	7.95	7.35	6.95

### Shugart 604 WINCHESTER

\$99



These 6.7 Megabyte drives are new units recently released by the Shugart division of Xerox. The Shugart 604 is fully 506 industry compatible. Each drive is tested before shipment and is supplied with a 90 day warranty. SHU-604

#### Five Inch Winchester Hard Disk Drives

FUJITSU M2235AS 27 Meg.	899	859
RODIME RO-208 53 Meg.	1589	1493
MAXTOR XT10140 140 Meg.	3895	3785
SHUGART 712 13 Meg. 1/2 Ht	495	465
SHUGART 604 6.7 Meg.	99	89
TANDON 502 10 Meg.	419	395
TANDON 503 19 Meg.	695	675
SEAGATE 225 25 Meg.	695	625

### TEAC 55B 48 TPI

One Two Ten

#### Five Inch Double Sided Drives

TEAC FD55B half height	99	95	89
TEAC FD55F 96 TPI, half ht.	119	115	109
CONTROL DATA 9409 PC	169	159	155
SHUGART SA455 Half Height	99	95	89
SHUGART SA465 1/2 Ht. 96TPI	99	95	89
TANDON 100-2 full height	129	125	119
TANDON 101-4 96TPI full ht.	199	189	179
MITSUBISHI 485 1 half height	139	135	129
MITSUBISHI 485 3 96/TPI 1/2 Ht.	155	149	139
MITSUBISHI 485 4 8" elec.	295	285	275
QUME 142 half height	119	105	99

#### Eight Inch Single Sided Drives

SHUGART 801R			
SIEMENS FDD 100-8	119	115	109
TANDON 848E-1 Half Height	369	359	349

#### Eight Inch Double Sided Drives

SHUGART SA851R	495	485	475
QUME 842 "QUME TRACK 8"	319	319	313
TANDON 848E-2 Half Height	459	447	435
REMEX RFD-4000	219	219	209
MITSUBISHI M2896-63 1/2 Ht.	459	449	409

Shipping: First five pounds \$3.00, each additional pound \$.50.  
Foreign orders: 10% shipping, excess will be refunded.  
California residents add 6 1/2% sales tax. • COD's discouraged.  
Open accounts extended to state supported educational institutions and companies with a strong "Dun & Bradstreet" rating.



# California Digital

17700 Figueroa Street • Carson, California 90248

## XEROX SUNRISE COMPUTER

# \$299

~~\$2995~~

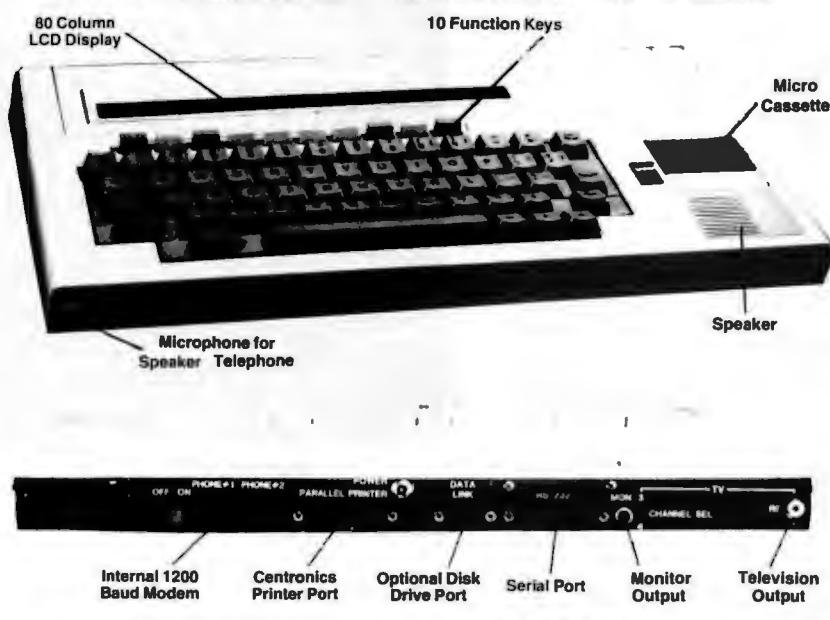

The Xerox Sunrise 1810 is by far the best value we have ever seen in a micro computer. This is a self contained battery and AC operated portable. The Sunrise was originally priced at \$2995. Xerox has since elected to drop the computer from their product list. California Digital has purchased all the remaining inventory and is making the unit available at a fraction of its original cost.

This portable features a built in 80 column liquid crystal display, along with both RF monitor and television outputs. The internal 300/1200 baud modem includes an auto dial telephone assembly. The units has both centronics parallel and a serial port programmable to 19,200 baud.

The self contained micro cassette is capable of capturing data from the keyboard as well as doubling as an recorder for dictating messages.

An optional dual floppy disk drive module, pictured above, is available for only \$219. (when purchased with the Sunrise 1810). Also available, for \$59 is an 80 column printer that mounts in the drive module. The Sunrise features a CP/M operating system which allows the operator to use any CP/M program in Xerox 5 1/4" disk format and over 5000 CP/M programs available in public domain.

## PRINTERS

### MATRIX PRINTERS

Star Gemini SG10 120 char/sec	STR-SG10	230 00
Star Gemini SG15 100 char/sec 15 paper	STR-SG15	380 00
Star Gemini Delta 10 160 Char/sec	STR-D10	350 00
Citizen MSP 10PT 160 char/sec	CTI-MSP10	280 00
Toshiba P1351 132 char/sec letter quality	TOS-1351	1450 00
Okidata 182A serial & parallel 9" paper	OKI-182A	257 00
Okidata 192A parallel interface 180 char/sec	OKI-182A	345 00
Okidata 84P parallel 15 paper	OKI-84P	780 00
Epson LX-80 10 120 Char/sec	EPS-LX80	230 00
Epson FX80PT 10 160 char/sec with graphics	EPS-FX80	360 00
Epson RX100 15 with graphics	EPS-RX100	380 00
Epson FX100F 15 110 char/sec with graphics	EPS-FX100	480 00
Epson LX1500 15 continuous paper quality	EPS-LX1500	890 00
Epson JX80 color printer	EPS-JX80	510 00
Plover 9510 parallel 9" paper	PRO-9510P	320 00
D-Data Products B 600-3 band printer 600 LPM	DPS-B600	690 00
Intertec P100 high speed printer 300 lines per minute	PTX-P300	390 00
Intertec P100 ultra high speed 600 lines per minute	PTX-P600	570 00

### WORD PROCESSING PRINTERS

StarWriter F10 parallel 40 char/sec	PRO-F10P	490 00
NEC8810 55 char second serial interface	NEC-8810	1650 00
NEC8830 55 char/sec par interface	NEC-8830	1650 00
NEC3550 popular printer designed for the IBM/PC	NEC-3550	1590 00
NI C2050 ix signed for IBM/PC 20 char/sec par I	NEC-2050	680 00
5-pin Reed EXPS50 11 char/sec par interface	SRD-EXPS50	310 00
5-pin Reed EXPS50 17 Char/sec par I interface	SRD-EXPS50	420 00
11 pin 830 40 char/sec serial	DBL-630	1560 00
11 pin 820 proportional spacing horiz & vert tab 20 cps	DBL-620	780 00
11 pin 6100 18 char/sec	JUK-6100	390 00
Ju-6300 40 char/sec	JUK-6300	690 00
Centrix CR2 8k buffer proportional spacing, par I	CRX-CR2P	395 00

## TERMINALS

Freedom 140 split screen, detachable keyboard	LUB-F100	495 00
Qume 102 gr. vt phosphor terminal	QUM-102	630 00
Ampex Delta 100 125 green screen	AMP-D125G	875 00
Ampex Dialogue 175 amber screen two page func keys	AMP-D175A	710 00
Wayne 50 14 green phosphor	WYS-50	495 00
Wayne 300 Eight color display split screen	WYS-300	1150 00
Zenith 29 terminal VT52 compatible detach keyboard	ZTH-229	765 00
Televideo 910 Plus black matrix	TVA-910P	575 00
Televideo 925 detachable keyboard 22 function keys	TVA-925	750 00
Televideo 950 14 alpha char split screen 22 func	TVA-950	950 00
Televideo 970 14 green 11 column European	TVA-970	1090 00

## 1200 BAUD UNIVERSAL DATA

**\$119**



The UDS-212LP is a compact desktop modem designed to obtain all its operating power entirely from the telephone line thus eliminating the need to connect to an external AC power source. NOT Hayes compatible but the ideal 1200 baud modem to connect to any CRT terminal or computer when accessing dial up data bases.

The Universal Data Division of Motorola original suggested list price on the 212/LP was \$495 but California Digital is offering at only \$119

## SMARTTEAM 1200 \$189

The Team 212A offers all the features of the Hayes Smart Modem 1200 for a fraction of the price. Now is your opportunity to purchase a 1200 baud modem at the price of a 300 baud modem.

## MODEMS

Hayes Smartmodem 2400 baud modem	HYS-2400	590 00
Fujitsu 2400 1200 baud auto everything	FUJ-19350	430 00
Team 1200 Hayes Compatible	TEM-SM1200	180 00
UltraLink 1200 data and voice on same line	ULI-1200A	150 00
Hayes 1200B for use with the IBM PC 1200 baud	HYS-1200B	390 00
Terminal software for CTS 212AH	CTS-212SFT	35 00
Prometheus 1200 super features	PRM-P1200	310 00
Prometheus 1200B internal PC	PRM-P1200B	270 00
Signalman Mark 12 1200 baud Hayes compatible	SGL-MK12	230 00
Signalman Mark VI 300 baud internal PC	SGL-MK6	50 00
Hayes Smart Modem 1200 baud auto answer auto dial	HYS-12AD	420 00
Hayes 1200B for use with the IBM PC 1200 baud	HYS-1200B	390 00
Hayes Smartmodem 300 baud only auto answer auto dial	HYS-103AD	220 00
Hayes Micromodem II 103 Apple direct connect	HYS-MM2	270 00
Hayes Chronograph time & date	HYS-CHR230	180 00
Penril 300 1200 industrial quality	PEN-12AD	385 00
Universal Data 103LP line power auto answer	UDS-103LP	30 00
Universal Data 212LP full 1200 baud duplex line power	UDS-212LP	110 00
Universal Data 212A 1200 baud industrial line	UDS-212A	170 00

## PLOTTER

**\$219**



The Comscriber I is the ideal solution to make short work of translating financial and numeric data into a graphic presentation. Many ready to run programs such as Lotus 1-2-3, Visi-on and Apple business graphics already support this plotter.

The Comscriber I features programmable paper sizes up to 8 1/2 by 120 inches, 6 inch per second plot speed and 0.004" step size. Easy to implement Centronics interface allows the Comscriber I immediate use with the printer port of most personal computers.

The Comscriber I is manufactured for Comscriber by the Enter Computer Corporation. The plotter is marketed by Health Kit and also sold under Enters own "Sweet P" Label. This is your opportunity to purchase a plotter which was originally priced at \$795 for only \$219. Also available is a support package which includes demonstration software, interface cable, a multicolor pen assortment and a variety of paper and transparency material.



## NEC RGB COLOR MONITOR

**\$219**

The NEC JC-1401D is a 13" medium/high resolution RGB monitor suitable for use with the Sanyo MBC-550/555 or the IBM/PC. The monitor features a resolution of 400 dots by 240 lines. Colors available are Red, Green, Blue, Yellow, Cyan, Magenta, Black and White. The NEC monitor carries the Litton-Monroe label and was originally scheduled for use in their "Office of the Future" equipment. A change in Monroe's marketing strategy has made these units excess inventory which were sold to California Digital. We are offering these "new" RGB monitors at a fraction of their original cost. Sanyo compatible NEC-1401/S; IBM/PC Computer compatible NEC-1401/PC

TOLL FREE ORDER LINE  
**(800) 421-5041**

TECHNICAL & CALIFORNIA  
**(213) 217-0500**



# Giant System Sale

## 200 Systems Must Go!

**COMPUTER CONNECTION**  
**TOLL FREE ORDER LINE**

### PERSONAL SYSTEMS

#### APPLE

Apple Professional System incl: Apple IIE, 128K, Tilt Monitor, Duo Disk, 80 col. card	\$1350
Mac 128K w/Drive, Mac Write, Mac Paint and mage Writer	2425
Fat Mac 512K, same as above	2995
Apple IIc	989
Apple IIc w/Monitor & Stand	1059

#### IBM

IBM PC Bare w/Cont. & 64K	\$1345*
IBM PC 64K, 1 Drive	1475*
IBM PC 64K, 2 Drives	1575*
IBM PC 128K, 1 Drive	1495*
IBM PC 256K, 2 Drives	1599*
IBM XT, 10 Meg. Floppy & 128K	2899*
IBM XT, Bare w/256K & IBM Floppy	1999*
IBM AT Base	3125*
IBM AT Enhanced	4199*

\*Call For Current IBM Prices

#### SANYO

MBC 550-2 w/1 320K Drive & sftwr.	\$ 750
MBC 555-2 w/2 320K Drives & more software	990
775 Portable	Call
Serial Port for Sanyo	69
Sanyo Video Board	175

#### COMPAQ

256K, w/2-320K Drives	\$1985
Desk Top Model 1	1899
Desk Top Model 2	1999
Desk Top Model 3	3795
Desk Top Model 4	4495

Call about 288's

### SOFTWARE

#### LOTUS DEVELOPMENT CORP.

Lotus 1-2-3	\$ 299
Symphony	434
Jazz	399

#### ASHTON TATE

D Base II	\$ 299
D Base III	389
Framework	429

### PRINTER SWITCHBOX

SRS-2 Serial	\$ 69
SRS-4 Serial	99
SCN-2 Parallel	79
SCN-4 Parallel	105

Run 2 to 4 Printers off 1 Computer

### ACCESSORIES

8087 Math Chip	\$ 99
<b>COMPUSERVE</b>	
Starter Kit Includes: Intopex, Electronic Conferencing, Professional Forums and Much More	\$ 39
Executive	55

**20% to 40%  
OFF LIST  
ALWAYS**

### PRINTERS

#### OKIDATA

ML182P 120 cps	219
ML182 IBM Graphics Comp	219
ML182S 10" Carriage	265
ML192P, 160 cps	359
ML192 IBM Graphics Comp	359
ML192S, 160 cps	419
ML193P, 160 cps	499
ML193 IBM Graphics Comp	499
ML193S, 160 cps	569
ML84P, 200 cps	655
ML84 IBM	655
ML84S, 200 cps	775
Okimate 20	129
Interface Module for OKI 20	79

#### EPSON We are an Authorized Dealer

LX80, 120 cps NLQ	Call
FX80 +, 160 cps 10" carr.	Call
JX80	Call
RX100	Call
FX185	Call
LQ1500	Call
SQ2000	Call

#### QUME

Letterpro 20P Prop. Spc. Enh Prnt	\$ 399
Sprint 1140 +, 2K, 40 cps, 132 col. width	1229

#### STAR MICRONICS

SG10Fi, 120 cps, corr. qual.	\$ 229
SG15Fi, 120 cps, corr. qual.	389
SD10Fi, 160 cps, corr. qual.	359
SD15Fi, 160 cps, corr. qual.	475
SR10Fi, 200 cps, corr. qual.	499
SR15Fi, 200 cps, corr. qual.	629
SB10 Draft, 144 cps, NLQ 60 cps	795
Powertype, 18 cps Bi-Di	359

#### C. ITOH

7500 AP, Parallel	\$ 219
7500 EP, IBM Compatible	219
7500 AR, Serial	265
8510 AP, Parallel	299
8510 AP + NLQ Mode	319
8510 BP, IBM Compatible	319
1550 P, Parallel	440
1550 BP + NLQ Mode	460
1550 EP, IBM Compatible	440
1550 BCD, Serial	499

#### BROTHER

HR25, 25 cps	\$ 629
HR35, 36 cps	839

#### DYNAX

DX15XL By Brother, 20 cps	\$ 379
---------------------------	--------

#### JUKI

6100, L.Q. 18 cps w/proportional spc.	\$ 369
6300, 40 cps	689

#### TOSHIBA

P1340 P	\$ 575
P1340 S	575
P351 P, Faster than 1351	1229
P351 P/S, Faster & more versatile	1250

#### PANASONIC

1091 w/Tractor, 120 cps, 1 yr. war.	\$ 259
1092, 10" car., 160 cps	439
1093, 15" car. 160 cps	669

#### COPAL

SC-1200, 120 cps FT & Graphics	\$ 215
SC-1200L, 120 cps w/NLQ	245
SC-1500, 180 cps FT & Graphics	295
SC-1500L/1, 180 cps NLQ & IBM comp.	335
SC-5500L/1, 15" NLQ & IBM comp.	475

Very Quite — 1 Yr. Warranty

### SYSTEM

#### EXECUTIVE COMPAQ

- Compaq Desktop w/640K
- Two 360K Disk Drives
- 10 meg Hard Disk
- Tape Backup
- Taxan Green Monitor
- Epson FX185 w/Cable

**\$3995**

#### COMPAQ STARTER

- Compaq Desk Top I
- 128K
- 1 Dbl/Dbl Disk Drive
- Taxan Amber #116

**\$1899**

**"THE COMPANY"**

### PRINTER ACCESSORIES

#### ORANGE MICRO

Grappler +	\$ 85
Buffered Grappler +, 16K exp. 64K	150

#### TOSHIBA

Bi-Directional Trac 1351/351	\$ 149/155
Font Disk for Down loading P1351	50

#### MICROTEK

Dumpling GX (same as Grappler +)	\$ 69
Dumpling GX w/16K buffer	135
Dumpling GX w/32K buffer	147
Additional Buffering 16K	12

#### FOURTH DIMENSION

Par. Card & Cable for Apple	\$ 47
-----------------------------	-------

#### OKIDATA

Plug and Play for IBM	\$ 49
Okigraph I for 82A	49
Okigraph I for 83A	49
Tractor for 182	39

#### JUKI

Bi-Directional Tractor, 6100/6300	\$ 125/135
Serial Interface	65

#### BROTHER

Tractor for DX-15	\$ 99
Tractor for HR25	129
Tractor for HR35	129
Cut Sheet Feeder for DX15	175
Cut Sheet Feeder for HR25/35	199
Keyboard for DX15	165

#### STAR MICRONICS

Graphstar, Apple Interface	\$ 69
Serial to Parallel Converter	79
Universal Commodore	59
Serial Interface Card	59

#### CABLES

IBM PC to Parallel Printer	\$ 18
Serial Cable	18
Cent. to Cent. MIM or MIF	18

### We Stock What We Sell!!

**IF YOU SEE IT ADVERTISED FOR LESS,  
CALL COMPUTER CONNECTION FIRST  
FOR LOWEST QUOTE!**

**GIVE US A CHANCE TO BEAT THE  
COMPETITION'S ADVERTISED PRICE.**



**NO SURCHARGE  
FOR CREDIT CARDS**



We accept VISA, MasterCard, COD (w/Deposit), Certified Checks or Wire Transfers. Minimum Shipping Charge \$4.00. Some items subject to back order. California Res. add 6 1/2% Sales Tax. All returns are subject to a 15% restocking charge and must be authorized by store manager within 10 days. Prices subject to change without notice. This Ad supersedes all others.

**COMPUTER CONNECTION**

# We Are Overstocked

## No Reasonable Offer Refused

**COMPUTER CONNECTION**  
**TOLL FREE ORDER LINE**

### SPECIALS

#### EXECUTIVE IBM

- IBM AT w/512K
- 33 meg Hard Disk
- 1.2 meg Floppy
- Monochrome Monitor Card
- Parallel & Serial Ports
- Amdek V310A

**\$4695**

#### IBM STARTER

- IBM PC w/256K
- Two 360K Disk Drives
- Color Card
- Taxan Amber #116

**\$1799**

### THAT DELIVERS™

### APPLE & FRANKLIN ACCESSORIES

<b>ACCESSORIES</b>	
Kensington System Saver	\$ 69
Fan for Apple II & IIE w/surge	45
<b>APPLE</b>	
Super Serial Card	\$ 139
Monitor II	159
80 Col. Card	65
<b>ASTAR</b>	
RF Modulator	\$ 17
<b>MICRO-SCI</b>	
64K, 80 Col. Card	\$ 85
Pac Para. & Ser. converter for IIC	75
<b>ADVANCED LOGIC SYSTEMS</b>	
Z Engine 2.2	\$ 115
CPM/3.0	245
<b>MICROMAX</b>	
Viewmax 80e, 128K extended 80 col. card for Apple IIE w/64K	\$ 124
Viewmax 80, 80 Col. Card for Apple II & II+	139
<b>MICROTEK</b>	
Serial Int. for Apple	\$ 75

### DISKETTES

<b>PC DISKETTES</b>	
Sgl./Dbl. (Box of 10)	\$ 16
Dbl./Dbl. (Box of 10)	18
<b>COMPUTER CONNECTION</b>	
Sgl./Dbl. (Box of 10)	\$ 14
Dbl./Dbl. (Box of 10)	16
Sgl./Dbl. w/Disk Container (10)	20
Dbl./Dbl. w/Disk Container (10)	22
Bulk 50 & Up — Sgl./Dbl.	1.25 ea.
Bulk 50 & Up — Dbl./Dbl.	1.35 ea.

All Diskettes come w/5 Year Warranty

### IBM PC ACCESSORIES

<b>IBM</b>	
IBM Mono Card w/Printer Port	\$ 245
IBM Mono Monitor	265
IBM Dos 3.1	69
IBM Tech Ref. for PC	85

<b>AST RESEARCH</b>	
Six Pak + w/Sidekick	\$ 255

<b>PARADISE</b>	
Modular Graphics Card	\$ 265
Multi Display	249
Module A Parallel or Serial	75
Module B	189
5 Pack	175

<b>PC PEACOCK</b>	
Color Graphics Card w/Par. Printer Port, Compat. w/All IBM Software, 2 yr. war.	\$ 199

<b>64K MEMORY UPGRADE</b>	
64K (9 chips) 200 ns, 90 day war.	\$ 15

<b>QUADRAM</b>	
Quad Color 1 Board	\$ 179
Exp. Quadboard w/64K & Game Port	199
Quadlink 3000 Run Apple sftwr on IBM	329

<b>VUTEK</b>	
Vutek - CPS Board, RGB & Composite w/Par. & Ser. Ports, 2 Yr. War.	\$ 199
Color Card (Herc. comp.)	159
Monographic Card (Herc. comp.)	275

<b>TECHMAR</b>	
Graphics Master	\$ 449

<b>PERSYST BOARD</b>	
Bob Hi-Res Display Adp.	\$ 365

<b>KEYTRONICS</b>	
KB5151	\$ 175

<b>HERCULES</b>	
Monochrome Graphics Card	\$ 345
Color Card w/Printer Port	185

<b>ORCHID</b>	
Blossom, like Six Pak + w/Network capabilities	\$ 245

<b>DATA PLUS</b>	
384K Mem. Board w/OK	\$ 115
XT Short Card, 384K Mem.	183
Multiplex, same as Six Pak	199

<b>MICROTEK</b>	
Monochrome Text Card Par & Ser	\$ 185
Color Graphics Card	165
Serial Port for IBM	75

### MODEMS

<b>ANCHOR</b>	
Mark XII	\$ 217
Volksmodem XII, 5 yr. warranty	185
Express 1200	265

<b>HAYES MICRO</b>	
300 Baud Smart Modem	\$ 149
1200 Baud Smart Modem	389
1200 B for IBM PC	379
2400 Baud Modem	645
Micro Modem IIE	149

<b>BIZCOMP</b>	
Intelli Modem ST	\$ 299
Intelli Modem XL w/Voice	339
Intelli Modem XT Short Modem	369

### HARD DISK DRIVES

<b>RODIME</b>	
10 meg. w/cont. 1 yr. warr.	\$ 595

<b>SEAGATE</b>	
10 meg. w/cont. 1 yr. warr.	\$ 650

<b>ALPHA OMEGA</b>	
10 meg w/cont.	\$ 625
20 meg w/cont.	1099
30 meg w/cont.	1395
20 meg for AT	699
33 meg for AT	899

13 Month Warranty

<b>TALL GRASS</b>	
25 meg. w/55 meg Tape B.U.	\$2795

### DISK DRIVES

<b>TANDON</b>	
TM100-2 for IBM PC	\$ 95

<b>TEAC</b>	
55B Dbl/Dbl for IBM	\$ 99

<b>MITSUBISHI</b>	
1/2 Ht. 360K	\$ 110

<b>Drives For Apple &amp; Franklin MICRO-SCI</b>	
A-2 Full Ht. 100% comp.	\$ 159
A.5C for IIC w/cable	169
A.5 1/2 Ht. for IIE	185
Controller Add	55

<b>IBM</b>	
IBM Logo Disk Drive	\$ 160

### DISPLAY MONITORS

<b>QUADRAM</b>	
Amber chrome IBM compatible	\$ 169

<b>AMDEK</b>	
V300G	\$ 119
V300A	129
V310A for IBM PC	149
Color 300	235
Color 600	399
Color 710	545

<b>TAXAN</b>	
Composite #115, Green	\$ 115
Composite #116, Amber	120
IBM Green Monochrome #121	129
IBM Amber Monochrome #122	139
RGB IBM w/Cable #420	389
RGB Super Hi-Res. #415	393
RGB Super Hi-Res. #440	499
RGB/Comp. Med. Res. #220	245

<b>PRINCETON GRAPHICS</b>	
HX-12 for use with IBM PC	\$ 425
Max 12 Amber for IBM	175
SR 12 Super Hi-Res	575
Scan Doubler	185

**MOST ORDERS SHIPPED SAME DAY**

### MAIL ORDER & WAREHOUSE:

17121 South Central, Unit L  
 Carson, California 90746

### CUSTOMER SERVICE:

**(213) 635-5065**

Mon.-Fri. 9 a.m. to 3 p.m.

**ORDER LINE**  
**(800) 732-0304**

(Outside California)

**(213) 635-2809**

(Inside California)

Mon.-Fri. 7 a.m. to 6 p.m.  
 Saturday 11 a.m. to 3 p.m.

**COMPUTER CONNECTION**



# PRICE WAR!

Name Brands, Fast Service, & Satisfaction Guaranteed

**INTEL/LOTUS**  
**4 MEGABYTE ABOVE BOARD**  
**\$349<sup>95</sup>** With 64K Installed for IBM PC

For Your IBM PC		For Your IBM PC-AT	
256K	\$399 <sup>95</sup>	128K	\$529 <sup>95</sup>
512K	\$449 <sup>95</sup>	512K	\$629 <sup>95</sup>
1 MB	\$549 <sup>95</sup>	1 MB	\$729 <sup>95</sup>
2 MB	\$749 <sup>95</sup>	2 MB	\$929 <sup>95</sup>
4 MB	\$1399 <sup>95</sup>	4 MB	\$1599 <sup>95</sup>

**TALLTREE JRAM-2/JRAM-3**  
**2 MEGABYTE CARD**  
**\$199<sup>95</sup>** JRAM-2 Without Memory

1 MB JRAM-2	\$399 <sup>95</sup>
2 MB JRAM-2	\$599 <sup>95</sup>
256K JRAM-3	\$329 <sup>95</sup>
1 MB JRAM-3	\$499 <sup>95</sup>
2 MB JRAM-3	\$629 <sup>95</sup>

**JADE ExpandoRam Multifunction Card**  
**For Your IBM PC \$169<sup>95</sup>**

Up to 384K, parallel printer port, RS-232 serial port, game port, clock/calendar, RAM disk/printer buffer and diagnostic software package.

	LIST	JADE
OK JADE Expando RAM	\$299	\$169. <sup>95</sup>
64K JADE Expando RAM	\$449	\$194. <sup>95</sup>
256K JADE Expando RAM	\$549	\$259. <sup>95</sup>
384K JADE Expando RAM	\$649	\$279. <sup>95</sup>

**AST for IBM PC**

	LIST	JADE
Six Pak Plus 64K	\$395	\$249. <sup>95</sup>
Six Pak Plus 256K	\$695	\$319. <sup>95</sup>
Six Pak Plus 384K	\$945	\$349. <sup>95</sup>
I/O Plus	\$165	\$129. <sup>95</sup>
Preview	\$399	\$309. <sup>95</sup>

**135/150 WATT**  
 Drop-in replacement  
**POWER SUPPLY**  
 For your IBM PC

	List	JADE
135 Watt	\$199	\$99 <sup>95</sup>
150 Watt	\$249	\$119 <sup>95</sup>

**IBM PC-XT**  
 10 Megabyte, 256K, Serial Port  
**\$2895**  
**IBM PC-AT**  
 Enhanced With 20 Megabyte  
**\$4995**

**Expansion Boards for Your IBM-AT**

	LIST	JADE
128K AST Advantage-AT	\$595	\$449. <sup>95</sup>
3.0 MB AST Advantage-AT	\$4145	\$1299. <sup>95</sup>
Quadport-AT 1S, 1P	\$154	\$139. <sup>95</sup>
128K Upgrade Kit	\$395	\$129. <sup>95</sup>
20 Megabyte Hard Disk	\$1790	\$895. <sup>95</sup>

**COLOR CARD FOR YOUR IBM**

	LIST	JADE
JADE RGB w/Parallel Port	\$199	\$99. <sup>95</sup>
JADE RGB w/Parallel & Serial	\$299	\$189. <sup>95</sup>
JADE TTL Monochrome 720x348	\$299	\$149. <sup>95</sup>

**IBM Video Boards**

	LIST	JADE
Hercules Color	\$245	\$189. <sup>95</sup>
Hercules Graphic	\$499	\$339. <sup>95</sup>
Tecmar Graphics Master	\$699	\$499. <sup>95</sup>
Quadcolor I	\$295	\$209. <sup>95</sup>
Quadcolor II	\$275	\$209. <sup>95</sup>
Paradise Graphics Card	\$395	\$319. <sup>95</sup>
Everex Graphics Edge	\$599	\$349. <sup>95</sup>

**10 MEGABYTE Hard Disk System**  
**FOR YOUR IBM PC**  
**\$489<sup>95</sup>**

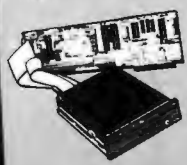

Complete with controller card, data cable, and mounting hardware, totally PC/XT compatible. External model includes cabinet & power supply.

	LIST	JADE
10 MEGABYTE Internal 1/2 High	\$1350	\$489. <sup>95</sup>
10 MEGABYTE External	\$1585	\$699. <sup>95</sup>
15 MEGABYTE Internal	\$1765	\$679. <sup>95</sup>
15 MEGABYTE External	\$1897	\$1049. <sup>95</sup>
20 MEGABYTE Internal	\$1800	\$999. <sup>95</sup>
20 MEGABYTE External	\$2060	\$1199. <sup>95</sup>
33 MEGABYTE Internal	\$3298	\$1569. <sup>95</sup>
33 MEGABYTE External	\$3388	\$1799. <sup>95</sup>
10 MEGABYTE 1/2 High Tape	\$1000	\$579. <sup>95</sup>
20 MB Disk w/ 10 MB Tape	\$2980	\$1799. <sup>95</sup>

**HAYES SMARTMODEM**  
 YOUR CHOICE **\$169<sup>95</sup>**  
 HAYES Smartmodem 300  
 HAYES Micromodem IIc  
 HAYES Smartmodem IIc  
**SAVE UP TO \$200!**



**HAYES Smartmodems**

Sophisticated direct-connect auto-answer/auto dial modem, touch tone or pulse dialing RS232 interface programmable

	LIST	JADE
HAYES Smartmodem 2400	\$899	\$629. <sup>95</sup>
HAYES Smartmodem 1200	\$699	\$389. <sup>95</sup>
HAYES 1200B w/o Smartcom II	\$539	\$339. <sup>95</sup>
HAYES 1200B for IBM PC	\$599	\$359. <sup>95</sup>
HAYES Smartmodem 300	\$289	\$169. <sup>95</sup>
HAYES Chronograph	\$249	\$199. <sup>95</sup>
HAYES Micromodem IIc	\$299	\$169. <sup>95</sup>
HAYES Smartmodem IIc	\$399	\$169. <sup>95</sup>
HAYES Transet 1000	\$399	\$299. <sup>95</sup>
HAYES Smartcom II	\$149	\$99. <sup>95</sup>
Modem Cable	\$35	\$24. <sup>95</sup>

**PROMODEMS**  
 As Low As \$149<sup>95</sup>



	LIST	JADE
ProModem 300c for Apple IIc	\$199	\$149. <sup>95</sup>
ProModem 1200B for IBM PC	\$399	\$289. <sup>95</sup>
ProModem 1200 RS-232	\$495	\$299. <sup>95</sup>
ProModem 1200A for Apple	\$449	\$349. <sup>95</sup>
ProModem 1200 for Macintosh	\$495	\$349. <sup>95</sup>
Alpha/num Display Option	\$99	\$79. <sup>95</sup>
Options Processor	\$99	\$79. <sup>95</sup>
64K Mem Expansion for Above	\$99	\$19. <sup>95</sup>
Modem Cable	\$35	\$24. <sup>95</sup>

**JADE 1200 BAUD Modem \$179**

HAYES Smartmodem 1200 Compatible at a fraction of the price. FCC approved.

	LIST	JADE
JADE 1200 BAUD External	\$349	\$179. <sup>95</sup>
JADE 1200B Card for IBM	\$399	\$239. <sup>95</sup>
JADE 2400 BAUD External	\$699	\$449. <sup>95</sup>
Copylink Software for IBM PC	\$99	\$29. <sup>95</sup>

### Mouse By MOUSE SYSTEMS

	LIST	JADE
PC MOUSE with Pop-ups	\$195	\$139.95
PC MOUSE with Paint	\$220	\$159.95
FIELD MOUSE (male or female)	\$175	\$129.95
PC PAINT Software	\$99	\$69.95

### 256K RAM Chip Upgrade Kits **\$5985**

High speed RAM upgrade kit with FREE! parity (error detection) and one year warranty. We ship thousands of these kits to satisfied customers every week.

	LIST	JADE
64K RAM Chip Kit For PC	\$49	\$14.95
128K RAM Chip Kit For AT	\$395	\$99.95

### QUADRAM for IBM PC

	LIST	JADE
Quadboard No RAM	\$269	\$214.95
Quadboard 64K	\$395	\$235.95
Quadboard 384K	\$795	\$299.95
Quadlink	\$680	\$349.95

### TEAC 55B **\$9995** 360K Disk Drive for IBM PC



	LIST	JADE
Double-sided, double density		
TANDON 100-2	\$299	\$119.95
TEAC 55B	\$249	\$99.95

### KEYTRONICS



	LIST	JADE
KB5150 Improved IBM Keyboard	\$209	\$159.95
KB5151 Deluxa IBM Keyboard	\$299	\$199.95
KB5152B & KB5152V Also Available		

### High Speed 8087 APU

LIST PRICE \$293 ..... SALE PRICE \$119.95

### FREE PC PAINT W/ MICROSOFT Mouse

	LIST	JADE
Microsoft Word	\$495	\$319.95
Microsoft Mouse, RS-232 Serial	\$199	\$129.95
Microsoft Mouse, IBM Buss	\$199	\$129.95

### HIGH RESOLUTION 640 x 260, .38 Dot Pitch TAXAN 415 RGB COLOR MONITOR

LIST PRICE \$699 For cable add \$1900 **\$295**

### Disk Drive for Your Apple IIC

**\$12995**

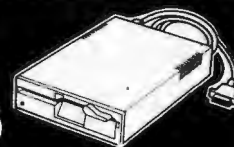

	LIST	JADE
Disk Drive for Apple IIC	\$249	\$129.95
Printer Parallel Cable For IIC	\$99	\$59.95
Full Height Disk Drive	\$299	\$139.95
Half Height Disk Drive	\$249	\$129.95
ALS Z Engine	\$299	\$145.95
16K RAM Card	\$99	\$39.95
64K 80 Column Card for IIC	\$219	\$119.95
Best 80 Column Card II/II+	\$219	\$139.95
Printer Card & Cable	\$109	\$49.95
Fan with Surge Protection	\$99	\$59.95
Grappler Plus	\$175	\$99.95
64K Buffered Grappler+ w/16K	\$275	\$149.95

### High Resolution Video Monitors



	LIST	JADE
Amdek 300G	\$179	\$139.95
Amdek 300A	\$199	\$149.95
Amdek 310A	\$230	\$179.95
Amdek Color 500	\$525	\$399.95
Amdek Color 600	\$650	\$449.95
Amdek Color 710	\$799	\$589.95
PGS MAX-12	\$269	\$179.95
PGS HX-12 640x240	\$699	\$449.95
PGS SR-12 720x480	\$799	\$629.95
PGS Scan-Doubler	\$299	\$199.95
Taxan 440 Ultra Hi-res RGB	\$799	\$599.95
Taxan TV Tuner for Monitor	\$99	\$89.95

## JADE XPC PORTABLE

- 256K Expands to 512K
- 600 x 400 HI-Res Video
- 110 Watt Power Supply
- Parallel and Serial Ports
- Four IBM Expansion Slots
- Deluxe Keyboard
- 90 Day Warranty

**\$1395** Includes Two 360K Disk Drives & Disk Controller

### 10 MEGABYTE PORTABLE

- 512K of RAM
- 10 MB Hard Disk
- One 360K Drive

**\$1995**

## JADE XPC IBM PC

- 256K of RAM Expands to 640K on Main Board
- 140 Watt Power Supply
- 4.77 or 7 MHz Clock
- 8 Expansion Slots
- Deluxe Keyboard
- 90 Day Warranty



- 256K of RAM Maximum on Main Board
- 63 Watt Power Supply
- 4.77 MHz Clock
- 5 Expansion Slots
- IBM Keyboard
- 90 Day Warranty

256K of RAM, Two 360K Disk Drives & Disk Controller

**\$1295**

### OPTION #3

- 640K of RAM
- 10 Megabyte of Hard Disk
- One 360K Drive
- 130 Watts of Power
- Parallel & Serial Ports
- Color Card
- Taxan RGB Monitor

### OPTION #1

- 256K of RAM
- Two 360K Drives
- Color Card
- Amdek 300

IBM PC **\$1995**

JADE XPC **\$1595**

**\$1695**

### OPTION #2

- 256K of RAM
- Two 360K Drives
- Parallel & Serial Ports
- Taxan RGB Monitor

IBM PC **\$2395**

JADE XPC **\$1995**

Place Orders Toll Free!



# JADE

## Computer Products

Continental U.S.A. Inside California Los Angeles Area  
 (800) 421-5500 (800) 262-1710 (213) 973-7707

4901 W. Rosecrans Ave. Box 5046 Hawthorne, CA 90251-5046



**EPSON Printers**



**NEW EPSON  
FX-85 & FX-185  
IN STOCK!  
Call For Low, Low Prices**

	LIST	JADE
2K Serial Board for RX/FX	\$149	\$99.95
NLQ Board for RX/FX	\$219	\$99.95
LetterWriter NLQ Kit for FX	\$75	\$59.95
LX-80 Tractor	\$59	\$29.95
FX-80 Tractor	\$59	\$39.95
LQ-1500 Tractor	\$89	\$49.95
LQ-1500 Sheet Feeder	\$499	\$399.95

**NEW! OKIDATA PRINTER  
MICROLINE  
192 \$349.95  
Call For Price  
160 CPS, Near Letter Quality, & Graphics**

	LIST	JADE	CALL FOR PRICE
OKIMATE 20 Color printer	\$150	\$139.95	
PLUG-N-PRINT for OKI 20	\$75	\$69.95	
OKI 182 120 cps, graphics	\$299	\$259.95	
OKI 192 160 cps, graphics	\$499	\$349.95	
OKI 193 160 cps, 15" paper	\$699	\$549.95	
OKI 92 160 cps, graphics	\$599	\$349.95	
OKI 93 160 cps, 15" paper	\$995	\$599.95	
OKI 84 200 cps, parallel	\$1399	\$799.95	
OKI 84 200 cps, serial	\$1499	\$949.95	
Tractor for OKI 192	\$50	\$44.95	
Tractor for OKI 92	\$89	\$54.95	
2K Serial Board for 192/193	\$99	\$69.95	
2K serial Board for 92/93	\$120	\$99.95	
Extra Ribbon	\$9	\$4.95	

**Double-sided  
Double-density  
Diskettes 99c Each  
In bulk packages of 125 pcs.**

	LIST	JADE
Includes envelopes and labels.		
Single-sided, double-density	\$34	\$16.50
Double-sided, double-density	\$42	\$19.50
Double-sided, 1.2 MB for AT	\$69	\$49.50
3 1/2" Single-sided for Mac	\$69	\$39.50
3 1/2" Double-sided for DG/1	\$89	\$49.50
Bulk Diskettes as low as		90c

**Continental U.S.  
800-421-5500  
Inside California  
800-262-1710**

**For Technical Inquiries  
or Customer Service call:  
213-973-7707**

**ISO-BAR**



These industrial quality ISO-BARs contain surge suppression circuitry and built-in noise filters plus a 15 amp circuit breaker.

	LIST	JADE
6 Socket, 1 Filter ISO-BAR	\$69	\$44.95
4 Socket, 2 Filter ISO-BAR	\$89	\$59.95
8 Socket, 4 Filter ISO-BAR	\$99	\$69.95

**UNINTERRUPTABLE POWER SUPPLY**  
Emergency back-up power to save your computer system. A must for every computer system.

	LIST	JADE
200 Watt UPS	\$359	\$279.95
425 Watt UPS	\$539	\$459.95
1000 Watt UPS	\$1179	\$995.95

**Printer Accessories**

	LIST	JADE
IBM PC style cable	\$54	\$19.95
Standard parallel cable	\$40	\$19.95
RS-232C serial cable	\$30	\$24.95
Ribbons	as low as	\$4.99
Apple IIC cable	39	\$19.95

**SHUGART 851R**  
Double-sided, Double-density  
**8" DISK DRIVE**  
LIST PRICE \$605  
**\$249.95**

	LIST	JADE
Dual 851 Sub-System Kit	\$1445	\$599.95
Dual 851 Sub-System A&T	\$1645	\$799.95

Complete dual 851 disk drive sub-system with two Shugart SA-851R, cabinet, power supply, fan, etc.

**WHY PAY \$1149 FOR A C. ITOH  
STARWRITER™ F-10**  
When Our 40 CPS Letter-Quality Daisywheel  
From The Same Manufacturer

IS ONLY **\$499.95**

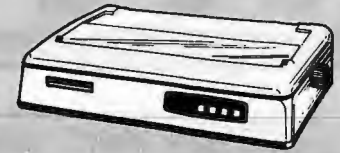

\* StarWriter is a Trademark of C. Itoh Digital Products, Inc.

**C. ITOH Printers**

C. Itoh's best-selling ProWriter and StarWriter printers are now available with parallel interfaces for Apple & IBM, or a serial interface for Apple IIc, Macintosh, Data General, etc. Full one year manufacturers warranty.

	LIST	JADE
ProWriter 7500 FT 105 cps	\$289	\$209.95
ProWriter 8510 AP 120 cps	\$429	\$299.95
ProWriter II 1550 FT 120 cps	\$619	\$439.95

**CITIZEN Printers**

Best Near-Letter-Quality printers for under \$1000 !!!

	LIST	JADE
CITIZEN MSP-10 FT 160 cps	\$499	\$349.95
CITIZEN MSP-15 FT 160 cps	\$749	\$529.95
CITIZEN MSP-20 FT 200 cps	\$699	\$489.95
CITIZEN MSP-25 FT 200 cps	\$949	\$669.95
CITIZEN Serial Option	\$60	\$49.95

**Letter Quality  
Printers On Sale!**

	LIST	JADE
JUKI 6100 18 CPS	\$599	\$399.95
COMREX CR-IIe 20 CPS	\$599	\$399.95
DIABLO 630 40 CPS	\$2340	\$1569.95
TOSHIBA P1340 180 CPS	\$995	\$599.95
TOSHIBA P351 288 CPS	\$1850	\$1299.95
T.I. 855 150 CPS	\$935	\$689.95
T.I. 865 150 CPS	\$1299	\$949.95

**STAR Printers**

	LIST	JADE
SG-10 120 CPS	\$299	\$239.95
SG-15 120 CPS	\$499	\$399.95
POWERTYPE 18 CPS	\$499	\$359.95

**A-B Printer Switch**

Fully bi-directional switch allows your computer to run either of two printers, or allows two computers to share one printer, standard parallel switch box.

	LIST	JADE
Printer Switch	\$149	\$69.95
Extra Cable	\$40	\$29.95

**Data Switches**

	LIST	JADE
SERIAL A-B Switch	\$129	\$79.95
PARALLEL A-B Switch	\$129	\$79.95
SERIAL A-B-C-D Switch	\$175	\$89.95
PARALLEL A-B-C-D Switch	\$175	\$99.95

**QUADRAM  
MICROFAZER Buffers**



Expandable to 64K (parallel model expands to 512K)

8K Parallel in/Parallel out	\$169	\$139.95
64K Parallel in/Parallel out	\$225	\$164.95
128K Parallel in/Parallel out	\$445	\$269.95
8K Serial in/Parallel out	\$199	\$169.95
64K Serial in/Parallel out	\$260	\$199.95
8K Parallel in/Serial out	\$199	\$169.95
64K Parallel in/Serial out	\$260	\$199.95
8K Serial in/Serial out	\$199	\$169.95
64K Serial in/Serial out	\$260	\$199.95

**PRACTICAL PERIPHERAL  
MICROBUFFERS**

Stand alone Microbuffers for Printers & Modems

	LIST	JADE
32K Parallel in/Parallel out	\$299	\$229.95
64K Parallel in/Parallel out	\$349	\$249.95
32K Serial in/Serial out	\$299	\$229.95
64K Serial in/Serial out	\$349	\$249.95
64K Add-on Board	\$179	\$149.95

We accept cash, checks, credit cards, or purchase orders from qualified firms and institutions.  
Minimum prepaid order \$15.00 California residents add 6 1/2% tax. Export customers outside the US or Canada please add 10% to all prices. Prices and availability subject to change without notice. Shipping and handling charges via UPS Ground 50c/lb. UPS Air \$1.00/lb. minimum charge \$3.00

**JADE  
Computer Products**





**CORONA PORTABLE PC**  
Includes MSDOS 2.11, PC TUTOR & PC PAL

FULLY IBM PC COMPATIBLE

W/ 640 X 400 resolution graphics, built-in green monitor, 256k RAM expandible to 512k RAM on board, serial port, parallel port, enhanced IBM PC type keyboard, 90 Day exchange warranty

W/ 1 Floppy	\$1375.00
W/ 2 Floppies	1495.00
W/ 1 Floppy & 10MB Hard Disk	1895.00
W/ 1 Floppy & 20MB Hard Disk	2195.00
W/ 1 Floppy & 40MB Hard Disk	3195.00

Additional 256k RAM 79.00  
Padded Carrying Bag 100.00  
Shugart 1/2 height 48tpi floppy (DSDD 360k IBM PC Compatible) 85.00

**CORONA LASER PRINTER** 2995.00  
**DAISY LASER (Diablo Compatible)** 2695.00

Immediate Delivery - Satisfaction Guaranteed  
Full Maintenance Support Thru CompuMend(tm).

**MICRO SPEC**  
(713) 358-6954  
1882 Crockett Houston, TX 77067  
Mastercard - Visa - C.O.D.  
2% Discount for Pre-Paid Orders.  
Watch this space for our monthly specials!

Inquiry 245



**IBM PC/XT Compatible Products**

DYNA PC 64K Basic Unit (up to 256K)	\$ 610
DYNA PC 256K Full System	\$1325 & up
DYNA XT 256K Full System	\$1850 & up
Teac FD-55B DS/DD 360k Disk	\$ 95
Shugart 8A455 DS/DD 360k Disk	\$ 95
Teac SD-510 10MB Disk w/Controller	\$ 525
Teac SD-520 20MB Disk w/Controller	\$ 675
Interdyne 10MB Tape Drive w/cable, Tape Monochrome/printer Card	\$ 525
Color Graphic Card	\$ 140
DYNA 6-Funpack Board (AST compatible)	\$ 130
EPROM Burner Board	\$ 160
	\$ 150

**DYNA SYSTEMS**  
Tel: (408) 748-8501  
1500 Wyatt Drive, Suite #8  
Santa Clara, CA 95054  
Dealers - Call for Quantity Prices

Inquiry 126

**PROFESSIONAL CONTOURING**

Mainframe Contour Mapping for your PC

Not just another gridding package, and no polynomials running wild. TRIMAP is the PC implementation of sophisticated contouring algorithms used in multi-kilobuck geophysical/geological packages over the last 10 years. It honors all data points (gridding packages can't) and does not introduce artificial search parameters. Runs under MS-DOS with 256K and supports HP 7475A, HP 7580 and other plotters. Your valuable data deserves TRIMAP's professional quality.

**ONLY \$800**

**CONTOURSOFT CORP.**  
Phone (403) 420-6017 (Head Office)  
or write  
3212 West 133 Avenue  
Broomfield, Colorado 80020

Inquiry 419

**1st PLACE**  
COMPUTER SYSTEMS  
13422 N. CAVECREEK RD.  
PHOENIX, AZ. 85022

CALL FREE 1-800-841-2748

**ALYOS - LEADING EDGE - SANYO** **HAYES - PRO METHUENS - NEC.**



Hi - I'm Joan, We are still doing business as usual, same low prices, fast and courteous service. We've gone small for the summer to keep our prices low. Call me for current pricing. I'll be waiting for your call.

Thanks again and God Bless  
-Joan

**WYSE - JUKI - CITO**

Inquiry 402

**FREE DEMO DISK** **DON'T CALL A PROGRAMMER**  
Let Your Secretary Do It!  
EASY TO USE

**DATAMASTER™**

Allows you to maintain complete control of building and styling your own database without complicated programming.

**FREE DEMO DISK** Circle Reader Service Number or Call us at (818) 986-3233.  
**LIMITED PACKAGE** Try out limited package for \$15.00 (applied to purchase).

**DATAMASTER** **INTRODUCTORY SPECIAL**  
When you order, ask about our money back guarantee! Through Sept 85. **\$175.00**  
Regular price \$495.

Use your Master Card or VISA and call today!

IN CALIF **800-423-0320** OUTSIDE CALIF **800-482-DATA**  
**C.D.A. INTERNATIONAL SOFTWARE CORP.®**  
(818) 986-3233 Telex: 215666

Inquiry 46

**WHOLESALE**

AST 6-PACK + 64K ..... \$239  
ANCHOR VOLKSMODEM 12 . . . 164  
AUTOCAD ..... CALL  
(DIGITIZERS, PLOTTERS) PENCEPT, HOUSTON, HITACHI, CALCOMP, NICOLET, ENTER, GTCO  
JUKI 6300 ..... 639  
MAC 3.5 FLOPPY DRIVE ..... 279

**CALL FOR LATEST PRICE**

APPLE	HAYES	PANASONIC
AXIOM	IBM	PARADISE
CITIZEN	JUKI	PRINCETON
C. ITOH	LEGEND	SILVER REED
COMPAC	LOTUS	TAXAN
EPSON	NEC	TOSHIBA
ENTER	NOVATION	VENTEL
GENOA	MICROPRO	ZENITH

**MINORITY INDUSTRIES** **VISA**  
5021 N. 20th St., #10261, Phoenix, AZ 85064  
ORDERS ONLY 1-800-428-7979  
OTHER INFORMATION (602) 890-0596

Prices subject to change & reflect cash discount. Please add 2% for shipping on most items.

Inquiry 420

**Osborne**

As available only! Very limited quantity.

Important: Always call to check availability before ordering.	To fix yourself, or for parts. Complete, but known not working.	Guaranteed for 30 days. May be new or refurb., depending on avail. Exch/Repair	Outright
Main Board OS-1	\$79	\$79	\$138
Main Board Exec.	\$159	\$139	\$299
Battery Pack, 40 Watt	—	—	\$49
Double Density Kit **	—	—	\$79
** Includes board, cable, documentation & disk			
8" CRT (Grrn/White)	\$9.95	\$18	\$29
7" CRT (Amber)	\$18	\$49	\$99
15" CRT, no case	—	—	\$85
Drive Analog Card	\$9.95	\$29	\$59
Drive Mechanism	\$18	\$25	\$59
Power Supply	\$4.95	\$24	\$29
Keyboard (No enclos.)	\$9.95	—	\$99

Shipping charged on all orders  
Computer Parts Mart 415-493-5930  
3200 Park Blvd \* Palo Alto \* CA 94306

Inquiry 82

**LOW COST UNIVERSAL E(R) PROM PROGRAMMER**



- \* SUPPORTS: (EPROMS) 2516 THRU 64, 2716 THRU 512, 27C16 THRU 128, 68732 THRU 66 (EPROMS) 52813 THRU 33, 2816A THRU 64A (MICROS) 8741 THRU 49H
- \* NO PERSONALITY MODULES, ONBOARD POWER SUPPLY
- \* RS232C INTERFACE, KON-YOFF, RTS, CTS, DTR
- \* ACCEPTS KEYBOARD ENTRY WITH LINE EDITING
- \* ACCEPTS ASCII, INTEL, AND MOTOROLA FORMATS
- \* USER FRIENDLY MONITOR FOR I/O DEBUGGING
- \* FAST PROGRAMMING SUPPORTED: 2764 UNDER 3 MIN.
- \* LOW/HIGH BYTE PROGRAMMING FOR 16 BIT DATA PATH
- \* BYTE, BLOCK, OR CHIP ERASE (EPROMS ONLY)
- \* LIST IN INTEL OR MOTOROLA HEX FORMAT
- \* VERIFY PROGRAM AND VERIFY BLANK COMMANDS

* 1409-01: 4K FIRMWARE, PCB, XFORMER, DOC	\$90.00
* 1409-02: 1409-01 + FULL SET OF PARTS	\$200.00
* 1409-03: ASSEMBLED AND TESTED UNIT	\$300.00
* 1409-11: 8K FIRMWARE, PCB, XFORMER, DOC	\$125.00
* 1409-12: 1409-11 + FULL SET OF PARTS	\$250.00
* 1409-13: ASSEMBLED AND TESTED UNIT	\$350.00
* COMMUNICATION DRIVERS FOR MOST PC'S	\$35.00

**B&C MICROSYSTEMS**  
6322 MOJAVE DR, SAN JOSE, CA 95120  
Tel. (408) 997-7685, TWX 4996363

Inquiry 46

**20% DISCOUNT**

**SEMIDISK**  
for S-100, IBM-PC, QX10, TRS-80 II  
**S-100 EQUIPMENT**  
incl. MACROTECH, LOMAS, ILLUMINATED TECHNOL.  
IMS, INTERCONTINENTAL MICRO DIGITAL GRAPHICS SYSTEMS

**NEC APC III IBM PC Compatible**  
**IBM PC Enhancements**  
(at varying discounts)  
incl. Emerald Sys., ALLOY, AST, QUAD, etc.

**We Discount Software**  
**Modems, Printers, CRTS**  
**Plotters & Digitizers**  
Prices & avail. subject to change without notice

**WE EXPORT Telex:**  
**710 588 2844 (OWENSASSOC)**  
**JOHN D. OWENS ASSOCIATES, INC.**  
12 Schubert St. Staten Island, NY 10305  
**(718) 448-6298**  
**(718) 448-6283**

Inquiry 422

**Micro Products International**  
714/898-0840

# BACK TO SCHOOL SPECIALS

**We Cater to IBM™ Dealers**  
\* Hardware \* Software \* Training Tapes  
Call for our Catalog now!

Forms: We accept Visa, M/C, Pre-pay by Check or Money Order. COD's are accepted by Telephone & Mail. COD Terms are: Cashier's Check for first time orders over \$100.  
Fax: 714/897-3363 Tlx: 887841 XORDATA HTBH

## New Hayes SmartModem Compatible!

Finally a price breakthrough on a Hayes compatible, external 300/1200 baud modem. This low price is without driver software, but if you need it add \$25.00. Call for a 26 page catalog of our special deals. Look in this spot every month for Hot, New items sure to catch your interest.



- Runs the popular Hayes communications software
- FCC approved direct RJ-11 connection
- Phone Cable & power supply one low price.

MOD-8100-00 ..... \$199.00

## IBM PC-XT SELECTRIC KEYBOARDS

Our volume purchase of these excellent Selectric type keyboards will bring the features you have been wanting down to a price you can't resist. So many features you'll love!!!

- Single key reset
- Separate numeric keypad
- Separate "Arrow" keypad
- Dimple marked "S", F, & J keys

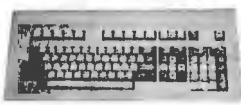

KEY-1051-00 Selectric ..... \$129.00  
KEY-1050-00 Standard ..... 89.00

## ADD-ON POWER SUPPLIES

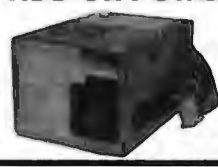

Two new, thoroughly tested IBM PC/XT power supplies for your system upgrade. Best price in Byte with ONE YEAR warranty!!

POW-1040-00 135 watt ..... \$ 99.00  
POW-1044-00 150 watt ..... \$115.00

## TURBO MOTHERBOARD

Micro Products announces a powerful new IBM XT type motherboard. 4 layers for superior reliability & speed. Turbo mode allows 75% higher thru-put by increasing system clock to 7 MHz under software control. Designed to use new 256K RAM chips or 64K chips. 640K memory expansion does not require use of valuable card slots. Many outstanding features combined with our new 7 PAK Multifunction board make previously expensive options standard features at a LOW LOW Cost.

BOA-6078-00 Supplied with 0K ..... \$349.00



## SUPER 12 PAK MULTI-FUNCTION

This one is really loaded! Features: One Parallel Port, One RS232-C Serial Port, One Game Port, RealTime Clock / Calendar with Battery Back-up, Expandable to 384K of Parity-checked Memory, Supplied 0K Memory, all cables, PrintSpooler and RAM Disk Software.

BOA-6335-00 ..... \$129.95  
Additional (9) 64K Memory Chips  
KIT-8000-00 ..... \$ 10.00

## Do it Yourself!

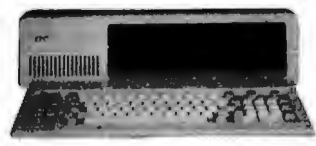

three ways to begin - an Empty cabinet - a "Basic" Full system - all that you assemble yourself!  
**CABINET ONLY**  
Slot CAB-3068-00 ..... \$75.00  
"BASIC"  
abinet, Keyboard, Power Supply, Motherbrd w/0K  
YS-8000-00 ..... \$525.00

## This is OUR Junior!

Use this "Drivesless" workstation for low-cost Networking. Features: • 4-slot IBM™ compatible Motherboard • 128K Standard Memory • 8088,8087 Math Co-processor • Optional Floppy Drive with Controllers.  
YS-8100-00 ..... \$475.00  
Full System w/Keyboard, Mono Monitor, Video Display Card, 256K 1 RAM Drive ..... SYS-8725-00 \$895.00

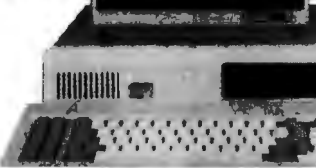

## \$1395<sup>00</sup> WOW! Complete System!

**NEW 17,000 In Service!**

- Features!**
- RAM Disk
  - Game Port
  - 640K cpcty
  - PrintSpooler
  - Turbo mode!
  - 4.77MHz to 7MHz!
  - Ser,Par
  - Clock



10 Meg H.D. Complete System!  
\$1995<sup>00</sup>

20 Meg Color Complete System!  
\$2550<sup>00</sup>

40 Meg w/Tape Complete System!  
\$3035<sup>00</sup>

- Software**
- XWORD
  - XBASIC
  - XBASE
  - XCALC
  - XCOM

- Check These Standard Features:**
- Full-Size, Feather-Touch, Capacitance Keyboard, 10 Function Keys, Calculator-Type Numeric Keypad
  - Parallel & Serial I/O • Real Time Clock • Game Port • 2-Stimline 5 1/4" DS/DD 48 TPI 360K Drives
  - 8 IBM expansion slots • RAM Disk • Print Spooler • 4 DMA & 3 Timer channels
  - Full 640K capacity on-board • 8088 16-bit CPU • Monochrome Video Card
  - Up to 32K of EPROM (full 8K supplied) • Supports PC-DOS • MS-DOS • CP/M-86
  - Power Supply Hard-Disk-Ready, no need to add-on additional power
  - High resolution 12" Monitor, Green Screen, 22 MHz bandwidth

## Add-On H.D. & Tape



10 or 20 Megabyte on the top, your choice of Hard Disk on the bottom. Super appearance! Requires one slot in your PC for SASI interface and an extension connector on the floppy card. Everything else is supplied by us.

10 Meg \$1095	40 Meg \$1695
20 Meg \$1295	105 Meg \$4195
26 Meg \$1395	140 Meg \$4895

## Add-On Hard Disk

Two ways to go. The internal system is cheaper because it does not need a P/S & Chassis. The same P/S & Chassis can be used for a 10 Meg Tape Back-up on your XT!

10 Megabyte \$525 Int/\$695 ext	40 Megabyte \$1195 Int/\$1295 ext
20 Megabyte \$650 Int/\$795 ext	105 Megabyte \$3795 Int/\$3995 ext
26 Megabyte \$795 Int/\$895 ext	140 Megabyte \$4395 Int/\$4695 ext

## Add-On 20 Meg Tape



Sub-8300-00 ..... \$595.00

# Not enough room here - Call for Catalog

### PROM LASER

This is the One! Our PROM Burner allows reading, storing-to-disk, recalling, and burning. Hi-speed algorithms burns 2764 in 45 seconds! Also handles 2716, 2732, 2712B, 27256. Features: Zero insertion force sockets; On-board Voltage Generator; No interference with normal computer operations.  
BOA-8640-00 ..... \$199.00

### We want your DRIVE business!

Shugart 360K	TEAC 360K	NEC 10meg	Tulin 26meg	Moment 60 meg
\$85 <sup>00</sup>	\$95 <sup>00</sup>	\$345 <sup>00</sup>	\$695 <sup>00</sup>	\$495 <sup>00</sup>

### Now IBM-XT in a Kit!

Completely XT Compatible

## \$1095<sup>00</sup>

### MISCELLANEOUS \$\$\$ SAVERS

7 PAK Multifunction Floppy, RTC, 2 Serial, 1 Parallel, Game, RAM Disk BOA-8250-00	\$189.00
64K Memory Chips (8) NEC for IBM KIT-8000-00	\$ 10.00
256K DRAM Memory Chips (8) = 256K KIT-9000-00	\$ 45.00
Add-On Memory (up to 512K) supplied OK BOA-6350-00	\$ 99.00
Floppy Controller, Controls up to four drives, 5 1/4" 48/96 TPI BOA-8100-00	\$ 95.00
Monochrome Graphics Card, (Hercules type) (1-2-3 compatible) 720h x 345v BOA-8150-00	\$175.00
Color Graphics Card, 320 x 200 Res. Color, 640 x 200 Monochrome BOA-8200-00	\$145.00
Clock Calendar Board, fits in "short slot" w/battery Back-up BOA-8375-00	\$ 55.00
Hard Disk Controller, standard ST-506 interface for DOS 2.1 & 3.1 BOA-8060-00	\$155.00
300 / 1200 Baud Modem Internal w/PC Talk III Communications Software BOA-8725-00	\$210.00
Monochrome Monitor, 22MHz bandwidth, composite input or TTL MON-1725-00 Green/Comp	99.00
MON-1700-00 Amber/Comp	104.00
MON-1775-00 Green/TTL	104.00
MON-1750-00 Amber/TTL	109.00

### INTERNATIONAL ORDERS

Micro Products is ready to serve your needs in several countries. Each Office has Sales Literature, Local Pricing, Inventory and Technical Service available to support your needs. There are no problems with U.S. Export Forms.

**USA OFFICE**  
15392 Assembly Lane, Unit A  
Huntington Beach, CA 92649  
Tel: 714 / 898-0840  
Tlx: 887841 XORDATA HTBH

**MARACAIBO OFFICE**  
Av. 3F Esq. Calle 81  
Centro Com. Maelga - Local #5  
Maracaibo, Venezuela 4001-A  
Tel: 061-813328 - Tlx: 62344 PEMIN

**AMSTERDAM OFFICE**  
Building 70, 4th Floor  
1117 ZH Schiphol-East  
Amsterdam, The Netherlands  
Tel: (020) 45 26 50 - Tlx: 18306

**BOMBAY OFFICE**  
311 Sindhi Lane  
Nambhal Desai Rd.  
Bombay 400-004 India  
Tel: 357172 - Tlx: 011-2868

**AUSTRALIA OFFICE**  
8 Irwin Street, Bellevue  
W. Australia 6056  
Tel: 274-3701

**CANADA OFFICE**  
264 Principale, St. Blaise,  
Quebec, Canada J0J1W0  
Tel: 541/291-3118

**Why didn't anybody think of it before?** If you have a Phillips screwdriver and 1 - 2 hours available, SAVE yourself a bundle of MONEY! No where will you beat this deal on a complete 8 slot ready-to-assemble and run XT compatible.

- Cabinet
- 135 watt Power Supply
- Keyboard
- 8 Slot Motherboard
- 256K RAM
- 2-360K Shugart Drives
- Floppy Controller & Cable
- Mono Video Card
- TTL Amber Monitor



<b>IBM PC</b> 256k, 2 floppies	<b>IBM PC 20 + 20</b> 256k, 1 or 2 floppies 20MB HD & 20MB Backup	<b>IBM XT 10 + 10</b> 256k, 1 or 2 floppies 10MB HD & 10MB Backup
<b>IBM PC 10 MB</b> 256k, 1 or 2 floppies	<b>IBM XT</b> 256k, 2 floppies	<b>IBM XT 20 + 20</b> 256k, 1 or 2 floppies 20MB HD & 20MB Backup
<b>IBM PC 20 MB</b> 256k, 1 or 2 floppies	<b>IBM XT 10 MB</b> 256k, 1 or 2 floppies	<b>IBM AT 20 MB</b> 512k, 1 or 2 floppies
<b>IBM PC 30 MB</b> 256k, 1 or 2 floppies	<b>IBM XT 20 MB</b> 256k, 1 or 2 floppies	<b>IBM AT 30 MB</b> 512k, 1 or 2 floppies
<b>IBM PC 10 + 10</b> 256k, 1 or 2 floppies 10MB HD & 10MB Backup	<b>IBM XT 30 MB</b> 256k, 1 or 2 floppies	<b>IBM AT 40 MB</b> 512k, 1 or 2 floppies

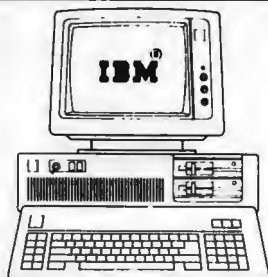

**FOR EXTRA SAVINGS**  
Call for the latest prices for your custom configuration. All systems are configured and tested at no extra cost and come only with CompuMail's 90 day warranty.

<b>IBM AT 20 + 20</b> 512k, 1 or 2 floppies 20MB HD & 20MB Backup	<b>COMPAQ DESKPRO 10 MB</b> 640k, 1 or 2 floppies	<b>COMPAQ PORTABLE 286</b> Custom Configurations
<b>IBM AT 30 + 60</b> 512k, 1 or 2 floppies 30MB HD & 60MB Backup	<b>COMPAQ DESKPRO 10 + 10</b> 10MB HD & 10MB Backup	<b>COMPAQ DESKPRO 286</b> Custom Configurations
<b>IBM AT 40 + 60</b> 512k, 1 or 2 floppies 40MB HD & 60MB Backup	<b>COMPAQ DESKPRO 20 MB</b> Backup Available	<b>IBM XT COMPATIBLE</b> Custom Configurations
<b>COMPAQ PORTABLE</b> 256k, 1 or 2 floppies	<b>COMPAQ DESKPRO 30 MB</b> Backup Available	<b>IBM AT COMPATIBLE</b> Custom Configurations
<b>COMPAQ PORTABLE 10 MB</b> 256k, 1 or 2 floppies	<b>COMPAQ DESKPRO 40 MB</b> Backup Available	<b>IBM COMPATIBLES ARE YOUR LOW COST ALTERNATIVE</b>

**★ PRICE WAR ★ CALL US LAST WITH YOUR BEST QUOTES ★**

**PRINTERS      FLOPPY/HARD DISKS      MONITORS      MODEMS**

<b>EPSON</b> Daisy Wheel DX-10/DX-15 FX-85 + NLO. \$339 FX-185 + NLO. \$459 Sht Fdr FX-85/FX-185 \$249/\$299 NLO Upgrade Kit for FX-80/FX-100 CALL LX-80/HI-80/JX-80 \$219/\$359/\$469 Tractor LX-80/FX-80/HI-80 \$50/\$60/\$70 LQ-1500 w/Parallel Module \$889 LQ Tract/Sing/Dual Sht Fdr \$70/\$450/\$750 LX-90 w/Par Interface & Tractor \$279	<b>OKIDATA</b> . . . . . <b>TOO LOW TO QUOTE</b> OKIMATE 20 w/IBM Plug & Print 182-P/182-IBM . . . . . 192-P/192-IBM 193-P/193-IBM . . . . . 84-P/84-IBM 192 Tractor \$70 84 Sht Fdr. \$390	<b>TOSHIBA</b> 1340P . . . . . \$499 TOSHIBA 351P . . . . . "REDUCED" \$499	<b>JUKI</b> 6100/6200/6300 . . . . . \$349/\$549/\$679 6X00 Tractor/Sht Fdr . . . . . \$150/\$250 5510P (160cps) \$369 5510 Color Kit. \$150	<b>BROTHER</b> . . . . . <b>TOO LOW TO QUOTE</b> HR-10/HR-15XL . . . . . HR-15 Trac/Kybrd/Sht Fdr . . . . . \$110/\$160/\$190 HR-25P/HR-35P . . . . . \$439/\$639 HR-25/35 Tractor/Sht Fdr . . . . . \$120/\$200 2024L LQ/Graphics-24 pin, 160/80 cps. \$899 2024L Sht Fdr-Narrow/Wide . . . . . \$220/\$290 TWINWRITER 5 . . . . . World's First Dot Matrix & Daisy Wheel combined in ONE . . . . . Best Price TWINWRITER 5 Sht/Sht Fdr . . . . . \$150/\$250
---	---	--	--	--

<b>CDC/MITSUBISHI/PANASONIC/TANDON/TEAC</b> Half Ht DDDD . . . . . "REDUCED" \$90 Free Mounting Kit with 2 Drives <b>CDC/TANDON Full Ht DDDD</b> . . . . . \$99	<b>HARD DISKS FOR IBM PC/XT</b> 10 MB Int w/Controller. . . . . "REDUCED" \$449 10 MB Ext w/Controller. . . . . "REDUCED" \$649 20 MB Int w/Controller. . . . . "REDUCED" \$599 20 MB Ext w/Controller. . . . . "REDUCED" \$799 33 MB Int w/Controller. . . . . "REDUCED" \$849 33 MB Ext w/Controller. . . . . "REDUCED" \$1049 44 MB Int w/Controller. . . . . "REDUCED" \$1049 44 MB Ext w/Controller. . . . . "REDUCED" \$1249 70 MB Int or Ext w/Controller . . . . . CALL 140 MB Int or Ext w/Controller . . . . . CALL	<b>HARD DISKS/BACKUP FOR IBM PC AT</b> . . . . . CALL <b>BACKUP FOR IBM PC/XT</b> 10 MB Int/Ext. . . . . "REDUCED" \$499/\$669 20 MB Int/Ext. . . . . "REDUCED" \$599/\$749 40/60 MB Int/Ext. . . . . CALL	<b>TALL GRASS NEW PC/T FORMAT</b> 25/35 MB w/60 MB Backup . . . . . \$2599/\$3399 50/80 MB w/60 MB Backup . . . . . \$4299/\$5499 60 MB Tape Backup only . . . . . CALL Controller. \$140 Cartridge (60 MB). \$60
--	---	--	---

<b>PGS</b> MAX-12/HX-12/HX-12E . . . . . \$169/\$419/\$499 HX-9/HX-9E/SR-12 . . . . . \$419/\$499/\$549 SR-12 w/Scan Doubler . . . . . \$699 SR-12 w/Sigma 400 . . . . . \$999 <b>TAXAN COMPOSIT</b> 115 Green/116 Amber . . . . . \$129 MONO 121 Gr/122 Amb . . . . . \$139/\$149 COLOR 410 . . . . . \$289 COLOR 411 . . . . . \$299 COLOR 420 . . . . . \$359 COLOR 420L . . . . . \$369 COLOR 425 . . . . . \$369 COLOR 440 . . . . . \$489 COLOR 440 w/TAXAN 555 RGB Card . . . . . \$449 COLOR 440 w/Persyst Bob Brd . . . . . \$799 COLOR 440 w/Sigma 400 . . . . . \$939 COLOR 440 w/Sigma 400 & PC Mouse . . . . . \$1039 <b>AMDEK</b> 300G/300A/310A(M) . . . . . \$139/\$149/\$159 COLOR 300/500/600 . . . . . \$239/\$349/\$419 710 . . . . . \$489 w/Teclar Graphics Master. \$899	<b>QUADRAM AMBERCHROME</b> . . . . . \$159 <b>ROLAND</b> MB-142 14" Mono B/W . . . . . Best Price <b>TECMAR</b> Color \$529 w/Graphics Master. \$939 <b>TILT/SWIVEL</b> Monitor Pedestal . . . . . \$30
--	--

<b>EasyData</b> 12B 300/1200 Bd Int w/PCTalk III. . . . . \$199 <b>SmartTEAM</b> 212A 1200 Bd Ext w/o sft . . . . . \$209 <b>HAYES</b> 1200 B w/SmartCom II . . . . . \$319 <b>HAYES</b> 1200 Ext. w/o Software . . . . . \$339 Smartcom II. \$89 NEW 2400 Bd Ext. \$589 <b>HAYES</b> Transet 1000 . . . . . "REDUCED" \$699 <b>POPCOM</b> C-150 Int w/PFS:Access . . . . . \$289 <b>POPCOM</b> X-150 Ext w/PFS:Access . . . . . \$299 <b>AST</b> Reach! 1200 Bd short card w/Crosstalk . . . . . \$359 <b>PROMETHEUS</b> PROMODEM 1200 Ext . . . . . \$279 Options Processor. . . . . \$89 w/Modem. \$75 Alphanum Display . . . . . \$89 w/Modem. \$75 <b>PROMODEM</b> 1200 Ext + Both Options . . . . . \$419 <b>PROMODEM</b> 1200 B Int w/MITE software. \$249 <b>QUADMODEM</b> II shortcard w/Crosstalk XVI . . . . . CALL 2400 Bd Upgrade Kit for Quadmode II . . . . . CALL <b>Ven-Tel</b> Half Card w/Crosstalk XVI . . . . . \$379 1200 Plus Ext w/o software . . . . . \$349 <b>BIZCOMP</b> IntelliModem EXT . . . . . \$319 ST/XT/XL . . . . . \$289/\$319/\$359 <b>WATSUN</b> Integrated Voice Data Modem . . . . . CALL <b>RIXON</b> Complete Line . . . . . CALL <b>U.S. ROBOTICS</b> Complete Line . . . . . CALL
---

<b>C. ITOH</b> ProWriter Jr w/NLO . . . . . \$219 8510BPI . . . . . \$309 8510SEP + NLO. \$379 8510SCEP + NLO. \$449 1550-EP. \$429 1550SEP + NLO. \$519 1550SCEP + NLO. \$619 24LQP . . . . . \$949 A10-30SP. \$439 Y10-20P . . . . . \$379 A10 Tractor. \$160 F10-40P . . . . . \$869 F10-55P. \$1069 F10 Tractor/Sht Fdr . . . . . \$190/\$290 CX-4800P 4 Pen Plotter. . . . . \$429
---

<b>EVEREX</b> 10/20 MB Int w/Cont. . . . . \$579/\$699 <b>EXCEL</b> 4500 45MB B/U-Int/Ext. . . . . \$949/\$999 <b>APEX</b> MEG-1000 100MB Tape B/U-EXT. \$1399 <b>EXTERNAL EXPANSION SYSTEMS</b> . . . . . CALL <b>INTERDYNE TAPE BACKUP</b> 10 MB Int/Ext. . . . . "REDUCED" \$469/\$640 20 MB Int/Ext. . . . . "REDUCED" \$569/\$749	<b>HARD DISKS/BACKUP FOR COMPAQ</b> <b>IOEMGA</b> Bernoulli Box 10 + 10 . . . . . CALL Auto Boot also Available <b>AMPEX</b> PC Megastore . . . . . CALL <b>EMULEX</b> JAVELIN HD & BACKUP . . . . . CALL <b>PWR SUPPLY</b> 130/150 Watts . . . . . \$89/\$109
--	---

<b>HERCULES</b> MonoGraphics. \$279 Color. \$149 <b>HERCULES COMPATIBLE</b> MonoGraphics. \$199 <b>EVEREX</b> The Edge . . . . . Best Price Ever Graphics Edge . . . . . Even Better Price <b>AST</b> Monograph Plus . . . . . \$339/\$369 Preview for Mono Graphics . . . . . \$279 Graphpack w/64k . . . . . \$549 <b>PERSYST</b> Short Color/Mini Mono . . . . . \$159/CALL Color Combo: Multifunction & Color . . . . . from \$299 Mono Combo: Multifunction & Mono . . . . . from \$299 <b>PERSYST</b> Bob Board . . . . . \$339 <b>PERSYST</b> w/TAXAN 440 . . . . . \$799 <b>QUADRAM</b> Quadcolor I . . . . . \$179 Gold Quadboard: Multifunction & Color . . . . . CALL <b>STB</b> Chaffer . . . . . "REDUCED" \$299 <b>PARADISE</b> Modular Brd . . . . . from \$259 <b>ORCHID</b> Turbo Graphics Controller . . . . . CALL <b>TECMAR</b> Graphics Master . . . . . \$429 G Master w/TECMAR Color Monitor . . . . . \$939 G Master w/AMDEK 710 Color Monitor . . . . . \$899	<b>GENOA</b> Spectrum . . . . . Best Price <b>MYLEX</b> Chairman . . . . . \$399 <b>SIGMA</b> COLOR 400 (specify Monitor) . . . . . \$479 COLOR 400 w/PGS SR-12 . . . . . \$999 COLOR 400 w/TAXAN 440 . . . . . \$939 3 Button PC Mouse w/PC Paint . . . . . Add \$100
---	---

<b>DCA:</b> IRMA, IRMAlette, IRMAline, IRMAprint Emulates 3278, 3279 <b>CXI:</b> PCOX Emulates 3274, 3278, 3279 <b>FORTE:</b> PJ Card Emulates 3278, 3279, 3287 3270PC, 278RJE, 3780RJE (Specify) <b>AST</b> 3780, 5251/11, 5251/12, BSC, SNA, PCOX <b>ORCHID</b> PCnet Plus Complete Line . . . . . CALL <b>OBERTON</b> OMNI READER Optical Character Reader w/IBM Interface Software . . . . . CALL <b>POLAROID</b> Palette . . . . . \$1249 General Parametric's VideoShow . . . . . CALL <b>CHORUS</b> PHOTOBASE/PC-EYE . . . . . CALL
---

**MULTI-FUNCTION CARDS**

<b>QUME</b> LetterPro 20P (20 cps) . . . . . \$399 20P Trac/Sht Fdr . . . . . \$150/\$390 <b>SPRINT</b> 1140+/1155+ . . . . . \$1299/\$1399 SPRINT Interface Module . . . . . \$80 SPRINT Trac/Sht Fdr . . . . . \$210/\$690	<b>PANASONIC</b> KX-P3151 LQ (22cps) . . . . . \$459 KX-P1090/91/92/93 . . . . . \$179/\$249/\$349/\$449	<b>STAR</b> Power Type/SB-10 . . . . . \$329/CALL SG-10/SG-15 (120cps) . . . . . \$239/\$389 SD-10/SD-15 (160cps) . . . . . \$349/\$549 SR-10/SR-15 (200cps) . . . . . \$499/\$699 <b>NEC</b> PINWRITER P-2/P-3 . . . . . \$499/\$699 Sht Fdr for P-2/P-3 . . . . . \$350/\$420 2050/3550/8850 . . . . . \$649/\$999/\$1399 <b>SPINWRITER</b> Trac/Sht Fdr . . . . . \$190/\$790 ELF 360 Par (16cps) . . . . . \$419	<b>DIABLO</b> Advantage D-25 . . . . . \$499 630 API . . . . . \$1599 630 ECS-IBM . . . . . \$1799 Trac/Mech Single Bin Sht Fdr. . . . . \$230/\$470	<b>CITIZEN:</b> 18 months manufacturer warranty MSP-10/15 (160/40cps) . . . . . \$299/\$449 MSP-20/25 (200/50cps) . . . . . \$439/\$589 Sht Fdr (Specify Model) . . . . . \$229 <b>LEGEND</b> CP-VII. . . . . \$899 1200. . . . . \$259 880/1080/1380/1385. . . . . \$199/\$219/\$259/\$319 <b>ANAHEID</b> 9620B/9625B-PLUS . . . . . \$1199/\$1299 9725B COLOR . . . . . \$1399 WP6000/DP6500 . . . . . \$2299/\$2569 Anadex Tractor/Sht Fdr . . . . . \$150/\$950
--	---	--	--	--



<b>AST</b> SIXPAK 0-K . . . . . \$229 384K. . . . . \$259 Rampage! . . . . . Advantage 0-K. . . . . \$379 <b>ORCHID</b> Blossom 0-K . . . . . \$169 384K. . . . . \$199 Conquest for IBM PC/XT (up to 2MB). . . . . CALL Cram-RAM for IBM XT short slot (up to 2MB). . . . . CALL Eccell for IBM AT (up to 4MB) . . . . . CALL <b>TECMAR</b> Captain 0-K . . . . . \$169 384K. . . . . \$199 <b>MAESTRO</b> AT w/Treasure Chest . . . . . Best Price <b>INTEL</b> Above Board (up to 4MB) . . . . . CALL <b>PARADISE</b> 5-Pack 0-K. \$159 384K. . . . . \$189 <b>BT6</b> Plus w/64k . . . . . \$175 384K. . . . . \$199 <b>MF-100</b> 0-K . . . . . \$179 384K. . . . . \$209 Par, Ser & Game Ports, Clock/Cal . . . . . \$219 <b>QUADBOARD</b> 0-K . . . . . \$189 384K. . . . . \$219 Silver Quadboard: 0-K to 640K . . . . . CALL Gold Quadboard: Multifunction & Color . . . . . CALL Quadmeg-AT (up to 4 MB) . . . . . CALL Quadport-AT/Expansion Kit . . . . . CALL <b>INSTALL</b> RAM & test brd for PC/AT . . . . . \$20/\$40
--

**CHIPS ETC.**

<b>HIGHEST QUALITY!</b>	<b>Major Brands</b>
64K RAM Set. \$7 10+ Sets. \$6 50+ . . . . . \$5 128K RAM Set. \$35 10+ Sets. \$33 50+ . . . . . \$30 256K RAM Set. \$30 10+ Sets. \$28 50+ . . . . . \$25 8087-3 for IBM PC . . . . . "REDUCED" \$440 8087-2 for COMPAQ . . . . . "REDUCED" . . . . . CALL 80287-3 for IBM AT . . . . . "REDUCED" . . . . . \$299 ORCHID Pctorbo w/128k . . . . . \$549-640k. . . . . \$699 QUADRAM QUADSprint . . . . . "REDUCED" . . . . . \$499 MICROWAY'S Fastbreak // Smasher . . . . . CALL	

**SILVER REED** Daisywheel - Parallel Models  
400/500/550/770 . . . . . \$189/\$269/\$379/\$669  
**TELEVIDE** 750 Daisywheel-50 cps . . . . . CALL  
**AB/ABC/ABCD** Switch Boxes . . . . . CALL  
**KENSINGTON** Universal Printer Stand . . . . . \$20

**COMPANY POLICY:** Min. order \$100. Prices & availability subject to change. We ship UPS only. Shipping/handling charges vary. Prices reflect cash discount on prepaid orders. Add 1% for COD orders, 3% for MC/VISA & 5% for AMEX. COD requires cashiers check. All merchandise sold is new and all sales are final. Refused shipments subject to 20% charge (Min \$50). Products shipped in factory cartons come with manufacturer warranty. For others, including IBM systems, call tech support for return auth. # for warranty repairs. Non-defective items returned as defective subject to 10% service charge (Min. \$50). Not responsible for hardware or software compatibility of any product. No open acid PO's or foreign orders. No showroom, demonstrations or walk-in sales. Personal or company checks take 3 weeks to clear. FOR ADVANCE PAYMENTS or PICKUP, PLEASE CALL FIRST FOR WORKORDER #.

**MISC. ADD ONS**

<b>CABLE</b> Parallel, 6ft. . . . . \$20 Serial, 6 ft. . . . . \$25 Keyboard Extension, 6 ft. . . . . \$10 <b>FLOPPY</b> Drive Controller . . . . . \$109 <b>FLOPPY</b> Controller w/P.S.G & Clock/Cal . . . . . \$199 <b>FLOPPY &amp; HD</b> Controller. . . . . "REDUCED" \$299 <b>HAYES</b> Transet 1000 . . . . . "REDUCED" \$299 <b>MOUSE</b> SYSTEMS PC Mouse w/PC Paint . . . . . \$129 <b>MICROSOFT</b> MOUSE w/PC Paintbrush Bus/Serial. . . . . \$129/\$139 <b>KEYTRONIC</b> KB 5151. \$165 AT Upgrade Kit. \$15 KB 51537 w/Touch Pad . . . . . CALL <b>AB/ABC/ABCD</b> Switch Boxes . . . . . CALL <b>COMPUTER ACCESSORIES</b> P 1-2-3 . . . . . \$299 <b>POWER DIRECTOR</b> P2(5). \$89 P12(6). \$129 <b>KENSINGTON</b> Master Piece (5 outlets) . . . . . \$89 <b>KENSINGTON</b> Universal Printer Stand . . . . . \$20 PC Keyboard Storage Drawer . . . . . \$99 <b>STANDBY</b> PWR SUPPLY w/surge protection 200 Watts . . . . . \$269 300 Watts . . . . . CALL 800 Watts (Sine Wave) . . . . . \$679 <b>TILT/SWIVEL</b> Monitor Pedestal . . . . . \$30 <b>PWR SUPPLY</b> 130/150 Watts . . . . . \$89/\$129
---

**CALL FOR OUR WEEKLY UNADVERTISED SPECIALS**



**JUST IN TIME FOR OUR 6 YEAR ANNIVERSARY,**

**JDR HAS JUST**

**SLASHED THE PRICES**

**ON OUR MOST POPULAR ITEMS!**

**FOR EXAMPLE:**

**INTEGRATED CIRCUITS**

**4164** 200ns **79¢**

**41256** 200ns **\$3.19**

**27256** 250ns **\$9.95**

8088	7.95	MSM5832	2.95
8251	1.95	UPD765	4.95
8253	1.95	74LS00	.16
8255	1.95	74LS74	.24
8284	2.95	74LS244	.69
8288	4.95	4011	.19
68000	9.95	LM555	.29
6821	1.95	7805T	.49
6845	4.95	CRYSTALS	1.95
Z80A-CPU	1.89	OSCILLATOR	4.95

**IBM COMPATIBLE CARDS**



<b>348K MULTIFUNCTION CARD</b>	<b>\$129.95</b>
<b>1200 BAUD MODEM CARD</b>	<b>\$195.00</b>
<b>COLOR GRAPHICS CARD</b>	<b>\$99.95</b>
<b>MONOCHROME/PRINTER CARD</b>	<b>\$129.95</b>
<b>FLOPPY DISK CONTROLLER</b>	<b>\$59.95</b>

**TEAC DRIVES**



**FD-55B \$89.95**  
**FD-55F \$99.95**

**CONNECTORS**

<b>DB25S</b>	RS232 FEMALE	<b>\$1.50</b>
<b>DB25P</b>	RS232 MALE	<b>\$1.25</b>
<b>25 PIN HOOD</b>		<b>65¢</b>
<b>62 PIN</b>	EDGE CARD FOR IBM	<b>\$1.95</b>
<b>16 PIN IC SOCKET</b>		<b>12¢</b>
<b>GENDER CHANGER</b>		<b>\$7.95</b>

**IBM COMPATIBLE CASE**



**\$59.95**

**DRIVE CASE**

**WITH POWER SUPPLY**  
• FITS TWO 5 1/4" 1/2 HT. FDDs



**\$49.95**

**NASHUA DS/DD DISKETTES**

**9.90 .89 .79**  
**BOX OF 10 BULK QTY 50 BULK QTY 250**

**MONITORS**

**TAXAN RGB \$289.95**  
**MONOCHROME FOR IBM \$99.95**

**100 CPS PRINTER**  
PARALLEL & SERIAL INPUT

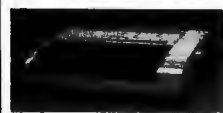

**\$149.95**

**300 BAUD MODEM**  
FOR APPLE OR IBM  
SOFTWARE INCLUDED

**\$49.95**

**PRINTER CABLE**  
FOR IBM  
DB25 TO CENTRONICS

**\$9.95**

**HALF HEIGHT DRIVE**  
FOR APPLE



**BAL \$99.95**  
**525**



**JDR Microdevices**

1224 S. Bascom Avenue, San Jose, CA 95128  
800-538-5000 • 800-662-6279 (CA) • (408) 995-5430  
FAX (408) 275-8415 • Telex 171-110

RETAIL STORE - 1256 S. BASCOM AVENUE  
HOURS: M-W-F, 9-5 TU-TH, 9-9 SAT, 10-3

PLEASE USE YOUR CUSTOMER NUMBER WHEN ORDERING

TERMS: Minimum order \$10.00. For shipping and handling include \$2.50 for UPS Ground and \$3.50 for UPS Air. Orders over 1 lb. and foreign orders may require additional shipping charges - please contact our sales department for the amount. CA. residents must include applicable sales tax. All merchandise is warranted for 90 days unless otherwise stated. Prices are subject to change without notice. We are not responsible for typographical errors. We reserve the right to limit quantities and to substitute manufacturer. All merchandise subject to prior sale.

© COPYRIGHT 1985 JDR MICRODEVICES



# SPECIAL THANKS TO ALL THE FOLKS AT BYTE MAGAZINE

## STATIC RAMS

2101	256x4	(450ns)	1.95
5101	256x4	(450ns)(CMOS)	3.95
2102-1	1024x4	(450ns)	.89
2102L-4	1024x1	(450ns)(LP)	.89
2102L-2	1024x1	(250ns)(LP)	1.45
2125	1024x1	(45ns)	1.95
2111	256x4	(450ns)	2.49
2112	256x4	(450ns)	2.99
2114	1024x4	(450ns)	.99
2114L-4	1024x4	(450ns)(LP)	1.09
2114L-2	1024x4	(200ns)(LP)	1.49
2114L-15	1024x4	(150ns)(LP)	1.95
TC5514	1024x4	(650ns)(CMOS)	4.95
2141	4096x1	(200ns)	2.95
2147	4096x1	(55ns)	3.95
2148	1024x4	(70ns)	4.95
TMS4044-4	4096x1	(450ns)	1.95
TMS4044-2	4096x1	(250ns)	2.95
UPD410	4096x1	(100ns)	3.95
MK4118	1024x8	(250ns)	9.95
TMM2016-150	2048x8	(150ns)	1.69
TMM2016-100	2048x8	(100ns)	2.49
HM6116-4	2048x8	(150ns)(CMOS)	1.79
HM6116-3	2048x8	(150ns)(CMOS)	1.89
HM6116-2	2048x8	(120ns)(CMOS)	2.95
HM6116LP-4	2048x8	(200ns)(CMOS)(LP)	1.89
HM6116LP-3	2048x8	(150ns)(CMOS)(LP)	1.99
HM6116LP-2	2048x8	(120ns)(CMOS)(LP)	2.95
TC5516	4096x8	(250ns)(CMOS)	3.95
Z-6132	4096x8	(300ns)(LSTATT)	15.95
HM6264P-15	8192x8	(150ns)(CMOS)	4.75
HM6264LP-15	8192x8	(150ns)(CMOS)(LP)	4.95
HM6264LP-12	8192x8	(120ns)(CMOS)(LP)	5.95

LP=Low power      Qata=Quasi-Static

## DYNAMIC RAMS

TMS4027	4096x1	(250ns)	.95
2107	4096x1	(200ns)	1.95
MM5280	4096x1	(300ns)	1.95
TMS4050	4096x1	(300ns)	1.95
UPD411	4096x1	(300ns)	1.95
TMS4060	4096x1	(300ns)	1.95
MK4108	8192x1	(200ns)	.19
MM5298	8192x1	(250ns)	.19
4116-250	16384x1	(250ns)	1.49
4116-200	16384x1	(200ns)	.89
4116-150	16384x1	(150ns)	.95
4116-120	16384x1	(120ns)	1.49
2118	16384x1	(150ns)(5v)	1.89
MK4332	32768x1	(200ns)	0.95
4164-200	65536x1	(200ns)(5v)	.79
4164-150	65536x1	(150ns)(5v)	.89
4164-120	65536x1	(120ns)(5v)	1.95
MCM6065	65536x1	(200ns)(5v)	1.95
TMS4164	65536x1	(150ns)(5v)	1.95
4164-REFRESH	65536x1	(150ns)(5v)(REFRESH)	2.95
TMS4416	16384x4	(150ns)(5v)	4.95
41128-150	131072x1	(150ns)(5v)	5.95
41256-200	262144x1	(200ns)(5v)	3.19
41256-150	262144x1	(150ns)(5v)	3.29

5v=Single 5 Volt Supply      REFRESH=Pin 1 Refresh

## EPROMS

1702	256x8	(1us)	4.95
2708	1024x8	(450ns)	3.95
2758	1024x8	(450ns)(5V)	4.95
2718-6	2048x8	(650ns)	2.29
2718	2048x8	(450ns)(5V)	2.49
2716-1	2048x8	(350ns)(5V)	3.95
TMS2516	2048x8	(480ns)(5V)	3.95
TMS2716	2048x8	(450ns)	6.75
TMS2532	4096x8	(450ns)(5V)	3.95
2732	4096x8	(450ns)(5V)	2.49
2732A	4096x8	(250ns)(5V)(21V PGM)	2.69
2732A-2	4096x8	(200ns)(5V)(21V PGM)	4.95
27C64	8192x8	(250ns)(5V)(CMOS)	7.95
2764	8192x8	(450ns)(5V)	2.29
2764-200	8192x8	(200ns)(5V)	4.95
TMS2564	8192x8	(450ns)(5V)	6.95
MCM68764	8192x8	(450ns)(5V)(24 pin)	15.95
MCM68768	8192x8	(350ns)(5V)(24 pin)	17.95
27128	16384x8	(250ns)(5V)	3.49
27C256	32768x8	(250ns)(5V)(CMOS)	15.95
27256	32768x8	(250ns)(5V)	9.95

5V=Single 5 Volt Supply      21V PGM=Program at 21 Volts

## \*\*\*\*\* HIGH-TECH \*\*\*\*\*

### NEC V20 $\mu$ PD70108 \$20<sup>95</sup>

REPLACES 8080 TO SPEED UP IBM PC 10-40%

- \* HIGH SPEED ADDRESS CALCULATION IN HARDWARE
- \* PIN COMPATIBLE WITH 8088
- \* SUPERSET OF 8086/8088 INSTRUCTION SET
- \* LOW POWER CMOS

## \*\*\*\*\* SPOTLIGHT \*\*\*\*\*

- \* COMPUTER MANAGED INVENTORY - VIRTUALLY NO BACK ORDERS!
- \* VERY COMPETITIVE PRICES
- \* FRIENDLY STAFF
- \* FAST SERVICE - MOST ORDERS SHIPPED WITHIN 24 HOURS!
- \* WE ACCEPT VISA AND MASTERCARD

## CRYSTALS

32.768 KHz	.95
1.0 MHz	2.95
1.8432	2.95
2.0	1.95
2.037162	1.95
2.4576	1.95
3.2768	1.95
3.579546	1.95
4.0	1.95
4.032	1.95
5.0	1.95
5.0688	1.95
5.185	1.95
5.7143	1.95
6.0	1.95
6.144	1.95
6.5536	1.95
7.0	1.95
10.0	1.95
10.738635	1.95
12.0	1.95
14.31818	1.95
15.0	1.95
15.0	1.95
17.430	1.95
18.0	1.95
18.432	1.95
20.0	1.95
22.1184	1.95
24.0	1.95
32.0	1.95

## CRYSTAL OSCILLATORS

1.0MHz	5.95	8.0	4.95
1.8432	5.95	10.0	4.95
2.0	5.95	12.0	4.95
2.4576	5.95	12.480	4.95
2.5	4.95	15.0	4.95
4.0	4.95	16.0	4.95
5.0688	4.95	18.432	4.95
6.0	4.95	20.0	4.95
6.144	4.95	24.0	4.95

## 74LS00

74LS00	.16	74LS191	.49
74LS01	.18	74LS192	.69
74LS02	.17	74LS193	.69
74LS03	.18	74LS194	.69
74LS04	.16	74LS195	.69
74LS05	.18	74LS196	.59
74LS08	.18	74LS197	.59
74LS09	.18	74LS221	.59
74LS10	.16	74LS240	.69
74LS11	.22	74LS241	.69
74LS12	.22	74LS242	.69
74LS13	.28	74LS243	.69
74LS14	.28	74LS244	.69
74LS15	.26	74LS245	.75
74LS20	.17	74LS247	.79
74LS21	.22	74LS248	.69
74LS22	.22	74LS249	.99
74LS26	.23	74LS251	.49
74LS27	.22	74LS253	.29
74LS28	.26	74LS256	1.79
74LS30	.17	74LS257	.39
74LS32	.18	74LS258	.49
74LS33	.28	74LS259	1.29
74LS37	.26	74LS260	.49
74LS38	.26	74LS261	1.49
74LS40	.17	74LS266	.39
74LS42	.39	74LS273	.79
74LS47	.59	74LS275	1.95
74LS48	.69	74LS279	.39
74LS51	.39	74LS280	1.95
74LS51	.17	74LS283	.69
74LS54	.22	74LS290	.89
74LS55	.22	74LS293	.89
74LS56	.89	74LS295	.69
74LS73	.29	74LS298	.69
74LS74	.24	74LS299	1.49
74LS76	.29	74LS322	3.95
74LS76	.29	74LS323	2.49
74LS78	.49	74LS324	1.75
74LS83	.49	74LS348	1.29
74LS86	.49	74LS362	1.29
74LS86	.22	74LS363	1.29
74LS90	.39	74LS363	1.35
74LS91	.89	74LS384	1.95
74LS92	.49	74LS385	.39
74LS93	.39	74LS386	.39
74LS96	.48	74LS367	.39
74LS96	.49	74LS368	.39
74LS107	.34	74LS373	.79
74LS109	.36	74LS374	.79
74LS112	.29	74LS375	.95
74LS113	.34	74LS377	.79
74LS114	.34	74LS378	1.18
74LS122	.45	74LS379	.95
74LS123	.49	74LS385	3.90
74LS124	2.75	74LS386	.45
74LS125	.39	74LS390	1.19
74LS126	.39	74LS393	.79
74LS127	.39	74LS395	1.49
74LS133	.49	74LS396	1.89
74LS138	.39	74LS399	1.49
74LS137	.99	74LS424	3.95
74LS138	.99	74LS447	.95
74LS139	.39	74LS490	1.95
74LS147	.49	74LS516	1.49
UPD765	4.95	74LS541	1.95
MB8876	12.95	74LS448	.99
MB8877	12.95	74LS624	1.95
1691	6.95	74LS645	.95
2143	6.95	74LS648	1.49
		74LS669	1.29
		74LS670	.89
		74LS674	14.95
		74LS682	3.20
		74LS683	3.20
		74LS684	3.20
		74LS685	3.20
		74LS688	2.40
		74LS689	3.20
		74LS763	22.95
		81LS95	1.49
		81LS96	1.49
		81LS98	1.49
		81LS98	1.49
		25LS218	4.13
		25LS251	2.80
		25LS258	3.74
		25LS259	2.80
		25LS261	1.95
		26LS32	1.95

## BIT RATE GENERATORS

MC14411	9.95
BR1941	4.95
8703	9.95
COM5016	16.95
COM8116	8.95
MMS307	4.95

## CRT CONTROLLERS

6845	4.95
68B45	8.95
6847	11.95
68047	12.95
HD46505SP	6.95
MC1372	2.95
8272	26.95
7220	19.95
CRT5027	12.95
CRT5037	9.95
TMS9918A	19.95
DP8350	39.95

## DISK CONTROLLERS

1771	4.95
1791	9.95
1793	9.95
1795	12.95
1797	12.95
2791	19.95
2793	19.95
2795	29.95
2797	29.95
6843	19.95
8156	2.95
UPD765	4.95
MB8876	12.95
MB8877	12.95
1691	6.95
2143	6.95

## MISC.

TMS99531	9.95
TMS99532	19.95
ULN2003	.79
3242	7.95
3341	4.95
MC3470	1.95
MC3480	8.95
MC3487	2.95
11C90	13.95
96H90	7.95
2513-001 UP	6.85
2513-002 LOW	9.85
AY5-2376	11.95
AY5-3800 STD	11.95
AY5-3600 PRO	11.95

## UARTS

AY5-1013	3.95
AY3-1015	4.95
PT1472	1.95
TR1602	3.95
2350	4.95
2661	4.95
IN6402	6.95
IN6403	9.95
UPD7201	4.95
INS8250	6.95

## Z-80 2.5 MHz

Z80-CPU	1.79
Z80-CTC	1.85
Z80-DART	4.95
Z80-DMA	4.95
Z80-PIO	1.85
Z80-SIO/0	4.95
Z80-SIO/1	4.95
Z80-SIO/2	4.95
Z80-SIO/3	4.95

## 4.0 MHz

Z80A-CPU	1.89
Z80A-CTC	1.95
Z80A-DART	5.95
Z80A-DMA	5.95
Z80A-PIO	1.95
Z80A-SIO/0	5.95
Z80A-SIO/1	5.95
Z80A-SIO/2	5.95
Z80A-SIO/3	5.95

## 6.0 MHz

Z80B-CPU	4.95
Z80B-CTC	8.95
Z80B-PIO	8.95
Z80B-DART	14.95
Z80B-SIO/0/12.95	
Z80B-SIO/2/12.95	

## ZILO8

Z6132	19.95
Z8771	19.95

## 6500 1

Table with 4 columns of part numbers and prices. Section header: 7400. Includes parts like 7400, 7401, 7402, etc.

Table with 4 columns of part numbers and prices. Section header: CMOS. Includes parts like 4000, 4001, 4002, etc.

Table with 4 columns of part numbers and prices. Section header: HIGH SPEED CMOS. Includes parts like 74HC00, 74HC01, etc.

Table with 4 columns of part numbers and prices. Section header: VOLTAGE REGULATORS TO-20 CASE PACKAGE. Includes parts like 7805T, 7808T, etc.

Table with 4 columns of part numbers and prices. Section header: 74S00. Includes parts like 74S00, 74S01, 74S02, etc.

Table with 4 columns of part numbers and prices. Section header: 74S00. Includes parts like 74S00, 74S01, 74S02, etc.

Table with 4 columns of part numbers and prices. Section header: 74HCT00. Includes parts like 74HCT00, 74HCT01, etc.

Table with 4 columns of part numbers and prices. Section header: LINEAR. Includes parts like LM301, LM301H, etc.

Table with 4 columns of part numbers and prices. Section header: OPTO-ISOLATORS. Includes parts like 4N26, 4N27, etc.

Table with 4 columns of part numbers and prices. Section header: DATA ACQUISITION. Includes parts like ADC0800, DAC0806, etc.

Table with 4 columns of part numbers and prices. Section header: 8000 SERIES. Includes parts like 9304, 9312, etc.

Table with 4 columns of part numbers and prices. Section header: SOUND CHIPS. Includes parts like 76477, 76489, etc.

Section header: DIFFUSED LEDs. Includes part numbers like JUMBO RED, JUMBO GREEN, etc. and diagrams of LED packages.

Section header: LED DISPLAYS. Includes part numbers like FND-357(359), FND-500(503), etc. and diagrams of display packages.

Section header: IC SOCKETS. Includes part numbers like 8 PIN ST, 14 PIN ST, etc. and diagrams of socket packages.

Section header: TRANSISTORS. Includes part numbers like 2N918, 2N3772, etc. and diagrams of transistor packages.

Section header: RCA. Includes part numbers like CA3023, CA3039, etc. and diagrams of RCA packages.

CALL FOR VOLUME QUOTES

© COPYRIGHT 1985 JDR MICRODEVICES



## DIODES

1N761	5.1 VOLT ZENER	.25
1N769	12.0 VOLT ZENER	.25
1N4148	(1N41) SWITCHING	25/1.00
1N4001	50PIV 1A RECT	12/1.00
1N4004	400PIV RECT	10/1.00
1N5402	200PIV 3A RECT	.25
KBPO2	200PIV 1.5A BRIDGE	.45
KBPO4	400PIV 1.5A BRIDGE	.85
KB35A	50PIV 5A BRIDGE	.85
MDA990-2	100PIV 27A BRIDGE	2.25
VM48	DIP BRIDGE	.35

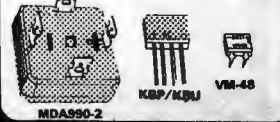

## ELECTRONIC SOLDER

\* .025" DIAM.  
\* ROSIN CORE  
\* 60% TIN  
\* 40% LEAD  
\* 1 lb. SPOOL  
**\$9.95**



## 25 PIN D-SUB RENDER CHANGERS

**\$7.95**



## SHIELDED ROUND CABLE

\* 11 CONDUCTOR  
\* COLOR CODED

**99¢/FOOT**



## BYPASS CAPACITOR SPECIALS

.01µf	50 VOLTS	100/95.00
.1 µf	12 VOLTS	100/96.50
<b>MONOLITHIC</b>		
.01µf	50 VOLTS	100/910.00
.1 µf	50 VOLTS	100/912.50

## MOLDED RF CHOKES

1µH	.75	22µH	1.00
3.3	.75	47	1.00
10	1.00	68	1.00
15	1.00	100	1.25
18	1.00	220	1.25
		270	1.25

## DIP SWITCHES

4 POS	.85	7 POS	.95
5 POS	.90	8 POS	.95
6 POS	.90	10 POS	1.20

## SWITCHES

SPDT	MINI-TOGGLE ON-ON	1.25
DPDT	MINI-TOGGLE ON-ON	1.50
DPDT	MINI-TOGGLE ON-OFF-ON	1.75
SPST	MINI-PUSHBUTTON N.O.	.39
SPST	MINI-PUSHBUTTON N.C.	.39
SPST	TOGGLE ON-OFF	.49
BCD	OUT 10 POSITION 6 PIN DIP	1.95

## TRANSISTOR MFG. HDW.

HEAT SINK	TO-220	SCREW ON	.35
HEAT SINK	TO-220	CLIP ON	.35
HEAT SINK	TO-3	SCREW ON	.85
INSULATOR	TO-220		10/1.00
INSULATOR	TO-3		10/1.00
SOCKET	TO-3		.39



## D-SUB ACCESSORIES

STAINLESS STEEL  
WALL PLATE  
SINGLE \$1.95  
DOUBLE \$1.95



## MOUNTING HARDWARE

INCLUDES  
2 BOLTS,  
2 NUTS,  
4 WASHERS  
\$1.00/PAIR

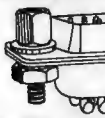

## EMI FILTER

\* MAJOR MANUFACTURER  
\* LOW COST  
\* FITS OUR LINE  
CORD LC-HP

**\$4.95**



## SHORTING BLOCKS

GOLD CONTACTS SPACED AT .1"  
CENTERS IDEAL FOR DISK DRIVES,  
OR ANY .1" HEADER

**5/\$1.00**



## HARD TO FIND

"SNAPABLE" HEADERS  
CAN EASILY BE SNAPPED APART TO  
MAKE ANY SIZE HEADER,  
ALL WITH .1" CENTERS

1x40	STRAIGHT LEAD	.89
1x40	RIGHT ANGLE	1.49
2x40	STRAIGHT LEAD	2.49
2x40	RIGHT ANGLE	2.99

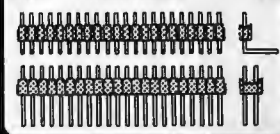

## 36 PIN CENTRONICS

IDCEN36	RIBBON CABLE MALE	6.95
IDCEN36/F	RIBBON CABLE FEMALE	7.95
CEN36	SOLDER CUP MALE	4.95
CEN36PC	RT ANGLE PC MNT MALE	4.95

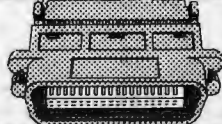

## CRIMP STYLE D-SUB CONNECTORS

9 PIN	MALE SHELL	75¢
9 PIN	FEMALE SHELL	80¢
25 PIN	MALE SHELL	90¢
25 PIN	FEMALE SHELL	95¢

CRIMP PINS MALE 08¢  
CRIMP PINS FEMALE 10¢

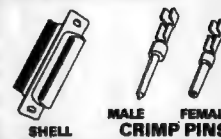

## TRANSFORMERS FRAME STYLE

12.6V AC CT	2 AMP	5.95
12.6V AC CT	4 AMP	7.95
12.6V AC CT	8 AMP	10.95
25.2V AC CT	2 AMP	7.95

## PLUG CASE STYLE

6V DC	350ma	2.95
12V DC	350ma	3.95
12V AC	250ma	3.95
12V AC	500ma	4.95
12V AC	1 AMP	5.95
12V AC	2 AMP	6.95

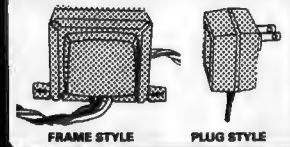

## DIP CONNECTORS

DESCRIPTION	ORDER BY	CONTACTS									
		8	14	16	18	20	22	24	28	40	
HIGH RELIABILITY TOOLED ST IC SOCKETS	AUGATxxST	.82	.79	.89	1.09	1.29	1.39	1.49	1.69	2.48	
HIGH RELIABILITY TOOLED WW IC SOCKETS	AUGATxxWW	1.30	1.80	2.10	2.40	2.50	2.90	3.15	3.70	5.40	
COMPONENT CARRIES (DIP HEADERS)	ICCxx	.49	.59	.68	.99	.99	.99	.99	1.09	1.49	
RIBBON CABLE DIP PLUGS (IDC)	IDPxx	---	.95	.95	---	---	---	1.75	---	2.95	

FOR ORDERING INSTRUCTIONS SEE D-SUBMINIATURE BELOW

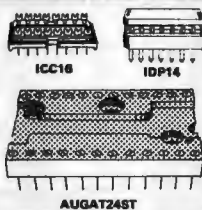

## RIBBON CABLE

CONTACTS	SINGLE COLOR		COLOR CODED	
	1'	10'	1'	10'
10	.18	1.80	.30	2.75
18	.28	2.50	.48	4.40
20	.36	3.20	.60	5.50
26	.45	4.00	.75	6.85
28	.46	4.10	.78	7.15
34	.61	5.40	1.07	9.35
40	.72	6.40	1.20	11.00
50	.89	7.50	1.50	13.25

## D-SUBMINIATURE

DESCRIPTION	ORDER BY	CONTACTS					
		9	15	25	37	50	
SOLDER CUP	MALE	D8xxP	.82	.90	1.25	1.80	3.48
	FEMALE	D8xxS	.85	1.15	1.50	2.35	4.32
RIGHT ANGLE PC SOLDER	MALE	D8xxPR	1.20	1.49	1.95	2.65	---
	FEMALE	D8xxSR	1.25	1.55	2.00	2.79	---
WIRE WRAP	MALE	D8xxPWW	1.69	2.56	3.89	5.60	---
	FEMALE	D8xxSww	2.78	4.27	6.84	9.95	---
IDC	MALE	IDBxxP	2.70	2.95	3.98	5.70	---
RIBBON CABLE	FEMALE	IDBxxS	2.92	3.20	4.33	6.78	---
HOODS	METAL	MHOODxx	1.25	1.25	1.30	---	---
	GREY	HOODxx	.85	.65	.65	.75	.95

ORDERING INSTRUCTIONS: INSERT THE NUMBER OF CONTACTS IN THE POSITION MARKED "xx" OF THE "ORDER BY" PART NUMBER LISTED.  
EXAMPLE: A 15 PIN RIGHT ANGLE MALE PC SOLDER WOULD BE DB15PR.

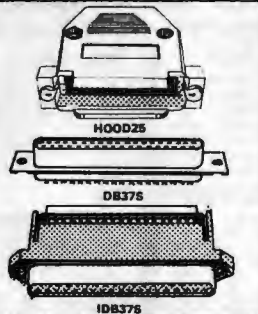

## TEXTTOOL ZERO INSERTION FORCE SOCKETS AND RECEPTACLES

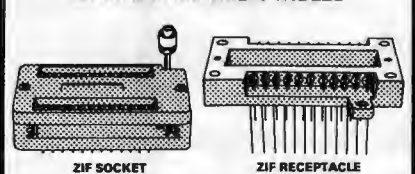

TYPE	CONTACTS				
	14	16	24	28	40
ZIF SOCKET	4.95	4.95	5.95	6.95	9.95
ZIF RECEPTACLE	8.25	8.75	9.75	10.50	12.75

## IDC CONNECTORS

DESCRIPTION	ORDER BY	CONTACTS					
		10	20	26	34	40	50
SOLDER HEADER	IDHxxS	.82	1.29	1.68	2.20	2.58	3.24
RIGHT ANGLE SOLDER HEADER	IDHxxSR	.95	1.35	1.76	2.31	2.72	3.39
WW HEADER	IDHxxW	1.86	2.98	3.84	4.50	5.28	6.63
RIGHT ANGLE WW HEADER	IDHxxWR	2.05	3.28	4.22	4.45	4.80	7.30
RIBBON HEADER SOCKET	ID8xx	.79	.99	1.39	1.69	1.99	2.25
RIBBON HEADER	IDMxx	---	6.50	6.25	7.00	7.50	8.50
RIBBON EDGE CARD	IDExx	1.75	2.25	2.65	2.75	3.80	3.95

FOR ORDERING INSTRUCTIONS SEE D-SUBMINIATURE ABOVE

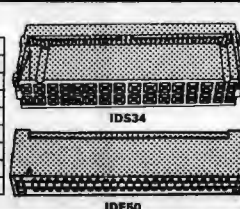

## EDGECARD CONNECTORS

TYPE	CONTACTS	PRICE	
		100	500
100 PIN SOLDER TAIL	S-100	.125	3.95
100 PIN WIREWRAP	S-100	.125	4.95
72 PIN SOLDER TAIL	STD	.100	6.95
72 PIN WIREWRAP	STD	.100	7.95
62 PIN SOLDER TAIL	IBM PC	.100	1.95
50 PIN SOLDER TAIL	APPLE	.100	2.95
44 PIN SOLDER TAIL	STD	.156	1.95
44 PIN WIREWRAP	STD	.156	4.95

**ALL MERCHANDISE 100% GUARANTEED**

© COPYRIGHT 1985 JDR MICRODEVICES

**CAPACITORS**

SILVER MICA ±5% TOLERANCE				ELECTROLYTIC							
				RADIAL		AXIAL					
10pf	100V	.38	100pf	100V	.40	.47μf	50V	.14	1	50V	.14
12	100V	.39	120	100V	.40	1	50V	.14	1	50V	.14
22	100V	.39	180	100V	.40	2.2	35V	.15	4.7	16V	.14
27	100V	.39	220	100V	.50	4.7	50V	.15	10	16V	.14
30	100V	.39	330	100V	.50	10	50V	.15	10	50V	.16
33	100V	.39	470	100V	.80	47	35V	.18	22	16V	.14
39	100V	.39	510	100V	.80	100	16V	.18	47	50V	.20
47	100V	.39	560	100V	.80	100	50V	.23	100	15V	.20
56	100V	.39	620	100V	.80	220	35V	.20	100	35V	.25
68	100V	.35	680	100V	.75	470	16V	.25	220	25V	.30
82	100V	.35	820	100V	.75	470	25V	.30	470	50V	.80
			1000	100V	.75	1000	16V	.80	1000	16V	.80
						2200	16V	.70	1000	35V	.75
						4700	25V	1.45	2200	16V	.70
									4700	16V	1.25
MONOLITHIC				COMPUTER GRADE							
.01μf	50V	.14	.1μf	50V	.18	32,000μf	25V	2.95	44,000μf	30V	3.95
.04	50V	.16	.47	50V	.25						
TANTALUM				CERAMIC DISC							
.22μf	35V	.40	3.3μf	35V	.85	10pf	50V	.05	560pf	50V	.05
.33	35V	.40	4.7	10V	.85	22	50V	.05	680	50V	.05
.47	35V	.45	4.7	35V	.85	27	50V	.05	820	50V	.05
.68	35V	.45	6.8	15V	.70	33	50V	.05	.001μf	50V	.05
1.0	15V	.35	6.8	25V	.75	47	50V	.05	.0015	50V	.05
1.0	20V	.38	10	10V	.65	56	50V	.05	.0022	50V	.05
1.0	25V	.40	10	15V	.80	68	50V	.05	.005	50V	.05
1.0	35V	.45	10	20V	.85	82	50V	.05	.01	50V	.07
2.2	15V	.40	10	25V	.90	100	50V	.05	.02	50V	.07
2.2	20V	.45	10	35V	1.00	220	50V	.05	.05	50V	.07
2.2	35V	.65	22	10V	1.00	330	50V	.05	.1	12V	.10
3.7	35V	.65	22	15V	1.35	470	50V	.05	.1	50V	.12
3.3	15V	.50	27	15V	1.25						

**RESISTOR NETWORKS**

SIPs		DIPs	
<b>10 PIN 9 RESISTOR</b>		<b>14 PIN 7 RESISTOR</b>	
1-24	25 UP	1-24	25 UP
.69	.48	.99	.73
<b>8 PIN 7 RESISTOR</b>		<b>16 PIN 8 RESISTOR</b>	
1-24	25 UP	1-24	25 UP
.59	.38	1.09	.82
<b>14 PIN 13 RESISTOR</b>		<b>16 PIN 15 RESISTOR</b>	
1-24	25 UP	1-24	25 UP
.99	.76	1.09	.85

16 PIN 14 LINE TERMINATOR	
AVAILABLE IN ONLY 180/330, 220/270, 220/330	
1-24	25 UP
1.49	1.08

**TRIMMER POTENTIOMETERS**

SINGLE TURNS 72PRxx		15 TURN 89PRxx	
1-24	25 UP	1-24	25 UP
.98	.85	1.49	1.28
SINGLE TURN 91ARxx			
1-24	25 UP		
.99	.88		

AVAILABLE VALUES: 100, 500, 1K, 5K, 10K, 20K, 50K, 100K, 1 MEG.  
ORDERING INSTRUCTIONS: INSERT RESISTANCE VALUE IN PLACE OF "xx".  
EXAMPLE: A 500 OHM 89 SERIES POTENTIOMETER WOULD BE 89PR500.

**THUMBWHEEL POTS**  
THUMBxx  
1-24 25 UP  
.49 .46

AVAILABLE VALUES: 1K, 2.5K, 5K, 10K, 25K, 50K, 100K, 250K, 500K  
ORDERING INSTRUCTIONS: SEE TRIMMER POTENTIOMETERS ABOVE

**PAGE WIRE WRAP WIRE**

**PRECUT AND STRIPPED**  
Note: 1 inch of insulation is stripped on each end. 3.5" wire has only 1.5 inches of insulation.

LENGTH (INCHES)	QUANTITY 100	QUANTITY 500
2.5	1.80	4.70
3.0	1.80	4.70
3.5	1.85	5.00
4.0	1.75	5.40
4.5	1.80	5.75
5.0	1.85	6.10
5.5	1.90	6.80
6.0	2.00	6.85
6.5	2.30	7.90
7.0	2.40	8.20
8.0	2.60	8.95
9.0	2.70	9.20
10.0	2.90	10.50

**RESISTORS**

**1/4 WATT 5% CARBON FILM ALL STANDARD VALUES FROM 1 OHM TO 10 MEG. OHM**

10 PIECES SAME VALUE	.05
50 PIECES SAME VALUE	.025
100 PIECES SAME VALUE	.02
1000 PIECES SAME VALUE	.015

**MUFFIN FANS**

MADE BY	JDR #	SIZE	CFM	VOLTS	PRICE
MASUSHITA	MUFFIN-DC	3.15" sq x 1.25"	16	12 VDC	\$16.95
ROTRON	MUFFIN-ROTRON	3.15" sq x 1.50"	24	115 AC	\$14.95
ETRI	MUFFIN-3	3.65" sq x 1.00"	32	115 AC	\$12.95
ETRI	MUFFIN-4	4.70" sq x 1.50"	55	115 AC	\$14.95
TORIN	MUFFIN-230	4.70" sq x 1.50"	60	230 AC	\$4.95

**IC EXTRACTION TOOL**

ONE PIECE METAL CONSTRUCTION EXTRACTS 8-24 PIN DEVICES



**\$1.49**

**PRECUT ASSORTMENT IN ASSORTED COLORS \$27.50**

100ea: 5.8", 6.0", 6.5", 7.0"  
250ea: 2.8", 4.5", 5.0"  
500ea: 3.0", 3.5", 4.0"

**SPOOLS**

100 feet	\$4.30	250 feet	\$7.25
500 feet	\$13.20	1000 feet	\$21.95

Please specify color: Blue, Black, Yellow or Red

**TWO LEVEL WIRE WRAP SOCKETS**

THESE SOCKETS HAVE .50" LEADS, JUST A LITTLE BIT SHORTER THAN THE 3 LEVEL WIRE WRAP SOCKETS WITH .6" LEADS

	1-99	100-UP
8 PIN WW-2	.40	.35
14 PIN WW-2	.45	.39
16 PIN WW-2	.45	.39
20 PIN WW-2	.75	.59
22 PIN WW-2	.50	.39
24 PIN WW-2	.69	.75
28 PIN WW-2	.89	.75



**WIRE WRAP PROTOTYPE CARDS**

FR-4 EPOXY GLASS LAMINATE WITH GOLD-PLATED EDGE-CARD FINGERS

**IBM**  
BOTH CARDS HAVE SILK SCREENED LEGENDS AND INCLUDES MOUNTING BRACKET

IBM-PR1	WITH +5V AND GROUND PLANE	\$27.95
IBM-PR2	AS ABOVE WITH DECODING LAYOUT	\$29.95

**S-100**

P100-1	BARE - NO FOIL PADS	\$15.15
P100-2	HORIZONTAL BUS	\$21.80
P100-3	VERTICAL BUS	\$21.80
P100-4	SINGLE FOIL PADS PER HOLE	\$22.75

**APPLE**

P500-1	BARE - NO FOIL PADS	\$15.15
P500-3	HORIZONTAL BUS	\$22.75
P500-4	SINGLE FOIL PADS PER HOLE	\$21.80
7060-45	FOR APPLE IIe AUX SLOT	\$30.00

**GENERAL PURPOSE**  
22/44 PIN EDGE-CARD (.158" SPACING)

P441-1	4.5" x 6.0" BARE - NO FOIL PADS	\$9.45
P441-3	4.5" x 6.0" VERTICAL BUS	\$13.95
P441-4	4.5" x 6.0" SINGLE FOIL PADS	\$14.20
P442-1	4.5" x 9.0" BARE - NO FOIL PADS	\$10.40
P442-3	4.5" x 9.0" VERTICAL BUS	\$14.20
P442-4	4.5" x 9.0" SINGLE FOIL PADS	\$13.50

36/72 PIN EDGE-CARD (.1" SPACING)

P721-1	4.5" x 6.0" BARE - NO FOIL PADS	\$9.45
P721-3	4.5" x 6.0" VERTICAL BUS	\$13.25
P721-4	4.5" x 6.0" SINGLE FOIL PADS	\$14.20
P722-1	4.5" x 9.0" BARE - NO FOIL PADS	\$10.40
P722-3	4.5" x 9.0" VERTICAL BUS	\$14.20
P722-4	4.5" x 9.0" SINGLE FOIL PADS	\$15.15

NO EDGE-CARD FINGERS

P25x45	2.5" x 4.5" BARE - NO FOIL PADS	\$2.40
P45x65	4.5" x 6.5" BARE - NO FOIL PADS	\$4.70
P45x85	4.5" x 8.5" BARE - NO FOIL PADS	\$6.20
P45x17	4.5" x 17.0" BARE - NO FOIL PADS	\$11.35
P85x170	8.5" x 17.0" BARE - NO FOIL PADS	\$18.95

**BW-630 WIRE WRAP GUN**

BATTERY POWERED-USES 2 NI-CAD C CELLS (NOT INCLUDED)  
POSITIVE INDEXING  
ANTI-OVERWRAP DEVICE \$41.55

**WSU-30 WIRE WRAP TOOLS**

- WRAPS, STRIPS, AND UNWRAPS
- WSU-30M WRAPS AN EXTRA TURN OF INSULATION

WSU-30 98.84 / WSU-30M \$10.14

**WIRE WRAP TERMINALS**

WWT-1	SLOTTED	25 / \$7.06
WWT-2	SINGLE SIDED	25 / \$4.25
WWT-3	IC SOCKET	25 / \$7.06
WWT-4	DOUBLE SIDED	25 / \$2.80
INS-1	INSERTION TOOL	\$3.64

**WIRE DISPENSER**

WITH 60" ROLL OF WIRE  
BUILT IN PLUNGER CUTS WIRE  
BUILT IN STRIPPER STRIPES 1"  
REFILLABLE



**WD-30 \$6.50 WD-30TRI \$9.50**  
Specify Blue, white, Yellow or Red  
With 50' of each: Red, Blue and White

**SOCKET-WRAP I.D.™**

SLIPS OVER WIRE WRAP PINS  
IDENTIFIES PIN NUMBERS ON WRAP SIDE OF BOARD  
CAN WRITE ON PLASTIC, SUCH AS IC #

PINS	PART#	PCK. OF	PRICE
8	IDWRAP 08	10	1.95
14	IDWRAP 14	10	1.95
16	IDWRAP 16	10	1.95
18	IDWRAP 18	5	1.95
20	IDWRAP 20	5	1.95
22	IDWRAP 22	5	1.95
24	IDWRAP 24	5	1.95
28	IDWRAP 28	5	1.95
40	IDWRAP 40	5	1.95

PLEASE ORDER BY NUMBER OF PACKAGES (PCK. OF)

**OK INDUSTRIES**

**EX-2 IC EXTRACTION TOOL**

- EXTRACTS 24-40 PIN DEVICES
- HEAVY DUTY METAL CONSTRUCTION
- GROUND LUGS FOR MOS EXTRACTIONS
- EASY ONE HAND OPERATION \$12.74

**IC INSERTION TOOLS**

INS-1416	for 14-16 pin IC's	\$5.15
MOS-1416	for 14-16 pin IC's	\$10.92
MOS-2428	for 24-28 pin IC's	\$10.92
MOS-40	for 40 pin IC's	\$12.43

MOS series insertion tools have metal construction and include grounding lug for CMOS applications.

**WSU-30 WIRE WRAP TOOLS**

WSU-30	WRAPS, STRIPS, AND UNWRAPS	\$10.14
WSU-30M	WRAPS AN EXTRA TURN OF INSULATION	\$10.14

**WIRE WRAP TERMINALS**

WWT-1	SLOTTED	25 / \$7.06
WWT-2	SINGLE SIDED	25 / \$4.25
WWT-3	IC SOCKET	25 / \$7.06
WWT-4	DOUBLE SIDED	25 / \$2.80
INS-1	INSERTION TOOL	\$3.64

**WIRE DISPENSER**

WITH 60" ROLL OF WIRE  
BUILT IN PLUNGER CUTS WIRE  
BUILT IN STRIPPER STRIPES 1"  
REFILLABLE

**WD-30 \$6.50 WD-30TRI \$9.50**  
Specify Blue, white, Yellow or Red  
With 50' of each: Red, Blue and White

**SOCKET-WRAP I.D.™**

SLIPS OVER WIRE WRAP PINS  
IDENTIFIES PIN NUMBERS ON WRAP SIDE OF BOARD  
CAN WRITE ON PLASTIC, SUCH AS IC #

PINS	PART#	PCK. OF	PRICE
8	IDWRAP 08	10	1.95
14	IDWRAP 14	10	1.95
16	IDWRAP 16	10	1.95
18	IDWRAP 18	5	1.95
20	IDWRAP 20	5	1.95
22	IDWRAP 22	5	1.95
24	IDWRAP 24	5	1.95
28	IDWRAP 28	5	1.95
40	IDWRAP 40	5	1.95

PLEASE ORDER BY NUMBER OF PACKAGES (PCK. OF)



**CALL FOR VOLUME QUOTES**



## LITHIUM BATTERY

AS USED IN CLOCK CIRCUITS



3 VOLT BATTERY \$3.95  
BATTERY HOLDER \$1.49

## RELAYS

VOLTAGE	CONTACTS		FITS	PRICE
5 VDC	SPST	REED	DIP	3.95
12 VDC	DPDT	2 AMP	DIP	3.95
6 VDC	6PDT	3 AMP	RELAY SOC	2.95
12 VDC	4PDT	3 AMP	RELAY SOC	3.95
24 VDC	DPDT	3 AMP	RELAY SOC	3.95
48 VDC	4PDT	3 AMP	RELAY SOC	3.95
120 VAC	4PDT	3 AMP	RELAY SOC	3.95

## RF MODULATOR

ASTECH MODEL UM1082  
\* PRESET TO CHANNEL 3  
\* USE TO BUILD TV-COMPUTER INTERFACE  
\* +5 VOLT OPERATION

\$6.95



## MICRO CHART® INSTANT DATA CARDS

ONLY \$5.95

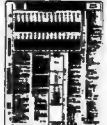

\* CLEAR AND CONCISE DATA ON MICROPROCESSORS, ELECTRONICS, PROGRAMMING AND MORE  
\* SOLID PLASTIC, LASTS A LIFETIME  
\* PLANNED FOR INSTANT ACCESS TO DATA  
\* TWO COMPREHENSIVE 8 1/2" x 11" SIDES  
\* ATTRACTIVE TWO COLOR SHARP PRINTING  
\* CLEARS WORKSPACE OF BOOKS AND MANUALS  
\* NOTE: MPU CARDS COVER FULL INST. SET (DESCR., HEX, CYCLE, FLAG), DISASSEMBLY, ASCII, HEX/DEC, INTERRUPT STRUC., PINOUT, DIAGRAMS, NOTES AND MORE

### AVAILABLE TITLES

- MC-8086 8086 AND 8088 MPUs
- MC-Z80 Z80 MPU
- MC-8502 8502 (85xx)MPUs
- MC-8085 8080A AND 8085A MPUs
- MC-8048 8048 SINGLE CHIP MPU FAMILY
- MC-CL "C" LANGUAGE COMPREHENSIVE REFERENCE FOR PROS AND BEGINNERS
- MC-IBAS FAST AND EASY INTRO TO BASIC PROGRAMMING
- MC-7400 PINOUTS AND FUNCTIONS OF VIRTUALLY ALL 54/7400 TTL IN NEW COMPACT TABLE FORMAT (REG., H., L., S.)
- MC-COMP BASIC OPERATION OF DIODES, TRANSISTORS, THYRISTORS, OP-AMPS AND MUCH MORE
- MC-WS WORDSTAR/MAILMERGE REFERENCE — TWICE THE INFO OF KEYBOARD OVERLAYS
- MC-STAT HOW TO GENERALIZE FROM SMALL SAMPLES — FOR D/C TESTING, RESEARCH, POLLING, ETC.
- MC-ALG ALGORITHMS (PROGRAMS) IN BASIC FOR SORTING, SEARCHING PLOTTING, ETC.

## 6E NICKEL-CADMIUM RECHARGEABLE BATTERIES

NI-CAD CHARGER PACKAGE  
PRICE INCLUDES CHARGER (WALL PLUG), BATTERIES, & MODULAR BATTERY HOLDER

AAA CELLS	QTY. 2	\$11.71
AA CELLS	QTY. 2	\$11.71
C CELLS	QTY. 2	\$13.21
D CELLS	QTY. 2	\$13.21
9 VOLT	QTY. 1	\$13.21

### BATTERIES ONLY

AAA CELLS	PKG. 2	\$6.07 pr.
AA CELLS	PKG. 1	\$3.03 ea.
C CELLS	PKG. 1	\$3.78 ea.
D CELLS	PKG. 1	\$3.78 ea.
9 VOLT	PKG. 1	\$7.57 ea.

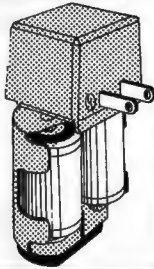

## SIX FOOT LINE CORDS

- LC-2 2 CONDUCTOR .39
- LC-3 3 CONDUCTOR .99
- LC-HP 3 CONDUCTOR WITH STANDARD FEMALE SOCKET 1.49
- LC-CIR CIGARETTE LIGHTER PLUG 2.95

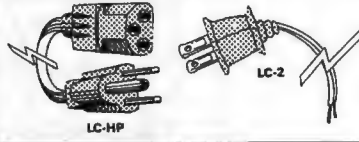

## SWITCHING POWER SUPPLIES

**PS-IBM \$99.95**  
\* FOR IBM PC-XT COMPATIBLE  
\* 130 WATTS  
\* +5V @ 15A, +12V @ 4.2A  
\* -5V @ .5A, -12V @ .5A  
\* ONE YEAR WARRANTY



**PS-IBM-150 \$129.95**  
\* FOR IBM PC-XT COMPATIBLE  
\* +12 @ 5.2A, +5 @ 16A  
\* -12 @ .5A, -5 @ .5A  
\* ONE YEAR WARRANTY

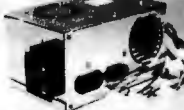

**PS-100 \$89.95**  
\* 100 WATTS  
\* SWITCH ON REAR  
\* FOR USE IN OTHER IBM TYPE MACHINES  
\* 90 DAY WARRANTY



**PS-130 \$99.95**  
\* 130 WATTS  
\* SWITCH ON REAR  
\* FOR USE IN OTHER IBM TYPE MACHINES  
\* 90 DAY WARRANTY



**PS-A \$49.95**  
\* USE TO POWER APPLE TYPE SYSTEMS  
\* +5V @ 4A, +12V @ 2.5A  
\* -5V @ .5A, -12V @ .5A  
\* APPLE POWER CONNECTOR



**PS-3 \$39.95**  
\* AS USED IN APPLE III  
\* +5V @ 4A, +12V @ 2.5A  
\* -5V @ .25A, -12V @ .30A,  
\* 15.5" x 4.5" x 2.0", .884 LBS.



**PS-ASTECH \$19.95**  
\* CAN POWER TWO 5 1/4" FDDS  
\* +5V @ 2.5A, +12V @ 2A  
\* -12V @ .1A  
\* +5V @ 5A IF +12V IS NOT USED  
\* 6.3" x 4.0" x 1.9", 1 LB.



**PS-TDK \$29.95**  
\* +5V @ 4A, +12V @ 2A  
\* +12V @ 2.8A, -12V @ .30A  
\* 6.2" x 7.4" x 1.7", 1.6 LBS.



## PS-PLUG \$9.95

\* SPACE SAVING DESIGN - POWER SUPPLY HOUSED IN PLUG STYLE CASE  
\* +5V @ 600ma  
\* +12V @ 200ma  
\* -12V @ 200ma  
\* 5.5" x 2.5" x 2.0", 2.0 LBS.  
\* UL APPROVED



## NEW BOOKS BY STEVE CIARCIA

- BUILD YOUR OWN Z80 COMPUTER \$19.95
- CIRCUIT CELLAR VOLUME 1 \$17.95
- CIRCUIT CELLAR VOLUME 2 \$18.95
- CIRCUIT CELLAR VOLUME 3 \$18.95
- CIRCUIT CELLAR VOLUME 4 \$18.95

## MICROCOMPUTER HARDWARE HANDBOOK FROM ELCOMP \$14.95

OVER 800 PAGES OF MANUFACTURER'S DATA SHEETS ON THE MOST COMMONLY USED ICs

- TTL - 74, 74LS & 74F
- CMOS
- Voltage Regulators
- Memory - RAM, ROM, EPROM
- CPUs - 6800, 6500, Z80, 8080, 8085 & 8086/8
- MPU Support & Interface, 6800, 6500, Z80, 8200, etc.

## DATARASE EPROM ERASER \$34.95

\* ERASES 2 EPROMS IN 10 MINUTES  
\* LOW COST  
\* COMPACT - NO DRAWER  
\* SLIDE EPROMS INTO CASE  
\* THIN METAL SHUTTER PREVENTS UV LIGHT FROM ESCAPING



## EPROM ERASERS



Model	Timer	Capacity Chip	Intensity (uW/Cm²)	Unit Price
PE-14	NO	9	8,000	\$83.00
PE-14T	YES	9	8,000	\$119.00
PE-24T	YES	12	9,600	\$175.00
PL-265T	YES	30	9,600	\$255.00

## IC MASTER \$79.95 THE INDUSTRY STANDARD



A COMPLETE LISTING OF CURRENTLY MANUFACTURED INTEGRATED CIRCUITS FROM OVER 225 MANUFACTURERS. IT INCLUDES A PART NUMBER INDEX, AN ALTERNATIVE SOURCE GUIDE AS WELL AS SPECIFICATION AND APPLICATION NOTES ON THOUSANDS OF DEVICES.

## NATIONAL SEMICONDUCTOR DATABOOKS

- CMOS DATABOOK \$9.95
- LOGIC DATABOOK (2 VOL SET) \$24.95
- VOLTAGE REGULATOR DATABOOK \$7.95
- TRANSISTOR DATABOOK \$7.95

## BEST SELLING BOOKS OSBORNE

- APPLE II USERS GUIDE \$18.95
- CRT CONTROLLER HANDBOOK \$9.95
- MS DOS USERS GUIDE \$18.95
- 68000 ASM. PROGRAMMING \$19.95
- THE 8086 BOOK \$18.95
- UNDERSTANDING DBASE II \$22.95

### SYBEX

- PROCESSOR INTERFACING TECH. \$19.95
- THE MS DOS HANDBOOK \$16.95
- THE RS232 SOLUTION \$18.95
- Z80 APPLICATIONS \$17.95
- PROGRAMMING THE 8086/8088 \$15.95

## WISH SOLDERLESS BREADBOARDS



PART NUMBER	DIMENSIONS	DISTRIBUTION STRIP(S)	TIE POINTS	TERMINAL STRIP(S)	TIE POINTS	BINDING POSTS	PRICE
WBU-D	.38 x 6.50"	1	100	---	---	---	2.95
WBU-T	1.38 x 6.50"	---	---	1	630	---	6.95
WBU-204-3	3.94 x 8.45"	1	100	2	1260	2	17.95
WBU-204	5.13 x 8.45"	4	400	2	1260	3	24.95
WBU-206	6.88 x 9.06"	5	500	3	1890	4	29.95
WBU-208	8.25 x 9.45"	7	700	4	2520	4	39.95

ALL MERCHANDISE 100% GUARANTEED

© COPYRIGHT 1985 JDR MICRODEVICES

ORDER TOLL FREE

800-538-5000

800-662-6279 (CA)

**IBM PRINTER BUFFERS**

- FREES COMPUTER FOR OTHER TASKS WHILE PRINTING LONG DOCUMENTS.
- STANDALONE DESIGN - WORKS WITH ANY COMPUTER OR PRINTER.
- ALL MODELS FEATURE PRINT PAUSE, MEMORY CHECK AND GRAPHICS CAPABILITY.

**SP120P PARALLEL \$139.95**  
 • 64K UPGRADABLE TO 256K  
 • LED INDICATOR SHOWS VOLUME OF DATA IN BUFFER

**SP120S RS232 SERIAL \$159.95**  
 • 64K UPGRADABLE TO 512K  
 • SIX SELECTABLE BAUD RATES FROM 600B - 19,200B

**SP110 PARALLEL \$249.95**  
 • 64K UPGRADABLE TO 256K  
 • SPOOLS OUTPUT OF UP TO THREE COMPUTERS  
 • LED BARGRAPH DISPLAYS AMOUNT OF DATA IN BUFFER  
 • RESET FUNCTION CLEARS DATA IN BUFFER  
 • REPEAT FUNCTION CAN PRODUCE MULTIPLE COPIES OF A DOCUMENT



SP120



SP110

**IBM 3-WAY SWITCH BOXES**

- SERIAL OR PARALLEL
- CONNECTS 3 PRINTERS TO 1 COMPUTER OR 3 COMPUTERS TO 1 PRINTER
- ALL LINES SWITCHED
- HIGH QUALITY ROTARY SWITCH MOUNTED ON PCB
- GOLD CONTACTS
- STURDY METAL ENCLOSURE



**SWITCH-3P CENTRONICS PARALLEL 99.95**  
**SWITCH-3S RS232 PARALLEL 99.95**

**IBM PRINTER CABLE**

- DB25 TO CENTRONICS
- SHIELDED CABLE

**\$9.95**

**JOYSTICKS**



**\$7.95**

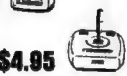

**\$4.95**

**FLOPPY DISK DRIVES**

**TEAC**  
**FD-55B 1/2 HEIGHT DS/DD \$89.95**  
**FD-55F 1/2 HEIGHT DS/QUAD \$99.95**

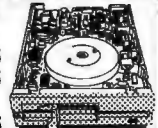

TEAC FD-55B

**SHUGART**  
**SA460 5 1/4" (80 TRACK) DS/QUAD \$199.95**

**TANDON**  
**TM100-2 5 1/4" (FOR IBM) DS/DD \$99.95**

**MPI**  
**MPI-B52 5 1/4" (FOR IBM) DS/DD \$89.95**

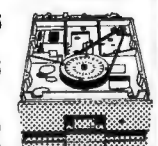

TANDON TM100-2

**SIEMENS 8" DISK DRIVES**

**FD100-8 SS/DD SA801 EQUIV. \$119.00**  
**FD200-8 DS/DD SA851 EQUIV. \$159.00**

**JFORMAT-2 SOFTWARE \$49.95**  
 SUPPORT FOR QUAD DENSITY DRIVES FROM TALL TREE SYSTEMS

**DISK DRIVE CABINETS**

**5 1/4" DRIVE ENCLOSURES**

**CAB-APPLE APPLE TYPE DRIVE CABINET WITHOUT POWER SUPPLY \$24.95**  
**CAB-1FH5 FULL HEIGHT 5 1/4" BEIGE DRIVE CABINET WITH POWER SUPPLY \$69.95**  
**CAB-2SV5 DUAL SLIMLINE 5 1/4" CABINET WITH POWER SUPPLY - VERTICAL MOUNT \$49.95**

**8 INCH DRIVE ENCLOSURES BY JMR**

**CAB-2SV8 DUAL SLIMLINE 8" DRIVE CABINET WITH POWER SUPPLY - VERTICAL MOUNT \$209.95**  
**CAB-2FH8 DUAL FULL HEIGHT 8" DRIVE CABINET WITH POWER SUPPLY - HORIZONTAL \$219.95**



CAB-1FH5



CAB-2SV5



CAB-2FH8

**NASHUA DISKETTE SPECIALS**

**5 1/4" SOFT SECTOR DS/DD WITH HUB RINGS**

**\$9.90 BOX OF 10**    **89cea BULK QTY 50**    **79cea BULK QTY 250**

NASHUA DISKETTES WERE JUDGED TO HAVE THE HIGHEST POLISH AND RECORDED AMPLITUDE OF ANY DISKETTES TESTED. SEE "COMPARING FLOPPY DISKS", BYTE 9-84.

**DISKETTE FILE**

**\$8.95**



**DISKETTES**

**NASHUA 5 1/4"**

**N-MD2D DS/DD SOFT SECTOR \$9.90**  
**N-MD2F DS/QUAD SOFT SECTOR \$34.95**  
**N-MD2H DS/HIGH DENSITY FOR AT \$49.95**

**NASHUA 8"**

**N-FD1 SS/DD SOFT SECTOR \$27.95**  
**N-FD20 DS/DD SOFT SECTOR \$34.95**

**N-3.5SS 3.5" SS/DD FOR MACINTOSH \$32.95**

**VERBATIM 5 1/4"**

**V-MD1D SS/DD SOFT SECTOR \$23.95**  
**V-MD2D DS/DD SOFT SECTOR \$29.95**  
**V-MD110D SS/DD 10 SECTOR HARD \$23.95**

**IBM STYLE COMPUTER CASE**

ATTRACTIVE STEEL CASE, WITH HINGED LID. FITS POPULAR PC/XT COMPATIBLE MOTHER-BOARDS.

- SWITCH CUT-OUT ON SIDE FOR PC/XT STYLE POWER SUPPLY
- CUT-OUT FOR 8 EXPANSION SLOTS
- ALL HARDWARE INCLUDED

**ONLY \$59.95**



**IBM COMPATIBLE KEYBOARDS**

**DKM-2000 \$79.95**

- FULLY IBM COMPATIBLE
- 83 KEY WITH CAPACITANCE TYPE SWITCHES
- LED STATUS INDICATORS FOR CAPS, NUMBER LOCK
- AUDIBLE CLICK



**KB-5151 \$89.95**

- ENHANCED IBM COMPATIBLE
- SEPARATE CURSOR AND NUMERIC KEYPADS
- CAPS LOCK & NUMBER LOCK INDICATORS
- IMPROVED KEYBOARD LAYOUT



**EXTENDER CARDS**

**IBM-PC \$45.00**  
**IBM-AT \$68.00**  
**APPLE II \$45.00**  
**APPLE IIe \$45.00**  
**MULTIBUS \$86.00**

**POWER STRIPS**

- UL APPROVED
- 15A CIRCUIT BREAKER

**\$12.95**



**KEYBOARD-AP**

- REPLACEMENT FOR APPLE II KEYBOARD
- CAPS LOCK KEY
- AUTO-REPEAT
- ONE KEY ENTRY OF BASIC OR CPM COMMANDS

**\$49.95**



**CASE WITH KEYBOARD**

FOR APPLE MOTHER-BOARD MODEL KB-1000 **\$79.95**

- USER DEFINED FUNCTION KEYS
- NUMERIC KEYPAD WITH CURSOR CONTROL
- CAPS LOCK
- AUTO-REPEAT

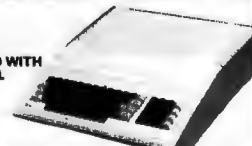

**ONLY \$79.95**

**HIGH QUALITY TEST EQUIPMENT FROM JDR INSTRUMENTS**

**20 MHz DUAL TRACE OSCILLOSCOPE**



**MODEL 2000 \$389.00**

- BAND WIDTH - DC TO 20MHz (-3db)
- SWEEP TIME - .2 μSEC TO .5 SEC/DIV ON 20 RANGES
- COMPLETE MANUAL AND HIGH QUALITY HOOK-ON PROBES INCLUDED
- INPUT IMPEDANCE: 1 MEG OHM
- TV VIDEO SYNC FILTER
- X-Y AND Z AXIS OPERATION
- 110/220 VOLT OPERATION
- COMPONENT TESTER
- LP CONSUMPTION - 19 WATTS
- BUILT-IN CALIBRATOR
- AUTOMATIC OR TRIGGERED TIMEBASE

**35 MHz DUAL TRACE OSCILLOSCOPE**



**MODEL 3500 \$549.00**

- BAND WIDTH - DC TO 35MHz (-3db)
- SWEEP TIME - .1 μSEC TO .5 SEC/DIV ON 21 RANGES
- DELAYED TRIGGER - 100 mSEC TO 1 μSEC WITH INTENSIFIED AND DELAYED MODES
- COMPLETE MANUAL AND 1X-10X COMPENSATED HOOK-ON PROBES INCLUDED
- VARIABLE HOLD OFF FOR VIEWING COMPLEX WAVES
- TV VIDEO SYNC FILTER
- TRIGGERING OF CH-A, CH-B, ALTERNATING, LINE OR EXTERNAL
- X-Y AND Z AXIS OPERATION

**DIGITAL MULTIMETER PEN**



**MODEL DPM-1000 \$49.95**

**AUTO RANGING, POLARITY AND DECIMAL**

- LARGE 3.5" DISPLAY
- DATA HOLD SWITCH FREEZES READING
- FAST, AUDIBLE CONTINUITY TEST
- LOW BATTERY INDICATOR
- OVERLOAD PROTECTION
- ONLY 1 1/2 x 6 1/4 x 3/4"
- DC VOLTS 1mV-500V
- AC VOLTS 1mV-500V
- 1 OHM - 2 MEG OHM
- WEIGHS ONLY 2.5 OUNCES
- LOW PARTS COUNT-CUSTOM 80 PIN LSI INSURES RELIABILITY
- INCLUDES MANUAL, BATTERIES, HARD CASE, AND ALLIGATOR CLIP

**CALL FOR VOLUME QUOTES**

© COPYRIGHT 1985 JDR MICRODEVICES



**IBM COMPATIBLE INTERFACE CARDS**  
ALL WITH A ONE YEAR WARRANTY

**MULTIFUNCTION CARD \$129.95**  
ALL THE FEATURES OF AST'S 6 PACK PLUS AT HALF THE PRICE



- 0-348K RAM
- SERIAL PORT
- PARALLEL PORT
- GAME PORT
- SOFTWARE INCLUDED

PRINTER CABLE \$9.95 64K RAM UPGRADE 9/\$7.11

**COLOR GRAPHICS ADAPTOR \$99.95**  
FULLY COMPATIBLE WITH IBM COLOR CARD



- 4 VIDEO INTERFACES: RGB, COMPOSITE COLOR, HI-RES, COMPOSITE MONOCHROME, CONNECTOR FOR RF MODULATOR
- COLOR GRAPHICS MODE: 320 x 200
- MONO GRAPHICS MODE: 640 x 200
- LIGHT PEN INTERFACE

**MONOCHROME GRAPHICS CARD \$129.95**  
FULLY COMPATIBLE WITH IBM MONOCHROME ADAPTOR AND HERCULES GRAPHICS CARD



- LOTUS COMPATIBLE
- TEXT MODE: 80 x 25
- GRAPHICS MODE: 720 x 348
- PARALLEL PRINTER INTERFACE
- OPTIONAL SERIAL PORT

**FLOPPY DISK DRIVE ADAPTOR \$59.95**



- INTERFACES UP TO FOUR STANDARD FDDs TO IBM PC OR COMPATIBLES
- INCLUDES CABLE FOR TWO INTERNAL DRIVES

**1200 BAUD INTERNAL MODEM FOR IBM**  
INCLUDES PC TALK III COMMUNICATIONS SOFTWARE



- Hayes COMPATIBLE
- AUTO DIAL/AUTO ANSWER
- AUTO RE-DIAL ON BUSY
- OPTIONAL SERIAL PORT
- ONE YEAR WARRANTY

**EASYDATA-12B \$195**

**300 BAUD MODEM FOR APPLE OR IBM**  
CLOSE-OUT SPECIAL NOW ONLY

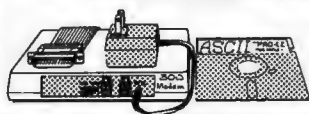

**\$49.95**

INCLUDES ASCII PRO-EZ SOFTWARE (A \$100 VALUE IN ITSELF)

- FCC APPROVED
- BELL SYSTEMS 103 COMPATIBLE
- INCLUDES AC ADAPTOR
- AUTO DIAL/AUTO ANSWER
- DIRECT CONNECT

CABLE FOR APPLE IIc \$14.95

**100 CPS ESPRIT PRINTER**

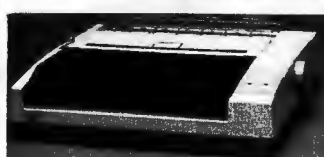

**BEST BARGAIN \$149.95**

- 9 x 9 DOT MATRIX
- 100 CPS - BIDIRECTIONAL
- FRICTION AND TRACTOR FEED
- PROPORTIONAL SPACING
- 80 COLUMN
- PARALLEL AND SERIAL INTERFACES
- 8 CHARACTER SETS AND GRAPHICS

CABLE TO IBM PC \$9.95  
REPLACEMENT RIBBON CARTRIDGE SZ-44 \$11.95

**PS-IBM \$99.95**  
130 WATTS

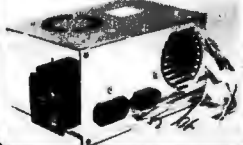

**TEAC DISK DRIVES FOR IBM PCs**



**FD-55B DS/DD \$89.95**  
**FD-55F DS/QUAD \$99.95**

**UNBELIEVABLE MONITOR DEALS**



**TAXAN RGB VISION III MODEL 415**

- 18 MHZ BAND WIDTH
- 640 x 262 PIXEL RESOLUTION
- 16 COLORS WITH INTENSITY CONTROL
- 12" BLACK MATRIX
- IBM AND LOTUS COMPATIBLE

CABLE FOR IBM \$15.95

**\$289.95**



**SAKATA COMPOSITE COLOR MODEL SC-100**

- TOP RATED FOR APPLE
- 13" COMPOSITE VIDEO
- RESOLUTION: 280H x 300V
- INTERNAL AUDIO AMPLIFIER
- ONE YEAR WARRANTY

**\$169.95**



**SAMWOO MONOCHROME MODEL DM-216B**

- PERFECT COSMETIC MATCH FOR IBM PC
- IBM COMPATIBLE TTL INPUT
- 12" NON-GLARE SCREEN
- P39 GREEN PHOSPHOR
- HI-RES 22 MHZ BAND WIDTH

**\$99.95**

**MONITOR STAND TILTS AND SWIVELS**



**\$12.95**

**APPLE COMPATIBLE INTERFACE CARDS**

**EPROM PROGRAMMER \$79.95**



**MODEL RP525**

- DUPLICATE OR BURN ANY STANDARD 27xx SERIES EPROM
- EASY TO USE MENU-DRIVEN SOFTWARE INCLUDED
- MENU SELECTION FOR 2716, 2732, 2732A, 2764 & 27128
- HIGH SPEED WRITE ALGORITHM
- LED INDICATORS FOR ACTIVITY
- NO EXTERNAL POWER SUPPLY REQUIRED
- ONE YEAR WARRANTY

**16K RAMCARD \$39.95**

- FULL TWO YEAR WARRANTY
- EXPAND YOUR 48K APPLE TO 64K
- USE IN PLACE OF APPLE LANGUAGE CARD

BARE PC CARD W/ INSTRUCTIONS \$9.95

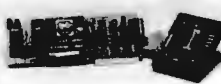

**IC TEST CARD \$99.95**

- QUICKLY TESTS MANY COMMON ICs
- DISPLAYS PASS OR FAIL
- ONE YEAR WARRANTY
- TESTS: 4000 SERIES CMOS 74HC SERIES CMOS 7400; 74LS, 74L, 74H, 74S, SOME PROMS AND RAMS

**DISK DRIVES**

FOR APPLE COMPUTERS



**BAL-525 \$99.95**

- 1/2 HEIGHT ALPS MECHANISM
- 100% APPLE COMPATIBLE
- FULL 1 YEAR WARRANTY

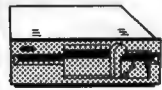

**BAL-500 \$129.95**

- TEAC MECHANISM - DIRECT DRIVE
- 100% APPLE COMPATIBLE
- FULL 1 YEAR WARRANTY

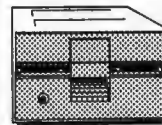

**AP-135 \$129.95**

- FULL HT. SHUGART MECHANISM
- DIRECT REPLACEMENT FOR APPLE DISK II
- SIX MONTH WARRANTY

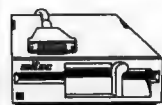

**FOR APPLE IIc AD-3C \$139.95**

- 100% APPLE IIc COMPATIBLE, READY TO PLUG IN W/ SHIELDED CABLE & MOLDED 19 PIN CONNECTOR
- FAST, RELIABLE SLIMLINE DIRECT DRIVE
- SIX MONTH WARRANTY

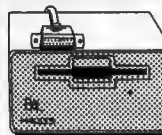

**FOR MACINTOSH MAC 535 \$299.95**

- 3.5" ADD-ON DISK DRIVE
- 100% MACINTOSH COMPATIBLE
- SINGLE SIDED 400K BYTE STORAGE
- HIGH RELIABILITY DRIVE FEATURES
- AUTO-EJECT MECHANISM
- FULL ONE YEAR WARRANTY

**DISK DRIVE ACCESSORIES**

**DISK CONTROLLER CARD \$49.95**  
**APPLE IIc ADAPTOR CABLE \$19.95**  
CONVERTS DRIVES FOR APPLE II AND IIc TO MATE WITH APPLE IIc

**COMREX CR-1000 DUAL SLIMLINE DISK DRIVE FOR APPLE COMPUTERS**

**\$189.95**

SPACE SAVING DESIGN STACK BETWEEN COMPUTER AND MONITOR

CLOSE-OUT SPECIAL WHILE SUPPLY LASTS

- QUIET, RELIABLE 1/2 HEIGHT DRIVES
- TOTAL STORAGE CAPACITY: 286K BYTES
- AUTO-EJECT MECHANISM
- SHIELDED CABLE INCLUDED



INCLUDES CONTROLLER AND DOS 3.3 WITH DISK UTILITIES

**CALL FOR VOLUME QUOTES**

© COPYRIGHT 1985 JDR MICRODEVICES

# U·N·C·L·A·S·S·I·F·I·E·D A·D·S

**WANTED:** Nonprofit educational institution seeks tax-deductible contribution of a disk-based microcomputer with printer (Apple, IBM, or TRS-80 preferred) for classroom use with handicapped students. Risa K. Allen, Midway Elementary School, Milledgeville, GA 31061. (912) 452-2413.

**WANTED:** Nonprofit school for disadvantaged adults seeks tax-deductible donation of personal computers or stand-alone machines. Dr. Dodd, Omaha Opportunities Industrialization Center, 2724 North 24th St., Omaha, NE 68110. (402) 457-4222.

**WANTED:** Catholic Social Services needs tax-deductible donation of IBM PC or equivalent with printer for spreadsheet, database word processing, and mailing list to use in family-focused adolescent sexuality program. Gail Zettel, Catholic Social Services, Wayne County, 9851 Hamilton Ave., Detroit, MI 48202. (313) 883-2100.

**WANTED:** Tax-deductible contribution of operational word processor. Rev. Virginia Jones, Ashburnham Community Church, Ashburnham, MA 01430. (617) 827-5553.

**WANTED:** Hard-disk microcomputer, preferably a Vector Graphic, for a 501 (c) (3) nonprofit public policy research and education organization. Tax-deductible. APJ Education Fund, Suite 218, 806 15th St. NW, Washington, DC 20005.

**NEEDED:** Nonprofit educational group devoted to Western mysticism and new science needs word-processing equipment (two or more terminals with printers), IBM PC-compatible or CP/M. Tax-deductible. Contact Jim Holland, Friends of Creation Spirituality, POB 19216, Oakland, CA 94619.

**WANTED:** Computer engineering student would like to exchange public-domain programs and information for the NCR Decision Mate V computer. Juan Flo. Toro G., Apartado Aéreo 52020, Medellín, Colombia, South America.

**WANTED:** High-technology student needs Apple II or II+ public-domain software for education. Will send in return programs from my public-domain library. Would also like to buy a used graphic lightpen system. Joakim Lindberg, Hökavägen 20, 93143 Skellefteå, Sweden.

**WANTED:** Computer enthusiasts worldwide to exchange views and ideas. I am an Apple II user. Oscar Lau, P.O. Box 1133, Sibul, Sarawak, Malaysia.

**FOR SALE:** MPX-16 microcomputer, IBM-compatible. Power supply, case, Micromint ST-1000 smart terminal board, 128K, support ROMs for terminal or IBM-type keyboard and keyboard adapter, two Tandem SS/DD disk drives in separate case with power supply, and more. \$1400. Richard Bryant, 1631 Kings Dr. #411, Bartlesville, OK 74006. (918) 335-0888.

**FOR SALE:** Auto-dial/auto-answer, direct-connect 300-bps modem for Apple. Bare PC board with EPROM and TMS99532: \$50. Tab and Heath books, assorted electronic components: will sell or trade for back issues of BYTE, pre-1981 Radio-Electronics, or Apple books, magazines, or hardware. Send list. Michael Schwarz, POB 146, Danville, VA 99121.

**FOR SALE:** TRS-80 Model 100 with 32K RAM, DC power supply, cassette (CCR-82) with cable and DC power supply, direct-connect modem cable, cigarette lighter DC adapter, and two cassette pallets. Books, manuals, and more. \$600 or best offer. Kenneth Humbard, POB 4-972, Anchorage, AK 99509. (907) 563-4376.

**FOR SALE:** Osborne I computer with tan case and SS/DD drives. Excellent condition, recently underwent preventive maintenance. \$500. Jeremy Kezer, (203) 535-2623.

**WANTED:** Persons wishing to correspond with individual just learning BASIC on a TImex Sinclair 1000. Interested in exchanging information on practical usages, new modes, and "living symbols." S. Steps, c/o POB 163777, Sacramento, CA 95816.

**FOR SALE:** Early BYTE issues, from number 1 to 1980. Also early issues of *Kilobaud* and *80 MicroComputing*. Greg Ludwig, 910 Soo Blvd., Rice Lake, WI 54868. (715) 234-2680.

**FOR SALE:** Alphacom printer, datasette, TV/monitor for Commodore 64-compatible, and public-domain software: \$470. New; good condition. Wish to buy Commodore 64 disk drive and monitor in good condition. Nicole Taroin, 52-06 Skillman Ave. 2R, Woodside, New York, NY 11377. (718) 507-2484.

**FOR SALE:** Intel SBC/Multibus System: SBC 80/20-4 board with 8080A CPU, clock, 4K RAM, 8K ROM, 48 I/O lines, RS-232C drivers and receivers; SBC 016A 16K RAM expander board; SBC 204 disk controller; Vector plug-board; mounted in Intel 4-slot card cage, manuals: \$850 plus shipping. Rich Myers, 3211 Standish, Cleveland, OH 44134. (216) 845-1015.

**FOR SALE:** Ohio Scientific C8P computer system. Includes 48K RAM, dual 8-inch disk drives, Epson MX-80 printer with serial interface card and ribbons, RF (TV) converter, 12-inch black-and-white TV, all cables, manuals, and more. We will pay to ship in original cartons. Asking \$2000. Brad Chase or Tim Jones, POB 321, Epping, NH 03042. (603) 679-2404.

**WANTED:** Information, manuscripts, and reprints of articles dealing with software copyright protection, software law, and software piracy. D. C. Eschbaugh, Department of Anthropology, Arizona State University, Tempe, AZ 85287.

**FOR SALE:** Cromemco Z-2D 64K with dual 5-inch floppies. Spare 16K board and many other extras. No reasonable offer refused. Steve Robinson, Precept Ministries, POB 23000, Chattanooga, TN 37422. (615) 892-6814.

**FOR SALE:** First three and a half volumes (missing volume 3, number 3) of *S-100 Microsystems* magazine. First offer over \$60. C. Hill, Apt. #312, 27904 Pacific Highway S, Federal Way, WA 98003.

**FOR SALE:** S-100 Sol-20 computer: \$500. 64K static memory board: \$150. Morrow controller: \$150. 8-inch SS/DD enclosed drives: each \$350. Sanyo 9-inch black-and-white monitor: \$75. Anderson Jacobson 841 Selectric with parallel interface: \$400. BYTE, 1978 through 1983: \$125. John Ross, 327 Chestnut St., Batavia, IL 60510. (312) 879-2583.

**WANTED:** Broken Apple IIs, II+, or IIs and broken peripheral devices (cards, drives, etc.). Good price; I will pay shipping. Gary Raabe, 4729 Broughton, Corpus Christi, TX 78415.

**FOR SALE:** Video-display terminal, Model ADM IA, full keyboard with numeric pad, special function keys, block and line transmit functions. Excellent condition. \$250. T. Kruckewitt, 7749 College Town Dr. #130, Sacramento, CA 95826. (916) 383-0782.

**FOR SALE:** Used 192K-byte memory-expansion module for DEC Rainbow 100A (PC1XX-AB): \$200. Henry Suzukawa, 22266 Schoenborn, Canoga Park, CA 91304.

**FOR SALE:** IBM PC Portable with 256K, two DD/DS disk drives, serial port, and more. Excellent condition: \$2700. Joe Decker, 93-95 Lake St., Rouses Point, NY 12979. (518) 297-7933.

**FOR SALE:** Big Board II with two Shugart SS/DD 600K drives, 15-inch monitor, and keyboard: \$850; two MPI DS/DD 360K disk drives in a Heath Z-37 case and power supply: \$250; Centronics One parallel printer. Silver Paper: \$50. John Wytmsa, 9 Pitch Pine Dr., Topsham, ME 04086. (207) 725-4209.

**FOR SALE:** Commodore 64 system. Includes 1541 disk drive, 1701 color monitor, 1525 dot-matrix printer, KoalaPad graphics tablet, 80-column card, other add-ons, joysticks, etc. Light use: \$900 or best offer. Michael Feldman, 615 Finch Ave. W, Toronto, Ontario M2R 1N8, Canada. (416) 633-1750.

**FOR SALE:** Motorola 68000 VERSAmodule computer system with 512K-byte RAM, universal I/O, universal disk controller, 16-megabyte hard disk, card cage, and power supplies: \$3000. Hugh Shane, 7 Green Meadow Rd., Pleasantville, NY 10570.

**FOR SALE:** Hewlett-Packard 87XM computer, 82905B

printer, 82936A ROM drawer, 00087-15002 plotter ROM, 00087-15012 electronic disk ROM, and more. Perfect condition. J. A. Henebry, (518) 371-0423.

**WANTED:** June and September 1981 BYTE. First response gets \$6 check for each; you forward prepaid. Ed Niebuhr, 15 Springhill Lane, Lafayette, CA 94549. (415) 283-2644.

**WANTED:** Motorola MEX 68KECB 68000 education board. Don Lewis, 606 Hazel Ave., Folsom, PA 19033. (215) 586-5212.

**FOR SALE:** S-100 cards. IMSAI MPU-A: \$35. MPU-B: \$200. PIC-8: \$35. Processor Technology 8K static RAM: \$20. CUTS cassette interface: \$20. As is. John Lin, 5501 South Kenwood, Chicago, IL 60637. (312) 684-3689, evenings.

**WANTED:** SpectraVideo 328 user seeks correspondence with other SV users. R. A. Fortune, 46 West 17th St., New York, NY 10011.

**WANTED:** Schematic/documentation on Vector Graphic Flashwriter IV card and Micropolis PCB transmitter and bus receiver cards. Will reimburse costs. G. Carroll, 4915 Berryman Ave., Culver City, CA 90230. (213) 398-9110.

**WANTED:** KIM-1 ROMs or complete board. The two 6530s must be in good working condition. Also interested in any information about dynamic memory controller chips. Glenn Valenta, 1626 Connecticut Ave., Joplin, MO 64801. (417) 782-3008.

**FOR SALE:** Sage II with 128K, two 640K disk drives, TeleVideo 925 green terminal, and more. Runs at 8 MHz. Perfect for programming. Like new. Asking \$2300 or best offer. Gordy Kastner, 4760 North Creosote Place, Tucson, AZ 85749. (602) 749-1739.

**FOR SALE:** Four Intel 86/12A CPU multibus boards with 16-bit 8086, 32K dual port memory, 24 digital I/O lines, RS-232C port: \$200 each or \$725 for all. Two TRS-80 Model IIs, Level II, 16K CPU and monitor; expansion interface, serial interface, and DD adapter; two SS/DD floppy drives; PROM programmer and 80 Micro. \$1000. Steve Wisel, 5472 Delhi Park, Cincinnati, OH 45238. (513) 922-6450.

**FOR SALE:** Smoke Signal Broadcasting 6809 2-MHz SS-50 with 4-megabyte hard disk, DS/DD floppy, 96K, and more. Best offer. Also DS/DD drive, SS-50 chassis, SWTPC boards, two terminals, and Epson MX-80 printer. Robert Field, 1228 Carlotta Ave., Berkeley, CA 94707. (415) 527-7962.

**FOR SALE:** Four floppy drives, TEC-FB501, half-height, SS/DD direct drive, like new: \$70 each or \$65 each for two to four. Also, four Shugart 8-inch 800-2 drives: \$75 each or \$70 each for two to four. I pay shipping. Two Condor power supplies: \$25 each. Steve Gilley, POB 810, Hermosa Beach, CA 90254.

**FOR SALE:** Hayes Smartmodem, 300 bps: \$125. Rarely used. Overseas Crusades, 25 Corning Ave., Milpitas, CA 95035. (408) 263-1101 or David Nesmith, (408) 270-1185.

**FOR SALE:** Two IMSAI S-100 housings, two 8080 CPUs, 4K static RAM, and two MIOs. Dual North Star drives with interface. Ithaca Audio Z80 CPU, CCC 64K dynamic RAM. Four Godbout 8K RAMs. Two video interfaces. Extender/probe. Monitor. 8-inch drive. Best offer. R. Thinko, 185 Walnut St. #3, New Orleans, LA 70118. (504) 464-3368 or 866-0233.

**WANTED:** DDDC Disk Control Board: 32K, 48K, or 64K memory board and SMB2 I/O board for Technical Design Labs Xitan computer. William Leonard, 14956 Ronda Dr., San Jose, CA 95124. (408) 377-8582, evenings.

**FOR SALE:** IMSAI 8080 with ZPU processor board, 22-slot motherboard, 48K RAM, ROM monitor, one serial and three parallel I/O ports, cassette interface. Vistar GTX CRT, many extra boards, and more. Assembled and working. Asking \$1100. Steve Dover, 821 Laramie, Wilmette, IL 60091. (312) 251-4683.

**WANTED:** Owners of true IBM-compatibles and users groups worldwide for exchange of opinions and self-written or public-domain software. Languages: BASIC, Pascal, assembler. Write in English, French, Spanish, or Italian. Mario Manuzzi, Via Serraglio, 37, I-47023 Cesena (FO), Italy.

**WANTED:** LNW-80 users to exchange software (user-written) and hardware modifications. Have written fast graphics printer dump that I'll supply source code for; also designed speech board and drive software I'll supply design for. Neil Breeden II, 2916 West 3875 S #4, West Valley City, UT 84119.

UNCLASSIFIED ADS MUST be noncommercial, from readers who have computer equipment to buy, sell, or trade on a onetime basis. All requests for donated computer equipment must be from nonprofit organizations. Programs to be exchanged must be written by the individual or be in the public domain. Ads must be typed double-spaced, contain 50 words or less, and include full name and address. This is a free service; ads are printed as space permits. BYTE reserves the right to reject any unclassified ad that does not meet these criteria. When you submit your ad (BYTE, Unclassified Ads, POB 372, Hancock, NH 03449), allow at least four months for it to appear.



# B·O·M·B

## BYTE'S ONGOING MONITOR BOX

ARTICLE#	PAGE	ARTICLE	AUTHOR(S)	ARTICLE#	PAGE	ARTICLE	AUTHOR(S)
1	9	Microbytes	staff	17	229	EGO: A Homebuilt CPU,	
2	37, 431	What's New	staff	18	247	Part 1: The Software	Kelley
3	44	Ask BYTE	Ciarcia	19	257	The Quarter-Meg Atari 800XL	Buchholz
4	57	Book Reviews	Klein, Hughes, Walker, Edgington	20	263	A Parallel-to-Serial Printer Port Adapter	Austerlitz
5	86	Ciarcia's Circuit Cellar: Build the SB180 Single-Board Computer.		21	276	Add Function Keys to Your Microcomputer	Hanslip
6	104	Part 1: The Hardware	Ciarcia	22	284	The Kaypro 16	McMahon
7	116	Programming Project: An Analysis of Sorts	Amsterdam	23	291	The Osborne 3	Osgood
8	129	The DSI-32 Coprocessor Board, Part 2: The Software	Marshall, Scolaro, Rand, King, Williams	24	297	WordStar 2000	Rubel
9	141	An Algorithm for Disk Caching with Limited Memory	McKeon	25	305	XyWrite II Plus	Rabinovitz
10	141	Astrophysical Number Crunching	Cameron	26	311	Filevision	Norman
11	161	Two Generalized Floating-Point Representations	Salomon	27	321	DB Master for the Macintosh	Jacques
12	171	Turbo Pascal Drives the Mouse	Figueras	28	325	Paradise Modular Graphics Card	Krause
13	183	IBM Compatibility for the NEC APC III	Stein	29	331	The RAMDISK-64	Block
14	193	Build a Travesty Tree	Wayner	30	347	Keypoint 717	Salahi
15	197	Printing Pascal Graphics	Davis	31	385	Computing at Chaos Manor: PCs, Peripherals, Programs, and People	Pournelle
16	209	10th Anniversary Section	staff	32	395	BYTE U.K.: Seventh Anniversary of Microcomputing	Pountain
		Evolution of the Microprocessor	Garetz	33	401	BYTE Japan: A History of Japan's Microcomputers	Raike
				34	409	According to Webster: West Coast Faire, Mac Stuff, and the Amiga	Webster
				35	418	Mathematical Recreations: $\pi$ , e, and All That	Kurosaka
						BYTELINES	Libes

## BOMB Results

### June's Seating Arrangements

Computing at Chaos Manor, composed by Jerry Pournelle "From the Living Room," wins June's top seating. Runner-up is Gregg Williams's "Debugging Techniques," followed by What's New in third. Steve Ciarcia's wrap-up on how to "Build the Home Run Control System, Part 3: The

Software" is fourth. Arthur Huston wins \$100 for placing fifth with "Structuring BASIC." In sixth: staff-written Microbytes. Ask BYTE, conducted by Steve Ciarcia, is next, and "Choosing a Programming Language" not only wins eighth but its author, Gary Elfring, wins \$50.

### BYTE ADVERTISING SALES STAFF:

**Dennis J. Riley, Advertising Sales Manager, 70 Main Street, Peterborough, NH 03458, tel. (603) 924-9281**

#### NEW ENGLAND

ME, NH, VT, MA, RI, EASTERN CANADA  
Paul McPherson Jr. (617) 262-1160  
McGraw-Hill Publications  
575 Boylston Street  
Boston, MA 02116

#### ATLANTIC

NY, NYC, CT, NJ (NORTH)  
Leah Goldman (212) 512-2096  
McGraw-Hill Publications  
1221 Avenue of the Americas—  
39th Floor  
New York, NY 10020

Dick McCurk (203) 968-7111  
McGraw-Hill Publications  
Building A—3rd Floor  
777 Long Ridge Road  
Stamford, CT 06902

#### EAST

PA (EAST), NJ (SOUTH), MD, VA, W.VA, DE, D.C.  
Daniel Ferro (215) 496-3833  
McGraw-Hill Publications  
Three Parkway  
Philadelphia, PA 19102

#### SOUTHEAST

NC, SC, GA, FL, AL, TN  
Maggie M. Dorvee (404) 252-0626  
McGraw-Hill Publications  
4170 Ashford-Dunwoody Road—  
Suite 420  
Atlanta, GA 30319

#### MIDWEST

IL, MO, KS, IA, ND, SD, MN, WI, NB, IN  
Bob Denmead (312) 751-3740  
McGraw-Hill Publications  
Blair Building  
645 North Michigan Ave.  
Chicago, IL 60611

#### GREAT LAKES, OHIO REGION

MI, OH, PA (ALLEGHENY), KY, ONTARIO, CANADA  
Mike Kisseberth (313) 352-9760  
McGraw-Hill Publications  
4000 Town Center—Suite 770  
Southfield, MI 48075

#### SOUTH PACIFIC

SOUTHERN CA, AZ, NM, LAS VEGAS  
Jack Anderson (714) 557-6292  
McGraw-Hill Publications  
3001 Red Hill Ave.  
Building #1—Suite 222  
Costa Mesa, CA 92626

Karen Niles (213) 480-5243, 487-1160  
McGraw-Hill Publications  
3333 Wilshire Boulevard #407  
Los Angeles, CA 90010

#### NORTH PACIFIC

HI, WA, OR, ID, MT, NORTHERN CA, NV (except LAS VEGAS), W. CANADA  
David Jern (415) 362-4600  
McGraw-Hill Publications  
425 Battery Street  
San Francisco, CA 94111

Bill McAfee (415) 964-0624  
McGraw-Hill Publications  
1000 Elwell Court—Suite 225  
Palo Alto, CA 94303

#### SOUTHWEST, ROCKY MOUNTAIN

UT, CO, WY, OK, TX, AR, MS, LA  
(214) 458-2400  
McGraw-Hill Publications  
Prestonwood Tower—Suite 907  
5151 Beltline  
Dallas, TX 75240

**WEST COAST SURPLUS AND RETAIL ACCOUNTS**  
Tom Harvey (805) 964-8577  
3463 State Street—Suite 256  
Santa Barbara, CA 93105

**The Buyer's Mart**  
Karen Burgess (603) 924-9281  
BYTE Publications  
70 Main Street  
Peterborough, NH 03458

#### Post Card Mailings National

Bradley Browne (603) 924-6166  
BYTE Publications  
70 Main Street  
Peterborough, NH 03458

### International Advertising Sales Representatives:

Mr. Hans Csokor  
Publimedia  
Reisnerstrasse 61  
A-1037 Vienna, Austria  
222 75 76 84

Mrs. Gurit Gepner  
McGraw-Hill Publishing Co.  
PO Box 2156  
Bat Yam, 59121 Israel  
3 866 561 321 39

Mr. Fritz Krusebecker  
McGraw-Hill Publishing Co.  
Liebigstrasse 19  
D-6000 Frankfurt/Main 1  
West Germany  
69 72 01 81

Mrs. Maria Sarmiento  
Pedro Teixeira 8, Off. 320  
Iberia Mart 1  
Madrid 4, Spain  
1 45 52 891

Mr. Andrew Karnig  
Andrew Karnig & Associates  
Finnbodavagen  
S-131 31 Nacka, Sweden  
8-44 0005

Mr. Jean Christian Acis  
McGraw-Hill Publishing Co.  
17 rue Georges Bizet  
F 75116 Paris  
France  
1 720 33 42

Mr. Arthur Scheffer  
McGraw-Hill Publishing Co.  
34 Dover St.  
London W1X 3RA  
England 01 493 1451

Mr. Savio Pesavento  
McGraw-Hill Publishing Co.  
Via Flavio Baracchini 1  
20123 Milan, Italy  
02 86 90 617

Seavex Ltd.  
400 Orchard Road, #10-01  
Singapore 0923  
Republic of Singapore  
Tel: 734-9790  
Telex: RS35539 SEAVEX

Seavex Ltd.  
503 Wilson House  
19-27 Wyndham St.  
Central, Hong Kong  
Tel: 5-260149  
Telex: 60904 SEVEX HX

Hiro Morita  
McGraw-Hill Publishing Co.  
Overseas Corp.  
Room 1528  
Kasumigaseki Bldg.  
3-2-5 Kasumigaseki,  
Chiyoda-Ku  
Tokyo 100, Japan  
3 581 9811

# READER SERVICE

Inquiry No.	Page No.	Inquiry No.	Page No.	Inquiry No.	Page No.	Inquiry No.	Page No.	
402	1ST PLACE COMP. SYSTEMS...	474	76	COMPUTER BOOK CLUB THE	243	146	FLAGSTAFF ENGINEERING...	223
2	4-5-6 WORLD...	473	77	COMPUTER CONNECTION	468, 469	409	FORTH INC.	146
3	A.S.T. RESEARCH...	19	78	COMPUTER INNOVATIONS	356	147	FORTRON, INC.	450
4	A.S.T. RESEARCH...	19	79	COMPUTER MAIL ORDER	364, 365	148	FORTRON, INC.	450
5	AB COMPUTERS...	77	80	COMPUTER MART	301	149	FOX SOFTWARE INC.	258
7	ACS INT'L INC.	241	81	COMPUTER MEDIA MARKETING	447	150	FREELANCE NETWORK INC.	473
8	ADDMASTER CORP.	453	82	COMPUTER PARTS MART	474	152	GENERAL MICRO SYSTEMS	473
9	ADTEK	370	83	COMPUTER WAREHOUSE	175	153	GENERAL TECHNOLOGY	358
10	ADV. DIGITAL CORP.	36	84	COMPUTER WAREHOUSE	175	154	GENEST TECHNOLOGY, INC.	60
11	ADV. DIGITAL CORP.	36	85	COMPUTERBANC	75	155	GENEST TECHNOLOGY, INC.	60
12	ADVANCED COMP. PROD.	462, 463	86	COMPUTRADE	68	156	GENTIAN ELECTRONICS LTD.	457
	* ALF PRODUCTS INC.	445	87	CONCORD TECHNOLOGY INC.	473	157	GIFFORD COMP. SYS.	5
13	ALLIED MICRO DEVICES	473	88	CONROY-LAPOINTE	72, 73	158	GOLD HILL COMPUTERS	228
	* AMBER SYSTEMS	102, 103	89	CONROY-LAPOINTE	72, 73	159	GOLDEN BOW SYSTEMS	447
411	AMERICAN MICRONICS	162	90	CONROY-LAPOINTE	72, 73	160	GTEK INC.	408
16	AMERICAN MICRO SYSTEMS	455	419	CONTOURSOFT CORP.	474	161	H&E COMPUTRONICS	233
17	AMERICAN RESEARCH	384	91	CONTRIVER ENTERPRISES	473	162	HAMMER COMP. SYS.	340
18	AMERICAN RESEARCH	384	92	CORE INTERNATIONAL	140	164	HANZON DATA INC.	48
19	AMERICAN SEMICONDUCTOR	457	93	CORVUS SYS. INC.	128	165	HARMONY VIDEO & COMP.	230
21	AMPRO COMPUTERS INC.	173	94	COSMOS	320	166	HAYES MICROCOMP. PROD.	126, 127
22	APPARAT INC.	457	95	CRANE ASSOCIATES	453	413	HAYES MICROCOMP. PROD.	394
	* APPLE COMPUTER INC.	CII, 1		* CRESCENT COM. INC.	453	167	HEATH COMPANY	251
	* APROTEK	231	96	CUESTA SYSTEMS	366	168	HERCULES COMPUTER TECH.	255
23	APROTEK	447	97	CURTIS INC.	457	169	HERCULES COMPUTER TECH.	303
24	ARCTEC SYSTEMS	101	415	CUSTOM COMP. TECH.	442		* HEWLETT-PACKARD	313
25	ARK ELECTRONIC PRODUCTS	353	416	CUSTOM COMP. TECH.	443	171	HEWLETT-PACKARD	315
26	ARTIFICIAL INT'L RESRCH.	455	98	CYMA CORPORATION	393	172	HEWLETT-PACKARD	133
	* AT&T INFORMATION SYS.	423	99	CYMA CORPORATION	393		* HI TECH INT'L INC.	334
28	ATKINS ASSOCIATES	119	401	DAC SOFTWARE INC.	47	174	HOFFMAN INT'L	457
29	AVOCET	421	101	DATA EXCHANGE	455	175	HOOLEON COMPANY	18
	* AWESOME TECHNOLOGY, INC.	473	102	DATA SPEC	164	176	HOOLEON COMPANY	18
310	BASIC TIME	34, 35	103	DATA SPEC	164	177	HOUSTON INSTR/BAUSCH&LOMB	310
31	B&B ELECTRONICS	447	104	DATA SPEC	60	178	IBEX COMP. CORP.	449
	* B&C MICROSYSTEMS	474	105	DATA SPEC	60	179	IBM CORP.	12, 13
32	BAY TECHNICAL ASSOC.	23	106	DATABROKERS	451	405	IBM CORP.	270, 271
33	BDS CORPORATION	391	107	DATACOPY CORP.	336	180	IBM/SMALL SYS. DIV.	317, 318, 319
34	BINARY TECHNOLOGY	430	108	DATASOUTH COMP. CORP.	367	181	IBS CORP.	232
35	BITTNER ELECTRONICS	430	109	DATASOUTH COMP. CORP.	417	182	IBS CORP.	232
36	BLAISE COMPUTING INC.	413	110	DAYNA COMM.	282, 283	183	IC EXPRESS	232
37	BORLAND INT'L	39	111	DCC DATA SERVICE	447	185	INMAC	112
38	BORLAND INT'L	39	112	DELUXE COMP. FORMS	62	187	INPUT/OUTPUT TECHNOLOGY	235
39	BORLAND INT'L	41	113	DIGITAL RESEARCH COMPUTERS	570	188	INTEGRAND	58
40	BORLAND INT'L	41	114	DIGITALK	150	189	INTERCONTN. MICRO SYS.	24
41	BORLAND INT'L	43	115	DISK MERCHANT	236	190	INTERCONTN. MICRO SYS.	24
42	BORLAND INT'L	43	116	DISKETTE CONNECTION	422	191	INTERFACE INC.	31
43	BUSINESS TOOLS INC.	419	117	DISK WORLD! INC.	441	192	INTERFACE INC.	31
44	BYNAS DIV./UNY CO. LTD.	186	118	DISK WORLD! INC.	448		* INTERFACE TECH. CORP.	341
	* BYTE SUBSCRIBER MESSAGE	422	119	DISK WORLD! INC.	459	193	IOMEGA	137
	* BYTE SUBSCRIBER SERVICE	342	120	DISPLAY TELECOMMNTNS	444	194	ITT INFORMATION SYSTEMS	191
45	BYTEK COMP. SYS. CORP.	32	121	DIVERSIFIED COMPUTER SYS.	447	195	ITT INFORMATION SYSTEMS	191
	* C.WARE/DESMET C.	184	421	DIVERSIFIED GROUP	381	196	JADE COMP. PROD.	470, 471, 472
46	C.D.A. INT'L SOFTWARE	474	122	DOCUTEL/OLIVETTI	123	197	JAMECO ELECTRONICS	52, 53
47	C.I. COMPUTERS	179	123	DOKAY COMP. PROD. INC.	464, 465	198	JANDEL SCIENTIFIC	445
48	C.I. COMPUTERS	179	124	DOW JONES NEWS RETRIEVAL	69	199	IC INFORMATION SYSTEMS	343
49	C.R.E. WHOLESALE	445	125	DOW JONES SOFTWARE	22	414	IDR INSTRUMENTS INC.	196
50	CALIF. COMPUTER COMPONENT	266	126	DYNA SYSTEMS	474	200	IDR MICRODEVICES INC.	477
51	CALIF. COMPUTER COMPONENT	266	127	DYNATECH	239	201	IDR MICRODEVICES INC.	478, 479
	* CALIF. DIGITAL	466, 467	403	EAST DIGITAL CO. LTD.	186	202	IDR MICRODEVICES INC.	480, 481
52	CALIF. MICRO HOUSE	54	129	EASTMAN KODAK CO.	237	203	IDR MICRODEVICES INC.	482, 483
418	CANETICS	447	130	ECLIPSE SYSTEMS	455	204	IDR MICRODEVICES INC.	484
53	CAPITAL EQUIPMENT CORP.	333	131	ECOSOFT	326	400	IEDEN	372
54	CAPITAL MICRO	392	132	ELEKTEK	377	422	JOHN D. OWENS	474
55	CARINT LTD.	68	133	ELEXOR INC.	449	205	IUKI INDUSTRY OF AMERICA	296
57	CENNA TECHNOLOGY, INC.	387	134	ELITE SFTW DEVELOPMENT	177	206	KADAK PRODUCTS LTD.	451
58	CENTROID CORP.	455		* ELLIS COMPUTING, INC.	363	399	KEA SYSTEMS LTD.	362
	* CERMETEK MICROELECTRONICS	411	135	ENERTRONICS	28	207	KIMTRON CORP.	379
61	CHILTON BOOK COMPANY	309	423	ENERTRONICS	29	208	KRUEGER TECHNOLOGY INC.	452
62	CHORUS DATA SYSTEMS	324	137	ENTER COMPUTER	361	209	KRUEGER TECHNOLOGY INC.	452
63	CHRISLIN INDUSTRIES, INC.	253	138	ENTER COMPUTER	361	210	KUSTOM ELECTRONICS	74
64	CIVIL COMPUTING CORP.	449	140	EVEREX SYSTEMS	56	211	LABORATORY MICROSYS	76
	* COALITION FOR LITERACY	350	141	EXPRESS BUSINESS SOFTWARE	110		* LANGLEY ST. CLAIR	451
	* CODEX CORPORATION	295	142	EXPRESS SYSTEMS INC.	224, 225	212	LARK SOFTWARE	360
65	COGITATE	449	144	FARBWARE	473	213	LATTICE, INC.	300
66	COGITATE	455	145	FLAGSTAFF ENGINEERING	223	214	LEARNING TECHNOLOGY INST.	236
	* COMMODORE BUSN. MACHINES	25						
68	COMP. COMPTS. UNLTD.	460, 461						
	* COMPAQ COMPUTER CORP.	82, 83						
70	COMPETITIVE EDGE	234						
71	COMPUADD CORP.	425						
	* COMPUMAIL	476						
73	COMPUSAVE	446						
74	COMPUSERVE	327						
75	COMPUTER AFFAIRS INC.	157						
215	LEO ELECTRONICS	445						
216	LINTEK INC.	67						
217	LOCKHEED-GETEX	165						
218	LOGIC SOFT	INSERT 32 A-B						
219	LOGICAL DEVICES	144						
220	LOGICAL DEVICES	473						
221	LOGICAL SYSTEMS INC.	445						
	* LOGITECH INC.	352						
222	LOMAS DATA PRODUCTS	163						
	* LOTUS DEVELOPMENT	152, 153						
224	LYBEN COMP. SYS.	67						
225	LYBEN COMP. SYS.	190						
226	LYBEN COMP. SYS.	430						
227	LYCO COMPUTER	429						
229	MANX SOFTWARE SYS.	55						
230	MARK WILLIAMS CO.	59						
231	MARK WILLIAMS CO.	61						
232	MARYMAC INDUSTRIES INC.	449						
233	MASTERBYTE COMP. OF NY.	428						
234	MAXELL DATA PRODUCTS	7						
235	MAYNARD ELECTRONICS	15						
	* MCGRAW-HILL CEC	369						
151	MCGRAW-HILL/							
	FUTURE COMPUTING	389						
236	MEGATEL COMPUTER TECH.	188						
237	MERRITT COMP. PRODUCTS	451						
238	MFI ENTERPRISES INC.	166						
239	MICRAY ELECTRONICS	172						
424	MICRO BUSINESS PRODUCTS	162						
425	MICRO BUSINESS PRODUCTS	162						
240	MICRO DATA BASE SYS.	256						
241	MICRO DESIGN INT'L	139						
242	MICRO MART, INC.	64, 65						
243	MICRO PRODUCTS, INC.	475						
244	MICRO SOLUTIONS	158						
245	MICRO-SPEC	474						
246	MICROCOMPUTER ACCESSORIES	111						
247	MICROCOMPUTER ACCESSORIES	111						
248	MICROGRAFX	17						
	* MICROMINT INC.	400						
249	MICROPROCESSORS UNLTD.	453						
250	MICROSHOP	454						
251	MICROSHOP	454						
	* MICROSOFT CORP.	131						
252	MICROSTUF, INC.	371						
253	MICROSTUF, INC.	373						
254	MICROSTUF, INC.	375						
255	MICROWARE SYSTEMS CORP.	167						
256	MICROWAY	330						
257	MICROWAY	404						
420	MINORITY HI-TECH INDUSTRIES	474						
	* MIX SOFTWARE	397						
260	MOUNTAIN VIEW PRESS	261						
261	MTI SYSTEMS CORP.	48						
262	MULTI-TECH SYSTEMS	274						
266	NANTUCKET	45						
267	NANTUCKET	45						
268	NAT'L PUBLIC DOMAIN SFTW.	451						
269	NATIONAL INSTRUMENTS	4						
265	NBS INC.	164						
270	NEC HOME ELECTR. USA	374						
271	NEC INFORMATION SYS.	CIII						
272	NEWSNET INC.	16						
	* NORTH HILLS CORP.	449						
	* NORTH HILLS CORP.	455						
273	NORTHROP DEFENSE	427						
274	NOSTRADAMUS INC.	113						
	* NRI SCHOOLS ELECTR. DIV.	337						
275	OKIDATA	244, 245						
277	OLDEN	46						
279	ORION INSTRUMENTS	316						
406	ORYX SYSTEMS	262						
407	ORYX SYSTEMS	262						
408	ORYX SYSTEMS	262						
281	P							





# NEC PRINTERS. THEY ONLY STOP WHEN YOU WANT THEM TO.



Color Pinwriter CP2  
dot matrix printer.

Spinwriter 8800  
letter-quality printer.

Pinwriter P3  
dot matrix printer.

NEC printers are incredibly reliable.

In fact, with normal use, an NEC printer can run an average of 5 years before it needs a repair. And chances are, that repair will take only about 15 minutes.

To become that reliable, an NEC printer has to go through some of the most demanding tests in the industry.

First, we test every single part before it goes into the printer. Then we test the printer itself. Nothing is forgotten. Nothing is left to chance.

But reliability is only part of the story. There's much more. Our printers work with every popular PC. With more leading software programs. And with more forms handlers to make paperwork a snap.

So no matter what your printing needs—and no matter what size your budget—NEC has a printer for you. Our full line of Spinwriter® printers, for low to high speed letter quality printing. And our versatile Pinwriter™ and Color Pinwriter printers, for high resolution dot matrix printing.

To find out more about NEC printers, call 1-800-343-4418 (in Mass. 617-264-8635).

Or write: NEC Information Systems, Department 1610,  
1414 Massachusetts Ave., Boxborough, MA 01719.

**NEC PRINTERS. THEY ONLY STOP WHEN YOU WANT THEM TO.**

# NEC

NEC Information Systems, Inc.

**C&C**

Computers and Communications

Spinwriter is a registered trademark of NEC Corporation. Pinwriter is a trademark of NEC Corporation.

Inquiry 271



# Another Price Breakthrough from Radio Shack!

## FINALLY...A HIGH-PERFORMANCE 1200-BAUD MODEM FOR UNDER \$400

Save money on long-distance telephone service and on information network connect time with our high-performance DC-2212 Modem.

### Superior Performance for Less than Lesser Modems

You can find other modems with only some of the same features as the DC-2212 selling elsewhere for \$500, \$600 and more. But why pay that much? The DC-2212 (26-1176) is just \$399.95 and includes the features you need to save time and money. And the DC-2212 is compatible with any personal computer equipped with an RS-232C

communications interface (just add appropriate software and cable).

### Advanced Features for Convenient, High-Speed Data Communications

The DC-2212 is easy to use and will automatically dial or answer telephone calls, receive and transmit data and then hang up. Just connect the DC-2212 to a modular telephone jack for menu-driven, Bell 212A-compatible asynchronous or synchronous operation. The DC-2212 automatically selects 300 or 1200 baud operation to match incoming calls and lets you download

at 1200 baud to save time and money. The DC-2212 is fully compatible with Xenix systems and is perfect for use with any of our Videotex telecommunications software packages.

### See It Today

Step up to high-speed data communications with the DC-2212.

Available at over 1200  
Radio Shack Computer Centers and at  
participating Radio Shack stores and dealers.

**Radio Shack**<sup>®</sup>  
**COMPUTER CENTERS**  
A DIVISION OF TANDY CORPORATION

Inquiry 311



Prices apply at Radio Shack Computer Centers and at participating Radio Shack stores and dealers. FCC registered. Use only with Bell-compatible equipment. Not for multi line use without optional-extra controller. XENIX is a trademark of Microsoft.