

DECEMBER 1985

# BYTE

THE SMALL SYSTEMS JOURNAL

DECEMBER 1985 VOL. 10, NO. 13

\$3.50 IN UNITED STATES  
\$4.25 IN CANADA / £2.10 IN U.K.  
A MCGRAW-HILL PUBLICATION  
0360-5280

BYTE

## COMPUTER CONFERENCING

COMPUTER CONFERENCING



Volume 10, Number 13

## TURBO "NEW" PACK \$95.00

You get both our terrific new Turbos, and pay only \$97.50 each. Sold separately, they're \$69.95 each.

- Turbo GameWorks™
- Turbo Editor Toolbox™

**NEW!**

## TURBO HOLIDAY PACK \$125.00

At about a 30% savings, you get our standard holiday special.

- Turbo Pascal® 3.0
- Turbo Tutor®
- Turbo DataBase Toolbox™

All this for only \$125.00. See the order form at right.

Turbo Pascal and Turbo Tutor are registered trademarks and Turbo Database Toolbox, Turbo Graphics Debugger, Turbo Editor Toolbox, Turbo GameWorks and MicroStar are trademarks of Borland International, Inc. WordStar is a trademark of MicroPro International Corp. MultiMate is a trademark of the same international corp. Microsoft is a registered trademark and Word is a trademark of Microsoft Corp. WordPerfect is a trademark of Software Technology International.

SAVE OVER 30% ON OUR GIFT PACKS!

# Announcing Borland's New Turbo Editor Toolbox™ \$69.95

**IT'S ALL YOU NEED TO BUILD YOUR OWN WORD PROCESSOR FOR ONLY \$69.95!**

You get all the modules you need to build your own word processor.

- You get ready-to-compile source code.
- You get a full-featured word processor that looks and acts like WordStar™; we call it MicroStar™
- You get a 200-page manual that tells you how to integrate the editor procedures and functions into your programs.

You can use Turbo Editor Toolbox "as is" or modify it any way you want.

And you don't get a bill for Royalties. Because Borland doesn't believe you should pay for something more than once.

All this and more for only \$69.95.

And until March 1, 1986 you can get Borland's new Turbo Editor Toolbox for even less! (Only \$47.50 when you buy the special Turbo New Pack.)

**YOU CAN HAVE MANY WINDOWS ON THE WORLD.** The new Turbo Editor Toolbox features windowing, a technique that lets you see several documents—or several parts of the same document—at once. You know best what your needs are. Turbo Editor Toolbox lets you open the windows you want. And to make those windows part of your program.

**WITH TURBO EDITOR TOOLBOX YOU CAN HAVE THE BEST OF ALL WORD PROCESSORS IN YOUR WORD PROCESSOR.** You can make WordStar behave like Multi-Mate. Support windows just like Microsoft's® Word™. And do it as fast as WordPerfect does it. Incorporate your new "hybrids" into your programs to achieve incredible control and power.

Turbo Editor Toolbox. It's the kind of tool that almost everyone needs—and we're the kind of company to give it to you at a reasonable price, without any compromise on quality. (We're so sure you'll be satisfied that we offer a 60-day money-back guarantee—something no one else does.)

### THE CRITICS' CHOICE

"Turbo Pascal has got to be the best value in languages on the market today—and Borland International, by delivering excellent products at reasonable costs, is leading the software industry where it has to go. Turbo Pascal is more than just a good program at a low cost. It's also a low-cost, well-conceived programming language making it possible for lots of people to produce good programs."

**Jerry Pournelle, BYTE**

"This compiler, produced by Borland International, is one of the best programming tools presently available for the PC."

**Michael Covington, PC Tech Journal**

"Language deal of the century...Turbo Pascal."

**Jeff Duntemann, PC Magazine**

**BORLAND**  
INTERNATIONAL

**Three  
Special  
Gift Packs**



60-DAY MONEY-BACK GUARANTEE

# Introducing Borland's New Turbo GameWorks™ \$69.95

**THE GAMES YOU CAN PLAY, REPLAY, REVISE AND REWRITE BUT CANNOT RESIST.**  
(Turbo Pascal Source Code included!)

We give you the source code, the manual, the diskettes, the 60-day guarantee and the competitive edge. Let the games begin. Chess. Bridge. Go-Moku.

State-of-the-art games that let you be player, referee, and rules committee—because you have the Turbo Pascal source code. Which means that you can play a game or create a game, any time and any way you want.

Borland's new Turbo GameWorks lets you combine gamesmanship with craftsmanship. Discover the secret techniques and moves used by the Old Masters. Learn exactly how state-of-the-art computer games are made—so you can go off and make your own. Since you have the source code, you can always change the game. Or rig the game, if no one's looking. Pure Magic. That's Turbo GameWorks. And part of the "sourcery"—Turbo GameWorks is only \$69.95. When combined with our new Turbo Editor Toolbox in the Turbo New Pack, it's only \$47.50.

**SHORT CUTS, SECRETS AND STRATEGIES.** The Turbo GameWorks manual takes you step-by-step through all the games. How to play them. How to modify them. How to use the power of Turbo Pascal to write new games.

You'll learn general problem analysis, how to identify all possible moves, "rule of thumb" strategies, procedures for testing strategies, and ways to rate options. You'll also be introduced to "top down" program design, the development of basic algorithms, the use of constants and data structures and ways to design short cuts with incremental updating.

On top of all that, you'll have a lot of fun (if you want to).

So go to play (and work) with Borland's new Turbo GameWorks. It's unique. It's fascinating. And it's brand-new. Be first with the latest and greatest—order your Turbo GameWorks today.

4585 Scotts Valley Drive, Scotts Valley CA 95066  
Phone (408) 438-8400 Telex 172373

Inquiry 37 for End-Users. Inquiry 38 for DEALERS ONLY.

## BORLAND'S TURBO GAMEWORKS AND SOME OF ITS MASTER PIECES

**Chess**, the ultimate strategic game. A game so old that no one knows its exact origins. Turbo GameWorks lets you play chess at six different levels from the beginner to the sophisticated user. And you have many ways of playing with your Turbo GameWorks. Let the computer solve checkmate problems. Set the time limit for each game. And there's more.

Decide whether you or the computer "goes first." Trade places with the computer at any point in the game. It's all possible with GameWorks.

**Go-Moku**, also known as "Five-in-Line," is a very old Japanese game played on a board of squares. The first player to get five game pieces in a row—either horizontally, vertically, or diagonally—wins the game.

It's an intriguing game. But you're not limited to playing it one way. With Turbo GameWorks, you can modify it your way.

**Bridge**. Play bridge with a friend or team up against the program—you decide which hands the computer plays. You can even decide to let the program cheat! The program automatically bids and plays its own hands. And, since you can tinker with the source code, you can make "your" Bridge unlike any other.

## TURBO HOLIDAY JUMBO PACK

\$245.00

Now you get the whole Turbo Pascal family, including its newest members, at an incredible price.

- Turbo Pascal 3.0 combines an integrated programming environment with the fastest Pascal compiler in the galaxy.
- Turbo Tutor teaches you step-by-step how to use the Turbo Pascal development environment. With commented source code for all program examples on diskette.
- Turbo DataBase Toolbox gives you all the tools you need to sort and search your data and build powerful database applications.
- Turbo Graphix Toolbox™ gives you a complete library of Pascal procedures to build applications using high resolution graphics and graphics window management.
- Turbo GameWorks—Chess, Bridge, Go-Moku. Secrets and strategies of state-of-the-art computer games are revealed with complete source code.
- Turbo Editor Toolbox—the Pascal modules that let you build your own word processor. A full-featured WordStar-like program, MicroStar™, is included on your disk.

You're getting everything at only \$40 each. And if you already own one or several members of the Turbo family, be creative—nothing can stop you from buying the Jumbo Pack, picking out the ones you already have and giving them as holiday gifts for family or friends. At these prices you can afford to give to others and to yourself.

NEW!

NEW!

## Holiday Gift Packs, Turbo GameWorks™ & Turbo Editor Toolbox™

NOT COPY-PROTECTED

Available at better dealers nationwide. Call (800) 556-2283 for the dealer nearest you. To order by Credit Card call (800) 255-8008, CA (800) 742-1133.

The holiday packs include an upgrade coupon for both options so you get BCD and 8087 support for \$39.95 (regularly \$55.00).

Carefully describe your computer system!

Mine is:  8-bit  16-bit  
I use:  PC-DOS  MS-DOS  
 CP/M-80  CP/M-86

My computer's name and model is: \_\_\_\_\_

The disk size I use is:  3 1/2"  5 1/4"  8"

Name: \_\_\_\_\_

Shipping Address: \_\_\_\_\_

City: \_\_\_\_\_

State: \_\_\_\_\_ Zip: \_\_\_\_\_

Telephone: \_\_\_\_\_

NOTE: Turbo Editor Toolbox and Turbo GameWorks are available for the IBM PC and true-compatibles using Turbo Pascal 3.0 ONLY.



	Quantity
*Turbo Holiday Jumbo Pack	\$245.00
*Turbo Holiday Pack	\$125.00
*Turbo New Pack	\$69.95
Pascal	\$109.90
Pascal w/8087	\$109.90
Pascal w/BCD	\$124.95
Pascal w/8087 and BCD	\$54.95
Turbo DataBase	\$54.95
Turbo Graphix	\$34.95
Turbo Tutor	\$69.95
Turbo Editor	\$69.95
Turbo GameWorks	\$69.95

These prices include shipping to all U.S. cities. All foreign orders add \$10 per product ordered.

Amount: (CA add 6% tax) \_\_\_\_\_  
 Payment:  VISA  MC  Check  Bank Draft  
 Credit Card Expiration Date: \_\_\_\_\_ / \_\_\_\_\_  
 Card # \_\_\_\_\_

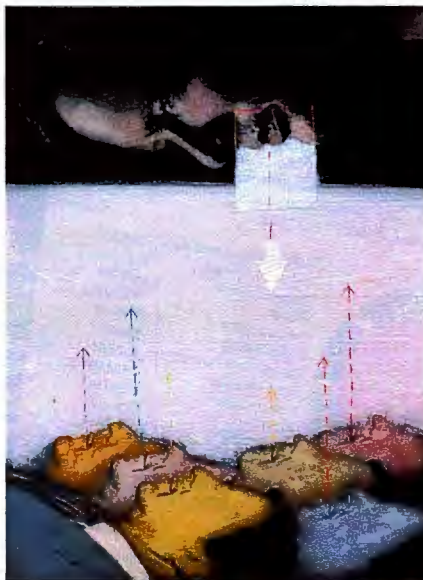
COD's and Purchase Orders will not be accepted by Borland International. California residents: add 6% sales tax. Outside USA: add \$10 and make payment by bank draft, payable in U.S. dollars drawn on a U.S. bank. H15

With  
Dazzling  
Discounts!

# C·O·N·T·E·N·T·S



90



166

## FEATURES

- INTRODUCTION** ..... 90
- CIARCIA'S CIRCUIT CELLAR: TURNKEY BULLETIN-BOARD SYSTEM**  
*by Steve Ciarcia* ..... 93  
Steve combines the SB180 computer and Xecom's MOSART chip to produce a state-of-the-art system.
- PROGRAMMING PROJECT: A SIMPL COMPILER, PART I: THE BASICS**  
*by Jonathan Amsterdam* ..... 106  
This is the first of a three-part series on the construction of a compiler for a high-level language.
- PRODUCT DESCRIPTION: THE TANDY 600 AND THE TANDY 3000**  
*by G. Michael Vose* ..... 118  
A production version of the 600, an 80C88-based laptop machine, is examined, as well as a prototype of the 3000, a clone of IBM's PC AT.
- ENGLISH RECOGNITION** *by Roy E. Kimbrell* ..... 125  
English gives you a variety of ways to express complex actions with a minimum of program interaction.
- SCIENTIFIC APPLICATIONS SOFTWARE** *by John C. Nash* ..... 145  
The author tells how to choose suitable scientific software.
- PROGRAMMING INSIGHT: VIRTUAL FIELDING IN MICROSOFT BASIC**  
*by C. R. J. Currie* ..... 155  
Handle files with large record lengths on Microsoft BASIC systems.
- PROGRAMMING INSIGHT: TRAVESTY WITH DATABASE** *by Neil J. Rubenking* ..... 161  
This Turbo Pascal travesty generator stores frequency information in a database.

## THEMES

- INTRODUCTION** ..... 166
- AN OVERVIEW OF CONFERENCING SYSTEMS** *by Brock N. Meeks* ..... 169  
The author presents a guided tour through COM, EIES, PARTI, NOTEPAD, and other systems.
- CONFERENCING STANDARDS** *by Jacob Palme* ..... 187  
The search for a universal conferencing standard continues.
- DATABASE STRUCTURE IN PORTACOM** *by Jacob Palme* ..... 195  
The discussion focuses on the functions that affect database structure in computer conferencing systems.
- THE NETWORK APPLICATION MANAGER** *by Robert A. Flavin and Jack D. Williford* ..... 203  
You can put any application involving communications on a conferencing system.
- STORAGE ARCHITECTURES** *by Alastair J. W. Mayer* ..... 221  
The author of CoSy discusses the implications of storage architecture for conferencing systems.
- COMMON GROUND** *by Chris Hancock* ..... 239  
The user-friendliness of this microcomputer-based conferencing system derives from its easy-to-visualize functions.
- LOCAL POWER IN A REMOTE LINK** *by Chuck McManis* ..... 251  
Conferencing systems can let microcomputers handle much of the processing load.
- CONVERSATIONS** *by Douglas E. Comer and Larry L. Peterson* ..... 263  
The authors discuss an alternative to memos and conferences.
- CROSS-SYSTEM CONFERENCING WITH CLACR** *by Sherwin M. Levinson* ..... 273  
Micros may offer a way to link systems and cut costs.

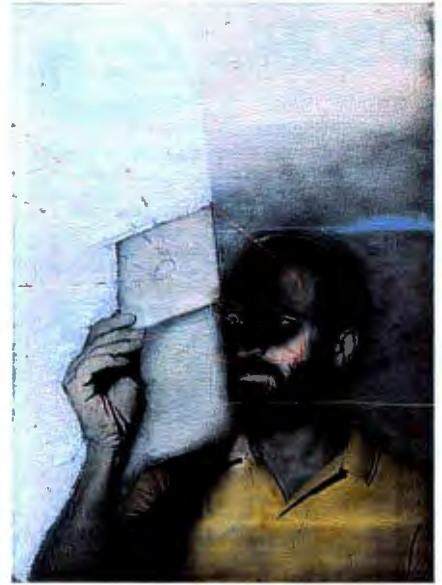
BYTE (ISSN 0360-5280) is published monthly by McGraw-Hill Inc. Founder: James H. McGraw (1860-1948). Executive, editorial, circulation, and advertising offices: 70 Main St., Peterborough, NH 03458, phone (603) 924-9281. Office hours: Mon-Thur 8:30 AM - 4:30 PM, Friday 8:30 AM - 1:00 PM, Eastern Time. Address subscriptions to BYTE Subscriptions, POB 590, Martinsville, NJ 08836. Postmaster: send address changes, USPS Form 3579, undeliverable copies, and fulfillment questions to BYTE Subscriptions, POB 596, Martinsville, NJ 08836. Second-class postage paid at Peterborough, NH 03458 and additional mailing offices. Postage paid at Winnipeg, Manitoba. Registration number 9321. Subscriptions are \$21 for one year, \$38 for two years, and \$55 for three years in the USA and its possessions. In Canada and Mexico, \$23 for one year, \$42 for two years, \$61 for three years, \$69 for one year air delivery to Europe, 17,100 yen for one year surface delivery to Japan, \$37 surface delivery elsewhere. Air delivery to selected areas at additional rates upon request. Single copy price is \$3.50 in the USA and its possessions, \$4.25 in Canada and Mexico, \$4.50 in Europe, and \$5 elsewhere. Foreign subscriptions and sales should be remitted in United States funds drawn on a U.S. bank. Please allow six to eight weeks for delivery of first issue. Printed in the United States of America.

# BYTE December

VOLUME 10, NUMBER 13, 1985

## REVIEWS

INTRODUCTION .....	290
REVIEWER'S NOTEBOOK <i>by Glenn Hartwig</i> .....	293
THE AT&T PC 6300 <i>by Bob Troiano</i> .....	294
IBM PC compatibility, an 8086-2 processor, and graphics capability.	
THE TANDY 200 AND THE NEC PC-8401A <i>by Harry Krause</i> .....	306
Comparing two under-\$1000 laptops.	
GOLDEN COMMON LISP <i>by Bruce D'Ambrosio</i> .....	317
Gold Hill Computers' implementation for microcomputers.	
THE NORTON UTILITIES <i>by Rubin Rabinovitz</i> .....	323
Tools for recovering data and managing directories.	
HYPERDRIVE FOR THE MACINTOSH <i>by Gregg Williams</i> .....	329
An add-in hard-disk drive holding 10 or 20 megabytes.	
UPGRADES FOR THE TRS-80 MODEL 100 <i>by Terry Kepner</i> .....	335
Equipment for expanding a portable.	
THE IBM PROPRINTER <i>by Rich Malloy</i> .....	343
A dot-matrix machine.	
PANASONIC'S 4-COLOR GRAPHIC PENWRITER <i>by Jon R. Edwards</i> .....	351
An electronic typewriter, a printer, and a graph maker combined.	
REVIEW FEEDBACK .....	359
Readers respond to previous reviews.	



290

## KERNEL

INTRODUCTION .....	360
COMPUTING AT CHAOS MANOR: THE EUROPEAN CONNECTION <i>by Jerry Pournelle</i> .....	363
Jerry tours the Continent but doesn't forget about computers.	
CHAOS MANOR MAIL <i>conducted by Jerry Pournelle</i> .....	383
Jerry's readers write, and he replies.	
BYTE U.K.: THE TORCH TRIPLE X <i>by Dick Pountain</i> .....	385
Dick introduces a new low-priced UNIX personal computer from Torch Ltd.	
BYTE JAPAN: COMPUTING IN TAIWAN <i>by William M. Raike</i> .....	397
Bill describes the new products he saw at the Computex '85 computer show and more.	
ACCORDING TO WEBSTER:	
MICROCOMPUTER COLOR GRAPHICS-OBSERVATIONS <i>by Bruce Webster</i> .....	405
Bruce looks at the graphics systems on some popular microcomputers.	
CIRCUIT CELLAR FEEDBACK <i>conducted by Steve Ciarcia</i> .....	420
Steve answers project-related queries from readers.	
EDITORIAL:	
NEW SERVICES .....	6, 60
MICROBYTES .....	9
LETTERS .....	14
FIXES AND UPDATES .....	33
WHAT'S NEW .....	37, 429
ASK BYTE .....	48
CLUBS AND NEWSLETTERS .....	58
BOOK REVIEWS .....	65
EVENT QUEUE .....	86
UNCLASSIFIED ADS .....	477
BYTE'S ONGOING MONITOR BOX:	
BOMB RESULTS .....	478
READER SERVICE .....	479



360

Address all editorial correspondence to the Editor, BYTE, POB 372, Hancock, NH 03449. Unacceptable manuscripts will be returned if accompanied by sufficient first-class postage. Not responsible for lost manuscripts or photos. Opinions expressed by the authors are not necessarily those of BYTE. Copyright © 1985 by McGraw-Hill Inc. All rights reserved. Trademark registered with the United States Patent and Trademark Office. Where necessary, permission is granted by the copyright owner for libraries and others registered with the Copyright Clearance Center (CCC) to photocopy any article herein for the flat fee of \$1.50 per copy of the article or any part thereof. Correspondence and payment should be sent directly to the CCC, 29 Congress St., Salem, MA 01970. Specify ISSN 0360-5280/85 \$1.50. Copying done for other than personal or internal reference use without the permission of McGraw-Hill Inc. is prohibited. Requests for special permission or bulk orders should be addressed to the publisher, BYTE is available in microform from University Microfilms International, 300 North Zeeb Rd., Dept. PR, Ann Arbor, MI 48106 or 18 Bedford Row, Dept. PR, London WC1R 4EJ England. Subscription questions or problems should be addressed to: BYTE Subscriber Service, POB 328, Hancock, NH 03449



# PRINTERS ONLY

**UNBELIEVABLE SAVINGS!**

Our 6 year industry reputation guarantees you:

1. Immediate delivery
2. Mail-order with confidence
3. Lowest prices
4. Professional expertise

## EPSON® LX80



SAVE, SAVE, SAVE!

Fast, economic printing. Let the LX80 print your next business letter or report.

- Complete Epson Line \_\_\_\_\_ **10-40% off**  
 LX80 (100cps, NLQ, 80 col) \_\_\_\_\_ **\$CALLS**  
 FX85+ (160cps, NLQ, 8K buf) \_\_\_\_\_ **SAVE 20%+**  
 FX185+ (160cps, NLQ, 132 col) \_\_\_\_\_ **\$CALLS**  
 LQ1500 (200cps, NLQ, 18 pin) \_\_\_\_\_ **SAVE 25%+**  
 HS80 (Ink Jet, Portable, 160cps) \_\_\_\_\_ **10-40% off**

## brother HR15XL



Daisy Wheel Printer Plus. Two color and Shadow Printing. Economically priced and superior quality.

- Complete Brother Line \_\_\_\_\_ **Save 10-35%**  
 HR15XL (17cps, 3K buffer, 13.5" carriage) \_\_\_\_\_ **\$CALLS**  
 HR15 & 15XL Keyboard attachment \_\_\_\_\_ **SAVE 15%+**  
 HR25(23cps, 16.5" carriage, 3K buffer) \_\_\_\_\_ **\$SAVES**  
 HR35 (32cps, 16.5" carriage, 7K buffer) \_\_\_\_\_ **SAVE 20%+**  
 M1509 (180cps, serial/parallel std., NLQ) \_\_\_\_\_ **\$CALLS**  
 Twinwriter 5 (Dots & Daisies, 140cps, 40 LQ) \_\_\_\_\_ **SAVE 20%+**



## Canon PC PERSONAL COPIERS

Ideal for Home or Office. Personal copying at its finest.

Entire copying process in the convenient disposable cartridge. Virtually service free.

- Complete Canon Line \_\_\_\_\_  
 PC10 Single sheet feed \_\_\_\_\_ **\$599**  
 PC14 Multiple copies, NEW \_\_\_\_\_ **\$CALLS**  
 PC25 Reduce, Enlarge, Legal size \_\_\_\_\_ **\$SAVES**

## AND MORE PRINTERS!

- Complete Smith Corona Line \_\_\_\_\_ **10-40% off**  
 Complete Dataproducts Line \_\_\_\_\_ **up to 35% off**  
 Complete Okidata Line \_\_\_\_\_ **15-30% off**  
 Complete Hewlett Packard Line \_\_\_\_\_ **\$CALLS**  
 Panasonic 1091 (120cps, NLQ, 1K buffer) \_\_\_\_\_ **\$CALLS**  
 Anadex 9625B (240cps, 3.5K buffer, Commercial) \_\_\_\_\_ **\$CALLS**  
 Anadex DP6500 (500cps, Corresp. Quality) \_\_\_\_\_ **\$CALLS**  
 Amdek 5055 (55cps, LQ, Quiet) \_\_\_\_\_ **\$CALLS**



★ FREE CATALOG ★

**CALL TODAY!**

- Anaheim, CA (714) 630-3622  
 San Diego, CA (619) 278-2560  
 San Francisco, CA (415) 673-0170  
 Sherman Oaks, CA (818) 501-3486  
 Santa Clara, CA (408) 980-1213  
 Houston, TX (713) 789-1014  
 Dallas, TX (214) 239-4300  
 Seattle, WA (206) 453-0151  
 Denver, CO (303) 750-5900



"Computer Printer Specialists"

# BYTE

## EDITOR IN CHIEF

PHILIP LEMMONS  
**MANAGING EDITOR, PRINT**  
 GENE SMARTE

## MANAGING EDITOR, ELECTRONIC PUBLISHING AND COMMUNICATIONS

GEORGE BOND  
**CONSULTING EDITORS**

STEVE CIARCIA  
 JERRY POURNELLE  
 BRUCE WEBSTER

## SENIOR TECHNICAL EDITORS

G. MICHAEL VOSE, *Themes*  
 GREGG WILLIAMS

## TECHNICAL EDITORS

THOMAS R. CLUNE  
 JON R. EDWARDS  
 RICHARD GREHAN  
 GLENN HARTWIG, *Reviews*  
 KEN SHELDON  
 JANE MORRILL TAZELAAR  
 TOM THOMPSON  
 CHARLES D. WESTON  
 EVA WHITE  
 STANLEY WSZOLA  
 MARGARET COOK GURNEY, *Associate*  
 DONNA OSGOOD, *Associate, San Francisco*  
 ALAN EASTON, *Drafting*

## NEWS AND TECHNOLOGY

EZRA SHAPIRO, *Bureau Chief, San Francisco*  
 RICH MALLOY, *Senior Technical Editor, New York*  
 PHILLIP ROBINSON, *Senior Technical Editor, Palo Alto*  
 TONY LOCKWOOD, *Senior News Editor, Peterborough*

## ASSOCIATE NEWS EDITORS

DENNIS BARKER, *Peterborough*  
 BRENDA McLAUGHLIN, *San Francisco*  
 LYNNE M. NADEAU, *Peterborough*  
 MARK WELCH, *San Francisco*

## CONTRIBUTING EDITORS

JONATHAN AMSTERDAM, *programming projects*  
 DAVID BETZ, *programming*  
 MARK DAHMKE, *video, operating systems*  
 MARK HAAS, *at large*  
 RIK JADRNICKEK, *CAD, graphics, spreadsheets*  
 MARK KLEIN, *communications*  
 ROBERT T. KUROSAKA, *mathematical recreations*  
 ALASTAIR J. W. MAYER, *software*  
 ALAN MILLER, *languages and engineering*  
 JOHN C. NASH, *scientific computing*  
 DICK POUNTAIN, *U.K.*  
 WILLIAM M. RAIKE, *Japan*  
 PERRY SAIDMAN, *computers and law*  
 ROBERT STERNE, *computers and law*

## COPY EDITORS

BUD SADLER, *Chief*  
 DENNIS BARKER  
 ELIZABETH COOPER  
 ANNE L. FISCHER  
 NANCY HAYES  
 LYNNE M. NADEAU  
 PAULA NOONAN  
 JOAN VIGNEAU ROY  
 WARREN WILLIAMSON

## ASSISTANTS

PEGGY DUNHAM, *Office Manager*  
 MARTHA HICKS  
 CATHY KINGERY  
 JUNE N. SHELDON

## ART

ROSSLYN A. FRICK, *Art Director*  
 NANCY RICE, *Associate Art Director*

## PRODUCTION

DAVID R. ANDERSON, *Production Director*  
 DENISE CHARTRAND  
 MICHAEL J. LONSKY  
 JAN MÜLLER

**Editorial and Business Office:** 70 Main Street, Peterborough, New Hampshire 03458, (603) 924-9281.

**West Coast Offices:** McGraw-Hill, 425 Battery St., San Francisco, CA 94111, (415) 362-4600.

McGraw-Hill, 1000 Elwell Court, Palo Alto, CA 94303, (415) 964-0624.

**New York Office:** 1221 Avenue of the Americas, New York, NY 10020, (212) 512-2000.

Officers of McGraw-Hill Information Systems Company: President: Richard B. Miller. Executive Vice Presidents: Frederick P. Jannott. Construction Information Group: Russell C. White. Computers and Communications Information Group: J. Thomas Ryan. Marketing and International. Senior Vice Presidents: Francis A. Shinal, Controller; Robert C. Violette. Manufacturing and Technology. Senior Vice Presidents and Publishers: Laurence Altman, Electronics Week; Harry L. Brown, BYTE and Popular Computing; David J. McGrath, Construction Publications. Group Vice Presidents: Peter B. McCuen, Communications Information, Vice President; Fred O. Jensen, Planning and Development. Officers of McGraw-Hill, Inc.: Harold W. McGraw, Jr., Chairman; Joseph L. Dionne, President and Chief Executive Officer; Robert N. Landes, Executive Vice President and Secretary; Walter D. Serwatka, Executive Vice President, Publishing Services; Ralph R. Schulz, Senior Vice President, Editorial; Shel F. Asen, Vice President, Manufacturing; George R. Elsing, Vice President, Circulation; Ralph J. Webb, Vice President and Treasurer.

## SENIOR VICE PRESIDENT/PUBLISHER

HARRY L. BROWN  
**PUBLISHER'S ASSISTANT**  
 BEVERLY JACKSON

## PERSONNEL

CHERYL HURD, *Office Manager*  
 PATRICIA BURKE, *Personnel Coordinator*

## TYPOGRAPHY

SHERRY MCCARTHY, *Chief Typographer*  
 LEN LORETTE  
 DONNA SWEENEY

## ADVERTISING SALES

DENNIS J. RILEY, *Director of Sales and Marketing*  
 SANDRA FOSTER, *Administrative Assistant*  
**ADVERTISING/PRODUCTION (603-924-6448)**  
 LISA WOZMAK, *Supervisor*  
 ROBERT D. HANNINGS, *Senior Account Coordinator*  
 MARION CARLSON  
 KAREN CILLEY  
 LYDA CLARK  
 MICHELE GILMORE  
 DENISE PROCTOR  
 WAI CHIU LI, *Quality Control Manager*  
 JULIE NELSON, *Advertising/Production Coordinator*

## CIRCULATION (800-258-5485)

GREGORY SPITZFADEN, *Director*  
 ANDREW JACKSON, *Subscriptions Manager*  
 CATHY A. RUTHERFORD, *Assistant Manager*  
 LAURIE SEAMANS, *Assistant Manager*  
 SUSAN BOYD  
 PHIL DECHERT  
 MARY EMERSON  
 LOUISE MENEGUS  
 AGNES E. PERRY  
 JENNIFER PRICE  
 JAMES BINGHAM, *Single-Copy Sales Manager*  
 CAROL AHO  
 CLAUDETTE CARSWELL  
 KAREN DESROCHES

## MARKETING COMMUNICATIONS

HORACE T. HOWLAND, *Director (603-924-3424)*  
 VICKI REYNOLDS, *Marketing Production Manager*  
 LISA JO STEINER, *Marketing Assistant*  
 STEPHANIE WARNEKY, *Marketing Art Director*  
 SHARON PRICE, *Assistant Art Director*  
 DOUG WEBSTER, *Director of Public Relations (603-924-9027)*  
 WILBUR S. WATSON, *Operations Manager, Exhibits*

## PLANNING AND DEVELOPMENT

MICHELE P. VERVILLE, *Manager*  
 PATRICIA AKERLEY, *Research Manager*  
 CYNTHIA DAMATO SANDS, *Reader Service Coordinator*  
 FAITH KLUNTZ, *Copyrights Coordinator*

## ACCOUNTING

KENNETH A. KING, *Assistant Controller*  
 VICKI WESTON, *Accounting Manager*  
 LINDA SHORT, *D/P Manager*  
 EDSON WARE, *Credit*  
 MARILYN HAIGH  
 DIANE HENRY  
 VERN ROCKWELL  
 JOANN WALTER

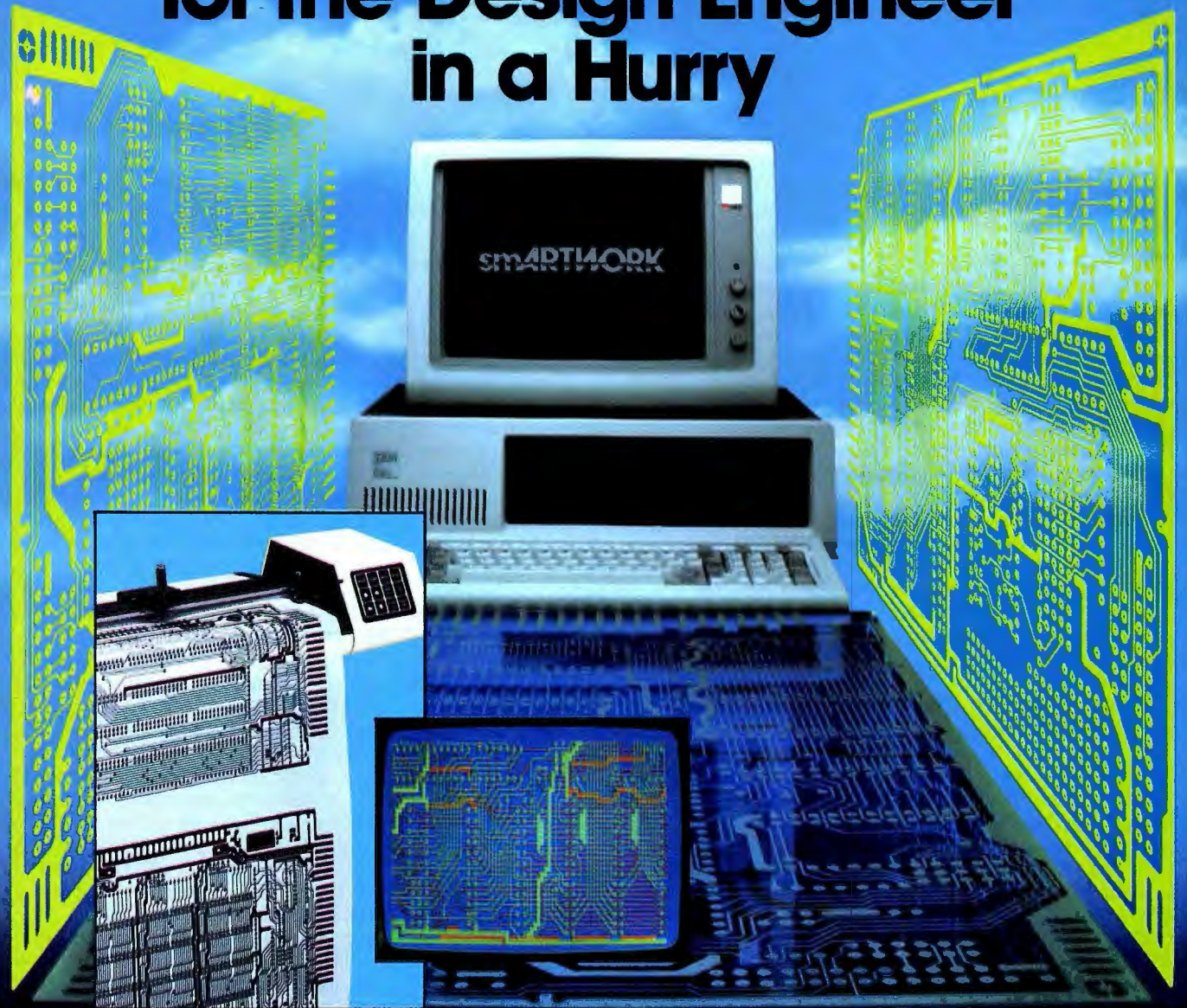
## BUILDING SERVICES/TRAFFIC

ANTHONY BENNETT, *Building Services Manager*  
 BRIAN HIGGINS  
 MARK MONKTON

## RECEPTIONISTS

L. RYAN McCOMBS  
 CHERYL CASTRO, *Assistant*

# Circuit-Board-Artwork Software for the Design Engineer in a Hurry



For only \$895, smARTWORK® lets the design engineer create and revise printed-circuit-board artwork on the IBM Personal Computer. You keep complete control over your circuit-board artwork — from start to finish.

Forget the tedium of taping it yourself or waiting for a technician, draftsman, or the CAD department to get to your project.

smARTWORK® is the only low-cost printed-circuit-board artwork editor with all these advantages:

- Complete interactive control over placement and routing
- Quick correction and revision
- Production-quality 2X artwork from a pen-and-ink plotter
- Prototype-quality 2X artwork from a dot-matrix printer

- Easy to learn and operate, yet capable of sophisticated layouts
- Single-sided and double-sided printed circuit boards up to 10 x 16 inches
- Multicolor or black-and-white display

#### System Requirements:

- IBM Personal Computer, XT, or AT with 256K RAM, 2 disk drives, and DOS Version 2.0 or later
- IBM Color/Graphics Adapter with RGB color or black-and-white monitor
- IBM Graphics Printer or Epson FX/MX/RX series dot-matrix printer
- Houston Instrument DMP-41 pen-and-ink plotter
- Optional Microsoft Mouse

#### The Smart Buy

At \$895, smARTWORK® is proven, convenient, fast, and a sound value. Call us today. And put it to work for yourself next week.



Wintek Corporation  
1801 South Street  
Lafayette, IN 47904-2993  
Telephone: (317) 742-8428  
Telex: 70-9079 WINTEK CORP UD

Inquiry 375

In Europe contact: RIVA Terminals Limited,  
Woking, Surrey GU21 5JY ENGLAND,  
Telephone: 04862-71001, Telex: 859502

"smARTWORK", "Wintek" and the Wintek logo are registered trademarks of Wintek Corporation.

## NEW SERVICES

It is now 15 years since Murray Turoff invented computer conferencing as a renegade project in, of all places, the Office of Emergency Preparedness of the Executive Office of the President of the United States. (See *The Network Nation: Human Communication Via Computer* by Starr R. Hiltz and Murray Turoff, Addison-Wesley, 1978, for details.) It is seven years since Ward Christensen and Randy Sues invented the electronic bulletin board. Their article, "Hobbyist Computerized Bulletin Board," in the November 1978 BYTE (page 150) describes how they devised CBBS as a means of communications for members of their computer club and as a source of material for the club's newsletter.

Today it is clear that computer conferencing and electronic bulletin boards are the means by which personal computer users form a new kind of community, united by shared interests rather than geography. This month we examine computer conferencing in depth. We also extend our services to readers.

Many of you have written us about difficulties in getting program listings that go with BYTE articles. Some listings appear in the magazine, but lack of space prevents us from printing all of every listing in BYTE. The listings are available for downloading from our three electronic bulletin boards or from the BYTE Information Exchange (BIX), but some of you don't take part in telecommunications. Others are outside the U.S. and face technical or financial obstacles to participation.

We've been working hard to overcome these problems and are at last ready to announce some solutions. These include availability of program listings on disk, availability of computer conferencing and on-line listings throughout Europe, and free availability of listings on many bulletin boards outside the U.S.

## BYTE LISTINGS ON DISKS

Starting December 9, program listings for BYTE articles will be available in a great variety of disk formats. The listings are text files of source code and are to be used for noncommercial purposes only. We have reached an agreement with Media

Duplication Services, a subsidiary of Control Data Corporation, that will enable us to offer disks containing each month's listings for a cost to you of \$5 for most 5¼-inch floppy disks and \$6 for micro-floppies, high-density 5¼-inch disks, and single-density 8-inch CP/M disks. These prices include postage in North America. Shipping and handling add \$1 to the cost of orders from Europe and South America and \$2 to the cost of orders from Asia, Africa, and Australia.

Which formats are available? Media Duplication Services has agreed to duplicate, at a cost permitting the prices above, any soft-sectored format that we can give them. We may need time to arrange the downloading of the listings to some obscure formats if we don't have the target machine here at BYTE. (If you're concerned about availability of your format, call us at (603) 924-9281 and see if we have it. If we don't, we may arrange to pay you a small fee for downloading to your machine and sending us the resulting master disk for your machine's format.) We can't guarantee availability of every format, but we'll make an effort to provide any format requested. You will find an order form on page 60 of this issue if you wish to purchase listings on disk.

## BYTECOM: CONFERENCING IN EUROPE

Jacob Palme, author of two articles in this issue, is also the principal author of COM and PortaCOM, two conferencing programs that run on a variety of systems. COM antedates and influenced CoSy, the software on which BIX is based. OZ, the same Swedish company that developed and sells COM and PortaCOM, also offers time-sharing in Europe. OZ will be putting BYTE program listings up and conducting computer conferences on BYTE and BYTE-inspired topics. Readers in Europe can subscribe to BYTECOM by contacting OZ, Stockholm University Computing Center, Box 27322, S-102 54, Stockholm, Sweden, telephone: 46 8 679280. To reach BYTECOM via telecommunications network, you must first obtain a modem, establish an account with your local telephone administration, and then contact OZ and send a sign-up fee using Swedish postal

giro 184070-1 for the equivalent of 200 Swedish crowns (about \$25). Hourly connect-time charges at night for BYTECOM will be the equivalent of \$6. Note that telecommunications charges themselves are billed directly to the end user by the local telephone administration; Europe lacks the kind of billing to vendor that is normal in the U.S. The telecommunications charges by telephone administrations vary from country to country but are in many cases approximately \$10 to \$15 per hour in the evening. See page 60 for further information on BYTECOM.

## LISTINGS ON BULLETIN BOARDS OUTSIDE THE UNITED STATES

There's nothing quite like the interactivity of computer conferencing, but if using BYTECOM is difficult, you can also obtain BYTE program listings free of charge from electronic bulletin boards in many countries. We owe thanks to the many readers who responded to our request for bulletin boards outside the U.S. to carry BYTE program listings so that all readers have a means of obtaining them. Page 60 contains a partial listing of these bulletin boards. We're also making arrangements with more bulletin boards and will announce them in a future issue.

We hope these new services make BYTE more useful and valuable to many of you.

## QUERY FOR INTEREST

We have looked at Cauzin Systems' interesting new Softstrip system. This system encodes data in graphics patterns printed on paper, and a special reader available from Cauzin reads the data into a computer's serial port. The Softstrip format packs a lot of information into a small space. We ran a test of a Softstrip on page 392 of our October issue, and the data proved readable. The disadvantage of the system is that you must purchase the Cauzin reader for approximately \$200 in order to take advantage of the strips. As a means of distributing program listings, Softstrips would be an alternative to telecommunications and disks rather than a substitute for them. Please let us know whether you would like us to use Softstrips to present program listings in BYTE.

—Phil Lemmons, Editor in Chief



Maxell Corp. of America, 60 Oxford Drive, Moonachie, NJ 07074



**maxell**<sup>®</sup>  
FLOPPY DISKS  
THE GOLD STANDARD  
Inquiry 227

## SmarTerm 220 software makes DEC terminals obsolete!

You don't need a DEC terminal to access DEC's new generation host software. Now you can use your IBM PC and SmarTerm 220 terminal emulation software to access All in One, A to Z, and other popular mainframe software. SmarTerm 220 gives you sophisticated, accurate DEC VT220, VT100, VT102 and VT52 emulation, and includes TTY mode to link you to popular services like The Source, CompuServe, Dow Jones, EASYLINK, and Tymnet.

As you've learned to expect from Persoft, the industry leader in software terminal emulation, SmarTerm 220 continues the tradition of offering "smart" software solutions where IBM PC hardware limitations prevent exact duplication of DEC terminal features. For example, we give you horizontal scrolling for 132-column text display, and also support popular 132-column

video display boards. And we provide "convenience" features not found in other terminal emulation packages like: "Branch to DOS" hot key, automatic installation, color support, multiple setups, "smart" softkeys, remappable keyboard layouts, and online help screens detailing PC and AT keyboard mappings. Our unique support for DEC's popular EDT editor includes convenient keyboard mapping of the "GOLD" and PF function keys, as well as an EDT specific on-line help screen, and keytop chart.

International business people take note: SmarTerm 220 fully supports European versions of the DOS operating system, 8 bit mode, the VT220 multinational character sets, and the compose key.

SmarTerm 220 is a powerful communications package as well, allowing text and binary file transfer at speeds up to 19,200 baud. In addition to the



popular XMODEM "error-free" protocol, we include our own PDIP protocol and supply you with free BASIC and FORTRAN programs which implement the protocol on VAX/VMS systems.

So "farm out" your obsolete DEC terminal, and join more than 35,000 satisfied users who "reap" the benefits of SmarTerm!

### The SmarTerm family:

SmarTerm 220—DEC VT220  
SmarTerm 100—DEC VT100  
SmarTerm 125—DEC VT125  
SmarTerm 400—Data General Dasher D400  
SmarTerm 4014—Tektronix 4014

# PUT YOUR DEC TERMINAL OUT TO PASTURE!



After SmarTerm, what do you do with your obsolete terminal?

**IDEA CREDIT: Ann Garner Riddle of Winston-Salem, N.C.**

\*SmarTerm is a registered trademark of Persoft, Inc. \*PDIP is a trademark of Persoft, Inc. \*DEC, VT, ReGIS, A to Z and All in One are trademarks of Digital Equipment Corp. \*DASHER is a registered trademark of Data General Corp. \*Tektronix is a registered trademark of Tektronix, Inc. © Persoft, Inc. 1985. All rights reserved.

**Persoft, Inc - 2740 Ski Lane - Madison, WI 53713  
(608) 273-6000 - Telex 759491**

# persoft

---

## Graphics Software Systems Unveils New Graphics Program

---

Graphics Software Systems—which developed the VDI graphics standard—introduced GSS•CGI, a raster-based operating-system extension for graphics. It includes pop-up menus, window support, custom design functions (including definable cursors and fill patterns), and definable fonts. GSS will publish its font definition specifications and will market its own fonts (including Swiss, Times, and Century).

All bit-map-management routines are in the GSS•CGI device drivers, so applications written with GSS•CGI will run on any device—even if the driver did not exist when the application was written. Compatible devices include CD-ROMs, scanners, laser printers, desktop publishing stations, bit-map displays, intelligent graphics controllers, and controllers with on-board bit-map memory.

With DOS, the GSS•CGI program core uses 5K bytes of memory. The remaining 64K bytes, used by the controller and device drivers, can be swapped out of memory to make room for other programs using a least-recently-used algorithm.

Versions of GSS•CGI are available for both DOS and UNIX. For OEMs, single copies of the controller and driver software are priced at \$200; language bindings are \$150 each.

---

## Fairchild Announces Clipper

---

Fairchild unveiled its Clipper 32-bit microprocessor and said the 33-MHz Clipper will execute an average of 5 million instructions per second, with a peak rate of 33 million. The Clipper is said to be five times the speed of a DEC VAX-11/780 minicomputer. In addition to 101 hard-wired instructions that execute in one 30-nanosecond clock cycle, up to 2048 macro-coded instructions can be added in ROM (Fairchild currently includes 67 macros in ROM). The Clipper uses three CMOS chips: one CPU and two cache/memory management chips, one each for instructions and data; all three 132-pin chips fit on a single 3- by 4½-inch printed-circuit card that uses a single 96-pin connector. Samples of the Clipper will be available in June 1986 for \$2451.80 each.

---

## IBM Introduces Token-Ring Network

---

IBM's October announcement of its Token-Ring Network was followed by related product introductions from compatible-network vendors. IBM's network will allow PCs, PC Networks, and mainframes to link to other computers and networks using data-grade cable or standard unshielded telephone-wire cable at a speed of 4 megabits per second. IBM said it would cost \$828 per computer to connect eight IBM PCs to a small Token-Ring Network.

The network was designed to meet the specifications of the IEEE-802.5 and ECMA-89 token-ring baseband network standards. To support the Token-Ring Network, IBM and Texas Instruments jointly developed a five-chip set (three processors and two interface chips); Texas Instruments will sell the TMS380 chip set.

Novell announced that its NetWare operating-system software would be modified to allow users of Novell's file-server-based networks to link to IBM's Token-Ring Network.

Proteon and Ungermann-Bass immediately announced complete network systems compatible with IBM's Token-Ring Network, and 3Com said it will also develop a compatible network.

Most of the Token-Ring Network or compatible products were scheduled to be available in the first three months of 1986.

---

## Laser Printer Developments

---

CIE Terminals planned to introduce a new laser printer at COMDEX, based on a 10-page-per-minute Konica printer engine. The printer will include both serial and parallel interfaces, Diablo 630 and Epson FX-80 emulation, and both downloadable and cartridge-based character fonts. The printer should be available for about \$3500 early next year.

(continued)

Ultre, Melville, NY, announced a laser-printing engine that produces output at a resolution of 2400 dots per inch on photo film. Without a controller or case, the Ultr\*Setter will cost OEMs about \$5000 in quantity.

IBM announced the Pageprinter, a 12-page-per-minute electrophotographic LED-array printer priced at \$7490. The Pageprinter can print text and graphics at a resolution up to 240 by 240 dots per inch.

## Nanobytes

Former BYTE columnist **Sol Libes** has started a new magazine for hardware and software developers. The bimonthly magazine is \$20 per year; for information, contact *Micro/Systems Journal*, POB 1192, Mountainside, NJ 07092. . . . **Hitachi** has developed a 2½-inch hard-case floppy disk that works with a prototype drive from **Suwa Seikosha**. The disk can hold up to 500K bytes (unformatted), recording on 200 tracks per inch; the drive requires only 2 watts during read and write and weighs half as much as a 3½-inch drive. . . . **MicroPro** announced release 2.0 of WordStar 2000; enhancements will include the ability to directly read Lotus 1-2-3 and Symphony worksheet files, multiple-column printing, on-screen justification, a document-history screen, and support for more than 200 printers. MicroPro also announced that WordStar 2000 will be available for the UNIX PC (running under AT&T's UNIX System V). . . . **Texas Instruments** is developing a 32-bit CMOS LISP processor chip under contract to the Department of Defense Advanced Research Projects Agency. Roughly 10 times more complex than a 68000, the 40-MHz processor will directly execute a superset of Common LISP with extensions like object-oriented programming and message passing. . . . **Waferscale Integration**, Fremont, CA, has developed a CMOS 32-bit microprocessor slice for use in standard-cell chips. The processor is rated at between 3 and 5 million instructions per second. . . . **Hitachi** and **Motorola** expected to sample a CMOS version of the 68000 microprocessor by the end of 1985. . . . **SoftKlone Distributing**, Tallahassee, FL, announced Mirror, a \$50 telecommunications program it says is completely compatible with Microstuf's Crosstalk XVI. . . . **Oki Semiconductor** is now shipping production quantities of its 1-megabit CMOS ROMs. . . . **Thoughtware Inc.**, Coconut Grove, FL, announced the Jingle Disk, a Christmas card on a disk for \$9.95. Holiday scenes are displayed while Christmas carols are played. The program is available for the IBM PC (256K bytes), Apple II, and Commodore 64 and 128. . . . **Lotus Development Corp.** unveiled Signal, a combined software/hardware product that lets users in major cities receive stock quotes via FM side-band radio signals and automatically enter the information into 1-2-3 or Symphony. The cost is \$595 plus subscription fees for available exchange services. Lotus also recalled and replaced its initial shipment of Symphony version 1.1 after discovering a serious bug. . . . **Drexler Technology Corp.** was granted two patents in October related to its wallet-size optical-memory-card recording system. . . . **General Transformation Corp.**, Berkeley, CA, hopes to validate its Ada compilers for the IBM XT and AT early next year. The company says the \$1000 XT version will compile 1000 lines of source code per minute and the \$1200 AT version will compile 2000 lines per minute. . . . To avoid a court battle with **Apple**, **Digital Research** agreed to change its GEM programs (currently available on the IBM PC and Atari ST) so they will look less like Apple's Macintosh software. . . . **Pacific Bell** is now offering public switched-digital service to customers in the San Francisco and Los Angeles areas, allowing direct data transmission within those areas at up to 56,000 bits per second. Cost for the measured service starts at \$197 per month. . . . Like **AT&T** and **Hitachi**, **Toshiba** has begun sampling its 1-megabit DRAMs. . . . **Intel** introduced a one-time-programmable 256K-bit EPROM that can be programmed in less than 4 seconds using a new Quick-Pulse programming algorithm. . . . **Gould AMI**, Santa Clara, CA, announced that two chips—its S35213 modem chip and S35212A filter chip—will perform all signal processing necessary for a Bell 212A-compatible 1200-bps modem. . . . **Microsoft** is shipping the XENIX System V operating system—a version of UNIX System V for the 80286—to OEMs. . . . **MicroRIM's** R:base 5000 database-manager program will be marketed by **Microsoft** outside North America and the Far East. . . . **Honeywell** introduced the XP and AP, two new personal computers compatible with the IBM XT and AT. . . . **Tiac Manufacturing** announced the PC-320, a \$995 signal-processing board for the IBM PC, XT, or AT, using a Texas Instruments 20-MHz TMS32010 single-chip DSP (digital signal processor). . . . **Chips and Technologies**, Milpitas, CA, announced a 5-chip set that replaces 63 chips on IBM AT-compatible motherboards. The PC AT-compatible CHIPSet is priced at \$72.50 in quantity. Another product—the 4-chip Enhanced Graphics CHIPSet—allows EGA-compatible boards to be built with 32 chips instead of the previously required 76.



# TACTICAL FIGHTER

You're on the road.

Fifty-five miles an hour and you're still three hours from Atlanta. On the seat next to you is the little miracle that will make the trip worthwhile. It's an Epson® Geneva™. A full-blown personal computer that runs on batteries and fits in a briefcase. You can't live without it.

You've got sales people to beat up, cheer up, and pump up. So before you hit the road, you got

sales data from the mainframe at headquarters and competitive information from the IBM® PC in the regional office with Geneva's optional modem.

With Geneva's powerful Portable Calc software, you analyze, organize, and print the data with the optional printer. Now you're ready to give them the good word. Or the bad news.

The Epson Geneva will help your

troops get ready to take Atlanta. And it just might take you a lot further. With a massive software library and a complete line of system peripherals, the Epson Geneva PX-8™ portable computer can handle sales management, or any other job you take on. And for less than \$1000. For more information, call 800-421-5426 or 213-539-9140 in California.

**EPSON Geneva**

Epson is a registered trademark of Epson Corporation. Geneva and PX-8 are trademarks of Epson America, Inc. IBM is a registered trademark of International Business Machines Corp.

# If you *don't* have data worth preserving, then the reasons for buying Cartrex's new 1/4-inch, high performance, virtually error-free tape cartridge won't mean anything

But, if you are one of the many 1/4-inch tape cartridge users that assume 3M's cartridges just *have* to be "good enough" for today's high performance tape drives, read these simple facts to understand why that isn't true anymore.

PILOTS HAVE A SAYING, "There are those who have made a wheels-up landing—and those who will."

You can apply this expression to those who have lost data and those who will. Unfortunately, data loss isn't always because users haven't backed-up their hard disk. Sometimes it's because their 1/4-inch tape cartridge, where they back up their hard disk, developed hard errors—those insidious errors that tend to increase over time. That's why Cartrex has developed a 1/4-inch data cartridge for today's high performance drives that virtually eliminates errors.

## Why a new cartridge

When 3M announced its cartridge in 1971, it was designed for a low capacity tape drive with less than 3 megabytes—2.88 to be exact. The tape was low in density—1600 bits per inch with only 4 tracks and 300 feet of tape.

The tolerances required for the tape drives of the early 1970's were fine for then, but today's tape drives require much tighter tolerance. Today's tape cartridges must work with drives that have 9 or more tracks and bit densities as high as 12,000 bits per inch on 600 feet of tape. That means capacity increases of 2,000 percent packed into the same cartridge.

The reasons that yesterday's cartridge technology simply won't work properly in today's high capacity drives is inherent in the cartridge design.



The new Cartrex 1/4-inch tape cartridge is the first new tape cartridge design in almost a decade and a half. Tape drive manufacturers now have a new cartridge technology which allows them to advance beyond this previous artificial barrier.

it's no surprise to find out that the closer the tape drive head is to the tape, the better the reading. This closeness is particularly important when the embedded iron filings get packed tighter in today's high density tape.

It's also important with the increase in the number of tracks. After

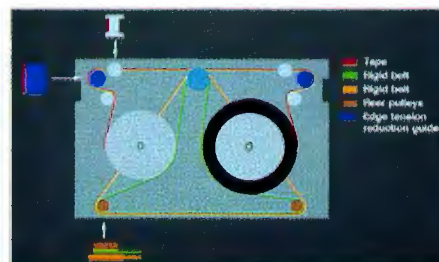
all, you wouldn't want the head to be reading an adjacent track any more than you'd want it reading more than one magnetic representation of a bit.

Unfortunately, tape tension historically has not been constant. As the tape unwound, the tension increased. What's important is both the *amount* and *range* of tension. A fluctuating increase or decrease in tension is as unacceptable as low tension is in the first place. As the accompanying graphs

With the significant increases in capacity, the three culprits that make cartridge tolerances so important are fluctuating tape tension, redeposit nodules, and instantaneous speed variations (or ISV).

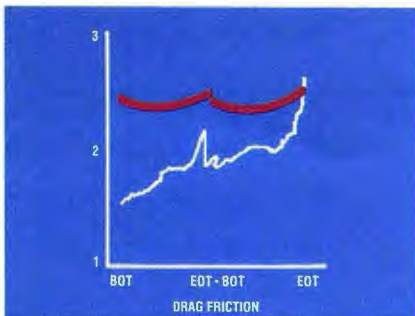
## Tape Tension

Any child who has played with a magnet understands that as the magnet is separated from metal, the magnet's ability to work is decreased. So



The Cartrex cartridge design (upper left) uses the N2 principle which creates head-to-tape tension by applying a mechanical differential at the rear pulley between a stiff transport belt and a stiff tensioning belt, indicated in green and yellow in the color schematic (upper right).

The conventional 3M design applies drag at the rear pulley to create tension, which creates heat, and limits future speeds much above 90 inches per second.



Good head-to-tape tension ensures the highest probability of reliably capturing data. Fluctuating tape tension allows data loss due to head-to-tape separation and smearing redeposit nodules across the tape head. The Cartrex cartridge, compared to the conventional design, creates constant and higher tension.

show, the Cartrex cartridge has higher tension and flatter profile than the 3M cartridge. This means more reliable data across the entire tape.

### Redeposit Nodules

Another reason to keep constant tension is to avoid "redeposit nodules" from smearing across your tape drive's head. What are redeposit nodules? They are the insidious flakes of tape media that break off from the edges of the tape and get dragged up to the edge of the tape head. If the tension is low, or becomes low when the tape starts or reverses, the flakes come up over the edge, get smeared over the head, and reduce its ability to read the data.

Even worse, however, is that these redeposit nodules are dragged along the surface of the tape and get embedded and packed over time. When your drive tries to read the data, the redeposit nodules act as a tent pole holding up the tape away from the head. As a result, even the best error-recognition algorithm can only tell you one thing—you've lost the data.

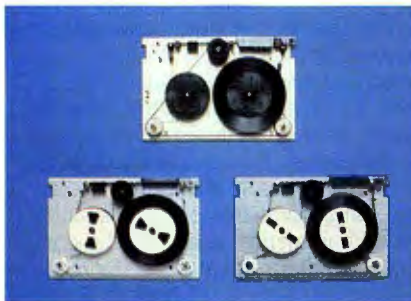
You might be wondering what causes the flaking in the first place. Again, it is cartridge design. The basic design uses a tape guide, shown in the accompanying illustration. The problem with this approach, is that it presupposes that the tape will always run parallel to the top and bottom caps of the tape guides. At the low speeds of

30 inches per second typical of when the 3M cartridge was designed, it was less of a problem. But at today's speeds of 90 inches per second and more, the tape wanders. When it presses against the top of the tape guide, the tape's edge pressure builds. Not only does media flake off, but you lose data due to the "coining" or "scalping" effect.

Cartrex eliminated the cause of the tape coining or scalping by developing a barrel-shaped roller placed prior to the tape guide. The laws of physics show that by riding on a rounded barrel, the tape will always seek the middle, reducing the tape edge pressure. This seemingly simple addition causes the tape to always enter the tape guide with zero edge pressure. In this way, the possibility of media flaking off and creating redeposit nodules is virtually eliminated.

### Instantaneous Speed Variation (ISV)

Instantaneous speed variations is exactly what it sounds like—small, instantaneous changes in tape speed as it crosses the tape head. At slow tape



You can compare the Cartrex design on top with the conventional 3M design (lower left) and DEI, a 3M licensee (lower right). The omission of "edge tension reduction guides" (indicated in dark blue on the color schematic) on either the 3M or DEI design means that tape edge pressures will increase causing the magnetic media to flake off, smear across the tape head, and cause "redeposit nodules" to become embedded in the tape.

speeds and low bit densities—like the 1971 standard of 30 inches per second and 1,600 bits per inch—ISV wasn't as big a problem. At that time, the bits were crossing the head at 48,000 bits per second.

Today, however, the story has changed. 90 inches per second and 8,000 bits per inch mean that 720,000

bits cross the head every second. A 1,500% increase.

As you may have guessed, speed fluctuations in the 48,000 bits per second made reading data difficult for tape drive electronics. But when the electronics have to guess whether or not the bit rate of 720,000 bits per second is accurate, the electronics can become overwhelmed.



High speed tape without the "edge pressure reduction guide" seldom enters tape guides parallel to the top and bottom. The edge pressure which results creates "scalping" or "coining" on the tape. The effect is data loss due to head-to-tape separation, flaking media that smears across the head, and "redeposit nodules" that create hard errors.

### Never a Single Issue

Your tape drive seldom has the luxury of dealing with an isolated problem. It's usually a combination of ISV, redeposit nodules, and tension problems all together. Now you understand why Cartrex wanted to develop a cartridge for a market that needed a modern alternative.

### Where to get it

Not only has Cartrex improved on the industry's 15 year old technology, they have done it for a competitive price.

Now you can have peace of mind when you back up your hard disk on today's sophisticated tape drives.

And you can have it fast. Simply phone:

**(619) 485-6603 EXT 400**

and give Cartrex your credit card number and they will send your cartridges by return mail.



**CARTREX CORPORATION**  
MARKETING HEADQUARTERS

11590 WEST BERNARDO CT. SUITE 230

SAN DIEGO CALIFORNIA 92127

619-485-6603

**CARTREX**

Inquiry 52 for End-Users. Inquiry 53 for DEALERS ONLY.

DECEMBER 1985 • BYTE 13

## MORE TRAVESTY

Murray Lesser's "Travesty Revisited" (July, page 163) is the second BYTE article to present a compiled-language version of Brian Hayes's random text generator (the first was "A Travesty Generator for Micros" by Hugh Kenner and Joseph O'Rourke, November 1984, page 129). If the subject is really that interesting, an interpreted BASIC generator would make it available to a larger number of casual programmers. Lesser's program is too loopy to run well in an interpreted language, but a useably fast version could be derived from his listing if lines 86 through 106 were replaced with those shown in listing 1.

My code embodies a small variation on the Hayes algorithm but is functionally equivalent to it. It requires a BASIC interpreter that allows long string variables, and LETTER(*n*) should be dimensioned to 255, which is large enough to handle input files of 10,000 characters or so as long as the scan order is greater than 2.

A generator using this strategy and written in MS-BASIC (1.0) on a Macintosh runs a 1000-character in/out benchmark in 90 seconds. This compares well enough with the 130 seconds reported by Kenner and O'Rourke for the same test on a Heath H-89 with the original form of their Pascal generator. This is 5 to 10 times faster (depending on scan order and input-file size) than an interpreted generator using the Hayes algorithm as given.

Travesties become tiresome very quickly, but the method itself can lead to valuable insights into written language if one has the patience to follow up some of its formal results. For example, the generator allows the computation of several constants that measure aspects of the text in

the input file. The easiest of these to handle is linear convergence, which is given by  $(\Sigma(1/T))/C$ , where  $T$  is the number of matches to each gram and  $C$  is the total number of output characters. Linear convergence measures the tendency of the source text to reproduce itself through the generator. At high scan orders (greater than the number of characters in the longest recurring string in the text) its value is 1, and for lower orders, less than 1. It can be approximated very well by adding the function  $T = T + 1/LETTER(0)$  as the second line under the WHILE statement above, and then dividing  $T$  by the total number of output characters at the end of the run. If the convergences measured for orders 3 through 8 are plotted and the curves compared for different kinds of text and for different authors, some very interesting things suggest themselves. It is fascinating to realize that so nebulous a quality as "literary style" can be formally measured, and that there is a numerical aspect to the comparative study of literature.

ROBERT GREEN  
Annapolis, MD

*Murray Lesser replies:*

*In response to Mr. Green's letter, I offer a few comments. First, the program as published does an order-4 verse scan of "Jabberwocky" (1013 bytes) with 1000 bytes output in 33 seconds on my IBM PC. Time is by stopwatch, files are on memory-mapped virtual disk.*

*Second, the intent was to make minimum changes to the program structure established in the original article by Kenner and O'Rourke. The purpose of the piece was to show the effect of a more*

*suitable language, not to monkey with the algorithm.*

*A major performance improvement for very long input files (over 5K bytes) is to eliminate the repeated input string concatenation with every character accepted. This can be done with a couple of assembly-language subroutines to write the entire input string into string space only once, albeit one character at a time. I leave this as an exercise for the interested reader.*

*If the technique is to be used for anything other than a stunt, the program should be restructured in a major way. For example, if one were to implement Mr. Green's suggestion of using it to compare "literary style," the program should run all the desired outputs from a single reading of the input, gather the appropriate statistics, and then move on to the next input file.*

*Finally, I wouldn't use an interpreted language for anything. In addition to the performance improvement, it is much easier to write and debug long programs for a compiler than it is for an interpreter. Try it; you'll like it.*

## HOPE AND PASCAL RECURSION

I would like to respond to Roger Bailey's article "A Hope Tutorial" (August, page 235). In comparing Pascal with Hope on the mult function, he only showed an example of writing the function in Pascal using iteration. It is possible to write the function in Pascal using recursion (as shown in listing 2). This method is not the method normally taught to students, since recursion is not always the best route to follow. Except for that one example, I think

(continued)

Listing 1: Reader Green's modification to TRAVPCI.BAS.

```
LET I = INSTR(STRING,PATTERN)      'Scan for first match.
LET LETTER(0) = 0                  'Initialize match count
WHILE I > 0 AND I <= LEN(STRING) - N.PAT 'Set loop conditions
LET LETTER(0) = LETTER(0) + 1      'Increment match count
LET LETTER(LETTER(0)) = I          'Record match location
LET I = INSTR(I + 1,STRING,PATTERN) 'Scan for next match
WEND                                'Repeat
LET L = INT(LETTER(0)*RND) + 1      '1 < random integer <= match count
LET OUTCHAR = MID$(STRING,LETTER(L) + N.PAT,1) 'Record selected letter
```

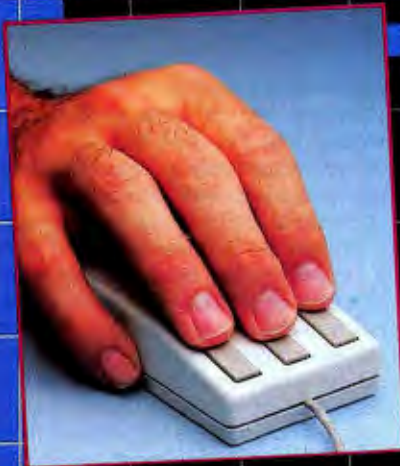
LETTERS POLICY: To be considered for publication, a letter must be typed double-spaced on one side of the paper and must include your name and address. Comments and ideas should be expressed as clearly and concisely as possible. Listings and tables may be printed along with a letter if they are short and legible.

Because BYTE receives hundreds of letters each month, not all of them can be published. Letters will not be returned to authors. Generally, it takes four months from the time BYTE receives a letter until it is published.



**THE ACCENT™ IS ON EXPANDED MEMORY...**

**WITH MAYNARD'S NEW LOTUS-COMPATIBLE CARD!**



Now, Maynard gives you 2MB of Lotus-compatible Expanded Memory with Accent™. Designed expressly for your personal computer, Accent™ adds memory power to Lotus 1-2-3\*, Symphony\*, and all other Expanded Memory programs so you can create larger spreadsheets than ever! An optional mouse places speed, access, and customized commands at your fingertips, saving time and eliminating inconvenient, multi-key cursor controls. Accent™ is available at the finest computer retail stores everywhere. Contact your local dealer or write to us today for product information.

\*Lotus 1-2-3 and Symphony are trademarks of Lotus Development Corporation.

**Accent™**  
Expanded Memory Card by Maynard Electronics

**Maynard Electronics**  
Shaping tomorrow's technology.

430 E. SEMORAN BLVD., CASSELBERRY, FL 32707 305/331-6402

Inquiry 228

# Why you should ignore 95% of the news

**Because NewsNet automatically finds the 5% you need.** From our database of authoritative, up-to-date business news, you get just the stories you want, delivered instantly to your microcomputer. You choose your own, unique keywords, and NewsNet saves—just for you—every new article containing those words. Or, you can find that critical 5% on your own, with NewsNet's powerful keyword searching and text scanning.

Just what's in NewsNet's database? The full text of over 300 valuable business newsletters. In-depth news, written by experts, filled with analysis and interpretation. News from 34 different industries and professions—everything from Computers to Investments, from Management to Telecommunications. Plus extras such as wire services, online stock quotes, air fares, and business credit reports.

**Computer News:**  
**Your Specialty is our Specialty.** Here are just a few of the 25 Electronics and Computers newsletters on NewsNet:

The Artificial Intelligence Report  
The Business Computer  
The Computer Cookbook  
Consumer Electronics  
Data Base Informer  
Electronic Mail News  
Outlook on IBM  
Japan High Tech Review  
Micro Moonlighter

Mini/Micro Bulletin  
Personal Computers Today  
Robotronics Age  
Newsletter  
Semiconductor Industry & Business Survey  
The Seybold Report on Professional Computing  
Stanley Klein Newsletter on Computer Graphics

**ONLINE  
BUSINESS  
NEWS**

# NewsNet

**Call Today!**  
We'll send all you need to subscribe.

**(800)  
345-1301**

(in PA 215-527-8030)

NewsNet Inc. 945 Haverford Road, Bryn Mawr, PA 19010

## LETTERS

Listing 2: A recursive mult function written in Pascal.

```
01 program test (input, output);
02
03 var
04   x,y, num : Integer;
05
06 function mult (x,y :integer)
   :integer;
07
08 begin
09   if y = 0 then
10     mult := 0
11   else
12     mult := mult(x,y-1) + x
13 end;
14 begin
15   repeat
16     read (x,y);
17     num := mult (x,y);
18     writeln (' num is ', num : 3);
19   until num = 0
20 end.
```

this was an excellent presentation of Hope. Since I have no way of testing out the language, I can only say that Hope appears to be an easy language to understand.

CHARLENE FILZ  
Santa Clara, CA

**Roger Bailey replies:**  
Charlene Filz is certainly correct in stating that the mult function may be written recursively in Pascal. My example using a loop was not a deliberate misrepresentation of Pascal but an attempt to compare a "traditional" iterative program with Hope's recursive approach. In the former, a sequence of data values (such as the successive values of prod in the example) is ordered in time and must be generated in that order; in Hope, a sequence of values is ordered only in space and may be generated in any order. This is shown most clearly in the Pascal and Hope versions of the programs for printing a sequence of natural numbers, and it is the property of Hope that makes it so suitable for parallel machines such as ALICE.

As Ms. Filz correctly states, the recursive method is not normally taught to students, which is very unfortunate. Recursion is widely regarded by practicing programmers as "inefficient" or even "unnatural," yet neither of these criticisms bears up to examination. The

(continued)

# Introducing In·a·Vision

## Complex Drawing Made Easy

We created In·a·Vision just for you. The engineer who needs more productive drafting support. The designer who needs versatility for alternate ideas or quick revisions. The architect who needs to manage a variety of working drawings. And the businessman who needs first-class presentation materials as well as detailed flow charts and organization charts.

### Point. Click. Draw.

Now all you do to create complex technical drawings, systems designs, blueprints, diagrams, illustrations, and proposals is point,

click and draw. With In·a·Vision's mouse support, windowing, icons, and pull-down menus, you produce drawings more quickly, accurately and efficiently than ever before.

In·a·Vision's advanced technology includes many features not found on comparable systems costing thousands more. For example,

you can pan around in a user-definable drawing space up to 68" x 68" and zoom in on specific areas for greater detail. Scale, rotate and dimension symbols, fill an area with your choices of predefined colors and patterns, as well as draw lines with multiple styles and widths. Other features include overlays, predefined and user-definable page sizes, rulers, grids, and symbol libraries.

### Multi-tasking in a PC-based CAD system.

In·a·Vision uses multi-tasking to enable you to continue drawing while printing hard copies as well as edit multiple drawings simultaneously.

Unlike more expensive CAD systems, In·a·Vision is easy to install and use. Even the computer novice can be productive in less than a day. And In·a·Vision is not copy-protected.

### Ten Day Trial Period.

We're so sure In·a·Vision will

make you more productive, we'll give you ten days to prove it to yourself. If In·a·Vision doesn't improve your productivity, return it within ten days for a full refund.

In·a·Vision will make your complex drawing tasks simple and make you more productive. Satisfaction guaranteed. Dial 800-272-3729 to order or for a free brochure. In Texas

or for customer support, call (214) 234-1769. MICROGRAFX, Inc., 1820 North Greenville Avenue, Richardson, Texas 75081.

**MICROGRAFX™**  
The Picture of Success.

(Most popular graphics cards, plotters and printers supported.)  
Microsoft Windows compatible. Call for specific operating environment requirements.

Inquiry 242

In·a·Vision and MICROGRAFX are trademarks of MICROGRAFX, Inc.  
Windows and Microsoft are trademarks of Microsoft, Inc.

# DataSaver<sup>400</sup><sup>®</sup>

## Standby UPS

Power protection for high-level microcomputers with peripherals, multi-tasking systems, and communication networks is here, now, with the 400 Watt DataSaver. Placed between the desktop computer and system monitor, the DataSaver 400 features a master power switch directing four power outlets. 2-stages of overvoltage transient suppression and built-in, automatically recharged batteries stand by to assure clean, uninterrupted power for the five minutes you might need to shut down before the power shuts off. 90 and 200 Watt models available.



**Cuesta Systems Corporation**  
3440 Roberto Court  
San Luis Obispo, CA 93401

©1985, Made in U.S.A.  
Write or call 805/541-4160  
Dealer, O.E.M. inquiries invited

## LETTERS

*first goal of all programming is to produce programs that are demonstrably correct. What use is the program that is highly optimized yet gives unreliable results or crashes unpredictably?*

*Clarity and conciseness are our greatest aids to correct programming and recursion provides both. Compare Ms. Filz's recursive mult with my iterative version: It consists of only two statements, has no variables, and more importantly, no concept of states because no values get changed when it's evaluated. It can be seen to be correct without testing or hand-simulation, whereas the iterative program needs much more careful examination before we can be sure it will work correctly.*

*Except in rare circumstances, I would always favor a recursive Pascal program over the equivalent iterative one. Recursive procedures are handled as efficiently in Pascal as nonrecursive ones. As for the charge that recursion is unnatural, I would simply remark that all programming languages are unnatural until they've been learned. In the Department of Computing at Imperial College, we teach recursion before any of Pascal's loop constructs, and our students regard it as completely natural. To those of your readers like Ms. Filz who like the style of Hope but have no way of testing it, I should mention that it's even possible to write Pascal programs that manipulate large data structures in a completely functional style.*

### OKAY, BLAME THE COMPUTER ... SOMETIMES

It was interesting to read Michael Russell's letter ("Don't Blame the Computer," August, page 14). His examples of what some people called "computer mistakes"—poorly scheduled lunch periods and a \$6539.97 phone bill—are indeed, as he points out, attributable to human error.

I get the impression from his letter, however, that he is unaware of the fact that true machine-based errors are very common.

Over the eleven years in which I have been working with computers, it seems like I have encountered a roughly equal number of machine-based and human-based computer errors.

A bug in software, an obvious design flaw in hardware, or an error in operations are all human-based errors, of course. Machine-based errors occur when, for example, a semiconductor component fails (for no apparent reason), when a

*(continued)*

## NEW RELEASE PC SOFTWARE

### Take total control of your PC from the Inside!!

**Machine Code Tutorial** helps you understand and program the very heart of your PC or compatible. Using several unique teaching techniques, your PC becomes the teacher as you explore the 8088 CPU and hundreds of other subjects as they relate to your PC.

**Machine Code Tutorial** is intelligent teaching software which will bridge the gap between having a general knowledge of BASIC and being able to use and understand a typical 8088 CPU manual. This course will give you the ability to program the CPU directly and thus move with confidence amongst the "Grass Roots" of PC software design and architecture. You will then assume total control of your PC. A working understanding of what is happening behind the scenes will give you a major advantage in almost all areas of PC usage.

#### SUBJECTS COVERED INCLUDE:

- |                               |                                |                                   |
|-------------------------------|--------------------------------|-----------------------------------|
| Using the supplied Monitor    | High & Low Ram                 | Keyboard Control & Extended Codes |
| Hand Coding the 8088 CPU      | Rom Bios Routines              | Codes                             |
| Most 8088 Mnemonics           | Self Testing                   | Keyboard Scan Codes               |
| 8088 Architecture             | Compilers                      | Special Control Areas             |
| — Registers & Flags           | Character Set                  | Joystick Control                  |
| — Interrupts, Speeds & Timing | Speaker Usage                  | Add-on Boards                     |
| "Secret" 8088 Codes           | Disk Copy Protection Routines  | Clock Functions                   |
| Assembly Language             | Other Software Copy Protection | Dos Memory Map                    |
| High & Low Level Languages    | Communication with Printers    | Device Drivers                    |
| Interfacing BASIC             | Communication with Modems      | Cassette Interface                |
| Basic Work Areas              | Networking                     | Program Development               |
| Parameter Passing             | Parallel & Serial Interfacing  | — Sound Effects Generator         |
| Disk Operating System         | Memory Map Explained           | — Speech Digitizing               |
| — Scratch Areas               | Screen Manipulation & Control  | — Creating Real Time              |
| — File Headers                | Programming the 6845 CTR       | Animation                         |
| — Entry Points                | Cursor Control                 | — Games Development               |
| — Disk Allocation             | DMA Channels                   | — Programming Tips                |
| — Initialization              | Graphics Modes & Storage       |                                   |
| — Available Functions         | Colour Control                 |                                   |
| — File Management             | Game Controller                |                                   |
| — Disk Transfer Areas         | Keyboard Re-assignment         |                                   |

AN AFFORDABLE  
**\$49.95**

**Machine Code Tutorial** requires an IBM PC or compatible with 128K RAM and one disk drive. Check your local computer store or wherever software products are sold. If unavailable, complete the Order Form and send to Intouch Computing. Dealer enquiries invited. Intouch Computing is a division of Intouch Australia Pty Ltd.

#### ORDER FORM

Please airmail me "Machine Code Tutorial" for a total price of \$49.95 including first class airmail.

Name .....  
Address .....  
Town/Suburb ..... Area Code ..... Country .....

#### Method of Payment: (Please tick one)

- Personal Cheque  Bank Cheque  Money Order  Mastercharge  Visa  
 Diners Club  Bankcard  Other Credit Card  Other method of payment.

Name on credit card (If applic) .....  
Credit card No. (If applic) ..... Exp. ....

Send to "Intouch Computing", 6th Floor, 1 Kent St, Bicton, Western Australia, 6157. Ph: (09) 339 4431

# For those times when 640K memory just doesn't seem to be enough.

AST introduces RAMpage!™ with up to 2 Mb of PC RAM.

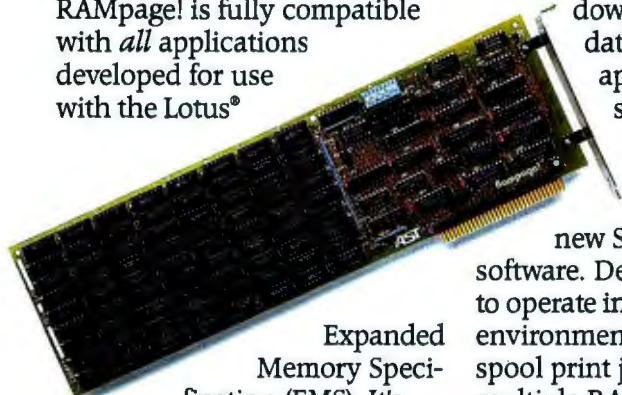
Feed your byte-gobbling applications with the expanded memory of RAMpage! And stop wasting valuable time with frustrating "Memory Full" messages.

### Breaking The 640K Barrier.

RAMpage! breaks through the PC's 640K-byte barrier delivering up to 2 megabytes of parity checked memory for expanded memory applications. Up to 4 RAMpage! boards can be used in a single PC for a full 8 Mb of memory per system.

### EMS Compatibility.

RAMpage! is fully compatible with *all* applications developed for use with the Lotus®



Expanded Memory Specification (EMS). It's also supported by Enhanced EMS software—offering more versatility for even greater value and performance.

New software updates of popular applications like Symphony™, Framework™ and 1-2-3®, designed

specifically for use with EMS boards, are now becoming available. And a wide variety of other packages, including windowing, spreadsheet, database and CAD applications, will soon follow.

**A Super Bonus.** RAMpage! includes AST's new SuperPak™ utility software. Designed specifically to operate in expanded memory environments, it allows you to spool print jobs and create multiple RAM disks for added performance.

Don't let your valuable byte-hungry applications starve. Get RAMpage! today. For more information call our Customer Information Center (714) 863-1333.

Or write, AST Research, Inc., 2121 Alton Avenue, Irvine, California 92714  
TWX: 753699 ASTR UR.

### Specifications

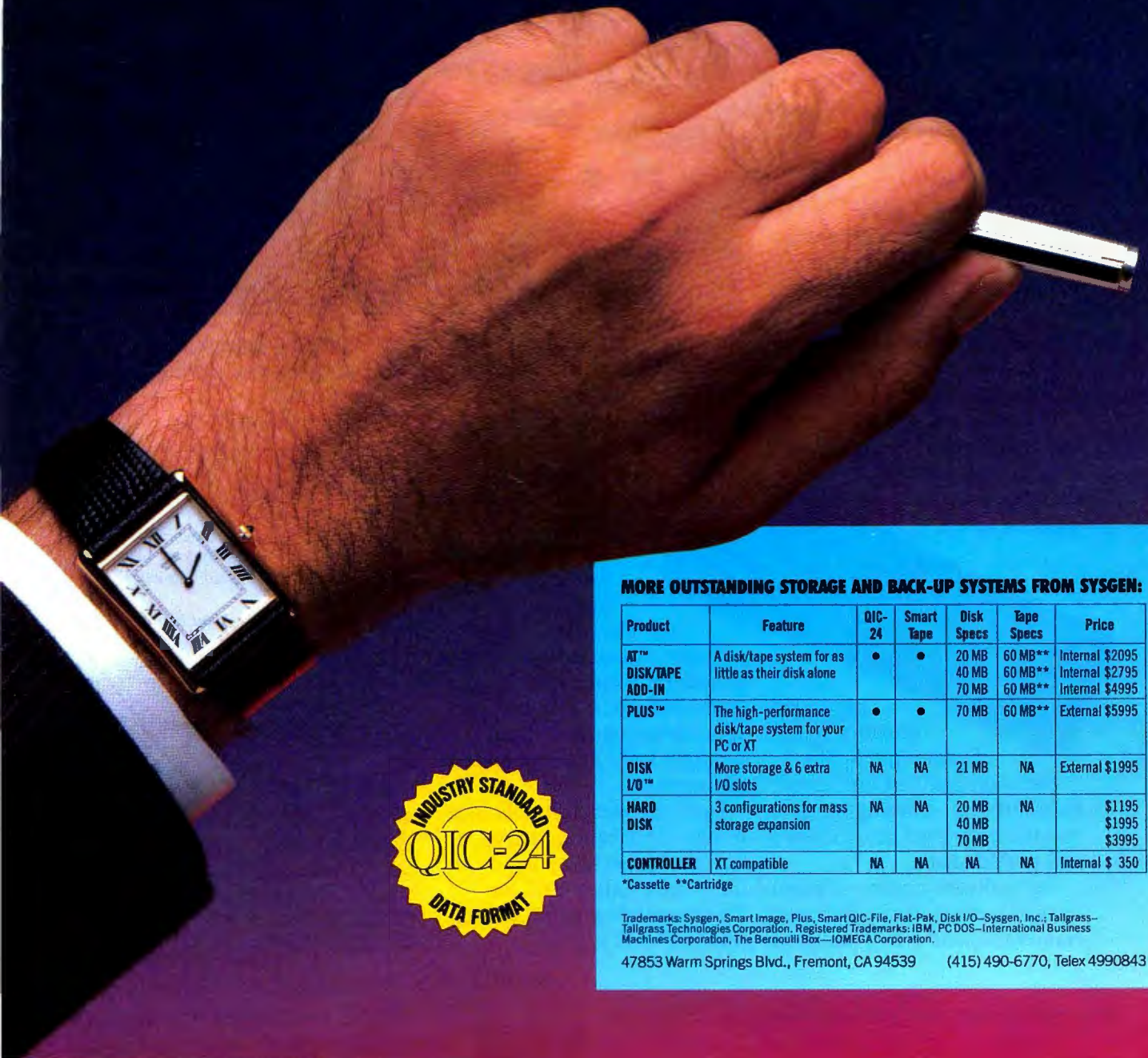
- For use with IBM® PC, PC-XT, 3270 PC and compatibles.
- Up to 2.0 Mb expanded memory per board—8.0 Mb total per system.
- Socketed and user upgradeable with 256K DRAMS.
- Fully compatible with Lotus EMS 3.0.
- Enhanced EMS design for greater performance with enhanced EMS software.
- AST Expanded Memory Manager software standard.
- New SuperPak™ utility software standard.

## AST RESEARCH INC.

RAMpage! and SuperPak trademarks of AST Research, Inc. Lotus and 1-2-3 registered trademarks and Symphony trademark of Lotus Development Corp. Framework trademark of Ashton-Tate. IBM registered trademark of International Business Machines Corp.



**IT'S 2PM. OVER AT THE OFFICE  
YOUR SYSGEN SYSTEM JUST WOKE UP  
AND BACKED-UP YOUR PC HARD DISK.  
HOW ABOUT THAT!**



**MORE OUTSTANDING STORAGE AND BACK-UP SYSTEMS FROM SYSGEN:**

Product	Feature	QIC-24	Smart Tape	Disk Specs	Tape Specs	Price
<b>AT™ DISK/TAPE ADD-IN</b>	A disk/tape system for as little as their disk alone	•	•	20 MB 40 MB 70 MB	60 MB** 60 MB** 60 MB**	Internal \$2095 Internal \$2795 Internal \$4995
<b>PLUS™</b>	The high-performance disk/tape system for your PC or XT	•	•	70 MB	60 MB**	External \$5995
<b>DISK I/O™</b>	More storage & 6 extra I/O slots	NA	NA	21 MB	NA	External \$1995
<b>HARD DISK</b>	3 configurations for mass storage expansion	NA	NA	20 MB 40 MB 70 MB	NA	\$1195 \$1995 \$3995
<b>CONTROLLER</b>	XT compatible	NA	NA	NA	NA	Internal \$ 350

\*Cassette \*\*Cartridge

Trademarks: Sysgen, Smart Image, Plus, Smart QIC-File, Flat-Pak, Disk I/O—Sysgen, Inc.; Tallgrass—Tallgrass Technologies Corporation. Registered Trademarks: IBM, PC DOS—International Business Machines Corporation, The Bernoulli Box—OMEGA Corporation.

47853 Warm Springs Blvd., Fremont, CA 94539 (415) 490-6770, Telex 4990843

**THE SYSGEN FLAT-PAK:  
UNBEATABLY AFFORDABLE  
DISK AND TAPE ADD-ON**



- \$1395 10Mbyte disk/20 Mbyte cassette tape
    - Automatic tape back-up feature
    - Automatic error correction
  - \$2095 20Mbyte disk/60Mbyte cartridge tape
    - QIC-24 industry standard tape data format
    - Automatic tape back-up feature
    - Automatic error correction
- Optional XT compatible controller:  
Add \$350

**THE SMART QIC-FILE:  
POWERFUL 60MBYTE  
BACK-UP**



- \$1395 Internal 60Mbyte
- \$1495 External 60Mbyte
- QIC-24 industry standard tape data format
- Automatic tape back-up feature
- Automatic error correction

**THE SMART IMAGE:  
A BEST SELLER  
IMPROVED**



- \$795 Internal
- \$895 External
- 20 Mbyte cassette tape back-up
- Automatic back-up feature
- Automatic error correction

**THE ONLY FAMILY OF AUTOMATIC TAPE BACK-UP SYSTEMS AVAILABLE.**

Sysgen,<sup>™</sup> already the bestseller in IBM<sup>®</sup> tape back-up systems, just got even better. Now Sysgen tape back-up works by itself, automatically! Set it once, like a VCR. The Sysgen tape backs-up your hard disk up to twice daily, seven days a week, as programmed. If you're away, your data's protected. If you're using your system, it waits until you're finished, then backs-up your data by selected files.

Automatic tape back-up is a Sysgen *exclusive*, and a hard disk necessity.

**Sysgen gives you the QIC-24 standard too.**

QIC-24 is the standard tape data format for interchangeable tape. A must. Sysgen is the leader.

**A rugged and reliable system: An unbeatable price/performance value.**

You need a system you can *count* on. Make sure you get Sysgen quality. And Sysgen disk and tape products give you more for your dollar. Take this ad with you when you shop. We invite comparison.

Make sure you back up your data with the QIC-24 industry standard and Sysgen *smart* innovations.

Sysgen systems are your *smartest* choice because they let nothing stand between you—and your work. A reliable Sysgen hard disk keeps your data on-line—no juggling disks or cartridges. And only Sysgen backs-up your data *automatically*.

Sysgen's disk and smart tape family is IBM standard compatible for all current versions of PC DOS<sup>®</sup>. Whatever your storage and back-up needs, Sysgen offers the best solution.

Compare Tallgrass<sup>™</sup>

Compare Bernoulli<sup>®</sup>

You'll buy Sysgen.

For a Sysgen dealer near you, call

**1-800-821-2151.**

**Dept. 17**



**SYSGEN**  
INCORPORATED

# Introducing the Most Powerful Business Software Ever!

FOR YOUR IBM • APPLE • MAC • TRS-80 • KAYPRO • COMMODORE • MSDOS OR CP/M COMPUTER\*

OVER  
**100,000**  
SOLD



## The VERSABUSINESS™ Series

Each VERSABUSINESS module can be purchased and used independently, or can be linked in any combination to form a complete, coordinated business system.

### VERSARECEIVABLES™ \$99.95

VERSARECEIVABLES™ is a complete menu-driven accounts receivable, invoicing, and monthly statement-generating system. It keeps track of all information related to who owes you or your company money, and can provide automatic billing for past due accounts. VERSARECEIVABLES™ prints all necessary statements, invoices, and summary reports and can be linked with VERSALEDGER II™ and VERSAINVENTORY™.

### VERSAPAYABLES™ \$99.95

VERSAPAYABLES™ is designed to keep track of current and aged payables, keeping you in touch with all information regarding how much money your company owes, and to whom. VERSAPAYABLES™ maintains a complete record on each vendor, prints checks, check registers, vouchers, transaction reports, aged payables reports, vendor reports, and more. With VERSAPAYABLES™, you can even let your computer automatically select which vouchers are to be paid.

### VERSAPAYROLL™ \$99.95

VERSAPAYROLL™ is a powerful and sophisticated, but easy to use payroll system that keeps track of all government-required payroll information. Complete employee records are maintained, and all necessary payroll calculations are performed automatically, with totals displayed on screen for operator approval. A payroll can be run totally, automatically, or the operator can intervene to prevent a check from being printed, or to alter information on it. If desired, totals may be posted to the VERSALEDGER II™ system.

### VERSAINVENTORY™ \$99.95

VERSAINVENTORY™ is a complete inventory control system that gives you instant access to data on any item. VERSAINVENTORY™ keeps track of all information related to what items are in stock, out of stock, on backorder, etc., stores sales and pricing data, alerts you when an item falls below a preset reorder point, and allows you to enter and print invoices directly or to link with the VERSARECEIVABLES™ system. VERSAINVENTORY™ prints all needed inventory listings, reports of items below reorder point, inventory value reports, period and year-to-date sales reports, price lists, inventory checklists, etc.

### VERSALEDGER II™ \$149.95

VERSALEDGER II™ is a complete accounting system that grows as your business grows. VERSALEDGER II™ can be used as a simple personal checkbook register, expanded to a small business bookkeeping system or developed into a large corporate general ledger system without any additional software.

- VERSALEDGER II™ gives you almost unlimited storage capacity (300 to 10,000 entries per month, depending on the system),
- stores all check and general ledger information forever,
- prints tractor-feed checks,
- handles multiple checkbooks and general ledgers,
- prints 17 customized accounting reports including check registers, balance sheets, income statements, transaction reports, account listings, etc.

VERSALEDGER II™ comes with a professionally-written 160 page manual designed for first-time users. The VERSALEDGER II™ manual will help you become quickly familiar with VERSALEDGER II™, using complete sample data files supplied on diskette and more than 50 pages of sample printouts.

### SATISFACTION GUARANTEED!

Every VERSABUSINESS™ module is guaranteed to outperform all other competitive systems, and at a fraction of their cost. If you are not satisfied with any VERSABUSINESS™ module, you may return it within 30 days for a refund. Manuals for any VERSABUSINESS™ module may be purchased for \$25 each, credited toward a later purchase of that module. All CP/M-based Computers must be equipped with Microsoft BASIC (MBASIC or BASIC-80)

To Order:  
Write or call Toll-free (800) 431-2818  
(N.Y.S. residents call 914-425-1535)

- \* add \$3 for shipping in UPS areas
- \* add \$4 for C.O.D. or non-UPS areas
- \* add \$5 to CANADA or MEXICO
- \* add proper postage elsewhere

Inquiry 159

DEALER INQUIRIES WELCOME

All prices and specifications subject to change / Delivery subject to availability.

# COMPUTRONICS!

50 N. PASCACK ROAD, SPRING VALLEY, N.Y. 10977





mechanical component (e.g., a disk-drive head assembly) works itself out of alignment, when a bad spot appears on a magnetic recording surface (within its rated lifetime), when a normally reliable data-transmission link garbles a message, when oxide builds up on a mechanical keyboard switch causing it to stop working, when a potentiometer (e.g., in a joystick) wears out prematurely, when supposedly nonvolatile (battery backed-up) memories get shuffled, when metal or plastic fatigue causes a part in tension to fail (various printer components are prone to this one), and even (remember this?) when a card reader chews up a punched card because of a frayed edge created by prior passes through the reader.

Some people will likely object to this list on the basis that all these errors have some cause external to the computer itself. Some possibilities are: an error made during manufacture, a cosmic ray striking an integrated circuit, static electricity, or an oversight in the design.

But, to be fair, realize that human errors have their external causes as well. A programmer may be distracted by a phone call and return to his terminal with his thought pattern disturbed; he may then unknowingly introduce a bug into the program. A looming deadline may mean that prerelease testing is cut short. Many other examples (some would say "excuses") can be found.

Here I have been making the distinction between machine-based error and human error. Mr. Russell, however, simply refers to "computer errors." Since most users (understandably) view the computer as an undifferentiated entity separate from themselves, it may be more appropriate to draw the distinction between computer error and user error.

It seems to me the computer did make a mistake in printing the \$6539.97 phone bill. So what if the programmer programmed the fault into the software? The fact that the computer error could have been prevented by a programmer at some point in the development of the system does not change the fact that the computer made the mistake.

Of course, a computer is only a tool. If the operator or user enters wrong data or gives faulty commands, the direct result is his mistake (user error).

If someone makes a mistake while creating a program, the result is a faulty program, or in a larger sense, a flawed computer. When that program is later executed, any wrong answers from correct

(continued)

# The most flexible printer-sharing device you can buy is from BayTech



Or any combination in-between

Introducing the new Model 528DB multiport controller. It will let eight users automatically share one printer, or in multiple printer applications, let users code-select a specific printer or contend for the first available printer. Flexible, user-selectable features include: the number of printers versus the number of computers, printer select code, CTS DTR or XON-XOFF handshaking, operating mode, form-feed mode, header-page message, disconnect time-out, and baud rates. To set up, simply connect the multiport between your computers and printers. It interfaces easily with any RS-232C serial device. Model 528DB with 9 ports, \$659. Larger models also available.

Now!  
Models with  
up to

## 1 megabyte buffer



BAY TECHNICAL ASSOCIATES, INC.  
DATA COMMUNICATIONS PRODUCTS

800-523-2702

Highway 603, P.O. Box 387, Bay Saint Louis, Mississippi 39520  
Phone: 601-467-8231 Telex: 910-333-1618 (BAYTECH)

user input can rightly be called computer errors. It is interesting to note that a program could have several bugs (in that it did not correctly meet the design objectives) and never generate any errors (where the conditions to trigger the errors never occur in practice).

Why do we wish to ascribe to computers the inability to err? If our child hits a baseball through a window we are quite

ready to blame him for it, not ourselves for failing to ensure that "not hitting the window" had a sufficiently high priority in his "operating system."

In summary, my point is this: Computers are prone to errors, just as humans are. This is true regardless of whether you use the narrow definition of a machine error or the broader (and I feel fairer) concept of the computer system as a whole.

The difference, of course, is that a computer generates fewer errors for a given amount of work produced and the probability of any given error being made is much less for a computer than it is for a human.

TERRY J. DEVEAU  
Bedford, Nova Scotia, Canada

**AND NOW, ADWARE**

In response to the letter by Mr. Tate ("Don't Sell Software, Sell Ad Space," August, page 26) regarding the selling of advertising space in entertainment software: Wow! What a great idea. *Adware* (that's my term for it) could resurrect the failing home computer industry.

Let's face it, most home computers are used for entertainment; however, the general public is not usually willing to spend \$30 to \$100 for a game. In general I feel that this attitude applies to all types of home entertainment. Look at how successful television has become simply because you don't have to pay for it to enjoy it (unless you want cable or pay TV, but even that is relatively inexpensive). With *Adware* you would still have to incur the cost of downloading from the telephone. This same reason also accounts for the to-date unsuccessful home videotex systems.

Mr. Tate mentions the advantages of *Adware* but fails to mention the virtues of the *Freeware* concept and what *Adware* could bring to it. I personally do not agree with the idea of selling copy-protected entertainment software commercially. Computers are very good at copying software, and so this fact should be put to good use. *Freeware* (the free distribution of software by encouraging copying) offers the users a *better* and more *dynamic* product. For example, I have a *Freeware* product that I continue to update as improvements and additions are implemented. When a new release is ready I simply make it available on the *Freeware* market. You cannot do this economically with a similar commercial product without covering your expenses by raising the retail price. With *Adware* you could make it a policy to release a new version every few months to insure a dynamic advertising medium.

At present the *Freeware* distribution network is not firmly established, but if the amount of *Freeware* and the demand for it grew large enough I am sure that regular channels would establish themselves quickly so that everyone could have almost immediate access to the updates. Another benefit of this concept would be

(continued)

## DISCOVER THE LANGUAGE OF ARTIFICIAL INTELLIGENCE

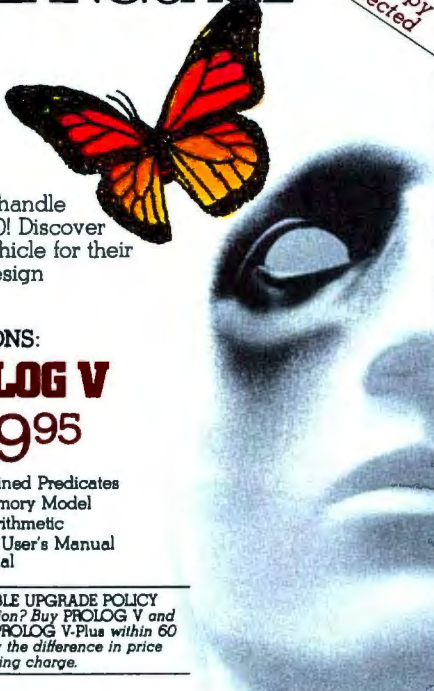
# PROLOG V

At last! A Prolog with enough muscle to handle real-world applications for UNDER \$100! Discover why Japan has chosen Prolog as the vehicle for their "Fifth Generation Machine" project to design intelligent computers.

**CHOOSE FROM TWO GREAT VERSIONS:**

<p style="margin: 0;"><b>PROLOG V-Plus</b></p> <p style="margin: 0; font-size: 1.5em;"><b>\$99<sup>95</sup></b></p> <ul style="list-style-type: none"> <li><input type="checkbox"/> More Than 100 Predefined Predicates</li> <li><input type="checkbox"/> Large Memory Model (to 640K)</li> <li><input type="checkbox"/> Floating Point Arithmetic</li> <li><input type="checkbox"/> 150-Page User's Manual and Tutorial plus Advanced Programming Documentation</li> <li><input type="checkbox"/> Co-Resident Program Editor</li> <li><input type="checkbox"/> Calls to Co-Resident Programs</li> <li><input type="checkbox"/> Text and Graphic Screen Manipulation</li> </ul>	<p style="margin: 0;"><b>PROLOG V</b></p> <p style="margin: 0; font-size: 1.5em;"><b>\$69<sup>95</sup></b></p> <ul style="list-style-type: none"> <li><input type="checkbox"/> 70 Predefined Predicates</li> <li><input type="checkbox"/> Small Memory Model</li> <li><input type="checkbox"/> Integer Arithmetic</li> <li><input type="checkbox"/> 122-Page User's Manual and Tutorial</li> </ul>
---	--

**UNBELIEVABLE UPGRADE POLICY**  
*Tough decision? Buy PROLOG V and upgrade to PROLOG V-Plus within 60 days for only the difference in price plus a handling charge.*



Not Copy Protected

**STANDARD FEATURES ON BOTH:**

<ul style="list-style-type: none"> <li><input type="checkbox"/> Clocksin &amp; Mellish-Standard Edinburgh Syntax.</li> <li><input type="checkbox"/> Extensive Interactive Debugging Facilities</li> </ul>	<ul style="list-style-type: none"> <li><input type="checkbox"/> Dynamic Memory Management (garbage collection)</li> <li><input type="checkbox"/> Custom-Designed Binder and Slipcase</li> </ul>
---	---


**THE CHOICE OF UNIVERSITIES**  
Generous university site licenses and an excellent teaching tutorial and reference guide have made PROLOG V the choice of universities nationwide. Call for details.

<p style="margin: 0;"><input type="checkbox"/> PAYMENT ENCLOSED \$ _____</p> <p style="margin: 0; font-size: 0.8em;">CA residents add 6% sales tax</p> <p style="margin: 0;"><input type="checkbox"/> CHARGE MY:    <input type="checkbox"/> MasterCard    <input type="checkbox"/> Visa</p> <p style="margin: 0;">Card No. _____ Exp. Date _____</p> <p style="margin: 0;">Signature _____</p> <p style="margin: 0;">Mr./Mrs./Ms. _____ <small>(please print full name)</small></p> <p style="margin: 0;">Address _____</p> <p style="margin: 0;">City/State/Zip _____</p>	<p style="margin: 0; font-size: 0.8em;"><b>PROLOG V-Plus \$99.95</b></p> <p style="margin: 0; font-size: 0.8em;"><b>PROLOG V 69.95</b></p> <p style="margin: 0; font-size: 0.8em;"><b>UPGRADE ONLY 40.00</b></p> <p style="margin: 0; font-size: 0.8em;"><i>Return factory diskette and \$30 plus \$10 Handling</i></p> <p style="margin: 0; font-size: 0.8em;"><b>SHIPPING:</b></p> <p style="margin: 0; font-size: 0.8em;">\$ 5.00 U.S.</p> <p style="margin: 0; font-size: 0.8em;">7.50 Canada</p> <p style="margin: 0; font-size: 0.8em;">10.00 Caribbean,</p> <p style="margin: 0; font-size: 0.8em;">Hawaii Air</p> <p style="margin: 0; font-size: 0.8em;">20.00 Overseas Air</p> <p style="margin: 0; font-size: 0.8em;"><i>COD Orders Not Accepted</i></p> <p style="margin: 0; font-size: 0.8em;"><i>15 day check clearance</i></p>
---	---

Interpreter for MS-DOS/PC-DOS

**PHONE ORDER**  
(619) 483-8513

**NO RISK OFFER**  
*Examine the documentation at our risk for 30 days. If not fully satisfied, return with disk still sealed for full refund.*



**CHALCEDONY SOFTWARE**

5580 LA JOLLA BLVD.  
SUITE 126 B  
LA JOLLA, CA  
92037

# Princeton SR-12 and Sigma Designs Color 400

## "The Ultimate in Graphics Resolution and Performance"...

PC Products June 1985

**SR-12 and Color 400. A brilliant combination for super-high resolution graphics and a crisp character display.**

For a brighter, sharper display with your IBM PC, XT, or AT, here's a team that can't be beat. The SR-12 super-high resolution RGB monitor from Princeton Graphic Systems and Color 400, the advanced color graphics adapter card from Sigma Designs.

**A Revolution in Resolution.** Begin by snapping the Color 400 into your PC. Without any software modification, text suddenly becomes readable. Graphics turn sharper and cleaner. Jagged edges smooth out, and annoying flicker fades away. Color 400 automatically *doubles* the number of lines on standard line software. It allows true high

resolution display of Lotus 1-2-3 and Symphony charts, graphics from Dr. Halo, CadPlan, Lumena 400, and others. Also, create dazzling business charts in 16 vibrant colors with Paintbrush 400, included with the card. Enjoy fully formed, monochrome quality characters in text mode. For word processing, spreadsheet, CAD/CAM, or pro-

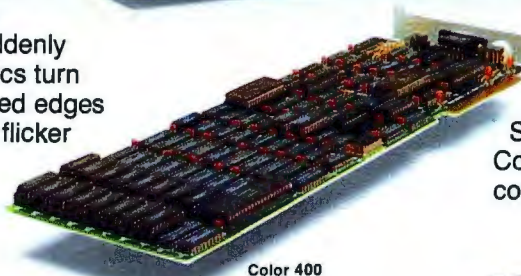
fessional design applications, Color 400 is the answer to your graphic needs.

**Turn on SR-12 for the impressive**

**results.** The SR-12 displays your Color 400 image with unmatched clarity and brilliant color. Because the SR-12 combines a .31mm dot pitch tube and a non-glare screen with an incredible 640 x 400 non-interlaced resolution, you get a flickerless image that's as crisp and clean as a personal computer can produce.

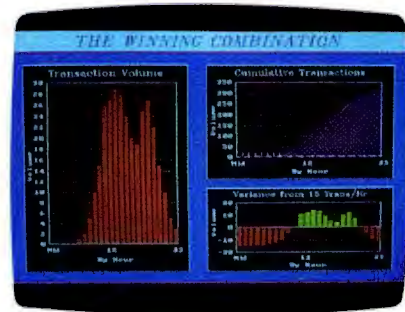


SR-12



Color 400

See how impressive this state-of-the-art image can be on your own PC system. Visit your local retailer today and ask about this new color graphics team. Princeton Graphic Systems' SR-12 and Sigma Designs' Color 400. An unmatched, brilliant combination.



**COLOR  
400**

**SIGMA  
DESIGNS**

SIGMA DESIGNS, INC., 2023 O'Toole Avenue, San Jose, CA 95131  
(408) 943-9480 Telex: 171240

**PRINCETON**  
GRAPHIC SYSTEMS  
AN INTELLIGENT SYSTEMS COMPANY

Princeton Graphic Systems, 601 Ewing Street, Bldg. A, Princeton, N.J. 08540  
(609) 683-1660, Telex: 821402 PGS PRIN, (800) 221-1490 Ext. 1204

Graphic Screens courtesy Mouse Systems, Inc. and Forthright Systems, Inc.

IBM PC, PC XT, and PC AT are registered trademarks of International Business Machines, Inc.

## LETTERS

to ensure the survival of the best games. These will get the best advertisers, ensuring their survival and offering you and me the best quality entertainment from these marvelous little machines.

So how about it? Is it time for another revolution in the home computer game market?

WESLEY STEINER

*Vancouver, British Columbia, Canada*

### A HEATH TIMELINE

I enjoyed your list of microcomputer milestones in the tenth anniversary issue (see "A Microcomputing Timeline" by Gregg Williams and Mark Welch, September, page 198). However, I must add my voice to the probable hundreds of others who will be pointing out that one pioneer in the field was entirely ignored. Namely, the Heath Company. Following is a list of a number of events unique to the Heath contribution to microcomputing:

**August 1977:** The H-8 was introduced. 8080 microprocessor. Octal front-panel keypad. Bus-type architecture. The first

microcomputer kit that an average person could expect to successfully build and use. Still in daily use and supported by several third-party vendors.

**August 1977:** Benton Harbor BASIC. High-level language and quasi-operating system for H-8. Operated with the ultrareliable Heath cassette interface (1200 bps, vanishingly small error rate).

**October 1978:** H-19 introduced. At the time, the H-19 was one of the lowest-cost intelligent terminals available. Used a Z80 microprocessor. All commercial CP/M software eventually included H-19 control codes in their installation protocols. Still in daily use. For a time, the H-19 led the market in terminal sales.

**June 1979:** The H-19 terminal was upgraded with a Z80 computer card and became the H-88. Still used the 1200-bps cassette interface. Shortly after this, disk-drive peripherals were offered for the H-8 and H-88 (which then became the H-89). Benton Harbor BASIC was upgraded to Extended Benton Harbor BASIC, which included disk file functions and for a short while was Heath's disk operating system.

(Microsoft BASIC was also a language/operating system when first introduced.)

**October 1980:** H-DOS was introduced. Predated MS-DOS in the use of modular device drivers for peripherals. This system was proprietary and failed in competition with CP/M, though many felt it to be a superior operating system. It has its own ZCPR-like add-ons and is supposed to be available in version 3.0 "real soon now." In daily use and supported by several third-party vendors.

**December 1982:** The H-100 series introduced. This model was marketed earlier by Zenith Data Systems as the Z-100 series. A dual-processor machine (one of the first), it included an 8085 for handling 8-bit CP/M programs and an 8088 for MS-DOS and CP/M-86 capability. Included five S-100 slots for expansion. One of the first to conform to IEEE S-100 standards as several Heath engineers were appointed to the committee.

All of these products are (were) available  
*(continued)*

## FOR TAPE BACKUP SYSTEMS -

### We Have the Right Products, at the Right Prices . . . Right Now!



Interdyne



Irwin



QIC-02  
20 MB Cassette Tape



QIC-02 ST  
60 MB Cartridge Tape

20 MB  
Hard Disk/  
Tape Expansion  
Chassis

	Formatted Capacity per Tape	Time to Backup 10 MB	Time to Preformat Blank Tape	Type of Tape Media/ Price per Tape	Type of Controller Required	Software Fast Image Backup/ File by File Restore	Power Requirement for Internal Unit	Our Price Internal/ External	20 MB Hard Disk/Tape in Expansion Chassis with I/O Slots
<b>10 MB Interdyne</b>	10 MB	15 Min.	20 Min.	Spool reel/ \$13	IBM Floppy Controller	Yes	130 Watt	\$425/ \$550	—
<b>10 MB Irwin</b>	10 MB	15 Min.	38 Min.	3M DC1000/ \$22	IBM Floppy Controller	No	135 Watt	\$595/ \$725	—
<b>QIC-02 20 MB Cassette</b>	20 MB	3 Min.	Not Needed	Digital Cassette \$22	Controller Included	Yes	130 Watt	\$695/ \$795	\$1795
<b>QIC-02 ST 60 MB Cartridge Tape</b>	60 MB	2½ Min.	Not Needed	3M DC 300/600 \$30	Controller Included	Yes	150 Watt	\$875/ \$950	\$2195

**No Risk - 30 Day**

**Money-Back Guarantee**

Call us today

**408/942-8086**

Telex: 5101002379 QICRCH



**QIC RESEARCH  
INCORPORATED**

489 Valley Way  
Milpitas, CA 95035

QIC-601

# A few smart reasons to buy our smart modem:

Features	Ven-Tel 1200 PLUS	Hayes
1200 and 300 baud, auto-dial, auto-answer	Yes	Yes
Compatible with "AT" command set	Yes	Yes
Can be used with CROSSTALK-XVI or Smartcom II software	Yes	Yes
Regulated DC power pack for cool, reliable operation	Yes	<b>No</b>
Eight indicator lights to display modem status	Yes	Yes
Speaker to monitor call progress	Yes	Yes
Attractive, compact aluminum case	Yes	Yes
Two built-in phone connectors	Yes	<b>No</b>
Compatible with The Source and Dow Jones News Retrieval	Yes	Yes
Unattended remote test capability	Yes	<b>No</b>
Phone cable included	Yes	Yes
Availability	Now	
<b>Price</b>	<b>\$499</b>	<b>\$599</b>

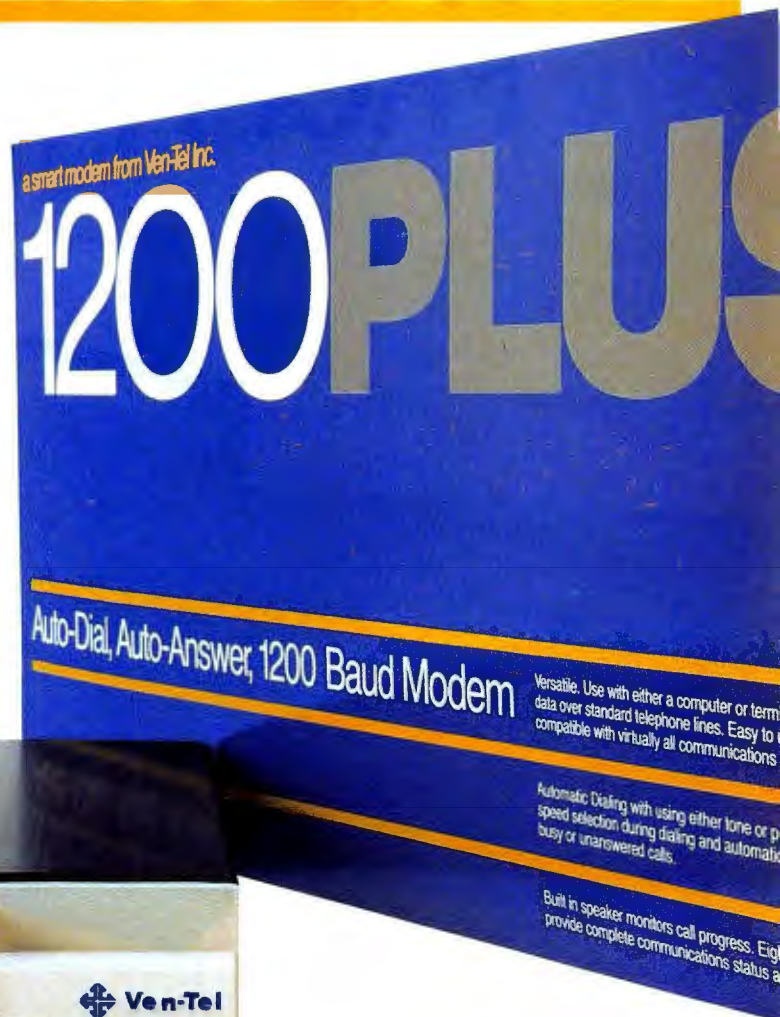
The Ven-Tel 1200 PLUS offers high speed, reliable telecommunications for your personal computer or terminal. Whether you use information services or transfer data from computer to computer, the Ven-Tel 1200 PLUS is the best product around. Available at leading computer dealers and distributors nationwide.

Also from Ven-Tel: internal modems for the IBM and HP-150 Personal Computers with all of the features of the 1200 PLUS.

**You choose. The Ven-Tel 1200 PLUS—the smartest choice in modems.**

## Ven-Tel Inc.

2342 Walsh Avenue  
Santa Clara, CA 95051  
(408) 727-5721

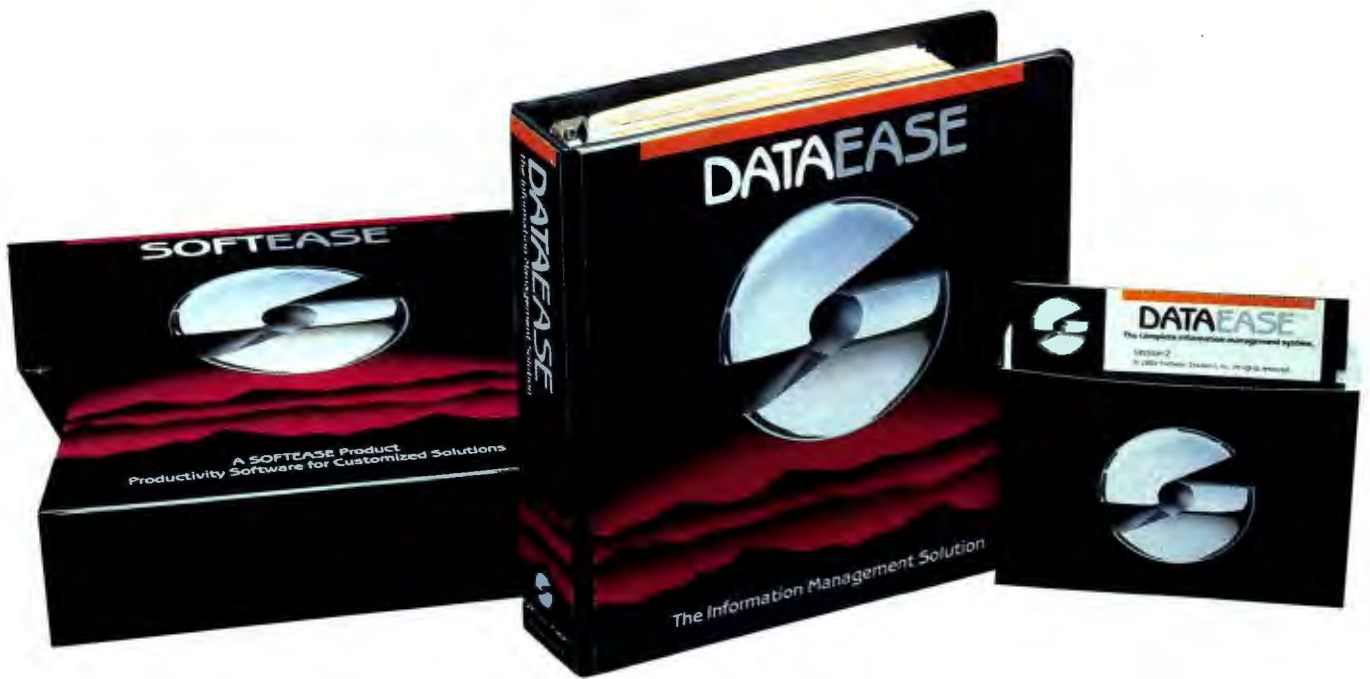


Crosstalk is a trademark of Microstuf; Hayes and Smartcom II are trademarks of Hayes Microcomputer Products.

Inquiry 367

DECEMBER 1985 • BYTE 27

YOU CAN'T GET  
A GOOD FEEL  
FOR A  
SOFTWARE  
PACKAGE  
FROM AN AD.



## If you're searching through the ads in this magazine for the "right" software package, good luck.

Let's say you're looking for a data base manager. You read a dozen ads. Each one offers its list of features. Each one talks about the ideal combination of power and ease of use. And each one promises to "solve your problems", "answer your needs", or both.

### Don't Believe Anybody

We could make the same claims for DATAEASE. Even before Release 2.5, tens of thousands of users made DATAEASE the corporate data base standard. We could tell you that they found DATAEASE to be an invaluable productivity tool because of its fully relational capabilities, full screen editor and unique combination of menus and commands. But don't believe us.

More than 100 reviewers from major publications agree with our productivity claims. Data Decisions called DATAEASE "perhaps the most effective blend of ease-of-use and performance available for PC users to date." But don't believe the reviewers.

Application developers, MIS/DP/IC managers, and all kinds of other users from Fortune 1000 companies throughout the country have reached strikingly similar conclusions. A user at General Instruments reports that "those same factors that

make DATAEASE preferable for non-programmers — ease of use and speed of development — make it the program of choice for many technical types, too." But don't even believe other users.

### Nobody knows what you know.

Even if all these people are absolutely right about DATAEASE, does that mean it's the right product for you?

The best way to know if DATAEASE fits your needs is to get your hands on our free sample diskette. Fifteen minutes with the sample will give you a feel for our best DATAEASE yet — Release 2.5. It has features that appeal to all users; from developers to data entry people: A complete procedural language; quick reports at the press of a button; a direct interface to Lotus 1-2-3; the ability to move rapidly from file to file on a common piece of data; and built-in scientific, mathematical, financial, date, time, and string functions.

### Productivity takes more than a good product.

It takes a good company, too. Buying a software package is the beginning of a relationship. Technical support, product upgrades, special corporate and dealer programs and informational seminars should all be part of this relationship. If the only thing you get is a product, forget about productivity. At Software Solutions, you find more than a product. You find software solutions.

### Find out for yourself.

The advances in DATAEASE's Release 2.5, and the support behind it, offer you practical advantages that leave all the other data base managers far, far behind — including R:Base 5000<sup>™</sup> and dBase III<sup>™</sup>. But don't believe us. Call or write for information and your free sample diskette today.



**Software Solutions, Inc.**

### CALL OR WRITE FOR YOUR FREE SAMPLE DISKETTE.

Send information and a free DATAEASE sample diskette for my PC (check one):

IBM  WANG  DEC  TI

Include materials relating to:

Corporate Client  Retailer  
 MIS/DP/IC Professional  VAD  
 Other \_\_\_\_\_

Name: \_\_\_\_\_

Title: \_\_\_\_\_ Phone: \_\_\_\_\_

Company: \_\_\_\_\_

Street: \_\_\_\_\_

City: \_\_\_\_\_ State: \_\_\_\_\_ Zip: \_\_\_\_\_

Mail to: \_\_\_\_\_ BYT 12/85

Software Solutions, Inc.,  
12 Cambridge Drive,  
Trumbull, CT 06611 Telex: 703972

**Don't like samples? Then just call us. We'd be happy to talk about your information management needs and advise you.**

**800-243-5123**

©1985 Software Solutions, Inc.  
Trademarks are of their respective companies.

Scandinavia  
West Soft A/S, Alesund, Norway; (47) 71-41141

Switzerland, France  
Softsource, S&A 1222 Vesenz, Switzerland; 022-3518-55

United Kingdom  
Sapphire Systems, Essex; 01-554-0582

West Germany, Austria  
M&T Software Verlag, Munich; 089-4613-0

# OUR PLUG-IN CARD GIVES YOU PLUG-IN CONTROL.

**PCϕ488** allows your IBM PC/XT/AT or compatible to control IEEE-488 instruments.

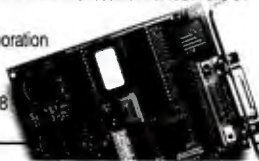
With **PCϕ488**, you can:

- Plug-in to BASIC, C, FORTRAN, or Turbo Pascal™
- Emulate hp controllers,
- Use Tek Standard Codes and Formats,
- Run IBM's IEEE-488 software, and much more.

Just \$395 for the complete hardware and software interface.



Capital Equipment Corporation  
10 Evergreen Avenue  
Burlington, MA 01803  
Call today (617) 273-1818



Turbo Pascal is a trademark of Borland International

## LETTERS

both as kits and preassembled units. The Heath Company is now a unit of the Zenith Corporation and its assembled computer products are sold under the Zenith Data Systems name.

Heath also pioneered in the larger system arena when it introduced the H-11, which was a Digital Equipment Corporation minicomputer in kit form. It was too expensive to compete in the personal computer market; nonetheless, it was offered and supported for several years. Software was never readily available to the average person.

Heath and Zenith computer owners are supported by a large network of third-party vendors of software and peripherals. At least two commercial newsletters and one commercial magazine are dedicated to the brand. There is also the inimitable Heath Users' Group with about 25,000 members worldwide. Its monthly journal, REMark, and software library are, in my opinion, unmatched. You may also find the very active HUG-SIG on CompuServe of interest. (One has to be a HUG member to log on the SIG.) Numerous local groups such as our Tallahassee Heath Users' Group (Tally-HUG) are available.

To sum up, the Heath computer user community has been a cornerstone of the personal computer movement from early on and deserved a prominent listing in a compilation of historical microcomputer events.

WELBREY A. HILL  
Tallahassee, FL

### DECLARATIVE FEEDBACK

The August issue had as its theme declarative languages, hailed as the next step forward for programming. One of the most prominent of the languages featured was Hope, two articles and a column being devoted at least in part to it (see "Program Transformation" by John Darlington on page 201, "A Hope Tutorial" by Roger Bailey on page 235, and "BYTE U.K.: Declarative Update" by Dick Pountain on page 341). There is a point I wish to make about the way source code is presented to the programmer in Hope, and maybe some other languages.

The use of symbols instead of plain English used to be a thing of the past, an evil caused by a lack of memory and processing power. Now that there is not as much of a limitation in processing power, there is no excuse for these symbols being used any more than for a modern interpreter giving error numbers instead of proper messages.

(continued)

# The Personal EE/EPROM Programmer

FOR YOUR  
**IBM P.C.**

**\$395.00**  
PLUS POSTAGE  
& HANDLING

*With Shooter  
You Aim Low  
in Price and High  
in Quality!*

- RS-232 Port. Works with any computer or terminal.
- Stand-Alone. Copies & verifies.
- 128K RAM Buffer.
- Upload / Download in Intel or Motorola Hex format.
- 90 Day Warranty.
- UV Erasers from \$49.95.



**LOGICAL**

1-800-EE-1-PROM (331-7766)  
FLA. (305) 974-0967 • TELEX: 383142 LOGICALTX  
1321E N.W. 65th PLACE, FT. LAUDERDALE, FL 33309



# PC Paintbrush™

## Because life is too short for monochrome pie charts.

### Fun is the best thing to have.

With PC Paintbrush, you can add color, flair, dimension and creativity to a chart, a presentation, or an otherwise dull day. From charts and graphs to serious computer art, our newest generation 3.0 PC Paintbrush will cheer you on with features no other graphics package can match.

Best of all, it's easy to use. You don't have to learn up to sixty commands, like you do with some products. If you can understand icons as simple as scissors, paintbrush, spray can and paint roller, you're ready to start using PC Paintbrush.

### The pen is mightier than the keyboard.

None of history's great artists drew with a keyboard, and you shouldn't have to either. So PC Paintbrush is now available with a cordless PenMouse, to give you complete freedom of expression. Of course, it also supports regular mice, joysticks, graphics tablets, and is compatible with most graphics cards.

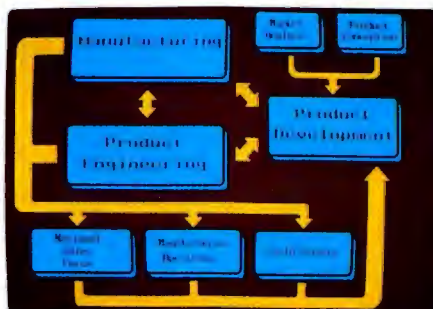
PC Paintbrush also has a beautiful way with words. The text icon lets you write in any of eleven fonts, in nine sizes, with italics, outline, shadow and boldface variations.

What's more, with the new 3.0 PC Paintbrush, you can draw rounded boxes, rubber band curves and circles, and edit pictures many times larger than the screen.

### Are we making fun of 1-2-3®? Why not?

For Lotus™ users, PC Paintbrush's new PIC

### Go on, live a little.



interpreter loads 1-2-3™ and Symphony™ charts and graphs at your equipment's best resolution, from an IBM EGA™ (640 X 350 X 16 colors) to a Number Nine Revolution™ (512 X 512 X 256 colors).

With our FRIEZE™ frame grabber you can pull graphics created by any program right off the screen into PC Paintbrush. So you can take your Paintbrush and palette anywhere, improving the looks of things as you go. And having a lot of fun on the way. In addition, our optional presentation package, PC PRESENTATION, allows you to program your graphics into a first class presentation with fades, zooms, quick cuts and animation.

PC Paintbrush supports 19 video graphics cards and 30 printers and plotters.

For more information on PC Paintbrush, call or write us at the address below, or ask your computer dealer for a demonstration.



Z-SOFT  
PC Paintbrush

#### Corporate Headquarters:

ZSoft Corporation, 1950 Spectrum Circle, Suite A 495, Marietta, GA 30067, 404/980-1950

#### West Coast Sales Office:

160 Sir Francis Drake Blvd., San Anselmo, CA 94960, 415/456-0955

PC Paintbrush is a trademark of ZSoft Corporation. Lotus, 1-2-3, and Symphony are registered trademarks of Lotus Development Corporation. IBM and Enhance Graphics Adapter are registered trademarks of International Business Machines, Corp. Number Nine Revolution is a trademark of Number Nine Computer Corp.

Hope appears to be offering the path back to using these symbols for their own sake. In Mr. Bailey's article we come across the phrase "should be read as" many times. In each case we are told that some symbols should be read as a certain phrase of English. Why can the interpreter not display the English, allowing us to read it directly? Surely the computer could accept the English instead of the symbols

when source code is input? I will concede that it may be harder for the interpreter to parse the English, and it takes longer to input, but the interpreter could compromise and accept the symbols in input while expanding them in listings to the full English. This is similar to some BASIC interpreters that allow the PRINT statement to be input as ? and then expand it to its full form in listings. Bearing in mind the

fact that the version of Hope used by Dick Pountain in his BYTE U.K. column rearranged the order of the source when it was displayed and put function declarations in a separate order from their equations when the workspace was saved, it seems apparent that the extra processing required to expand the symbols to English is minimal.

Let us hope (!) that this use of symbols does not drag us back to unfriendly and difficult-to-read source listings.

ANDREW MENADUE  
Hayle, Cornwall, England

Having just finished reading the August BYTE, with particular attention to the theme section devoted to declarative programming languages, I want first to express my appreciation to the editors for the quality of the articles presented. Susan Eisenbach and Chris Sadler's "Declarative Languages: An Overview" (page 181) was of particular interest to me and serves admirably to provide perspective on the background of the subject, particularly for one who has no ax to grind for any programming language in particular.

Even the inevitable redundancies amongst the several articles in reciting the advantages of precise problem formulation, facilitation of parallel processing, and reduction of programming effort may finally help to persuade even the more conservative members of the profession. Others have noted many times the common reluctance of programmers to abandon the comfort of whatever language they learned first. Witness FORTRAN!

The notion of using atomic routines coded in machine-efficient modules and organized through problem definition by task lists in functional form is clearly not new. I have just reread a speech of my own, given in the spring of 1961 as one of a series held in connection with MIT's Centennial Year. The speech was entitled "A New Concept in Programming" and appears in the book *Management and the Computer of the Future* edited by Martin Greenberger (The MIT Press and John Wiley & Sons, 1962). Granted that the technology has advanced far beyond what most might then have anticipated, I still feel that the ideas could have been applied more generally and quite profitably, even then. Perhaps the profession may soon recognize that such notions can apply far more widely than to artificial intelligence alone.

GEORGE W. BROWN  
Irvine, CA

(continued on page 424)



**The Compact Disc.**  
It brought you perfect sound.  
Now it brings you any fact  
in a 1000 volume library  
instantly.

**The New Standard of Reference.**  
For the first time, CD-ROM puts mainframe retrieval capacity, without connect charges, in your study or office, on your PC. With information giants like McGraw-Hill and Ziff-Davis Corporation bringing major databases to market, your instant access to huge volumes of information will expand with a growing laser-optic library.

**Reference Technology** brings the library of the future to you now—a plug-and-play DataDrive™ Series 500 for your IBM PC™ or compatible\* for only \$1,595.

**The Software Library DataPlate™** is included free—8800 PC software programs: business/financial, DBMS, word-processors, spreadsheets and games.

**Grolier's Electronic Encyclopedia**, with Actventure's software to search instantly to any word or phrase, is also available now (\$199).

**The Reference DataPlate**, including Roget's Thesaurus, a dictionary and a national phone directory, will be available soon.

**The Audio Option** lets you connect the DataDrive to your stereo system, creating the ultimate programmable compact disc player (\$149).

\*Minimum configuration 256K RAM, 1 floppy drive. DataDrive and DataPlate are trademarks of Reference Technology Inc. IBM PC is a trademark of IBM.

**Vast-volume information. We focus it for you.**

 **REFERENCE TECHNOLOGY INC.**  
1832 North 55th Street  
Boulder, Colorado 80301

To Order Call: 1-800-225-2749  
In Colorado: 1-800-826-7873

VISA and MasterCard orders welcome.  
3 week delivery. 90 day warranty.

Go ahead, accuse us of sensationalism.

Over the next four pages, we're going to bare our specs and divulge all the nitty gritty details about the latest developments to come out of Apple Computer.

Starting with our new Apple® ColorMonitor Iie and ColorMonitor Iic.

In all modesty, we think these are the best color monitors you can buy at any price for your Apple II, II+, Iie or Iic personal computer.

Both have composite color, 13-inch screens that let you produce a dazzling array of multi-hued graphics. Without going to the expense of adding an RGB interface card or external adaptor.

Simply plug the monitor directly into the video output jack on the back

# Here's the inside story on all the colorful things that have happened at Apple.

of your Apple, and you're ready to start computing in living color.

Which is terrific for games and graphics oriented programs like Apple Logo II, Instant Pascal™ and Dazzle Draw.

But not quite so terrific for text programs. As anyone who's ever gone blurry-eyed from trying to read words on a color CRT will readily attest.

Not to worry.

We've designed both ColorMonitors to automatically go from color to a high resolution, 80-column monochromatic mode anytime you use text software.

As you can see, we've also styled each ColorMonitor to fit in with our family looks. The ColorMonitor Iic is pure white, and has an optional rigid stand. While the ColorMonitor Iie is designed to rest



The ColorMonitor Iie on a Iie.



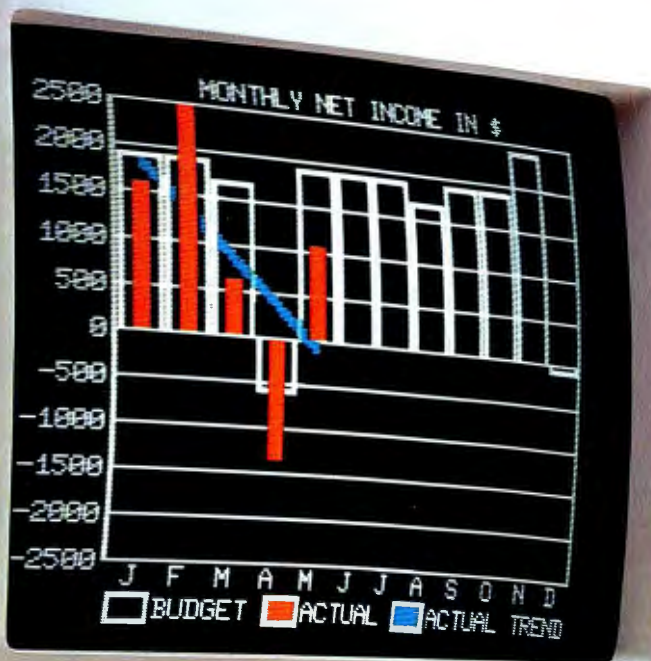
The ColorMonitor Iic on a Iic.

on top of your Apple II, and comes in our favorite shade of beige.

And thanks to some particularly bright Apple engineers, our ColorMonitors are compatible with virtually all existing Apple II software.

Well, there you have it. The scoop on one of the most colorful events in Apple history. But as you might expect, it's certainly not the whole story.

If you turn the page, you'll see that the saga continues.



# The truth about our new color printer in black and white.

In case you haven't heard, Apple has a whole new cast of characters.

Our ImageWriter™ II printer.

Like its predecessor, the original Apple ImageWriter, our ImageWriter II is one of the most dependable dot matrix printers very little money can buy. And it's compatible with every Apple personal computer.

But that's where the similarities end.

The ImageWriter II prints faster and clearer than the original ImageWriter.

It cruises through drafts at a blazing 250 characters per second. Produces sharp graphics. Creates near letter-quality text. And lets you print in six vivid colors.

Simply change the black ribbon to the continuous cloth, multi-color

ribbon, and you're ready to churn out reams of yellow, red, blue, orange, green and purple output.

You can print pictures and greeting cards with software like Stickybear Printer. Design your own

color drawings with Blazing Paddles and Dazzle Draw. And whip out color business graphics using SuperCalc 3A, pfs: GRAPH or Mouse Calc.

As you would expect, you can vary the pitch and spacing on the ImageWriter II. And print in standard or half height.

But as you would probably never expect, the ImageWriter II is also expandable.

By adding the ImageWriter II 32K Memory Option print buffer, you can continue to compute

while the printer continues to print.

Attach the ImageWriter II SheetFeeder, and you can automatically load single sheets of paper into the printer.

And by having your authorized Apple dealer install our AppleTalk™ Option, the ImageWriter II can even be shared by several different Macintosh™ workstations.

Which means, for businesses, it can vastly improve the looks of one very important piece of paper: Your budget sheet.



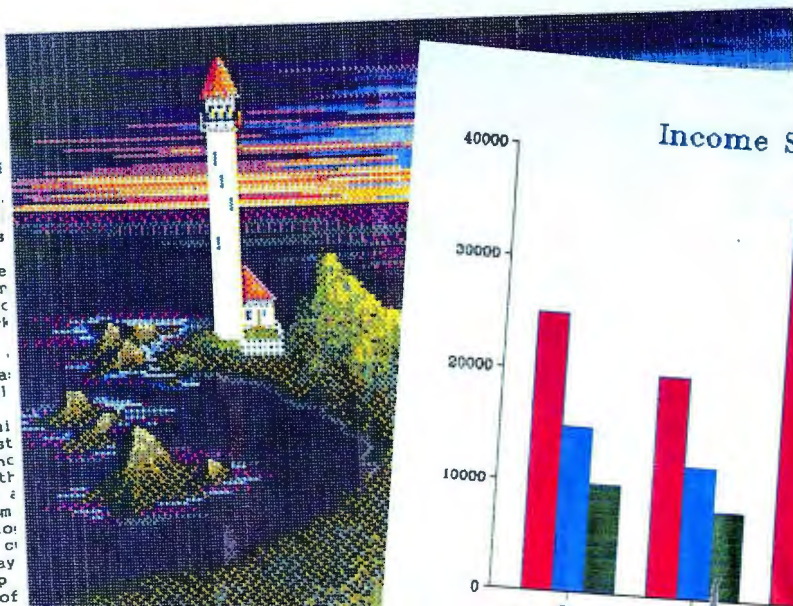
ImageWriter II 32K Memory Option.

## BOOK REPORT

The purpose of framing the art itself, all good reasons framing methods available, so he the pros and cons materials and cc favorite artwork

### Do-it-yourself

If the piece has sentimental val professional. yourself; frame will often cost the factor, chc sell you all th tools, advice a cost of custom hour to put to hours, while c unless you pay craftsmanship framer will of

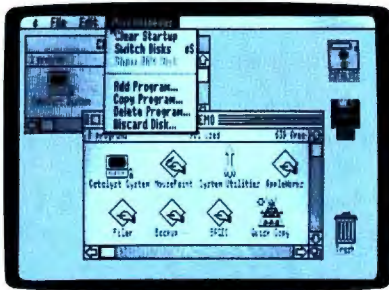


# Stop flipping between floppies.

We call it the "floppy disk shuffle."

Having to boot and re-boot floppy disks every time you want to go from one application to another.

Well, the end of your shuffling is in sight.



*Catalyst 3.0 with desktop icons.*

Quark, Inc., will soon be shipping a unique new program called Catalyst™ 3.0 that's designed to be used with Apple II computers equipped with mass storage.

Catalyst 3.0 lets you install multiple programs on a single storage device. Macintosh-type desktop icons show you what's loaded on the program. To select the item you want, simply use an optional mouse or keyboard to open the file.

Look for Catalyst 3.0 to show up on dealer shelves soon.

Then you'll finally be able to boot all those floppies for good.

## A plug for our new modem.

With the introduction of our new Apple Personal Modem, we've solved one of the biggest problems known to modems:

Where to hide them.

The Apple Personal Modem plugs directly into a standard A/C wall outlet. So unless your computer room is decorated with paisley wallpaper, it'll blend right into the

immediate surroundings.

Of course, aesthetics aside, it's also one darn good modem.

The Apple Personal Modem offers 300/1200 baud operation. Has the latest VLSI technology. Features automatic dial, re-dial and answer capabilities. Uses the industry standard Hayes AT Command Set. Plus it's totally compatible with current Apple communications software.

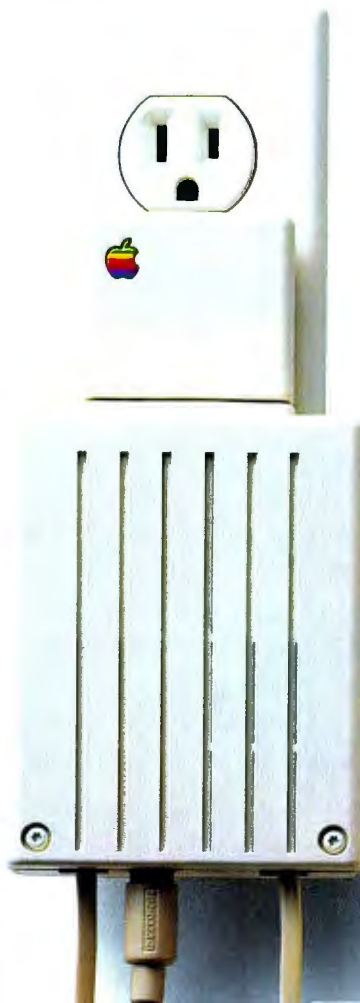
And even though we designed the Apple Personal Modem to be out of sight, there's one part of it that's definitely not:

The price.

## We've increased our drive.

Our capacity for work just got bigger.

The new Apple UniDisk™ 3.5 external drive uses 3½" dual-sided microdisks to add a humongous



800 kilobyte capacity to your Apple II, II+, IIe or IIc. Which is more than five times the amount of storage available from a standard 5¼" drive.

The UniDisk 3.5 is also faster than 5¼" drives. So you'll spend less time listening to that all-too-familiar whirring sound.

You can even "daisy chain" a second UniDisk 3.5 off the first one. In case you're planning to write the next great American epic or something.

As you may not know, disk drives are the most vulnerable components of any computer system. So it's nice to know that no other disk drive is closer to fail-safe than our UniDisk 3.5.

Because no other company has our dedication to quality. Our concern for reliability.

Or our drive.



## Coming Soon: The biggest Apple IIe in memory.

The Apple II Memory Expansion Card should be on dealer shelves soon.

Before long, you'll be able to instantly and easily add another 256K, 512K, 768K or full megabyte of RAM to your Apple II, II+ or IIe. Making it one of the most powerful personal computers in its class. Or business. Or home.

# Snow white and dwarf monthly payments.

Once upon a time, most people had to dwindle their checking accounts down to the right side of the decimal point in order to buy an Apple.

Or stretch their charge cards to the place where they didn't have a choice but to leave home without them.

Then, mercifully, our finance department invented the Apple Credit Card.



Apple Computer, Inc.

With an Apple Credit Card, you may qualify for up to \$2,500 of instant credit to spend on the Apple computer or peripherals of your choice.

And, from now until December 31st, 1985, we'll generously waive the 10% down payment.

Which means the only thing you'll have to come up with are the small monthly payments.

Getting your Apple Credit Card is almost as easy as breathing. All you need is another major credit card. And a valid I.D.\*

Which means, that very same

day, you'll be able to take your new Apple home.

Where you'll both live happily ever after.

## Group therapy for Apple users.

Have you ever felt like you needed help—serious help—with your Apple, but didn't know where to turn?

Then we suggest you join an Apple Users Group.

From Kennebunkport to Kaanapali, Apple Users Groups are springing up by the dozen.

They meet to discuss ProDOS™,

Pascal and WPL. Exchange public domain software. Demonstrate new products. Listen to guest speakers.

And provide the kind of moral support that comes in handy after "Range error" has popped up on your DOS 3.3 screen for the 42nd consecutive time.

Many groups publish regular newsletters and magazines. And operate bulletin boards that let you get the information you want from the comfort of your own modem.

But the most important thing to know about Apple Users Groups, is that they're not just for hackers. In fact, most members have only novice or intermediate computing skills. Which is why they join in

the first place.

To get in touch with the Apple Users Group in your area, check with your local authorized Apple dealer.

With over 400 Apple Users Groups already in existence throughout the U.S. and Canada, chances are the help you need is right around the corner.

## Your computer should join a health club.

Computers—even Apples—can sometimes be temperamental little devils.

And if something goes wrong with yours after the 90-day limited warranty expires, you're the one who'll be out of shape.

Unless you get AppleCare.<sup>SM</sup>

AppleCare is our extended service contract that covers the cost of parts and labor for up to three years. And the annual fee is usually about half the cost of a single repair.

You can buy AppleCare from your participating authorized Apple dealer. And the contract will be honored at more than 2,400 Apple dealers across the country.

So even if you decide to move to some out-of-the-way place like Keokuk, your AppleCare coverage will go along with you.

Although we can't guarantee your family will.

Introducing  
the health care plan  
for your Apple.



\* By major, we mean MasterCard, VISA, American Express, Diner's Club and Carte Blanche. Certain restrictions may apply. © 1985 Apple Computer, Inc. Apple and the Apple logo are registered trademarks of Apple Computer, Inc. ProDOS, DuoDisk, UniDisk, ImageWriter and AppleTalk are trademarks of Apple Computer, Inc. AppleCare is a service mark of Apple Computer, Inc. Macintosh is a trademark of McIntosh Laboratory, Inc. and is being used with its express permission. Catalyst is a trademark of Quark Incorporated. Instant Pascal is a trademark of Think Technologies. Dazzle Draw is a trademark of Broderbund, Inc. Stickybear is a trademark of Optimun Resource, Inc. Blazing Paddles is a registered trademark of Baudville, Inc. SuperCalc is a trademark of Sorcim Corporation. PFS is a registered trademark of Software Publishing Corporation. Mouse Calc is a trademark of Verston Soft. Hayes is a registered trademark of Hayes Microcomputer Products, Inc. For an authorized Apple dealer near you, call (800) 538-9696. In Canada, call (800) 268-7796 or (800) 268-7637.

# F·I·X·E·S A·N·D U·P·D·A·T·E·S

U.S. POSTAL SERVICE  
STATEMENT OF OWNERSHIP, MANAGEMENT  
AND CIRCULATION  
(Act of August 12, 1970, Section 3685, Title 39,  
United States Code)

1. Title of publication: BYTE
2. Date of filing: October 1, 1985
3. Frequency of issue: Monthly
- 3A. Number of issues published annually: 13
- 3B. Annual subscription price: \$21.00
4. Location of known office of publication: 70 Main St., Peterborough, NH 03458
5. Location of headquarters or general business offices of the publisher: 1221 Avenue of the Americas, New York, NY 10020
6. Names and addresses of publisher, editor, and managing editor: Publisher, Harry L. Brown—70 Main St., Peterborough, NH 03458; Editor, Philip Lemmons—70 Main St., Peterborough, NH 03458; Managing Editor, Gene Smarte—70 Main St., Peterborough, NH 03458
7. Owner: McGraw-Hill, Inc., 1221 Avenue of the Americas, New York, NY 10020. Stockholders holding 1 percent or more of stock: Donald C. McGraw, Jr.; Harold W. McGraw, Jr.; John L. McGraw; William H. McGraw; June M. McBroom; Elizabeth McGraw Webster; all in care of McGraw-Hill, Inc., 1221 Avenue of the Americas, New York, NY 10020; College Retirement Equity Fund c/o Bankers Trust Company, 280 Park Avenue, New York, NY 10015; Public Employees Retirement System of Ohio, 277 East Town Street, Columbus, OH 43215.
8. Known bondholders, mortgagees, and other security holders owning or holding 1 percent or more of total amount of bonds, mortgages, or other securities: None
9. Not applicable.
10. Extent and nature of circulation:

	Average No. Copies Each Issue During Preceding 12 Months	Actual No. Copies of Single Issue Published Nearest to Filing Date
A. Total No. Copies Printed . . .	487,500	476,000
B. Paid Circulation		
1. Sales through dealers and carriers, street vendors and counter sales . . . . .	95,389	159,698
2. Mail subscriptions . . . . .	316,859	306,236
C. Total Paid Circulation . . . . .	412,248	465,934
D. Free Distribution by Mail, Carrier or Other Means; Samples, Complimentary, and Other Free Copies . . . . .		
	5,735	4,959
E. Total Distribution . . . . .	417,983	470,893
F. Copies Not Distributed		
1. Office use, left over, unaccounted, spoiled after printing . . . . .	6,529	5,107
2. Return from news agents . . . . .	62,988	none to state
G. Total . . . . .	487,500	476,000

11. I certify that the statements made by me above are correct and complete.  
—Harry L. Brown, Publisher

## UPDATE

### NEC Patches Compatibility Gap

NEC Information Systems now offers an alternative to Herbert Stein's patch described in his "IBM Compatibility for the NEC APC III" (see the September BYTE, page 171). The SLE adapter board, priced at \$150, and the accompanying

software provide almost total compatibility without affecting the operation of standard APC software, NEC said. For more information, contact NEC Information Systems at 1414 Massachusetts Ave., Boxborough, MA 01719.

## BYTE'S BUGS

### Mr. Slaughter Is Not Depressed

Don Slaughter of Seattle wrote to advise us of an improvement to the Macintosh, the Mini-Finder (see October, page 392). Our published version of the letter said he was "depressed" by the upgrade.

The truth is, Mr. Slaughter was not depressed but impressed. We apologize to Mr. Slaughter, and we hope our error did not leave him depressed. We are certain it didn't leave him impressed.

### Quicksort Corrected

There is an error in the Quicksort algorithm as it appears on page 108 of the September BYTE (see "An Analysis of Sorts" by Jonathan Amsterdam, page 105). If the first element is chosen as the pivot,

as the text suggests, the algorithm will not work. The solution is to swap the pivot with the last element of the array before partitioning. The corrected algorithm is shown in listing 1.

#### Listing 1: The corrected Quicksort algorithm.

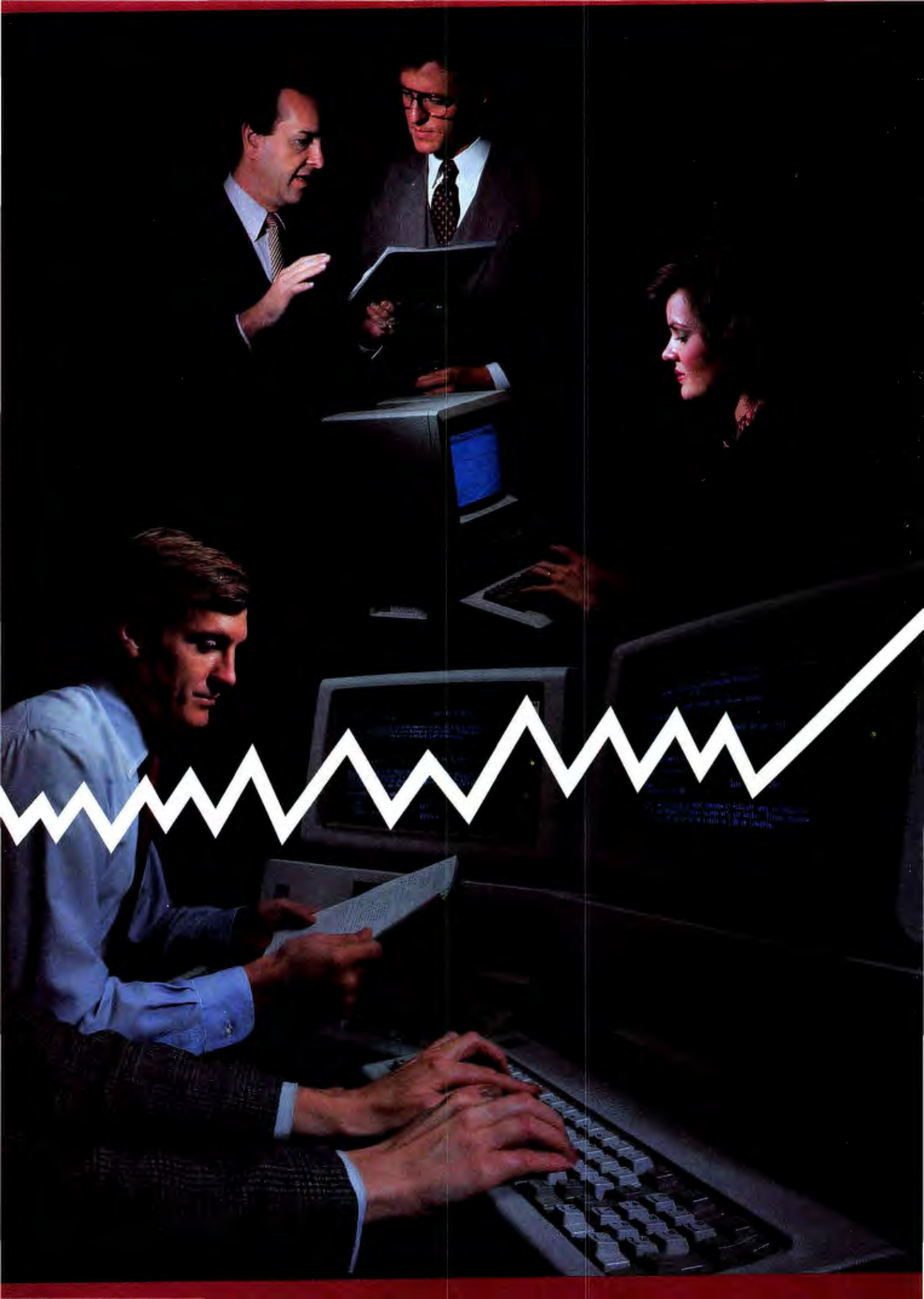
```
Quicksort.
Input: an array A, with items from 1 to n.
Output: the same array, sorted.
begin
  choose a pivot;
  swap the pivot with the last element in
  the array;
  partition in the list so that all
  items < - pivot are <= i;
  Quicksort A from 1 to i-1;
  Quicksort A from i to n;
end.
```

## BYTE'S BITS

### Public-Domain Powerhouses, Please

BYTE is planning a theme issue on public-domain powerhouses. If you have, or are working on, a worthy application or utility that you are willing to place in the

public domain, please contact Jon Edwards at BYTE, POB 372, Hancock, NH 03449, (603) 924-9281. He needs to hear from you before the end of January.







# eForum

The Electronic Meeting System

## Until eForum-- bulletin boards, e-mail and computer conferencing were just a lot of static.

Every major communications breakthrough has its infancy. Computer conferencing's first buzz started with randomly networked bulletin boards, experimental CB's and then e-mail. Of course, Federal projects gave conferencing real legitimacy. But at a prohibitive price.

Now comes the giant step. eForum. It shoots computer conferencing right off the evolutionary chart by bringing long-awaited sophistication that business needed to truly put computer conferencing to work.

In a nutshell, eForum creates electronic "meetings" which allow groups of people, not just two or three, to communicate and "chat" on a myriad of subjects. Without worrying about time or geographic zones.

Since eForum maintains all the meetings in one place, each person simply "attends" the meeting at the most accessible time. And eForum not only keeps track of what can literally be hundreds of meetings, allowing only those authorized to "attend," but the easy-to-follow structure keeps the "attende" from getting lost or reading unnecessary material.

Then eForum automatically organizes, indexes and files and gives each person an individualized view of what's new in the meeting and a complete written record of each meeting. Even sending totally private

messages is easy with eMemo, the enhanced electronic mail facility.

That's revolutionary. Yet eForum goes further by letting each organization set up eForum the way that's most efficient for it. By using internal host computers. Or by accessing eForum through a national communications network like General Electric Information Service.

And, if that's not breakthrough enough, eForum is even designed to let each person use a personal computer and the most popular software around—Lotus 1-2-3™, WordStar™, MultiMate™, DisplayWrite™ and more—so "electronic handouts" can be brought to each meeting.

Too, if you have need to do document development with a team of people, docuForum is our document editing and transfer software which uses the conferencing capabilities of eForum to let team members comment and propose changes to a document.

So, don't let the newest explosion in computer conferencing catch you asleep at the keyboard. Call our 800 number and get "on the meeting" now. And soon, just like when the microchip changed the world's idea about computers, you'll wonder how you ever got along without eForum.

Call 800-638-4832 to find out how you can get an immediate on-line eForum demonstration! In Michigan, call 313-994-4030. In Canada, call 604-682-6265.



Network Technologies International, Inc.  
The Arbor Atrium Building  
315 West Huron  
Ann Arbor, Michigan 48103  
Inquiry 265

# MORE USERS FOR YOUR PC

*Advanced Digital's PC-Slave is the solution to your multi-user or local area network problems.*



Just plug Advanced Digital's PC-Slave board into your PC expansion slot, a connecting cable, a low-cost dumb terminal or a PC look-alike terminal and you're in business. As many as 31 low-cost workstations may be added to your IBM-PC, AT, XT, and the compatibles. Share a common data base without loss of speed or efficiency since each PC-Slave has its own 8088 CPU, 256-768K RAM dedicated to each user. Advanced Digital provides additional software which supports File & Record locking and print spooling. Advanced Digital's slave concept provides the best multi-user PC system available today! For the location of the dealer nearest you contact:

**Advanced Digital Corporation**  
5432 Production Drive  
Huntington Beach, CA 92649  
(714) 891-4004 / (800) 251-1801  
Telex 183210 ADVANCED HTBH

**ADVANCED  
DIGITAL  
CORPORATION**

**Advanced Digital U.K. Ltd.**  
27 Princes Street, Hanover Square  
London W1R8NQ-United Kingdom  
(01) 409-0077 (01) 409-3351  
TLX 265840 FINEST

**Regional Distributors:** In California, Western Micro (800) 338-1600 / Micro Computer Distributors (714) 895-6301 / Thomas Data Systems, Inc. (213) 214-4661;  
In Ontario, Canada, B&L (416) 289-7660; In Australia, Archives Computers (03) 699-8377; in New York, Quinn Data (914) 939-0002

## Turbo Lightning Provides Fast Access

**B**y itself, Turbo Lightning from Borland International is a flexible spelling checker/thesaurus program for the IBM Personal Computer and compatibles. However, as the first element of the Turbo Lightning Library, the program represents a gateway to a wide range of future applications. Its word-oriented search mechanisms could be used as the nucleus for a variety of sophisticated data-retrieval systems.

### BASIC OPERATION

The initial release of Turbo Lightning is a memory-resident program that checks and corrects spelling as you type. It monitors your keystrokes and compares each word to those in a RAM-based dictionary. (When you install the program, you can choose one of several word lists, ranging from approximately 10,000 to 130,000 words. The size of the dictionary determines the amount of memory the program occupies. In the minimum configuration, Turbo Lightning consumes 78K bytes; the maximum is 236K bytes.) If the program can't find a match for what you have entered, it beeps. You can continue writing, or you can request a listing of alternate spellings. Using a sound-alike algorithm, Turbo Lightning builds a list of possibilities, which it presents in a window. You can scroll through the list and select a replacement.

Executing the commands of the application program you're using, Turbo Lightning moves back to the begin-

ning of the incorrect word, deletes the word, and makes the substitution. Even if you have chosen one of the smaller word lists, Turbo Lightning lets you go to the disk and search the largest dictionary. A "full-screen check" command highlights all unknown words on the screen; as Turbo Lightning can correct only words stored in an 80-character keyboard buffer, the check is a simple way to remind yourself of uncorrected words.

You can also ask to consult the thesaurus. Starting with either your original word or any of the alternate spellings, Turbo Lightning can derive a list of words with similar meanings. The replacement routine is the same as the one already described.

Turbo Lightning comes with 11 preset "environments" that allow you to use it while working with any of five popular word processors (WordStar, pfs:Write, MultiMate, Word, and Displaywriter), Lotus 1-2-3, BASICA, Turbo Pascal, SideKick, DOS, and modem communications (straight ASCII). You can customize and rename any of the environments to match your primary software.

The program is operated with pop-up menus (similar to those used by Borland's SuperKey utility) and with single-keystroke "hot" keys.

### THE DICTIONARY

A Turbo Lightning dictionary is compressed using several

techniques. First, a character-frequency analysis identifies frequent letter combinations in the entire word list. The combinations are reduced to bit patterns. Next, allowable suffixes and groups of suffixes are assigned bit codes. Finally, because the words in the dictionary are stored in alphabetical order, a word can be abbreviated to a record of the changes from the previous word.

Searches through the dictionary are speeded by indexing. The program uses the first letter of a word to isolate a region of the word list, then it uses the second letter, and so on. Only a few full words are actually scanned during a search. Indices can be nested, so disk-based dictionaries can be much larger than resident ones with little loss of speed.

### THE IMPLICATIONS

By combining data compression with multilayered indexing, the Turbo Lightning system can be used to provide quick access to any data organized in dictionary-like fashion. In the same way that the word list can be used as a key to the thesaurus, it could be used as the key to an encyclopedia or database. Going one step further, if the initial dictionary were replaced with a list of proper names, for example, a link could be made to addresses or phone numbers or employment records. The full-screen-check feature would

provide cross-referencing capability.

Because the Turbo Lightning program generates a unique "word number" for every word in the dictionary, it could be used to develop on-the-fly data compression for communications. The sound-alike techniques coupled with the thesaurus could serve as the basis for an AI-like approximate query language.

### THE FUTURE

The Turbo Lightning Library will be a collection of inter-related products capitalizing on this potential. Borland plans to release a package of word games based on Turbo Lightning, including source code in Turbo Pascal, early in 1986. The source code will illustrate techniques for interfacing external programs to the Turbo Lightning engine. Also in the first quarter of 1986, Borland will begin publishing reference works that utilize the engine for access. By the third quarter, Borland hopes to market compression/indexing utilities that allow you to convert your own data into Turbo Lightning format. The company is also open to licensing the technology to other software firms.

Turbo Lightning comes with an installation program, several Random House dictionaries, and the Random House Pocket Thesaurus. It costs \$99.95. Prices for future products have not been determined. Contact Borland International Inc., 4585 Scotts Valley Dr., Scotts Valley, CA 95066, (408) 438-8400. Inquiry **600**.

by Ezra Shapiro

(continued)

## AT&T's 80286-based System Merges UNIX with MS-DOS

**A**T&T Information Systems has released a version of the PC 6300, its IBM PC-compatible desktop computer. The new system, called the PC 6300 Plus, features a 6-MHz 80286 processor with no wait states; it's said to run approximately 25 percent faster than the IBM PC AT. AT&T said its new machine runs all software for the IBM PC or AT, including Microsoft's Flight Simulator.

The distinguishing feature of the PC 6300 Plus, however, will be its implementation of the UNIX operating system. In the first quarter of 1986, AT&T will release a full version of UNIX System V for the machine. This implementation is said to include advanced versions of many of the same easy-to-use features of AT&T's UNIX PC. In addition, because of a hardware unit called OS Merge, this edition of UNIX can run all MS-DOS applications as one of several concurrent UNIX tasks. AT&T claims that OS Merge allows MS-DOS software to "think" it has complete control over the system, thereby allowing almost complete compatibility with IBM PC software. This software, including Flight Simulator, can run under UNIX with a performance penalty of only about 15 percent.

Under single UNIX tasks, the PC 6300 Plus is said to be about 20 percent slower than the UNIX PC, which uses a 68010 processor. Under multitasking situations, the difference is even greater.

The combination of the new rendition of UNIX with OS Merge allows some interesting capabilities: You



AT&T's PC 6300 Plus.

can call both UNIX and MS-DOS applications from the same menu. UNIX and MS-DOS files reside on the same area of a disk, and they can be accessed by application programs under either operating system. Data can be piped from a UNIX program to an MS-DOS program and vice versa. And MS-DOS files can take advantage of the robust set of file attributes and protection facilities available to UNIX files.

The PC 6300 Plus comes with 512K bytes of memory, with sockets for an additional 512K bytes on the

motherboard. Expansion boards with 2 megabytes of memory reportedly will be available soon and will allow a maximum internal memory of 7 megabytes.

The machine has one serial and one parallel port and seven expansion slots compatible with the IBM PC. Three of these slots are compatible with the PC 6300. The new system also has a socket for an 80287 numeric coprocessor. UNIX utilities will be available to take advantage of the 80287 chip.

AT&T is selling a new keyboard as an option for both the PC 6300 Plus and the older PC 6300. The keyboard has a Selectric-style key layout; it's similar to that of the IBM PC AT except

that the function keys are laid out horizontally above the other keys. The older PC 6300 keyboard, which resembles the IBM PC keyboard, is also available.

The PC 6300 Plus comes in two configurations: The hard-disk model features a 20-megabyte hard disk, a 1.2-megabyte or a 360K-byte floppy-disk drive, either keyboard, and a monochrome monitor with high-resolution graphics and text capability. This version will sell for \$6320. A floppy-disk-based system, which includes all the above except the hard disk and features both types of floppy-disk drives, will sell for \$5095. Either system is available with a color monitor for an additional \$650. MS-DOS version 3.1 with BASIC sells for an additional \$65. When available, the UNIX operating system will sell for approximately \$395. An upgrade is available to owners of the PC 6300 for \$2995. Contact AT&T Information Systems at (800) 247-1212. Inquiry 601.

—Rich Malloy

## MC68000 Plug-in Board with Full UNIX System V

**M**otorola is now selling a 68000-based plug-in CPU board for the IBM Personal Computer. The PC/68000 hardware consists of a 10-MHz 68000, an MMU (memory management unit), a cache, and 2 megabytes of dual-ported RAM. The accompanying software contains a complete System V/68 operating system as well as an I/O kernel and diagnostics. (The System V/68 was derived from and is functionally

(continued)

# Borland Introduces Reflex, The Greatest Analytical Tool Since The Couch

## INTRODUCING REFLEX, THE ANALYST.

If you use Lotus 1-2-3™, dBASE® or PFS File™, you need Reflex™—because it's a totally new way to look at your data. It shows you patterns, relationships and interrelationships you didn't know were there, because they were hidden in data and numbers.

Reflex is the first database that separates the trees from the forest. The first database that understands that what you see depends on how you look at it.

The first database that probes relationships—then shows them to you in various graphic forms—scatter, line, bar, stacked bar and pie charts.

The first database to break the bonds of traditional DBMS (Data Base Management Systems) and give a dramatic visual turn to data analysis.

Reflex makes graphic leaps far beyond 1-2-3. With Reflex, when you look, you see.

## REFLEX OPENS MULTIPLE WINDOWS WITH NEW VIEWS AND GRAPHIC INSIGHTS.

You use Reflex's Form View to build your database; the List View lets you put data in tabular List form; the Graph View gives you instant interactive graphic representations; the CrossTab View gives you amazing "cross-referenced" pictures of the links and relationships hidden in your data. Report View allows you to import and export data to and from Reflex, 1-2-3, dBASE, PFS File and other applications and prints out information in the formats you want. In fact, Report View is probably the best 1-2-3 report generator you can buy today. It's also the cheapest—and you're getting all the other features free.

The commands for all five Views are consistent—so you're not stuck learning five different ways to get something done. And because Reflex uses advanced windowing techniques, you can see several views on the screen at the same time—without having to switch back and forth. You get the picture—and the pictures—all at once—if that's the way you want to look at things.

Modify a number and all your Views—List, Form and Graph—are immediately updated, on-screen. Changing a number changes the picture—which is mighty handy when you're analyzing (let's say) sales figures by salesperson; or you're in "What-If?" country asking yourself "What if we could add 2.5% in January sales?" "Show me."

"Give me the picture." "Show me what happens when we shift 11% of Nebraska's inventory to the new store in Hawaii." "Show me how many Gizmo 28's we have in every store in every state as of midnight last night and what happens to our East Coast stocks if the shipping strike lasts more than a week." "Show me."

So Reflex shows you. Instant answers. Instant pictures. Instant analysis. Instant understanding.

## HOW IN THE WORLD CAN BORLAND SELL A PHENOMENAL PRODUCT LIKE REFLEX FOR ONLY \$99.95?

At \$495.00, Analytica's original price, Reflex was a bargain. Acclaimed by critics and praised by users, Reflex also got our attention at Borland International. We were so impressed by Reflex that we bought the company!

To celebrate that, we're making business software history by offering Reflex—FOR A LIMITED TIME—for ONLY \$99.95! (Offer good through March 31, 1986).

That's \$395.05 off the original price—which is a pretty good return on your toll-free phone call.

We think Reflex should be an "automatic product," a "standard" that every PC owner should own. That's why we priced it at \$99.95. Naturally we've added our 60-day money-back guarantee and Borland's Reflex is not copy-protected.

### HOW THE CRITICS REACT TO REFLEX

"The next generation of software has officially arrived."

*Peter Norton, PC Week*

"Reflex is one of the most powerful database programs on the market; its multiple views, interactive windows and graphics, great report writer, pull-down menus and cross tabulation make this one of the best programs we have seen in a long time...The program is easy to use and not intimidating to the novice...Reflex not only handles the usual database functions such as sorting and searching, but also "what-if" and statistical analysis...it can create interactive graphics with the graphics module. The separate report module is one of the best we've ever seen."

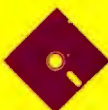
*Marc Stern, InfoWorld*

"What you see, then, is an interesting hybrid of a database and a spreadsheet that is ideal for analyzing tabular data."

*Adam B. Green, InfoWorld*

"More flexible than spreadsheets, this easy-to-use database analysis package presents information with visual clarity...Reflex is for you. The flexibility of switching between different views of the data lets you see relationships you may have previously overlooked...Without "what-if" analysis, key variables—such as cost of goods sold or travel expenses—may be out of hand but unnoticed. The type of analysis to uncover such a foible is awkward to do on a spreadsheet; yet, it may mean the difference between success and failure in a competitive situation."

*Ira H. Krakow, Business Computer Systems*



**BORLAND**  
INTERNATIONAL

4585 Scotts Valley Drive, Scotts Valley CA 95066  
Phone (408) 438-8400 Telex 172373

Trademarks: Reflex is a trademark of BORLAND/Analytica Inc. Lotus is a registered trademark and Lotus 1-2-3 is a trademark of Lotus Development Corporation. dBASE is a registered trademark of Ashton-Tate. PFS is a registered trademark and PFS File is a trademark of Software Publishing Corporation. IBM PC, XT, AT, PC-DOS and IBM Color Graphics Adapter are registered trademarks of International Business Machines Corporation. Hercules Monochrome Graphics Card is a trademark of Hercules Computer Technology.

Inquiry 39 for End-Users.  
Inquiry 40 for DEALERS ONLY.

**REFLEX** THE ANALYST™

To order by Credit Card call (800) 255-8008, CA (800) 742-1133.  
Available at better dealers nationwide. Call (800) 556-2283 for the dealer nearest you.

YES! Rush  
Reflex to me.  
Send me \_\_\_\_\_ copies.

**60-DAY  
MONEY-BACK  
GUARANTEE**

**\$99.95**

This price includes shipping to all U.S. cities. All foreign orders add \$10 per product ordered.

System requirements.  
IBM® PC, XT, AT and compatibles. 584K RAM minimum. IBM Color Graphics Adapter®, Hercules Monochrome Graphics Card™, or equivalent. PC-DOS® 2.0 or greater. Hard disk and mouse optional.

Subtotal \_\_\_\_\_  
(CA res. add \$6 tax per copy) \_\_\_\_\_  
Amount Enclosed \_\_\_\_\_  
Payment VISA MC BankDraft Check  
Credit Card Exp. Date \_\_\_\_\_  
Card # \_\_\_\_\_

Name: \_\_\_\_\_  
Shipping Address: \_\_\_\_\_  
City: \_\_\_\_\_  
State: \_\_\_\_\_ Zip: \_\_\_\_\_  
Telephone: \_\_\_\_\_

COD's and Purchase Orders WILL NOT be accepted by Borland. California residents: add 6% sales tax. Outside USA add \$10 and make payment by bank draft, payable in US dollars drawn on a US bank.

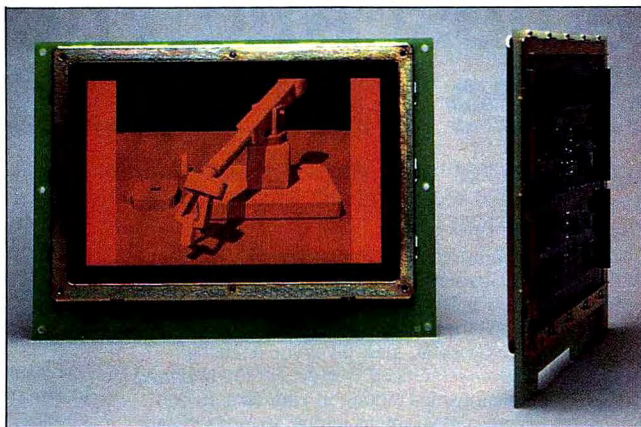
Copyright 1985 Borland International. BI-1020 A

equivalent to AT&T's UNIX System V, M68000 version.)

While System V/68 runs on the PC/68000, PC-DOS running on the 8088 (or 80286 in the AT) handles the 68000's I/O requests. Pressing the Alt-M key combination switches between System V/68 and PC-DOS. Motorola uses buffering and cache memory in both the main PC and on the PC/68000 card to let the 68000 run at top speed. Files may be transferred either way between the two systems.

At the same time that the new PC/68000 promises to transform IBM PC hosts into 68000 development systems, Motorola is terminating some of its older 8-bit and 16-bit development support systems. After December 31 of this year, Motorola will not accept orders for the EXORmacs 16-bit development host and peripherals; EXORciser 8-bit development host, peripherals, and plug-in expansion boards; EXORset 8-bit development host and peripherals; VMC 68/2 microcomputer system and peripherals; several other hardware development stations, bus state analyzer personality modules, evaluation modules, system analyzers, and all associated software for those products.

The PC/68000 can be used with IBM PCs that have at least a 10-megabyte hard disk. The complete PC/68000 module (hardware and software) carries part number MPCKN2M and a list price of \$4500. Contact Motorola Semiconductor Products Inc., POB 20912, Phoenix, AZ 85036, (800) 521-6274. Inquiry 602.



Planar Systems' EL8358 M flat-panel display.

### Flat-Panel Display for MS-DOS

**P**lanar Systems' EL8358 M is a flat-panel monitor with an electroluminescent display for MS-DOS machines. It has a resolution of 640 by 200 pixels, providing 83 lines per inch within a 5- by 8-inch active matrix. Each pixel is individually addressable and has a pixel aspect ratio of 2:1.

A complete EL8358 M, including the electroluminescent panel, driver and control electronics, bezel, frame, and connector, is 5.7 inches high, 10.3 wide, and 0.55 deep and weighs 16 ounces. It is not affected by electromagnetic environments and will run in temperatures of 0 to 55° Celsius, Planar said. It can withstand shocks of 100 Gs on all axes and storage temperatures of -40 to 75° Celsius.

The system uses patterned indium tin oxide and aluminum electrodes around a layer of bright yellow emitting phosphor. It requires a 12-volt power supply to operate.

An EL8358 M developer's kit, including a monitor, a circular polarizer, and a power supply, costs \$1750.

Contact Planar Systems Inc., 1400 Northwest Compton Dr., Beaverton, OR 97006, (503) 690-1100. Inquiry 603.

### Keyboard System for Visually Handicapped

**T**he Audiodata/IBM PC Keyboard from Frank Audiodata GmbH of West Germany uses tone and speech capabilities to make the IBM PC accessible to blind and visually impaired users. The system generates different tones depending on the type of data at the cursor's screen location. To position the cursor, you use sliding switches that correspond to the horizontal and vertical axes.

The vertical switch is on the left-hand side of the Audiodata keyboard, next to the function keys. Moving it from top to bottom yields a series of tones that tells you whether lines are blank or full of text. The horizontal switch is below the space bar. Moving it left and right yields tones that indicate letters, spaces, numbers, and punctuation marks in a line. By moving the switches and listening to the resulting

tones, you can tell how many characters of what type are at what position on the screen.

The keyboard contains a Votrax SC-01 speech processor, so you can literally have the system read a portion of text out loud. Pressing a button on the vertical switch tells the system to read the line of text that corresponds to its position. Using the vertical and the horizontal switches together, you can have the system read or spell particular words.

The Audiodata keyboard works with standard or large-print monitors or with no monitor at all. It comes with a 6-inch add-in card and the system software for \$3450. Contact Maryland Computer Services, 2010 Rock Spring Rd., Forest Hill, MD 21050, (301) 879-3366. Inquiry 604.

### C Compiler for Apple IIe

**T**he C++ Compiler is a complete C compiler for the Apple IIe that generates pseudocode; it includes an assembler to convert that pseudocode to 6502 assembly language and a 6502 native code assembler. A pseudocode interpreter allows the compiler's output to be immediately tested without generating native 6502 code. The interpreter can also be used to distribute large programs more compactly if execution speed is acceptable.

C++ contains all the features of C as defined by Kernighan and Ritchie, except that floating-point arithmetic is not supported. Extensions and enhancements, such as enumerated types, structure and array

(continued)

# Borland introduces Turbo Lightning™ the fastest, most amazing information system since your brain

## You can now find out everything in a flash.

With instant access to electronic versions of the 83,000 word *Turbo Lightning*™ Random House® Speller & Word List; the 50,000-word *Turbo Lightning* Random House Thesaurus™ and the soon-to-be-released *Turbo Lightning* Encyclopedia™ — and to an astonishing array of electronic reference books which form Borland's new *Turbo Lightning* Library™.

Hitting one key on your IBM® personal computer — taps you into this new electronic age of instant information.

You get the right word, the right spelling, the right name, the right address, right now.

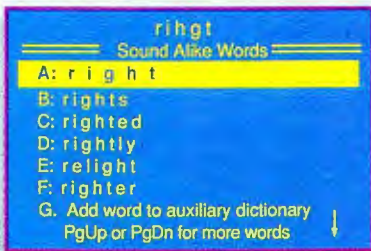
What we've done has been called "Artificial Intelligence," we simply call it "*Turbo Lightning*." This information revolution — driven by *Turbo Lightning* — means that the way you look things up is definitely looking up.

## No matter what program you're running, Turbo Lightning instantly checks your spelling as you type.

You could be running WordStar®, MultiMate™, SideKick®, Microsoft® Word, MCI Mail®, CompuServe®, or whatever, because as you work, as you write, *Turbo Lightning* is waiting in the wings, watching how you spell every word, but not getting in the way of what you're doing.

So how does it work? Let's say the word you meant to type was "RIGHT," but you accidentally typed "RHGT," which is wrong. What happens then?

You immediately hear a 'beep,' so you know there was a boo-boo. You instantly see a window, that doesn't list "RHGT" but it does list "RIGHT" and its sound-alike words. So your screen looks like this:



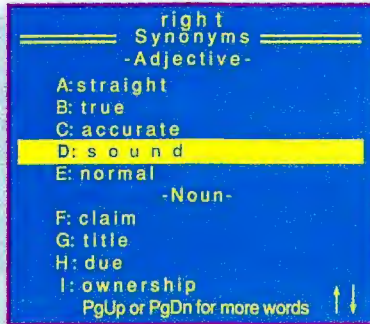
So you move your cursor to "A," which is the right "right," hit Return and the spelling mistake is instantly fixed. And the program you were working on has continued to run while you did a little spelling sidetrip with *Turbo Lightning*. (If you'd rather not remember your Spelling grades in school, the beep might make you out; but you can choose the "whole page" option. Which means that when you finish writing the entire page, any spelling mistakes will be highlighted. You go in and straighten things out straight away.)

*Lightning* never goes away, is 100% concurrent, reliable, accurate and cannot, does not, will not 'crash & burn.'

Your document, letter, report, spreadsheet is word perfect and no one ever knows that you can't spell for beans.

## Turbo Lightning does a lot more than spell "right" right, it also gives you instant synonyms.

Because you also have *Turbo Lightning*'s Random House Thesaurus at your fingertips, you can really get to know your 'rights.' So back to the word "Right," but this time in the thesaurus. Type in "Right" and what you see in the on-screen window is:



So you instantly know more than one way to say, "The Boss is always right," which is handy if you get cornered and have to lie like that.

Introduce yourself to *Turbo Lightning* and it will never ever forget your name. It's conceivable, if unfair, that your name is not in the dictionary already, but you can instantly teach *Turbo Lightning* your name and all the other names and words it needs to know to help run your business or personal life.

Once you've taught *Turbo Lightning* what it needs to know, you'll never blow it with a letter to the *Joint Chiefs of Staff*, the *Raygan White Howse* or mess something up on your IBM PC. (IBM PC is not a trademark of International Business Machine Corp.)

**Not \$500, not \$400, not \$300, not \$200, not \$100, just \$99.95 for this instant electronic miracle.** Our success is pretty simple. We're not greedy. We believe that it is better to sell hundreds of thousands of software programs at a reasonable price—instead of a few at prices that would make Jesse James blush.

Just \$99.95 gets you into the *Turbo Lightning* Library—which is an incredible deal when you look at what you're getting. You're getting the 'access system'—*Turbo Lightning*—which is the "engine" that powers the whole *Turbo Lightning* Library. You're getting the "engine" plus the 83,000-word *Turbo Lightning* Random House Speller and Word List; the 50,000-word *Turbo Lightning* Random House Thesaurus. And you're getting all that for an *incredible* \$99.95!

If you ever write a word, think a word or say a word, you need *Turbo Lightning*. We give you a 60-day money-back guarantee and of course there's no copy protection. \$99.95 isn't much to pay for a mistake-free life. Not to mention an education. No matter who you are or what you do, you need *Turbo Lightning*. That \$99.95 will be the best \$99.95 you ever spent on yourself or your company.

Do yourself, your assistants, your secretary, your boss, your readers, your audience and your career a favor, get *Turbo Lightning* today!



Turbo Lightning, Turbo Lightning Encyclopedia, and Turbo Lightning Library are trademarks and SideKick is a registered trademark of Borland International, Inc. Random House is a registered trademark of Random House, Inc. IBM, IBM PC, AT, and XT are registered trademarks of International Business Machine Corp. MultiMate is a trademark of MultiMate International Corp. WordStar is a registered trademark of MicroPro International Corp. Microsoft is a registered trademark of Microsoft Corp. MCI Mail is a registered trademark of MCI Communications Corp. CompuServe is a registered trademark of CompuServe Corp.

Inquiry 41 for End-Users. Inquiry 42 for DEALERS ONLY.

T U R B O

# Lightning

60-DAY MONEY-BACK GUARANTEE!

To order by Credit Card call (800) 255-8008, CA (800) 742-1133.  
Available at better dealers nationwide. Call (800) 556-2283 for the dealer nearest you.

\$99.95

YES! Rush Turbo Lightning to me  
Send me \_\_\_\_\_ copies

This price includes shipping to all U.S. cities. All foreign orders add \$10 per product ordered

Subtotal: \_\_\_\_\_  
(CA res. add \$6 tax per copy)

Amount Enclosed \_\_\_\_\_  
Payment VISA MC BankDraft Check  
Credit Card Exp. Date \_\_\_\_\_  
Card # \_\_\_\_\_

City \_\_\_\_\_ Zip \_\_\_\_\_  
State \_\_\_\_\_ Telephone \_\_\_\_\_

COD's and Purchase Orders WILL NOT be accepted by Borland. California residents add 6% sales tax. Outside USA add \$10 and make payment by bank draft payable in US dollars drawn on a US bank

L15

Copyright 1985 Borland International BI-1021

assignments, anchored variables, and nested functions are also included but do not interfere with compilation of standard C source code.

A proprietary operating system, C-DOS, is used so that more program space is available on disk and in memory; complete C source code for the operating system, the pseudocode interpreter, and all libraries are included. The operating system or interpreter can be incorporated in programs developed under C++ without royalty charges.

While neither C++ nor programs generated by it run directly under DOS 3.3 or ProDOS, it is possible to modify object files to run under ProDOS, according to the publisher.

C++ is available for \$43.95 plus a \$6 shipping charge. For more information, contact the WSM Group, Suite 241, 1161 North El Dorado Place, Tucson, AZ 85715, (602) 298-7910. Inquiry 605.

### Microcomputer-based Storage and Transmission of Color Video Pictures

Widcom's Rapics 500 attaches to a personal computer and uses digital video-compression techniques to store and recall NTSC-compatible television color images. The compressed images can be stored (100 will fit on a standard 360K-byte floppy disk) or transmitted over a standard modem (a typical 8K-byte image can be sent in approximately 50 seconds at 1200 bps). An image can usually be compressed or expanded in less than 5 seconds.



The PC/IT from Sperry.

The video compression takes place inside the stand-alone unit that connects to the microcomputer through the RS-232C interface. The interface can operate at 1200, 2400, 9600, or 19,200 bps. The system is controlled by menu-driven software, and the computer acts as a file server.

Images are captured in 192K bytes of RAM and are then compressed using a transform-coding technique. Each image is analyzed for the best resolution, clarity, and compression ratio; simple images are compressed more than complex images. A typical compressed image occupies 8K bytes, a simple image 2K bytes, and a highly-complex image 12K bytes.

The Rapics 500 can overlay black-and-white or color labels on an image. You can put a total of 480 characters at any position on the screen. The computer-generated text overlay is handled as a separate file and can be disabled for viewing the underlying image.

Video output from the Rapics 500 is standard NTSC and can be fed into any video printer. You can capture a live off-air television image, store it, and recall it. Widcom claims the Rapics 500 can retrieve a color television picture stored on another computer system at a remote location and display it on a local television monitor in less than 10 seconds.

Widcom is selling a copy stand that includes a color television camera and zoom lens. This allows you to

digitize material for the Rapics system.

General Electric Information Services helped fund the development of the Rapics 500 and also has rights to market it.

The Rapics 500 suggested list price is \$4500. The optional copy stand is also \$4500. Contact Widcom Inc., 1500 East Hamilton Ave., Campbell, CA 95008, (408) 377-9981. Inquiry 606.

### Sperry AT-compatible Runs at 6, 7.16, or 8 MHz

Sperry's PC/IT Personal Computer is compatible with programs written for IBM's PC AT but is said to operate faster and support more users. Based on Intel's 8-MHz 80286 processor, the PC/IT allows switch-selection of clock speed to operate at 6, 7.16, or 8 MHz for compatibility with software designed to run using IBM's 6-MHz PC AT. You can expand the PC/IT's standard 512K bytes of RAM to 1 megabyte on the main circuit board or to 5 megabytes using two expansion cards. The system's standard 1.2-megabyte floppy-disk drive can be supplemented with one or two 44.6-megabyte hard-disk drives and a 60-megabyte tape drive.

The PC/IT comes with MS-DOS 3.1, GW-BASIC, and a diagnostics disk. As an option, you can use the XENIX System V operating system to provide support for up to eight additional users running software compatible with AT&T's UNIX System V.

The basic PC/IT with one 1.2-megabyte disk drive,

(continued)



# Discover EVEREX

## Feature by Feature

### Chapter 1: Graphics Boards

- **Mono Resolution**  
Text and Graphics—720 x 348.
- **Color Resolution**  
Medium, High and Extra High Capabilities.
- **Compatibility**  
Runs Color or Mono Software on Mono Monitor.
- **Extended Display**  
132 Columns by 44 or 25 Rows.
- **Display Quality**  
Flicker Free, Snow Free.
- **Mono and Color Monitor Connector**  
Standard Feature on The Graphics Edge.
- **Ease of Use**  
Automatic Boot up Without Software Patch.
- **Parallel Printer Port**  
100% IBM Compatible.
- **Price**  
Very Attractive Discounts.
- **High Reliability**  
Full 1 Year Warranty.
- **Company**  
The Technology Leader in Graphics Boards  
—Everex.

*The Edge and The Graphics Edge* are part of a family of peripheral products for your IBM PC, PC/XT, PC/AT—multifunction boards, tape backup, hard disk storage, modems and expansion systems.

Use this ad to compare us to our competition . . . then call your local dealer for a hands-on demonstration.

Inquiry 135 for End-Users.  
Inquiry 136 for DEALERS ONLY.

Department B  
47777 Warm Springs Blvd.  
Fremont, CA 94539  
(415) 498-1111

**EVEREX**  
EVER for EXcellence



Inside California:  
(800) 821-0807

Outside California:  
(800) 821-0806

monochrome-graphics adapter and monitor is priced at \$4340. A multiuser configuration with 1-megabyte RAM, a 44.6-megabyte hard disk, 1.2-megabyte floppy disk, and a multi-terminal adapter is \$6834.

For more information, contact Sperry Corp., Information Systems Group, POB 500, Blue Bell, PA 19424, (215) 542-4213. Inquiry 607.

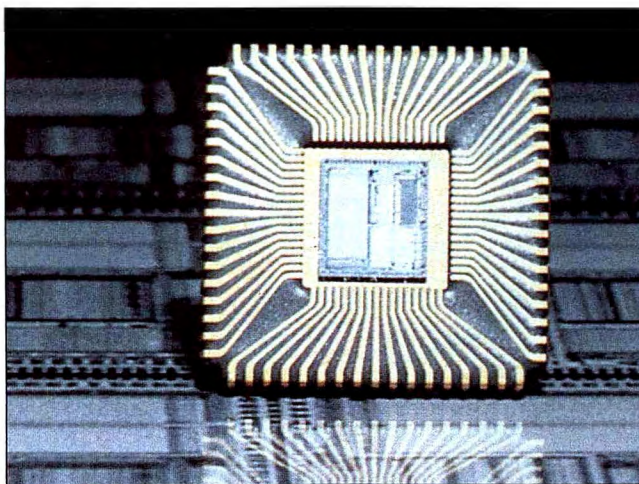
### Touchpad Accessory for the IBM PC

**P**olytel Computer Products has introduced the Keyport 60, a small rectangular touchpad that fits along the top of the IBM PC keyboard. It has 60 touch-sensitive regions that can be programmed as function keys and defined in regular and shift modes, so the Keyport 60 will accommodate a maximum of 120 macro commands.

To record a macro, you press the Alt key on your regular keyboard and a touchpad key simultaneously. Any keystrokes that follow are recorded until you press the Alt and touchpad keys a second time.

The touchpad package comes with KPEDIT, a full-screen editor that allows you to edit key definitions.

Keyport 60 works with the IBM PC, XT, AT, and compatible personal computers, using the joystick adapter to allow concurrent operation with your regular keyboard. It costs \$99. Contact Polytel Computer Products, Suite 310, 1250 Oakmead Parkway, Sunnyvale, CA 94086, (800) 245-6655; in California, (408) 730-1347. Inquiry 608.



*The first of the Transputers, the IMS T414.*

### Inmos Releases First Transputers

**I**nmos has released the first of its linkable self-contained computer chips called Transputers. Each Transputer chip holds a fast microprocessor, a small amount of memory, and four communications links for connections with external devices or other Transputers (see the May issue of BYTE, page 219). The Transputers run under a proprietary language called Occam, which can accommodate multiprocessing tasks.

The first Transputer to become available is the IMS T414, which features a 32-bit processor (executing instructions at a reported rate of 10 MIPS), 2K bytes of RAM, and four high-speed data links (10 megabits/second). A version with 4K bytes of RAM should be available soon, according to Inmos.

The T414 is sold as a single chip (\$500 each in 100-unit quantities) or as

part of an evaluation board. Several boards are available, including the B001-1, with 64K-byte RAM and two serial ports (\$2500); the B002-1, with 1-megabyte RAM and two serial ports (\$3500); and the B004-1, with 1-megabyte RAM and an IBM expansion bus connector (\$3500).

To develop software for the Transputer, you need the Transputer Development System software (\$4000 for the IBM PC XT version). Contact Inmos Corp., POB 16000, Colorado Springs, CO 80935, (303) 630-4000; or Inmos Limited, Whitefriars, Lewins Mead, Bristol BS1 2NP, England, (0272) 290861. Inquiry 609.

### Dot-Matrix Printers Offer Font Cartridges, IBM PC/Epson Graphics

**T**he MT85 and MT86 dot-matrix printers from Mannesmann Tally run at 180 characters per second in draft mode and 45 cps in near-letter-quality mode. Both printers can connect

through plug-in interface modules with most popular personal computers, offer changeable typefaces in the NLO mode, and generate sound levels below 55 dBA. The only difference between the two models is that the MT85 can print 80 columns across a page and the MT86 can print 136.

The machines are programmable from computer or interface and retain programs even when power is shut off. Full IBM PC/Epson character sets are standard. With the plug-in interface modules, the MT85 and MT86 can emulate IBM Graphics, Apple Imagewriter, and Epson FX printers. You can change the standard Quadrato typeface to Courier, Letter Gothic, or Script Italics by using the optional typeface cartridges. The printers can also produce both condensed and expanded print.

The MT85 and MT86 use standard fabric ribbon cartridges or high-carbon mylar cartridges. Both friction feed and tractor feed are standard features. The tractor feed can be adjusted to the full width of the MT86.

List prices are \$499 for the MT85 (80-column) and \$599 for the MT86 (136-column). Typeface cartridges are \$34.95. Contact Mannesmann Tally Corp., 8301 South 180th St., Kent, WA 98032, (800) 447-4700; in Washington, (206) 251-5500. Inquiry 610.

*(continued)*

# IT EXPECTS YOU TO GROW.

## INTRODUCING THE NCR PC6.

If you don't want your business to stay small, why get a computer that does? No personal computer gives you more growing room than the new NCR PC6.

The PC6 can be upgraded to 40 megabytes—room for 7,575 pages of charts, inventory lists or business letters.

As your business takes off, you'll take on more jobs, more responsibilities, and have less time for them. So the PC6 runs the estimated 10,000 compatible programs at 8MHz processing speed. (Almost *twice* as fast as the PC XT™) And for low speed programs, a switch downshifts the PC6 to 4.77 MHz.

When you're ready for multitasking, more memory, and new applications, so is the PC6.

There are four integral drive positions for hard and floppy disks plus a tape backup. Mix and match to suit your needs. And no PC offers more expansion slots (eight in all).

Expand your staff and the PC6 extends your authority. It's the perfect nucleus for a computer network.

And no matter how big you get, you'll never outgrow NCR's support. We're big in 120 countries, with 1,200 service support offices.

So if you're a small businessman with big ambitions, take on the new NCR PC6. It's as anxious to grow as you are.

For the nearest NCR dealer, call toll-free 1-800-544-3333\*

**A BETTER PERSONAL COMPUTER. IT'S EXACTLY WHAT YOU'D EXPECT FROM NCR.**

**NCR**

Inquiry 262



**Revelation® is a classic case of 'you get what you pay for.' It costs a bit more than most, but it gives you the best there is.**

— PC Magazine, September 4, 1984

If you think that dBASEIII™ or R:base 5000™ is the solution to your information processing needs, consider for a moment the high expectations you and your company should have for your next database management system.

**For starters, it needs to network.**

Revelation is ready to network now, not "someday soon." You choose the best hardware and software for your unique needs, including IBM®'s PC Network or any networks running Novell NetWare.™

Network Revelation also locks data at the record level. That's a critical capability that means the difference between a working network and disappearing data.

**Make sure that it has an excellent command of the language.**

R/Design, Revelation's application generator is your ticket to the most powerful applications running on PC's. That's because R/Design steps you through the entire application generation process, from defining databases to writing the documentation. And when you're done, Revelation will compile your application in R/Basic source code, a complete, structured relational language.

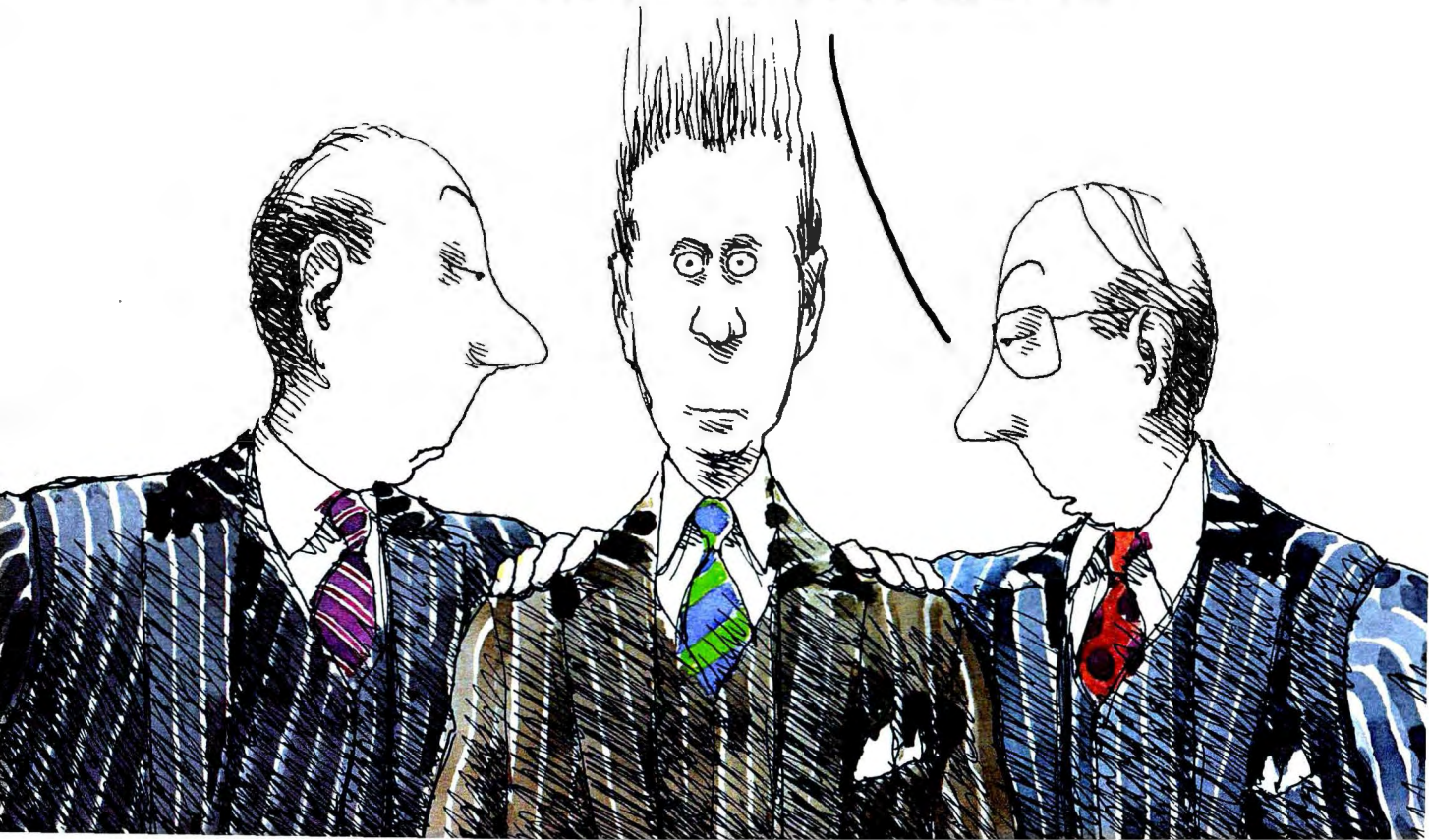
**Find out how easily you can retrieve information.**

With R/List, Revelation's query language, you ask questions in plain English. Simple sentences produce detailed reports in just about any format you can imagine.

And while you're at it, ask Revelation about its variable-length fields, unlimited files, and fields, data dictionaries, and high-speed compiler. You'll find all the tools you need for serious applications development. With prices starting at only \$1495\* for a complete four-user system, Network Revelation gives you *more* than you paid for.

\*Suggested U.S. price.

**IF YOU CHOOSE A WIMPY DATABASE THAT'S UNABLE TO KEEP PACE WITH OUR GROWING COMPANY, YOU'LL HAVE TO CHANGE YOUR NAME AND MOVE TO PARAGUAY!**



**A revealing comparison between R:base 5000, dBASE III and Revelation**

	Revelation	R:base 5000	dBASE III
Maximum Characters/Record	65000	1530	4000
Maximum Fields/Record	65000	400	128
Relational Operators	9	6	6
Data Dictionary	Yes	Yes	No
Procedural Language	Yes	Yes	Yes
Variable-Length Fields	Yes	No	No
Report Writing Features:			
A) Access to Date/Time	Yes	Yes	No
B) Row or Column Formats	Yes	Yes	No
C) Accessible Tables	6000	40	10
Password Security	Yes	Yes	No
Definable Data Entry Rules	Yes	Yes	No
Pre-Defined Macros	Yes	Yes	Yes
Application Generator	Yes	Yes	No
Application Compiler <sup>(1)</sup>	Yes	Yes	No
Run-Time Module	Yes	Yes <sup>(2)</sup>	Yes <sup>(2)</sup>
Natural Language	Yes	Yes <sup>(3)</sup>	No
Network Version	Yes	No <sup>(4)</sup>	No

1) From original manufacturer; 2) Available soon; 3) Extra cost option; 4) Announced for late 1985. dBASE III is a trademark of Ashton-Tate. R:Base 5000 is a trademark of MicroRIM, Inc. MS is a trademark of Microsoft. IBM is a registered trademark of International Business Machines Corporation. NetWare is a trademark of Novell, Inc.

**It's your choice: The vice presidency or Paraguay**

Cosmos' worldwide network of sales representatives stand ready to show you the incredible power of Revelation. Call today to schedule a career altering demonstration or to request an evaluation copy.

Cosmos, Inc., 19530 Pacific Hwy. S.  
Seattle, WA 98188, (206)824-9942,  
Telex:9103808627 (Cosmos WA)

Inquiry 88



**HOWEVER, IF YOU FIND ONE THAT CAN GROW AS WE GROW, EVEN NETWORK, YOU JUST MIGHT BE OUR NEXT VICE PRESIDENT! WHY ARE YOU SMILING?**



## Conducted by Steve Ciarcia

### PRINTER BUFFER

Dear Steve,

Like many Macintosh owners, I am interested in building a printer buffer for the Apple Imagewriter. The printer's built-in buffer is only 1K byte, and I desperately need a 64K-byte upgrade. In the June 1984 BYTE on page 142, John Bono introduced a printer buffer featuring a Z80 microprocessor and 64K bytes of memory. Unfortunately, the buffer presented had only a parallel interface. Is there some way of converting Mr. Bono's design to work with a serial printer?

MARK EWERT  
Ann Arbor, MI

*The printer buffer described in Mr. Bono's article can easily be modified to provide a serial output. All you have to do is provide a couple of serial ports and software modifications to drive them. This could be an addition to Mr. Bono's circuit, so it could support both types of interface.*

*Circuits for serial ports can be found in many books on microprocessor interfacing. One of them is Interfacing to S-100 IEEE 696 Microcomputers by Sol Libes and Mark Garetz (Osborne/McGraw-Hill, 1981). This book deals specifically with the S-100 bus but gives interfacing for 8088/Z80 microprocessors and has software examples.*

*The March BYTE has a short article on page 129, "Build a Serial Card" by Robert Kong Win Chang shows a serial port using a different UART than in the Libes and Garetz book. This one is for a Sanyo MBC-550 but is general enough to be adapted to the buffer.—Steve*

### DISK DRIVES

Dear Steve,

I have read much lately concerning the use of a Shugart SA400 disk drive on the Apple. I understand that attaching the SA400 would require an entirely different interface than the standard Apple one and that some modifications must be made to the drive itself.

Are there any drives that do not require a different interface? I own an Apple IIc and would like to add a higher-capacity disk drive as a second drive. Also, can you

use a 40- or 80-track drive with the IIc?

Additionally, what do you know about the IWM (integrated Woz machine)? I can't find out anything from Apple, and I would appreciate any information you might have.

Finally, what mechanisms are used in the Rana Elite series of disk drives?

KARL C. BUCKENMAIER  
Westport, CT

*As far as I can determine, there are currently no drives specially made for the Apple IIc with capabilities greater than the standard 143K bytes. Using industry-standard drives is impossible without adaptation because Apple uses a non-standard drive and a controller differing considerably from industry norms. For that reason, standard 40- and 80-track drives cannot be used without extensive hardware and software modifications. Some of the high-capacity drives for the Apple II+ and IIe, such as those made by Rana, may be able to work with the IIc; consult the manufacturers.*

*The integrated Woz machine is functionally the same as the Apple Disk II controller card. The Woz machine is contained in a single IC package, however, instead of the eight packages on the controller card. For a detailed description of that controller and how it works, see Understanding the Apple II by Jim Sather (Quality Software, 21601 Marilla St., Chatsworth, CA 91311).*

*The Rana Elite drives are based on a mechanism made by Micro Peripherals Inc.—Steve*

### IDEA PROTECTION

Dear Steve,

Thank you for your wonderful columns, books, and projects. It is rare to find an experienced individual who will provide patient, thoughtful answers to both the beginner and expert.

I am an electronics technician, dabbling into engineering whenever the opportunity arises. Twice in the past I have developed ideas that someone else with more time, money, and expertise has made profitable. Not a case of plagiarism, just that they also recognized the need for the product and capitalized on it.

Once again I've got a couple of ideas I've been kicking around. Unfortunately, I know few people who would understand the ideas and their applications. But even if I find someone with the ability to understand and the means to do something with an idea, how do I protect my interest?

ROCKY J. SEELBACH  
San Diego, CA

*Thank you for your enthusiasm about my columns.*

*I am sure your feelings are shared by thousands of hobbyists, experimenters, and other people who are just as creative and talented as the designers who do that sort of thing professionally. The potential for abuse of the ideas of those who are unable to immediately implement them is great.*

*As far as how to protect your rights, let me say first of all that this is best handled by an attorney, specifically a patent attorney. This person will be able to explain the laws concerning such topics and what your options are.*

*The first thing to do with any idea that you feel has merit is to write it down. Sign and date the entry. If possible, get someone you trust to witness it. Explain your idea to your witnesses, and make sure they understand it. Have them write words to this effect ("witnessed and understood by me") and sign and date it. This provides proof that you did indeed have this idea at this date and may be used as evidence in a potential patent-infringement lawsuit. Your witnesses may be called to explain your notes as they understood them in order to verify your claims.*

*One way to protect written material that you may want to copyright is to send a copy of that material to yourself via registered mail. The cancellation on the envelope is proof of the date the material inside existed. Do not open the envelope; it must stay sealed in order for the date to remain legal proof. This will establish a time reference in case you need to demonstrate that you originated the material before someone else did. Also, any material that you wish to have pro-*

*(continued)*

# 100 MHz scope, counter, timer, multimeter: All one integrated system.

**100 MHz dual time base scope.**

3.5 ns risetime; sweeps from 0.5 s to 5 ns/div; alternate sweep;  $\pm 2\%$  vertical/horizontal accuracy; vertical sensitivity to 2 mV/div @ 90 MHz.

**9-digit fluorescent display.**

Digitally accurate readouts accompany the CRT waveform. Error messages and prompts also appear on the display.

**Dc volts and ac coupled true RMS volts.** Measured through the Ch 1 scope input.

**Gated measurements.**

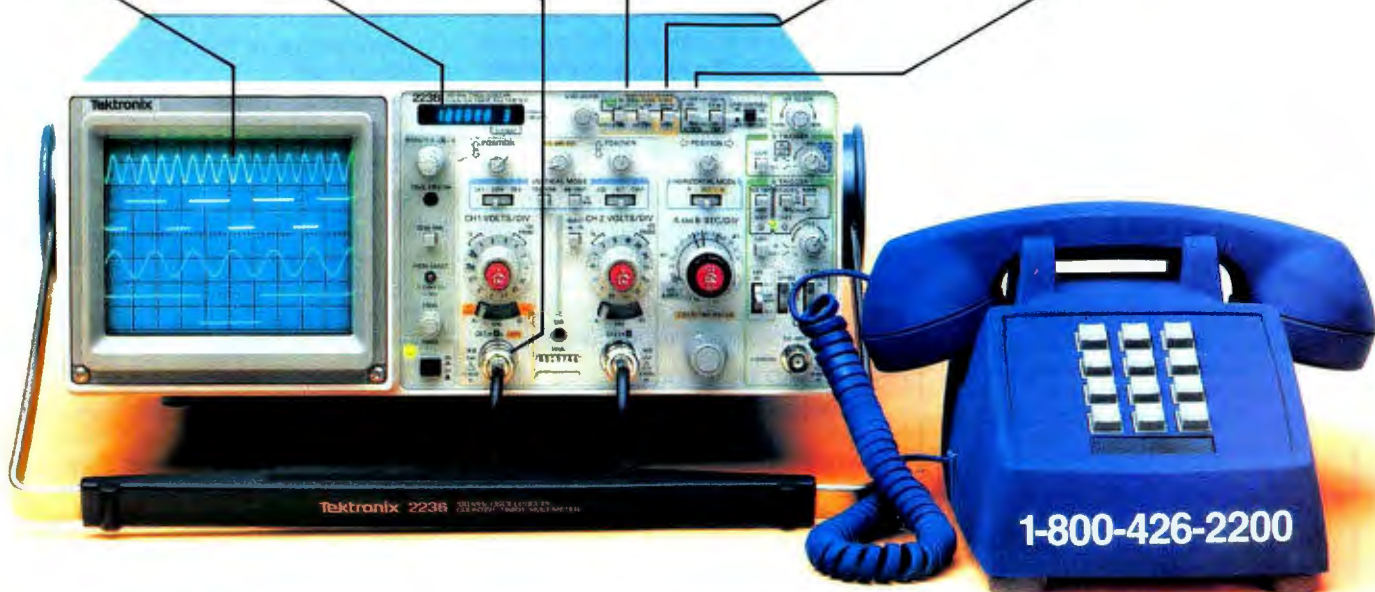
Use the scope's intensified marker to measure frequency, period, width and to count events within specified portions of the signal.

**Auto-ranged, auto-averaged counter/timer.**

Frequency, period, width, delay time,  $\Delta$ -time, plus totalize to more than 8 million events — with 7 digits plus exponent displayed.

**Auto-ranged DMM.**

Use floating DMM side inputs with up to 5000-count resolution. Get precise readouts of average dc and true RMS voltage. Measure resistance from milliohms to gigohms.



**Now make measurements faster, easier, with greater accuracy and user confidence.**

The Tek 2236 makes gated counter measurements, temperature, time, frequency, resistance and voltage measurements push-button easy. You see results concurrently on the 9-digit numeric readout and CRT display.

Its complete trigger system includes pushbutton trigger view, plus peak-to-peak auto, TV line, TV field, single sweep and normal modes.

At just \$2650\*, the 2236 includes the industry's first 3-year warranty on all parts and labor, including the CRT.

**Integrated measurement system. 3-year warranty. 15-day return policy. And expert advice. One free call gets it all!** You can order, or obtain literature, through the Tek National Marketing Center. Technical personnel, expert in scope applications, can answer your questions and expedite delivery. Direct orders include probes, operating

manual, 15-day return policy, full warranty and worldwide service back-up.

**Order toll-free:  
1-800-426-2200  
Extension 57**

In Oregon call collect:  
(503) 627-9000 Ext. 57  
Or write Tektronix, Inc.  
P.O. Box 1700  
Beaverton, OR 97075

**Tektronix®**  
COMMITTED TO EXCELLENCE

# ON-LINE HELP for DOS only \$29



DOS-Helper is an ON-LINE Help System for DOS. With DOS-Helper you no longer have to scramble for the DOS manual because it is on your disk, easily accessed at any time.

## FEATURES

- Both standard and **co-resident** versions included.
- Complete & clear information, including examples, for all DOS & Debug commands, and most other topics in the manual.
- Easily add **YOUR OWN** help files, for any topic.
- For PC, XT, AT & compatibles. Requires DOS 2.00 & up. Any 80x25 screen. Min 128k & 1 disk drive.

**General help system also available for software developers.**

**30 DAY UNCONDITIONAL  
MONEY BACK GUARANTEE!**

Ordering Information:  
- \$29 + \$3 S&H. Chk, Visa, MC.  
- Texas + 6% tax. Outside USA + \$4.  
- Site licensing available.  
- Dealer inquiries welcome.

**ARISTO SOFTWARE**  
16811 El Camino Real  
Suite 213-D  
Houston, TX 77058  
**1-(800) 3ARISTO** or  
(713) 480-6288

## ASK BYTE

tected under copyright laws must bear the copyright symbol (©) along with the year and your name, or the name of the entity (like a company) that holds the rights to the material. This can provide some protection even if you have not filed with the Copyright Office.

If you are going to discuss your ideas with someone who may be able to help you implement them, you should consider what is known as a nondisclosure agreement. This is a document the person with whom you are discussing confidential matters signs, agreeing not to disclose the information without your permission. This provides you some legal recourse in case the person passes your information on to someone who may attempt to use it. The wording of the agreement need not be complex legalese, but you should consult an attorney for assistance in preparing it.

Again, let me stress that consulting a lawyer may seem like a high cost to pay for your protection, but it could save you thousands of dollars in lost products and future legal fees, not to mention saving you headaches and the "I wish I had done it" feeling later on.—Steve

## SPEECH PATHOLOGY

Dear Steve,

I would appreciate any advice you can give me regarding a project I want to develop for use in my work as a speech pathologist. I would prefer to make use of a home computer. I own an Apple II+, an IBM PC XT-compatible machine, and a Kaypro 10.

The data I am dealing with relates to a voice input producing one- or two-syllable words of between 0.5- and 6-second duration. I want to monitor this data graphically on a video display. I would like the display to represent 1000 samples per second of the relative loudness levels across time, the amplitude of the breath component in voice as well as the amplitude of the voiced component across time, and the fundamental pitch of the voice across time. I would also like to be able to store this data.

HARVEY J. GARDNER  
Huntington, NY

*You can easily accomplish your project with any of your computers. However, I recommend use of the IBM PC XT-compatible machine because a number of instrumentation hardware/software packages are available to aid you during the development stages.*

*Most of the parameters you desire to*

*record and analyze can be obtained with an analog-to-digital-converter board and some well-written software. I would begin by talking to your local computer store about various A/D boards and related software. In addition, check ads for A/D boards and other instrumentation hardware/software packages in publications like BYTE.*

*I also recommend the following books:*

Interfacing Microcomputers to the Real World  
Murray Sargent III and  
Richard L. Shoemaker  
Addison-Wesley, 1981

From Chips to Systems: An Introduction to Microprocessors  
Rodnay Zaks  
Sybex, 1981

Microprocessor Interfacing Techniques  
Rodnay Zaks and Austin Lesea  
Sybex, 1983

Microprocessor-Based Process Control  
Curtis D. Johnson  
Prentice-Hall, 1984

*The information presented in the above books can turn you into an expert on interfacing microprocessors to various transducers and other devices.—Steve*

## RAINBOW

Dear Steve,

I am trying to write onto single-sided IBM PC disks (512 bytes/sector, 8 or 9 sectors) using a DEC Rainbow. I have used a public-domain program called DOSFLX to read and write IBM disks, but the program has proved unreliable. I would like to write my own program in C to do the job.

DOSFLX would foul up some of the last 16 bytes in a sector when I used it to copy a file from Rainbow disks to IBM disks. Is this due to some timing problem? DEC says the Rainbow 100 can read IBM disks (and I have verified that this is true). Why can't I write to IBM disks?

DAVE HACKETT  
Lima, NY

*According to sources at DEC, the reason you are having trouble writing to PC-DOS disks is due to the Rainbow's ability to write to disks in more precise track increments than those on other computers. They recommend a product called Media Master, which allows disks of many different formats to be used by*

*(continued)*



# TAS™

the "Hard-nosed" Relational Database

**\$199.**

the Database + Integrated Accounting

**\$349.**

## If You Liked DBase III, You'll Flip Over TAS™

Hard-nosed business owners have been asking for the power of DBase III™ and RBase 5000™ but without the high price. That's why Business Tools, Inc. created TAS™.

Compare TAS with DBase III and RBase 5000. You'll see why we think TAS is the best "Hard-nosed" value around. TAS includes a data dictionary. TAS includes a true procedural language. TAS includes a run-time compiler. Plus TAS can be upgraded to multi-user for \$100.

TAS lets you develop your own professional menu-driven business applications. And not just simple ones either. TAS applications can hold up to 17 million records. And because TAS compiles them, they run fast.

## Get TAS Accounting Software for \$349

But why stop with just a database? For just \$349, you get TAS Relational Database/Language plus General Ledger, Accounts Receivable and Accounts Payable. And for \$499 you get all the above plus Inventory, Sales Order Entry, Purchase Order Entry, and Payroll.

Source code is included FREE! So you can even modify the accounting to fit your business.

	TAS™	DBASE III	RBASE 5000
Multi-User	\$100	No	\$1400
Data Dictionary	Yes	No	Yes
Procedural Language	Yes	Yes	Yes
Compiler	Yes	No	Yes
Records Per File	Unlimited	Unlimited	Unlimited
Files Open	16	10	40
Fields Per File	Unlimited	128	400
File Size	Unlimited	Unlimited	Unlimited
Record Size	10,254	4,000	1,530
Field Size	254	254	1,530
Prices	\$199	\$696	\$700

And TAS is no new comer. TAS was written by Phil Mickelson, the same "Hard-nosed" business person who created The Sensible Solution™ (relational database) in 1982.

TAS comes with a 30 day money back guarantee (less handling fee of \$15 Level 1, \$30 Level 2, \$45 Level 3 and \$10 Multi-User). TAS is available for the IBM PC/XT/AT™, Compaq™, AT&T 6300™, Tandy 1000, 1200, 2000™ and most MS-DOS™, CP/M™ and MP/M™ systems. Multi-user and LAN versions also available.

**Call Today 1-800-648-6258**  
**Ask for operator 11**

Call our Toll-Free Hotline. Use your VISA or MasterCard to order today. Outside Washington call 1-800-648-6258. Washington residents call 1-206-644-2015.

**Dealer Inquiries Welcome.**



**BUSINESS TOOLS INC.**  
4038-B 128th Ave. SE  
Suite 266  
Bellevue, WA 98006

Inquiry 44

The following are registered trademarks of these companies: TAS, Accounting Solution, Business Tools Inc., RBase 5000, Microhm Inc., DBase III, Ashton-Tate Inc., CP/M and MP/M, Digital Research Inc., IBM PC/XT/AT, International Business Machines Corp., Compaq, Compaq Computer Corp., AT&T 6300, AT&T Information Systems Inc., Tandy 1000, 1200, 2000, Tandy Corp., MS-DOS, Microsoft Corp., The Sensible Solution trademark rights are claimed by O'Hanlon Computer Systems Inc.

© Copyright 1985 Business Tools Inc.

**TAS™**

**"Affordable Software For Your Business Needs"**

**NOT COPY-PROTECTED**

Describe your computer system:

6 bit  16 bit

CP/M, MP/M  MS-DOS

TurboDOS  PC-DOS

Disk size is:

5 1/4"  6"

Computer name/model is: \_\_\_\_\_

Name: \_\_\_\_\_

Street: \_\_\_\_\_

City: \_\_\_\_\_

State: \_\_\_\_\_ Zip: \_\_\_\_\_

Phone: \_\_\_\_\_

4038-B 128th Ave. SE  
Suite 266  
Bellevue, WA 98006

Quantity:

\_\_\_ TAS Database/Language—\$199

\_\_\_ Level 2 Accounting (TAS, GL, AR, AP)—\$349

\_\_\_ Level 3 Accounting (Level 2, SO, PO, INV, PAY)—\$499

\_\_\_ Multi-user upgrade—\$100

Subtotal (WA add 7.8% tax)

Shipping (USA—\$5.00 ea.)  
(Foreign—\$20.00 ea.)

Total Enclosed: \_\_\_\_\_

Payment:  VISA  MC  Cashier's Check  
(All amounts are payable in U.S. funds only.)

Credit Card Expiration Date: \_\_\_\_\_

Card Number: \_\_\_\_\_

Name on card: \_\_\_\_\_

Signature: \_\_\_\_\_



### COMPUTERS

AT&T 6300 256K, 2 Dr, Mono	\$1999
640K, 1 Dr, 10 MB, Mono	\$2499
COMPAQ All Models	\$Call
<b>CORONA</b>	
PC-400-22 W Monitor (2DR)	\$1329
PPC-400-22 (2 DR PDRT)	\$1239
<b>EPSON</b>	
Equity 1 256K, 2 Dr	\$965



### IBM

PC 256K, 2 Dr	\$1699
PC 256K, 1 Dr, 10 MB	\$2149
PC 256K, 1 Dr, 10 MB, 10 MB Tape	\$2750
PC 256K, 1 Dr, 20 MB, 10 MB Tape	\$2899
XT 256K, 1 Dr, 10 MB 10 MB Tape	\$2895
XT 256K, 1 Dr, 30 MB, 60 MB Tape	\$3995
AT 512K, 1 Dr, 20 MB, 60 MB Tape	\$4799
AT 512K, 1 Dr, 60 MB, 60 MB Tape	\$5999

### ITT XTRA

XTRA-2, 256K, 2 Dr, Mono	\$1599
XTRA-3, 1 Dr, 10 MB, Mono	\$2169

### NCR

PC4, 256K, 2 Dr, Mono	\$Call
PC6, 256K, 2 Dr, Mono	\$2079

### NEC APC III

H102M Mono 2 Dr	\$1499
B102M7 Mono 2 Dr, Wordstar Pro, Elf 350	\$2050
H121C 1 Dr, 20 MB, Color	\$2799
H121C w/AUTOCAD ADE3	\$4599

### PANASONIC

Sr. Partner 256K, 2 Dr	\$1699
Sr. Partner 256K, 1 Dr, 10 MB, Executive Partner	\$2099

### WANG

PC-PK5 2 Dr, IBM Emulation	\$2484
PC-PK6 1 Dr, 10 MB, IBM Emu	\$3539
WOA 40 512K, w/PM015	\$2759
APC 80286, 512K, 1.2 MB Dr	\$2659

### ZENITH

ZF-148-42 2 Dr, 256K	\$1229
ZF-241-81	\$2899

### PRINTERS

C. ITOH All Models	\$Call
<b>BROTHER/DYNAX</b>	
DX-15XL/DX-35	\$359/729
<b>EPSON</b>	
FX-85	\$345
FX-185	\$485
LQ-1500	\$879
LX-80	\$225
JX-80 Color	\$459
SO-2000	\$1559
<b>HEWLETT-PACKARD Laser Jet</b>	\$2499
<b>NEC</b>	
P2/P3	\$499/699
P560	\$999
ELF 350	\$379
3550	\$999
<b>OKIDATA</b>	
ML-182	\$219
ML-192	\$339
ML-193	\$510
Pacemark	\$Call
<b>PANASONIC</b>	
KX-P1091	\$249
KX-P1093	\$479
<b>QUME SPRINT 1140/1155/1190</b>	\$Call
<b>SILVERHEAD EXP 500/550</b>	\$250/419
<b>STAR MICRONICS</b>	\$Call
<b>TOSHIBA 1340/1351</b>	\$489/1099

### HARD DISKS & TAPE BACKUP

#### INTERNAL HARD DISK KITS FOR PC/XT

PRIAM 51MB/72MB	\$1445/1645
SEAGATE, TANDON 10/20/30 MB	\$459/569/988

#### INTERNAL HARD DISK KITS FOR IBM AT

PRIAM (30 mil) 51/72 MB	\$1245/1445
SEAGATE (45 mil), TANDON 30 MB	\$879

CORVUS All models	\$Call
IONEGA Bernoulli Box	\$Call
IRWIN Tape Backup Systems	
Internal 10 MB/20 MB	\$499/799
External 10 MB/20 MB	\$599/899
TALLGRASS TG5025	\$2299

### PLOTTERS & DIGITIZERS

CALCOMP 1043GT	\$7959
ENTER COMPUTING Six Shooter	\$759
<b>HOUSTON INSTRUMENTS</b>	
PC-895	\$645
DMP-41/42	\$2369
DMP-29	\$1799
DMP-51/52	\$3559



<b>ROLAND</b>	
DXY-101	\$439
DXY-800	\$629
DXY-880	\$889
DXY-980	\$1159
GTCD All Models	\$Call
HITACHI Tiger Tablet II	\$699
SUMMAGRAPHICS Summasketch	\$489
TAXAN 710S	\$679

### MONITORS & TERMINALS

<b>AMDEK</b>	
Video 300/300A/310A	\$125/130/155
Color 500/710	\$289/480
MITSUBISHI All models	\$Call
PRINCETON GRAPHICS MAX-12E	\$175
HX-12/HX-12E/SR-12	\$469/519/599
<b>ROLAND</b>	
MB-121G/A	\$109
MB-122G	\$125
MB-142	\$269
CC-121	\$409
TAXAN NEW 600 Series	\$Call
<b>WYSE</b>	
WY-30/WY-50/WY-75	\$319/459/599
<b>ZENITH ZVM-1220/ZVM-1230</b>	\$99
<b>QUME 101G</b>	\$329

### COMMUNICATIONS & NETWORK

<b>HAYES</b>	
Smartmodem 1200/2400	\$379/625
Smartmodem 1200B w/Software	\$350
<b>NOVATION Smartcat Plus Ext</b>	\$319
PRENTICE POPCOM C100/X100	\$249/265
PROMETHEUS Promodem 1200	\$315
<b>NOVELL Networking</b>	\$Call
3 COM Networking	\$Call

### SOFTWARE

<b>ASHTON-TATE DBASE III</b>	\$389
Framework	\$389
<b>HARYARD Total Project Manager</b>	\$255
<b>MICROPRO Wordstar Propak</b>	\$265
Wordstar 2000	\$259
<b>MICROSOFT Word</b>	\$235
MULTIMATE	\$229
SSI Wordperfect	\$235
<b>PFS: Write/File/Plan/Graph</b>	\$85

### GENTECH STANDARD

384K Multifunction board OK	\$169
Hercules compatible video card	\$159
Standard Floppy Controller w/Cable	\$75
Standard ASYNC/CLK	\$79

### HARDWARE

AST Six Pack Plus 64K	\$219
Advantage 128K	\$415
RAMpage!	\$375
EVEREX Graphics Edge	\$299
HERCULES Graphics Card	\$299
Color Card	\$155



<b>INTEL Above Board</b>	\$299
<b>PARADISE SYSTEMS Mod. Graphics</b>	\$269
ORCHID PC-TURBD 186 w/128K	\$655

### QUADRAM

Expanded Quadboard 64K	\$195
Microfazer Par/Par 16K	\$139
Microfazer S/S, S/P, P/S 8K	\$139
<b>SIGMA DESIGNS Color 400</b>	\$499
STB Systems	\$469
TECMAR Graphics Master	\$469
TALL TREE JRAM-3, 256K	\$Call
<b>MEMORY UPGRADES</b>	1-9 10+
64K Set	\$7.50 \$6.90
128K Set	\$53.00 \$49.00
256K Set	\$39.00 \$33.00
8087-3	\$129.00 \$119.00
8087-2	\$139.00 \$129.00
80287	\$209.00 \$189.00

### ACCESSORIES

#### SURGE PROTECTORS

CURTIS Diamond	\$33
NETWORK Wiretree/Plus	\$39/55
KENSINGTON Masterpiece	\$95
COMPUTER ACCESSORIES	\$Call

#### EMERGENCY POWER SYSTEMS

DATASHIELD PC-200	\$315
SOLA Mini UPS 400	\$599
TRIPPELITE BC-425-FC	\$399
DATASPEC Switchboxes	\$Call

#### DISKETTES 3.5" DSDD 5.25" DSDD

3M	\$30.50	\$24.00
MAXELL	29.00	21.00
FUJI		17.50
SONY	29.00	17.00
POLARDID		17.90
WABASH		15.90

### CUSTOMER SERVICE

## 401-781-0020

### ORDERS ONLY

## 800-843-4302

217 Broadway, Suite 615, NY, NY 10007  
Hours 9-8 EST, Monday-Saturday

VISA, MASTERCARD, AMEX Accepted.

All returned non-defective merchandise are subject to a 20% restocking charge. GenTech reserves the right to change advertised prices.

the Rainbow. This software is available from

Intersecting Concepts Inc.  
4573 Heatherglen Court  
Moorpark, CA 93021  
(805) 529-5073

-Steve

### PRODUCT SELECTION

Dear Steve,

I am currently looking at modems and external hard-disk drives for my IBM PC-compatible computer. I find it exceedingly difficult to determine differences between the offerings of various manufacturers.

Modems are available that cost from \$300 to \$600. My main concern is determining differences in transmission quality.

I encounter similar problems with disk drives. Seemingly comparable disk drives vary in price by almost \$1000. One of the main differences appears to be average access time (which seems to be either 35 or 70 milliseconds). In terms of using the drive in a normal business environment, can 35 milliseconds really be noticed? Even if the computer must make 10 accesses to find a record in a file, the increased time in accessing the records will be just 0.35 second. Thirty accesses would require only an additional second.

I would appreciate any help.

RICHARD L. ROSENHEIM  
Paradise Valley, AZ

*The best way to select a modem or hard-disk drive is by analyzing your needs and then searching for a product that fills those needs.*

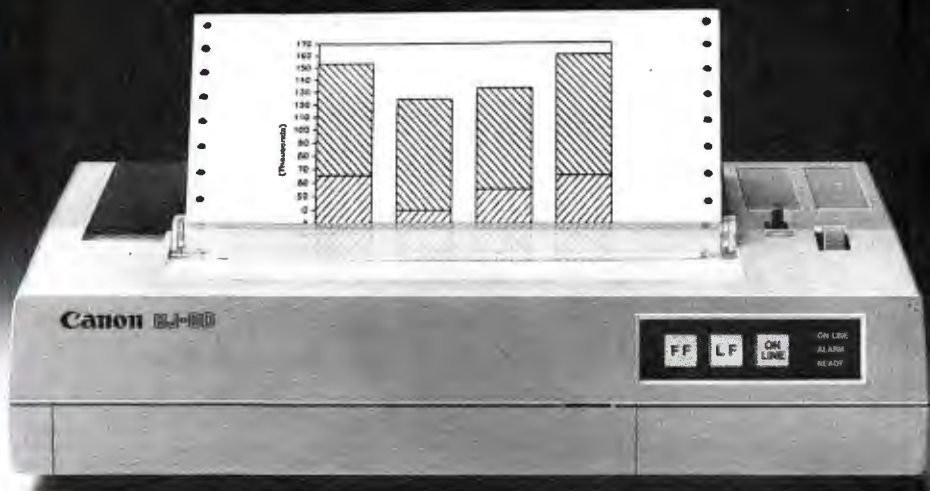
*Many of the modems on the market today are similar in transmission and reception quality. Manufacturers of products that connect to telephone company property must follow rules imposed by the Federal Communications Commission and telephone companies.*

*As semiconductor manufacturers continue their move into VLSI components, the number of chips required to build a modem is on the downswing. If you were to take apart modems of similar functionality from different manufacturers, you would be surprised at the similarity in electrical composition.*

*When purchasing disk drives, the storage capacity, access time, cost, and backup media are important. Your calculations on access times are correct, but you should expand your calculations to include a typical database or large sequen-*

(continued)

# The new Bubble-Jet Printer from Canon. Feature for feature, you can't burst our bubble.



Canon's exclusive bubble-jet technology has rewritten the industry's standards in four categories. Speed, quality, quietness and economy.

The Bubble-Jet Printer with bi-directional logic-seeking capabilities can quickly and quietly turn even the most complicated printing job into a breeze. It prints out 80 characters per line at an ultra-fast 220 characters per second. And its whisper quiet operation prevents your nerves from rattling.

If you're heavy into word processing, you'll be glad to know that the Bubble-Jet Printer's characters have character. The Near-Letter-Quality mode produces a whirlwind 110 characters per second. And you can choose from condensed, enlarged, superscript and subscript printing.

And since a picture says a thousand words, the new

Bubble-Jet Printer from Canon has two different high resolution graphic image modes, including a remarkably clear 1440 dots per line.

The Bubble-Jet Printer also incorporates a large capacity ink cartridge. So you can produce a small mountain of printouts before you need to replace the cartridge.

What's more, it can feed in roll paper, fan fold paper or single sheets with equal ease. And the Bubble-Jet Printer is IBM compatible. Plus it gets along well with most popular software programs.

If you're interested in speed, quality, quietness and economy, look into the lightweight, compact Bubble-Jet Printer from Canon. Because feature for feature, you can't burst our bubble.

**Canon**  
PRINTERS

© 1985 Canon U.S.A., Inc.

Inquiry 50

For more information: call 1-800-323-1717, ext. 300. (In IL, call 1-800-942-8881, ext. 300.)  
Or write Canon U.S.A., Inc., Printer Division, P.O. Box CN 11250, Trenton, NJ 08650.

# PRODOS PROGRAMMERS:

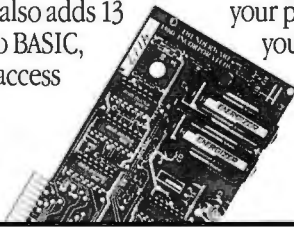
*Find files fast, add 13 new commands with Thunderclock.<sup>®</sup>*

Apple<sup>®</sup> designed ProDOS to automatically read Thunderclock. So Thunderclock can automatically time and date stamp your disk files. Every time you create or revise one. Now you can instantly identify your latest entry. Without slowing down or losing your concentration.

Thunderclock also adds 13 new commands to BASIC, making it easy to access

the time and date, measure intervals in milliseconds and use interrupts. That can add a new depth of functionality to your programs. Not to mention the rest of the available ProDOS-based software, like AppleWorks.

So if you've got a vacant slot, fill it with Thunderclock. For \$149, it's a great way to improve your programming, and your programs. See your dealer or contact us.



**THUNDERWARE, INC.**  
21 Orinda Way, Orinda, CA 94563  
(415) 254-6581

Apple is a registered trademark of Apple Computer, Inc. ProDOS and AppleWorks are trademarks of Apple Computer, Inc.

## ASK BYTE

tial file that is often found in a business environment. The few milliseconds per record search add up. You will also find that the few milliseconds difference adds up considerably when backing up a 20- or 40-megabyte device.—Steve

### MEMORY CHIPS

Dear Steve,

I am trying to design a homebrew computer, and I would like to find RAM, ROM, EPROM, and EEPROM chips with a 20-nanosecond to 1-picosecond access time. I don't care about their cost, only their access times. Any help would be appreciated.

TOM HANSEL  
Cincinnati, OH

*Memory chips with the access time you are looking for will be very hard, if not impossible, to find. Advertisers in BYTE sell bipolar memory with 45-nanosecond access times, but to get that kind of speed off the shelf, you give up density. These chips are designed to serve as scratch-pad memory, not for storing programs or large amounts of data. The Cray supercomputer, one of the fastest computers in the world, uses main memory with a 50-nanosecond access time. To get much faster than that, a technology like ECL (emitter-coupled logic) is required. But ECL requires more power, more space, and more cooling than TTL (transistor-transistor logic), and it is hard to work with because the voltage requirements are more complicated.*

*Good luck with the design of your homebrew computer. Don't be discouraged; the engineers at IBM and Cray managed to design a pretty fast computer without 1-picosecond memory chips.—Steve ■*

IN ASK BYTE, Steve Ciarcia answers questions on any area of microcomputing. The most representative questions received each month will be answered and published. Do you have a nagging problem? Send your inquiry to

Ask BYTE  
c/o Steve Ciarcia  
POB 582  
Glastonbury, CT 06033

Due to the high volume of inquiries, personal replies cannot be given. All letters and photographs become the property of Steve Ciarcia and cannot be returned. Be sure to include "Ask BYTE" in the address.

The Ask BYTE staff includes manager Harv Weiner and researchers Larry Bregoli, Bill Curlew, Jeannette Dojan, Jon Elson, Roger James, Frank Kuechmann, Dick Sawyer, Andy Siska, and Robert Stek.

**30-Day Money  
Back Guarantee**

## The Little Black Book™

### Publish the Most Important Book You'll Ever Own.

Names here, phone numbers there, addresses and notes everywhere. That's why we created The Little Black Book. With it, an IBM Personal Computer can capture, sort and manage your business contacts. And print them into an "address book" that fits your shirt pocket (leatherette cover included).

If you have a modem, The Little Black Book will dial the numbers automatically. Right through SPRINT, MCI, etc. No modem? Load LBB as a "Pop-Up" and get personal white and yellow pages for your PC. And your pocket.

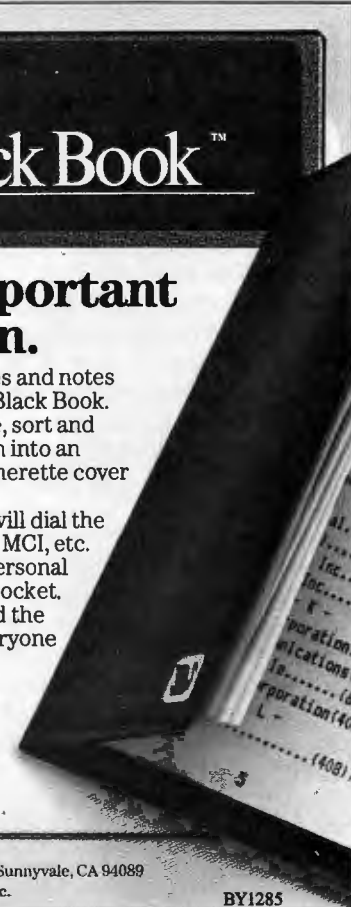
Make a different book for home, business and the road. Buy one program and make books for everyone in the company. All for \$49.95. Complete.

Call now for info or to order risk-free:

**(800) 621-4292**

**(800) 331-9113 in Calif.**

*Handy Software for Busy People*



**CYGNET**

1296 Lawrence Station Road, Sunnyvale, CA 94089  
© 1985 Cygnet Technologies, Inc.

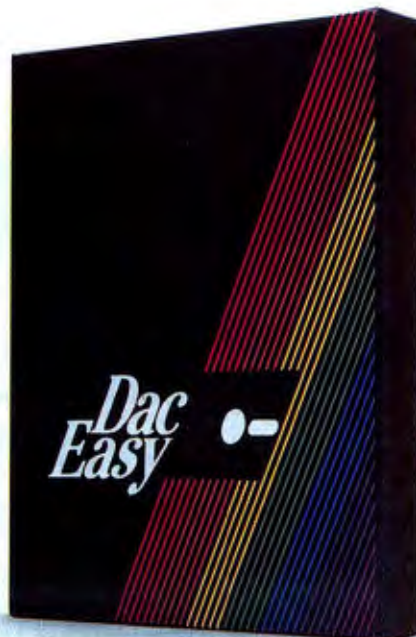
BY1285

# "Dac-Easy Accounting is a genuinely amazing deal."

PC Magazine, October 15, 1985

"I've never before in a review come right out and told readers to buy a product, but I'm doing it now. Dac-Easy is an incredible value."

PC Week, August 27, 1985.



"Amazing". "Incredible". "Unbelievable". That's how the industry's most important reviewers describe Dac-Easy Accounting — Dac Software's feature-packed, fully integrated accounting package priced at only \$69.95. They compare it favorably to accounting packages (sold module by module) costing up to five thousand dollars!



Seven powerful, integrated modules

But it's more than our price that has the critics raving. Compare our features to those of any other account-

ing package at any price.

Dac-Easy Accounting offers instant access to General Ledger, Accounts Receivable, Accounts Payable, Inventory, Purchase Order, Billing and Forecasting. Perfect integration between all seven modules gives you fast, accurate, flexible management of information. Data entered once is automatically posted to all pertinent modules. And Dac-Easy is designed to manage both product and service oriented businesses.



Three-year history maintained, with forecasting

Only Dac-Easy maintains a three-year history on all principal files, and provides spreadsheet-like forecasting based on this history.

Plus, you can generate any of 300 different reports for instant access to the exact information you need.

Find out for yourself why Dac-Easy is the fastest selling accounting package in history. Call us today!

## Dac Easy Accounting

# \$69.95

"Dac-Easy is remarkable, amazing, revolutionary, sensational..."

Computer Buyer's Guide & Handbook  
September 1985

#### PARTIAL LIST OF FEATURES

##### General Information

- Menu driven
- Password protection
- File capacity limited only by disk space
- Support contract available

##### General Ledger

- Unlimited multi-level accounts
- Three-year account history for CRT inquiry
- Pencil and pen feature to correct mistakes
- Unique budgeting routine
- CRT transaction inquiry
- Activity report, trial balance, financial statements, unlimited departments and journals

##### Accounts Receivable

- Open invoice or balance forward
- Customized aging report
- Unlimited number of customers
- Flexible mailing labels and directories
- Supports partial payments & finance charges
- Three-year customer history for number of invoices, sales, costs, and profits
- Customized statements
- Cash flow analysis/sales analysis
- Automatic sales forecasting

##### Accounts Payable

- Check printing with multiple invoices and cash available routines
- Aging reports with seven customized columns
- Unlimited number of vendors
- Flexible mailing labels and directories
- Three year vendor history
- Unlimited allocations per invoice

##### Inventory

- Supports average, last purchase, and standard costing methods
- Powerful physical inventory routines
- Accepts any unit of measure
- Three-year product history in units, dollars, cost, and profits
- Automatic forecast of product sales
- Automatic pricing assignments
- Alert and activity reports with 11 sorts
- CRT shows on-hand/on-order/committed/sales/cost/profit/turns/GROI

##### Purchase Order

- Inventory and non-inventory items
- Allows up to 99 lines per P.O.
- Per line discount in %
- P.O. accepts generic discounts/freight/taxes/insurance
- P.O. accepts back orders and returns
- Purchase journal

##### Billing

- Service or Inventory invoicing on plain or preprinted forms with remarks
- Prints sales journal
- Allows return credit memo

##### Forecasting

- Unique program that automatically forecasts using your three-year history:
- Revenue and expense accounts
- Vendor purchases
- Customer sales, cost, and profit
- Inventory item usage
- Forecast by same as last year, or % base from last year, or trend, or least square trend line analysis method

"EDITOR'S CHOICE"  
PC MAGAZINE

"Despite its low price, Dac-Easy includes a lot of extras that you wouldn't expect to find even in a more expensive package."

Bill Machrone, Editor  
PC Magazine, October 15, 1985

"This is an incredibly good value."

InfoWorld, September 23, 1985

Rated 4 disks

To Order Call Toll Free

# 1-800-431-0800

Ask For Operator 112A

For More Information

## 214-458-0038

dac software, inc 4801 Spring Valley, Rd.  
Building 110-B, Dallas, TX 75244

Send in this coupon with your credit card number, money order or check for \$69.95 plus \$7.50 for postage and handling. In Texas, add 6 1/8% sales tax (\$4.28). U.S. prices only.

CHECK  MONEY ORDER  
 AMEX  VISA  MASTERCARD Expires \_\_\_\_\_

Account No. \_\_\_\_\_

Name \_\_\_\_\_

Company Name \_\_\_\_\_

Address \_\_\_\_\_

City \_\_\_\_\_ State \_\_\_\_\_ Zip \_\_\_\_\_

Phone \_\_\_\_\_

Signature \_\_\_\_\_

30-Day Money Back Guarantee: dac software, inc. provides a 30-day money back guarantee that all claims and features listed in this ad are true.

Minimum Hardware Requirements:  
IBM (PCjr, PC, XT, or AT)<sup>1</sup> or other compatibles. 128K memory, one 5 1/4 DSDD floppy disk, 132 column printer in compressed mode, 80X24 CRT, MS-DOS<sup>2</sup>, PC DOS<sup>1</sup> 2.0 or later.

<sup>1</sup>Trademarks of International Business Machines Corporation.

<sup>2</sup>Trademark of Microsoft Corporation.

Dac Easy Accounting

112A

# Save the

Millions of IBM PCs and compatibles are fighting for their lives.

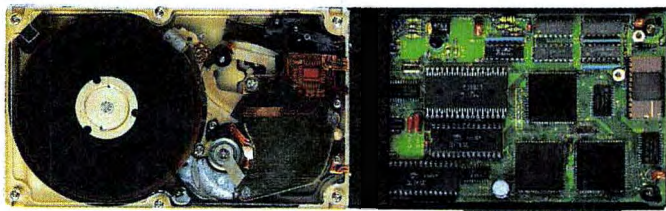
Because users like you are demanding more and more storage space. For bigger programs. For more applications. For downloading from the mainframe to the micro.

It's really more than a little PC can handle.

Which is why more and more of them are being replaced by expensive XT's.

But now you can help your PC survive in a rapidly changing business environment.

And save yourself (or your company) the cost of buying a new XT.



With Hardcard.<sup>™</sup>

A 10 megabyte hard disk drive on a card that makes your PC\* function exactly like an XT.

In fact, the only difference is that Hardcard has a faster access time than the XT's built-in drive.

It's also faster to install than any other add-on drive.

Because everything is compressed onto a single card that quickly plugs into any expansion slot inside the PC. With no additional cable connections. No external power supply. No adapter cards to buy.

And with Hardcard's special installation software, you can load the operating system and be ready to install your programs in minutes. Without any outside help.

Hardcard also saves all the money you've invested in software. Because it runs all the most popular programs exactly like an XT would. With no extra fuss or modification.

And its built-in Hardcard Directory program lets you easily access your most valued files and programs at the touch of a key.

# PCs.

Plus Hardcard is the only add-in drive that lets you keep both your floppies up and running.

As for reliability, there's simply less to go wrong. In fact, Hardcard has fewer parts than any other drive. Which makes it twice as reliable as the XT's built-in drive.

Because of Hardcard's superior reliability, we can offer you a warranty that goes well beyond the usual 90 days. We give you a full year. Should anything go wrong within the year, simply

take it to your nearby authorized service location, and you'll get a replacement Hardcard the same day.

Best of all, Hardcard is affordable enough to save all the PCs.



So see Hardcard now at your local computer dealer. Or call Plus Development Corp. for the dealer nearest you: (408) 946-3700.

And do your part to save these friendly, intelligent little machines.

\*Hardcard is compatible with IBM PC, IBM PC XT, Compaq Portable, Compaq Plus, AT&T PC 6300.

Plus and Hardcard are trademarks of Plus Development Corporation. IBM, IBM PC and IBM PC XT are trademarks of International Business Machines Corporation. Compaq Portable and Compaq Plus are trademarks of Compaq Computer Corp. AT&T PC 6300 is a registered trademark of AT&T Information Systems, Inc.

## Hardcard from Plus

## 3.5" DISK COMPATIBILITY FOR YOUR PC



**MANZANA'S 3.5" ADD ON  
DISK DRIVE FOR THE IBM PC  
(AND MANY COMPATIBLES)**

**COMPATIBILITY** with the new generation of lap-top computers using 3.5" disk drives.

**CONVENIENCE** of rugged 3.5" disk media.

**CAPACITY** of 730K additional storage for your PC.

**FLEXIBILITY** of using either 5.25" or 3.5" disks.  
**DIRECT ACCESS** on your PC to files generated on DG/One, TI Pro-Lite, GRiD Case, HP 110, 150 via our flexible, powerful software device driver.

*Built-in voltage spike protection  
FCC-approved*

*UL-listed plug-in AC transformer  
Limited 6-month factory warranty*

MDP3 disk drive with an MAP3-PC accessory package forms a complete add-on package for the IBM PC or XT. Absolutely no tools needed for installation. See your dealer or call direct for more information and details on accessory packages for other computers.

**COME SEE US AT COMDEX  
NOVEMBER 20-24, 1985**

**BOOTH M251 at the MGM GRAND**



**MANZANA™**  
935 Camino del Sur  
Isla Vista, CA 93117  
(805) 968-1387

## C·L·U·B·S A·N·D N·E·W·S·L·E·T·T·E·R·S

**SANTA FE MESSAGE BBS**, Bill and Kathy Christison, Rt. 9, Box 90X, Santa Fe, NM 07505, (505) 988-5867. Information on Santa Fe, tax information service.

**TULSA REGIONAL ATARI COMPUTER ENTHUSIASTS (TRACE)**, Tulsa South Regional Library, 6737 South 85th East Ave., Tulsa, OK 74133. Monthly meetings, newsletter, BBS at (918) 749-9049. Annual dues: \$12.

**AKRON SANYO COMPUTER CLUB**, Bruce Creager, 5425 Diana Lynn Dr., Stow, OH 44224. For Sanyo MBC-550 series users. Biweekly meetings, public-domain library.

**WEST COAST HEATH USERS GROUP (WCHUG) NEWSLETTER**, Van Christopher, 10784 Magnolia Ave. #2H, Santee, CA 92071. Newsletter for Zenith/Heath users from the Pacific Northwest Heath User Group and the Santee, California, Heath User Group. Annual subscription: \$15.

**NEW YORK PERSONAL COMPUTER INC.**, Margaret Levine, Suite 614, 80 Wall St., New York, NY 10005, (212) 533-6972. Non-profit group for users of the IBM PC and compatibles. Monthly meetings and newsletter, SIGs, library. Annual dues: \$15.

**WASH 'N WARE BULLETIN BOARD**, Joey Robichaux, 1036 Brookhollow Dr., Baton Rouge, LA 70810, (504) 292-7353. 24-hour BBS, 300- or 1200-bps access, various interests.

**EXEC-PC NETWORK**, Bob Mahoney, POB 11191, Shorewood, WI 53211. 24-hour BBS for users of the IBM PC and compatibles. 2300 public-domain files. Registration: \$20 per half year; \$35 annually.

**IBM & COMPATIBLE USER GROUP**, Emiliano Llano, Félix V. Gómez 107, Col. Cove ZP18, Mexico 01120 D.F., tel: 271-34-23. Non-profit group, monthly newsletter in Spanish.

**INTERNATIONAL MIDI ASSOCIATION**, Karen R. Morin, 11857 Hartsook St., North Hollywood, CA 91607, (818) 505-8964. Non-profit organization dedicated to MIDI (musical instrument digital interface). Monthly bulletin. Annual dues: \$40.

**NEWBURYPORT BIRDERS' EXCHANGE NEWSLETTER**, Edward Mair, 31 Plummer Ave., Newburyport, MA 01950, (617) 462-4796. Monthly newsletter on hardware and software for birdwatching. Annual dues: \$10.

**ACE-NET**, Jay Desio, (318) 537-4085. 24-hour, 300-bps BBS in west central Louisiana. SIG for educators and support for Franklin users, upgrading planned.

**SLICER BBS**, Slicer Computers Inc., 2543 Marshall St. NE, Minneapolis, MN 55418. 300- or 1200-bps, 24-hour BBS at (612) 788-5909; technical support.

**SOUTH FLORIDA SYSTEM OPERATORS ASSOCIATION**, POB 63-04, Miami, FL 33163, (305) 944-2111. Code of ethics for sysops.

**MPX-16 USERS GROUP NEWSLETTER**, Michael Bamberg, 1059 Northwest Danielle St., Hillsboro, OR 97124, (503) 640-5920, evenings. Dedicated to Steve Ciarcia's invention. Annual dues: \$5.

**DATA GENERAL ONE SPECIAL INTEREST GROUP**, Robert Weaver, POB 6897, Oxnard, CA 93030, (805) 654-1302. BBS at (805) 642-0189 is dedicated to using telecommunications with the DG/One but is open to all users. Access is 24 hours at 300 or 1200 bps.

**NATIONAL EPSON USERS GROUP**, Richard Shoemaker, Box 1076, Lemont, PA 16851, (814) 237-5511, evenings and weekends. Nonprofit group, on-line SIG on Delphi. Annual dues: \$25; free sample newsletter.

**PRACTICAL ANALYSIS & PROGRAMMING**, Auerbach Publishers Inc., 6560 North Park Dr., Pennsauken, NJ 08109, (609) 662-2070. Monthly newsletter on data-processing techniques for professionals. Annual dues: \$96. ■

*CLUBS AND NEWSLETTERS is an acknowledgment of new clubs and newsletters received at BYTE. Please allow at least four months for your club's mention to appear. Send information to BYTE, Clubs and Newsletters, POB 372, Hancock, NH 03449.*



# MARK WILLIAMS

Those who insist on C compiler performance  
are very big on Mark Williams.

And the compiler is just part of our total C Programming System.

NEW 3.0  
ENHANCEMENTS

These and other powerful utilities now *included* in the C Programming System:

- make: compiles only what's necessary from multiple modules, a powerful programming discipline
- diff: identifies differences between two files
- m4: macroprocessor expression editing and substitution
- egrep: extended pattern search
- MicroEMACS: full screen editor with source

#### COMPILER FEATURES

- Runs under MS-DOS
- Full Kernighan & Ritchie C with recent extensions including void and enum
- Register variables for fast, compact code
- Full UNIX™ compatibility and complete libraries
- Large and small memory models
- MS-DOS linker compatibility
- 8087 Support
- One-step compiling
- English error messages
- ROMable code
- Linker, assembler, archiver
- Extensive third party library support

#### csd C SOURCE DEBUGGER

- Debugs at C source level without assembly language
- Separate evaluation, source, program and history windows
- Can execute any C expression
- Capabilities of a C interpreter, but runs in real time
- Set trace points on any statement or variable

Mark Williams' C compiler has earned a place in some very big companies for some very good reasons: it proves the benchmarks right with the speed, code density, consistent performance and expert support required in professional development environments.

But a total development tool shouldn't stop with compiling. Or go on and on with extras that add up and up.

Only Mark Williams' C Programming Systems *includes* the csd C Source Debugger with true source level debugging to speed your programming job.

And only Mark Williams' new 3.0 version *includes* utilities like "make" to make quick work of even the largest projects.

From source code to final product, only one takes you all the way: Mark Williams' C Programming System.

All for only \$495. Ask about our 30-day money back guarantee when you call

**1-800-692-1700** to order today.\*

You'll be big on the total C Programming System from Mark Williams, too.

 **Mark  
Williams  
Company**

1430 West Wrightwood  
Chicago, Illinois 60614

© 1985 Mark Williams Company  
UNIX is a registered trademark of Bell Labs.

\*In Illinois call 312-472-6659.

# N·E·W S·E·R·V·I·C·E·S

## ORDERING DISKS OF BYTE LISTINGS

Source-code listings in the form of text files of programs that accompany BYTE articles are now available from BYTE on disk. To order a disk of these listings for noncommercial purposes, indicate the issue (the first available is December 1985) and the kind of disk below. Enclose a check or money order in the correct amount made out to BYTE Listings. All prices include postage.

BYTE issue: \_\_\_\_\_

### COMMON 5¼-inch FORMATS

(all cost \$5 per disk in North America, \$6 in Europe and South America, \$7 in Asia, Africa, and Australia)

- IBM PC
- Apple II 5¼-inch DOS 3.3
- Apple II 5¼-inch ProDOS
- Commodore 64
- Hewlett-Packard 125
- Kaypro 2 CP/M
- TRS-80 Model III
- TRS-80 Model 4
- Texas Instruments Professional
- Zenith Z-100
- Atari

### COMMON 3½-inch FORMATS

(all cost \$6 per disk in North America, \$7 in Europe and South America, \$8 in Asia, Africa, and Australia)

- Apple Macintosh
- Atari 520ST
- Commodore Amiga
- Hewlett-Packard 150
- Data General/One

### CP/M STANDARD 8-inch FORMAT

(\$6 per disk in North America, \$7 in Europe and South America, \$8 in Asia, Africa, and Australia)

- Single-sided single-density

### OTHER FORMATS

(all cost \$6 per disk in North America, \$7 in Europe and South America, \$8 in Asia, Africa, and Australia)

- | Size                             | Machine |
|----------------------------------|---------|
| <input type="checkbox"/> 8-inch  | _____   |
| <input type="checkbox"/> 5¼-inch | _____   |
| <input type="checkbox"/> 3½-inch | _____   |

### SEND DISK TO:

Name \_\_\_\_\_  
Street \_\_\_\_\_  
City \_\_\_\_\_ State or Province \_\_\_\_\_  
Postal Code \_\_\_\_\_ Country \_\_\_\_\_  
Check or money order enclosed for \$ \_\_\_\_\_

## SIGNING UP FOR BYTECOM

To sign up for computer conferencing among BYTE readers in Europe, write to

OZ/BYTE  
Stockholm University Computing Center  
Box 27322  
S-102 54 Stockholm, Sweden  
Telephone: 46 8 679280

The BYTECOM system includes program listings that go with BYTE articles. Send a sign-up fee using Swedish postal giro 184070-1 for the equivalent of 200 Swedish crowns (about \$25) and fill in the form below. There will be an additional connect-time charge of \$6 per hour for accessing BYTECOM.

Name \_\_\_\_\_  
Street \_\_\_\_\_  
City \_\_\_\_\_ State or Province \_\_\_\_\_  
Postal Code \_\_\_\_\_ Country \_\_\_\_\_  
Telephone \_\_\_\_\_

What kind of computer do you use?  
\_\_\_\_\_

## BULLETIN BOARDS OUTSIDE THE U.S.

Listed below are some computer bulletin boards that will carry program listings from BYTE outside the U.S. Programs are for noncommercial use in connection with BYTE articles only. There are no usage charges but you must pay your own telephone charges.

### CANADA

Western Canadian Distribution Center (101 1112 101st St., Edmonton, Alberta T5G 2A2) will be supplying listings to its member bulletin-board systems.

Canadian Remote Systems, Toronto, Ontario,  
(416) 231-9202

Edmonton, Alberta, (403) 454-6093

Meadowlark, Alberta, (403) 435-6579

Prince George, British Columbia, (604) 562-9519

Regina, Saskatchewan, (306) 586-5585

Winnipeg, Manitoba, (204) 452-5529

### ENGLAND

Frank Thornley's Fido, Compulink, 0 4867 6535

### NETHERLANDS

Henk Wevers' Fido, +31-8380-37156

Mr. Wevers serves as the main distribution center for 16 other Fidos in The Netherlands.

In addition, arrangements for BYTenet Listings are being made with one or more system operators in the following nations: Australia, Canada, Chile, Denmark, England, France, Hong Kong, Ireland, Italy, Japan, Norway, Singapore, and West Germany.

# Mark Williams Let's C

Now the biggest name  
in C compilers comes in a size  
everybody can afford.  
**Let's C.™**

**Introducing Mark Williams' \$75 C compiler.** Want to explore C programming for the first time? Or just on your own time? Now you can do it in a big way without spending that way. With Let's C.

This is no little beginner's model. Let's C is a powerful programming tool, packed with all the essentials of the famous Mark Williams C Programming System. The one chosen by Intel, DEC, Wang and thousands of professional programmers. The one that wins the benchmarks and the reviewers' praise:

*"(This compiler) has the most professional feel of any package we tested..."—BYTE*  
*"Of all the compilers reviewed, (it) would be my first choice for product development."—David W. Smith, PC WORLD*

And now for more big news. Get our revolutionary csd C Source Debugger for just \$75, too. You can breeze through debugging at the C source level ignoring clunky assembler code.

Affordable, powerful, debuggable. Mark Williams Let's C is the big name C compiler at a price you can handle. Get your hands on it now.



1430 West Wrightwood  
Chicago, Illinois 60614 Inquiry 224

#### Mark Williams Let's C

- For the IBM-PC and MS-DOS
- Fast compact code plus register variables
- Full Kernighan & Ritchie C and extensions
- Full UNIX™ compatibility and complete libraries
- Small memory model
- Many powerful utilities including linker, assembler, archiver, cc one-step compiling, egrep, pr, tail, wc
- MicroEMACS full screen editor with source
- Supported by dozens of third party libraries
- Upgradeable to C Programming System for large scale applications development

**Let's C Benchmark Done on an IBM-PC/XT, no 8087.**  
Program: Floating Point from BYTE, August, 1983.

Exec Time in Seconds

Let's C	134.20
MS 3.0	347.45

Use this coupon or charge by calling toll-free:  
1-800-MWC-1700. In Ill. call 312-472-6659.

Mark Williams Let's C  
**\$75**

Please send me:

\_\_\_\_\_ copies of Let's C and \_\_\_\_\_ copies of csd (C Source Debugger) at \$75 each. (Ill. residents add 7% sales tax.)

Check    Money Order    Visa, MasterCard or American Express

Name \_\_\_\_\_

Address \_\_\_\_\_

City \_\_\_\_\_ State \_\_\_\_\_ Zip \_\_\_\_\_

Card # \_\_\_\_\_ Exp. Date \_\_\_\_\_

Signature \_\_\_\_\_



**TECHLAND** Blue Lynx.  
Complete line \_\_\_\_\_ Call!  
**IRMA** Complete line From \$849  
**HARD DISCS**  
**PEACHTREE TECHNOLOGIES**  
10 & 20 Meg. internal &  
external \_\_\_\_\_ From \$549  
**IRWIN/TANDBERG** Tape  
back-up systems \_\_\_\_\_ From \$495  
**SEAGATE** Fast 10, 20, 75 Meg.  
for PC & AT \_\_\_\_\_ From \$495  
**SYSGEN** Complete line \_\_\_\_\_  
New Low Prices. Call!

**HEY  
SANTA  
CLAUS!**

AT&T 128K of mem-  
ory, 1 disk drive  
including a mono-  
chrome monitor \_\_\_\_\_  
\$1795

**PARADISE** Multi-display  
or modular graphics  
cards \_\_\_\_\_ From \$199  
**STB** Chauffeur &  
Colorific \_\_\_\_\_ \$289 & \$189  
**SIGMA** Color 400 for  
PGS SR-12 New Low Price!  
**FLOPPY DISK  
DRIVES**  
1/2 HEIGHT Disk  
Drives from Shugart,  
Mitsubishi & TEAC.  
PC, XT & AT Compatible  
From \$115

**SUPER  
STOCKING  
STUFFERS!**

**FLIGHT SIMULATOR**  
from Microsoft \_\_\_\_\_ \$32  
**MAXELL DISKETTES**  
(free Flip 'n File box) \$25  
**PROFESSIONAL  
TRIVIA FEVER** \_\_\_\_\_ \$34  
**F-15 STRIKE EAGLE** \$30  
**OR \$110 FOR ALL FOUR.**

**COMPUTERS**  
AT&T Color and Mono Systems  
in stock \_\_\_\_\_ Start at \$1795  
**COMPUTER SPECIAL OF  
THE MONTH** Call for details! \_  
**NETWORKING/  
PROTOCOL  
CONVERSION**  
**SNA & BISYNC** 3780, 5251.  
Mod 11 & 12, 3274, 3278 \_\_\_\_\_  
**PC TURBO** 186/187 board,  
128K, 8087 Serial Board  
attached \_\_\_\_\_ \$875

**BERNOULLI TECHNOLOGY**  
Hard disc Subsystems \_\_\_\_\_ \$2595  
**PRIAM** Superfast 40 & 60  
Meg. for AT \_\_\_\_\_ Call!  
**PRINTERS &  
PLOTTERS**  
We have thousands in stock.  
**PRINTER SPECIAL OF THE  
MONTH** Call for details!  
**HOUSTON INSTRUMENTS**  
Plotters and Digitizers in stock \_\_\_\_\_  
**DOT MATRIX**  
**EPSON FX85/185** \_\_\_\_\_ NEW!  
**EPSON LX80/LQ1500** \_\_\_\_\_  
**COMREX** 420, Epson com-  
patible, 400cps \_\_\_\_\_ \$1695  
**OKIDATA** 192 & 193, ML84,  
Pacemark 2410 \_\_\_\_\_  
**OKIDATA** Color printers,  
complete line \_\_\_\_\_  
**TOSHIBA** P-351 & 1340 \_\_\_\_\_  
New Low Prices!  
**TEXAS INSTRUMENTS** 855 \_\_\_\_\_  
From \$799  
**LETTER QUALITY**  
**NEC** Spinwriters 2050, 3550,  
8850 \_\_\_\_\_ New Low Prices!  
**COMREX** CR II E, CR III & CR  
IV \_\_\_\_\_ Start at \$369  
We carry a full range of form  
handling options.

**MULTIFUNCTION  
BOARDS**  
We have a complete line of  
Multifunction Boards compati-  
ble with the Portable, XT/AT.  
**THE BOARD SPECIAL OF  
THE MONTH** \_\_\_\_\_ Call for details!  
**SIX PAK** 64-384K, multifunc. \_  
I/O **MINNIE** I/O shortboard  
for Portable & AT \_\_\_\_\_  
New Low Price!  
**ADVANTAGE** 128K-3Mb,  
expansion for AT \_\_\_\_\_  
**QUADRAM QUADBOARD**  
Loaded, 384K \_\_\_\_\_ \$279  
**TECMAR CAPTAIN**, 0-384K,  
multifunc. \_\_\_\_\_ \$175  
**TALLTREE J-RAM II** \_\_\_\_\_  
New Low Price!



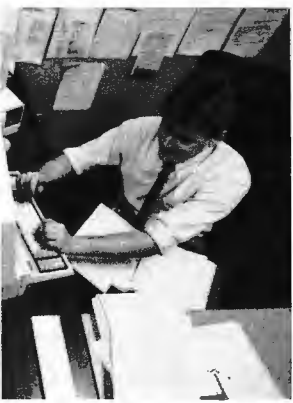
**TANDON TM 100-2,**  
DD/DS, 360K \_\_\_\_\_  
New low, low price!

**CHIPS**  
All our chips are tested  
and priced for quick  
sale. Call us!  
**INTEL** 8087, 80287,  
high speed coproc. \_\_\_\_\_  
From \$125  
**64K—256K  
RAMCHIPS**  
\_\_\_\_\_ Call for Market Price.  
**128K** Piggy-back chips  
for your AT \_\_\_\_\_  
Call for Market Price.



**GRAPHIC  
CARDS**  
**PREVIEW** Mono Graphics/  
Hercules look-alike \_\_\_\_\_ \$269  
**HERCULES** Mono & Color  
Graphics cards. New Low Prices!  
**TECMAR** Graphics Master,  
HiRes Color & Mono supports  
Lotus \_\_\_\_\_ \$449  
**QUADRAM** Quadcolor I & II  
color cards \_\_\_\_\_

**MISCELLANEOUS**  
**MAXELL** Diskettes in a  
FREE flip N' file box \$25  
**DYSAN** Diskettes at  
the lowest price in the  
USA \_\_\_\_\_ Call!  
**MOUSE SYSTEMS**  
PC Mouse, optical  
w/software \_\_\_\_\_ \$139  
**MICROSOFT** Mouse,  
bus or serial mechanical  
**KEYTRONICS** 5151 &  
5152 keyboards \_\_\_\_\_  
From \$149  
**KENSINGTON MICRO-  
WARE** MasterPiece. \$99  
**CURTIS** Accessories,  
Pedestals, cables, etc. \_\_\_\_\_  
**HAYES** Mach II & Mach  
III Joysticks \_\_\_\_\_ \$39/\$45  
**QUADRAM** Microfazer  
print buffer 8-128K \_\_\_\_\_  
From \$129  
**TRIPPELITE** ISOBAR  
surge protectors, 4 & 8  
plug \_\_\_\_\_ From \$49



YOUR PERSONAL BLUE CHIP CARD

**MICRO  
MART**

1234 567 890 123

Micro Mart has financing  
options available. Ask for  
a Micro Mart Blue Chip  
Credit Card, today.



©Copyright 1985  
Micro Mart, Inc.  
Technology Corporate Campus ,  
3159 Campus Drive  
Norcross, Georgia 30071  
**IBM** is a registered trademark of  
International Business Machines  
Corporation.  
Prices are subject to change  
without notice and are similar,  
but may vary at over 20 Micro  
Mart Retail Stores.





**MICRO MUSIC** New synthesizer system for PC, incl. keyboard & digitizer \$1895  
**POLAROID** Palette \$1195

**SOFTWARE**

**SOFTWARE SPECIAL OF THE MONTH.** Call for details!

**ACCOUNTING**  
**SORCIM/IUS** Complete line including Windows. From \$289/each  
**SPREADSHEETS & INTEGRATED PACKAGES**  
**SORCIM** SuperCalc 3, vers. 2.0 New Low Price!  
**ENHANCEMENTS & UTILITIES**

**FOX & GELLER** Complete line for dBase II/III, Rbase 4000 \$69  
**NORTON** Utilities 3.0 \$69  
**ROSESOFT** ProKey 3.0 \$89

**CENTRAL POINT SOFTWARE** Copy II PC \$35  
**SOFTSTYLE** Set FX+ and Printworks, printer control  
**SIDEWAYS** Inverts printout \$35  
**BORLAND** SideKick and SuperKey From \$40

**COMPILERS & LANGUAGE TOOLS**  
**LATTICE** C-Compilers \$279  
**MICROSOFT** Complete line  
**BORLAND** Turbo Pascal, Turbo Toolbox & more From \$35/each

**GRAPHICS**

**Z-SOFT** PC Paintbrush, mouse graphics \$95

**DECISION RESOURCES**  
**ChartMaster** Latest version \$239  
**MICROSOFT** Chart \$169

**COMMUNICATIONS**

**MICROSTUF** Crosstalk XVI. Latest version \$99  
**HAYES** Smartcom II \$85

**WORD PROCESSORS**

**MULTIMATE** w/spelling checker & tutorial New Low Price!  
**SAMNA +** \$350  
**MICROSOFT** Word. New version New Low Price!  
**LIFETREE** Volkswriter Deluxe \$169  
**SSI** WordPerfect, version 4.0 \$249

**MICROPRO** WordStar Professional series New Low Price!

**OFFICE & PROJECT PLANNING**

**HARVARD** Total Project Manager \$299  
**SORCIM/IUS** Super Project \$199  
**MICROSOFT** Project \$175

**DATA BASE MANAGERS**

Call for unadvertised Data Base Managers.  
**MICRORIM** 4000 or 5000, Report Writer & Clout New Low Price!

**WARNER SOFTWARE** The Desk Organizer \$145  
**MICROSTUF** Infoscope \$99

**MODEMS**

**HAYES** Smartmodem 300, 1200, 1200B & 2400. We have the best stock in the USA Call!  
**VEN-TEL** 1200 Baud Half Card w/Crosstalk \$399

**MONITORS AND CRT'S**

**PGS** Max 12 (E) amber, HX12, HX12 (E), & SR-12 New Low Prices!  
**QUADRAM** Quadchrome, 690 dot RGB \$449  
**AMDEK** Color 300, 500, 600, 700, 710 Call!  
**AMDEK** 300A/300G/310A \$129/\$119/\$165

MICRO MART IS A SERVICE MARK OF MICRO MART, INC.

Inquiry 236

**WELCOME TO THE WORLD OF MICRO MART.**

A world of friendly micro-computer experts. And your window to the world of computer products, information, service and support. Or just good microcomputer advice.

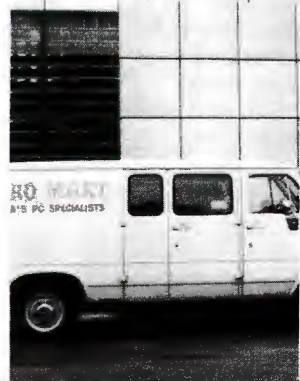
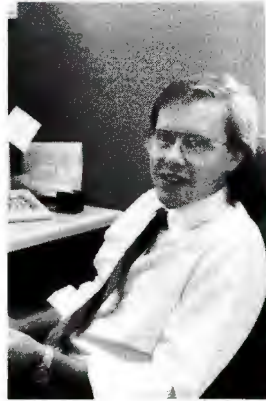
Micro Mart presents the latest and best-selling PC products at some world-beating prices. And with our 15 million dollar inventory on-line to our IBM mainframe, we quickly know what's in stock. And how to get it to you fast.

You'll find Micro Mart Service to be world class, too. Highly trained technicians repair and replace any product we sell. On-site, depot and customized Micro Mart Service can fit your business needs. No question. But if you have any questions about any aspect of microcomputers, Micro Mart will give you the answers.

So for all your PC needs, call on the people at Micro Mart. They make all the difference in the world. "We're America's PC Specialists."

**1-800-241-8149. ORDERS ONLY**  
**(404) 449-8089. INFORMATION**

**MICRO MART** 12/1 BT



©D. Martin 1985



# The C for Microcomputers

PC-DOS, MS-DOS, CP/M-86, Macintosh, Amiga, Apple II, CP/M-80, Radio Shack, Commodore, XENIX, ROM, and Cross Development systems

## MS-DOS, PC-DOS, CP/M-86, XENIX, 8086/80x86 ROM

### Manx Aztec C86

*"A compiler that has many strengths... quite valuable for serious work"*

Computer Language review, February 1985

**Great Code:** Manx Aztec C86 generates fast executing compact code. The benchmark results below are from a study conducted by Manx. The Dhrystone benchmark (CACM 10/84 27:10 p1018) measures performance for a systems software instruction mix. The results are without register variables. With register variables, Manx, Microsoft, and Mark Williams run proportionately faster, Lattice and Computer Innovations show no improvement.

	Execution Time	Code Size	Compile/Link Time
<b>Dhrystone Benchmark</b>			
Manx Aztec C86 3.3	34 secs	5,760	93 secs
Microsoft C 3.0	34 secs	7,146	119 secs
Optimized C86 2.20J	53 secs	11,009	172 secs
Mark Williams 2.0	56 secs	12,980	113 secs
Lattice 2.14	89 secs	20,404	117 secs

**Great Features:** Manx Aztec C86 is bundled with a powerful array of well documented productivity tools, library routines and features.

Optimized C compiler	Symbolic Debugger
AS86 Macro Assembler	LN86 Overlay Linker
80186/80286 Support	Librarian
8087/80287 Sensing Lib	Profiler
Extensive UNIX Library	DOS, Screen, & Graphics Lib
Large Memory Model	Intel Object Option
Z (vi) Source Editor -c	CP/M-86 Library -c
ROM Support Package -c	INTEL HEX Utility -c
Library Source Code -c	Mixed memory models -c
MAKE, DIFF, and GREP -c	Source Debugger -c
One year of updates -c	CP/M-86 Library -c

Manx offers two commercial development systems, Aztec C86-c and Aztec C86-d. Items marked -c are special features of the Aztec C86-c system.

<b>Aztec C86-c Commercial System</b>	<b>\$499</b>
<b>Aztec C86-d Developer's System</b>	<b>\$299</b>
<b>Aztec C86-p Personal System</b>	<b>\$199</b>
<b>Aztec C86-a Apprentice System</b>	<b>\$49</b>

All systems are upgradable by paying the difference in price plus \$10.

**Third Party Software:** There are a number of high quality support packages for Manx Aztec C86 for screen management, graphics, database management, and software development.

<b>C-tree \$395</b>	<b>Greenleaf \$185</b>
<b>PHACT \$250</b>	<b>PC-lint \$98</b>
<b>HALO \$250</b>	<b>Amber Windows \$59</b>
<b>PRE-C \$395</b>	<b>Windows for C \$195</b>
<b>WindScreen \$149</b>	<b>FirsTime \$295</b>
<b>SunScreen \$99</b>	<b>C Util Lib \$185</b>
<b>PANEL \$295</b>	<b>Plink-86 \$395</b>

## MACINTOSH, AMIGA, XENIX, CP/M-68k, 68k ROM

### Manx Aztec C68k

*"Library handling is very flexible... documentation is excellent... the shell a pleasure to work in... blows away the competition for pure compile speed... an excellent effort."*

Computer Language review, April 1985

Aztec C68k is the most widely used commercial C compiler for the Macintosh. Its quality, performance, and completeness place Manx Aztec C68k in a position beyond comparison. It is available in several upgradable versions.

Optimized C Macro Assembler Overlay Linker	Creates Clickable Applications
Debuggers	Mouse Enhanced SHELL
Librarian	Easy Access to Mac Toolbox
Source Editor	UNIX Library Functions
MacRam Disk -c	Terminal Emulator (Source)
Library Source -c	Clear Detailed Documentation
	C-Stuff Library
	UniTools (vi,make,diff,grep) -c
	One Year of Updates -c

Items marked -c are available only in the Manx Aztec C86-c system. Other features are in both the Aztec C86-d and Aztec C86-c systems.

<b>Aztec C68k-c Commercial System</b>	<b>\$499</b>
<b>Aztec C68d-d Developer's System</b>	<b>\$299</b>
<b>Aztec C68k-p Personal System</b>	<b>\$199</b>
<b>C-tree database (source)</b>	<b>\$399</b>

**AMIGA, CP/M-68k, 68k UNIX** call

## Apple II, Commodore, 65xx, 65C02 ROM

### Manx Aztec C65

*"The AZTEC C system is one of the finest software packages I have seen"*

NIBBLE review, July 1984

A vast amount of business, consumer, and educational software is implemented in Manx Aztec C65. The quality and comprehensiveness of this system is competitive with 16 bit C systems. The system includes a full optimized C compiler, 6502 assembler, linkage editor, UNIX library, screen and graphics libraries, shell, and much more. The Apple II version runs under DOS 3.3, and ProDOS, Cross versions are available.

The Aztec C65-c/128 Commodore system runs under the C128 CP/M environment and generates programs for the C64, C128, and CP/M environments. Call for prices and availability of Apprentice, Personal and Developer versions for the Commodore 64 and 128 machines.

<b>Aztec C65-c ProDOS &amp; DOS 3.3</b>	<b>\$399</b>
<b>Aztec C65-d Apple DOS 3.3</b>	<b>\$199</b>
<b>Aztec C65-p Apple Personal system</b>	<b>\$99</b>
<b>Aztec C65-a for learning C</b>	<b>\$49</b>
<b>Aztec C65-c/128 C64, C128, CP/M</b>	<b>\$399</b>

### Distribution of Manx Aztec C

In the USA, Manx Software Systems is the sole and exclusive distributor of Aztec C. Any telephone or mail order sales other than through Manx are unauthorized.

## Manx Cross Development Systems

Cross developed programs are edited, compiled, assembled, and linked on one machine (the HOST) and transferred to another machine (the TARGET) for execution. This method is useful where the target machine is slower or more limited than the HOST, Manx cross compilers are used heavily to develop software for business, consumer, scientific, industrial, research, and educational applications.

**HOSTS:** VAX UNIX (\$3000), PDP-11 UNIX (\$2000), MS-DOS (\$750), CP/M (\$750), MACINTOSH (\$750), CP/M-68k (\$750), XENIX (\$750).

**TARGETS:** MS-DOS, CP/M-86, Macintosh, CP/M-68k, CP/M-80, TRS-80 3 & 4, Apple II, Commodore C64, 8086/80x86 ROM, 68xxx ROM, 8080/8085/Z80 ROM, 65xx ROM.

The first TARGET is included in the price of the HOST system. Additional TARGETS are \$300 to \$500 (non VAX) or \$1000 (VAX).

Call Manx for information on cross development to the 68000, 65816, Amiga, C128, CP/M-68K, VRTX, and others.

## CP/M, Radio Shack, 8080/8085/Z80 ROM

### Manx Aztec CII

*"I've had a lot of experience with different C compilers, but the Aztec C80 Compiler and Professional Development System is the best I've seen."*

80-Micro, December, 1984, John B. Harrell III

<b>Aztec C II-c (CP/M &amp; ROM)</b>	<b>\$349</b>
<b>Aztec C II-d (CP/M)</b>	<b>\$199</b>
<b>C-tree database (source)</b>	<b>\$399</b>
<b>Aztec C80-c (TRS-80 3 &amp; 4)</b>	<b>\$299</b>
<b>Aztec C80-d (TRS-80 3 &amp; 4)</b>	<b>\$199</b>

### How To Become an Aztec C User

To become an Aztec C user call 1-800-221-0440 or call 1-800-832-9273 (800-TEC WARE). In NJ or outside the USA call 201-530-7997. Orders can also be telexed to 4995812.

Payment can be by check, COD, American Express, VISA, Master Card, or Net 30 to qualified customers.

Orders can also be mailed to Manx Software Systems, Box 55, Shrewsbury, NJ 07701.

### How To Get More Information

To get more information on Manx Aztec C and related products, call 1-800-221-0440, or 201-530-7997, or write to Manx Software Systems.

### 30 Day Guarantee

Any Manx Aztec C development system can be returned within 30 days for a refund if it fails to meet your needs. The only restrictions are that the original purchase must be directly from Manx, shipped within the USA, and the package must be in resalable condition. Returned items must be received by Manx within 30 days. A small restocking fee may be required.

### Discounts

There are special discounts available to professors, students, and consultants. A discount is also available on a "trade in" basis for users of competing systems. Call for information.

Inquiry 222

# MANX

To order or for information call:

## 800-221-0440

# B·O·O·K R·E·V·I·E·W·S

## BACK TO BASIC: THE HISTORY, CORRUPTION, AND FUTURE OF THE LANGUAGE

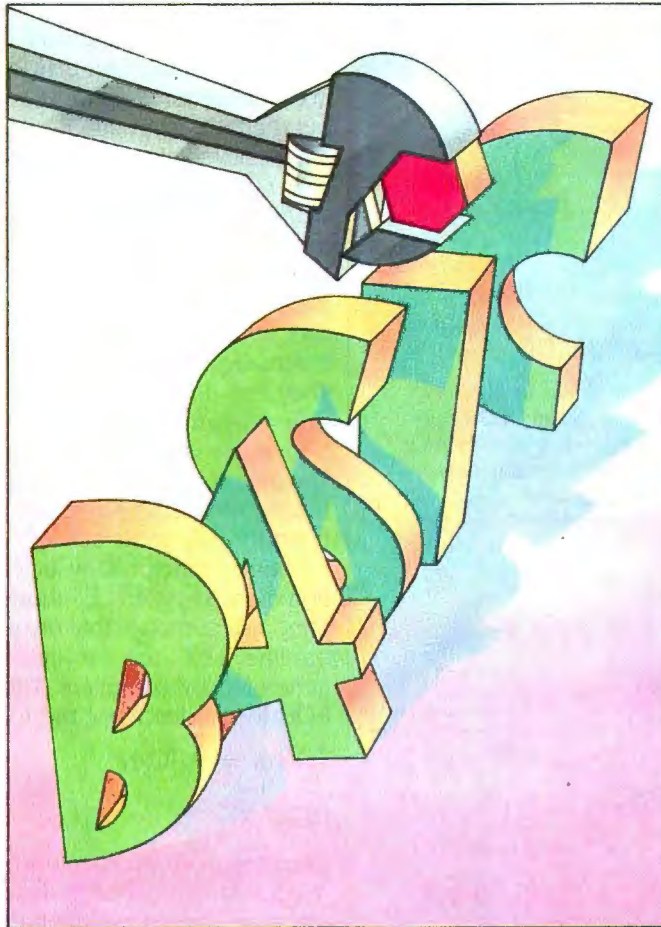
John G. Kemeny and  
Thomas E. Kurtz  
Addison-Wesley  
Reading, MA: 1985  
142 pages, \$12.95

## ETHICAL ISSUES IN THE USE OF COMPUTERS

Deborah G. Johnson and  
John W. Snapper, eds.  
Wadsworth Publishing  
Belmont, CA: 1985  
363 pages, \$19

## IBM PC/8088 ASSEMBLY LANGUAGE PROGRAMMING

Avtar Singh and  
Walter A. Triebel  
Prentice-Hall  
Englewood Cliffs, NJ: 1985  
448 pages, \$39.95  
(floppy disk optional)



## BACK TO BASIC: THE HISTORY, CORRUPTION, AND FUTURE OF THE LANGUAGE

Reviewed by G. Michael Vose

**M**ore than 20 years ago, John G. Kemeny and Thomas E. Kurtz created the BASIC computer language and placed it in the public domain. Now they have tried to reclaim their progeny and exert an influence on its future.

To reestablish their control over the language, Kemeny and Kurtz founded a private company and oversaw the creation of a version of BASIC for microcomputers that they call True BASIC (see my review of True BASIC in the May BYTE, page 279). In conjunction with the release of this version of "pure" BASIC, Kemeny and Kurtz teamed up to write *Back to BASIC* to explain why they thought it

necessary to develop another version.

The book's subtitle, "The History, Corruption, and Future of the Language," establishes a clear point of view early—that the noble language originally created to help bring computing power to the mass of college students in 1964 has been fouled in the intervening years by its association with anemic-powered machines and a nonacademic, nonprofessional cadre of casual programmers who care not to nourish the language.

The professors may in fact have a point here. There is just enough of a hacker's mentality in the way they describe the birth and evolution of BASIC at Dartmouth College to make believable their claim that they created True BASIC to correct the inadequacies ascribed to the language's many inferior versions.

Unquestionably the historical account of the birth of BASIC (and the time-sharing operating system designed concurrently with it) constitutes the most pleasurable part of this book. The reminiscences of the professors reveal their excitement at the prospect of opening up to young minds the powerful potential of computing. There is in these vignettes a strong undercurrent of the "hacker ethic"—as described by Steven Levy in *Hackers: Heroes of the Computer Revolution* (Doubleday, 1984)—a need to share the magic of the computer with people who could create new uses for the machine and thereby add to its power.

Before creating BASIC, Kemeny and Kurtz came up with eight rules for language design. These rules boil down to the following generic sentence that today applies to many high-level languages: A language should be easy to learn,

(continued)

# A NEW WAY TO SPELL PERFORMANCE

**'WESTERN AT TURBO'<sup>TM</sup>**  
THE ULTIMATE COMPUTING MACHINE  
WITH IBM COMPATABILITY



MADE IN  
**USA**

## NOW WITH OPTIONAL:

- 6MHz-8MHz switching capability giving 33% faster operation than IBM PC/AT
- 2 MB ram onboard capability with a built-in parallel printer port
- 80286 or 80286-8 CPU with optional 80287 co-processor
- 8 expansion slots • On board battery-backed clock calendar
- Optional 20/33/80 MB Winchester disk memory • Optional multifunction card with total 4 MB RAM and 4 serial ports, 1 parallel port and game port capability.

**\$2595.00**



MADE IN  
**USA**

## WESTERN PC TURBO

(\$1495.00 — 256K, 2x360K floppy drives, CC/MC mono monitor 1 printer port)

Now with: 8 expansion slots • Dual clock speed of 8MHz — 4.77 giving 50% faster operation • Up to 1 MB RAM on mother board — optional ram disk software to address above 704 K • 1 parallel port • Optional floppy controller & drive 1.2 MB floppy drive with serial parallel ports • 10/20/33 MB Winchester disk capability.

**Western Computer**

WARNER CORPORATE PARK  
1381 WARNER AVE., SUITE B, TUSTIN, CA 92680  
(714) 259-7755 TELEX 756731 ANSWERBACK WESTERN COMP.

EUROPEAN HEAD OFFICE  
BELECTRONIC SA, RUE CENTRALE 43  
CH-1880-BEX, SWITZERLAND  
PHONE (025) 631250  
TELEX 456 168 ANSWERBACK BELE CH.

## BOOK REVIEWS

general purpose, extensible, interactive, fast for small programs, and descriptive about errors; and it should also shield the programmer from the hardware and the operating system. In terms of these design criteria, Microsoft BASIC stacks up well as an implementation of the language.

Kemeny and Kurtz detail the growth of BASIC at Dartmouth through seven major versions and revel in the remembrance that it was often students and faculty who significantly improved it. They detail the entry of the language into the commercial world through General Electric, the company that provided hardware for the college in exchange for its faculty's software expertise. They point out that at Dartmouth, BASIC was always a compiled language, never interpreted (as the majority of today's BASIC community has come to know it).

BASIC's implementation as an interpreter is just one of the criticisms the professors level at the many versions of what they call "Street BASIC." Curiously, one of the major faults they find with interpreters is that they don't check code lines for accuracy as the lines are entered. This is actually a function performed by incremental compilers. They also don't like an interpreter's disapproval of dimension arrays more than once. This attitude no doubt arises from many years of using machines with lots of memory. The authors appear unwilling to concede that the interactive nature of the Microsoft BASIC interpreter may have been the key to its success on microcomputers.

Another criticism they level at Street BASIC is its elimination of the keyword LET (done, they feel, to save memory). They also complain that error messages like "Syntax error on line 230" are far inferior to the error messages generated by compilers. The criticism they make about FOR loops describes the following situation:

```
FOR X = 1 TO N
.....
NEXT X
```

executes the loop once even if N=0, as in the FORTRAN model. Mathematical practice specifies that when N=0, the loop should be skipped, but FORTRAN and Street BASIC execute the loop once anyway. The professors want BASIC to skip the loop entirely when N=0.

Kemeny and Kurtz also criticize Street BASIC for having primitive graphics commands that often require the programmer to calculate individual pixels to draw a line on the screen. They feel that pixel calculations are best left to computers, which calculate quickly and without error.

The professors similarly criticize BASICs for converting program keywords and variable names into uppercase letters regardless of how they were typed in, and they fault editors that do not automatically indent code within block structures. They feel that these kinds of style conventions are not trivial, and they list academic references to back up their contention that good style enhances program readability.

(continued)



---

---

# If you're looking forward to the day when programming is sophisticated and simple, here's the day to look forward to.

**F**rom this day on, you'll actually be able to watch your own programs run.

From this day on, you'll never make another syntax error. Or be frustrated by searches through cryptic user manuals.

Because on this day, you'll discover the programming system you've been looking for.

**YOU CAN'T MISS IT!**

A free demonstration disk is yours on the cover of January's issue of COMPUTER LANGUAGE Magazine.

**Software  
Channels Inc.**

900 Rockmead Dr.,  
Kingwood, Texas 77339

International and Canada:  
212 King St. W.,  
Toronto, Ontario  
M5H 1K5



# AB makes the best value for Xmas!



- 1 2 DS/DD 380K Disk Drive**  
384 RAM Memory, Amber 20 MHz Monitor PC3  
Built in ROM Diagnostics, 1 Expansion Slot  
CZF-148-42BU ..... **1,350**
- 2 One Plus**  
7 Expansion Slots  
CZF-158-42BU ..... **1,850**
- 3 One Plus**  
Hard Disk System, 20 Meg Writing 1/05/00 380K  
384 RAM Memory, 8 MHz with 7 Expansion Slots  
CZW-158-42BU ..... **2,429**
- 4 New Advance Technology PC IBM PC/AT Compatible**  
Single DS/DD 1.2 Meg Disk Drive  
512K RAM, Serial Parallel  
Amber 20 MHz Monitor (PC3)  
Expandability for up to 12 simultaneous users  
CZF-241-81 ..... **Call**
- 5 Four Plus**  
Hard Disk System  
Same as above including 40 Meg Hard Disk  
CZW-241-82BU ..... **Call**
- 6 Portables** Zenith Quality IBM Compatible  
Back Lit Screen 8 MHz  
2 Standard DS/DD/380K Drives  
840 x 200 Dot Graphs  
14.3 lbs, 250K RAM  
CZ171-42 ..... **1,995**
- 7 Trans Portable**  
1 DD 380K Drive  
8 MHz Clock, 128K RAM  
24.2 lbs.  
CZF-138-21 ..... **1,299**



**SOFTWARE**  
for IBM, Macintosh Apple  
All Major Brands  
**25% - 40% OFF**  
Call for pricing.  
Corporation users' volume  
purchase contracts available.  
Call for money saving details

**HARD DISKS**  
10 Meg, bare/mt/est. . . 299/489/889  
20 Meg, bare/mt/est. . . 459/889/889  
30 Meg ..... Call  
85 Meg ..... Call  
WD Hard Disk Controller ..... 190

**Canon**  
**Laser Beam Printer**  
Many Advantages over HP  
No Additional Cost, Quantity Discounts  
**IBM Parallel Interface**  
It can THINK It's a Diablo 530  
4 Resident Fonts  
Downloadable Fonts  
Choose number of copies from keyboard  
or software  
For BEST PRICE ..... Call

**MODEMS**  
Hayes ANCHOR  
Call

**CLOSEOUT SPECIAL**  
Vic 20 software grab bag  
3 assorted pieces  
\$20 to \$128 Value  
10 assorted pieces  
\$55 to \$428 Value  
Act now while they last!

**EPSON**  
RX-100, LX-80 ..... Call  
FX-85+, FX-185+ ..... Call  
LD 1500, XB80 Color ..... Call  
HomeWriter 10 ..... Call  
NEW LX-80, SO-2000, DX-10,  
DX-20, HS-80 ..... Call  
Free printer stand with each  
printer purchased!

**Canon A-40**  
**Impact Dot Matrix Printer**  
Near letter quality 23 x 18 matrix  
140 cps  
3 kinds of Graphic Image  
Selectable Linehedding  
IBM Printer Compatible  
Push Feed Adjustable Toner  
Fanfold Single Sheet &  
Multipart Copy Paper Usable  
Many More Features ..... Only \$259

## BUILD YOUR OWN P.C.

**PC-XT Mother Board**  
IBM™ Fully Compatible  
8088 Micro-Processor  
with 8087 Math Procs Socket,  
8 I/O Slots, 256K On Board Memory  
Assembled & Tested Board & All Components  
1 - \$229 3-4 \$219 4-10 \$200  
Over 10 Call  
IBM is a trademark of International Business Machines

**PC Case with Hinged Top**  
Easy, Quick Access  
Fits IBM PC/XT  
Mother Board  
Hardware for Mounting  
2 - 4 Drives  
Quality Case - All Metal  
1 - \$79 2-3 \$75 4-10 \$70

**Enhanced Keyboard for IBM PC**  
Enlarged Return  
Key & Shift Key  
LED Indicators on  
Cap's Lock &  
Number Keys  
Fully IBM  
Compatible  
1 - \$89 2-3 \$85 4-10 \$80

**PC-XT Compatible includes**  
640K RAM, 2 - DS/DD Disks 380K  
135 Watt Power Supply  
1 RS232 Serial Port  
1 Parallel Port  
Read Time Clock - Cal Bat Backup  
RAM Disk, Print Spooler  
Assembled & Tested! Everything you  
need except Monitor & Card!  
1 - \$1,059 2-3 \$1,000 4-10 \$975  
20 Meg Version ..... \$1,575

**Multifunction Card PRICE BREAKTHROUGH**  
1 Serial Port  
Printer Port • Game Port  
Real-Time Clock-Calendar  
Ram Disk • Print Spooler  
Optional second serial port available  
With 384 RAM ..... \$229  
3 or more ..... \$199

**135 WATT Power Supply**  
• 4 Drives Power Plugs  
• Side Switch Model like IBM  
1 - \$109  
2-3 \$105  
4-10 \$100

**PC PLUS™ Add-Ons for IBM™ PC & Compatibles**

• Disk Controller Card ..... 69	• Color Graphics Card ..... 89
• Disk I/O Card (2 Sse, Pa, Disk & Gma) 148	• Color Card/Parallel Port ..... 119
• Parallel Printer Card ..... 35	• Mono Graphic Card/Printer Port ..... 129
• Hi-Res Mono Card ..... 75	• Speaker ..... 2.00
• Serial Card ..... 49	• I/O Port Card ..... 89
• Game Adapter ..... 29	

**PAPER**  
8 1/2" x 11" Kern Edge ..... 29  
9 1/8" x 11" Standard ..... 27  
14 1/8" x 11" Standard ..... 38  
20 lb - other weights available  
2700 sheets per case

**ORDERING INFORMATION:** Order by check, Mastercard or VISA. Personal checks take 15 days to clear, no waiting on certified checks or money orders. Add 3% shipping and handling on all orders (minimum \$2.00) Mail, APD/PPD. Air may require additional charges. PA residents add 6% sales tax. MA residents add 5%. All items subject to availability. Prices subject to changes. Additional discounts available to qualified educational institutions. Requests for bid on volume requirements invited.



Since 1976  
Customer Service  
215-822-7727  
Use our TOLL FREE Order Line Mon-Fri 9am-6pm EST  
**800-822-1211**  
In PA: 215-822-7727  
252 BETHLEHEM PIKE, COLMAR, PENNSYLVANIA 18915

## BOOK REVIEWS

The professors make a lot of the fact that Dartmouth BASIC underwent seven major revisions but fail to note that Microsoft BASIC has seen at least six. These revisions have added significant improvements to the language's power and syntax and have even provided for true compilation. In addition, companies other than Microsoft have produced implementations of BASIC that are arguably as good as the Dartmouth versions.

### THE MESSAGE

Being learned men, Kemeny and Kurtz understand that BASIC's corruption was often by necessity—squeezing the language into 4K-byte and 8K-byte microcomputers required some compromises in functionality. But since today's machines impose fewer performance restrictions, the professors assert that it's time for a refurbished BASIC to take its place alongside Pascal and other respectable languages as a legitimate functional and educational tool.

That constitutes the message of *Back to BASIC*. Using example program fragments written in True BASIC, the professors argue that BASIC is a good programming language. Their arguments are well founded even if their objectivity might be questioned. The latest version of Dartmouth BASIC, the proposed ANSI standard for BASIC, and the professors' commercial version of the language are all useful and powerful programming systems.

Many people question, however, the need for versions of BASIC that differ from the widely used Microsoft version. The important issues of data-file compatibility and source-code transportability of Microsoft BASIC programs with other versions of the language concern many people who can appreciate the potential of a new BASIC but have an existing software investment to protect.

### NOT CONVINCING

Since *Back to BASIC* was apparently written in part to justify the existence of the new True BASIC and to anticipate objections to its adoption, it is surprising that the issues of compatibility and transportability between ANSI BASIC and the Microsoft version are never addressed. Similarly, Kemeny and Kurtz never discuss the relearning process that many programmers who grew up with Microsoft BASIC will have to undergo in order to adapt to the "new" BASIC.

As a result, the book doesn't convince me that an ANSI standard version of BASIC is right for me. And the space that Kemeny and Kurtz devote to espousing the message that a standard is necessary could have been put to better use by elaborating on the historical narrative of the first few chapters.

For example, one of the narrative's most charming passages concerns how students, working during the summer to help GE polish an operating system, cracked GE's security system to humble the system's creators, who had bragged about its invulnerability. More of this kind of insight into the evolution of BASIC within the fertile environs

(continued)

We have over 1000 Software and hardware items in stock. Shipments on almost all items within 24 hours!



**FREE SOFTWARE!**  
With over \$100 purchase you will receive a free diskette for your IBM PC with label maker, checker game and banner program

**TOLL-FREE ORDER LINE 1-800-421-3135**

Call for programs not listed.

Technical & Other Info. (602) 246-2222

**SOFTWARE**

**—DATA BASE MANAGERS—**

Alpha Data Base manager	\$165
Clout 2	129
Condor III	299
Fox and Geller Quickcode	145
Fox and Geller Quickreport	145
Friday	159
Knowledgeman	225
K Paint	60
K Graph	135
K Text	105
K Report	135
Nutshell	55
PFS: File	78
Power Base 2.1	199
RBase 5000	Call
Think Tank	98
Tim IV	169

**—WORD-PROCESSING—**

Easy (Micro Pro)	89
Leading Edge w/Merge	85
Microsoft Word	225
Multimate	Call
Multimate Advantage	255
Oasis Word Plus	85
Peachtext 5000	145
PFS: Write	78
Random House Spell Checker	36
Samna III 3.0	265
Volkswriter Deluxe	139
Word Perfect 4.1	195
Wordstar	170
Wordstar Propac	238
Wordstar 2000	238
Wordstar 2000+	285

**—SPREADSHEETS—**

Lotus 1-2-3	Call
Microsoft Multiplan	115
PFS: Plan	78
Supercalc II	145
Supercalc III 2.1 (New)	169

**—ACCOUNTING—**

BPI Accounts Payable	299
BPI Account Receivable	299
BPI General Accounting	299
BPI Payroll	299
Cyma	Call
Dollars and Sense	95
MBSI	Call
Tobias Managing Your Money	95

**TCS. Big Four equivalent of Peachtree Series 4** - Specially augmented and customized for your IBM PC Terminal and Printer - GL, AR, PA, AP, CP/M-80, CP/M-86 for PC XT, DOS 1.1, 2.0.  
Each Module \$65 For All Four \$249

**—INTEGRATED—**

Enable	Call
Smart Software	Call

**—TRANSFER PROGRAMS—**

Crosstalk XVI	89
Hayes Smartcom II	88
Microsoft Access	149
Move-It	79
Remote	99

**—GRAPHICS—**

Chartmaster	220
-------------	-----

**SOFTWARE**

Dr. Halo II	\$99
Energraphics w/o Plotter	170
Energraphics w/Plotter	220
Fontrix	99
Graphwriter/Combo	310
Microsoft Flight Simulator	32
PC Paint Brush	69
PFS Graph	78
Signmaster	145

**—LANGUAGES—**

Concurrent PC/Dos	Call
Fortran 77	208
Lattice C Compiler	249
Lifeboat Run C Interpreter	89
Microsoft C Compiler	239
Microsoft Fortran	209
Microsoft Macro Assembler	89
Microsoft Pascal Compiler	179
Microsoft Quick Basic	65
Multi Halo	140

**—PROJECT MANAGEMENT—**

Harvard Project Manager	199
Microsoft Project	150
Super Project	185
Total Harvard Project	245

**—UTILITIES—**

Copy II PC	22
Copy II PC Board	79
Copywright	45
Norton Utilities 3.0	52
PC Tools	22
Prokey 4.0	75
Superkey	36

**HARDWARE**

**BUYS OF THE YEAR**

Expansion Board 0 to 576K	\$69
KB5151 Keyboard Equivalent	89
Hercules Graphic Board w/Par Port Equivalent	118
1 Year Warranty - 30 Day Return Priviledge.	

**—MODEMS—**

Anchor Express	239
Hayes 1200	Call
Hayes 1200B w/Software	Call
Hayes 2400	605
Promodem 1200B w/Software	265
Promodem 1200	309

**—RAM—**

64K 150NS Chips (Set of 9)	6.50
256K Ram Chips (Set of 9)	39.50

**—BOARDS—**

AST Advantage	385
AST Sixpack (384K)	249
Hercules Color Card	145
Hercules Graphics Card	275
J RAM III	Call
Paradise Five Pak w/64K	155
Paradise Modular Graphics Card	249
Quadram Board with Par/Ser and Game Port	199
Quadcolor I	185
Sigma Maximizer Multifunction	169
Sperry 512K Expansion w/128K	145
STB Chauffeur Board	249
STB Mono Board	155
AB Parallel Print Switch	75

**HARDWARE**

**—COMPUTERS—**

Corona PC ..... Call

Sperry PC Mono 256K Dual Drive Serial Port, Clock, MS/DOS 2.11	\$1650
--	--------

IBM PC-AT ..... Call

IBM PC Clone, 256K, Amber Monitor, Hercules Graphics Card Equivalent	\$950
--	-------

ITT Computers PC Compatible 256K Dual Drive, Mono, MS/DOS . 1395

ITT XP80286 IBM/PC Compatible, 3 times faster than an XT. 30% faster than an AT	\$2650
---	--------

Zenith 171 ..... Call

**—PRINTERS—**

**FREE! PRINTER SET SOFTWARE**  
Purchase an Okidata, Epson, Gemini, Citizen or Toshiba printer and receive at no charge a menu driven program to set print characteristics or to make your computer function as a correcting typewriter. Retail value \$35. Available for most disk formats.

<b>CITIZEN</b>	
MSP-10	255
MSP-15	355
MSP-20	329
<b>DAISYWRITER 2000</b>	850
<b>EPSON</b> - Call on all models	

<b>JUKI</b>	
Juki 6100	349
Juki 6300	685
Juki Tractors	120

<b>NEC</b>	
3550	989
8850	1349
P5 Parallel	Call

**OKIDATA** - Call on all models

<b>PANASONIC</b>	
1091	239
1092	349
1093	429
KXP3151	410

<b>SILVER REED</b>	
EXP 400P	205
EXP 550P	389
EXP 770P	689

<b>STAR MICRONICS</b>	
SG-10	Call
SG-15	369

Call for prices on other models

<b>TOSHIBA</b>	
1340	499
P351	1075

**—MONITORS—**

<b>AMDEK</b>	Call for price
Taxan 610	319
Taxan 121 Green	125
Taxan 122 Amber	134
Princeton HX-12	445
Princeton Max 12	170
Samsung TTL, Amber	95

**TERMS:** Prices include 3% cash discount. Add 3% for charge and C.O.D. orders. Shipping on most software is \$5.00. AZ orders +6% sales tax. Personal check - allow ten (10) days to clear. Prices are subject to change.

**TOLL-FREE ORDER LINE 1-800-421-3135**

**WAREHOUSE DATA PRODUCTS**

2701 West Glendale Ave. • Phoenix, AZ 85021

Inquiry 373





# CONROY

TELEX 910 380 3980

**ALL MAIL: 12060 SW Garden Place, Portland, OR 97223**

### FOR YOUR APPLE



#### MACINTOSH

#### COMPUTERS

#### BUSINESS SOFTWARE

#### UTILITIES SOFTWARE

AEGIS, Challenger or Pyramid, ea.	\$ 50 \$ 37
ASSIMILATION, Numeric Turbo	\$ 79 \$ 59
Mac Port Adaptor	\$ 60 \$ 38
BLUECHIP, Millionaire, Barron, Tycoon, ea.	\$ 85 \$ 45
BORLAND, Sidekick (copiable)	\$ 40 \$ 22
CENTRAL POINT, Copy II Mac	SEE BELOW
CONROY-LA POINTE, Diskettes	SEE BELOW
CONTINENTAL, Home Accountant	\$ 100 \$ 65
CREIGHTON, Home Pak or Mac Office, ea.	\$ 39 \$ 26
Mac Spell+	\$ 99 \$ 61
DOW JONES, Market Manager Plus	\$ 249 \$ 159
EXPERTELLIGENCE, ExperLogo	\$ 150 \$ 95
FIRST BYTE, Smooth Talker	\$ 100 \$ 63
FOREHOUT, Fact Finder	\$ 150 \$ 95
HABA, 400K Ext. Disk Drive	\$ 449 \$ 339
800K DS/DD Ext. Drive	\$ 599 \$ 489
HAYDEN, Sargon III	\$ 50 \$ 31
HUMAN EDGE, Mind Prober	\$ 50 \$ 29
INFOCOM, Hitchhiker's Guide	\$ 40 \$ 25
KOALA, Mac Vision	\$ 400 \$ 229
LIVING VIDEOTEK, Think Tank	\$ 145 \$ 92
LOTUS, Jazz	\$ 595 \$ 389
MANHATTAN, ReadySetGo	\$ 125 \$ 69
MEGAHAUS, Megaform	\$ 295 \$ 189
MICROSOFT, Business Pak	\$ 295 \$ 189
Excel	\$ 385 \$ 259
Multiplan, Word, or File, each	\$ 185 \$ 125
Fortran	\$ 285 \$ 199
MILES, Mac the Knife, v. 1	\$ 39 \$ 25
MONOGRAM, Dollars & Sense	\$ 150 \$ 89
NOVATION, Smartcal Plus Modern w/Software	\$ 499 \$ 349
ODESTA, Helix	\$ 385 \$ 249
PROVUE, Overview	\$ 285 \$ 185
SIMON & SCHUSTER, Typing Tutor III	\$ 60 \$ 39
SOFTW. PUBL., PFS: File & Report Control	\$ 175 \$ 105
STATE OF THE ART, Electronic Checkbook	\$ 80 \$ 50
STONEWARE, DB Master	\$ 195 \$ 125
TELOS, File Vision	\$ 195 \$ 119
VIDEX, MacCalendar	\$ 85 \$ 49
WARNER, Desk Organizer	\$ 149 \$ 99

<b>Apple</b>	
<b>FLOPPY DISK DRIVES</b>	
Micro-SCI, A2 Disk Drive, 143K	LIST CONROY \$ 289 \$ 159
A2 Controller Card	\$ 100 \$ 59
Half Height Drive for II+/IIx	\$ 269 \$ 159
Half Height Drive for IIc	\$ 299 \$ 169
TEAC, T40 Half II, 163K, Direct	\$ 249 \$ 149
Controller Card for T40 by ComX	\$ 79 \$ 45

<b>HARD DISKS</b>	
IOMEGA, 5 meg Barron/II Box (iMac)	\$1999 \$1595
QUARK, QC10 for IIc/IIx/II+III	\$1999 \$1095

<b>OTHER HARDWARE</b>	
APPLE, Mouse for II	\$ 150 CALL
CCS, 7711 or 7710-A Interface, ea.	\$ 115 \$ 95
CPA/EASTSIDE, Wild Card II (copier, + file)	\$ 140 \$ 79
COMX, 16K RAM Card (II+ & IIx) or IIc	\$ 119 \$ 39
HAYES, Mach II, IIx Joysticks (II+/IIx)	CALL
KEYSINGTON, System Saver Fan	\$ 90 \$ 65
KEY TRONIC, Keyboard (+)	\$ 398 \$ 248
KOALA, Muppet Keys	\$ 80 \$ 44
Touch Tablet w/Micro II Illustrators (+/ie)	\$ 130 \$ 75
KRAFT, Joystick (IIc/IIx)	\$ 50 \$ 25
MICRO-SCI, 80 Col. Card + 64K RAM Card (file)	\$ 179 \$ 89
MICROSOFT, Premium Softcard (II)	\$ 395 \$ 275
280 Softcard II, 64K	\$ 425 \$ 295
ORANGE MICRO, Buffered Grappler Plus, 16K	\$ 209 \$ 149
16K Buffer Board for Grappler Plus	\$ 99 \$ 59
Hot Link, S-P cable for I/c	\$ 70 \$ 44
TITAN, Accelerator I/c	\$ 319 \$ 229
128K RAM Card (II+)	\$ 329 \$ 149
TRACKHOUSE, Numeric Key Pad (file)	\$ 100 \$ 79
VIDEO 7, V Color 7 RGB Card	\$ 150 \$ 129
V Color II	\$ 130 \$ 89
V Color III	\$ 250 \$ 169
VIDEX, UltraTerm 132 Col. (II+/IIx)	\$ 299 \$ 189
VidExTerm 80 Col. Card (II+ file)	\$ 279 \$ 175
WICO, Smartcard (Series IIII + file)	\$ 199 \$ 159

ALS, Word or List Handler, ea.	\$ 80 \$ 36
Handler Pak (Word/List/Spell)	\$ 170 \$ 73
APPLE, Applworks	\$ 250 \$ 225
ASHTON-TATE, dBase II (Req CP/M 80)	\$ 495 \$ 289
BPI, AR, AP, PR or INV, each	\$ 395 \$ 240
DATA TRANS, Fontrix	\$ 95 \$ 63
DOW JONES, Market Analyzer	\$ 349 \$ 219
HOWARD SOFT, Tax Preparer '85	\$ 250 \$ 159
HUMAN EDGE, Sales or Mgmt Eds, ea.	\$ 250 \$ 139
LIVING VIDEOTEK, Think Tank	\$ 145 \$ 89
MEGAHAUS, Megaworks	\$ 125 \$ 79
MICRO PRO, WordStar (req. CP/M)	\$ 350 \$ 189
WordStar w/ Starcard	\$ 495 \$ 265
WordStar Professional, 4 Pak	\$ 495 \$ 265
MICROSOFT, Multi-Plan (Ap DOS)	\$ 95 \$ 62
QUARK, Word Juggler & Lexicheck (IIc/IIc)	\$ 189 \$ 129
SATELLITE, Word Perfect	\$ 179 \$ 115
SENSIBLE, Sensible Speller	\$ 125 \$ 79
SIERRA/ON-LINE, Screen Writer II	\$ 130 \$ 89
SOFTWARE PUBL, PFS: File or Write, each	\$ 125 \$ 79
PFS: Graph or Report, each	\$ 125 \$ 79
PFS: Access	\$ 70 \$ 43
Best Sellers Combo	\$ 250 \$ 159
SPRINGBOARD, Newsroom	\$ 50 \$ 32
STONEWARE, DB Master, v. 4+	\$ 350 \$ 189

PENGUIN, Graphics Magician	\$ 80 \$ 41
QUALITY, Bag of Tricks	\$ 40 \$ 29
UNITED SWI, ASCII Express-Pro DOS	\$ 130 \$ 82
UTILICO, Essential Data Dupliator III	\$ 80 \$ 49

<b>HOME &amp; EDUCATIONAL</b>	
BARRONS, Study for SAT	\$ 90 \$ 60
BEAGLE BROS., Full Line IN STOCK	CALL
BRODERBUND, Print Shop	\$ 50 \$ 31
Print Shop & Refill	\$ 65 \$ 39
Bank St. Mailer or Filer, ea.	\$ 70 \$ 45
Bank St. Writer or Speller, ea.	\$ 70 \$ 45
Bank St. Combo (Writer & Speller)	\$ 140 \$ 85
CONTINENTAL, Home Accountant	\$ 75 \$ 43
HARCOURT, Computer SAT	\$ 80 \$ 51
KOALA, Full Line IN STOCK	CALL
MICROSOFT, Typing Tutor II	\$ 25 \$ 17
MINDSCAPE, Dollars & Sense	\$ 50 \$ 35
MINOGRAM, Crosswalk & Sense (II+ file)	\$ 100 \$ 59
Dollars & Sense (IIc/file 128K)	\$ 120 \$ 60
Forecast	\$ 60 \$ 38
SCARBOROUGH, Mastertype	\$ 40 \$ 25
Your Personal Net Worth	\$ 80 \$ 50
SIERRA/ON-LINE, Homeward	\$ 70 \$ 45
SIMON & SCHUSTER, Typing Tutor III	\$ 50 \$ 33

<b>RECREATIONAL SOFTWARE</b>	
BLUECHIP, Millionaire or Barron, ea.	\$ 50 \$ 35
ELECTRONIC ARTS, Bard's Tale	\$ 45 \$ 35
Sky Fox & others, ea.	\$ 40 \$ 29
Movie Maker	\$ 40 \$ 30
Deluxe Music Construction	\$ 50 \$ 37
Dr. J & Larry Bird	\$ 40 \$ 30
HAYDEN, Sargon III (Chess)	\$ 50 \$ 30
INFOCOM, Zork I, II, or III, ea.	\$ 40 \$ 29
MICROPROSE, Strike Eagle	\$ 35 \$ 23
ORIGIN, Ultima III	\$ 60 \$ 39
Ultima IV	\$ 64 \$ 44
PENGUIN, Transylvania	\$ 35 \$ 24
SPECTRUM HOLOBYTE, Gato (128K)	\$ 40 \$ 25
SPINNAKER, Full Line IN STOCK	CALL
SWB LOGIC, Flight Simulator II	\$ 50 \$ 30

<b>UTILITIES SOFTWARE</b>	
BEAGLE, GP/LE or Alpha Plot, ea.	\$ 50 \$ 27
Pronto DOS or Disk Quick, ea.	\$ 30 \$ 19
Apple Mechanic or I.O. Silver	\$ 30 \$ 19
BORLAND, Turbo Pascal (req. CP/M)	\$ 70 \$ 36
Turbo Toolbox	\$ 55 \$ 30
CENTRAL POINT Copy II Plus (bit copier)	\$ 40 \$ 22
EPSON, Graphics Dump	\$ 15 \$ 7
FLINK, Schedules	\$ 60 \$ 37
HAYES, Terminal Prog. for Smartmodem	\$ 99 \$ 65
MICROSOFT, Full Line IN STOCK	CALL
MICROSTUF, Crosstalk	\$ 195 \$ 109
MEGA, Locksmith	\$ 100 \$ 73
DUNGA, Complete Graphics System II	\$ 90 \$ 49

<b>DISKETTES</b>	
★ CONROY-LAPOINTE™ DISKETTES ★	
We guarantee these top quality products with our name.	
5 YEAR LIMITED WARRANTY.	

10 ea. SS/SD, (Apple, etc) 35 Trk, W/FLIP BOX	\$ 13
100 ea./1000 ea. SS/SD, 35 Trk	\$99/\$669
10 ea. SS/DD, 3 1/2" (MAC, H/P), W/FLIP BOX	\$ 25
50 ea./100 ea. SS/DD, 3 1/2"	\$115/\$235
10 ea. DS/DD, (IBM, H/P) 40 Trk, W/FLIP BOX	\$ 16
100 ea./1000 ea. DS/DD, 40 Trk	\$119/\$759
10 ea. DS/HD, (IBM-AT) 96 TPI W/FLIP BOX	\$ 29
100 ea. DS/HD, (IBM-AT) 96 TPI	\$ 269

<b>IBM PRE-FORMATTED</b>	
10 ea., DS/DD, 40 Trk W/FLIP BOX	\$ 20
100 ea./1000 ea., DS/DD, 40 Trk	\$149/\$959

<b>SINGLE-SIDED, DOUBLE DENSITY</b>	
CDC, 10 ea. SS/DD, 40 Trk (Apple, etc)	\$ 45 \$ 19
DYAN, 10 ea. SS/DD, (Apple, etc.)	\$ 40 \$ 27
MAXELL, 10 ea. SS/DD, MD1 (Apple)	\$ 47 \$ 19
VERBATIM, 10 ea. SS/DD, MD5-01 (Apple)	\$ 49 \$ 17

<b>DOUBLE-SIDED, DOUBLE DENSITY</b>	
CDC, 10 ea. DS/DD, 40 Trk (IBM, H/P)	\$ 59 \$ 23
DYAN, 10 ea. DS/DD, (IBM, H/P)	\$ 69 \$ 35
MAXELL, 10 ea. DS/DD, MD2 (IBM)	\$ 65 \$ 21
VERBATIM, 10 ea. DS/DD, MD34 (IBM)	\$ 75 \$ 21
<b>3 1/2" MICRO DISKETTES</b>	
MAXELL, 10 ea. SS/DD (MAC, H/P)	\$ 55 \$ 35
MEMOREX, 10 ea. SS/DD (MAC, H/P)	\$ 60 \$ 33
VERBATIM, 10 ea. SS/DD (MAC, H/P)	\$ 65 \$ 32

<b>HIGH DENSITY DISKETTES FOR IBM-AT</b>	
MAXELL, 10 ea. DS/HD (IBM-AT)	\$ 75 \$ 49
MEMOREX, 10 ea. DS/HD (IBM-AT)	\$ 84 \$ 49

<b>GENERIC DISKETTES</b>	
Top quality, w/packets, no inserts. Quantity discounts. 90 day "No hassle, money back guarantee."	
100 ea. SS/SD, 35 Track (Apple, etc)	\$ 75
100 ea. DS/DD, 40 Track, (IBM, H/P)	\$ 79
10 ea. DS/HD, (IBM-AT) 96 TPI	\$ 27
100 ea. DS/HD, (IBM-AT) 96 TPI	\$ 249

<b>MODEMS</b>	
ANCHOR, Signatman Mark XII	LIST CONROY \$ 399 \$ 299
HAYES, 2400 External Modem	\$ 899 \$ 619
Smartmodem 1200B (IBM)	\$ 549 \$ 379
Smartmodem II Software (IBM or MAC)	\$ 149 \$ 107
Smartmodem 1200 (External)	\$ 599 \$ 419
Micromodem file w/Smartcom (AP)	\$ 199 \$ 139
Transit 1000 - 128K	\$ 399 \$ 309
Transit 1000 Access Paks AP/IBM/MAC	\$ 40 \$ 35
NOVATION, Apple Cal II 300 Baud (AP)	\$ 369 \$ 219
240 External	\$ 735 \$ 595
212 Apple Cal. 1200 Baud (AP)	\$ 525 \$ 409
SmartCal Plus w/software (MAC)	\$ 499 \$ 349
PROMETHEUS, 3200 Standalone Modem	\$ 495 \$ 349
ProModem 1200 w/software (MAC)	\$ 549 \$ 399
ProModem 1200A (AP)	\$ 449 \$ 329
ProModem 300C (AP I/c)	\$ 199 \$ 149
ProModem 1200B (IBM)	\$ 399 \$ 289
VENTEL, PC Halfcard (IBM)	\$ 549 \$ 399

<b>MONITORS</b>	
AMDEK, 300G, 12" Green/Comp	\$ 179 \$ 119
300A, 12" Amber/Comp	\$ 169 \$ 129
310A, 12" Amber/IBM	\$ 230 \$ 159
Color 300, Comp/Audio	\$ 349 \$ 239
Color 500, Comp or RGB/Audio	\$ 525 \$ 319
Color 600, Hi Res RGB/Audio	\$ 599 \$ 399
PRINCETON, MAX-12, Amber (IBM)	\$ 249 \$ 179
HX-12, Hi Res/RGB	\$ 795 \$ 449
HX-12e, Hi Res/RGB or IBM-EGA	\$ 795 \$ 559
SR-12, Hi Res/RGB	\$ 795 \$ 599
QUADRAM, Amber/Chrome, 12"	\$ 250 \$ 149
ZENITH, ZVM-1220, 12" Amber/Comp	\$ 159 \$ 109
ZVM-1230, 12" Green/Comp	\$ 159 \$ 109
ZVM-1240 & ZVM-135	15-25% OFF

<b>CABLES</b>	
ARBO, IBM-PC to Modern Cable	\$ 31 \$ 19
ASTAR, RF Modulator for T.V. (Apple)	\$ 35 \$ 20
COMPUABLE, NeoNex Smartmodem Cable	\$ 32 \$ 18
CURTIS, Monitor Extension Cable (IBM)	\$ 50 \$ 32
3'-9" Keyboard Extens. Cable (IBM)	\$ 40 \$ 26
PCA, Monitor Cable	\$ 15 \$ 9

#### PRINTERS

<b>DOT MATRIX:</b>	
EPSON, FX85 - 160 cps DQ/32 cps NLQ/10"	LIST CONROY \$ 499 \$ 389
FX185 - 160 cps DQ/32 cps NLQ/15"	\$ 699 \$ 539
LX80 - 100 cps DQ/16 cps NLQ	\$ 295 \$ 249
LQ1500 - 200 cps DQ/67 cps LQ	\$129 \$ 995
Tractor feed for LX80	\$ 40 \$ 33
Tractor feed for LQ1500	\$ 70 \$ 55
Tractor feed for FX85	\$ 45 \$ 35
HEWLETT-PACKARD, LaserJet	\$3495 CALL
Thinkjet - 150 cps Inkjet	\$ 495 CALL
OKIDATA, Okimate 20, 182, 84	LOW PRICES
92, 192, 193, 2410 Pagecrack	IN STOCK
PANASONIC, P1092 - 120 cps/10"	\$ 599 \$ 399
1093	\$ 699 \$ 469
QUADRAM, Quadjet - Inkjet Color	\$ 895 \$ 395
STAR MICRO, SG10 - 120 cps DQ/30 cps NLO	\$ 299 \$ 249
SD10 - 160 cps DQ, 40 cps NLQ	\$ 449 \$ 379
SR15 - 200 cps DQ, 50 cps NLQ, 16K	\$ 799 \$ 679
TEXAS INSTRUMENTS, 855 - 150 cps	\$ 995 \$ 795
TOSHIBA, 351 - 288 cps	\$1695 \$1249

<b>LETTER-QUALITY:</b>	
JUKI, 6300 - 40cps/para.	\$ 895 \$ 699
Ghost - 18 cps/para/3 pitch	\$ 599 \$ 409
Sheet Feeder for 6300 (single)	\$ 275 \$ 225
PANASONIC, P3151 - 22 cps/15 1/2"	\$ 659 \$ 439
TOSHIBA, Prop. spacing & hi-res graphics:	
1340 - 144 cps DQ & 54 cps LQ	\$ 799 \$ 619
BI-directional Tractor Feed	\$ 195 \$ 175

<b>PLOTTERS:</b>	
EPSON, 4 Pen Plotter	\$ 599 CALL
HEWLETT-PACKARD, 8 Pen Plotter	\$3900 CALL

<b>PRINTER SUPPLIES:</b>		
CONROY LAPOINTE,		
Colored Paper Pack (250 sheets)		\$ 13 \$ 8
PAPER: White, Colored, Laser Cut, etc.		
<b>REBBS, DAISYWHEELS</b>		IN STOCK

#### PRINTER INTERFACES AND BUFFERS

ARBO, IBM-PC to Para Printer Cable	\$ 36 \$ 25
Switchbox, TS-0902	\$ 85 \$ 59
ASSIMILATION, Mac to Epson Conn I/F	\$ 89 \$ 69
Daisywheel Connection	\$ 99 \$ 80
EPSON, Parallel Interface for LQ1500	\$ 100 \$ 79
Serial Interface Board	\$ 130 \$ 110
OKIDATA, Plug In Play, Tractors, Okigraph	CALL
ORANGE MICRO, Grappler Plus for Apple	\$ 145 \$ 95
Serial Grappler	\$ 119 \$ 79
Buffered Grappler Plus, 16K	\$ 209 \$ 145
Hot Link, S-P cable for I/c	\$ 70 \$ 44
Grappler C	\$ 119 \$ 75
QUADRAM, Microfazers, Full Line IN STOCK	CALL
Microfazers 8K, P-P, w/copy	\$ 189 \$ 139
SMT, Apple II I/F & Cable	\$ 89 \$ 39
STAR MICRO, Mac/Star Interface	\$ 100 \$ 89

#### ACCESSORIES

CURTIS, Diamond, 6 outlets, switched	\$ 50 \$ 29
Emerald, 6 outlets, 6' cord	\$ 60 \$ 35
Ruby, 6 outlets, 6' cord, filter	\$ 90 \$ 55
Sapphire, 3 outlets, w/filter	\$ 80 \$ 46
EPD, Lemon, 6 outlets/w/air	\$ 45 \$ 29
Lime, 6 outlets/cord	\$ 70 \$ 45
Orange, 6 outlets/cord/filter	\$ 100 \$ 66
Peach, 3 outlets/w/air/filter	\$ 60 \$ 39
INNOVATIVE, Datacase 50 (disk holder)	\$ 15 \$ 10
KENSINGTON, Printer Stand	\$ 30 \$ 17
NETWORK, Wiretree, 4 outlets/filter/surge	\$ 70 \$ 39
Wiretree Plus, 6 outlets/filter/surge	\$ 100 \$ 59
PROD TECH INTL, Uninterruptible Power Supply	
200 Watts, PC200 for IBM-PC	\$ 359 \$ 289
300 Watts, XT300 for IBM-XT	\$ 499 \$ 399
600 Watts, AT600 for IBM-AT, 72 lbs.	\$ 899 \$ 789

**CONROY-LAPOINTE CREDIT CARD**  
Send me a Conroy-LaPointe credit application form, so I can get cash discount prices with credit card convenience, \$400 Minimum initial purchase.

NAME: \_\_\_\_\_  
ADDRESS: \_\_\_\_\_  
CITY: \_\_\_\_\_ STATE: \_\_\_\_\_ ZIP: \_\_\_\_\_  
MAIL TO: 12060 SW Garden Place, Portland, OR 97223  
CHECK OFF (SEE ORDER FORM)

**ORDERING INFO & TERMS:** MAIL TO: 12060 SW Garden Place, Portland, OR 97223 - Include telephone number. Check your figures for shipping, insurance and handling (S/H). All items ship in stock. NO C.O.D. Cashless checks, money orders, Fortune 1000 checks and government checks honored immediately. Personal and other company checks - allow 20 days to clear. Prices reflect 3% cash & Conroy-LaPointe Credit Card discount. An ADD 3% to above prices for VISA/MasterCard/American Express. Your card NOT charged if no ship. OHN Certificates available in any amount. We ship Federal Express Standard Air. U.S. and Puerto Rico, add 3% (\$5 minimum). Canada, add 12% (\$15 min). Foreign add 18% (\$25 min). APO, FPO & other U.S. territories shipment possible. Add 5% (\$50 min.). Orders received with insufficient S/H will be held for balance due. All prices, availability and specifications subject to errors or change without notice. All items are new, include warranty and are guaranteed to work. Due to our low prices and our assurance that you will get new, unused products - ALL SALES ARE FINAL. We do not guarantee compatibility. Call before returning goods for repair or replacement. ORDER DESK HOURS - 9AM to 6PM PST, Monday through Friday, Saturday 8 to 4, PC Mastercards, Ecomer/AM, Faxtrak and Genesis are trademarks of Magnum Computers, Inc.

# -LA POINTE INC.

© 1984 LaPointe Inc. All Rights Reserved.

LOW PRICES TO PROFESSIONALS WHO KNOW WHAT THEY WANT AND KNOW HOW TO USE IT!

## TO ORDER, CALL (800) 547-1289

### FOR YOUR IBM-PC, XT, AT or JR



#### COMPUTER SYSTEMS

#### OTHER HARDWARE

#### OTHER HARDWARE

#### MEMORY



### MAGNUM

8088-2 PC/XT-2

## \$995

640K, Two 360K Drives

Plus: MS-DOS 2.11, Parallel Port, 2 Serial Ports (RS 232C), Clock/Calendar, Floppy Drive & Tape Backup Controller, 5 slots, 135 Watt Power Supply, 8087-2 optional, Selectric PC/AT Style Keyboard.

w/1 Floppy & 10 meg Hard Drive **\$1595**

Please call for other configurations  
Above prices do not include video card or monitor

#### IBM-PC

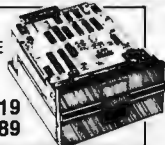
256K, 2 360K Disk Drives **IN STOCK**

#### FLOPPY, HARD & TAPE DRIVES

##### CDC, 360K DS/DD DISK DRIVE

Limited 30 day warranty  
Call for quantity prices

Full Height **\$119**  
Half Height **\$ 89**



CDC, (39 msec. access time) LIST CONROY  
Internal 20 meg kit FOR AT **\$1695 \$1195**

CORE INT'L., (39 msec. access time) LIST CONROY  
ATplus 20 meg kit FOR AT **\$1595 \$1195**  
ATplus 30 meg kit FOR AT **\$2495 \$1075**

**IRWIN,** LIST CONROY  
10 meg tape backup system **\$ 795 \$ 495**  
10 meg tape cartridges (by 3M) **\$ 25 \$ 19**

**KAMERMAN,** LIST CONROY  
10 meg kit w/controller **\$ 895 \$ 579**  
20 meg kit w/controller **\$ 995 \$ 695**  
Masterflight 10 meg w/tape **\$2295 \$1795**

**SEAGATE,** LIST CONROY  
10 meg w/controller **\$ 745 \$ 459**  
20 meg w/controller **\$ 895 \$ 595**

**TALLGRASS,** LIST CONROY  
24 meg disk, 10 meg tape **\$3495 \$2490**

	LIST PRICE	CONROY PRICE
MAYNARD, SAND STAR SERIES IN STOCK		
Multifunction (R) Card	\$ 195	\$ 79
Memory Card w/ RAM	\$ 195	\$ 139
Floppy Cont. Card (accepts 3 modules)	\$ 265	\$ 195
Hard Disk w/ Module	\$ 495	\$ 359
Serial Port Module	\$ 55	\$ 79
Para or Clock Cal. Module, ea.	\$ 59	\$ 49
MICROSOFT, Mouse (for PC)	\$ 195	\$ 129
Serial Mouse	\$ 105	\$ 145
MOUSE SYSTEMS, PC Mouse & Paint	\$ 220	\$ 145
PARADISE, Modular Graphics Card	\$ 385	\$ 279
Parallel or Serial Para. ea.	\$ 55	\$ 66
Z56K Module w/clock	\$ 195	\$ 165
PERYSYST, PC/Mono Board, w/para	\$ 250	\$ 159
PC/Color Graphics Board	\$ 245	\$ 176
QUADRAM, Quads w/ no RAM, to 384K	\$ 295	\$ 195
Quadboard 84K, to 384K, S/P/C/C/G	\$ 395	\$ 239
Quadboard 256K, to 384K, S/P/C/C/G	\$ 675	\$ 299
Quadboard 384K (full), S/P/C/C/G	\$ 795	\$ 279
Quadboard II, no RAM, to 256K	\$ 295	\$ 215
Quadboard II, 84K, to 256K, 25/C/C	\$ 385	\$ 265
Quadboard II, 256K, 25/C/C	\$ 595	\$ 395
Quad 512 + 64K w/serial port	\$ 325	\$ 245
Quadcolor I, board, 4 colors	\$ 295	\$ 175
Upgrade Quadcolor I to II kit	\$ 275	\$ 149
Quadnet VI	\$1995 \$1045	
Quadlink	\$ 495	\$ 375
Quadprint	\$ 245	\$ 495
TALLTREE, J RAM II Board	\$ 215	\$ 159
JRAM II Modules		<b>IN STOCK</b>
JRAM III, 256K Board	\$ 395	\$ 319
TECMAR, Maestro, 128K to 3MB, S/P for AT	\$ 569	\$ 459
Graphics Master	\$ 695	\$ 519
TITAN, 128K PC Accelerator	\$ 795	\$ 595
WICO, Smartboard Keyboard	\$ 400	\$ 279

#### ★ ★ FOR YOUR PC-JR ★ ★

KEY TRONIC, KD5151 Jr. Keyboard	\$ 255	\$ 189
Numeric Keypad	\$ 69	\$ 52
KEYAL, Touch Tablet for Jr.	\$ 125	\$ 75
MICROSOFT, Booklet 128K w/Mouse	\$ 295	\$ 195
MOUSE SYSTEMS, Mouse w/software	\$ 220	\$ 138
QUADRAM, Expansion Chassis	\$ 695	\$ 540
Memory Expansion Board 128K	\$ 275	\$ 215
RACORE, Expansion Chassis	\$ 675	\$ 449
128K Expansion Board	\$ 275	\$ 189
TECMAR, Jr. Captain	\$ 395	\$ 309



90 Day Warranty by us

CALL FOR QUANTITY PRICES

### MAGNUM

#### PC MASTERCARD™

The Only Multifunction RAM Card Expandable to 1.5 MB

	LIST	CONROY
"0" KB	\$169	<b>\$139</b>
384 KB	\$199	<b>\$179</b>
1.5 MB	\$399	<b>\$349</b>

Works like AST SixPak™ except includes game port Also has serial port, parallel port, clock/calendar, 1.5 MB RAMdisk, 1.5 MB print spooler, 1.5 MB bank switching development and utility software: SiliconBullet™ 1 Year Limited Warranty.

#### EconoRAM™ 384K Single Function Board

LIST **\$89**

With Fastrak™ RAMdisk and Print Spooler. Fully Compatible

## SOFTWARE FOR YOUR IBM-PC, XT, AT or JR

#### BUSINESS

#### BUSINESS

#### BUSINESS

#### UTILITIES

	LIST PRICE	CONROY PRICE
ASHTON-TATE, Framework	\$ 695	\$ 379
dBase III	\$ 695	\$ 389
dBase II, (req. PC-DOS & 128K)	\$ 495	\$ 289
BORLAND, Reflex: The Analyst	\$ 99	\$ 65
BPI, General Acctg. AR, AP, or PR, ea.	\$ 585	\$ 365
BREKTHROUGH, Timeline	\$ 495	\$ 295
BRODERBUND, Bank St. Writer (PC or Jr.)	\$ 80	\$ 51
CDEX, Advanced Training for Lotus 1-2-3	\$ 70	\$ 45
CONTINENTAL, Ultrafile	\$ 195	\$ 115
Tax Advantage	\$ 70	\$ 40
Property Management	\$ 495	\$ 295
DATA TRANS., Fontrix	\$ 155	\$ 99
Font Packs, each	\$ 20	\$ 19
DOW JONES, Market Manager Plus	\$ 249	\$ 159
Market Analyzer	\$ 349	\$ 229
Spread Sheet Link	\$ 249	\$ 159
FOX & GELLER, Quickcode III	\$ 295	\$ 185
HARVARD, Total Project Manager	\$ 495	\$ 295
HOWARDSON, Tax Preparer '85	\$ 295	\$ 195
HUMAN EDGE, Mind Manager (PC or Jr.)	\$ 50	\$ 29
Sales Edge or Management Edge, ea.	\$ 50	\$ 139
Negotiation Edge	\$ 295	\$ 165
INFOCOM, Cornerstone	\$ 495	\$ 309
LIFETREE, Volkswriter Deluxe	\$ 295	\$ 159
LIVING VIDEOTEK, Think Tank	\$ 195	\$ 109
LOTUS, 1-2-3	\$ 495	\$ 309
Symphony	\$ 695	\$ 449
MDBS, KnowledgeMan	\$ 500	\$ 275
MECA, Managing Your Money (PC)	\$ 199	\$ 105
MICROPRO, Easy	NEW \$150	\$ 99
WordStar (PC)	\$ 350	\$ 189

	LIST PRICE	CONROY PRICE
MICROPRO, WordStar (Jr)	\$ 195	\$ 109
WordStar 2000 (copiable)	\$ 495	\$ 265
WordStar 2000 Plus (copiable)	\$ 595	\$ 295
WordStar Professional, 4 Pak	\$ 495	\$ 265
MICROMIN, R:Base Series 5000	\$ 695	\$ 385
Upgrade 4000 to 5000	\$ 245	\$ 135
R:Base 4000	\$ 495	\$ 259
R:Base Clout	\$ 249	\$ 133
Extended Report Writer	\$ 150	\$ 92
MICROSOFT, Multiplan (PC or Jr)	\$ 195	\$ 124
Chart or Project, each	\$ 250	\$ 159
Word	\$ 375	\$ 239
MOASIC, Twin	\$ 145	\$ 75
MULTIMATE, Ultimate Ver. 3.3	\$ 495	\$ 229
PALADIN, FlashCalc	\$ 129	\$ 86
PEACHTREE, Back to Basics	\$ 395	\$ 239
Peach Pak (GLAR/AP)	\$ 395	\$ 219
PRENTICE HALL, Inside the IBM, by P. Norton	\$ 22	\$ 17
QUE, Using 1-2-3 (book)	\$ 18	\$ 14
1-2-3 for Business (book)	\$ 17	\$ 13
Using Symphony (book)	\$ 20	\$ 15
SAMNA, Word Plus	\$ 695	\$ 349
Word III	\$ 550	\$ 279
SATELLITE, WordPerfect (PC)	\$ 495	\$ 219
WordPerfect (Jr)	\$ 69	\$ 46
SOFTWARE ARTS, Spotlight	\$ 150	\$ 96
SOFTWARE GROUP, Enable	\$ 695	\$ 385
SOFTWARE PUBL. PFS:Report	\$ 125	\$ 75
PFS:Write, File or Graph, each	\$ 140	\$ 84
PFS:Plan or Access, each	\$ 140	\$ 84
PFS:Proof	\$ 95	\$ 57

	LIST PRICE	CONROY PRICE
SORCIM, SuperCalc III	\$ 395	\$ 229
Superwriter	\$ 295	\$ 195
SPRINGBOARD, Newsroom	\$ 50	\$ 32
THORN EM, Parlor For Jr (Writer/Spell/Translator)	\$ 139	\$ 89
UNISON, Print Master	\$ 60	\$ 38
WARNER, Desk Organizer (PC or Jr)	\$ 99	\$ 63
XANARO, Ability	\$ 495	\$ 319

#### UTILITIES

	LIST PRICE	CONROY PRICE
BORLAND, Sidekick (copiable)	\$ 85	\$ 49
Turbo Pascal or Super Keys, ea.	\$ 70	\$ 36
Turbo Pascal w/0807 or BGD, ea.	\$ 110	\$ 66
Turbo Pascal w/8087 & BCD	\$ 125	\$ 69
Toolbox or Turbo Graphics, ea.	\$ 55	\$ 29
Turbo Tutor	\$ 35	\$ 19
CENTRAL POINT, Copy II PC	\$ 40	\$ 22
PC Tools	\$ 40	\$ 22
DIGITAL RES., Gem Draw	\$ 150	\$ 95
Gem Collection	\$ 199	\$ 125
Gem Desktop	\$ 50	\$ 32
CP/M-86™ (PC/XT)	\$ 100	\$ 64
DR LOGO-86 (CP/M-86)	\$ 150	\$ 99
FUNK SOFTWARE, Sideways	\$ 60	\$ 37
IMSI, CP Paintbrush	\$ 139	\$ 85
LIFEBOAT, Lattice C	\$ 495	\$ 279
Dr. Halo	\$ 100	\$ 59
MAGNUM, Fastrak™, RAMDisk & spooler	\$ 50	\$ 39
MICROSOFT, Macro Assembler	\$ 150	\$ 99
QuickBASIC	\$ 99	\$ 65
BASIC Compiler or C Compiler, ea.	\$ 395	\$ 269
Business BASIC Compiler	\$ 450	\$ 295
COBOL Compiler	\$ 700	\$ 459
FORTRAN Compiler	\$ 350	\$ 229
PASCAL Compiler	\$ 300	\$ 199

#### HOME & EDUCATIONAL

	LIST PRICE	CONROY PRICE
BPI, Personal Accounting	\$ 99	\$ 63
BRODERBUND, Print Shop	\$ 80	\$ 36
CONTINENTAL, Home Accountant (Jr)	\$ 75	\$ 45
Home Accountant Plus (PC)	\$ 150	\$ 90
DAVIDSON, Spell II	\$ 30	\$ 30
MINDSCAPE, Crossword Magic	\$ 30	\$ 35
MONOGRAM, Dollars & Sense w/lottery	\$ 180	\$ 100
SCARBOROUGH, Master Type (PC or Jr)	\$ 40	\$ 25
Your Personal Not Worth	\$ 100	\$ 63
SIMON & SCHUSTER, Typing Tutor III	\$ 50	\$ 33

#### RECREATIONAL

	LIST PRICE	CONROY PRICE
BLUECHIP, Millionaire Barron Tycoon, ea.	\$ 80	\$ 35
BRODERBUND, Large Inventor in Stock		<b>CALL</b>
ELECTRONIC ARTS, Large Inventory in Stock		<b>CALL</b>
HAYDEN, Sargon III (Chess)	\$ 50	\$ 34
INFOCOM, Hitchhiker's Guide to Zork II, ea.	\$ 40	\$ 25
Zork II or III, each	\$ 40	\$ 29
MICROPROSE, Snake Eagle	\$ 35	\$ 23
MICROSOFT, Flight Simulator (PC or Jr)	\$ 50	\$ 33
ORIGON, Ultima III (PC or Jr)	\$ 80	\$ 39
SIERRA/ON-LINE, Ultima II (PC or Jr)	\$ 80	\$ 43
SPECTRUM HOLOBYTE, Galo	\$ 40	\$ 25
SPINNAKER, Amazon, Dragon, each	\$ 40	\$ 25
SUBLOGIC, Jet	\$ 50	\$ 32

#### CONROY-LOAPINTE COMPUTER STORES, INC.

Retail sales only. Store prices may vary.  
SAN FRANCISCO — 550 Washington Street (at Montgomery, opposite the Pyramid), Interstate 80 to Highway 480; take Washington Street Exit. CALL (415) 982-8212.  
PORTLAND, OREGON — At Park 217, Tigar at intersection of Highways 217 and 99A. CALL (503) 620-5595.  
SEATTLE, WASH. — NEW LOCATION! 1131 Bellevue Way N.E. in Bellevue Plaza, 2 blocks north of Bellevue Square. CALL (206) 641-4736.



#### OUR REFERENCES:

We have been in computers and electronics since 1968, a computer dealer since 1979 and in computer mail order since 1980. Banks: 1st Interstate Bank. (503) 643-6578. We belong to the Chamber of Commerce (503) 229-9411, and Direct Marketing Association, call Dan and Bradstreet if you are a subscriber. Recipient of OREGON BUSINESS MAGAZINE's 1984 Enterprise Award.

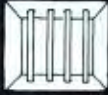


**(800) 547-1289**  
In Oregon: (800) 451-5151 (503) 620-9877  
**QUESTIONS**  
(503) 620-9878  
Mon-Fri 9am-5pm (PST)  
Weekdays Only

**ORDER DESK HOURS**  
Mon-Fri 6am to 6pm (PST)  
Saturday 8am to 4pm (PST)  
(6 am here is 3 am in New York)

NO SALES TAX

What use is 68000 power if you can't get at it?



You can with the U-MAN!

Look at these languages and tools available for the programmable 68000 power U-MAN Series 1000 supermicro

**UCSD p-system with text editor, filer, many utilities.**

- PASCAL
- FORTRAN 77
- BASIC
- Advanced Developers Tool Kit including 68000 Assembler

**CP/M 68K with editor, many utilities, 68000 Assembler.**

- C
- CBASIC
- PASCAL M T Plus
- SVS FORTRAN
- Whitesmiths 'C'
- SVS Basic Plus
- SVS Pascal
- Cambridge LISP
- PROLOG
- FORTH
- VED 68K program editor
- XED screen editor

Where else can you get a 68000 based supermicro starting at \$2500

for an extremely well-equipped system\* expandable to 1MB RAM and Winchester?

- \* 192K RAM 68000 (10MHz) and 6809 Dual 800K floppies
- Clock & timers
- Two serial ports
- Centronics port
- Sound generator
- Speech synthesizer
- 10 bit A/D
- 16 parallel I/O lines

Note that all the CP/M68K languages can use whatever RAM is installed — unlike CP/M86 and MS-DOS where the limit is usually only 64K.



Keyboard and 4 slot expansion system.



Although the big software houses have their parts to play we believe individuals can still make a big contribution to the software scene. If you've a program bursting to get made, needing 68000 power or U-MAN features, give us a call — we can offer up to 40% off for a bono fide project!

**College or University** — ask about education discounts for Feb. & March.

**OEM and dealer enquiries welcomed.**

**MASTERBYTE**  
Computers of New York  
19 W. 34th St., Suite 815  
New York, NY 10001  
(212) 760-0340/1/2  
TWX: 9103801502  
(MASTERBYTE)

**MASTERBYTE**  
COMPUTERS OF NEW YORK

BOOK REVIEWS

of a university community would have made *Back to BASIC* a most enjoyable book.

G. Michael Vose is a BYTE senior technical editor. He can be reached at 70 Main St., Peterborough, NH 03458.

ETHICAL ISSUES IN THE USE OF COMPUTERS  
Reviewed by Stan Czarnik

Trends in current ethical philosophy have not taken into account technological development. Conversely, the creators of technological novelty have not considered the ethical or social effects of their work. And most philosophers probably do not understand computer technology well enough to convince the technologists that they know what they are talking about.

*Ethical Issues in the Use of Computers* is a well-organized and successful collection of 23 articles designed to bring the two factions together. Editors Deborah G. Johnson and John W. Snapper divide the book into five sections on codes of conduct, responsibility, privacy and security, power, and the ambiguous legal status of computer software. Each section begins with an overview of the contributions to follow; the articles themselves are arranged systematically, complete with case studies and examples.

This variety of topics is broken down into three areas of ethical difficulties: existing contentions that have increased with the proliferation of computers; traditional ethical problems forced into new forms of representation due to computers; and questions that would not exist were it not for computers.

EXISTING CONTENTIONS

Large databanks containing accessible information on the status and activities of individual citizens facilitate the penetration of our privacy. David Burnham's piece on databases indicates that the government has accumulated over four billion records about the people of this country, with 17 items for every person. Americans make some 500 million telephone calls per day, with computers recording all the juicy details, like how many times somebody dialed the wrong number. And with enough information like this, it might seem possible to surreptitiously reconstruct an individual's lifestyle, if not his "state of mind." But hard evidence of such abuse of personal data—if indeed it would count as abuse—remains scarce.

Further, as R. Turn and W. H. Ware mention in another article, a study for the National Academy of Sciences came to the conclusion that most organizations that have switched to automated record-keeping systems have not significantly changed how they use records.

WIDENING THE GAP

The allocation of power is developing more significance as computer technology works its way into the fabric of

(continued)

IBS

AT MOTHER BOARD (OEM QTY. PRICE) \$595  
AT BIOS CONTRACT CALL

- PC-2000 256K/2 TEAC DRIVES (To Dealers) \$ 895
- XT-2000 256K/10 MEG. HARD DISK (To Dealers) \$1390
- AT-7000 1024K/1.2 MEG. TEAC (To Dealers) \$1995
- (10/20/60 Meg. Tape Back-Up, 10/20/33/44 Meg. Hard Disk)

\* DEALERS/OEMS PLEASE CALL FOR DETAILS (714) 579-0691 579-0692 579-0693

PLEASE CALL FOR DEALER NEAREST YOU AT-7000/TURBO NOT SHOWN BELOW



IBM is a trademark of IBM Corporation

**IBS**  
CORPORATION

2700 E. IMPERIAL HWY. - BLDG. A  
BREA, CA 92621  
(714) 579-0680, 579-0691  
TELEX 753197

The future... a little sooner than you expected.™



**ACHIEVE THE POWER  
AND SPEED OF TOMORROW'S  
TECHNOLOGY. TODAY.**

**INTRODUCING  
THE EXEC. PARTNER™ FROM  
PANASONIC®**

The Panasonic Exec. Partner. What makes it an executive? The 7.16 MHz 8086-2 microprocessor for high-speed processing. So you can do more in less time.

What makes it your partner? Like all ambitious achievers the Panasonic Exec. Partner gets along with others. Namely, IBM hardware and software.

You'll also accomplish more with the new high-resolution plasma display. It lasts four times longer, offers clearer definition and is easier to read than an ordinary screen.

The Exec. Partner's built-in dual mode printer will help

you make a good impression. From silent, draft-quality mode to correspondence quality.

The 256K internal memory has built-in expandability to 640K. So the Exec. Partner will run the most sophisticated data base management programs. And its expansion slot allows you to fulfill the needs of specific applications like telecommunications and Local Area Networks.

Tomorrow's technology for today's executives. The new Panasonic Exec. Partner. **Panasonic Industrial Company**

Get a carrying case (model FXZC751) at no charge with any Exec. Partner purchased through 12/31/85. For the location of your nearest participating dealer, call 1-800-PIC-8086.

IBM is the registered trademark of International Business Machines, Inc.

*Send Your Data...  
..on Route 96!*

**9600 BAUD \$895\***

\*UPTA 96/S \$995 WITH RS-232C



**DIALUP ASYNC PC MODEM**

UPTA 96/S STANDALONE

**STANDARD UPTA 96 FEATURES:**

- Uses 'AT' Commands
- CRC-16 Error Detection and Correction
- AUTODIAL/AUTOANSWER
- Fits IBM PC, XT, AT & Compatibles
- Program Selectable for 9600, 7200, and 4800 BAUD
- Operates with standard asynchronous communications programs



UPTA 96 INTEGRAL

**TO ORDER YOUR UPTA 96 CONTACT YOUR LOCAL DEALER OR CALL US DIRECT AT (703) 620-3900**

ALL ORDERS PREPAID OR C.O.D. PLEASE ADD \$12.50 SHIPPING & HANDLING PER MODEM. VA. RESIDENTS ADD 4% SALES TAX. MAJOR CREDIT CARDS ACCEPTED

**Electronic Vaults, Inc.**  
• 12347-E Sunrise Valley Drive • Reston, Virginia 22091 •

BOOK REVIEWS

our society. And now, in the middle of this decade, the degree to which various sorts of people have access to computers will have a profound effect on their marketability. The unevenly distributed access to computers will further widen the economic, social, and even intellectual gap between rich and poor. In the opinion of some educators, for instance, school-age children with easy access to microcomputers seem to become more involved with learning in general; they spend extra time studying, revising their work, and perfecting it.

But all children are not so lucky. *Ethical Issues* makes this disturbingly clear. A survey taken by Market Data Retrieval Inc. found that 80 percent of America's 2000 wealthiest public high schools have at least one microcomputer; 60 percent of America's 2000 poorest secondary schools have none. In the words of Herbert Lobsenz, Market Data Retrieval's president, "If computers are the wave of the future, a lot of America is being washed out."

**NEW ETHICAL ISSUES**

In the second and third categories, the new technology begins to transform ethical matters qualitatively. The proliferation of computer equipment in health-care centers, coupled with the introduction of medical advisory programs, is one example. Who is to be held responsible for harm to humans in circumstances involving computerized control or consultation is far from clear. I abbreviate Johnson and Snapper's hypothetical situation: Suppose a hospital purchases a medical-diagnosis system from the XYZ Corporation. The company never claims the system is 100 percent accurate. Imagine that Dr. Jones uses the program to help him identify the affliction of Mr. Smith. The computer narrows it down to renal failure. Dr. Jones finds the diagnosis reasonable and prescribes treatment. It becomes apparent over time that Mr. Smith is actually suffering from something else, and worse, that he has developed a serious infection as a result of the treatment suggested by the misdiagnosis.

Who should be blamed for Mr. Smith's condition? The question, in fact, is much more complicated, as the relevant material in *Ethical Issues* demonstrates. What about the hospital administrators, who could have purchased a diagnostic program from another company? What about Dr. Jones, who was in no way compelled to take the computer's advice? What about Mr. Smith, who knew the doctor was getting help from a machine? As contributor James Moor asks, "Are there decisions computers should never make?"

To return to our hypothetical hospital, the situation would be somewhat less problematic if agreement could be reached on whether the sale of software is the sale of a product or the sale of a service. If the diagnostic system is a product, then strict liability applies; XYZ could be held responsible for selling defective merchandise, despite the fact that the company did everything it could to make the product safe. In this sense, the computer pro-

(continued)

*Bluestreak*  
QUALITY COMMUNICATION SOFTWARE

**TERMINAL EMULATION FOR THE IBM PC**

- **TWO COMPORTS** — allows two terminal sessions simultaneously
- **EMULATES VT100** and nine other popular terminals
- **PROGRAMMABLE**
- **MODEM** support for the D.C. Hayes standard
- **DOS** access with a single keystroke
- **ASCII - EBCDIC** code translation
- **KEYBOARD DEFINITION** for all function keys
- **CHARACTER** filtering
- **BAUD RATES** to 9600
- **CODE TRANSLATION** by user table
- **PHONE** directory
- **ASCII and XMODEM** file transfer
- **HELP** screens
- **USER DEFINED XON-XOFF** characters

**\$49.95**

PLUS \$3.00 FOR POSTAGE AND HANDLING  
TO ORDER CALL TOLL FREE — 1-800-237-6360  
IN FLORIDA CALL 1-800-282-1152  
**ASK FOR OPERATOR 222**  
MASTERCHARGE, VISA, CHECK OR MONEY ORDER

OR WRITE: **LANG-ALLAN, INC.**  
2431 ALOMA AVE. SUITE 103  
P.O. BOX 1341, WINTER PARK, FL 32790  
(305) 677-1539

IBM and D.C. Hayes are registered trademarks of IBM CORP. and HAYES Microcomputer Products.



# BUY ONE ANTHRO CART<sup>TM</sup> WITH JUST ONE OPTION. GET A SECOND CART FOR \$100.



That's right. If you order an AnthroCart with either a printer basket or extension shelf between now and January 31, 1986 we'll send you a second cart for just \$100 more.\*

This is the cart that was just named a 1985 Product Design Award Winner by the Institute of Business Designers.

It's completely mobile, and lets you stack your entire system in only 5½ sq. ft. Sturdy steel construction supports up to 150 lbs. Unconditionally guaranteed for five years.

So don't wait another minute for your AnthroCart. Find a friend, and order two for just a little more than the price of one. Basic unit \$495. Printer Basket \$119.95. Extension shelf \$119.95. To order, or for more information call our toll free number. 7 a.m.-6 p.m. PST. Credit cards accepted.

  
**ANTHRO**<sup>®</sup>  
TECHNOLOGY FURNITURE/A Tektronix Company

3221 N.W. Yeon Street  
Portland, OR 97210  
503) 241-7113

Limited Time Offer. Call:  
**1-800-325-3841 Ext. 501**  
15 Day Free Evaluation  
\*Factory direct and dealer discounts  
do not apply. See us at COMDEX

Contact us for other low prices on hardware and software.

Next Day Air Extra

**FREE SHIPPING**  
**NO SURCHARGE FOR**  **OR** 

Call for latest prices.

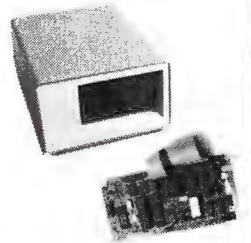
# 20 and 33 MEG INTERNAL AND EXTERNAL HARD DISK SYSTEMS

	20 MEG	33 MEG
<b>Internal</b>	<b>\$495</b>	<b>\$929</b>
<b>External</b>	<b>\$645</b>	<b>\$1029</b>

Externals mounted with independent power supply and fan. Fully DOS 2.X or 3.X compatible. Both Internals and Externals boot from Hard Disk. 33 Meg Internal Disks include extender power supply. The system comes complete and ready to install with the Hard Disk, Controller, Cables, Manual, Software, and Mounting Hardware. One Year Warranty.



Half Height

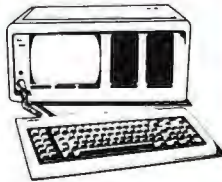


**20 and 33 Meg Hard Disks are available with combined Floppy/Hard Disk Controller Card for additional \$75.**

**COMPAQ**

**256K, 1/360K drive, 10 Meg Internal**

Functional equivalent to a Compaq Plus.™



**\$2549**

Now using 3 1/2" shock-mounted Winchester drives. The same as used in the Compaq Plus™. Also available with 2 half-height drives and 10 MEG HD- **\$2749**

Or upgrade your Compaq to a Compaq Plus™ equivalent with our 3 1/2" shock-mounted Winchester disk kit. Includes Hard Disk, Controller, Cables, Manual, software, and Mounting Hardware. One year warranty. **\$519**

Compaq is a registered trademark and Compaq Plus and Compaq Desktop are trademarks of Compaq Computer Corporation.

## DISK DRIVES

**MITSUBISHI**  
Half-Height, DS/DD

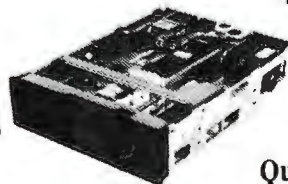
**\$85**

Quantities of 10 or more \$75 each

**TEAC**

55-B, Half-Height, DS/DD

**\$95**



Call us for competitive prices on larger quantities of RAM chips.



**64K RAM**

Set of 9 chips, 200 or 150 Nanoseconds

**\$8**

Quantities of 100 or more sets

**\$4<sup>50</sup>**  
per set.

**256K RAM**

Set of 9 chips

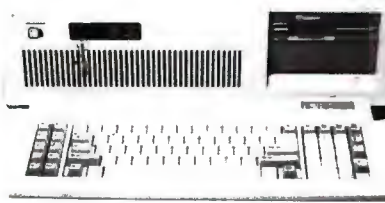
**\$39**

Quantities of 50 or more sets

**\$29**  
per set.

# PRICES AND MACHINES THAT OUTRUN THE COMPETITION.

## PC'S LIMITED AT™ High Performance Competitive Price



# \$1995

Includes: 80286-based System Unit, 1024K on Mother Board, 1.2 Meg Floppy Drive, Combined Floppy and Hard Disk Controller Card, AT Keyboard, 192W Power Supply, 2 Serials and 1 Parallel Port, and Clock/Calendar with Battery Backup, all on Mother Board.

Runs all Major Software written for the IBM PC™, PC XT™, and PC AT™. (Processor) Intel 80286 running at 6MHZ. (Expansion Slots) :8. 7 are available in above configuration. Same Bus Configuration as IBM PC AT™.

### PC'S LIMITED TURBO PC™

## High Performance Competitive Price



# \$795

Includes: System Unit, 640K on Mother Board, 360K Floppy Drive, Keyboard, 135W Power Supply.

Runs all Major Software written for the IBM PC™ and PC/XT™, 40% faster, without modifications. (Processor) 16-bit 8088-2, 4.77 or 6.66 MHZ Clock Speed. (Expansion Slots) :8; 7 are available in above configuration.

### SOLVE YOUR POWER PROBLEM. XT™ POWER 135W

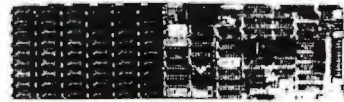


# \$89

Fully XT™ compatible.  
One Year Warranty.  
Directly replaces power supply in PC™

25 or more \$75 each

### PC'S LIMITED Six Function Card



# w/384K \$149

Two Year Warranty

- Upgradable to 384K
- Clock/Calendar
- Software included
- Parallel Port
- Serial Port
- Game Port

### Irwin Tape Backup System



# \$595

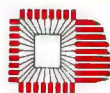
10 or more  
\$495 each

- Uses Floppy Controller Card
- 10.35 Meg Formatted Capacity
- Used in Compaq Deskpro.
- Half Height
- Low Power

Also available with external chassis \$795

Compaq, TEAC, IBM, Irwin, Mitsubishi, and Intel are registered trademarks of their respective companies. All brand names are registered trademarks. We are an independent sales organization.

Some quantities may be limited. PC'S LIMITED reserves the right to substitute equivalent items.



# PC'S LIMITED

**OUTSIDE TEXAS, ORDERS ONLY, CALL 1-800-426-5150**  
**1611 Headway Circle, Building 3, Austin, Texas 78754**  
**All sales-related calls inside Texas — (512) 339-6800**  
 Telex No. 9103808386 PC LTD

Terms: Due to our low prices and assurance that all merchandise is new, unused product, all sales see final call technical support for return authorization number on all warranty repairs. Any unauthorized return subject to a 10% restocking fee. Prepaid checks, money orders, VISA, MasterCard, American Express, or approved company purchase orders are accepted. No exchange for VISA or MasterCard. 5% surcharge for American Express.

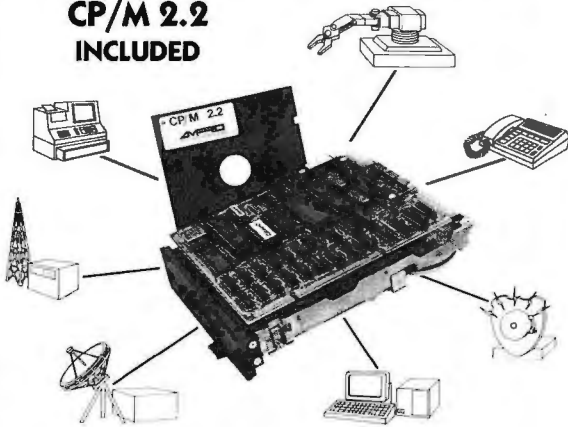


Ad number 412

# Little Board™ ... \$249

The World's Least Expensive CP/M Engine

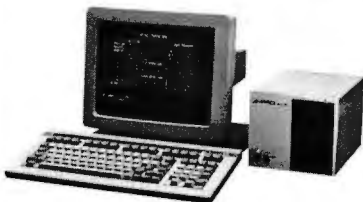
**CP/M 2.2  
INCLUDED**



- 4 MHz Z80A CPU, 64K RAM, Z80A CTC, 4-32K EPROM
- Mini/Micro Floppy Controller (1-4 Drives, Single/Double Density, 1-2 sided 40/80 track)
- 2 RS232C Serial Ports (75-9600 baud & 75-38, 400 baud), 1 Centronics Printer Port
- Power Requirement: +5VDC at .75A; +12VDC at .05A / On board -12V converter
- Only 5.75 x 7.75 inches, mounts directly to a 5-1/4" disk drive
- Comprehensive Software Included:
  - Enhanced CP/M 2.2 operating system with ZCPR3
  - Read/write/format dozens of floppy formats (IBM PC-DOS, KAYPRO, OSBORNE, MORROW...)
  - Menu-based system customization
  - Operator-friendly MENU shell
- **OPTIONS:**
  - Source Code
  - TurboDOS
  - ZRDOS
  - Hard disk expansion to 60 megabytes
  - SCSI/PLUS™ multi-master I/O expansion bus
  - Local Area Network
  - STD Bus Adapter

## BOOKSHELF™ Series 100

Fast, Compact, High Quality, Easy-to-use CP/M System



**Priced from  
\$895.00  
10MB System  
Only \$1645.00**

- Ready-to-use professional CP/M computer system
- Works with any RS232C ASCII terminal (not included)
- Network available
- Compact 7.3 x 6.5 x 10.5 inches, 12.5 pounds, all-metal construction
- Powerful and Versatile:
  - Based on Little Board single-board computer
  - One or two 400 or 800 KB floppy drives
  - 10-MB internal hard disk drive option
- Comprehensive Software Included:
  - Enhanced CP/M operating system with ZCPR3
  - Word processing, spreadsheet, relational database, spelling checker, and data encrypt/decrypt (T/MAKER III™)
  - Operator-friendly shells; Menu, Friendly™
  - Read/write and format dozens of floppy formats (IBM PC-DOS, KAYPRO, OSBORNE, MORROW...)
  - Menu-based system customization

### DISTRIBUTORS

**ARGENTINA:** FACTORIAL, S.A., (1) 41-0018, TLX 22408 **BELGIUM:** CENTRE ELECTRONIQUE LEMPEREUR, (041) 23-4541, TLX 42621 **CANADA:** DYNACOMP COMPUTER SYSTEMS LTD., (604) 872-7737 **ENGLAND:** QUIANT SYSTEMS, (01) 253-8483, TLX 946940 REF:19003131 **FRANCE:** EGAL+, (1) 502-1800, TLX 620893 **SPAIN:** XENIOS INFORMATICA, 593-0822, TLX 50364 **AUSTRALIA:** ASP

**MICROCOMPUTERS,** (613) 500-0628 **BRAZIL:** CNC-DATA LEADER LTDA., (41) 262-2262, TLX 041-6364 **DENMARK:** DANBIT, (03) 66-20-20, TLX 43558 **FINLAND:** SYMMETRIC OY, (0) 585-329, TLX 121394 **ISRAEL:** ALPHA TERMINALS, LTD., (3) 49-16-95, TLX 341667 **SWEDEN:** AB AKTA, (08) 54-20-20, TLX 13702 **USA:** CONTACT AMPRO COMPUTERS INC., TEL: (415) 962-0230 TELEX: 4940302

**AMPRO**  
COMPUTERS, INCORPORATED

67 East Evelyn Ave. • Mountain View, CA 94041 • (415) 962-0230 • TELEX 4940302

IBM®, IBM Corp.; Z80A®, Zilog, Inc.; CP/M®, Digital Research; ZCPR3™ & ZRDOS™, Echelon, Inc.; Turbo DOS®, Software 2000, Inc.; T/MAKER III™, T/MAKER Co.

Inquiry 19 for End-Users.  
Inquiry 20 for DEALERS ONLY.

## BOOK REVIEWS

gram itself is the central legal concern. But if the system is a service, then the hospital sues XYZ for negligence. However, as Susan Nycum notes, since no human is infallible and no machine perfect, and since small programming errors with catastrophic practical consequences can go undetected until it is too late, just what constitutes negligent behavior becomes very hard to determine.

This brings up the subject of codes of conduct and moral principles in a computerized society. Formal codes have been written for computer professionals. Reproduced in *Ethical Issues* are standards of the British Computer Society, the Institute for Certified Computer Professionals, the Data Processing Management Association, and the Association of Computing Machinery (ACM). The ACM divides its principles into two categories: ethical considerations and disciplinary rules. These are further organized and subsumed by five canons. No ACM member is bound to observe the ethical considerations or the canons. Only by disregarding a disciplinary rule can a member be held accountable. But how often will all of this work?

According to disciplinary rule 5.2.1, a member of the ACM must inform employers and clients whenever "any adverse consequences to the public" may follow as a "result from work proposed to him." Sounds fine. But consider this: Since nearly all computer-related work involves being in front of a video-display terminal, and since VDTs may be hazardous to your health, then must an ACM member tell the boss that teaching the new secretary how to use the word processor may have "adverse consequences"? Strict obedience to proscriptions like this could bring automated activity to a halt. Furthermore, failure to adhere to the rules may bring "expulsion," "suspension," or "admonition." Even if an individual is caught violating a disciplinary rule, the punishment might amount to little more than the proverbial slap on the wrist.

In a brilliant series of thoughts entitled "Professional Ethics: An Intellectual and Moral Confusion," John Ladd points out that codes of conduct may actually do more harm than good. Ethical codes are necessarily minimal; they formulate *the least* that needs to be done. This may incline professionals to *not* do their best but do just what the code requires. Perhaps worse, codes of conduct can stifle the dissenter, the critic, or the creative person and degenerate into that situation John Stuart Mill called the "tyranny of the majority."

Throughout this book, question follows question as opinions diverge in what Johnson and Snapper term "an interval of uncertainty" brought about by the new technology and occupied by a dense intellectual pluralism. It is just this tolerance of so many different points of view in a single volume that makes *Ethical Issues in the Use of Computers* a valuable and commendable book.

Stan Czarnik is a teacher, musician, and technical specialist. He works at Information Access Company (The Computer Database, 2265 Carlson Dr., Suite 5000, Northbrook, IL 60062).

(continued)

# The floppy disk with the flop proof guarantee.



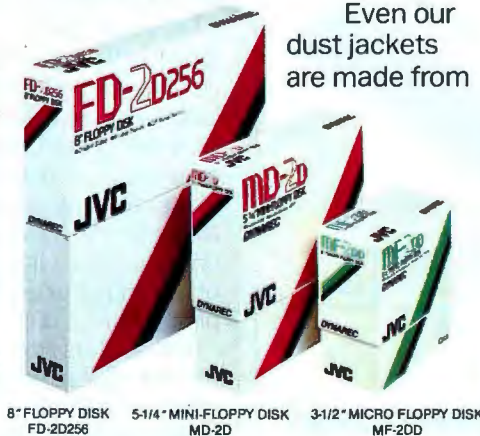
We put it down in writing. So every time you insert a JVC Floppy Disk into your disk drive, you know it will be free of magnetic defects. It's guaranteed for life.

Why are we so confident? Because every JVC Floppy Disk is made with a durable, exceptionally smooth magnetic emulsion that significantly reduces friction and abrasion. Less friction results in fewer dropouts, and substantially extends the life of the floppy disk. In fact, every JVC Floppy Disk is designed to

operate error free for up to ten million passes.

Even our dust jackets are made from

polyvinyl non-woven fabric that keeps out dust, moisture and contaminants that can cause floppy disk error. How do we do it? Simple. We've been making the best video and audio magnetic tapes for years. And practice makes for a perfect floppy disk.



8" FLOPPY DISK FD-2D256    5-1/4" MINI-FLOPPY DISK MD-2D    3-1/2" MICRO FLOPPY DISK MF-2DD

THE GOAL IS PERFECTION.



Magnetic Tape VHS

JVC COMPANY OF AMERICA, Magnetic Tape Division, 41 Slater Drive, Elmwood Park, N.J. 07407 JVC CANADA INC., Scarborough, Ont.

Fourth Annual Conference on

# INTERACTIVE INSTRUCTION DELIVERY

**in Education, Training and Job Performance**

February 19-21, 1986  
Hyatt Orlando Hotel  
Orlando, Florida

*Presentations cover applications in:*

**Videodisc CD-ROM  
Microcomputers  
Software Development Methodology**

**Pre-conference tutorials** are scheduled for February 17 and 18.

**Exhibits** of representative technology will be available to conference registrants in an adjacent area.

*For further information contact:*



**SALT**

**Society for Applied Learning Technology**

50 Culpeper St. Dept. B  
Warrenton, VA 22186 (703) 347-0055

## BOOK REVIEWS

IBM PC/8088 ASSEMBLY LANGUAGE PROGRAMMING  
Reviewed by Larry Clark

The primary reason I bought a PCjr was to develop a threaded interpretive language similar to FORTH. I soon discovered that the 8088's use of segmented memory addressing introduced new ideas that I could not readily grasp from the terse, though complete, assembler manuals. For learning 8088 assembly language, I needed a more complete explanation. Avtar Singh and Walter A. Triebel's *IBM PC/8088 Assembly Language Programming* provides that kind of explanation.

This book's format is "goal directed"—at the beginning of each chapter, the authors outline the ideas to be covered in order to keep the reader aware of educational goals that lie ahead. They try to give the beginning assembly-language programmer a good, useful understanding of the 8088. The reader needs a basic mathematical background to understand the binary and hexadecimal math sections.

Programmers who need the speed that 8088 assembly-language programs offer will find this book valuable. It starts with a discussion of binary and hexadecimal arithmetic. In a lucid review of basic machine language, Singh and Triebel do an especially good job of convincing the reader that hand-coding can be done but is not to be tackled for large programs. The majority of the text follows with an introduction to 8088 assembly-language programming and debugging. The text refers to the IBM version 1.0 assembler, but my version 2.0 assembler performed with no detectable errors; a non-IBM assembler may do as well, provided it handles standard mnemonics and IBM pseudo operation codes.

You'll need Debug, the assembler's linker, and enough memory for the assembler. I recommend two disk drives; otherwise, you'll have to swap disks frequently.

The book uses Debug, a PC-DOS utility, in the examples. It is an excellent learning tool. Debug traces show exactly what an instruction does and so relieves readers of having to visualize an instruction's effect on CPU (central processing unit) register contents. Listings contained in each chapter show exactly what each debugging session will look like. I noted only one omission here that was provided in the DOS Debug manual—some of the Macro assembler statements cannot be assembled with the line-by-line assembler in Debug. Only one or two of my sessions brought this to light, and that was after I left the bounds of a working example and tried some of the more complex addressing modes.

The authors not only include examples of how to use the debugger but also demonstrate how to use the assembler and linker. A session on the use of the EDLIN editor will probably go unused, as most readers will prefer to use a full-screen editor instead.

An optional disk contains a copy of the book's machine-run examples. A note in the book says the disk can be

*(continued)*

**IT IS WORTH MORE THAN WHAT YOU PAY!**



**STAFF-K8**  
• 86-key keyboard  
• Fast repeat



**STAFF-K9**  
• 105-key keyboard  
• Independent cursor control pad  
• Practical function keys:  
KEY-in-lock, Key Beep, Fast Repeat,  
Line-Feed, Pause, Break, Previous  
word, Next word

**Common Features:**

- Both PC & PC-AT compatible encoded
- Low profile design, DIN standard
- Excellent tactile feeling, mechanical keyswitch
- Double-shot, step sculpture keytops
- Various languages available: English, German, French, Spanish, Italian, Swedish
- IBM is a registered trademark of IBM Corp.



5FL, No 40, Deh Hwei Street Taipei Taiwan R.O.C.  
Phone (02)591-7138  
Cable: "MONTEREY" Taipei  
Telex: 25171 MONTEREY

# The IBM® upgrade path.



It's still a great system—in perfect condition. But now you're ready to make a deal on your IBM PC or XT.

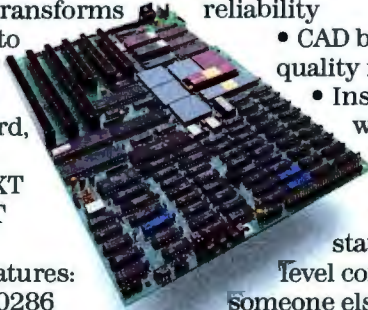
Maybe your business needs have grown, or your new application package runs too slow.

Don't dump your present IBM system. Red River Technology has a better offer—Atlas—a single-board plug-in package that transforms your IBM PC or XT into a super-AT.

Atlas isn't a semi-compatible plug-in card, but completely transforms your PC or PC XT into a 100% IBM PC AT compatible system.

Consider these features:

- 8 or 10 Mhz 80286 CPU. 50-100% more performance than IBM's PC AT (switch selectable—6, 8, or 10 Mhz)
- IEEE 802.3 standard LAN option on the base board (your choice, StarLAN or Ethernet)



- IBM compatible serial port
- IBM compatible parallel port
- 512K memory standard, expandable to 1.0 megabyte without using precious IO expansion slots

• Three 8-bit slots, use more of your existing add-in boards

• Five CMOS VLSI gate arrays eliminate over 60 chips to lower power consumption and improve reliability

- CAD based design, highest quality multi-layer board
- Installs in 10 minutes

with nothing but a regular screwdriver.

Red River Technology has defined state-of-the-art in board-level computers. So don't take someone else's best offer for your IBM PC or XT. Red River Technology believes an upgrade path should not be a dead end.

For more information on the Atlas single-board computers, call us today, at 817-571-5714.

Assembled and tested board:  
**\$1495** (8 Mhz CPU) **\$2395** (10 Mhz CPU)  
 (Specify PC or XT version)  
 Kit form (includes board, 5 gate arrays, 8 Mhz 80286) **\$595** (8 Mhz CPU)

Complete Kit	<b>\$ 795</b>
Complete System	<b>\$2195</b>

**CALL 817-571-5714**

Quantity discounts available. Dealer and OEM inquiries welcome. Other unique 8088 and 80186 boards also available. Write for details.

TERMS: VISA, MASTERCARD, AMERICAN EXPRESS, CHECK, MONEY ORDER. \$5 SHIPPING AND HANDLING PER ORDER. TEXAS RESIDENTS ADD 6% SALES TAX.



**Red River Technology, Inc.**

Red River Technology, Inc., DFW West,  
 4001 W. Airport Fwy., Suite 500,  
 Bedford, Texas 76021

# XT-PLUS

IBM PC XT Compatible Computer runs DOS 2.1, 3.1, Lotus, Wordstar, dBase 111, and any known software. XT-Plus has eight Slots, 640KB memory on Mother Board.



**Limited time special offer: 640KB CPU, Floppy Controller, Keyboard, Parallel Port, Serial Port, Game Port, Clock, two 360 KB Disk Drives . . . . . all for \$799**

(Suggested Retail Price \$1399.)

**AMERICAN MICRO TECHNOLOGY**

(714) 972-2945

TWX 5106003265

## IBM PC, XT AT & COMPATIBLES at Wholesale Prices

**AMT 286** an IBM PC AT Compatible Computer  
640K on Board, 1.2MB Disk Drive,  
20 MB Disk Drive, Keyboard **\$1995**

(Suggested Retail Price \$3995.)

640K Ram . . . . .	each	.45
128K Ram . . . . .	each	3.50
256K Ram . . . . .	each	2.50
Toshiba Drive 360KB . . . . .		79.00
1.2MB Disk Drive for AT . . . . .		129.00
20MB Hard Drive w/Controller and Cables . . . . .		449.00
10MB Tape Back Up Drive for XT . . . . .		299.00
10MB Tape B/U Drive for AT . . . . .		375.00
135 watt Power Supply . . . . .		79.00
195 watt Power Supply . . . . .		125.00
FDC with P/P, S/P, Clock & Game Port . . . . .		99.00
AT Mother Board . . . . .		799.00
XT Mother Board . . . . .		125.00
Floppy/HD Controller for AT . . . . .		219.00

**AMT**  
**(714) 972-2945**  
TWX 5106003265

Ask for our  
Free Catalog

## BOOK REVIEWS

purchased separately for \$24.95. I recommend that you buy the disk because it will save you time and quicken the learning process. I found only one discrepancy between the disk and the book.

The examples in the text are generally short and might not take more than one or two iterations to correct. But there are 31 examples; it is not hard to imagine being so slowed down by entering programs that you don't finish the last chapters, which are the most interesting.

This is a thorough text that delivers the fundamentals of 8088 programming. The questions at the end of each chapter served as a gauge of how well I understood the material. Working examples consist of a source listing, assembler output, and a complete Debug session. You should have no trouble duplicating the results given in the text when the proper tools are used.

I found only two obvious errors, but neither stood in the way of learning about the 8088. On page 55, the authors say that index registers are always combined with the DS (data segment) register. The iAPX 88 user's manual disagrees with this, saying the DI index register is limited to the ES (extra segment) register instead. Second, the contents of the CS, DS, ES, and SS registers listed in the Debug sessions never matched those on my PCjr. Apparently the Debug program can adjust the segment at which a program resides according to the memory available. I learned in the text that the 8088 supports relocation by means of segmentation, which could explain why the programs worked even though they were placed in memory locations different from those described by the authors.

The 8088 instructions are explained in groups of similar instructions, and the simpler instruction groups are followed by the more complex types. Among the more interesting examples are the looping instructions similar to those found in high-level languages.

*IBM PC/8088 Assembly Language Programming* is more than 400 pages long and is very thorough, but it does not review macro programming, nor does it completely cover the pseudo-ops the assembler is capable of using.

The examples not only demonstrate key features and capabilities of the 8088's assembly language but provide sample sorting routines and floating-point math routines as well. The math programs are good introductions that are extremely interesting. All routines are designed to be reused by the reader in later programming projects. One set of examples deals with simple input/output calls to PC-DOS; other examples deal with the timer chip in the PC.

The book helped me learn to program the 8088 because of its organized approach and extensive examples. This is a good introductory text on 8088 assembly-language programming. I recommend it if you're ready to plunge into this challenging branch of microcomputers. ■

Larry Clark (8103 Thornewood Dr., Hixson, TN 37343) works in microcomputer systems development and is a robotics instructor.



# THE PROFESSIONAL'S CHOICE

Lotus 1-2-3 <b>\$309</b>	Lotus Symphony <b>\$429</b>	dBase III <b>\$369</b>	FrameWork <b>\$369</b>	MultiMate <b>\$239</b>	Word Perfect <b>\$209</b>
--------------------------------	-----------------------------------	---------------------------	---------------------------	---------------------------	---------------------------------

## Software

<b>Word Processing Editors</b>	<b>Database Systems</b>	<b>Graphics/Statistics</b>	<b>Multifunction Boards</b>	<b>Displays</b>
FANCY FONT \$139	ALPHA DATA BASE \$179	BPS BUSINESS \$229	AST ADVANTAGE \$389	AMDEK 310A \$169
FINAL WORD \$189	MANAGER II \$399	GRAPHICS \$229	AST 6 PAK PLUS (64K) \$229	PRINCETON HX-12 \$459
MICROSOFT WORD \$229	CLIPPER \$139	CHARTMASTER \$229	AST 6 PAK PLUS (384K) \$269	PRINCETON MAX-12E \$179
MULTIMATE \$239	CLOUT V 2.0 \$329	CHARTSTAR \$169	ORCHID BLOSSOM (OK) \$209	PRINCETON SR-12 \$589
MULTIMATE ADVANTAGE \$299	CONDOR III \$289	DIAGRAM MASTER \$259	ORCHID BLOSSOM (384K) \$269	PRINCETON HX-12E \$Call
OFFICE WRITER/ SPELLER \$249	CORNERSTONE \$289	EXECUVISION \$199	ORCHID PC TURBO (384K) \$699	PRINCETON HX-9 \$Call
PFS: WRITE \$ 95	DBASE II \$369	ENERGRAPHICS \$ 89	PERSYST TIME SPECTRUM (OK) \$209	QUADRAM AMBERCHROME \$179
SAMNA WORD III \$259	DBASE III \$269	GEM DRAW \$359	PERSYST TIME SPECTRUM (384K) \$269	TAXAN 1200 AMBER \$159
VOLKSWRITER DELUXE \$159	KNOWLEGEMAN PC FOCUS \$1195	GRAPHWRITER COMBO \$329	QUADBOARD (OK) \$229	TAXAN 420/440 \$399/599
VOLKSWRITER SCIENTIFIC \$279	PFS: FILE/PFS: REPORT \$169	INNOVISION MS CHART \$159	QUADBOARD (384K) \$249	ZENITH 124 AMBER \$145
WORD PERFECT 4.0 \$209	POWERBASE \$319	OVERHEAD EXPRESS \$109	TECMAR CAPTAIN (OK) \$169	ZENITH 135 COLOR \$Call
WORDSTAR \$189	QUICKCODE III \$169	PC DRAW \$249	TECMAR CAPTAIN (384K) \$229	
WORDSTAR 2000 \$259	QUICKREPORT \$189	PC PAINTBRUSH \$ 89	TECMAR JR CAPTAIN (128K) \$329	<b>Modems</b>
WORDSTAR 2000+ \$299	R BASE 4000 \$249	PC PAINT \$ 79	TECMAR JR WAVE (64K) \$249	AST REACH 1200 \$389
WORDSTAR PRO \$199	R BASE 5000 \$379	PFS: GRAPH \$ 95	TECMAR WAVE (64K) \$209	HAYES 1200 \$389
<b>Spreadsheets/Integrated Packages</b>	REFLEX \$329	SIGNMASTER \$165		HAYES 1200B \$385
ELECTRIC DESK \$209	REVELATION \$729	STATGRAPHICS \$595		HAYES 2400 \$609
ENABLE \$359		STATPAK-NWA \$329		TRANSNET 1000 \$299
FRAMEWORK \$369	<b>Languages/Utilities</b>	STATPAC- WALONICK \$349		VENTEL 1200 HALF CARD \$389
JAZZ \$399	CONCURRENT DOS \$169	SYSTAT \$419		WATSON \$449
LOTUS 1-2-3 \$309	C86 C COMPILER \$299		<b>Display Boards</b>	<b>Mass Storage/Backup</b>
MULTIPLAN \$135	DIGITAL RESEARCH C COMPILER \$219		EVEREX EDGE \$319	ALLOY MT25 TAPE (EXT) \$885
OPEN ACCESS \$389	DR FORTRAN 77 \$219	<b>Professional Development</b>	EVEREX GRAPHICS \$329	CORE AT PLUS \$Call
SMART SYSTEM \$559	LATTICE C COMPILER \$299	LIGHTYEAR \$329	EDGE \$309	IONEGA BERNOULLI BOX-NEW! \$2549
SPREADSHEET AUDITOR \$109	MICROSOFT C COMPILER \$249	THINK TANK \$119	HERCULES COLOR CARD \$159	IRWIN 310A 10MB TAPE (EXT) \$850
SUPERCALC 3 \$219	MS BASIC COMPILER \$249		HERCULES COLOR CARD \$159	IRWIN 110D 10MB TAPE (INT) \$549
SYMPHONY \$429	MS FORTRAN \$239	<b>Personal Finance</b>	PARADISE MODULAR GRAPHICS \$275	SYSGEN IMAGE \$850
	NORTON UTILITIES \$ 89	DOLLARS AND SENSE \$119	PARADISE MULTIDISPLAY CARD \$285	TALLGARSS TG5025 \$2845
	TURBO PASCAL \$ 59	HOWARD TAX PREPARER 85 \$185	PERSYST BOB \$369	TECMAR QIC-60H TAPE (EXT) \$1499
	XENIX \$Call	MANAGING YOUR MONEY \$119	PRINCETON SCAN DOUBLER \$199	TECMAR QIC-80AT TAPE (INT) \$1199
			SIGMA COLOR 400 \$529	<b>Printers/Plotters</b>
			STB CHAUFFER \$279	DIABLO \$Call
			STB GRAPHICS PLUS II \$309	EPSON FX-85 \$369
			TECMAR GRAPHICS MASTER \$459	EPSON FX-185 \$499
			TSENG ULTRA PAK \$429	EPSON LQ-1500 \$999
			TSENG ULTRA PAK-S \$369	HP 7475A PLOTTER \$Call
				JUKI 6300 \$799
				JUKI 6100 \$389
				NEC P3 \$799
				NEC 3550 \$1139
				OKIDATA \$Call
				QUME SPRINT 1155 \$1569
				TOSHIBA P1340 \$629
				TOSHIBA P351 \$1149
				<b>Input Devices</b>
				KEYTRONIC 5151 \$179
				KOALA \$Call
				MICROSOFT MOUSE \$139
				PC MOUSE W PAINTBRUSH \$129

## Hardware \*

<b>Accessories</b>	<b>Emulation Boards</b>	<b>Networks</b>
CURTIS SURGE \$Call	AST \$Call	AST PC NET \$Call
PROJECTORS \$Call	CXI 3276/9 Plus \$959	CORVUS NET \$Call
DATASHIELD BACKUP \$Call	IRMA \$799	ORCHID PC NET \$Call
POWER \$Call	IRMALINE \$999	3 COM \$Call
GILTRONIX A/B SWITCH \$Call	IRMAPRINT \$Call	
MICROBUFFER INLINE (64K) \$Call		
MICROFAZER INLINE (64K) \$219		
256K RAM SET \$ 49		
8087 MATH CHIP \$139		

Harvard HTPM <b>\$259</b>	Chart-Master <b>\$229</b>	Quadboard 384K <b>\$249</b>	Tseng Ultra Pak <b>\$429</b>	Smartmodem 1200B <b>\$365</b>	Smartmodem 2400 <b>\$609</b>
---------------------------------	------------------------------	-----------------------------------	------------------------------------	-------------------------------------	------------------------------------

\*CALL FOR SHIPPING COSTS



## LOWEST PRICE GUARANTEE!!

We will match current nationally advertised prices on most products. Call and compare.



# 1-800-221-1260

In New York State call (718) 438-6057

### TERMS:

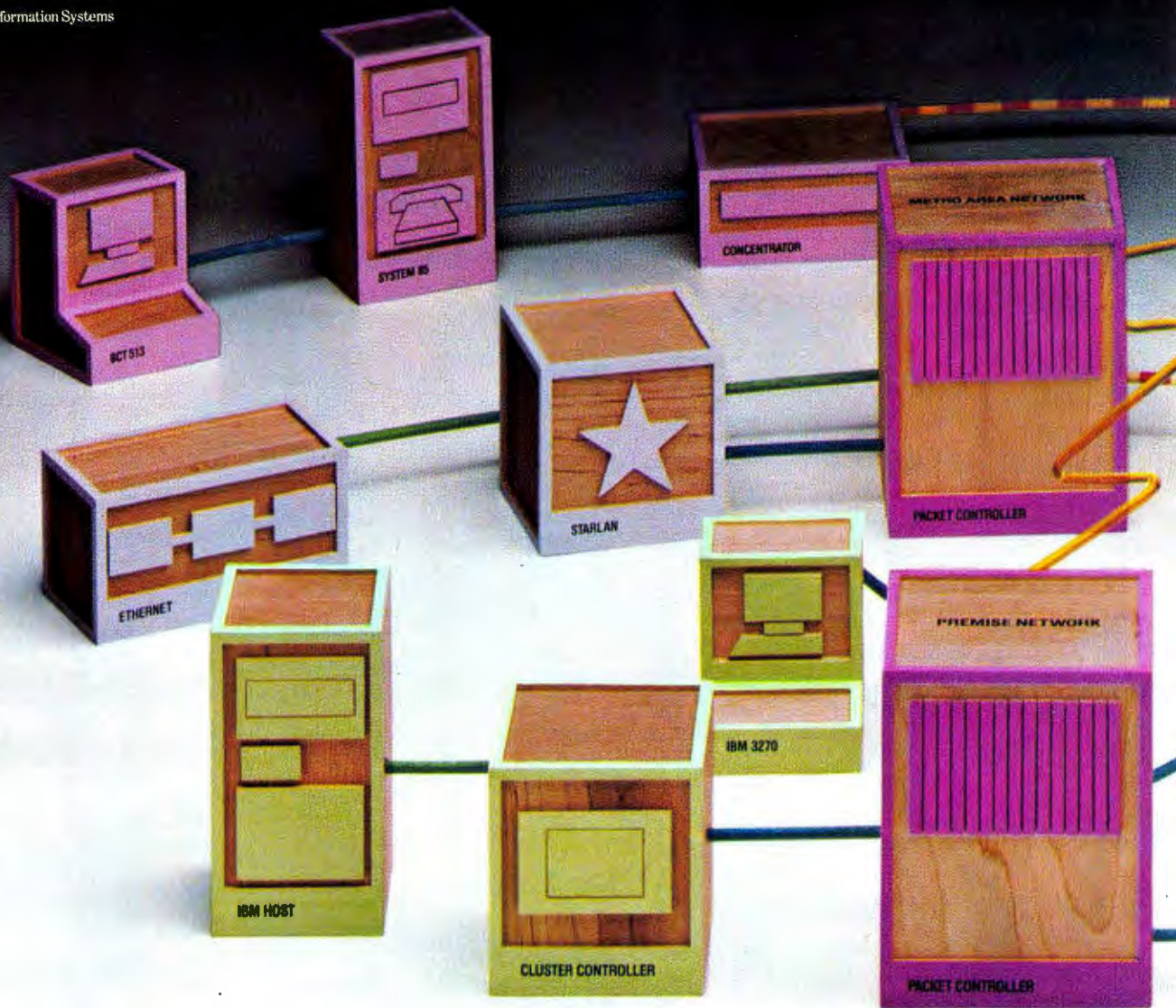
Checks—allow 14 days to clear. Credit processing—add 3%. COD orders—cash, M.O or certified check—add \$5.00. Shipping and handling UPS surface—add \$3.00 per item (UPS Blue \$8.00 per item). NY State Residents—add applicable sales tax. All prices subject to change.



MON.-THURS. 9:00 AM-8:00 PM  
SUN. & FRI. 9:00 AM-4:00 PM

# Softline

Softline Corporation  
P.O. Box 729, Brooklyn, N.Y. 11230  
TELEX: 421047 ATLN UI



# ONLY A NETWORK THE CENTER OF YOUR EXPANDING

A local area network. Sure it can integrate some of your stand-alone equipment. But what about the departmental systems you have? And what about next year? Will it be able to handle new applications that come along? Can it grow? Is it a long-term solution or just a quick fix?

The Information Systems Network from AT&T is the data network that can meet your immediate and long-term needs. It's the only network open and flexible enough to integrate the equipment and systems you have now, and willingly accept what the future might bring. It's the data network that can expand with your business—grow from a local to a corporate-wide network.

## You can build a strong foundation

Different systems—Incompatible hardware from different vendors—A few stand-alone pieces here and there—ISN can tie it all together.

ISN's open architecture lets it act as the backbone data network that integrates your disparate systems and smaller networks.

Its unique wiring system of twisted pair and fiber optics allows ISN to support the equipment you have now, and what

you'll buy later. You can easily and economically add and rearrange equipment. Plus, no matter how far apart devices are, with ISN, you still get maximum network performance.

So once your backbone network is in place, the possibilities are endless. Grow upward, outward, backwards and sideways. With ISN, your options are always open.

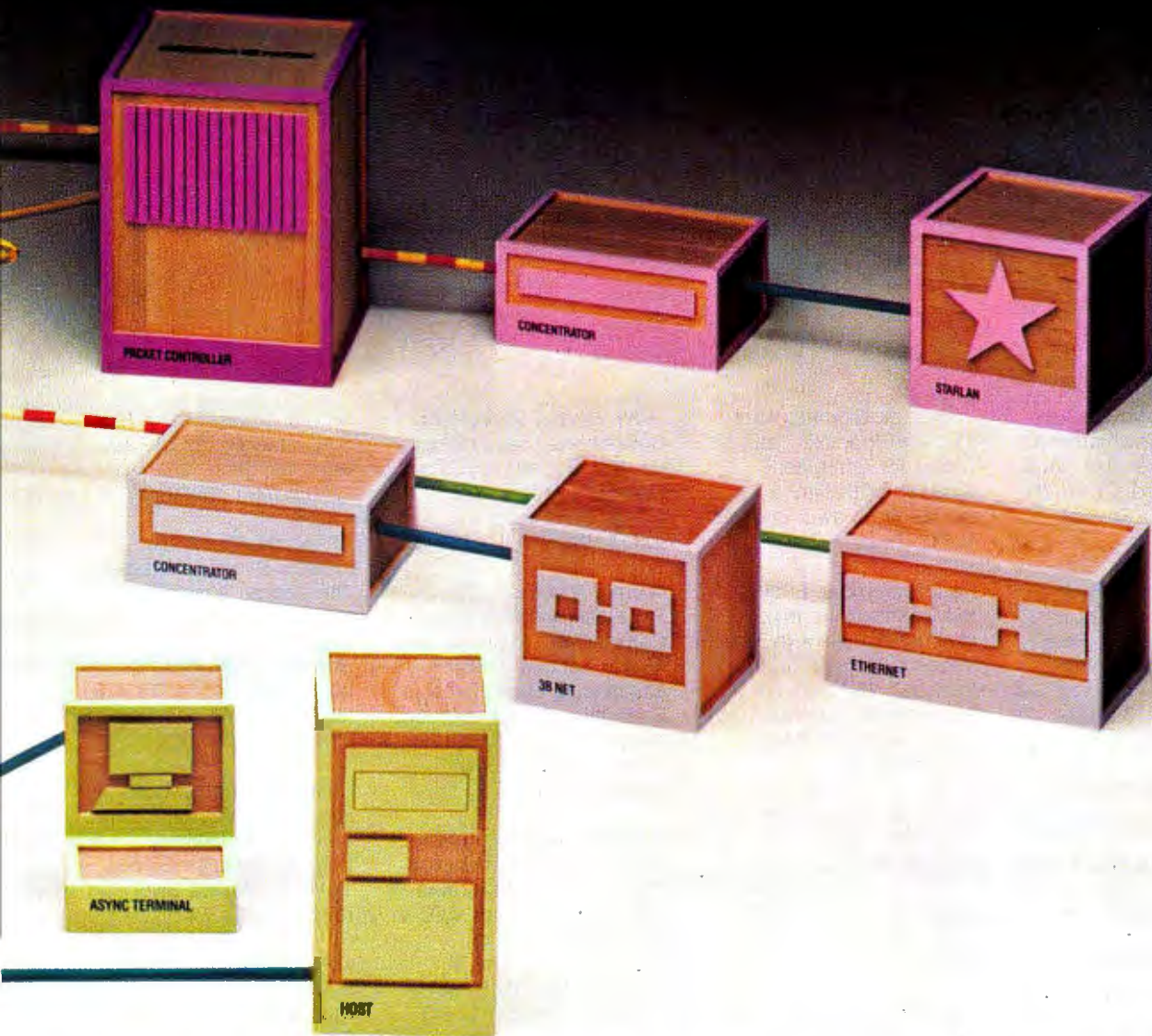
## You can break the ties that bind you

At the local level, ISN is a hierarchical star network with a fast-switching Packet Controller at the hub. The Packet Controller is linked to all devices in your network and manages all network communications.

So ISN can set up communication links between all your equipment and systems. AT&T System 85 and AT&T System 75 PBXs, mini-computers and mainframes, isolated Ethernet\* systems, AT&T STARLAN NETWORK and 3BNET, smart and dumb terminals, even equipment from IBM—ISN gets it all on speaking terms. All working even harder for you.

ISN protects your 3270 investment. It lets your Bisync terminals access multiple IBM\*\* hosts. Low-cost dumb terminals and personal computers can do the same. Syn-

\*Ethernet is a registered trademark of Xerox Corp. \*\*IBM is a registered trademark of International Business Machines Corp.



# THIS OPEN AND FLEXIBLE CAN BE UNIVERSE.

chronous and asynchronous traffic can travel through your network with the same speed and efficiency.

With ISN, you're never locked into one vendor or one location. Since ISN uses the same technology for local and wide-area networking, its growth potential is limitless.

Linking multiple Packet Controllers lets you start with one ISN and grow across a premises. Add another ISN and grow across the city, or across the country. There's nothing holding you back.

## You can handle it all

No matter how large your network becomes, ISN still provides fast, reliable communications between all users. With a high backplane and fiber rate of 8.64 mbps, and a very efficient packet structure, ISN maintains a high throughput rate even when traffic is at its peak.

Long messages or bursty transmissions—ISN's been engineered to handle it all. A unique centralized short bus and perfect scheduling access method permit messages to travel through the network almost instantaneously. And arrive with their integrity intact.

Premises-wide or nationwide, ISN puts you in command.

No matter how large your network gets, you choose the means of control—centralized or distributed.

## You've made the right connection

AT&T has a long history of solving complicated networking problems with clear-cut, intelligent solutions. We make the pieces fit.

We work with you every step of the way. Our professional sales and service people are trained to plan, design and maintain a network that will meet your business needs.

ISN reflects AT&T's better approach to office networking. To learn why it's the right choice for your business, call your AT&T Information Systems Account Executive, or 1 800 247-1212.



**AT&T**

The right choice.

# E·V·E·N·T Q·U·E·U·E

## December 1985

**DATA PROCESSING COURSES**, Hartford, CT. The Hartford Graduate Center, 275 Windsor St., Hartford, CT 06120, (203) 548-2470. *December*

**THE IBM PC DATA COMMUNICATIONS SURVIVAL COURSE**, various sites throughout the U.S. Data-Tech Institute, Lakeview Plaza, POB 2429, Clifton, NJ 07015, (201) 478-5400. *December*

**MICRO TO MAINFRAME SEMINARS**, Atlanta, GA. The MOM Corp., Two Northside 75, Atlanta, GA 30318, (800) 241-1170; in Georgia, (404) 351-2902. *December*

**TESTING COMPUTER SOFTWARE**, various sites throughout the U.S. U.S. Professional Development Institute, 1620 Elton Rd., Silver Spring, MD 20903, (301) 445-4400. *December*

**OFFICE AUTOMATION DESIGN & MANAGEMENT**, various sites throughout the U.S. Thomas Wilds Associates Inc., POB 11120, Greenwich, CT 06830, (212) 986-2515. *December-March*

**SECOND ANNUAL WASHINGTON, DC, EASTERN SIMULATION SYMPOSIUM: WHAT'S NEW IN SOFTWARE**, Crystal City, VA. The Society for Computer Simulation, POB 2228, La Jolla, CA 92038, (714) 459-3888. *December 3*

**SECOND ANNUAL BITS & BYTES NATIONAL COMPUTER SHOW**, Dallas, TX. Information Processing Group, Suite 305, 87 North Raymond Ave., Pasadena, CA 91103, (818) 792-5111. *December 6-8*

**COMPUTER GRAPHIC ARTS** 85, New York, NY. Pratt Center for Computer Graphics in Design, 9 Skyline Dr., Hawthorne, NY 10532. *December 8-11*

**FALL INDUSTRIAL ENGINEERING CONFERENCE: INTEGRATING PEOPLE AND TECHNOLOGY**, Chicago, IL. IIE Registrar, 25 Technology Park/Atlanta, Norcross, GA 30092, (404) 449-0460. *December 8-11*

**COMPUTER CAREER CONVENTION**, Los Angeles, CA. Shomex Productions, Suite 310, 2601 Ocean Park Blvd., Santa Monica, CA 90402, (213) 450-8831. *December 10-11*

**1985 VIDEODISC, OPTICAL DISK, & CD-ROM CONFERENCE AND EXPOSITION**, Philadelphia, PA. Meckler Publishing, 11 Ferry Lane W, Westport, CT 06880, (203) 226-6967. *December 10-12*

**HI TECH UPDATE '85**, Ottawa, Ontario, Canada. Conference Coll Inc., 1138 Shermer Dr., Ottawa, Ontario K2C 2M4, Canada. *December 11-12*

**DEXPO WEST 85: THE EIGHTH NATIONAL DECOMPTABLE EXPOSITION**, Anaheim, CA. Expoconsul International Inc., 55 Princeton-Hightstown Rd., Princeton Junction, NJ 08550, (609) 799-1661. *December 11-13*

---

IF YOU WANT *your organization's public activities listed in BYTE's Event Queue*, we need to know about them at least four months in advance. Send information about computer conferences, seminars, workshops, and courses to *BYTE, Event Queue*, POB 372, Hancock, NH 03449.

**1985 WINTER SIMULATION CONFERENCE**, San Francisco, CA. The Society for Computer Simulation, POB 17900, San Diego, CA 92117. *December 11-13*

**WINTER NATIONAL DESIGN ENGINEERING SHOW AND CONFERENCE**, Anaheim, CA. Winter National Design Engineering Show, Cahners Exposition Group, 999 Summer St., Stamford, CT 06905, (203) 964-8287. *December 11-13*

**DATA COMMUNICATIONS AND NETWORKING FOR THE IBM PC AND OTHER PERSONAL COMPUTERS**, Denver, CO. Software Institute of America, 8 Windsor St., Andover, MA 01810, (617) 470-3880. *December 12-13*

**FIRST INTERNATIONAL CONFERENCE ON SUPERCOMPUTING SYSTEMS**, Tarpon Springs, FL. Supercomputing Conference, POB 639, Silver Spring, MD 20901, (301) 589-8142. *December 16-20*

*Catalogs and brochures for upcoming courses and seminars are available from the following:*

**CATALOG OF PERSONAL COMPUTER COURSES**, American Management Association, 135 West 50th St., New York, NY 10020.

**CENTER FOR ADVANCED PROFESSIONAL EDUCATION SEMINARS**, Center for Ad-

vanced Professional Education, Suite 110, 1820 East Garry St., Santa Ana, CA 92705, (714) 261-0240.

**COMMUNICATIONS/ELECTRONICS SHORT COURSES**, The George Washington University, School of Engineering and Applied Science, Washington, DC 20052, (800) 424-9773 (U.S.), (800) 535-4567 (Canada), or (202) 676-6106 (DC).

**COMMUNICATIONS/MICROCOMPUTER CURRICULUM**, Datapro Educational Services, Datapro Research Corp., 1805 Underwood Blvd., Delran, NJ 08075.

**COMPUTER COMPETENCE SEMINARS AND PROFESSIONAL DEVELOPMENT SEMINARS**, Boston University Metropolitan College, 755 Commonwealth Ave., Boston, MA 02215.

**COURSE CALENDARS**, Integrated Computer Systems, 6305 Arizona Place, POB 45405, Los Angeles, CA 90045, (213) 417-8888.

**DIGITAL CONSULTING ASSOCIATES INC. SEMINARS**, Software Institute of America Inc., 8 Windsor St., Andover, MA 01810.

**INFORMATION PROCESSING SERIES**, QED Information Sciences Inc., QED Plaza, POB 181, Wellesely, MA 02181.

**INTENSIVE SEMINARS FOR PROFESSIONAL DEVELOPMENT**, Worcester Polytechnic Institute, Office of Continuing Education, Higgins House, Worcester, MA 01609, (617) 793-5517. ■



## The world's best selling monochrome graphics card for the IBM PC.

There are more Hercules™ Graphics Cards in more IBM® PCs, XT's and AT's than any other monochrome graphics card in the world.

Over a quarter of a million demanding users around the world use a Hercules Graphics Card to improve the performance of their software.

### The Lotus® 1-2-3® Booster.

Consider Lotus 1-2-3. Hercules gives an off-the-shelf copy of 1-2-3 the highest resolution possible on an IBM PC, XT or AT. More 1-2-3 users choose the Hercules Graphics Card to get crisper text and sharper graphics than any other monochrome graphics card.

And we bring the same performance to other integrated programs like Symphony™, Framework™, and SuperCalc®3.

But we don't stop there. The Hercules Graphics Card

improves all kinds of software.

Like Microsoft® Word, a word processor that enables you to display text with subscripts, superscripts and italics.

Or pfs:Graph, an easy-to-use business graphics program that converts your data into presentation quality graphs.

Or Microsoft® Flight Simulator, the high flying game for the overworked executive.

Or our own Graph X™, a library of graphics sub-routines that eases graphics programming.

Or AutoCAD™, a computer aided design program that offers features normally associated with expensive CAD systems.

And we supply free software with each card to do hi-res graphics using the PC's BASIC interpreter.

### State-Of-The-Art Hardware.

The Hercules Graphics Card gives you graphics resolution of 720h x 348v and a

parallel printer port. Our unique static RAM buffer provides sharp 9 x 14 characters and flicker-free scrolling. Our exclusive safety features help



prevent damage to your monitor.

State-of-the-art custom IC technology delivers unsurpassed reliability. Ordinary graphics cards use up to 30 ICs to do what one Hercules IC does. By using fewer parts, we reduce the possibility of component failure.

Which is one reason we warranty the Hercules Graphics Card for two years.

Unbeatable reliability. Advanced technology. Proven by over a quarter of a million users. Why settle for anything less than Hercules?

Call 1-800-532-0600 Ext 408 for the name of a Hercules dealer nearest you and we'll rush you our free info kit.

**Hercules.**  
We're strong on graphics.



# Discover what 60,000

Discover the finest peripherals available in terms of features, reliability and price/performance. Corporations like IBM, General Motors and Exxon buy peripheral equipment from Qubie', and have for years. Check some of your old back issues of PC -- we've been satisfying PC owners since 1982.

Discover low prices, with service and support unparalleled in the microcomputer industry. Our 30 day No Risk Guarantee and 48 Hour Turnaround on warranty repairs is proof our products are first rate. We stand behind what we sell. We also offer our exclusive Preferred Customer

Plan with 24 hour repairs and 24 months of coverage.



Discover money-saving prices that are the total prices. No small print telling you to add up for credit card charges or shipping and handling. Our prices include surface UPS charges and insurance. In a hurry? 2-day air UPS service is available.

Then discover it takes more than a low price to keep customers satisfied. We answer your questions and concerns before and after you buy.

The Staff of Qubie'



## HARD DISK SUBSYSTEMS

PC20 (Internal) \$599

PC20E (External) \$749

With Spooling Tape Backup, Add \$400

20 Megabyte Capacity • Boot From The Hard Disk -- No Software Patches Or Drivers To Install • Runs All The Popular Software--DOS 2.0 Or Later • Low Power Consumption • 5 1/4" Controller Card • High Reliability And Durability -- Specially Plated Drives • Faster Access Time

**NEW**



## AT ENHANCEMENT KIT

BT44 Hard Drive &

AT4X4Plus (512K) \$1375

44 Megabyte Drive • Runs All The Popular AT Software • 28 msec. Access Time • Voice Coil Driven Heads with Closed Loop Servo Positioning • Full-Height Unit • No Extra Chips Needed

Than XT -Changeable Interleave Value • Full-Height and Half-Height Bezels • Includes Cables, 1 dir "Visual Shell" and ZYINDEX "Info Searcher" Software

External Model (PC20E) Includes Case And Power Supply • Auxillary Power Supply For Internal Model (PCPWR) Available



# PC owners now know.



**NEW**

## AT MULTIFUNCTION CARD

AT4X4Plus (128K) \$265

AT4X4Plus (512K) \$295

Memory Sockets For Adding Up To 4 Megabytes • 1 Standard and 3 Optional Serial Communications Ports • Parallel Printer Port • Game Port Option

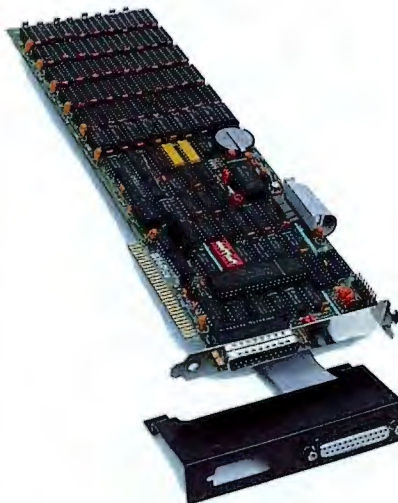


## PC MULTIFUNCTION CARD

BT6Plus (64K) \$147.50

BT6Plus (384K) \$197.50

Memory Sockets For Adding Up To 384K • Parallel Printer Port • Asynchronous Serial Communications Port • BTPak Software (Disk Emulation and Printer Spooling) • Battery-Powered Clock/Calendar • Optional Game Port • Includes Dual Mounting Bracket



## 300/1200 BAUD MODEMS

PC212A/1200 (Internal) \$179

212A/1200E (External) \$199

Auto-Dial, Auto-Answer, Bell 103/212A Modems • Fully Hayes Compatible, Runs Crosstalk, Sidekick, Etc. • Internal Modem Includes External RS232-C Serial Port And PC-TALK III Software • External Has Eight Status Indicators Lamps

**NEW**



And Front Snap Hatch For Quick Switch Access • Both Include Instruction Manual And Modular Phone Cord • Shielded Cable For External Modems \$19 (Specify Type)

### No Risk Guarantee

If you are not completely satisfied with your purchase you return it within 30 days of purchase for a complete refund, including the cost to send it back. If you can get any dealer or competitor to give you the same No Risk Guarantee, buy both and return the one you don't like.



## RGB & MONOCHROME MONITORS

with Tilt/Swivel Base!

RGB Color HR31-200 \$399

RGB for EGA HR31-350 \$499

Mono. Green HR39 \$139

Mono. Amber HR134 \$149

RGB Color Monitors Feature .31mm Dot Pitch And Large 14" Screen • HR31-200 Compatible With IBM Color Graphics Adapter (640x200) • HR31-350 Compatible With Enhanced Graphics Adapter (640x350) • Monochrome Monitors Have IBM Compatible 720x348 Resolution On 12" Diagonal Screen.

For fastest delivery, send cashier's check, money order, or order by MasterCard/Visa. Personal checks allow 18 days to clear. Company purchase orders accepted, call for prior authorization. California residents add 6% sales tax.

Hours: M - F 8 am - 5 pm PTZ  
Sat 8 am - 12 pm PTZ



London (01) 223-4569

Paris (01) 321-5316

Sydney (02) 579-3322

Canada (403) 434-9444



Outside California

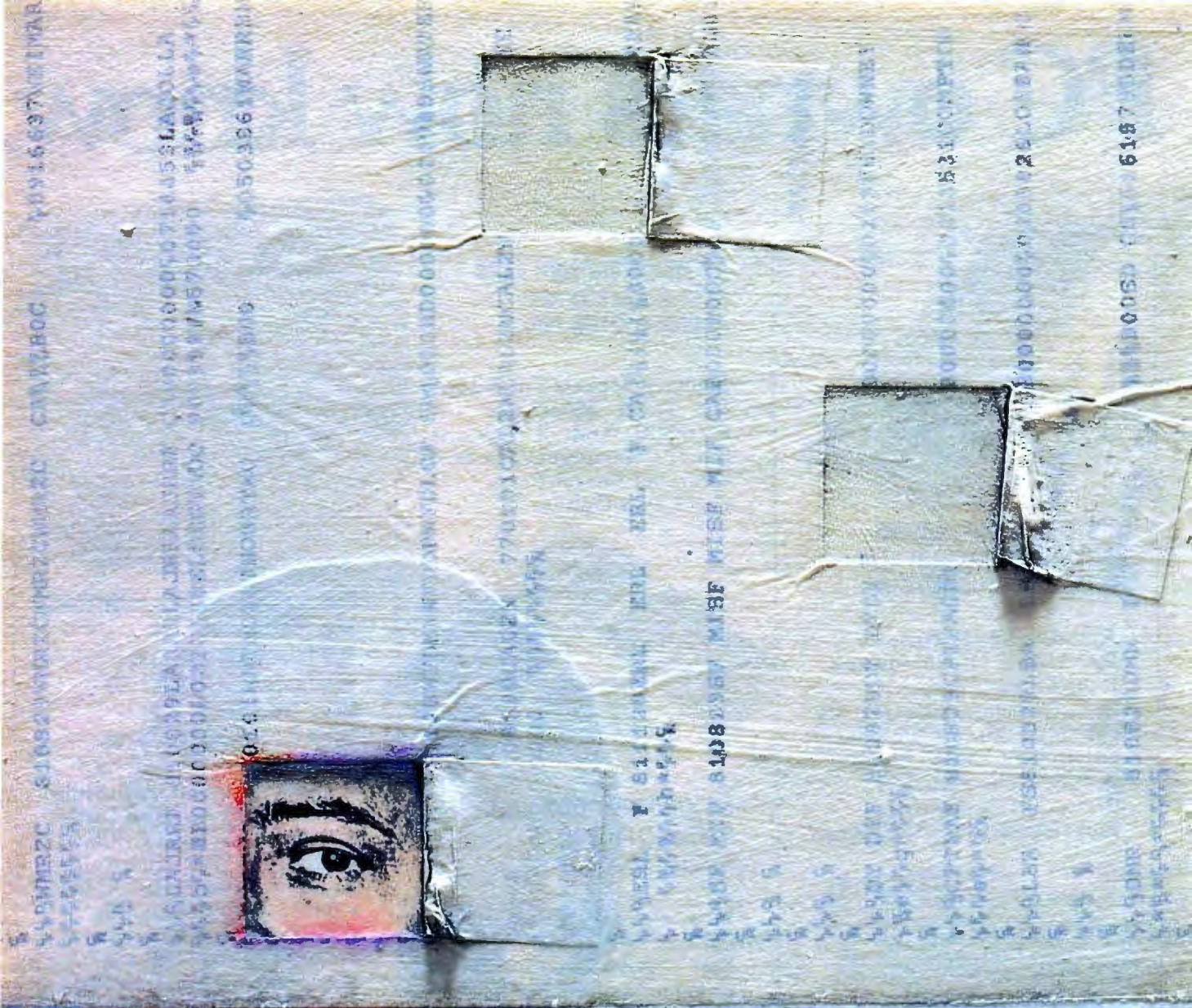
800-821-4479

Inside California

805-987-9741

# QUBIE'

Department B  
4809 Calle Alto  
Camarillo, California 93010





# Features

---

<b>CIARCIA'S CIRCUIT CELLAR: TURNKEY BULLETIN-BOARD SYSTEM</b> <i>by Steve Ciarcia</i> . . . . .	93
<b>PROGRAMMING PROJECT: A SIMPL COMPILER, PART I: THE BASICS</b> <i>by Jonathan Amsterdam</i> . . . . .	106
<b>PRODUCT DESCRIPTION: THE TANDY 600 AND THE TANDY 3000</b> <i>by G. Michael Vose</i> . . . . .	118
<b>ENGLISH RECOGNITION</b> <i>by Roy E. Kimbrell</i> . . . . .	125
<b>SCIENTIFIC APPLICATIONS SOFTWARE</b> <i>by John C. Nash</i> . . . . .	145
<b>PROGRAMMING INSIGHT: VIRTUAL FIELDING IN MICROSOFT BASIC</b> <i>by C. R. J. Currie</i> . . . . .	155
<b>PROGRAMMING INSIGHT: TRAVESTY WITH DATABASE</b> <i>by Neil J. Rubenking</i> . . . . .	161

---

IN THE CIRCUIT CELLAR this month, Steve gives us a state-of-the-art bulletin-board system. This particular BBS is made up of his last two projects: the SB180 single-board computer (September and October) and the MOSART chip from Xecom (November). This month's article is both a tutorial on bulletin boards and a functional expansion for people who have built the SB180. Incidentally, BYTE is setting up an SB180 bulletin-board system for internal use.

This month Jonathan Amsterdam begins his three-part series on the construction of a compiler for a high-level language. This first part deals with the basics of the compiler, including a description of SIMPL, his programming language.

A visit to Fort Worth, Texas, gave BYTE's Mike Vose a chance to see two recent releases from Tandy. The Tandy 600 is a portable with the features users of the Model 100 and Tandy 200 most often requested: more memory, a disk drive, and an 80-column screen. The Tandy 3000 is an IBM PC AT clone that Tandy claims is faster, and it is priced as low as \$2599.

English is hardly ever used to communicate with computers. This is unfortunate, because English can be very effective; it gives you a variety of ways to express compiler actions with a minimum of training and program interaction. In "English Recognition," Roy Kimbrell describes how you can apply understanding to an application.

John Nash tells us to consider three things when trying to choose scientific applications software: the purpose of the package, the style in which it's presented, and its overall quality. He also provides a list of various sources of information to help us in our search.

C. R. J. Currie describes a technique for handling files with record lengths that are more than a sector on Microsoft BASIC systems. If your system can automatically handle variable-length records of a size less than the system's maximum, you can use this technique. It works well on both 8-bit and 16-bit versions of Microsoft BASIC.

"Travesty with Database" is the third travesty-generator program that we have had since November 1984 when we ran the original, "A Travesty Generator for Micros" by Hugh Kenner and Joseph O'Rourke. This new version, which the author has named Breakdown, is written in Turbo Pascal, and it improves performance and avoids rereading the input text by storing the frequency information in a database.

# "NOW IN OUR 8TH YEAR"

## THE WORLD OF PC UPGRADES

### FREE

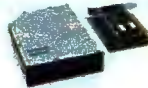
5 Mega Bytes Of software with the purchase of any P.C. hard disk

PC HARD DISK



10 Mbyte  
IS10 \$495

PC HARD DISK



20 Mbyte  
IS20 \$545

PC HARD DISK



30 Mbyte  
IS30 \$895

TANDY 1000  
MULTI-FUNC BOARD



TMF-1 \$255

CASH ASSIST



SPEEDS  
DISK  
ACCESS  
\$49.95

DIRECT ASSIST  
SIMPLIFIES  
DOS  
OPERATIONS



\$49.95

COMMAND ASSIST



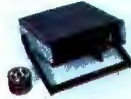
\$49.95

INTERNAL  
TAPE BACKUP



10 Mbyte  
MT10 \$385

PORTABLE  
TAPE BACKUP



10 Mbyte  
MT10P \$525

INTERNAL  
TAPE BACKUP



60 Mbyte  
MT60 \$895

DESK TOP  
TAPE BACKUP



MT10E \$575  
MT60E \$995

AT HARD DISK



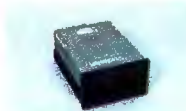
20 Mbyte  
AT20 \$545

AT HARD DISK



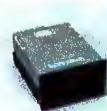
33 Mbyte  
AT33 \$750

AT HARD DISK



70 Mbyte  
AT70 CALL

PC/AT HARD DISK



120 Mbyte  
AT120 \$4,995

ORDER LINE **800-228-0891**  
**305-677-8333**



## Micro Design International Inc.

6566 University Boulevard, Winter Park, Florida 32792 (305) 677-8333 TELEX 332559 MDII ORL UD

1 YEAR WARRANTY, 30 DAY MONEY BACK GUARANTEE ON ALL OUR PRODUCTS

# TURNKEY BULLETIN-BOARD SYSTEM

BY STEVE CIARCIA

*A functional cost-effective expansion  
for those who have built the SB180*



You might have noticed that the theme of this issue is computer conferencing. It is no mere coincidence that this month's Circuit Cellar project has something to do with communication. Since I have just finished presenting the SB180 single-board computer and a single-chip modem as separate projects, it is only natural to combine the two to produce something grander.

The concept of electronic messaging and information exchange has been revolutionized by low-cost computers. Not too long ago, only expensive mainframes could function in such a capacity. Now, any computer with a disk drive and a modem can be configured to perform basic communication functions.

The most typical personal computer communication configuration is the electronic bulletin-board system (BBS). While I will explain it in greater detail later, a BBS is designed to exchange messages, data, or programs. It can be either public or private.

While the quality of the information being exchanged sometimes comes into question, bulletin boards serve a useful function that could not otherwise be performed without great expense. I like to think of them as a 24-hour answering service that says more than "Sorry, can I take a mes-

sage?" Callers with the proper access authority can receive private information left only for them, perform tasks within the computer system, and leave messages for specific third parties who will also call the BBS.

Computer experimenters discovered the entertaining aspects of bulletin boards years ago. However, such versatile message-listing and information-retrieval systems have now assumed important business applications. For example, field service and sales personnel away from the office now have a way to stay in contact. Or the workday customer-service line into the company can become a BBS after hours so that customers feel attended to on a full-time basis.

The limiting factors in business use of bulletin boards, either public or private, have been price and start-up effort. While a minimally configured computer with BBS software and a modem can be assembled for about \$2500, you still have to gather the components and integrate the software. With few exceptions, the concept of a truly turnkey BBS has not emerged. Because

*(continued)*

Steve Ciarcia (pronounced "see-ARE-see-ah") is an electronics engineer and computer consultant with experience in process control, digital design, nuclear instrumentation, and product development. He is the author of several books about electronics. You can write to him at POB 582, Glastonbury, CT 06033.

most BBS software is generic rather than designed for a specific hardware configuration, you must port the BBS software and install the device drivers for your system's peripheral devices. The real definition of the words "port" and "install" is time. When the hardware configuration and the software operating system are explicitly known, it is much easier to build a turnkey BBS.

This month, I'm combining the SB180 single-board computer, presented in the September and October issues, and Xecom's MOSART chip, described in last month's column. When combined with some fancy software, these two projects become a state-of-the-art turnkey BBS.

The MOSART and associated components are mounted on a printed-circuit board that plugs into the SB180's I/O (input/output) expansion bus and is called a COMM180 expansion board. This MOSART-based BBS, unlike most others, can understand Touch-Tone inputs and give voice responses.

Unlike the COMM180 BBS software (explained in detail later), which is specific to the SB180, my discussion and descriptions are intended to be somewhat generic. You may or may not decide to build the exact BBS I am outlining, but you will gain some benefit by understanding the salient points of BBS configurations. This particular BBS requires a minimum of computer knowledge.

To give you some real-time evaluation of its capabilities, I have installed a working SB180/COMM180 BBS in Connecticut that you can call for a demonstration. If you like this direct line to me and there aren't thousands of messages to answer, I will establish it as a continuing Circuit Cellar BBS where you can get past, present, and future project information. More on this later.

### TURNKEY BBS

The primary difference between an SB180/COMM180 system and any other lies in the unique combination of hardware and software being used. I intend this article both as a tutorial

on bulletin boards and as a functional cost-effective expansion for those of you who have built the SB180. You may elect to not use the prepackaged bulletin-board software that I will describe and instead use software available in the public domain to set up a bulletin board. That is a viable option. However, the Term III/Z-MSG software is available preconfigured for the SB180/COMM180 combination and can be run out of the box.

Essentially, this software is a turnkey electronic mail and file-transfer system. To use it, you merely place the disk into your SB180/COMM180 computer system, turn on the terminal, hook up a telephone line, and give it some electricity. You then make your decision as to what you want to use the bulletin board for.

Naturally, you can personalize the system to a large extent if you want. Since the software is modular, adding or deleting modules will let you configure any desired functions. Before getting down to details, let me first discuss a few more features of the Circuit Cellar SB180 turnkey bulletin-board system (TKBBS).

### TKBBS FEATURES

The features are grouped into four major areas: electronic mail, file transfer, voice response (not voice recognition), and DTMF (dual-tone, multiple-frequency) control.

Electronic mail provides the capability of leaving messages for other people. Messages, which usually consist of ASCII (American Standard Code for Information Interchange) characters, are made up of a sender's name, addressee's name, subject, and message text. Sending someone an electronic message is similar in principle to sending them a letter.

File transfer is a technique for the transmission or reception of files and is usually referred to as downloading and uploading from the point of view of the TKBBS. The TKBBS will support file-transfer protocols like XMODEM, Kermit, CIS (CompuServe), and XON/XOFF. Until now, it was highly improbable that this wide selection of protocols would be available in one

software package, but the TKBBS has them all.

Finally, the voice-response feature of the Xecom 1203 MOSART internal LPC (linear predictive coding) speech synthesizer is available for your use as well as a wide variety of DTMF-decoding functions of the MOSART.

### A LITTLE HISTORY

A short history lesson will help us appreciate what it takes to make a turnkey bulletin-board system. The TKBBS traces its roots back to the first computerized bulletin-board system. Although access to computers via telephone lines and modems has existed for 20 years or so, this had been done only for time-sharing mainframe computers and the military until personal computers appeared. Personal computers made their debut in the middle 1970s, based on the Intel 8080 microprocessor and others. In 1977, Ward Christensen became interested in using a modem with his personal computer. He wrote an assembly-language program called MODEM, which allowed a microcomputer to send and receive characters via the modem and telephone line. This was during the time when modems usually ran at 110 bits per second (bps), and a 300-bps modem was considered fast.

MODEM was a program intended to be operated by a person—nothing about it was automatic. It also incorporated a protocol for transferring files. This protocol would send a file 128 bytes at a time. Because telephone lines are subject to transmission errors, it ensured that each 128-byte block was received properly by the destination. If an error was detected in a 128-byte block, that block was retransmitted until the receiver detected no errors.

MODEM was placed in the public domain, where it was eventually enhanced by other people, becoming MODEM7. To this day, the popularity and widespread acceptance of the file-transfer protocol embodied in the original MODEM can be traced to Christensen's placing the program in the public domain. And the prece-

dent of placing communications software in the public domain has been followed to this day by many authors.

Dave Jaffe, meanwhile, envisioned another use of his personal computer for communications. Instead of a situation where two people used MODEM on each computer, he pictured a scenario where an unattended computer could be accessed by a person using MODEM. When accessed, the unattended computer would let the caller access the CP/M operating system. Callers would be able to perform all the functions supported by CP/M as though they were with the unattended computer, even though they could be anywhere in the world that had telephone lines. The result of his work in this area was an assembly-language program called BYE.

After Jaffe wrote BYE, Christensen began work on yet another program, this one intended to function as a message system. Its purpose was to let callers accessing a computer using BYE leave messages for other callers or the owner of that computer. The resulting program was named CBBS, which stands for computer bulletin-board system. He saw it as the electronic equivalent of the bulletin board in a supermarket or other public place.

With these three programs, Christensen and Jaffe invented the BBS. Another significant early development was a program called XMODEM by Keith Petersen, which let the unattended computer using BYE send and receive files using the protocol implemented in MODEM. This protocol is more widely known today as the XMODEM protocol, although it has been referred to as the Christensen protocol or MODEM protocol with equal validity.

#### TODAY'S PUBLIC DOMAIN

Bulletin boards have progressed considerably beyond those first implementations. One of the significant changes has been the introduction of security to the bulletin-board software. In the first implementations of BYE, all the commands of CP/M were available to anyone calling the system.

Thus, anyone could erase a file. This allowed unauthorized users to penetrate bulletin boards, and system integrity became an important issue.

The first elements of security were added by introducing ZCPR1, an early forerunner of ZCPR3. Ultimately, many other sysop (system operator) and user functions were added. Among them, BBS software now keeps track of time, which prevents visitors from overstaying their welcome. This means that the system can limit a user's access to a length of time determined by the sysop.

Early versions of BYE required extensive programming knowledge and expertise in the inner workings of CP/M. It has evolved into a program that uses advanced software techniques but is much easier to set up. Although BYE remains somewhat complicated and could not be recommended for a novice user, it has been extensively enhanced and is an excellent example of the powerful software available in the public domain.

XMODEM also has been enhanced significantly, and it currently logs file-transfer activities and prevents certain types of system security compromises.

The concept of a message system first introduced by CBBS has been greatly improved. Modern message systems allow both private (can be read only by the sender and addressee) and public (anyone can read) messages. Configuration information about the caller—like how many characters per line can be displayed, privileges while logged onto the system, and more—is recorded along with the name and password. Extensive menu structures can be created or changed without requiring recompilation or reassembly of the message-system program itself. Categories of users can be defined separately, with each category having different privileges when logged onto the system.

Modems have also evolved significantly since 1977. The transmission rate has increased from 110/300 bps to 2400 bps, with the hardware cost remaining the same. Also, modems

## *A significant change to bulletin-board software has been the introduction of security.*

are considerably more intelligent, with the ability to determine the stages of call progression and report them back to the computer or the user as well as dialing the desired telephone number.

And last, but not least, have been the corresponding improvements in the software run by callers on their own computers when calling other computers running BYE and XMODEM. These programs take the place of the original MODEM. Currently available programs, like MDM740 by Irv Hoff or MEX by Ron Fowler, possess advanced features like automatic redial until connection is established, printer buffering for slow printers, and much more.

The programs mentioned in the preceding paragraphs are available for the price of a telephone call from many of the thousands of bulletin boards across North America. It is quite possible for SB180 owners to put together their own BBS using these programs, if they have the appropriate technical expertise.

I did not use public-domain software in the SB180 TKBBS because this is a "how to" article instead of a "what if" article. As such, I am under certain legal restrictions.

My overriding determination is to provide a true turnkey system that supports the best features of the SB180 and the MOSART and can be easily implemented by software novices like me. I don't have the time to delve into the inner workings of various communication packages and port them to my computer ("port" is the hackers' word for withdrawing from society while integrating a piece of copied software). There's a point in the evolution of bulletin boards where

*(continued)*

## CIRCUIT CELLAR

we simply want to take it out of the box and plug it in.<sup>1</sup>

Most of the public-domain BBS programs are intended for generic computer systems and would not directly support the MOSART on the COMM180 (they will if you use a stand-alone modem plugged into the SB180's modem port). To use them,

I would have to modify the original software and distribute the new routines to the public through the Circuit Cellar.

Support to this degree unfortunately presents a legal problem. While we all think of public-domain software as free, that is not a license for it to be copied and distributed. Like the soft-

ware I frequently supply with articles, authors often copyright their work but allow end users to make one copy of it for their "personal and noncommercial use." By modifying and distributing thousands of copies of so-called public-domain software, I might overlook someone's copyright and find myself in a legal jam.

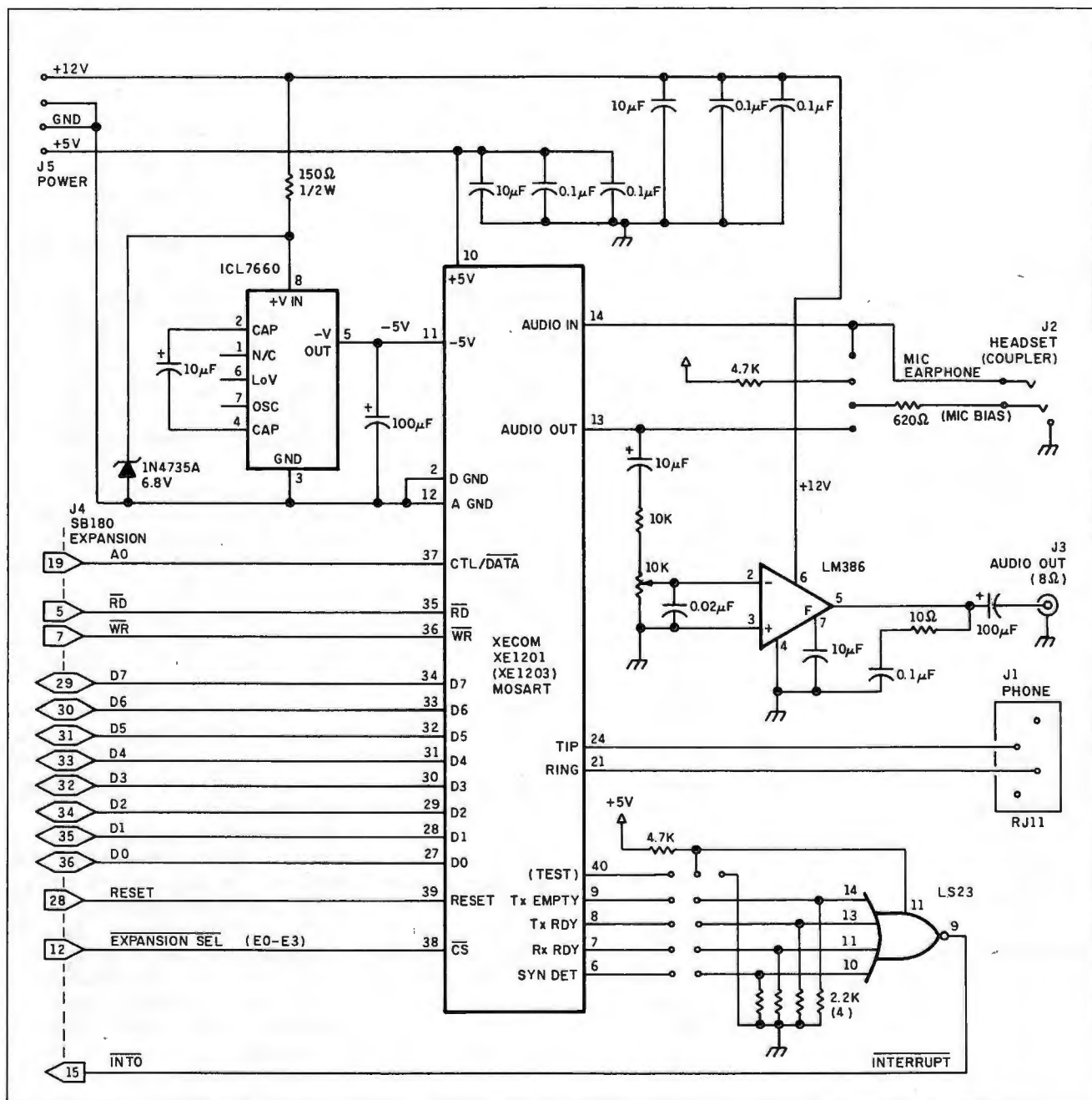


Figure 1: The schematic diagram of the Circuit Cellar COMM180 modem expansion board.

Intelligent individuals with more than modest software knowledge should not be deterred from doing what I cannot. By all means, download CBBS or some other software and use it on the SB180. Being CP/M-compatible, the SB180 should require virtually no modification if you implement the BBS with a Hayes (or Hayes-compatible) modem. Unfortunately, for me the only preventive measure is original composition and absolute knowledge of the distribution license. For that reason, Term III and Z-MSG have been specifically adapted to support the SB180/COMM180 BBS.

### WHAT IS A BBS FOR?

Public bulletin boards have generally specialized in certain areas. Examples are systems specializing in the uploading or downloading of public-domain software, systems for the private use of a computer club or user group, or even computerized dating! These are major divisions, with a wide spectrum of possibilities within each. A system specializing in the uploading and downloading of software may specialize yet further and concentrate on programs written in the C language for 8-bit computer systems.

Many magazines, including BYTE, use bulletin boards to deliver programs detailed in articles. As long as you possess a modem, you can avoid the tedium of manually typing program listings. Magazines also use bulletin boards as a collection point for authors' submissions. Jerry Pournelle mentions transmitting his column to BYTE via modem. The advantage of not having to cope with the delays of the mail more than makes up for the cost of the telephone call.

Even some radio stations have bulletin boards where listeners can leave song requests and other messages.

Some public commercial bulletin boards have appeared. Often, computer stores configure an in-house microcomputer as a bulletin board, promoting products and services. Although commercial possibilities for bulletin boards exist, the single-user

nature of most personal computers limits how many callers can be handled, and there are restrictions as to what the caller might do on the system once access is granted.

An alternative to a public system is a private system with limited access. An example of this is an employee who uses a terminal or computer at home to work on a computer at the office. Another one is the after-hours messaging or order-entry system. With access limited to a relatively few suppliers and customers, communication is maintained at all times.

The SB180 TKBBS will operate in either a private or public mode.

### LEGALITIES

Private systems are likely to become popular due to the unfavorable legal atmosphere regarding bulletin boards. This has resulted from misuse of public bulletin-board systems by people known as "phreaks," "pirates," "worms," and "crackers." Phreaks defraud the telephone company of toll charges through a variety of schemes. Pirates use bulletin boards to exchange information on how to illegally duplicate copyrighted software. Worms and crackers break into

other computers to access confidential files and destroy information. These activities have spurred many state legislatures and the U.S. Congress to pass a variety of laws aimed at restricting the activities of bulletin boards (an extensive discussion on this topic, complete with voluminous source data, is available on BIX under "BBS/other" and "tele.policy" conferences).

Many of these laws make the person who operates the BBS responsible for all activities that occur on the system. One result of this has been that not many systems are open to first-time callers. Many operators of bulletin boards now require that people register for access. This usually involves some sort of verification that the person is not operating with a phony name and that the person provides a real address and telephone number. If a caller does perform some illegal activity, the sysop can refer appropriate law enforcement officials to that caller. Nearly all sysops have no intention of engaging in illegal activities, and these measures are their way of protecting themselves. You should bear these legalities in mind

(continued)

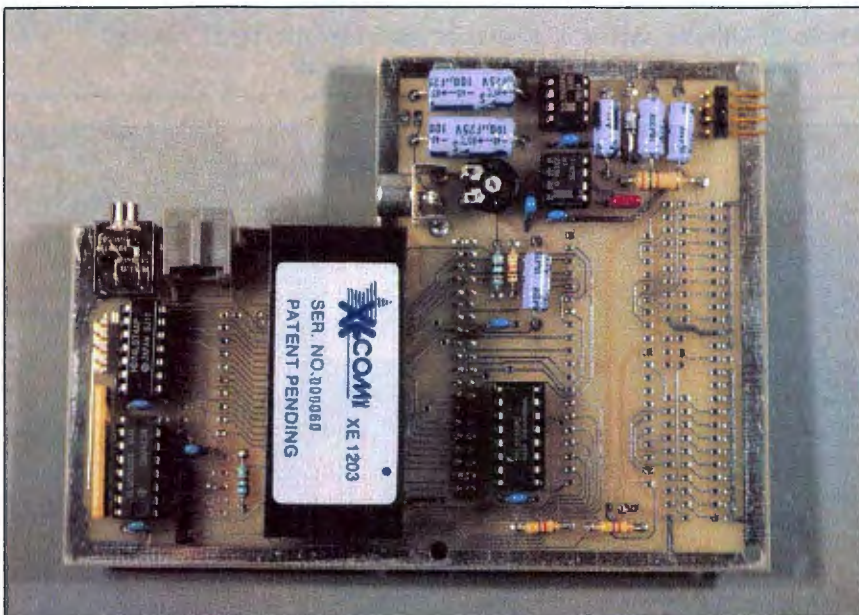


Photo 1: A prototype of the COMM180 expansion board, shown here populated with the MOSART communications chip and its supporting circuitry.

if you intend to operate a public system.

**THE TKBBS**

The hardware of the TKBBS consists of the SB180 single-board computer; the COMM180 expansion board containing the MOSART; two disk drives capable of storing approximately 1600K bytes; and an enclosure, power

supply, and necessary cables. The software of the TKBBS includes the Z-System (see the October Circuit Cellar). Also included are the two software packages that make up the core of the TKBBS: Term III and Z-MSG.

Because the hardware components and the Z-System were extensively discussed in previous Circuit Cellar articles, I will discuss them only briefly

here so that the BBS software can be discussed in further detail.

**THE SB180**

The SB180 is a single-board computer based on the Hitachi HD64180 microprocessor, which is upward-compatible with Z80 software. The SB180 contains 256K bytes of RAM (random-access read/write memory); two serial ports; an SMC 9266 floppy-disk-controller chip that handles 3½-, 5¼-, and 8-inch drives (concurrently); an 8K-byte monitor in EPROM (erasable programmable read-only memory); a Centronics-compatible parallel printer port; and an I/O expansion bus. This all fits on a circuit card that measures 4 by 7½ inches (the size of a 3½-inch disk drive). I described the SB180 hardware extensively in the September Circuit Cellar.

**COMM180 EXPANSION CARD**

The COMM180 expansion card, shown in figure 1, consists of the MOSART and a few other components. The XE1203 MOSART chip, discussed in great detail in last month's Circuit Cellar, is a 300/1200-bps modem with DTMF-decoding and speech-synthesis capabilities. It is unique in that it incorporates all these functions into one small device, 2 square inches, designed to interface directly into the data bus of a microprocessor (see photo 1).

The MOSART operates on +5 and -5 volts. The +12 V supplied to the COMM180 board is reduced and converted to -5 V through a 6.8-V Zener and an ICL7660 voltage-inverter IC (integrated circuit). The COMM180 expansion card has two audio jacks for audio in/audio out but also contains an LM386 amplifier chip that will drive an external speaker for call monitoring.

Addressing for the MOSART is pre-decoded on the SB180 board, and connections are made directly to the I/O-expansion-bus signals. Only a single 7423 is required to combine the various MOSART status outputs into a suitable interrupt to the microprocessor.

The COMM180 is built on a 4- by

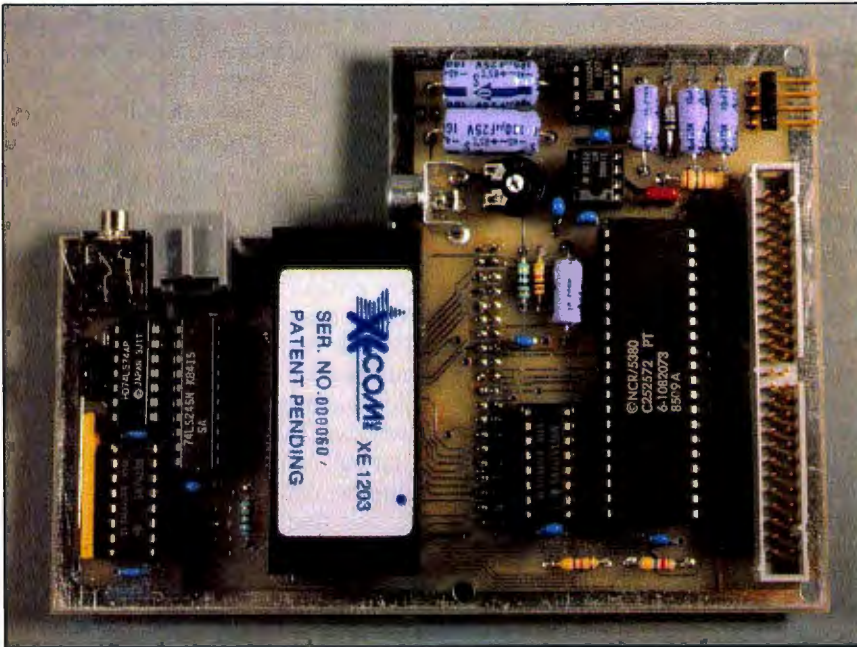


Photo 2: With the addition of a few chips and a connector, the COMM180 from photo 1 can also support an SCSI hard-disk interface.

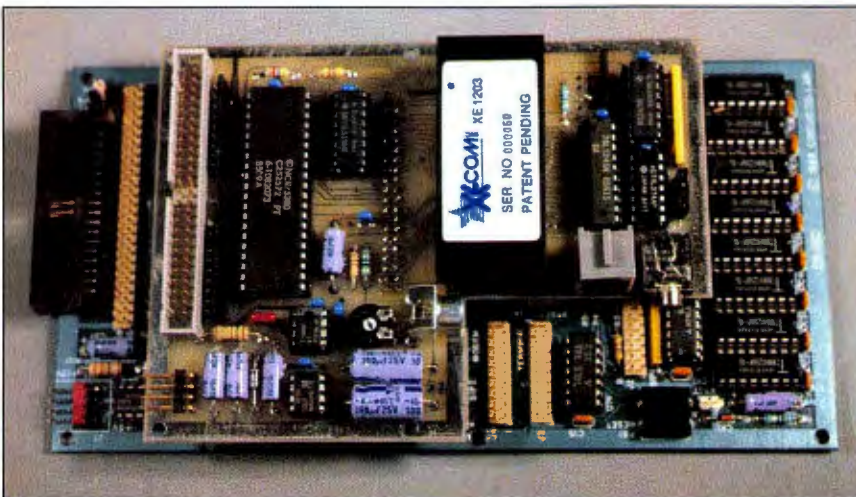


Photo 3: The COMM180 modem/SCSI board rides piggyback on the SB180 single-board computer, connecting via the SB180's expansion I/O connector.



4-inch board that mounts directly over the SB180 and plugs into the I/O expansion bus. Since the COMMI80 is so simple and I had a lot of board space remaining, I decided to fill it up with yet another useful but presently undocumented expansion to the SB180. The COMMI80 expansion board can optionally contain the necessary SCSI (small computer standard interface) hardware interface to attach a hard disk to the SB180 (see photos 2 and 3). The hardware is there, and the software should be finished by the time you read this. It will be the subject of a future Circuit Cellar article.

### Z-SYSTEM

The Z-System is an advanced single-user operating system compatible with programs intended to run under CP/M 2.2. It was discussed in detail in the October Circuit Cellar. The version supplied with the TKBBS differs slightly from the standard Z-System in that the ZCPR3 portion has been reconfigured as a "secure" system. The other significant difference is that an Input/Output Package (IOP) ZCPR3 system segment done especially for the TKBBS is included.

A secure configuration of ZCPR3 has some distinguishing characteristics. The major one is that the system no longer accepts what is known as the DU: form of changing the currently active disk drive and user area. This means that the caller cannot move from area to area in the system using commands like A0: and B3:. If a command of the DU: type is entered, it is simply ignored. Instead, the Named Directory functions of ZCPR3 are used for this purpose for system security. DU: references, if enabled, allow the user to enter any area of the system.

When configured so that named directories are the only way to change areas, the operator of the BBS can protect certain directories by defining them with passwords. Callers to the TKBBS will be able to freely enter areas that do not have passwords defined but will be unable to enter areas where a password is defined

unless they know the password. In a public bulletin-board environment, security is mandatory. Files containing user names and passwords, for example, cannot be accessible to everyone.

In addition to the disabling of the DU: form, another characteristic of a secure ZCPR3 environment is the use of the wheel byte, again for system security. The wheel byte provides a convenient way of disabling dangerous commands that callers to the system should not be allowed to use. Examples of dangerous commands are erase a file (ERA), rename a file (REN), copy a file (CP), memory peek and poke (P and POKE), and SAVE. The convenient aspect of the wheel byte is that these commands can be activated if the wheel byte is set (non-zero). So, the sysop can make use of these commands by setting the wheel byte, yet when a caller is accessing the system, the TKBBS software will reset the wheel byte so that they cannot be used.

The special IOP system segment performs many important system functions in the TKBBS, like sensing if a caller disconnects and placing the local console in parallel with the modem so that the actions of the caller can be observed locally. Another important function of the TKBBS IOP is measuring the amount of time the current caller has been logged in. A caller exceeding the limit is disconnected.

### TERM III

Term III is similar in philosophy and structure to the ZCPR3 portion of the Z-System. This is not surprising because both Term III and ZCPR3 were written by Richard Conn. Term III is a collection of 23 programs that perform various communication functions, like file transfer or answering an incoming call. Term III uses many of the features of ZCPR3 in its operations and will run only with ZCPR3.

Like ZCPR3, Term III (T3 for short) works on a tools concept. The various programs and files are intended to be used together to create new programs and applications. The 23 programs

## Like ZCPR3,

## Term III works on a tools concept.

are listed with a short description of each in the "Term III Programs" text box on page 100. It is important to note that T3 is a complete computer communications system intended to replace the functions of *all* the public-domain software mentioned previously. For this reason, the TKBBS software uses only certain programs from the 23 available. The ones not used by TKBBS are used in other applications, like on a caller's computer when calling a TKBBS. (However, there is no requirement that callers to a TKBBS use T3.)

In operation, T3 relies heavily on the message buffers and two ZCPR3 programs, Alias and Menu. Alias is a ZCPR3 utility program that creates .COM files (executable programs) that contain operating-system-level commands. Using Alias, we can create an invokable program that carries out a sequence of commands in a fashion similar to the CP/M Submit and MS-DOS Batch functions. The user gives a name to the program created by Alias, and these programs are also known as aliases. The advantage of aliases over the CP/M or MS-DOS equivalents is that once the alias is invoked, it passes its embedded command string directly into the ZCPR3 multiple command line buffer, where it remains resident in RAM until the entire sequence of commands is executed. The CP/M and MS-DOS equivalents take their command strings, one command at a time, from a file. This difference means that an alias executes much faster than Submit or Batch since it does not access the disk drives to find the next command.

The Menu program is a ZCPR3 utility that processes menus. The Menu program reads a file, presents a screen to the user as defined in that file, and uses the remainder of the in-

(continued)

## TERM III PROGRAMS

Following is a list of the programs provided with the Term III communications system. Programs marked with an asterisk are used as part of the TKBBS software. The other programs are not required for TKBBS operation.

### COMMUNICATION

**T3FILER:** File transfer using XMODEM, MODEM7 Batch, Kermit, XON/XOFF, CIS (CompuServe), and Term protocols.

**T3FLUSH:** Used to gobble up unneeded characters from the modem.

**T3SEND:** Sends ASCII text via the modem port.

**T3TERM:** Emulates a terminal interfaced to the modem port, with extensive data-capture and -transmission options.

**T3TERMB:** Like T3TERM, but with some of the options stripped to allow for larger data buffers.

**T3TEST:** A simple test program to check communications with the modem.

### TELEPHONE CONTROL

**T3ANSWER:** Monitors the modem and answers the telephone when a call comes in.

**T3DIAL:** Uses the dialing functions of the modem to initiate a call.

**T3HANGUP\*:** Commands the modem to hang up the phone (go on hook).

**T3INIT\*:** Initializes the modem to the desired speed and default conditions.

### ACCESS CONTROL

**T3LOGIN\*:** Establishes the system environment when the current caller logs on.

**T3LOGCK\*:** Checks the LOGIN.TXT file used by T3LOGIN for proper syntax and reports statistics.

### COMMAND-FILE PROCESSING

**T3DO:** A command-file processor that allows unattended operation of the Term III system.

**T3VIEW:** Records the user's interactions with a remote system. It is used in conjunction with T3MONRPT (described below) to create T3DO command files.

**T3MONRPT:** Analyzes the records made with T3VIEW to assist the user in creating T3DO command files.

### COMMUNICATIONS SERVER

**T3SERVER\*:** Allows a second computer system to be controlled by a computer running T3MASTER. All resources of the second computer (disk files, peripherals, etc.) are made available.

**T3MASTER:** Used as the controller of another computer executing T3SERVER. Can be suspended to run another program and then resumed with no effect on the corresponding T3SERVER.

### EDITORS

**EDCST:** Communications set editor.

**EDTMC:** Keyboard macro editor.

**EDTXD:** Telephone directory editor.

**EDXLT:** Translation table (for transmitted and received data) editor.

### MISCELLANEOUS

**T3NOTE\*:** Logs system activity in the ACTIVITY.TXT file. It is used to track the caller's activities and comments.

**T3INS:** Similar to the ZCPR3 installation utility Z3INS. It is used to install the Term III programs if any major changes are made to the system.

formation in that file to process input by the user.

The ZCPR3 message buffers are a way for programs to exchange information. Physically, the message buffer is an 80-byte reserved area of RAM that contains various ZCPR3 entities known as registers, the ZCPR3 IF command status, and the ZCPR3 error flag. T3 uses the error flag and registers extensively. Listing 1 is an example showing the use of an alias and the error flag with the T3 software. Note the use of the ZCPR3 IF command, which determines if the T3ANSWER program terminated because a caller is present or because the sysop typed a Control-C locally.

### THE T3ANSWER PROGRAM

T3ANSWER has the function in the TKBBS software of waiting until a caller is present. The COMM180's MOSART is repeatedly sampled by T3ANSWER until the MOSART indicates that it is receiving a ring signal from the telephone line. At this point, T3ANSWER sends a command to the MOSART to answer the call (go off hook) and emit what is known as answertone to the telephone line. Answertone is a high-pitched tone intended to indicate to the calling party that they have reached a modem. T3ANSWER then continues sampling the status of the MOSART until the MOSART indicates it is receiving a carrier tone from a calling modem. If no carrier tone is detected after 20 seconds, T3ANSWER commands the MOSART to hang up (go on hook) and returns to checking for the ring signal. If a carrier tone is received within the 20 seconds, T3ANSWER terminates and sets the ZCPR3 error flag to the false (zero) state.

A special enhancement to the TKBBS T3ANSWER makes use of the DTMF-decoding functions of the MOSART. During the 20-second time period that the MOSART is emitting answertone, if the DTMF digit "#" is received, T3ANSWER acts as though a carrier was received from a remote modem and terminates.

In addition to resetting the ZCPR3 error flag, T3ANSWER places the

value 01 into ZCPR3's register 4. Therefore, if you want to use the DTMF/voice response features of the MOSART, you can still use T3ANSWER and the TKBBS software for callers who have modems yet allow someone who does not have a modem to interact with the system. An example might be the sysop calling in from a pay telephone. Assuming he has written a program that lets him check the status of the TKBBS that takes its input as DTMF digits and outputs audio using the voice-synthesis capability of the MOSART, he can call, enter the "#" digit during the answertone period, and invoke the program. His program can then inform him of recent callers, read messages to him, or whatever else he may have programmed. A program to do something like this is not supplied with the TKBBS software, but this "escape code" or "hook" built into T3ANSWER allows a TKBBS to be much more than a bulletin board. (If anybody writes this program before I do, I'd like to see it.)

**Z-MSG**

Z-MSG is a message-handling system (see photo 4). As such, it is the electronic mail portion of the TKBBS. Z-MSG uses advanced programming techniques like program overlays and totals about 78K bytes of files, independent of the message storage and other accessories. The author of Z-MSG, Tim Gary, has optimized it for use with ZCPR3 and T3, transforming the TKBBS into a cohesive unit.

Originally written in C source code, Z-MSG is supplied as executable programs and overlay files. To allow the user a wide range of configuration flexibility, a program called ZMCONFIG is supplied. ZMCONFIG lets the user select whether the BBS is to be public or private, set the special sysop name and password, specify filenames and locations of files used by Z-MSG, set the maximum number of messages allowed and their length, edit the eight user types regarding their privileges, and much more.

Z-MSG features include large messages (up to 100 lines or more), the

ability to change the options of the system without requiring recompilation, multiple categories of users (callers), extensive editing functions for messages being entered, and selective searching of available messages for those of interest. One nice feature of Z-MSG is that help for the user is available throughout the system just by entering a question mark.

Figure 2 illustrates a sample session with Z-MSG. It shows a caller logging onto Z-MSG. When somebody logs

on, the message files are searched for any mail addressed to that caller. If a message is found, as shown, the caller is given the message number and the sender's name. Once the message is retrieved, Z-MSG asks the caller if a reply is to be made.

A powerful function of Z-MSG is its use of the ZCPR3 environment to allow execution of other programs (.COM files) from within the message system. This function's implementation lets the sysop add commands to

*(continued)*

**Listing 1:** An alias called TKBBS.COM is used to put the turnkey bulletin-board system on line.

Alias Contents	Comments (not part of the file)
1: T3INIT 2;	Initialize the modem
2: REG 4 0;	Flag T3ANSWER to not allow the DTMF "#" to be specially treated
3: T3ANSWER;	Execute T3ANSWER
4: IF ERROR;	If T3ANSWER did set the error flag...
5: ECHO LOCAL ABORT	The sysop aborted T3ANSWER locally
6: ELSE;	If T3ANSWER did not set the error flag...
7: DEV C CRTMODEM;	We have a caller, put console and modem in parallel (handled in the IOP), and...
8: Z-MSG X;	Execute Z-MSG
9: FI	Clean up IF status

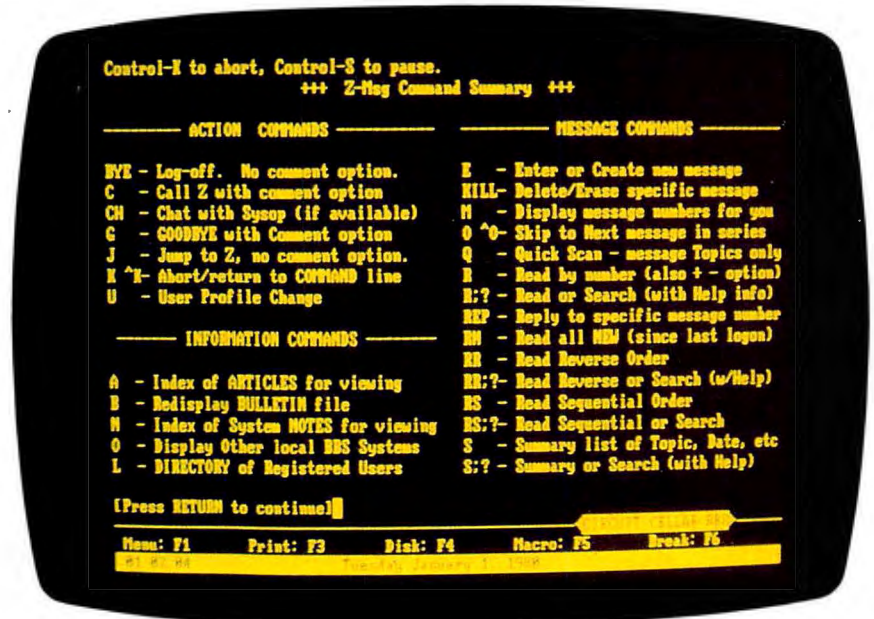


Photo 4: A sample screen from the Circuit Cellar's TKBBS, showing a command summary of the Z-MSG message-handling program.

```

What's your name (or SYSTEM ID)? steve ciarcia
[Checking for previous logon]
[.....]
Enter password? 1234

[Updating logs]
Z-MSG Message-Handling System.
Version 1.30xx

You are caller 7996 (User #378).
You've called 2 time(s), last one being on 07/10/85.

There are 130 active messages. (26 are private)
Your last read message was 2540.
The current high message is 2541.

[Checking for your Mail]
[You have Mail!]

Number: From:
2541 David McCord [new] [private]

(Enter '?' for help) Command: r

Read message #(first = 1, Last = 2541)? 2541

Msg #2541 posted 07/10/85 by David McCord
To: Steve Ciarcia <Priv> About: SB180 (4 lines)

Steve, I really like the SB180 I have. I especially like the built-in RAM disk.
A very nice design! By the way, what's the power consumption at 5 volts?
.....Dave

[Reply to this msg (y/n)? ] [yes]

To: David McCord
Subject: SB180
[Is the subject ok (y/n)? ] [yes]
(Private/Normal)? p

Enter message text following each line number.
To edit or end, hit RETURN alone on a line.
Up to 77 characters (letters/numbers) on a line
and 100 lines maximum.
1: Dave, the power consumption of the SB180 is 500 mA at 5 volts and
2: 40 mA at 12 volts. Thanks for the compliments.
3: Steve Ciarcia
4:

(A)bort, (C)ontinue, (D)elete, (E)dit,
(I)nsert, (L)ist, (R)eplace, (S)ave,
(U)pload :: Select ? s

[Saving message #2542]

[Kill Message you've just replied to (y/n)?] [yes]

Msg #2541 posted 07/10/85 by David McCord
To: Steve Ciarcia <Priv> About: SB180 (4 lines)

Confirm (y/n)? [yes]

[Delete message #2541]

```

Figure 2: A sample session with the electronic mail system Z-MSG.

Z-MSG by editing a simple text file. No recompilation or reassembly is required, a unique feature for any program, be it message system or whatever.

### TKBBS SECURITY

As discussed previously, several files must be kept confidential in order to prevent compromising system security. The best way to keep them confidential is to store them in a disk drive/user area that has no directory name associated with it. Remember, the secure implementation of ZCPR3 accepts only directory names to change the active drive and user area. Therefore, if no name is defined for an area, it is impossible to enter that area. However, you may be asking yourself how the sysop can place files in these areas if they are impossible to enter. The answer is that the current set of directory names are changed easily by loading a different ZCPR3 Named Directory system segment into RAM. Thus, the sysop, when using the system locally, can operate with a set of directory names that includes names for the secure areas. When the system is being used by a caller, a different set of directory names is in effect, which does not include names for those areas. And the caller has no way of changing the active set of directory names.

The PATH function of ZCPR3 is also different depending on who is using the system. Typically, executable programs (.COM files) that callers can execute are stored on drive A, user area 0 (A0:). Examples of this kind of program are Z-MSG and T3HANGUP. So, the PATH for a caller is simply A0:, which means that the programs in A0: can be invoked from any other area of the system. However, sysops may have useful programs on the system that they do not want callers to be able to use. Examples of this kind of program are DU3 (disk utility) and the TKBBS.COM Alias discussed previously. For the sysop's convenience, the PATH can be set to A0: -> A15: when using the system locally. The PATH setting is independent of the named directories and can invoke programs

in unnamed drive/user areas, if necessary.

As another protection against compromise of system security, files received by the TKBBS in an uploading function are subject to being renamed because some caller may attempt to upload a .COM file in order to compromise system security. If this is attempted, the TKBBS software automatically renames it an .OBJ file to prevent it from executing. This protection can be overridden if the wheel bit is set.

## CIRCUIT CELLAR BBS

As mentioned earlier, I have set up a Circuit Cellar private-access BBS that uses the configuration outlined in this article. It can be reached 24 hours a day at (203) 871-1988. I intend to use it to supplement projects by providing part lists, program listings, project updates, and other useful information. I invite you to join.

For the month of December, you can call and see a demonstration of the TKBBS and register for continued access. On January 15, 1986, subsequent access will be limited to those who have registered and received an ID by mail. To become a member after that date, send me a postcard or letter with your return address, and I will send you an ID and password for the system. You will retain access as long as the following code of ethics is maintained:

1. No distribution of copyrighted software or encouragement thereof.
2. No distribution of private access codes, credit card codes, or engaging in any other unlawful activities.
3. No obscene or offensive language permitted in open areas.
4. No X-rated activities or messages permitted in open areas.
5. Any user guilty of violating any of the published rules will be denied access.
6. Any attempt to tamper with the board, alter the system, or gain sysop access will result in deletion.
7. No use of abusive language or conduct toward any other user in open areas.

8. Users will follow all posted system regulations. A warning note will be given to a user if they have done something that is not publicly posted but is against the wishes of the sysop.

9. This board is not funded by BYTE and is my private property. I have the right to deny the use of this system to anyone for any reason I deem fit.

These rules are not intended to be restrictive. They are intended to make this system a pleasure to use by all responsible parties and prevent the abuses that have brought legal action against BBS sysops and users alike. Circuit Cellar readers are of all ages and both sexes, and I am concerned for their welfare. If we cannot control the activities of our own boards, numerous federal and state agencies will happily do it for us, and the last thing we need is government controls.

## CONCLUSION

The SB180 TKBBS hardware and software is an extremely powerful package that makes the most of the capabilities of the Xecom 1203 MOSART and the Z-System operating system of the SB180.

Perhaps the only significant limitation of the TKBBS lies in the amount of storage available as dictated by the current BIOS (basic input/output system). Although the system could be expanded to about 3.1 megabytes of storage by using four 96-tpi (tracks per inch) floppy-disk drives, it is not unusual for a public bulletin board to make use of hard disks in the 5- to 40-megabyte range. A tremendous amount of public-domain and free-ware-type software is available, which necessitates a large amount of storage capacity if your bulletin board is to carry a wide selection. Of course, this limitation will disappear when the hard-disk interface on the COMM180 board is operational.

## CIRCUIT CELLAR FEEDBACK

This month's feedback is on page 420.

## NEXT MONTH

A multichannel 12-bit A/D converter for the BCC52. ■

*Special thanks to Dave McCord, Rick Conn, and Tim Gary for their contributions to the TKBBS.*

The following items are available from

The Micromint Inc.  
25 Terrace Dr.  
Vernon, CT 06066  
(800) 635-3355 for orders  
(203) 871-6170 for information

The COMM180 expansion interface is a combination MOSART-based modem and SCSI hard-disk interface expansion board for the SB180 computer. The modem section, which includes a DTMF encoder/decoder and LPC speech synthesizer, is designated as the COMM180-M. It comes with Term III communication software and manual. The TKBBS consists of a COMM180-M and Z-MSG installed on an SB180.

The SCSI hard-disk-interface section is designated as the COMM180-S. It has a 50-pin SCSI bus header and is Zebec 1410/Adaptec ACB4000 controller-compatible. It comes with a BIOS upgrade on disk.

The printed-circuit board for either version is completely socketed and can be upgraded to include both functions at any time. The combination modem/SCSI interface board is designated as the COMM180-M-S. Software is supplied on 5¼-inch double-sided double-density SB180 format disks with manuals. Boards are available assembled and tested only.

COMM180 MOSART modem with Term III	COMM180-M, \$350
COMM180 SCSI interface with BIOS upgrade	COMM180-S, \$150
COMM180 MOSART modem and SCSI	COMM180-M-S, \$500
Z-MSG BBS software	\$100

Please include \$5 for shipping and handling in the continental United States, \$10 elsewhere. Connecticut residents please include 7.5 percent sales tax.

**Editor's Note:** Steve often refers to previous Circuit Cellar articles. Most of these past articles are available in book form from BYTE Books, McGraw-Hill Book Company, POB 400, Hightstown, NJ 08250.

*Ciarci's Circuit Cellar, Volume I* covers articles in BYTE from September 1977 through November 1978. *Volume II* covers December 1978 through June 1980. *Volume III* covers July 1980 through December 1981. *Volume IV* covers January 1982 through June 1983.

To receive a complete list of Ciarci's Circuit Cellar project kits, circle 100 on the reader-service inquiry card at the back of the magazine.

# Filling your needs m

Today's PC buyer is no pushover. Not only are low prices and prompt delivery demanded, but professional support, sound advice and innovative servicing of accounts is expected. It's no coincidence then that PC buyers all across the nation call PROGRESSIVE MICRO DISTRIBUTORS first. Here's why.

## **LOW COST, HIGH TECH SOLUTIONS.**

PROGRESSIVE MICRO DISTRIBUTORS has the best prices on popular IBM PC hardware and software in the country (call and compare). Most orders are shipped the same or next day from our 25,000 sq. ft. warehouse. Although we ship literally hundreds of orders daily, all PC's are burned in overnight to insure that your system arrives in excellent condition.

We believe it takes a professional to provide professional service. That's why all sales and service staff members, from our factory authorized technical experts to our highly experienced account representatives, are rigorously trained on all current and new hardware and software. And if the need ever arises, direct access to our on-line customer service and technical support centers is available and convenient to use.

## **HOW TO KEEP UP WITH PROGRESSIVE.**

As a PROGRESSIVE MICRO DISTRIBUTORS' customer, you'll also be privy to new product information and special money saving incentives through the Microgram,<sup>™</sup> our monthly customer newsservice. You'll also receive monthly price lists showing current pricing on our complete line of hardware, software and services. Lists are shipped automatically with all system orders and are available on disk when requested. Plus, **FREE** UPS shipping is guaranteed on all prepaid orders with confirmation of current pricing.

Call PROGRESSIVE MICRO DISTRIBUTORS today, **TOLL FREE** at **1-800-446-7995**, and we'll mail a current price list to you immediately. And remember, only PROGRESSIVE MICRO DISTRIBUTORS gives you all of these benefits: low prices, sound advice, prompt delivery, professional support and direct customer service.



## **POLICIES**

1. We accept VISA, MC, AMEX; No surcharge for VISA or MC.
2. COD requires cash or certified check; Company check when approved.
3. Allow 1 week for personal and company checks to clear.
4. Wiring information available upon request.
5. Corporate, Government and Institutional volume purchase agreements available.
6. Call for exact shipping charges; air shipments take priority.
7. If we must split shipment, you incur no additional shipping charges.
8. All orders shipped insured — No additional charge.
9. All products fully warranted; Some up to 5 years.
10. All items subject to availability; Prices subject to change without notice.

## **FOR ORDERS**

**1-800-446-7995**

## **CUSTOMER SERVICE**

**1-404-446-7996**

## **ORDERING INFORMATION**

**1-404-446-7995**

## **TECH ASSISTANCE**

**1-404-446-7997**

**HRS: 9AM-9PM EST. SAT. 12N-5PM EST.**

©1985 AT&T Information Systems.  
IBM is a registered trademark of the International Business Machines Corp.

# Makes us Progressive.

## PC SYSTEMS

### AT&T PC 6300

640K, 2 drives, monochrome monitor/adaptor, DOS/BASIC..... \$1995  
 640K, 2 drives, color monitor/adaptor, DOS/BASIC \$2495  
 640K, 1 drive, 10MB hard disk, DOS/BASIC..... \$2595

### AT&T PC 6300 PLUS

25% faster than IBM's AT..... **CALL FOR BEST PRICE.**

### IBM PC

256K, 2 drives, monochrome/printer adapter & monitor..... \$2195  
 256K, 2 drives, color/graphics adapter & monitor \$2495  
 256K, 2 drives, 10MB internal hard disk..... \$2595

### IBM PC XT

256K, 2 drives, monochrome/printer adapter & monitor..... \$2295  
 256K, 2 drives, color/graphics adapter & monitor \$2595  
 256K, 2 drives, 10MB internal hard disk..... \$2695  
 256K, 2 drives, 20MB internal hard disk..... \$2895

### IBM PC COMPATIBLE

256K, 2 drives, 8 slots, 135w power supply..... \$995  
 256K, 1 drive, 10MB, 8 slots, 135w power supply \$1595

### SANYO MBC 555-2

MS/DOS w/128K, 2 drives, color monitor..... \$995  
 These systems are brand new, shipped fully tested and burned in, fully warranted for ninety days AND ARE ALWAYS IN STOCK! All system orders include our PC Utilities Package at no extra charge!

## PRINTERS

### EPSON

FX-85 (160 cps narrow carriage NLQ dot matrix) \$569  
 FX-185 (160 cps wide carriage NLQ dot matrix)... \$609  
 LX-80 (100 cps narrow carriage NLQ dot matrix) \$349  
 JX-80 (160 cps narrow carriage color dot matrix) \$585  
 LQ-1800 (LQ dot matrix w/parallel interface)..... \$995  
 DX-10, 20, 35 (new EPSON daisywheels) .. **ON SPECIAL!**

### OKIDATA

ML 192 (160 cps narrow carriage dot matrix).... \$399  
 ML 195 (160 cps wide carriage dot matrix)..... \$559  
 FACEMARK 2410 (350 cps wide carriage dot matrix)..... \$1995

### CANON

LBP-8A1 (8 ppm, better than HP)..... \$2195  
 PW-1080A (160 cps dot matrix)..... \$589  
 Pj-1080A (32 cps color printer)..... \$549

### TOSHIBA

P-351 (192 cps wide carriage LQ dot matrix)..... \$1095  
 P-1340 (120 cps narrow carriage LQ dot matrix).. \$595

### TEXAS INSTRUMENTS

TI-855 (160 cps narrow carriage LQ dot matrix) **CALL**

### BROTHER

HR-16+ (17 cps narrow carriage letter quality) .. \$395  
 HR-25 (23 cps wide carriage letter quality)..... \$550  
 HR-35 (32 cps wide carriage letter quality)..... \$795  
 M-1609 (180 cps, wide carriage NLQ, S&P Dot Matrix)..... **CALL**

### C. ITOH

Starwriter (40 cps letter quality)..... \$595  
 Printmaster (55 cps letter quality)..... \$1195

### NEC

Pinwriter P-2 & P-3..... **CALL**  
 Spinwriter 2080, 3580, 8850..... **CALL**  
 Ask about our full line of tractors and cut sheet feeders!

## PLOTTERS

We carry all HOUSTON INSTRUMENTS and HEWLETT-PACKARD plotters

## FLOPPY DISK DRIVES

HALF-HEIGHT 360K (PC/XT/AT compatible)..... \$119  
 HALF-HEIGHT 1.2MB (PC/XT/AT compatible)..... \$159

## MISC. HARDWARE

POLAROID Palette (Makes color slides from your PC's screen)..... \$1595  
 ORGHID PC Turbo (adds 8MHz processor, multitasking to PC)..... **from \$449**  
 KEYTRONIC KB 8161 & 8153 keyboards..... **CALL**  
 MOUSE SYSTEMS Optical PC MOUSE w/PAINT..... \$188  
 MICROSOFT Serial or Bus mouse w/Mouse Menu..... \$188  
 GIS Power Back-ups (SP8' and UP8')..... **CALL**  
 QUADRAM Microfazer Printer Buffer..... **from \$155**  
 CURTIS System accessories..... **CALL**

## HARD DISK DRIVES

<b>Internal</b>	AT 105MB.....	\$2995
PC/XT 10MB ...	from \$429	
AT 20MB .....	\$695	
PC/XT 20MB .....	\$845	
AT 30MB .....	\$895	
PC/XT 30MB .....	\$995	
AT 55MB .....	\$1995	
<b>External</b>	AT 105MB.....	\$3995
AT 140MB.....	\$3595	
AT 190MB.....	\$4595	
PC/XT 10MB.....	\$695	
PC/XT 20MB.....	\$945	
380MB.....	\$6995	

We proudly offer what we think are the best price/performance hard disk and streaming tape sub-systems available. We will gladly test and format any hard disk we sell at a nominal charge. Our line includes: ALLOY, BERNOULLI TECHNOLOGY, CIPHER DATA, DMA, EMERALD SYSTEMS, EPSON, GENOA, IRWIN, MAXTOR, PEACHTREE TECHNOLOGIES, QUADRAM, RODIME, SYSGEN, TALLGRASS and WANGTEK

## MULTIFUNCTION BOARDS

We carry the finest quality multifunction boards at prices too low to mention. We are factory authorized centers for the top names in the industry. Our volume buying allows us to set the most competitive prices anywhere. Call us for the lowest prices a full service distributor can give you.

## CHIPS

64K (nine chips)..... \$10 128K (AT RAM)..... \$38  
 8087 (coprocessor) .. \$189 256K (jr & AT boards) \$58  
 80287 (coprocessor) \$199

**CALL FOR QUANTITY DISCOUNTS**

## GRAPHICS CARDS

We carry a variety of display adapters. So, call us if you don't see the one you want or need help choosing.

### AT&T

Enhance Display Adapter (runs 640x400 w/a palette of 16,000 colors on AT&T's Hi Res color monitor ... **CALL**

### HERCULES

Graphics Card (Lotus compatible monochrome graphics)..... \$529  
 Color Graphics Card (Short-slot color card w/par) \$179

### PARADISE

Modular Graphics Card & Multi-Display Card **from \$299**

### TECMAR

Graphics Master (640x400 16 colors and monographs)..... \$459

### PERSYST

BoB Board (clear text on a color monitor)..... \$489

### TSENG LABS

UltraPAK (132 col. mono graphics, ser, par, C/C)... \$489

## MONITORS

### AMDEK

300G & 300A (Green or Amber, composite video monitors)..... \$189/\$159  
 310A (Amber TTL input, non-glare tube)..... \$169  
 COLOR 600 (13" 640x240 RGB w/text button, audio) \$428  
 COLOR 700 (13" 720x480 RGB w/.31mm dot)..... \$475  
 COLOR 710 (13" 720x480 RGB, non-glare/flicker) \$578

### PRINCETON GRAPHICS

PGS MAX-12 (Amber TTL input, non-glare tube) .. \$189  
 PGS HX-12 (690x480 RGB w/.31mm dot)..... \$449  
 PGS SR-12 (690x480 non-interlaced RGB w/.31 dot) \$595

### QUADRAM

Amberchroms (Amber TTL monochrome)..... \$149  
 Quadchrome (690x480, .31mm dot pitch)..... \$499  
 Quadchrome II (same as IBM Color Monitor)..... \$599

### TAXAN

RGBvision 420, 420L, 425 & 440..... **CALL**  
 We carry WYSE and KIMTROM terminals, call for prices.

## PROTOCOL CONVERSION

We carry all AST and DCA products, call for prices.

## MODEMS

### HAYES

Hayes 1200 (external 300/1200, auto answer/dial) .. \$419  
 Hayes 1200B (internal 300/1200, w/Smartcom II) .. \$579  
 Hayes 2400 (New external 2400 baud modem)..... \$675

### DCA

New Fastlink 10KB modem..... **from \$1595**

## ANCHOR AUTOMATION

Signalman Mark XII (1200 baud at 500 baud price) \$259  
 We also carry modems by AST RESEARCH, BIZCOMP, FENRIL, QUADRAM, RIXON, VENTEL — please call for current pricing.

## NETWORKING

We carry all the best names including 3COM, AST RESEARCH, FOX, IBM, and ORCHID TECHNOLOGIES. Call our Networking Applications experts to design a cost-effective device-sharing networked layout for your office! Regional ON-SITE installation and training available.

## G.A.D.

We sell and support the finest computer aided drafting/design packages available. Regional ON-SITE installation and training available.

## DISKETTES

### VERBATIM

Single sided/Single density:..... 10/\$24 100/\$199  
 Double sided/Double density:..... 10/\$29 100/\$249

### DYSAN

Double sided/Double density:..... 10/\$29 100/\$249  
 High density AT diskettes:..... 10/\$59 100/\$249

### MAXELL

High density AT diskettes:..... 10/\$59 100/\$249

### PMD

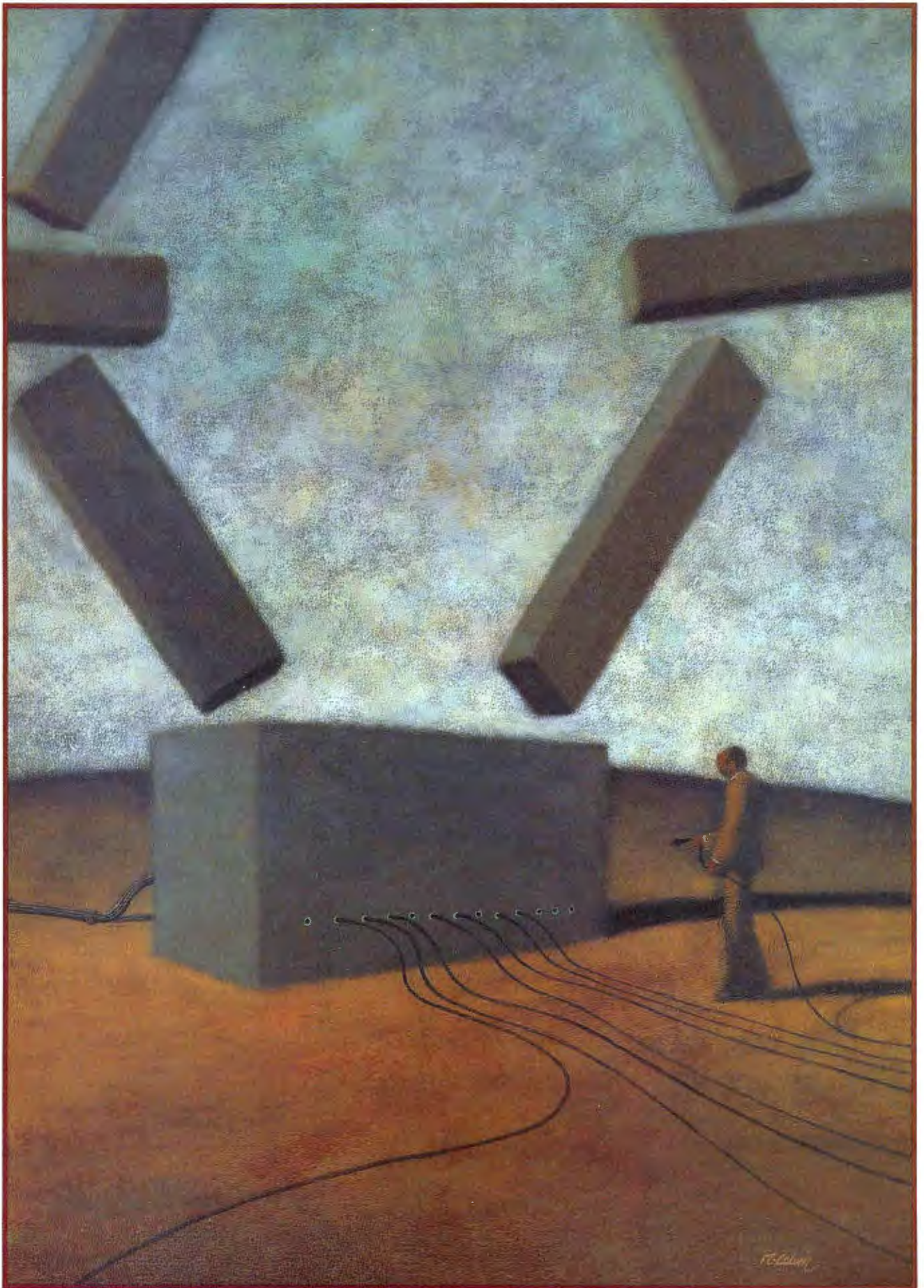
Double sided/Double density..... 10/\$18 100/\$139

## SOFTWARE

LOTUS Symphony..... \$449  
 MICROSOFT Excel..... **CALL**  
 ASHTON-TATE Framework II..... \$599  
 ENABLE by Software Group..... **CALL**  
 PFS Write, File, Graph, Report..... **from \$79**  
 SSI WordPerfect..... \$259  
 MULTIMATE, Multimate ADVANTAGE, JUST Write... \$259  
 MICROSOFT Word 4.0..... \$259  
 LIFE TREE Volkswriter Deluxe w/Textmerge..... \$169  
 LOTUS 1-2-3..... \$509  
 ASHTON-TATE dBase III..... \$599  
 MICRORIM 5000..... \$589  
 MICROSTUP Crosstalk XVI..... \$109  
 PERSOFT SmartTerm 100, 125, 400..... **CALL**  
 RELAY..... **CALL**  
 DOW JONES All products..... **CALL**  
 SORCIM/IUS Complete accounting modules..... **from \$289**  
 BPI ACCOUNTING Complete accounting modules... **CALL**  
 OPEN SYSTEMS Accounting..... **CALL**  
 SYSTEMS PLUS Books! accounting system..... **CALL**  
 MECA/TOBIAS Managing Your Money..... \$199  
 MONOGRAM Dollars and Sense..... \$119  
 DECISION RESOURCES Signmaster/Chartmaster..... \$179/\$249  
 ZSOFT PC Paint Brush..... \$95  
 HARVARD Harvard Project Manager..... **CALL**  
 MICROSOFT Project..... **CALL**  
 CLIPPER dBase compiler by Nanbucket..... **CALL**  
 BORLAND Turbo Pascal & Toolbox..... **ea. \$39**  
 MICROSOFT All products..... **CALL**  
 DIGITAL RESEARCH All products..... **CALL**  
 BORLAND All products..... **from \$59**  
 SOFTSTYLE Printworks printer utilities..... \$55  
 NORTON Utilities..... \$89  
 QUAD Copywrite, Disk Explorer & Zero Disk..... **CALL**  
 CENTRAL POINT Copy II PC copies  
 protected software..... \$55  
 FASTBACK by 8th Generation..... \$115  
 ATI Training..... \$55

**PROGRESSIVE  
 MICRO  
 DISTRIBUTORS**

3039 Amwiler Road, Atlanta, Georgia 30360

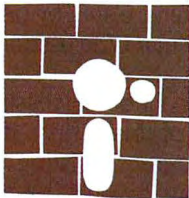




## A SIMPL COMPILER PART 1: THE BASICS

BY JONATHAN AMSTERDAM

*An implementation of a compiler  
for a simple structured language*



In this article—the first of a three-part series on the construction of a compiler for a high-level language—I will discuss the basics of the compiler. Next month I will talk about procedures and functions, and in the third part of the series I will describe some of the compiler's extensions.

Three of my earlier Programming Projects are prerequisites for this one. "Context-Free Parsing of Arithmetic Expressions" (August, page 138) explains the parsing technique I will be using. "Building a Computer in Software" (October, page 112) describes VM2, the virtual machine for which my compiler is targeted. And "A VM2 Assembler" (November, page 112) details the assembly-language code that the compiler will generate.

### THE SIMPL PROGRAMMING LANGUAGE

I will be describing a compiler for a language of my own design, called SIMPL. SIMPL, which stands for "SIMPL Isn't Much of a Programming Language," isn't much of a programming language. SIMPL's grammar is given in figure 1. There are a few points that are not described by the grammar. An identifier is any string of letters and numbers beginning with a letter. Unlike most implementations of Pascal, SIMPL is

case-sensitive, so the identifiers READ and Read mean different things. SIMPL keywords, like PROGRAM and BEGIN, are capitalized. Comments in SIMPL are delimited by braces ({ }). As in Pascal, character constants are delimited by single quotes, but SIMPL also allows the backslash character (\) to act as an escape. When followed by an n or a t, the backslash denotes a new line (carriage return) or tab; when followed by any other character, it denotes that character. For example, the character constant for the single quote looks like '\ '.

SIMPL's WHILE and IF statements, like those of Modula-2, are explicitly terminated by an END. The AND operator has the same precedence as OR, and both have weaker precedences than those of all other operators, so it is unnecessary to put parentheses around expressions connected by AND and OR. Furthermore, expressions surrounding an AND or OR will be evaluated from left to right, and no more than necessary will be evaluated. For example, in the expression TRUE AND FALSE AND TRUE, the first TRUE will be evaluated and then the FALSE will be

*(continued)*

*Jonathan Amsterdam is a graduate student at the Massachusetts Institute of Technology Artificial Intelligence Laboratory. He can be reached at 1643 Cambridge St. #34, Cambridge, MA 02138.*

evaluated; at that point, evaluation of the second TRUE will be skipped because the value of the whole expression must be FALSE.

SIMPL has procedures and functions much like those of Pascal, but rather than assigning a value to the name of the function, a value is returned from a SIMPL function using the RETURN statement. A RETURN without an expression can be used to exit from a procedure. It cannot be used in the main program.

SIMPL has two built-in procedures, READ and WRITE. These procedures can only read or write integers or characters and only from the keyboard or screen. Both take any number of arguments. The arguments to READ must be variables; those to WRITE can be any expression.

SIMPL supports variables of types INTEGER, BOOLEAN, and CHAR. It has five kinds of statements: WHILE, IF, RETURN, assignment, and procedure call. SIMPL has no FOR loops, strings, case statements, arrays, constants, reals, type declarations, records, sets, repeat loops, GOTOs, labels, files, scalar types, VAR parameters, pointers, or math functions. Indeed, SIMPL lives up to its name.

Still, even for this language, writing a compiler is not easy. The compiler consists of 12 modules and is over 3000 lines long. The source code, written in Modula-2, is available on BYTEnet Listings at (617) 861-9764.

### WHAT IS A COMPILER?

A compiler is a program that translates other programs from one form to another. The compiler's input is a source file, which is a sequence of characters that constitutes the human-readable text of the program. Some compilers translate this directly into object code, which can be loaded and executed by the machine. Other compilers produce as output another text file containing an assembly-language version of the program. This text file must then be translated into object code by an assembler. Although going directly from source code to object code saves a step in the translation process, my compiler takes the second approach for two reasons. First, producing an assembly-language version of the program makes it easier to write the compiler because I don't have to worry about bookkeeping details (like forward references of labels) that the assembler

can handle. Second, I can examine and change the human-readable assembly-language file. This can be useful for debugging the compiler and hand-optimizing its output.

Readers of "A VM2 Assembler" will recall that an assembler is also a program translator. But whereas assembly is relatively easy, compilation is considerably more difficult. There are two reasons for this, the first of which is fairly clear: Assembly-language programs correspond line for line with the object code that has to be generated, but high-level-language programs, by definition, do not. A standard computer instruction set does not provide WHILE loops, IF...THEN...ELSE statements, evaluation of arithmetic expressions, etc. Furthermore, at the machine level a variable is simply a memory location, but a high-level-language variable is something else. For one thing, it has a particular type associated with it, as well as a scope, or range of visibility (a topic I'll be discussing at length in part 2 of this series). If you compare the program in listing 1 with the one in listing 2, you'll get a sense of how different high-level language and assembly language are from each other.

Compilation is difficult for another reason as well: Users of high-level languages would like the object code produced by the compiler to be just as short and run just as fast as hand-coded assembly-language programs. So compiler writers strive to improve the compiler's generated code. For example, it is a good idea to keep frequently used values in the registers of the computer because they can be accessed faster than memory locations; therefore, compiler writers have developed algorithms for optimizing register usage. Also, most computers have "special case" instructions that can speed up certain common operations (such as incrementing a number), and a good compiler will use these instructions where appropriate.

While writing my compiler, I did have to deal with translating high-level SIMPL statements into low-level VM2 instructions, but I could avoid some

```

program ::= PROGRAM id; vars routines block .
vars ::= empty | VAR varlist
varlist ::= decl | decl varlist
decl ::= idlist : type ;
idlist ::= id | id , idlist
type ::= INTEGER | BOOLEAN | CHAR

block ::= BEGIN stmts END
stmts ::= empty | stmt ; stmts
stmt ::= while | if | return | assign | call
while ::= WHILE expr DO stmts END
if ::= IF elsif END
elsif ::= expr THEN stmts else
else ::= empty | ELSIF elsif | ELSE stmts
assign ::= id := expr
exprlist ::= expr | expr , exprlist

expr ::= expr | relexpr | relexpr OR expr | relexpr AND expr
relexpr ::= intexpr | intexpr relation intexpr
intexpr ::= term | term + intexpr | term - intexpr
term ::= factor | factor * term | factor / term
factor ::= id | number | funcall | char | -factor | NOT factor | ( expr )
relation ::= > | < | = | <> | >= | <=
    
```

Figure 1: The SIMPL grammar used by the parser.

# PROGRAMMING PROJECT

Listing 1: A program written in SIMPL that calculates the greatest common divisor of two integers, using Euclid's algorithm.

```

PROGRAM Euclid;
VAR m, n, temp, r: INTEGER;
BEGIN
  WRITE("?");           { Prompt user for two integers }
  READ(n);
  WRITE("?");
  READ(m);
  IF n < m THEN        { Make sure n is the larger of the two }
    temp := n;
    n := m;
    m := temp;
  END;
  r := n - m*(n/m);    { r := n MOD m }
  WHILE r > 0 DO
    n := m;
    m := r;
    r := n - m*(n/m); { r := n MOD m }
  END;
  WRITE(m);           { m is the GCD—output it }
END.

```

of the complexities of generating good code because I was compiling for VM2, a machine I designed to make it easy to compile high-level languages. For example, I didn't have to worry about register allocation because VM2 doesn't have any registers (except for some special-purpose ones with which the compiler needn't be concerned). This simplification was behind my decision to make VM2 a stack machine. Also, VM2's instruction set is simple and provides no special-case instructions, so I don't have to worry about using them.

A compiler's job can be divided into at least four phases: lexical analysis, parsing, type checking, and code generation.

## LEXICAL ANALYSIS

The compiler's first task is to translate the stream of characters that constitute the input into a more agreeable form. The lexical analyzer transforms the character stream into a stream of tokens, or lexical items that are meaningful to the compiler.

What counts as meaningful depends on the program, of course. My lexical analyzer for SIMPL has many different types (or classes) of tokens, including IDENTIFIER for vari-

ables, INT for integers, and a different class for each keyword. For example, the lexical analyzer will consume from the input the five characters W, H, I, L, and E, when they occur consecutively and are delimited on both sides by white space (spaces, tabs, or carriage returns), and will then return a token of class WHILE. If the lexical analyzer sees the characters 3, 4, and 5 occurring consecutively, it will convert them into an integer, 345, and return a token of class INT, which also contains the number 345.

The lexical analyzer's design is similar to that of the VM2 assembler's lexical analyzer. Where the lexical analyzer of the assembler allowed you to "unget" the last character that was taken from the input, the SIMPL lexical analyzer allows you to unget a token—that is, to arrange matters so that the next call to the lexical analyzer will return the same token.

## PARSING

SIMPL programs are more than just lists of tokens. They have a complex structure, as reflected by the grammar shown in figure 1. A WHILE loop, for example, consists of a Boolean test and a group of statements; an assignment statement has a variable on the

*(continued)*

Listing 2: VM2 assembly-language code produced by the SIMPL compiler upon compilation of the program in listing 1.

```

BRANCH Euclid
m: 0
n: 0
temp: 0
r: 0
Euclid:
  PUSHC '?'
  WRCHAR
  RDINT
  POPC n
  PUSHC '?'
  WRCHAR
  RDINT
  POPC m
  PUSH n
  PUSH m
  LESS
  BREQL L1
  PUSH n
  POPC temp
  PUSH m
  POPC n
  PUSH temp
  POPC m
L1:
  PUSH n
  PUSH m
  PUSH n
  PUSH m
  DIV
  MUL
  SUB
  POPC r
L2:
  PUSH r
  PUSHC 0
  GREATER
  BREQL L3
  PUSH m
  POPC n
  PUSH r
  POPC m
  PUSH n
  PUSH m
  PUSH n
  PUSH m
  DIV
  MUL
  SUB
  POPC r
  BRANCH L2
L3:
  PUSH m
  WRINT
  HALT

```

left side and an expression on the right; and so on. It is the parser's job to impose structure on the token stream. In my compiler, the parser will actually construct a parse tree—a data structure that reflects the structure of the program. A typical parse tree is shown in figure 2.

Readers of "Context-Free Parsing of Arithmetic Expressions" will recall that I built a parse tree from an expression by writing a procedure for each rule of the grammar and by having the procedure consume just as much of the input as was necessary to parse its particular rule. I'll use the same technique, called top-down or recursive-descent parsing, for my compiler.

**TYPE CHECKING**

Every variable and function in SIMPL has a particular type—integer, character, or Boolean—and the use of these types is governed by several rules. For example, you can only add integers, you can only compare two expressions of the same type for equality, and the types of the arguments to a procedure and the procedure's formal parameters must be identical. Pascal programmers should be familiar with these rules. The compiler enforces them by checking each expression as it is parsed to make sure it conforms. Since variables, procedures, and func-

tions must be declared before they are used, the compiler always knows the types of the variables involved in the expressions.

**CODE GENERATION**

In the fourth phase of compilation, the compiler translates the parse tree into the actual assembly-language code. As I mentioned, this process can be very involved, but for my compiler it is fairly straightforward.

Some compilers have additional phases. Often, an optimization phase occurs either just before or just after code generation. In this phase, transformations are made to either the parse tree or the assembly-language code to make the generated code more efficient.

**INTERMEDIATE REPRESENTATION**

As I've described it, the SIMPL compiler constructs a parse tree from the input and then generates code from the tree. Why not skip the parse tree altogether and have the parser call the code generator directly? This is certainly possible and has the advantage of speed—constructing the parse tree takes some time. But I think it's a good idea to have some sort of intermediate representation (IR) like a parse tree for a couple of reasons.

First, it allows you to separate the "front end" of the compiler—the lex-

ical analyzer, parser, and type checker—from the "back end"—the code generator. The IR serves as a common language that lets the two ends communicate. For instance, if your compiler is too big to fit into memory all at once, you can first generate the IR, then swap in the back end to generate the code. Such multi-pass compilers are common, but mine will only make a single pass over the input.

An IR also makes it easy to mix and match compiler parts, which means you can use the same code generator for Pascal and C or the same front end for a compiler that generates VM2 code and for one that produces Motorola 68000 code. Or, instead of generating code from the IR, you can write an interpreter for it. In short, an IR helps make your compiler more modular, and modularity is the essence of good software engineering.

There's another important reason for using an IR: It provides a more abstract view of the program being compiled. The source code and object code are just lists of characters or numbers, but the IR can represent the program in a way that more clearly reveals its structure to the compiler. For instance, if the compiler wants to know what statements are part of the WHILE loop in listing 1, it can much more easily determine that information from the parse tree in figure 2 than from the source code in listing 1. A compiler may want to use this information for optimizing the code. The IR can aid code generation by making certain aspects of the code explicit. For a stack machine like VM2, the parse tree is a natural choice.

**THE COMPILER IN DETAIL**

I described the various phases of compilation as if they occurred one after the other in a simple procession. In fact, they overlap in a complex dance choreographed by the parser. In the text that follows I'll explore the compiler in greater detail, using the grammar of SIMPL as my guide. I will be referring to specific VM2 instruc-

*(continued)*

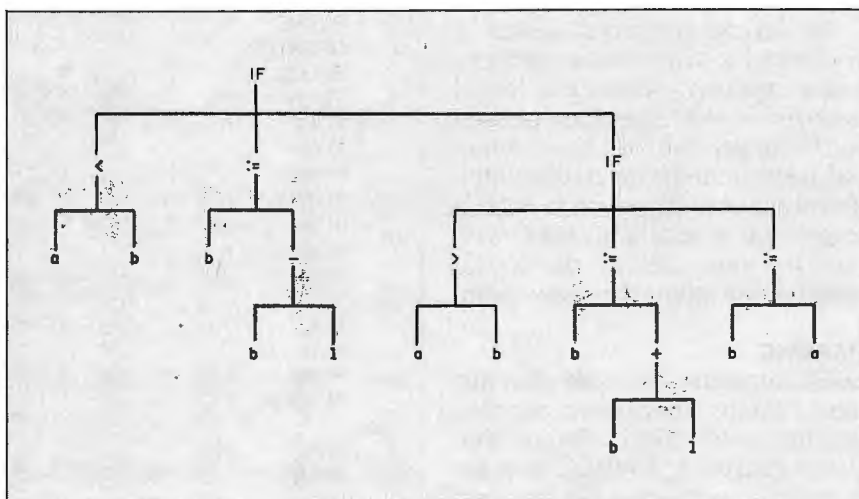
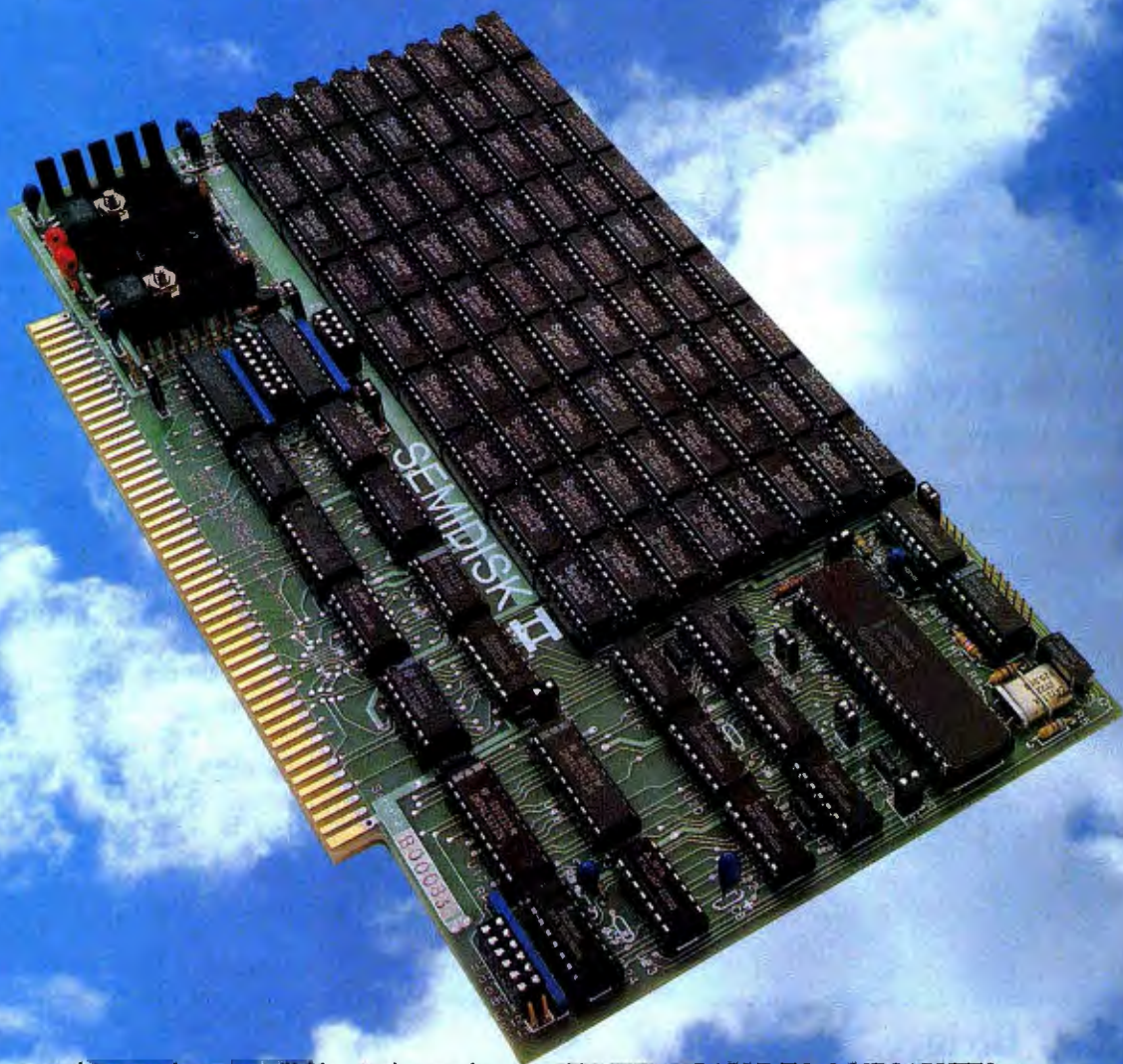


Figure 2: Parse tree for the SIMPL statement IF a < b THEN b := b - 1; ELSIF a > b THEN b := b + 1; ELSE b := a.

# TIME & MONEY

SemiDisk is the disk emulator that saves you more of both.



We've just done something we know you'll like. We've made the SemiDisk far more affordable than ever before. With price cuts over 25% for most of our product line. Even our new 2 megabyte units are included.

#### COMPARE WITH THE OTHERS.

SemiDisk Systems builds fast disk emulators for more microcomputers than anyone else. S-100, IBM PC, Epson QX-10, TRS-80 Models II, 12, and 16. Up to 2 megabytes per board, standard. Up to 8 megabytes per computer, using only four bus slots, max! Software drivers are available for CP/M 80, MS-DOS, ZDOS, TurboDOS, VALDOCS 2, and Cromix. SemiDisk turns good computers into great computers.

#### GREAT NEWS FOR IBM PC AT USERS.

New MS-DOS 3.0 software drives take full advantage of the 80286's expanded instruction set, moving data four times faster than can be done on PC or XT.

#### BATTERY BACKUP, TOO.

At 0.7 amps per 2 megabytes, SemiDisk consumes far less power than the competition. And you don't have to worry if the lights go out. The battery backup option gives you 5-10 hours of data protection during a blackout. Nobody else has this important feature. Why risk valuable data?

#### IT'S EXPANDABLE TO 8 MEGABYTES.

You can start with as little as 512K bytes, and later upgrade to 2 megabytes per board. At your own pace, as your needs expand.

In an IBM PC, XT, and AT you can have multiple drives on a single system. And the SemiDisk gives you mainframe performance on the top of your desk.

#### AND THE BEST NEWS IS SAVED FOR LAST:

	512K	1Mbyte	2Mbyte
SemiDisk I, S-100	\$695	\$1395	
SemiDisk II, S-100	\$995		\$1995
IBM PC, XT, AT	\$595		\$1795
QX-10	\$595		\$1795
TRS-80 II, 12, 16	\$695		\$1795
Battery Backup Unit	\$150	\$150	\$150

## SEMIDISK

SemiDisk Systems, Inc.

P.O. Box GG, Beaverton, Oregon 97075

503-642-3100

Inquiry 324



tions (the instruction set can be found in my October Programming Project "Building a Computer in Software"). [Editor's note: Lowercase routine names refer to routines written in Modula-2, which implement the compiler; uppercase names are either SIMPL keywords or VM2 instructions.]

Compilation begins with the first

line of the grammar. This line corresponds to a procedure in the parser named, not surprisingly, program. The program procedure first calls the lexical analyzer to make sure the first token is the keyword PROGRAM. Then it gets another token, which should be an identifier. This token is the name of the program. The parser

now calls the code generator to output a BRANCH instruction using the program name as a label. This must be done because the main program code is not compiled until after the routines and global variables are compiled; you have to jump over the routine and variable code to get to the main program. The main program occurs at the end of the file because the SIMPL compiler is a one-pass compiler—everything has to be defined before it's used, including the main program's procedures, functions, and variables.

The program procedure then calls two other parser procedures, vars and routines. Then it outputs the program name as a label, calls the block procedure to compile the text of the program, and finally, when it sees the dot token, outputs a HALT instruction. A degenerate SIMPL program—one with no variables, routines, or main program body—such as PROGRAM foo; BEGIN END. compiles into the following two-line program:

```

                BRANCH foo
foo:            HALT
    
```

**VARIABLE DECLARATIONS**

The next five rules—those for vars, varlist, decl, idlist, and type—handle variable declarations. You'll note that the vars rule can be empty; that is, the program might not have any variable declarations. The parser can easily recognize this simply by checking whether the next token is VAR:. If so, the varlist procedure is called; if not, the parser calls the lexical analyzer's ungetToken routine to return the token to the input for future consumption.

The varlist procedure calls the decl procedure, then examines the next token to see if it is a BEGIN, PROCEDURE, or FUNCTION. If it's any of these three, then there are no more variable declarations; if it isn't, then there are more declarations, and varlist calls decl again. In either case, the token is ungetten.

A declaration consists of a list of identifiers—the variable names—followed by a colon and then by a

**If you're tired of waiting, you're using the wrong file manager.**



**Be fast. Btrieve.™**

If batch jobs and reports turn waiting time to nighttime, then wake up! You're using the wrong file manager.

Btrieve™ file management hates waiting as much as you do. It's written in assembly language especially for the IBM PC. And based on b-tree file indexing, with automatic balancing for access speed that won't degrade as your database grows. With Btrieve, your applications always run fast. So you'll be out the door faster.

**The standard for networking.** Btrieve/N (network version) sets the standard for the industry's most popular LANs, including IBM's PC Network. Btrieve/N offers safe network file management that coordinates simultaneous updates and prevents lost data.

**Automatic file recovery.** Btrieve provides automatic file recovery after a

system crash. Your Btrieve data always comes back intact.

**Fully-relational data management.** SoftCraft's entire family of products gives you a complete, fully-relational database management system. Rtrieve™ adds report writing capabilities. Xtrieve™ speeds users through database queries with interactive menus.

**For professional programmers.** Btrieve is the fast, reliable answer for all your application development in BASIC, Pascal, COBOL, C, FORTRAN, and APL. With Btrieve, you can develop better applications faster. And know they'll run—fast.



P. O. Box #917 Austin, Texas 78766  
(512) 346-8380 Telex 358 200

Suggested retail prices: Btrieve, \$245; Btrieve/N, \$595; Xtrieve, \$195; Xtrieve/N, \$395; Rtrieve, \$85; Rtrieve/N, \$175. Requires PC-DOS or MS-DOS 1.X, 2.X, or 3.X. Now available for XENIX.

# SAVE 50% \*



United States  One Year \$21  2 Years \$38  3 Years \$55  
Canada/Mexico  One Year U.S. \$23  2 Years U.S. \$42  3 Years U.S. \$61  
Europe  \$69 (air delivery), U.S. Funds enclosed  
Worldwide  \$37 (surface mail), U.S. Funds enclosed

**BILL ME.** If I'm not completely satisfied with my first copy, I'll simply write "cancel" across your invoice, mail it back, and my subscription will be cancelled.

Check Enclosed  Bill VISA  Bill Mastercard

Please allow 6-8 weeks for processing your subscription.

Name \_\_\_\_\_ 42C5

Address \_\_\_\_\_

City/State/Zip \_\_\_\_\_

Card # \_\_\_\_\_ Expires \_\_\_\_\_

Signature \_\_\_\_\_

\*off newsstand price of \$42.00



# SAVE 50% \*



United States  One Year \$21  2 Years \$38  3 Years \$55  
Canada/Mexico  One Year U.S. \$23  2 Years U.S. \$42  3 Years U.S. \$61  
Europe  \$69 (air delivery), U.S. Funds enclosed  
Worldwide  \$37 (surface mail), U.S. Funds enclosed

**BILL ME.** If I'm not completely satisfied with my first copy, I'll simply write "cancel" across your invoice, mail it back, and my subscription will be cancelled.

Check Enclosed  Bill VISA  Bill Mastercard

Please allow 6-8 weeks for processing your subscription.

Name \_\_\_\_\_ 42C5

Address \_\_\_\_\_

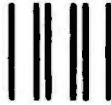
City/State/Zip \_\_\_\_\_

Card # \_\_\_\_\_ Expires \_\_\_\_\_

Signature \_\_\_\_\_

\*off newsstand price of \$42.00





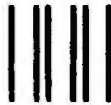
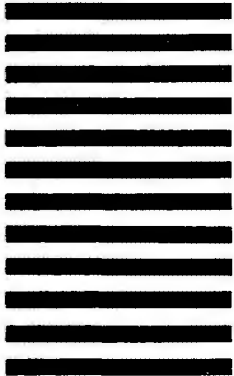
NO POSTAGE  
NECESSARY  
IF MAILED  
IN THE  
UNITED STATES

**BUSINESS REPLY MAIL**  
FIRST CLASS PERMIT NO. 39 MARTINSVILLE, NJ

POSTAGE WILL BE PAID BY ADDRESSEE

**BYTE**

Subscription Dept.  
P.O. Box 597  
Martinsville, NJ 08836-9956



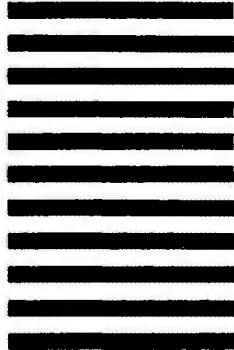
NO POSTAGE  
NECESSARY  
IF MAILED  
IN THE  
UNITED STATES

**BUSINESS REPLY MAIL**  
FIRST CLASS PERMIT NO. 39 MARTINSVILLE, NJ

POSTAGE WILL BE PAID BY ADDRESSEE

**BYTE**

Subscription Dept.  
P.O. Box 597  
Martinsville, NJ 08836-9956





type name. The decl procedure begins by calling idlist, which returns the identifiers in a linked list. Then decl reads the type name and calls the code generator to generate code for the variables. Then, a label—the variable's name—has to be generated, followed by some initial value for the variable. I use 0 as an initial value, which is interpreted as FALSE for Boolean variables and as the ASCII NUL character for character variables.

However, the compiler must do more than merely generate code. It also has to store information about these variables for use later in the compilation. The type of a variable is needed for type checking, and the fact that a variable is global will affect how the code generator produces references to it. My compiler puts all this information into a record called a symbol and inserts it into its symbol table. The symbol table is a close relative of the label table used in the VM2 assembler—it has a similar purpose and is also best implemented as a hash table. The compiler's symbol table is rather more complex, though, because it also has to handle local variables. I'll defer discussion of its complexities to the second part of this series.

**STATEMENTS**

The bulk of the compiler is involved in translating SIMPL statements. Statements occur in lists, as the stmts line in figure 1 indicates. A list of statements can be empty. How does the stmts procedure recognize this? If you examine the grammar closely, you'll notice that any statement list is ended by one of the three keywords ELSE, ELSIF, or END, so these can be used to tell when a statement list is empty.

Let's examine each of the SIMPL statements in turn. I will defer treatment of the procedure call and RETURN statements to part 2 of this series. Figure 3 illustrates the code generated for each type of statement.

**ASSIGNMENT STATEMENTS**

To parse an assignment statement, the parser first calls the lexical analyzer to get the identifier on the left side

of the statement. The parser can't distinguish an assignment statement from a procedure call until it calls the lexical analyzer to read the next token. If the next token is a =, the parser knows this is an assignment statement. Then the parser checks to see if the identifier has been defined by looking it up in the symbol table. It also checks to make sure the identifier is the name of a variable, not a procedure or function. The parser then calls the expr routine to parse the expression and subsequently calls a special tree-building procedure to construct the parse tree from the variable and the expression. Parse trees consist of several different types of nodes. The tree-building procedure for the assignment statement creates a symbol node for the variable, an expression node for the expression, and makes both these nodes the children of an assignment node. It also checks the types of the variable and the expression to make sure they match.

To generate the code for an assign-

ment statement, the code generator first generates code for the expression. At run time, after this code is executed, the result of the expression will be on the top of the stack. To store it in the variable, the compiler needs only to generate a POPC instruction with the variable's name as an argument (see figure 3a).

**THE WHILE STATEMENT**

The parser's while procedure reads the expression following the WHILE token and checks to make sure its type is BOOLEAN. It then reads the DO followed by a list of statements. A tree-building procedure creates a WHILE node and makes the Boolean expression and the statement list its children.

To generate code for a WHILE statement, the compiler first creates two new labels; let's call them START and END for now, although in the actual code generator there is a special function that generates a unique label

*(continued)*

(a) var := expr	(code for expr) POPC var
(b) WHILE expr DO stmts; END;	START: (code for expr) BREQL END (code for stmts) BRANCH START END:
(c) IF expr THEN stmts END;	(code for expr) BREQL END (code for stmts) END:
(d) IF expr THEN stmts1 ELSE stmts2 END;	(code for expr) BREQL ELSE (code for stmts1) BRANCH END ELSE: (code for stmts2) END:
(e) WRITE(intexpr, charexpr);	(code for intexpr) WRINT (code for charexpr) WRCHAR
(f) READ(intvar, charvar);	RDINT POPC intvar RDCHAR POPC charvar

Figure 3: VM2 code generated for SIMPL statements.

name each time it is called in order to avoid name conflicts. The code generator begins by outputting the START label and then generates code for the Boolean expression. If this expression evaluates to FALSE, the loop shouldn't be executed, so the instruction BREQL END is output; this will have the effect of branching to the END label if the expression evaluates to FALSE. Now the body of the loop is generated, followed by a BRANCH START instruction to repeat the loop. Finally, the code generator outputs the END label (see figure 3b).

**THE IF STATEMENT**

The IF statement is a bit tricky to parse because it may contain ELSIFs and an ELSE. I have divided the work among three procedures, if, elsif, and else. You can tell when an ELSE is empty by seeing if the next token is END.

As with the WHILE statement, I check to make sure that I have parsed a Boolean expression. When I am done parsing, I build a tree whose root is an IF node and whose three children are the Boolean test, the THEN part, and the ELSE part. Note that the ELSE part may itself be another IF statement; this is what happens when ELSIF is used (see figure 1). If there is no ELSE part, I fill the

ELSE slot of the IF node with the value NIL.

To generate code for an IF with no ELSE part, I create a single new label: END. I generate code for the Boolean expression and then output a BREQL END instruction, because I want to skip the THEN part if the expression is false. Then I generate the THEN part and finally output the END label (see figure 3c).

When an IF has an ELSE part, I create two new labels—ELSE and END. Again, I first generate the Boolean expression. Now, if this expression is false I want to branch to the ELSE part, so I generate a BREQL ELSE instruction. Then I generate the THEN part of the code, but I follow it by a BRANCH END instruction so control doesn't fall through to the ELSE code. I then output the ELSE label followed by the code for the ELSE part. Finally, I output the END label (see figure 3d).

**THE READ AND WRITE STATEMENTS**

The parsing of READ and WRITE statements is similar; in both cases, I read a list of expressions and attach this list to either a READ or a WRITE node, as the case may be. I also check each argument to make sure it is of type, INTEGER or CHAR. For a READ

statement I check to make sure the argument is a variable.

To generate code for a WRITE statement, I generate the code for each expression, immediately followed by either a WRINT or a WRCHAR instruction, depending on the type of the expression. For each variable in a READ statement, I first generate either a RDINT or a RDCHAR instruction, then a POPC with the name of the variable (see figures 3e and 3f).

**EXPRESSIONS**

The parser used for expressions is similar to the one I described in "Context-Free Parsing of Arithmetic Expressions." It has been expanded to handle variables, function calls, and Boolean operators, and it has been made left-associative so that it parses arithmetic operators in this way:  $a + b + c$  will be parsed as  $(a + b) + c$  rather than as  $a + (b + c)$ .

The compiler type checks expressions as their trees are constructed. Before constructing the tree for  $a + b$ , for example, the compiler makes sure that  $a$  and  $b$  have been defined as variables of type INTEGER. The Boolean operators AND, OR, and NOT require Boolean operands. For relational operators like  $=$  and  $>$ , it doesn't matter what type the two operands are, so long as they are of the same type.

Because of the way I designed VM2's instruction set, generating code for expressions is easy. I first generate the code to place the operands on the stack using the instructions PUSH (for variables) or PUSHC (for constants), then I output the instruction corresponding to the operator. All operators but AND and OR have a corresponding instruction. See figure 4a for the code generated by an expression.

The operators AND and OR are special cases because the second argument shouldn't be evaluated unless absolutely necessary. I treat them much like IF statements. For AND, I first create two new labels, which I'll call FALSE and END. I generate the code for the first argument, then generate a BREQL FALSE

(a) $1 + x = 5 - y * z$	PUSHC 1 PUSH x ADD PUSHC 5 PUSH y PUSH z MUL SUB EQUAL
(b) $a = b \text{ AND } c <> d$	PUSH a PUSH b EQUAL BREQL FALSE PUSH c PUSH d NOTE Q BRANCH END FALSE: PUSHC 0 END:

Figure 4: VM2 code generated for SIMPL expressions.

instruction. After that I generate the code for the second argument and then a BRANCH END. Then I output the label FALSE, followed by a PUSHC 0 instruction. Finally, I output the END label. This code will have the following effect at run time: If the first argument evaluates to FALSE, then a FALSE (that is, a 0) is pushed on the stack and the code for the second argument is skipped. If the first argument comes out TRUE, then the second argument is evaluated, and its result is the result of the entire AND. Things are reversed for OR. If the first argument is TRUE, I push TRUE and skip the second argument; otherwise, the result of the second argument is the result of the entire OR. The code generated for an AND statement is in figure 4b.

#### ERROR HANDLING

It is notoriously difficult to write a compiler that can recover gracefully from an error in the source program and continue compiling. On the other hand, you wouldn't want to make the compiler too lenient when it encounters an error—a friend of mine speaks of how he used to feed interoffice memos to a COBOL compiler to see if they would compile successfully. They often did.

One solution to the error-handling problem is to stop the compiler after the first error is found, but this is a cop-out. I'd like the compiler to find as many errors as it can so I can try to fix them all at once. At the same time, I want to avoid cascades of errors, where the first error triggers new ones that wouldn't have appeared if the first error had not occurred. A compiler that frequently produces error cascades is just as bad as one that dies after the first error because you will trust the compiler only for the first error anyway. Error cascades are particularly common for syntax errors because it's hard to know where to continue parsing when something unexpected appears.

My compiler is far from ideal at handling syntax errors, but it deals with other errors reasonably well. The basic rule I use in parsing is, if an

expected token does not appear in the input, pretend it did appear and continue on without it. For example, if the keyword PROGRAM does not appear at the beginning of the program, the compiler prints out an error message and acts as if it did appear. Similarly, if the program name is omitted, the compiler prints an error message, makes up a dummy name, and continues. Sometimes such errors are not handled so gracefully. If you meant to write WHILE a > b DO ... and instead omitted the WHILE keyword, the parser would read the identifier a and begin compiling the statement as if it were a call or assignment. The resulting error cascade isn't pretty.

A common source of error cascades is an undeclared variable. Some compilers will tell you over and over again that a variable is undeclared, outputting a message every time the variable is encountered. A much better solution is to print the message once and then ignore that variable from then on. I do this by inserting the variable in the symbol table once it has been seen. But what type should it be given? If I decide to make it an integer when in fact the programmer intended it to be a Boolean, I will find myself with a bunch of unnecessary type errors.

My solution is to give undeclared variables the special type Unknown. Unknown is compatible with every other type, so the type-checking routines will never find a problem with a variable of type Unknown.

#### IMPLEMENTATION NOTES

The key to writing a program as large as a compiler is breaking it up into small, independent parts. As I said before, my program is divided into 12 modules.

The main module is called Compiler. It is short and does little more than read an input filename and call the parser. Because of its size, the parser is divided into three separate modules: Parser handles the bulk of SIMPL, ExprParser takes care of expressions, and Routines is concerned with procedures and functions.

## *A common source of error cascades is an undeclared variable.*

The LexAn module contains the lexical analyzer. The Token module defines the token data structure as well as some other useful types and constants. TypeChecker handles type checking, of course. Equally obvious is the function of SymbolTable. The Symbol module defines the data structure used for storing identifiers in the symbol table, and the Node module defines the data structure used to construct parse trees. Node also contains the important tree-building procedures.

Two other modules constitute the compiler's back end. CodeGen takes parse trees and calls procedures in CodeWrite to actually output the VM2 instructions.

My motivation for dividing the work up as I did was to distribute the load evenly. The code generator's time is split between the abstract work of generating code from parse trees, handled by CodeGen, and the nitty-gritty details of outputting VM2 assembly-language instructions, handled by CodeWrite. The parser definitely has the hardest job in this compiler, so I tried to make its tasks as simple as I could. The lexical analyzer looks up keywords in the symbol table and provides several routines that handle the work of generating syntax errors, thus relieving the parser of those burdens. The tree-building routines of the Node module not only construct trees but do much of the type checking as well. The code generator need only be given the parse tree to generate code.

#### CONCLUSION

As it stands now, the compiler is incomplete. The implementation of procedures and functions remains to be done, but the framework is in place. At heart, all compilers resemble the program described here. ■

# How to Save Money ...

## IBM PC SYSTEMS

### MAINSTREET ENHANCED

**PC \$1965**  
with 10 MB Disk



Same System with  
20 MB Hard Disk  
**\$2085**

- 360kb Tandon Floppy
- 10 MEG ADEPT Hard Disk
- 256K RAM
- All Controllers, Cables, Manual
- 1 Year Warranty

Monitor Not Included Many Options Available

## IBM PC/AT

**AT PLUS**  
**\$3860**

20MB System  
Includes:

- 12 MB Floppy
- 360 KB Floppy
- 512K RAM
- 20 MB Hard Disk
- Serial/Clock
- All Cables, Controllers, Manual



Same System  
with 32 mb  
**\$4071**

Monitor Not Included

## MORE IBM PC SYSTEMS FROM MAINSTREET

### ← SUPER PC

- 256K RAM
- 360K Floppy
- 10 MEG

- Tape Drive
- 135 Watt
- 640K RAM

### ← Slot Saver

- 2-360K Floppies

- ✓ • 20 MB Hard Disk
- Perisyst Video Combo
- 3 Slots Available

### ← SUPER PC+

- 640K RAM
- 2 Floppy
- 20 MEG HARD
- Tape Backup

- AST 6 PAK
- 135 Watt Power

### ← PC 2/20

- 256K RAM
- 2-360K Floppies
- 20MB Hard Disk

### CHIPS

64K - **\$8**  
DRAMS

256K - **\$35**  
DRAMS

8087-3-\$129  
80287-\$250

## Printers

EPSON FX-80+ .....	\$299
EPSON LQ-1500 .....	\$929
EPSON FX-185 .....	\$499
EPSON LX-80 .....	\$220
TOSHIBA 1340 .....	\$569
TOSHIBA 351 .....	\$1099
TOSHIBA 1351 .....	\$999
TOSHIBA 341 .....	\$939
NEC E•L•F .....	\$449
CITIZEN MSP-10 .....	\$299
OKIDATA 182 .....	\$239
OKIDATA 192 .....	\$349
OKIDATA 193 .....	\$549
OKIDATA 84 .....	\$759

### BACK-UP POWER

#### ADEPT

DataShield AT 900 ..	\$699
Back up power 800 Watts	
DataShield XT300 ..	\$369
DataShield PC200 ..	\$285
DataShield AT500 ..	\$559

### SURGE Protection

DataShield S100 .....	\$59
DataShield S85 .....	\$49
DataShield S75 .....	\$36
Keatington Masterpiece .....	\$95

Computer Accessories

## COMPAQ DESKPRO™

20 MB  
System  
**\$2999**

- FAST 8086 Processor
- 640K RAM
- 20 MB Hard Disk
- 2 - 360kb Floppy
- High Resolution Monitor
- Basic
- 1 Year Warranty

Tape Back Up  
10 MB \$590  
20MB  
\$739

TO PLACE YOUR ORDER CALL  
**1-800-426-MAIN**

**RODIME**  
10 MB  
For  
Compaq  
**\$475**

**COMPAQ Portable**  
**\$2466**

256K, 360KB Floppy, 10MB Hard Disk

**ORDERING INFO:** All Mail: 1025 Main St., Bastrop TX 78602. We accept personal and corporate checks. No delay if driver's license and expiration included. Shipping is free on prepaid orders via UPS Ground. Air is extra. We accept VISA, MC. (Am. Exp. and Diner's Club = 3% surcharge.) We double manufacturer's warranty on all hardware. Software is not returnable. All goods are new.  
Inquiry 220 B1285



# Buy Mainstreet and Adept

## ADEPT PC



**\$749**  
ADEPT  
Personal  
Computer

- 640K RAM
- 360Kb Floppy
- "Touch Type" Keyboard
- 1 Year Warranty
- Runs IBM™ Software

30 Day Trial / 100% Credit Towards IBM PC

**ADEPT**  
SYSTEMS

## ADEPT AT



**\$1975**

- 80286 Microprocessor
- 1 Megabyte Motherboard
- 1.2 MEG Floppy Drive
- Hard Disk Controller
- "Touch Type AT" Keyboard
- Runs IBM PC, XT, AT Software
- 8 Full-Size Expansion Slots
- 1 Year Warranty

Ask About Our 30 Day Trial Offer

### Quick-Six Multifunction Board **\$139**

- Serial Port
- Parallel
- 384K RAM
- Clock/Calendar
- RAM Disk Software
- Print Spooler

For A Limited Time

Includes **SIDEKICK!**  
\$54.95 Value Free

### AT E•X•P BOARD

- 3MB RAM
  - Serial Port
  - Parallel Port
  - For IBM or ADEPT AT
- \$289**

### MONO/GRAPHICS BALANCE I **\$229**

- 720 x 348 Resolution
- Parallel
- Serial
- Runs 1-2-3

**Balance II  
\$299**

**Mono/Color Graphics**

### HIGH SPEED TAPE BACK-UP

**\$739**  
20MB

Backs up 20 MB in  
less than 10 minutes

**60 MB**

**\$899**

Similar to TECMAR  
QIC-60

### HARD DISKS by ADEPT

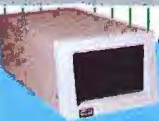
**20MB  
\$490**

- Half-Height
- Complete System
- Mounts Internally
- 1 Year Warranty

**10 MB - \$390**

**32MB - \$695**

For really FAST access, call our  
hard drive specialist — 800-426-6246

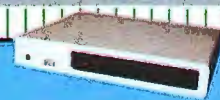


10,20,32MB... From **\$595**  
10 MB

#### Combination Systems

HARD DRIVE	TAPE	PRICE
10 MEG	10 MEG	\$1185
20 MEG	20 MEG	\$1390
20 MEG	60 MEG	\$1665
32 MEG	60 MEG	\$1870

A perfect match! Colors and casing to conform with your IBM or ADEPT PC. In two convenient models to suit your space requirements. Add hard drives in 10, 20, 32 or 40 megabytes. Cartridge tape backup in 10, 20 or 60 megabytes. Combine hard drive and tape backup for complete storage solutions. All units come with power supply, cables, software and manual.



10,20,32MB... From **\$635**  
10 MB

#### Combination Systems

HARD DRIVE	TAPE	PRICE
10 MEG	10 MEG	\$1225
20 MEG	20 MEG	\$1430
20 MEG	60 MEG	\$1705
32 MEG	60 MEG	\$1915

IBM, XT and AT are trademarks of International Business Machines Corporation. Copy II is a trademark of the Computer Corporation. All brands are registered trademarks. Prices are subject to change without notice.

**800 426-6246** Mainstreet Computer  
**ORDERS** 1025 Main St.  
**512 321-4406** Bastrop, TX 78602  
Hours:  
Mon-Fri: 9 am-6 pm  
Saturday: 9 am-3 pm

### SOFTWARE—Many titles available 800 426-6246

Call for Latest Version and Price  
Examples—Borland Superkey \$35 Copy II PC \$25  
Multimate \$238 Norton Utilities \$49

24 Hour  
Bulletin  
Board  
Service  
UPLOAD  
SIGS  
MAIL  
DOWNLOAD  
ORDERING  
512-321-7317  
All Non-  
Order Calls  
512-321-4406

# THE TANDY 600 AND THE TANDY 3000

## A laptop computer with disk storage and an IBM PC AT clone

*Editor's note: The following is a BYTE product description. It is not a review. We provide an advance look at these new products because we feel they are significant. This description is based on a look at a production version of the Tandy 600 and at a prototype Tandy 3000.*

**A** new Tandy Corporation laptop computer and an IBM PC AT clone debuted this fall (see photo 1). Announced on October 28th, the Japanese-made Tandy 600 is an 80C88-based laptop machine with a maximum RAM (random-access read/write memory) potential of 224K bytes and a built-in 360K-byte 3½-inch disk drive. A 9½-pound machine with a flip-up 80-character by 16-line LCD (liquid-crystal display), the Tandy 600 costs \$1599. Unveiled at COMDEX in Las Vegas, the Tandy 3000, a clone of IBM's PC AT, carries a price tag as low as \$2599.

### THE TANDY 600

Product designers at Tandy describe the Tandy 600 as a machine with the features that users of the Model 100 and the Tandy 200 most often requested: an 80-column screen, a disk drive, and more RAM. Tandy also availed itself of the opportunity to upgrade its previous portable computer software in this addition to its laptop computer line.

To address more RAM without complicated bank-switching hardware and software, Tandy chose to power the 600 with a CMOS (complementary metal-oxide semiconductor) version of the Intel 8088 microprocessor running at 3.07 MHz. Standard RAM is a paltry 32K bytes, but 96K-byte RAM upgrade kits are available for \$399.95 per kit, plus installation by Tandy. The Tandy 600 can accommodate up to 224K bytes of RAM. Thus, a Tandy 600 with maximum RAM will cost a tidy \$2398.90 plus memory installation costs.

The 80-column by 16-line LCD is adjustable for lighting conditions and has a matte finish to reduce glare. The 9- by 2½-inch LCD flips up to reveal a keyboard similar to the Tandy 200's. This 72-key, typewriter-style keyboard offers 10 function keys, 4 cursor-control keys, a Label key, and a Num Lock key to turn letter keys on the right side of the keyboard into a numeric keypad.

The built-in disk drive is a 3½-inch, 360K-byte drive located at the right rear of the case. Using a limited operating system called Microsoft Works 1.20, the drive can store text files or programs. For example, Microsoft Multiplan, a bundled spreadsheet program supplied in ROM (read-only memory), can be copied onto disk so that the ROM socket can be used for a custom application or for the optional BASIC ROM (\$129.95). BASIC also can be saved to disk and loaded into RAM when needed.

All this hardware can be powered for up to 11 hours (with minimal disk activity) by built-in nicad (nickel-cadmium) batteries or by an external AC adapter/charger. The adapter/

charger charges the nicad batteries up to a maximum of 14 hours when it is attached.

The other standard features of the Tandy 600 include an internal 300-bps (bits per second) modem with auto-dial/auto-answer and host modes, an expansion bus for an external disk drive, a parallel printer port, an RS-232C serial port, and a built-in clock that can power up the machine at a preset time to take a phone call or run an application.

### TANDY 600 SOFTWARE

Bearing a coincidental resemblance to the DeskMate software that Tandy bundles with its MS-DOS computers, the Tandy 600's software features an operating system and five applications. The System Manager is a shell around Microsoft Works that handles file management for the disk drive and RAM. The five bundled applications are Word, a word processor whose files are compatible with the Microsoft word processor of the same name; Calendar, an alarm-driven appointment scheduler; File, a database manager; Telcom, for driving telecommunications activity; and Multiplan, reportedly a "99.5 percent version" of the IBM PC spreadsheet. In addition, a four-function memory calculator is available at any time as well as an

alarm function that can be preset to act as a reminder.

Microsoft Works was originally developed for the Heath ZP-150 laptop machine and looks vaguely like MS-DOS. Its functions are limited to formatting and copying disks, copying files from RAM to disk (or vice versa), listing or deleting files from RAM or disk, renaming files, and running applications. You invoke these functions by selection from a menu. The System Manager does allow wild-card characters in command operations. In spite

of the passing resemblance to MS-DOS, however, the Tandy 600 disk format is not compatible with any other 3½-inch disk format. The System Manager also has a Set command to adjust the time for the sleep mode, to switch the machine's beep tone on and off, to preset power-up date and time for the wake-up mode, and to specify printer parameters (margins, page length and width, and continuous or sheet feed).

The text editor offers broader features than the rudimentary editors

that came with the Model 100 and the Tandy 200. Called Word, this revamped editor provides more complete formatting functions, including right justification, multiple format lines, and automatic page numbering, plus enhanced editing commands like global search and replace. Liberal use of the function keys to implement a variety of text selection operations,

*(continued)*

G. Michael Vose is a senior technical editor at BYTE. He can be contacted at POB 372, Hancock, NH 03449.



Photo 1: The Tandy 3000 and the Tandy 600.

*The liveliest game  
in personal computers  
today is building  
IBM PC AT clones.*

such as select word or select sentence, make copying, moving, and deleting text a simple operation. You can merge two documents and alter the format of any part of a document.

The appointment scheduler bundled with the Tandy 600 can be set to sound an alarm to remind users of appointments and will even display a text message at the bottom of the screen to explain the alarm. This Calendar application uses two calendar types: a month calendar and daily diaries. The diaries supply detailed information for individual days in the month calendars.

The Tandy 600's database manager, called File, can sort records alphabetically, numerically, or chronologically and search the database according to numerous search criteria. Each File database can provide up to 4095 records having up to 64 fields of up to 230 characters per field.

One of the most practical applications for a laptop computer is its use as a smart terminal for telecommunications. The Tandy 600's Telcom program drives an internal 300-bps modem and offers auto-answer, auto-dial, wake-up, and host modes. With the proper script, the Telcom software can turn the computer on, call another computer, and upload or download files to RAM or disk. It supports the XMODEM protocol for error detection during data transmission. Telcom displays its status (on-line or off-line) plus connect time on the Tandy 600's sixteenth screen line; this static display naturally draws the eye away from the scrolling text just above it and may confuse some first-time users.

Finally, there is Multiplan, extended from the Tandy 200 version to be very close to the IBM PC version. Multiplan

data can be lifted from a spreadsheet and pasted into a Word document, and the program can generate SYLK files for transporting data to other programs. There are some limitations to this and all Tandy 600 applications; for example, the maximum size for any data file is 64K bytes.

#### OPERATION

The Tandy 600 features an automatic power-off, or sleep, function that turns the machine off after a user-selectable time period (the default setting is 5 minutes). Disk-intensive operations will decrease the time the machine can function on batteries between charges. One hour of disk I/O (input/output), for example, reduces the operating time between charges to 8 hours.

RAM in the Tandy 600 is battery-backed so that the machine can be turned off without losing the contents of memory. But the disk-storage capability of the machine will greatly ease the pressure to clutter up RAM with dozens of files.

An especially attractive feature is the potential for placing custom applications in the ROM slot occupied by the Multiplan ROM. Using standard 27256 EPROMs (erasable programmable read-only memories) and a Molex chip carrier for easy removal/insertion of chips, you can plug in any new application designed to run on the Tandy 600. Software developers can get all the information necessary to customize 8088 applications from the owner's manual or the separate hardware service manual (available for "less than \$25").

Tandy supplies a 302-page, indexed, spiral-bound owner's manual that is organized by application. Each section provides a quick reference to that application's functions, followed by an extensive tutorial.

#### THE TANDY 3000

The liveliest game in personal computers today is building clones of IBM's PC AT. At least a dozen clones had been announced through September of this year and most offered something IBM didn't. The only

surprising thing about the Tandy AT clone, called the Tandy 3000, is that it took the company so long to get the machine to market.

Made by Tandy in Fort Worth, the Tandy 3000 claims a 33 percent speed increase over the AT due to a higher clock speed (8 MHz versus 6 MHz) and single-wait-state operation (as opposed to two wait states in the AT). A standard Tandy 3000 offers 512K bytes of RAM and a 20-megabyte hard disk and a 1.2-megabyte floppy disk. The cabinet has room for an additional disk drive, either fixed or floppy. The machine supports four disk drives altogether, two fixed and two floppy, including a 360K-byte floppy.

A Tandy 3000 with two floppy drives, one 360K-byte and one 1.2-megabyte quad-density drive, costs \$2599. The same machine with a 20-megabyte fixed-disk drive in place of one of the floppy drives carries a \$3599 price tag.

RAM in the Tandy 3000 is expandable to a full 16 megabytes; the motherboard holds 640K bytes (using 256K-byte dynamic RAMs) and 2-megabyte expansion boards are scheduled for January 1986 shipment. These memory-expansion boards can occupy up to six AT expansion slots; two XT slots are available as well.

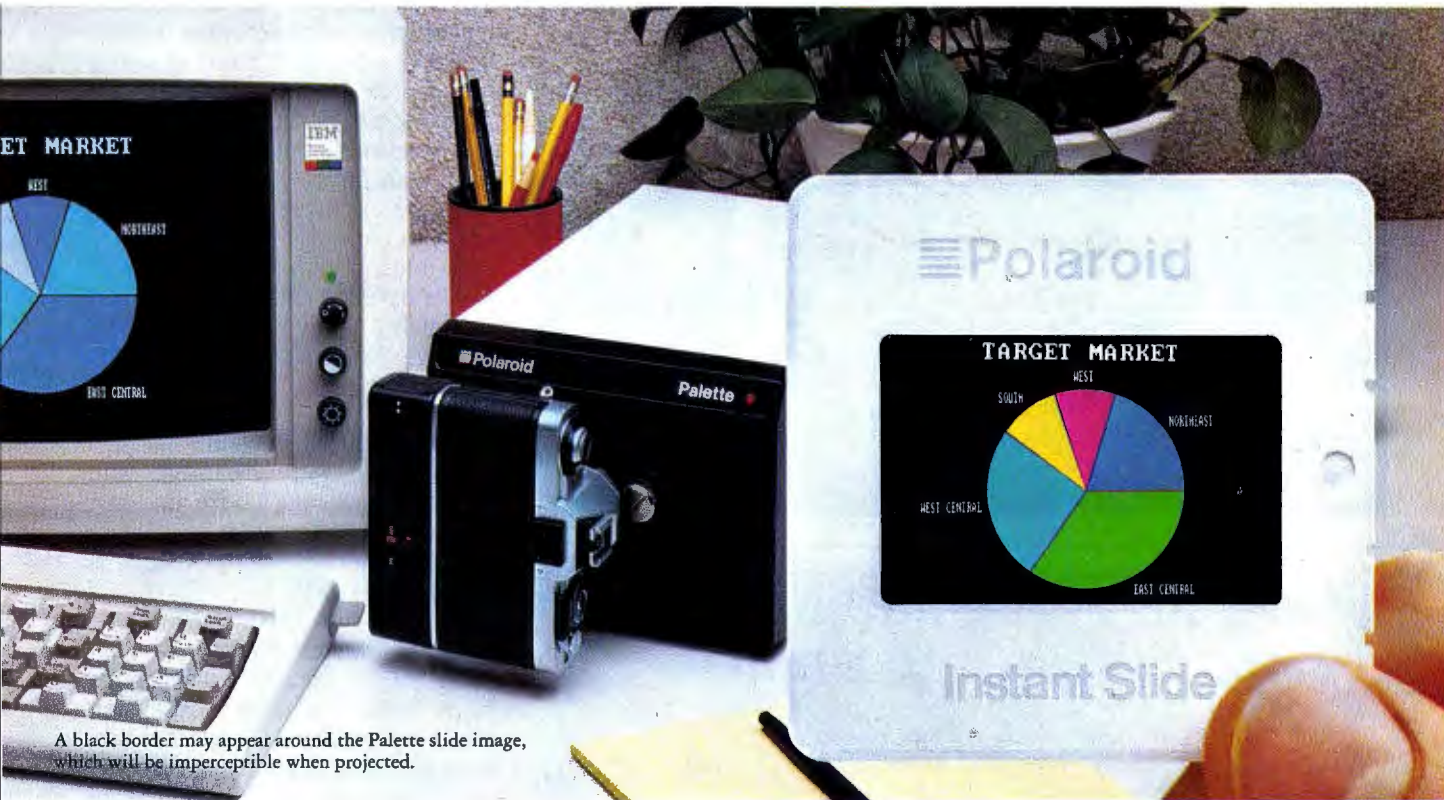
Other standard equipment includes battery-backed CMOS RAM and a real-time clock, plus a serial/parallel adapter that uses an XT-compatible expansion half-slot to provide one serial and one parallel port. The keyboard is a copy of the AT keyboard and is not compatible with the Tandy 1000/2000 keyboard.

To reduce the cost of the computer, Tandy engineers eliminated the key that disables the keyboard and locks the case of an AT. Utilizing 256K-byte dynamic RAMs reduces power demands sufficiently to allow the use of a 175-watt power supply. The power supply is switchable between 120- and 240-volt operation via a Molex jumper inside the power supply's case. A two-speed, thermostatically controlled fan cools the internal

*(continued)*



# Now last minute presentations can be made from your personal computer. In color. In house. In minutes.



A black border may appear around the Palette slide image, which will be imperceptible when projected.

## Introducing Polaroid Palette.

Whether your presentation is in 30 minutes or 30 days, the new Polaroid Palette Computer Image Recorder will make it easier. Priced at under \$2000,\* it lets you make Polaroid 35mm instant color slides or prints from personal computer generated data. In minutes you can create a presentation right at your desk. Without sending out for processing, paying for rush service or risking the security of confidential information.

**Works with the graphics packages of the IBM PC or XT, DEC Rainbow or PRO, Apple IIe or II+ and AT&T 6300.**

When using such popular software packages as Graphwriter, Chart-Master, Sign-Master, Mirage, DR Draw and DR Graph, Palette can virtually double both

the horizontal and vertical resolution of your monitor. Plus, a "backfill" feature reduces raster lines for a smoother, more finished appearance. The result — presentation quality slides. On-the-spot.

### Color 35mm slides, even from a black and white CRT

Think of it as an artist's palette "painting" your graphs, charts and text with up to 72 colors. Even if you have a black and white monitor. If you don't like red, press a few keys — it's green. And if you're not the artistic-type, Polaroid has developed a menu of color sets specially coordinated to complement your presentations.

To find out more about how Palette can make your deadlines in no time, call this number or return this coupon.

Look at it this way, now you can change your presentations as fast as you change your mind.

For a demonstration, call toll-free, or mail the coupon to Polaroid Corp., E.I. Marketing, Dept. 616, 575 Technology Sq., Cambridge, MA 02139.

**CALL 1-800-225-1618**

Send information.  Have representative call.

Name \_\_\_\_\_ Title \_\_\_\_\_

Company \_\_\_\_\_

Address \_\_\_\_\_

City \_\_\_\_\_ State \_\_\_\_\_ Zip \_\_\_\_\_

Telephone (\_\_\_\_) \_\_\_\_\_

PC make and model \_\_\_\_\_

 **Polaroid**

B-12/85

\*Suggested list price. Polaroid®

**SUNDA 10-5** **PROMPT DELIVERY**

ATARI PRINCE  
Apple  
brother  
**COMPUTERS, PRINTERS,  
DISK DRIVES, MODEMS,  
MONITORS, ACCESSORIES,  
FURNITURE & EXPERIENCE**

IBM  
QUADRAM  
SONY  
SHARP  
MAXELL  
MDEK  
easywriter  
HARPER  
MAXAN  
KIDATA  
OPAQ  
VENUE  
KHOA  
STAR  
AKA  
POLYMER  
Verm  
Car  
OLYMP  
M  
Tandy  
lay  
com

**GUARANTEED  
LOWEST PRICES**

**COMPUTER: 1-800-874-1235  
VIDEO: 1-800-223-6779**

**TOLL FREE  
OUT OF N.Y.**

**IN N.Y. CALL (718) 237-2828**

**S'N W ELECTRONICS & APPLIANCES**  
633 Bedford Ave, Bklyn, NY 11211

Hours: Mon-Thurs 9-6  
Fri 9-2, Sun 10-5, Sat Closed

C.O.D. Accepted

Credit Card Access charged at time of order  
Add Ship. & Ins. charges  
Prices subject to change without notice  
Not responsible for transportation errors

TANDY 600 & 3000

electronics of the machine.

There are no custom parts in the Tandy 3000, and its disk controller is the same Western Digital controller used in the AT. Tandy engineers do not expect any hard-disk problems with their machine due to finer tuning of the noise-sensitive phase-locked loop circuitry. To ensure better data capture from the data bus, the phase-locked loop circuit requires a high bandwidth, but undertuning the circuit can fail to filter out enough noise and this may have been a problem with early ATs.

The Mitsubishi fixed-disk drives in the Tandy 3000 are shock-mounted for stability. Tandy expects to offer a 40-megabyte version of this drive by March 1986.

**TANDY 3000 SOFTWARE**

MS-DOS 3.1 with GW-BASIC and DeskMate or XENIX 5.0 are the operating-system options for the Tandy 3000. Neither operating system is bundled; MS-DOS and XENIX will cost extra, and XENIX will not be ready until March 1986.

XENIX 5.0 supports six users on the Tandy 3000, using an expansion board that provides a separate microprocessor and memory to support four of the users. Since version 5.0 of XENIX is not expected for the MC68000-based Tandy 6000 in the near future, the Tandy 3000 will not be directly compatible with the 6000. The machines can share the Vianet local-area network recently announced by Tandy. Vianet can connect a mixture of MS-DOS and XENIX machines.

The Tandy 3000 uses a Phoenix Software BIOS (basic input/output system) and claims 100 percent compatibility with the PC AT.

A run of BYTE's BASIC version of the Sieve of Eratosthenes benchmark on a non-production model of the Tandy 3000 yielded a 55.3-second average execution time, a 30.8 percent decrease over the published execution times for the same benchmark on an AT (see "The IBM PC AT" by Alan Finger, May BYTE, page 270). ■

**Powerful InCircuit Emulation,  
Priced Within Your Budget.  
That's NICE™**

Remember the NICE™ Z80? Nicolet has added a "+" to give you full speed, real-time execution, operation up to 8 MHz, 16 hardware breakpoints, 8k of overlay RAM, histograms and loading of Intel Hex Code. It even works with the new Z80C microprocessors.

Designed for system development, troubleshooting, debugging or testing in the lab, field, or at home, the NICE Z80+ simply plugs directly into the target microprocessor socket and any RS-232 terminal or terminal emulator.

At \$1295\* the NICE Z80+ gives you the best emulator price/performance available. For info call 800-NICOLET X259 (outside California) or 415 490-8300 X278 (in California).



**NTE Nicolet**  
Digital Systems Division

\*Send check, money order, or VISA/MasterCard to Nicolet, 201 Fourier, Fremont, Ca. 94539. C.O.D.s accepted.

\*Other NICE emulators for the Z80, 8085, 8088 and NSC800 start at \$550 (68000 available Q1 '86). NICE is a trademark of Nicolet, Digital Systems Division. Z80 is a trademark of Zilog, Inc.

# Back up 10 megabytes in 8 minutes! (or less)

## with Fastback™

If you've ever lost valuable data, you know backing up your hard disk is a *MUST*. For your business, this necessity can become an expensive nightmare. Until now. Fastback™ (Version 5.0) is the hard disk backup (and restore) software utility that eliminates the need for expensive and time consuming tape backup systems. It's so fast you can back up a full 10-megabyte hard disk on standard 5¼" floppies in less than 8 minutes or 10 megabytes of data on the IBM™ PC-AT in less than 4 minutes! This can mean a 95% savings of time and money. And it's easy to use.

Fastback is fully self-contained and functions with any make or size hard disk. It works with PC-DOS™, or MS-DOS™ version 2.0 or higher and requires no additional hardware to take up valuable expansion slots in your IBM PC/XT/AT or compatible. **FASTBACK USES ADVANCED ERROR CORRECTION TECHNIQUES TO RECOVER DATA FROM DAMAGED DISKETTES.** So if your disk is

damaged after the backup procedure, Fastback (Version 5.0) will still be able to recover the data.

Fastback allows rapid lookup of archived data and prevents accidental overwriting. Fastback is completely file oriented, not an image mode backup.

Suggested Retail Price: **\$179.**

### INTRODUCTORY OFFER

Yes, send me \_\_\_\_\_ Fastbacks at the Special Introductory price of \$149 each. That's \$30 off the regular retail price of \$179.

I am enclosing:  BankDraft  Check **\$30 OFF**

Name: \_\_\_\_\_

Address: \_\_\_\_\_

City: \_\_\_\_\_

State: \_\_\_\_\_ Zip: \_\_\_\_\_

Telephone (\_\_\_\_) \_\_\_\_\_

These prices include shipping to all U.S. cities. All foreign orders add \$10 per product ordered. COD's and purchase orders WILL NOT be accepted by Fifth Generation Systems. Outside USA: payable in U.S. dollars drawn on a U.S. bank. FASTBACK is also available at better dealers nationwide. Call (213) 439-2191 for the dealer nearest you.

Offer Expires December 31, 1985



**Fifth  
Generation**  
SYSTEMS

7942 Picardy Avenue  
Baton Rouge • LA • 70809  
Telephone: (213) 439-2191  
Inquiry 414

Dealer Inquires Invited  
Marketing and Sales by CSSL, Inc.

# A SIGHT FOR SORE EYES

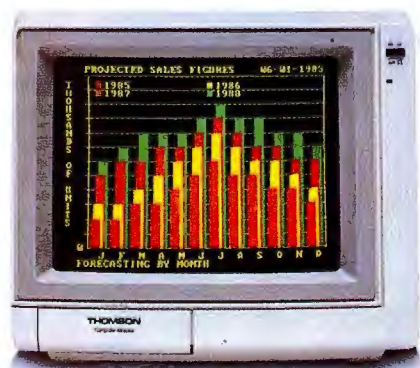
T H O M S O N

To those of you who stare and stare—and stare at computers, blessed relief has arrived. Thomson™ monitors. We promise clearer, crisper resolution, remarkable colors and print-like text. Thomson builds a full line of monitors, from basic monochrome to high-resolution color models. All are designed to fulfill your needs today, and sophisticated enough to fulfill your needs in the future.

Thomson monitors are designed and built by Thomson, a \$6 billion international corporation. They're going to change the way America looks at computers.

Ask your local computer dealer for a Thomson monitor, or call 1-213-821-2995, ext. 34, for the Thomson dealer nearest you. Then take a stare at a Thomson monitor. It's a sight for sore eyes.™

Telex 3720233. Thomson is a trademark of Thomson S.A.



Model CM 3131SL. 12" diagonal, 31mm dot pitch RGB color monitor with text switch and non-glare tinted screen.

# THOMSON



# ENGLISH RECOGNITION

## *The ultimate in user-friendliness*

**P**lain English is hardly ever used to communicate with a computer. This is unfortunate because it can be very effective, and programs that recognize and use relatively complex English sentences have been written for microcomputers. English gives you a variety of ways to express complex actions with a minimum of training and program interaction. Menus, on the other hand, are often highly complex and cumbersome—both for the user and the programmer. Special languages are difficult to learn and to design and implement correctly.

Some applications seem to demand a natural-language controlling mechanism (for example, database programs and games). When you design these kinds of programs, it is hard to predict the questions or commands a user might enter. Even in the largest and most expensive custom database systems, there always seem to be questions outside the scope of the programming.

However, English *has* been used successfully to control database programs. The first public success was LUNAR (Lunar Sciences Natural-Language Information System), which allowed scientists to query a large file

of physical and chemical data on the lunar rock samples brought back by the Apollo 17 mission in December 1972. More recently, Larry Harris of Artificial Intelligence Corporation has been successfully selling a database-retrieval system called ROBOT (now INTELLECT) that uses natural English. It runs on IBM machines and licenses for tens of thousands of dollars. R:base CLOUT by MicroRIM, another English-based database-retrieval system, runs on microcomputers, but it's not cheap either.

Several game designers have recog-

nized the benefits of using English to communicate with computers and have tried to use it as their controlling mechanism. However, the approach they take seems a bit limited. The games often have trouble recognizing what should be valid directions or questions by the players.

*(continued)*

Roy E. Kimbrell is a senior programmer/analyst with Planning Research Corporation (1410 Wall St., Bellevue, NE 68005). He has one M.S. in computer science from the University of Nebraska and another in meteorology from Creighton University.



Both games and database programs must be able to react in many complex and unpredictable ways. You can achieve this versatility by creating a library of functions or routines that do fundamental things. The user must be able to combine these functions in an endless variety of ways. English recognition is a surprisingly useful tool for this; it has been used in university labs for years. Its techniques have been developed to the extent that now you can apply them even on microcomputers.

**ENGLISH RECOGNITION**

There are two parts to applying English understanding to an application. The first is *recognition*—observing that the text forms grammatically correct English sentences and identifying such elements as subjects and verbs. The second part is *understanding*—the ability to react to a sentence in a meaningful manner.

Suppose we have a program named Higgins (after Professor Henry Higgins of *My Fair Lady* fame), a fictional expert in the science of speech. And suppose Higgins knows about wines; that is, it interfaces with a wine database. A question such as "How much does a 1976 bottle of Cabernet Sauvignon cost?" should be meaningful to Higgins, while "Where can I find a date for tonight?" would not be, even though it is a respectable English sentence. Higgins has files of data on wines and knows the name for each field in those records, but it knows about nothing else. It has no way of understanding anything about "date" or "tonight."

Higgins can recognize valid English sentences and break them up into identified pieces. It identifies the subjects, verbs, and other parts of speech in a manner that makes them usable in other parts of the program. Once the information is recognized, using it to do something can be easy.

Database questions can be simple. Higgins's verbs are usually forms of "to be" or "to do." Its subjects are usually either "wh-" words such as who, when, or where, or phrases such as how much. The objects with their

<b>Adjective (ADJ)</b>				
Examples: red, heavy				
<b>Binder (BINDER)</b>				
Words: because, so, since, until, before, while				
<b>Complement (COMP)</b>				
Words: that, to, whether, for				
<b>Conjunction (CONJ)</b>				
Words: and, or				
<b>Determiner (DET)</b>				
Number: <i>singular (S)</i> , plural (P)				
Question: yes (Y), no (N)				
Words: a, an, each, every, few (P), her (SP), his (SP), how many (PY), its (SP), many (P), most (P), my (SP), no, our (SP), some (P), that, the (SP), their (SP), these (P), this, those (P), what (SPY), which (SPY), whose (SPY)				
<b>Noun (NOUN)</b>				
Number: <i>singular</i> , plural				
Case: <i>subjective (SUBJ)</i> , <i>objective (OBJ)</i> , possessive (POSS)				
Examples: sky, house, committee's (POSS), sheep (singular, plural)				
<b>Number (NUMBER)</b>				
Examples: first, second, third, twenty-one				
<b>Preposition (PREP)</b>				
Words: in, on, at, for, without, next to, in spite of, in between, by, to, of				
<b>Pronoun (PRON)</b>				
Number: <i>singular</i> , plural				
Person: first, second, <i>third</i>				
Case: <i>SUBJ</i> , <i>OBJ</i> , POSS				
Question: yes, no				
Words:				
		<b>SUBJ</b>	<b>OBJ</b>	<b>POSS, OBJ</b>
first		I	me, myself	mine
second		you	you, yourself	yours
third		she	her, herself	hers
third		he	him, himself	his
third		it	it, itself	its
first plural		we	us, ourselves	ours
second plural		you	you, yourselves	yours
third plural		they	them, themselves	theirs
OBJ: this, that, these (plural), those (plural)				
OBJ, yes: who, whom, whose, what				
SUBJ, OBJ: Pick one from each column.				
	any		thing	
	some		body	
	every		one	
	no		where	
			place	
			time	
			how	

Figure 1: The definitions of the various word types according to Higgins. Italics indicate default.

Verb (VERB)

Type: *nonauxiliary* (NONAUX), to be (BE), to do (DO), to have (HAVE), modal (MODAL)

Form: *infinitive* (INFIN), *present* (PRES), past (PAST), present participle (PRESPART), past participle (PASTPART), third-person present singular (THIRDSING)

Transitivity (Trans): *intransitive* (INTRANS) — no object; *transitive* (TRANS) — one object; *bitransitive* (BITRANS) — two objects

Most verbs are nonauxiliary, and a common dictionary can give their forms and transivities. Transitivity is expanded a bit in Higgins with the addition of "bitransitive." "Gave," as in "I gave my love a cherry," is bitransitive. Although the default transitivity is TRANS, it wouldn't hurt to define each verb as all three, INTRANS, TRANS, and BITRANS. Although this will allow some nonsensical sentences, it might be a great simplification. Because of this, transitivity isn't specified for the verb descriptions below. MODAL verbs are "helping" verbs and work in conjunction with other verbs.

BE:

be	INFIN
am, are	PRES
was, were	PAST
being	PRESPART
been	PASTPART
is	THIRDSING

DO:

do	INFIN, PRES
did	PAST
doing	PRESPART
done	PASTPART
does	THIRDSING

HAVE:

have	INFIN, PRES
had	PAST, PASTPART
having	PRESPART
has	THIRDSING

MODAL: Words: can, could, may, might, shall, should, will, would, must. All BE, DO, and HAVE verbs are also MODAL.

Particles: This is not a type; a particle is a sequence of words used as a single word; for example, "next to" is used as a preposition. Particles are used mostly as prepositions, verbs, and determiners, although nouns, especially proper nouns, are frequently particles.

Determiners: how many, all the, all this, all these, and other combinations of "all" and a determiner

Half a, half an, and other combinations of "half" and a determiner

Prepositions: next to, in spite of, in between

Verbs: Pick one from each column.

put	out
turn	on
get, got	off
get it, got it	in
go, went, gone	up
take, took	down
shut	away
come, came	around

descriptive modifiers are found in the database. In the sentence about the bottle of wine, Higgins considers "bottle" and "cost" to be objects with the limitations on "bottle" that it be Cabernet Sauvignon and 1976. "Bottle" is the key to one or more fields in a bottle record on specific wines in the database. Though several fields may need to be searched, the name Cabernet Sauvignon can be found.

**PATTERN MATCHING**

Recognizing English is a matter of pattern matching. The patterns of a language are what we refer to when we say someone speaks a foreign language well or when we complain of ungrammatical speech. Patterns occur in poetry as well, but these are as much a matter of the poem's *meaning* as they are of how the words are connected in phrases and sentences. The patterns we are looking for are word patterns—the patterns of English grammar.

One tool we use in pattern matching is the ATN (augmented transition network). It's been around a long time and has proved itself valuable in a variety of applications. For a discussion of how to build and use Higgins's networks, see the text box "English Grammar Network" on page 128.

**THE GRAMMAR AND THE DICTIONARY**

The basic unit used in Higgins is the individual word (see figure 1). [Editor's note: C-language source listings of HIGGINSC, BTREE.C, BTREE.H, and DICT.H are available for downloading on BYTEnet listings. (617) 861-9764.] In the grammar we'll use, there are the traditional types of words: nouns, verbs, and adjectives. There are also some rather special types: relatives, binders, complements, determiners, and others. In Higgins's dictionary, words are divided into 12 types. All but three of them have a limited number of words. Nouns (including proper nouns), adjectives, and verbs make up the bulk of English words. A word may be used in several different ways and therefore may have several different types.

(continued)

## ENGLISH GRAMMAR NETWORK

Figures A and B provide examples of simple networks. Figure A recognizes the word "cat." A circle with a number in it is called a *state* and a curved arrow with a letter beside it is called a *transition*. In this network the program starts in state0 and reads characters. If the next character read

is a "c," the program goes on to state1, otherwise it reports failure and quits. If the program reaches state3 (the double-circled state), it reports success. Figure B recognizes either "cat" or "cow." In state1, if the next character is an "a," the program takes the transition to state2; if it is an "o," it takes the

transition to state4; if it is something else, the program reports failure. If the program reaches state3, it recognizes "cat"; if it reaches state5, "cow."

Networks can match more than just simple character strings. The value used to decide which, if any, transition to take can be a single character, a class of characters, a word, or a class of words. You can use this kind of network to write a recognizer for a computer language where each transition is based on specific words (reserved words) or on categories of words (variables, numbers, strings, and so on). In fact, this idea is basic to the way many compilers are actually written.

In figures A and B, each transition has a unique value at each state. But if duplicate transition values aren't allowed, the network can become exceedingly complex. Look at figure C. This network matches character strings composed of an unlimited number of "a" and "b" characters followed by the sequence "abb." Compare figures C and D. They both match the same string of characters, but figure D is obviously more complex. In the network in figure C, the question is which of the two "a" transitions to take out of state0. The answer is, both of them.

You need a simple mechanism for following several paths simultaneously as you read transition values (characters, words, or whatever). If there is a failure, an improper value encountered at one of the states, you stop traveling that particular path but continue all other paths as long as you are reading valid transition values. If you stop traveling all paths, then you report a failure. Eventually, you either reach the end of the string or reach a success state along some path.

Take the case of the network in figure C. Suppose the string you are going to test is "ababb." You read the first "a" and go to both state0 and state1. Then you read the first "b" and go to both state0 and state2. Next you read the second "a" and quit at state2 but continue at state0 and go to state1. When

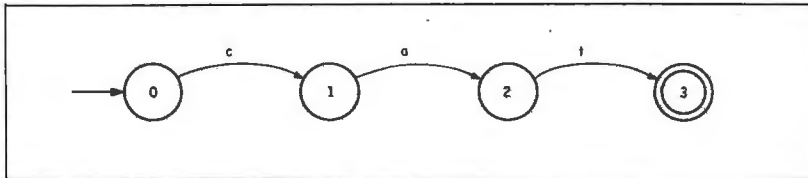


Figure A: A simple network that recognizes the word "cat."

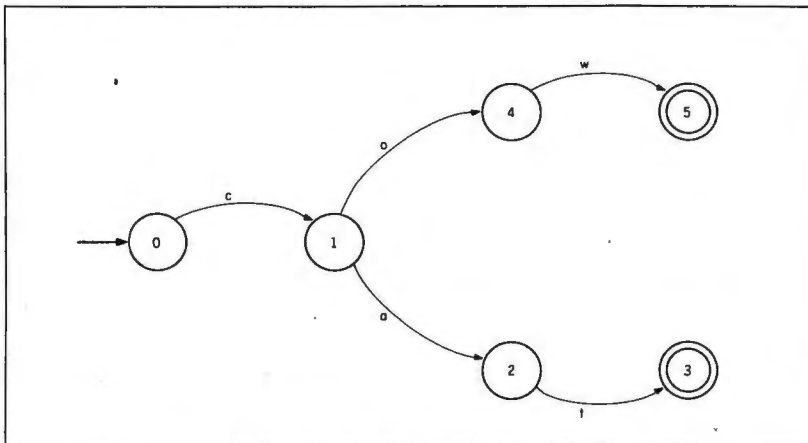


Figure B: A simple network that recognizes either "cat" or "cow."

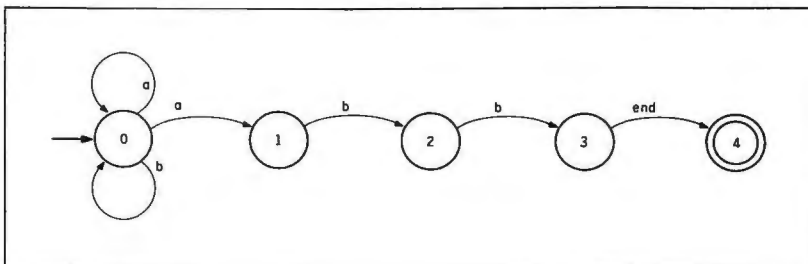


Figure C: This network involves relaxing the rule that requires a unique set of transition values on each arc. Since there are two "a" transitions, the network follows both.



you read the second "b," you continue at state0 and go to state2. Then you read the last "b" and stay at state0 and go to state3. Finally, you read the end of the string and quit at state0 but report success at state4.

**WRITING A NETWORK RECURSIVELY**

There is a simple mechanism for traveling several paths—recursion. Although it isn't simultaneous, the effect is the same. Look at listing A. A state is now a separate *function* that tests its transition values and either calls the next function or reports failure. Where you can take several transitions on the same value (as in state0), a reported failure along one path simply allows the program to try other paths.

In the function state0 in listing A, *location* is a local variable because integers are passed by value. When you first call state0, the calling line of code might look like this:

```
if (state0("ababb",0)) success();
```

In other words, the variable *location* is initially 0.

State0 checks the first character. If it is an "a," state0 calls state1 passing it the string and the location of the next character. If state1 returns success, then state0 can report success because state1 can be successful only if state2 and state3 are also successful. If the character checked in state0 is a "b," state0 calls itself (recursively) with the location of the next character. If the character is neither an "a" nor a "b," it is an invalid character and state0 reports a failure. This failure never occurs in a valid string of characters because the transitions to state1 and beyond are tested first and given a chance to succeed.

The recursive method has considerable advantages in simplicity. The amount of code necessary to implement a network is considerably less when the network allows duplicate transition values than when it does not.

(continued)

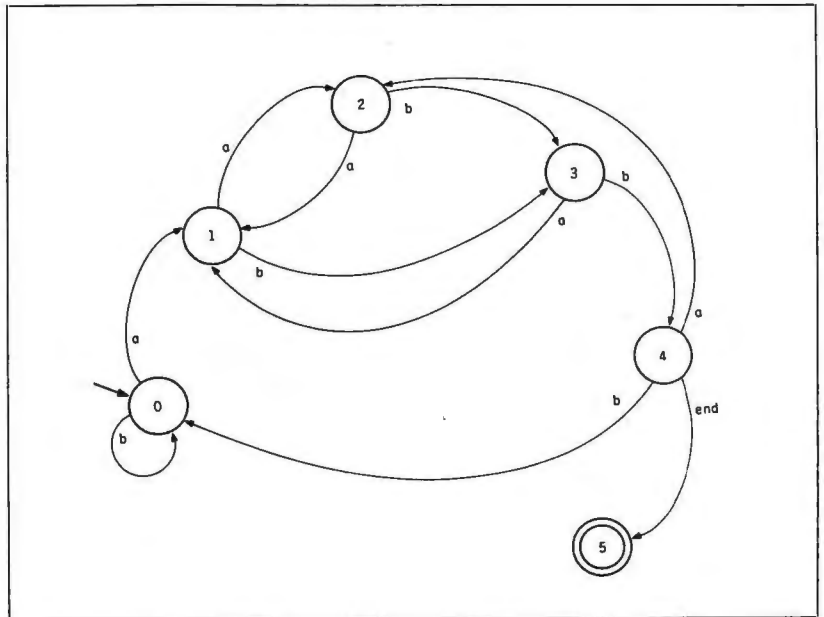


Figure D: This network performs the same function as the one in figure C. However, it is much more complex because it has a unique transition value on each arc and follows only one path.

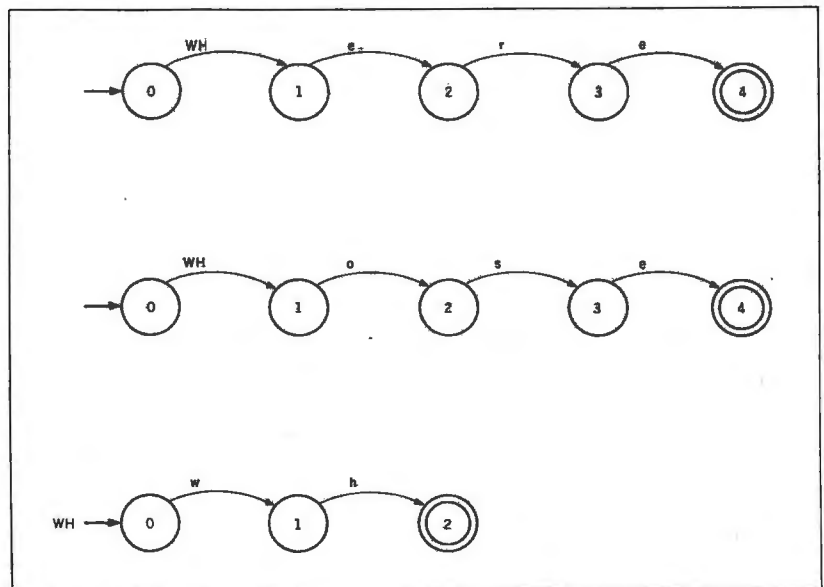


Figure E: The WH network replaces two arcs and states and matches "wh."

Interestingly, both kinds of networks are equally powerful in describing and matching patterns.

**SUBNETWORKS**

Calling a state as a subroutine or function has other advantages. You can build networks where a transition from one state to the next depends on the successful matching of an entire net-

work, not just the matching of a single transition value. For example, look at figures E and F. The network matches "where" or "whose" but the "er" and "os" are recognized by a subnetwork. If the network reaches a success state, it has matched either "where" or "whose."

A collection, or *packet*, of information created as the network runs is a con-

venient mechanism for keeping track of the path taken. (The C language calls them structures; in Pascal they are records.) Because you don't want to limit the system's ability to process very long data strings, you usually allocate storage for the packets from the runtime heap and fill them with information as the called network processes the data string. If the called network is unsuccessful, it frees the storage used by the packets and reports failure. If the called network is successful, it reports success and returns a pointer to the string of information packets. Once a subnetwork—or any network—has completed its task, the packet contains the significant information found during the matching process.

For English recognition, the packets must have a description that varies depending on the kind of information placed in them. Understanding how to use this information requires some comprehension of the reasons behind the design of a network that recognizes valid English sentences. Such a network is based on English grammar.

**GRAMMAR LIKE YOU NEVER SAW IN SCHOOL**

We humans are extraordinary pattern matchers. We quickly recognize shapes and sounds and even large and complex combinations of shapes and sounds. We also have the ability to create these patterns. A pattern is a set of rules. We create shapes and sounds that *fit* patterns—that is, we create according to a set of rules (even if the rules aren't well understood).

English grammar works the same way. The grammar is the pattern you use to create and understand English sentences. It is also basically the pattern you use to write a program that recognizes English sentences. (The grammar used by Higgins is a bit permissive—it lets a few ungrammatical things pass by.)

Higgins's grammar is based on networks, but instead of going from one state to another based upon a specific character, the transition is based on word type. Examples of these networks are in figures G and H and in table A. The program might make a transition based on whether the incoming word is a noun, a verb, or another kind of

*Listing A: A pseudocode implementation of the pattern matching described by figure C. A transition to a new state is made by recursively calling the next state. Although the paths aren't taken simultaneously, the effect is the same, since the local variables at each state keep a current-place marker in the string being tested.*

```
function state0: arguments -
    string, an array of characters.
    location, an integer.
    if the character at location in string is 'a',
        call state1 passing string, location+1.
        if state1 returns success, return success.
        otherwise, call state0 passing string, location+1.
        if state0 returns success, return success.
        otherwise, fail.
    if the character at location in string is 'b',
        call state0 passing string, location+1.
        if state0 returns success, return success.
        otherwise, fail.
    otherwise, fail.
function state1: arguments -
    string, an array of characters.
    location, an integer.
    if the character at location in string is 'b',
        call state2 passing string, location + 1.
        if state2 returns success, return success.
        otherwise, fail.
    otherwise, fail.
function state2: arguments -
    string, an array of characters.
    location, an integer.
    if the character at location in string is 'b',
        call state3 passing string, location+1.
        if state3 returns success, return success.
        otherwise, fail.
    otherwise, fail.
function state3: arguments -
    string, an array of characters.
    location, an integer.
    if the character at location in string is end,
        call state4 passing string, location+1.
        if state4 returns success, return success.
        otherwise, fail.
    otherwise, fail.
function state4: arguments -
    string, an array of characters.
    location, an integer.
    return success.
```

word. The program can also make a transition based on whether the next sequence of words matches a pattern—a pattern defined by a sub-network.

When making a transition based upon a single word, the program looks up the word in the system dictionary to determine its type (noun, verb, adjective, or preposition). There are also some rather special kinds of words that might be unfamiliar—relatives, binders, complements, determiners, and others. Luckily, these groups of words are small, and once you enter them into the dictionary, you can usually ignore them.

All of the words the recognizer program might encounter must be in the dictionary. It doesn't really understand English and can't use the context of the sentence to make any guesses about what the word might mean. Some recognizers have the ability to ask about the type of an unfamiliar word. Since most of the words not in the dictionary are usually nouns and adjectives, this is a reasonably easy thing to do.

The network grammar for English that Higgins uses is close to one developed by Terry Winograd and described in considerable detail in his *Language As a Cognitive Process*. Higgins's grammar bears considerable resemblance to others that are similarly constructed, such as the network grammar used in LUNAR. The purpose of Winograd's grammar is to *define* English syntax. This is a little different from only trying to *recognize* valid English. However, it works well in a large variety of situations and applications.

Making a transition based on word type is easy. You look the word up in the dictionary. If one of its usages corresponds to the one demanded by the transition (and some possible other conditions are met), then you take the transition.

Some other conditions are usually checked also. These conditions may vary at each state. They are special checks that ensure that the path taken is valid. They are often important in deciding which of several possible paths to take. In addition, most states require special actions. These are all associated with recording information about the sentence or phrase in the

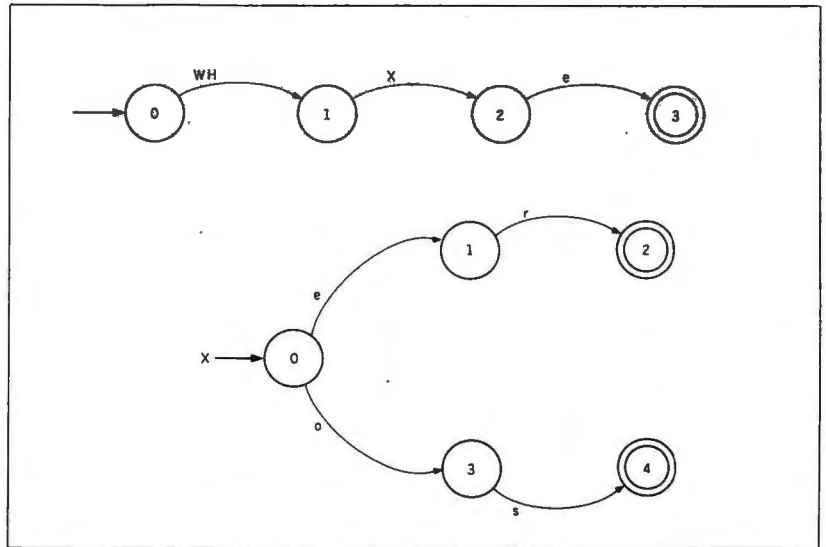


Figure F: The X subnetwork replaces arcs and states matching either "er" or "os."

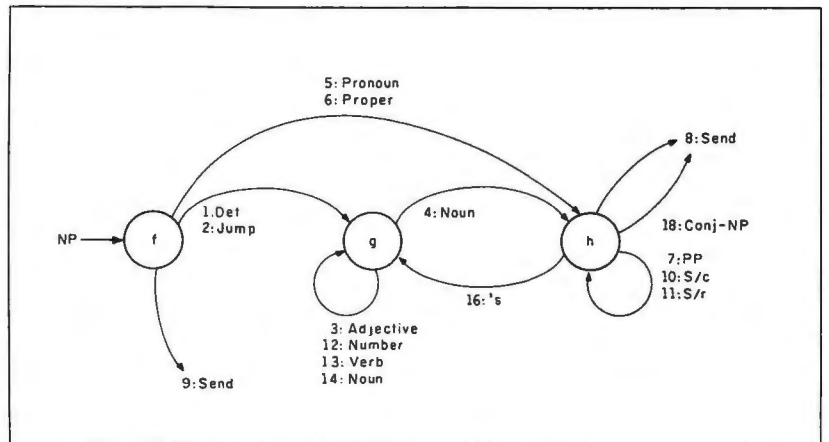


Figure G: The NP (noun phrase) network.

packets. Sometimes the actions create implied constructions, such as the "you" implied in the sentence "Go!"

The transitions based on matching a network are similar. Instead of matching a word type, you match a network. When making a transition based on word type, each transition uses up one word. That is, the first word in the sentence is checked at the first state, the second word at the second, and so forth. When making transitions based on matching a network, you use up as many words as necessary to make the match. If you fail to find a match, then no words are used up.

The networks in figures G and H are examples of networks used to describe a grammar. Table A specifies the conditions and actions associated with the transitions of the NP (noun phrase) network.

English sentences are built from noun phrases, prepositional phrases, and verb phrases. A noun phrase describes the actor in a sentence or perhaps the person, place, or thing acted upon. The NP (noun phrase) network (see figure G and table A) builds an NP packet that contains pointers to determiner (Det), header  
(continued)

# IEEE-488



## GPIB ↔ PC

### Hardware Flexibility

- Low cost for instrument control
  - 300K bytes per second
  - \$395 complete with software
- High performance data links
  - Maximum speed of GPIB
  - On-board buffering

### Software

- Over \$1,000,000 in software development
- Easy to use, yet handles any GPIB application
- Works with Lotus 1-2-3
- UNIX, DOS and over 12 languages

### Applications Support

- Applications Library with sample programs & TIPS for all major instruments
- Full staff of Applications Engineers dedicated to support your specific needs

### Other IEEE-488 Products

- Interfaces & Software for
  - Multibus VMEbus
  - DEC Q-bus & UNIBUS
  - STD & S-100 bus
- General GPIB Products
  - GPIB Bus Testers
  - GPIB Bus Extenders
  - Stand-Alone Controllers



12109 Technology Boulevard  
Austin, TX 78727  
1 (800) 531-GPIB  
In Texas (800) IEEE-488  
Telex: 756737 NAT INST AUS

## ENGLISH RECOGNITION

(Head), descriptor (Desc), and qualifier (Qual) packets. These are packets returned from calls to the other networks. The NP packet has places for four features: number (Num), Person, question (Ques), and Case. Num may be singular or plural, no default. Person may be first, second, or third, default third. Ques may be yes or no, default no. Case may be SUBJ (subjective), OBJ (objective), or POSS (possessive), no default. The current word under examination is kept in a packet of its own. The values in the packet are filled from the dictionary. The features of the current-word packet depend on the type of the current word.

Associated with each arc in the network are initialize: (initializations), if: (conditions), and then: (actions). See

table A. Any of these may be absent. The initializations require the definition of a new packet before calling a sub-network. The packet is empty except for defaults and the initializations. The conditions are checked after the word type on the arc has been matched with the current word or the subnetwork on the arc has reported success and has returned a packet. The current word may enter into these conditions. If the conditions are met, the actions are taken, and a transition to the next state may be made.

Hold is a global variable used to temporarily hold a copy of a packet. When the copy is made, the source of the copy must be made empty as its emptiness is a flag for further action. Likewise, if Hold is copied somewhere, it must also be emptied.

Table A: *The transitions of the NP network.*

1. then: NP.Num = current-word.Num;  
NP.Ques = current-word.Ques; NP.Det = current-word;
2. none.
3. then: Append current-word to NP.Desc;
4. if: current-word.Num == NP.Num or NP.Num is empty;  
then: NP.Num = current-word.Num; NP.Head = current-word;
5. then: NP.Num = current-word.Num;  
NP.Person = current-word.Person; NP.Ques = current-word.Ques;  
NP.Head = current-word;
6. then: NP.Num = current-word.Num; NP.Head = current-word;
7. then: Append current-word to NP.Qual;
8. then: Success; NP.Case = NP.Head.Case; return the NP packet;
9. if: Hold is an NP;  
then: Success; Empty and return Hold;
10. initialize: S/c.Subj = copy of the current NP packet;  
S/c.Mood = REL; S/c.MV = dummy VP = "to be"  
dictionary values;  
then: Append S/c to NP.Qual;
11. initialize: Hold = copy of the current NP packet;  
S/r.Mood = WHREL;  
then: Append S/r to NP.Qual;
12. then: Append current-word to NP.Desc;
13. if: VP.Form == PRESPART or PASTPART;  
then: Append VP to NP.Desc;
14. if: current-word.Num == SINGULAR;  
then: Append current-word to NP.Desc;
15. not used.
16. if: NP.Head is not a pronoun;  
Note: The only thing being tested on this arc is the occurrence of the string 's indicating possession (POSS).  
then: Create a new NP packet; copy the current NP packet into the new NP packet; new-NP.Case = POSS;  
set all NP values to defaults; NP.Det = new-NP;
17. not used.
18. Note: If the current word is a conjunction, then the NP network is recursively called; if an NP is returned, form a list of these NPs.

A prepositional phrase is a sequence of words containing a noun phrase and beginning with a preposition. Its purpose is to modify or qualify a noun phrase. The PP (prepositional phrase) network builds a PP packet, which contains pointers to Prep (preposition) and Prepobj (preposition object) packets. These are either packets returned from calls to the NP network or current-word packets.

The verb phrase describes the action taken in a sentence. It might be a single verb or a series of words. The VP (verb phrase) network builds a VP packet that has pointers to Verb packets, current-word packets of type Verb. They form a list starting at the VP.Verbs (verb phrase.verbs) pointer. Similar to a verb, the VP packet has Form (tense), transitivity (Trans), and Type features.

Form may be INFIN (infinitive), PRESENT (present), PAST (past), PASTPART (past participle), PRESPART (present participle), or THIRDSING (third person present singular). Trans may be INTRANS (intransitive), TRANS (transitive), or BITRANS (bitransitive). Type may be NONAUX (nonauxiliary, that is, acting alone), BE, DO, HAVE, or MODAL (supportive words, such as "can," "could," "may," "should," "must" etc.).

The S/ (sentence) network builds a packet, S, that has places for pointers to Subj (subject), DO (direct object), IO (indirect object), MV (main verb), Binder (binder), Auxs (auxiliaries), Mods (modifiers), and QE (question element) packets. These are the packets returned from the NP, PP, VP, and S/ networks. It also has places for

two features: voice and mood. The voice may be ACTIVE or PASSIVE, default ACTIVE. The mood may be DECL (declarative), INT (interrogative), IMPER (imperative), BOUND (bound by a binder), REL (relative), or WHREL (who, what, why, where, when relative), default DECL. These features are used to report the form of the sentence and to direct processing.

The S/ network is shown in figure H. NP, PP, VP, S/, Jump, and Send refer to either a network to be entered or to special transitions to be taken. The other labels (Noun, Verb, Particle, Binder, Rel, and so forth) are all word types or usages.

The NP, VP, and PP networks match noun phrases, prepositional phrases, and verb phrases. The S/ network is (continued)

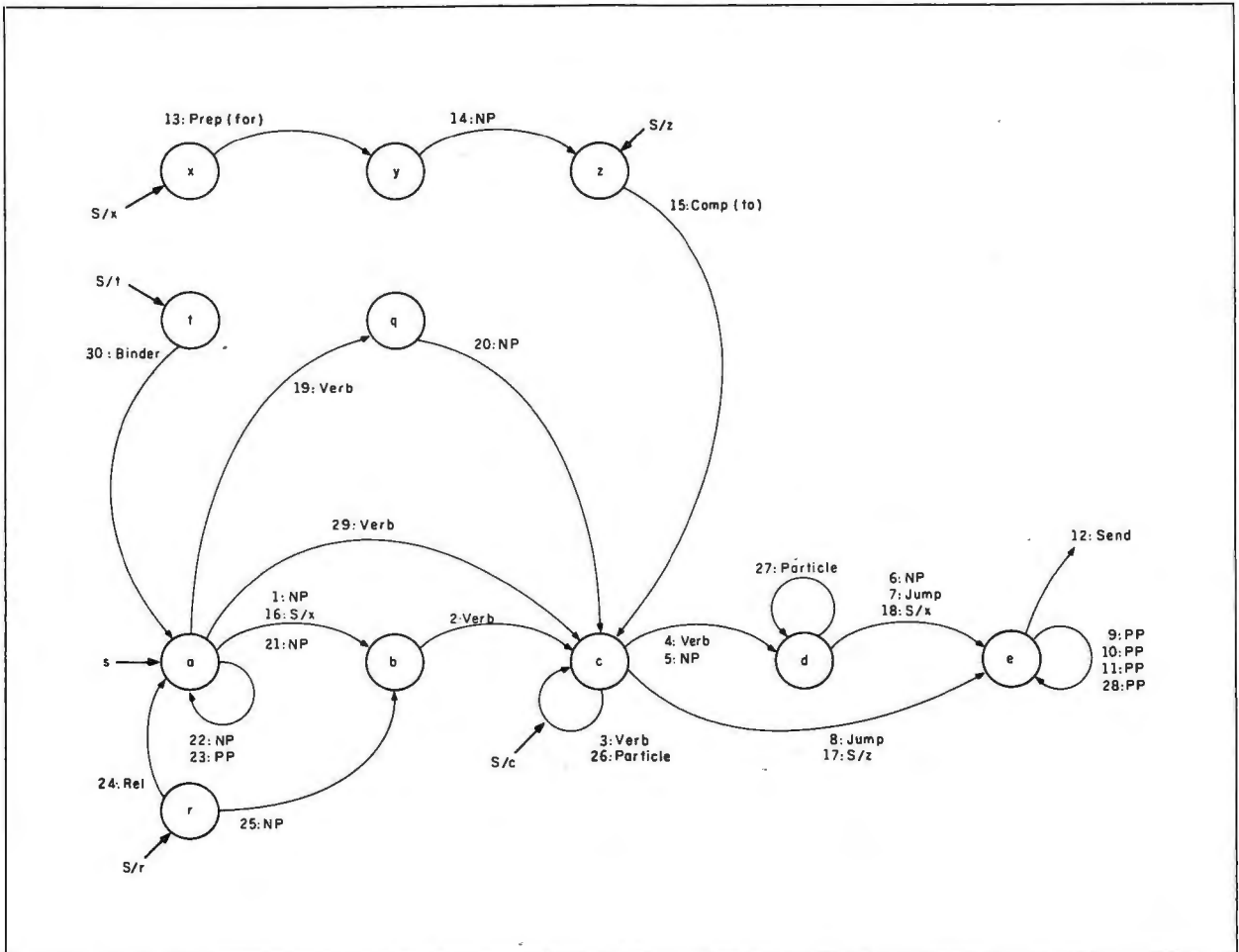


Figure H: The S/ (sentence) network.

rather special. The main (sentence) network can be entered at the state designated by the letter following the slant (e.g., S/x is entered at state $x$ ). This is a recursive call and control returns to the *calling* state, not state $a$ , just as if the NP or PP network were called. If the use of the S/ network call seems far-fetched, consider "For Joe to eat spicy food is unusual." The phrase "For Joe to eat spicy food" is matched by the S/x network.

The Jump and Send transitions are special in that they don't match a word or phrase. The Jump only asks that the

special conditions be met; if they are, the transition is made without reading the current word, which is then tried at the next transition.

The Send transition isn't really a transition at all. It is used to report success. If the special conditions at the state are met, the special actions are carried out and a success indication is returned to the calling state. If control returns to the caller of state $a$ , a sentence has been recognized. The return goes through all of the states called before it reaches the Send transition.

The simplest sentence matched by the network is a one-word sentence, such as "Go!" or "Run!" State $a$  is called (see figure H). Eventually, the Jump transition to state $b$  is taken, "go" or "run" is recognized as a verb, and the verb transition to state $c$  is taken. After a few attempts, the Jump transition to state $e$  is taken, where the Send transition is finally taken. Now, success is reported to state $c$ , which reports success to state $b$ , which reports success to state $a$ , which reports success to its caller. The sentence has been successfully analyzed.

**Listing B: A pseudocode representation of a typical (skeleton) state in Higgins.**

```
function state0:
  arguments -
    curword — points to the current word packet.
    packet — points to the packet to be filled in.

  — An attempt to make a transition based on matching a word type:
  if curword is a NOUN, — or whatever. . .
    if special conditions,
      perform special actions.
      call state1(curword.next, packet).
      if state1 returns success,
        return success and the packet.

  — An attempt to make a transition based on a subnetwork's success:
  create an NP-packet.
  call NP(curword, NP-packet).
  if NP returns success,
    — Presumably, curword has been modified to point to a
    word past the sequence matched by the subnetwork.
    if special conditions,
      perform special actions.
      call state2(curword, packet).
      if state2 returns success,
        return success and the packet.

  — A Jump:
  if special conditions,
    perform special actions.
    call state3(curword, packet).
    if state3 returns success,
      return success and the packet.

  — A Send:
  if special conditions,
    perform special actions.
    return success and the packet.

  — If we got this far, we've failed.
  return failure.
```

**CODING A RECOGNIZER**

Listing B is a skeleton state. It shows, in pseudocode, how a state—actually the function representing the state—is programmed. It illustrates four kinds of transitions. The first is an attempt to make a transition to a new state based on the type of the current word; the second is an attempt to make a transition by calling a subnetwork; the third is a Jump—if the special conditions are met, make the transition without trying to match a word type or a subnetwork; and the fourth is a Send—success is reported. The actual coding will vary from this example, but the basic steps remain the same: If the word or phrase is of the requisite type, check the special conditions; if they are met, perform the special actions to save information and call the function representing the next state.

Much of the information saved comes from the dictionary. This information is kept in a large packet passed from state to state during the recognition process. When a network is called to recognize a phrase, an empty packet is created to hold the expected information. If the phrase is recognized, the packet is filled in and passed back to the calling state where it is appended to the calling state's packet. As a sentence is processed, the basic packet is filled in with pieces attached to it representing phrases recognized by the various subnetworks.

If success is reported from a call to a network, such as the NP network, the current position in the sentence is also returned so processing can continue following the matched phrase. If failure is reported, the position returned by the network is ignored.

# FASTER THAN TURBO

# ZBASIC

## New lightning-fast ZBASIC zaps the competition.

It's hot. It's brand-new. And light years ahead of anything else.

It's ZBASIC. Written for programmers by programmers. (If you know BASIC—you know ZBASIC!) Now you can write a program exactly the same way on an Apple, an IBM, a Tandy, or any other major micro and port the source code. You only write the program *once* ...and it runs on all the major micros. The commands stay the same—regardless of the computer\* (even graphic commands and disk I/O!).

ZBASIC. Starting now, it's the only language you'll ever have to know.

\*subject to hardware limitations.

The finest implementation of the BASIC language for microcomputers!

**YES N/A=Not available	ZBasic Interprier 3.0	TURBO PASCAL 3.0	MBASIC compiler	True BASIC	BASICA Interpreter (IBM PC)
IBM and compatibles	•	•	•	•	•
Apple IIe, IIc (8502)	•	N/A	N/A	N/A	N/A
Macintosh	4th Qtr.	N/A	N/A	N/A	N/A
CP/M-80 2.2, 3.0	•	•	•	N/A	N/A
TRS-80 Mod I, III, 4, 4p	•	N/A	•	N/A	N/A
Direct commands	•	N/A	N/A	•	•
Maximum scientific digits of accuracy (COS, SIN, ATN, LOG, EXP etc.)	8 to 54 selectable by the user	11 Binary BCD N/A	16	16	6
Device Indpdnt Graphics (same CMDS all graphic modes and computers)	•	N/A	N/A	N/A	N/A
SAME File commands all computers?	•	N/A	N/A	N/A	N/A
STRUCTURED: Labels, Functions, LONG IF etc.	•	•	N/A	•	N/A
Same editor commands all versions/computers	•	•	N/A	N/A	N/A
Sieve benchmark (Byte January 1983, 10 lines)	13.7 sec.	14.1 sec.	14.9 sec.	261 sec.	2190 sec.
Shell-Metzner SORT (Sybex-BASIC for Scientist's and Eng. 2,000 5 char. strings)	19 sec.	26 sec.	71 sec.	194 sec.	2700 sec.
Executable Machine Lang. & approx. File size	12k	12k	32k	N/A	N/A
PRICE with BCD BCD=No rounding errors)	89.95	109.95	450.00	N/A	N/A
PRICE without BCD	89.95 BCD FREE	69.95	395.95	149.95	Comes with computer

**AVAILABLE NOW!**

- Works the same on all micros
- Uses same commands—regardless of computer make
- Structured Basic—(spaghetti optional)
- Device-independent graphics (same graphic commands on all computers)
- 6 – 54 digits of precision (selectable by user)
- Built-in interactive editor and compiler—to compile and execute, just type "run."
- Choice of alphanumerics labels or line numbers
- Chaining with shared variables

**Not copy protected—No Run Time Fees or Royalties**

**One low price gives you everything—there are no hidden costs. Only \$89.95 complete.**

## ZBASIC™

### The lightning-fast BASIC from Zedcor

To order use this coupon or call  
**ORDERS ONLY: 1-800-482-4567**

SCHOOLS — Call For Special Package  
Utah Residents 1-800-662-8666. Alaska Residents 1-800-982-1500

**INQUIRIES : (602) 795-3996**

Mail to: ZEDCOR  
3438 N. Country Club Road / Tucson, AZ 85716

(Name) \_\_\_\_\_

(Address) \_\_\_\_\_ (Apt.) \_\_\_\_\_

(City) \_\_\_\_\_ (State) \_\_\_\_\_ (Zip) \_\_\_\_\_

(Day Phone) \_\_\_\_\_

ZBASIC IBM PC/Compatible (128K, MS DOS 2.0 or better recommended) \$89.95 \$ \_\_\_\_\_

ZBASIC Apple IIe, IIc (128K, Dos 3.3) (Integrate text & graphics) \$89.95 \$ \_\_\_\_\_

ZBASIC CP/M-80 (Z-80-2.2 or 3.0) (Provided on 5 1/4" KAYPRO II-SSDD Format) \$89.95 \$ \_\_\_\_\_

XAYPRO graphics Version (11, 4, 10) \$89.95 \$ \_\_\_\_\_

ZBASIC TRS-80 (48K) (Circle Model 1.3 or 4-8.2) (Hi Res Bd's Supported) \$89.95 \$ \_\_\_\_\_

ZBASIC Macintosh (Delivery 4th quarter) \$89.95 \$ \_\_\_\_\_

DEVELOPERS—BUY ALL 5. SAVE \$140 \$449.75 VALUE \$399.75 \$ \_\_\_\_\_

Arizona Residents Add 5% Sales Tax \$ \_\_\_\_\_

SHIPPING: U.S. add \$5.00 per program \$ \_\_\_\_\_

Foreign or C.O.D. add \$10.00 per program (U.S. currency only) \$ \_\_\_\_\_

TOTAL \$ \_\_\_\_\_

ZBASIC is a trademark of ZEDCOR, Inc. © 1985 IBM is a registered trademark of International Business Machines Corp. Apple IIe, IIc are trademarks of Apple Comp. Inc. Macintosh is a trademark licensed to Apple Comp. Inc. PM-80 is a registered trademark of Digital Research Inc. TRS-80 is a registered trademark of the Tandy Corp. TURBOPASCAL is a registered trademark of Borland Inc. MBASIC is a registered trademark of Microsoft Corp. True BASIC is a registered trademark of Addison-Wesley Publishing Co. BASICA is a registered trademark of International Business Machines Corp.

All benchmarks and accuracies apply to standard IBM PC with 8088. Other computer's entire CPU benchmark speed, accuracies and output code file sizes will vary depending on the computer clock speed, operating systems and other factors beyond our control.

## Comparisons can be difficult for Higgins because they often imply so much.

"Bordeaux" is the name of a place and is therefore a noun, but it can also be an adjective, as in "the Bordeaux wine." A word may also have one or more features depending on its type, and it may have more than one value for a single feature. For example, Noun.Number of "sheep" is both singular and plural. A noun's case feature is most often both subjective and objective.

When Higgins reads the definition of a word from its dictionary, it builds a packet similar to the sentence, noun phrase, and other packets. The type of the packet is the type of the word.

Unfortunately, some words are of more than one type; that is, they are used in more than one way. For example, "gun" is both a verb (gun the engine) and a noun (shoot the gun). The special types of words (relatives, binders, etc.) all make up a relatively small group. English is built mostly of nouns and adjectives with a lot of verbs added for good measure.

The words that are subclassified—the verbs, nouns, etc.—have several *feature values* within a subclassification. For example, "see" is both an infinitive form and a present form. These multiple feature values are critical to Higgins's operation. It is often important for a verb to have all of its relevant feature values defined in Higgins's dictionary in order to process a sentence properly. This is especially true of the "to be" type verbs.

Adding feature values to words may blur the distinctions between grammatical and ungrammatical sentences. For example, if you want to ignore the difference between nouns and proper nouns, you might type each noun as both. Comparisons are a little difficult for Higgins because a sentence containing comparisons often *implies* so

much. To simplify this process, words such as "greater" and "than" are typed as verbs (in addition to their other types). Their verb features are present, past, and modal, and the phrase "is greater than" is recognized as a sequence of verbs.

The features in the packet are filled in from the dictionary entry. The allowable values for each feature are also specified in figure 1; the default value, if there is one, is shown in italics.

### THE ANALYSIS OF A SENTENCE

Recognition of a sentence—including filling the packets with information from the sentence—makes understanding possible. The packet structure created during sentence analysis is a tree. As the sentence is scanned via successful transitions through the networks, packets are added to the structure. When finished, the completed structure parallels the successful path through the network. In keeping with the tree structure, let's call a packet a node.

The primary node is the sentence node. It has places for recording voice and mood information and places for pointers to other nodes. The other nodes describe the sentence's subject (there is always a subject, although it may be implied), verb (there is always a verb), and any of several other dimensions. The objects, if they exist, specify what is to be acted upon. The auxiliaries, if there are any, are helping verbs, such as "will have been" in the sentence "By tomorrow, the cat will have been drinking from the cup." The main verb is "drinking." Modifiers such as "from the cup" are attached to the sentence node when they modify the sentence. If they modify a part of the sentence, they are attached to the node representing that part of the sentence.

The parts of a sentence are represented by nodes. The subject and objects are noun-phrase nodes; the verb is a verb-phrase node; and the modifiers are prepositional-phrase nodes. There is one exception. In the place of a noun- or prepositional-phrase node, you may substitute a

sentence node. For example, in "The cat who drank the wine went to sleep;" "who drank the wine" qualifies the subject of the sentence and has the form of a sentence (a subject, "who"; a verb, "drank"; and an object, "the wine").

When you design a program to use the information Higgins provides, remember the model of the sentence: subject, verb, and possible objects. In the sentence "How much does a bottle of Cabernet Sauvignon cost?" according to Higgins the subject is "how much," the verb is "does," and the objects are "a bottle of Cabernet Sauvignon" and "cost." If you were translating this into a database query, it might come out: SELECT COST FROM WINELIST WHERE NAME = "Cabernet Sauvignon." In making this translation, you assume a lot about what the user might be asking, the possible range of queries, and the possible range of subject matter. You can make these kinds of simplifying assumptions because anything outside this range of information wouldn't be understood anyway—it wouldn't be in the database.

Higgins is a powerful tool for an application program in understanding the language used in framing sentences. Once the purpose of the program is clearly understood, you can put a variety of sentences through your version of Higgins to see how it stores them in its packets. When you understand this, you can write the part of the program that does the real work—perhaps with a version of Higgins at the beginning. Listing 1 shows an example sentence analyzed by a version of Higgins written in C.

### LIMITATIONS AND PECULIARITIES

When placing information in the packet, Higgins can make mistakes. The fault is not entirely Higgins's, though, because English is an ambiguous language. Its ambiguity is both its power and its failing. A sentence often quoted by grammarians is "Time flies like an arrow." If "time" is a noun (a thing), then "flies" must be a verb, and the

(continued)



# Get up to speed for under a hundred bucks.

If you're writing in the BASIC that came with your IBM® PC, now you can make your programs scream. Microsoft's new QuickBASIC Compiler will punch you right into warp speed, accelerating your programs by as much as ten times. And all with hardly any code changes.

You get all this at a price that won't slow you down, either. Just \$99 and you're in.

The new QuickBASIC Compiler was designed to work with the

CIRCLE, PSET, and COLOR.

So your graphics and music routines will look and sound as they should.

And when you're ready to move into structured programming, QuickBASIC also offers language extensions for a speedy transition. With optional alphanumeric labels you can make your programs more readable. And compiled subprograms will save you time.

So get moving. **MICROSOFT**  
Call us now for The High Performance Software™  
more information on the QuickBASIC Compiler and the name of your nearest Microsoft dealer. Just ring (800) 426-9400. In Washington State, Alaska, Hawaii and Canada, call (206) 828-8088.

Then go give your programs a swift kick.



programs you've already written. It supports all BASIC sound and graphic statements including PLAY, SOUND, LOCATE, DRAW, GET, PUT, LINE,



sentence is modified by the prepositional phrase "like an arrow." If "time" is a verb, however, then the sentence is a command (an imperative sentence). The subject is an implied "you," and "like an arrow" describes how to time the flies (nouns, things). Whether this makes any sense is unimportant to Higgins. The program

doesn't understand what the words mean, just how they fit together in English.

When we read or hear English, we process the words syntactically and semantically—by form and by meaning—at the same time so the ambiguity usually is not recognized. Therefore, the internal order Higgins uses

in processing sentences may be of particular interest. To see how Higgins does it, try a few potentially ambiguous sentences. If Higgins doesn't process them the way you want it to, you may have to tinker with the code or perhaps simply limit the meanings of the words in the dictionary.

Some features of English are difficult to analyze without also incorporating a great deal of knowledge about sentence meaning and context into the program. Surprisingly simple English can confuse poor Higgins. One feature that Higgins knows very little about is the simple conjunction, such as "and" or "or." Higgins can handle noun and verb phrases with embedded conjunctions, but that's all. The problem occurs when parts of the sentences are only implied, not specified. You and I have no problem with these because we understand the meaning of the sentence and fill in the missing phrases easily. Higgins doesn't understand meanings and can't fill in anything. The following sentences were taken from Terry Winograd's book *Language As a Cognitive Process* (Addison-Wesley, 1981):

1. Paul and Joy came to dinner.
2. They brought some yellow and purple flowers.
3. They gave Joan a kiss and Eileen a hug.
4. We opened and drank some wine and ate falafel.
5. Paul liked to play tunes on the guitar, and Joy on the mandolin.
6. He played and she sang every old tune in the book.

The first sentence contains a simple conjunction between noun phrases—no problem for Higgins. The second sentence has a conjunction of adjectives; Higgins doesn't know how to analyze these, but it can be modified to do so. In the third sentence, "they gave" is understood to follow "and" ("They gave Joan a kiss and they gave Eileen a hug."). In the fourth sentence, "we" is understood to follow the "and." In the fifth sentence, "liked to play tunes" is understood to follow "Joy." Finally, in the sixth sentence,

(continued)

**Listing 1:** *The structure of packets built during sentence analysis. This example was created by an implementation of Higgins written in C. The exact form of the structure depends on the form of the sentence. See table 1 for the meanings associated with the numbers shown.*

What does the wine cost?

Sentence: mood = 2, voice = 1

S.Subject:

Noun phrase: number = 2, person = 8, case = 6, question = 6

NP.Determiner:

Pronoun: "what" number = 2, person = 8, case = 6, question = 6

NP.Head:

Pronoun: "what" number = 2, person = 8, case = 6, question = 6

S.Direct object:

Noun phrase: number = 6, person = 8, case = 6, question = 4

NP.Head:

Noun: "cost" number = 6, case = 6

S.Indirect object:

Noun phrase: number = 2, person = 8, case = 6, question = 4

NP.Determiner:

Determiner: "the" number = 6, question = 4

NP.Head:

Noun: "wine" number = 2, case = 6

S.Main verb:

Verb phrase: form = 40, transitivity = e, type = a

VP.Verbs:

Verb: "does" form = 40, transitivity = e, type = a

**Table 1:** *The various numbers are hexadecimal representations of the binary values in that feature. The meaning of each bit is determined from the constant definitions in Higgins's implementation. For example, case=6 means both bit 1 and bit 2 are set on; this word can be either subjective or objective in its present form.*

mood = 2	interrogative
voice = 1	active
number = 2	singular
= 6	singular or plural
person = 8	third
case = 6	subjective or objective
question = 4	no
= 6	yes or no
form = 40	present tense
transitivity = e	intransitive, transitive, or bitransitive
type = a	do and modal

**New Version**

# Mighty Macro Assembler.

The new Microsoft® Macro Assembler package. A complete development environment that makes you a more productive programmer. Whether you're using Macro Assembler or any Microsoft high level language.

A common calling convention lets you easily call assembly language routines from any high level Microsoft language to add an extra burst of blinding speed.

## **Better Debugging.**

The new Symbolic Debug Utility lets you stay close to the source. Now you can step through your assembled or compiled code by name rather than by address. Source level display for Microsoft Pascal, FORTRAN, and C allows you to view both your original source and the resulting code.

And we stuffed our package with a full set of the most useful utilities around. So that you can link, maintain and organize your programs like never before.

Who else but Microsoft could build so much into one package for \$150?

For the name of your nearest Microsoft dealer call (800) 426-9400. In

Washington State, Alaska, Hawaii and Canada, call (206) 828-8088. And if you're already using Microsoft **MICROSOFT**® The High Performance Software™ or IBM® Macro Assembler, ask us how you can upgrade to the mightiest Macro of them all.

### **Microsoft Macro Assembler Package:**

#### **Macro Assembler**

- ♦ For the 8086/8087/8088 and now the 186/286/287.
- ♦ Define macros.
- ♦ Conditional Assembly.
- ♦ Case sensitivity for symbols.

#### **New Interactive Symbolic Debug Utility**

- ♦ Controlled testing environment for debugging.
- ♦ Source line display of Microsoft FORTRAN, Pascal and C Programs.
- ♦ Set breakpoints on line numbers and symbols.
- ♦ Single step to follow program execution.
- ♦ Disassemble object code.
- ♦ Display values.
- ♦ Make minor changes without reassembling.

#### **New Program Maintenance Utility**

- ♦ Rebuilds your applications after your source files have been changed.
- ♦ Similar to UNIX™ Make utility.

#### **Library Manager**

- ♦ Create, organize and maintain your object module libraries created with Microsoft Languages.
- ♦ Set page size (default of 16 bytes).

#### **Object Code Linker**

- ♦ Simple overlaying linker combines relocatable object modules created using Microsoft Languages into a single program.
- ♦ Load Map generation.
- ♦ Specify from 1 to 1024 segments.

#### **Cross Reference Utility for the Macro Assembler**

- ♦ Creates a cross-reference listing of the definitions and locations of all symbols used in an assembly language program.



**MICRO  
SOFT**

Microsoft is a registered trademark and The High Performance Software is a trademark of Microsoft Corporation. IBM is a registered trademark of International Business Machines. UNIX is a trademark of Bell Laboratories.

"every old tune in the book" is understood to follow "played." Higgins won't be able to do much with these kinds of sentences.

You can increase Higgins's abilities to analyze these sentences, but it is difficult to do things in a general way. You will encounter a host of details and special cases, but with some per-

sistence you can successfully add a lot to your program's abilities.

Comparisons are also often difficult to analyze. The problem is much the same as that of the conjunctions—implied meanings and implied constructs. The comparisons implemented in Higgins depend on giving words such as "greater" and "than"

modal features so that "is greater than" is analyzed as a verb phrase. Higgins understands "Find the boxes that have width greater than height," if you define "greater" as having a "to be" verb form. However, Higgins won't analyze "Find the boxes that have width greater than height and weigh more than 20 pounds" because of the implied construction following the "and." If you want to analyze these kinds of sentences, you'll have to add to Higgins's abilities.

A final sentence form that Higgins doesn't analyze is the compound sentence: "The cat drank the wine, and he had a hangover."

**CONCLUSION**

Higgins is based on pattern matching. This pattern matching uses a particular form of state network called ATN. The network is augmented by adding packet structures that are carried from state to state in the network. Network transitions from state to state are made by recursively calling the next state rather than by simply jumping to it. The call and return allow a simplicity of control at the programming level by placing the burden on the run-time system to keep track of local variables.

Higgins's design is open and simple enough to allow modification. You can add to its abilities to analyze English and keep more information in the packet structures. You can also modify the design to allow ungrammatical sentences and to merge various word types, such as nouns and proper nouns. In addition, you may assign words in the dictionary types and features in such a way that they pass tests they otherwise would not.

Higgins can be a powerful tool for understanding and using English as a part of an application program's operating ability. Remember, Higgins doesn't do anything, it just explains the sentence to you. And recognition is the first step toward understanding.

[Editor's note: The networks described in the text box are documentation for Higgins. You can get a complete set by sending the author a large, self-addressed stamped (two stamps) envelope.] ■



**YOU GET MORE THAN LATTICE C FROM LATTICE, INC.**

When you purchase a C Compiler from Lattice, you get the "complete" compiler chosen by more than 26,000 professional software developers world-wide for its:

- Fast compile time
- Compatibility with proposed ANSI C standard
- Extremely efficient code generation
- Seven iAPX 86 memory models
- Comprehensive XENIX and UNIX compatible library
- High-quality documentation
- Free periodic updates during the warranty period
- Support by more than 50 compatible software libraries and tools
- Unconditional money-back guarantee
- Competent telephone support

Join the thousands of Lattice C users. Call Lattice today for complete information on the Lattice C Compiler, Lattice C Cross Compilers, C Function Libraries, and C Utilities!

Ask about our "Trade Up To Lattice C" Policy!



Lattice, Inc.  
P.O. Box 3072, Glen Ellyn, IL 60138  
Phone: (312) 858-7950 TWX:910-291-2190

International Sales Offices:

BENELUX: De Vooght. Phone (32) 2-720.91.28 ENGLAND: Roundhill. Phone (0672) 54675 JAPAN: Lifeboat, Inc. Phone (03) 293-4711

**14.95**  
SUGGESTED  
RETAIL PRICE

A NEW SOLUTION from  
MicroComputer Accessories, Inc.

# OPEN AND SHUT CASE.



## LOCKING 50 DISK + 4 FILE

Holmes, it's criminal—these "sloppy disks" all over the desk! How can we keep them secure and dust-free and still have access to the active ones?

Mystery solved, Watson. This new 50 + 4 Locking Disk File provides a locking, smoked plastic enclosure for up to 50 5¼" diskettes, *plus* an open, up-front, instant access, swap-rack for 4 diskettes. Let me call your attention to the built-in handle, and the adjustable dividers with adhesive labels. Note the rear storage pocket for extra labels.

By Jove, Holmes, open and shut simultaneously! It's perfect for those powerful integrated, multi-disks systems—and no one's thought of it before! Holmes, you never cease to amaze me.

Elementary, my dear Watson.

MicroComputer Accessories, Inc. 



Open—swap-rack for 4



Shut—locking storage for 50



Built-in carry handle

USA: P.O. Box 3725, Culver City, CA 90231. Telephone 213/641-1800. EUROPE: Rue de Florence 37, 1050 Bruxelles, Belgique. Telephone 02/538.61.73.

Inquiry 240 for End-Users. Inquiry 241 for DEALERS ONLY.

DECEMBER 1985 • BYTE 141

# In 1876 Alexander Graham Bell gave people an easier way to stay in touch. Today, we're doing the same for computers.

At Kyocera, we think it's about time computers had an easier way of staying in touch. That's why we're introducing a telecommunications package featuring our 1200 bps modem and Microsoft's Access software for IBM-PC, XT, AT and all compatibles.

It's the most advanced bundled system on the market. But you don't need an advanced degree in computer science to use it.

We designed our 1200 bps modem with a mind of its own. It can answer automatically, distinguish busy and dial-tones, even handle voice and data communications at the same time. And you won't

Kyocera's intelligent stand alone modem with Microsoft Access software.



have to work overtime memorizing mind boggling command sequences, because we've also given our modem built-in help menus.

Of course, any businessperson worth his weight in data knows the best hardware needs the best software.

That's why we teamed up with the most advanced telecommunications program available, Microsoft's new Access.

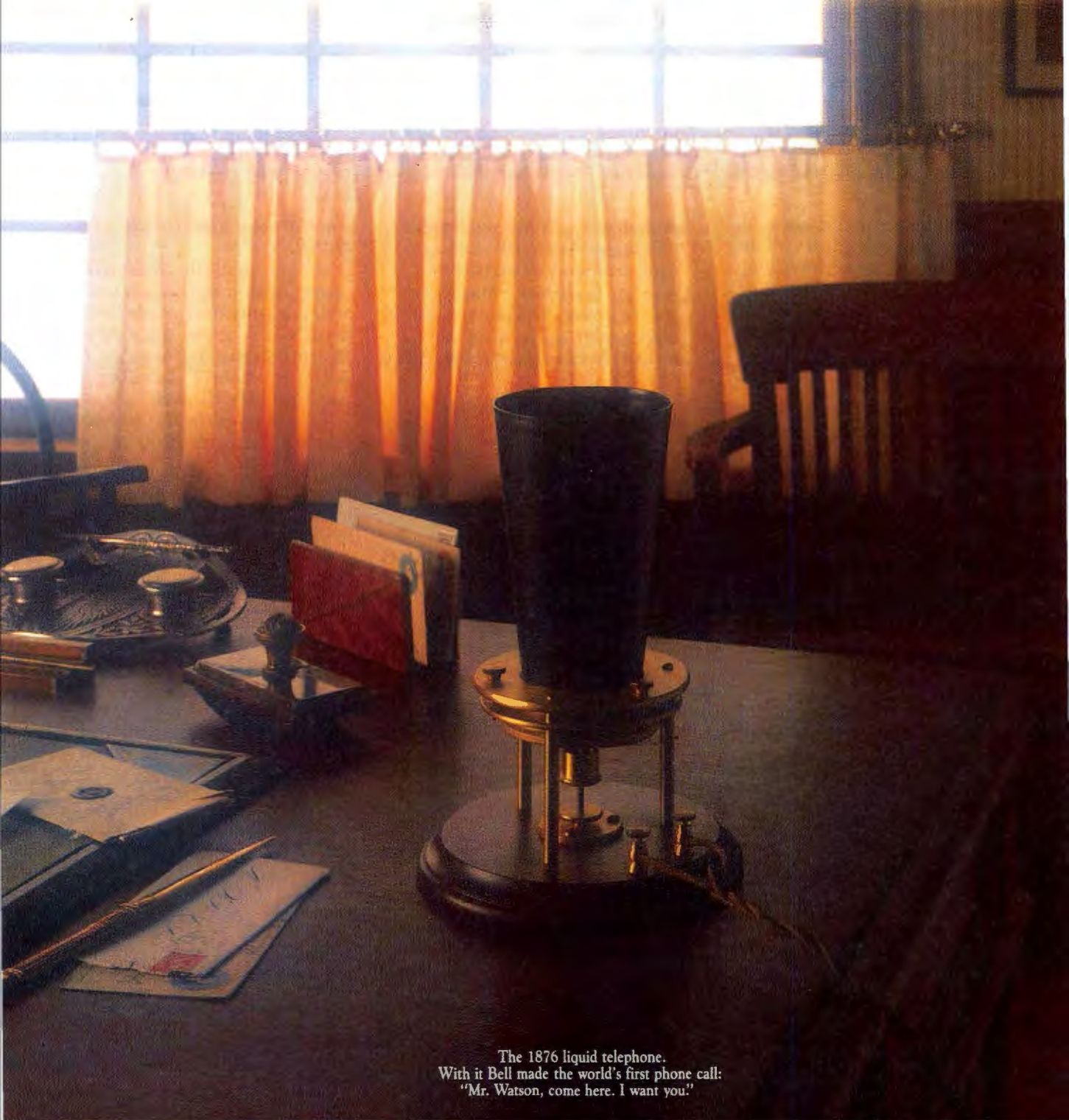
Only Access features X.PC protocol which lets you simultaneously monitor up to 15 live connections through separate "windows" on your screen. For instance, as one window displays stock market returns, another can provide market analysis. Through a third window, you can book an airline flight via OAG (Official Airline Guide). All the while, X.PC checks data transmissions for errors.

Access also lets you compose, send and receive letters through electronic mail services. The Kyocera 1200 bps modem with Microsoft Access is available in stand alone or

For the Kyocera dealer nearest you, call toll-free (800) 235-1222 or (408) 257-8000.

\*IBM, IBM-PC and IBM-XT are trademarks of International Business Machines Corporation. Microsoft is a registered trademark of Microsoft Corporation. OAG is a registered trademark of Official Airline Guide Inc.





The 1876 liquid telephone.  
With it Bell made the world's first phone call:  
"Mr. Watson, come here. I want you!"

direct card. The bundled package contains all necessary accessories, including an RS-232C cable (for IBM-PC, XT\* and compatibles). And because it's bundled, you'll save a bundle.

The Kyocera 1200 modem with Microsoft Access software. If Alexander Graham Bell were around today, he'd wish it was his idea.

 **KYOCERA Modems**  
A tradition of innovation.



# Today, there are lots of BASICs. All but one are a forced fit.

BASIC is so popular it was worth chopping and squeezing it to fit the earliest micros. Stretching it again as memory expanded. And twisting it to do things like graphics. Now, its creators think it's worth reinventing.

## *Every first draft deserves a second chance.*

John Kemeny and Tom Kurtz think the language they created deserves a fresh approach. One that offers structured programming, making line numbers optional but unnecessary. A language that understands external libraries, matrix algebra, and parameter type checking. Graphics syntax that's ready for new hardware when you are. An editor and compiler that are easy for beginners but ready for professional developers.

## *Sometimes, it's the small details.*

Like support for the 8087 and up to 640K of memory on the IBM-PC®. Access to Quickdraw™ routines on the Macintosh®. Long strings, fast floating-point and an editor that includes block copy and global replace.

## *That's why we call it True BASIC™.*

Because it's still the easiest place to learn programming. Because you and your programs won't have to start from scratch with a new language. All you have to do is visit your local dealer and ask for True BASIC™. Or call us directly at (603) 643-3882.

Because your computer and programming language should be a perfect fit.

*True*  
**BASIC** inc.

39 South Main Street  
Hanover NH 03755

Inquiry 362



True BASIC is a trademark of True BASIC, Inc. IBM and IBM PC are trademarks of International Business Machines Corporation. Macintosh is a trademark of Apple Computer, Inc. Microsoft BASIC is a trademark of Microsoft.



# SCIENTIFIC APPLICATIONS SOFTWARE



## *How to find and select suitable scientific software*

**T**o determine whether a scientific applications software package is suited to your needs, you should consider three things—the purpose of the package, the style in which it's

presented, and its overall quality.

Most of the software mentioned in the text boxes for this article is targeted for microcomputers, and the applications are scientific and engineering tasks. But the suggestions I present should help you find and select scientific software in general.

### **THE PURPOSE OF A SOFTWARE PACKAGE**

When considering a particular program or package, you first have to determine what it is supposed to do. If it does not address your problems or needs, it is unlikely to be of further interest to you.

Various sources of information can help you determine which software products have the functionality you need. Some of these sources are listed in the text box "Search Aids" on page 146.

Because the subject matter of scientific software is complicated, it is worthwhile subdividing topics, not by scientific discipline, but by the author's intended audience.

A program may have been developed to perform a particular computational task or tasks for a limited set of scientific or engineering problems. An example of this type of program is one that does structural analysis of buildings.

Or the software may have been developed as a general tool for use in data reduction, data analysis, or docu-

*(continued)*

*John C. Nash (Nash Information Services, 1975 Bel Air Dr., Ottawa, Ontario, Canada K2C 0X1) is a computational mathematician whose research and writings cover many areas of computer applications. He is also a BYTE contributing editor.*

## SEARCH AIDS

### ON-LINE DATABASES

It is often difficult to find the "right" software by means of a database search because of the general lack of precision of the search process. Either the number of "hits" will be large and most citations will prove to be of marginal value, or the number of hits will be small because the search can find few records in the database that match the search profile entered. One reason you may end with a large number of hits is that vendors want you to see their entries even if they aren't of direct value to you. Therefore, the product description they put in the database is often overly generalized. Another reason this happens is because database suppliers want to have as many entries as possible, so they pay little attention to the package's quality or even its existence (apart from an announcement).

Despite these drawbacks, I recommend the following three databases that may be of help to you in your search for scientific software. These are available through the Knowledge Index service of Dialog Information Services, 3460 Hillview Avenue, Palo Alto, CA 94304. There are also agents in other countries around the world. The service rates for these databases (at the time of this writing) are \$35 initial fee for manuals and two hours of on-line use, and \$24 per hour of on-line use thereafter. (Note that there are other database services that may provide these files.)

- Menu—International Software Database (produced by Imprint Software Ltd.)
- Microcomputer Index—(produced by Microcomputer Information Services, 1982)
- Mathfile—(produced by the American Mathematical Society). The first two of these files focus on mini- and microcomputer software offerings, while Mathfile contains abstracts to the mathematical, statistical, and computing literature, including application areas, and covers approximately 1600 journals.

### PUBLICATIONS

The following is a list of periodicals, catalogs, and reports that often discuss scientific software packages. Some of these sources are devoted to particular subject areas. This is not a complete list; there are other sources that offer reviews of interesting software. To obtain more information on these publications, contact the addresses provided.

- *ACM Transactions on Mathematical Software*. Although this periodical is mainly devoted to mainframes, some of the material may be suitable to microcomputers. Contact the Association for Computing Machinery, 1133 Avenue of the Americas, New York, NY 10036.
- *Advances in Engineering Software*. Some articles include program code. Microcomputers are increasingly being featured in this magazine. Contact CML Publications, 125 High St., Southampton SO1 0AA, England.
- *American Statistician*. This magazine includes announcements of statistical software. It also has a regular statistical software review section. The emphasis is on microcomputer software. Contact the American Statistical Association, 806 15th St. NW, Washington, DC 20005.
- *AMSTAT News*. This magazine is mainly of value for its advertisements, which are directed at professional statisticians. It often lists workshops and meetings where software is to be discussed. Contact the American Statistical Association, 806 15th St. NW, Washington, DC 20005.
- *BYTE: The Small Systems Journal*. This magazine provides monthly software reviews. Contact BYTE, 70 Main St., Peterborough, NH 03458.
- *The College Mathematics Journal*. This journal has a regular software review column. Contact the Mathematical Association of America, 1529 18th St. NW, Washington, DC 20036.
- *Computer Physics Communications*. Includes a section on software but main-

ly is of use to mainframe users. Contact North-Holland Publishing Company, Box 211, 1000 AE Amsterdam, Netherlands.

- *Computers & Chemistry*. Includes a regular section on software and the Quantum Chemistry Program Exchange. Contact Pergamon Press Inc., Maxwell House, Fairview Park, Elmsford, NY 10523.
- *Computers & Geosciences*. Some programs included, many of which are designed for, or could be adapted to, microcomputers. Contact Pergamon Press Inc., Maxwell House, Fairview Park, Elmsford, NY 10523.
- *Computers & Structures*. Discusses structural engineering methods. A software survey section is being introduced. Contact Pergamon Press Inc., Maxwell House, Fairview Park, Elmsford, NY 10523.
- *Computers in Mechanical Engineering*. The January 1985 issue is devoted to microcomputer software for analysis and design. Other issues have included similar material. Contact the American Society of Mechanical Engineers, 345 East 47th St., New York, NY 10017.
- *Econometrica*. Occasional discussion of microcomputer software. Contact Econometric Society, c/o Department of Economics, Northwestern University, Evanston, IL 60201.
- "Guide to Available Mathematical Software," *National Bureau of Standards Report NBSIR 84-2824 (1984)*. Boisvert, R. F., S. E. Howe, and D. K. Kahaner. Contact National Technical Information Service, U.S. Department of Commerce, 5285 Port Royal Rd., Springfield, VA 22161.
- *IEEE Micro*. Includes announcements of microcomputer software. Contact *IEEE Micro*, 10662 Los Vasqueros Circle, Long Beach, CA 90720.
- *Journal of Computational Chemistry*. Surprisingly little discussion of software. Contact Wiley/Interscience Scientific Journals, 605 Third Ave., New York, NY 10158.

## SCIENTIFIC SOFTWARE

- *Journal of Computational Physics*. Covers only a few software packages and has a mainframe bias. Contact Academic Press Inc., 111 Fifth Ave., New York, NY 10003.

- *Journal of Forecasting*. Occasional discussion of software, including that for microcomputers. Contact John Wiley and Sons, 605 Third Ave., New York, NY 10158.

- *Journal of Microcomputer Applications*. Interesting material with some scientific applications, e.g., medicine and astronomy, but little direct treatment of software. Contact Academic Press Inc., 111 Fifth Ave., New York, NY 10003.

- *Physics Education*. Includes software reviews, mainly for microcomputer programs. Contact the Institute of Physics, Techno House, Redcliffe Way, Bristol BS1 6NX, England.

- *Science and Engineering* (1984 software catalog). Short listings on over 4300 programs, mostly for microcomputers, indexed by subject and applications. Contact Elsevier Science Publishing Company, 52 Vanderbilt Ave., New York, NY 10017.

- "Scientific Word Processing," *SIAM News*. Wong, P. K. November 1984, page 8. A review of several packages from a mathematician's perspective in the newspaper of the Society for Industrial and Applied Mathematics (SIAM). Related articles frequently appear. Contact SIAM, 1405 Architects Building, 117 South 17th St., Philadelphia, PA 19103.

- *Simulation*. Technical journal of the Society for Computer Simulation. Simulation Councils Inc., POB 228, La Jolla, CA 92038. Periodically includes a software catalog that has a specific section for microcomputers.

- *1984 Guidebook to Statistical Analysis and Graphics Software for Microcomputers*. Goss, T. I. One of the more useful directories in the statistics subject area. Available from Goss, Gilroy and Associates, 124 O'Connor St., Ottawa, Ontario, Canada K1P 5M9.

mentation of work in a number of fields, such as a word-processing system for mathematical or scientific systems or a statistical package.

Alternatively, the package may have been designed primarily to educate users in a certain subject area rather than to provide serious computational power to practitioners. An example of this kind of program is one that illustrates how simultaneous linear equations are solved or one that prepares test questions in a specific discipline from a master set.

### STYLE

The way a software producer presents and packages his creation is the factor that most often causes buyers to rave or curse about software. If several software packages can perform the same function, style may become the hinge of your buying decision.

To determine if a program's style suits you, you should consider three things—the way in which the program must be used, the level of satisfaction or frustration you experience while using it, and the suitability (or fit to application) of the program's packaging and documentation.

Although it is relatively easy to list the features of a software product, even extensive reviews may fail to capture the style of the product. The expanding availability of demonstration disks (especially those that allow you to try all of a program's functions) is to be welcomed as an aid to software selection.

The three subdivisions of software I described earlier—software designed to perform certain tasks, to be used as a tool, or to be used as a teaching aid—can also be applied to the discussion of style.

Early scientific software took the form of single programs or subroutines (tasks) (for example, the collected algorithms of the Association for Computing Machinery). Libraries of subroutines are still a common and useful form of software packaging. However, unless source code is available, this form of packaging requires that you write driver programs and

(continued)



### FoxBASE. The Multi-user DBMS Everyone Can Get Their Hands On.

FoxBASE™ is the only multi-user relational DBMS that's source compatible (including full macro usage) with dBASE II®. Existing dBASE II databases can be used unchanged. What's more, because it's written in C, FoxBASE is extremely portable. Applications need not be changed when porting from one machine or operating system to another.

FoxBASE features full file and record locking capabilities, maintenance of a B+ Tree index structure, and a two billion record file capacity. FoxBASE uses termcap so it can run on most terminals.

#### Multi-user Versions:

Xenix® \$995. MultiLink™ \$995.  
IBM-PC Net™ \$995.

#### Single-user Versions:

MS/PC-DOS™ \$395; AOS/VS \$995.

Don't be outfoxed by the others. Call or write Fox Software today.

dBASE II is a registered trademark of Ashton-Tate.

**FOXBASE™** 

From  
**FOX SOFTWARE, INC.**

27475 Holiday Lane, Perrysburg, OH 43551  
419-874-0162

## SOFTWARE TOOLS FOR SCIENTIFIC COMPUTATIONS

There are a number of software products that attempt to cover most aspects of scientific computation. Others provide a toolbox for a given area of application. Jack Dongarra looked at some of these and provided much of the information below.

### GENERAL SCIENTIFIC SOFTWARE COLLECTIONS

- MATH/LIBRARY \$440; \$320 for universities

This selection, which is from the well-known IMSL subroutine library, is for use on an IBM PC or PC XT with Microsoft FORTRAN 3.2 under MS-DOS 2.0. It contains 540 mathematical subroutines to solve for differential equations and integration, eigensystem analysis, error functions, gamma functions, interpolation, approximation, smoothing, linear algebraic equations, nonlinear equations, optimization, and vector/matrix arithmetic and sorting. Both single- and double-precision versions of the routines are available. Contact IMSL Inc., 7500 Bellaire Blvd., NBC Building, Houston, TX 77036-5085.

- microSUB:MATH . . . . . \$250

This program consists of a set of FORTRAN subroutines in relocatable-object form. The subroutines cover special math functions, interpolation, integration, matrix/linear systems, polynomials/nonlinear systems, and differential equations. Contact Foehn Consulting, POB 5123, Klamath Falls, OR 97601.

- NAG FORTRAN PC50 Library \$345; 20 percent off for universities

This package consists of 50 routines from the NAG FORTRAN library. It can be run on the IBM PC with Microsoft FORTRAN 3.13 under MS-DOS 1.0 (or later) and on the IBM PC XT with Microsoft FORTRAN 3.2 under MS-DOS 2.0. The routines cover a wide range of subjects in numerical and statistical computing, including root finding, Fourier transforms, quadrature, ordinary differential equations, optimiza-

tion, linear algebra, basic statistics, random numbers, linear programming, and special functions. Contact Numerical Algorithms Group Inc., 1011 31st St., Suite 100, Downers Grove, IL 60515.

- The Scientific Desk One-time fee of \$480; maintenance fee \$84 per year

This library of subroutines can be called by a user and embedded in his or her program. The package has a set of applications program menus called Problem Solving Environments (PSEs). The PSEs provide the user with a set of commands that are familiar to the subarea and can be used without programming. They provide programs in the following areas: simultaneous linear-equation solving, vector/matrix arithmetic, inversion, matrix-condition estimation, and statistical inference and estimation. They can handle real matrices stored in two-dimensional form, calculate the roots of polynomials, eigenvalues, and eigenvectors for real square matrices. Contact C. Abaci Inc., 208 St. Mary's St., Raleigh, NC 27605.

### SOFTWARE FOR LINEAR ALGEBRA

- LEQB05 . . . . . \$50

This small linear-algebra algorithm package (of BASIC source code) consists of a number of subroutines and three driver programs that, on most computer systems, can be loaded simultaneously. The programs solve the following types of equations: linear least-squares problems, linear equations problems, matrix inverse, Moore-Penrose generalized matrix inverse, matrix eigenvalue problems for symmetric matrices, and nonlinear least-squares problems. Contact C. Abaci Inc., 208 St. Mary's St., Raleigh, NC 27605.

- LINPACK . . . . . \$75

This collection of FORTRAN subroutines analyzes and solves linear equations and linear least-squares problems. The package solves linear systems whose matrices are general,

banded, symmetric indefinite, symmetric positive definite, triangular, and tridiagonal square. The routines are available in single-precision, double-precision, complex, and double-precision complex. Contact IMSL Inc., 7500 Bellaire Blvd., NBC Building, Houston, TX 77036-5085.

- PC-MATLAB . . . . . \$695

This highly optimized second-generation MATLAB for the IBM PC has been completely rewritten in the C language. New features of the program include graphics, user-defined functions, IEEE arithmetic, test data types, fast-compiled FOR and WHILE loops, and many new analytical commands. The program is available from The Math Works Inc., 124 Foxwood Rd., Portola Valley, CA 94025.

### SOFTWARE FOR NONLINEAR EQUATIONS

- SEQS (The Simultaneous Equation Solver) . . . . . \$100

This program handles up to 20 equations with 20 variables; it is made for the Apple II+ and IIe. Contact CET Research Group Ltd., POB 2029, Norman, OK 73069.

- TK!Solver . . . . . \$299

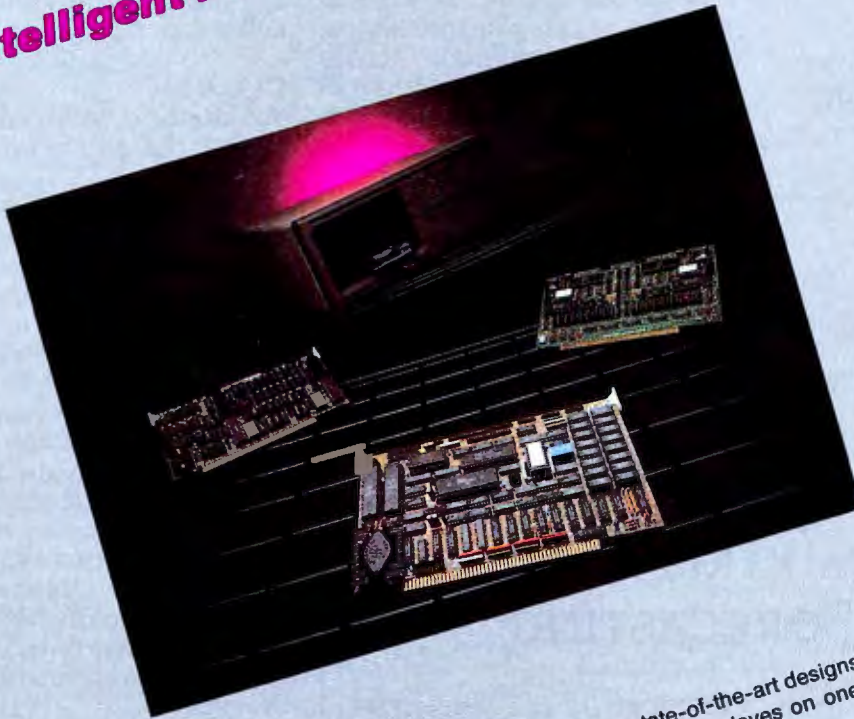
This program also solves equations, but it provides a worksheet-like user interface. For more information, see "TK!Solver" by Alan R. Miller, December 1984 BYTE, page 263. Contact Software Arts Inc., 27 Mica Lane, Wellesley, MA 02181.

### SOFTWARE FOR MATHEMATICAL PROGRAMMING

- LIPS . . . . . \$80
- LPSUBS . . . . . \$99

These two products consists of FORTRAN subprograms for Large-Integer Programming (LIPS) and Linear Programming (LPSUBS) problems on the IBM PC. It is available from Software Designs 2000, POB 13238, Albuquerque, NM 87192.

**Intelligent Ideas  
Come From  
Intelligent Minds**



**Intelligent Computer Designs** XL series S-100 products offer the latest in state-of-the-art designs. Our slave products, the 8-bit XL-DLZ80 and the 16-bit XL-DL88, feature two slaves on one card, enabling system integrators double the number of users previously possible.

The XL-M180, a high-performance system master for single or multi-user applications, complete with hard disk, streaming tape and floppy capabilities introduces something new. An onboard Local Area Network with up to 5Mbps transfer speed. With it, interfacing other XL-M180's or even IBM-PC's is a snap!

If you think ICD has solutions for your systems' needs, write or give us a call.

**XL-DL88**

- 2 completely independent slaves
- 8mhz 70108 processor
- 128k to 512k memory expansion
- 4 serial communication channels
- DMA transfers to/from system master
- CP/M 86, MS-DOS, PC-DOS, TurboDOS compatible

**XL-M180**

- High performance
- HD64180 uPD
- 512k memory with burst refresh
- 5Mbps local area network
- 4 bi-directional parallel ports
- 2 serial ports
- 1 clocked serial port
- Pipelined architecture
- Z SYSTEMS O/S available

- Hard disk controller/Streaming tape option
- All digital floppy disk controller
- Extended instruction set
- Programmable instruction set
- 20 level interrupt structure
- Over 80 I/O ports
- Software programmable baud rates

**XL-DLZ80**

- 2 Z80H 8mhz processors
- 1/2 megabyte memory
- 2 190k local drives
- 4 serial ports
- Draws only 700 millilamps
- No wait states
- CP/M, MP/M, TurboDOS compatible

All ICD products have a one-year part/labor warranty.

XL-SERIES is a trademark of Intelligent Computer Designs Corp.  
 CP/M is a trademark of Digital Research Corp.  
 PC-DOS is a trademark of IBM Corp.  
 MS-DOS is a trademark of Microsoft Corp.  
 Turbo-DOS is a trademark of Software 2000, Inc.  
 Z SYSTEMS is a trademark of Micromin Inc.



9252 Garden Grove Boulevard, Garden Grove, CA 92644 • 714 638-3622/Telex 312659-INTELL Comp-UD

*For your own protection, you should be aware of the quality of a scientific program before you buy it.*

learn how to link to the compiled sub-routines.

More recently, the microcomputer

has come to be viewed as a workstation, which in turn has led to the development of more scientific software in the form of command- or menu-driven packages (tools) that do not require that you program them. As the command set becomes richer, you are given more control over data manipulation, and you can group commands into procedures that are interpreted, compiled, or otherwise processed for execution. The end product is a new programming language in all but name.

Another approach some software developers take is to provide a prototype program that is designed to be easily modified by the user (the

teaching aid approach). You can adapt it to particular tasks or personal preferences. This approach is not widely used commercially, partly because there are difficulties in protecting the authorship of programs.

**QUALITY**

The degree to which software performs as claimed is far too often taken for granted.

In scientific computations, subtle interactions between the problem presented and the floating-point arithmetic used to solve the problem may dramatically alter the results a program obtains. Thus, scientific software must operate correctly on the tasks it shares with such programs as word processors or database managers. However, it must also be produced in such a way that the approximations and iterative processes it uses give results that well-informed users consider reasonable. Alternatively, diagnostic information that allows troublesome situations to be understood and corrected in an appropriate way must be output.

For your protection, you should be aware of a program's quality before you buy it. This means you should pay attention to reviews by competent professionals in the field, the documentation of authorship, methods of program development, the history of the software, and the reputation of the software producer and vendor.

**CONCLUSION**

The text boxes "Software Tools for Scientific Computations" on page 148 and "Microcomputer Software for Econometric Modeling and Forecasting" at left list a number of scientific software packages. However, with the development of new products and the improvement of existing ones, this information will soon be dated. In order to obtain more up-to-date information, you should also consider the following sources: reviews in scientific journals, reviews in computer journals and magazines, publications dedicated to scientific software and its uses, and public-access software databases. ■

**MICROCOMPUTER SOFTWARE FOR ECONOMETRIC MODELING AND FORECASTING**

This list illustrates the variety of software that may be available for a given subject area.

- ESP (The Econometric Software Package)..... \$795

This package uses menus, function keys, and commands to build a specialized language for estimation, forecasting, simulation, and analysis. Contact Alpha Software Corporation, 30 B St., Burlington, MA 01803

- Horizon/370 Software for the AT/370 One-time fee of \$50,000; maintenance fee is \$5000 per year

This forecasting workstation incorporates econometric forecasting and time-series techniques. Contact Chase Decision Systems, 1000 Massachusetts Ave., Cambridge, MA 02138.

- INSTAT-QF..... \$19.95

The QF stands for "quick forecaster." This program is for the IBM PC or PC XT. It uses ARIMA modeling and is menu-driven. The price of both programs is more than reasonable. Contact Statistical Consulting Services, 517 East Lodge Dr., Tempe, AZ 85283.

- MICROBJ..... \$295

This ARIMA system is based on the Box-Jenkins philosophy. It is for the Apple II or IBM PC. Contact Stratix, POB 1014, Woodinville, WA 98072-1014.

- Nuametrics..... \$195

This econometrics package uses single- and multiple-regression techniques for statistical analysis and forecasting. Contact Stratix, POB 1014, Woodinville, WA 98072-1014.

- RATS (Regression Analysis of Time Series)..... \$250

This is a comprehensive command-driven system for knowledgeable users of the IBM PC. The summary listing of commands is 12 pages long, so it's not a product you can just switch on and use. A hard disk is not mandatory, but it helps. The program is available from VAR Econometrics, 134 Prospect Ave. S, Minneapolis, MN 55419.

- XTRAPOLATOR..... \$195

This is an automatic forecasting system. Contact Stratix, POB 1014, Woodinville, WA 98072-1014.

# THERE IS NO FINE PRINT.



## IT PERFORMS, OR WE REPLACE IT.

With all the care and precision that goes into every Kodak diskette, it's only natural that you'd expect extraordinary performance.

And that's exactly what you'll get.

You see, Kodak diskettes are made for any application where trouble-free performance is essential and data protection is critical.

For openers, every Kodak diskette has the stamina to sustain signal strength far above industry performance standards, even after millions of read-write passes.

Every Kodak diskette is individually tested for read-write performance over every sector, every track.

And it's not until those tests and many others are completed that

Kodak diskettes are certified error-free.

Naturally, every Kodak diskette is backed by our Performance Guarantee, which promises a free replacement in the unlikely event that a Kodak diskette is defective. No other warranties are expressed or implied.

You'll find Kodak diskettes at computer stores, office supply dealers, and other retail outlets. In standard-density 8- and 5 1/4-inch formats, plus high-density 5 1/4-inch diskettes, and 3 1/2-inch micro diskettes. The Kodak diskettes. Performance without the fine print.



**KODAK.**  
The name says it all.



COMPAQ could have stopped here

---





# ...but we didn't.

## Presenting the COMPAQ DESKPRO 286™ More features, more speed...more power.

Most people think the IBM® Personal Computer-AT™ holds the records for speed, memory, and storage. But COMPAQ® has a personal computer that pushes the technology much further.

### A faster computer

Most computer companies would have been satisfied with a computer that ran programs as fast as the IBM PC-AT. But not COMPAQ. The COMPAQ DESKPRO 286 runs all the popular programs 30% faster.

### Work alone or network

Most would have been content with 3 Megabytes of memory, the IBM PC-AT's maximum. But again, not COMPAQ. The COMPAQ DESKPRO 286 can expand to 8.2 Megabytes.

And most would have been comfortable with 40 Megabytes of storage, the IBM PC-AT's maximum. But we designed the COMPAQ DESKPRO 286 to expand up to 70 Megabytes so it can become a faster, more powerful network file server.

Like the IBM PC-AT, COMPAQ offers 360-K byte and high-capacity 1.2-Megabyte diskette drives. But

we didn't stop there. We offer you more. Like the *internal* fixed disk drive back-up system pioneered by COMPAQ, to protect all the data on your 20-, 30-, or 70-Megabyte fixed disk drive system. There's room to accommodate up to four storage devices.

### No compromises

The COMPAQ DESKPRO 286 offers a monitor that displays both high-resolution text *and* graphics. To get the same feature with the IBM PC-AT, you'd have to pay considerably more.

In short, with the COMPAQ DESKPRO 286, you don't get compromises. Just a more powerful, more advanced, more complete personal computer for anyone who demands the utmost in performance.

And if you need all this power to go, we also offer it in a package half the size of an IBM PC-AT, complete with a handle. It's called the COMPAQ PORTABLE 286™.

Portable or desktop, COMPAQ offers computers without equal. Because we design them without compromise.

For a free brochure or the location of your nearest Authorized COMPAQ Computer Dealer, call toll-free 1-800-231-0900 and ask for operator 7.



It simply works better.

**COMPAQ**  
**DESKPRO 286™**



# WOULD YOU BUY A PACEMAKER FROM MATTEL?

*IBM/PC-based LOGIC LINE-1™ artificial intelligence software is so advanced, that competitive products are toys by comparison.*

There aren't very many who'd stake their lives on a toy-store pacemaker. Luckily, we won't have to worry about their rancid cells polluting mankind's gene pool very long anyhow. Such brain-damaged geeks tend to die young.

If you've recently spent money on artificial intelligence software, you might be wishing a few programmers had croaked before writing that blithering swill they named AI and palmed off onto you. What they call an "inference engine" is nothing more than an IF-THEN decision tree that can't even do a very good job of arithmetic\*

We're Clarity Software, and we're introducing a product that can take a massive amount of text from any machine-readable source, and mathematically distill thought processes for query and analysis. This process, as distinguished from *expert systems*, is referred to as *natural-language intelligence*.

In this ad, we're going to explain to you why you'd be crazy not to have our package in your portfolio of data-manipulation assets.

## DERIVE THE DNA/RNA OF ANY WRITER'S THOUGHT PROCESSES.

LOGIC LINE-1 was the result of the interaction between a couple of cyberneticists and a physicist, with combined experience in high-performance learning and pattern-recognition programming. The physicist was responsible for one of the first DNA/RNA-tracking systems (the *RNA-of-thought* assertion is more than just an advertising creation). We are not your ordinary bunch of yahoos.

Imagine having the collected thoughts of Voltaire online. If you were interested in viewing Voltaire's thoughts on "job security," you would enter that term in the search menu.

Now you're thinking: "Nuts! These yahoos are trying to sell me something my supposedly *toy* text editor can do with a search command. Right?"

Wrong, pussycat. Your inference process was a little quick on the trigger. Never, in any of Voltaire's writing, was there ever the phrase "job security."

"Ok," you reply. "You have a dictionary of synonyms, eh?" Wrong again. LOGIC LINE-1 has no dictionary. Interesting?

Essentially, LOGIC LINE-1 uses a series of mathematical transformations on text, the out-

put of which is cataloged in a database analogous to a biological DNA/RNA imprint of that text.

There are approximately one dozen parameters that make up a *thought's DNA/RNA*. Some transformations fingerprint syntax patterns; some look at subject/predicate relationships via a small dictionary of several dozen *noise* words.

After setting up the above Voltaire "job security" query, LOGIC LINE-1 will present you with high-possibility "hits." You will type "Y" when they are relevant, and "S" for skip, when they are not.

The first several "hits" might be rejected, since the term "job security" will not be found. Once you get an acceptable entry, however, and lock onto an acceptable *RNA-of-thought* pattern, the accuracy of LOGIC LINE-1 will be staggering. Or we'll refund your money. Simple enough?

## "I'M NOT INTO VOLTAIRE," YOU SAY. "WHY DO I NEED LOGIC LINE-1?"

How would you like to be able to turn any textbase into an expert system? For example, most PC users rely upon word processing. The problem is, we store our correspondence in files with names like "LT062185" or "REJECT21" or "RANDOMTH." As a result, we reinvent the wheel with each letter we compose. Why do this?

Using LOGIC LINE-1, you can append all your written correspondence into one textbase file. Sure, any word processor could do a straight search for a term like "quality." But none can do this search as fast as LOGIC LINE-1. And none could turn up the "quality" references if queried for the term "workmanship!"

Thus, when writing letters and speeches, use LOGIC LINE-1 to collect previously articulated thoughts on any given subject. Whatever your profession, be it law, medicine, engineering or information management, LOGIC LINE-1 is an indispensable tool for true thought processing.

Now that thousands of textbases are publicly available, LOGIC LINE-1 is the key to their intelligent use. Once the computer establishes associative links in a large body of material, many creative applications are possible.

## TRUE AI! CLONE THE GREAT MINDS ON YOUR PC.

Did Bacon write Shakespeare? Did Albert Einstein have anything relevant to say on the subject of "generation gap?" How many congressmen consistently contradict themselves in the *Congressional Record*?

The uses of LOGIC LINE-1 are limited only by the availability of textbases, and by your imagination.

Do you dare send a student to college without LOGIC LINE-1 and a PC? Would YOU care to compete in business with someone else who has this leading-edge, decision-support software?

Einstein should write your papers on relativity. Alfred North Whitehead should write your papers on philosophy. And Shakespeare should write your love letters.

## 1985'S SPECIAL \$100 LIMITED-TIME OFFER WILL BE HISTORY IN 1986.

This is our very first, and only, announcement ad. For the rest of this year, you may obtain LOGIC LINE-1 for only \$100 (note, we didn't try to fool you with a \$99.95 price tag; we *do* give you, as well as your computer, some credit for intelligence). As of January 1, 1986, LOGIC LINE-1 will retail for \$250.

To find out more about LOGIC LINE-1, call 216/729-1132. You may order by phone by calling 800/621-5839 (or in Illinois, call 800/972-5855). Return the product for any reason whatsoever within 30 days for a full refund. If you are with the US government or one of the intelligence *spook shops*, LOGIC LINE-1 is available to federal/DOD buyers through IBIS Corporation, 131 Elden Street, Herndon, VA 22070 (call 800/532-3344 or 703/478-0300).

You **COULD** spend your next \$100 for other software. You could also ask Weird Al Yankovic to install that terrific new pacemaker from your kids' *Young Doctor* toy kit. Call today and save more than just money.

 **CLARITY  
SOFTWARE®**

A Div. of EXPANSION PGMS INT'L, Inc.  
PO BOX 839 • Chesterland, OH 44026 • USA  
(216)729-1132

\*The only other package out there worthy of the label "artificial intelligence" is from Teknowledge in Palo Alto, and we don't compete with them. They build "expert systems," while our emphasis is on "natural language" systems. We mention them in passing, because they're one of the few "good guys." Copyright © 1985 by Clarity Software. LOGIC LINE-1™ is a trademark of Clarity Software, and requires a 128K IBM PC with at least one diskette drive and runs under MS/DOS 2.1 and up. IBM™ IBM Corp. MATTEL™ Mattel. We hope the swell people at Mattel can take a joke. Advertising & PR by TRBA, 408/258-2708.

# VIRTUAL FIELDING IN MICROSOFT BASIC

BY C. R. J. CURRIE

## *A method for handling files with large record lengths*

THIS ARTICLE DESCRIBES a technique for handling files with record lengths exceeding a sector on Microsoft BASIC (MBASIC) systems. I originally devised this technique for use on Tandy's TRS-80 Models I, II, and III, which have sector lengths and maximum record lengths of 256 bytes, but it should be usable with little or no change on most versions of MBASIC. Your version of BASIC should be able to automatically handle variable-length records of a size less than the system's maximum.

On the TRS-80s and other systems with short maximum record lengths, the usual method for handling long logical records is called span blocking. Fields of the records are written to disk one by one. Before each is written, the position of the start of the field within the physical sector is calculated. If the field will then overflow the sector, the extent of the overflow must be determined, the field split into two, and the remainder written to the next sector. The calculations are then repeated for each successive field. The procedure is slow and cumbersome.

In more advanced versions of MBASIC, including those running on

machines that use the Intel 8086 microprocessor or its derivatives, there is automatic span blocking; logical record lengths up to 32K bytes can be handled directly. Nevertheless, you will encounter two serious difficulties when you manage such long records. First, the FIELD statement can only cope with buffers up to approximately 7K bytes. Second, MBASIC allows the program to address only 64K bytes of memory (one segment if the 8086 is used). You must reserve file buffers before entering BASIC, and the space they use is deducted from the memory available for programs and data. Moreover, the space you reserve for every buffer must equal that needed for the largest file buffer. Thus, if you need to handle a large data file with 20K-byte records, using two other index files each with a much smaller record length, you still must reserve 60K bytes, which leaves hardly any space for the program. In some cases, where the total space used by the file buffers exceeds 64K bytes, the system will appear to leave more memory—but that is deceptive and potentially disastrous, since some of the file buffers may in fact be mapped onto the

program area. Therefore, the very large file buffers that the system seems to permit are virtually useless.

By contrast, the "virtual-fielding" method, which uses a virtual-memory technique to control the buffers, allows you to handle up to 15 files simultaneously, with combined record lengths of 300K bytes on the 48K-byte TRS-80 (or half a megabyte or more on a 128K-byte machine running MBASIC-86). The virtual-fielding method requires no span blocking and does most of the few needed calculations only once at the beginning of the program. Moreover, you can treat each long record (for purposes of data transfer, hash coding, or tree searching) as a single logical record. Compared with span blocking, there is usually a waste of some disk space, but it should never be as much as 1 percent within each logical record. Since span blocking generally wastes a little space in the last sec-

*(continued)*

C. R. J. Currie (Institute of Historical Research, Senate House, Malet Street, London WC1E 7HU, England) has been involved since 1981 with the use of microcomputers in the fields of historical research, writing, and publishing.

tor of each file, virtually fielded files will seldom be longer than span-blocked files.

The technique requires that you reserve an area of high memory for the record buffers of long files. The area must be slightly greater than the longest record length used in the files that the program accesses, and you

must protect the area when you enter BASIC from the operating system. In MBASIC, you type MBASIC /M:nnnnn from the operating-system prompt, where nnnnn is the address above which the memory is to be protected. The same area of memory will be mapped to handle all the files' logical records.

The management program must know the number of files, their record lengths, and the number and lengths of the fields in each file. For each file, an initialization routine calculates the number of 256-byte sectors required for each logical record and then calculates a standard buffer length. If the logical record length is (or is just one byte short of) a multiple of the sector length, the routine assigns a 128-byte buffer. In other cases where the record length is not an exact multiple of the sector length, the buffer length will be less than 256 bytes, and the record length will be rounded up to a multiple of the buffer length. Each buffer will be treated as a single field for interaction with the interpreter. Single-dimensional arrays (one of integers, the other of strings) hold the file buffer lengths and the buffer field variables. The number of elements of the arrays is the number of files to be handled. A third array of dummy strings is set up at the same time; the length of each string element is set to that of the corresponding file buffer. You can then open the files with the appropriate buffer lengths.

Next, the routine sets up a two-dimensional array of strings for the logical fields. One dimension's size equals the total number of files; the other dimension's size is the largest number of fields used in any file. For each file, the routine points the appropriate strings in the array sequentially at the protected memory buffer by manipulating the array's VARPTR function. All the logical records are thus mapped onto the same area of memory, a safe process because only one file can be read from or written to at any time and because the buffer is only used for temporary storage.

When the routine writes a record, it transfers data to the fields in the memory buffer using the LSET or RSET block-move commands, just as if the fields were ordinary field variables. It then uses the appropriate dummy string as a window and steps across the memory buffer by manipulating the pointer to its address. After each step, it uses LSET to trans-

(continued)

# You already own a computer that can talk. Now let it.

Now you can upgrade almost any personal computer and make it more powerful than ever, by giving it the power of speech.

The Votrax Personal Speech System is the least expensive sophisticated voice synthesizer available today. The PSS's text-to-speech vocabulary is virtually unlimited, and you can define an exception word table and customize your translations. So the PSS can say just about anything!

### It's a speech and sound specialist.

The PSS can also mix speech and sound effects or speech and music. It contains its own speaker, a programmable master clock, 256 programmable frequencies, a programmable speech rate for a more natural rhythm, and 16 programmable amplitude levels for incredible control of word emphasis. You can control the volume. Plus, it doesn't use any of your computer's valuable memory.

### It's computer friendly.

The PSS is unbelievably easy to use. It doesn't need an interface card for most computers. It comes with standard serial and parallel ports. Speech, music, and sound effects are as simple as printing out a document.

### What do you do with a talking computer?

There are countless practical applications. Businesses may want the PSS for spoken transmission of information, narration of displays, and product demonstrations. It makes verification of data input possible for the blind. It can be part of a burglar alarm system. Children can use the PSS as a study aid. And it helps games come alive, speaking while you play.

Whatever your computer can do, the PSS can help it do it better, at a cost that makes it all worthwhile: only \$395.\* Call (313) 583-9884 to hear an actual voice demonstration of the PSS.

\*Suggested retail price

### There's also the Type 'N Talk.

If you want a less sophisticated unit and want to spend a little less, consider the Votrax Type 'N Talk (TNT). Its vocabulary is also limited only by what you can type. It doesn't use any computer memory, it's compatible with most computers, and it's only \$249.\* Just plug it in to your own speaker and go!

For more information about the Personal Speech System or the Type 'N Talk, see your local computer retailer, call toll-free or write:

**votrax**  
1394 Rankin  
Troy, Michigan 48063  
1-800-521-1350  
(In Michigan, call collect  
313-588-0341)

GIVE YOUR  
COMPUTER  
THE POWER OF  
SPEECH.





# IF STAYING WELL INFORMED CAN KEEP YOU WELL AHEAD, COMPU SERVE'S GOT BIG NEWS FOR YOU.

**Introducing the Executive News Service and state of the art access to all the news you need.**

CompuServe's exclusive Executive News Service is an electronic clipping service that puts the power and scope of the entire Associated Press news wire at your fingertips. Simply enter words or phrases that interest you ... from business to politics to hometown news. The Executive News Service then screens all state and national AP wires around the clock and files selected stories for reading at your convenience.

Then there's USA TODAY Update, with late breaking business information available

for quick analysis by busy executives. USA TODAY's editors monitor hundreds of national and international news sources to bring you the latest, most important developments. General news reports are updated hourly. Reports for specific industries are provided daily in a concise, executive summary format.

Or access The Washington Post, with its fingers on the pulse of the national political scene. CompuServe delivers it all, plus a variety of other information, entertainment and communications options.

You can access CompuServe with almost any computer and modem, terminal or communicating word processor. To buy a Subscription Kit, see your nearest computer dealer. To receive our informative brochure, or to order direct, call **800-848-8199**

(In Ohio, call 614-457-0802). Or send this coupon today.

**YES. Please send me your CompuServe Information Services brochure.**

Name \_\_\_\_\_  
 Address \_\_\_\_\_  
 City \_\_\_\_\_  
 State \_\_\_\_\_ Zip \_\_\_\_\_  
 Business Phone \_\_\_\_\_

**CompuServe®**

Information Services  
 P.O. Box 20212, 5000 Arlington Centre Blvd.  
 Columbus, Ohio 43220  
**800-848-8199**

In Ohio, call 614-457-0802 ENS-412  
 An H&R Block Company

Listing 1: A short demonstration program.

```

10 REM DEMO LONG BUFFER PROGRAM FOR TWO FILES:MULTIFILE
METHOD.
11 ' C.R.J. CURRIE. 18 DECEMBER 1984
14 '
15 REM *** CLEAR (STRING SPACE IF NEEDED), SET SAFETY MARGIN
20 ' FOR MBASIC-86, USE 600: FOR TRS-80, USE 10
24 '
25 CLEAR 5000:DEFINT F:MG = 600
26 '
27 REM *** DETERMINE ADDRESS OF PROTECTED MEMORY BUFFER
28 ' LINE 30 MUST BE EXECUTED BEFORE ANY OTHER STRING WORK
29 '
30 AS = AS:HI = PEEK(VARPTR(AS) + 1) + PEEK(VARPTR(AS) + 2)*256:HI = HI + MG
40 REM *** FOR TRS-80 MODEL I/III USE:
41 REM *** HI = PEEK(16561) + PEEK(16562)*256:HI = HI + MG
42 '
43 REM *** MOD FUNCTION IF YOUR BASIC LACKS IT
44 '
45 DEF FNMD%(A,B%) = A - (INT(A/B%)*B%)
49 '
50 READ NF%:DIM F$(NF%):' NUMBER OF FILES
57 '
58 REM *** TEST ON TWO EXISTING FILES FOR DEMO PURPOSES
59 '
60 FOR N% = 1 TO NF%:PRINT"NAME OF FILE NUMBER";N%:" ";LINE INPUT
F$(N%)
70 NEXT
79 '
80 GOSUB 6000: REM *** INITIALIZE BUFFERS
87 '
88 REM *** DEMO ARRAY
89 '
90 DIM B$(FO(1))
297 '
298 REM *** DEMO READ (E.G., OF EXISTING TEXT FILE) - SECOND RECORD
299 '
300 FOR M% = 1 TO NF%
310 KT$ = TIMES$:RC = 2:GOSUB 1000:FOR N% = 1 TO
FO(M%):PRINT B$(N%):NEXT N%,M%:CLOSE:END
497 '
498 REM *** WRITE VARIABLES TO MEMORY BUFFER: DEMO ONLY
499 '
500 FOR N% = 1 TO FO(M%):LSET F$(M%,N%) = B$(N%):NEXT:RETURN
697 '
698 REM *** READ VARIABLES FROM MEMORY BUFFER:DEMO ONLY
699 '
700 FOR N% = 1 TO FO(M%):B$(N%) = F$(M%,N%):NEXT:RETURN
997 '
998 REM *** READ RECORD FROM DISK-INVARIANT; M% = FILE NUMBER,
RC = LOGICAL RECORD NUMBER
999 '
1000 FSTART! = HI:FOR N% = 1 TO NBUF%(M%)
1020 GET M%,(RC - 1)*NBUF%(M%) + N%
1024 '
1025 GOSUB 23000:REM *** MOVE WINDOW THROUGH MEMORY BUFFER
1029 '
1030 LSET FC$(M%) = FB$(M%):NEXT
1050 RETURN
1997 '
1998 REM *** WRITE RECORD TO DISK-INVARIANT
1999 '

```

(continued)

fer the contents of the memory buffer to the file buffer and that buffer is written to disk. A loop handles these operations easily. To read a record, the routine reverses the procedure. To ensure that the logical field strings keep pointing at their correct places in the memory buffer, you need only avoid using them on the left side of an assignment statement other than MID\$, LSET, or RSET.

The sum of the longest record length and the space occupied by the 3-byte string pointers of the logical field array determines the maximum number of files and fields and the size of record. A 15-row by 100-column string array uses less than 5K bytes for pointers. With 255-byte logical fields, that would allow each record of each of the 15 possible files to have up to 25,500 bytes, or a total of 382,500 bytes, at a sacrifice of only 30K bytes of RAM (random-access read/write memory). In 16-bit MBASIC, that still leaves 32K bytes for the program and space in which to manipulate the data.

A demonstration program (see listing 1) reads data from two files whose record lengths are 1066 bytes and 701 bytes. The program assumes a default record length of 256 bytes; in some versions of MBASIC, you must specify this default when you load BASIC. The demonstration files use all string fields, but the method is equally applicable to MBASIC's compressed numeric fields. You can use existing text files to test the program.

DATA statements at the end of the program store the number of files, and for each file the record length and the number and length of fields. For files with very long record lengths, however, it would be more appropriate to store that information in a separate sequential file and read it in at the beginning of the run, replacing all READ statements by INPUT# statements. Note that the data for the file with the most fields must head the list. Line 45 defines a modulo function; it is not needed for MBASIC versions that have a MOD function. For

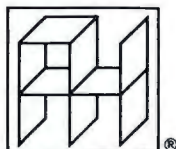
(continued)



# The \$69.<sup>95</sup> solution.

**Order GP-Tools by calling toll-free: 1-800-821-2165  
(In Florida, call collect: 305/657-1144)**

Major Credit Cards Accepted



ALLEN-HARRIS INDUSTRIES, INC.  
130 UNIVERSITY PARK DRIVE - SUITE 185  
WINTER PARK, FLORIDA 32792  
TELEPHONE 305/657-1144

## VIRTUAL FIELDING

```

2000 FSTART! = HI:FOR N% = 1 TO NBUF%(M%):GOSUB 23000:LSET
      FB$(M%) = FC$(M%)
2010 PUT M%,(RC - 1)*NBUF%(M%) + N%:NEXT
2020 RETURN
5997 '
5998 REM *** BUFFER INITIALIZATION ROUTINE: INVARIANT
5999 '
6000 DIM BU%(NF%),FC$(NF%),FB$(NF%),NBUF%(NF%),FO(NF%)
6010 FOR M% = 1 TO NF%:GOSUB 6020:NEXT M%:RETURN
6017 '
6018 REM *** CALCULATE BUFFER LENGTHS FOR EACH FILE
6019 '
6020 FSTART! = HI
6030 READ RL:REM *** RECORD LENGTH
6040 READ FO(M%):REM *** NUMBER OF LOGICAL FIELDS
6050 IF M% = 1 THEN DIM FA$(NF%,FO(1)): ARRAY FOR FIELDS
6060 NBUF%(M%) = INT(RL/256):IF FNMD%(RL,256) = 255 THEN
      RL = RL + 1:GOTO 6060
6070 IF FNMD%(RL,256) = 0 THEN
      NBUF%(M%) = NBUF%(M%)*2:BU%(M%) = 128:GOSUB 20015 ELSE GOSUB
      20000:REM *** FIELD FILE BUFFER AND DUPLICATE BUFFERS
6097 '
6098 REM *** NOW FIELD LOGICAL FIELDS
6099 '
6100 FSTART! = HI
6110 FOR N% = 1 TO FO(M%):READ A%:TP = VARPTR(FA$(M%,N%)):POKE
      TP,A%:GOSUB 25000:FSTART! = FSTART! + A%
6120 NEXT N%
6130 RETURN
19997 '
19998 REM *** FILE BUFFERS FOR IRREGULAR RECORD LENGTH
19999 '
20000 NBUF%(M%) = NBUF%(M%) + 1:BU%(M%) = INT(RL/NBUF%(M%))
20010 IF FNMD%(RL,NBUF%(M%)) < > 0 THEN BU%(M%) = BU%(M%) + 1
20015 FC$(M%) = FC$(M%):GOSUB 22000:RETURN
21997 '
21998 REM *** OPEN FILES
21999 '
22000 OPEN "R",M%,F$(M%),BU%(M%)
22010 FIELD M%,(BU%(M%)) AS FB$(M%)
22020 RETURN
23000 TP = VARPTR(FC$(M%)):POKE TP,BU%(M%)
23010 GOSUB 25000
23020 FSTART! = FSTART! + BU%(M%): RETURN
24997 '
24998 REM *** POINT STRING AT MEMORY BUFFER
24999 '
25000 POKE TP + 1,FNMD%(FSTART!,256):POKE
      TP + 2,INT(FSTART!/256):RETURN
29997 '
29998 REM *** DEMO DATA:CHANGE AS APPROPRIATE
29999 '
30000 DATA 2:REM *** NUMBER OF FILES
30005 DATA 1066:REM *** RECORD LENGTH OF FIRST FILE
30010 DATA 6:REM *** NUMBER OF LOGICAL FIELDS
30020 DATA 101,151,202,203,204,205:'LOGICAL FIELD LENGTHS
30030 DATA 701:REM *** RECORD LENGTH OF SECOND FILE
30035 DATA 4:REM *** NUMBER OF LOGICAL FIELDS, FILE 2
30040 DATA 200,200,200,101:'FIELD LENGTHS FOR FILE 2

```

those versions, you can replace calls of the form  $X\% = \text{FNMOD}\%(A,B\%)$  with  $X\% = A \text{ MOD } B\%$ .

The program begins by calculating the address of the bottom of protected memory (line 30), allowing a safety margin (MG) above the top of BASIC's string space (which you must adjust for your version of MBASIC). The program then reads the number of files and sets up an array of file-names that it reads from the keyboard. Line 6000 begins the main initialization routine, which is invariant in form for all virtual-fielding applications. The initialization sets up the arrays for buffer lengths (BU%), dummy string windows (FC\$), file buffers (FB\$), buffer numbers (NBUF%), and numbers of fields (FO). A separate subroutine at line 6020 calculates the number of sectors needed for the logical record of each file. If required, that separate subroutine calls the routine that computes irregular buffer lengths (beginning at line 20000) and then calls the file-opening routine at line 22000. The program can later call the file-opening routine if any file has been closed in the meantime, after setting M% equal to the number of the closed file. Lines 6100–6130 set up the logical fields (FA\$).

Lines 500 and 700 provide two straightforward demonstration subroutines for transferring data to and from the logical record buffers; only the read routine is used here. The routines for reading and writing a record to disk are at lines 1000–1050 and 2000–2020. Like the initialization routine, they are invariant for all virtual-fielding applications. Both call a subroutine at 23000, which steps the FC\$ dummy string through the memory buffer by altering its address.

Virtual fielding should remain useful in the future because the technique works well under both 8-bit and the current 16-bit versions of Microsoft BASIC. Today we have more advanced 16-bit versions of Microsoft BASIC that allow for 64K-byte strings and a megabyte or more of address space, and we have computers using optical storage media with capacities of hundreds of megabytes. ■



# READ ONLY



*A review of the IBM Personal Computer Family. Vol. 2, No. 3*



## HARDWARE NEWS

### A growing family of PC Printers.

Different jobs demand different printers. IBM has developed a full line of printers for its Personal Computer Family to answer those demands. Two of the most recent—the IBM Proprinter and the IBM Color Jetprinter—deserve special mention.

Both are compatible with the IBM PC Family of Personal Computers as well as with many other leading home and office personal computers. And both offer the traditional high standard of IBM reliability and support.



### The IBM Proprinter:

The IBM Proprinter alone can help you complete a variety of different home or office jobs.

It has an unusual feature that will be welcomed by everyone who has spent time switching back and forth from single-sheet to continuous forms printing. A special slot in the front of the Proprinter allows you to print single pages or envelopes quickly and easily without removing the continuous forms paper.

The Proprinter's high-speed (200 cps), dot-matrix technology can make short work of your day-to-day

printing tasks like first drafts of letters or reports.

For more finished work, the Proprinter does near-letter-quality printing (at 40 cps) and lets you add emphasis to your text (at 100 cps) with bold print, condensed print and underlining.

It also has all-points-addressable graphics capabilities that can help you produce a complete range of charts and graphs to illustrate your text.

One additional plus: it's very competitively priced.



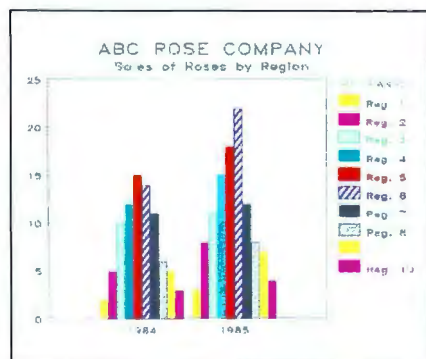
*IBM Proprinter has a convenient slot for printing envelopes or single pages.*



*IBM Color Jetprinter quietly utilizes "drop-on-demand" ink jet technology.*

### The IBM Color Jetprinter.

The IBM Color Jetprinter is an unusually quiet, compact workstation printer that utilizes advanced "drop-on-demand" ink jet technology.



*Samples of color graphics and texts produced by IBM Color Jetprinter.*

Designed to be used with the IBM PC and many other personal computers, it's supported by a wide selection of software programs.

You can use it to produce draft and near-letter-quality text and high-quality graphics in up to seven colors.

In addition, the Jetprinter allows you to highlight your text with bold and underlined passages done in color or printed against a background color.

The Color Jetprinter also prints graphs, charts, engineering drawings and texts directly onto special Jetprinter transparencies for presentations.

And, thanks to a unique non-clogging ink formula, it performs all these functions very reliably.



### FAMILY TIES

Videotex connections.

Videotex provides a key to much of our future shopping, entertainment and business information. Videotex services, using existing

telephone lines, already supply travel information, personal shopping options and personalized messaging, banking and investing services.

PC Videotex software from IBM allows you to access these services from your IBM Personal Computer, IBM Personal Computer XT<sup>™</sup>, IBM Personal Computer AT<sup>®</sup> or IBM PCjr<sup>™</sup>.

With only a few simple commands, you can use your IBM PC to receive, display, store and replay the data you choose in high-resolution color graphics and texts.

And if you need more than information retrieval, PC Videotex, in certain configurations, can be used to support your own Videotex data base.



### WHAT'S THE PROGRAM?

Create your own presentations.

Everyone who has ever put together a visual presentation for a business meeting or other educational purpose can now take heart. With the help of IBM PC Storyboard software, an IBM PC and a color graphics monitor you can turn out professional-looking, captivating presentations complete with color, special effects and eye-catching graphics.

PC Storyboard's four modules—Picture Taker, Picture Maker, Story Editor and Story Teller—make it fast, easy and comparatively inexpensive to create, combine and modify pictures and stories. There's even an animation function that makes it possible for birds to fly, ships to move across water, words to become bigger.



IBM PC Videotex software makes Videotex connections in high-resolution color graphics and text.

Picture Taker lets you store the contents of screen displays from software you regularly work with, such as spreadsheet, business graphics, drawing or word processing programs.

You can use the Picture Maker module to edit and combine the graphics you've saved. Picture Maker also allows you to create completely new pictures containing both text—in a variety of type styles—and graphic figures.

Story Editor helps you organize and edit your pictures into a presentation and add various special effects. The results can be dramatic.

You can then use the Story Teller module to display the results on an IBM PC Color Display, on a TV or with a video projector.

The finished presentation can be copied on diskettes for distribution. You can also produce printed copies with a graphics printer like the IBM Color Jetprinter reviewed in this issue of *Read Only*.

After that, all you need is a director's chair from which to view the finished product.

Expand capabilities with IBM Planning Assistant Solutions, IBM Document Retrieval Assistant and PC Storyboard software.

## Information at your fingertips.

A few months ago in this space, we reviewed Office Correspondence Retrieval System (OCRS) software from IBM, which provides a convenient way to keep track of information that otherwise might be filed and never found again.

That same application is now available as a member of the IBM Assistant Series, with an easy-to-use menu system that's consistent with those found in other Assistant Series programs.

Like the original OCRS software, IBM Document Retrieval Assistant makes life much easier for anyone who stores large amounts of information on a fixed disk or who has a library of documents, memos or files stored on diskettes.

First, it automatically summarizes information and stores it for future reference. Second, and most important, Document Retrieval Assistant allows you to locate information with simple English-language queries.

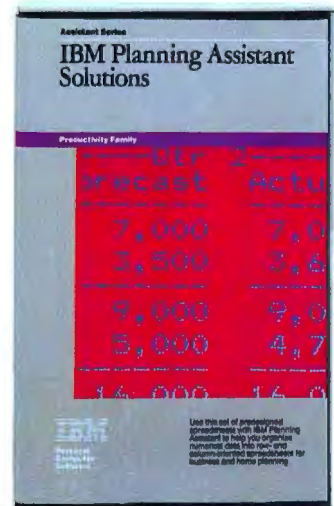
Among other popular word processing software, Document Retrieval Assistant works with IBM Writing Assistant, IBM PCWriter, the IBM DisplayWrite Series, and WordStar® (version 3.10 or higher).

WordStar is a registered trademark of MicroPro International Corporation.



## Financial planning.

Life is riddled with seemingly straightforward questions that result in headaches instead of answers. Questions like, "What's my net worth?" and "How much will my monthly payments be?"



IBM Planning Assistant Solutions and IBM Planning Assistant work together to help you find the answers even if you're not familiar with the math involved. All you have to do is fill in the required informa-



*IBM BASIC Compiler 2.00 updates an indispensable business programming tool.*

tion on simply designed spreadsheets. Your IBM Personal Computer does the hard part.

Planning Assistant Solutions includes spreadsheets like Loan Calculation and Real Estate Analysis for home use. Others, like Travel Expense Form and Financial Statement Worksheet, can help you sort out your business finances.

Many of the spreadsheets can use information from files you've created with IBM Filing Assistant. You can also include the results of your Planning Assistant Solutions work in IBM Writing Assistant documents and present them graphically with IBM Graphing Assistant.

### **BASIC improvements.**

It's good to know that in a business based on technological advances, the basics aren't forgotten.

The IBM BASIC Compiler 2.00 gives exactly that reassurance. It's an improved version of an indispensable business programming tool for the entire Family of IBM Personal Computers.

Among many significant improvements, the most recent version of IBM's BASIC Compiler includes better program control structures, allows you to compile larger programs and supports larger arrays. It also supports the IBM PC Network environment, provides better access to your IBM Disk Operating System (DOS), runs under TopView, and offers expanded graphics capabilities.

And there's a trade-up offer for current licensees that represents a significant savings on the IBM BASIC Compiler 2.00. See your Authorized IBM Personal Computer Dealer or IBM Product Center for details.



### **Guides to the top.**

IBM TopView™ is a program that allows you to run more than one program at a time (multitasking) and to view screens from more than one



program on your display (windowing). This, in turn, makes fast work of switching back and forth among programs that you use frequently—word processing, filing and spreadsheet applications, for example.

The TopView Application Guides shown below are now included when you purchase a TopView program. They're useful listings of the many programs—IBM applications and software from non-IBM sources—that can be used with TopView. Both are arranged alphabetically and include special operating considerations and notes whenever necessary.



*TopView Application Guides now included with the program.*

IBM and Personal Computer AT are registered trademarks of International Business Machines Corporation. Personal Computer XT, PCjr and TopView are trademarks of International Business Machines Corporation.

For more information about IBM Personal Computer products discussed in this issue of *Read Only*, see your Authorized IBM Personal Computer Dealer or IBM Product Center. Or call 800-447-4700. In Alaska call 800-447-0890.

© 1985 International Business Machines Corporation  
Little Tramp character licensed by Bubbles Inc., S.A.

# TRAVESTY WITH DATABASE

BY NEIL J. RUBENKING

*Breakdown is a fast travesty generator  
that stores frequency information in a database*

*Editor's note: Travesty generation has apparently caught the interest of BYTE readers. The original travesty generator—a Turbo Pascal program using letter-combination frequencies to generate random text—was presented by Hugh Kenner and Joseph O'Rourke ("A Travesty Generator for Micros," November 1984 BYTE, page 129). The program's execution time, however, depends on the product of the lengths of the input string (the input text file) and the output string (the desired amount of output text). Readers have been working on improving the speed and capabilities of Travesty, the original program, since then. First, we had Murray Lesser ("Travesty Revisited," July BYTE, page 163) rewrite Travesty in Microsoft BASIC. Next, we had Peter Wayner ("Build a Travesty Tree," September BYTE, page 183) use a BASIC program that improves execution time by storing frequency tables as data trees in memory. Now we have a different version of Travesty—Breakdown—written in Turbo Pascal by Neil J. Rubenking. This program improves performance and avoids rereading the input text by storing the frequency information in a database.*

I was fascinated by the original travesty-generator program, but I found the execution speed unbearably slow for large texts. Scanning the

whole text for each character took too long, and the limitations of Hellbat were not acceptable to me. I developed a different version of Travesty, which I call Breakdown to distinguish it from the original program. In brief, what makes Breakdown different from Travesty is that it stores its data as a file of frequency tables with B-tree access. You don't have to read through the original text each time you want to create a travesty, and you can even read in several texts by the same author, producing a more detailed "style table."

Note that there are calls (AddRec, FindKey, GetRec, PutRec, etc.) to an optional software package—Turbo Toolbox—that may require modification for use with your particular configuration. This program may be freely copied for noncommercial use only. [Editor's note: The source code for Breakdown and a documentation file are available for downloading via BYTEnet Listings. The telephone number is (617) 861-9764.]

To analyze a text, Breakdown looks at it in chunks of a particular size (one less than the "order") and keeps a record of which characters occur immediately after that pattern. If the chunk is new to the frequency table,

it is added to the table. Its frequency array is initially all zeros, except for the current next character. If the chunk already exists in the table, its frequency array is incremented by one for the current next character. Then the chunk is shifted one character to the right and the process goes on—that is, the chunk's first character is dropped and the current next character is tacked onto the end.

Checking to see if the chunk is present would be a difficult task if the frequency table were stored sequentially. Fortunately, Borland International's Turbo Toolbox implements fast indexed storage using the B-tree system. The chunks of text are stored in the B-tree index file—they are the *keys*. The data file contains only the frequency arrays. Ordinarily, the keys would also be stored in the data file, but this redundancy is not strictly necessary. Since the data file can conceivably contain one record for every byte in the source, we want to keep the record size to a minimum. (This

*(continued)*

Neil J. Rubenking (300 Page St., San Francisco, CA 94102) is a systems analyst for the Zen Center of San Francisco and is president of the San Francisco PC Users' Group.

**Breakdown lets you  
combine data files  
to make bizarre hybrids  
of two authors' works.**

"worst case" would occur only if no pattern in the text occurred more than once.)

At present, Breakdown tracks 34 characters. These are the 26 lower-case alphabetic characters, along with the space, period, comma, dash, question mark, number symbol, single quote, and ASCII character 20 (the paragraph symbol). If a line is shorter than the constant LineWidth (currently set to 55), it is considered to have ended "early" with a hard carriage return and is marked with the paragraph symbol at the end. In the pre-processing phase (procedure Clean-Up), all letters are converted to lower-case, all numbers are reduced to a single # symbol, double quotes become single quotes, and all unused punctuation is removed. It would, of course, be possible to track more characters, but each character adds a byte to every record.

To generate new text, Breakdown randomly selects a key that begins with a space (i.e., one that doesn't start in the middle of a word.) It then looks up the frequency array for that key and selects the next character at

random from the characters with non-zero frequencies, weighted by the frequencies. This character is added to the current output line and to the current key chunk. If the paragraph symbol is encountered, the line is automatically ended. Also, the current line ends at the first space encountered after its length surpasses the LineWidth constant. The first alphabetic character after a period, question mark, or line end is capitalized.

Breakdown is a prime candidate for RAM-disk operation. The B-tree file access limits the number of disk accesses quite a bit, but there are still several accesses for each byte in the source file. The data file of a text under 10K bytes in length will definitely fit on one 360K-byte floppy disk, but an 11K-byte file could run over that length. You may distribute your files to various disk drives—a likely arrangement is .DAT file on drive B and source, .INX file, and the Breakdown program on drive A.

The higher the order, the more intelligible the output will be. However, a high order and a short text will mostly just regenerate the original. Experiment with various texts and various orders. You can use the List (L) option to see what sort of records are being generated. For a 2000-byte file using an order of 8, Breakdown takes 9 minutes to input and 7 minutes to output. Breakdown has been tried on a 100K-byte text file, with the order set to the maximum of 8. It took over 6 hours and generated a 1.8-megabyte

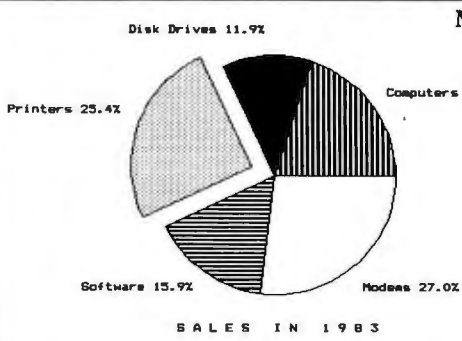
data file, but it worked.

Breakdown will prompt you for the order each time you make a selection from the menu. After you have entered an order, you can just press the carriage return for the previous value. The filename Main works the same way—after the first time you enter it, pressing the carriage return will recall the same name. The default for the .DAT and .INX drives and the output file, if any, is the same as the source file. Thus, if you have Analyzed (A) a text with all its files on one drive, you can fill in the blanks for Generating (G) a travesty by repeatedly pressing the carriage return.

The Merge (M) option lets you combine two data files, possibly from wildly different sources. The data and index files of the "source" will be permanently changed, so you may want to keep a copy of the original files. You can also "read in" another text into an existing data file. Use this option to build up a frequency-table "model" of a particular author or to make bizarre hybrids by combining two authors' works.

Breakdown is a moderately sophisticated database program with almost no "serious" uses. However, there are all kinds of nonserious uses for it. For instance, you can read in three or four "letters from camp" and then let the computer generate more, or you can generate new speeches based on our President's proclamations, or make up your own use for this new travesty-generation technique. ■

**GRAPHS WITHOUT GRAPHICS?**



No need for color monitor or graphics board.  
Make graphs on dot matrix printers.

Easy to Use. No Programming.  
CP/M 2.2, 3, 80, or 86, MS-DOS or PC-DOS.  
Excellent Manual. Most disk formats.

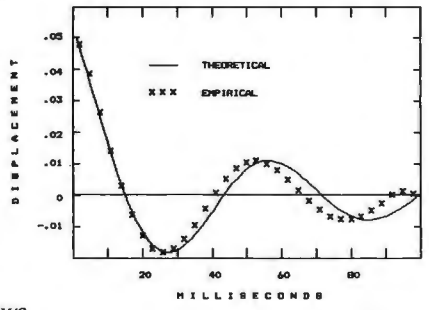
**DataPlotter™**

Line Graphs & Scatterplots . . . \$69  
Bar Graphs & Pie Charts. . . . \$69  
Both for \$99

(Prices include manual)  
Add \$3 shipping,  
\$8 outside US and Canada.

**Lark Software™**  
131 N. Leverett Rd.  
Leverett, MA 01054

Specify type of Printer.  
(413) 773-8687 Visa, M/C



**Which leading  
monitor company  
lets you best  
display the  
advantages of IBM's  
new color  
graphics cards?**



*Hint,  
It's not IBM!*



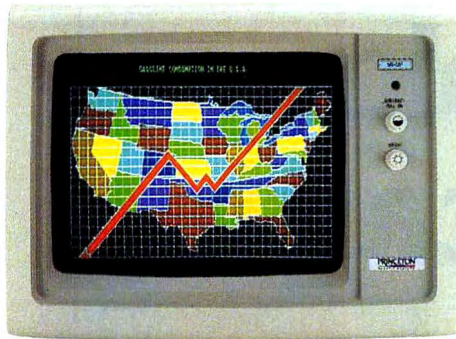
# Princeton Gra

## In a class

When you put Princeton Graphic Systems Monitors to work with IBM's new graphics cards, you step up to a new class of performance. Exciting RGB color, sharp, crisp graphics and text and Princeton's quality and reliability...all at a great price! Our full line of monitors clearly demonstrates why Princeton is an industry leader in high-resolution technology.

### Princeton SR-12P Color Monitor

The *first* IBM compatible monitor available for the IBM Professional Graphics Controller.\*



### Princeton HX-12E Color Monitor

The superior choice for use with IBM's Enhanced Graphics Adapter.\*



<b>COMPARE:</b>	<b>Princeton SR-12P</b>	<b>IBM 5175</b>
Dot pitch (The lower, the better.)	<b>.26 mm</b>	<b>.31 mm</b>
Sugg. Retail Price (The lower, the better too!)	<b>\$999</b>	<b>\$1295</b>
Warranty	<b>1 Year</b>	<b>90 days</b>

Designed for demanding professionals who won't settle for anything less than the finest color graphic capabilities. Displays more than 4,000 brilliant colors... features an anti-reflective coated black matrix tube for less fatigue and eye strain. You get the sharpest graphics and text... at a substantial savings!

<b>COMPARE:</b>	<b>Princeton HX-12E</b>	<b>IBM 5154</b>
Dot pitch	<b>.28 mm</b>	<b>.31 mm</b>
Sugg. Retail Price	<b>\$785</b>	<b>\$849</b>
Tinted Black Matrix Tube	<b>Yes</b>	<b>No</b>
Warranty	<b>1 Year</b>	<b>90 days</b>

Ideal for most computing applications, the HX-12E offers 64 high-resolution colors and easy-to-read text. It gives you sharp colors, crisp characters... for less eye strain and easier viewing, hour after hour. Built-in versatility also allows you to display 16 colors with the IBM Color Graphics Adapter\* automatically.



# Graphic Systems above the rest

## Princeton HX-9E

The first 9" RGB monitor to take advantage of IBM's Enhanced Graphics Adapter.\*



For more performance in less space, the Princeton HX-9E is in a class by itself. Nobody else—not even IBM—offers a 9", high-resolution display. Features 64 brilliant colors and a .28mm dot pitch for sharp, crisp text. Can be conveniently used with IBM's Color Graphics Adapter.\*

### Our other monitors also give you full IBM compatibility:

**Princeton HX-9 Color Monitor**—features a built-in switch for green or amber text. Built-in tilt-and-swivel base.

**Princeton SR-12 Color Monitor**—boasts twice the vertical resolution of the IBM Color Display\*\* ... and works with other cards such as the Sigma Designs Color 400.

**Princeton MAX-12 Amber Monochrome Monitor**—ergonomically designed to give you up to 15\*\*\* shades of high-resolution amber... plus high-resolution text and graphics when used with a monochrome card.

**Princeton HX-12 Color Monitor**—16 sharp, clear colors and superb character definition make the HX-12 the winning choice among monitor users...



See the clearly superior Princeton Monitors at your Authorized Princeton Graphic Systems Dealer. For the dealer nearest you, please call: **800-221-1490 (Extension 653)**, 609-683-1660 (NJ only), Telex: 821402 PGS PRIN.

Princeton Graphic Systems, 601 Ewing Street, Bldg. A, Princeton, NJ 08540.



1984 and 1985 winner of the PC World "World Class PC Competition"!



Princeton HX-12



IBM 5153

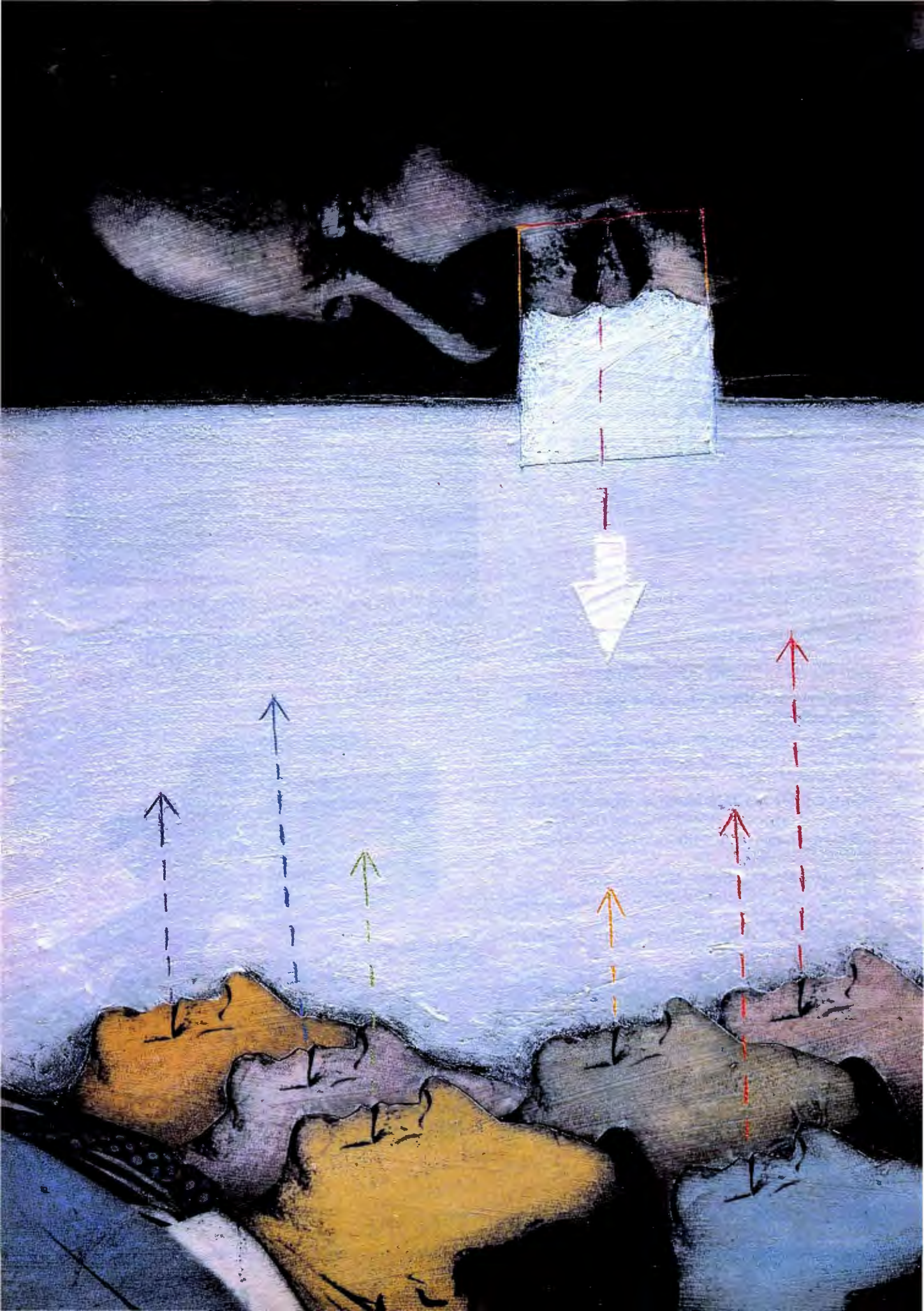
\* Or equivalents.

\*\* When used with the Princeton Scan Doubler.

\*\*\* When used with IBM Color Graphics Adapter or equivalent.

IBM is a registered trademark of International Business Machines Corporation. Sigma Designs Color 400 is a registered trademark of Sigma Designs, Inc.

**PRINCETON™**  
GRAPHIC SYSTEMS  
AN INTELLIGENT SYSTEMS COMPANY



# Computer Conferencing

---

<b>AN OVERVIEW OF CONFERENCING SYSTEMS</b> <i>by Brock N. Meeks</i> . . . . .	<b>169</b>
<b>CONFERENCING STANDARDS</b> <i>by Jacob Palme</i> . . . . .	<b>187</b>
<b>DATABASE STRUCTURE IN PORTACOM</b> <i>by Jacob Palme</i> . . . . .	<b>195</b>
<b>THE NETWORK APPLICATION MANAGER</b> <i>by Robert A. Flavin and Jack D. Williford</i> . . . . .	<b>203</b>
<b>STORAGE ARCHITECTURES</b> <i>by Alastair J. W. Mayer</i> . . . . .	<b>221</b>
<b>COMMON GROUND</b> <i>by Chris Hancock</i> . . . . .	<b>239</b>
<b>LOCAL POWER IN A REMOTE LINK</b> <i>by Chuck McManis</i> . . . . .	<b>251</b>
<b>CONVERSATIONS</b> <i>by Douglas E. Comer and Larry L. Peterson</i> . . . . .	<b>263</b>
<b>CROSS-SYSTEM CONFERENCING WITH CLACR</b> <i>by Sherwin M. Levinson</i> . . . . .	<b>273</b>

---

COMPUTER CONFERENCES bring together people with similar interests and complementary needs to exchange information and discuss problems. Conference participants can join a discussion whenever they please, wherever they have access to a computer or a terminal, a modem, and a phone line. Often, in fact, conference members carry on lively discussions with people they have never met face to face. BYTE's own conferencing system, BIX (BYTE Information Exchange), is a good example of this emerging trend, with active discussions on hundreds of topics of interest to BYTE readers.

This month, Brock Meeks's "An Overview of Conferencing Systems" compares several conferencing systems, including systems designed for business, academia, research, and general discussion and recreation.

Many people who use conferencing systems and electronic bulletin boards extensively find themselves subscribing to several services. Communication between conferencing systems would allow users to expand their information networks without the confusion involved in joining many systems. This sort of exchange of message traffic requires standards, however. "Conferencing Standards" by Jacob Palme offers guidelines for these standards.

The internal structure of a conferencing system can affect its flexibility and efficiency. Three articles in this issue—Alastair Mayer's "Storage Architectures," Jacob Palme's "Database Structure in PortaCOM," and "Conversations" by Douglas Comer and Larry Peterson—describe effective solutions to problems inherent in designing conferencing systems.

"Common Ground" by Chris Hancock describes a microcomputer-based conferencing system designed to be flexible and easy to use. "The Network Application Manager" by Robert Flavin and Jack Williford details the design and implementation of GRANDiose, a huge network-based system that can support any application that involves communication.

It seems a shame to waste the power of the microcomputer by using it as a dumb terminal when, with proper programming and cooperation from the host system, the micro could handle much of the processing involved in conferencing. Chuck McManis's "Local Power in a Remote Link" and Sherwin Levinson's "Cross-System Conferencing with CLACR" approach this problem.

As more and more people discover the advantages of computer conferencing over more traditional forms of communication, electronic communities are beginning to take shape, bringing together people of diverse backgrounds and similar interests to exchange ideas and information.

—Donna Osgood, Associate Editor

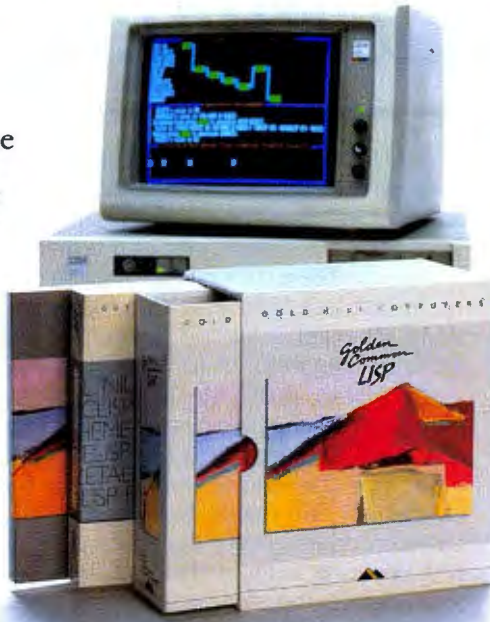
# AI: The Future is at Gold Hill Today.

You know artificial intelligence is the wave of the future. Programs based on the ideas of artificial intelligence are being written today in COMMON LISP—the new LISP standard developed by researchers from universities and corporations such as Carnegie Mellon, DEC, MIT, Stanford, Symbolics and TI. LISP allows the development of programs that are intelligent, flexible, and even human-like. The problem has been that hardware needed to run LISP is expensive.

No longer. GOLDEN COMMON LISP (GC LISP) makes it possible for you to learn and use LISP on your *personal computer*. When you use GC LISP in combination with the AI examples provided, you will be able to develop such exciting applications as expert systems, natural language systems, and intelligent interfaces to complex software. The possibilities are endless. With GC LISP you can tackle problems that you could not solve before with ordinary number crunching programs. You will be able to write powerful programs that can accommodate casual computer users who want intelligible answers quickly.

## Easy to Learn

GC LISP makes it easy for you to learn the technology of AI at your own pace. Each package includes the *San Marco LISP Explorer*—an interactive software tutorial developed by Patrick H. Winston and his associates. This 800-frame instructional



*GOLDEN COMMON LISP is the best selling AI language.*

system guides you through the steps of LISP programming and makes the full range of LISP's power accessible to both novice and experienced programmers. The second edition of the classic *LISP* textbook by Winston and Horn is also included.

## More Power

GC LISP comes complete with the intelligent GMACS editor (based on EMACS), full on-line documentation of all GC LISP and GMACS functions, the *Common LISP Reference Manual* by Steele, and a comprehensive user manual. In short, GOLDEN COMMON LISP comes with everything you need to program in LISP. GC LISP is the most powerful

LISP available today on PCs; some of its advanced features include lexical and dynamic scoping, defstructs, closures, stream I/O, and multiple-value returning functions.

## The Complete Solution

In addition to GC LISP, Gold Hill offers an entire line of development and delivery tools designed to increase your organization's productivity in artificial intelligence. These include the GC LISP Compiler, PC-to-Symbolics™ network, HALO™ Graphics, and training and consulting services. Gold Hill is also proud to introduce GC LISP LM (Large Memory)—the first PC-DOS language to take advantage of the 15-megabyte memory capacity of the latest generation of PCs (such as the IBM PC AT). For multiple-user sites, Gold Hill offers a Corporate License Package which features quantity discounts and service and support.

## Order Today

For order information on Gold Hill products please call today.

# 800-2GC-LISP

GC LISP requires an IBM PC, PC XT, PC AT, or IBM-compatible with a minimum 512K and PC-DOS 2.0.

*Gold Hill Computers  
Setting the AI Standard for  
Personal Computers.*

G O L D H I L L C O M P U T E R S

163 Harvard Street, Cambridge, Massachusetts 02139

GOLDEN COMMON LISP and GC LISP are trademarks of Gold Hill Computers. The San Marco LISP Explorer is a trademark of San Marco Associates. LISP is copyrighted by Addison-Wesley Publishing Company, Inc. The *COMMON LISP Reference Manual* is copyrighted by Digital Equipment Corporation. IBM PC, PC XT, PC AT, and PC-DOS are trademarks of International Business Machines. Halo Graphics is a trademark of Media Cybernetics. Symbolics is a trademark of Symbolics, Inc.

# AN OVERVIEW OF CONFERENCING SYSTEMS

BY BROCK N. MEEKS

*A guided tour  
through COM, EIES, PARTI, NOTEPAD, and other systems*

NUOSO LIVES on the African continent. Exactly where he lives and the name of his tribe is not important; Nuoso is a nonperson. Convicted of a crime against his tribal society, he is forbidden to communicate with his family, his friends, in short, with anyone. His communication cut off, Nuoso quickly withdraws from the village. Eventually he will cease to exist even in his own mind, and he will literally die from lack of communication.

Just as people need food, water, and shelter, so they need to communicate. From the earliest days of history, our ancestors sought better ways to communicate. Primitive maps scrawled in the dust gave way to cave paintings, where information retrieval entailed nothing more complicated than remembering the right wall in the right cave. But just as society became more complex, so did the communication needs of the population.

Early telegraph links, in Napoleon's time, had signal speeds of about two characters per second. In 1913 vacuum-tube repeaters were introduced to telephony, and a rapid suc-

cession of advancements in the world of electronics followed. In 1918 the first carrier system permitted several voice channels to occupy a single pair of wires. The early 1940s saw high-capacity coaxial cables beginning to replace twisted-pair cables. Microwave links emerged in 1946 with the capacity to carry more than 10,000 telephone channels. Today's phone system uses satellite links and will soon use fiber optics. In a hundred years our communication capability has risen from fifteen to a billion bits per second, from two to over a hundred million characters per second. And all for the sake of improving communication with each other.

## **THE BIRTH OF COMPUTER CONFERENCING**

Early in 1970, political and economic pressures set the stage for the creation of a revolutionary means of communication. In the fall of 1971 the entire economic structure of the United States fell under the control of President Nixon's wage-price freeze. Because of the tremendous need to handle the reporting and information

dissemination of the price freeze, the Office of Emergency Preparedness (OEP) commissioned Murray Turoff to create a computerized version of the "conference call." Turoff responded by developing the Emergency Management Information System and Reference Index (EMISARI).

The EMISARI system operated as an electronic network linking the ten OEP regional offices. The new price controls created a nationwide demand for information, guidelines, rulings, official statements, and policy clarifications from businesses, labor unions, and administrators. Because EMISARI eliminated the constraints of time and geographic location, the OEP's regional administrators were able to secure time-critical information at their convenience. The instant access of EMISARI allowed Washington to update policy as it happened and gave all involved the opportunity to respond or ask questions—with both

*(continued)*

*Brock N. Meeks (161 East Main St., San Diego, CA 92020) is a freelance writer. He can usually be found on line in places too numerous to mention.*

answers and responses maintained on line for all to review. This revolutionary idea of storing messages on line and allowing "many-to-many" communications became the first computer-based conferencing system.

EMISARI consisted of two systems: Party-Line, the computerized counterpart of the telephone conference call, and Discussion, an on-line "file cabinet" of topic-specific messages stored on line for all to see and comment on. These two elements became the building blocks for the computer conferencing systems of today.

Although EMISARI was preceded by the Department of Defense's packet-switched message-transfer network ARPANET, the history of computer conferencing after EMISARI reads like the Bible's first chapter of Matthew: EMISARI conceived two offspring, Party-Line and Discussion. Party-Line and Discussion begat EIES. EIES begat PARTICIPATE, which bore many sons (revisions). And so on. What follows is an overview of these and other top computer conferencing systems.

### **COM: GATEWAY TO THE WORLD**

Developed by the Swedish National Defense Research Institute starting in 1977, COM has since undergone many revisions and has even spun off a "portable" system called PortaCOM. PortaCOM, developed by a joint European research project, is designed to act like its big brother COM while running on a variety of different computers and operating systems. Because the two systems are almost identical, I'll refer to them both as simply "COM."

COM operates as a gigantic international electronic mailbox, with one incredible advantage: It offers full-blown computer conferencing capability.

COM is a gateway to the world of networks because it lets you route electronic messages through a complicated maze of networked computer systems around the world. Using computer systems at strategic sites as "gateways," COM routes your message to just about anyone that participates in an electronic mail (E-

mail) system. (A gateway is a computer that acts as a switching point between various networks. COM sites do not have direct access to computer systems on ARPANET, for example, but by routing messages through a gateway system—one that does have access to ARPANET—it can deliver messages to ARPANET sites.)

What separates COM from the standard computer-based message system is its ability to create and maintain computer conferences. It also lets you create "parallel" conferences on systems that use COM. Parallel conferences allow participants at different sites to contribute to the conferences without logging onto a remote computer. New additions to the conference are then forwarded to the other participating computer systems and placed in the appropriate conference. Thus, identical conferences reside at separate locations.

COM operates mostly in academic and research environments and carries a very academic personality. This personality doesn't make for a lot of light conversation. However, if you want to extend your knowledge base in a global way, COM is the route to go. High-level technical discussions abound, and anyone who is anyone in computer development is within reach via COM. But there is a price to pay in that the system is difficult to learn. Experienced computer conferencing/electronic mail users will pick up on the system's intricacies in the first few on-line sessions, while a novice could be hopelessly lost. So much is possible on COM that a new user is overdosed on a plethora of menus for almost every possible user response.

Once you have slogged your way through the basic commands (to read messages, join conferences, and comment on messages), you begin to appreciate the power of COM.

Any person can create a new conference (yes, there is separate menu for that as well); however, statistics published by the system's developers show that users are reluctant to do this and instead use the comment capability to create a sort of "com-

ment tree." The comment tree functions like a branching capability and lets you follow a particular line of thinking without the formality of creating a separate conference.

There is no subscription service for COM in the U.S., so to use it you must be affiliated with an organization or institution that is using the system.

For all the complexity and seriousness that is a part of COM, I found a refreshingly wry sense of humor residing just below the surface. Plowing through the seemingly never-ending command structure, I hit on something called "Get Encouragement." Like the U.S. Cavalry in a John Wayne movie, COM delivered the following to my weary 9-inch CRT:

You are a very special person, beautiful and wise, respected by everybody around you. You are doing a splendid job. Many people love you, body and soul. You make life easier for others. You are a very warm and sensitive person.

Be proud of being You! You have a very good reason.

### **EIES: CUSTOMIZED CONFERENCING**

Murray Tuross's Electronic Information Exchange System (EIES), itself an offshoot of EMISARI, is the "biological" breeding ground of the computer conferencing world. It is the example that all other computer conferencing systems have followed—and improved upon.

Like any venerable software in today's computer environment, EIES has shouldered its share of abuse from critics and the new kids on the block. The complaints range from "Its response time is too slow" (true) to "The commands are so numerous you can never learn them all" (also true). But a software package doesn't thrive (or even survive) if it does not have solid support and input—both of which EIES is privileged to have, and from some of the best computer minds in the on-line community.

Scanning the various conference rosters (EIES has hundreds of con-

*(continued)*

# The TeleVideo AT. The Performance AT.



as hundreds of powerful mini computer and multi-user programs. And the TeleVideo AT offers optional graphics with remarkably enhanced 640 x 400 display resolution.

**Starts at \$3395.\***

Innovative design brings you these significant performance advantages at a price that's a good deal less than the IBM AT.

And this could be the least expensive AT-class computer to own. Because the quality of its components promises better reliability and less costly down time.

Should you need it, the Performance AT carries a complete warranty and easy TRW service around the world.

Call toll-free (800) 521-4897. Or, in California, (800) 821-3774. Ask to see the Performance AT. A computer with the power to save you hundreds of dollars.

IBM is a registered trademark of International Business Machines.  
\*Monitor not included.

The Performance AT™ is quite an appropriate name for TeleVideo's® new computer. Especially when you measure performance by what's most important—memory, flexibility and speed.

### **30% Faster.**

The Performance AT is designed around the Intel 80286 running at 8Mhz—a third faster than the 6Mhz IBM® AT. A standard 640 Kbyte memory and eight expansion slots give you better configuration flexibility. And our AT has an edge with its 45-Mbyte hard disk and Personal Mini network compatibility.

You'll run the popular PC software library, as well

TeleVideo  
Systems  
© TeleVideo Systems, Inc.

**Regional Sales Offices:** Northwest (408) 971-0255, Southwest (714) 476-0244, Southcentral (214) 258-6776, Midwest (312) 397-5400, Southeast (404) 447-1231, Mid-Atlantic (703) 556-7764, Northeast (617) 890-3282, East (516) 496-4777, Rocky Mountain (714) 476-0244.

ferences on line at any one time, and each conference maintains a separate roster of members), the EIES "community" begins to read like a who's who of the computer industry.

EIES's many commands, their options, and the modifiers to the commands seem endless. Someone has said that even Turoff doesn't know all the commands and the full capability of the system anymore. That is because so many people have helped with the development, creating various command sets in an effort to build the system's efficiency.

The system offers help on line (even a "Chinese menu" that allows you to create personal subsets of EIES commands, which you can rename to your liking). If you need a quick command fix, an ever-present "?" key reveals the EIES Survival Guide (and a handy piece of phosphor it is).

EIES is a curious mix of technical, academic, and nonsense conferences whose topics range from High-Level Programming Techniques to Computers in the Third World to Graffiti.

Rummaging around EIES, you almost get the feeling that you're some kind of electronic archaeologist. Conferences that at one time virtually exploded with discussion comments now lie dormant, the last entry dated, in one case, March 17, 1983. What happened to all those hundreds of participants? A "dead" conference is something of a cultural phenomenon in the Information Age, and EIES contains plenty of these kind of conferences to explore.

In keeping with the pioneer spirit of the system, a couple of EIES users have been attempting to trace and chronicle the vast electronic rivers and tributaries of the world's research networks (ARPANET, USENET, CSNET, MAILNET, and so on). In so doing they are a kind of Lewis and Clark of the Information Age. Because EIES has access to the research networks via a MAILNET gateway, users of EIES have access to just about any research or academic institution that has electronic messaging capability.

EIES has a real-time capability that boils down to an electronic, person-

to-person exchange of one-line electronic messages. There are two modes of sending a real-time message. One is the "flash" method, where the receiver is greeted with a one-line blast of text on his or her screen. This often causes (without too much surprise) a reciprocal action, and usually a message of like content is broadcast to your CRT. This is all done in a "semisynchronous" fashion. In other words, both parties are sending one-shot messages without really making any kind of link between their machines. If you want to engage in an extended "chat" mode, EIES allows this via its +LINK command. Using +LINK, two people can carry on a conversation much faster, as the +LINK has actually "linked" their machines via software.

Though EIES does have some shortcomings, there isn't a lot you can't do on it. If you find something you can't do, chances are someone is working on the solution right now. The whole system reminds me of draft horse: It may be big and slow, but it will never quit.

### IT'S PARTI TIME

The PARTICIPATE conferencing system offered by PSI (Participation Systems Incorporated) is aptly nicknamed PARTI.

On line with PARTI you immediately sense that a kind of electronic party is being carried on in the phosphor—this is computer conferencing for the masses. Talking to users (and using the system itself), you get a feeling that using PARTI really means "belonging" to PARTI.

C. H. "Harry" Stevens, developer of PARTI and president of PSI, is known throughout the industry by a bit of on-line folklore surrounding what has become a personal trademark for him—the Eskimo word "chimo," which means "I'm your friend."

During a "name that newsletter" contest for the EIES conferencing system, Stevens suggested "Chimo" (the same name used for a newsletter he published as a consultant at MIT). The name won and is a de facto standard for PARTI on-line newsletters.

Stevens developed PARTI while working on the EIES system. Frustrated by the large amount of chatty conferences on EIES, Stevens began to develop a way to break a large topic into "sections" through what he calls "inquiry networking." (Ironically, PARTI has evolved into the ultimate chatty on-line system.)

Inquiry networking allows a conference to have many different *branches*. For example, a conference titled Programming Languages might have branches dealing with Ada, Turbo Pascal, BASIC, and so on. Once a conference has been *organized*, anyone involved in the conference can create a branch—which sometimes results in an unwieldy conference structure (a branch conference can have several branches itself). Should this happen, the original conference organizer can choose to *prune* the conference by deleting disruptive branches.

Creating a conference on PARTI is as easy as expressing your personal dogma. As a conference *organizer* (creator) you are free to choose any topic you wish. Conferences on PARTI run from the esoteric (Meditation and Heightened Sexual Awareness) to the serious (such as the national headline-grabbing conference that took place after the 1983 downing of Korean Air Lines Flight 007) and all topics in between.

One unique aspect of PARTI is that users play a major role in its ongoing development. Originally just an overlay on the EIES system, PARTI first went public (on the commercial information utility The Source) with an organizational structure that was the result of suggestions and comments made to Stevens by EIES users. Even now, an ongoing conference on The Source acts as a clearinghouse for suggested improvements. Stevens takes such suggestions into serious consideration. The Suggestions conference on The Source (which uses PARTI version 3.4) led to the development of the much-improved version 4.45.

PARTI lets you operate a flexible range of on-line tools such as a



private, person-to-person message system, searching a conference by a keyword or phrase, on-line balloting, and a person-to-person real-time messaging capability. You can send a one-line message in real time to any other person using PARTI, to which they can respond in like manner. This is not an efficient method of real-time conferencing, but it's good for "routing" someone to a critical conference he may have missed or for setting up time to get together on a voice call. The ability to create *open* or *closed*

conferences gives a conference organizer the ability to tailor the membership of any conference to his or her specifications. A conference can consist of as little as one person (pretty boring, but you don't catch a lot of flak about your opinions) to literally thousands.

PARTI is not the easiest system to use. It has many undocumented features that can remain unknown until you get your hands on a user's manual. A manual is available from PSI, but most public systems don't tell

you that, choosing instead to furnish you with their version of a "cheat sheet." Without the user's guide in hand, you can build up a good deal of frustration and a sizable bill. On-line help is available, but it's only as good as your latest question. Overcoming the initial frustration, however, is well worth the time (not to mention the expense). Soon the frustration turns to fun (or addiction, depending on your self-discipline), and after a while Chimo certainly seems an apt

(continued)

## COMPUTER CONFERENCING AND TECHNOLOGY TRANSFER

BY PATRICK L. SWEET

Computer conferencing is integral to the information and technology transfer network being developed by the Industrial Technology Institute (ITI) of Ann Arbor, Michigan, to encourage the application of advanced manufacturing technology (AMT) in the United States.

AMT falls into the category of "programmable" manufacturing technology, which refers to manufacturing technology that can be programmed for one operation and then another. In AMT, machines may or may not be integrated by a central computer, but they usually work in tandem with other programmable devices that minimize human intervention in the production process.

ITI is a not-for-profit corporation initiated in 1982 by the State of Michigan's High Technology Task Force to conduct basic research in the area of automated manufacturing, develop new techniques, and serve as a technology transfer agent between those who are familiar with AMT and those who are not.

To encourage the use of AMT, ITI plans to use computer conferencing for three areas. First, as a complement to face-to-face seminars that address the application and implementation of specific technologies, computer conferencing will be used to extend seminars and training programs over

a period of time. Programs will be marketed to the advanced manufacturing community, including companies, trade and professional associations, academia, and government agencies.

ITI also anticipates the development of *technology-specific* forums (e.g., forums on robotics, machine vision, or computer-aided design). These will be offered to the manufacturing community at large or may be organized for specific companies or users of a particular vendor's systems. A forum may be designed as a user support group, modeled after personal computer user groups, or as a means of sharing current research in an area of AMT or its application.

ITI will also offer project-focused communication services. Companies about to deploy various technologies or solve specific technological problems in different sites often establish task forces to coordinate the effort. Whether in the early stages of investigation or in the late stages of implementation, tight communication between sites can enhance deployment efforts. In addition, professional associations responsible for developing industry standards may use computer conferencing to coordinate standards-development projects. Other company- or organization-specific services are planned.

ITI has organized a number of com-

puter conferences already. Its first, "The Forum on Integrating Research in Socio-Technical Systems," lasted six months and was initiated primarily to develop a research agenda for ITI's Center for Social and Economic Issues. With participants from industry, government, and labor and academic organizations, the conference proved to be a valuable follow-up to a face-to-face conference titled "Managing Manufacturing Technologies Through the 1990s," cosponsored by the National Science Foundation. This initial experience provided ITI with important insight as to how to successfully organize and run a six-month-long "discussion," something that takes a good deal of experience and motivation due to the unique characteristics of computer conferencing.

Computer conferencing at ITI will take a variety of forms and is becoming an essential means for enhancing discussion and information exchange among those familiar with AMT and those just becoming aware of its potentials and implications. ITI's computer conferencing network promises to be a powerful tool for enhancing the understanding and diffusion of advanced manufacturing technology.

Patrick L. Sweet (ITI, Information Systems Center, POB 1485, Ann Arbor, MI 48106) is a research associate at ITI.

motto for what is often called an impersonal medium.

**NOTEPAD: THREE-PIECE  
CONFERRING**

NOTEPAD is the three-piece suit of the conferencing world. This con-

ferencing system is a stripped-down, easy-to-use, no-nonsense business tool. Using NOTEPAD may remind you of a corporate boardroom meeting.

NOTEPAD feels less powerful than some of the other commercial con-

ferencing systems, but this is because of its inherent simplicity. The number row of your keyboard (1-9) activates the entire range of NOTEPAD commands. A small three-page fold-out brochure holds all the commands and is written in straightforward English.

## COMPUTER CONFERRING: THE GLOBAL CONNECTION

BY LAWRENCE B. BRILLIANT

As if in pain, the helicopter's jet turbine engine screeched sharply, groaned once, and died. Now, silhouetted against the Himalayan mountains, the quiet helicopter began to spiral slowly toward the ground. The passengers, a group of United Nations doctors, looked around furtively as the pilot, his jaw clenched, maneuvered the paralyzed bird down in tight circles.

After a silent eternity, the pilot brought the craft down just outside of Biratnagar in the remote terrain of Nepal.

"What's wrong?" a passenger asked. "Nothing much," the pilot replied. "But we'll need to file a spare parts order: 'Engine. One.'"

Under almost any other circumstances, a crippled aircraft sitting on the ground in one of the most remote places on earth would rust long before a replacement engine could be located, airlifted in, and installed. But thanks to the then-new technology of computer conferencing, a worldwide "spare parts order" was filled swiftly, and the chopper flew out of Nepal only days later.

Here is how computer conferencing rescued that helicopter and the U.N. project:

The helicopter was on loan from Evergreen Helicopter Company in McMinville, Oregon. The only "spare" jet engine was in France, at Allouette Helicopter Company. Four additional organizations were involved in orchestrating the "spare parts order": the United Nations office in New York, the government of Nepal, the World Health Organization regional office in New Delhi, and a Michigan-based interna-

tional charity, the Seva Foundation, which was funding the project.

Using a computer conferencing system to which several companies in the aerospace industry subscribe, an "electronic forum" was quickly convened. Despite the differences in time zones, computer terminals, and geographical locations, the participants were able to take part in an on-line meeting in which they could read the views and positions of all the other organizations. They quickly reached a consensus on who would pay for the replacement engine, how it would be shipped into Kathmandu, how customs duties might be waived on the new engine, how it could be trucked into the remote landing site, and what would be done with the damaged but still valuable original engine. Telephone tag, internal organizational hierarchies, and diplomatic protocols were dealt with easily, and the meeting lasted less than a day.

This event illustrates a lesson for anyone trying to get things done in complicated organizations. When speed and effectiveness are the issue, nothing surpasses electronic forums for disseminating information to all concerned and making decisions rapidly.

Today, the computer conferencing revolution is burgeoning, due to three factors: (1) The enormous investment made in the international telephone system in past decades has provided us all with relatively low-cost communication lines. (2) Technology has brought the cost of personal computers within the reach of virtually everyone in modern industrial societies. (3) Increasingly sophisticated

software enables individuals to take part in computer conferencing at home and gives them the option of renting time on worldwide networks.

Until now, organizational culture has been determined by a critical mass of intelligent people in proximity to each other. This has created towns, universities, and tall office buildings. It is why we have Bell Labs and Xerox PARC.

With the advent of electronic meeting technology, the thrust of civilization can now occur without the factor of proximity. The synergism and excitement of a critical mass of intelligent people will remain a factor, but now they need not live or work close to each other. For the first time, engineers in San Diego, New York, Rome, and Hong Kong, all members of a special-interest group, can meet on line all year without ever seeing each other. Perhaps, with this technology, we are seeing the realization of Marshall McLuhan's "global village."

The benefits to business are obvious: Decision making is improved by bringing the best minds of a company together without restrictions of time and location; participants can productively enter a meeting after organizing ideas; they can discuss many different subjects in one meeting without the confusion that sometimes occurs in traditional meetings; immediate printed records of the discussion are available; and spreadsheets, databases, and other productivity tools can be entered into the meeting. Used wisely, the result is increased efficiency.

Computer meeting systems can make a horizontal cut through the standard vertical organizational chart. This

NOTEPAD provides a combination of real-time and stored-message conferencing to build the contents of a message base. A real-time computer conference discussion can consist of up to 32 people on line at the same time. Messages are stored sequential-

distributed electronic organization (DEO), a horizontal stratification of personnel within a company, results in a new and higher quality of interactive group process and organizational decision making. For the first time, through computer conferencing, we will see communication exchanged on a continuous basis between all the department managers, all the engineers, and all the supervisors, no matter where they are located. These horizontal levels of communication will remove previous barriers of time and location, allowing unlimited communication in a thoughtful, productive process.

The Seva Foundation, a nonprofit international charity, is a good example of a DEO. It uses electronic meeting systems to allocate its money and make other business decisions. The board of directors meeting lasts all year, and, as a result, the structure of the organization has changed. The executive committee, whose members once flew from various corners of the world for meetings four times a year, has been abolished. Now the entire board is intimately involved on a day-to-day basis with operational decisions, though the members live all over the world.

The impact of these horizontal links within society is still difficult to foresee, but from this free exchange of ideas and information will come new solutions to old problems.

*Lawrence B. Brilliant, M.D., M.P.H.J., is the founder and chairman of Network Technologies International Inc. (NETI), which markets eForum and docuForum electronic meeting systems. He can be reached at NETI, 315 West Huron, Suite 320, Ann Arbor, MI 48103.*

ly as they are entered by each individual. These real-time messages then become part of the complete stored-message base. This storing of real-time conference messages allows you to arrive late to a conference and quickly review all that has been said up to the time you logged on. You can even miss the entire real-time conversation, log on later, review the entire discussion, and add comments, which the others will see the next time they log on.

A Service option lets anyone in the conference create a survey ("How can we increase sales in Outer Mongolia?") or post an on-line ballot ("Should we go public with our stock?"). Members of the conference respond in essay fashion to a general survey or by "voting" (yes, no, or abstain) on ballot questions. The creator of the survey or ballot can compile the results with two keystrokes and send the results to the rest of the conference members.

Conference contents can be searched by keywords or phrases, time, dates, or person—even during a real-time conference.

NOTEPAD is marketed through InfoMedia, which is headed by computer conferencing pioneer Jacques Vallee. Vallee's influence on the concept and personality of NOTEPAD is obvious. A longtime advocate of the importance of putting the human factor in computer conferencing, Vallee has succeeded in transferring that human factor into the environment of person-computer-person communications. NOTEPAD operates under a general philosophy of "people first, then machines." This attitude leads to the phrase "transparent technology," which InfoMedia uses to describe the NOTEPAD conferencing environment.

NOTEPAD is used by corporations like Bechtel to coordinate worldwide construction projects and by governmental bodies such as NASA, which is running an ongoing international research and development conference. For this reason, most of the conferences are closed, meaning the contents are known only to the participating members. Even NOTEPAD's

support and service team does not have access to conference contents, unless it is specifically invited. This high degree of confidentiality appeals to businesses needing to discuss sensitive issues while taking full advantage of computer conferencing technology. As a consequence, this is not a system to which you would subscribe. Most users are involved in specific projects, and the sponsoring organization picks up the tab. If you're lucky enough to use NOTEPAD, you'll find what that ambiguous phrase "user-friendly" is really all about.

#### **eFORUM: NEW KID ON THE BLOCK**

Chronologically speaking, eForum from Network Technologies International Inc. (NETI) is the youngest member of the computer conferencing family. Being the youngest, eForum has some big shoes to fill, but it appears to be off to a good start.

NETI has a long history of working with computer conferencing, and that experience shows in the features of eForum. Drawing heavily on the electronic meeting theme, eForum is another attempt to draw the business meeting into the Information Age. To achieve this goal NETI has pumped eForum full of user-friendliness while bypassing most of the "computerese" that makes boardroom executives cringe behind walnut desks. The company has also developed a slick documentation manual and a slick advertising program. If you want a computer conferencing system that "feels" like it belongs in a BMW or on the cover of the *Wall Street Journal*, this is the package.

The documentation is by far the most complete and accurate (though not error-free) that I received during my electronic journey of conferencing systems. To a novice user, documentation is priceless. NETI gets high marks for its efforts in this area. Included in the documentation is an excellent discussion of the "how to's" of electronic meeting management and organization (no simple task, I assure you).

*(continued)*

eForum provides what it calls an eForum WS software package (the WS stands for workstation) that is compatible with IBM PCs and their clones. The WS software handles communications, word processing, printer control, and uploading/downloading procedures by interfacing with eForum's command set. The software uses an abundance of windows, similar to today's desktop utilities programs, although you don't have to have this special software to interact with eForum.

When I first used the system, I ran my workhorse engine: a pre-1984 Kaypro 2, a Prometheus 1200-bps (bits per second) modem, and MEX public-domain software. This setup worked flawlessly (though it was like eating plain yogurt after running the WS software).

NETI bills eForum as the "electronic meeting manager." True to its claim,

it is just that: a meeting manager, with no electronic mail function available. One way around this is to organize a closed meeting between two people or among a small group. (I've been told that NETI is close to releasing an integrated E-mail program.)

As in other systems, comments entered in a conference are readable by anyone who has access to the conference. There are four different levels of security you can assign to a conference. The security levels range from Open (which even the corporate janitors could contribute to if they had access to a micro) to something bordering on paranoiac—a closed, invitation-only conference that requires a special code word to enter.

Using eForum reminds me of a formal business meeting; this is indeed a "structured" system. Major discussion topics (such as Software Development) are listed as Meetings. These

meetings can then be divided into various discussions (such as User Documentation). Anyone involved in the meeting can create a new discussion (bring up a new topic). In these different discussions you can read others' comments and contribute your own views. A particularly intriguing command is listed as punt (as in "when all else fails—punt."). Punt does exactly what you might expect; it logs you out of the system and returns you to the log-in sequence, giving you a second chance at a particular on-line session. (If only NETI could transfer the electronic punt command to face-to-face business meetings!)

If a discussion runs its course, it can be tabled, which removes it from the general meeting structure. This "self-cleaning" keeps the main topic manageable and creates an atmosphere of a face-to-face meeting where discussions are started, talked through, and then dropped.

With the growing move to regional information networks (like the Whole Earth's WELL and NETI's own M-NET), eForum could be a package that springboards this new breed of network into prominence. And while eForum is not yet powerful enough to handle the needs of a Fortune 500 company, a large corporation might do well to have several eForums available for its smaller intercorporation divisions.

#### PUTTING BYTE INTO CONFERENCING

Alastair J. W. Mayer leads a charmed life. Born in London, England, in December of 1952, he just missed the infamous "Killer Fog." After several careers as a country club kitchen helper, typist, tobacco planter, and bartender, Mayer became terminally involved in the computing field during a 1974 Computing 101 course, which forced him to learn APL. He says, simply, "I was hooked."

Winding his way through various "rent-a-programmer" jobs, Mayer ended up at Concordia University in Montreal. After revamping a

(continued)

## HOW TO JUSTIFY A LASER PRINTER

You'd love to have one of those high-speed laser printers. But aren't they hard to cost-justify? Not if you have two or more computers that you want to hook up.

### WITH PrintDirector

What's PrintDirector?

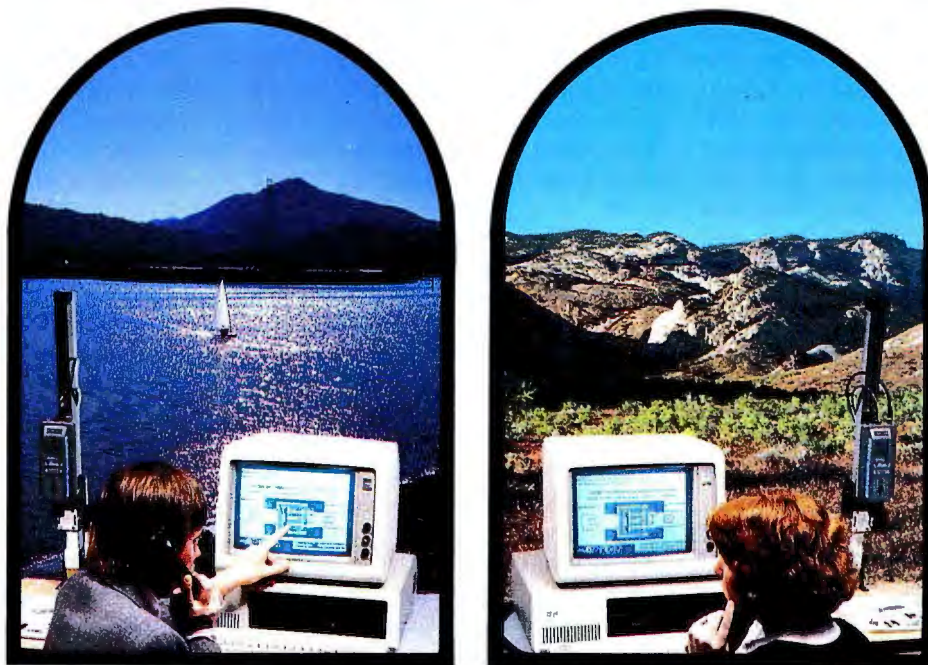
It's a product family of buffered, intelligent printer managers that allows you to more than cost-justify that laser printer. It lets you hook up minis, PCs, modems, multiple printers, parallel and serial . . . you name it. Any mix of models and makes. It can even be a Print Server in a larger LAN. The buffer (60KB to 500KB) provides concurrent input and output. It handles different baud rates and protocols. No cable or switch flipping. No modifications to your hardware or software. For more information on PrintDirector, the ultimate in printer managers, call or write:

## PrintDirector

Digital Products Inc. • The Simple Network Solution Company  
600 Pleasant Street, Watertown MA 02172  
(617) 924-1680 (Outside Mass., call 1-800-243-2333)  
Prices start at \$645.



# An Interactive Digital Telecommunications System Sends Photos, Graphics, Text and Voice



## Makes Communicating and Decision-making Easier, Faster

Now you can do it. Dial up your home office, client or service organization and have a two-way conversation with pictures, graphics and text to make your communications more effective and immediate. Point to areas of interest, draw in changes, transfer a file, exchange typed messages or switch to voice mode and hold a two-way conversation.

Easy to use PhotoMail is the system designed for organizations that must send complex information between offices or client facilities.

Applications abound in business, design and engineering, medicine, service and maintenance, insurance, security, access control, law enforcement, news and wire services.

PhotoMail is a complete hardware/software family of products that lets you send and receive pictures over ordinary phone lines to remote computers. Pictures of people, diagrams, text, houses, construction sites, property damage — anything you can capture with standard video equipment can be displayed and transmitted at resolutions up to 640 x 400 x 16 levels of gray. PhotoMail supports disk storage and hard copy printout and file conversion for "electronic mail" systems.

### Simple to Use

1. Select a picture from disk file or capture it with a video camera. 2. Dial your party. 3. When the party answers, PhotoMail automatically links the two computer systems. 4. You can now discuss your business — using a

"mouse" to select the functions you desire: communicating, filing, capturing, edit screen and send image. Subfunctions "pop-up" for additional instructions.

### Configure Your Own—You may already have some of the components . . .

	Component	PhotoMail Package	PhotoMail System	PhotoMail Workstation	Expansion Slots Used
REQUIRED	Computer (IBM PC, XT, AT)	User	User	•	—
	Monitor	User	•	•	—
	GA-1000 Graphics Adapter	•	•	•	1 Full
	PC-EYE Video Capture	•	•	•	1 Full
	PhotoMail Software	•	•	•	—
	Modem	User	•	•	•••
	Video Camera	User	•	•	—
RECOMMENDED	Pointing Device	•	•	•	1/2 Slot
	ScreenMaster	•	•	•	1/2 Slot
	Camera Accessory Kit	User	•	•	—
OPTIONAL	Expansion Chassis (8-Slot)	User	•	—	1 Full Slot in host for interface
	Printer	User	User	User	1 Slot for printer adapter

User - Supplied by user  
 • - Supplied with PhotoMail  
 ••• - 1 full slot for plug-in board modem, 1/2 slot for external modems which connect to an asynchronous communications adapter board.

# CHORUS

Write for Information including applications, operation, system configuration and specifications or call 1-800-OCHORUS.

documentation system for the Academic Computer Services department, he wrote his own mainframe-based text formatter called FORMAL. His intensive research and development work with the Interactive Graphics Lab led him to develop VAXteroids, a mainframe color-and-sound version of the popular Asteroids video game. After VAXteroids was written, Mayer searched for a real challenge and ended up at Canada's University of Guelph working on CoSy.

CoSy, a blend of many different computer conferencing systems, echoes its developer's own background. CoSy is a type of academic system (like EIES), while maintaining a sense of electronic community (like PARTI). BYTE has chosen CoSy as the software that BIX (the BYTE Information Exchange) will run under.

CoSy is a deliberately ambiguous

acronym that originally stood for Conferencing System, Collaboration System, Conversational Syncretism, and even multilingual names like Conduité à Synergie (conduit to synergy). This identification crisis sums up CoSy well and is also the reason it functions well in a computer conferencing environment; it can be anything you want it to be.

The CoSy conferencing system at Guelph has officially been on line since April of 1983. "We started charging people real money for the service in the fall of 1984," said Mayer. The University provides individual accounts on CoSy, on a per-fee basis. To date there are 400 off-site users in 28 different countries using CoSy, notably by organizations that are geographically dispersed.

CoSy runs on any machine that will handle UNIX. Mayer says the software was demonstrated successfully on an

AT&T UNIX PC with 1 megabyte of RAM (random-access read/write memory) and a 10-megabyte hard disk (with obvious limitations regarding simultaneous users and number and size of conferences).

CoSy supports electronic mail and both open and closed conferencing. In addition, a function called Conversation lets users form an informal conference of invited members. Conversation looks like regular E-mail, but when you enter comments, each person on the "guest list" is sent a copy of the message. This facilitates quick conferences without going through the formalities of setting up an official conference.

CoSy has numerous on-line help functions and even a "guided tour" that allows you to learn enough commands in 10 minutes to handle 80 percent of all the functions you will ever use on CoSy.

To make CoSy respond, you only have to hit a carriage return. If there are unread messages waiting for you, CoSy automatically displays them. If you are ever in doubt about what to do in CoSy, you just hit a carriage return, and something will pop onto your screen. If it's not an unread message, then it will be a list of executable options. The CoSy installed at Guelph has links to the BITNET network and can therefore reach any number of research networks. (As pointed out earlier, figuring out these research networks is something of a black art, but the potential is there.) If you want to take a shot at on-line "exploration," you can subscribe to CoSy (at a much more reasonable fee than EIES) and begin traveling the tributaries of the electronic community.

According to Mayer, there is talk about linking the Swedish COM with CoSy, which would allow parallel conferencing between the two systems to become a reality.

CoSy represents a trend in computer conferencing that is highly desirable—portability from a mainframe environment to the micro level. This evolution could well lead to a

(continued)

## Subscription Problems?



### We want to help!

*If you have a problem with your BYTE subscription, write us with the details. We'll do our best to set it right. But we must have the name, address, and zip of the subscription (new and old address, if it's a change of address). If the problem involves a payment, be sure to include copies of the credit card statement, or front and back of cancelled checks. Include a "business hours" phone number if possible.*

**BYTE**  
**Subscriber Service**  
**P.O. Box 328**  
**Hancock, NH 03449**

# Famous Canon National Brand

10" Carriage

HI-SPEED

15" Carriage

# PRINTER SALE

**Below Wholesale Cost Prices!!!**

- 160-180 CPS • High Speed Dot Matrix • Letter Quality Modes
- Tractor/Friction • 4 Character Styles • Business or Personal
- Programmable Characters • 2K Buffer • 15 Day Free Trial
- ONE YEAR IMMEDIATE REPLACEMENT WARRANTY



**SUPER GRAPHICS!**

Print Sample

15" Printer uses 10" and 15" paper

```
*** NLQ PICA PRINTING ***
CANON IMPACT MATRIX PRINTER  CANO
CANON IMPACT MATR
```

Check these features & prices

## 10" Printer

List \$499.00

# \$199<sup>00</sup>

Call for Volume Discounts

## 15" Printer

List \$699.00

# \$279<sup>00</sup>

Call for Volume Discounts

(IBM — Commodore)

## SPECIFICATIONS

(Apple — Atari — Etc.)

**Printing Method**  
Impact dot matrix

**Printing Speed**  
160 CPS at standard character printing  
27 CPS at NLQ character printing

**Printing Direction**  
Text Mode — Bi-directional  
Graphic Mode — Unidirectional

**Print Head Life**  
100 million characters

**Printing Characters**  
Standard 11 x 9 dot matrix  
NLQ 23 x 18 dot matrix  
Character size: 2 x 2.42 mm (standard)  
Character set: Full ASCII character set (96),  
32 special European characters

**Down Loading**  
11 x 9 dot matrix; NLQ 23 x 18 dot matrix  
optional

**Print Buffer**  
2K-byte utility buffer

**Image Printing**  
Image Data: Vertical 8, 9 and/or 16 dot  
Resolution: Horizontal 60 dots/inch  
Horizontal 120 dots/inch (double density)  
Horizontal 240 dots/inch (quadruple density)

**Interface**  
8-bit parallel interface (Centronics type)

**Paper**  
Plain paper, Roll paper, Single sheet,  
Fanfold, Multipart paper: max. 3 sheets  
(original plus 2)

**Ink Ribbon Cartridge**  
Ribbon Life: 3 million characters/cartridge

**Maximum Number of Characters**

Standard:	10 cpi	80 cpl
Enlarged:	5 cpi	40 cpl
Condensed:	17.1 cpi	136 cpl
Condensed enlarged:	8.5 cpi	68 cpl
Elite:	12 cpi	96 cpl
Elite enlarged:	6 cpi	48 cpl
NLQ pica:	10 cpi	80 cpl
NLQ pica enlarged:	5 cpi	40 cpl

**Physical Dimensions**  
10": Size: 15 3/4" x 12 5/8" x 4 3/8"  
Weight: 17.6 lbs.  
15": Size: 23 1/2" x 13 4/5" x 5 1/10"  
Weight: 26.4 lbs.

Cartridge Ribbon. List \$29.95. Sale \$14.95.

## Interfaces

IBM \$89.00

Apple \$59.00

Atari \$59.00

Commodore \$39.00

Add \$13.50 (\$15.00 for 15" Printers) for shipping, handling and insurance. Illinois residents please add 6% tax. Add \$20.00 for CANADA, PUERTO RICO, HAWAII, ALASKA, APO-FPO orders. Canadian orders must be in U.S. dollars. WE DO NOT EXPORT TO OTHER COUNTRIES, EXCEPT CANADA.

Enclose Cashiers Check, Money Order or Personal Check. Allow 14 days for delivery, 2 to 7 days for phone orders, 1 day express mail!

VISA — MASTER CARD — C.O.D. No C.O.D. to Canada, APO-FPO.

## PROTECTO

We Love Our Customers

22292 N. Pepper Rd., Barrington, Illinois 60010

**312/382-5244 to order**

vast network of high-powered conferencing systems dotting the phosphorescent landscape, in much the same way single-user bulletin-board systems do today.

**VISIONARY CONFERENCING**

The conferencing system AUGMENT can trace its roots to a 1945 *Atlantic Monthly* article by Vannevar Bush called "As We May Think." In the article, Bush described the "memex," a personal workstation that includes concepts such as associative indexing, windowing, and database trails. Drawing heavily on the concepts of Bush's article, Doug Engelbart began thinking of ways to "augment" the office work environment. As a result of early work in workspace augmentation, Engelbart developed a system called NLS.

Engelbart is often overlooked in the general history of the development of

computer conferencing. In the early 1960s he wrote about the type of computer system that has evolved into modern-day computer conferencing. The focus of NLS was to create a complete "knowledge workshop" for the user, not just an isolated set of tools. The early NLS system was so impressive that in 1978 Tymshare took over the rights to the NLS system and now markets it commercially as AUGMENT.

AUGMENT allows you to navigate through what it calls an "information space," using several on-line tools. In a computer conference you can display text in several ways—by subject headers only, by controlling the number of lines displayed on screen at a given time, or by presenting text only from a certain person. The system also allows the screen to be divided horizontally or vertically into eight rectangular windows for display-

ing different sections of a text or separate sections of different texts. This use of a split-screen concept was an early forerunner of windowing so common today.

The manipulation of text on AUGMENT allows you to delve into what Engelbart terms "hypertext." In dealing with your "information space," you can jump to previously marked passages, to adjacent passages, to a specified point in the text, or to a point that satisfies a certain test. AUGMENT also lets users jump to other documents that are referenced in the current on-screen text. The effect is a type of "word window."

Beyond the normal aspect of storing written notes in a hierarchical fashion, with subsequent comments being added by other members of the computer conference, AUGMENT adds a fascinating dimension to the

(continued)

**TURN YOUR  
COMMODORE 64  
INTO AN ENVIRONMENTAL  
CONTROL CENTER**

**NEW!**

**Introducing FIRST ADE™  
for Commodore 64.**

Controlling the environment since 1983, FIRST ADE™ is now available for use on the Commodore 64. FIRST ADE™, a complete 8 bit data acquisition and control card that just plugs into your Commodore 64, allowing you to control the indoor and outdoor functions of home or business.

Control your heating, lighting, small appliances, freezer, sprinkler system, pool level and temperature, and much, much more.

No special wiring required. BSR compatible by simply connecting to remote control modules.

**INTRODUCTORY OFFER! \$495.95**

Check/M.O./C.O.D./Visa/Mastercard  
Add 3% shipping/CA add 6% Sales Tax  
Allow 4 to 6 weeks delivery



**A/D ELECTRONICS**  
P. O. Box 26357  
Sacramento, California  
95826 (916) 486-1411

**SOFTWARE CONTROL CARD/INTERFACE**

- FIRST ADE™ features -
- 8 Analog Input Channels
  - 8 Digital Input Channels
  - 8 Digital Output Channels
  - 8 120V 6A Relays/Receptacles
  - 8 Analog Input Terminations
  - 8 Digital Input Terminations
  - RS 232 Port
  - Real Time Clock w/battery
  - 3 month warranty

FIRST ADE™ Version 1.4  
Disk Based/Menu Driven  
Logic Functions  
Programmable Setpoints

**COMING SOON!**

FIRST ADE™ for  
IBM PC and Apple II

Distributorship available.



# "SwyftCard™ is an incredible addition to my Apple® IIe."

Steve Wozniak,  
Apple IIe user

**This new \$89.95 plug-in card gives you an amazingly easy, blindingly fast way to write, file, communicate and calculate.**

You've never seen an Apple IIe do word processing, filing, communicating and calculating the way it does with a SwyftCard.

Steve Wozniak calls it revolutionary, adding "If I had thought of the SwyftCard while creating the Apple II, I would have built it in." Fomenting revolutions comes naturally to SwyftCard inventor Jef Raskin, whose previous efforts to make computers simple and useful include creating the Macintosh™ project at Apple.



SwyftCard creator Jef Raskin and Apple II creator Steve Wozniak

**SwyftCard transforms the Apple IIe into the computer it ought to be.**

The SwyftCard creates a 40K-byte working space, or "universe," capable of holding about 20 pages of single-spaced text. The universe accepts whatever you put in — text, numbers and data, in any form you choose, without you having to switch programs or modes.

Throughout your workday, you can enter information into the universe in free form: a report, names and addresses, daily to-do list, new telephone numbers, client list — anything you're working on.

A universe resides in memory while you are using it, and when you are done you save it to a disk. An unlimited number of universes can be created, each kept on a separate disk.

The secret to working in a SwyftCard universe is the patent-pending cursor. It works faster than control keys or a mouse, and doesn't make you take your hands off the keyboard.

SwyftCard is a better solution to your day in, day out word processing and data management needs. It is faster, easier and more useful.

## How much faster is SwyftCard?

From a power-off start, SwyftCard loads a universe and displays exactly where you were last working in just six seconds, automatically, with no commands.

SwyftCard finds and displays any piece of information in your universe in less than 300 milliseconds.

SwyftCard saves an entire universe to a disk in just eight seconds, including automatic formatting if necessary.

## How much easier is SwyftCard?

For all it does, SwyftCard uses only seven commands. And each is available immediately by pressing a single key once.

To start using SwyftCard, simply plug the card into Slot 3 (which most other cards can't use), turn the Apple IIe power on, wait six seconds and begin typing.

To use an Apple program, just load it in; SwyftCard turns itself off and won't interfere.

## How much more does SwyftCard do?

SwyftCard communicates with data services without you having to learn their editors, and lets you directly edit information you bring in without special commands or file transfers.

SwyftCard is great with numbers, performing calculations — including scientific work — anywhere in your universe.

Using the SwyftCard-ProDos utility disk, which is included, you can transfer information developed in SwyftCard to other programs, and vice versa.

SwyftCard is not a spreadsheet, nor will it do everything for everybody. But no other system delivers the common sense utility of SwyftCard.

Of course, SwyftCard comes with a complete manual and an on-screen tutorial.

## Try SwyftCard for 30 days.

Everyone we've shown this ad to has said SwyftCard sounds too good to be true. Maybe you feel that way too. But everyone we've then shown the SwyftCard to says it's better than the ad claims. So we want you to try it at our risk.

If we sent you product literature or tried to answer your questions by phone,

we would just repeat this ad. The only practical way to find out if SwyftCard will help you is to accept the 30-day, no questions asked, money-back trial offer. If you don't like your SwyftCard, return it within 30 days and we'll send you your money back.

To order, call us at:

**800-982-5600 in the U.S.  
800-562-7400 in Calif.**

### Computer system requirements

Apple IIe, regular or extended 80-column card, 80-column monitor, one disk drive with controller. For communications: 300 or 1200 baud modems and Super Serial card. To transfer data between SwyftCard and Apple programs with ProDos utility: extended 80-column card or two drives. To print: any Apple, Brother, C.Itoh, Centronics, Epson, HP, NEC, Okidata, Panasonic, Qume, Star, Toshiba and most other printers.

Apple is a registered trademark of and Macintosh is a trademark licensed to Apple Computer Inc.

**Order SwyftCard on a 30-day money-back trial offer. Call toll-free: 800-982-5600 in the U.S., 800-562-7400 in California. Or use this coupon.**

Name \_\_\_\_\_

Address \_\_\_\_\_

City \_\_\_\_\_

State \_\_\_\_\_ Zip \_\_\_\_\_

Phone (\_\_\_\_\_) \_\_\_\_\_

Send \_\_\_\_\_ SwyftCards at \$89.95\* plus \$3.50 U.S. or \$10.00 foreign shipping and handling each, totalling \$\_\_\_\_\_ I prefer to pay as follows:

My check or money order is enclosed (payable to Information Appliance Inc.)

Please bill my credit card account:  Visa  MasterCard

Card # \_\_\_\_\_

Expiration Date \_\_\_\_\_

Signature \_\_\_\_\_

\*California residents please add \$6.30 for sales tax.

Mail to: Information Appliance Inc., 530 University Ave., Palo Alto, CA 94301.

## Information Appliance Inc.

real-time computer conference. Users can link their terminals to allow for a common screen information display, with each person being able to control a pointer on the screen and able to call up related files on different windows.

In Engelbart's own words, AUGMENT "permits a user to call an on-

line conference of two or more people, view and edit files, add and remove conferees, pass the gavel, and transparently connect to other machines."

Many of the concepts displayed in Engelbart's work with AUGMENT are being researched by computer conferencing developers today. The idea

of a knowledge workshop goes beyond the basic needs of a computerized meeting room. It appears, however, that the types of concepts AUGMENT displays are still ahead of its time.

**GENIE: QUILL AND INK IT AIN'T**

Stephen Heitmann, developer of the GENIE conferencing system, must have been a medieval monk in his past life. There is no other explanation for GENIE's highly flexible text-processing capabilities. Only a monk that had spent his entire life hand lettering with quill and ink could have turned all his frustrations into fantasies by creating a computer conferencing system with the capabilities of GENIE, which must have taken hard work, late hours, and a natural creative ability.

The first thing that hits you about GENIE is the many ways it handles text. Entering comments into a conference is handled in a standard way. You enter the comments into a scratchpad, and then the contents of your scratchpad are entered into the conference. That's where the standard procedure ends.

While participating in an on-line conference, you will sooner or later enter a message you wish you could take back, such as one written while you were mad or half asleep. Most conferencing systems allow you, as author, to delete a message if you choose. Revising the message might be preferable, but on most systems your options are to delete or suffer the consequences (usually an electronic mailbox stuffed with comments that don't exactly resemble fan mail). GENIE solves this all-or-nothing problem by letting you revise messages. You can even authorize "editing rights" to other members of the conference.

An example of this "many editors" function would be when issuing a general request for information. Instead of having everyone who replies to your message create separate entries in the conference, each person could append his or her information

(continued)

# UNLOCK™ Removes Copy Protection

## RUNS YOUR SOFTWARE ON ANY HARD DISK

Currently supports only programs listed below:

**UNlock ALBUM "A"**  
**\$49.95** Plus \$4 ship/handling

- LOTUS 1-2-3™ (1.A. & 1.A')
- dBASE III™ (1.0, 1.1 & 1.2)
- FRAMEWORK™ (1.0 & 1.1)
- SYSTAT™ (1.3 & 2.0)
- SPOTLIGHT™ (1.0 & 1.1)
- GRAPHWRITER™ (4.3)
- REALIA COBOL™ (1.20)

**UNlock ALBUM "B"**  
**\$49.95** Plus \$4 ship/handling

- SYMPHONY™ (1.0 & 1.1)
- CLIPPERT™ (1.0)
- ELECTRIC DESK™ (1.04)
- DOUBLEDOS™
- MANAGING YOUR MONEY™ (1.5 & 1.51)
- smARTWORK™ (1.0 REV 8)
- DATA BASE MANAGER II™ (ALPHA 2.02)

**Best of UNlock ALBUM "D"**  
**\$74.95** Plus \$4 ship/handling

- MICROSOFT WORD™ (2.0)
- dBASE III™ (1.0, 1.1 & 1.2)
- LOTUS 1-2-3™ (1.0 & 1.A')
- SYMPHONY™ (1.0 & 1.1)
- FRAMEWORK™ (1.0 & 1.1)
- CLIPPERT™
- MULTILINK™ (3.02)

- Produce non-protected DOS copies from popular software programs.
- For IBM® PC, XT, AT, compatibles

TranSec UNlock is a unique software copying disk that removes copy protection, providing standard non-protected DOS copies. UNlock runs on IBM® PC, XT, AT, and compatibles with 256K or more, DOS 2.0 or higher.

**BACKUP COPIES.** UNlock safely and easily makes backup copies.

**RUN ON HARD DISK.** Programs load faster, use less disk space and work with any hard disk, including Bernoulli Boxes. No longer do you need the original in drive "A".

**RUN ON RAM DISK.** UNlock is the only software that can run copy protected software on a RAM disk or micro-floppy.

**EASY TO USE.** 1) Type UNlock. 2) Select program destination. 3) Insert program disk.

**SAFE ORIGINAL.** UNlock does not alter your original distribution disk. UNlock works by creating a copy of your distribution disk on a hard or floppy disk. It then removes copy protection from the copy!

**NEW! HOLIDAY SPECIAL!**  
**"Best of UNlock"**

ORDER TODAY BY TELEPHONE!

**1-305-474-7548**

**TRANSEC™**



TranSec Systems, Inc., 1802-200 North University Drive, Plantation, FL 33322  
 Trademarks are the sole property of their respective owners. • UNlock is For Use Only to Improve the Useability of Legally Acquired and Operated Software.

# At NEC, monitors and printers are not peripheral issues.

All too often, brand-name CPUs are "bundled" with mediocre peripherals — a practice that makes for profitable sales, but does nothing for the system's performance.

In Japan, where most computer peripherals are actually built, NEC is the largest personal computer company — by far. And NEC didn't make it to first place by offering second rate peripherals.

## The monitors with the broadcast video heritage.

While dozens of companies market display monitors, only a handful possess the tube technology and manufacturing capability to actually *build* them. NEC is one of the few. In fact, NEC's complete line of color and monochrome monitors reflects the professional and broadcast video

expertise that twice earned NEC Emmy Awards from the National Academy of Television Arts & Sciences.

## Winning the printer race takes both speed and endurance.

Ask people who really know about printers, and they'll tell you that NEC builds the best. They may also point out that NEC builds printers for other computer companies. And if you ask them to choose one word to sum up what makes NEC printers stand out, it will probably be "reliable." This is why NEC has become the printer of choice for the most demanding installations.

So before you buy a peripheral from any name company, make sure the company puts more into the peripheral than just its name.

PC-PR105A IBM PC PLUG COMPATIBLE TRI-MODE DOT MATRIX PRINTER.



JB-1280DA IBM PC PLUG COMPATIBLE GREEN PHOSPHOR BLACK SCREEN MONITOR.



# NEC

NEC Home Electronics (U.S.A.) Inc.

Personal Computer Division  
1401 Estes Avenue  
Elk Grove Village, IL 60007  
312-228-5900

## CONFER can broadcast notices, called bulletins.

onto your first request. In the end, you have a single message that amounts to a minidatabase of responses.

GENIE allows the author of a message to place certain locks on the text. You can stop anyone from copying a note you wrote and placing it somewhere else in the system. This hinders the "leaking" or mass distribution of critical information. (Of course, if someone downloaded the message to disk, he could upload it anywhere he desired.)

Who uses GENIE? I don't know, since its user base is proprietary. (I am sworn by a phosphor oath not to reveal the system I used to review GENIE.) I was told that the target market for GENIE is the scientific/engineering (read "research and development") community. That didn't make sense when I first heard it, but after using GENIE I see why. The science and engineering fields create an enormous amount of papers that need constant revision.

### CONFER: THINK TANK WITHOUT WALLS

CONFER is a computer conferencing system developed by Bob Parnes that resides on a mainframe somewhere on the campus of Wayne State University in Detroit. Hewlett-Packard chose to license CONFER for its own use and now has an effective way to electronically link its employees, who are geographically dispersed among 100 major corporate divisions. HP's corporate "suits" have hailed CONFER as "the best thing on the market for distributed meetings." Meanwhile, the Army's Training and Doctrine Command uses CONFER for its "think tank without walls," called The Delta Task Force. The Independent Investor's Forum caters to investors with \$5000 to \$10,000 and dispenses advice to its subscribers via CONFER.

In operation since 1975, CONFER is a greenhouse for various think tanks and free thinkers. If ever a system could create a feeling of excitement, CONFER is the one. Bouncing around the various CONFER conferences, I was amazed at the level of "idea projection" taking place. This is due in part to the structure of the software.

The structure of CONFER and the philosophy behind it are based on "information mapping." This type of system, according to Robert E. Horn's book, *How to Write Information Mapping* (Information Resources Inc., 1982), includes the following principles and procedures:

- identifying
- categorizing
- interrelating
- sequencing
- presenting

CONFER follows these ideas in "mapping out" the way it handles computer conferencing.

CONFER differs from other conferencing systems in that its conferences are more circular than branching. A *conference* is described as "the basic social structure" of CONFER. Major topics of discussion within a conference are called *items*. Each item relates to the general conference theme. If you want to comment on a particular item, your comments are logged as *responses*, which are short, concise points of view or pieces of additional information relating to the item. Responses must be short and to the point because they are limited to 1500 characters (about 24 lines of text). If new ideas evolve from the responses to items, additional items can be entered into the conference. From what I saw, an incredible amount of discussion can take place under a major topic without straying from the general theme. Contributing to the overall creative force of CONFER is the ability to create an agenda for each conference.

The agenda function of CONFER allows you to digest a conference by grouping items under a single topic. For example, a conference titled Productivity may have 15 items relating

to different aspects of human relations. In your agenda you can create the heading Human Relations and then cross-reference all the items relating to the subject. This gives you a powerful information-management tool. Since everyone interprets information in different ways, each person can create an agenda according to his or her personal perspective (or if you find someone who thinks along the same lines, you can share agendas).

CONFER can broadcast notices, which it calls *bulletins*. Bulletins can be sent to all members of a certain conference, informing them of activities or pieces of information. Additionally, bulletins can be time-released, so that you can create a bulletin on May 8 and instruct CONFER to broadcast it on May 30. (You can do the same thing personally, by sending yourself personal bulletins called *notes*, which come in handy for reminding you of important dates or activities scheduled in advance.)

Private correspondence is handled through the sending of messages. Messages function like a standard E-mail system.

CONFER is also the Ferrari of computer conferencing. This software responds quickly to all commands, including those calling for keyword searches of an entire conference database. Until you've been "under the clock," knowing that each tick-tick-tick is literally being measured in greenbacks, you can't appreciate a responsive system.

The most impressive feedback I received on CONFER was this user's statement: "When using CONFER, people don't think of themselves as 'subscribing to' a system; they feel like members of a community."

### CHOOSING A SYSTEM

How do you choose a conferencing system? The best way is to try out the various systems for yourself. All the companies marketing these systems are more than willing to let you test-drive their systems. After spending some time with each one, you'll know which suits your needs best. It will be the one that "feels" right. ■

# Introducing the first IBM™ AT Compatible Kit!

## Building your own AT is as easy as it looks.

Now, it's easy to have the IBM AT that you want by building your own from ADTEK's SERIES 286AT™ compatible, board-level kit. Choose from a complete kit (chassis, motherboard, cables, disk controller, keyboard and enhancement boards) and add your own monitor and disk drives. Or buy just the parts you need for your project. Either way, all series 286AT products are hardware and software AT compatible.

But you won't be on your own. The ADTEK SERIES 286AT comes with illustrated, step by step instructions that even a beginner can follow. (Some basic knowledge of electronics will be helpful.) With just a few simple household tools you can put your new computer together in a Saturday afternoon. And you'll feel confident about your SERIES 286AT because every ADTEK product is protected by a full, one year factory warranty.

## And amazingly frugal.

**IBM-XT**  
Compatible Kits  
now available.  
Call for price list.



Fully assembled SERIES 286AT



AT compatible disk controller handles 2 floppies, 2 Winchester.

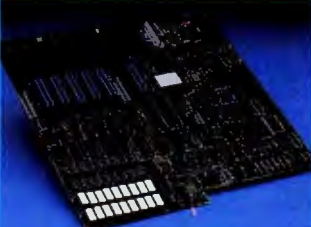


192 Watt switchable AT compatible power supply.

If you're ready for AT power and speed, but don't want to pay IBM's premium price, rest easy. A complete ADTEK SERIES 286AT kit is priced significantly less than a comparably assembled IBM AT. That's engineering excellence at a real bargain! Call or write today for a detailed brochure and price list on the SERIES 286AT and other fine ADTEK products.



AT compatible keyboard with IBM configuration or LEDs on cap, num lock keys.



6 or 8 MHz 80286 motherboard, 640K standard memory, upgradable to 1M, clock calendar, fully compatible.



Fully AT compatible chassis with LEDs and lock. Mounts standard floppy and fixed disk drives.

### \$1998

Basic AT kit includes 640K motherboard, disk controller and cables, power supply, keyboard, case, documentation and warranty.



IBM compatible name brand floppy or Winchester drives available at discount prices.



Wide selection of AT compatible I/O expansion, memory and multifunction cards.



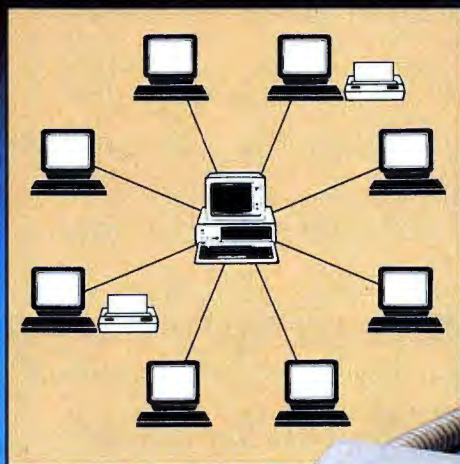
Fully tested RGB and monochrome monitors in stock.



High res color and monochrome video controllers are fully interfaced with system.

# Kimtron

# MULTI-USER SOLUTION for IBM PC, XT, AT



## Compare the Solution!

The Multi-User Solution of the future is now available.

Convert your IBM PC, XT, AT or Compatibles to a true multi-user system while maintaining display, keyboard and software compatibility.

Since the KT-7/PC display is the same as your PC monochrome monitor, with its look-alike keyboard, operators will feel they're using an IBM PC and can also use the same software manual. Kimtron's multi-user solution includes file and record locking, shared data access, and communication between users. It is **the** intelligent alternative.

The KT-7/PC supports Time Sharing, Enhanced Time Sharing

and Multi-Processor implementation under PC DOS, MS DOS, UNIX, XENIX, CPM 86, Multilink, Concurrent PC DOS, and other compatible multi-user operating systems.

Kimtron's multi-user solution may be tailored for cost effectiveness; as low as \$1095 for an additional user, and for speeds more than ten times faster than LAN. You can add one or as many as 31 additional users per PC. Kimtron delivers the future now by allowing an ever-widening network of multi-user PC's.

The KT-7/PC may be complemented with one (or more) I/O Card, Memory Card, 8086 Speed

Enhancer Card, 80286 AT Card, 8088 Multi-Processor Card, 80186 Speed Enhancer Card, 68000 Card, and related software.

For more information about Kimtron's Multi-User Solution, or general video data terminals for other mini or micro multi-user systems, call your local computer dealers, distributors or Kimtron Corporation Today!

**(408) 286-8790**  
**TWX 910-338-0237**



1705 Junction Court  
Building #160  
San Jose, CA 95112

# Kimtron

# CONFERENCING STANDARDS

BY JACOB PALME

## *The search for a universal conferencing standard continues*

USERS OF A SINGLE computer conferencing system who communicate only with people who use the same computer have little need for standards. The need for standards arises when a user wants to communicate with people on several different computers or wants to connect a personal computer to a conferencing system.

If two different machines are to communicate, a standard for communication between them is needed. In computer conferencing, this could be either the interconnection of personal computers with multiuser conferencing systems or communication between several multiuser conferencing systems. Such a standard need not prescribe the internal functions, structuring, or user interface of the connected systems. The standard only has to prescribe the interconnection between the systems.

It is easier to develop a standard if you have some idea of the structure of the systems to be interconnected. Thus, standards are often based on models of the internal structure of the systems to be interconnected. The existence of such a model does not mean that only systems structured according to the model can be intercon-

nected. A model that is used to develop standards and that does not exactly agree with existing systems is called an *abstract* model. To connect a system whose internal structure is somewhat different from the model requires some mapping between the model and the real system in the interconnection software.

Today, many people are forced to keep accounts in several different conferencing and message systems. A comprehensive standard for interconnections might allow them to have an account in only one system and get all their information through this system from conferences and people in other systems. They would then have to connect to only one system and learn only one user interface.

### **GROUP COMMUNICATION**

Computer conferencing is a tool for communication within a group of people and provides an environment similar to task groups, discussion groups, and so on. A typical computer conferencing system consists of a number of conferences, each of which has a set of members and a sequence of messages.

Usually, the system stores informa-

tion about how far every member has read in each conference; this is often called the *conference marker*. This makes it possible for the system to tell users which messages are new to them when they connect to the system.

Bulletin boards are tools very similar to computer conferences. In this article, "computer conference" will also refer to bulletin boards.

Another tool for group communication common in computer-based message systems (CBMSs) is the *distribution list*. A distribution list, like a conference, has a set of members. A distribution list, however, usually does not store messages. When a message is sent to a distribution list, the "list" will just expand the number of recipients of the message and forward it as individual mail to all the members

*(continued)*

Jacob Palme, chief researcher at OZ, Stockholm University Computing Center, studies the social effects of computers and specializes in research and development of computer-based message and conferencing systems. He is one of the developers of the COM and PortaCOM computer conferencing systems. He can be contacted at OZ, Stockholm University Computing Center, Box 27322, S-102 54 Stockholm, Sweden.

of the distribution list.

Some systems provide special facilities to support other group communication tasks like voting, scheduling of face-to-face meetings, joint production of a manuscript, and so on. The first versions of future standards will probably cover only conferences and distribution lists, leaving more specialized group tasks for future versions of the standards.

### THE GROUP AGENT CONCEPT

Instead of developing one standard for each type of group communication, it is better to develop general concepts in the standard. For example, computer conferences and distribution lists can be combined into a more general concept called a *group agent*.

The group agent can store messages to be retrieved by some of its members, as in a computer conference, and forward messages as mail to some of its members, as with a distribution list.

Some group agents do not store messages and work as pure distribution lists. Other group agents may have no facility for automatic forwarding of messages and work as pure computer conferences. But many of the operations on the group agent (for example, adding a member or entering a message) can be similar for both kinds of group agents. This sharing of operations functionality for

both types of group agents reduces the size of the standard.

A further advantage is that the group agent concept can be used not only to interconnect a conference system to other conference systems but also to interconnect to simpler mail systems. Conferences will then appear as distribution lists to users of the mail system, who will have the conference messages sent to them as mail, as shown in figure 1.

### CONFERENCE-SYSTEM INTERCONNECTION

Since most conference systems can also handle personal electronic mail, one way of connecting them might be the one shown in figure 1. However, two other modes of connection are possible, as shown in figures 2 and 3.

Figure 2 shows a structure of parallel conferences. A similar structure for connecting distribution lists is possible. Every message entered into the conference in CBMS A is copied into the parallel conference in CBMS B. Any local user in either the A or the B system can read all the messages in the conference, originally entered in either the A or the B system, in the same way as in a stand-alone conference system.

The conference in system B, CB, can be seen as a member of the conference in system A, CA, and vice versa. Conference CA could work partly as a distribution list to ensure

that a new message, entered into CA, is copied into CB, automatically forwarding all new entries (except those coming from CB) to CB. This is another reason why a good standard should combine computer conferencing and distribution lists into one general concept.

Of course, messages could also be forwarded from A to B only when B asks for them. This might be suitable if, for example, B is a personal computer that does not stay on line all the time.

Figure 3 shows an alternative structure, where messages are stored only in conference CA in system A. Whenever a user of system B wants to read a message, that message is retrieved automatically from system A. This, of course, requires fast networks to give users acceptable response times.

The structures shown in figures 2 and 3 can be combined. For example, system B might request the new messages from system A the first time any user wants to read them but then keep the messages for some time for other members of CB or for retrieval by the original reader who wants to look at the message once more.

### DATA STRUCTURES

Standards for the interconnection of message systems need to define two things: an abstract model of the data structures involved and definitions of the operations used for communication between the systems.

Here is a typical example of the data structure and attributes for "members" of the group agent concept: A group agent will have a list of members. Members can be users or other groups (for example, a parallel conference in another system). Each member will have a number of attributes, defining his or her relationship within the group. Examples of such attributes are listed below.

**Auto-forwarding:** New messages to the group are forwarded automatically as mail to members with this attribute. It is used when the group agent acts as a distribution list.

**Read access:** Members with this at-

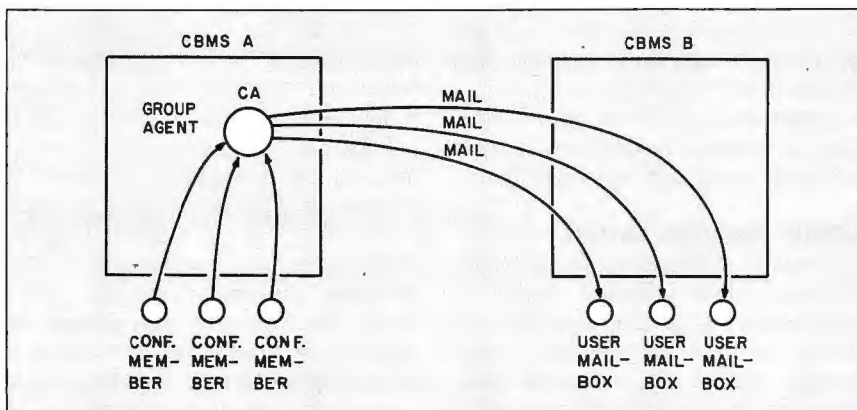


Figure 1: In this alternative, the group agent CA in CBMS A will act like a group agent to local users, who get messages from the conference, but like a mailing list to remote users at CBMS B, to whom messages are sent by CA.



tribute are allowed to request entries from the group.

**Write access:** Members with this attribute are allowed to enter messages to the group.

**Organizer access:** Members with this attribute are allowed to modify the list of members and other attributes of the group. Organizer access can be divided into different rights to modify various attributes. A special, but important, case is the right to modify only the value of an attribute with respect to yourself. You might thus be allowed to enter and remove yourself from the list of members of a group but not to enter and remove other members. In standards work, people with the right to modify information only about themselves are usually called *friends*.

The set of members with different rights in relation to a group need not always be defined by an explicit list of all the members. For open (public) conferences, for example, anyone may be allowed to read or become a member of the group. The set of members with a certain right may also be defined by what is known as a *class description*, for example, "everyone" or "all citizens of Sweden" or "all employees of IBM," provided that a database is available that can check whether a certain person belongs to a certain class or not.

### MESSAGE DATA STRUCTURE

A very important property of a standard is the facility to give every message a globally unique identifier that will not be changed even if the message is forwarded many times or stored and forwarded again. Such an ID can, for example, be used to ensure that the relation between a message and a reply to it is preserved even if the message and the reply are forwarded at different times.

The basic data structure for messages is the conference. A conference defines an ordered sequence of messages. The same message may belong to more than one conference.

Another important kind of message data structure is the binary relation-

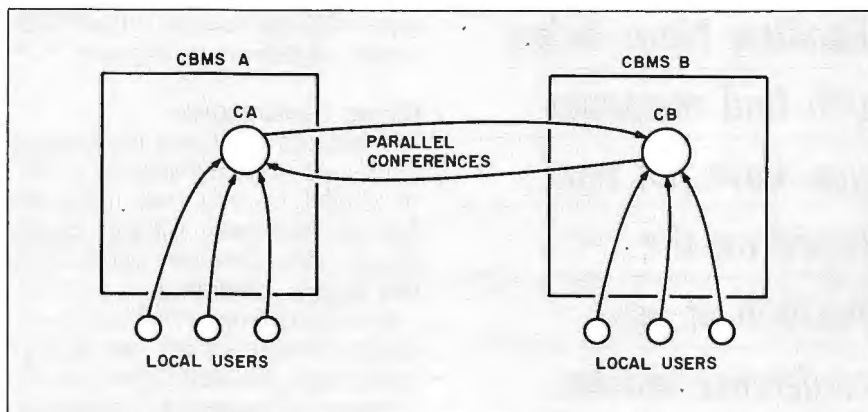


Figure 2: There are two parallel conferences in this alternative, CA in CBMS A and CB in CBMS B, storing the same set of messages. Local users get the messages from their local instance of the conference. Mailing-list forwarding is done only between the two conferences, not to personal mailboxes.

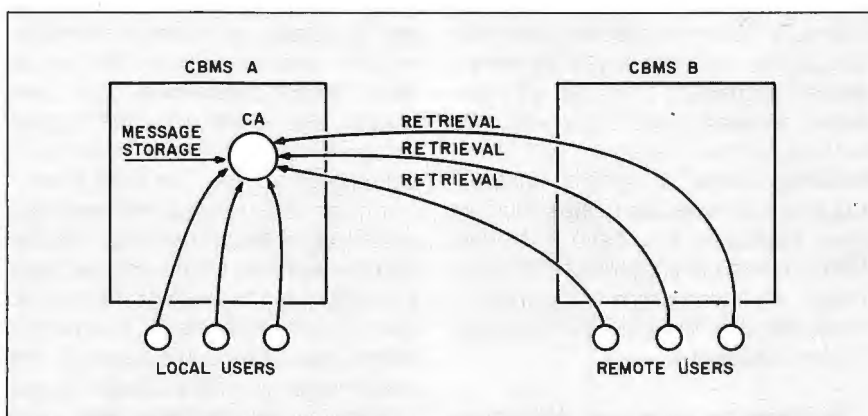


Figure 3: In this alternative, messages are stored only in conference CA at CBMS A. Users at CBMS B get the messages at reading time from CBMS A using remote retrieval operations. No automatic forwarding of messages (mailing-list functionality) is used.

ship between messages like "in reply to." Many other relations are possible, such as "continuation of," "subchapter to," etc. A standard will probably not place a restriction on such relations, such as allowing them only between messages within the same conference.

### OPERATIONS

Operations between connected systems have to be fully defined in the standard and are in many ways similar to the operations that a local user of a conference system can perform from his or her terminal. Here are some of the main types of operations:

**Search Group Directory:** You might search the group directory to find where a conference exists on a particular subject that interests you. All groups in the directory may, of course, not be available for search by all users.

**Creation Operations:** Create and remove group agents.

**Read and Set Attributes:** Read and modify the attributes of a group, such as a list of members.

**Membership Operations:** Read and modify information in the lists of members with various rights in relation to a group.

(continued)

*Reading News helps  
you find messages  
you have not read,  
based on the  
position of your  
conference marker.*

**Submitting Messages:** Enter messages to a group.

**Reading Messages:** Retrieve messages from the storage connected to a group agent, using simple retrieval requests ("Give me the message with the unique identifier X") or advanced search requests ("Give me all messages between these dates with certain keywords in them").

**Reading News:** A special case of reading. This operation helps you find new messages you have not read from a conference, based on the position of your conference marker, which is placed after the last-read message in the conference.

An important issue is where to store this conference marker. If every message in a conference is identified by a sequential position number in the conference, the conference markers for all conferences, even on remote

systems, might be stored in your local system or personal computer.

#### USING OPERATIONS

You might first tell your local system to find a conference about a subject of interest to you, say, multicolor printers. Your system will then use the Search Group Directory operation to find such a conference.

When a conference has been found in some remote system, you tell your system that you want to read the description of the remote conference. Your system will find this description using the Read Group Attributes operation. If you decide that you want to join the conference, your local system sets up a local conference (in your local system) on the same subject in parallel with the remote conference. You then ask for the last 20 items in the conference. Your local system gets these from the remote system and stores them in the local conference so you can read them.

You can also tell your personal computer to connect to the networks and retrieve all news. Your personal computer then automatically connects to the networks and gets all your unread letters and unread messages in the conferences you have chosen to participate in using the Read News operation. It will then disconnect, and you can locally read the new messages and write your replies and comments. You then tell your computer to connect again to enter the new messages

you wrote locally, using the Submit Messages operation.

#### LAYERED STANDARDS

Standards for computer network applications are based on layers. Each layer uses the facilities of the layer below. Figure 4 shows how two layers may relate to each other. Layer  $N$  sees a message consisting of a layer  $N$  header and a layer  $N$  body. Layer  $N$  sees the body only as a sequence of bytes; it does not understand any structure within the body. In layer  $N+1$ , however, what was only a body in layer  $N$  actually has a structure, for example, with a layer  $N+1$  header and a layer  $N+1$  body.

#### THE MHS MODEL

The message-system model behind the X.400 recommendation (see the text box "Standards Work in Progress" below) is called the MHS (message handling system). The model is shown in figure 5.

The basic components of this model are user agents (UAs) and message transfer agents (MTAs). Every personal mailbox has one UA representing that user. Using the UA, a user can, for example, locally edit a message. When the message is ready, it is delivered from the UA to an MTA, and the MTA will forward the message to the MTA connected to the recipient UA.

The protocol used to communicate  
*(continued)*

## STANDARDS WORK IN PROGRESS

Two main international organizations are involved in developing computer conferencing standards. These are ISO, the International Standards Organization (whose U.S. member is ANSI), and CCITT, the International Telegraph and Telephone Consultative Committee (organization of telegraph and telephone providers). Important also is ECMA, the European Computer Manufacturers Association, which in reality also includes the major American manufacturers and provides

input to both ISO and CCITT.

CCITT has developed a standard for interconnecting message systems, called the MHS (message handling system) or X.400 recommendation. (CCITT standards are called recommendations, not standards.) This recommendation was officially accepted by CCITT in late 1984. The X.400 recommendation is purely for interconnection of personally addressed mail—there is no facility in it for group communication, not even for distribution lists.

ISO will soon adopt a standard called MOTIS that is a copy of X.400 with minor revisions.

ISO decided in April 1985 to ask all member countries whether ISO should begin to study the group communication area. This vote will probably be ready in late 1985, and, if positive, ISO will begin work in the group communication area in 1986.

During the autumn of 1985, CCITT began studying possible revisions and extension of X.400.

# KNOWLEDGE man/2®



## LETS YOU GET TODAY'S WORK DONE . . . AND PLAN FOR TOMORROW



KnowledgeMan/2, the most advanced business software available, lets you be more productive than ever before and in less time. These powerful business capabilities, tightly fused into a single program, work together for you:

- Relational data management
- Spur-of-the-moment inquiry
- Spreadsheets
- Statistical analysis
- Forms management
- Programming language
- Options for creating graphs, processing text, generating reports, painting forms, mouse processing and remote communications.

KnowledgeMan/2's four user interfaces make it easy for you . . . and all your business people . . . to work with KnowledgeMan/2:

- Menus, help screens and easy-to-use documentation guide your every step, if you're just beginning.
- Direct commands for the power user, with help available when you want it.
- K-Chat, the optional natural language interface, for asking for information in plain English.
- Procedural programming for the advanced user.

Get KnowledgeMan/2 working for you today. And start planning for tomorrow.

KnowledgeMan/2 is available for IBM PC, XT, AT and compatibles with PC DOS, 16-bit micros with MSDOS or CP/M-86. Special versions are available for UNIX multi-user operating systems and IBM, 3Com and Novell Local Area Networks (LANs).

For the name of the KnowledgeMan/2 dealer near you, call or write Micro Data Base Systems, Inc./ Marketing & Sales, P.O. Box 248, Lafayette, IN 47902. 317/463-2581, Telex 209147 ISE UR.

KNOWLEDGE  
man/2®  
THE UNIVERSAL KNOWLEDGE MANAGEMENT SYSTEM

*The MHS is a  
model of message  
exchange; it is not  
a description of how  
a message system  
must be organized.*

between a UA and an MTA is called P3, and the protocol used to communicate between two MTAs is called P1. Another level of protocol is P2, which is actually on top of P1 and is used

for formatting the messages being forwarded. Although the messages passed via P1 and P2 are formatted according to P2 protocol, this information is not interpreted by the MTAs, so the P2 protocol can be seen as a protocol used between UAs (see figure 5).

It is very important to understand that the MHS is a model of message exchange used to develop the standard. It is not a description of how a message system must be organized. A message system can communicate perfectly well according to the X.400 recommendation but have a totally different internal structure. Some message systems with many users on one computer may not have any sharply defined user agent in them. They can

still communicate with other MTAs by using the P1 and P2 protocols.

Since X.400 will probably be the accepted standard for message handling, a way must be found to handle group communication within X.400. Group communication will probably be implemented by introducing group agents into X.400. A group agent in this context will be similar to a user agent. It will have a name, and it will interpret the P2 protocol information.

The functions of a group agent, however, may be split into several separate modules. X.400 will be extended with a directory system, and the lists of members of groups will probably be stored there. The actual storage of messages belonging to a certain group may be done by special services for filing and retrieving messages instead of by the group agents. ■

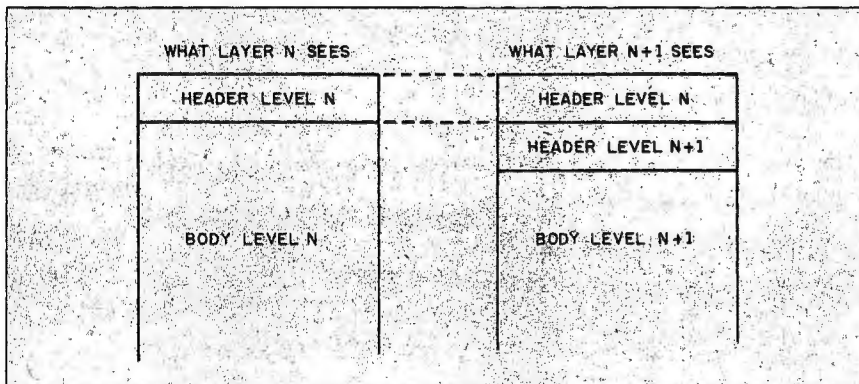


Figure 4: This figure shows how a new layer (N+1) can be built on top of a lower layer (N). The protocol in layer N is used to forward a message, but what looks like just a body with no structure to layer N is further structured by layer N+1, with, for example, a new layer N+1 header and body.

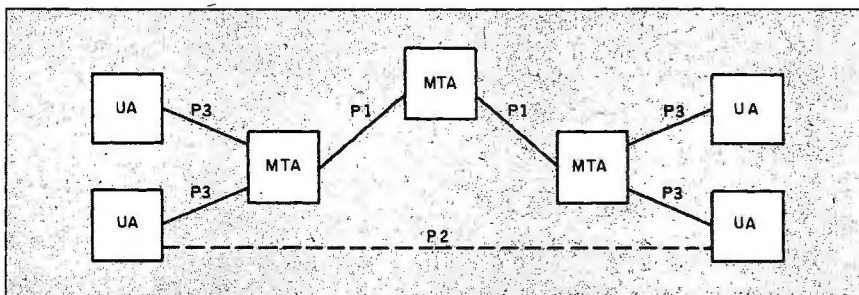


Figure 5: This figure shows how messages are passed from UAs (user agents) via one or more MTAs (message transfer agents) to the recipient UA in the MHS model. The P1 protocol is used between MTAs, and the P3 protocol is used between a UA and an MTA. The messages passed via P1 and P2 are formatted according to the P2 protocol, but this information is not interpreted by the MTAs, so the P2 protocol can be seen as a protocol between UAs.

## BIBLIOGRAPHY

"CCITT—Recommendation X.400: Message Handling Systems: System Model Service Elements." For information, contact Omnicom, 501 Church St. NE, Suite 304, Vienna, VA 22180.

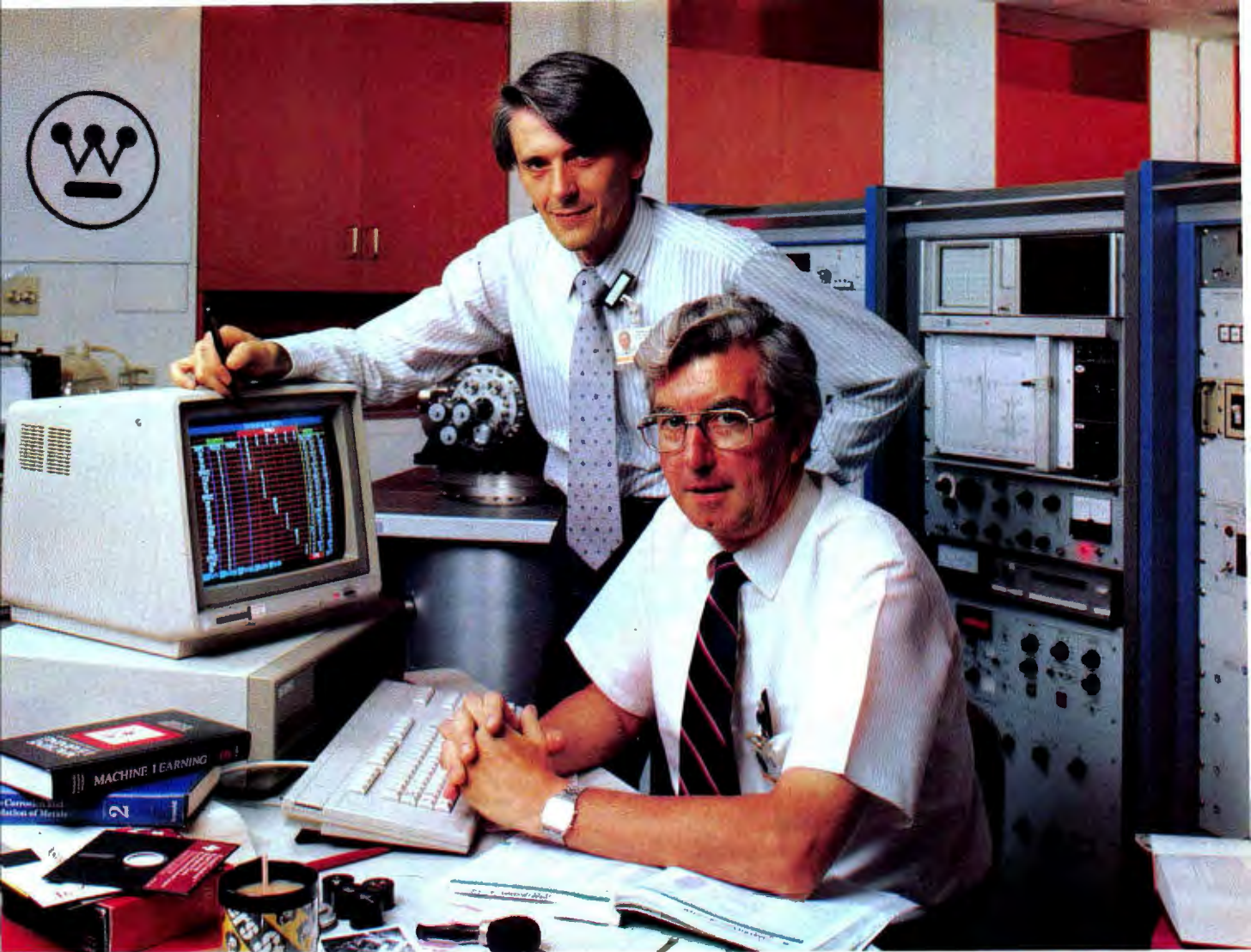
"GILT—Interconnection of Computer Based Message and Conference Systems." Green Version, June 1983. Available from Computing Center, Universitätsstrasse 1, Duesseldorf, Germany.

Huitema, Christian. "The COSAC Electronic Conferencing Experiment." Paper presented at the IFIP Second International Symposium on Computer Message Systems, Washington, D.C., September 1985.

Palme, Jacob. "Distribution Agents (Mailing Lists) in Message Handling Systems." Paper presented at the IFIP Second International Symposium on Computer Message Systems, Washington, D.C., September 1985.

Palme, Jacob. "Survey of Computer-based Message Systems." Paper presented at Interact '84, the first IFIP Conference on Human-Computer Interaction, September 1984.

Wosnitza, Lothar. "Group Communication in the MHS Context." Paper presented at the IFIP Second International Symposium on Computer Message Systems, Washington, D.C., September 1985. (Papers from IFIP conferences are published in book form by North-Holland.)



## Westinghouse brought in TI's Personal Consultant<sup>™</sup> because these experts don't have time to waste.

Personal Consultant is the expert systems development software that's turning the time they spend answering routine questions into research and development.

Dr. Neil Pessall and Dr. Jan Schreurs, research scientists at the Westinghouse Research and Development Center, had a problem. How could they make hundreds of man-years worth of practical knowledge at the Center readily available to Westinghouse and its customers, without pulling the scientists away from their research to answer routine questions?

Their solution was Personal Consultant, a new expert systems development software tool from Texas Instruments for TI or IBM® personal computers.

Designed to run on 512K-Class Personal Computers, Personal Consultant

provided Westinghouse an eminently affordable new tool for the development of expert systems. Pessall and Schreurs were especially impressed with its ability to aid experts in developing the knowledge bases and prototyping programs which even first-time computer users could consult for expert advice.

"With Personal Consultant software," says Schreurs, "we found it far easier to teach our experts how to develop a system than teach a programmer to be an expert." In fact, the software's rapid expert system prototyping and simple debugging features enabled the two scientists to demonstrate three different expert systems in as many weeks. Schreurs produced one for training new salespeople and a second to guide repairs and maintenance for the Center's X-ray diffractometer.

Pessall's makes material recommendations for tubes and support plates in steam generators.

"Our development of expert systems isn't aimed at replacing experts," says Dr. Pessall. "Its purpose is to give them the time to extend their expertise while the expert systems handle consultations on well-established knowledge and methodology."

To put Personal Consultant from TI to work for your business, call (800) 527-3500, in Canada call (416) 884-9181. Because an expert's time is too valuable to waste.

  
**TEXAS  
INSTRUMENTS**

Creating useful products  
and services for you.

**BANNERS**

**PROJECT DEVELOPER**

PROJECT NAME: \_\_\_\_\_

PROJECT MANAGER: \_\_\_\_\_

PROJECT OBJECTIVE: \_\_\_\_\_

PROJECT DESCRIPTION: \_\_\_\_\_

FORMS INVOLVED: \_\_\_\_\_

EQUIPMENT/PERSONNEL: \_\_\_\_\_

FINANCED: \_\_\_\_\_

SCHEDULE OF DEVELOPMENT

DATE	ACTIVITY	COMPLETION	STATUS	COMPLETION	ADMIN



STATISTICS

DATE	TIME	PERCENTAGE	STATUS	COMPLETION	ADMIN

**REPORT**

HELLO!!  
PLEASE

STATISTICS

**MONTHLY SCHEDULE**

	SUN.	MON.	TUE.	WED.	THU.	FRI.	SAT.

FROM THE DATE OF

CORRESPOND

ACTUAL DAISY WHEEL PRINT-OUTS

# AT LAST! INSTANT GRAPHIC SIMULATION . . . ... FOR EVERYONE EVEN WITH "DAISY WHEEL" PRINTERS!

**NOW—IMMEDIATE CREATIVITY WITH YOUR WORD PROCESSING PROGRAM**

It's a new three-diskette software package with understandable documentation and great illustrations covering around 150 (or more) graphic-like files you can quickly copy to your working (editing) files while operating any full-size word processing program.

And, yes, you can print the attractive results with almost ANY printer, including "ball," "thimble" and "daisy wheel" cast-element printers! Impossible? Not now, it isn't.

Disk-1 has headings and inserts. Disk-2 has forms and graphs. Disk-3 has banners and special illustrations. It's just about every-

thing you could imagine and more, and for less than \$25. per disk! (And, there will be more where that came from.)

This is the one you've been waiting for and the entire package is just \$74. complete! And that includes our guarantee of performance and membership in an important "special opportunities" club. (Yes, Virginia, quality software need NOT cost a fortune.)

Order right now by mail (with purchase order or coupon below) or through our toll free number with your charge cards. You'll want to put this one to work for you right away.

Type or print clearly

Name \_\_\_\_\_ Company (if any) \_\_\_\_\_

Address \_\_\_\_\_

Computer & Model \_\_\_\_\_ Operating System \_\_\_\_\_

Disk (or diskette) size \_\_\_\_\_

Enclosed is check in amount of \$74. and \$4. for shipping & handling (plus 6% tax for Calif. residents). Send 3-disk "DaisyGraphics" set immediately.

Signature \_\_\_\_\_ Date \_\_\_\_\_



FOR DIRECT VISA, MASTER CARD, AMERICAN EXPRESS ORDERS:

In CA 1-800-372-0012, ext. 43  
Other 1-800-423-5660, ext. 43

The AMERICAN COMMUNICATION ARTS Organization  
8690 Aero Dr. Dept. M148 San Diego, California 92122  
Dealer Inquiries Invited

Inquiry 389 for End-Users. Inquiry 390 for DEALERS ON

# DATABASE STRUCTURE IN PORTACOM

BY JACOB PALME

*A look at the functions  
that affect database structure*

COMPUTER CONFERENCING systems are often more database-oriented than other message systems. Thus, the database structure is an important property of a conferencing system. We will examine some of the functions that affect database structure within the COM and PortaCOM computer-based conferencing systems.

A message can belong to one or more ordered sets of messages. For example, such a set can be the letters to or from a certain person or the messages in a conference. The word *activity* is used for such a set of messages. An activity also has a *name*, a list of users who are *members* of the activity, and a sequential list of *references to messages*. One message can be entered into several activities. Only one copy of the message text is stored, with references from the activities to the message text. Figure 1 shows links between messages and activities containing lists of links to messages.

Every user has a personal *mailbox*, which is an activity containing letters sent and received by that user. A user

can also create additional personal activities and sort messages by entering references to them in one such personal activity. A computer conference is an activity with several users as members who normally can both read and write messages in the conference. For example: A certain message may be entered into the three activities "Joan Smith," "COM Experience," and "PortaCOM Development." This message is then available to "Joan Smith" as a letter and to all members of the conferences COM Experience and PortaCOM Development as a conference entry. When someone writes a comment on the message, the comment is sent to all the above recipients so that all who read the original message also receive the comment. The comment is also sent to the author of the commented message if he or she is not a member of any of the other receiving activities. It is also possible to write personal answers that are sent only to the author of the message.

## LINKING ENTRIES

The recipient of a message can

establish *links* to it. In other words, he or she can "send it along" to other activities such as personal mailboxes or conferences.

Figures 2, 3, and 4 illustrate a user dialogue made up of linking entries.

The recipient links to the new entry can be changed during or after the writing of it. Commands exist for adding and removing recipient links on an entry. Figure 4 shows the use of the *lmove* command, which removes all existing recipient links and adds one or more new links.

## MESSAGE SINGULARITY

Under the COM/PortaCOM system, you can't receive the same message twice. A chain of comments is often

*(continued)*

Jacob Palme, chief researcher at OZ, Stockholm University Computing Center, studies the social effects of computers and specializes in research and development of computer-based message and conferencing systems. He is one of the developers of the COM and PortaCOM computer conferencing systems. He can be contacted at OZ, Stockholm University Computing Center, Box 27322, S-102 54 Stockholm, Sweden.

sent to the same set of recipients, which could be, for example, two conferences and two personal mailboxes. A user will not see this entry twice even if he or she is a member of both conferences.

Users who do not have their personal mailboxes in a certain COM system can have messages sent to them via message networks such as MAILNET or ARPANET. The recipients' COM conference will appear as a conference to local users and as a mailing list to external users. Note also

that, in this case, an external user who is a member of two COM conferences will only get one copy as mailing-list mail.

In ARPANET, there is an unwritten rule that a message should not be sent to more than one mailing list. In COM/PortaCOM, there is no need for such a restriction.

**MULTIPLYING RECIPIENTS**

In COM a comment is normally sent to all the recipients (conferences and mailboxes) of the commented mes-

sage. In general, this function works well. In some cases, however, you may wish to send a message to one or more conferences or mailboxes without having them flooded with all of these extraneous comments. This can be done with a special kind of link between the text and the recipient called "single copy."

Comments (by default) are not sent to single-copy recipients of the commented message. The author of the comment can, of course, give a command to also send the comment to these recipients (unless they are write-protected).

**TYPES OF CONFERENCES**

A COM/PortaCOM conference is categorized by the following attributes:

- Open:** Anyone can become a member.
- Closed:** Only the organizer(s) can add new members.
- Restricted:** Open to one set of users, closed to another set.
- Protected:** A closed conference, where nonmembers cannot even find out that the conference exists.
- Write-protected:** Only some can create links between texts and the conference. Note that the restriction is not on who may write texts but who can link them. An editor of a write-protected conference can therefore link texts (written by noneditors) to that conference.
- Original:** These conferences are most often used for getting a selection of the most interesting items out of other conferences. The original conference will not automatically get comments on entries sent to it.

Whenever a message cannot be sent to a conference because of restrictions for write-protected or original conferences, a *super-conference* can be defined to which the comments are sent. For example, a newsletter may be write-protected, but anyone can comment on the news items. Comments will be sent to a writable conference for comments on the news. I will cite some examples of the types of conferences described

(continued)

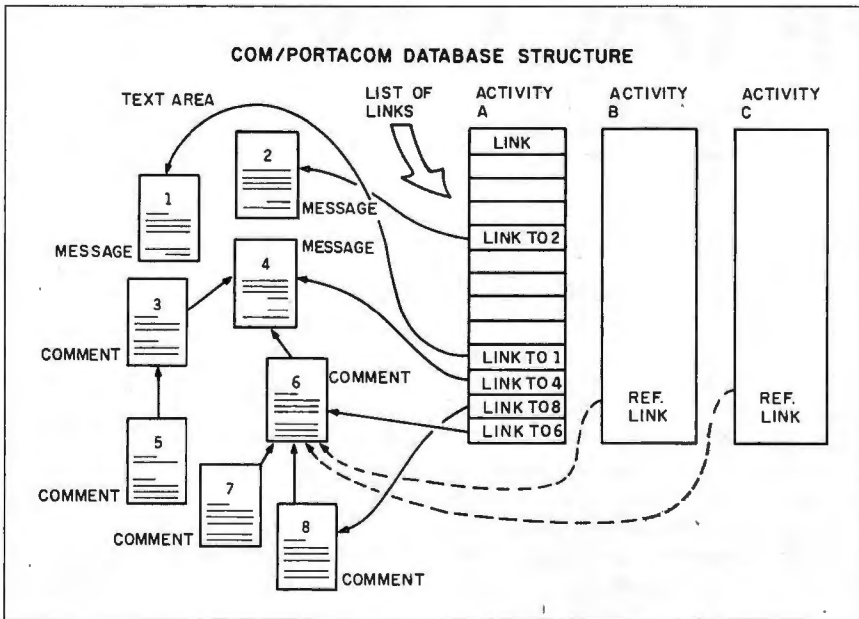


Figure 1: In the database structure shown here, message 6 is linked to activities A, B, and C. Messages 7 and 8 are comments on comment 6. Activity A contains a list of links that describes the relationship between all the messages in the text area.

(Text 22545) 85-04-05 22.27 Dennis Jennings Univ. College Dublin  
 Receiver: Computer networks  
 Receiver: IBM computers  
 Receiver: NSIN01 @ RLGB.JNT-MAIL(Paul Bryant)  
 — Received: 85-04-06 05.02  
 Comment on: (Text 21135) by Ulf Beyschlag CERN  
 Subject: BITNET

See my earlier comment.  
 (Text 22545)

Figure 2: The user reads an entry, which was in this case linked to two conferences and one personal mailbox, remotely accessible via mail networks.



# Take Your Bus



## To Greater IBM Compatibility

### ...And Leave the Savings to Us.

No matter how far you want to take your S100 BUS, Lomas Data Products has the IBM capability and power you need.

At a cost that won't hold you back.

Lomas Data Products is the reliability leader in 16 bit microprocessor S100 BUS products. With a 5 year reputation to prove it. Our boards can punch up your S100 BUS with 3 to 5 times the performance of an IBM-PC. Complete with IBM PC-DOS compatibility and multitasking. Our system capabilities run the distance between 8MHz 8086 and 8MHz 80286 performance. Each supporting 8MHz math co-processors.

And when it comes to prices . . . no other S100 BUS board supplier can offer so much for so little.

Get your ticket to IBM capability and 3 to 5 times the performance. From the only supplier of S100 BUS IBM-PC compatibles—Lomas Data Products.

#### **MEGARAM: High performance high density Dynamic RAM.**

Offers cost effective memory expansion in 16 bit systems.  No wait states with 8086's up to 10MHz  Only one wait state with 8MHz 80286  Up to two MegaBytes of memory  
Price . . . 256K—\$595.00 . . . 512K—\$749.00  
1024K—\$1095.00 . . . . . 2048K—\$1795.00

#### **COLOR MAGIC: IBM-PC compatible S100 BUS graphics board.**

Gives your 16 bit S100 BUS system IBM-PC compatibility.  RGB and composite outputs  IBM PC keyboard port  All IBM-PC display modes plus two higher resolution modes  
PRICE . . . . 16K—\$595.00 . . . . 32K—\$695.00

#### **THUNDER 186: Single board 16 bit microprocessor offers 10MHz 8086 performance.**

THUNDER requires no other support boards.  
 256K RAM  FDC controller  
 2 Serial ports  Parallel printer port  Concurrent DOS is included  
PRICE . . . . . \$1195.00

#### **LIGHTNING ONE: The standard by which other 16 bit boards are judged.**

The LIGHTNING ONE offers math processing capabilities only available on large mainframes previously.  Up to 10MHz operation  8MHz 8087 option  Optional 8089 co-processor  
PRICES start at \$425.00  
.....8086/87 (8MHz) \$900.00  
.....8086 (10MHz) \$625.00

#### **LIGHTNING 286: Highest performance processor available on the S100 BUS.**

This 8MHz 80286 offers performance equivalent to an 18MHz 8086.  5 times IBM-PC performance  16 Mbyte physical memory space  1 Giga byte virtual address space  
PRICE . . . . . 80286—\$1095.00  
.....80286/287—\$1645.00

*Prices and specifications are subject to change.*

**Lomas Data Products, Inc.**



182 Cedar Hill Street, Marlboro, MA 01752 Telephone (617) 460-0333 Telex 4996272

For orders outside the U.S., contact our exclusive dealers:  Australia—LAMRON PTY. LTD., (02) 808-3666  
 Malaysia—EXA COMPUTER (M) SENDIRIAN BERHAD, 795284  England—RATIONAL SYSTEMS, 0908-613209 or 0908-611349

above and show how they relate to specific tasks.

**ELECTRONIC PUBLISHING**

An author sends a new item to an activity for incoming manuscripts. This is a closed activity, readable by one or more of the editors. They look at

the paper and establish a new link from it to the personal mailbox of one or more referees.

The referees' comments are entered into a special activity for such comments, together with a reference link in the database that connects each comment to the original entry. The

editor decides to accept the paper (possibly after revision by its author) and then establishes a link between the paper and the activity for published papers, such as the electronic journal itself. This activity is write-protected so that only the editors can link items to it.

```

What do you want to do? (Read) next notice, Quit, Comment (on
entry), (Send a) letter (to), Personal (answer), Other.

- [comm]
Comment (on entry)

Receiver: Computer networks
Receiver: IBM computers
Receiver: NSIN01 @ RLGB.JNT-MAIL(Paul Bryant)
Comment on: Text 22545 (by Dennis Jennings Univ. College Dublin)
Subject: BITNET
    
```

Figure 3: The comment command starts a new entry, with a comment link to the previous entry and with recipient links to the same entries as the previous entry.

```

[!move BITNET planning]
Move (entry) BITNET planning
BITNET planning added as receiver

You are at the end of the entry.
Subject: Doing the rounds
[Moved entry]
[!enter]
Enter (it)
17.32 Letter (Text 30767) sent to:
BITNET planning

What do you want to do? (Read) next notice, Quit, Read (the)
rest, Comment (on entry), (Send a) letter (to), Personal (answer),
(Re-)type (the text), Other.
- [type]
(Re-)type (the text)

(Text 30767) Today 17.32 New Userman
Receiver: BITNET planning
Comment on: Text 22545 (by Dennis Jennings Univ. College Dublin)
Subject: Doing the rounds

Moved entry
(Text 30767)
    
```

Figure 4: At this point, the user wishes to !move the entry (comment on Text 22545) to the BITNET planning conference. He uses the !move command, which removes all previous recipient links from the message.

**SYSTEM DEVELOPMENT**

A conference is opened for users of a certain software system. A user in this conference suggests an improvement to the system. Some other users comment on this improvement. The system designers then discuss how to implement this improvement in a closed conference for those responsible for development of the system.

Even though their discussion is in a separate conference, it can still be linked to the original discussion, since commentary links in COM/PortaCOM can cross conference boundaries. When the change is implemented, a comment is entered into the user conference again, commenting on the original proposal and informing the users that the change has now been implemented.

If users ask the system to print all entries in a certain structure of directly and indirectly linked messages, they will be shown only the subset that they are allowed to see. Thus, the ordinary user will be shown only the discussion in the user conference, while the implementers will be shown the discussion in their closed conference as well.

**SELECTING MESSAGES**

Participants in large public conferences can select messages of special interest to themselves or someone else and link them to special selection conferences. For example, I select those messages that I think my manager should read, and I send them along to him by linking them to his personal mailbox or to a closed conference for the two primary managers of our computer center.

Selected messages can also be sent to public conferences, designed so that original entries cannot again be

(continued)



## The Most Powerful LAN Fits on a Disk.

**Network Power.** You knew that someday there would be a powerful LAN that didn't need old-technology network boards. It would be fast, easy to install, and run 99% of PC-DOS software. It would be expandable, provide remote access, password-protection, and enable you to use inexpensive terminals as workstations in a PC-DOS environment.

Dream no more, because the power is here.

Its name is LANLink™

**A Software-Driven LAN Powerful Enough To Use RS-232 Ports for Network Communications.** In development for over three years, LANLink™ represents the next generation of local area networks. All of the logic which has traditionally resided on network boards is on LANLink's Satellite and Server Diskettes.

No additional hardware is required. Inexpensive serial ports replace "Kilobuck" Network Interface Boards making installation costs one-third that of a board-driven network.

**How To Configure a Smart Network...With Dumb Terminals, But Without Dedicated Servers.** Boasting a wide variety of configurations, LANLink™ is most often set up as a "Star" having up to eight satellites connected to a central, nondedicated server. Larger networks can have multiple servers, supporting a total of 73 or more network users.

**R-LAN™ (Remote-LAN)** gives users the ability to interact with a LANLink™ network in real time via modem. Plus, if MultiLink Advanced™ is run on a Satellite, inexpensive dumb terminals can be used to access network disks, files, and programs.

**99% of PC-DOS Applications Run In a Totally-Transparent Network Environment.** If you know DOS, you already know how to use LANLink™ COPY transfers files among users, and a 2-drive PC Satellite boots 1-2-3 from the Server's hard disk with the entry c:\lotus. Each satellite's access can be limited to specific disks, printers, and sub-directories. A wide variety of software including Lotus 1-2-3, dBASE III, and WordStar 2000 is fully compatible. LANLink™ has a collision-free data transfer rate which exceeds 115,000 BPS.

**Power Up Your PCs Today.** For complete details and the authorized dealer nearest you, call The Software Link TODAY. The LANLink™ Starter Kit is \$495 and includes modules for both a Server and a Satellite. For a limited time, 50 feet of shielded RS-232 cable will be included free of charge. Additional Satellite Modules are only \$195, each.

LANLink™ is immediately available and comes with a money-back guarantee. VISA, MC, AMEX accepted.

# LANLink™



**THE SOFTWARE LINK, INC.**  
Developers of LANLink™ and MultiLink Advanced™

8601 Dunwoody Place, Suite 632, Atlanta, GA 30338 Telex 4996147 SWLINK

CALL: 404/998-0700

Dealer Inquiries Invited

**THE SOFTWARE LINK, INC./CANADA** 400 Esna Park Drive, Suite 18  
Toronto (Markham), Ont./L3R 3K2 CALL: 416/477-5480

LANLink™ MultiLink Advanced™ & R-LAN™ are trademarks of  
The Software Link, Inc.

IBM, PC, & PC-DOS are trademarks of IBM Corp. WordStar 2000,  
dBASE III, and Lotus 1-2-3 are trademarks of MicroPro, Ashton-  
Tate, and Lotus Development Corp., respectively.

sent to them; only entries that have been referred there from other conferences can be sent.

### TELEX HANDLING

Suppose that you want to introduce a system in which all outgoing telexes have to be approved by certain telex controllers. You can then create an activity for all suggested telexes or, if you prefer, separate activities for suggested telexes, one to be handled by each telex controller.

The telex controllers have the right to move entries from these activities to other activities of messages to be sent as outgoing telexes. The program that transmits outgoing telexes appears to the system as a special kind of human user who takes messages from the activity for outgoing telexes and sends them. In the same way, incoming telexes can be entered into a conference for incoming telexes before a human decides to which activities to move these telexes for handling.

### LINKS BETWEEN MESSAGES

COM/PortaCOM also allows links between messages when one message is a comment on, or a reply to, a previous message. These links are also stored in the database and will create a structure consisting of all the messages related via these links.

There are commands for traversing these links. They are used, for example, to find all the comments on the message or for traversing (backward

or forward) the whole structure of all the messages linked together. There are also commands to tell the computer that you do not want to read the rest of the entries in this set of messages but that you still want to remain a member of the conference.

### DATABASE STRUCTURE

To a novice user, COM/PortaCOM is a system for handling letters and conference entries. The fact that both letters and conference entries are handled by the general-purpose activity concept is transparent to the novice user.

The database structure of COM/PortaCOM does not use a separate storage area for each conference. Instead, the database consists of objects and links.

Text items, personal mailboxes, and conferences are objects. Entering a text item into a conference, sending it to a mailbox, or making it a comment on a previous message entails the creation of a new link in the database. Each object has a list of links to and from it. All links are members of the list of links of both the linked objects, so that a link can always be found starting at either end.

New links can be added, or old links removed, at any time. Thus, the forwarding of a message to a new recipient only entails the creation of a new link in the database, between the text item and the mailbox of the recipient. The removal of a message from a conference entails the removal of a

link (not deletion of the text itself, as it may still be linked to other conferences or mailboxes). For example, it is possible to create a link between two text items long after they have been added to the database by saying that one of them is a comment on the other.

A user has the authority to add and remove links to his or her own messages. The organizers of a conference have authority to add and remove links to the conference. The creator of a link has the authority to remove the links he has created. The COM administrator can assume privileged powers to create or remove any links in the database. One of the challenges of designing computer message systems is to find suitable principles for such access rights to further smooth information flow while protecting privacy requirements. ■

*Editor's note: The COM and PortaCOM manuals are available from OZ, Stockholm University Computing Center, Box 27322, S-102 54 Stockholm, Sweden.*

### REFERENCES

1. Palme, Jacob, and Eva Albertson. *COM Teleconferencing System—Advanced manual*. Stockholm, Sweden: OZ Computing Center, September 1983.
2. Palme, Jacob. "Survey of Computer-based Message Systems." *Interact '84 conference papers*. Amsterdam: North-Holland, 1984.
3. *PortaCOM Teleconferencing—User manual*. Stockholm, Sweden: OZ Computing Center, December 1982.

## ATronics Delivers AT® Compatible System Boards!

### ATI-1000-6 6MHz System Board

- 640 Kbyte Main Memory Expandable to 1 Mega Byte

### ATI-1000-8 8MHz System Board

- Bios Eprom Standard.
- 8 I/O Expansion Slots—
- Socket for 80287 Math Co-Processor
- CMOS Clock Calendar with Battery Back Up Holder
- Board Size 12" x 13.7" Fits Standard AT Case
- Full 1 Year Warranty

### New! ATI-2000 8 MHz System Board

- Features Dual Speed 6MHz/8MHz selected by Software Switch.
- ZERO WAIT STATE! 8MHz Mode Runs 67% Faster than IBM AT®, \*Based on Norton Sys Info Rating of 9.2.

### New! ATI Enhanced Graphics Adapter

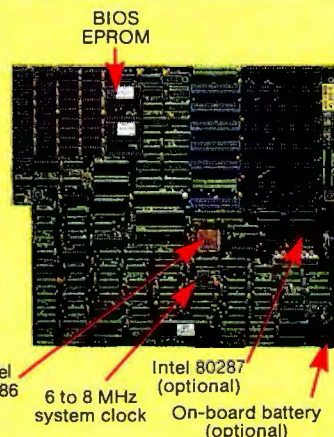
- Features 256 Kbyte Video Memory
- 16 Colors 640 x 350 resolution.
- Fully Compatible with IBM EGA Card.

### Accessories For The AT® System Unit Price

- All Metal AT Style Case . . . . . 129.00
- AT® Low Profile Keyboard . . . . . 129.00
- 195 Watt Power Supply . . . . . 179.00
- Combination Hard Disc/Floppy . . . . . 275.00 Controller Card

Dealers - OEM - Corporate Accounts -  
Call For Quantity Pricing. (408) 943-6629

ATronics International, Inc.  
491 Valley Way Milpitas, CA 95035



AT® is a registered trademark of International Business Machines.

# ASCII and you shall receive.

Just tell us what you want. Price? The WY-30, right out front, makes your system look and feel like a million bucks for \$399. Flat screen, crisp 80-column display, Touch-Tilt, 41 programmable functions.

Heavy duty applications? The WY-50, at \$599, is the industry's favorite for a lot of good reasons. 132 columns, tilt/swivel, 16 dedicated function keys.

Even more sophistication? The WY-50+, at \$699, packs top-end functionality: multi-page memory, variable length function keys, bidirectional auxiliary port, and so on.

Color? The WY-350 gives you full WY-50 emulation plus 64 colors, 16 palettes for \$1195.

All our ASCII terminals share the exclusive Wyse keyboard layout, 26-line screen, and across-the-board software compatibility, so you have complete design flexibility. Users can move from one Wyse terminal to another without relearning or reprogramming.

No matter what you ASCII for, your answer is Wyse. Call us today.

*Regional Sales Offices: Northeast (201) 725-5054; Southeast (305) 862-2221; North Central (313) 471-1565; South Central (214) 490-0968; Southwest (818) 340-2013; Northwest (408) 559-5911; OEM inquiries (408) 946-7115.*

Inquiry 378

# WYSE



# FULLHOUSE



**BUY THE  
WORLD'S #1  
PRINTER  
FROM THE  
WORLD'S #1  
SOURCE!**

It's an unbeatable combination.

We're the nation's largest-mail order source for everything in computing. Epsons are the nation's best-selling family of printers... and for good reason.

Epsons are unmatched in speed, versatility, letter and correspondence quality, choice of fonts, and are backed by the strongest local service network in the nation. So we stock them in tremendous volume, ready for immediate shipment... at the kind of prices that helped make us #1. Epson printers, as well as 30,000 other products are priced at Wholesale +8%.

Also, when you join the Network you get our 600 page catalog, our own quarterly newsletter, a vast software rental library, free phone consultation, our 10 day money-back guarantee and more!

Watch your benefits stack up.  
Join PC Network today!

**CALL TOLL-FREE 1-800-621-S-A-V-E**  
B3ZE In Illinois Call (312) 280-0002

**PC NETWORK**

**GET THE NETWORK ADVANTAGE!!!**

# THE NETWORK APPLICATION MANAGER

BY ROBERT A. FLAVIN AND JACK D. WILLIFORD

*You can put any application involving communications  
on a conferencing system*

WE DEFINE computer conferencing much more generally than most people do. We see traditional computer conferencing as a subset of the spectrum of applications of computer-mediated communications. The network application manager is a system that provides the functions needed to support many communications applications.

Even a distributed chess-playing program could be considered to be an adaptation of raw computer conferencing to a specific task. In a traditional computer conference, a group of people submit short notes or pieces of text to a system that stores and redistributes the information. You can also use such a communication system to transmit the moves of a chess game between two players and their spectators. However, special-purpose interfaces that understand chess shorthand and how to display chess moves would be even more desirable to tailor the conferencing system to the needs of the chess players.

Convinced that such a computer communication system needed to be

built, we set about designing one. What characteristics should such a system have? We already had some in mind. But, to the consternation of many of the developers, some of the system's design considerations were premises a posteriori, design points that we weren't able to articulate until after we had seen the consequences of violating them.

Many of the characteristics that set the direction for the system were lessons learned from an earlier conferencing effort, the PALTRY Computer Conferencing System. (PALTRY was so named to ward off criticism of the early system.) Our new system was christened GRANDiose, or GRAND for short. (See the text box, "GRANDiose Design Considerations" on page 204.)

## **VNET: AN ENORMOUS TESTING GROUND**

It would be impossible to experiment and test the ideas behind GRAND without getting it into the hands of real users. A suitable collection of such users was available on IBM's VNET system. VNET is a collection of

about 2000 major computers distributed among 215 cities throughout the world. The computers are connected together by a variety of means, including channel-to-channel adapters, satellite links, fiber-optic cables, and phone lines. The terminals and workstations of the 200,000 network users are connected to the main computers by channel attachments, 1.2-megabyte-per-second direct coaxial cables, local-area networks, and twisted-pair, dedicated, and dial-up phone links.

The major computers on VNET run various versions of IBM's VM/370 and MVS operating systems. VNET's users include experienced systems pro-

*(continued)*

Robert A. Flavin and Jack D. Williford are research staff members at IBM (T. J. Watson Research Center, POB 218, Yorktown Heights, NY 10598). Bob studied electrical engineering and computer science at Princeton University and is interested in operating-system and microcomputer design. Jack studied mathematics at Lyman Briggs College of Michigan State University and has interests in natural-language processing and home computer applications.

grammers, novice users, computer scientists, secretaries, corporate executives, summer students, manufacturing workers, administrators, and managers. In various combinations and for various purposes, all these people need to communicate.

Because VNET is the principal electronic means by which people in IBM communicate, the conferencing applications must compete and cooperate with established electronic-mail and communications programs. Merely providing electronic mail isn't enough to get anyone's attention.

VNET is a store-and-forward net-

work that can transmit both files and messages (short, about 100-byte, priority transmissions). Hardware and software problems can delay or even lose messages and files. No end-to-end acknowledgments of transmission are built into the basic transmission system, which is based on VM/370's RSCS (remote-spooling control system).

Although this community is an excellent test bed for GRAND, we had to design it to fit into other operating systems and into communications networks with different characteristics. This meant that we had to include the

appropriate interfaces so it could run on and communicate with other systems.

### THE NETWORK-BASED APPLICATION

If you wanted to write a program to maintain a database about hiking trails, you could write it on your microcomputer. If you gave a copy of the program to a friend, he or she could maintain his or her own database about hiking trails. While you have saved your friend the effort of writing the program, you will both be

*(continued)*

## GRANDIOSE DESIGN CONSIDERATIONS

### THE NETWORK

- GRAND users should be able to remain in their normal electronic environment, which includes the operating system, file, profiles, and tools that they have available during normal use of their computers. They should not have to log onto someone else's computer, have all their commands taken by the conferencing system, and be separated from the tools and files that they are accustomed to. To accomplish this, some conferencing-system programs must run in the user's environment to transmit data to the rest of the system.
- You cannot serve all users with one main computer. Even if you are willing to force people to (logically) leave their normal environment, no one computer could support a very large community of users (i.e., the world). Thus, you must distribute the system among a collection of computers.
- You must isolate part of the system from direct user control to ensure that data is secure from unauthorized use, to ensure data integrity, and for system reliability. Therefore, you need to establish server tasks.
- You should be electronically as close to the computer that is providing the conferencing service as possible. Computer users are neither happy nor productive if they get poor performance from their computers; therefore, transaction speed is important. If you use

a large computer and if the conferencing data is stored on disks that you have access to, you can get extremely fast service. If, however, your connection to the data is over a T-1 carrier (a 1.5-megabit-per-second telecommunications line), your service is not as good. If you must go through voice-grade phone lines, it's even worse. In some situations your interactive communication must be handled by a series of hops across various communication lines. But the closer you can be, the better.

### THE APPLICATIONS

- GRAND must support a variety of communications applications. No single design of a traditional computer conferencing system is well-suited for all users in all situations. For example, the features and functions that a computer conference needs to arrange a Frisbee game among 30 people differ from those needed by a professor to conduct a class.
- Because the tastes, expertise, and practices of different users are quite different, no single user interface is satisfactory. Therefore, you need more than one UIP (user-interface program). To make practical the support of multiple UIPs, GRAND needs a well-defined programming interface for the UIPs to communicate with. This interface must include command syntax and the for-

mat and interpretation of application data.

- To authenticate who each user is, run private conferences, and accommodate individual preferences about how users deal with the system, GRAND needs the ability to verify that a transmission comes from where it claims to come from. This allows the system to restrict certain commands to certain people no matter where they are. This task becomes more complex because the system is distributed throughout a large network of machines.
- The application programs within the conferencing system should be independent of the user communications programs. If users remain in their normal environments, they are unlikely to all choose the same method of communication with the system. Therefore, the applications must not contain any code for user communications.
- You don't want either central or completely independent server operation. However, the parts of the system should work in concert rather than as a collection of independent domains. Since we are unwilling to impose central control, this task becomes a difficult communications problem. To solve it, we treat managing the system as a GRAND application. Thus, even the operation and maintenance of GRAND become a specialized conferencing application.



# It's the best thing since 1-2-3.

We asked current 1-2-3® users how to get more out of 1-2-3.

And you told us.

Introducing 1-2-3 Release 2 from Lotus.®

New 1-2-3 is more powerful and a lot more versatile.

You wanted to handle larger jobs with 1-2-3. Now you can. The new 1-2-3 worksheet has been expanded to 8192 rows—4 times its original size. And your worksheet is actually more flexible because advanced memory management allocates memory more efficiently and allows data to be stored anywhere on the worksheet. When used with new expanded memory boards, new 1-2-3 can address memory beyond 640K.

New 1-2-3 is designed to support the Intel® 8087/80287 math coprocessors so you can now do many calculations faster. We've even added some features that make it possible to do things like regression analysis, string functions and string arithmetic. And new 1-2-3 comes with 40 new macro commands so you can work more efficiently and a lot more productively.

Now you can start 1-2-3 directly off a hard disk without putting a system disk in the floppy disk drive.

**But we still kept things simple.**

In many respects, new 1-2-3 isn't any different from the original. You wanted us to keep things simple and we did. If you're already familiar with 1-2-3, you're ready to use new 1-2-3.

You don't have to retrain. And new 1-2-3 can read and process existing 1-2-3 files so that virtually all applications already developed can easily be used.

It's even easy to upgrade to new 1-2-3.

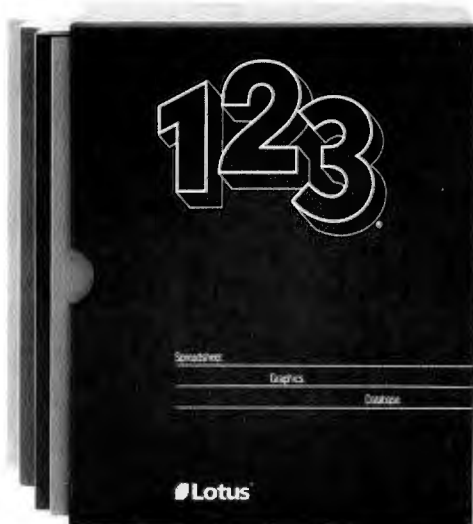
If you're a registered 1-2-3 user and want to upgrade to new 1-2-3, you'll find all the details in a mailing from Lotus. If you haven't registered yet, complete and send in your Warranty Registration Card or call 1-800-TRADEUP\* so we can send you the mailing.

The cost of the Upgrade product is \$150. You are eligible for a free upgrade if you purchased 1-2-3 Release 1A on or after April 24, 1985.

And for everyone who upgrades, there's also a rebate offer of \$40 on the Intel Above™ Board, the first expanded memory board certified by Lotus.

We think you'll find new 1-2-3 the best thing since, well, 1-2-3.

\*In Canada call 1-800-447-4700.



Suggested retail price of new 1-2-3 is \$495. 1-2-3 Release 2 requires 256K of memory. The minimum memory requirement for 1-2-3 Release 1A is 192K.

developing different databases.

If you wrote the database system on a time-sharing system, or if your microcomputers were connected together, you could maintain a common database. You could both benefit from the work that each of you does. This is a fundamental improvement in the system's usefulness.

If you gave this program to another set of people on another time-sharing system, they could create their own database. But the two databases will differ. If these time-sharing systems or networks of microcomputers were connected together, the database programs could create one massive, common database from which all the users could benefit.

For these reasons, applications should be designed so that they treat the entire network as a uniform collection of users; you should not write them with one microcomputer or one

time-sharing system in mind. The power of microcomputers is great, but it pales in comparison to the potential of networks of computers, large and small.

### THE NETWORK APPLICATION MANAGER

Once you accept the value of network-based applications, how do you design them? Should each hiker's database, chess-game manager, news-distribution system, program-library manager, mail system, and conferencing system be independent? All these systems have a large overlap in the functions that they need in order to work. Rather than duplicate the effort each time a new application comes along, you should distill their common parts into a support system for all the applications. This network application manager (NAM) would provide the basic communication and

support services that the applications need in order to maintain and distribute their data and to communicate to the users.

By providing these services, the NAM reduces the effort required to develop new network-based applications. Thus, applications that previously were too costly to develop have become cost-effective. This is an ordinary benefit of standardization and careful modular design. The virtue of establishing a network of servers that supports many applications is that the overhead cost—both in terms of computer resources consumed and administrative and operational burden—of supporting the applications in the shared system is less than the cost of operating all the applications as separate systems. Thus, still more possible applications become practical. One of our challenges is to figure out what sorts of heretofore outlandish computer uses are now reasonable.

### THE GRAND DESIGN

How did we decide to organize our system? The proper choice of interfaces between parts of the system was critical to its survival as it grew and matured (see figure 1). The real work is done by the servers. A server is a task that waits for a user request to come in, interprets its commands when it arrives, and then waits for the next request. Typically, servers maintain local copies of databases and communicate to users and other servers. They treat each other as peers; there is no one server that is master of all.

Servers are sprinkled around the network so that transmission delays between the user and the local data stores are not long. Most other conferencing systems rely on only one server. In these systems your terminal is connected directly and exclusively to the conferencing system. This system design is easier because you don't have to maintain a distributed database. However, it rules out having a large number of active users and leaving them in their normal elec-

(continued)

## Upgrade your dot matrix printer to letter quality now.

**And we'll include a 64K buffer with multiple type styles FREE.**

StyleWriter™ is a smart printer buffer that converts your dot matrix printer into a letter quality machine. It lets you choose from dozens of typestyles and other enhancements like bold face, proportional spacing, left justification, double underlining, highlighting and reverse printing.

The MicroPhonics™ StyleWriter sells for only \$199 and works with any computer, any software program, and any dot matrix printer. It's easily upgradeable to a 128K buffer.

### Unconditional Money Back Guarantee

If you're not completely satisfied, return StyleWriter undamaged within 30 days for a full refund. Call to order now and ask about our unique voice input system, Pronounce™

**1-800-325-9206**

Major bank cards and CODs accepted.

MicroPhonics Technology Corporation  
234 S.W. 43rd Street, Renton, WA 98057—Telephone: (206) 251-9009

**MicroPhonics™**



## Doesn't your IBM PC deserve IBM service?

You chose an IBM Personal Computer for lots of good reasons. And now that you depend on it to help keep your office running smoothly, doesn't it make sense to help protect your investment with blue chip service from IBM?

No matter what IBM PC you have, blue chip service is more than just expert repair.

Blue chip service offers the choice of service that's right for you at the price that's right for you. It means we'll exchange your monitor, for example, at your place or at any of our Service/Exchange Centers.

And blue chip service means a lot of things you don't see. Quality. Speed. Commitment. And IBM experience. Every year IBM invests many hours of training to keep its service representatives current on technologies that never stand still.

As an IBM customer you deserve blue chip service. It's the best thing you can do for your IBM Personal Computer.

For more information, use the coupon or call 1 800 IBM-2468, Ext. 104, and ask for the Service/Exchange Maintenance Department.

Blue chip service from **IBM**<sup>®</sup>

IBM Direct  
Service/Exchange Maintenance Dept.  
One Culver Rd.  
Dayton, NJ 08810

104-12-85

Please send me more information on IBM PC service.

Name \_\_\_\_\_ Title \_\_\_\_\_

Company \_\_\_\_\_ Phone \_\_\_\_\_

Address \_\_\_\_\_

City \_\_\_\_\_ State \_\_\_\_\_ Zip \_\_\_\_\_

APPLICATION NETWORK

**1st PLACE**

COMPUTER SYSTEMS  
13422 N. CAVECREEK RD.  
PHOENIX, AZ. 85022

OTHER INFORMATION: 602-867-9897



Send cashier's check or money order ..... all other checks will delay shipping two weeks.

Prices & availability subject to change without notice.

CALL FREE  
1-800-841-2748



Hi - I'm Joan,  
I want to wish you all Happy Holidays and thank you for making my business a success.

All of you who haven't tried us and are afraid of mail order, call us and give us a try. I'm

sure you will like our fast and courteous service.

Get your order in soon, as Christmas is not far away. Thanks again and God bless.

Joan

P.S. Hearing handicap, call us on your TTY.

**COMPUTERS**

ALTOS 186-10	\$4415
ALTOS 486-20	\$4195
ALTOS 580-20	\$3310
ALTOS 586-20	\$5299
ALTOS 986T-40	9355
ALTOS 2086-T80	\$14,779
IBM PC	\$CALL
ITT PC	\$CALL
LEADING EDGE	\$CALL
ZENITH	\$CALL
SOFTWARE	\$CALL

**PRINTERS**

CITIZEN MSP-10	\$249
C. ITOH	\$CALL
EPSON	\$CALL
JUKI 6100	\$349
OKIDATA	\$CALL
STAR MICRONICS SG10	\$207
NEC 3550	\$999
DIABLO D-25	\$529
SILVER REED	\$CALL
TOSHIBA 351P	\$1029

**TERMINALS - MONITORS**

WYSE 50	\$419
WYSE 85	\$579
QUME 101G	\$299
QUME 202G	\$599
TELEVIDEO	\$CALL
AMDEK	\$CALL
TAXAN 630	\$429
TAXAN 420	\$399
PRINCETON MAX 12E	\$169
PRINCETON HX 12	\$445
PRINCETON SR 12	\$615

**DISK DRIVES & BOARDS**

7 PK. MULTI FUNCTION	\$149
PARADISE 5 PK.	\$154
HERCULES CL. GR.	\$145
EVEREX EDGE	\$315
TANDON	\$CALL
TEAC	\$CALL
BERNOULLI BOX	\$CALL
TALLGRASS	\$CALL

**MODEMS**

PROMETHEUS 1200 EXT	\$305
FAMOUS MAKER INT.	\$189
FAMOUS MAKER EXT.	\$224
HAYES SMARTMODEM 1200	\$369
HAYES SMARTMODEM 1200B	\$315
HAYES SMARTMODEM 2400	\$605

tronic environments.

You don't need to make all applications available at all servers. And you don't need to duplicate all conference databases at all servers. These matters are specific characteristics of the applications rather than architectural requirements of GRAND itself.

**YOUR RELATIONSHIP TO THE SERVER**

If you are sitting in your own environment and the servers are off somewhere else talking to each other, how do you get anything done? When you want to use some application that uses the server network, you invoke

a user-interface program (UIP) that figures out what you want and, if necessary, sends a command to the local server. Because the UIP runs in your environment, it isn't protected from you. As a matter of fact, you are encouraged to develop your own UIPs if they would better suit your needs and preferences. The server is out of your direct control, so it can do the testing required to ensure the security of the server network.

You may select any UIP you wish to communicate to the servers. Your decision may be dependent on personal preference, degree of experi-

(continued)

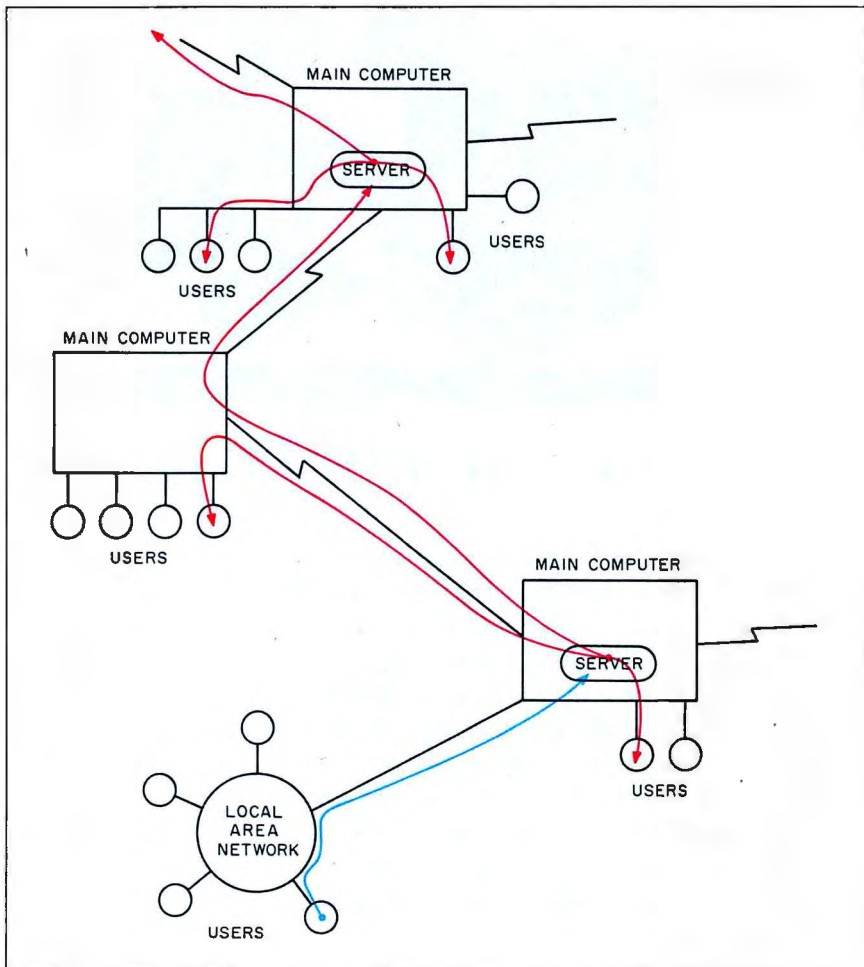


Figure 1: GRANDiose server network. Some of the main computers have servers in them, and some don't. The user workstations can be microcomputers or terminals. The blue line represents the transmission of a news bulletin over an LAN to the nearest server. The red lines from the server represent the transmission of notification of the news bulletin to various users and servers.

## The Fox



### A Complete MS-DOS System at \$995

Our Fox system is more than the only complete 16-bit, 8088 computer for less than \$1,000. The Fox includes more storage, more extras, and more software than systems costing twice as much.

**1.6 Megabytes!** Dual Drives with 800K storage on each, yet the Fox is nimble enough to read and write to standard 160K, 320K, and 360K formats.

All the Extras that cost extra on other machines are included in our price. You get a full 12", 25x80, green display monitor, plus RGB color output, a printer port, a better keyboard, and a full 256K of RAM.

**Free Software** All the software most people will ever need including: MS-DOS 2.11, HAGEN-DOS, DOS Tutor, WordStar 3.3, EasyWriter, Spell, Mail Track, FILEBASE, CalcStar, games, graphics, utilities, and a graphics BASIC.

Strictly speaking the Fox isn't IBM compatible, but will run hundreds of the same programs including dBASE II, Multiplan, and Turbo Pascal. Because the Fox is born on a totally automated assembly line in Japan we can back it with a full one year limited warranty. For a free booklet explaining why the Fox is your best buy call 1-800-FORAFox and leave your name and address after the beep.

The Fox ..... \$995



**NEW!**

## The Quick TurboFox Jumps Over The Big Blue Clones

Introducing the TurboFox At Last - IBM-PC compatibility, 256K RAM, a monochrome monitor and bundled software at a price that leads the pack. Compare its features with any other clone on the market.

**Greater Speed.** Capable of running virtually all PC software at 8MHz the TurboFox can also slow down to IBM's 4.77MHz at the flick of a switch. **More RAM.** We've installed a RAM card in one of the 8 PC Compatible slots so when you're ready for up to 640K just plug in the chips. For a slight additional fee we can install and test them at time of purchase.

Your Choice....of a green or amber monochrome monitor.

Plus...MS-DOS 2.11, GW BASIC, WordStar, CalcStar, RGB and monochrome outputs, a parallel port and room for extras. If you're looking for a low cost, high speed comparable with loads of features and high quality call us now at Scottsdale Systems.

TurboFox ..... \$1499  
TurboFox XT (20MB) .... \$2199

Extra 128K Ram ..... \$60

## The New ALTOS 2086-2

The high performance Xenix based system for 20 work stations from Altos - a world leader in multi-user systems and software.

The 2086-2 features 2 MB of RAM, an 80MB hard disk, a 60MB tape backup and an 80286 CPU. Options include: 10 more user stations, up to 8MB of RAM, up to 189MB of hard disk storage and an 80287 co-processor.

**ALTOS 2086-2 ... \$14599**

The power of a mini at a fraction of the cost

### ALSO

Altos 986-40 ..... \$8619

Altos 586-40 ..... \$6989

## THE ATARI 520ST

- Precision Graphics-640x400 resolution.
- 512 Colors with options RGB monitor.
- Parallel and Serial Interface Standard.
- Double Density Disk Drive Standard.
- Two Button Mouse Standard.
- Optional 10 MB Hard Drive.
- 68000 CPU Architecture.
- 512K RAM Standard.
- 8MHz Clock Speed.
- MIDI Interface.

**\$699**

with monochrome monitor

**\$899**

with RGB monitor

### PLUS...

Word processing, spreadsheet, database and integrated software is available now! Call for pricing and inquire about the national 520ST Users Group.

## REACH OUT AND TEACH SOMEONE

### THE AMSTRAD 128K

- Z-80A CPU
- Keyboard
- Monitor (RGB opt.)
- 3" Disk Drive
- Cassette Interface
- Joystick Port
- Parallel Port
- CP/M, LOGO, AM-DOS
- Word Processor
- Spreadsheet
- Games, Graphics

Introduce Your Family To  
Computing For Only

**\$439**

with green monitor

## PRINTERS

### YOUR CHOICE:

STAR SG-10 ..... \$239  
EPSON LX-80 ... \$244  
JUKI 6100 ..... \$389

More Star & Epson ..... CALL  
All Okidatas ..... CALL  
All Diablos ..... CALL  
Citizen MSP-10 ..... \$295  
Panasonic 1091 ..... \$269  
Toshiba 1340 ..... \$539  
Toshiba 351 ..... \$1169  
DataProducts 8050 ... \$1099

### OLYMPIA



To quote PC magazine, "The (NP) printer is a sure thing..." If you're considering the purchase of an Okidata 92, or an Epson FX-80 give us a call before you spend \$50 to \$100 more for an inferior printer. Let us send you an actual print sample from the NP, and additional information on the features that make the Olympia NP the best value in dot matrix printers.

**\$295**



Closed for the Holidays  
December 21 thru January 5

# Scottsdale Systems

617 N. Scottsdale Road, Suite B, Scottsdale, Arizona 85257



**(602) 941-5856**



Call 8-5 Mon.-Fri.



We participate in arbitration for business and customers through the Better Business Bureau of Maricopa County.

## SINCE 1980

TELEMARKETING ONLY: If you plan to stop by please phone ahead. Prices listed are for cash. P.O.'s from Fortune 1200 companies and universities with good credit add 2% / Mastercard and Visa add 3% / Arizona residents add 6% sales tax / Shipping extra / All items are new with manufacturer's warranty / Returned merchandise subject to 20% restocking fee / Personal or company checks take up to 3 weeks to clear / No COD's or APO's. Prices and specifications subject to change / Product subject to availability. Trademarks: Altos, Altos Computer Systems, Silver Fax, MyWrite, and MyCalc, Software Toolworks, Apple II and Macintosh, Apple Computer Inc., Atari by Atari Corp, HAGEN-DOS, and Jackinosh, Scottsdale Systems, Ltd., Wordstar and CalcStar, Micropro International, MS-DOS, and Multiplan, Microsoft Corporation, FILEBASE, EWDP Software, Inc., dBASE II, Ashton-Tate, IBM-PC DOS, and IBM-PC, International Business Machines.

### Houston Instruments

DMP-40 ..... \$769  
DMP-29 ..... \$1795  
DMP-41 ..... \$2340  
Other models ..... call

### TERMINALS

Wyse 50 ..... \$449  
Gurme QVT101 ..... \$298  
Gurme QVT101A ..... \$325

## COLOR MONITOR SALE

NEC JC 1460 RGB ..... \$298  
Taxon 420 RGB ..... \$409



### THE BERNOULLI BOX

- Hard disk capacity and performance
  - Removable cartridge economy
  - Cartridge convenience
  - Flexible disk economy
  - Winchester capacity
  - Unparalleled reliability
- 10 Mb ..... \$1839  
20 Mb ..... \$2489  
5Mb/Mac ..... \$1379  
Call For Half Height Prices

ence, and choice of editors. All of an application's users do not need to be using the same UIP; they only need to be using UIPs that know how to deal with the particular application that they are using.

To reduce the complexity of writing UIPs, there is a service routine that provides a standard way of finding and communicating with the local server. This lets you change the communication techniques without affecting the UIP.

### IN A GRAND STYLE

One of the most important things we learned from PALTRY is that there is no one right way of doing something. Depending on the application and the needs of the users, you may need different *styles* of doing a particular task. This leads to the concept of style programs, interchangeable programs that

perform well one style of doing something.

In order to notify you of some news, we need notification-style programs, or NSPs. If a conference wants to notify an ARPANET user of a new entry, it might be appropriate to package the new entry with an RFC822 (ARPANET mail-format standard) header, with its "To," "From," and "Subject" lines and send it off. If you usually log on the very machine that the server is on, then sending you mail about a new entry may be unnecessary. In this case, you may prefer to have a message written to your terminal telling you to look at some file for the new entry. Both are reasonable ways of notifying you. Therefore, both methods are written into NSPs, and you select the one you want from the library of NSPs.

In addition to NSPs, other system

functions that may need to be tailored to match the preferred way of doing something are broken out from the basic kernel of the system. These functions include things like conference-style programs (CSPs), arrival-style programs (ASPs), and user-interface-style programs (UIPs). See figure 2 for a diagram of how these functions interact.

### THE DESIGN OF A SERVER

Lopping off all the functions that need tailoring leaves the common part of the system, the NAM. Its function is to wake up when something needs to be done, perform various functions, and pass the request, along with any information about its context, to the program that actually does the work. The NAM finds some input, figures out who sent it, and proceeds to parse the command and execute the request. Certain common commands are processed directly by the NAM. For example, the NAM verifies that requesters are who they say they are before it honors their requests. A request usually names the application, or *conference*, that it is addressing. Based on the conference name, the NAM invokes the correct program to handle the request and passes the remainder of the request to it for processing.

### THE CONFERENCE-STYLE PROGRAM

The program that processes all requests directed to a particular conference is called the CSP. Its scope is any matter related to the application's function. Other parts of the system merely provide services to the application, but none infringe on the CSP's ability to define what the application does. Typically, the CSP manages a database of its choosing, honors commands of its choosing, and transmits data to users and other servers. It also determines which users may execute which commands. Of course, if the CSP doesn't make a good choice about what it's going to do, it won't be a very useful application.

For example, CSAPP, one of

(continued)

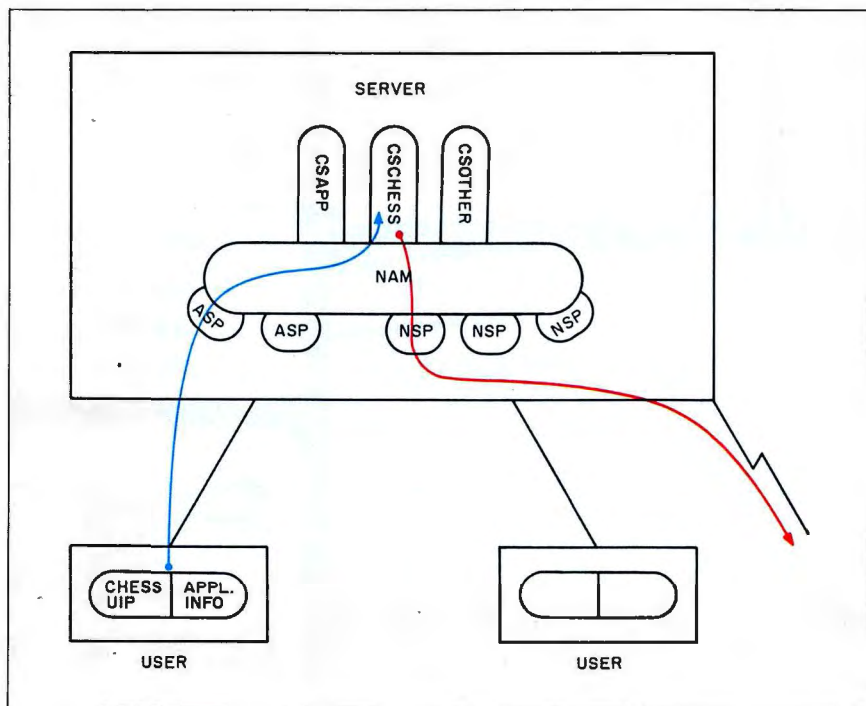


Figure 2: GRANDiose server internal organization. The NAM routes commands to the CSPs that contain the application-specific code. The ASPs and NSPs transmit and receive information to and from the server. The UIP exists within the user's sphere; half of the UIP communicates with the server, and the other half interprets the application-specific information. The blue line from one user represents the transmission of a chess move from the CHESS UIP through an ASP to the NAM and on to the CSCHES application. CSCHES then forwards the move, via the red line, through an NSP out over the network.

# New from Logitech.

## LOGIMOUSE® C7



The professionals' choice. Find out why AT&T, DEC, and Hewlett-Packard have chosen LOGITECH's mouse as part of their systems.

With LOGIMOUSE C7 there's no pad or tablet to clutter up your desk. There's no external power supply with extra wires and plugs.

It's clean and simple. The professionals' choice for making all your software run faster and easier.

# At a new \$99 price.

### Hardware Superiority

- HIGH resolution (twice as high as most other mice)
- NO external power supply required
- NO pad or grid required
- ENHANCED opto-mechanical design with CMOS technology

### Software Superiority

- Logimouse C7 comes with its own software
- Universal Mouse Driver makes your mouse compatible with almost ALL applications. With an easy menu system for creating and saving mouse settings.

- TAG, the Text-And-Graphics editor, is ideal for memos containing maps, organization charts, simple schematics. With file editing capabilities.

### Technical Support

- Fully documented package backed by complete engineering support.

To order LOGIMOUSE C7 for your application call our toll free number:

**800-231-7717**

In California:

**800-552-8885**

# LOGITECH

805 Veterans Blvd., Redwood City, CA 94063  
Phone 415/365-9852

LOGIMOUSE is a registered trademark of LOGITECH.

GRAND's CSPs, implements rather ordinary computer conferencing as its application. It accepts the commands ADD, DELETE, REPLACE, GET, JOIN, LEAVE, ADDTOPIC, and DELTOPIC. The database it maintains includes files that are accumulations of things that users have added and control files to tell it who is allowed

to do what to each of the other files. Imbedded in CSAPP are certain decisions about how it plans to maintain its distributed database and what rules it has about how people can manipulate the data.

If users running other conferences like CSAPP, they can create another instance of a CSAPP conference. If

they feel strongly enough that they want their conference run differently, they can develop another CSP that does things the way they think best. Thus, several different conferencing applications, tailored to the needs of the users, can coexist on GRAND.

Of course, another application, such as the chess-game manager, would have vastly different assumptions about the way to manage its conference, but it would have roughly the same general organization.

At some point, the CSP is likely to need to communicate to its users. However, this is a very complicated task. Each CSP may have to communicate to users and servers on different types of machines, running all sorts of operating systems, connected to the network in strange ways, and having the most incomprehensible preferences. Rather than having the CSPs be aware of all the appropriate means of communication, the NSPs handle that function.

**NOTIFYING USERS**

Notification-style programs are another group of programs that the NAM calls on to honor requests from the CSPs. The NAM tells the NSP who to notify and what to tell them about; beyond that there are no limits to what the NSP can do. Typically, the NSP sends mail or a message. Some NSPs just record the fact that there is new information and that you should check the database to see what it says. Some NSPs do things, such as send the information by telegram or print the information on paper (for those people who don't routinely connect to the network). NSPs can also serve as the gateways to GRAND servers on other networks and between the GRAND network and other conferencing systems and applications.

The logical counterpart of the NSP is the arrival-style program. Usually, a server receives GRAND commands in their correct format. In order to handle input from systems that do not produce GRAND-format commands, the server lets each ASP check any in-

(continued)

**USE US...  
TO SAVE A BUNDLE!!**

**W**e save educational, business and Institutional buyers hundreds or even thousands of dollars on their computer supply needs. HOW ABOUT YOU?

**W**e deal only in first quality, guaranteed products — all in stock for immediate shipment!!



**BULK DISKETTES**

<b>JANUS</b>	FROM .. SS/DD ..	<b>69¢</b> EACH	100 LOT	DS/DD ..	<b>79¢</b> EACH	100 LOT
<b>VERBATIM</b>	FROM .. SS/DD ..	<b>85¢</b> EACH	100 LOT	DS/DD ..	<b>\$1.05</b> EACH	100 LOT
<b>SENTINEL</b>	FROM .. SS/DD ..	<b>75¢</b> EACH	100 LOT	DS/DD ..	<b>85¢</b> EACH	100 LOT

**OTHER MAJOR MANUFACTURERS AVAILABLE, CALL...**

**SENTINEL  
COLOR DISK**

SS/DD ..	<b>89¢</b> EACH	100 LOT
DS/DD ..	<b>99¢</b> EACH	100 LOT



**3-1/2" DISKS**  
for Macintosh & HP ..... **\$1.89** EACH  
100 LOT

**Verbatim  
DATA CASSETTES**

T300	<b>\$4.99</b> EA	A300	<b>\$4.49</b> EA
------	------------------	------	------------------



**DISK STORAGE BOXES**  
(many to choose from)  
Including our DX85A —  
Holds 100 disks  
**AT JUST \$12.95** EA

**PRINT WHEELS**

Diablo .....	low as \$5.45
Qume .....	low as 5.45
Wang .....	low as 6.45
Royal .....	low as 14.50
Nakajima .....	low as 13.95
IBM Displaywriter .....	low as 15.95
Alcoh .....	low as 24.95
Silver Reed .....	low as 12.95

**ALL TYPES & STYLES  
IN STOCK.**

**PRINT RIBBONS**

**PRICES PER DOZEN RIBBONS**

Epson MX 80 .....	low as \$3.49
Epson MX 100 .....	low as 4.99
Diablo .....	low as 3.49
Imagewriter .....	low as 3.99

**ALL ABOVE AVAILABLE IN COLOR  
AS WELL! WE STOCK RIBBONS FOR  
ALL MAJOR BRAND PRINTERS!!!  
CALL TODAY!!**

**CALL FOR VOLUME DISCOUNTS!!!**



780 Trimble Road, Suite 608, San Jose, California 95131  
800/437-0900 • 800/435-9700 in CA  
P.O.'s accepted from Institutional, Educational & Government Accounts.  
Dealer and Distributor Calls are Welcome.



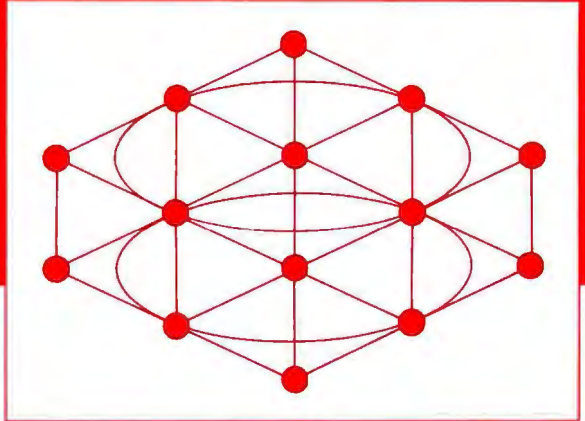
**C.O.D. ADD \$2.00**

**SUPPLY ORDERS  
\$25.00 MIN.**



# New from Logitech.

## MODULA-2/86 VERSION 2.0



## The Professional Modula-2 for \$89.

Now the same powerful tools Micropro used to develop its latest word processing system are available to you at a new \$89.00 price.

### Building Blocks for Tomorrow's Technology

Universities are switching to LOGITECH MODULA-2. Innovative programmers now develop applications and products with LOGITECH MODULA-2. The most productive teams at major companies depend on LOGITECH MODULA-2.

Now you can create your professional software development system using the proven technical sophistication of LOGITECH MODULA-2/86.

### Base Language System **\$89**

- Compiler and Linker: compiles to efficient native machine code and gives you direct hardware and operating system access.
- Library Modules: include modules for file I/O, formatted I/O, string handling, real number math, RS232, clock, and mouse interface.
- LOD2EXE: utility to produce .EXE files.

### Run-Time Debugger **\$69 (\$59 with Base Language System)**

- Allows you to control the execution of a MODULA-2/86 program to find and correct software errors.
- You monitor the execution of a program with user defined breakpoints or by stepping through the program.
  - You can modify the values of the variables.
  - Symbolically displays source code, data, the procedure call chain, and raw memory.

### MODULA-2 Editor **\$59 (\$49 with Base Language System)**

- Fast on-line Modula-2 syntax check.
- Can run compiler and linker from the editor.
- User definable templates for Modula-2 syntax constructs.
- Full screen and multiple windows.
- Edits more than one file at a time.
- Pop-up menus, single keystroke commands, and mouse support.

### Numeric Library **\$49 (\$39 with Base Language System)**

- REALs and MathLib modules for 8087.
- Decimals module: provides functions for decimal integer arithmetic with a precision of up to 18 decimal digits.

### Utilities Package **\$49 (\$39 with Base Language System)**

- Decoders: disassemble MODULA-2/86 link and load files.
- Post-Mortem Debugger: allows the user to symbolically inspect a dump file created when a program terminates abnormally.
- Cross Reference: produces a cross-reference listing of a Modula-2 program.

### INTRODUCTORY OFFER:

Through the end of January you get the new MODULA-2 Editor for free when you buy the Base Language System for \$89.

To place an order call our special toll free number:

**800-231-7717**

In California:

**800-552-8885**

# LOGITECH

LOGITECH, Inc.

805 Veterans Blvd., Redwood City, CA 94063, USA Telephone: (415) 365-9852

LOGITECH SA

Box 32, CH-1143 Apples, Switzerland Telephone: 41 (21) 774545

coming data for a recognizable format. If an ASP recognizes the format, the ASP accepts the data, converts it into GRAND-format commands, and passes it along to be processed normally. Using combinations of ASPs and NSPs, you can connect GRAND servers to existing non-GRAND applications like single-machine databases and other networks.

### AN APPLICATION EXAMPLE

What must you consider to design an application for GRAND? See the text box "A GRAND Application." One rather conventional GRAND computer conferencing application is news distribution. In this conference, one person, the person who writes and edits the news items, can write to the conference, while a large number of people can listen. Many of the details of how this conference works were set up for this application; if you have another application in mind, or even another way of managing this application, you can probably accommodate it by changing the control information for the conference or, if necessary, by modifying or replacing the CSP or the NSPs.

Let's say that some hot news just occurred and you want to communicate

this to the subscribers of your conference. You invoke your favorite UIP, suspending the other work you are doing. After entering the text of the bulletin, you enter a command to transmit the data from your virtual machine to your local GRAND server. The UIP prefixes the text of your entry with control information that identifies you to the conferencing system, indicates that you are addressing the News conference, and indicates that you are adding a news bulletin. When the server receives the request, it verifies that the request came from you. It then passes the command to the CSP that manages the News conference, which determines that you are permitted to add news bulletins and processes your request.

Processing the command to add a news bulletin consists of adding the bulletin to the local database and then notifying all the conference subscribers. To notify the subscribers, the CSP goes through its list of subscribers and invokes the NOTIFY program once for each subscriber. NOTIFY looks into the subscriber's profile and runs the NSP that it has selected, passing the NSP a pointer to the subscriber and another to the news bulletin.

There are no restrictions on what an NSP may do to notify you. Typically, it sends you a file containing the news bulletin. Some NSPs send immediate messages containing the news, some print the news on printers, and some just add a pointer to a list of things that you should look at sometime.

Among the list of subscribers to the News conference are some other servers. In the same manner that you are notified of the news, the NSPs for the servers are run, and the news bulletin is transmitted to them. Typically, a server has the news bulletin delivered to it in a file over VNET with the same sort of control information your UIP added to the entry. When the bulletin arrives at the other servers, they go through the same process, updating their own databases and notifying their News subscribers of the news.

Depending upon the manner of notification that you have selected, you do different things. If you are logged onto a machine that has a server that maintains at least part of the News database, you can link to the disk that contains the data and browse it by using any of a battery of editors, utilities, and other UIPs. If you are on a machine where no local copy of the data is maintained, you may have the data sent to you in a file. You would invoke some program to see the news, either using a standard mail reader or a GRAND UIP especially written for the purpose.

It may take only a few seconds between the time that you press the button to transmit the story and the time that NEWS subscribers are reading the story. Barring network problems and unusually long delays, news on GRAND is usually available around the U.S. and Europe within 10 minutes.

### THE SERVE CONFERENCE

Developing, maintaining, and operating the network of GRAND servers is a big communications task. Various commands, programs, and data must be transmitted between certain people and servers around the network. The details are quite complex. We

(continued)

## A GRAND APPLICATION

The common parts of GRAND should not limit what an application can do. In addition to the design decisions that you would normally make when writing any computer program, as a CSP developer you need to consider the following points:

- Should you maintain the database at one server, some servers, or all of the servers? If the cost (in terms of money or time) of transmitting the data as needed is greater than the cost of maintaining the data at more than one server, then you should probably maintain multiple copies.
- How do you want to maintain a distributed database? If you have more than one server with write access, this is difficult to do well, if possible at all.

(Most attempts at maintaining distributed databases require complicated and expensive locking arrangements that make them unpalatable.) Fortunately, most applications do not require solving this problem.

- What if you don't have local access to the disk containing the data you need? For most applications, this is not a problem because the CSP can easily send it. However, if you need access to a great deal of data, the server can't send you the entire database. The CSP can, however, do a search for you and send you the result. The UIP checks to see if it has local access to the data. If so, it does the search. If not, it sends the request to the server to do for you. In either case, you don't have to know how your request is being honored; you just get the result you asked for.

# A CROSSTALK<sup>®</sup>

XVI

# Klone FOR \$49<sup>95</sup>

The Closer You Look, the Better We Look!



**MIRROR** is the mirror image of Crosstalk XVI, the industry standard in data communications software for small business computers. **MIRROR**'s design closely reflects Crosstalk XVI's menus, commands and features. In fact, if you have used Crosstalk XVI before, you will feel right at home with **MIRROR**. The one thing you will not find reflected in **MIRROR** is Crosstalk XVI's \$195.00 price. Because we control the reflection, **MIRROR** costs only \$49.95.

If you are new to data communications, it makes sense to go with the industry standard in data communications software, but why pay the industry standard price. **MIRROR** lets you have the industry standard at 1/4 the price. If you or your company have already standardized on Crosstalk XVI, then consider **MIRROR** for future purchases and upgrades, you'll realize significant savings, without sacrificing on quality, standardization or features.

**MIRROR** even gives you features that Crosstalk XVI doesn't provide, such as background operation which lets **MIRROR** handle your communications while you are using other productivity packages. **MIRROR** includes a built-in Wordstar-like text editor, and many file transfer protocols such as: XMODEM, XMODEM MULTI-FILE, KERMIT, HAYES and of course, CROSSTALK.

With SoftKlone's **60-Day money back guarantee**, you can't lose. Pick-up the phone and dial our toll-free number, or fill-out the coupon. **EITHER WAY, DO-IT-TODAY.**

MIRROR  
WILSOB

**SOFTKLONE**<sup>TM</sup>  
DISTRIBUTING CORP.  
The Age of KloneWare Has Arrived

Order Call Toll-Free:



1210 East Park Avenue  
Tallahassee, Florida 32301

National: **1-800-538-8157** Ext. 848  
California: **1-800-672-3470** Ext. 848

For Information Call: 1-904-878-8564

MIRROR, KloneWare and SoftKlone are trademarks of SoftKlone Distributing Corporation. Crosstalk XVI and Microstuf are registered trademarks of Microstuf, Inc., HAYES is a registered trademark of Hayes Microcomputer Products, Inc., Wordstar is a registered trademark of Micropro International.

Yes, Please send me \_\_\_\_\_ copy(ies) of **MIRROR** at **\$49.95** plus \$5.00 postage/handling (\$8.00 for COD orders) ea.

**MIRROR** is available for the IBM PC/XT/AT and compatibles.

Payment Method:

VISA  MC  COD  Check/Money Order

Credit Card #: \_\_\_\_\_

Card Expiration Date: \_\_\_\_ / \_\_\_\_

Sub-Total \_\_\_\_\_

(Fl residents must add 6% sales tax)

Shipping/Handling \_\_\_\_\_

Amount Enclosed: \_\_\_\_\_

Name: \_\_\_\_\_

Shipping Address: \_\_\_\_\_

City: \_\_\_\_\_ State: \_\_\_\_\_

Zip Code: \_\_\_\_\_ Telephone #: \_\_\_\_\_

Signature: \_\_\_\_\_

Mail Coupon To: SoftKlone, 1210 East Park Avenue, Tallahassee, Florida 32301

Site Licensing Available

Purchase Order and site license inquiries please call (904) 878-8564.

**NOT COPY PROTECTED!**

## APPLICATION NETWORK

decided to use GRAND itself to manage this communications task, so we developed a special CSP to manage the Serve conference.

One special feature of GRAND is the GRREP function. If you need to correct a bug or add a new feature, simply connect from your microcomputer to one of the mainframes on the network, invoke your favorite editor, edit the errant program, and execute the GRREP command. GRREP is a special-purpose UIP that can install a program on GRAND.

Unless you are accessing a copy of a program that is maintained directly by the GRAND server, GRREP saves the file you have edited on your disk and transmits the edited program to the local server. GRREP then asks you to describe the nature of the changes that you have made to the program. Finally, it transmits the description of the changes to the server. (If you are

accessing a copy of a program maintained by the GRAND server, GRREP doesn't have to save the original file, because the server already has it.)

The server verifies who you are and passes your input command to the CSP that manages the Serve conference. That CSP verifies that you are allowed to replace that program on the server and replaces the old version with your new one. The previous copy of the program is saved, on the chance that you made a mistake, and the fact that you changed the program is recorded in the journal log.

With the new program in place, you issue the commands to test out the new code. You can have the server trace the execution of the program and send you the results. When you are satisfied that your change is correct, you can issue another command to the Serve conference to transmit the new version of the program to all

the servers in the network.

Each server receives the files, updates its copy of the program, makes appropriate journal entries, and notifies the appropriate operators of the change. GRAND manages this without interrupting any server's operation. Using the Serve conference we can develop and operate the entire system or parts of it from anywhere.

### CONCLUSION

The ultimate goal of our effort is to make possible the development of computer applications that can be used throughout the network. The system should be flexible enough to accommodate the different needs and preferences of various users as well as the different needs of the applications. We don't profess to know the right ways of doing everything. GRAND's flexibility lets us try out new ideas with relatively little effort. ■

# DREAMER

Inquiry 345

## Make 1-2-3™, WordStar™, VisiCalc™, easier!

### NO MORE MEMORIZING AND TRAINING

- Are you always forgetting those keystroke sequences required for your sophisticated business software?
- Wouldn't it be easier to press a key labelled "Format Right" instead of typing "/ R L R" to right-justify a cell in Lotus 1-2-3 ? or a key labelled "Save File" instead of typing "Ctrl K S" in WordStar?
- Now, with the help of Dreamer's descriptive keys, you can execute oddly-constructed commands with no more memorization, no more flipping through instruction manuals.
- Cut training time and costs for yourself and your staff to a minimum by putting a Dreamer next to your system. The Dreamer will make your computer a dream to use.
- The Dreamer is available for the IBM PC or XT and the Apple //e or ][ Plus.

### DREAMER FEATURES:

- 20-key numeric pad with separate cursor controls
- IBM version:
  - 70 Lotus 1-2-3 commands
  - 30 WordStar commands
- Apple version:
  - 60 WordStar commands
  - 40 VisiCalc commands
- Templates included for alternate command pages
- Easy selection between command pages
- Easy installation
- Full 90-day warranty

**T. S. MICROTECH INC.**  
(213) 644-0859  
12565 Crenshaw Blvd.  
Hawthorne, CA 90250



**\$259**

# TATUNG



CM-1380

13" RrGgBbl Super High Resolution, 22KHz/15KHz dual frequency, 64 color display with 640 x 350 line resolution.



CM-1370

13" RGBI  
Super High Resolution  
16 color display  
with 720 x 400  
line resolution.



CM-1360

13" RGBI  
High Resolution  
16 color display  
with 640 x 200  
line resolution.  
color/amber/green  
selectable.



CM-1322

13" RGBI  
High Resolution  
16 color display  
with 640 x 200  
line resolution.



CM-1222

12" High Quality  
Monochrome display  
with 800 x 350  
line resolution.  
amber/green.

## PICTURES PERFECT.

Tatung monitors. What you get is more than what you see. What you see is a picture of startling clarity. A picture that's sharp, clear, and crisp... whether color or monochromatic.

The kind of picture you can sit in front of for hours.

A Tatung picture.

What you can't see,



**TATUNG**

but will feel, is Tatung value. Dollar for dollar, feature for feature, you'll look a long time for a better, more capable, IBM compatible monitor... regardless of what kind of system you'll use it with. For more information and specifications, call or write for our brochure.

For complete information call (213) 979-7055.

TATUNG COMPANY OF AMERICA, INC. 2850 El Presidio Street, Long Beach, California 90810.

In Northern California, call (408) 732-4671.

TATUNG SCIENCE & TECHNOLOGY, INC. 780 Charcot Ave., San Jose, California 93131.

# Like our ads, seem to go

## The **NON-STOP** small business printers.

A simple printer failure can be the downfall of a small business.



No invoices. No computer generated letters. No labels, proposals or reports. And no printer in the next office to pick up the slack.

That's why most small business people rank reliability as the number one priority in a printer. And that's why more businesses of all sizes use Epson® printers than any other printer in the world.



## YEARS AHEAD OF THE **COMPETITION**

*While most other printers only offer standard 90 day warranties, we stand behind Epson printers for a full year. And we've been doing it longer than most printer companies have been in business.*

*Of course the warranty is one benefit of owning Epson printers that very few people have ever had the opportunity to take advantage of.*

Is it an Epson  
????? **OR** ?????  
Isn't it an Epson?

For over a decade, major computer companies have staked their own reputations on the reliability of Epson, by coming to us for the printers they sell with *their* computer systems.

Epson dot matrix printers have very graphic advantages. Besides the versatility of draft and Near Letter Quality and the corresponding speed options, they can draw some very convincing pictures, including true circles.

## **INCOMPATIBILITY:** *the irreconcilable difference.*

Software drives your computer. Software also drives your printer. And it's possible that your computer software will not be compatible with your printer.

This can be shocking when the p's on your monitor come out as q's on your printer.

But Epson printers are the standard to which virtually all major computer software is written. So whether it's IBM® or the newest name on the market, you can use your Epson printer with almost any hardware/software combination.

# Epson printers on forever..

## HARD COPY DECISIONS MADE EASY.

Depending on what you print, how much you print, and how much you want to invest, you'll find the right small business printer right here.



*"So the question is:  
Which Epson?"*

**For Starters.** You're a small business just starting to use computers. Well, just because you don't want to invest a lot doesn't mean you have to settle for less than you need. The new low cost *Spectrum™ LX-80* operates at 100 characters per second in draft mode,

prints Near Letter Quality text, has 160 typestyles and has a full range of expansion options. Backed by the same full year warranty as our more expensive printers, it's built to work just as hard.

**The New Standard.** The Epson FX series have again set new standards as the workhorses of the industry. With print head speeds of 160 characters per second in draft mode, easy access to Near Letter Quality, and excellent graphics, they're the number one selling printers from the number one printer company. For spreadsheets and financial reports, there's a wide carriage model.

**The Complete Printer.** For speed, quality and versatility, there isn't a

better choice than the new *LQ-1500*. Its type rivals that of an office typewriter, at four times the speed of the average daisywheel printer. In draft mode it flies at 200 characters per second. And its graphics are among the highest resolution of all dot matrix printers.

**ONLY  
EPSON  
PRINTERS  
COULD GENERATE  
PRINT LIKE THIS**

*"Thank you for making such a rugged yet so fantastic piece of hardware."*

*L.F.G., Martinez, CA*

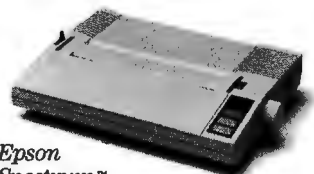
*"... a relief in this industry often faulted by products designed to last about ninety days."*

*John Cameron,  
Medical Director,  
Raleigh Hills Hospital*

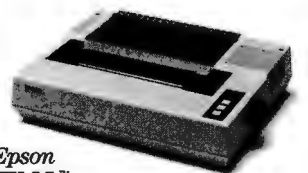
*"I have had my Epson FX-80+ about six weeks... my only regret is that I didn't replace my old printer a year ago."*

*L.A.R., 29 Palms, CA*

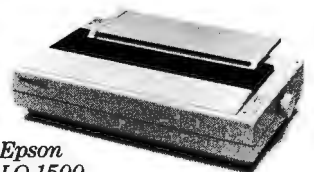
· SMALL ·  
**BUSINESS  
OPPORTUNITIES.**



*Epson  
Spectrum™  
LX-80*



*Epson  
FX-85™*



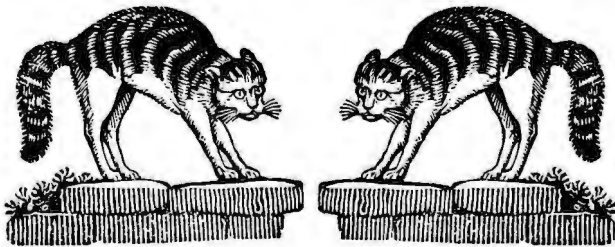
*Epson  
LQ-1500*

For more details, call (800) 421-5426 or in California (213) 539-9140.

**EPSON**

**Number One.  
And built like it.**

Epson is a registered trademark of Epson Corporation. Spectrum, FX-80, FX-80+ and FX-85 are trademarks of Epson America, Inc. IBM is a registered trademark of International Business Machines Corporation.



***Recently in Martinez, California, two cats knocked an FX-80™ printer 4 feet onto a tile/concrete floor. Although it didn't land on its feet, it is still running.***

# We wrote the books on C...



## Ecosoft's Eco-C88 C Compiler. \$49.95

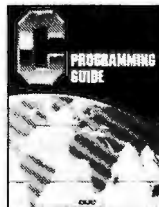
This has to be one of the best values on the market today. Eco-C88 has all operators and data types (except bit fields), has 8087 support, and comes with one of the most complete libraries available - over 180 functions including functions for color and memory files. The compiler produces fast, efficient code (as shown in the table) at one-tenth the cost of other compilers.

You also get a UNIX-like cc with "mini-make" that makes the compiler a snap to use. For a limited time, you will also get the Eco-C88 editor (described below) free of charge. Works with all IBM PC's and MSDOS machines.

	Eco-C88	L (1)	C86 (1)	MS (1)	MW (1)
sieve	12	11	13	11	12
fib	43	58	46	109	—
deref	14	13	—	10	11
matrix	22	29	27	28	29

1. Computer Language, Feb., 1985, p. 79. Reproduced with permission.

The employees at Ecosoft think everyone should explore what C has to offer. To further that goal, the books listed at right were written by the employees at Ecosoft to get you up and going as quickly as possible and to expand your understanding of C. Over 100,000 readers have placed two of the books on the best sellers list.



## The C Programming Guide (Purdum, Que Corp.). \$20.00

This best seller walks you through the C language in an easy-to-read manner. All aspects of the language are covered with plenty of examples. Many of the error messages issued by the Eco-C88 compiler have page numbers that reference this book making the compiler and book perfect for the beginning C programmer.

### The ECOSOFT family of C products ORDER FORM

- C Compiler \$49.95 \_\_\_\_\_
- Programming Guide \$20.00 \_\_\_\_\_
- Self-Study Guide \$17.00 \_\_\_\_\_
- Programmer's Library \$20.00 \_\_\_\_\_
- Program Editor \$29.95 \_\_\_\_\_
- Total\* (Ind. res. add 5% tax) \_\_\_\_\_
- \*Please add \$4.00 for shipping.
- Payment: VISA MC AE Check \_\_\_\_\_
- Credit card expir. date \_\_\_\_\_
- Card # \_\_\_\_\_
- Name \_\_\_\_\_
- Address \_\_\_\_\_
- City, state \_\_\_\_\_
- Zip \_\_\_\_\_ Phone \_\_\_\_\_

#### Ecosoft, Inc.

6413 N. College Ave.  
Indianapolis, IN 46220

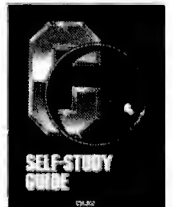
(317) 255-6476 • 8:30-4:30



TRADEMARKS: ECO-C88, ECOSOFT, TURBO PASCAL, BORLAND INT'L.

## The C Self-Study Guide (Purdum, Que Corp.). \$17.00

This new book is designed for the individual that is learning C on their own. The book is filled with questions-answers and many examples about C and illustrates many of the tips, traps, and techniques in C that may take years to learn otherwise. Although written to complement the Guide, it can be used with any introductory C text.



## The C Programmer's Library (Purdum, Leslie, Stegemoller, Que Corp.). \$20.00

This best seller is an intermediate text designed to teach you how to write functions in a generalized fashion. The book contains many useful library additions, including a complete ISAM file handler, plus sections on several advanced C topics.



## CED Program Editor. \$29.95

You're gonna love CED (pronounced "said"). It was written specifically for use with the Eco-C88 compiler. (CED creates a programming environment similar to that of Turbo Pascal.) You create the source file with CED, compile the program and, if there are any errors, CED automatically reloads the source file and places the cursor on the offending section of code. CED also has windows for editing multiple files, macro capability, and is configurable to suit your needs. CED is fast and has many features found only in editors costing up to ten times as much. Perfect for use with Eco-C88.



# STORAGE ARCHITECTURES

BY ALASTAIR J. W. MAYER

## *Their implications for conferencing systems*

A COMPUTER CONFERENCING system can be looked on as a special case of a database where the entries consist mainly of variable-length text messages plus associated information about who wrote them, when, and in what context. The choice of file and record structures, or "storage architecture," can have profound implications on what can be implemented easily at the user-interface level and, indeed, on how the messages relate to one another.

When my colleagues and I sat down to design the conferencing system that would become known as CoSy, we did not immediately start worrying about file layouts, record structures, and the like. We started thinking about how the user would view and use the system and then worked backward from there. Of course, the design process is never quite that simple. We had to go through several iterations, because something that we'd thought might be a great idea at the user level turned out to be impossibly complicated to implement but could be done easily with a small change to the user interface.

Still, this was just a prototype. However, in a system of this sort, the files

created with the prototype tend to get inherited by successive generations of the software. Think how annoyed users would get if the old conferences became unreadable whenever a change to the software was made! (Indeed, one of the very first conferences on the prototype, for discussion among the developers and test users, was still going strong a year later when the software was well into its second release and on its third hardware home!)

Thus, the organization of the information (the storage architecture) in the system can have profound implications to later development of the software. You can't just say, "Well, with version 4 we'll go to a totally new file organization," because then conversion programs will need writing, and some of the imaginable conversions may not even make sense (because certain necessary data was never stored in the original files).

In this article I'll discuss some of the trade-offs involved in deciding how to store conferencing-system information. Since I am responsible for most of the detailed design and the coding of the University of Guelph's CoSy system, many examples will come from

that. I'll make some comparisons with other conferencing systems (COM, for example). It is not the specifics (of any particular conferencing system) but the implications and limitations of certain designs that are important. These designs may be considered hypothetical.

I had to decide whether to approach this subject from the top down, starting at the user-interface layer or at least the general file-layout layer, and working down to character coding. Or I could start from the bottom up, deciding how to store characters in messages. Good programming practice is to start at the top and progress downward. One of the first decisions was to use UNIX to develop the system. (UNIX doesn't care what a file contains; it is just a stream of bytes.)

### CONFERENCES

The top level of organization in all conferencing systems is obvious: *conferences*. All conferences can be viewed

*(continued)*

Alastair J. W. Mayer (University of Guelph, Institute of Computer Science, Guelph, Ontario, Canada N1G 2W1) is the author of the CoSy conferencing system.

# WALTZ LISP

## The universal, superefficient LISP for MS-DOS and CP/M.

**Waltz Lisp** is a very powerful and complete implementation of Lisp. It is substantially compatible with established mainframe Lisps such as *Franz* (the Lisp running under *Unix*), *Common Lisp*, and *MacLisp*.

**Ultra fast.** In independent tests, **Waltz Lisp** was up to twenty(!) times faster than competing microcomputer Lisps.

**Easy to use.** Built-in WS-compatible full-screen file editor. Full debugging and error handling facilities are available at all times. No debuggers to link or load.

**Practical.** Random file access, binary file support, and extensive string operations make **Waltz Lisp** suitable for general programming. Several utilities are included in the package.

**Full Lisp.** Functions of type *lambda (expr), nlambda (fexpr), lexpr, macro*. Splicing and non-splicing character macros. Full suite of mappers, iterators, etc. Long integers (up to 611 digits). Fast list sorting using user defined comparison predicates. Built-in prettyprinting and formatting facilities. Nearly 300 functions in all.

**Flexible.** Transparent (yet programmable) handling of undefined function references allows large programs to reside partially on disk at run time. Automatic loading of initialization file. Assembly language interface.

**Superbly documented.** Each aspect of the interpreter is described in detail. The 300+ page manual includes an exhaustive index. Hundreds of illustrative examples.

Order **Waltz Lisp** now and receive *free* our  
**PROLOG Interpreter**

**Clog PROLOG** is a tiny (but very complete) PROLOG implementation written entirely in **Waltz Lisp**. In addition to the full source code, the package includes a 50 page **Clog** manual.

16-bit versions require DOS 2.x or CP/M-86 and 128K RAM (more recommended). Z-80 version requires CP/M 2.x or 3.x and 48K RAM minimum. **Waltz Lisp** runs on hundreds of different computer models and is available in all disk formats.



**\$169**

\*Manual only: \$30 (refundable with order). Foreign orders: add \$5 for surface mail, \$20 for airmail. COD add \$3. Apple CP/M, hard sector, and 3" formats add \$15. MC/Visa accepted.

For further information or to order call

 **1-800-LIP-4000 Dept. 31** 

In Oregon and outside USA call 1-503-684-3000.

**PC**<sup>™</sup>  
**RO**  
**CODE**  
INTERNATIONAL

15930 SW Colony Pl.  
Portland, OR 97224

## STORAGE

as structures in their own right. On all systems that I am familiar with, a conference contains a collection of messages (which may be further grouped or structured), together with information about who reads or contributes to that collection (or has permission to).

Also associated with conferences is descriptive information, such as the date the conference was created, a short narrative about the purpose of the conference, and so on. Another type of data associated with a conference is the user ID of the person who is allowed to manipulate the conference in some special way, such as adding or removing participants, messages, or groups of messages (this person is usually referred to as the conference moderator). Information about which messages have been read by particular participants (stored to simplify the presentation of new messages to the user) can be viewed as being conference information. This information can also be treated as *user* information belonging with other data about the user.

We've now come to the first decision point. Does "last message read" information belong in a user-related file or in a conference-related file? Here the term "file" is used loosely; a conference "object" may be made up of several files.

Keeping "last message read" in the conference file simplifies such housekeeping operations as adding a user to a conference (or removing one), removing messages, and so on. On the other hand, an element of redundancy is lost by doing this. If such information is stored in user files, then the system becomes easier to reconstruct should something catastrophic happen to a conference file. (I am thinking more of a software error than a hardware problem here, since full backups are done regularly.)

In CoSy, I chose the latter approach, with some redundancy. Each conference has connected with it a list of the members of that conference, and each user has a list of the conferences to which he or she belongs. Should problems occur, one list can be rebuilt

from the others in the system. The "messages read" information is kept with the users' lists. Since this information changes often when a user is signed on and reading or writing messages, this list can be read into memory and continually updated without the disk I/O (input/output) that would be needed if this information were kept with conference files. COM and Telecenter also keep this information in the user files, although the details are significantly different (see references 1 and 2).

## CONFERENCE-SYSTEM HIERARCHY

Are "conferences" really the topmost level of conference-system architecture? In any type of business environment there have to be classes of conferences. For example, there should be public or open conferences (or forums, if you prefer) that anyone can browse through or contribute to. Indeed, these are usually the most popular and active ones on the system. There are some discussions, however, that should have restricted (closed) access, although you may want to post their existence so that someone who is interested enough can ask to be invited in. Finally, there are conferences that are closed and which the participants have no intention of letting anyone else into. Such a conference might be a private conversation between two or three people, for example. These unlisted conferences are called "confidential" in CoSy parlance.

We knew at the outset that we would want these three classes of conferences. But all three classes can be treated alike (indeed, a CoSy conference can be switched from one class to another). Thus, there is no real "class layer" above the conference layer. Rather, information is logically included within each conference according to conference type.


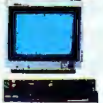
Another upper layer is "groups" of related conferences. This is an especially useful concept in an application where there are many open conferences (electronic publishing, for ex-

(continued)

## Industry Standards Upgraded!

**The Models 630 And 640 Are 100% Compatible With The AT&T 6300 and 6300 Plus!**

A perfect upgrade/replace-ment for the standard IBM color graphics monitor and card, the Taxan model 630 and 555<sup>®</sup> create a higher resolution at a greater savings!

	
IBM Display IBM CGA Color Adaptor \$924.00	TAXAN 630 TAXAN 555 SCG Board \$890.00
<b>PRICE/PERFORMANCE RATIO</b>	

<b>IBM</b>	<b>TAXAN</b>
	
<p><b>Screen Test</b>—This actual unretouched photograph demonstrates the superior text resolution created by the TAXAN 630 monitor and 555 color card! For maximum resolution and ease of viewing, Taxan's the winner!</p>	

### 630 Super High Resolution Text and Graphics.

**Superior Text and Graphics Beyond IBM.**

640(H) x 200(V) Resolution  
(640(H) x 400(V) Non-Interlaced Resolution

0.37mm Dot Pitch  
24.75Khz Scan Frequency  
**100% compatible with IBM PC, XT, and AT<sup>®</sup> when used with the Taxan 555 board.**  
**\$645.00 Suggested Retail**



**555** The Taxan 555 is basically equivalent to the IBM standard color board. This means that the 555 is 100% compatible with all IBM software!

COMPATABILITY	IBM	TAXAN
Text Mode	16 Colors	16 Colors
320 X 200	4 Colors	4 Colors
640 X 200	1 Color	1 Color
<b>Alphanumeric Text Resolution</b>		
Character Cell	8 X 8	10 X 16
Scan Frequency	15.75 Khz	24.75 Khz

▶ Compatible with AT&T 6300 Computer

**RGB Color, and FOUR Monochrome Capabilities in One Monitor!**



RGB



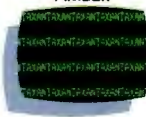
REVERSE BLUE



REVERSE B & W



AMBER



GREEN

▶ No one else offers the monochrome options available with the new Taxan 600 series!

The Taxan 630 & 640 monitors offer Green, Amber, B&W Reverse, and a White on Blue Background as their total spectrum of monochrome options.

**Only Taxan offers such a wide variety of monochrome capabilities.**

**Total CAD/CAM Compatibility 720 x 400 Resolution!**

**640**

**The Taxan 640 The Ultimate in Monitor Resolution.**

640(H) x 400(V) Non-Interlaced Resolution

4,000 Character Display Capability  
0.31mm Dot Pitch  
24.75Khz Scan Frequency



▶ Compatible with AT&T 6300 Computer

**100% Compatible with the new generation of graphics boards Taxan (555), Persyst B.O.B.<sup>®</sup>, Sigma 400<sup>®</sup>,**

**Artist II<sup>®</sup>, STB 400<sup>®</sup> and others for the IBM PC, XT, and AT.**  
**\$745.00 Suggested Retail**

ample). The new user is likely to be a bit bewildered by all the available choices, so some method of grouping conferences is desirable. There might be a languages group, an operating-systems group, and so on, each group comprising a number of separate conferences.

Had we thought of this idea at the beginning, we would have been tempted to incorporate it into the file structure, using UNIX's directory

hierarchies. This concept, however, did not arise until later, as the number of active conferences grew and the group structure became more virtual than real. A group is really just a named list of conferences, nothing more. This, I think, is preferable to the group/conference hierarchy that we might have implemented, since it permits users to transfer easily from one conference to another without worrying about whether they are crossing

a group boundary or not.

On the other hand, there are advantages to having some sort of group boundary in terms of giving users easier control over how they read their messages. The differences are better appreciated if you've actually used CoSy. However, I'll try to explain.

In CoSy, each user has a list of conferences to which he or she belongs. CoSy provides a simple mechanism

(continued)

## A PROTOTYPE FOR YOUR PROTOTYPES



**METHODS BY DIGITALK. A SMALLTALK PROGRAM DEVELOPMENT ENVIRONMENT FOR THE IBM PC. AN OBJECT-ORIENTED SPEED DEMON. AN EXCITING WAY TO PROGRAM.**

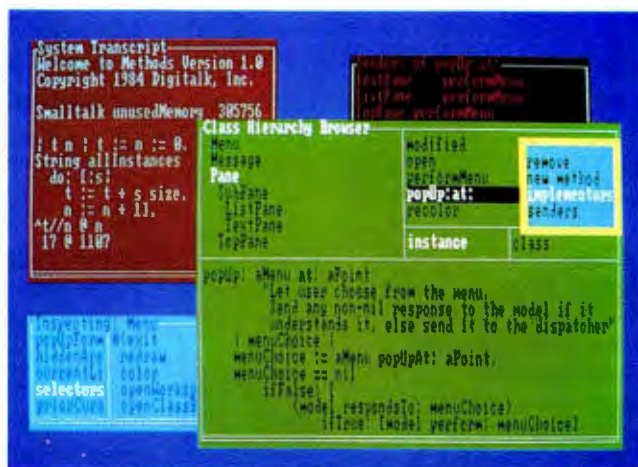
Think about your problem. Browse the Methods Smalltalk source code. Select some building blocks like pop-up menus, windows, text-editors and dictionaries. Put them together. Try it. Oops, Methods tells you something is missing. No problem. Continue thinking, changing and trying. Now you're prototyping! Try out new ideas. Redefine your problem. And you don't have to throw this prototype away. Refine it until you like the finished product.

Methods by Digitalk. A new way to develop software for the PC. Use it for windowing, simulation and artificial intelligence applications. Use it by prototyping.

Methods is Smalltalk-80™ language compatible. It includes its own Smalltalk source code. You can extend it in Smalltalk and assembly language.

Methods operates on IBM PCs with 512K bytes RAM using MS-DOS or PC-DOS. Color and monochrome monitors are supported. No mouse is required. A Smalltalk language manual and an environment guide are included.

Smalltalk-80™ is a trademark of Xerox Corporation. IBM is a registered trademark of International Business Machines Corporation. MS is a trademark of Microsoft Corporation.



Available from Digitalk for \$250. Outside U.S. add \$15.00 for shipping and handling. California residents add 6% sales tax. Visa and MasterCard accepted. Educational and Dealer Discounts Available.

### DIGITALK, INC.

5200 West Century Boulevard  
Los Angeles, California 90045  
(213) 645-1082

# CompuPro Opens The Door...



## ... For Total Solutions With Our Family of Multi-User Systems And System Components.

Sometimes it seems like opportunity is just behind the door. At CompuPro, we've created a family of multi-user systems and system components that open many doors—from high performance multi-user business systems to industrial control.

CompuPro products have earned an enviable reputation for delivering performance, quality and reliability—at prices that shut the door on the competition.

So whether you use systems or build them, let CompuPro open some doors for you.

***CompuPro***<sup>™</sup>

Inquiry 369

Viasyn Corporation  
26538 Danti Court  
Hayward, CA 94545-3999

800-842-7961  
800-842-7962 (California)

for reading messages from these conferences. Just hitting the Return key will cause an automatic search for the next unread message. The search starts within the conference topic you are already connected to, if any, and continues on to the other topics in the same conference (if the user has read all the messages in the initial topic). If all the messages in this conference have been read, the search starts at the top of the user's list of conferences and progresses down through it, stopping at the first unread message.

With few conferences or a relatively quiet system, this is perfectly acceptable. An "order" command is provided so that users can rearrange conferences on their lists, to place higher-priority ones at the top. However, in a situation where you are a member of many conferences and there are many other people on line at the same time who are adding messages,

you can sometimes find yourself "ping-ponging" from one conference to another as messages get added elsewhere while you are reading the messages in one conference. It would be nice to be able to group conferences in such a way that the ones you use for work, say, are distinct from those you participate in out of interest, so that you are not distracted by messages in lower-priority conferences. This is not really that significant a problem, as the "order" command can deal with this, although it does illustrate that any feature can have both positive and negative effects.

Telecenter has no concept of groups of conferences in that sense, but it does use the UNIX file permissions to define open and closed classes of conferences. COM (and most other conferencing systems) also allows open, closed, and unlisted con-

ferences. Neither of these systems support the concept of named groups of conferences, however.

#### BELOW CONFERENCES

Not all conferencing systems have a named level below conferences (such as "topics"). They just start right in with messages, although there is usually some structure to the way in which messages are presented. It seemed logical to us, though, that within a given conference there should be the option of dividing discussion into several areas. One analogy is of agenda items at a face-to-face meeting, although with a computer conferencing system, users can carry out discussion on all the agenda items almost simultaneously.

This is easy to do in UNIX. We just implemented each conference as a directory and the topics as files within

(continued)

## NOW—12 Sentinel Color Diskettes

# for the price of 10

In a see-through, reuseable container.



Give the perfect gift, Sentinel Color Diskettes. Now you can provide the PC user with the ability to classify stored data by color and retrieve by sight the appropriate diskette for any given category. In addition, each Sentinel diskette comes with a written guarantee assuring flawless performance for as long

as you own it. As an added value for the Holiday Season, Sentinel is offering 12 color diskettes for the price of 10 in a reuseable crystal styrene container for continued diskette storage. It would even be a nice gift to give to yourself.



**Sentinel Technologies, Inc.**  
One Sentinel Plaza, Hyannis, MA 02601  
Tel: 800-323-5005 (MA: 800-323-5001)

# Avocet turns an ordinary PC into an extraordinary development system. And saves you \$20,000 in the process.

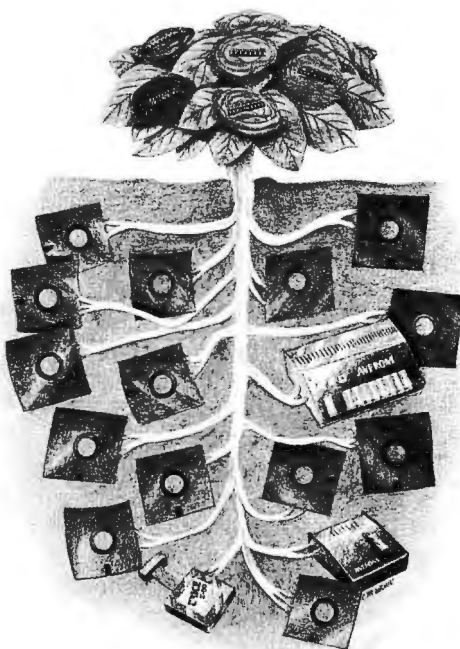
Now, there's a way to see all your best microprocessor designs take root, easily and effectively. Avocet cross-assemblers, simulators,

THE AVOCET CROSS-ASSEMBLER FAMILY.			
Avocet Cross-assembler	Target Micro-processor	CP/m*-80	CP/M-86 IBM PC, MSDOS**
XASM04	6804	\$250.00	\$250.00
XASM05	6805	200.00	250.00
XASM09	6809	200.00	250.00
XASM18	1802/1805	200.00	250.00
XASM48	8048/8041	200.00	250.00
XASM51	8051	200.00	250.00
XASM65	6502/65C02	200.00	250.00
XASM68	6800/01,6301	200.00	250.00
XASM75	NEC 7500	500.00	500.00
XASM85	8085	250.00	250.00
XASM400	COP400	300.00	300.00
XASMF8	F8/3870	300.00	300.00
XASMZ8	Z8	200.00	250.00
XASMZ80	Z80	250.00	250.00
<b>NEW!</b>			
XASM6811	68HC11	250.00	250.00
<b>NEW!</b>			
XASM180	HD64180	250.00	250.00
XMAC682	68200	595.00	595.00
XMAC68K	68000/68010	595.00	595.00

\*Trademark of Digital Research  
\*\*Trademark of Microsoft

emulators and EPROM programmers turn your personal computer into a sophisticated development system. No more waiting for the continually overloaded main-frame. Or, wondering how to pay for a \$20,000 dedicated development system. Avocet products save time and money, and provide the most flexible development system available.

Avocet allows you to develop software for practically any microprocessor without switching development systems. And equally important, Avocet development tools are easy to install and easy to use. We provide you with everything you need to develop microprocessor software, from data entry through assembly, debugging and final EPROMs.



## Now "debug" on your PC.

Avocet has realistic answers for users who want low cost debugging capability. Until now, engineers have been very much on their own in the area of testing. But now Avocet simulators and emulators virtually eliminate the frustrating and often costly "crash and burn" method.

## New AVSIM family of full screen simulators.

Avocet's new software simulator/debuggers let you test your code in a crashproof, interactive environment, without additional hardware. Your PC's screen becomes a "window" into the simulated target CPU. Extensive break point, I/O, and interrupt facilities make AVSIM a truly useful development tool. Price \$299.

## New TRICE in-circuit emulator.

At last, an affordable in-circuit

emulator! With the self-powered TRICE, you can examine target memory and register, set break points, single-step, trace and more; TRICE recognizes 34 different commands. Its serial interface lets you control emulation and download code from your terminal or PC. Priced from \$498.

## AVPROM programmer works with any PC.

The AVPROM programs over 37 different devices, including EPROMs through 27512, CMOS and E<sup>2</sup> PROMS, and MPU/EPROM combos, using fast "adaptive" algorithms. Intelligent, self-contained units work with any personal computer, using Avocet's GDx driver software...from \$429. Gang programmers from \$979.

To find out more about Avocet software development tools and accessories, call us toll-free:

# 1-800-448-8500

(In the U.S. except Alaska and Hawaii.)

VISA and Mastercard accepted. Most popular disc formats now available—please specify. Shipping and handling additional—call for exact quotes. OEM INQUIRIES INVITED. Avocet Systems Inc., P.O. Box 490-B9, Rockport, Maine 04856, (207) 236-9055. Telex: 467210 AVOCET CI.

**AVOCET SYSTEMS INC.** 



# dBASE

## III

### POWER TOOLS

#### QUICKREPORT™

##### dBASE Report Writer

- Prints *any kind* of report or form
- Up to **6 databases** per report!!
- Use bold, italics, etc.
- Incredibly easy to use
- No programming required

#### QUICKCODE III™

##### dBASE Program Generator

- Create PRG files *automatically*
- Data entry screens
- Data input error checking
- Computed fields & totals
- Link up to 8 databases!

Why write programs yourself?  
Let QUICKCODE III do it!

#### dGRAPH III™

##### dBASE Graphics System

- Pie, line, bar charts
- Printer, plotter, or CRT
- Many automatic features

#### dUTIL III™

##### dBASE Program Utility

- Finds program errors
- Improves code
- Saves time

NEW

#### QUICKINDEX™

- Index dBase files up to  
**10 times** faster than dBASE

—Versions available for dBASE II—

FOR  
INFORMATION  
201-794-8883

**FOX & GELLER**

Fox & Geller, Inc. 604 Market St., Elmwood Park, N.J. 07407

dBASE II and dBASE III are trademarks of Ashton-Tate  
QUICKCODE and QUICKCODE III are trademarks of Fox & Geller, Inc.

## STORAGE

that directory. (I am simplifying slightly.) Going this route had the bonus of making it easy to add attributes to a conference. Another file could be added within the conference directory. The "UNIX-ness" of all this is transparent to the users, who are never exposed to the raw system.

COM does not provide for this hierarchical conference/topic structure. However, the method COM uses to store messages and other information does provide a number of other features. COM does most of its own storage management, relying little on the underlying operating system. This is discussed more fully later.

Although Telecenter uses the UNIX file system—indeed, relies on it heavily—conferences are not subdivided into topics. Possibly the implementers decided that the extra layer of complexity added to the user commands was not worth the slight advantage. On the Guelph CoSy system, many conferences have only one topic, but some have as many as seven, eight, or even more (there is no inherent limit).

### PARTICIPATE

The PARTICIPATE conferencing system (PARTI on The Source) uses a different structuring concept altogether and allows each note in a conference the potential to become the root of another conference, building into a many-branched tree structure. The comment structure of messages within a CoSy topic is similar to this, although the branches remain within the topic and a member of the conference has access to all messages in all branches. (A new conference can be formed from them by copying, if desired.)

### THE MESSAGE LEVEL

Now we get down to the real meat of a conferencing system: the messages. It is also here that the differences in implementation really start to show up. In Telecenter, for example, each message is a separate UNIX file. These are grouped into conferences following the normal UNIX directory system. A message can be shared by

two or more conferences by using UNIX file-system "links," although there is no user-friendly way to do this.

Given this implementation, several things become easy and tempting. For example, a user's new messages are links stored in the user's directory, connecting to the conference messages, and they are unlinked as they are read. This makes for a system that is easy to construct, using existing UNIX commands and writing the Telecenter commands as UNIX command files or execs (called "shell scripts"). It reportedly took Mike Pearson about one week's programming effort to get the first version of Telecenter running. (The CoSy prototype took about six or seven weeks' worth of programming plus, of course, design, documentation, and testing time.)

The disadvantages to this approach lie in the storage overhead of all those separate files, as well as the program overhead necessary for command scripts. While excellent for prototyping, this method sacrifices some speed and is portable only to other UNIX systems.

As mentioned briefly above, COM does all its own file management and indeed is almost an operating system unto itself. COM reserves several large chunks of file space and then manages its own "internal" file system using this space. Several of these files are used to store such information as numbers of objects, their names and their addresses, information and details about users, etc. (in effect, a directory).

The most interesting of these files is the TXT (for "text") file and its associated OBJ and DIR files. Actual message text and some information about author and creation date is stored in the TXT file. More detailed information about the text (rather than the text itself) is stored in the OBJ and DIR files, including pointers linking comments together with the texts they comment on (CoSy handles these comment pointers differently).

All the relevant information about record lengths, position in file, and so

(continued)



# Powerful MS-DOS™ Software.

For the IBM®-PC, XT, AT & compatibles with MS-DOS/PC-DOS 2.0 or higher.

Only **\$39.95** Each

## UTAH COBOL™

**ALL NEW!** We believe this is the fastest COBOL compiler on any micro; for example, we have compiled 4500 statements per minute on an IBM-AT. Utah COBOL is based on ANSI-74 standards with powerful level 2 features, including compound conditionals & full CALL CANCEL. Speed and simplicity are certain to make it a favorite in the classroom as well as with professional programmers. Package includes diskette, 165-page manual, many examples & 16 complete COBOL source code programs. **\$39.95.**

COBOL Application Package, Book 1: \$9.95.

## UTAH PASCAL™

Has many advanced features including: 14 digit precision, BCD math (no round-off errors), floating point + 63 -64, TRACE debugging, Arrays up to 8 dimensions, 64K strings, External procedures & Dynamic Module loading. Package includes diskette & 134-page manual. **\$39.95.**

## UTAH PILOT™

Written by Prof. J. Starkweather, the language's creator, Utah PILOT exceeds all PILOT-73 standards. And it has an integrated full-screen text editor for easy program development. Ideal for classroom instruction, business training & home study. Package includes diskette, 129-page manual & 10 sample programs. **\$39.95.**

## UTAH EDIT™

A full-screen, video-display text editor designed specifically for computer program text preparation. Completely user-changeable, it can be configured to almost any terminal & takes only 12K disk space. Package includes diskette & 58-page manual. **\$39.95.**

UTAH **BASIC™** \$39.95

Package includes diskette & 239-page manual.

**BIGPRINT™** DISKETTE \$19.95

Great for making signs. Requires 132-print position printer.

UTAH software requires 128K RAM (i.e., 90K user RAM) an IBM-PC, XT, AT, PCjr, or compatible (16-bit) microcomputer with MS-DOS or PC-DOS Operating System, Rev. 2.0 or higher. For 8-bit CP/M-80 systems, ask about our **NEVADA** Software Series.

MS is a trademark of Microsoft Corp. IBM is a registered trademark of International Business Machines, Corp. Utah COBOL, Utah BASIC, Utah PASCAL, Utah PILOT, Utah EDIT, BIGPRINT, & Ellis Computing, Inc. are trademarks of Ellis Computing, Inc. ©1985 Ellis Computing, Inc.

**SATISFACTION GUARANTEED.** If for any reason you're not completely satisfied, just return the Utah package within 15 days—in good condition, with the sealed diskette unopened—and we'll refund your money. **There's absolutely no risk to you, so why wait?—order today.**

**Please send me these UTAH Software packages**

(IBM-PC diskette):

- COBOL     BASIC     EDIT  
 PASCAL     PILOT     BIGPRINT

Send me \_\_\_\_ (how many) software packages: TOTAL \$ \_\_\_\_\_

Utah COBOL Application Book 1; BIGPRINT: \_\_\_\_\_

California residents add sales tax (6% or 6½%): \_\_\_\_\_

HANDLING/SHIPPING: no shipping charge within U.S.;  
Overseas add \$10 for first package, \$5 each additional. \_\_\_\_\_

- Check     VISA     MasterCard

Checks must be  
in U.S. Dollars,  
drawn on a U.S. bank.



(Sorry, no C.O.D.s.)

Enclosed: TOTAL \$ \_\_\_\_\_

Send my UTAH order to:

CARD NO. \_\_\_\_\_ EXP. \_\_\_\_\_

SIGNATURE \_\_\_\_\_

SHIP TO NAME \_\_\_\_\_

STREET \_\_\_\_\_

CITY/STATE/ZIP \_\_\_\_\_

COUNTRY \_\_\_\_\_

Order now from:

**ELLIS COMPUTING, INC.**  
3917 Noriega Street  
San Francisco, CA 94122

Phone (415) 753-0186



SINCE 1977

**ELLIS COMPUTING™**

on, is maintained by COM. Additionally, COM buffers file blocks in and out of core. If a user accesses a particular message, COM first checks to see if that block is already in memory. The use of UNIX provides this buffering automatically for CoSy and other UNIX-based systems.

COM's ability to handle files and messages allows a very flexible file structure. As in Telecenter, all COM messages are separate entities that are linked by pointers to wherever they belong. Thus, a COM message can be in several conferences and several people's mail baskets and need not be replicated. This saves storage space and obviates the complications of "copy" and "file" commands to manipulate messages. A message can be copied to another conference, or as mail to another user, just by manipulating links.

On the other hand, the develop-

ment of COM required great effort since, in effect, a major part of an operating system (storage allocation, file buffering) had to be written. An early version of COM was about 30,000 lines of DEC-10 assembly language, and the design-stage estimate for PortaCOM was 90,000 lines of Pascal. The CoSy prototype was about 3000 lines of C, excluding the editor; it is now about 12,000 lines, including the editor.

COM also imposes some structure on the content of messages that is not present in CoSy or Telecenter but may be present in other systems. For example, most nonprintable ASCII characters are stripped off when text is input, and lines are restricted in length. Lines are formatted to the user's desired line length on output, up to a maximum of 76 characters. This is perfectly acceptable, even desirable, in a conferencing system consisting

solely of text messages. However, it precludes the later incorporation of graphics messages (messages containing graphics codes or information) without some serious reprogramming.

CoSy compromises by doing its own storage management within a single topic, but it falls back on the operating system's facilities for other functions. Thus, a topic is a single file containing the text of messages as well as associated information, such as the author of the message, the date and time written, and pointer information linking comments to the original message on which they comment (this pointer information is stored in a separate file in COM).

In CoSy, a topic file can be viewed as being made up of variable-length records, consisting of a fixed "header" portion containing data about the

(continued)

## Concurrent™ PC DOS Works For These People



"PhoneXpress™, our voice messaging product, needs the powerful multi-tasking environment that Concurrent PC DOS offers. Also, our programmers love it, they can be compiling in one window and switch into an editor which increases productivity."  
**Dennis King**  
Executive Vice  
President, Founder  
Applied Voice  
Technology



"The file manager is great. It's a step above the old DOS system. You don't have to remember commands and you don't have to read the manual."  
**John Martinson**  
Engineer  
Pacific Gas  
Transmission



"Concurrent PC DOS gives us the capability to attach additional terminals for a more productive office. It has a true multi-user capacity. We can now meet deadlines."  
**Richard Vananda**  
Principal  
Patrick Sullivan  
Associates,  
Architects



"I couldn't live without the product. Time is money and the ability to switch consoles and run more than one program has been a great time saver."  
**Joe Capp**  
Project Engineer  
Union Carbide



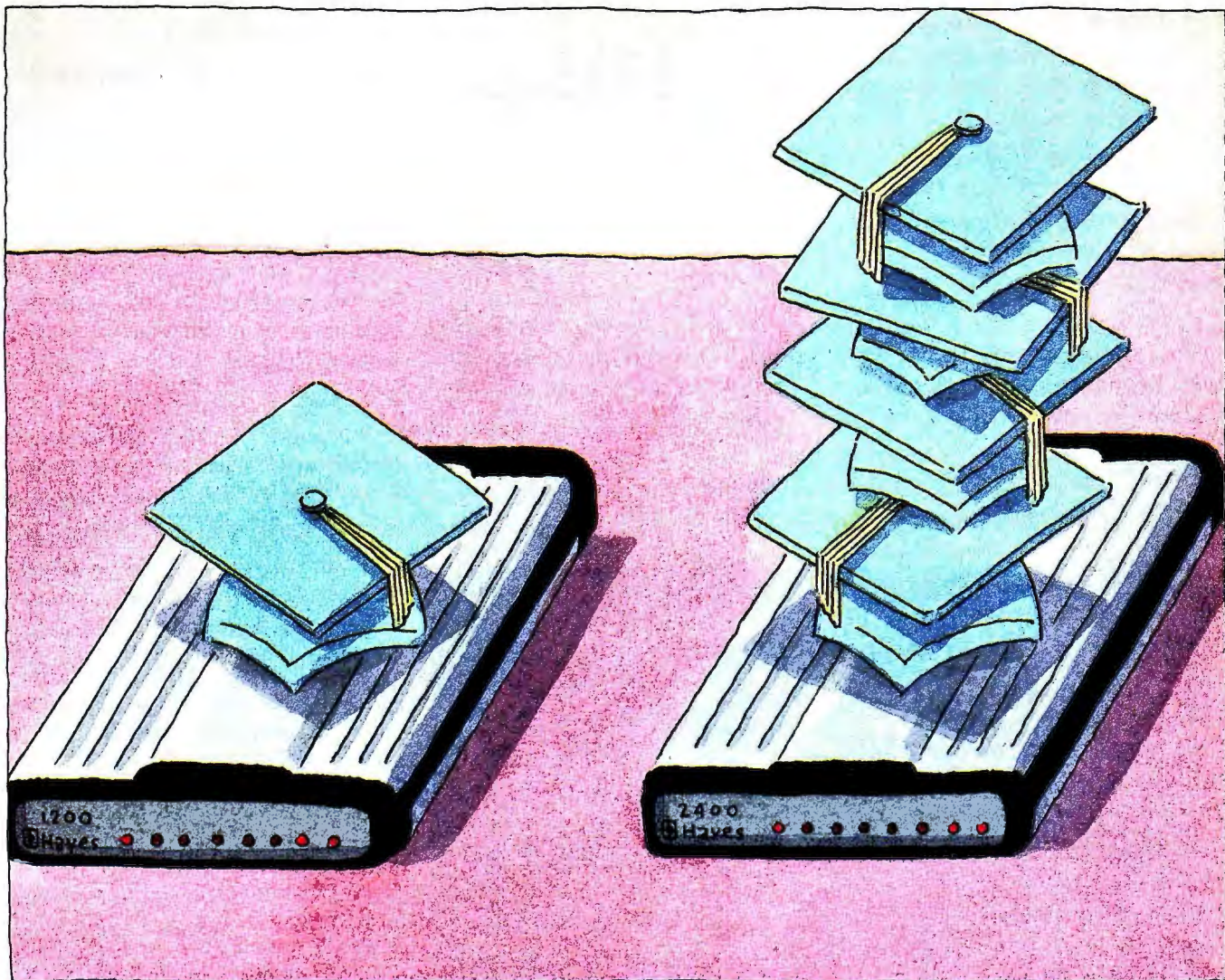
"We have created a menu driven system that is totally transparent to our customers. By utilizing the menu system and 4 consoles concurrently we are able to fully utilize Concurrent PC DOS"  
**Subbasb Chadba**  
MIS Director  
Secoin Inc.

## Make It Work For You!

Call (800) 443-4200 for the dealer or sales representative nearest you.

Concurrent PC DOS is a trademark and Digital Research is a registered trademark of Digital Research Inc. PhoneXpress is a trademark of Applied Voice Technology.

**DIGITAL  
RESEARCH®**  
We make computers work.™



## If the Hayes® Smartmodem 1200™ is smart, this one is utterly brilliant.

First came the Smartmodem 1200. Now, there's the smarter Smartmodem 2400.™ It's twice as fast. Or just as fast. Or even not as fast. Because it's smart enough to automatically adjust to 2400, 1200 or 300 bps communications. And to make sure you can communicate, it gives tests. It tests the phone line, it tests remote modems, it even tests itself. Because the Smartmodem 2400 features advanced diagnostics.

Moreover, the 2400 is a smart



communicator. It communicates with mainframes and minis. Both synchronous and asynchronous transmissions are supported by the Hayes standard command set for 2400 bps. And you can transmit data to another room, or another country because the 2400 meets CCITT international standards.

So, if you want to make fast work of high-volume communications, you'd be very smart to see your authorized Hayes dealer for a look at the Smartmodem 2400.

Now you can be smart, smarter and smartest all at once.

### SMARTMODEM 2400

- Direct connect • Auto-answer/auto-dial
- Bell 103, 212A and CCITT V.22 and V.22 bis compatible • Synchronous or Asynchronous • Full or half duplex • Nonvolatile memory for communications settings
- Automatic fallback to 1200 or 300 bps
- Voice/data switching • Audio speaker
- Advanced diagnostic tests: analog, digital and remote digital loopback • Touch tone or pulse • Automatic adaptive phone line equalization • Two-wire lease line capability • Supports single and multi-line phone systems • Call progress monitoring

### SMARTCOM II®

- Sold separately • Menu-driven communications software • 26 communications sets for automatic log-ons • Error-free XMODEM and Hayes Verification protocols • VT100/102 and VT52 emulation • Unattended batch operation • For most popular computers

© 1985 Hayes Microcomputer Products, Inc.

# Hayes®

Say yes to the future with Hayes.

message (including comment pointers) and a variable-length "text" portion containing the actual message.

There are two ways of storing information of variable length. One is to include a "length" field as part of the record; the other is to have a unique terminator sequence signifying the end of the record.

Since I needed a header field anyway and wanted to speed up scans through the topic file (by doing a direct disk seek to the next header rather than reading sequentially through the intervening text), I chose the former method, encoding the text length as part of the header. This storage method turned out to have

significant advantages for later development.

Since there is no special character indicating the end of a message, there is no limitation on what data is stored in a text field of a message. And since UNIX imposes no structure on user files either, they can be an arbitrary stream of bytes. This potentially useful feature was preserved by not doing any filtering of what the user entered as a message. Nonprintable ASCII characters were left unchanged when input and instead were converted to displayable form on output. By providing an option to turn off this output filtering (and carriage-return insertion for wrapping long text lines), we automatically created the capability of storing and sending graphic messages (or any other byte stream, for that matter).

The first tests of this technique were done using Tektronix codes and were quite successful. The currently supported code is NAPLPS (North American Presentation-Level-Protocol Syntax), which is an ANSI (American National Standards Institute) and international standard for representing graphs and images as special text and picture-drawing instructions. (See the four-part article by Jim Fleming and William Frezza, "NAPLPS: A New Standard for Text and Graphics," in the February through May 1983 issues of BYTE for more about NAPLPS.) This inherent graphics capability would have been impossible, or at least very difficult, had we limited ourselves by imposing any sort of structure as messages were input, a point in favor of not imposing limits on yourself until you have to.

#### USER-INTERFACE IMPLICATIONS

It is the user interface that can make or break the success and usability of a system (assuming that the basic requirements of a conferencing system are present). This has more to do with careful choice of command vocabulary, wording of prompts and help files, design of the command parser, and an intelligent choice of defaults than it does with the underlying

(continued)



With the Digi-Data 2000 PC 1/2" tape system you can move data between your IBM PC, XT, or AT and a mainframe or minicomputer. IBM/ANSI compatible 9-track 1600 bpi 1/2" tape is the only truly standardized and interchangeable medium between the PC and mainframes or minis.

The 2000 PC includes tape drive, PC controller board, cables, and complete ready-to-run DOS software utilities for just \$3,995. The utilities provide file interchange in ASCII, EBCDIC, or binary—as well as high speed disk backup and restore functions.

Make the PC/Mainframe connection. Call us today at (301) 498-0200.



DIGI-DATA  
CORPORATION  
8580 Dorsey Run Road  
Jessup, MD 20794-9990  
® (301) 498-0200 Telex 87-580

In Europe contact: Digi-Data Ltd. • Unit 4 • King's Grove • Maidenhead, Berkshire • England SL6 4DP  
Telephone No. 0628 29555/6 • Telex 847720

# IN THE SPIRIT OF THE SEASON, VERBATIM® DATALIFE® GIVES YOU A FREE CALCULATOR IN EVERY TEN-PACK.



This holiday season, the leading manufacturer of flexible disks is giving you something more. For a limited time, Verbatim is packing a high-quality calculator — absolutely free — in every specially-marked box of Verbatim DataLife flexible disks.\* This handy, credit card-sized calculator features an 8-digit LCD display, an independent memory system, automatic shut-off, and a protective carrying case. And it's backed by a one-year warranty.

It's easy to figure why the Verbatim Holiday Pack makes a wonderful present for your friends, your family — or even for yourself. But the holidays are coming up soon, and calculator supplies are limited, so don't wait. Hurry to your favorite computer store right away, and get your free calculator in specially-marked ten-packs of high-quality Verbatim DataLife disks. And get in the spirit of holiday gift-giving — with Verbatim.

**VERBATIM**  
MORE THAN EVER,  
YOU CAN COUNT ON US.

## Conferencing-system users can discuss multiple subjects almost simultaneously.

storage architecture.

The particular file-system design can have more subtle effects. As we've already seen with the example of exchanging graphics via CoSy, the underlying architecture (in this case, the storage of message records in the topic file) can have a significant influence on how easy or difficult it is to implement desirable features for the user. There are other ramifications, too, in terms of how users cope with the volume of information available on a busy conferencing system.

For example, suppose you are a participant in two similar but distinct conferences on a given system, and you have something to say that really fits both conferences. You may also want to explicitly mail the same message to someone who is not participating in either conference but is a user of the system.

In COM, this can be done at a single stroke, because each message or "text" is stored only once, and all references to it (whether from a conference or an individual's mailbox) are via special pointers. Telecenter also stores each message as a single physical entity but uses the UNIX file system to maintain links or pointers to the appropriate places.

In the early version of Telecenter with which I am familiar, there is no single command to direct a message to several different conferences at once; the appropriate links have to be added later. CoSy does not provide such a linking mechanism at the message level. To place a message in more than one conference, it has to be physically copied from one to the other, increasing slightly the disk space used. There are, of course, commands to facilitate this copying.

It is possible for a whole topic to be

shared between two or more conferences, with the messages entered by members of either conference available to all. In the systems described (CoSy, COM, and Telecenter) the messages entered into a conference (or conference topic) may be new thoughts, specific references, or answers to other messages.

In all three systems there is some indication when a given message is indeed a reference to or comment on another message. This contextual information is very useful—indeed, necessary—if an answering comment consists solely of "I agree" or "No." Telecenter doesn't go much beyond providing the number of the original message, but both CoSy and COM let you know, when you are reading a message, if there are any comments or responses to it. This is useful when reading an item that asks a question. It is helpful to know if anyone else has responded yet; if so, you may not need to bother answering.

COM and CoSy also provide ways for reading all the responses to a message before reading the next chronologically entered message. Other systems have similar mechanisms for handling messages and responses. In PARTICIPATE, for example, any message may have comments to it, forming a tree structure of comments, comments to comments, and so on. Any such message may become the root of a whole new conference with its own name.

CoSy also supports trees of comments to comments, but to start a new conference (or topic) at an arbitrary point, the relevant branches must be explicitly copied. In my opinion this keeps the system as a whole easier to manage and is perhaps less bewildering for users.

PicoSpan, developed by Marcus Watts, is another UNIX-based conferencing system. However, the structure of its messages and comments is perhaps more like a comb than a tree. In a PicoSpan conference, there can be sequential messages, called "items," with a number of "responses" to each. The user has the option of reading the responses before going

on to the next message, as in COM or CoSy. However, in PicoSpan the responses are handled differently than the base-level sequential messages, and there is no additional level of branching. Hence, it has a comb structure, with the base-level messages, or items, forming the spine of the comb, and the responses forming the teeth. In some respects this can be viewed as a hypothetical CoSy conference in which any participant can add a new topic, and members are only allowed to comment on the first message in a topic.

### SUMMARY

In this top-down comparison of conferencing systems I've illustrated some of the different trade-offs and compromises involved in designing systems that are intended for a broad audience. I've also shown how different decisions about data-storage methods (the storage architecture) can have later implications on what can or cannot be easily done in terms of adding new features or subsystems to existing programs.

I'm sure many of you have had to make a change in a program and thought, "Darn, if I'd done it that way instead, it would have been so easy." Or, if you're lucky or exceptionally farsighted, "Gee, I'm glad I did it this way, this new feature just slides right in."

Any system design involves compromises. The decisions made generally depend more on the intended users and usage than any absolute scale of "good" or "efficient" design. It is always a good idea to keep the maximum number of options open for as long as possible. ■

### REFERENCES

1. Palme, Jacob, Stefan Arnborg, Lars Enderin, Carl Meyer, and Torgny Tholerus. "The COM Teleconferencing System Functional Specification." FOA Report C 10164-M6(H9), File COMSPE.VIP, revised October 22, 1980. OZ, Stockholm University Computing Center.
2. Pearson, Michael M. L., and James E. Kulp. "Creating an Adaptive Computerized Conferencing System on UNIX." Laxenburg, Austria: International Institute for Applied Systems Analysis, 1981.



**Commodore® Accessories**



**RS232 Adapter for VIC-20 and Commodore 64**

The JE232CM allows connection of standard serial RS232 printers, modems, etc. to your VIC-20 and C-64. A 4-pole switch allows the inversion of the 4 control lines. Complete installation and operation instructions included.

• Plugs into User Port • Provides Standard RS232 signal levels • Uses 6 signals (Transmit, Receive, Clear to Send, Request to Send, Data Terminal Ready, Data Set Ready).  
**JE232CM . . . . . \$39.95**

**VOICE SYNTHESIZER FOR COMMODORE VIC-20 AND C-64**  
*Plug-In - Talking in Minutes!*  
**JE520CM. (NEW Software-see right) . . . \$99.95**

**TRS-80 Accessories**



**MPI 5 1/4" DISK DRIVE**  
Use as a second disk drive • Single-sided • Single/double density • Full-height drive • 48 TPI • Documentation included • Weight: 3.7 lbs.

**MPI51S. . . . . \$69.95**

**EXPAND TRS-80 MEMORY TRS-80 MODEL I, III**

Each Kit comes complete with eight MM5290 (UPD4164/4116) 16K Dynamic RAMs and documentation for conversion. Model I; 16K equipped with Expansion Interface can be expanded to 48K with 2 Kits. Model III. Can be expanded from 16K to 48K using 2 Kits. Each Kit will expand computer by 16K increments.

TRS-16K3 200ms (Model III) . . . . . \$5.95  
TRS-16K4 250ms (Model I) . . . . . \$5.49

**TRS-80 COLOR AND COLOR II**

Easy to Install Kit comes complete with 8 each 4164N-20 (200ns) 64K Dynamic RAMs and documentation for conversion. Converts TRS-80 Color Computers with D, E, ET, F and NC circuit boards to 2K. Also converts TRS-80 Color Computer II to 64K. Flex DOS or OS-9 required to utilize full 64K RAM on all computers.

TRS-64K-2. . . . . \$9.95

**Update! TRS-80 MODEL IV, 4P Update!**  
Easy to Install Kit comes complete with: TRS-64K-2 (8 ea. 4164N-20 (200ns) 64K Dynamic RAMs); TRS-64K-2PAL (8 ea. 4164 plus PAL chip) and documentation for conversion.

TRS-64K-2 Expands Model IV from 16K-64K or Model IV 4 P from 64K-128K (includes 200ns Disk) . . . \$ 9.95  
TRS-64K-2PAL Expands Model IV (w/Black & White Monitors only) from 64K to 128K . . . . \$29.95

**• TRS-80 Model 100 • NEC • Olivetti**

Easy to Install Module plugs right into the socket increasing memory in 8K increments. Three modules will increase your memory to its full capacity. Complete with module and documentation for installation.  
M100AK (TRS-80 Model 100 Expansion) . . . . . \$29.95 ea. or 3/\$79.95  
NEC8KR (NEC PC-8201A) . . . . . \$29.95 ea. or 3/\$79.95  
OM108K (Olivetti M10) . . . . . \$29.95 ea. or 3/\$79.95

**TANDY 200**

Easy to Install module plugs right into the socket increasing memory in 24K increments. Complete with module and documentation for installation.  
M200R (Tandy 200 Expansion) . . . \$99.95 ea. or 2/\$189.95

**PROMETHEUS MODEMS**



**Intelligent 1200/300 Baud Modem with Real Time Clock/Calendar**

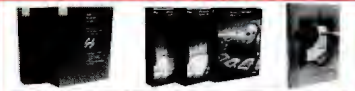
The ProModem™ is a Bell 212A (1200/300) intelligent stand-alone modem • Hayes compatible set compatible plus an additional extended command set • Shown with alphanumeric display option.

PM1200 RS-232 Stand-Alone Unit. . . . . \$299.95

**OPTIONS FOR ProModem 1200**

PM-COM (ProCom Communication Software) . . . . . \$ 79.95  
Please specify Operating System — IBM: PC DOS or MS DOS or IBM: PC DOS or MS DOS  
PM-OPS12K (Communication Buffer Option) . . . . . \$129.95  
BUF512K (512K Memory for PM-OPS12K) . . . . . \$ 54.95  
PM-ALP (Alphanumeric Display) . . . . . \$ 79.95  
PM-Special #2 (Includes PM-OPS12K, BUF512K and PM-ALP) . . . . . \$249.95

**DATA BOOKS**



- 30009 Internal Data Book (1989) . . . . . \$9.95 (Complete Line 11075 pages)
- 30013 Logic Data Book (1989) . . . . . \$9.95 (Microprocessors)
- 210830 Intel Memory Components Hndbk. (1983/84) . . . \$14.95 (Contains 40 Applications Notes, Article Reprints, Data Sheets & other single information on 8085 RAMs, DRAMs, EPROMs, SDRAMs and Static Memories 8085 1292p.)
- 220443 Intel Microsystem Components Hndbk. (1983/84) \$19.95 (Contains Data Sheets on all of Intel's Microprocessors & peripheral & 2 manuals 1270 p pages.)
- 30022 National Logic Data Book Set (1984) . . . . . \$24.95 (Microseries 1 & 2 1940 pages)

**Muffin-Style & Sprite-Style Fans**

MUF60 (SPH3-15-2462) Howard Industries (4.68"sq, 60cfm) . . . \$9.95  
SU2C7 EG&G Rotron (3.125"sq, 32cfm) . . . . . \$9.95

\*\*\*\*\* APPLE® Accessories \*\*\*\*\*

**GIVE YOUR COMPUTER A GIFT THIS SEASON... A VOICE!**

**Voice Synthesizers for Apple, Commodore, IBM & RS232 Computers**



**JE520 VOICE SYNTHESIZER FOR COMMODORE 64, VIC-20 — APPLE II, II+, IIe**  
Add speech capability to your Commodore 64 or VIC-20, Apple II, II+, IIe computer with JAMECO's JE520 Series Voice Synthesizer Speech — the most effective means of communication available to man — is now immediately available for your computer.

**Applications:**  
• Education • Entertainment • Instrumentation  
• Games • Telecommunications • Handicap Aids

**JE520 Features:**  
• More than 250 basic words, prefixes, suffixes, which allow the formation of well over 500 total words  
• Allows music, graphics and speech simultaneously  
• Programs in BASIC and/or Assembler  
• Very understandable and realistic male voice  
• Built-in amplifier, speaker, volume control and audio jack  
• Plug-in use-ready with complete documentation and sample software

The JE520 will plug right into your computer and be talking in minutes. It produces a very clear, natural male voice. The outstanding speech quality is produced using National Semiconductor's Digitalizer™ speech processor IC with four JAMECO custom memory chips. Case size: 7.1" x 3.6" x 1.3" Weight: 1 lb.

**COMMODORE 64 or VIC-20**

JE520CM	Voice Synthesizer for Commodore 64 or VIC-20 (includes JE521 Interface Module) . . .	\$ 99.95
JES21TS	Text-to-Speech Program for Commodore 64 or VIC-20 (5 1/4" Disk) . . . . .	\$ 9.95
JES21	Commodore Interface Module . . . . .	\$ 19.95

**APPLE II, II+ and IIe**

JES20AP	Voice Synthesizer for Apple II, II+ or IIe (includes JE525 Interface Module) . . . . .	\$119.95
JES23TS	Text-to-Speech Program for Apple II, II+ or IIe (5 1/4" Disk) . . . . .	\$ 8.95
JES23	Apple Interface Module . . . . .	\$ 39.95



**JE525 VOICE SYNTHESIZER FOR IBM or ANY RS232 COMPUTER**

The JE525 voice synthesizer for IBM or RS232 computers has the same features as listed above. The JE525 Interface Module allows the JE520 Series Voice Synthesizer to be interfaced with most popular microcomputers with the use of the standard RS232 port and logic levels. The JE525 Interface Module is powered from a wall transformer. Sample program is included in the User Manual.

**JE525 Interface Module Features:**  
• IBM compatible  
• CP/M Compatible  
• Power ON Indicator  
• Switch for DTE and DCE RS232 formats  
• Indicators for DTE or DCE modes  
• Standard D25S female connector

**IBM or Computers with RS232**

JES20IBM	Voice Synthesizer for IBM or RS232 Computers (includes JE525 Interface Module) . . .	\$199.95
JES25TS	Text-to-Speech Program for IBM (5 1/4" Disk) . . . . .	\$ 9.95
JES25	IBM/RS232 Interface Module . . . . .	\$119.95

**NEW! QUALITY APPLE COMPATIBLE CARDS For Apple II, II+ and IIe\***

**Jameco** **Five Key Software Programs! For Apple II, II+ and IIe\*** **RAM Disk!**

The JE866 is functionally compatible with the Apple II language card and can be utilized with all software that can be used with a standard 16K card. The JE866 requires no modifications to your Apple computer. Five key software programs are included: Memory Management System, utilities, diagnostics, demos, and RAM disk emulators for DOS 3.3, CP/M and Apple Pascal. Also features DOS relocater. Complete with instructions.

**JE866 (Expand-A-RAM) . . . . . \$119.95**

**Appareance Diagnostic Disk Controller Card Prevents Crashes! For Apple II, II+ and IIe\***

The JE877 serves as a diagnostic tool, an assurance/maintenance tool and a dual disk controller. The JE877 will verify and check the operating hardware of your system each time you turn on your Apple II, II+ or IIe. Test your RAM, ROM, CPU, and disk drives. Diagnostic routines may be cancelled at the touch of a key. Complete with instructions.

**JE877 (DRV-1/Appareance II) . . . . . \$69.95**

**Parallel Printer Card For Apple II, II+ and IIe\***

The JE880 Printer Card interfaces to most of today's popular dot-matrix graphics printers. The JE880 is fully compatible with Apple CP/M, Apple Pascal (or FORTRAN), and most other operating systems and software packages available for Apple II, II+ and IIe. The JE880 is shipped configured for the Centronics standard and can be re-configured for other standards if necessary. Advanced text printing features include: video screen on or off, auto-disable latched after carriage return, set clear the 8th bit of the output data, set left margin and more! Complete with instructions.

**JE880 (PRT-1) . . . . . \$59.95**

**Parallel/Serial Buffer Card For Apple II, II+ and IIe\***

The JE883 provides the user with up to 64K of additional or buffered memory (16 pages of information). Using the parallel/jumper cable supplied, the JE883 will attach to the JE520 (above). Parallel Card needed for operation. The JE883 includes a standard parallel input with both parallel and serial (RS232) buffered outputs. With these features you may increase buffer information to two types of printers, (one serial, one parallel) simultaneously. Complete with instructions.

**JE883 (P/S Buffer) . . . . . \$79.95**

**Jameco's New 1986 Catalog!**  
Filled with New Products, Reduced Pricing and Valuable Pin-out Data.  
Send \$1 Postage for FREE 1986 Jameco Catalog!

\$20 Minimum Order — U.S. Funds Only CA Residents: Add 6% or 6 1/2% Sales Tax Spec Sheets — 30¢ each Shipping: Add 5% plus \$1.50 insurance Send \$1 Postage for FREE 1986 Jameco Catalog! Prices Subject to Change Send stamped, self-addressed envelope to receive a Quarterly Sales Flyer — FREE!

Mail Order Electronics Worldwide

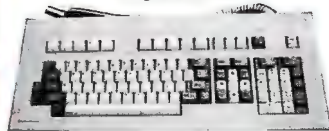
**Jameco** ELECTRONICS

1355 SHOREWAY ROAD, BELMONT, CA 94002  
12/85 PHONE ORDERS WELCOME — (415) 592-8097 — Telex: 176043

MasterCard VISA

**IBM® Accessories**

**IBM PC/XT Compatible Keyboard**



IBM-5151 (Equivalent to Keytronic's 5151) . . . . . \$129.95

**Additional Add-Ons Available!**

**MEMORY EXPANSION KITS IBM PC, PC XT and Compatibles**

The IBM64K Kit will increase memory in 64K byte increments. The Kit is simple to install — just insert the 9 - 64K RAM chips in the provided sockets and set the 2 groups of switches. Conversion documentation included.  
**IBM64K (Nine 200ns 64K RAMs) . . . . . \$7.95**

**IBM PC AT**

Each kit comes complete with nine 128K dynamic RAMs and documentation for conversion.  
**IBM128K (Nine 200ns 128K RAMs) . . . \$43.95**

**IBM PCXT Equivalent 130 Watt Power Supply**



**UPGRADE YOUR PC!**  
• Input: 110V @ 60Hz • Output: +5VDC @ 15A, -5VDC @ 0.5A, +12VDC @ 4.2A, -12VDC @ 0.5A • Plug compatible connectors • Fits into IBM PC • Weight: 6 lbs.  
**IBM-PS. . . . . \$99.95**

**Prometheus Modems**

The ProModem 1200B/BS is a 1200/300 baud modem card which plugs into IBM PC and XT. Provides a third serial Comport. Two versions available: 1200B (without software) and 1200BS (with software). The PM1200BS is supplied with powerful MITE communications software from Mycroft Labs. Software available: PC DOS or MS DOS.  
**PM1200B (without Software) . . . . . \$239.95**  
**PM1200BS (with MITE Software) . . . . . \$274.95**

**IBM Compatible! DISK DRIVES**



- Documentation Included**
- RFD480 (Remex 5 1/4" DS full-ht.) . . . . . \$69.95
  - FD55B (Teac 5 1/4" DS half-ht.) . . . . . \$99.95
  - SA455 (Shugart 5 1/4" DS half-ht.) . . . . . \$99.95
  - TM100-2 (Tandon 5 1/4" DS full-ht.) . . . . . \$99.95
- JMR 5 1/4" DISK DRIVE ENCLOSURES**  
Complete with power supply, switch, power cord, fuseholder and connectors
- DDE-1FH (Houses 1 full-ht. 5 1/4" floppy drive) . . . \$ 69.95
  - DDE-2HH (Houses 2 half-ht. 5 1/4" floppy drives — vertical) . . . \$ 79.95
  - HDDE-1FH (Houses 1 hard drive) . . . . . \$199.95

**General Application Keyboards**

**Mitsumi 54-Key Unencoded Keyboard**

- SPST keyswitches • 20 pin ribbon cable connection
- Low profile keys • Features: cursor controls, control, caps (lock), function, enter and shift keys • Color (key-caps): grey • Weight: 1 lb. • Pinout incl. • Size: 13 1/2" L x 4 1/4" W x 3/4" H

**KB54. . . . . \$9.95**

**74-Key ASCII Cherry Keyboard**

• 7-bit parallel ASCII • Full Upper Case, Full Lower Case except i, n, o and p • Cursor keypad • SPST mechanical keyswitches • 26-pin header connector • Color: white • Size: 18 1/2" x 6 1/2" W x 1 1/4" H • Spec Included

**KB8201. . . . . (1500 available) . . . . . \$14.95**

**UV-EPROM ERASER**

**8 Chips - 21 Minutes**

**1 Chip - 15 Minutes**

Erases all EPROMs. Erases up to 8 chips within 21 minutes (1 chip in 15 minutes). Maintains constant exposure distance of one inch. Special conductive foam liner eliminates static build-up. Built-in safety lock to prevent UV exposure. Compact — only 9.000" x 3.700" x 2.600". Complete with holding tray for 8 chips.

- DE-4 UV-EPROM Eraser . . . . . \$74.95
- UVS-11EL Replacement Bulb . . . . . \$17.95



CALL FOR QUANTITY DISCOUNTS

7400

Table listing 7400 series ICs with columns for Part No., Price, and other details.

74LS

Table listing 74LS series ICs with columns for Part No., Price, and other details.

74S/PROMS\*

Table listing 74S/PROMS series ICs with columns for Part No., Price, and other details.

74ALS

Table listing 74ALS series ICs with columns for Part No., Price, and other details.

74F

Table listing 74F series ICs with columns for Part No., Price, and other details.

CD - CMOS

Table listing CD - CMOS series ICs with columns for Part No., Price, and other details.

SPECIAL!! SPECIAL!! SPECIAL!!

MOTOROLA MC68701 - Microcomputer with EPROM. Includes description of 8-bit microcomputer and price of \$24.95.

CUSTOM COMMODORE CHIPS

Table listing Commodore chips with columns for Part No., Description, Price, and other details.

MICROPROCESSOR COMPONENTS

Table listing microprocessor components with columns for Part No., Price, and other details.

EEPROM

2816A 2x 2048x8 16K EPROM 350ns. \$8.95. Includes description of non-volatile memory and price.

Digitalizer™

DT1050 Applications: Tracking, digitizing, checks, arithmetic, communications. Includes description and price.

DT1050 Digitalizer™... \$24.95 ea. MM54104 Processor Chip... \$12.95 ea.

INTERSIL

Table listing Intersil products with columns for Part No., Price, and other details.

30009 1985 Intersil Data Book (1075 pgs) \$9.95

74HC HIGH SPEED CMOS

Table listing 74HC HIGH SPEED CMOS products with columns for Part No., Price, and other details.

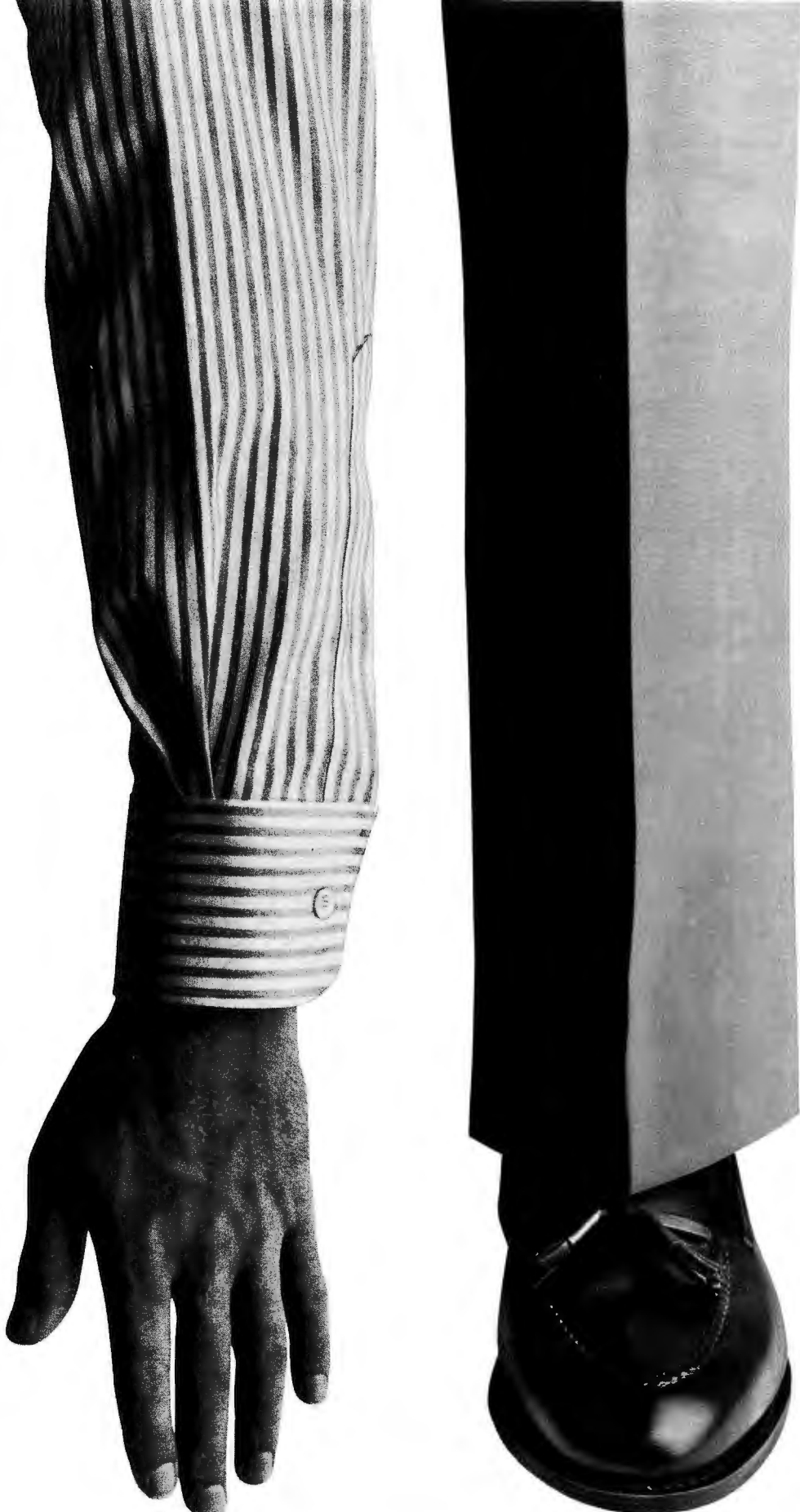
74C-C/MOS

Table listing 74C-C/MOS products with columns for Part No., Price, and other details.

LINEAR

Table listing linear ICs with columns for Part No., Price, and other details.

MasterCard, Visa, 1355 SHOREWAY ROAD, BELMONT, CA 94002. PHONE ORDERS WELCOME - (415) 582-8097 - Telex: 176043



IF YOU'RE TIRED OF PAYING OUTRAGEOUS LONG DISTANCE CHARGES EVERY TIME YOUR COMPUTER TALKS ON THE PHONE, GTE TELENET OFFERS AN ALTERNATIVE. IT'S CALLED PC PURSUIT<sup>SM</sup>

NOW FOR ONLY \$25 A MONTH (PLUS A ONE-TIME INSTALLATION FEE OF \$25) YOU'LL BE ABLE TO REACH OTHER PC USERS, FREE LOCAL DATABASES AND BULLETINBOARDS IN ATLANTA, BOSTON, CHICAGO, DALLAS, DENVER, DETROIT, HOUSTON, LOS ANGELES, NEW YORK (AREA CODE 212), PHILADELPHIA, SAN FRANCISCO AND WASHINGTON D.C. AND TAKE ADVANTAGE OF LOCAL SOFTWARE DOWNLOADING CAPABILITIES, AS WELL.

YOU CAN USE THE PC PURSUIT SERVICE BETWEEN 6PM AND 7AM WEEKDAYS. AND ALL DAY ON WEEKENDS. ALL YOU NEED IS AN AUTO-ANSWER MODEM AND COMMUNICATIONS SOFTWARE.

FOR MORE INFORMATION AND TO REGISTER, CALL A GTE TELENET REPRESENTATIVE AT 800-368-4215 BETWEEN 8AM AND 5PM EASTERN TIME. OR USE YOUR MODEM TO CALL 800-835-3001 FOR OUR ON-LINE USER'S GUIDE 24 HOURS A DAY.

TRY PC PURSUIT, FROM GTE TELENET—WORLD LEADER IN PUBLIC NETWORK SERVICES, INTERNATIONAL NETWORK SERVICES, PRIVATE DATA NETWORKS AND INNOVATIVE NETWORK APPLICATIONS.

FINALLY YOU CAN GET YOUR HANDS ON THE INFORMATION YOU NEED. WITHOUT PAYING AN ARM AND A LEG.

**GTE Telenet**

NOW YOU DON'T HAVE TO PAY THIS MUCH  
TO ACCESS INFORMATION WITH YOUR HOME COMPUTER.

## COMMON GROUND

BY CHRIS HANCOCK

---

*The user-friendliness of this microcomputer-based conferencing system derives from its easy-to-visualize functions*

IN THE COURSE of putting together a computer-based conference for science teachers, my colleagues and I wound up writing a complete conferencing system that runs on a microcomputer. It's called Common Ground, and we think it's the best in its class. In this article I'll talk about the program and some of the thinking that went into its design, and I'll present some of the program's internal structures. I'll also discuss some issues to consider in running your own conference using Common Ground.

The Educational Technology Center is an organization funded by the National Institute of Education and based at the Harvard Graduate School of Education. Its mission is to study how computers and other new technologies might help improve the teaching of math, science, and computing. One problem we've been looking at is the isolation of science teachers: Many science teachers, especially in rural areas, have very limited opportunities to share ideas with colleagues or to find out what's new and interesting in their scientific fields. Computer conferencing seems to be one promising way to address

the problem. We've been putting together an experimental computer-based conference for science teachers in order to see the ways it might help.

We needed our conferencing software to satisfy several requirements. First, it had to be easy to understand and use; this was our single most important criterion. At the same time, it needed to be a real conferencing system with enrolled participants, full capabilities for private messages, flexible organization of public discussions, and effective ways of searching through messages to find what you're looking for. Finally, we wanted a system that would run on a microcomputer.

School districts, like many other organizations, have modest budgets, and for most of them a large computer is out of reach. Of course, there are limitations to using a microcomputer. For the time being, at least, most micros can support only one user at a time. This imposes a pretty hard limit on the total number of participants, but the limit is not as low as one might think, provided people's schedules are varied enough. We have seen a conference with as many as

100 regular participants run comfortably on a micro. Given that one of our goals is to develop a strong conference community, more than 100 people would probably be undesirable anyway. The one-user-at-a-time limit also means that occasionally you do get a busy signal when you call, and you have to try again later. This wouldn't do for businesses where messages need to get through quickly and without fail, but for our application that isn't so crucial.

### **AN EASY SYSTEM TO USE**

We couldn't find the system we wanted, so I wrote it. We feel that its simplicity and ease of use are a design triumph. The single most important reason for this is the spatial metaphor around which the system is structured. We picture the Common Ground system as a building with rooms in it. Every enrolled participant has a private office that no one else can get into. Private mail sent to a par-

*(continued)*

*Chris Hancock is a project associate at Harvard's Educational Technology Center (Gutman 337, Harvard Graduate School of Education, 6 Appian Way, Cambridge, MA 02138).*

participant is delivered to that person's office. The building also has other rooms, called forums, that anyone can visit. Each forum is devoted to a particular discussion topic.

The power of the spatial metaphor is that it makes it easy to understand the state of the program ("where" you are in it) at any moment. Most interactive programs can change their states in a couple of ways: The data that is active or loaded may change (for example, you might load a new text file into a word-processor buffer) or the current mode may change (for example, in a database program you might go from record-definition mode to data-entry mode). In the Common Ground system, the idea of moving from room to room stands for a change of active data. When you are in your office, you have access to your personal mail; if you move to a public forum, you have access to the public mail there. As for modes, I have consciously worked to keep the number to a minimum. In fact, for the ordinary user there are just three modes. The main mode has just 10 commands. Then there's message-entry mode, where you type in your messages. The third mode is the text editor, which can be avoided by novices. (There are also special modes for the operator and other privileged users.) The main-mode commands are as follows:

**scan:** lists the messages in the current room.

**read:** reads messages in the current room. The scan and read commands both accept qualifiers that select messages in the room, based on date, author, topic, and whether you've read them before.

**send:** sends a message to any room or combination of rooms. The send command features a line editor for those who want to edit their messages before sending them.

**scout:** lists all forums on the system and the number of new (for you) messages in each one.

**visit:** lets you move from room to room.

**home:** takes you back to your own office.

**whois:** provides information about a participant or a forum.

**set:** lets you change your password as well as specify the width and height of your screen.

**help:** provides full on-line documentation.

**bye:** ends the session.

The short sample session shown in figure 1 gives the flavor of the system. As you can see, private and public mail is read and sent in pretty much the same way, using the read, scan, and send commands. Their effect simply depends on what room you're in and what room(s) you send messages to. This is a good example of the design principle known as orthogonality: One set of features operates independently from another set, with every possible combination having a meaning.

Orthogonality is prized by software people because it generally lets you express a lot in terms of just a few basic concepts. Sometimes, though, an orthogonal structure forces you to abandon your commonsense understanding of the application in favor of a more abstract one. This trade-off came up in the issue of groups and forums. Besides participants and forums, there is one other kind of entity to which you can address a message: a group. Groups do not correspond to rooms in the system. Instead, each group has a membership list, and any message sent to that group is distributed to the offices of all members of the group. Membership in groups is controlled; you have to ask to be enrolled in them. Groups are intended for topics that are confidential or urgent.

So groups and forums differ in two ways: Groups have restricted access, while forums have open access; and group messages are delivered to their members, while forum messages go to a room of their own. Thinking orthogonally, it's possible to imagine two other kinds of entities: forums with limited access, so that not everyone can visit them; and groups with free access, which participants can enroll in at will (perhaps using com-

mands like subscribe and cancel, to invoke the home-delivery feature).

This time, we decided the orthogonality wasn't worth it. For one thing, it makes the solution more complicated than the problem. For almost any conceivable purpose, one of the existing options (forum or group) will do just fine. Moreover, a lot of attention devoted to access and privacy schemes would be out of place in a system intended to promote a feeling of community. The other important consideration was simplicity. Forums and groups are easy to understand: The words "forum" and "group" resonate well with the way they actually work on the system. Abstracting out the two dimensions they differ on would lose us that valuable intuitive base, unless we devoted a lot of effort and emphasis to a more extended metaphor (perhaps involving keys or secret passwords to forum rooms, which begins to seem more like an adventure game!).

### DESIGN ISSUES

The most important work in producing a piece of software like Common Ground is not implementing it but specifying it—designing the way it will appear to users. Furthermore, in order to decide how the program should behave, you need, in effect, to design all the activities that will take place around the program. It is vital to recognize that the software system functions as a part of a larger system of human and technical interactions. As the principle of top-down design implies, the first task is to design that larger system and then to proceed down to the computer program itself. Design decisions at the top level will have implications for the design of the actual program.

In principle, this is true for any program. It is crucial in the case of a computer conferencing program for two reasons. First, computer conferencing consists of more than just the running of a computer program. Second, because computer conferencing is in its infancy, there are plenty of open questions concerning how a con-

## COMMON GROUND

ference should be run. These are also the reasons why our eventual goal is to produce a package that includes, in addition to software, an extensive guide to running an educational (or other) computer-based conference.

We began our top-level design work

by looking at the different kinds of problems that computer conferences can run into and thinking about ways to solve them. One of our conclusions was that a successful computer conference must have people working in several different roles, which are de-

scribed in the following sections. The existence of these roles has in turn affected how the software is designed. Naturally, the importance of these roles varies with the type of conference. In a very informal conference,

(continued)

```
COMMON GROUND version 1.0

  — ETC Science Teachers' Network Pilot —

codename: fred
password:
fred logged in at 3:17 PM July 14, 1985

__fred > mail

  message 414 from chris filed July 14, 1985 9:17 AM
  re: just saying hi
  message 400 from donh filed July 12, 1985 12:28 PM
  re: how about an AP physics forum
  * message 325 from cju filed June 22, 1985 7:25 PM
  re: invitation

__fred > read new

msg no. 400 filed 12:28 PM July 12, 1985
from donh
to bram fred ellenk
re: how about an AP physics forum
Hi folks. I'm thinking about proposing that we set up
a new forum for discussing problems and ideas for
teaching AP physics. One thing the forum could
work toward would be a series of tried and true
lab experiments. I know you have taught the course.
Would any of you be interested in such a forum? Do
you know who else would be?
OK to release? n
not released.

msg no. 414 filed 9:17 AM July 14, 1985
from chris
to fred
re: just saying hi
Hi Fred, how have you been lately? I
thought of you yesterday when I was
buying vegetables. Well, see you
later. /chris
OK to release? y
message 414 released

__fred > send
to: chris
re: hi
enter text, terminated by =

That's amazing. I thought of you yesterday
when I was feeding my parking meter. I wonder
if it was at the same moment? /F
=
send, review, edit, abort (s/r/e/a): s

__fred > scout
  forum # new messages
  whales 0
  nb 0
  system 0
  soft 6
  nsq 11
  halley 2
  mott 2

__fred > visit halley

__halley > scan
  message 357 from renee filed July 5, 1985 1:02 PM
  re: susan's radio idea
  message 330 from chris filed June 23, 1985 9:33 AM
  re: telescopes
  > message 319 from chris filed June 21, 1985 11:41 AM
  re: went to the lecture
  message 315 from renee filed June 20, 1985 7:14 PM
  re: comet halley
  message 291 from sburt filed June 18, 1985 11:18 PM
  re: I need telescope advice
  message 290 from kim filed June 18, 1985 11:14 PM
  ^O...
__halley > read 330

msg no. 330 filed 9:33 AM June 23, 1985
from chris
to sburt halley
re: telescopes
Hi Susan! I've just heard that if you
want to get a good view of Halley's
comet you should get a telescope with
a short focal length. This is because
the comet will be dispersed over the sky
...several times bigger than the moon.
/chris

__halley > bye
bye.
%%%%
```

Figure 1: A sample session on Common Ground. The user reads three private mail messages, sends a private mail message, checks for any new activity in the forums, visits the halley forum, and reads a message there.

*Many would-be participants never get over the initial hump of learning to use a conferencing system.*

with computer-literate participants, all the jobs can easily be done by one person.

#### **USERS' TECHNICAL PROBLEMS**

Many would-be participants never get over the initial hump of learning to use a conferencing system. Connecting one's modem, figuring out how to use the communications package, setting communication parameters, dialing up the system, logging in, and navigating the conferencing system itself—every one of these is difficult the first (and second) time and is an opportunity to get snagged. A few technical problems, compounded with bad documentation and a general distrust of computers on the part of the user, have put a quick end to many a novice's conferencing career.

Our response to this was twofold. First, we decided that if the conference participants are not experienced with computers, then it is vital for the conference to have a technical support person who helps novice users with the conferencing system and with their own communications equipment and software (a hand-holding session is often the best way to get over the initial hump). The support person should be available whenever users have technical problems or questions.

Second, we have worked very hard to make the system as easy to understand and use as possible. We have kept the number of commands to a minimum. The metaphor of forum rooms and private offices helps tremendously because it makes it easy to picture what's going on when

you're using the system. It's also worth noting that in trying to make the system simple I chose a command-driven structure rather than a menu-driven one, and that the commands are entire words, not single letters (actually, the words can be abbreviated, but we don't emphasize that fact to novices). It is generally assumed that menus with one-letter options are the most user-friendly way for an interactive program to work. However, this is really the case only when the program itself is the user's only resource for help. It is not the case when (1) the program is meant to be used often, at 1200 or 300 bits per second, and (2) there is someone to teach the user how to work the system. Under those conditions, commands are better because you don't have to sit through the menu display every time, and entire words are better because people who aren't computer experts relate better to words than to codes. This is a good example of how considering the human activities in the conference has affected the design of the software.

#### **RELUCTANCE TO PARTICIPATE**

Participants who do learn how to use the system often don't make any contribution to the discussion. They feel uncomfortable with the medium. After all, it can be scary to put your opinions and questions out in public view, when you can't even see who's reading your message and how they're responding to it. It's a disconcerting experience to write a message and get no acknowledgment back. What did people think? Was the message irrelevant? Was it dumb?

This, too, has affected our software design. First, we recognize the value of small scale in a conference. A huge enrollment contributes strongly to the anonymous feeling that makes people reluctant to participate. This is one of the main reasons why we were happy to run our conference on a microcomputer. It is also why Common Ground is not designed as an open-access system. One of the roles we envision in the running of a computer conference is the membership coordinator. This

person decides who gets to participate in the conference and keeps in touch with members about whatever administrative issues arise. The membership coordinator is also the chief steward (participants can be given stewarding privileges, which enable them to add participants to the system, create and delete forums and groups, change people's passwords, and so on).

In addition to limiting scale, we have also consciously limited the function of the conferencing system: It is meant to be used for having discussions, not for exchanging computer programs, keeping databases, or archiving old messages. These are functions that would dilute the sense of community that helps to make good discussion possible and would also make the system more complicated to use.

Finally, the program expects every forum to have a moderator. Unlike the other roles listed here, moderators for the various discussions will normally be drawn from the general conference membership. Although the technique of moderating a computer-based conference is not yet well understood, writers on computer conferencing agree that it is very important to have a moderator who keeps discussions on track, elicits comments from participants, and ensures that everyone feels rewarded for their participation. In the Common Ground system, moderator privileges include moving messages in and out of the forum and editing the topic headers of messages in the forum so that they more clearly reflect message content.

#### **CONTENT**

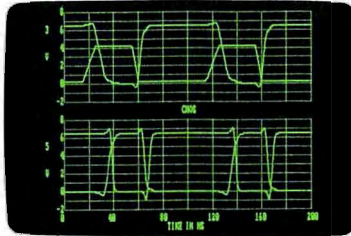
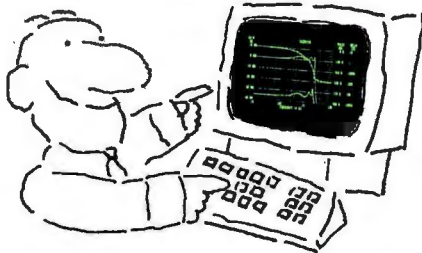
The bottom line is this: If the content on the network isn't interesting and important to the participants, they won't participate. Yes, just communicating by computer is fun, and for some of us that's enough to hold our interest. But for most people, after the novelty has worn off, computer conferencing has to compete with other daily pressures. If they don't perceive the experience as worthwhile, they'll

*(continued)*

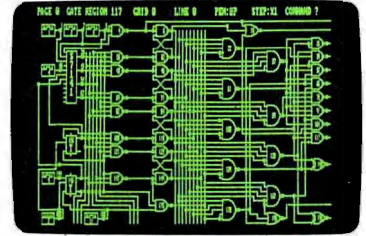
# MICRO CAP and MICRO LOGIC put your engineers on line... not in line.



## MY OWN WORKSTATION



"Typical MICROCAP Transient Analysis"



"Typical MICROLOGIC Diagram"

How many long unproductive hours have you spent "in line" for your simulation? Well, no more. MICROCAP and MICROLOGIC can put you on line by turning your PC into a productive and cost-effective engineering workstation.

Both of these sophisticated engineering tools provide you with quick and efficient solutions to your simulation problems. And here's how.

## MICROCAP: Your Analog Solution

MICROCAP is an interactive analog circuit drawing and simulation system. It allows you to sketch a circuit diagram right on the CRT screen, then run an AC, DC, or Transient analysis. While providing you with libraries for defined models of bipolar and MOS devices, Opamps, transformers, diodes, and much more, MICROCAP also includes features not even found in SPICE.

MICROCAP II lets you be even more productive. As an advanced version, it employs sparse matrix techniques for faster simulation speed and larger net-

works. In addition, you get even more advanced device models, worst case capabilities, temperature stepping, Fourier analysis, and macro capability.

## MICROLOGIC: Your Digital Solution

MICROLOGIC provides you with a similar interactive drawing and analysis environment for digital work. Using standard PC hardware, you can create logic diagrams of up to 9 pages with each containing up to 200 gates. The system automatically creates the netlist required for a timing simulation and will handle networks of up to 1800 gates. It provides you with libraries for 36 user-defined basic gate types, 36 data channels of 256 bits each, 10 user-defined clock waveforms, and up to 50 macros in each network. MICROLOGIC produces high-resolution timing diagrams showing selected waveforms and associated delays, glitches, and spikes—just like the real thing.

## Reviewers Love These Solutions

Regarding MICROCAP . . . "A highly recommended analog design program" (PC Tech Journal 3/84). "A valuable tool for circuit designers" (Personal Software Magazine 11/83).

Regarding MICROLOGIC . . . "An efficient design system that does what it is supposed to do at a reasonable price" (Byte 4/84).

MICROCAP and MICROLOGIC are available for the Apple II (64k), IBM PC (128k), and HP-150 computers and priced at \$475 and \$450 respectively. Demo versions are available for \$75.

MICROCAP II is available for the Macintosh, IBM PC (256k), and HP-150 systems and is priced at \$895. Demo versions are available for \$100.

Demo prices are credited to the purchase price of the actual system.

Now, to get on line, call or write today!

## Spectrum Software

1021 S. Wolfe Road, Dept. B  
Sunnyvale, CA 94087  
(408) 738-4387

Inquiry 339

leave. In some cases this means that a computer conference isn't appropriate. Many computer-based conferences have failed because they simply didn't fulfill any pressing need for the participants. When a computer-based conference is appropriate, somebody needs to be concerned with maintaining worthwhile content. The "content coordinator" keeps watch over the discussions, arranges for special guests or events on the system, and in general tries to promote interesting and valuable discussion content in the system. This person is also the system's chief moderator.

After all this talk about human roles, it's still true that you can't have a computer conference if your computer isn't working. That's why a conference also needs a system operator. The sysop takes the system up and down, worries about hardware, and periodically

runs file-maintenance routines. The Common Ground program starts up in operator mode. The operator can start a local Common Ground session at the console or put the program in wait mode (waiting for a call to come in). The operator can control monitoring of calls at the screen or at the printer. In addition, whenever a call is in progress the operator can "butt in"—that is, make the console share the remote user's input and output. This is intended mainly as a way to help novice users. It lets the operator type in commands for users, right before their eyes, and explain what's happening step by step.

**PRINCIPAL DATA STRUCTURES**

I developed Common Ground using Turbo Pascal on a DEC Rainbow Plus with a hard disk. The complete program is about 5000 lines long. The system's data is kept in three random-

access files: the recipients file, the message directory, and the message-body file.

Each component of the recipients file is a Pascal record containing complete information about a recipient ("recipient" is the general term I use to mean a person, forum, or group—anything you can send a message to), including its full name and a list of its current message numbers, or, in the case of a group, its membership list. Every time a new recipient is added to the system, a new record is appended to the file. As you can see in figure 2, a recipient's position in the file (its component number) is used throughout the program to stand for that recipient.

The message directory contains all the information about messages except for their actual content. Each component is a record that holds the

(continued)

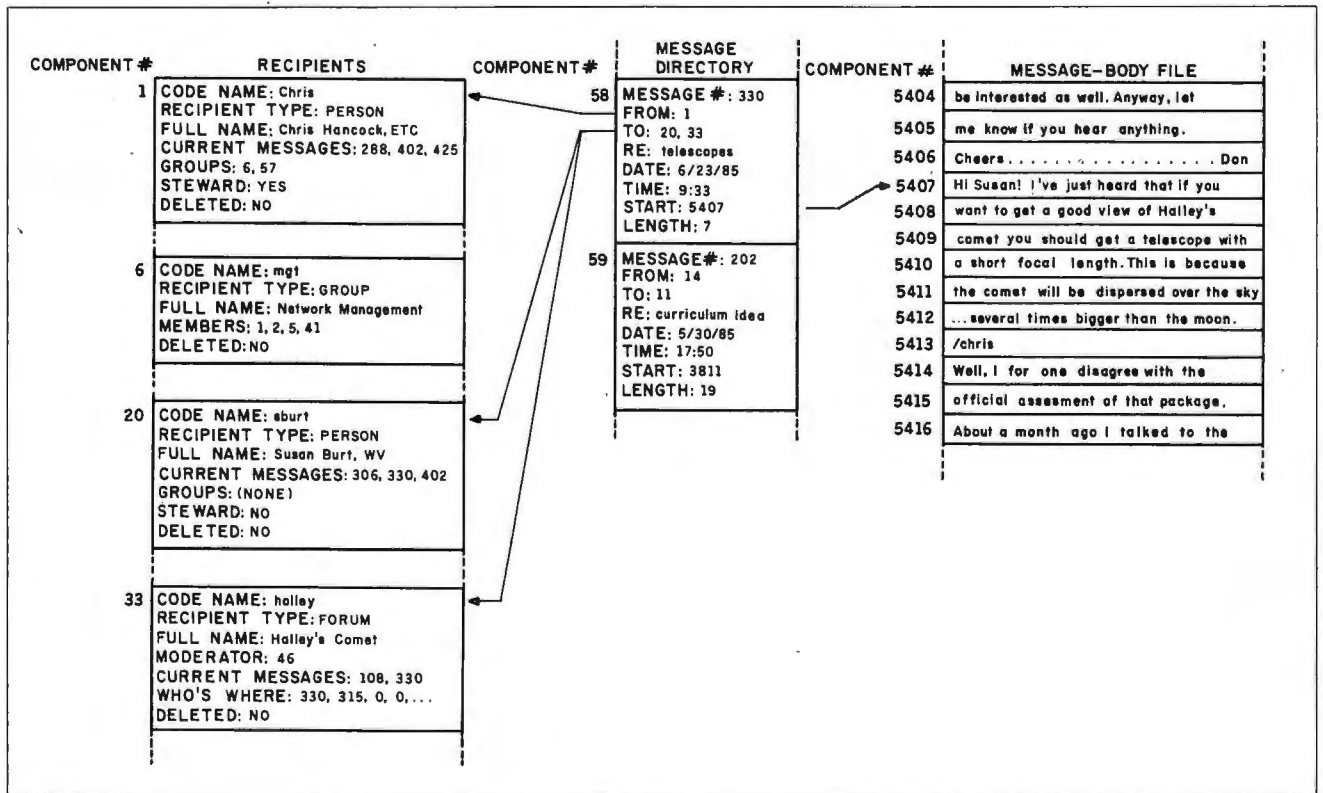


Figure 2: An example of Common Ground's three data files, showing how the different components are linked to one another. The WHO'S WHERE entry in the halley forum is a list showing how far recipients have read. For example, the 330 in the first position indicates that recipient 1 has read up to message 330. The 315 in the second position indicates that recipient 2 has read up to message 315.



# Look at what we're plugging now.

## Plug-in Teacs.

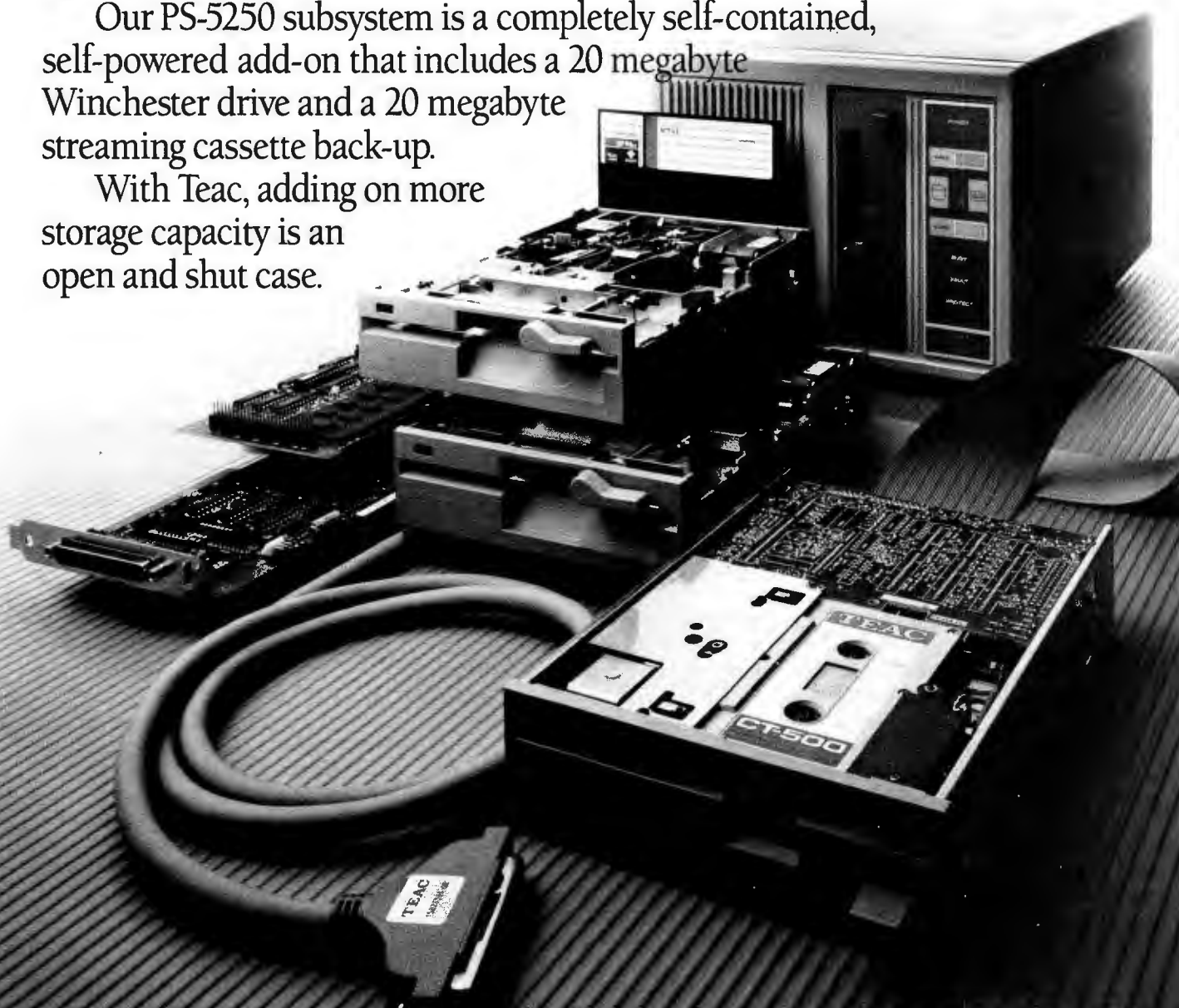
We offer a full line of PC compatible components to increase your floppy storage, to add Winchester drives, or to include a streaming cassette back-up.

Our FD-55 Series, half-height, low power, 5¼-inch floppy disk drives are the world-wide standard of excellence with over 3 million in service to date. A quick and easy way to double your capacity.

Our MT-2st Kit is all you need to plug-in a streaming cassette back-up system. With 90 ips performance, you can store up to 20 megabytes of back-up incredibly quick.

Our PS-5250 subsystem is a completely self-contained, self-powered add-on that includes a 20 megabyte Winchester drive and a 20 megabyte streaming cassette back-up.

With Teac, adding on more storage capacity is an open and shut case.



Built To Fanatical Standards. **TEAC**

INSTRUMENTATION AND COMPUTER PRODUCTS DIVISION, 7733 TELEGRAPH ROAD, MONTEBELLO, CA 90640

East (617) 475-7311 South/Midwest (312) 351-9124 Rocky Mountain (602) 242-4025 (303) 337-6329 (801) 532-2111

Northwest (408) 727-1427 Southern California (213) 726-0303

SEE US AT COMDEX BOOTH 0464

Inquiry 406

©1983

*While the limit of  
one user at a time  
is not a serious one,  
it would obviously be  
nice to overcome it.*

message's author, addressees, topic header, time and date of filing, and a pointer to the location in the message-body file where the text of the message can be found. Since messages are periodically purged and message numbers keep increasing throughout the life of the system, the entry for a message can't be stored in the component with the same number. Instead, the component number for a message entry is computed by a hashing function. Hashing collisions are resolved by the quadratic probe technique (if the component you want is full, look at the next one; if that's full, look at the one four positions away; if that's full too, look nine positions away, and so on).

The message-body file is a random-access file of strings containing the actual text of messages. It's a file of strings because you can't have random access to an ordinary text file; the components all have to be the same size. Because of the limit on the number of components in a random-access Pascal file (64,000), the message-body file is actually implemented as a sequence of files. Every time a message is sent, its text is appended to this file.

Let's look more closely at what happens when a message is sent. Suppose that user chris sends a message addressed to sburt (a person) and halley (a forum), as shown in the sample session in figure 1. Here's what happens:

- The body of the message is appended to the message-body file, and the message is assigned the next available number (330 in this example).

- 330 hashes to component 58 of the message directory, so the information about this message, including where its text can be found in the message-body file, is stored there.

- The number 330 is appended to the mail lists for sburt and halley in the recipients file.

When sburt logs in and types read new in her office, one of the messages she will see will be number 330. After displaying the message, Common Ground will ask her if it's okay to release it. If she says yes, the number 330 will be removed from her current message list; if not, it will be flagged as read (by changing it to a -330) so that it won't be displayed the next time she enters read new.

As time goes by, the system begins to fill up. Some of the recipients have been deleted by stewards and are using up space in the recipient file. Some messages are "dead," having been released from every room they were sent to. The purging process goes like this:

- The unused slots in the recipient file are freed for future use. This doesn't mean that any records are moved around in the recipients file. Instead, all references to the numbers of deleted recipients are changed. For example, suppose chris was deleted from the system and a new person, freida, was added in position 1. If message 330 were still around, it would now display as though it had been sent by freida. To avoid this, the purging process will change message 330's author from 1 to 0, which will display as -deleted-.

- A binary search tree of all active message numbers is built in main memory, containing all message numbers found in any active-message list in the recipients file.

- The program scans through the message directory, zeroing out the message numbers of messages that are no longer active and recording, in the active-message tree, the message-body file pointers for all active messages.

- The message-body file is collapsed, using the pointer information in the

active-message tree. The text of active messages is moved back over the space occupied by inactive message text.

- The header file is rehashed because the entries for active messages might now be out of position due to collisions with messages that are no longer active.

#### WHAT YOU NEED

Common Ground will run on a DEC Rainbow (running MS-DOS version 2.11 or later) or an IBM Personal Computer or compatible. For a big conference and optimal response time, you should have a hard disk with between 1 and 10 megabytes devoted to the conference, but you can also have a decent conference with a pair of floppy-disk drives. A third floppy-disk drive will increase the maximum number of active messages from approximately 300 to 500. You'll also need an auto-answer modem that can run at 300 bits per second, 1200 bps, or both. The original Common Ground system was developed with a Multi-Tech 300/1200 modem, but it will also work with a Hayes 1200 and most compatible modems. [Editor's note: The object code for Common Ground is available for downloading from BYTEnet Listings at (617) 861-9764.]

#### FUTURE DEVELOPMENTS

While the limit of one user at a time is not a serious one for our present purposes, it would obviously be nice to overcome it. If and when multitasking MS-DOS and Turbo Pascal become available, it will be possible to have more than one user logged in at a time. However, the most exciting next step for the system—and one that doesn't have to wait for new technology—is the interconnection of Common Ground systems. This will allow participants on one system to send messages to participants on other systems, as users of FidoNet are currently able to do. It will also allow a joint forum discussion to be shared by two or more nodes. The actual message transfers will normally happen automatically at night, when phone rates are lower. ■

# COMPUTER WAREHOUSE

CALL TOLL FREE **1-800-528-1054**

**FREE FEDERAL EXPRESS**  
Air Express Shipping  
See Details Below

**HARDWARE**

**SPECIAL** Zenith Computer Products  
**SAVE Up to 50%**

**PRINTERS**

Anadex All Models	Call
Brother All Models	Call
C-10h 8510 AP+	\$314
Citizen MSP-10	\$255
MSP-15	\$349
MSP-20	\$319
MSP-25	\$489
Datasouth DS180	\$1079
DS220	\$1299
DS-PP#1	\$419
DS-PP#2	\$615
Diablo D-25	\$549
630API	\$1484
630 ECS/IBM	\$1659
Other Printer Models	Call
Epson All Printer Models	Call
Juki 6000	\$169
6100	\$349
6300	\$679
NEC 2010, 2015, 2050	\$629
3510, 3550	\$989
3515	\$1009
3530	\$935
8810, 8830, 8850	\$1379
P2, P3	Call
E1f 360	\$399
E1f 370	\$389
Okidata All Printer Models	Call
Panasonic 1091	\$235
1092	\$349
1093	\$429
KXP3151	\$409
Star Micronics All Printer Models	Call
Silver Reed	
EXP400 Parallel	\$205
EXP500 Parallel or Serial	\$279
EXP550 Parallel or Serial	\$389
EXP770 Parallel or Serial	\$699
Toshiba P1340 Parallel or Serial	\$439
P351 Parallel	\$975

**DISKETTES**

3M 5 1/4 DS/DD (Qty 100)	\$169
Maxell MD-2 Plastic Box (Qty 100)	\$159
Sony MD/2 (Qty 100)	\$170

**MONITORS**

Amdex All Monitors	Call
NEC All Monitors	Call
Princeton Graphics	Call
Taxan 121 Green	\$125
122 Amber	\$129
Zenith All Models	Call

**VIDEO TERMINALS**

Altos Smart III	\$599
IBM 3161 & 3163 Series	Save
Qume QVT Green 101	\$299
QVT Amber 101	\$314
Wyse 30	\$299
50	\$419
75	\$559
Wyse 85	\$579
Wyse 350	\$859
Zenith Z-22	\$455
Z-29	\$599
Z-49	Call

**MODEMS**

AT&T	
4000 External	\$319
Anchor Automation	
Anchor Express	\$235
Hayes Smartmodem 300 Baud	\$129
Smartmodem 1200 Baud	\$369
Smartmodem 1200B (IBM)	\$319
Smartmodem 2400 Baud	\$599
Micromodem IIE (Apple)	\$134
Novation Smart Cat Plus	\$279
Prometheus All Models	Call
US Robotics Courier 2400	\$389
Password 1200	\$195

**COMPUTERS**

Sanyo MBC-775 Portable	\$1789
Televideo PM 4T	\$5089
PM 16T	Call
Wyse Wyse pc Dual	\$1199
Wyse pc 10 Meg	\$1959
Zenith	
Z-158 All Models	Call
Z-138 All Models	Call
Z-148 All Models	Call
Z-171	Call
Z-200	Call

**DISK DRIVES**

Alpha Omega Turbo 10	\$529
Turbo 20	\$529
Turbo 30	\$949
Everex	
10 Megabyte	\$549
20 Megabyte	\$689
60 Megabyte Tape	\$879
Haba Habadisk for Macintosh	\$279
lomega Bernoulli Box for IBM	
10 Megabyte	Call
20 Megabyte	Call
20 Megabyte Plus	Call
5 Megabyte for Macintosh	Call

**BOARDS**

AST Advantage	\$389
Six Pack Plus	\$219
Everex Boards	Call
Hercules Color Card	\$149
Graphic Card	\$299
Paradise Modular Graphic 06-1	\$259
Five Pak	\$119
Quadram	
Quadlink	\$325
Tec Mar Graphics Master	\$445
Captain No Memory	\$159

**PLOTTERS**

Enter Sweet-P600	\$759
Canon Hi-80	Call

**KEYBOARDS**

Keytronics 5151	\$159
5151 Jr.	\$179

**Canon «PC» PERSONAL COPIERS**

Canon PC-10	\$509
Canon PC-14	\$649
Canon PC-20	\$719
Canon PC-25	\$939



**SOFTWARE**

Gem Collection	\$115
Gem Desktop	\$29
Gem Draw	Call

**LANGUAGES**

C Compiler (Microsoft)	\$235
Fortran Compiler (Microsoft)	\$209
Macro Assembler	\$89
Pascal Compiler (Microsoft)	\$178
Turbo Pascal 3.0	\$35
Lattice C Compiler	Call
Run C Interpreter	\$85
Quick Basic	\$59
Turbo Tool Box	\$28

**PROJECT MANAGEMENT**

Harvard Total Project Manager	\$239
Microsoft Project	\$149
Super Project	\$182
Timeline 2.0	\$249

**COMMUNICATIONS**

CompuServe Starter Kit	\$17
Crosstalk XVI	\$94
PFS Access	\$78
Remote	\$94

**IBM PC and 100% Compatibles**

**INTEGRATIVE SOFTWARE**

Enable 11	\$299
Framework	Call
Smart Software System	\$459
Symphony	Call

**TRAINING**

Fight Simulator	\$30
Typing Instructor	\$29
Typing Tutor III	\$29

**GRAPHICS**

Chartmaster	\$206
PC Paintbrush	\$62
Turbo Graphix Tool Box	\$28
Diagram Master	\$190
Dr. Halo	\$55
Energraphics	\$165
Energraphics w/ Plotter Option	\$214
Microsoft Chart	\$149
PC Draw	\$203
PC Draw Light Pen	\$104
PC Paint w/ Mouse	\$123
PC Mouse w/ Paintbrush	\$107
PFS Graph	\$78
Printmaster	\$30
Signmaster	\$135

**WORD PROCESSORS**

Leading Edge Word Processor	\$50
Leading Edge W/P with Spell & Mail	\$137
Microsoft Word 2.0	\$223
Multimate 3.3	\$206
PFS:Write	\$78
Wordstar w/Tutor	\$169
Wordstar Pro Pack	\$239

Word Perfect (Ver.4.0)	\$199
Wordstar 2000	\$239
Wordstar 2000 Plus	\$285

**UTILITIES**

1 DIR	\$48
Copy II PC	\$19
Norton Utilities 3.0	\$49
Sidekick	\$28
Sidekick (Unprotected)	\$43
Sideways	\$31
Superkey	\$35
Printworks	\$36
Spotlight	\$43
Sidekick-Superkey (Bundle)	\$65

**SPREADSHEETS**

Lotus 1-2-3	Call
Multiplan	\$114
Spreadsheet Auditor 2.0	\$83

Supercalc 3 (Ver. 2) .. Call

**MONEY MANAGEMENT**

Dollars & Sense w/Forecast	\$95
Tobias Managing Your Money	\$95

**DATA BASE MANAGEMENT**

Cornerstone	\$255
dBase II	Call
dBase III	Call
Nutshell	Call
PFS:File	\$78
PFS:Report	\$70
Quickcode	\$139
QuickReport	\$139
Extended Report Writer	\$80
Think Tank	\$93
Clipper	\$355
KnowledgeMan II	Call
KnowledgeMan Upgrade Kit	Call

R:Base 5000 .. \$335

Many other titles available.

Inquiry 80 for MS-DOS Products. Inquiry 81 for all others.

# COMPUTER WAREHOUSE

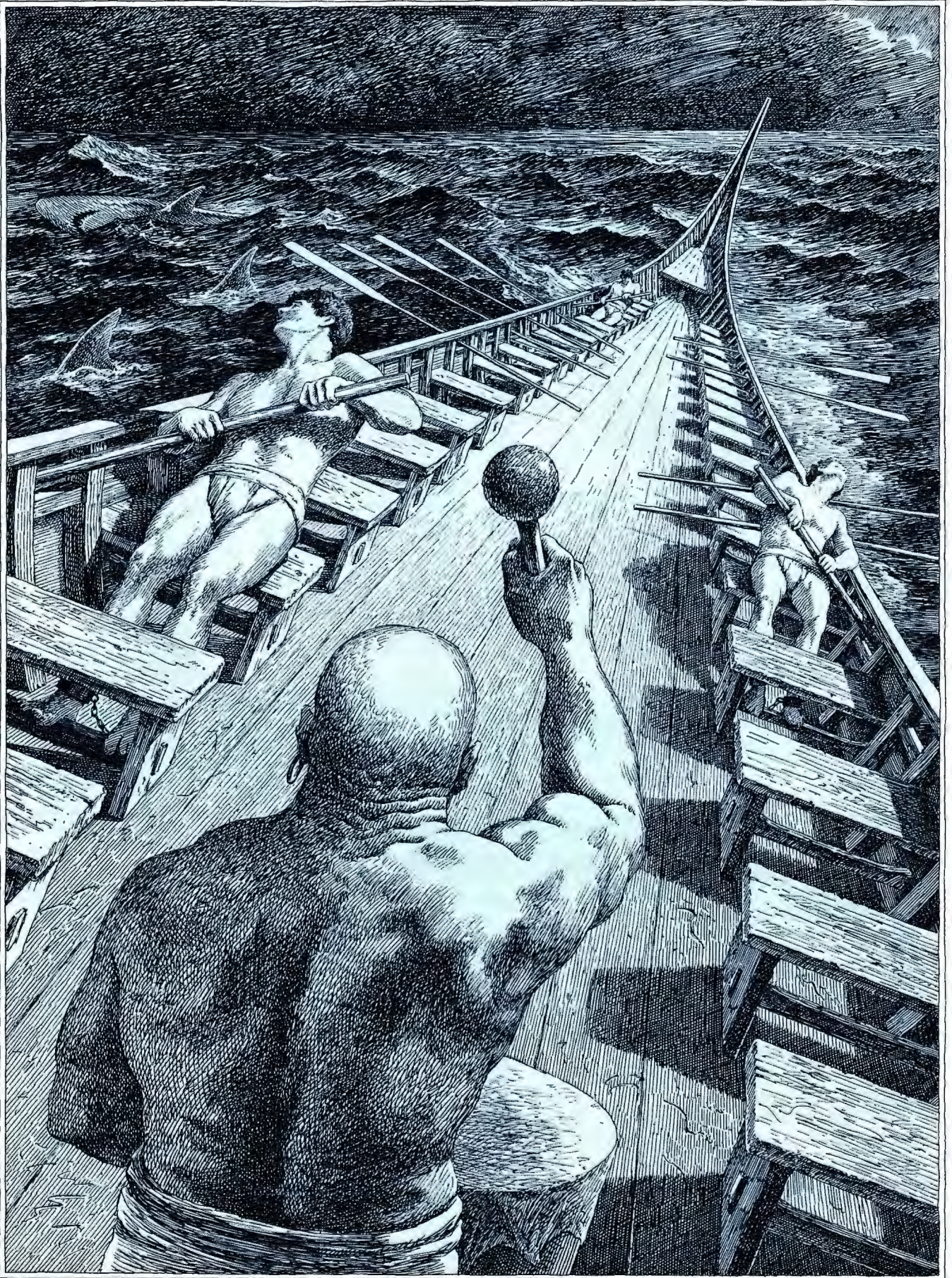
Order Line: 1-800-528-1054  
Order Processing: 602-224-9345  
2222 E. Indian School Rd.  
Phoenix, Arizona 85016  
602-954-6109

Store Hours: Mon-Fri 10-5:30  
Saturday 9-1  
Order Line Hours: Mon-Fri 7-5:30  
Saturday 9-1  
Order Processing Hours: Mon-Fri 10-3

Prices reflect 3% to 5% cash discount. Product shipped in factory cartons with manufacturer's warranty. Please add \$9.00 per order for UPS ground shipping. Orders 10 lbs. and under you pay for ground service, receive air service at no extra charge. Available on orders 11-20 lbs. \$16 for air service. Orders 21-30 lbs. \$26 for air service. Prices & availability subject to change without notice. Send cashier's check or money order...all other checks will delay shipping two weeks.



We do not guarantee computer compatibility.



COMMON SENSE IN DATABASE MANAGEMENT  
NUMBER THREE IN A SERIES.

# IT'S BETTER TO HAVE MORE POWER THAN YOU NEED THAN NOT ENOUGH.

**T**here's a funny thing about database users. A lot of people buy a program that has all the power they need to get started. And not a whole lot more.

Well, that makes perfect sense. If you plan to stay in the same place all your life. But as most users get the feel of things, they want to push themselves farther and farther. That's when they wish they'd bought a program that had some extra muscle. And if you look at this chart, you'll see that's the whole idea behind R:base™ 5000.

development tools that the most intense programmers can't outgrow.

To give you a better idea what this extra power can do, just take a look at one feature. With R:base 5000, you get a relational operator called SUBTRACT, which dBASE III doesn't offer. By using this command, you could take all the names in one file (such as your customer list) and subtract them from any other file (like the Fortune 500). The result? An instant list of new business opportunities. And this is only one way to use one of the extra capabilities on this chart; there are literally hundreds more.

**DBMS POWER**  
R:base 5000 vs. dBASE III

	R:base 5000	dBASE III
Comprehensive procedural language	Yes	Yes
Built-in application compiler	Yes	No
Choice of row or column report format	Yes	No
Accessible tables per report	40	10
Number of relational operators	6	2
Password security	Yes	No
User-definable data entry rules	Yes	No
Automatic key index maintenance	Yes	No
Data dictionary	Yes	No

## THE KIND OF POWER THAT'S EASY TO HANDLE.

We made R:base 5000 so easy to use that a complete novice can develop applications with it right off the bat. But that's just the beginning; we've built in a whole arsenal of high-powered

## SEE FOR YOURSELF:

1-800-547-4000.

If you believe in common sense as much as we do, you won't take our word for it; you'll get your hands on a copy and see for yourself. And that's just what we'd like you to do. For only \$9.95 (plus shipping) we'll send you a mini-version of the product that lets you build real applications.

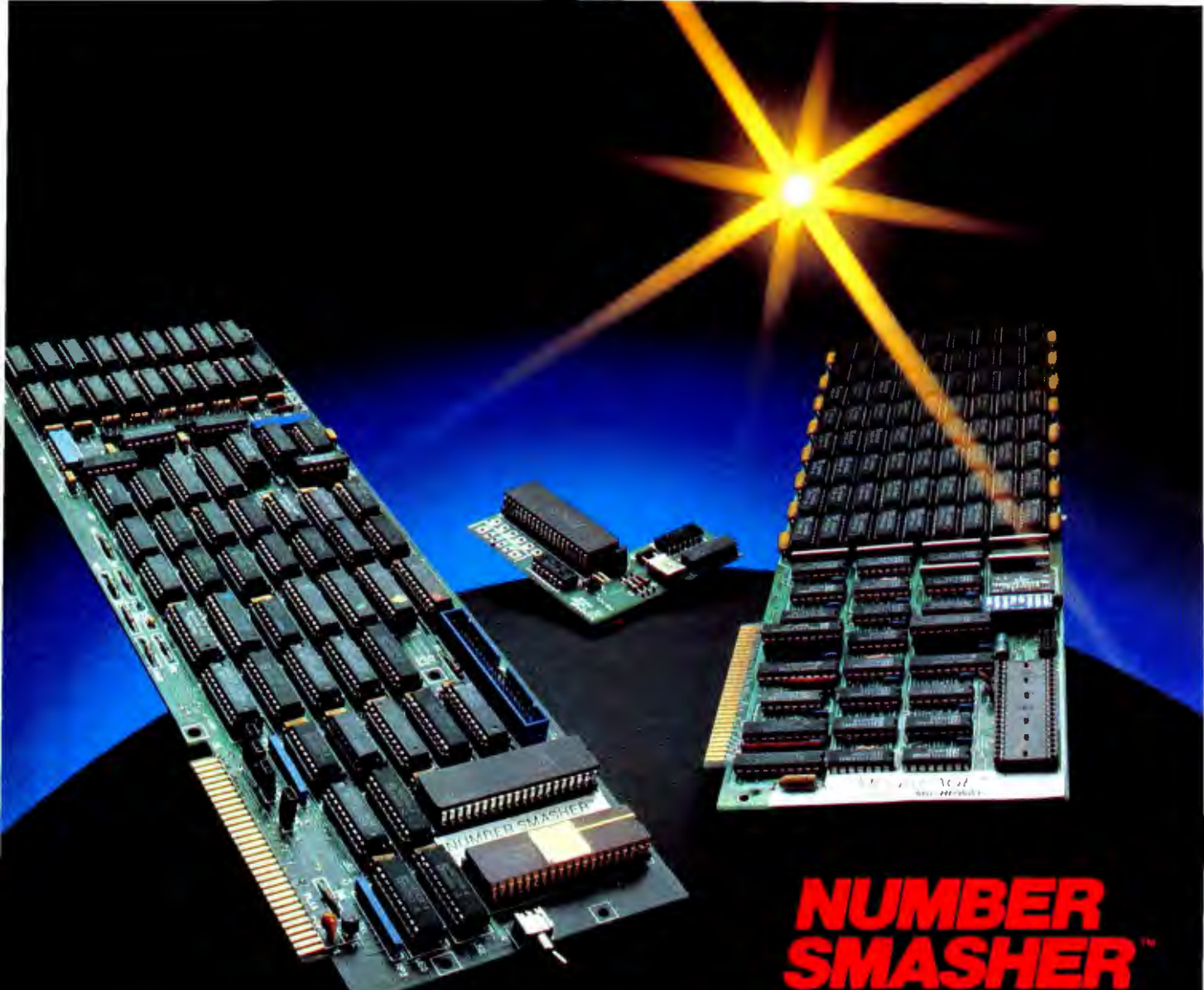
Just call 1-800-547-4000 and ask for Dept. 836. From Oregon, or outside the U.S., call 1-503-684-3000, Dept. 836. We'll send your copy right out. If you'd like to see R:base 5000 today, head straight for a leading store or computer dealer.

And see how far you can go when your DBMS has all its oars in the water.



## R:BASE 5000 FROM MICRORIM

IT ALL COMES DOWN TO COMMON SENSE.



# NUMBER SMASHER™

**Triple your PC speed for only \$799!**

## 8087 Upgrades™

MicroWay is the world leader in 8087 support. Our 8087 development software has been in use since 1982. By 1984 we had become Intel's 97th largest OEM account. When you buy from us, you can be confident that you will receive the 8087 chip designed for your PC and that our unique diagnostics will instantly verify that your processor works correctly as installed. Call for current prices.

## 287Turbo™

This card plugs into the 80287 socket on your AT or COMPAQ, doubling the 80287 clock from 4 to 8 Mhz. It does not change the 80286 clock speed or affect your warranty. The card comes with an 8 Mhz 80287 and has provisions for faster crystals as better 80287s become available. It also has a reset button and circuit that provide a hardware alternative to CNTRL-ALT-DEL. 287Turbo with Diagnostics and Reset . . . . . **\$395**

## Number Smasher™

Number Smasher gives you AT speed and 100% compatibility with all PC software and hardware. It comes with a 10 Mhz 8086 and 512K of no wait state RAM. Most are shipped with an optional matched 10 Mhz 8087 and 128K daughterboard. The card runs programs a factor of 2.5 to 4.0 faster than the PC, XT or compatibles it runs in. Other features include FASTROM, a Ram Disk, Print Spooler and Disk Cache. Revision 2 of the Smasher is designed and manufactured by MicroWay in the U.S.A. and has the best service and support of any accelerator card.

## MegaPage™

MicroWay's "Lotus/Intel" extended memory card has all the features of the others plus one: it uses low power, cool running CMOS DRAM. Ask for our pamphlet "Extended vs Expanded Memory" and learn why MegaPage is the right card for you. MegaPage with 2 Megabytes CMOS . . . . . **\$549**



Inquiry 247

*The World Leader in 8087 Support*

P.O. Box 79, Kingston, Mass. 02364 USA (617) 746-7341  
Tempo House, London, U.K. call 01-223-7662

Number Smasher, MegaPage and 287Turbo are trademarks of MicroWay, Inc. MicroWay is a registered trademark of MicroWay, Inc.

# LOCAL POWER IN A REMOTE LINK

BY CHUCK McMANIS

*Conferencing systems can let micros handle  
much of the processing load*

BY FAR THE MOST common remote systems are those that handle electronic conferencing. Despite their diversity, most of these systems share one unpleasant characteristic: They are too slow. However, there is a solution. The designers of conferencing systems can incorporate facilities into conferencing software for allowing microcomputers to handle much of the conferencing load.

This article describes a two-part software solution to the traditional I/O (input/output) bottleneck when you connect to a remote computer system. The first is a method of encoding the information you transmit to decrease the average number of bits per character. The second transfers from the conferencing system to your computer the task of providing the user interface.

As a user of the conferencing system, you will experience a dramatic increase in speed. With a faster connection, you can get more done in the same amount of time or reduce the amount of connect time. And, because you can personalize the commands, you will also find it easier to use the system.

System administrators will also ex-

perience a dramatic increase in speed. As the serial lines become intelligent I/O channels, they demand less of the CPU (central processing unit). The system could therefore support more serial lines, permitting more subscribers to have access to the system, or you might be able to use a less powerful, less expensive computer.

The relatively slow speed of remote systems owes mainly to two factors. The first is the rate at which the data can transfer to your system over a voice-grade phone line. The second concerns the sheer size of the data. Even in modest microcomputer bulletin-board systems (BBSs), the data can total several megabytes a month. Larger systems handle several megabytes a day. Handling all of this data does not require sophisticated numerical abilities, but it can quickly overwhelm the I/O bandwidth of any system.

There are two ways to mitigate the I/O bottleneck. One is to improve the communications hardware between the conferencing system and the remote site. Manufacturers are making remarkable improvements in this area. There are now full-duplex,

2400-bps (bits per second), asynchronous modems at prices that were attractive for 1200-bps modems five years ago. The other method is to maximize use of the existing bandwidth by adding an I/O processor at the remote site. This might seem more expensive than upgrading your communications hardware until you consider that, already at the remote site, there is probably an I/O processor, your computer, that is acting like a very expensive piece of wire between your terminal and the modem.

You can use your computer as an I/O processor in one of two ways. First, you could implement some form of data compression on the data stream between your computer and the host system. A somewhat more involved solution is to have your computer provide some of the facilities that the conferencing system traditionally provides.

*(continued)*

Chuck McManis is an engineer at Intel. He has been programming professionally for 10 years and spends his spare time writing system software for a Cromemco S-100 system running CP/M with ZCPR3. He can be reached at 1141 Vasquez Ave., Sunnyvale, CA 94086.

Data-compression techniques maximize the amount of meaningful information in a given number of bits by applying some statistical analysis on the original data. Obviously the frequency of occurrence of various ASCII (American Standard Code for Information Interchange) codes in text-only data streams will be greater than others; several letters appear often and most special symbols appear infrequently. One way to take advantage of this information is to apply a data-compression algorithm that reduces the number of bits used for frequently used characters. Huffman encoding, for example, can provide compressions on the order of 25 percent when used with a fixed encoding/decoding tree for textual data. With 25 percent compression a modem that transmits at 1200 bps will have an effective data-transfer rate of 1500 bps.

Data compression is effective for reducing the number of bits that you transmit to the host system, but you can program your computer to further reduce the amount of data you need to send. Careful analysis of the facilities that conferencing systems provide indicates that you can implement many of these facilities equally well with your computer.

### WHAT IS THE CONFERENCING SYSTEM DOING?

A conferencing system has two parts, the user interface and low-level code to open data files and display them on a terminal. The low-level code is machine-dependent, but the user interface is entirely the creation of the programmer who designed it. Generally, there are three principal capabilities: editing, command interpretation, and user-profile maintenance.

A computer system that accepts spontaneous user input must have built-in editing facilities. The degree of editing complexity can range from a single cancel command that erases previous input and allows you to start again, to a full set of line- and character-manipulation commands. During command entry, you are usually limited to using the backspace or

delete key to erase the previous character. Occasionally, you also have the option to delete the entire line. This type of editing is simple to implement in the terminal driver of the conferencing system. However, it requires some CPU intervention to determine if a character is in the input buffer when the delete key is pressed, to erase the character from your screen, or to indicate in some other way that the character has been discarded from the input stream.

Complex editing places more demand on the CPU. For example, when editing messages (limited-distribution files that are the basic unit of an electronic mail system), you must frequently change characters or words on a line other than the one on which you are currently working. Typically, the conferencing system will have available a section of code, either an integral part of the system or a separate program, for editing large amounts of input. The code may use some features of your terminal or none at all. Typically you will use this editor often, but it will probably differ from the other editors you regularly use.

Both line editors and screen editors help you to manipulate text before you send it to the world or save it in a file. Line editors were initially developed to be used over low-speed data lines, such as a modem connection, and with hard-copy terminals, such as the Teletype model 33. Line editors minimize the amount of information that you must transmit through the modem, but at the expense of both user-friendliness and cohesiveness of the displayed output. They perform equally well on dumb or smart terminals and are therefore somewhat "universal" in nature. Screen editors, on the other hand, were developed for use on high-speed data lines and are much more user-friendly. They can keep the message display up to date with continuous screen updates. However, continual updates reduce the effective data rate of your modem since character insertions and deletions can cause the updated contents of the

message buffer to rewrite large portions of the screen. A screen editor also needs to know more about your terminal functions than does a line editor. For example, it needs to know how your terminal addresses the cursor and how it clears a line. Naturally, managers cannot possibly know all of the various terminals that will access the system, nor can they write software to support all possible terminals and still leave room in memory for other things. As a result, screen editors are much less common on conferencing systems. Some editors, such as Digital Equipment Corporation's EDT, attempt to fill the needs of all users by changing from a line editor to a screen editor on command.

However, the editing functions of the conferencing system are some of the easiest to give to your computer.

### YOUR COMPUTER CAN HELP

If the conferencing program could command your computer to get an edited line of text from your keyboard, you would free up the time and memory that the conferencing system would normally use to provide the editing functions. Admittedly, this is a rather small portion of the overhead associated with command input. However, when applied to several users, the time savings was significant enough for IBM to provide this capability in its 3270 series terminals.

The next logical step would be a command from the conferencing system asking your computer to return an entire block of already-edited text. As opposed to the rather crude "block" mode of some terminals, your computer could invoke your favorite editor for entering a message or article and then transmit the edited text to the conferencing system only after you were satisfied with its appearance.

There are several benefits to local editing. First, the response time will be independent of both your modem speed and the number of users accessing the conferencing system. Second, it eliminates the performance

*(continued)*



**Want to hear  
a demonstration of  
Hewlett-Packard's  
ThinkJet Printer?**

penalty incurred when using a full-screen editor because there is a high-speed link between your terminal and the local computer. Third, you can minimize modem use since you are transmitting the message through the modem only after you complete the editing. Finally, and most important, you will be able to use your favorite editor, undoubtedly one well suited to your needs and tastes.

Implementing these commands can significantly reduce the load on the conferencing system. But your computer is still underutilized. We can further reduce the load on the conferencing system by having your computer handle command interpretation, the other half of the user interface.

### COMMAND-LINE INTERPRETATION

Like editors, the command-line interpreter can range from a simple menu system to a complex natural-language interface. The menu interface is the easiest to implement, but it is very expensive in terms of connect time. For example, the standard menu displays a list of choices on the screen and asks you to type a one-letter or one-number choice. The menu interface need only verify that your entry is within range of the choices given and, when so, use your input as an index into a table of addresses of other programs that implement the various choices. The interface is simple for novice users, it can keep familiar users aware of the available options, and the menus are less demanding of CPU resources than other command-line interpreters. However, the menus are full of text. To display a full page of text on a terminal at 300 bps can take more than a minute. The delay inherent in menu interfaces can require from 4 to 10 minutes to traverse a collection of menus to a particular command. If you are paying six dollars an hour for connect time, you don't want to spend a dollar to perform some commands.

An alternative to a menu interface is a command-line interpreter. To analyze your command, the interpreter must be able to tokenize the command line and parse it into rec-

ognizable pieces. This can take as many CPU clock cycles as editing an entire message.

Your computer can assume responsibility for command interpretation because it is already adept at it. And, as with editors, there are innumerable ways to present a command interface and innumerable reasons why some people prefer one over another. Currently popular command interfaces use keywords, menus, and icons to symbolize the various actions that you can request.

Of these interfaces, keyword-based interfaces are the most efficient for slow serial links. They become even more efficient if designers reduce the number of characters that uniquely specify a command. An example of a very efficient keyword command interpreter would be a machine-language monitor where you use single letters to specify commands. Menu-based command interfaces are the least efficient, owing to the large number of characters that the system must transmit to display a single menu. The icon interface is the most difficult, if not impossible, interface to implement over remote dial-up lines. In the interest of efficiency and user-friendliness, you can again turn to the computer on your desk for help.

If single letters represented all of the commands available to the conferencing-system user and an identifying number represented all of the conferences and subscribers to the system, it would be possible to specify most command sequences in as little as three characters or at most eight or nine characters. It would also be exceedingly difficult, if not impossible, to make all command characters relate mnemonically to the function they represent. You would need a document that listed all of the commands and their arguments so that you could translate your requests into the appropriate letter for the conferencing system. This type of translation can be implemented quite easily by your computer.

The advantages of a command translator are similar to those of local editing: The computer would provide

the actual user interface, you would minimize the number of characters that you send through the modem, and you would "preprocess" the command for syntax errors and acceptability, greatly simplifying the command interface on the conferencing system. One person could use menus, another keywords, and a third icons without changing the requirements of the conferencing system's software. Moreover, when your computer provides the command interface, it can take advantage of local features such as color graphics or cursor positioning by mouse. You could also obtain a much wider variety of sounds than the standard "beep" on terminals.

Command interpreters must also provide a means of giving you help when you need it. Usually the command-line interpreter looks for a "?" or the command HELP in the input stream. Most often the system implements the help command, sending a large help file to your terminal. Again, at 300 bps this can be an expensive tutoring session; even at 1200 bps there may be considerable expense if the item you need is at the end of the file. Again, the local computer can provide a solution. Since the commands to a conferencing system rarely change, the local computer can implement a complete help system, freeing the conferencing computer from supplying on-line assistance.

### THE USER PROFILE

With all of this editing and interpreting going on, it is easy to lose sight of the purpose of the conferencing system: to store and retrieve articles (the general-distribution files that are the basis of the conferencing system) to and from a mass-storage system. Although the commands on different conferencing systems may appear differently, making them harder to remember, they accomplish the same group of tasks: manipulating a user profile, moving around the system, and handling articles.

Usually, the user profile maintains information about your previous perusals of conferences, letting you

*(continued)*

# Want to hear it again?

You made about as much noise turning the page as the ThinkJet Printer makes turning one out.


So it lets you do two things at once. Print. And think. Without sound hoods. Without remote printing stations. Without aspirin. (And without a lot of clutter. The only thing smaller than the ThinkJet Printer is its price: \$495\*) Better still, it works with just about every personal computer.

Hear the ThinkJet Printer sound off.  
Call (800) FOR-HPPC, Dept. 276X, for the  
Hewlett-Packard dealer nearest you.



**HEWLETT  
PACKARD**

Inquiry 168

 **HEWLETT  
PACKARD**

easily continue a previous session. Many microcomputer bulletin boards use a simple single entry to indicate the last message you have read. The technique is easy to implement, but it does not provide much flexibility.

Larger conferencing systems may have several conferences, each with many articles. Some of the articles will relate to previous articles. Your user profile may contain a list of the conferences you regularly read and even the discussion you are following. Most systems will let you edit your user profile to keep it current. If there is an electronic mail system available, the user profile might also contain aliases for frequently used addresses or mailing lists of friends. The conferencing system can implement the maintenance commands in the command-line interpreter but at the expense of more CPU cycles, slowing the system down still further.

Smaller, less complex systems omit the user-profile manipulation commands and consider all conferences active; you would need to use the SKIP command to read selectively since you will have no control over which conferences the system will scan when you log in. More involved systems allow you to select the conferences in which you will participate, to SELECT or GOTO those conferences, to ADD an article to a conference as a response to the currently read article or as a new, unrelated article, and to SCAN your user profile for unread conference articles. By adding and deleting conferences, you can directly control the list the conferencing system scans when it determines which articles you have read.

Again there is a potential role for the local computer. Local software could recognize the "go to next conference" command, search through a

locally maintained file of active conferences for the next conference (X), and translate the command to "go to specific conference X." As a result, the conferencing system would not need to know anything about your preferences, and you could edit your user profile locally without tying up the main CPU of the conferencing system. It would also be possible to maintain the read/unread database locally, reducing the time required to access the data. Unfortunately, this approach would require that you always log on from the same software to keep your profile up to date.

A smart conferencing program could also contain the ability to save messages and articles and send them to your printer. Conferencing systems rarely support these two utilities because they require resources that are not cost-effective. For example, the SAVE command requires free disk

# Introducing Microfazer™ II

## The Universal Print Buffer Expandable to 2 Megabytes of Memory

### Why you need a print buffer.

If you have to wait on your printer to finish printing before you and your computer can get back to work, you need Microfazer II, the new universal print buffer from Quadram. Microfazer II stores data from the computer in its own memory, so your computer is free to do other things. And, with powerful features like memory expansion to two megabytes, dual serial and parallel operations,

Pause and Copy modes, and a special by-pass mode (when you want to go straight through to the printer), Microfazer II makes printing a breeze.



space on which to place copies of the selected articles and messages, and the PRINT command requires that someone print and mail you the text. Instead, your local computer can store a copy of the incoming characters in memory while displaying them on screen. If you choose not to save the text, you lose nothing; if you want to save the text, you can simply write it out to disk. Later, you can compose a reply to a message or comment to an article without first connecting to the system, thereby saving on connect charges.

To achieve a more symbiotic relationship with the conferencing system, there must be a way for the conferencing system to send commands to your computer. The standard way of injecting commands into a stream of ASCII characters is to use the escape character (27 decimal) to indicate that the next character in the stream is a

command and should not be displayed. The subsequent characters are then interpreted as a command and its parameters. The escape character, command character, and following parameters together are called an escape sequence. It is used by many computer programs to activate the various features of smart terminals. We can use it to activate the smart features of your computer.

**DIFFICULTIES AHEAD**

There are many difficulties to overcome before we can realize the benefits of this symbiotic relationship: first, how to provide software for all computer, modem, and terminal brands; second, how to provide updates when the software changes; third, how to distinguish between users with computers and users with only terminals and modems.

We can solve the first problem by

writing the software in a high-level language. Turbo Pascal would be an excellent choice because it is currently available for CP/M and MS-DOS machines and because it provides routines to access hardware-specific features on the computer on which it is running. Designers could use these features to implement the modem routines "read byte from modem," "write byte to modem," and "get modem status." Borland International plans to make the language available for the Amiga and the Macintosh, allowing the consumers of a very large portion of today's microcomputers to compile Turbo source code. Still, this would leave out owners of the 6500 family of processors like the Atari, Apple II, and Commodore 64. The Apple and Commodore will accommodate CP/M with some additional hardware, though the others

*(continued)*

**Parallel and Serial Operation**

Microfazer II features parallel and serial operations to match most any computer-printer connection. Front panel switches make it a snap to select Parallel/Parallel, Parallel/Serial, Serial/Parallel, or Serial/Serial. Such built-in flexibility makes Microfazer II truly universal.



**Powerful RAM Expansion and Multiple Copy feature.**

Microfazer II memory expands from 8K to two megabytes of memory to tackle even the biggest buffer tasks. Spreadsheets, database, graphics, you name it. And with features like

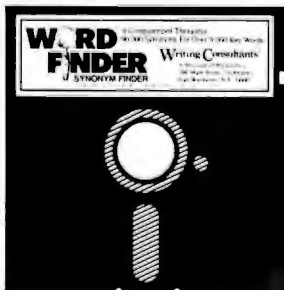
Microfazer II's Copy button (simply press the button once for every additional copy you wish) you can custom tailor print operations to suit every need, printing up to 255 copies without your supervision.



Ask for Microfazer II at the Quadram dealer nearest you. Or contact us at Quadram Corp., One Quad Way, Norcross, Georgia, 30093-2919 404-923-6666



# WHO KILLED ROGET ?



## WORD FINDER did.

Our electronic thesaurus sits *inside* your word processor instead of on your bookshelf. WORD FINDER gives you 90,000 synonyms for more than 9,000 words instantly with a single keystroke, while you're typing or editing.

Instead of leaving your keyboard to thumb-through worn pages of Roget, just place your cursor on the word you want changed, and open a *window* of new ideas. Select the one that says it best, and it will automatically replace the old word in the text, making your

writing clear, creative and concise.

Use WORD FINDER with your IBM PC/XT/AT or compatibles. Once you put WORD FINDER in your WordStar, WordStar 2000, Multimate, Word Perfect, Pfs:Write, Microsoft Word, IBM Writing Assistant, Easy Writer II or others,\* you can close the book on Roget's thesaurus—with WORD FINDER, the new Roget for the PC.™

\*Soon to include: Framework, Volkswriter, OfficeWriter, Palantir and others.



Rush me **WORD FINDER** for \$79.95.  
(Add \$2.50 shipping; NY residents add sales tax)

- Visa  
 MasterCard  
 Check  
 COD

Card Number \_\_\_\_\_ Exp. Date \_\_\_\_\_/\_\_\_\_\_/\_\_\_\_\_

Name \_\_\_\_\_ Phone \_\_\_\_\_

Company \_\_\_\_\_

Address \_\_\_\_\_

City \_\_\_\_\_ State \_\_\_\_\_ Zip \_\_\_\_\_

Word Processor \_\_\_\_\_ Computer/Op System \_\_\_\_\_

**Writing Consultants™**  
a Division of Microlytics, Inc.™

**Call 1-800-828-6293**

Techniplex Center, Suite 448 • East Rochester, NY 14445 • in NY 716-377-0130

Also available from your local dealer through **SOFTSA**, the leading software distributor.

**30 DAY, MONEY-BACK GUARANTEE.**

## LOCAL POWER

### *Copy protection need not be sacrificed for software updates.*

would require a different Pascal compiler. This strategy would accommodate 98 percent of the microcomputers in use today.

There is an easy solution to the update problem. Often users must send in their master disks before receiving updated versions. However, if the master were copy-protected, you would be unable to access the conferencing system until the new version arrived. To avoid this inconvenience without sacrificing copy protection, the designers of the software could include two additional commands. One would determine the current version of the conferencing software and compare it to an internally stored value. The second would let you download software updates whenever the versions were different.

The third problem has two simple solutions. The simplest approach would ask users when they log on what type of system they use. A more elegant solution would send a string, like a system identification, that the smart program would recognize. The program would then indicate to the conferencing system that it was capable of taking over the user-interface tasks. The second solution has the added advantage of being transparent and relatively foolproof.

### **WRAPPING UP**

Current communication programs such as Kermit and the MODEM7 variations do provide a number of features for remote computer access. However, when switched into "terminal" mode they become just that, a terminal. The software I have proposed will make your computer look less like a terminal and more like a node on a cooperating network. And by becoming an active participant in the network, overall performance will significantly improve. ■

# AW...

# WHAT THE HECK!

## ProDesign II The Easy to Use CAD System!

ProDesign II is one of the most advanced CAD packages available for microcomputers. We think it's absolutely the easiest to use. With competitive CAD systems priced at \$1500 to \$2500, we were posed with the problem of setting our price.

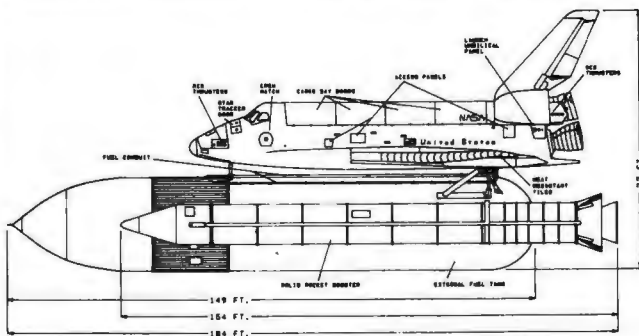
ProDesign II works a wide variety of digitizers and mouse devices. It works with nearly any plotter or printer available for the IBM PC. ProDesign II can produce plotter quality drawings on ordinary dot matrix printers - a feature found exclusively on ProDesign II. ProDesign II utilizes a virtual screen 4 times the size of the physical screen to make it practical to produce drawings on a normal resolution IBM monitor. ProDesign II is truly an outstanding CAD package for the IBM PC and compatibles. The question we had to answer was: Even though we had a better product, should we price it higher than the other CAD systems on the market?

We did market studies and calculations. We consulted with experts. We drew charts and graphs. We used the finest spreadsheet programs money could buy. When it came right down to it, we still didn't know what to sell ProDesign II for. \$2995? \$2495? \$1995? We even considered \$995.

Then, in the great American tradition, we said, "AW...WHAT THE HECK! Let's see the other guys beat this price!" ProDesign II costs \$299. At that price, you can't go wrong!

## AW...WHAT THE HECK!

# \$299.95

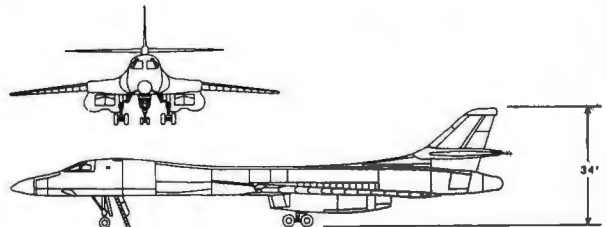
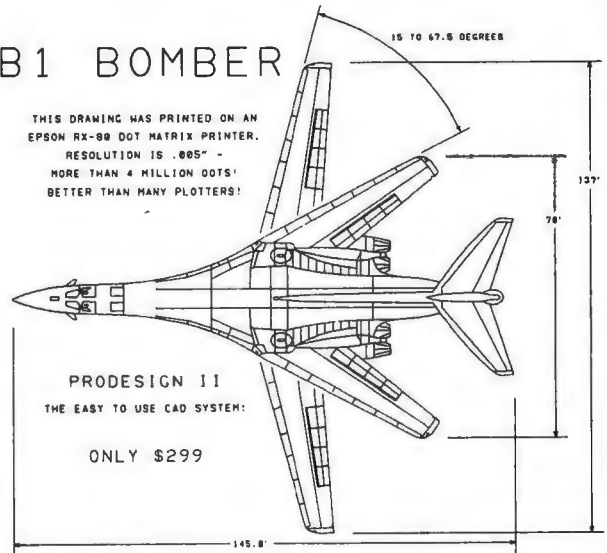


THE SPACE SHUTTLE DISCOVERY

**American Small Business Computers**  
118 South Mill  
Pryor, Oklahoma 74361  
918/825-4844

## B1 BOMBER

THIS DRAWING WAS PRINTED ON AN  
EPSON RX-80 DOT MATRIX PRINTER.  
RESOLUTION IS .005" -  
MORE THAN 4 MILLION DOTS!  
BETTER THAN MANY PLOTTERS!



Why should you get ProDesign II? Four simple reasons:

1. ProDesign II is easy to use. You won't have to spend weeks learning simple functions.
2. ProDesign II works with the hardware YOU own. ProDesign II supports most printers and plotters available for the IBM PC, as well as a wide variety of digitizers and mouse devices.
3. ProDesign II can produce plotter quality output on ordinary dot matrix printers. (The B1 Bomber above was printed on an Epson RX-80.)
4. ProDesign II is priced 70% to 80% below competitive products!

What do you need to run ProDesign II? An IBM PC or compatible with 512K RAM and graphics capability.

How do you get ProDesign II? See your local computer dealer or contact us.

ProDesign II - The Easy to Use CAD System!

Inquiry 18

# COMPUTER MAIL ORDER

## THE CMO ADVANTAGE

- ✓ THE BEST PRICES!
- ✓ Next day shipping on all in stock items.
- ✓ Free easy access order inquiry.
- ✓ Orders from outside Pennsylvania save state sales tax.
- ✓ Free technical support with our factory trained technical staff.
- ✓ There is no limit and no deposit on C.O.D. orders.
- ✓ There's no extra charge for using your credit card. Your card is not charged until we ship.
- ✓ No waiting period for cashiers checks.
- ✓ We accept purchase orders from qualified corporations. Subject to approval.
- ✓ Educational discounts available to qualified institutions.
- ✓ FREE CATALOG MEMBERSHIP

### ORDER LINE

CALL TOLL-FREE  
**1-800-233-8950**

**CUSTOMER SERVICE & TECH SUPPORT**  
1-717-327-1450

Dept. A112

### MAILING ADDRESS

Computer Mail Order  
Dept. A112  
477 East Third Street  
Williamsport, PA 17701



MEMBER DIRECT MARKETING ASSOCIATION

### CREDIT CARDS



Inquiry 77



### SHIPPING

Add 3%, minimum \$5.00 shipping and handling on all orders. Larger shipments may require additional charges.

All items subject to availability and price change.

Returned shipments may be subject to a restocking fee.

### CANADIAN ORDERS

**1-800-268-3974**  
Ontario/Quebec

**1-800-268-4559**  
Other Provinces

**1-416-828-0866**  
In Toronto

**TELEX: 06-218960**

2505 Dunwin Drive,  
Mississauga, Ontario  
Canada L5L1T1

All prices shown are for U.S.A. orders.  
Call The Canadian Office for Canadian prices.

## HOME COMPUTERS

### ATARI

**130XE (128K).....CALL**  
**520ST (512K).....CALL**

800XL 64K.....CALL  
1010 Recorder.....\$49.99  
1050 Disk Drive.....\$144.00  
1027 Letter Quality Printer.....\$209.00  
1030 Direct Connect Modem.....\$59.99

### Software Specials - While They Last!

8036 Atari Writer.....\$29.99  
Star Raiders.....\$4.99  
Missile Command.....\$4.99  
Defender.....\$4.99  
Galaxian.....\$4.99  
Asteroids.....\$4.99  
Centipede.....\$4.99  
Robotron.....\$4.99

### APPLE

APPLE IIe.....CALL  
APPLE IIc.....CALL  
MacINTOSH.....CALL  
IIc LCD Display.....CALL

### ASSIMILATION

Mac Port Adapter.....\$59.99

### HAYDEN

Art Grabber.....\$31.99  
Home Design.....\$49.99  
Media Works.....\$63.99

### PALADIN

Crunch 512.....\$189.00

### Commodore

C128 Computer.....\$299.00  
C1571 (Disk Drive for C128).....\$NEW  
C1902 (RGB 13" Monitor for C128).....\$NEW  
C1670 (Modem for C128).....\$NEW  
Commodore Plus 4.....\$199.00  
CBM 64.....\$149.00  
C1541 Disk Drive.....\$199.00  
C1530 Datasette.....\$39.99  
M-801 Dot Matrix Printer.....\$169.00  
MCS 803 Dot Matrix.....\$179.00  
C1702 Color Monitor.....\$189.00  
C1660 Auto Modem.....\$59.99  
DPS 1101 Daisy Printer.....\$339.00

### Christmas Special!

### EPSON/COMREX CR220AT for Atari 800

80 column, dot matrix printer  
with built-in Atari interface

was \$199.00, **Now \$79.99**

### BOARDS FOR ATARI

Axlon 32K.....\$39.99  
Axlon 48K (400).....\$69.99  
Axlon 128K.....\$199.00  
Bit 3 Full View 80.....\$169.00

### Macintosh Software

Lotus Jazz.....CALL  
Microsoft Excel.....\$259.00  
Living Videotext  
ThinkTank 512.....\$159.00  
Manhattan Ready, Set, Go.....\$79.99  
Creighton Development  
Mac Spell.....\$69.99  
Monogram Dollars & Sense.....\$99.99  
Peachtree Back to Basics - GLS109.00  
PFS File & Report (New Version)\$119.00  
Silicon Beach Airborn.....\$25.99

### Professional Software

Fleet System II w/Spell.....\$49.99  
Trivia Fever.....\$29.99  
Word Pro 4 Plus/5 Plus each.....\$239.00  
Info Pro.....\$179.00

### BRODERBUND

The Print Shop.....\$29.99  
Music Shop.....\$29.99



File (64).....\$49.99



PaperClip w/Spell Pack.....\$79.99

The Consultant DBMS.....\$69.99

Bus Card II.....\$139.00

80 Col Display.....\$129.00

## PORTABLE COMPUTERS



**HEWLETT  
PACKARD**

41CV.....\$189.99  
41CX.....\$249.99  
HP 71B.....\$419.99  
HP 11C.....\$62.99  
HP 12C/15C/16C.....\$89.99  
HP 75D.....\$94.99  
HPIL Module.....\$98.99  
HPIL Cassette or Printer.....\$359.99  
Card Reader.....\$143.99  
Extended Function Module.....\$63.99  
Time Module.....\$63.99

We stock the full line of  
HP calculator products

### NEC

PC-8401.....CALL  
PC-8201 Portable Computer.....\$269.00  
PC-8231 Disk Drive.....\$599.00  
PC-8221A Thermal Printers.....\$149.00  
PC-8281A Data Recorder.....\$99.99  
PC-8201-06 8K RAM Chips.....\$105.00

### SHARP

PC-1350.....\$159.99  
PC-1261.....\$159.99  
PC-1260.....\$109.99  
PC-1500A.....\$165.99  
PC-1250A.....\$88.99  
CE-125 Printer/Cassette.....\$128.99  
CE-150 Color Printer Cassette.....\$171.99  
CE-161 16K RAM.....\$134.99

## DISKETTES

### maxell

3 1/2" SS/DD.....\$39.99  
3 1/2" DS/DD.....\$54.99  
5 1/4" MD-1 w/Hardcase.....\$14.99  
5 1/4" MD-2 w/Hardcase.....\$19.99  
5 1/4" MD-2-HD for AT.....\$44.99



5 1/4" SS/DD.....\$19.99  
5 1/4" DS/DD.....\$24.99  
Disk Analyzer.....\$24.99

### Dennison

Elephant 3 1/2" SS/DD.....\$29.99  
Elephant 5 1/4" SS/DD.....\$13.99  
Elephant 5 1/4" SS/DD.....\$15.99  
Elephant 5 1/4" DS/DD.....\$16.99  
Elephant Premium DS/DD.....\$22.99



5 1/4" DS/DD Floppy Disks  
(Box of 10).....\$25.99

## DISK HOLDERS

### INNOVATIVE CONCEPTS

Flip-in-File 10.....\$3.99  
Flip-in-File 50.....\$17.99  
Flip-in-File 50 w/lock.....\$24.99  
Flip-in-File (400/800 ROM).....\$11.99  
Flip-in-File 100.....\$24.99

### AMARAY

50 Disk Tub 5 1/4".....\$9.99  
30 Disk Tub 3 1/2".....\$8.99

## MODEMS



Volkmodem.....\$59.99  
Volkmodem 300/1200.....\$189.99  
Signalman Express.....\$299.00  
Lightning 2400 Baud.....\$399.00

### DIGITAL DEVICES

AT300 - 300 Baud (Atari).....\$99.99



Smartmodem 300.....\$139.00  
Smartmodem 1200.....\$389.00  
Smartmodem 1200B.....\$359.00  
Smartmodem 2400.....\$599.00  
Micromodem IIe.....\$149.00  
Smart Com II.....\$89.99  
Chronograph.....\$199.00  
Transet 1000.....\$309.00

### AST

Reach 1200 Baud Half Card.....\$399.00

### MPP MICROBITS

MPP-1064 AD/AA (C-64).....\$69.99



Smart Cat Plus.....\$319.00  
J-Cat.....\$99.99  
Novation 2400.....CALL  
Apple Cat II.....\$229.00  
212 Apple Cat II.....\$379.00  
Apple Cat 212 Upgrade.....\$229.00  
Macmodem.....\$319.00



Quadmodem II  
300/1200.....\$339.00  
300/1200/2400.....\$499.00

### TELELEARNING

C64 300 Baud.....(Closeout).....\$39.99

## GRAPHICS



IBM.....\$89.99  
Apple/Franklin.....\$79.99



Palette.....\$1299.00

## DRIVES

### HARD



PC Stor.....CALL

### U-SCI

10 meg Internal IBM.....\$429.00  
20 meg Internal IBM.....\$569.00

### I-MEGA

10 meg Bernoulli Box.....\$1899.00  
20 meg Bernoulli Box.....\$2599.00  
5 meg "MacNoulli".....\$1499.00



12, 25, 35, 50, 80 meg (PC)  
.....from \$1499.00

### IRWIN

Tape Backup.....CALL

### EVEREX

20 Meg Internal (IBM).....\$799.00  
60 Meg Internal Backup System\$879.00

## FLOPPY



Atari GT.....\$219.00  
C-64 GT.....\$229.00

### MICRO SCI

A1.5 Apple.....\$179.00  
A2 Apple.....\$179.00



SD1 C-64 Single.....\$219.00  
SD2 C-64 Dual.....\$299.00



320K 5 1/4" (PC).....\$109.00

### TEAC

320K 5 1/4".....\$109.00

**CALL TOLL-FREE**



### MONITORS

<b>AMDEK</b>	
300 Green.....	\$129.00
300 Amber.....	\$139.00
310 Amber IBM-Plug.....	\$169.00
Color 300 Composite.....	\$179.00
Color 500 Composite/RGB.....	\$389.00
Color 600 Hi-Res (640x240).....	\$399.00
Color 700 Hi-Res (720x240).....	\$499.00
Color 710 Long Phosphor.....	\$579.00
Color 722 IBM Enhanced.....	\$579.00



12" Amber/Green Comp.....(ea.)	\$99.99
12" Amber/Green TTL.....(ea.)	\$119.00

### NEC

JB 1260 Green.....	\$59.99
JB 1201/1205.....(ea.)	\$99.99
JB 1270 Green/1275.....	\$119.00
JB 1275 Amber.....	\$119.00
JB 1280 G TTL/1285 A TTL.....	\$149.00
JC 1410 RGB.....	\$669.00
JC 1225 Composite.....	\$179.00

### PRINCETON

MAX-12E Amber.....	\$179.00
HX-9 9" RGB.....	\$469.00
HX-9E Enhanced.....	\$519.00
HX-12 12" RGB.....	\$469.00
HX-12E Enhanced.....	\$559.00
SR-12 Hi-Res.....	\$599.00
SR-12 P Enhanced.....	\$649.00

### TAXAN

115 12" Green Mono.....	\$119.00
116 12" Amber Mono.....	\$119.00
121 Green TTL.....	\$139.00
122 Amber TTL.....	\$149.00
420 Hi-Res RGB (IBM).....	\$429.00
440 Ultra Hi-Res RGB.....	\$559.00



8400 Quadchrome I.....	\$479.00
8410 Quadchrome II.....	\$429.00
8420 Amberchrome.....	\$179.00
8500 Quad Screen.....	\$1499.00



ZVM 1220/1230.....(ea.)	\$99.99
ZVM 1240 IBM Amber.....	\$149.00
ZVM 130 Color.....	\$269.00
ZVM 131 Color.....	\$249.00
ZVM 133 RGB/Color.....	\$429.00
ZVM 135 RGB/Color.....	\$459.00
ZVM 136 RGB/Color.....	\$599.00

### INTERFACES

### AST

Multi I/O (Apple II).....	\$169.00
---------------------------	----------



Graphcard.....	\$79.99
Serial Card.....	\$99.99
Microbuffer II +.....	\$169.00
Microbuffer 32K.....	\$189.00



Microfazer.....	from \$139.00
Efazer (Epson).....	from \$79.99

### Orange Mikro

Grappier CD (C64).....	\$99.99
Grappier + (Apple).....	\$89.99
Grappier 16K + (Apple).....	\$159.00

### DIGITAL DEVICES

Ape Face (Atari).....	\$49.99
U-Print A (Atari).....	\$54.99
U-A18/Buffer (Atari).....	\$74.99
U-Call Interface (Atari).....	\$39.99
U-Print C (C64).....	\$49.99
P-16 Print Buffer.....	\$74.99
U-Print II Apple IIc.....	\$89.99

### TYMAC

C64 Epson.....	\$59.99
C64 Okidata.....	\$59.99
C64 Star.....	\$59.99

### PRINTERS

### Canon

A40.....	CALL
LBP-8A1 Laser.....	CALL

### CITIZEN

MSP-10 (80 col.).....	\$279.00
MSP-15 (132 col.).....	\$389.00
MSP-20 (80 col.).....	\$349.00
MSP-25 (132 col.).....	\$509.00

### C.I.TOH

Prowriter 7500.....	\$219.00
Prowriter 8510 NLQ.....	\$329.00
Prowriter 1550P.....	\$449.00
Starwriter 10-30.....	\$459.00

### corona

Lazer LP-300.....	\$2799.00
-------------------	-----------

### DIABLO

D25 Daisywheel.....	\$549.00
630-109 Daisywheel.....	\$1749.00
D801F Daisywheel.....	CALL

### daisywriter

2000.....	\$749.00
-----------	----------

### EPSON

LX-80, LX-90, FX-85, FX-185	
JX-80, DX-10, DX-20, SQ 2000	
HS-80, Homewriter 10, DX-35.....	CALL

### JUKI

6000 Letter Quality.....	CALL
6100 Letter Quality.....	CALL
6200 Letter Quality.....	CALL
6300 Letter Quality.....	CALL

5510.....	CALL
-----------	------

### LEGEND

808 Dot Matrix 100 cps.....	\$179.00
1080 Dot Matrix 100 cps.....	\$259.00
1380 Dot Matrix 130 cps.....	\$289.00
1385 Dot Matrix 165 cps.....	\$339.00

### NEC

2007 Transportable.....	\$229.00
8020 Series.....	\$699.00
3000 Series.....	\$1099.00
8000 Series.....	\$1449.00
ELF 360.....	\$449.00
Pirwriter 560.....	\$999.00

### OKIDATA

182, 183, 192, 193, 2410, 84.....	CALL
Okimate 10 (Specify C64/Atari)	\$189.00
Okimate 20 (IBM).....	CALL

### OLYMPIA

Needlepoint Dot Matrix.....	\$289.00
Compact RO.....	\$289.00
Compact 2.....	\$349.00

### Panasonic

KX1091.....	\$259.00
KX1092.....	\$389.00
KX1093.....	\$479.00



Quadjet.....	\$399.00
--------------	----------

Quad Laser.....	CALL
-----------------	------

### SILVER-REED

500 Letter Quality.....	\$279.00
550 Letter Quality.....	\$419.00
770 Letter Quality.....	\$759.00

### Star

SG-10C (C64 Interface).....	CALL
SB/SD/SG/SR Series.....	CALL
Powertype Letter Quality.....	CALL

### Texas Instruments

Ti850.....	\$529.00
Ti855.....	\$799.00
Ti865.....	\$1049.00

### TOSHIBA

1340 (80 column).....	\$589.00
P351 (132 column).....	\$1149.00

### PC COMPATIBLES

Inquiry 77

### IBM PC SYSTEMS

Configured to your specification. Call for Best Price!

IBM-PC, IBM-PC II, IBM-XT, IBM-AT



Sperry-AT.....	as low as \$1749.00
Sperry-IT.....	as low as \$2699.00
Call for Specific Configuration!	
All Models.....	CALL



KP-2000 Portable.....	CALL
-----------------------	------

### SOFTWARE FOR IBM

### ASHTON-TATE

Framework.....	\$369.00
dBase III.....	\$369.00

### BORLAND

Turbo Pascal 3.0.....	\$49.99
Sidekick (unprotected).....	\$59.99

### CENTRAL POINT

Copy II PC-Backup.....	\$29.99
------------------------	---------

### DECISION RESOURCES

Chartmaster.....	\$229.00
Signmaster.....	\$169.00

### ENERTRONICS

Energraphics/Plot.....	\$289.00
------------------------	----------

### FOX & GELLER

Quickcode III.....	\$169.00
--------------------	----------

### FUNK SOFTWARE

Sideways.....	\$39.99
---------------	---------

### HARVARD SOFTWARE INC.

Harvard Project Manager.....	\$209.00
Total Project Manager.....	\$269.00

### LIFETIME

Volkswriter Deluxe.....	\$159.00
-------------------------	----------

### LIVING VIDEOTEK

Think Tank.....	\$109.00
Ready Tank.....	CALL

### LOTUS

Symphony.....	\$429.00
1-2-3.....	\$309.00

### MECA SOFTWARE

Managing Your Money 2.0.....	\$109.00
------------------------------	----------

### MICROSTUF SOFTWARE

Crosstalk XVI.....	\$89.99
Crosstalk Mark IV.....	\$149.00
Remote.....	\$89.99

### MICRORIM SOFTWARE

R:Base 4000.....	\$249.00
R:Base 5000.....	\$389.00
Clout 2.0.....	\$129.00

### MICROPRO

WordStar 2000.....	\$249.00
WordStar 2000+.....	\$309.00
WordStar Professional.....	\$299.00
Easy.....	CALL

### MICROSOFT

Word.....	\$239.00
Mouse.....	\$139.00
Flight Simulator.....	\$39.99
MultiPlan.....	\$129.00

### MULTIMATE

Advantage.....	\$289.00
Multi Mate Word Proc.....	\$249.00

### NOUMENON

Intuit.....	\$69.99
-------------	---------

### NORTON

Norton Utilities 3.0.....	\$59.99
---------------------------	---------

### PEACHTREE SOFTWARE

Peachtext 5000.....	\$169.00
PeachPack (GL/AP/AR).....	\$199.00

### PFS: IBM

First Success.....	\$218.00
Access.....	\$79.99
File/Graph.....(ea.)	\$79.99
Report.....	\$74.99
Plan.....	\$79.99
Write/Proof Combo.....	\$79.99

### PROFESSIONAL SOFTWARE

Wordplus-PC w/Boss.....	\$249.00
-------------------------	----------

### ROSESOFT

Prokey.....	\$89.99
-------------	---------

### THE SOFTWARE GROUP

Enable.....	\$339.00
-------------	----------

### SATELLITE SYSTEMS

Word Perfect 4.0.....	\$219.00
-----------------------	----------

### SORCIM/UIS

Accounting AP/AR/GL/INV/OE.....(ea.)	\$295.00
SuperCalc III.....	\$195.00
EasyWriter II System.....	\$195.00
Super Project.....	\$195.00

### SPI SOFTWARE

Open Access.....	\$379.00
------------------	----------

### SUBLOGIC

Jet.....	\$39.99
----------	---------

### THOUGHTWARE

Trigger.....	\$289.00
Sell, Sell, Sell Training.....	\$299.00
Application.....	\$179.00

### TLB

Solomon III GL.....	\$519.00
---------------------	----------

Safari (7300).....	CALL
6300.....	CALL

### corona

PPC400 Dual Portable.....	\$1289.00
PPCXT 10 meg Portable.....	\$1989.00
PC40022 Dual Desktop.....	\$1389.00
PC400-HD2 10 meg.....	\$1989.00

### ITT

ITT X-TRA 256K, 2 Drive System.....	CALL
256K, 10 meg Hard Drive System	CALL
XPS, 20 meg.....	CALL

### SANYO

MBC 550-2 Single Drive.....	\$669.00
MBC 555-2 Dual Drive.....	\$969.00
MBC 675 Portable.....	CALL
MBC 775.....	CALL
MBC 880 Desktop.....	CALL



PC-158-21 Single Desktop.....	CALL
PC-158-52 Dual Desktop.....	CALL
PC-158-53 10 meg Desktop.....	CALL
PC-161-21 Single Portable.....	CALL
PC-161-52 Dual Portable.....	CALL
Z-200 (AT).....	CALL
171 (Portable).....	CALL
138 (Transportable).....	CALL
148 (DeskTop).....	CALL

### MULTIFUNCTION CARDS

### AST

Six Pack Plus.....	\$239.00
Mega Plus II.....	\$269.00
I/O Plus II.....	\$139.00
Advantage-AT.....	\$399.00
Graph Pak /64K.....	\$599.00
MonoGraph Plus.....	\$399.00
Preview Mono.....	\$299.00
PC Net Cards.....	\$379.00
525/111 On-line.....	\$669.00
525/112 Remote.....	\$579.00
3780 Emulation Card.....	\$639.00

### dca

IRMA 3270.....	\$879.00
IRMA Print.....	\$999.00
IRMA Smart Alec.....	\$779.00



Edge Card.....	\$299.00
Color Card (Graphics Edge).....	\$299.00
Magic Card II.....	\$179.00

### HERCULES

Graphics.....	\$299.00
Color.....	\$159.00

### IDEAssociates

# PRINTERS *Plus*

## 800-562-2727

### User-Friendly Prices

**NEW!** From **EPSON FX-85**  
 WITH NLQ (REPLACES FX-80+)  
**\$339.**  
 Suggested Retail \$499.



**FX-185** WITH NLQ  
**WIDE CARRIAGE**  
 (REPLACES FX100+)

**\$459.**  
 Suggested Retail \$699.

- 160 CPS • IBM 5152 GRAPHICS
- NLQ MODE • 8K BUFFER
- SELECTYPE™ • 160 TYPESTYLES
- ONE YEAR WARRANTY

**EPSON LQ-1500**



**\$827.**  
 Suggested Retail \$1295.

**DRAFT TO LETTER QUALITY  
 IN ONE AMAZING PRINTER**

- 24 Pin Printer
- 200 CPS Draft Mode
- Over 200 Typestyles
- Ultra-High Resolution Graphics
- Four Times Faster than the Average Daisy Wheel at 67 CPS — Letter Quality

*New Low Prices On Options*

**Qualified Corporate & Educational Purchase Orders Accepted**

**EPSON LX-80** Suggested Ret. Price \$299. **\$214.**



- **SPEED** — 100 characters per second
- **QUALITY** — Near letter quality mode
- **EASE-OF-USE** — Choose popular typestyles from top control panel with SelectType™
- **VERSATILITY** — Over 160 possible type styles. Mix text and graphics on the same line.
- **WARRANTY** — Epson's one year warranty

WITH TRACTOR FEED

**LX-90** Suggested Retail Price \$329. **\$219.**

**PIC Cable Interfaces Available For:**

• IBM PC Emulates IBM 5152	• APPLE IIc Emulates Epson LX-80
• IBM JR. Emulates IBM Compact	• GENERIC PARALLEL* Emulates Epson LX-80
• ATARI Emulates Atari 1025	• COMMODORE Emulates Commodore MPS 801

\*Requires Cable

**NEW!** **EPSON AP-80**  
 for **APPLE'S Macintosh - IIC - IIE**

- WITH NLQ
- TRACTOR FEED
- IMAGE WRITER COMPATIBLE

**\$279.**  
 Suggested Retail \$379

**Special Pricing For Qualified Resellers**

**DIABLO COMPATIBLE DAISYWHEEL PRINTERS**



**EPSON-DX-10** **\$219.**  
 • 10 CPS • 1 YEAR WARRANTY Suggested Retail \$299.

**EPSON-DX-20** **\$319.**  
 • 20 CPS • 110 COLUMN Suggested Retail \$499.  
 • ALL-PURPOSE INTERFACE

**COMREX™** **PRICE BREAK!**

**ComRiter CR-420**  
**HIGH SPEED PRINTER**

- Computer Compatible—switch between standard parallel and serial interfaces
- 420 CPS (Draft Mode)
- Rear and Bottom Paper Entry
- Print up to 5-part Forms
- Standard Friction and Tractor Feed
- Change Fonts and form length with the push of a button
- Quiet quality printing with a built-in sound enclosure

Suggested Retail \$2,295.  
**SPECIAL PRICE**  
**\$1,281.**

**NEW!** **EPSON HS-80 LETTERJET**



- 160 CPS INK JET
- PORTABLE or AC
- STANDARD PAPER
- NLQ • EPSON CODE

**\$310.**  
 Suggested Retail \$499

**SPECIAL OFFER!**  
 with printer purchase

**COMREX PREMIUM DISKETTES**

**\$14.99** Suggested Retail \$39.95

**COMREX DS/DD**  
 Ten In durable plastic case

## 1-800-562-2727

Or In Missouri call: 1-314-227-4371



**PRINTERS PLUS / 910 Clayton Rd., #217, Ballwin, MO 63011**



SHIPPING AND HANDLING AT ADDITIONAL COST. (MC AND VISA AT NO ADDITIONAL CHARGE.) OFFER GOOD WHILE SUPPLY LASTS. PRICES ARE IN EFFECT UNTIL DECEMBER 31, 1985. SOME ITEMS MAY NOT BE AVAILABLE ON PUBLICATION DATE. ALL EQUIPMENT CARRIES MANUFACTURER'S WARRANTY. RETURNS REQUIRE PRIOR APPROVAL AND ARE SUBJECT TO A RESTOCKING FEE. ALL SALES ARE FINAL. WE CANNOT GUARANTEE EQUIPMENT COMPATIBILITY.

# CONVERSATIONS

BY DOUGLAS E. COMER AND LARRY L. PETERSON

## *An alternative to memos and conferences*

*This article is based on excerpts from a paper entitled "Conversations: An Alternative to Memos and Conferences," which was presented at the Workshop on Computer Conferencing and Electronic Messaging, University of Guelph, Canada, January 22-23, 1985.*

A CONVERSATION-BASED SYSTEM groups messages into conversations, with messages within a conversation ordered according to the context in which they are written. Message context defines a relation between messages that makes it easy to implement conversations in a distributed environment.

### DATA STRUCTURE

The underlying structures that support both the memo-based system DRAGONMAIL and teleconferencing systems are the mailbox and the conference, respectively. Simple interfaces, such as the UNIX mail system, place saved messages in a named file. Other interfaces, such as MH, MS, and Laurel, provide more advanced mechanisms for archiving messages, such as "folders" into which messages are filed. Commands allow the user to browse through the hierarchy of saved messages and select particular messages based on a specified attribute-value pair. User interfaces like Edmas and AUGMENT use the technique of "linking" related messages, providing yet another mechanism for allowing the user to traverse through a list of messages and replies to messages.

Despite their differences, all conventional user interfaces are founded on a memo-based model that resembles the office practice of memo communication. A new model for exchanging information combines the memo-based model and the teleconferencing model. This approach replaces

the first-in/first-out ordering of memos with a mechanism that groups messages into conversations and orders the messages within a conversation according to the context in which they were created. This model places a high-level structure on messages, where the fundamental object of communication is the *conversation* rather than the memo. Instead of reading, writing, and filing individual memos, users participate in a set of conversations.

### THE UNDERLYING MODEL

A conversation consists of a group of *messages*, denoted  $M = \{m_i \mid i > 0\}$ , shared by a set of *participants*, denoted  $P = \{p_i \mid i > 0\}$ . Also associated with a conversation is a *topic* defined by the user who starts the conversation. A topic is a short phrase that describes the conversation's general area of discussion.

Participants *view* the messages associated with a conversation as well as add new messages. In this system, participants *submit* messages to a specific conversation rather than mail them to a set of recipients. A conversation begins when a user defines the set of participants  $P$  and submits an initial message  $m_0$ . New members are added

*(continued)*

Douglas E. Comer, who has a Ph.D. in computer science from Pennsylvania State University, has worked as a professor and researcher at Purdue University and Bell Laboratories. He can be contacted at the Department of Computer Science, Purdue University, West Lafayette, IN 47907.

Larry L. Peterson received his Ph.D. in computer science from Purdue University, where his thesis investigated issues in electronic mail systems. He can be contacted at the Department of Computer Science, University of Arizona, Tucson, AZ 85721.

to a conversation by having the list expanded to include them. Similarly, old members may be removed. Being added to a conversation means having access to the entire *history* of the conversation (i.e., all of set  $M$ ). Removal implies not being able to read any further messages submitted to the conversation. The system also allows users to manipulate entire conversations; a user can *delete* an unwanted conversation, as well as *merge* two related conversations and *split* a diverging conversation.

The conversation-based system partitions messages in a conversation into *visible* and *hidden* subsets. The system automatically displays visible messages to participants when a conversation is viewed. Hidden messages are maintained in the history of the conversation and can be viewed by users via special commands. Participants may

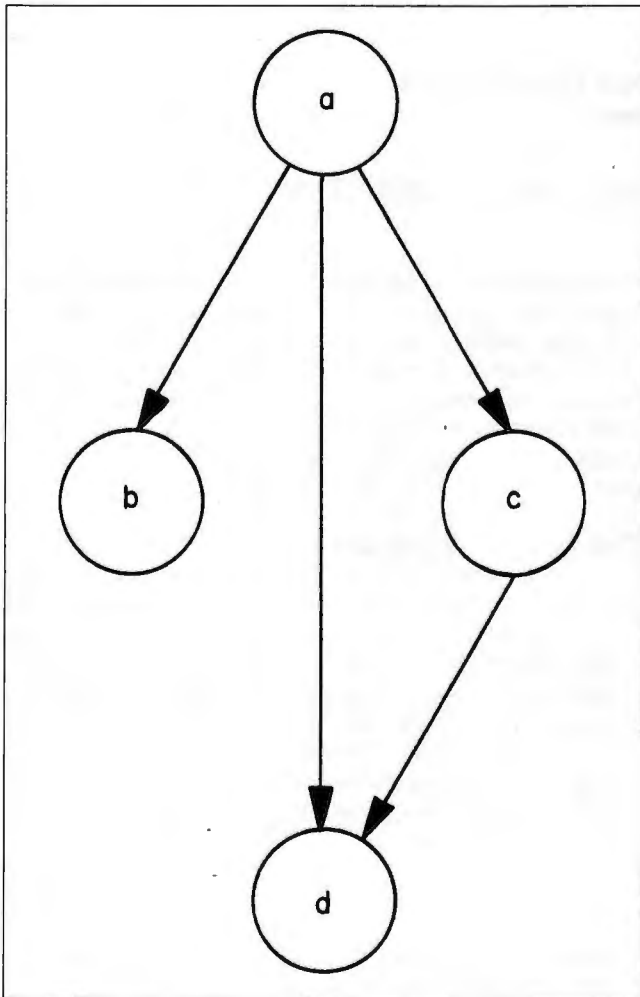


Figure 1: A context graph for a conversation in which message *a* was the initial message of the conversation. Messages *b* and *c* were submitted after their respective authors had read message *a*, but independently of each other. Message *d* was submitted after its author had viewed messages *a* and *c* but before he had viewed message *b*.

*hide* messages determined to be irrelevant to the conversation and *supersede* a group of messages with a single summarizing message.

## MESSAGE STRUCTURE

An individual message in a conversation consists of a *header*, a *body*, and a set of *attachments*. The header consists of the *sender* of the message, the creation or *date* of the message, and the *subject* of the message. The header may also contain a set of *parameters*, including the *urgency* and *lifetime* of the message.

The body of the message contains the lines of text meant to be viewed by the participants. Along with the text, a user may send a set of attachments with the message. Attachments might be binary programs, source programs, or data files that are not necessarily meant to be viewed by participants. Instead, participants remove attachments from the message and place them in files for further computation.

## PARTICIPANT HIERARCHY

Participants in a conversation are categorized according to their privileges within the system. Here are the classes of participants and their respective privileges:

**Reader:** A participant who is only allowed to read messages in a conversation.

**Contributor:** A participant who reads and also has the right to add messages to a conversation.

**Administrator:** A person who can remove or add participants as well as move irrelevant messages into the set of hidden messages.

**Owner:** The person who starts a conversation. In addition to having administrative authority, the owner has the right to extend or restrict the privileges of other participants.

## MESSAGE CONTEXT

The underlying structure of a conversation maintains the relationship among the messages that make up the conversation. Informally, when participants compose a message, they do so in the context of the messages they have already seen. Specifically, *message context* is a relation  $R$  that holds between messages  $i$  and  $j$  such that  $m_i R m_j$  if and only if  $m_i$  had been read by the author of  $m_j$  before composing  $m_j$ .

The set of message-context relations for the messages in a conversation is represented by a directed acyclic graph called a *context graph*, denoted  $G = (M, E)$ . The vertices of  $G$  correspond to the messages in the conversation, while the edges of the graph represent the message-context relation. An edge leading from node  $i$  to node  $j$  implies  $m_i R m_j$  and reads " $m_i$  precedes  $m_j$ ." Figure 1 is an example of a context graph.

Associated with each participant  $p_i$  is a subset of  $M$ , denoted  $\bar{M}_i$ , corresponding to those messages in  $M$

(continued)

**ORDER  
LINE  
800-354-7330**

**LOWEST PRICES**

**NO SURCHARGE  
ON BANK CARDS**

**SILICON SPECIALTIES**

**HARDWARE**

**PRINTERS**

Anadex All Models	Save
Brother All Models	Save
C-Itch 8510 AP+	\$314
Citizen MSP-10	\$255
MSP-15 or MSP-20	\$349
MSP-20	\$319
MSP-25	\$489
Datasouth DS180	\$1079
DS220	\$1299
DS-PP#1	\$419
DS-PP#2	\$615
Diablo D-25	\$549
630API	\$1484
630 ECS/IBM	\$1659
Other Printer Models	Save
Epson All Printer Models	Save
Juki 6000	\$169
6100	\$349
6300	\$679
NEC 2010, 2015, 2050	\$629
3510, 3550	\$989
3515	\$1009
3530	\$935
8810, 8830, 8850	\$1379
P2, P3	Save
Elf 360	\$399
Elf 370	\$389
Okidata All Printer Models	Save
Panasonic 1091	\$235
1092	\$349
1093	\$429
KXP3151	\$409
Star Micronics	Save
All Printer Models	Save
Silver Reed	Save
EXP400 Parallel	\$205
EXP500 Parallel or Serial	\$279
EXP550 Parallel or Serial	\$389
EXP770 Parallel or Serial	\$699

**BOARDS**

AST Advantage	\$389
Six Pack Plus	\$219
Everex Boards	Save
Hercules Color Card	\$149
Graphic Card	\$299
Paradise Modular Graphic 06-1	\$259
Five Pak	\$119
Quadram	
Quodlink	\$325
Tec Mar Graphics Master	\$445
Captain No Memory	\$159

**COMPUTERS**

Sonya MBC-775 Portable	\$1789
Televideo PM 4T	\$5089
PM 16T	Save
Wyse Wyse pc Dual	\$1199
Wyse pc 10 Meg	\$1959
Zenith	
Z-158 All Models	Save
Z-138 All Models	Save
Z-148 All Models	Save
Z-171	Save
Z-200	Save

**VIDEO TERMINALS**

Altos Smart III	\$599
IBM 3161 & 3163 Series	Save
Qume QVT Green 101	\$299
QVT Amber 101	\$314
Wyse 30	\$299
50	\$419
75	\$559
Wyse 85	\$379
Wyse 350	\$859
Zenith Z-22	\$455
Z-29	\$599
Z-49	Save

**DISK DRIVES**

Alpha Omega Turbo 10	\$529
Turbo 20	\$529
Turbo 30	\$949
Everex	
10 Megabyte	\$549
20 Megabyte	\$689
60 Megabyte	\$879
Haba Hobadisk for Macintosh	\$279
Imega Bernoulli Box for IBM	
10 Megabyte	Save
20 Megabyte	Save
20 Megabyte Plus	Save
5 Megabyte for Macintosh	Save

**MODEMS**

AT&T	
4000 External	\$319
Anchor Automation	
Anchor Express	\$235
Mark XII	\$229
Hayes Smartmodem 300 Baud	\$129
Smartmodem 1200 Baud	\$369
Smartmodem 1200B (IBM)	\$319
Smartmodem 2400 Baud	\$599
Micromodem IIE (Apple)	\$134
Novation Smart Cat Plus	\$279
Prometheus All Models	Save
US Robotics Courier 2400	\$389
Password 1200	\$195

**KEYBOARDS**

Keytronics 5151	\$159
5151 Jr.	\$179

**DISKETTES**

3M 5 1/4 DS/DD (Qty 100)	\$169
Maxell MD-2 Plastic Box (Qty 100)	\$159
MD-20 Plastic Box (Qty 100)	\$159
Sony MD/2 (Qty 100)	\$170

**PLOTTERS**

Enter Sweet-6000	\$759
Epson HI-80	Save

**SOFTWARE**

**WORD PROCESSORS**

Leading Edge Word Processor	\$50
Leading Edge W/P with Spell & Mail	\$137
Microsoft Word 2.0	\$223
Multimate 3.3	\$206
PFS-Write	\$78
Wordstar w/Tutor	\$169
Wordstar Pro Pack	\$239

Word Perfect (Ver.4.0)	\$199
Wordstar 2000	\$239
Wordstar 2000 Plus	\$285

**GRAPHICS**

Chartmaster	\$206
PC Paintbrush	\$62
Turbo Graphics Tool Box	\$28
Diagram Master	\$190
Dr. Halo	\$55
Energraphics	\$165
Energraphics w/Plotter Option	\$214
Microsoft Chart	\$149
PC Draw	\$203
PC Draw Light Pan	\$104
PC Point w/Mouse	\$123
PC Mouse w/Pointbrush	\$107
PFS Graph	\$78
Printmaster	\$30
Signmaster	\$135

**LANGUAGES**

C Compiler (Microsoft)	\$235
Fortran Compiler (Microsoft)	\$209
Macro Assembler	\$89
Pascal Compiler (Microsoft)	\$178
Turbo Pascal 3.0	\$35
Lattice C Compiler	Save
Run C Interpreter	\$85
Quick Basic	\$59
Turbo Tool Box	\$28

**UTILITIES**

1 DIR	\$48
Copy II PC	\$19
Norton Utilities 3.0	\$49
Sidekick	\$28
Sidekick (Unprotected)	\$43
Sideways	\$31
Superkey	\$35
Printworks	\$36
Spotlight	\$43
Sidekick-Superkey (Bundle)	\$65

**TRAINING**

Flight Simulator	\$30
Typing Instructor	\$29
Typing Tutor III	\$29

**MONEY MANAGEMENT**

Dollars & Sense w/Forecast	\$95
Tablas Managing Your Money	\$95

Gem Collection	\$115
Gem Desktop	\$29
Gem Draw	Save

**PROJECT MANAGEMENT**

Harvard Total Project Manager	\$239
Microsoft Project	\$149
Super Project	\$182
Timeline 2.0	\$249

**COMMUNICATIONS**

CompuServe Starter Kit	\$17
Crosstalk XVI	\$94
PFS Access	\$78
Remote	\$94

**INTEGRATIVE SOFTWARE**

Enable 1.1	\$299
Framework	Save
Smart Software System	\$459
Symphony	Save

**SPREADSHEETS**

Lotus 1-2-3	Save
Multiplan	\$114
Spreadsheet Auditor 2.0	\$83

Supercalc 3 (Ver.2)	SAVE
---------------------	------

**DATA BASE MANAGEMENT**

Cornerstone	\$255
dBase II	Save
dBase III	Save
Nutshell	Save
PFS:File	\$78
PFS:Report	\$70
Quickcode	\$139
QuickReport	\$139
Extended Report Writer	\$80
Think Tank	\$93
Clipper	\$355
KnowledgeMan II	Save
KnowledgeMan Upgrade Kit	Save
Powerbase	
(New Ver. Reb. 320K)	\$205

**R:Base 5000.\$335**

**ZENITH COMPUTERS**  
Always  
the lowest prices.  
Call us for a quote.

**TOSHIBA  
PRINTERS  
SPECIAL**

1340 Parallel	\$449
1340 Serial	\$449
341 Parallel	\$829
341 Serial & Parallel	\$879
351 Serial & Parallel	\$985

**MONITORS**

Amdex All Monitors	Save
NEC All Monitors	Save
Princeton Graphics	Save
Takan 121 Green	\$125
122 Amber	\$129
Zenith All Models	Save

Inquiry 326 for MS-DOS Products. Inquiry 327 for all others.

Prices reflect 3% to 5% cash discount. Product shipped in factory cartons with manufacturer's warranty. Please add \$10.00 per order for UPS shipping. Prices & availability subject to change without notice. Send cashier's check or money order...all other checks will delay shipping two weeks.

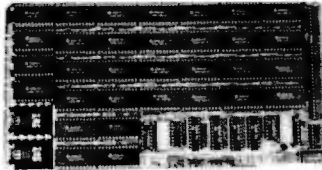


**SILICON SPECIALTIES**  
2034 WEST SOUTHERN  
MESA, ARIZONA 85202  
602-969-0909

CMSS-1085

## 64K S100 STATIC RAM

**\$119<sup>00</sup>**  
KIT



LOW POWER!  
150 NS ADD \$10

BLANK PC BOARD  
WITH DOCUMENTATION  
\$49.95

SUPPORT ICs + CAPS  
\$17.50

FULL SOCKET SET  
\$14.50

FULLY SUPPORTS THE  
NEW IEEE 696 S100  
STANDARD  
(AS PROPOSED)

FOR 56K KIT \$105

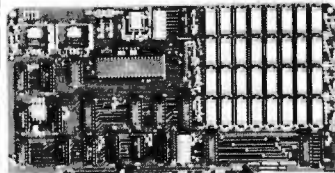
ASSEMBLED AND  
TESTED ADD \$50

### FEATURES: PRICE CUT!

- Uses new 2K x 8 (TMM 2016 or HM 6116) RAMs.
- Fully supports IEEE 696 24 BIT Extended Addressing.
- 64K draws only approximately 500 MA.
- 200 NS RAMs are standard. (TOSHIBA makes TMM 2016s as fast as 100 NS. FOR YOUR HIGH SPEED APPLICATIONS.)
- SUPPORTS PHANTOM (BOTH LOWER 32K AND ENTIRE BOARD).
- 2716 EPROMs may be installed in any of top 48K.
- Any of the top 8K (E000 H AND ABOVE) may be disabled to provide windows to eliminate any possible conflicts with your system monitor, disk controller, etc.
- Perfect for small systems since BOTH RAM and EPROM may co-exist on the same board.
- BOARD may be partially populated as 56K.

**256K S-100 SOLID STATE DISK SIMULATOR!**  
WE CALL THIS BOARD THE "LIGHT-SPEED-100" BECAUSE IT OFFERS AN ASTOUNDING INCREASE IN YOUR COMPUTER'S PERFORMANCE WHEN COMPARED TO A MECHANICAL FLOPPY DISK DRIVE.

### PRICE CUT!



BLANK PCB  
(WITH CP/M\* 2.2  
PATCHES AND INSTALL  
PROGRAM ON DISKETTE)  
**\$69<sup>95</sup>**  
(8203 1 INTEL \$29 95)

#### FEATURES:

- 256K on board, using +5V 64K DRAMS.
- Uses new Intel 8203-1 LSI Memory Controller.
- Requires only 4 Dip Switch Selectable I/O Ports.
- Runs on 8080 or Z80 S100 machines.
- Up to 8 LS-100 boards can be run together for 2 Meg. of On Line Solid State Disk Storage.
- Provisions for Battery back-up.
- Software to mate the LS-100 to your CP/M\* 2.2 DOS is supplied.
- The LS-100 provides an increase in speed of up to 7 to 10 times on Disk Intensive Software.
- Compare our price! You could pay up to 3 times as much for similar boards.

#LS-100 **\$149<sup>00</sup>**  
(FULL 256K KIT)  
(ADD \$50 FOR A&T)

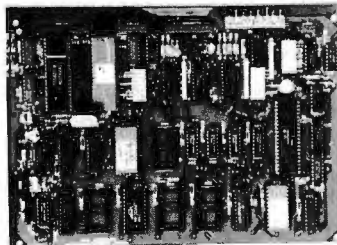
## THE NEW ZRT-80

### CRT TERMINAL BOARD!

A LOW COST Z-80 BASED SINGLE BOARD THAT ONLY NEEDS AN ASCII KEYBOARD, POWER SUPPLY, AND VIDEO MONITOR TO MAKE A COMPLETE CRT TERMINAL. USE AS A COMPUTER CONSOLE, OR WITH A MODEM FOR USE WITH ANY OF THE PHONE-LINE COMPUTER SERVICES.

#### FEATURES:

- Uses a Z80A and 6845 CRT Controller for powerful video capabilities.
- RS232 at 16 BAUD Rates from 75 to 19,200.
- 24 x 80 standard format (60 Hz).
- Optional formats from 24 x 80 (50 Hz) to 64 lines x 96 characters (60 Hz).
- Higher density formats require up to 3 additional 2K x 8 6116 RAMs.
- Uses N.S. INS 8250 BAUD Rate Gen. and USART combo IC.
- 3 Terminal Emulation Modes which are Dip Switch selectable. These include the LSI-ADM3A, the Heath H-19, and the Beehive.
- Composite or Split Video.
- Any polarity of video or sync.
- Inverse Video Capability.
- Small Size: 6.5 x 9 inches.
- Upper & lower case with descenders.
- 7 x 9 Character Matrix.
- Requires Par. ASCII keyboard.



**\$89<sup>95</sup>** #ZRT-80  
(COMPLETE KIT, 2K VIDEO RAM)

BLANK PCB WITH 2716  
CHAR. ROM. 2732 MON. ROM  
**\$49<sup>95</sup>**  
SOURCE DISKETTE - ADD \$10  
SET OF 2 CRYSTALS - ADD \$7.50

FOR 8 IN.  
SOURCE DISK  
(CP/M COMPATIBLE)  
ADD \$10

## Digital Research Computers

P.O. BOX 381450 • DUNCANVILLE, TX 75138 • (214) 225-2309

Call or write for a free catalog on Z-80 or 6809 Single Board Computers, SS-50 Boards, and other S-100 products.

TERMS: Add \$3.00 postage. Orders under \$15 add 75c handling. No C.O.D. We accept Visa and MasterCard. Tex. Res. add 5-1/8% Tax. Foreign orders (except Canada) add 20% P & H. Orders over \$50 add 85c for insurance.

## CONVERSATIONS

*Conversations move  
into the background after  
n idle days, whether  
a participant has viewed  
all the messages there or not.*

already viewed by  $p_i$ . We informally think of the context graph as having each node marked according to whether or not each participant has read it. Thus, when participant  $p_i$  views a message, the message is added to  $\bar{M}_i$ , and when  $p_i$  submits a message, it is connected to the context graph by edges leading from all the vertices in  $\bar{M}_i$ .

The messages in the graph are arranged topologically. Thus, if message  $m_j$  was composed by a participant after reading message  $m_i$ , then  $m_i$  is displayed to those viewing the conversation before  $m_j$ .

Anytime a user participates in a set of conversations, denoted  $K = \{k_i | i \geq 0\}$ , he or she defines subsets of  $K$  by supplying a subset name and specifying the conversations in  $K$  contained in the subset. (We represent the subset named  $S$  as  $K_S$ .) Defining subsets of conversations allows the user to treat a group of conversations collectively.

In addition to user-defined subsets of  $K$ , conversation-based mail maintains a collection of system-defined subsets. For example, the system partitions  $K$  into foreground and background subsets, denoted  $K_F$  and  $K_B$ , respectively. Conversation  $k_i \in K_F$  if and only if a participant has acted on it in the last  $n$  days.

The system also partitions  $K$  into the subset of conversations that contain messages not yet seen by the user, denoted  $K_u$ , and the subset of conversations in which the user is up to date, denoted  $K_c$ . Finally,  $K_v$  denotes the set of conversations containing unread urgent messages.  $K \subseteq K_u$ , but  $K \not\subseteq K_F$  because conversations move into the background after  $n$  idle days, whether a participant has viewed all the messages it contains or not.

### DISTRIBUTED SYSTEM IMPLEMENTATION

We abstractly view a conversation as having a single context graph. But because users expect a fast response time when viewing messages, a single graph is not practical if the participants in a conversation are distributed over two or more computer systems with inherent communication delays between them.

Therefore, each participant  $p_i$  is seen as having a resident copy of a subgraph of  $G$ , denoted  $G_i$ , that is quickly accessible for viewing. When participant  $p_i$  views the messages in a conversation, he or she sees only the messages

(continued)

# “A true data management product is inherently multi-user.”

**Edward M. Esber, Jr.**  
**President Ashton-Tate Software, “InfoWorld” July 22, 1985**

Thank you Mr. Esber. We at DataAccess Corp. couldn't agree more! That's why DataFlex was designed and implemented with *true* multi-user capabilities right from the start, way back in 1981.

And we mean RIGHT from the start.

Take for example DataFlex's multi-user data protection features. While other products deny users access to records... or even complete files... while they are in use, DataFlex allows all users access to all files and records at all times. With DataFlex's powerful data entry macro, locking occurs only during write operations, and then, only for the microseconds it takes to update the file. No user is ever affected by any other, and data integrity is absolute!

Another of DataFlex's multi-user facilities is its sophisticated, yet easy to use, on-line query program. Query allows even inexperienced users to produce complex multi-file reports simply by using a mouse or the cursor control keys to “point & shoot” at the data they wish to see presented. And because DataFlex maintains on-line data indices, query's output is sent to the screen, printer or file as quickly as it can be read from disk. You even have the option of generating error-free source code and using it as the basis of a more complex report.

Call your local dealer today and discover for yourself the joys of using “A True Data Management Product.”

## The TRUE Multi-User Applications Development Database

### SUPPORTED OPERATING SYSTEMS AND NETWORKS

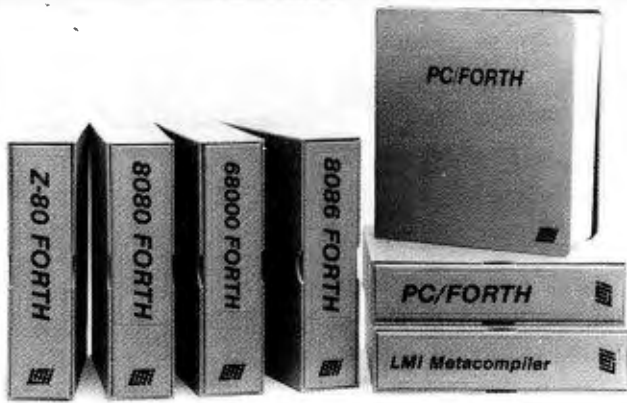
IBM PC DOS 1.x, 2.x, 3.x  
MSDOS 1.x, 2.x, 3.x  
IBM “AT” XENIX  
IBM PC NETWORK  
CP/M, CP/M-86  
Concurrent CP/M-86  
Concurrent DOS  
MP/M-86  
Novell NetWare  
TurboDos  
Corvus w/IBM PC  
Molecular N/Star  
TeleVideo Infoshare  
3Com EtherShare  
PC-Net  
NorthStar Dimension  
Action DPC/OS  
DMS Hi-Net  
Alloy Engineering RTNX



# DATA FLEX™

DataAccess Corp., 8525 S.W. 129th Terrace, Miami, FL 33156  
(305) 238-0012 TELEX 469021 DATA ACCESS CI

# TOTAL CONTROL with LMI FORTH™



**For Programming Professionals:  
an expanding family of  
compatible, high-performance,  
Forth-83 Standard compilers  
for microcomputers**

#### For Development:

##### Interactive Forth-83 Interpreter/Compilers

- 16-bit and 32-bit implementations
- Full screen editor and assembler
- Uses standard operating system files
- 400 page manual written in plain English
- Options include software floating point, arithmetic coprocessor support, symbolic debugger, native code compilers, and graphics support

#### For Applications: Forth-83 Metacompiler

- Unique table-driven multi-pass Forth compiler
- Compiles compact ROMable or disk-based applications
- Excellent error handling
- Produces headerless code, compiles from intermediate states, and performs conditional compilation
- Cross-compiles to 8080, Z-80, 8086, 68000, and 6502
- No license fee or royalty for compiled applications

#### Support Services for registered users:

- Technical Assistance Hotline
- Periodic newsletters and low-cost updates
- Bulletin Board System

**Call or write for detailed product information  
and prices. Consulting and Educational Services  
available by special arrangement.**

**LMI** Laboratory Microsystems Incorporated  
Post Office Box 10430, Marina del Rey, CA 90295  
Phone credit card orders to: (213) 306-7412

#### Overseas Distributors.

Germany: Forth-Systeme Angelika Flesch, D-7820 Titisee-Neustadt  
UK: System Science Ltd., London EC1A 9JX  
France: Micro-Sigma S.A.R.L., 75008 Paris  
Japan: Southern Pacific Ltd., Yokohama 220  
Australia: Wave-onic Associates, 6107 Wilson, W.A.

## CONVERSATIONS

*DRAGONMAIL is configured  
to run on three VAX/UNIX  
4.2BSD computers connected  
by a 10-megabit token ring;  
the source code is written in C.*

that are contained in  $G_i$ , where  $M_i \subseteq M$  is the set of messages resident at  $p_i$ 's system, and  $\bar{M}_i \subseteq M_i$ . Furthermore, when  $p_i$  submits a message, that message is added to  $G_i$  and the system propagates the update to all the other participants' copies to effect the change to  $G$  previously described.

Specifically, when  $p_i$  submits message  $m_{new}$  to a conversation, a new node is first attached to his or her graph  $G_i$  and then to each remote copy of  $G$ . Updating a graph involves transporting information over computer networks. Because of varying communication delays between computers, however, it is possible for  $p_i$  to receive a message, read it, and respond to it before  $p_j$  receives the original message.

Thus, we must ensure that all the nodes to which  $m_{new}$  connects are also present in  $G_j$ . That is, the operation of adding  $m_{new}$  to a given  $G_j$  is blocked until each node that precedes  $m_{new}$  is present in  $G_j$ . Finally, because a path from each message that precedes  $m_{new}$  is sufficient (rather than a direct edge), we require that the new message be attached only to the *leaf* vertices of  $M_i$ , thereby reducing the overhead of adding new nodes to a context graph.

#### THE PROTOTYPE

A prototype conversation-based mail system called DRAGONMAIL is being used as part of the TILDE project at Purdue University. DRAGONMAIL currently serves over 100 users and a dozen groups in the Computer Sciences Department and is configured to run on three VAX/UNIX 4.2BSD computers connected by a 10-megabit token ring. The DRAGONMAIL source code is written in C and is approximately 6500 lines long.

DRAGONMAIL's user population is distributed over three hosts, with a particular host designated as each user's home machine. Each host maintains a copy of all conversations in which the residents of that host participate. Also, a single copy of the context graph is replicated on each host for each of its resident participants.

When a user invokes an operation that alters a conversation, the local version of DRAGONMAIL distributes the change to the home machine of each participant. At each destination host DRAGONMAIL then makes appropriate

*(continued)*



# The Source<sup>SM</sup> Is Illuminating.



At last, a beacon to help you navigate the vast sea of personal computer technology.

It's The Source. The online information service that can guide you to the best deals in the PC market. Shed light on your software problems. And signal the latest developments in micros.

With The Source, you can buy, sell or swap hardware and software. Learn new applications from a Special Interest Group. See what's been written about the printer you're planning to buy. Or send out an SOS to thousands of other PC users when you need advice.

What's more, The Source can enlighten you with current information on everything from business to travel, investments to world news.

The Source is a service mark of Source Telecomputing Corporation, a subsidiary of The Reader's Digest Association, Inc. © 1985 Source Telecomputing Corporation.



Whatever kind of help you're after, you can find it faster on The Source. With a system of easy commands and menus. Plus a tutorial—free of online charges—that'll bring you up to speed in a snap.

To sign up today, call **1-800-336-3366**. For more information, mail this coupon, or visit your nearest dealer.

Then, no matter how many waves of new technology rock your boat, you'll stay right on course.

INFORMATION NETWORK  
**The Source**<sup>SM</sup>  
The most powerful resource any personal computer can have.

Show me the light.  
Please send more information about The Source.

Name \_\_\_\_\_

Address \_\_\_\_\_

City, State \_\_\_\_\_

Zip \_\_\_\_\_

Mail to: Source Telecomputing Corporation,  
P.O. Box 1305, McLean, VA 22102. In Virginia,  
or outside the U.S., call (703) 821-6666.

## A DRAGONMAIL CONVERSATION

CONV	TOPIC	NEW/TOT
1	TILDE reports	0/15
<b>*2</b>	<b>Do What I Mean</b>	<b>2/4</b>
<b>*3</b>	<b>Dragon Bugs</b>	<b>3/10</b>
4	Ethernet on 8086s	0/18

Figure A: Screen display after initiating a mail session. The Topic column contains a brief synopsis of the conversations shown. The lines in boldface are highlighted on the screen to indicate that the conversation contains an unread message. Conversations marked with an asterisk contain urgent messages. The user selects a conversation by entering the corresponding number in the command window.

### Conversation 2: Do What I Mean

MSG	Synopsis
1	<b>Chris / 5-16 9:30 / CR</b>
2	Steve / 5-17 8:44/ Control L
*3	Doug / 5-17 18:50 / More on CR
*4	Tim / 5-17 19:31 / I disagree

Figure B: Screen display after selecting conversation 2. This time the user selects message 1 via the command window. Note that the ID of the conversation is displayed in the upper window. Unread messages are in boldface. Previously read messages appear in this display to give surrounding context to new messages. Operations such as list, add, and delete participants can be executed at this level.

Conversation 2: Do What I Mean  
 Msg 1: Chris / 5-16 9:30 / CR

Instead of returning to the conversation level, carriage return should do what I mean (DWIM)—automatically display the next unread message.

Cheers,  
 Chris

Figure C: Screen display of conversation 2. Note that at this level conversation ID and message ID are displayed in the two upper windows. Executing an S (submit) command at

this point puts the user in the edit mode. An H (help) command may be executed at any point in the process and will display the command syntax for that level.

changes to its copy of the conversation.

Information is distributed between copies of a conversation through the existing mail-transport system, SENDMAIL. DRAGONMAIL was implemented on top of the existing message-transport system because the component hosts do not share a common transport-level protocol. The "sending" DRAGONMAIL encapsulates the message and header lines inside a "standard message." Specific header lines are added to the regular header, and other data is placed within the message body.

When a message arrives at a remote copy of the conversation, the local DRAGONMAIL updates its copy of the context graph associated with that conversation. If the message cannot be added to the local copy of G because the messages that precede it are not present, then the

message is placed in a queue. As additional messages arrive, DRAGONMAIL checks the queue for messages that can be added to G.

Because the message-transport system occasionally loses messages, queued messages "timeout" after a period of time, and the local copy of the conversation is refreshed by requesting the conversation's history from the home host. Figure A shows a typical screen display when a mail session is initiated. Figure B shows the display when a specific conversation ("Do What I Mean") is selected. Figure C is the display of the actual message viewed in the conversation "Do What I Mean."

We have described a new high-level computer mail service based on conversations rather than independent

(continued)

# THE PC'S LIMITED AT™ —\$1995. THE PC'S LIMITED TURBO PC™ —\$795.



At these prices, it's no wonder  
we're burning up the marketplace.

Yes, you can believe it. Since we ran our first advertisement for the PC's Limited AT™ and Turbo PC™, the calls we've received mostly start with comments like "Is this for real?" And "How can that be?" But now that our machines are in the hands of influential buyers, the questions tend to concern quantity discounts for further purchases. (Which are available.) You see, the PC's Limited machines are assembled from components bought worldwide with our strong buying power. Then they are offered directly to you—with no middleman markups. So light a match to your old budgets. With the savings we're providing, you'll have money to burn.

## PC'S LIMITED AT™

- 80286-based System Unit (runs at 6MHZ)
- 1024K on Mother Board
- 1.2 Meg Floppy Drive
- Combined Floppy/Hard Disk Controller Card
- AT Keyboard
- 192W Power Supply
- 2 Serials and 1 Parallel Port
- Clock/Calendar with Battery Backup

Runs all Major Software written for the IBM PC™, PC XT™, and PC AT™. Unit has 8 Expansion Slots, with 7 available in above configuration. Same Bus Configuration as IBM PC AT™.

## PC'S LIMITED TURBO PC™

- 16-bit 8088-2 System Unit (running at 4.77 or 6.66MHZ)
- 640K on Mother Board
- 360K Floppy Drive
- Keyboard
- 135W Power Supply

Runs all Major Software written for the IBM PC™ and PC XT™, 40% faster, without modifications. Unit has 8 Expansion Slots, with 7 available in above configuration.

IBM® is a registered trademark of International Business Machines Corporation.  
IBM PC, PC XT, and PC AT are trademarks of International Business Machines Corporation.

 **PC'S LIMITED™**

**OUTSIDE TEXAS, ORDERS ONLY, CALL 1-800-426-5150**

**1611 Headway Circle, Building 3, Austin, Texas 78754**

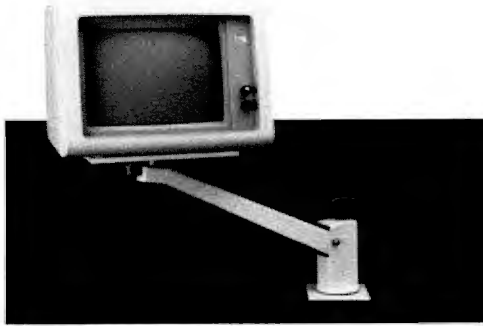
**All sales-related calls inside Texas — (512) 339-6800**

**Telex No. 9103808386 PC LTD**

**Ad number 412 A**

**FREE CATALOG**

## More Space Saving Products From LinTek Computer Accessories



- Monitor Mover (Adjusts 4 ways) ..... \$149.95
- Space Saver Arm (Adjusts 3 ways) ..... 89.00
- Dust Cover/Copy Holder (for IBM-PC) ..... 24.95
- Keyboard Drawer (25" x 15½" x 3½") ..... 84.95
- Medium Tilt & Turn (11" x 10" x 2½") ..... 27.95
- Large Tilt & Turn (14" x 14" x 2½") ..... 34.95
- PC Printer Stand (Fits all printers) ..... 19.95
- System Floor Stand (For IBM-PC) ..... 23.95

★ ★ ★ SEND FOR FREE CATALOG ★ ★ ★

**LinTek**   
Computer Accessories

Dealer inquiries  
welcome.

P.O. Box 8056, Grand Rapids, MI 49508 (616) 241-4040

### **NOVAS** PC/XT/AT TOP OF THE LINE IBM COMPATIBLE COMPUTER

- Affordable priced PC/XT/AT Compatible
- Runs PC-DOS, MS-DOS, CPM/86
- This versatile computer runs Flight Simulator, Lotus 1-2-3, Symphony, Framework, Peachtree, D Base II & III, PC Paint, Auto C.A.D., and tons of software.



#### COMPUTER SYSTEMS

**NOVAS PC BARE BONE**  
64K 8 slot mother board,  
case, 130W power supply,  
keyboard

**\$510.00**

**NOVAS PC 256K SYSTEM**  
256K 8 slot mother board,  
case, 130W power supply,  
2 ½ ht. Teac floppy drive.

**\$795.00**

**NOVAS XT 256K SYSTEM**  
256K 8 slot mother board,  
case, 130W power supply, 2 ½  
ht. Teac drive, 10MB H.D., DTC  
controller card.

**\$1295.00**

**NOVAS AT ENTRY MODEL**  
640K Mother board, #80286 CPU  
(Option 8 MHZ), 195W power supply,  
TEAC 1.2MB floppy drive, DTC  
floppy/hard disk controller card.

**\$2495.00**

**NOVAS AT ENHANCED MODEL**  
1MB Mother board, #80286 CPU  
(Option 8MHZ), 195W power supply,  
TEAC 1.2MB floppy drive, 20MB hard  
disk, DTC floppy/hard disk control.

**\$3495.00**

- IRWIN 10MB Tape back up system ..... \$525.00
- EVEREX 45/60M Tape back up system ..... \$875.00
- 10MB hard disk w/DTC controller ..... \$495.00
- IRWIN 20MB Tape back up system ..... \$650.00
- EXTERNAL case for H.D. or Tape backup \$150.00
- 20MB hard disk w/DTC controller ..... \$595.00

#### ADD-ON BOARDS:

- 6-function board (AST 6 pack compatible) with zero K. .... \$124.00
- Mono-graphic (Runs Lotus 1-2-3 graphic mode) ..... \$135.00
- EPROM Burner ..... \$135.00
- 2 serial/1 parallel card for PC or AT ..... \$119.00
- Memory expansion board (Expandable to 576k) ..... \$ 75.00

**NEED MORE DETAILS, PLEASE CALL NOW!**

### COMPUTRADE COMPANY

780 Trimble Road, Suite 605, San Jose, CA 95131

Tel: (408) 946-2442      Telex: 171605

## CONVERSATIONS

memos. Conversations have the advantage of being more consistent with the way humans communicate. Conversation-based mail also supports various message-exchange paradigms such as memo communication, mailing lists, and journals.

Conversations are as powerful as teleconferencing systems in their ability to group related messages while remaining as inexpensive to use (and start) as conventional memo-based systems. Conversation-based mail also supports a uniform interface to all forms of mail-like services. Most important, conversations provide a flexible communication paradigm that users can tailor to their needs. ■

*Editor's note: Dr. Peterson is currently working on a second version of DRAGONMAIL at the University of Arizona. The initial prototype demonstrated the workability of conversations as a medium for communication and pointed to several improvements in the initial model. The second version of DRAGONMAIL will be a stand-alone mail system that is fully integrated with the current computer mail environment. In other words, DRAGONMAIL will serve both as a conversation-based message system and as an interface to conventional memo-based mail.*

#### BIBLIOGRAPHY

- "The AUGMENT Mail User's Guide." Journal Document <AUGMENT,103481>. Tymshare Inc., Office Automation Division, November 1983.
- Allman, E. "SENDMAIL—An Internetwork Mail Router." *UNIX Programmer's Manual*, version 4.2. Berkeley Software Distribution, vol. 2, August 1983.
- Almes, G., A. Black, C. Bunje, and D. Wiebe. "Edmas: A Locally Distributed Mail System." Technical Report 83-07-01, University of Washington, July 1983.
- Borden, B. S., R. S. Gaines, and N. Z. Shapiro. "The MH Message Handling System." User's Manual R-2367-AF. Rand Corp., November 1979.
- Brotz, D. K. *Laurel Manual*. Technical Report CSL-81-6. Palo Alto, CA: Xerox Palo Alto Research Center, May 1981.
- Comer, D. E., and L. L. Peterson. "Conversation-Based Mail." TILDE Report CSD-TR-465. Purdue University, March 1984.
- Comer, D. E. "Transparent Integrated Local and Distant Environment (TILDE): Project Overview." TILDE Report CSD-TR-466. Purdue University, March 1984.
- Crocker, D. H. "Framework and Functions of the MS Personal Message System." R-2134-ARPA. Rand Corp., December 1977.
- Horton, M. "How to Read Network News." *UNIX Programmer's Manual*, version 4.1. Berkeley Software Distribution, vol. 2, 1979.
- Joy, W., and Wasley D. Msgs. *UNIX Programmer's Manual*, version 4.1. Berkeley Software Distribution, vol. 1, 1979.
- Knuth, D. E. *The Art of Computer Programming*, vol. 3. Reading, MA: Addison-Wesley, 1973.
- Lipinski, H. M., and R. H. Miller. "FORUM: A Computer-Assisted Communications Medium." *Proceedings of the 2nd International Conference on Computer Communications*, August 1974, pages 143-147.
- Palme, J. *COM/PortaCOM Conference System Design Goals and Principles*. Stockholm, Sweden: OZ, Stockholm University Computing Center, March 1984.
- Shoens, K. "Mail Reference Manual." *UNIX Programmer's Manual*, version 4.1. Berkeley Software Distribution, vol. 2, 1979.

PC NETWORK IS PROUD TO ANNOUNCE...

# WE'RE #1

## In Less Than 2 Years You've Made Us The World's Largest Mail-Order Supplier Of Personal Computer Products.

### Here's Why We're The World's Best...

**S**ome say that being the biggest and being the best are qualities that often have little impact on each other. We believe otherwise. In a marketplace as crowded as ours, PC Network has excelled by making your needs and your budget our prime considerations. To accomplish this, we merge 2 powerful but underused concepts ... We give you more. We charge you less. *PC Network is the "Value Added" Mail Order Firm.* We think that's good business. And so do you, as you've proven with an *astounding 90% repeat-buy rate!*

How does your Network membership give you the advantage? Read on.

#### #1 in Speed

We ship almost all of our orders *complete within 48 hours.* Additionally we maintain a special RUSH stock of many important products to fill your emergency needs *overnight!*

#### #1 in Support

We are over 100 strong, all working to serve you. Our sales people are consultants, not order takers. Our technical support staff are factory-trained and degreed engineers. *Excellence and a concern for your needs are stressed in every department of the Network ... and it pays off.*

#### #1 in Satisfaction

You know, only too well, the risks of products not turning out to be what they seemed in ads or show demonstrations. To insure your satisfaction, we offer a *10 day, money back, no-questions-asked, guarantee on all hardware ...* combined with our unique *"Try-Before-You-Buy" software rental program.* Get only what you want, without risk or hassle.

#### #1 in Stability

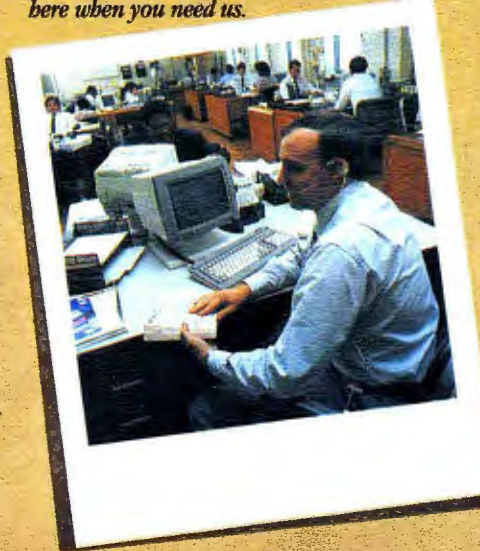
This is a time of industry ups and downs. Imitators and basement/garage operations abound. It seems as if a typical mail-order firm has the life expectancy of a match. Not so with the Network. We maintain the financial strength, supplier relations and industry savvy to insure that *we'll be here when you need us.*

#### #1 in Selection

We sell more computer products than any other firm in the business. We have over *40,000 square feet of inventory valued at over \$ 15,000,000.* The Network offers over *30,000 different products* for virtually any personal computer on the market.

#### #1 in Savings

Our huge volume has enabled us to lead the way in providing the lowest prices on the largest selection in the industry. We offer our unique *"Cost + 8%" formula on everything ...* not just the popular "grabber" products.



#### #1 in Even More

But to truly excel, PC Network must do even more for our members.

- You'll get the *Printout*, our quarterly newsletter, giving you fantastic specials and an unbiased analysis of new products and trends.
- You'll get our *600 page wholesale catalog*, the largest compilation of computer products anywhere ... plus quarterly updates.
- You'll get the *Network's On-Line Bulletin Board ...* a 24-hour-a-day, 7-day-a-week computer service with access to product updates, tech support, download free demo software, public domain software and much, much more.

#### The Challenge of Being #1

Above all, you'll receive our pledge to keep constant watch on all facets of this ever-changing industry, seeking new ways to reward your commitment to PC Network.

As for *our* commitment? With your satisfaction, we'll stay the biggest *and* the best.

CALL TOLL-FREE 1-800-621-S-A-V-E  
In Illinois Call (312) 280-0002

# PC NETWORK

GET THE NETWORK ADVANTAGE!!!



# IBM HARDWARE AND SOFTWARE AT WHOLESALE + 8%, AND GET 14-30 DAY SOFTWARE RENTALS†...

Listed below are just a few of the over 30,000 products available at our EVERYDAY LOW PRICES! The Network carries products for Apple, IBM, CP/M and most other popular computer families.

## GAMES & EDUCATIONAL SOFTWARE FOR YOUR APPLE II & MACINTOSH

(Please add \$1 shipping and handling for each title ordered from below.)

Wholesale		Wholesale	
Arrows Home Accountant-Mac Only	\$65.00*	Miles Computing Mac Attack-Mac Only	\$23.00*
Axon Art Portfolio & Card Shoppe	31.00*	Palatir Mac Type-Mac Only	23.50*
Bluechip Baron/Millionaire/Tycoon	26.00*	Penguin Graphics Magician	26.90*
Broderbund Loadrunner	19.75*	Penguin Pensate or Xyphus	29.00*
Broderbund Crophiler	19.00*	Penguin Transylvania-Mac Only	20.00*
Broderbund Print Shop	28.75*	Professional Software Trivia Fever	18.00*
Broderbund Dazzle Draw	31.97*	Priority Software Forbidden Quest	21.00*
CBS Mastering the GRE	53.50*	Scarborough Master Type	26.50*
CBS Murder by the Dozen	20.97*	Scarborough Run for the Money	26.00*
CBS Green Bridge Made Easy	45.00*	Simon & Schuster Typing Tutor III	28.25*
Counterpoint The News Room	25.97*	Sir-Tech Wizardry	26.97*
Davidson Speed Reader II	37.87*	Simon Knight of Diamonds	18.87*
Davidson Math Blaster	29.97*	Sir-Tech Rescue Raiders	18.87*
Davidson Word Attack	29.97*	Sublogic Night Mission Pinball	20.00*
1st Byte Smooth Talker-Mac Only	47.00*	Sublogic Flight Simulator II	27.25*
Hayden Da Vinci-House/Interiors/Landscapes	24.75*	Sprinkler Alphabet Zoo Face Maker	15.97*
Hayden Saigon III	35.75*	Kindler Comp. Sky Doodle Diddle	
Infocom Deadline or Suspended	24.00*	Rhymes & Riddles: Story Machine	
Infocom Enchanter, Planetfall	20.00*	Sprinkler The Most Amazing Thing	20.77*
Cuthroats, Witness or Zork I		Sprinkler Delta Drawing	24.97*
Infocom Hitchhiker's Guide or Sealstalker	20.00*	T/Maker Click Art-Mac Only	25.00*
Infocom Suspended, Sorcerer or Infidel	22.00*	Warner Desk Organizer	65.00*
Infocom Zork I or III	28.75*	Video Fun Pack-Mac Only	10.77*
Layered Front Desk-Mac Only	65.00*	Vindex Mac Checkers & Reversi	25.17*
Mirage Concepts Trivia	11.00*	Virtual Combinatics Micro Cookbook	21.00*

## BUSINESS SOFTWARE FOR YOUR APPLE II & MACINTOSH

(Please add \$2.50 shipping and handling for each title ordered from below.)

Wholesale		Wholesale	
Apple Apple Works	\$165.00*	Microsoft Word for Macintosh	\$102.00*
Broderbund International Turbo Pascal	102.00*	Microsoft Multiplan for Macintosh	102.00*
BPL GL, AP, AR, PR or INV	205.00*	Microsoft Basic for Macintosh	79.00*
Broderbund Bank Street Writer	40.00*	Microsoft Chart for Macintosh	66.00*
Central Point Copy II Plus or Copy II Mac	20.00*	Monogram Dollars & Sense for Apple IIc	55.00*
Funk Software Sideways	34.00*	Monogram Dollars & Sense for Macintosh	70.00*
Funsort Macasam	60.00*	Odessa Helix for Macintosh Reg 512K	200.00*
Haba Habotab	40.00*	Prove Overdue-Mac Only	135.00*
Haba Quartet	101.95*	Sensible Software Sensible Speller IV	67.50*
Harvard Mac Manager	29.95*	Softech Microsystems UCSU Pascal	140.00*
Human Edge Mind Prober	24.00*	Software Arts TK Solver for Mac	134.00*
Human Edge Sales Edge	110.00*	Software Publishing PFS: File, Write or Graph	65.00*
Human Edge Communication Edge	98.00*	Stoneware OD Master-Mac Only	95.00*
Living Videotext Tool (Think-Mac Top)	67.00*	Telos Fileviewer for Mac	87.50*
MAIN Street File-Mac Only	67.00*		
MECA Managing your Money	105.00*		

## HARDWARE FOR YOUR APPLE II & MACINTOSH

(Please add shipping and handling charges found in italics next to price.)

DISK DRIVES		MODEMS	
Alps AP-100A Dual Apple Drives in One Case	\$309.00* (7.00)	Hayes Micromodem II w/Smartcom	\$125.00* (2.50)
Apple Mac 400KB External Drive	349.95* (7.50)	Novation Apple Call II	174.45* (3.50)
Corvus 5 MB Hard Drive	933.00* (20.28)	Prometheus 1200 A	276.00* (6.00)
Omega Macintosh 5.1 Removable Drive for Macintosh	1,250.00* (27.00)	Low Cost 1200 Baud Internal Modem for Apple II	66.00*
Micro Sci A2 143KB Drive Just like Apple's Own	150.00* (5.00)	Prometheus Promodem 1200 w/Mac Pack	299.00*
Micro Sci Poppy Controller	55.00* (2.50)	Zoom Zoom! Modem II Micromodem Compatible-Free Dow Jones	90.00* (2.50)
PC Network 140K External Drive for Apple IIc	95.00* (2.50)		
Rana Elite 162K Drive	225.00* (5.00)	Apple Macintosh Carrying Case	\$69.00* (1.49)
Rana Elite II 326K Drive	320.00* (7.00)	Apple Macintosh Security Kit	29.00* (1.50)
Rana Elite III 652K Drive	398.99* (10.00)	Apple Macintosh Numeric Keypad	69.00* (2.50)
Tecmar 5MB Removable Drive for MAC	999.00* (21.58)	Hayes Match II Joystick	31.00* (1.50)
Tecmar 10MB MAC Drive	1,235.00* (21.58)	Warranty Protection for MAC or imagewriter	8.25* (1.50)
Tecmar 5MB MAC Drive Upgrade	999.00* (26.68)	Kensington Starter Pack	54.00* (3.00)
		Kensington Surge Protector	33.47* (2.50)
		Kensington System Saver Fan	58.97* (1.50)
		Koala MacVisor	158.00* (3.00)
		Koala Keypad/Touch Tablet	78.00* (1.50)
		MAR Sup-R-Mod RF Modulation	44.00* (1.50)
		PC Network Cooling Fan w/In Surge Protector & Dual Outlets	25.00* (2.50)
		PC Network 5.5/10 Diskettes (Box of 10)	7.95* (1.00)
		PC Network Quadchroms II New! Includes Free Rip & Fix Case	21.95* (1.50)
		These Diskettes are Guaranteed for Life! No Generics!	
		Sony MAC Diskettes (Box of 10)	22.95* (1.50)

## BOARDS AND BUFFERS

ALS Z-Engine	\$115.00* (2.50)
AST Main I/O-2 serial Clock	155.00* (2.50)
Microport Premium Software IIc	243.67* (2.50)
Microport Dumping/GX	55.00* (2.50)
Orange Micro Grappler	66.00* (2.50)
Orange Micro Serial Grappler	66.00* (2.50)
PC Network Z80 Card	35.00* (2.50)
Quadram APIC/G Graphics Interface	62.00* (2.50)
Quadram e-RAM-80	88.00* (2.50)
Quadram Multicolor-1 Parallel/1 Serial	140.00* (2.50)
Click Expanding to 256K	
Thunderhead Thunderclock	104.00* (2.50)

## MEMORY CHIPS

(All Memory Chips Guaranteed for Life!)

Wholesale		Wholesale	
64K Memory Upgrade Kits (9 Chips)	\$5.40* (1.00)	Amdtek Video 300G Composite Green	\$110.00* (3.00)
64K Dynamic Ram Chips (Each)	60* (1.00)	Amdtek Video 300A Composite Amber	120.00* (3.00)
256K Dynamic Ram Chips (Each)	3.00* (1.00)	Amdtek Video 310A IBM Type Amber	130.00* (3.00)
128K IBM AT Piggyback Chips (Each)	5.00* (1.00)	Amdtek Color 300-Composite	215.00* (4.84)
		Amdtek Color 600-High Res RGB	365.00* (17.88)
		Amdtek Color 700-Ultra High Res	455.00* (23.33)
		Amdtek Color 710-700 w/Non Glare Long Phosphor	475.99* (10.48)
		Princeton HX-12 RGB Monitor	CALL
		Princeton MAX 12e	CALL
		Work with Color or Mono Card!	
		Quadram Quadchroms II New! 640x200 RGB w/14 Screens Black Phosphor Mask/IBM Case	370.00* (8.21)
		Samsung 12 TTL IBM Type Amber	85.00* (5.00)
		A great looking/performing monochrome from the manufacturer of IBM's own color monitor	
		Taxan 440 Super Hi Res RGB	495.00* (10.69)
		Currently Available works with Peryst Bob Card	
		Zenith ZVM 1230A Green Hi Res/Non Glare	81.00* (17.75)

## EXTERNAL MODEMS

Anchor Signalman Express	\$205.00* (5.00)
Hayes Smartmodem 300	125.00* (5.00)
Hayes Smartmodem 1200	340.00* (5.00)
Hayes Smartmodem 1200B with new Smartcom II V1100 Emulator	317.00* (5.00)
Hayes Smartmodem 1200B Alone	265.00* (2.50)
Hayes Smartmodem 2400	535.00* (5.00)
Prometheus Promodem 1200	276.00* (6.00)
External 100% Hayes Compatible	
U.S. Robotics Courier 2400BPS Modem	450.00* (5.00)
U.S. Robotics Password	195.00* (4.00)
LOWEST PRICE 1200BPS Modem!	

## TERMS & CONDITIONS

PC NETWORK - Members pay just 8% above the wholesale price, plus shipping. All prices reflect a 3% cash discount. Minimum shipping \$2.50 per order. International orders call for shipping & handling charges. Personal checks please allow 10 working days to clear. All prices subject to change without notice!

RENTAL FOR YOU BUY - Members are eligible to join the NETWORK'S Business and Game software Rental Libraries and evaluate products for a full 14 (Regular) or 30 (VIP) days to see if it meets your needs. AND THE NETWORK'S rental charges are far less than other software rental services - just 20% OF THE MEMBER WHOLESAL PRICE. Rental titles available in IBM/Apple/MAC and CP/M Formats. Hardware prices highlighted by \* reflect recent major price reductions.

## GAMES & EDUCATIONAL SOFTWARE FOR YOUR IBM

(Please add \$1 shipping and handling for each title ordered from below.)

Wholesale		Wholesale	
ATI Intro to PC DOS Vbl 1.2 II	\$23.00*	Infocom Deadline or Suspended	\$24.00*
ATI Intro to BASIC	52.00*	Infocom Flight Simulator	27.00*
Bluebush Chess (Your Toughest Opponent)	34.00*	Mouse Systems PC Paint-Turn your PC into a Color Macintosh!	59.95*
Bluechip Millionaire/Oil Baron or Tycoon	28.25*	Scarborough MasterType	27.00*
Broderbund Iode Runner	19.75*	Sierra On-Line King's Quest II	27.00*
CBS Green Bridge Made Easy	40.00*	Sierra On-Line Crossfire	18.00*
CBS Mastering the SAT	50.00*	Spectrum Holobyte GATO	18.00*
CDEX Training for Word Star	32.25*	Sprinkler Alphabet Zoo Kinder Comp Story Machine Face Maker, Hey Diddle Diddle Rhymes & Riddles	15.97*
Comprehensive Intro to Personal Computing	37.00*	Sprinkler Delta Drawing	24.97*
Davidson Math Blaster Word Attack	26.50*	Sprinkler Most Amazing Thing	20.77*
Davidson Speed Reader II	35.50*	Sublogic Night Mission Pinball	20.00*
Hayden Saigon III	25.75*	Virtual Combinatics Micro Cookbook	21.00*
Individual Professor DOS	32.50*		
Individual The Instructor	24.50*		
Infocom Zork I or Witness	20.00*		

## BUSINESS SOFTWARE FOR YOUR IBM

(Please add \$2.50 shipping and handling for each title ordered from below.)

Wholesale		Wholesale	
Ashon-Tate DBase III	\$365.00*	Micro Pro Wordstar 2000	\$262.00*
Ashon-Tate Framework	365.00*	MicroRim RBase 5000	300.00*
Borland Turbo Pascal	25.75*	Microsoft C Compiler	220.00*
Borland Side Kick (Protected)	19.00*	Microsoft Word - Latest Version 2.0	205.00*
Borland Superkey	32.00*	Microsoft Multiplan	95.00*
BPI G/L AIR or AIP	305.00*	Microsoft Mouse	107.00*
BPI Aura	265.00*	Monogram Dollars & Sense	95.00*
BPI Personal Accounting	190.00*	Multimate Multimate (Latest Version)	48.00*
Breakthrough Timing	230.00*	Norton Norton Utilities 3.0	46.00*
Human Edge The Sales Edge	210.00*	Class The Word Processor	75.00*
Conceptual Instruments Desk Organizer	157.00*	Open Systems P/O Sales A/R/INVTG A/P	ea. 275.00*
Digital Research DR Logo	75.00*	Team Mgr	190.00*
Digital Research Gem Desktop	25.00*	Power Base Power Base	197.00*
Digital Research Gem Draw	25.00*	Real World G/L A/P AIR or OE/INV	ea. 325.00*
Electronics Energypapers with Plotter Option	190.00*	RoseSoft ProKey Versus 3	65.00*
Funk Software Sideways	34.00*	Ryan MacFarland RM C/OBOL (Dev System)	520.00*
Harvard Harvard Project Manager	175.00*	Samma Samma III Word Processor	227.00*
Harvard Total Project Manager	225.00*	Samma Word -	320.00*
Hayes Smartcom II - New V1100 Emulator	64.00*	Salesite Software Word Perfect	190.00*
Human Edge The Management Edge	137.50*	Softarc Fancy Fonts	125.00*
Human Edge The Sales Edge	110.00*	Software Arts TK Solver	200.00*
Human Edge Mind Prober	26.50*	Software Publishing PFS: File, Write, Graph	68.00*
Lifetree Volkwriter Deluxe	135.00*	Software Publishing PFS Report	64.00*
Lotus Development Lotus 1-2-3	160.00*	Sorcim Supercalc II	169.00*
MDBS KnowledgeMan? 2	295.00*	Xanaro Ability	252.50*
Micro Pro Wordstar 2000	219.00*		

## HARDWARE FOR YOUR IBM

(Please add shipping and handling charges found in italics next to price.)

DISK DRIVES		MODEMS	
Omega Bernouth Box Dual 10MB Drives	\$2,200.00* (41.52)	AST Reach! Short Slot 1200 Baud Internal Modem	\$345.00* (2.50)
Maynard WS-1 10MB Internal Hard Disk	730.00* (15.77)	Hayes Smartmodem 1200B with New Smartcom II V1100 Emulator	317.00* (2.50)
Maynard WS-2 Same as WS-1 but with SanDisk ProKey Controller (uses 1 slot)	930.00* (20.30)	IBM PC Network 1200B Internal Quadram Quadmodem II 200B Internal Hard Card w/Crosstalk XVI	225.00* (2.50)
PC Network 10MB INTERNAL Height Autoslot Drive New lower price Drives by Shugart or Tandem	330.00* (7.13)	Hayes Smartmodem 1200B Alone	265.00* (2.50)
PC Network 10MB Tape Backup Same unit used in Compaq's DeskPro!	460.00* (8.94)	Prometheus Promodem 1200B Internal Quadram Quadmodem II 200B Internal Hard Card w/Crosstalk XVI	275.00* (2.50)
PC Network Full Height DS/DD Drives	59.00* (1.21)		
Tandon TM 100-2 Full Height DS/DD Drives	93.00* (2.20)	Hercules Color Card w/Parallel Port	\$142.00* (2.80)
Tallgrass 25MB External Hard Disk with 60MB Tape Backup	2,375.00* (51.30)	Hercules Monochrome Graphics Card	263.00* (2.50)
Teac FD 55-B Half Height DS/DD Drives	90.00* (1.94)	Paradise Modular Graphics Card	235.00* (2.50)
Teac 1 2MB Half Height Disk Drive for AT	110.00* (2.40)	PC Network Hercules Mono Card Clone 100% Hercules Compatible!	105.00* (2.50)
		PC Network Color Card	80.00* (2.50)
		Peryst Bob Card Ultra High Res Color	299.00* (2.50)
		STB Graphics Plus II (simultaneous Mono Graphics & Color)	199.00* (2.50)

## MULTIFUNCTION CARDS

Apperart AT Ram Expansion card	\$139.00* (2.50)
AST Six-Pack Plus With 64K	195.00* (2.50)
AST II Plus II	120.00* (2.50)
AST Advantage for AT	355.00* (2.50)
Everex Magic Card 64K	160.00* (2.50)
PC Network 5.5/10 Memory Board w/DK	69.00* (2.50)
PC Network Six-Pack Clone w/DK Full Size Pack Features - Game Port Standards Direct Import from Taiwan at a Fabulous Price! 1 Year Warranty - Money Back Guarantee	89.00* (2.50)
PC Network II Plus II Clone Ser/Par Game Clock standard	69.00* (2.50)
Quadram Improved Quadboard w/DK	170.00* (2.50)
Tecmar Captain Multicard w/DK	146.00* (2.50)

## COMPLETE SYSTEMS

Wholesale		Wholesale	
Apple Macintosh Base Systems	CALL	COMPAQ Hard Disk Portable 10MB Hard Disk/Floppy/256K	\$2,235.00* (48.28)
AT&T 6300 PC CPU2	\$1,575.00* (34.02)	IBM PC Base System/20500 FDC 756K	1,495.00* (32.55)
AT&T 7300 CPU1	3,699.00* (79.90)	IBM PC Professional Hard Disk 2.25	1,749.00* (37.78)
10MB Hard Disk/1 Serial/1 Parallel		IBM PC AT Base System - 1 2MB Floppy 256K	2,795.00* (60.37)
COMPAQ DeskPro Tape Backup System w/640K/1 Floppy/10MB Hard Disk/10MB Tape Drive/Monitor	2,951.94* (63.70)		
		IBM AT Professional System 1 2MB Floppy/20MB Hard Disk/1 Serial/1 Parallel/512K	CALL

## PRINTERS

Citizen MSP-10 NEW 160CPS/80CPL/Fric - Trac	\$265.00* (5.72)	NEC 3530 33CPS/LQ Parallel	\$ 920.00* (19.87)
Citizen MSP-15 NEW 160CPS/132CPL/Fric - Trac	350.00* (7.56)	NEC 4050 50CPS/Printer	1,330.00* (28.73)
Citizen MSP-20 NEW 200CPS/80CPL/Fric - Trac	350.00* (7.56)	NEC Printwriter 7 New Color Dot Matrix	599.00* (12.94)
Citizen MSP-25 NEW 200CPS/132CPL/Fric - Trac	499.00* (10.76)	Okidata ML 102 New IBM Graphics - more	200.00* (4.72)
Epson FX 85	299.00* (6.46)	Okidata ML 192 New Sleek Design! 180CPS/LQ Mode/Fric/IBM Graphics	325.00* (7.25)
Epson FX 185	429.00* (9.27)	Okidata O Laser 700CPS/100 Columns/LQ Mode/IBM Graphics Mon./Ribbon/Printer	109.00* (2.35)
Epson L 1500	799.00* (17.26)	Okidata ML 102B Interface for Okimate Color 2	65.00* (1.50)
Epson SQ2000 New w/ Injet Printer 106CPS/LQ Mode/178CPS Draft/132CPL	1,359.00* (29.25)	Okidata ML 84P 200CPS/132CPL	599.00* (12.94)
Epson DX 1100CPS	569.00* (12.29)		



# MEMBERSHIP APPLICATION & INSTANT ORDER FORM

**You must be a Member to order merchandise, but you need not order merchandise to become a member.**

**YES!** Please enroll me as a member in the PC NETWORK™ and send my catalog featuring thousands of computer products, all at just 8% above DEALER WHOLESALE PRICES: I will also periodically receive "THE PRINTOUT," a special up-date on merchandise at prices BELOW even those in my wholesale catalog, and all the other exclusive, money-saving services available to Members.

I am under no obligation to buy anything. My complete satisfaction is guaranteed.

Please check (✓) all boxes that apply:

## Basic Membership With 14 Day Rentals

- One-year membership for \$8
- Two-year membership for \$15 (SAVE \$1)
- Business Software Rental Library for \$25 add'l. per year—14 day rentals
- Games Software Rental Library for \$10 add'l. per year—14 day rentals

## Special V.I.P. Membership With 30 Day Rentals

- One-year membership for \$15
- Two-year membership for \$25 (SAVE \$5)
- BOTH Business and Game Software Rental Libraries for \$30 add'l. per year—V.I.P. members only—30 day rentals.

**I am already a member of PC NETWORK, and would like to order merchandise ONLY. My Membership number is: \_\_\_\_\_**

### INSTANT ORDER FORM

PC NETWORK offers integrated, completely assembled systems by dozens of manufacturers, warranted and fully serviceable in your area. Please call for configurations, prices and configuration codes. Then indicate your choices by filling in the quantity, code and price in the spaces provided below adjacent to the respective manufacturer(s).

Qty.	Manufacturer	Code	Wholesale Price	Shipping & Handling
_____	IBM PC	# _____	\$ _____	(\$ _____)
_____	Other	# _____	\$ _____	(\$ _____)

Complete this section to order merchandise featured in this month's Advertisement:

Qty.	Description	Wholesale Price	Shipping & Handling
_____	_____	\$ _____	(\$ _____)
_____	_____	\$ _____	(\$ _____)
_____	_____	\$ _____	(\$ _____)
_____	_____	\$ _____	(\$ _____)
_____	_____	\$ _____	(\$ _____)
_____	_____	\$ _____	(\$ _____)
_____	_____	\$ _____	(\$ _____)

### See other side of order form for more products

Be sure to add and TOTAL all shipping and handling charges. (\$2.50 Min. per order)

3Z5

Total for Merchandise	\$ _____
8% Administrative Fee	\$ _____
Shipping and Handling	\$ _____
<b>SUBTOTAL</b>	\$ _____
Sales Tax (IL Residents)	\$ _____
CREDIT CARD ORDERS ADD 3%	\$ _____
<b>TOTAL</b>	\$ _____

Please provide the following information to insure compatibility with your system (check all boxes that apply):

- IBM PC (be sure to indicate version of PC below)
  - 64K System board  256K System Board  XT  AT
- Other: \_\_\_\_\_
- Number of drives: \_\_\_\_\_  Amount of memory: \_\_\_\_\_
- Monochrome or  Color monitor (check one)
- Bill my credit card:  VISA  MasterCard  American Express

Exp. Date \_\_\_\_\_  
mo. year

Account Number:

--	--	--	--	--	--	--	--	--	--	--	--	--	--	--	--	--	--	--	--

Check or money order enclosed for \$ \_\_\_\_\_

Name \_\_\_\_\_

Address \_\_\_\_\_ Apt. # \_\_\_\_\_

City \_\_\_\_\_

State \_\_\_\_\_ Zip \_\_\_\_\_

Telephone (\_\_\_\_\_) \_\_\_\_\_

Signature \_\_\_\_\_

(Signature required to validate membership)

Complete order form—please print—then fold at arrows, seal with tape or staple and mail today.

## PRICING MADNESS

Once again, as Federal Express picks up our ad at the very last millisecond before this issue's advertising deadline, ***here we sit with dozens of price reductions and new product announcements which have arrived too late for us to let you know.***

Why, our ad manager asks, do we always go through a last minute price update frenzy, just seconds before our ad is due at the publisher, when we know that despite our heroic effort, ***many of these products will cost even less by the time you read this ad.***

How, she asks, can we get a crystal ball to forecast what fantastic promotions and specials our suppliers are going to offer from now to the date ***this ad gets to the newsstand over two months from today?***

Well, we decided that she has a good point. While we'll still keep getting our grey hairs and ulcers from last minute revisions, we will start publishing this notice and ask our readers to make a simple check. Look at any four back issues of this magazine (*yes we're in every one*) and track the prices on the most popular products. ***You will see that many drop with every issue.*** Most of these price changes were instituted well before the issue was printed and ***our members always pay the lower price.*** This should prove that this notice is much more than hype.

Given the current madness in the PC industry with its spur of the moment pricing and instant product introductions, ***you will find it always pays to call for our latest prices.*** You will be glad you did.



### BUSINESS REPLY CARD

First Class

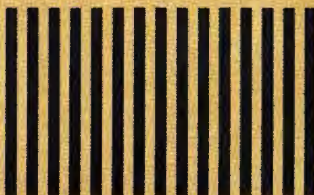
Permit No. 14823

Chicago, IL

POSTAGE WILL BE PAID BY ADDRESSEE

**PC NETWORK**  
320 West Ohio  
Chicago, Illinois 60610

NO POSTAGE  
NECESSARY  
IF MAILED  
IN THE  
UNITED STATES





# PC NETWORK GOES TO THE

# ORIENT DIRECT

How do you suppose most manufacturers of personal computer products get started?

They go to the Orient... taking either their designs or simply their ideas to one or more of the major electronics manufacturing concerns, getting bids for making these devices under contract to the creators. Multifunction Cards, Video Cards, Disk Controllers, Modems and I/O Boards all begin their life in this way.

This relationship between the manufacturing capabilities of the East and the design and marketing talents of the U.S. has resulted in the incredible selection of enhancement products for the IBM and Apple computer markets.

Well, with 100,000 members and growing strong, The Network sent its buyers east to visit some of these manufacturing

concerns to check out the feasibility of directly importing these products in the necessary volumes to *save our members money!* What they came back with was astounding.

Now, we always figured that there were some pretty substantial markups as these boards came into the country and got fancy boxes and marketing promotions under any one of a number of well known brand names in the peripheral add-on markets *but we had no idea they were so large!*

To prove our point, consider what they brought back. Each board is constructed to the same precise specifications, on exactly the same machinery as their name-brand duplicates. The difference? *As a Network member, you pay only 8% over our unusually low wholesale price... and you get our full 1 year warranty!*

## Hercules' Smarter Brother

A Monochrome Graphics Card with Printer Port... 100% compatible with Hercules product...



Wholesale price...  
**\$99.00\***

## Graphics Printer Interface

If all you want is a printer, this is the card for you. Supports all text and graphics printer features.

Wholesale price... **\$29.00\***



## The "9" Pack Plus

Multifunction like the AST "6" Pack... up to 384Kb of expansion memory, 1 serial, 1 parallel, and 1 game port, a clock/calendar and 3 software packages standard.



With 0 K...  
**\$89.00\***  
Wholesale

## IBM Color Card

100% compatible with the IBM offering. The wholesale price?

A mere **\$69.00\***



## The I/O Double Plus

If you don't need memory—just ports, identical I/O board to the AST I/O+ with 2 serial, (1 standard) 1 parallel, 1 game port and clock/calendar with software.

Wholesale price...  
**\$69.00\***



## 512 K Memory

The least expensive way to add memory to your current system. With 0 K installed.

Wholesale priced at only...  
**\$69.00\***



Watch our Network ONLINE listings for new products in this ORIENT DIRECT line for the Apple II and IBM AT computer families.

\*PC NETWORK Members pay just 8% above this wholesale price, plus shipping. All prices reflect a 3% cash discount. Minimum shipping \$2.50 per order. International orders call for shipping & handling charges. Personal checks: please allow 10 working days to clear.

**CALL TOLL-FREE 1-800-621-SAVE** In Illinois Call (312) 280-0002

# PC NETWORK

GET THE NETWORK ADVANTAGE!!!

### IBM PC BASE SYSTEM

IBM PC w/256K  
 Floppy Drive Controller  
 2 Double Sided Double  
 Density Disk Drives  
 Mix and Match with  
 your favorite Monitor  
 and Printer!

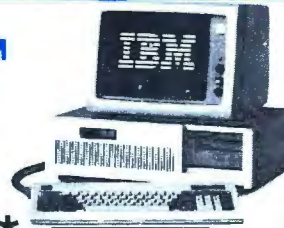


**\$1,495.02\***

### IBM PC HARD DISK SYSTEM

IBM PC w/256K  
 Floppy Drive Controller  
 1 Double Sided Double  
 Density Disk Drive  
 Half Height 10MB  
 Disk Subsystem

**\$1,749.00\***



### IBM PC/AT SYSTEM

Available NOW!!  
 Call for the  
 Configuration  
 of your choice

CALL FOR  
 LATEST IBM  
 ANNOUNCEMENTS

CUSTOM  
 CONFIGURATIONS  
 WELCOME

## COMPAQ™

### PORTABLE HARD DISK SYSTEM

w/256K/1 Floppy/10MB Hard Disk



**\$2,235.00\*** w/10MB  
**\$2,369.00\*** w/20MB

### DESKPRO SYSTEM WITH TAPE BACKUP

640K CPU/1 Floppy/10MB Hard Disk  
 10MB Tape Drive/Monitor



**\$2,951.94\*** w/10MB  
**\$3,151.94\*** w/20MB

## EPSON® PRINTERS

Unbelievable Low Prices!!!

NEW MODELS  
 NOW AVAILABLE!!



LX-80 80COL/100CPS . . . \$199.00\*  
 FX-85 80COL/160CPS . . . 299.00\*  
 FX-185 132COL/160CPS . . . 429.00\*  
 LQ-1500 132COL/200CPS . . . 799.00\*

### APPLE IIc



### APPLE IIe



### MACINTOSH SYSTEMS



NEW HOLIDAY  
 HOURS  
 M-F 7:30 AM-  
 9:00 PM CST  
 SAT 9:00 AM-  
 7:00 PM CST

CALL TOLL FREE  
**1-800-621-S-A-V-E**

In Illinois call (312) 280-0002  
 Your Membership Validation Number **B325**

You can validate your membership number and, if you wish, place your first money-saving order over the phone by using your VISA, MASTERCARD or AMERICAN EXPRESS. Our knowledgeable service consultants are on duty Mon.-Fri. 7:30 AM to 9 PM, SAT. 9 AM to 7 PM CST.



PERSONAL COMPUTER NETWORK  
 320 West Ohio  
 Chicago, Illinois 60610



Call now...Join the PC NETWORK and start saving today!

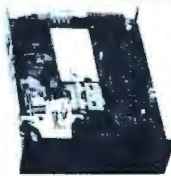
### 64K IBM PC MEMORY EXPANSION KITS

Quantity Discounts Available.  
 Guaranteed for Life!



Quantity of 100 Sets **\$3.96\*** per set  
 Set of 9 Chips **\$5.40\***

### 1/2 HEIGHT DS/DD DISK DRIVES



The Network buys direct and makes fantastic deals with manufacturers like Tandon/CDC/Shugart/Quime/TEAC/Hi-Tech and others to bring you fantastic prices on Name Brand drives for your PC/AT/XT/jr. or Compatible.

**\$59.00\***

Quantity Discounts Available

### INTERNAL PC HARD DISK

Low Power/Automatic Boot. Works on standard PC's and Compatibles. Includes drive/controller/cables/mounting hardware and instructions



Full one year warranty!  
 10MB **\$330.00\***  
 20MB **\$420.00\***

Quantity Discounts Available

## OMEGA®

Bernoulli Box  
 Dual 10MB Drives

**\$2,200.00\***

## TALLGRASS

TG-5025  
 25MB Hard Disk with  
 60MB Tape Backup

**\$2,375.00\***

### DISKETTES

Guaranteed for Life!

Brand name diskettes available in boxes 10 or in bulk packs of 50

5 1/4" DS/DD  
**\$8.95\***  
 Bx. 10 Bx. 50  
 ea. **.59\***

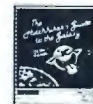
5 1/4" SS/DD  
**\$7.95\***  
 Bx. 10 Bx. 50  
 ea. **.47\***

3 1/2" SS/DD  
 Bx. 10  
**\$21.95\***  
 Free Flip & File Case

## INFOCOM®



**\$20.00\***



**\$20.00\***



**\$22.00\***



**\$22.00\***

Available for IBM, APPLE & MACINTOSH

Lotus  
**\$265.00\***

WordPerfect  
**\$190.00\***  
 MultiMate™

## MICROSOFT.

### Flight Simulator

The World's most popular computer game with Lifelike 3-D Graphics and 100% realistic simulation.

**\$27.00\***

## GATO

APPLE & IBM  
 Captain Your own submarine.  
 Great graphics!

**\$18.00\***

\*Members pay 8% above this wholesale price plus shipping.

# CROSS-SYSTEM CONFERENCING WITH CLACR

BY SHERWIN M. LEVINSON

*Microcomputers may offer a way  
to link systems and cut costs*

MOST PEOPLE HAVE probably used one or more electronic mail systems, bulletin-board systems (BBSs), or computer conferencing systems (CCSs). As on-line communications systems proliferate, many barriers make it difficult for any individual to regularly use more than a few of them. If you know people on several different systems, it may be hard to keep track of who is on which system. Also, command structures are inconsistent from one system to the next. Then there's the cost. To reach all the people you want, you need to access a number of systems that may charge for connect time, involve extra phone charges, or both.

By linking systems you could have a broader base of potential conference participants without the difficulties described above. You could communicate with a large pool of people who closely match your own specific interests without having to remember which system they are on or what the command structure for that system is. Any solution to the problem of linking systems must also take cost factors into account and pro-

vide an affordable means of communicating across systems.

What I propose is a personal computer communications program that provides timed automatic log-on to multiple systems, offers an index of incoming messages according to pre-specified categories, and allows the organization of computer conferences that span multiple BBSs, CCSs, and electronic mail systems. Cross-system conferences should be accomplished with no additional effort on the part of the conference's organizer or any of its members by porting the conference entries from each host system to all of the other systems where the conference is taking place.

I call the proposed software I will describe here the Conference Linker and Cost Reducer (CLACR). As the name implies, CLACR (pronounced "clacker") is intended to link conferences taking place on separate systems and to reduce the cost of using messaging systems. It also aims to address the other barriers to use described above.

The design goals for a full implementation of CLACR are as follows:

1. To make possible a computer conference whose participants span several different computer conferencing systems.
2. To make possible true computer conferencing on BBS and electronic mail systems.
3. To reduce the cost of participating in computer conferencing; especially, to reduce the cost sufficiently to make up for the additional cost of copying conference entries from one system to another.
4. To make participation on numerous different systems easier by providing a consistent user interface; to make that interface one that can be tailored to each user's preference.
5. To make the process of composing, sending, retrieving, and organizing messages easier.
6. To let users communicate with any other users without needing to remember what conferencing systems

*(continued)*

*After a 13-year management career, Sherwin M. Levinson left big business to devote full time to his consulting practice. He can be reached at POB 888231, Atlanta, GA 30356.*

they are on or what IDs they use on those systems.

7. To operate effectively without any changes required to the host messaging systems themselves.

The list is certainly ambitious, but it's quite possible to do using established programming techniques.

To accomplish these goals, CLACR must maintain a database containing several different tables of information. These are System Data for each remote system used, User Data for each user involved in correspondence, Conference Data, Message Pointers, Message Text, Inbox pointers to messages received but not

read, and Outbox pointers to messages to be transmitted (see tables 1 through 7 for detailed contents). These tables contain the information CLACR needs to achieve its goals.

**MESSAGE FORMAT**

CLACR is to be designed so that the organizer of a cross-system conference is the only one who absolutely must have CLACR. In fact, members of the cross-system conference who participate in a computer conferencing system don't even need to know that there's anything unusual about their conference; to them it will just seem that there's a higher level of activity than usual and they'll notice that some of the entries have a few odd lines at the top.

CLACR expects the first couple of lines of the body of each cross-system conference entry to conform to a specific format. The standard CLACR message format can be used on any messaging system and provides information about message routing and message type on the first line of text. Messages imported by CLACR also contain a second line describing the origins of the message. Because the CLACR header information is part of the message text as far as the host system is concerned, CLACR messages are totally transparent to the host system. This scheme doesn't significantly detract from the message's readability for those not using CLACR, and it allows CLACR to scan messages as they're being received to determine if they are to be saved by CLACR.

Message types include the following: conference entries, requests to join, requests to leave, conference invitations, requests for a joiner list, and private messages. As shown in table 4, each message pointer contains a message number and message author. If individual systems cannot be relied on to provide some message identification that is at least unique to that author on that system, CLACR could provide message numbers such that the message number and message author information

*(continued)*

*Table 1: The System Data table contains essential information about each remote system.*

- Internal system code
- For each access method (different networks, direct dial):
  - Phone number
  - Sequence required to connect to target system
  - Unique costs
- Log-on sequence (account, password, etc.)
- Type of system (BBS, CCS, or electronic mail)
- Commands to reach BBS, CCS, or electronic mail system
- Cost details by data-transfer rate, time of day, day of week, etc.
- Holiday schedule
- Downtime schedule
- Activity history
- Effective data-transfer rate history
- Cost history
- Maximum weekly cost
- Use history (e.g., average messages retrieved per session)
- Desired frequency of message retrieval
- Command translation table

*Table 2: The User Data table contains necessary data for each person involved in correspondence.*

- Internal user code
- User nickname
- "Real" name
- For each system where this user is active:
  - Internal system code
  - The user's name on that system
- Optional: address, phone numbers, comments, etc.

*Table 3: The Conference Data table contains all the information necessary to organize and manage a conference. Message number and author's internal user code together uniquely define this conference and point to the text of the opening statement stored in the Message Text table.*

- Message number
- Author's internal user code
- Conference nickname
- List of addressees and system where each invitation was sent
- Public or private
- List of joiners and system from which each joiner participates
- List of conference organizers

# VTERM. THE FASTEST WAY



## TO THE VAX™

## AND BACK.

VTERM II AND VTERM/4010: FOR VT100 AND TEKTRONIX™ 4010 EMULATION, AND THEN SOME.

More and more people make the trip every day. Often several times. They're off to the VAX for a session or a file, then back to PC-DOS.

That's why we wrote VTERM—the fastest, most advanced communications program for PC users who communicate with VAXes, and other minis or mainframes.



Of course, VTERM starts with everything you'd expect from state-of-the-art terminal emulation software. Like full keyboard emulation. Macros.

Disk capture. Unlimited setup files. Printer support. True plug compatibility, so you can run any VT100 or Tektronix 4010 program right from your PC keyboard.

### MAKE YOUR PC FLY.

But then VTERM goes beyond everything else on the market. With a Hotkey that instantly toggles between host and DOS sessions while preserving your terminal screen and communications link. That means you can run host and local programs almost simultaneously. And because VTERM is written in assembly language, you get full throughput at 9600 baud.

With VTERM, there's nothing to get in your way or slow you down. It's easy to use, yet packed with time-saving features. Like backscrolling, which redisplay up to 80 scrolled-off screens. And horizontal scrolling, which emulates 132-column display. (Of course, VTERM provides true 132-column display with an optional video board.)

### KERMIT FILE TRANSFER AND MORE.

VTERM delivers the most powerful file transfer system available with any general communications package. You get four error-correcting protocols including XMODEM and Kermit, the emerging micro-to-mainframe standard from Columbia University.

And you also get VTRANS, a remarkably easy-to-use file transfer system that transmits any file under local or host control. It even comes with ready-to-run host software for UNIX and three DEC operating systems – VMS, RSTS/E, and RSX11-M/M+.

So why waste time? Call Coefficient Systems Corp. to order your copy of VTERM today.

## Coefficient



Coefficient Systems Corporation, 611 Broadway, New York, New York 10012, (212) 777-6707, Ext. 221

©1985, Coefficient Systems Corp. TM signifies manufacturer's trademark.

together uniquely identify any message.

Participants on a BBS will need to understand those odd lines placed at the top of the messages by the con-

ference organizer's CLACR program (if they're to fully appreciate the discussion) because these messages will be interspersed with the normal message traffic of the BBS. They'll also need to

manually enter such lines in their own messages if they want them ported to the other systems hosting the conference. Of course, if they too were using CLACR, all these things would be taken care of automatically and they would receive their BBS messages organized by conference rather than strict chronology.

A cross-system conference would appear most foreign to those participating from an electronic mail system because by its nature a mail system forces all such conferences to be private. Again, CLACR would be helpful but not necessary to such conference participants. They could add their own comments to the conference by manually entering a header line showing the conference to which the comments are directed and then sending the message to the conference organizer. The organizer's CLACR would forward the message not only to the conference members on other systems but also to those on the same electronic mail system.

Since virtually all messaging systems provide your name as part of the message header, this need not be repeated on the first line of the text. (For internal purposes, once a message has been received, CLACR uses the unique internal user code as found in the User Data table based on the system of origin and the message author's name on that system.) The first line of text in a message conforming to CLACR's specifications contains a two-character combination identifying a CLACR header line, message-type code, message number, message number of target conference, urgent flag, reply-requested flag, acknowledgment-requested flag, type-dependent information such as subject or title of conference, and checksum (optional if the header was created manually).

The actual messages received during a connect session are scanned as they are received to check for a CLACR header line. If the CLACR header line is present and contains a checksum, the checksum is verified; if verification fails, CLACR requests the

*(continued)*

**Table 4:** *The Message Pointers contain the header information needed to identify a message. CLACR uses this information to assemble the CLACR header if the message is being sent to a BBS or electronic mail system.*

Message number  
 Location of text  
 Length  
 Subject  
 Author's internal user code  
 System of origin  
 Addressees (individuals or conferences)  
 For each addressee:  
     Date/time to be sent  
     Date/time actually sent  
     Is acknowledgment requested?  
     Is reply requested?

**Table 5:** *The actual text of a message is stripped of any CLACR header lines and stored in the Message Text table. Use of separate pointers and text speeds identification and retrieval of message text.*

Message number  
 Length  
 Text

**Table 6:** *The CLACR Inbox contains pointers to messages received but not yet read.*

Message number  
 Location of text  
 Length  
 Subject  
 Author's name on system of origin  
 System of origin

**Table 7:** *The CLACR Outbox contains pointers to messages to be transmitted.*

Message number  
 Location of text  
 Author's name on destination system  
 Destination system  
 Addressees (individuals or conferences)  
 For each addressee:  
     Date/time to be sent  
     Date/time actually sent  
     Is acknowledgment requested?  
     Is reply requested?

# To keep yourself from being burned to a crisp by a fire-breathing dragon, just cast a *nitfol* spell. Oops. Make that a *gondar* spell.



ne moment you're slipping the first disk of The Enchanter Trilogy in your computer—the next you're a novice magician, chosen by fate to battle an evil that threatens the very foundations of magic. And since you're the main character, every decision you make will determine the story's out-

come. Suppose, for instance, that when faced with a giant fire-breathing dragon you decide to cast a *nitfol* spell, which allows you to converse with beasts in their own tongue. You simply type, in plain English:

>CAST THE NITFOL SPELL ON THE DRAGON

And the story responds:

THE DRAGON PAUSES AND ROARS OUT A BENEVOLENT GREETING, WHICH, TO YOUR CHAGRIN, FRIES YOU TO A DELICATE CRISP. YOU HAVE DIED.

Suppose, on the other hand, you decide to invoke a spell that quenches open flames:

>CAST THE GONDAR SPELL ON THE DRAGON

In that case the story responds:

THE DRAGON'S FLAME IS DOUSED IN A TORRENT OF RUSHING WATER. IT DISAPPEARS WITH A TORTUOUS SCREAM.

As you progress from each story in this spellbinding trilogy to the next, the dangers you must face, the spells you must learn and the puzzles you must unravel grow to thrilling proportions. But so will your powers. Conquer the evil that lurks within all three and you'll be elevated from

sorcerer's apprentice to Leader of the Circle of Enchanters.

And along the way you'll face situations that are as lively as the text that describes them:

YOU FEEL VERY FUNNY, SORT OF SQUASHED AND PUSHED AND SQUEEZED. YOUR SURROUNDINGS ARE WAVERING, THEN GROWING, THEN WAVERING AGAIN. THE FEELING VANISHES, BUT YOUR SURROUNDINGS ARE TEN TIMES THEIR FORMER SIZE...OR IS IT THAT YOU ARE ONE-TENTH YOUR FORMER SIZE?

Infocom addicts think The Enchanter Trilogy is our best work ever. So *aimfiz* yourself into your local software store today. And let it cast its spell on you.



Progress from Standard Level ENCHANTER® to new Expert Level SPELLBREAKER™ and you'll gain the powers of a true Sorcerer.

## INFOCOM™

© 1985 Infocom, Inc. SORCERER and SPELLBREAKER are trademarks of Infocom. ENCHANTER is a registered trademark.

For more information call 1-800-262-6868. Or write to us at  
125 CambridgePark Dr., Cambridge, MA 02140

Available for most personal computers.

Inquiry 178



system to resend that particular message. Once a valid CLACR header line has been received, the message is saved if it is directed to a conference that is organized or joined by the owner of this CLACR system. CLACR also checks if the acknowledgment-requested flag is on and, if so, immediately places an acknowledgment-

of-receipt message in the Outbox.

If there is no CLACR header line present, CLACR can scan the entire text for sets of keywords that you have specified to identify non-CLACR messages of interest. In this way CLACR could even scan for messages that might be relevant to ongoing conferences. It might also be desirable to

allow a provision to always skip messages that contain certain keywords or were authored by certain users.

Once all incoming messages have been received, CLACR reviews the contents of the Outbox and sends all messages that are destined for this system and that do not indicate a delivery date and time later than the current date and time. As each message is sent, it is removed from the Outbox. This is also when any special commands are sent to the host system for execution; these would include such functions as deletion of old entries, modification of access permissions, modification of conference joiner lists, and so on.

CLACR adds a second header line to the messages it ports to other systems. This line identifies the author of the message, the system where it originated, and the date and time of its entry.

**INBOX PROCESSING**

While CLACR is connected to a remote system, messages that are to be saved are placed in an input buffer where they're held until after CLACR disconnects. They are then scanned to create the Inbox, Message Pointer, and Message Text entries as well as a portion of the Outbox. The Outbox is key to cross-system conferencing because through it conference entries made on one system get to all the others where the same conference is active.

Likewise, special CLACR messages representing requests to join or leave a conference or to get a copy of the full list of conference members are processed at this stage. Exactly how these are processed depends on the types of systems where the conference is active (BBS, CCS, or E-mail) and whether the conference is public or private. These concepts are discussed further in the next section.

When input-buffer processing is complete, you are notified that there are messages in the Inbox. These may be retrieved in various ways, including by keywords, by author, by subject, by system of origin, and by conference.

(continued)

# Atron's PC/AT Bugbusters

Hardware-assisted Software Debuggers for Bullet-proof PC/AT-based Products

**A BUGBUSTER STORY**

Brad Crain, a project manager at Software Publishing (the people who developed both PFS:WRITE and PFS:FILE), relates the following: "On Friday, March 22, 1985, I was about to get on an airplane with Jeff Tucker, who was co-author of PFS:WRITE with me, and fly to IBM's Boca Raton, Florida facility. For a week, we had been unsuccessfully trying to isolate a bug in a new software product. In a last, desperation move, I set up an early-Saturday morning appointment with ATRON.

"Three of us walked through ATRON's door at 8:00 the next morning. Using ATRON's hardware-assisted debugging tools, we had the problem identified and fixed by 10:30AM."

Mr. Crain concludes: "We'd never have found the bug with mere

software debuggers, which have the bad habit of getting over-written by the very bugs they're trying to find. It doesn't surprise me that almost all the top-selling software packages were written by ATRON customers. Now that they've broadened their PC family of debuggers to include a PC/AT debugging tool, those of us seriously into 80286 development are greatly relieved."

**ARE YOU TRYING TO DO SOMETHING SCAREY?**

Like developing your AT-based software product in the dark? Without professional debugging tools?

Seven of the ten top-selling software packages listed by the *THE WALL STREET JOURNAL*\* were produced by ATRON customers. The PC PROBE™ bugbuster (\$1595) accounts for much of this success. Now that the PC/AT is the new standard for advanced commercial and scientific development, ATRON is proud to announce the AT PROBE™ bugbuster (\$2495). It has even more debugging capabilities than the PC Probe.



**HOW BUGBUSTERS KEEP YOU FROM GETTING SLIMED**

The AT PROBE is a circuit board that plugs into your PC/AT. It has an umbilical which plugs into your 80287 socket and monitors all processor activity.

Since AT PROBE can trace program execution in real time, and display the last 2048 memory cycles, you can easily answer the questions: "How did I get here?" and "What are the interrupts doing?"

It can solve spooky debugging problems. Like finding where your program overwrites memory or I/O-impossible with software debuggers.

You can even do source-level debugging in your favorite language, like C, Pascal or assembler. And after your application is debugged, the AT PROBE's performance-measurement software can isolate your application's bottlenecks.

Finally, the AT PROBE has its own 1-MByte of memory. Hidden and write-protected. How else could you develop that really large program, where the symbol table would otherwise demand most of your PC/AT memory.

**BORLAND'S PHILIPPE KAHN: "THERE WOULDN'T BE A SIDEKICK™ WITHOUT ATRON'S DEBUGGERS."**

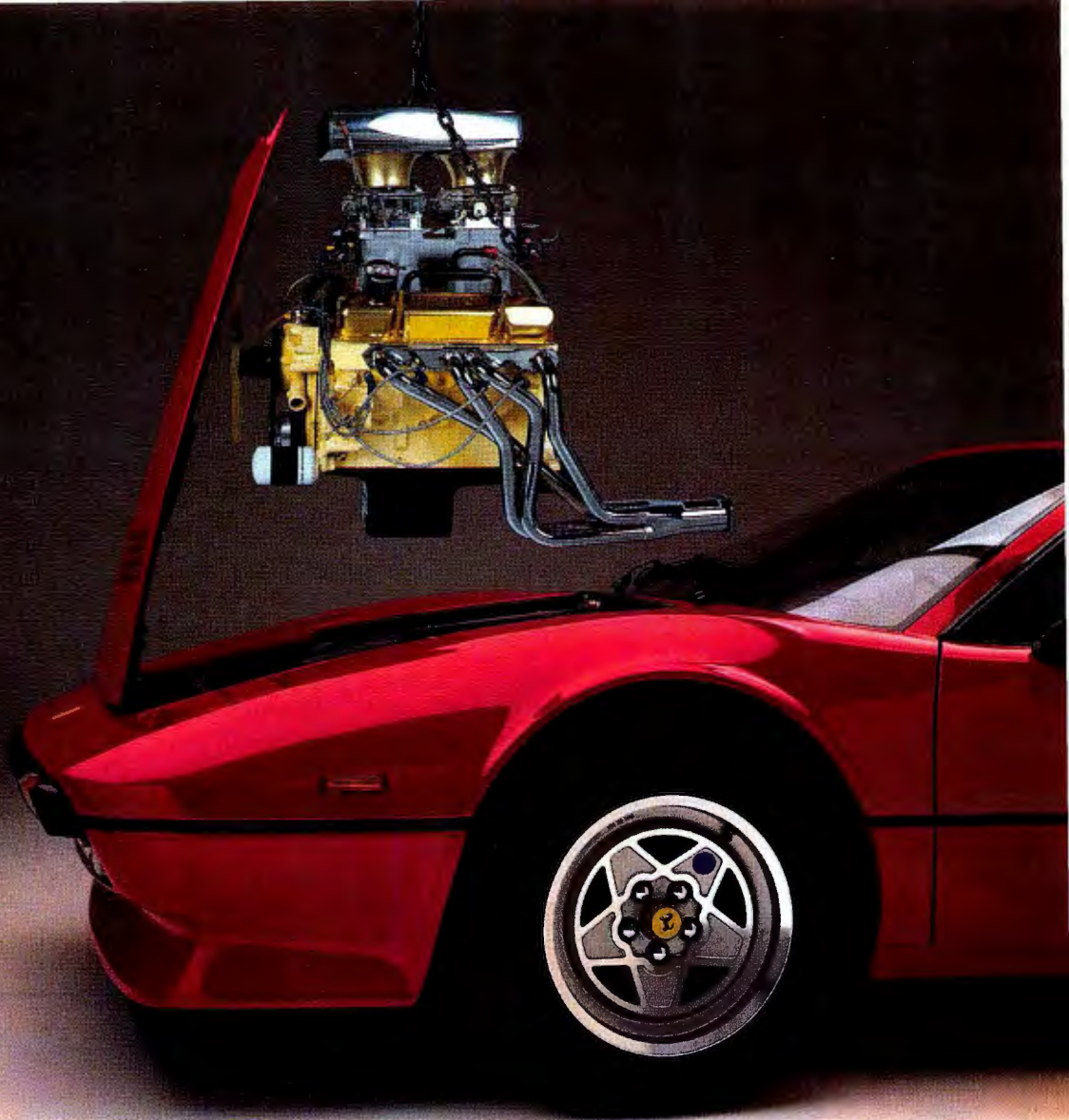
So why waste more time reading though your program listing for the ten thousandth time, trying to find why your program starts howling with every full moon. Be like BORLAND, get your Atron bugbuster today and bust bugs tomorrow.



THE DEBUGGER COMPANY  
20665 Fourth Street • Saratoga, CA 95070 408/741-5900

\*WSJ, June 24, 1985, reporting Sofasoft figures. © 1985 by ATRON. PC PROBE™ and AT PROBE™ ATRON. SIDEKICK™ Borland. IBM Corp. owns numerous trademarks. Ad by TRBA.





# AT™ Pfantasies for your PC or XT.™

Want better speed and memory on your PC or XT without buying an AT?

You've got it!

Phoenix's new Pfaster™286 co-processor board turns your PC or XT into a high-speed engine 60 percent faster than an AT. Three times faster than an XT. It even supports PCs with third-party hard disks. But that's only the beginning.

You can handle spreadsheets and programs you never thought possible. Set up RAM disks in both 8088 and 80286 memory for linkage editor overlays or super-high-speed disk caching. All with Pfaster286's 1mb of standard RAM, expandable to 2mb, and dual-mode design.

You can develop 8086/186/286 software on your XT faster. Execute 95 percent of the application packages that run on the AT, excluding those that require fancy I/O capabilities your PC or XT hardware just isn't designed to handle. Queue multi-copy, multi-format print jobs for spooling. Or, switch to native 8088 mode to handle



hardware-dependent programs and back again without rebooting. All with Pfaster286's compatible ROM software. And, Pfaster286 does the job unintrusively! No motherboard to exchange. No wires to solder. No chips to pull. Just plug it into a standard card slot, and type the magic word, "PFAST."

If you really didn't want an AT in the first place, just what it could do for you, call or write: Phoenix Computer Products Corp., 320 Norwood Park South, Norwood, MA 02062; (800) 344-7200. In Massachusetts, 617-762-5030.

Programmers' Pfantasies™  
by

*Phoenix*

XT and AT are trademarks of International Business Machines Corporation. Pfaster286 and Programmers' Pfantasies are trademarks of Phoenix Computer Products Corporation. For the Ferrari aficionado: yes, we know this is a rear engine car. We are showing the addition of a second engine to symbolize how Pfaster can be added to your PC or XT to increase performance.

The number of messages falling into each of these categories may also be displayed. You may store several standard Inbox processing methods and choose the desired one each time the Inbox is reviewed.

As each message in the Inbox is displayed, you may compose a reply and specify that it be directed privately to the message author, to the conference, or both. Of course, it's not necessary to reply, but CLACR will remind you to do so if the reply-requested flag is on. You may forward the message to other individuals and conferences, adding comments if desired. The message may also be left in the Inbox, either specifying a category or having it by default held in a "pending" category. Finally, action on the message may be deferred until some future date and time, in which case it is kept in the Inbox but not displayed until the specified date and time.

For each message in a conference you organize, you are asked if the message is to be ported to the other systems where the conference is active. While porting would normally be chosen, you have the option of not porting all notes. This can help avoid duplication and keep costs down. If porting is approved, appropriate Outbox pointers are created. Then the next time CLACR is connected to each of these systems, the appropriate messages are transmitted. In this way all the discussion from all the systems where this conference is active appears on every one of these systems.

The final action on each message is to specify whether it is to be kept in the Message Text table (and Message Pointer table) or purged. If it is to be kept, a retention period may be specified; a default retention will apply if none is specified. Regardless of the retention period chosen, any

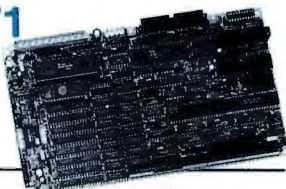
message for which an Outbox entry exists will be held until the Outbox entry is cleared.

A simple full-screen editor would be available when you want to enter replies and new messages. Since messages destined for electronic messaging systems are usually brief, the CLACR editor is relatively unsophisticated. Still, it would be far more usable than the line editor typically found in messaging systems, and it would be easier to learn, since the same editor would be used for all systems.

New messages may be addressed to any combination of users and conferences. And here is where one of CLACR's most valuable features comes into play. Addressees are specified by conference or user nicknames of your choosing; you need not keep track of the proper  
*(continued)*

## MSC-LAT1

\$649



### KAYPRO™

users can share the advantage to LAT1. Just take off your main KAYPRO board and put LAT1-K into your cabinet.

All advantage of LAT1 is yours now!

\$674

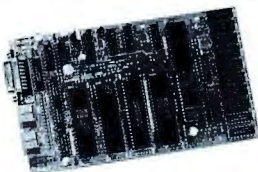
## ZENET NETWORK through twist pair

- 6Mhz HD54B180 (Z80 upward compatible) 512K byte on board (256K installed, 384K RAMDISK)
- LAN:ZENET port 800K baud CSMA CD twist pair bus type upto 500 meters HDLC
- Floppy: 3.5, 5 and 8 inch, d/s density, d/s sided and d/s track automatic density/format checking
- Hard disk: SCSI interface on board
- Video: 80 X 24 characters (color) and 640 X 200 pixels color graphic 128K byte video RAM character set is downloaded from disk
- Timer: battery back up calendar

- Serial: RS232C X 2 and TTL X 1
- Pararell: centronics type, 16 bit TTL, 7/8 bit keyboard port (32 characters FIFO)
- O.S.: Turbo Dos, MP/M (multiuser) banked CP/M plus (single user)
- Size: 10 X 6 inch 4 layered
- Assembled and tested
- BIOS source code available
- Completely faster than other Z80SBC

### MSC-PCX

8088 expansion card for LAT1 soon available



## MSC-MTC

## WORLD SMALLEST COMPUTER

- Full personal CP/M system in palm 4mhz Z80 256K RAM (128K RAM DISK)
- Serial: RS232C X 2 automatic baud rate checking
- Pararell: centronics type printer port
- Floppy: 3.5 inch micro floppy disk drive 800K byte (option 5, 3.5 inch drive d/s sided d/s track automatic density checking)

- O.S.: CP/M plus bank version
- BIOS source code available
- Completely faster than other Z80SBC

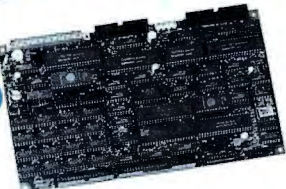
### MSC-MTC/P

Full assembled pcb of MTC Under \$189 in OEM quantity

\$299

## MSC-ICO

\$499



## Full featured CP/M plus system

- Z80 4mhz 128K Byte RAM Floppy: 3.5, 5 and 8 inch d/s density, d/s sided and d/s track upto 4 disk drives Automatic density/ format check
- Serial: RS232C X 2
- Pararell: Centronics type, 16 bits I/O, 7/8 bit keyboard port
- Timer: battery back up calendar
- Video: 80 X 24 high speed CRT controller
- O.S.: CP/M plus bank version included
- Size: 10 X 6 inch 4 layered

- BIOS source code available
- DRI CP/M plus manual \$50
- New word word processor program for MSC-ICO ADD \$50
- Completely faster than other Z80SBC

### MSC-HCS

Expansion card for ICO RAM disk (upto 2M byte) and SCSI hard disk interface card for ICO with installation program

\$199

CP/M plus is a registered trademark of Digital Research Inc.  
Z80 is a registered trademark of Zilog Inc.  
Turbo Dos is a registered trademark of Software2000 Inc.  
Mountain Side Computer and ZENET are trademark of Southern Pacific Limited

#### Distributors

England-Quanta systems 01-253-8423  
Denmark-Danbit 03-662020  
Finland-BB Soft 90-692-6297  
India-Betamatix PVT Ltd. 0812-71989

#### Manufacturer and international distributor

**SOUTHERN PACIFIC LIMITED**  
Sanwa Bldg., 2-16-20 Minamisaikai, Nishi, Yokohama, JAPAN 220  
Phone: 045-314-9514 Telex: 3822320 SPACIF J  
**Advanced single board computer technology company**

#### USA distributor

**SOUTHERN PACIFIC COMPUTER PRODUCTS U.S.A., INC.**  
P.O. BOX 4427, Berkeley, CA 94704-0427 U.S.A.  
Phone: 415-253-1270  
**Dealer and distributor inquiries welcome**

# DOES YOUR HI-RES GRAPHICS BOARD SHOW YOU ONLY PART OF A SPREADSHEET

When it comes to printing out spreadsheets, most IBM®-compatible graphics boards come up short.

But not the Genoa Spectrum™ Color/Mono/Graphics Board.



*The Spectrum Color/Graphics Board is the most compatible board you can buy. Which means it runs the most software. Including Flight Simulator™, Lotus® 1-2-3™, Symphony™, SideKick™, PC Paint™, and much, much more.*

It goes all the way to 132 columns. The largest text display of any graphics board you can buy. There's even a special driver that'll show you 132 columns of Lotus, which normally only has 80.

And together with your 132-column printer, the Spectrum can also print every one of those 132 columns. So you can see more of

Spectrum is a trademark of Genoa Systems Corporation. ©1985 Genoa Systems Corporation.

what you're doing. On the screen. And on paper.

But the best part is, you don't have to pay more to do it. Here's why:

Up until now, if you wanted

both graphics and color, you had to buy two boards. One for hi-res mono graphics, one for color.

But the Genoa Spectrum puts color and graphics *on the same board*. So you save yourself a slot. And about \$250.

You can also save yourself the price of a color monitor. Because Spectrum will emulate your color

software in monochrome. And for your monochrome software there's a 720 x 348 hi-res mode.

So either way, you're covered. Spectrum is compatible with all color and monochrome monitors. So you'll always get 16 beautiful colors in color. Or 16 shades of monochrome in mono.

For all the technical specs or the Genoa Spectrum dealer nearest you, just call us at 408-945-9720. Or write Genoa Systems Corporation, 73 E. Trimble Road, San Jose, CA 95131.

The Genoa Spectrum. It's the only board you'll ever need for color, graphics, and full size output.

Anything else is either too much money or incomplete.

 **Genoa**  
We make IBM PCs better.

## BUILD YOUR OWN IBM XT & IBM AT COMPATIBLE SYSTEMS

### Introducing XT-16 Self-Assembly Kit

#### At Super Low Cost

- Including 640K XT-16 CPU Mother Board, Color Graphic Card, Floppy Controller, One DS/DD Slim Drive, Flip-Top Case, 135 W Power Supply, Keyboard, Assembly Instruction, and User's System Manual.

**ONLY \$775.00**



### XT, AT CASE

- Same Dimension as IBM PC/AT
- For IBM PC/AT & Compatible Mother Boards **\$115.00**
- Flip-Top For Easy & Quick Access to Inside
- IBM Style Slide-In Case Also Available **\$69.00**



### XT, AT POWER SUPPLY

- XT-135 W **\$ 89.00**  
(Side Or Rear Switch)
- XT-150 W **\$115.00**
- AT-200 W **\$165.00**

### XT, AT KEYBOARD

- XT—LED for Cap Lock & Num. Lock Big Return Key & Shift Key **\$79.00**



AT—Same Layout as IBM PC/AT **\$109.00**



### XT, AT MOTHER BOARD

#### XT-16-II MOTHER BOARD

- IBM PC/XT Fully Compatible
- 8088 Microprocessor w/8087 Optional
- 8 I/O Slots, up to 640K on Board Assembled & Tested w/BIOS
- With 256K on Board **\$265.00**
- With 640K on Board **\$349.00**

#### AT-32 CPU Mother Board

- IBM PC/AT Fully Compatible
- 80286 Microprocessor w/80287 Optional
- 640K Standard, Upgradable to 1 MB on Board
- On Board Clock Calendar
- 8 I/O Slots **\$Call**

### PC/AT ADD-ON CARD

- ATS 1 MB Memory Card **\$Call**
- ATS 1.5 MB Multifunction Card **\$Call**
- ATS Hard & Floppy Drive Controller **\$Call**

### PC/XT ADD-ON CARD

- PCP-128 Eprom Programmer **\$139.00**
- Disk I/O Card (handle 2 Floppy Drive, Serial 2nd Optional), Parallel, Game, Clock w/cables & Software **\$149.00**
- Color Graphic Card **\$ 95.00**
- Floppy Disk controller (handle 4 drives) **\$ 59.00**
- Multi-Function (OK) **\$139.00**

- OEM Dealers Welcome
- Please Call For Our Special Dealer Price

## C.J. COMPUTERS CORP.

(Manufacturer & Distributor)

2424 W. Ball Road, STE B

Anaheim, CA 92804

Mail Order Hot Line: (714) 821-8922. (714) 821-8923

(IBM is a trademark of International Business Machines Corporation)

282 B Y T E • DECEMBER 1985

## CLACR

destination systems—this information is retrieved by CLACR from the User Data and Conference Data tables. Either of these tables could be scanned through windows during message creation and editing.

### CROSS-SYSTEM CONFERENCING

Several concepts have already been alluded to without being fully explained. There are certain basic functions present in any viable computer conferencing system regardless of what the system authors choose to call these functions. So while one system may use the command COMPOSE, another WRITE, and a third SAY, all three mean the same thing: Accept text that, once entered, is to be made available to particular other users of the system. This function requires that the system be told to whom the text is to be made available, the subject of the transmission, and the text itself.

Recognition of the list of basic functions is essential to our design because CLACR must provide a way to accomplish each of these on any system it uses. The basic functions available to all users include message creation, message addressing, message retrieval (both new and previously received), message deletion, joining and leaving conferences, accessing lists of joiners, and finding active conferences. Functions available to conference organizers include conference creation, management of conference access, management of retention periods, and deletion of conferences and individual messages.

That is far from a complete list, but it conveys the idea of what basics must be accomplished in any viable conferencing system. Some of these basic functions assume other components. For example, message creation assumes the ability to edit text that's already been entered, to retrieve and use text of previous messages, to forward received messages to other users, and so on.

### THE USER INTERFACE

The first step in designing CLACR's user interface is to provide a CLACR

command for each of the basic functions. Ease of use dictates typical design considerations such as the ability to perform any function with a single command, the ability to provide user-defined synonyms for each command, recognition of the shortest unique abbreviation for commands, display of a list of possible choices when a nonunique abbreviation or possible misspelling is entered, the availability of context-sensitive help, and, perhaps, a dual menu-driven and command-driven interface that lets you graduate to the briefer command-driven interface (once you have learned the command set) but still provides guidance when needed.

The set of basic conferencing functions is directly available on a computer conferencing system. However, if you are to extend conferencing to BBS and mail systems, the effects of some of these commands must be synthesized. Further, for a conference that spans several systems, even if these are computer conferencing systems, some of the native commands would not reflect the full extent of the conference. For example, the command to display the list of those who have joined the conference would only display those members who reside on that particular system.

The most important aspect of a cross-system conference is making available to all the members of the conference the entries of all other members. This is relatively easy. As part of Inbox processing, when CLACR receives entries in any conference, the Conference Data table is scanned to determine if you are the organizer of that conference. If not, the entry is handled as any normal received entry. But if you are the conference organizer, then (with your permission) pointers are added to your Outbox indicating that this entry is to be sent to each of the other systems where this conference resides. If a target system is a traditional electronic mail system, a mailing list is created using the list of joiners from the Conference Data table.

You can control what does and does

(continued)



Actual unretouched video image of Fred Molinari, President.

## “It’s easy to spot the difference between our IBM PC™-based frame grabber and the others.”

High performance and affordable cost, just \$1495 for a single plug-in board.



Laplacian Filter

Unlike other video I/O systems, the new DT2803 provides real-time image capture capabilities, digitizing a 6-bit video field every 1/30 second. An on-board, memory-mapped, dual-ported frame store memory (256 × 256 × 8) makes it ideal for the IBM PC’s 64K buffer size. And for real number crunching,



False Color

SPECIFICATIONS: DT2803	
A/D Input	RS-170 (CCIR), 6-bits at 5MHz
Frame Grab	1/30 (1/25) second per field
LUT's	8, 64 × 8 input; 4, 256 × 12 output
D/A Output	64 colors × 64 intensities, R-G-B; 64 grey levels, monochrome
Frame Memory	256 × 256 × 8 (2-bits for graphic overlays)

the DT2803’s external ports interface to high speed co-processors.

With our software package, VIDEOLAB™, the DT2803 is easy to use for image operations like averages, histograms, and convolutions.

So, if your application is manufacturing/automatic inspection, robotics, or medical research,

our new high performance video I/O board will really open your eyes – at an unbeatable price.

**Call (617) 481-3700**



Call for our new 576 pg. catalog/handbook or see it in Gold Book 1985.

# DATA TRANSLATION

World Headquarters: Data Translation, Inc., 100 Locke Dr., Marlboro, MA 01752 (617) 481-3700 Tlx 951 646.

European Headquarters: Data Translation, Ltd., 13 The Business Centre, Molly Millars Lane, Wokingham Berks, RG112QZ, England Tlx: 851849862 (#D)

In Canada: (416) 625-1907.

IBM PC is a registered trademark of IBM. VIDEOLAB is a registered trademark of Data Translation, Inc.

## **CLACR will automatically minimize connection costs.**

not appear in your inbox by joining the topics that interest you. Individuals can (if they even know that the private conference exists) make a request to join the conference, but they will actually receive new entries in the conference only if the conference organizer approves their request.

This process is made easier by constructing a preapproved access list, the list of conference addressees. When it receives a join request, CLACR compares the name on the join request to the conference-addressee list and adds that name to the joiner list only if it appears on the addressee list.

### **REDUCING COSTS**

The process of using "macros" or "scripts" to automate log-on has been implemented in many different ways. Making the connection to other systems transparent to you is essential not only to cost reduction but also to several other design goals. If you are to avoid the need to remember which person uses which messaging system and which systems host which conferences, then you must not be required to determine when to connect to each system. Instead, the information contained in the User Data and Conference Data tables will determine the ultimate destination of any messages you prepare and various parameters in the Systems Data table will determine when it is necessary to connect to those destination systems. The originating system is unimportant; the subject of the message, its author, and the conference in which it is an entry are the items of key importance.

The information in the Systems Data table allows CLACR to not only track expenses but also to automatically minimize the cost of connection to each system. Systems whose charges

do not include any time-based component aren't a consideration here. But for any systems that include some connect-time component in their charges or for which there are time-dependent telephone costs, CLACR can keep track of elapsed time as well as characters transmitted in both directions and thereby calculate an effective data-transfer rate. Idle time is calculated as the difference between the actual duration of the connection and the amount of time the same session would take if it had proceeded with no delays at the actual data rate. For simplicity, it's reasonable to assume that idle time would be the same regardless of actual data rate. From this assumption, it's possible to estimate what the cost would have been if the connection had been made at other data rates and thereby determine the least costly connect speed for each system.

You can carry this a step further if you recognize that the idle time is partly dependent on system and network loading, which, in turn, is partly dependent on time of day and day of the week. For example, you may find consistently poorer throughput on Monday mornings and Friday afternoons than late Sunday night or mid-afternoon on Wednesdays.

So the key components to track are time period (including not just time of day but also day of week and whether or not the day is a holiday), data-transfer rate, connect time, and character I/O (input/output). From this information it's possible not only to track the actual charges you're incurring but also to determine the best time, data-transfer rate, and even packet net to use for each system. A fine enough division of the connect history (by the hour, for example) and an adequate amount of this history could provide striking cost reductions if there are wide, but at least partly predictable, swings in network and system loading. Since conditions change frequently as new nodes are established and system operators add capacity, it is probably adequate to track connect history by broad categories such as morning, lunchtime,

afternoon, dinnertime, evening, and late night.

The usage history and cost information retained by CLACR would enable you to set usage limits in advance for each system used and to verify the amounts billed. CLACR would warn you as the usage limit is approached and would not exceed it without first prompting you for approval. Likewise, the usage history would enable CLACR to suggest connection at more or less frequent intervals depending on how many messages are usually waiting when each system is accessed and how frequently messages are sent to each system. Messages marked for immediate transmission might still be held for a short interval if significantly lower connect charges are about to go into effect.

A further refinement of CLACR's cost-reduction features would be to provide for some what-if analysis. For example, it may be less costly to access a system at a higher connect charge if idle time is cut in half. You could decide whether to use "800" numbers for those services that offer them, or if you should connect by long distance to a less busy packet network node, or even directly into the host system.

CLACR's handling of exceptions to log-on is a necessary concomitant to eliminating the need for you to initiate connections. Since the only thing certain about on-line connections is line noise, it is inevitable that responses from the system sometimes won't match those expected. So the command-translation information in the Systems Data table needs to include information on how to repeat commands, and the connect-sequence information needs to specify the action desired when expected prompts do not appear.

For each connect session, any exceptions to the expected system responses that could not be dealt with are placed in a special kind of message stored in the Message Text table. An appropriate Message Pointer table entry is created, and an Inbox entry is created and flagged as

*(continued)*

# A Printer For All Reasons

## Search For The Best High Quality Graphic Printer

If you have been looking very long, you have probably discovered that there are just too many claims and counter claims in the printer market today. There are printers that have some of the features you want but do not have others. Some features you probably don't care about, others are vitally important to you. We understand. In fact, not long ago, we were in the same position. Deluged by claims and counter claims. Overburdened by rows and rows of specifications, we decided to separate all the facts — prove or disprove all the claims to our own satisfaction. So we bought printers. We bought samples of all the major brands and tested them.

### Our Objective Was Simple

We wanted to find that printer which had all the features you could want and yet be sold directly to you at the lowest price. We didn't want a "close-out special" of an obsolete product that some manufacturer was dumping, so we limited our search to only those new printers that had the latest proven technology. We wanted to give our customers the best printer on the market today at a bargain price.

### The Results Are In

The search is over. We have reduced the field to a single printer that meets all our goals (and more). The printer is the SP-1000 from Seiko-sha, a division of Seiko (one of the foremost manufacturers in the world). We ran this printer through our battery of tests and it came out shining. This printer *can* do it all. Standard draft printing at a respectable 100 characters per second, and with a very readable 12 (horizontal) by 9 (vertical) character matrix. This is a full bi-directional, logic seeking, true descender printer.

### "NLQ" Mode

One of our highest concerns was about print quality and readability. The SP-1000 has a print mode termed Near Letter Quality printing (NLQ mode). This is where the SP-1000 outshines all the competition. Hands down! The character matrix in NLQ mode is a very dense 24 (horizontal) by 18 (vertical). This equates to 41,472 addressable dots per square inch. Now we're talking *quality* printing. It looks like it was done on a typewriter. You can even print graphics using the standard graphics symbols built into your computer. The results are the best we've ever seen. The only other printers currently available having resolution this high go for \$500 and more *without* the interface or cable needed to hook up to your computer.

### Features That Won't Quit

With the SP-1000 your computer can now print 40, 48, 68, 80, 96, or 136 characters per line. You can print in ANY of 35 character styles including 13 double width and 3 reversed (white on black) styles. You not only have the standard Pica, Elite, Condensed and Italics, but also true Superscripts and Subscripts. Never again will you have to worry about how to print H<sub>2</sub>O or X<sup>2</sup>. This fantastic

machine will do it automatically, through easy commands right from your keyboard. Do you sometimes want to emphasize a word? It's easy, just use **bold** (double strike) or use *italics* to make the words stand out. Or, if you wish to be even more emphatic, underline the words. You can combine many of these modes and styles to make the variation almost endless. Do you want to express something that you can't do with words? Use graphics with your text — even on the same line. You have variable line spacing of 1 line per inch to infinity (no space at all) and 143 other software selectable settings in between. You can control line spacing on a dot-by-dot basis. If you've ever had a letter or other document that was just a few lines too long to fit a page, you can see how handy this feature is. Simply reduce the line spacing slightly and ... VOILA! The letter now fits on one page.



### Forms? Yes! Your Letterhead? Of Course!

Do you print forms? No problem. This unit will do them all. Any form up to 10 inches wide. The tractors are adjustable from 4 to 10 inches. Yes, you can also use single sheets. Plain typing paper, your letterhead, short memo forms, labels, anything you choose. Any size to 10" in width. In fact this unit is so advanced, it will load your paper automatically. Multiple copies? Absolutely! Use forms (up to 3 thick). Do you want to use spread sheets with many columns? Of course! Just go to condensed mode printing and print a full 136 columns wide. Forget expensive wide-carriage printers and changing to wide carriage paper. You can now do it all on a standard 8½" wide page, and you can do it quietly. The SP-1000 is rated at only 55 dB. This is quieter than any other impact dot matrix printer that we know of and is quieter than the average office background noise level.

### Consistent Print Quality

Most printers have a ribbon cartridge or a single spool ribbon which gives nice dark

printing when new, but quickly starts to fade. To keep the printers output looking consistently dark, the ribbons must be changed quite often. The SP-1000 solves this problem by using a wide (½") ribbon cartridge that will print thousands of pages before needing replacement. (When you finally do wear out your ribbon, replacement cost is only \$11.00. Order #2001.)

### The Best Part

When shopping for a printer with this quality and these features, you could expect to pay around \$500 or more. *Not now!* We sell this fantastic printer for **only \$259.95!** You need **absolutely nothing else to start printing — just add paper.**

### No Risk Offer

We give you a 2-week satisfaction guarantee. If you are not completely satisfied for any reason we will promptly refund your purchase. A 1-year warranty is included with your printer. The warranty repair policy is to repair or replace and reship to the buyer within 72 hours of receipt.

### The Bottom Line

Be sure to specify the order # for the correct version printer designed for your computer.

Commodore C-64 & C-128, Order #2200, cable included

IBM-PC and compatibles, Order #2100, plus 8' cable #1103, \$26.00

Standard Parallel with 36 pin Centronics connector, Order #2400, no cable

We also have interfaces and cables for other computers not listed. Call Customer Service at 805/987-2454 for details.

Shipping and insurance is \$10.00 — UPS within the continental USA. If you are in a hurry, UPS Blue (second day air), APO or FPO is \$22.00. Canada, Alaska, Mexico are \$30.00 (air). Other foreign is \$70.00 (air). California residents add 6% tax. The above are cash prices — VISA and MC add 3% to total. We ship the next business day on money orders, cashiers' checks, and charge cards. A 14-day clearing period is required for checks.

For information call 805/987-2454

TO ORDER CALL TOLL FREE

1-(800) 962-5800 USA (8-6 PST)  
1-(800) 962-3800 CALIF.

or send order to:



# APROTEK

1071-A Avenida Acaso  
Camarillo, CA 93010

DECEMBER 1985 • BYTE 285

urgent. That way you can take note of any changes in the remote system's prompts or responses, any special announcements about downtime or access numbers, or any failures in the automatic message transmission and retrieval and take corrective action if necessary. While some of these exceptions can be eliminated by error-correcting protocols like X.PC, exceptions such as system announcements cannot.

Whenever a choice is available, CLACR should be set up to use the "brief" or "expert" modes of the target systems, thereby minimizing the number of characters transmitted and received and, consequently, the cost of connection.

**CONCLUSION**

Of course, the proposed CLACR software would still require some human intervention. But I believe it would

make cross-system conferencing possible at a lower cost and with far less effort than with any existing microcomputer software package. At the time of this writing, CLACR is no more than a dream. But if other people find the idea anywhere near as exciting as I do, it may soon be a reality, opening the benefits of computer conferencing to thousands and even millions who previously found it too complicated or too expensive. ■

**FREE SHIPPING ON ORDERS OVER \$100**

**HEWLETT-PACKARD**

**10 Series**  
\$15.00 Rebate on HP-12C\*

HP-11C	Scientific	\$ 55.95
HP-12C	Financial	\$ 87.95
HP-15C	Scientific	\$ 87.95
HP-16C	Computer Science	\$ 87.95

Solutions Books

HP-11C	Solutions	\$ 15.00
HP-12C	Real Estate	\$ 15.00
HP-12C	Leasing	\$ 15.00
HP-12C	Cash Flow Analyzer	\$ 32.95
HP-15C	Advanced Functions	\$ 15.00

\*Good thru 12/31/85

**HEWLETT-PACKARD**

**Additional Items**

VECTRA	AT Computer	CALL
2225B	Thinkjet Printer	\$ 379.00
7470A	2-Pen Plotter	\$ 843.15
9144A	740K Disc Drive	\$ 625.00
82143A	Thermal Printer	\$ 295.00
82161A	Cassette Drive	\$ 423.00
82162A	IL Printer	\$ 346.50
82164A	IL/RS-232 Interface	\$ 227.15
82166C	IL Interface Kit	\$ 304.15
82168A	Acoustic Coupler	\$ 389.95
92192A	Box of 10 Discs	\$ 55.20
92285A	Laser Jet Toner	\$ 79.20

**PRINTERS**

**Diablo**

D-25	25 cps Daisywheel	\$ 550.00
D-80	80 cps Daisywheel	\$ 2195.00

**Okidata**

ML182	120cps Dot Matrix	\$ 219.00
ML192	160cps Dot Matrix	\$ 389.00
Ok120	Color Dot Matrix	\$ 199.00
ML193	160cps Wide Carriage	\$ 499.00

**Brother**

M1509	180cps Wide Carriage	\$ 379.00
HR-15XL	17cps Daisywheel	\$ 345.00
HR-35	36cps Daisywheel	\$ 689.00
2024L	200cps & NLQ	\$ 825.00
CF100	Sheet Feeder	\$ 199.00
Twinwriter 5	Daisywheel/Dot Matrix	\$ 815.00

**HEWLETT-PACKARD**

**40 Series**

HP-41CV	Scientific	\$ 169.95
HP-41CX	Scientific	\$ 239.95

Accessories

82059D	Battery Recharger	\$ 16.00
82104A	Card Reader	\$ 150.15
82120A	Battery Pac	\$ 28.00
82140A	HP-IL Interface	\$ 96.25
82181A	Extend Memory	\$ 60.00
92266A	Extended Use Battery	\$ 39.95

Software

NEW	Math/Statistics Pac	\$ 36.00
44-15004	Financial Decision	\$ 28.00
44-14005	Surveying	\$ 28.00
44-14006	Circuit Analysis	\$ 36.00
44-15055	Advantage Rom	\$ 39.95

**EPSON**

LX-80	100cps & NLQ Dot Matrix	\$ 219.00
LX-90	100cps & NLQ Dot Matrix	\$ 239.00
FX-85	160cps Dot Matrix	\$ 339.00
FX-185	160cps Dot Matrix	\$ 479.00
JX-80	Inkjet Dot Matrix	\$ 469.00
HS-80	Inkjet	\$ 319.00
AP-80	Apple comp. Dot Matrix	CALL
SQ2000	Office Inkjet	\$ 1550.00
LQ1500	NLQ Dot Matrix	\$ 850.00
DX-10	Daisywheel	\$ 229.00
DX-20	Daisywheel	\$ 315.00
DX-35	35cps Daisywheel	CALL
PX-8	Geneva Computer	\$ 699.00
HX-20	Lap Computer	\$ 399.00

**Panasonic**

KXP1091 ..... \$ 249.00

**Citizen**

MSP-10	160cps Dot Matrix	\$ 269.00
MSP-15	160cps Wide Carriage	\$ 379.00
MSP-20	200cps Dot Matrix	\$ 359.00
MSP-25	200cps Wide Carriage	\$ 499.00

**Star**

SG10/15	120cps Dot Matrix	\$ 235/275
SD10/15	160cps Dot Matrix	\$ 339/449
SR10/15	200cps Dot Matrix	\$ 485/595
SB10	24 pin Head	\$ 549.00
PowerType	Daisywheel	\$ 309.00

**Juki**

6100	18cps Daisywheel	\$ 345.00
6200	30cps Daisywheel	\$ 515.00
6300	40cps Daisywheel	\$ 699.00

**HEWLETT-PACKARD**

**70 Series**

HP-71B	Handheld Computer	\$ 389.95
HP-75D	Handheld Computer	\$ 856.75

Peripherals

82400A	Card Reader	\$ 127.05
82401A	HP-IL Interface	\$ 96.25
82420A	4K Memory Module	\$ 60.00
82441A	FORTH Assembler	\$ 145.50
82483A	Surveying	\$ 145.50
82490A	41/71 Translator Pac	\$ 96.25
92198A	IL 80 Column Interf.	\$ 250.25
82489A	Statistics Pac	\$ 96.25

**AT&T**

4000 Modem	\$ 349.00
Softcall	\$ 59.95



**CAPITAL MICRO**

7600 FLOWER AVENUE  
WASHINGTON, D.C. 20912

**(800) 544-4442**

In Maryland, call  
**(301) 565-3595**

**EPSON**

**Equity I**  
IBM compatible computer

Single Roppy Disk Drive	\$ 799.00
Dual Roppy Disk Drive	CALL
Floppy/Hard Disk Drive	CALL

**TERMS:**

- Free Shipping on orders over \$100.
- NO ADDITIONAL CHARGE for credit cards.
- MD residents add 5% sales tax.
- Credit references required for open account.
- Allow 2 weeks for personal checks.
- C.O.D.'s—cash, money order, bank or certified check.



# OEM & OWN BRAND COMPOSITE & TTL COMPATIBLE COLOR & MONO MONITOR TERMINAL



TERMINAL; SD-M1201

SM-12SF 31A6; APPLE COMPATIBLE  
SM-12SF 39A7; IBM COMPATIBLE



OEM BRAND; SM-12CL 31A1



SM-CL401 SNS; 8 COLORS  
SM-C1402 SNS; 16 COLORS  
IBM COMPATIBLE



#### SEOUL OFFICE

6~8TH FL, THE JOONG-ANG DAILY  
NEWS BLDG., 7 SOONHWA-DONG,  
CHUNG-KU, SEOUL, KOREA  
TEL: 7516-955/7, 7516-959/961  
TLX: STARNEC K22596  
CABLE: "STARNEC" SEOUL

#### LONDON OFFICE

6TH FLOOR, VICTORIA HOUSE  
SOUTHAMPTON ROW W.C.  
1 LONDON, ENGLAND  
TEL: (01) 831-6951/5  
TLX: 264606 STARS LG  
FAX: (01) 430-0096

#### SANTA CLARA OFFICE

3003 BUNKER HILL LANE,  
SUITE 201 SANTA CLARA,  
CAL. 95050, U.S.A.  
TEL: (986)8473  
TLX: 171685 SAMSUNG SNTA

#### TOKYO OFFICE

KASUMIGASEKI BLDG., 2522  
KASUMIGASEKI 3-2-5 CHIYOTA-KU,  
TOKYO, JAPAN  
TEL: (03) 581-5804, (03) 581-9521~4  
TLX: 228009 SANSEI

It's not surprising that the company which invented Daisywheel printing should be the one to take it to a breakthrough level of performance.

Introducing the Xerox 635 Diablo Daisywheel Printer, the next generation of printers.

It's fast—up to 55 cps. It's quiet—perfect

for a busy office.

And because it's a Xerox printer, the 635 just won't quit.

In fact, we are so convinced of the 635's reliability, we'll add 21 months of free service to our standard 90 day limited warranty. That gives you two full years of protection if you buy before January 31, 1986.\*

That's way ahead of our competition. But then so is our printer. And it's our way of showing our confidence in the technological advancement it represents.

The 635 Diablo Printer has dozens of printwheels available including Memory-writer and IBM typestyles and fonts. So you can make almost all your office documents

# The people who set the industry standard just raised it.



For more information from XEROX, Circle 381 on the Reader Service Card.

XEROX, DIABLO® and the identifying numbers listed herein are trademarks of XEROX CORPORATION.

IBM is a registered trademark of the International Business Machines Corporation. APPLE® is a registered trademark of the Apple Corporation.

XEROX® standard limited warranty applies for the first 90 days, carry-in service for the following 21 months at XEROX® and DIABLO® service centers across the country. Call XEROX® or your authorized dealer for full details.

# XEROX

look the same.

Snap-in interface cartridges give instant compatibility to most micro-computer systems, including Xerox, IBM and Apple.

And only Xerox offers you such a complete line of peripherals. Like a bi-directional tractor, single-bin sheet feeder,

dual-bin sheet feeder or dual-bin sheet feeder with an envelope bin.



For more details visit your participating dealer or local Xerox sales office, or call 1-800-TEAM-XRX, ext. 122. Or send in the coupon. Because you gain a lot by setting higher standards.

Xerox Corporation, P.O. Box 24, Rochester, NY 14692  
I'm interested in learning more about the 635 Diablo  
Daisywheel Printer.  
 Please have a dealer or sales representative contact me.  
 Please send me more information.

NAME _____	
COMPANY _____	TITLE _____
ADDRESS _____	
CITY _____	STATE _____
ZIP _____	PHONE _____
122	192 12/85





# Reviews

---

<b>REVIEWER'S NOTEBOOK</b>	
<i>by Glenn Hartwig</i> .....	293
<b>THE AT&amp;T PC 6300</b>	
<i>by Bob Troiano</i> .....	294
<b>THE TANDY 200 AND THE NEC PC-8401A</b>	
<i>by Harry Krause</i> .....	306
<b>GOLDEN COMMON LISP</b>	
<i>by Bruce D'Ambrosio</i> .....	317
<b>THE NORTON UTILITIES</b>	
<i>by Rubin Rabinovitz</i> .....	323
<b>HYPERDRIVE FOR THE MACINTOSH</b>	
<i>by Gregg Williams</i> .....	329
<b>UPGRADES FOR THE TRS-80 MODEL 100</b>	
<i>by Terry Kepner</i> .....	335
<b>THE IBM PROPRINTER</b>	
<i>by Rich Malloy</i> .....	343
<b>PANASONIC'S 4-COLOR GRAPHIC PENWRITER</b>	
<i>by Jon R. Edwards</i> .....	351
<b>REVIEW FEEDBACK</b> .....	359

---

AT&T'S PC 6300, designed jointly by AT&T and Olivetti and manufactured by Olivetti, is fast, expandable, compatible with IBM PC software, and less expensive than the IBM product. Bob Troiano has taken a look at this machine and reports his findings in this month's first review.

Two laptop computers are compared by Harry Krause. Both the Tandy 200 and the NEC PC-8401A are flip-top LCD-screen portables with generally closed architectures. Each weighs between four and five pounds, uses a Z80-equivalent microprocessor, and may be operated on battery power. NEC has slightly modified its offering since this review was written. Chiefly, the Japanese laptop now has a series of click-stops built into the cover/screen's hinges as it folds back. This allows you to have more confidence in the screen staying where it is positioned. The unit is not, however, different in any substantive way from the one described in this review.

Golden Common LISP from Gold Hill Computers is an extended subset of Common LISP. It supports more than 400 primitives and includes stack groups, macros, closures, streams, and other advanced LISP features. In fact, this language implementation gets high marks from reviewer Bruce D'Ambrosio in just about every area.

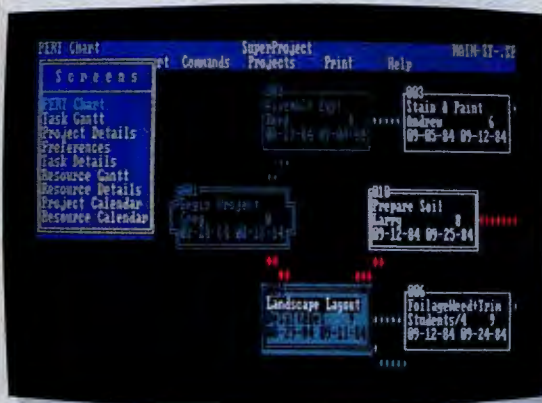
Rubin Rabinovitz takes a look at Peter Norton's data-recovery tools, the Norton Utilities. Mr. Rabinovitz describes types of data destruction and tells how the program gets your information back. Losing data is common enough, and infuriating enough, that this review should have a helpful tip or two for almost everyone.

Next, Gregg Williams, BYTE senior technical editor, takes a look at General Computer Company's HyperDrive hard-disk upgrade for the 512K-byte Apple Macintosh. Mr. Williams reports that, true to its promise, the HyperDrive is fast, unobtrusive, and easy to use. Less heartening, however, is a series of problems he encountered with the unit.

Back when the Radio Shack Model 100 was new, it was praised for being the only true laptop portable computer but criticized for its lack of hardware expandability. Since then, options have been introduced that let you increase memory, add disk drives, increase the display size, and add interface expansion boxes. In his review of "Upgrades for the TRS-80 Model 100," Terry Kepner takes a look at several products now available for the pioneer laptop and provides his assessment of their usefulness.

BYTE's New York editor, Rich Malloy, delivers his analysis of IBM's Proprinter. This unit lets you print fanfold and single-sheet paper, as well as envelopes, without going through several time-consuming paper changes.

Jon Edwards, one of our staff's technical editors, takes a close look at Panasonic's 4-Color Graphic Penwriter. At first glance, you'd think this was one of the newer electronic typewriters. Then you notice that it uses pens and is actually a writing typer. Portable, multifunctional, and shipped with built-in graphics programs, the Penwriter has a number of characteristics that make it worth considering.



Create your entire project on screen.



Help a keystroke aw



Unique project overview lets you see the big picture.



Everything on every res



Schedule tasks over weeks, months, even years.



SuperProject automatical



SuperProject outdates other project calendars by also providing calendars for every resource.



Track fixed, variable, and to

# THE DIFFERENCE BETWEEN SUPERPROJECT AND OTHER PROJECT MANAGEMENT SOFTWARE IS EVEN MORE GRAPHIC THAN THIS.

It's not hard to see why SuperProject™ is becoming the new standard in project management software. Bright colors, simple symbols, and clear graphics let you know exactly where you stand. Now, and as far into the future as you care to go.

But the real beauty of SuperProject lies in what it can do for you. Because no matter what you do, how much time you have to do it, how many people you're responsible for, and how much money is involved, SuperProject will help keep you in control.

So you can plan for the schedule changes. And react to the budget hacks, and unexpected costs that occur in real life.

And with SuperProject, you can even directly transfer information into SuperCalc® 3 Release 2, Lotus® 1-2-3®, dBASE™ and other leading software for more detailed financial analysis and reports.

SuperProject. Another business solution from Computer Associates, one of the most experienced business software companies in the world.



With a list of satisfied customers that includes over 80% of the Fortune 500.

To see how SuperProject can give your work a clear advantage, call Terry Smith at 1-800-645-3003. Or see your dealer.

After one look, you'll wonder how you ever managed without it.



Computer Associates Micro Products Division was formerly known as Sorcim/ILUS Micro Software.

©1985 Computer Associates International, Inc. SuperProject is a trademark and SuperCalc a registered trademark of Computer Associates International, Inc. Lotus and 1-2-3 are registered trademarks of Lotus Development Corporation. dBASE is a trademark of Ashton-Tate.

Apple's enhancements for the IIc and IIc consist of a color monitor, a 3½-inch disk drive, a 300/1200-bps modem, and a memory-expansion card. The color monitor gave us no surprises. It worked right out of the box and provides a good-size focal point after using the smaller IIc monochrome screen. The monochrome unit, however, has a crisp, bright, high-contrast display. The color monitor is pale, with shades more like pastels than bold primary colors.

I don't feel it can be used comfortably with text. With the lack of sharpness common to any color monitor and the muted shades provided by the Apple palette, I have some difficulty keeping my place as I work.

In spite of its shortcomings, the color monitor at least worked. The 3½-inch disk drive didn't work at all. After being plugged in, it simply disappeared as far as the computer was concerned. We found later that you need either ProDOS version 2.0 (or later) or the Apple IIc Add-On Kit enhancement to make the Unidisk visible to the computer. This information, however, was contained in a manual for "Apple Access II on the Unidisk," rather than in any information about the disk drive itself.

The manual packed with the unit was disappointingly uninformative. However, you will observe that the documentation provides the same sketchy generalities in English, German, Italian, Spanish, and French. Getting precious little to go on in five languages was not as helpful to me as getting details in one language.

Apple's new modem is a half-size 300/1200-bps unit. There is a circular seven-pin socket for the serial communications cable on the modem itself, but you can get a variety of interface cables to connect this modem with Apple computers other than a

IIc. Interface cables must be purchased separately. The technology represented by the choice of transmission rates and by the small size has been around for a while, but having it available for the Apple II line (and from Apple) is worth noting.

The memory-expansion card reportedly gives you an extra megabyte of RAM in your IIc. As with the modem, what's interesting is the fact that the product comes from Apple.

Seiko recently sent us a new version of its wrist terminal, the 2001. It's a fun little memo device as well as a pretty good timepiece. You download short messages from an Apple computer to your watch's memory. Then, when the alarm goes off, your watch tells you what you're supposed to be doing instead of making you puzzle out just why this little machine is chirping at you. I thought it was a little odd, however, that an expensive accessory like this would be designed to work with a less-expensive-type computer. I'm also curious about who would get a lot of use out of the terminal. It makes you run over to your computer whenever you want to load up on a new supply of memos. I wonder how convenient that would be after a couple of weeks or months.

Finally, a brief mention of the new Texas Instruments 80286 machine. The Business Pro emphasizes storage capacity in terms of both size and variety. Ours came with a 33-megabyte hard disk (but you can get them up to 72 megabytes), a 60-megabyte tape backup, a high-density 1.2-megabyte floppy-disk drive, and a 360K-byte double-density floppy-disk drive. Something else it seems to emphasize, albeit subtly, is compatibility with IBM software. For example, it comes with its own operating system

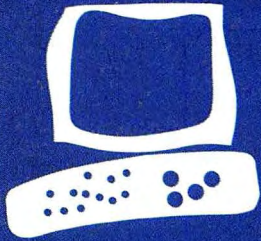
as well as a version of MS-DOS. This laying down of the welcome mat to an extended family of DOS applications is complemented by a less well-known compatibility with PC-DOS 3.0. Having more and more, instead of less and less, can do wonders for your whole attitude.

Using a variety of operating systems on the same machine results in some mental double-takes from time to time. For example, TI's operating system calls the hard-disk drive E, while MS- and PC-DOS call it drive C. If you put something on the hard disk under one type of operating system, you won't be able to call it up under the other. The files will still show up in the directory—they'll just be out of reach until you boot up again with the appropriate operating system. I didn't find it too confusing, especially since the prompt is different for each mode (`\>` for TI mode as opposed to `>` for the others), but I'm not sure whether or not this could get to be a headache in a busy office.

I like the Business Pro keyboard. It has a nice solid feel, a definite tactile-resistance threshold, and an audible click. I also find the middle-finger-bumps on the home row to be helpful. The display doesn't especially appeal to me. It's a color model, and it looks like TI chose gray as the default color for text. In color programs where characters are specifically designed to show up in other colors, the white lettering is quite brilliant. For the normal run of word-processing programs, however, you have the impression of looking at a screen with the brightness level turned way down.

The Business Pro is going to be treated fully as a review subject. I'm looking forward to reading the impression it makes on somebody else.

—Glenn Hartwig  
*Technical Editor, Reviews*



# The AT&T PC 6300

**IBM PC  
compatibility  
with a speed  
advantage**

BY BOB TROIANO

**T**he AT&T PC 6300 is an IBM PC-compatible computer featuring a fast 8-MHz 8086-2 processor, graphics capability, and high-resolution color text (see photo 1). The PC 6300, designed jointly by AT&T and Olivetti and manufactured by Olivetti, was introduced about a year ago and is quite similar to Olivetti's model M24. The computer is targeted at large corporate users, professionals, and others who desire a high-quality machine that runs two to three times faster than the IBM PC.

The PC 6300 will run most popular programs, such as Lotus 1-2-3, WordStar, dBASE III, Framework, and Flight Simulator, and it performs admirably in most respects. You can purchase a complete monochrome system with 128K bytes of RAM (random-access read/write memory), two floppy-disk drives, and a nonglare green monitor for less than \$3000, while a 10-megabyte hard-disk system costs about \$4000. The PC 6300's price includes MS-DOS 2.11 and GW-BASIC. Dealers are giving substantial discounts on this machine. I suggest that you check out a number of dealers' prices before making a purchase.

## HARDWARE

The AT&T PC 6300 consists of three separate units: the main system unit, a monitor, and a detached keyboard. The system unit is more compact than most other PC-compatibles, measuring 15 by 15½ by 6½ inches. The keyboard, which is slightly longer than the system unit, measures 17¼ by 7½ by 1.

On the rear of the system unit sits a large, slow-speed fan that keeps the computer cool 24 hours a day. The sound of this fan is quite unobtrusive, even in a quiet room. The trick here is that increasing the size of the fan and reducing the speed still maintains the same cooling capability while lowering the noise level.

The computer's circuitry is located in two areas: a large motherboard mounted on the bottom side of a dividing panel and a

smaller bus converter with seven expansion slots mounted on the top side with the dual floppy-disk drives and the power supply.

The main circuitry and DIP (dual in-line package) switches are easily accessible on the motherboard (see figure 1). You remove two screws on the rear panel, then slip off the bottom cover to expose the component side of the board. The bottom cover has vent holes punched on three sides to let air pass over the motherboard's components. Two screws on the rear panel attach the top cover. When removed, it allows access to the seven empty slots.

Most of the ICs (integrated circuits) are not socketed, with the exception of half of the RAM, all PROMs (programmable read-only memories), and a few large ICs. The motherboard has an empty socket for an optional 8087 numeric coprocessor. This computer requires the 8087-2, the 8-MHz version of the chip that costs almost two times more than the slower version. Another large empty socket is on this board, possibly for a special PROM chip that activates some networking or communications capabilities already built into the machine. I had no way to confirm this, however.

On the front panel you will find a green power indicator, access to the two floppy-disk drives (or one floppy and one hard disk), and a reset switch.

The power indicator is nearly useless because it is very faint, but the reset switch is a godsend. When a program crashes and the computer stops, you cannot always revive it with Ctrl-Alt-Del. A reset switch is handy because it lets you reboot the computer without having to turn it off and on, which is not particularly good for computers. [Editor's note: AT&T says that the problem with the dim light-emitting diodes (LEDs) has been resolved on later units.]

## KEYBOARD

The keyboard layout is similar to that of the IBM PC (see photo 2), with undersize enter

Bob Troiano is an independent consultant and also does work for General Instrument Corp., Hicksville, New York. He can be contacted at POB 97, Farmingdale, NY 11735.



and shift keys in the same locations. The keys have a distinctive snap to them, similar to the IBM PC's keyboard but not quite as loud, and the touch is not as heavy. The keys are responsive and not at all mushy.

The keyboard is moderately light, weighing about 4 pounds. It is made of impact-type plastic and has two feet that enable it to tilt upward slightly. It has two LEDs, one on the Num Lock and one on the Caps Lock keys. These LEDs reflect the actual status of the machine, as opposed to just toggling on and off when pressed. When the computer is first turned on or reset, the LEDs flash rapidly during the diagnostic checks.

A 5-foot coiled cord attached to the keyboard is connected to the rear of the computer by a DB-type 9-pin connector. On the rear of the keyboard is a connector for a mouse that AT&T has just released.

This keyboard is not compatible with any of the others available for the IBM PC, so if you don't like the way it feels, you're stuck. Maybe some third-party vendors will adapt their keyboards to work with the PC 6300.

#### **VIDEO DISPLAY**

The video display is one area where this computer really shines. Two monitors are available for the PC 6300: a green monochrome (see photo 3) and an RGB (red-green-blue) unit.

Built into the computer is the equivalent of a monochrome card and a color-graphics card. The same text font is used for both (an 8- by 16-pixel matrix), whereas the PC has a matrix of 8 by 8 pixels for the color mode and 9 by 14 for a monochrome monitor. All the graphics modes that are available on the IBM PC are available on the PC 6300, and 640- by 400-pixel monochrome high-resolution graphics are available as well. GW-BASIC has been modified to accommodate commands for this special graphics mode.

There is no obvious way at this time to use a color and a monochrome monitor simultaneously as you can with the IBM PC

and other compatibles. Some programs that use graphics allow text on one screen and graphics on the other simultaneously. This would be a nice feature, especially in scientific work.

The text font on the PC 6300 is a little different from the IBM PC font. It has 16 colors available in the text mode. With the high quality of the color text, you can easily use this system for word processing without strain on your eyes.

Both the monochrome and color monitors have only two controls hidden either on top or bottom: brightness and contrast. The monitors plug into the back of the computer and come on when you turn on the computer. In fact, the monochrome moni-

*(continued)*



**Photo 1:** The AT&T PC 6300 with one floppy-disk drive, monochrome monitor, and keyboard.

tor doesn't even have a power cord; it gets its DC power from the computer's power supply.

One complaint I have about the color monitor is a slight lack of linearity at the screen's upper left and lower left corners; the text at these positions "pulls" toward the screen's periphery. I inspected several units to see if it was a common problem. It was. Most people would not notice it,

but considering that the monitor lists for \$945, I find it unacceptable. Good engineering design should eliminate this kind of distortion. AT&T has been notified of the problem.

**PROCESSOR AND MEMORY**

The PC 6300 is a true 16-bit machine with 16 address lines and 16 data lines. This means that the computer's memory is accessed in words instead

of bytes (a word is 2 bytes or 16 bits). The PC 6300 uses an 8086-2 microprocessor with a clock speed of 8 MHz, nearly twice as fast as the IBM PC. This setup could theoretically run more than three times faster than the IBM PC, but in practice it is somewhere between two and three times faster and is program-dependent.

The bus-converter board contains the seven-slot expansion bus. It multiplexes the 16-bit data lines down to 8 bits to maintain compatibility with the existing IBM PC-type cards. The bus converter runs at 4 MHz instead of 4.77 MHz, so clock-speed-dependent IBM-compatible cards might not work. Most cards should run.

Two of the seven slots have an extra connector available for boards that can accept a 16-bit data bus. One problem here is that the second connector is not the same as in the IBM PC AT or any other computer, and I suspect that few manufacturers will market products that use this feature.

Some problems have been reported with standard memory cards other than the AT&T memory-expansion board (which has true 16-bit access by way of the second connector). Check out any memory-expansion boards before you make a purchase.

The motherboard of the dual floppy-disk unit comes with 128K bytes of RAM soldered in and has 18 additional sockets for RAM expansion. The hard-disk unit comes with 256K bytes of RAM soldered into the motherboard. All additional memory requires expansion boards.

The preliminary technical manual that I obtained from AT&T claimed that 256K-byte RAM chips will work in the 0 bank of memory (the ones soldered in) but gave no information on whether the 256K-byte chips will work in bank 1 (the socketed memory). A little experimentation with the DIP-switch settings showed that 256K-byte chips do work in bank 1, allowing 640K bytes of RAM on the motherboard. This was not mentioned in the technical manual. In fact, you won't find any switch settings in the manuals that come with the computer. If you

(continued)



Photo 2: The AT&T PC 6300 keyboard. Note that the keyboard layout is similar to the IBM PC's except for the Num Lock and Caps Lock keys, which contain LEDs.

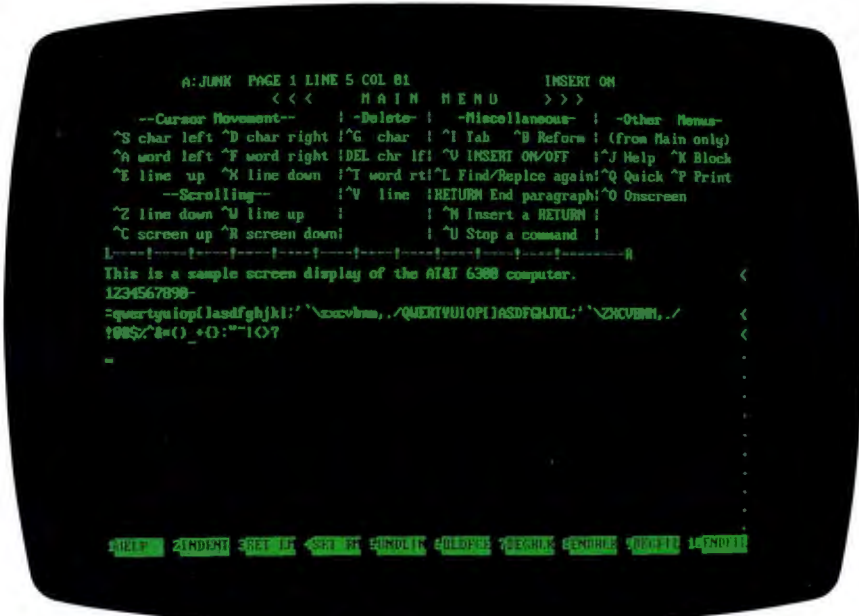


Photo 3: Text on the AT&T PC 6300 monochrome monitor.

## AT A GLANCE

### Name

AT&T PC 6300

### Company

AT&T Information Systems  
National Sales Center  
Suite 300  
111 Westwood Place  
Brentwood, TN 37027  
(800) 247-1212

### Size

15 by 15½ by 6½ inches

### Components

**Processor:** 8-MHz 8086

**Memory:** 128K bytes or 256K bytes, expandable to 640K bytes

**Mass storage:** Two 360K-byte floppy-disk drives or one floppy-disk drive and one 10-megabyte hard-disk drive

**Display:** Monochrome or color

**Keyboard:** IBM PC-type keyboard layout, not plug-compatible

**Expansion:** Seven IBM PC-compatible slots

**I/O Interfaces:** Serial, parallel, mouse

### Software

MS-DOS 2.11, GW-BASIC

### Options

Extended 16-bit memory board (384K bytes)	\$595
Color display	\$945
Mouse	\$150
XENIX operating system	\$395
External 10-megabyte hard disk	price n.a.
Optional display adapter	less than \$900

### Documentation

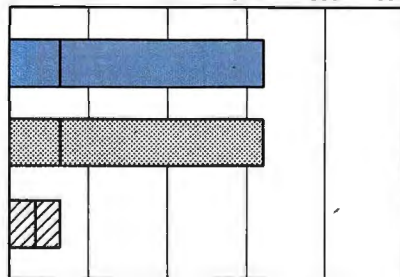
User's guide, guide to MS-DOS, guide to GW-BASIC

### Price

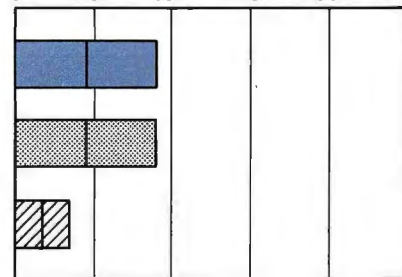
With monochrome monitor, 128K bytes of RAM, two floppy-disk drives, and keyboard \$2745  
With color monitor, 128K bytes of RAM, two floppy-disk drives, and keyboard \$3395  
With monochrome monitor, 256K bytes of RAM, and 10-megabyte hard disk \$3975



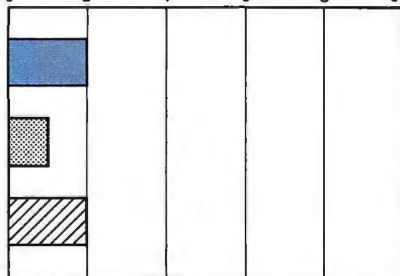
MEMORY SIZE (K BYTES)  
0 200 400 600 800 1000



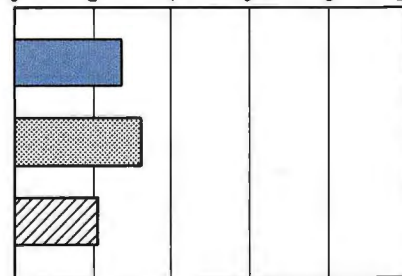
DISK STORAGE (K BYTES)  
0 400 800 1200 1600 2000



BUNDLED SOFTWARE PACKAGES  
0 2 4 6 8 10



PRICE (\$ 1000)  
0 2 4 6 8 10



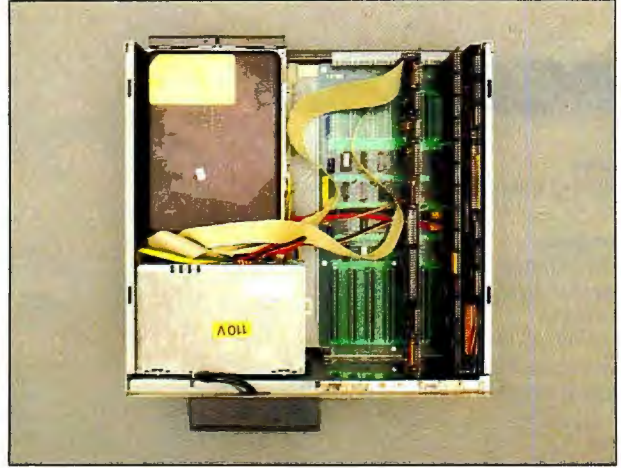
■ AT&T PC 6300    ■ IBM PC    ■ APPLE II E

The Memory Size graph shows the standard and optional memory available for the three computers under comparison. The Disk Storage graph shows the capacity of the AT&T PC 6300 in comparison with each of the other computers. The Bundled Software Packages

included with each system. The Price graph shows the list price of each system with two high-capacity floppy-disk drives, a printer port and a serial port, 256K bytes of memory (64K bytes for 8-bit systems), and a monochrome operating system and BASIC interpreter for each system.

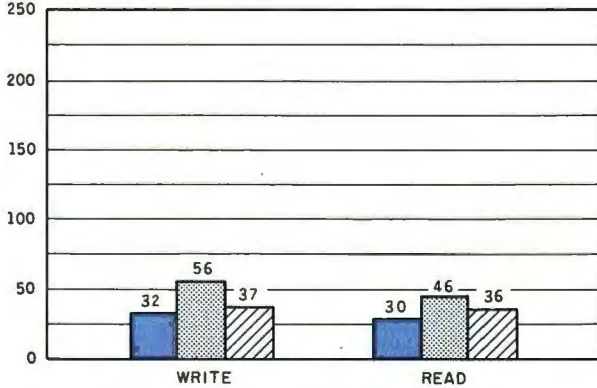


Rear view of the AT&T PC 6300 showing connectors for the serial port, parallel port, keyboard, and monitor. Note the oversized cooling fan, protective shroud, and connector access slots for the seven expansion boards.

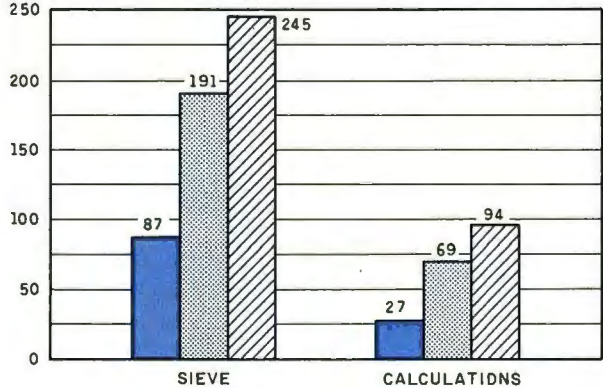


The inside of the AT&T PC 6300 showing disk drive, power supply, and motherboard with expansion connectors.

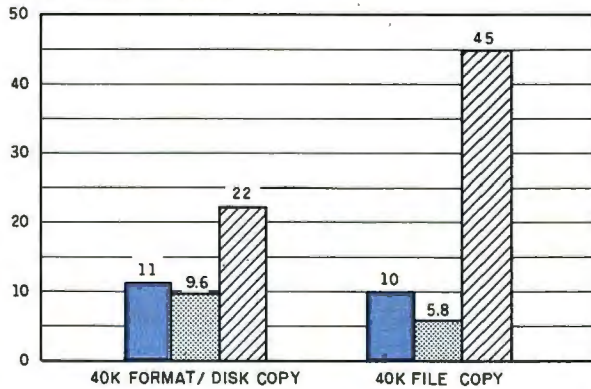
DISK ACCESS IN BASIC (SEC)



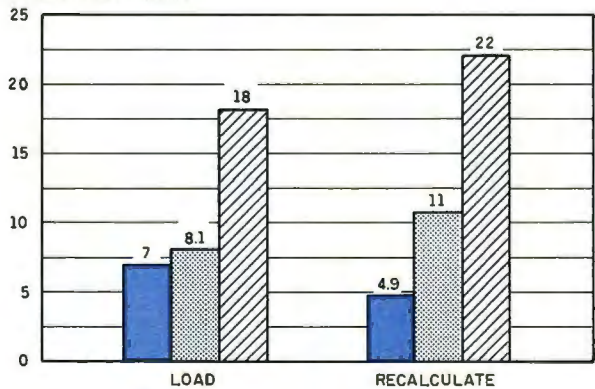
BASIC PERFORMANCE (SEC)



SYSTEM UTILITIES (SEC)



SPREADSHEET (SEC)



■ AT&T PC 6300    ▨ IBM PC    ▩ APPLE II E

The graph for Disk Access in BASIC shows how long it takes to write and to read a 64K-byte sequential text file to a blank floppy disk. (For the program listings, see June 1984 BYTE, page 327, and October 1984, page 33.) In the BASIC Performance graph, the Sieve results show how long it takes to run one iteration of the Sieve of Eratosthenes prime-number benchmark. In the same graph, the Calculations column shows how long it takes to do 10,000 multiplication and 10,000 division operations using single-precision numbers.

The System Utilities graph shows how long it takes to format and copy a disk (adjusted for 40K bytes of disk data) and to transfer a 40K-byte file using the system utilities. The Spreadsheet graph shows how long it takes to load and recalculate a 25- by 25-cell spreadsheet where each cell equals 1.001 times the cell to its left. The tests for the AT&T PC 6300 used MS-DOS 2.11 and GW-BASIC. The tests for the Apple IIe were done with ProDOS. The IBM PC was tested with PC-DOS 2.0 and BASICA.

want this information, you will have to call AT&T or ask your dealer. The switch settings I used for a 640K-byte motherboard are shown in figure 1. You can use only memory chips with access times of 150 nanoseconds or less for expansion.

The preliminary technical manual mentions a Z8001 coprocessor board for added throughput, but it is not clear how it would operate or if it will be available from AT&T.

**POWER SUPPLY AND INTERFACES**

The power supply in the PC 6300 is rated at 168 watts (output power) and has additional capability for momentary surges during power-up when you use a hard disk. In the system with dual floppy-disk drives, all seven slots are empty and available for expansion purposes. The floppy-disk controller is built into the motherboard, and the standard display controller is connected to the edge of the bus converter. The system includes as standard an RS-232C serial port, a Centronics parallel port, and a clock/calender with battery backup. A connector for a mouse is provided on the rear of the keyboard. AT&T has recently released a mouse for this machine and claims that it is Microsoft-compatible. I was unable to completely verify this, but the Microsoft programs that I tested worked perfectly.

The PC 6300 is ready to run as shipped, with no hidden costs except the extra memory that you might want to add to the motherboard (if you have the system with dual floppy-disk drives) or a memory-expansion board (if you have the hard-disk 256K-byte system).

AT&T has specifically stated that this is not a game machine and that it does not support games. This is because of the clock-speed differences mentioned earlier. However, I installed a game-port controller card and a joystick and had no trouble using them with Flight Simulator and a few other games. The games seem to run a little faster.

I discovered a slight problem when attempting to run the computer with a serial printer. When the MODE

command is used to redirect the computer's output to the serial port, the computer fails to initialize the DTR line and the printer doesn't respond (AT&T has been notified of this problem).

I got around this by writing a short assembly-language program that initializes the DTR line after MODE is run. The IBM PC-DOS MODE command works perfectly on this machine.

**SOFTWARE**

The PC 6300 comes with MS-DOS 2.11 and GW-BASIC. I recently received an updated disk from AT&T containing release 1.1 of MS-DOS 2.11 and an update to GW-BASIC. A BASICA driver program that loads GW-BASIC is now included and might help some programs that did not run before. Many bugs have been corrected in both DOS and BASIC. This disk should now be available from AT&T.

Another important change is that the hard-disk routines in DOS have

been modified to let more than one hard disk be present in the system. The FORMAT command can now format a hard disk larger than 16 megabytes, with or without bad sectors. This means that you could buy a 20-megabyte high-speed hard-disk drive and be running at almost the same speed as the AT.

Two types of diagnostics are included with the PC 6300: ROM-based and disk-based. The ROM diagnostics are performed upon power-up or reset and take only 15 seconds with 640K bytes of memory. If you do a warm boot, the memory test is excluded and the time is shortened to 5 seconds. The disk-based diagnostics are extensive; they include motherboard and video tests and a complex set of memory tests. They also can log errors to a printer.

**COMPATIBILITY**

Compatibility is probably the key issue that people will want to consider

*(continued)*

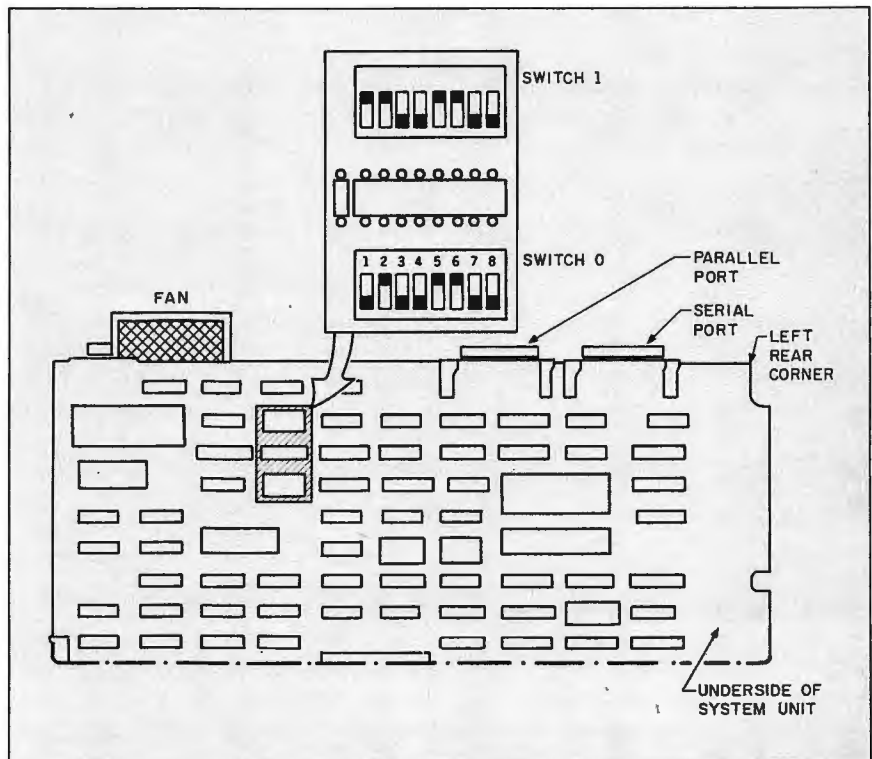


Figure 1: The bottom right corner of the AT&T PC 6300's motherboard, showing the location of DIP switches and switch settings for 640K bytes of RAM.

when deciding which computer to buy. The AT&T PC 6300 was designed to be software- and hardware-compatible with the IBM PC. Most of the desirable programs that run on the IBM PC will run on this computer. AT&T has sent dealers a list of about 350 programs that will run on the PC 6300, although a few require patches.

The patches are available free of charge from AT&T. Also on the list are several programs that don't run.

Among the programs that have been tested so far and do work are 20 word processors, 12 spreadsheet programs, 15 database programs, and some graphics and communications programs. All Borland products seem

to work perfectly with the PC 6300. The performance of Turbo Pascal 3.0 on this machine is breathtaking.

The Example 1 routine of a circuit-design-and-analysis program called PSPICE demonstrates the compatibility between the IBM PC AT and the PC 6300. This program from Microsim Corporation is written in FORTRAN and does mathematical calculations that make extensive use of the numeric coprocessor. Both computers tested were equipped with 640K bytes of RAM and numeric coprocessor chips (the 8087 in the PC 6300 and the 80287 in the PC AT). The test results show a high degree of mathematical processing compatibility.

The calculating time for the transient-analysis routine was 31.7 seconds for the PC AT and 36.5 seconds for the PC 6300. Calculating time for the AC-analysis routine was 31.86 seconds for the PC AT and 37 seconds for the PC 6300. The difference in speed for these tests is only about 15 percent, not bad considering that the PC AT uses a 20-megabyte hard disk and the PC 6300 has only two floppy-disk drives.

The overall time including I/O (input/output) was 137.3 seconds for the PC AT and 213 seconds for the PC 6300. These times reflect the effect of a hard disk on the overall job time.

Compatibility is dynamic in nature, and a program that doesn't run now might run in the future because software manufacturers want their programs to work on as many computers as possible.

Release 1.0 of MS-DOS and GW-BASIC and any other program using the UCSD p-System will not work. Also, programs that are dependent on clock speed, like disk-drive analyzers and certain copy programs, will not run. However, I tried PC-DOS 2.1 and 3.0 and had no difficulty with either.

If you are considering purchasing this computer, you should ask your dealer or AT&T for a copy of the program list.

**LIMITATIONS**

The PC 6300's limitations are few in

(continued)

# Tools for the Programmer from Blaise Computing

Save Up To \$130 On These Special Offers!

**TOOLS & TOOLS 2**

For C or Pascal

For a limited time, pick up both packages and save \$50 off our regular list price. The C version comes with libraries for the Lattice, Computer Innovations and Microsoft (version 2.03 and

3.00) compilers. The Pascal version supports IBM and Microsoft Pascal. **\$175.**

**VIEW MANAGER With Source**

All libraries are included. Please specify C or Pascal. Regular \$425. Save \$130. **\$295**

Blaise Computing provides a broad range of fine programming tools for Pascal and C programmers, with libraries designed and engineered for the serious software developer. You get clearly written code that's fully commented so that it can serve both as a model and also be easily modified to grow with your changing needs. Our packages are shipped to you complete with comprehensive manuals, sample programs and source code. None of the programs are copy-protected.

**FOR C AND PASCAL PROGRAMMERS:**

**TOOLS** ♦ \$125

Extensive string and screen handling, graphics interface and easy creation of program interfaces. Includes all source code.

**TOOLS 2** ♦ \$100

Memory management, general program control and DOS file support. Interrupt service routine support. Includes all source code.

**VIEW MANAGER** ♦ \$275

General screen management. Create data entry screens that can be easily manipulated from your application program. Block mode data entry and retrieval with fast screen access.

**VIEW LIBRARY Source** ♦ \$150

Source code to the VIEW MANAGER library functions.

**ASYNCH MANAGER** ♦ \$175

Powerful asynchronous communications library providing interrupt driven support for the COM ports. All source code included.

**FOR THE TURBO PASCAL PROGRAMMER:**

**Turbo POWER TOOLS** ♦ \$99.95

Extensive string support, extended screen and window management, interrupt service routines, program control and memory management, interrupt filters. All source code included.

**Turbo ASYNCH** ♦ \$99.95

Interrupt driven asynchronous communication support callable from Turbo Pascal. ASYNCH is written in assembler and Turbo Pascal with all source code included.

**PACKAGES FOR ALL PROGRAMMERS:**

**EXEC** ♦ \$95

Program chaining executive. Chain one program from another even if the programs are in different languages. Common data area can be specified. Source code included if you're a registered C TOOLS and C TOOLS 2 user.

**SPARKY** ♦ \$75

Run-time resident (or stand-alone) scientific, fully programmable, reverse polish notation calculator. No limit on stack size, variables or tape. Includes all standard scientific functions and different base arithmetic.

**TO ORDER, call Blaise Computing Inc. at (415) 540-5441**

♦ 2034 Blake Street ♦ Berkeley, CA 94704 ♦ (415) 540-5441 ♦



# SOLVE PROGRAMMING PROBLEMS THE WAY YOU THINK. PURE AND SYMBOL.



## Introducing the new **APL★PLUS® PC System, Release 5.0**

The shortest distance between two points is a straight line. But unfortunately, that's not the case in programming.

Most languages require you to go through an enormous number of steps before an idea becomes reality.

That's why the **APL★PLUS PC System** is such a dramatic and exciting software tool for serious PC programmers and application developers.

Instead of requiring you to learn—and write—long-winded and complicated programs, **APL** is based on your instinctive ability to deal in symbols. And once you begin using **APL**'s quick notations, you'll find it the ideal programming

environment for all your application needs.

The incredible shortcuts you get with **APL** will let you spend less time on drudgery and more time creating. Intricate calculations and modeling on PC's are a snap.

The Release 5.0 version features:

- multi-window, full-screen editing
- graphics primitives, now with EGA support
- spreadsheet-like numeric editing
- fast Assembler library
- built-in terminal mode
- and report formatting.

Plus concise notation for programs like sorting, matrix inversions, string searching,

and more. And the complete package price is just \$595 with major credit cards accepted.

Act now, and we'll send you a free Convincer Kit. Contact your local dealer, or call 800-592-0050 (in Maryland, call 301-984-5123) to order your system, or for more information about our other **APL★PLUS** products—from our **UNIX™** version to the new streamlined **Pocket APL™**.

Or write **STSC, Inc.**, Software Publishing Group, 2115 East Jefferson St., Rockville, MD 20852.

You'll see how symbol **PLUS★WARE** products are to use, the very first time you use them.



### Problem-solving at the speed of thought.™

**STSC**  
A Contel Company

APL★PLUS PC System requires 256K and DOS 2.0 or later. A soft character set can be used for computers with IBM compatible graphics board. A character generator ROM or software is included for the IBM PC or selected compatibles.  
PLUS★WARE and Pocket APL are trademarks of STSC, Inc. APL★PLUS is a registered trademark of STSC, Inc. UNIX is a trademark of AT&T Bell Laboratories.

## About 350 IBM PC programs will run, but some require patches.

comparison to its many features, low cost, and terrific color text. Aside from those already mentioned, the only problem I noticed is that, if you remove the bottom cover, you must be careful when you replace it because a plastic button that acts as an extension for the reset switch is located on the motherboard. It is somewhat fragile, and I damaged it when putting the cover back on.

The 8086 processor is quite fast when running programs that do a lot of calculations and screen I/O. However, disk access is not improved significantly by the faster CPU and clock speed. If the program you are going to use does a lot of disk access, you should consider buying the 10-megabyte hard-disk version of this machine.

### SPEED

I was curious to know how this 8086 machine fares against the 80286-based IBM PC AT. There is no question that the 80286 is a more powerful chip and that the throughput of the AT with its fast-access hard-disk drive would be better.

Disk Read and Disk Write BASIC benchmarks and the Sieve of Eratosthenes prime-number benchmark compare favorably with times for the IBM PC AT. Disk Read in BASIC takes 30 seconds for the PC 6300 versus 26 seconds for the PC AT. Disk

Write in BASIC takes 32 seconds for the PC 6300 versus 24 seconds for the PC AT. The Sieve of Eratosthenes benchmark comes very close to the PC AT time, taking 87 seconds for the PC 6300 and 80 seconds for the IBM PC AT.

These benchmarks demonstrate the raw processing power of the PC 6300, particularly when you consider that in these tests the IBM PC AT is using a hard disk. The "At a Glance" graphs show the results of the BYTE benchmarks for the PC 6300, the IBM PC, and the Apple IIe.

### DOCUMENTATION

Three manuals are included with the computer: a user's guide, a programmer's guide to GW-BASIC, and a user's guide for MS-DOS. All are in three-ring binders with slip covers and are fully typeset with illustrations. Each has a table of contents and a good index.

The user's guide has an introduction to the computer's hardware and some brief instructions on starting up the first time. It also has a nice glossary of computer terms. The disk diagnostic operating instructions are included in this manual. I would have liked a little more detail on what the diagnostics were doing, but for most users the information included will be sufficient.

Both the GW-BASIC and the MS-DOS manuals have a tutorial section and a reference section. Each command has at least one example showing how it is used. For some reason, the instructions for DEBUG and LINK usage were not mentioned in any of the manuals. I later found out that these programs are described in the

system programmer's manual.

I obtained a final copy of the system programmer's manual and a preliminary copy of the technical reference manual. I was also assured by AT&T personnel that a complete service manual with advanced diagnostics was in preparation. The system programmer's manual contains information on DEBUG, LINK, memory maps, file allocation tables, system calls, and drivers, and a complete commented ROM BIOS printout.

The technical reference manual is equally good. It describes each circuit subsection in detail, gives a summary of how the computer works overall, and has all DIP-switch information with the exception of how to set up the 256K-byte RAM chips on the motherboard. All that was missing was a complete set of schematics.

The manuals are expected to sell for under \$65, except the service manual, which will probably be about \$125. It was a wise move on AT&T's part to make this information available to users and programmers, especially since the computer's enhanced graphics and other special features can't be fully used without this kind of information. The part numbers for the above manuals are shown in table 1.

### SUMMARY

The PC 6300 is a fine computer with relatively minor problems. AT&T's reputation for product support is a guarantee that you won't end up with an orphan. The PC 6300 runs most of the best IBM PC software around and runs it two to three times faster.

The color monitor and text screen are considerably better than those of the standard IBM PC and are comparable to a PC with an Enhanced Graphics Adapter board. I would recommend this machine to anyone contemplating the purchase of a PC-compatible computer, including business users, programmers, and scientists. ■

### ACKNOWLEDGMENTS

I would like to thank Tony Nuzzi of Falcon Computers, Hicksville, New York, and John Logowski of Computer Factory, Garden City, New York, for their assistance in the preparation of this article.

Table 1: Part numbers and estimated prices for optional PC 6300 manuals.

Manual	Part number	Estimated price
System programmer's manual (available now)	403319015	\$65
Technical reference manual (available soon)	403319023	\$65
Service manual (available soon)	403319031	\$125



# Se habla Modula. On parle Modula. Modula gesprochen.

We speak **Modula**. Lilith speaks **Modula**. Lilith is a computer designed expressly for Modula by Niklaus Wirth, author of Modula and Pascal. Wirth intended Lilith to be the ideal programmer's workstation for developing programs in Modula-2. He succeeded.

Modula Corporation proudly introduces a new version of the Lilith—the Lilith/PC. The powerful Lilith engine is now available as a co-processor to the ubiquitous IBM PC/XT and compatibles.

In this set-up, the Lilith provides the computing horsepower and the PC provides the input/output. The disks, keyboard, mouse and other I/O are all handled on the PC side. The Lilith runs the display and the laser printer and does all the calculations. When the Lilith wants a disk sector, for example, the PC passes the sector from the PC disk directly into Lilith memory by maximum speed DMA transfer. The entire system is as effective as the original Lilith and only half the cost. And, of course, you still have the full usability of your PC.

All the wonderful software, developed by Wirth's group at the ETH (Swiss Federal Institute of Technology) in Zurich, runs on this system, including Wirth's spectacular WYSIWYG\* multi-font word processor, the Lidas Relational Database System, and the entire Modula-2 development system. For engineering applications, there are schematic generation programs, drawing packages, and our elaborate printed circuit board layout package. Source files are available for almost everything, as is customary with ETH software. It's hard to imagine a better environment for a Modula programmer!

When you see this system, you'll know why Jerry Pournelle is so up on it. (See "Chaos Manor," *Byte*, Jul. & Dec., 1985.) Call us. We speak Modula. And we are compatible.

- Lilith/PC Co-Processor, 2 Megabytes Memory, PC Interface, Display Interface, System Software ..... \$6551

#### Other products from Modula Corporation

- MacModula Compiler (for Apple MacIntosh) . . . \$150
- PC Modula-2 (for IBM PC and Compatibles) . . . \$150
- Wirth's Single-Pass, Native Code Modula-2 Compiler for the PC . . . . . \$300

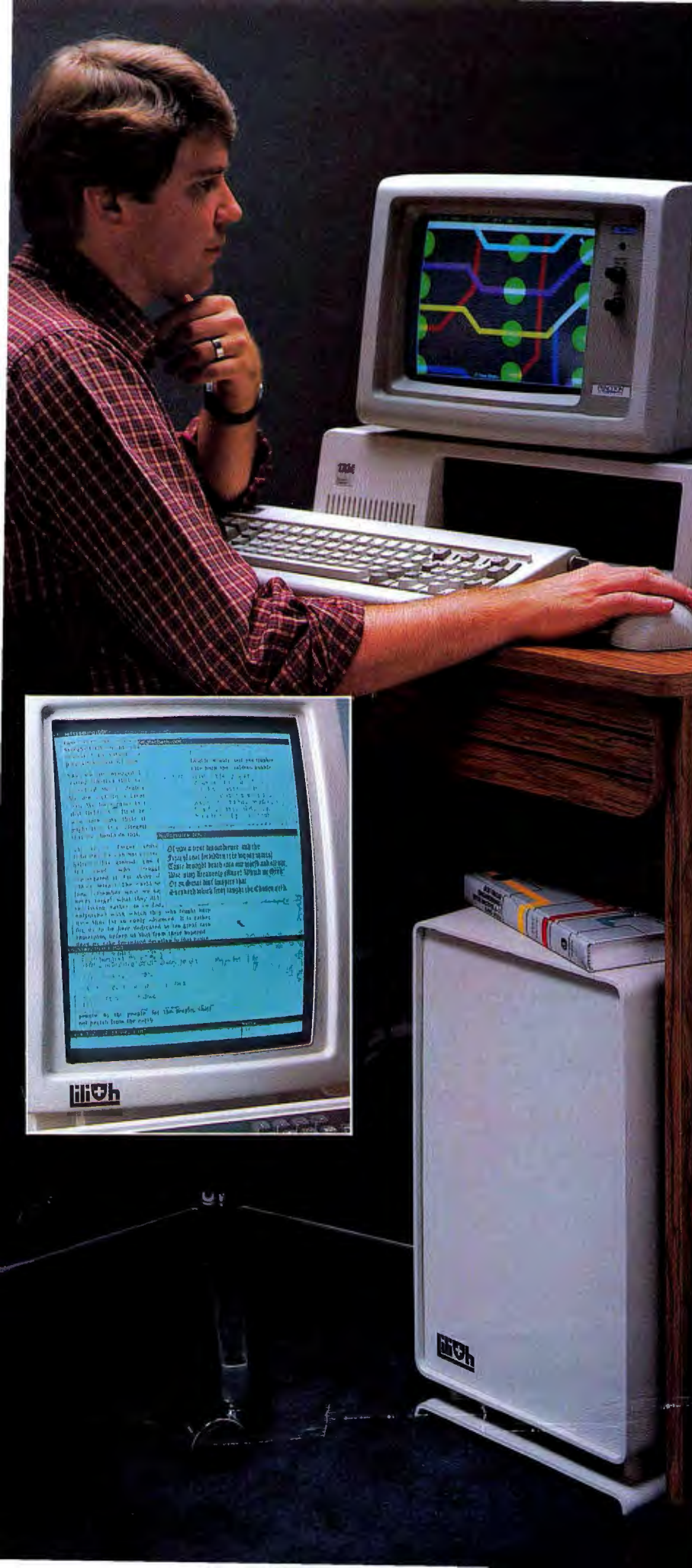
To order, or for more information, call toll-free:

**1-800-LILITH-2**

Charge cards accepted.

**MODULA CORPORATION** 950 N. University Ave.  
Provo, UT 84604  
(801) 375-7400  
Inquiry 251

\*What You See Is What You Get.  
© 1985 Modula Corporation.



# **C** *Low power* Complete hard disk kit \$395

Comes complete with virtually the identical controller that's in the IBM® XT, and Xerox® warranties the hard disk for one year

## **G**uaranteed 100 percent IBM PC compatible

How can we offer this fantastic price? Simple. We buy in such volume that even the most avaricious hard disk businessmen understand they have to give us the best price possible. We could pocket the difference, but we don't.

Instead, we put the extra profit into our testing facilities. That's why Xerox guarantees our \$395 10 megabyte hard disk for one year.

Xerox knows, as our customers know, that we have an extensive testing program. Here is what we contribute toward giving you the maximum hard disk performance.

### **Best Drives Available**

First, we buy the best drives available. Sounds trite, doesn't it? I mean, a drive's a drive—right? Hardly. You should see some of the junk we get in our labs. Some have such high failure rates that we even questioned our own \$10,000 hard disk tester. But when we tested other manufacturers' drives we were assured that our equipment was fine, which just confirmed that the bad hard disks were not only bad—they were real bad.

But that's just the weeding out process. We then take each drive that we've put through our tester and test it again with the controller you've requested. We call this a "tested pair."

### **DOS Doesn't Do It**

In case you're thinking that all

this is an unnecessary duplication of what DOS does for you, let me explain the disk facts of life.

If DOS did what you may think it is supposed to do when you format the disk, DOS would map around these bad areas. Unfortunately, DOS doesn't do this.

DOS 2.0 and 2.1 can't enter the bad tracks. DOS 3.0 can, but only on the IBM AT. Unfortunately, as the press has so well documented, the AT's hard disk develops bad tracks later on.

### **We do what DOS can't**

We believe the problem is so bad, we use a software program that performs a powerful test of your disk drive on all of the IBM or IBM compatible computers—PCs, XTs, and ATs. Our format takes hours to analyze the disk. But when we finish, you know that the bad tracks are really mapped out so you won't write good data that will disappear into a black hole. We even send you a printed statement of our test results.

Our software allows you to type in the bad track locations from the list supplied by the manufacturers, so you'll never write good data to them—even if DOS didn't identify them as bad. The software even lets you save the location of these bad sections to a file, so that you can reformat your disk without spending hours retesting.

We even include a program that will give you continuous comments on the status of your hard disk. No more waiting for that catastrophic failure.

### **Average Access Time**

As you might suspect, some hard disks are faster than others in their ability to move from one track of data to another. The time it takes the hard disk to move one-half way between the beginning of the disk to the end is called the "average access time."

The first generation of 10 megabyte hard disks had average access times of 80-85 milliseconds (msec). But computer users love speed, and guess what—the average access time for the new 20 megabyte hard disk in the IBM AT is only 40 msec. (We sell an AT equivalent with only 30 msec access time!)

There are some legitimate reasons for the shorter access time. It's particularly helpful when there are multiple users on the same hard disk. It's also important when running a compiler. But remember, before you get too wrapped up in the access speed, there's always that ST 506 interface which won't let data transfer from the hard disk to the computer any faster than 5 megabits/second. We've bypassed that choke hole, too. If you want the functional equivalent of a Ferrari with a turbocharger, order our 10 Mbit per second 100

### **Compatibility**

To be sure that your hard disk is 100 percent compatible with the IBM XT you don't need to buy the same hard disk that's in the XT. You can't even be sure what brand hard disk it is because IBM, like Express Systems, goes into the marketplace and buys hard disks from several vendors. However, they buy their XT hard disk controller from only one vendor—the same one we do.

You can buy the IBM XT controller from IBM for \$495 or you can buy from us, the functional equivalent, manufactured by the same company that makes it for IBM for only \$195. Is it the exactly identical IBM XT controller? No, it's better. First, it takes less power, and secondly, it can control from 5 to 32 megabytes—the IBM controller can work with only 10 megabytes. It is 100 percent IBM XT compatible, and 100 percent is 100 percent. If you want to save a slot, we carry a version that lets you operate two hard disks and two floppy disk drives.

### **More than 32 Megabytes**

You can operate with more than 32 megabytes (the limit of DOS) through the use of "device drivers." Express Systems can supply you with device drivers for our hard disks for over 32 megabytes formatted. But, if you don't have individual files, or databases that are large, you might want to consider one of our controllers that can divide our 65 megabyte (formatted) hard disk into two equal volumes of 32 megabytes each.

### **Reliability**

We offer you a choice between iron oxide and plated media—the stuff that covers the hard disk and gives it its magnetic properties. Iron oxide is, well, it's rust. If you inadvertently joust your disk, you may cause the low flying head to dig out some iron oxide. A little rust flake can ruin your whole day. Plated media is more resistant to damage, and if it happens, less data is lost.

We offer both types of hard disks. The iron oxide is older



technology, and quite frankly, manufacturers understand it better. Their better understanding, combined with some of the special head locking mechanisms, gives us peace of mind when we sell you one.

### Power

Hard disks consume power. Our small, half-high hard disks consume so little power that you can use them with your existing IBM PC power supply. If you plan to use lots of slots, you'll want to increase your power supply to be safe. We offer the same amount of power for your PC that comes in the XT.

### Our Customers

Some folks just never feel comfortable buying mail order. They forget that Sears began as a mail order house or that IBM is now into mail order. But, if it helps, here is a *partial* list of customers who have felt comfortable to buy from us.

IBM	Sears
American Express	Honeywell
U.S. Army	MIT
AT&T (Bell Labs)	RCA
Bausch & Lomb	Lockheed
Xerox	Sperry

### Easy to Install

If you're like most of us, raised on the boob tube rather than the Great Books, you'd rather see the movie than read the book. Well, now you can choose to read our installation manual or for only \$9.95 more, you can get a VHS or Beta video cassette showing the simple steps for installation.



### Warranty

We offer you a one year warranty on our hard disks—the same as IBM on the AT and 90 days on the tape drives. (It's all the manufacturer gives us.) If



### Complete Hard Disk Kits

Formatted MB	Height	Plated Media	Average Access	Transfer Rate	PC or PC/XT	AT
10	1/2	no	85 msec	5 Mb/s	\$ 395	\$ N/A
10	1/2	yes	85 msec	5 Mb/s	\$ 495	\$ N/A
21	1/2	yes	85 msec	5 Mb/s	\$ 795	\$ 595
21	Full	no	30 msec	5 Mb/s	\$ 1,535	\$ 1,340
32	1/2	yes	85 msec	5 Mb/s	\$ 995	\$ 795
32	Full	no	30 msec	5 Mb/s	\$ 1,775	\$ 1,575
65	Full	no	30 msec	5 Mb/s	\$ 2,295	\$ 2,070
100	Full	yes	18 msec	10 Mb/s	\$ 4,995	\$ 4,995



### Removable Hard Disk

10	1/2	no	90 msec	5 Mb/s	\$ 1,095	N/A
----	-----	----	---------	--------	----------	-----



### Tape Systems and Subsystems

Formatted Storage Capacity	Height	Data Transfer Rate (k/sec)	PC or PC/XT	AT
60 Mbytes	1/2	88	\$ 995	\$ 995
60 Mbytes Subsystem		88	\$ 1,295	\$ 1,295
21 Mbytes (unformatted) Start/stop Subsystem		24	\$ 595	\$ 595
26 Mbytes Floppy Tape® Subsystem		31	\$ 749	\$ 749



### Controllers

All of our hard disk and tape controllers are available separately: Please call for prices.

### Subsystem Chassis

Any of our disk or tape units are available in an external subsystem for an additional \$250.00. You can mix & match any of our 1/2 high hard disks or tape drives together or add any single full height hard disk.



### Tape Cartridges

Express Certified 555 foot 310 Hci 1/4-inch Data Cartridge **\$35.00**

### Power Supply

130 Watt Power supply **\$75.00\***  
150 Watt Power supply **\$125.00**

\*with the purchase of any drive

anything goes wrong with your tape or disk drive or hard disk, send it back in the box it came in. However, we have found that we can usually solve the problem over the phone. So call first for a return authorization number because we can't accept any returns without it.

### Comes complete

All Express Systems products come complete with the appropriate software, tape and/or hard disk controllers, and cables where required. Hard disks are formatted and tested with the PC DOS of your choice. All drive sizes are formatted capacities.

If your application requires a stacking kit, power splitter cables, daisy chain cable, or some other variation, we'll supply these items at a nominal charge. We even ship our hard disks with Command Assist™ an on-line DOS-like manual to give you help with your DOS commands.

### More questions?

Because we spend so much attention on the front end with ensuring that our disks will arrive in working order, we have a customer service department that, unlike many of our competitors, has little to do. When you need us, you won't get a constant busy signal.

Call our friendly, knowledgeable customer service staff to get answers to your questions—before or after the sale. Our people, who know the PC, can talk you through the sticky parts, and they'll respond to you quickly. Just call us.

### How to order

Pick up the telephone and call 1-800-341-7549, to order. We accept Master Card, VISA, American Express and Diners Club. Or send a cashier's check or



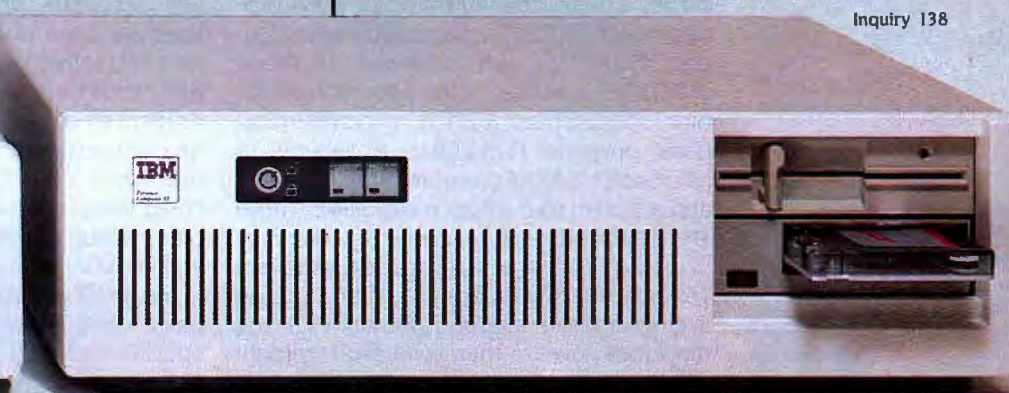
money order (We'll take a check, but you'll have to wait for it to clear) and tell us if you want one of our recommended configurations or you want to mix and match yourself. Corporations with a DUNS number may send purchase orders for quantities over five.

# EXPRESS SYSTEMS

Call Toll Free 1-800-341-7549 Ext. 1400  
In Illinois call (312) 882-7733 Ext. 1400

Express Systems, Inc., 1254 Remington, Schaumburg, IL 60195

Inquiry 138





## The Tandy 200 and the NEC PC-8401A

Real  
portability  
at a price

BY HARRY KRAUSE

**T**he Tandy 200 (see photo 1) and the NEC PC-8401A (see photo 2) are both second-generation offerings, substantially improved over their predecessors, the Tandy Model 100 and the NEC 8201A. Neither, however, seems designed to replace a full-featured desktop or transportable microcomputer; despite their refinements, these laptops present serious users with significant shortcomings. And, in relation to the low prices for which you can now buy an Apple IIc or even an IBM PC-compatible 16-bit machine, these laptops—at approximately \$1000 each—are expensive.

The Tandy 200 and the NEC 8401A are about the same size (12 by 8½ by 2½ inches) and weight (4 to 5 pounds), use a Z80-equivalent central processing unit (CPU), work off batteries or AC power, and have a built-in 300-bps (bits per second) modem. Both have a decent keyboard with full-size keys. Both are "closed" systems; you cannot easily open them to upgrade or add hardware functions. Lots of extra-cost (and pricey) exterior accessories are available for both. Aside from these similarities, the machines move along quite different paths.

### THE TANDY 200

The Tandy 200 has fewer potential software capabilities than the NEC 8401A but is easier and more fun to use. Software burned into its read-only memory (ROM) includes a functional but limited word processor called TEXT, an appointment calendar (SCHEDL), an address database (ADDRSS), a subset of the Microsoft Multiplan spreadsheet (PLAN), a communications program (TELCOM), a version of Microsoft's BASIC programming language, and a built-in four-function calculator. These are displayed on a readable liquid-crystal display (LCD) that is 40 characters wide and 16 lines deep (see photo 3). The LCD case is hinged at the back and also serves as the machine's cover. A thumbwheel on the right

of the machine controls the contrast.

You access the word processor and other applications through the machine's opening menu, which lists the available programs. To select a program, you simply move the cursor over the name of the program and tap the Enter key.

There are 72 keys on the QWERTY keyboard (see photo 4), including cursor controls and function keys, and I had no difficulties entering text or data. The keyboard's feel isn't much different than that of most other microcomputers, and the alphanumeric keys are in the usual places. The function keys are along the top of the keyboard, and the cursor controls are at the upper right-hand side.

Once selected, the TEXT word-processing program begins by asking you the name of the file you want to edit (or create). The Tandy 200 uses a six-character file-naming convention and creates its own extension. If you entered a letter named GEORGE, upon retrieval it would appear on the opening menu as GEORGE.DO, the .DO indicating the file is a text file and not a program.

As you enter text and reach the end of the 40 columns available on the screen, your words wrap to the next line. A printed file can be 132 columns wide. Because of the screen-width limitations, however, it is impossible to visualize how paragraphs and sentences will break in the final printed document. Also, while the PRINT command lets you control printout width, left margin, lines per page, and top margin, there were no direct references to printer control codes that would allow people with dot-matrix printers to select draft or correspondence quality or different type fonts or sizes. Since the Tandy 200 does include BASIC, you could write little routines to gain more complete printer control, but this assumes that you know or want to learn how to program.

The TEXT program allows you to cut and paste copy, move to the next word, find specific text, and move to the top or bot-

Harry Krause (10214 Forest Lake Dr., Great Falls, VA 22066) is a marketing consultant whose clients suddenly got microcomputers three years ago.

tom of a file. Word processing is viable on the Tandy 200, but not if you have a high level of expectation. The machine's predecessor, the Tandy 100, was very popular with itinerant journalists taking notes while on assignment. The Tandy 200 should be equally popular with them.

The SCHEDL, ADDRSS, and TELCOM programs use files created with the word processor and work similarly. In SCHEDL, for example, you create a text file called NOTE.DO. In the file, you'd enter information in the following format:

```
7/14/85, Call Fred about overdue check  
7/23/85, File property tax records  
12/31/85, Quit work early
```

Search functions call up entries with the same date or the same keywords.

The ADDRSS program uses a variation of the NOTE.DO format, with names listed first, followed by telephone numbers and addresses:

```
Joe Tandy: 703/936-3211: 123 Main St.,  
Alexandria, VA 22314
```

You can also access these address files through the TELCOM program in conjunction with the Model 200's built-in 300-bps modem (or an external 1200-bps modem). TELCOM also lets you set communications parameters and auto-dial phone numbers directly from the keyboard. The program makes good use of the function keys in interactive mode to auto-dial numbers, display communications parameters, enter the terminal mode, and return you to the main menu. In terminal mode, you can hit function keys for printing out transmitted data, sending special break signals, and saving data into text files.

Other than the built-in BASIC, the remaining software of interest is a variation of Multiplan. This spreadsheet program holds data in up to 63 columns and 99 rows (6237 cells), size enough for a substantial amount of data. It would not be fair to measure this implementation of Multiplan against the

versions that run on IBM PCs and compatibles. The subset includes more than three dozen functions and more than a

*(continued)*



Photo 1: *The Tandy 200.*



Photo 2: *The NEC PC-8401A.*

dozen commands from the Multiplan repertoire. Tandy commissioned a special instruction manual for its version of the spreadsheet; it is easier to read and follow than the manuals usually packed with this kind of software.

Tandy's ROM implementation of Microsoft BASIC is quite impressive and complete. People with IBM PC-

compatibles will recognize virtually all the commands and syntax on the Tandy 200 because they are a subset of the ones they've been using. In fact, to check compatibility, I entered the well-known Sieve of Eratosthenes program directly from a listing on my PC, changing only a comma into a semi-colon on the final line: PRINT J\$; TIME\$.

On the Tandy 200, the program found 15 primes and ran in 190 seconds. The same program on an IBM PC takes only about 30 seconds less.

Storage capacity for BASIC programs and other files is somewhat limited. The Tandy 200 comes standard with 24K bytes of RAM (random-access read/write memory), 19.5K bytes of which is accessible for programs or files. The machine can hold up to 72K bytes of RAM in "banks" that are switchable by tapping on the F1 or Tab key. Each bank is an island with room for 47 filenames. Programs will crash if they require more memory than is available on a single bank. All the ROM-based programs except SCHEDL are accessible from any of the RAM banks. The 24K-byte RAM banks are installed by the dealer and list for \$249.95, or slightly more than \$10 for each 1K byte of RAM—a fairly steep price.

If you have files that will not fit in internal RAM, you'll need to consider an exterior storage device, such as Tandy's data cassette recorder (\$59.95) or disk drive/CRT (cathode-ray tube) display unit (\$799). The latter includes a 5¼-inch floppy-disk drive and an adapter that you can attach to a television set or video monitor. The Tandy disk drive/display adapter unit seems overpriced, especially since its drive is only single-sided and formats floppy disks holding just 184K bytes.

Tandy says it will soon have a substantial library of software for the Model 200 available on cassette tape or in special ROM cartridges that plug into the bottom of the machine. In its instruction manual, the company points out that most of the software available for the Model 100 will not work on the 200.

I should briefly mention some of the machine's other features. There's a built-in calendar/clock addressable from BASIC, an automatic power shut-down, the four-function calculator that can be used in the midst of other programs, some modest graphics available from BASIC (and presumably from programs Tandy will release), an



Photo 3: The Tandy 200's LCD displays 16 lines of 40 characters each.



Photo 4: The Tandy 200's 72-key keyboard.

AC adapter, free introductory time on a couple of well-known databases, cables to connect the built-in modem and the phone jack, a printer cable, and a canvas carrying bag with shoulder strap. Actually, the bag may be an extra-cost accessory, but I have seen it advertised as a giveaway with the purchase of a Model 200. Tandy also claims its dealers can adapt the Model 200 to run on rechargeable nicad batteries. I got 10 hours of operation out of a fresh set of AA alkalines; according to Tandy's manual, I should have gotten 14.

**THE NEC PC-8401A**

The NEC PC-8401A is substantially more capable than the Tandy 200, with a subset of the 8-bit CP/M 2.2 operating system built in. The NEC's LCD (see photo 5) is 80 characters wide by 16 lines deep, a standard that perhaps exceeds the capabilities of the video hardware. The display, plain and simple, has so little contrast it is next to impossible to read in almost any kind of reflected light.

At first, I thought I had received a defective evaluation unit, so I looked over a few others at a dealer's. They were just as bad. The display has a contrast control and, like the Tandy 200, is hinged to serve as the machine's cover. All I had to show for my efforts was eyestrain. Readability is not helped by characters that barely fit in the allocated space; descenders on one line crash into ascenders on the next line. [Editor's note: As this review was being edited, NEC announced a new LCD screen for the 8401A that is 9½ inches wide by 3 inches high, approximately 40 percent larger than the earlier 7¾-inch by 2½-inch LCD. NEC claims the larger LCD allows for bigger dot size, larger characters, and a "substantial improvement in legibility." Other features of the 8401A remain the same.]

Two alternate character sets are available: Greek and graphics symbols. The Greek characters are no more readable than the alphanumeric.

The NEC keyboard has 68 keys (see photo 6), including 4 cursor control keys and 5 function keys that can per-

form more than one task. The keys are full size and work smoothly but make a loud click-clack sound when you're typing rapidly.

NEC is generous with built-in memory, with 64K bytes of RAM and 96K bytes of ROM. If you need more RAM, you can buy a 32K-byte cartridge for \$199, a sum that seems substantial when you consider that 150-nanosec-

ond 64K-byte RAM chips are available for \$2 each. Still, NEC's memory modules are cheaper than Tandy's.

The back of the machine is filled with ports: a DC input (the AC adapter is provided); a line jack and phone jack for connecting the built-in modem, an external modem, or a phone; an RS-232C port for a serial

(continued)

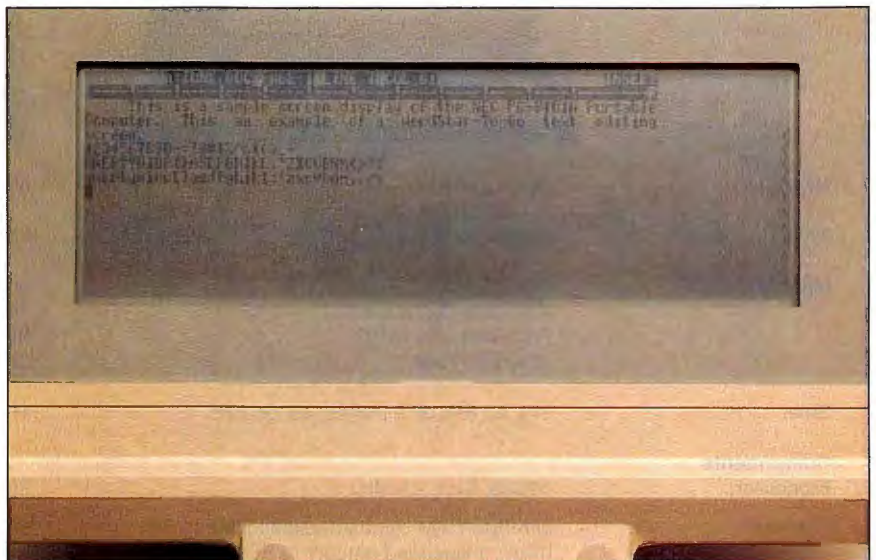


Photo 5: The NEC PC-8401A features an 80-character by 16-line LCD that is often difficult to read.



Photo 6: The NEC PC-8401A 68-key keyboard.

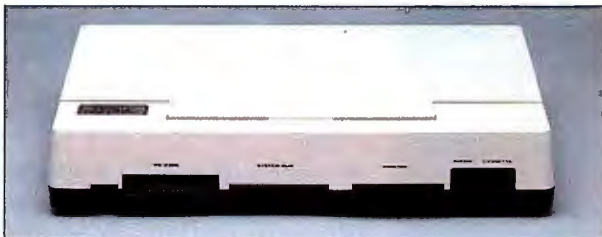
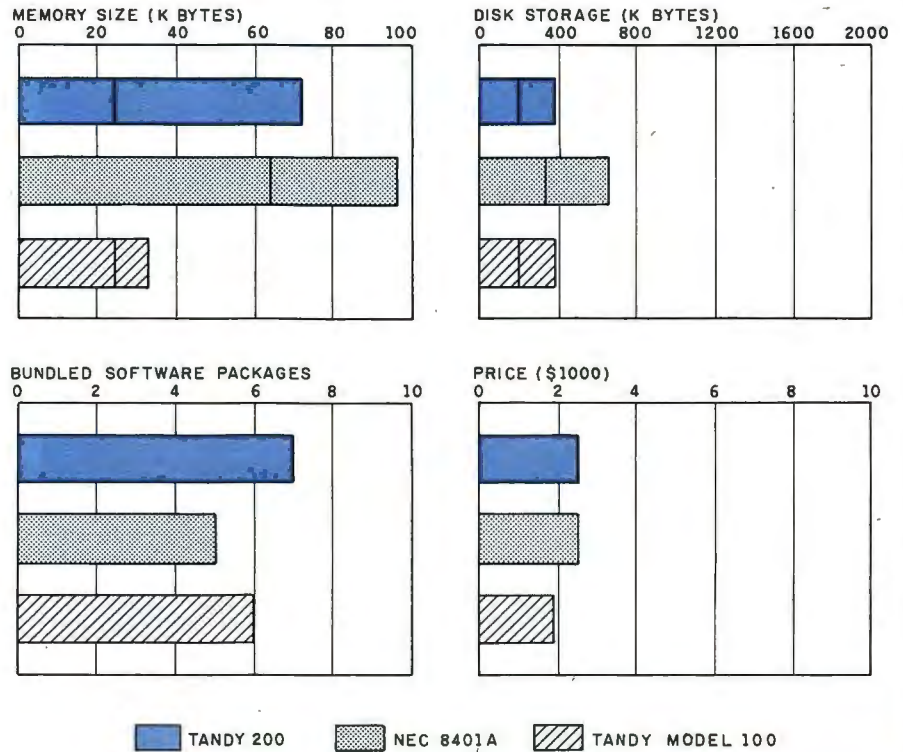
## AT A GLANCE



<b>Name</b>	Tandy 200	NEC PC-8401A
<b>Type</b>	Laptop computer	Laptop computer
<b>Manufacturer</b>	Tandy Corp. 1500 One Tandy Center Fort Worth, TX 76102 (817) 654-9369	NEC Home Electronics Inc. 1401 Estes Ave. Elk Grove, IL 60007 (312) 228-5900
<b>Size</b>	11 $\frac{5}{8}$ by 8 $\frac{1}{4}$ by 2 inches, 4.5 pounds	11 $\frac{3}{4}$ by 8 $\frac{1}{2}$ by 2 $\frac{1}{4}$ inches, 4.5 pounds
<b>Components</b>		
Processor:	80C85, 8-bit, 2.4-MHz	Z80-compatible $\mu$ PD70008C, 3.9936-MHz
Memory:	24K-byte RAM standard, expandable to 74K bytes; unspecified amount of ROM holding software programs	64K-byte RAM standard, expandable to 96K bytes; 96K bytes of ROM holding software programs
Display:	40-character by 16-line LCD; black letters on gray background	80-character by 16-line LCD; black letters on gray background
Keyboard:	72 keys (8 function keys), QWERTY	68 keys (5 function keys), QWERTY
Modem:	Built-in, 300-bps	Built-in, 300-bps
Power:	Battery or AC	Battery or AC
Expansion:	Memory can be added internally by authorized dealers; no slots	Memory can be added externally with a plug-in cartridge
Interfaces:	RS-232C, cassette, parallel printer (Centronics), modem, bar-code reader, external bus	RS-232C, cassette, parallel printer (Centronics), modem/phone/line jacks, external bus
<b>Software</b>	Proprietary operating system, Microsoft BASIC, Multiplan, word processor, appointment calendar, database, and telecommunications, all in ROM	CP/M 2.2 operating system, MicroPro WordStar-To-Go, Calc-To-Go, Personal Filer database, and telecommunications, all in ROM
<b>Options</b>	Disk drive with display adapter, \$799; cassette recorder, \$59.95; 24K-byte RAM, installed, \$249.95	Display/disk-drive adapter, \$249; 3 $\frac{1}{2}$ -inch disk drive, \$599; second drive, \$299; 32K-byte RAM cartridge, \$199; 1200-bps modem cartridge, \$299
<b>Documentation</b>	Owner's manual, Multiplan manual, TELCOM manual, BASIC manual	User's manual, quick guide, Calc-To-Go manual, WordStar-To-Go manual, TELCOM and Personal Filer manual
<b>Price</b>	\$999	\$999



The Memory Size graph shows the standard and optional memory available for the three computers under comparison. The Disk Storage graph shows the highest capacity of one and two floppy-disk drives for each system. The Bundled Software Packages graph shows the number of software packages included with each system. The Price graph shows the list price of a system with two high-capacity floppy-disk drives, a monochrome monitor, a printer port and a serial port, 64K bytes of memory, and the standard operating system and BASIC interpreter for each system. Note that the Tandy Model 100 has a maximum of 32K bytes of RAM.



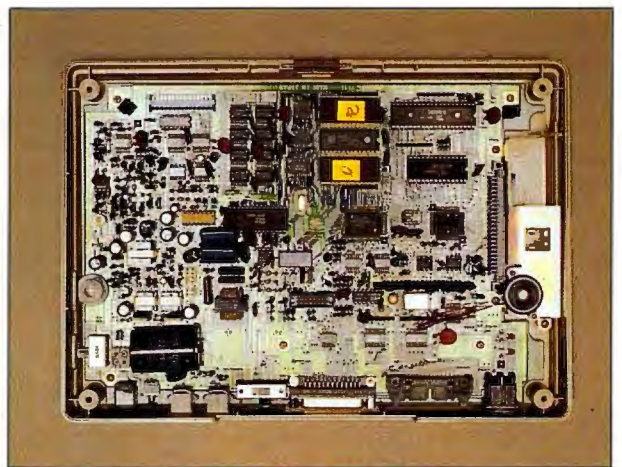
The back of the Tandy 200.



The back of the NEC PC-8401A.



The Tandy 200's internal circuitry.



The NEC PC-8401A's internal circuitry.

# Efficiency Expert.



When you use your AT&T Card at a public phone, you don't need a pocketful of coins. In fact, the AT&T Card is cheaper than coins for out-of-state AT&T Long Distance Service calls. You'll be provided with itemized billing. And you can use your AT&T Card anywhere. So on your next business trip—get organized. With the AT&T Card.

**Apply today. Dial 1 800 CALL ATT Ext. 4586**



**AT&T**

The right choice.

REVIEW: TANDY & NEC

*If you want to add peripherals to the 8401A, you will most likely have to stick with NEC offerings.*

printer or direct connection to another computer; a parallel printer port; and a data-recorder interface. On the side, there's a system slot for connecting a RAM cartridge, a CRT/disk-drive adapter, or NEC's proprietary 1200-bps modem.

Because the machine is a closed system, users who want to add flexibility with peripherals will most likely have to stick with NEC offerings. The list prices for many of these seem unnecessarily high. The CRT display/disk-drive adapter, for example, is \$249, and a 327K-byte 3½-inch disk drive (in a box big enough to hold two) is \$599. The second disk drive is \$299.

A system configured this way seems like less than the sum of its parts, since you'd end up paying around \$2300 for the machine, the display/disk-drive adapter, two drives, and an inexpensive monitor to replace the LCD. In today's market, \$2300 will buy a fully dressed IBM PC or Apple IIc or the new portable Kaypro 16—not laptops, to be sure, but more capable machines.

While operating on batteries, the NEC is a power hog. When I first got the machine, I popped in four fresh C batteries of the "el cheapo" variety. They were eaten up in a little more than two hours, or so said an indicator light on the machine's control panel. Next, I tried a set of name-brand alkalines; they lasted about six hours. The NEC also seems to drain batteries when turned off. I left the machine alone for a week with a new set of nonalkaline batteries installed; when I came back to it, I got the indicator light after only 45 minutes of opera-

tion. In its instruction manual, NEC mentions using rechargeable nicad batteries but states it makes neither nicads nor chargers. I'd be leery about installing nicads in a \$1000 piece of hardware without a specific recommendation from the manufacturer about approved vendors.

In a somewhat strange way to conserve battery power, NEC builds in what it calls a "sleep" mode. You can put the machine to sleep (without actually shutting it off) and then have it wake itself up at a predetermined time. Why you would want to do this instead of just turning off the computer escapes me, and none of the bundled software mentions the sleep capability. If it works with TELCOM, the ROM telecommunications program, I assume you could have the unit automatically dial a data bank at off-peak hours and download information while you sleep. But there's no documentation to support my theory; I simply don't know how the sleep mode could be addressed through software. While the sleep mode uses less battery power than the awake mode, it still consumes more of the machine's juice than the off mode. Perhaps later software implementations will make use of this peculiarity.

#### SOFTWARE

The ROM-based software includes CP/M 2.2, WordStar-To-Go, Personal Filer, TELCOM, and Calc-To-Go, a spreadsheet. The MicroPro WordStar is a subset of the full 8-bit CP/M version; people who have grown up with it on other machines will adapt quickly. The CP/M implementation is interesting, to say the least. You can control it almost totally through the opening menu and the function keys. The CP/M commands for TYPE, RE-NAME, PIP, STAT, and ERASE are on function keys 1 through 5, while additional commands are available by calling up an option macro and tapping the same function keys. I could find no CP/M assembler commands, however, and some of the CP/M commands varied from their disk-based counterparts.

*(continued)*

# Fast Forward.



When you use your AT&T Card at a public phone, you don't have to hang up after each call. Just hit this button after your first conversation, and dial the number of your next long distance call. The phone automatically remembers your AT&T Card number. So you have more time to take care of business.



**AT&T**

The right choice.

# **Instant-C™** **The Fastest** **Interpreter for C**

**Runs your programs 50 to 500 times faster than any other C language interpreter.**

**A**ny C interpreter can save you compile and link time when developing your programs. But only **Instant-C** saves your time by running your program at compiled-code speed.

**Fastest Development.** A program that runs in one second when compiled with an optimizing compiler runs in two or three seconds with **Instant-C**. Other interpreters will run the same program in two minutes. Or even ten minutes. Don't trade slow compiling and linking for slow testing and debugging. **Only Instant-C will let you edit, test, and debug at the fastest possible speeds.**

**Fastest Testing.** **Instant-C** immediately executes any C expression, statement, or function call, and display the results. Learn C, or test your programs faster than ever before.

**Fastest Debugging.** **Instant-C** gives you the best source-level debugger for C. Single-step by source statement, or set any number of conditional breakpoints throughout your program. Errors always show the source statements involved. Once you find the problem, test the correction in seconds.

**Fastest Programming.** **Instant-C** can directly generate executable files, supports full K & R standard C, comes with complete library source, and works under PC-DOS, MS-DOS, or CP/M-86. **Instant-C gives you working, well-tested programs faster than any other programming tool.** Satisfaction guaranteed, or your money back in first 31 days. **Instant-C** is \$495.

**Rational**  
Systems, Inc.

P.O. Box 480  
Natick, MA 01760  
(617) 653-6194

## REVIEW: TANDY & NEC

The CP/M possibilities can be expanded with the optional disk drive. When the 8401A is used as a true laptop, without an external storage device, the 64K bytes of RAM is actually divided in half, with 32K bytes used to hold the ROM-based software (copied from ROM into RAM) and the other 32K bytes available to store the files created by the software. You can store up to 31 files. With the optional disk drive or with a plug-in external RAM cartridge, NEC offers a "32K-byte CP/M Mode," and files can be stored externally. With the "64K-byte CP/M Mode," the machine with a disk drive (but not with the plug-in RAM cartridge) can operate as a fairly standard CP/M desktop. Much disk-based CP/M software, however, requires a screen 80 columns wide by 25 lines deep, so an optional monitor would be necessary.

Notably missing from the NEC is built-in programming capability; if you want BASIC, you have to buy it separately and load it from an optional tape recorder or disk drive.

Calc-To-Go is another MicroPro product and can hold a spreadsheet 64 columns wide and 256 rows deep, or 16,384 cells. That's more than twice as much capacity as the CALC program on the Tandy machine. Since the NEC's display shows a full 80 columns, you can fit the full width of Calc-To-Go on the LCD screen. Files created with Calc-To-Go can be stored in the data interchange format (DIF) and transferred to a desktop microcomputer using a spreadsheet that incorporates DIF files, such as VisiCalc.

NEC's ROM telecommunications software, TELCOM, is a complete implementation that takes full advantage of the machine's built-in 300-bps modem; it also lets you use an external 1200-bps modem. The program uses the machine's function keys to change communications parameters, to automatically dial numbers and log on, to upload and download, to list filenames on a disk, and to break a connection quickly. The documentation on TELCOM is easy to understand yet goes far enough to show you exactly how the little NEC can

establish communications with a Digital Equipment Corporation VAX minicomputer. In addition, instructions are given for connections with other computers, such as IBM PCs and Apples.

Personal Filer, the database manager, allows records to hold 13 lines of type, 80 characters across. The program lets you sort files alphabetically on any named field, delete records, edit records, search for character strings, and scroll through files forward and backward. If you have telephone numbers in your database, Personal Filer can dial them for you.

If you pay the price for a disk drive, the world of CP/M 2.2 opens and you have access to thousands of existing programs. CP/M 2.2, however, is somewhat of an obsolete 8-bit operating system. Few programs being written these days are crafted with CP/M 2.2 in mind.

### WHY A LAPTOP?

The most important question about the NEC and the Tandy 200 has nothing to do with software. What you really have to ask yourself before forking over \$1000 is, "Why do I want a laptop and what am I going to do with it?"

Journalists and other traveling writers can make good use of the Tandy 200, and they probably wouldn't need the extra accessories. Tap in your notes, work on them in the hotel room, and transmit the finished story to the newsroom, all for about \$1000. There's nothing heavy to lug around, either. Well-heeled students could use the machine to take readable lecture notes. The built-in scheduler and spreadsheet would enable a frequent flyer to get some real work done in what is usually dead air time, assuming the airline on which you are traveling lets you use portable computers.

A buyer of the NEC machine can enjoy the same advantages; however, the screen display might not be sufficient. The NEC is potentially much more useful than the Tandy, but if you can't read what you're entering, it won't do you much good. ■

# Tools That Make Your Job Easier

For PC DOS/MSDOS (2.0 and above/128K) • IBM PC/Compatibles, PC Jr., Tandy 1000/1200/2000, & others  
For CPM80 2.2/3.0 (Z80 required/64K) • 8" SSSD, Kaypro 2/4, Osborne I SD/DD, Apple II, & others

## MIX EDITOR

Programmable, Full/Split  
Screen Text Processor

Introductory  
Offer

# 29<sup>95</sup>

### Great For All Languages

A general purpose text processor, the MIX Editor is packed with features that make it useful with any language. It has auto indent for structured languages like Pascal or C. It has automatic line numbering for BASIC (255 character lines). It even has fill and justify for English.

### Split Screen

You can split the screen horizontally or vertically and edit two files simultaneously.

### Custom Key Layouts

Commands are mapped to keys just like WordStar. If you don't like the WordStar layout, it's easy to change it. Any key can be mapped to any command. You can also define a key to generate a string of characters, great for entering keywords.

### Macro Commands

The MIX Editor allows a sequence of commands to be executed with a single keystroke. You can define a complete editing operation and perform it at the touch of a key.

### Custom Setup Files

Custom keyboard layouts and macro commands can be saved in setup files. You can create a different setup file for each language you use.

### MSDOS Features

Execute any DOS command or run another program from inside the editor. You can even enter DOS and then return to the editor by typing exit.

## MIX C COMPILER

Full K&R Standard C Language  
Unix Compatible Function Library

Introductory  
Offer

# 39<sup>95</sup>

### Complete & Standard

MIX C is a complete and standard implementation of C as defined by Kernighan and Ritchie. Coupled with a Unix compatible function library, it greatly enhances your ability to write portable programs.

### The Best C Manual

MIX C is complemented by a 400 page manual that includes a tutorial. It explains all the various features of the C language. You may find it more helpful than many of the books written about C.

### Fast Development

MIX C includes a fast single pass compiler and an equally fast linker. Both are executed with a simple one line command. Together they make program development a quick and easy process.

### Fast Execution

The programs developed with MIX C are fast. For example, the often quoted prime number benchmark executes in a very respectable 17 seconds on a standard IBM PC.

### Standard Functions

In addition to the functions described by K&R, MIX C includes the more exotic functions like *setjmp* and *longjmp*. Source code is also included.

### Special Functions

MIX C provides access to your machine's specific features through BDOS and BIOS functions. The CHAIN function lets you chain from one program to another. The MSDOS version even has one function that executes any DOS command string while another executes programs and returns.

### Language Features

- Data Types: char, short, int, unsigned, long, float, double (MSDOS version performs BCD arithmetic on float and double-no roundoff errors)
- Data Classes: auto, static, extern, register
- Struct, Union, Bit Fields (struct assignment supported)
- Typedef, Initialization
- All operators and macro commands are supported

### 30 DAY MONEY BACK GUARANTEE

Orders Only: Call Toll Free 1-800-523-9520, (Texas only 1-800-622-4070)

MIX Editor \_\_\_\_\_ \$29.95 + shipping (\$5 USA/\$10 Foreign) Texas residents add 6% sales tax

MIX C \_\_\_\_\_ \$39.95 + shipping (\$5 USA/\$25 Foreign) Texas residents add 6% sales tax

Visa \_\_\_\_\_ MasterCard \_\_\_\_\_ Card # \_\_\_\_\_ Exp. Date \_\_\_\_\_

COD \_\_\_\_\_ Check \_\_\_\_\_ Money Order \_\_\_\_\_ Disk Format \_\_\_\_\_

Computer \_\_\_\_\_ Operating System: MSDOS \_\_\_\_\_ PC DOS \_\_\_\_\_ CPM80 \_\_\_\_\_

Name \_\_\_\_\_

Street \_\_\_\_\_

City/State/Zip \_\_\_\_\_

Country \_\_\_\_\_

Phone \_\_\_\_\_

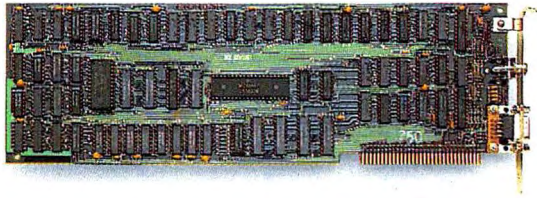
**MIX** 2116 E. Arapaho  
Suite 363  
Richardson, Tx 75081  
software  
Dealer Inquiries Welcome  
Call (214) 783-6001

MSDOS is a trademark of Microsoft PC DOS is a trademark of IBM CPM80 is a trademark of Digital Research WordStar is a trademark of MicroPro

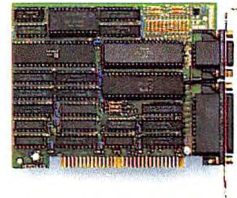
B

# Compare the Hercules™ Color Card to IBM's.

Five reasons why the Hercules Color Card is better.



**IBM Color Adapter \$244**



**Hercules Color Card \$245**

- |                  |  |   |
|------------------|--|---|
| 1. Compatibility | Runs hundreds of graphics programs.              | Runs the same hundreds of graphics programs. "The Hercules Color Card is so nearly identical to the IBM Color/ Graphics Card that it's almost uncanny." PC Mag. |
| 2. Printer port. | None.  | Standard. Our parallel port allows you to hook up to any IBM compatible printer.  |
| 3. Size.         | 13.25 inches. Limited to long slots.             | 5.25 inches. Fits in a long or short slot in a PC, XT, AT or <i>Portable</i> .  |
| 4. Flexibility.  | Can't always work with a Hercules Graphics Card. | Always works with a Hercules Graphics Card by means of a software switch.   |
| 5. Warranty.     | 90 days.   | Two years.  |

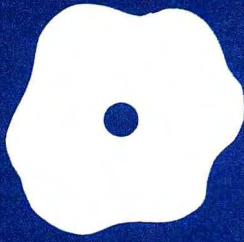
Any one of these five features is enough reason to buy a Hercules Color Card. But perhaps the most convincing reason of all is just how easy the Hercules Color Card is to use: "Right out of the box, the Hercules Color Card goes into an empty expansion slot, ready for you to plug in. . . and go to work—no jumpers, no software. For most applications, it's just that easy." PC Magazine.

Call 1-800-532-0600 Ext. 432 for the name of the Hercules dealer nearest you and we'll rush you our free info kit.

## Hercules.

**We're strong on graphics.**

Inquiry 166



## Golden Common LISP

An advanced  
LISP  
environment  
for micro-  
computers

BY BRUCE D'AMBROSIO

**G**olden Common LISP (GCLISP) is an extended subset of Common LISP that supports more than 400 primitives and includes stack groups, macros, closures, streams, and other advanced LISP features such as GMACS, an integrated, sophisticated EMACS-like editor.

GCLISP also comes with two books, *LISP* by Patrick H. Winston and Berthold K. Horn and the *Common LISP Reference Manual* by Guy Steele, together with a fat binder containing the GCLISP documentation and disks. Thoughtfulness and attention to detail are immediately apparent in the packaging and seem equally apparent in the product itself.

Two weeks, several hundred lines of LISP code, and tens of GMACS hours after opening the package, my initial impression has been confirmed. The wizards at Gold Hill Computers have not squeezed an entire LISP-machine programming environment into those five disks ("LISP machine" refers to a \$100,000 high-end system developed at MIT in the late 1970s specifically to execute LISP and programmed entirely in LISP). However, they have packed an amazing amount of functionality and performance into GCLISP, and, with a few caveats, I can recommend it as a LISP system worth serious consideration for several uses.

GCLISP seems intended for use as a training system for learning LISP. Two of the five disks included in the GCLISP package are devoted to an extensive LISP tutorial, and I can think of no other reason for the inclusion of the Winston and Horn book.

It might also be used as a system for developing serious (as opposed to toy or homework exercise) programs. These programs might be stand-alone or serve as the user-interface portion of larger programs running on larger machines. Finally, you might use GCLISP as a delivery vehicle for systems developed on larger LISP machines. The cost of an IBM PC is about one-fortieth the cost of a LISP machine, so this might offer an inexpensive way to distribute artificial-intelligence (AI) systems.

I will comment separately on each of three components of GCLISP: the language and interpreter, the development environment including the GMACS editor, and the LISP tutorial. While all three components are interrelated and the dividing lines are somewhat arbitrary, the distinctions are useful for review purposes.

### THE GCLISP INTERPRETER

GCLISP is a variant of Common LISP (a standard LISP blessed by the Department of Defense) and is a synthesis of many of the best ideas from previous experimental and research LISP systems (e.g., MacLISP, Franz LISP, Zetalisp, Scheme, and Nil). Unfortunately, GCLISP is a variant, not a fully faithful implementation.

The variances are of two types. First, GCLISP is a subset. This is not unreasonable since the complete language is large and would never fit in the 640K-byte memory limitation of MS-DOS. Second, GCLISP does not follow Common LISP's rules for variable scoping. These rules specify how the interpreter is to determine the value for a variable referenced within a function and not declared as either a parameter or local to the function. The Common LISP specification calls for lexical scoping (it looks at the program listing and uses the value assigned in the function that most immediately encloses the current one). But GCLISP is dynamically scoped (it uses the most recently assigned value for the variable). In this, GCLISP follows the tradition for LISP interpreters, which historically have implemented dynamic scoping. Lexical scoping has some theoretical advantages but is difficult to implement efficiently in an interpreter.

The choice of dynamic scoping for GCLISP is a serious problem in that some advanced LISP constructs cannot be written in GCLISP so they will work correctly in a true Common LISP system. This is perhaps not crucial for many applications,

(continued)

Bruce D'Ambrosio (555 Tulsa St., San Lorenzo, CA 94580) is a Ph.D. student at the University of California at Berkeley. He is doing research in efficient reasoning.

## AT A GLANCE

### Name

Golden Common LISP

### Type

LISP interpreter and development environment

### Manufacturer

Gold Hill Computers  
163 Harvard St.  
Cambridge, MA 02139  
(617) 492-2071

### Format

Five 5¼-inch floppy disks

### Computer

IBM PC, XT, AT, or compatibles; DEC Rainbow; Wang Professional Computer

### Features

LISP Interpreter, GMACS editor, debugging tools, and tutorial system

### Documentation

100-page user's guide, 200-page reference manual  
*LISP* by Winston and Horn  
*Common LISP Reference Manual* by Steele

### Price

\$495

since novices will never be aware of the difference as long as they follow a few simple conventions regarding variable use. The combined effect of these differences is that programs will not be easily transportable between GCLISP and more faithful Common LISP implementations unless they are originally implemented with the restrictions of GCLISP in mind. Also, the impact of the scoping-rule differences can be difficult for a novice to understand, and this reduces the utility of Golden Common LISP as a training system for Common LISP.

Aside from these variations, the GCLISP interpreter seems to faithfully implement a thoughtfully chosen subset of the Common LISP specification. For example, I could enter and run (with only minor modification) several pages of Common LISP code I had been developing on a Symbolics 3600 (a LISP-based personal computer derived from the MIT LISP-machine research).

GCLISP has a wide selection of primitive functions, including arrays (one-dimensional only, with no support for bit arrays), stack groups (a primitive mechanism out of which you can construct various forms of multi-tasking systems), *defstruct* (the LISP equivalent of Pascal records—GCLISP doesn't support subfields of arbitrary bit length), streams (the Common LISP input/output facility), macros (a facility that lets the skilled programmer extend the LISP language), *readtables* (LISP lets you redefine the meaning of each character in the basic character set), and a simple window system.

Those features that are part of the Common LISP specification (stack groups and windows are not) are implemented in a "compatible subset" of the standard. However, very few aspects of Common LISP are implemented in their entirety. Constant cross-reference between the Common LISP reference manual and the GCLISP reference manual is necessary to find out what features are valid. Also, a number of features are missing, including packages (despite what the documentation says, pack-

ages are not currently supported), *bignums* (arbitrary-precision integers, much appreciated by the symbolic-math folks), transcendental functions (e.g., sine, cosine), rational numbers, and hash tables.

In general, GCLISP retains the most useful aspects of any feature and omits those of more limited utility. But the cuts are deep, and anyone hoping for a full Common LISP implementation will be disappointed. Some features are implemented separately from the core interpreter and loaded only on demand. This permits a large number of language features, much larger than could all fit into memory at once. This is wonderful as long as you don't need all those features in any one program. And there's the rub. GCLISP wants lots of memory—more than MS-DOS on an IBM PC will support. The minimal interpreter requires about 250K bytes, and, once I loaded a few standard LISP features, my 512K-byte system had only 18,000 cons cells and about 80K bytes of atom space left. This was enough to load a typical program of several thousand lines, as long as it didn't create many large data structures. But a major piece of the programming environment, the editor, hadn't been loaded yet. On a 512K-byte system you can load either the editor or a large program, but not both.

### SPEED

GCLISP is not the fastest LISP I have ever run, but its overall speed is quite respectable. As shown in table 1, it is almost as fast as the Franz LISP (a LISP system developed at the University of California at Berkeley) interpreter running on a VAX-11/750. On a PC, *muLISP* is faster, but it's a highly nonstandard LISP and cannot use as much memory as GCLISP. *XLISP* is a public-domain LISP interpreter written in C by David Betz. The version I used was extensively modified by a friend, Frank Korzeniewski, and compiled using Digital Research's C compiler under the large-memory model.

One way to increase execution speed in LISP is to use a compiler. Typically, those functions that you



have already debugged are compiled and loaded into the environment as compiled functions, while those under development are executed interpretively. That way, you get the best of both worlds: the speed of compiled code for most of the overall system, and the flexibility and debugging support of an interpreter for those portions still under development.

Unfortunately, GCLISP does not come with a compiler. Gold Hill Computers has announced one, initially to be available in mid-1984, but now scheduled for release before the end of 1985 together with a large-memory (read 80286) version of GCLISP. The compiler has been announced for both versions of GCLISP but will apparently be more convenient to use in the large-memory system. Lexical scoping is also supposed to be part of the new improved GCLISP due at that time. I suspect that memory limitations will grow more restrictive with this release.

### THE GCLISP ENVIRONMENT

The environment includes all those aspects of a language system outside the syntax and semantics of the language itself. For GCLISP, this is the LISP listener, use of the keyboard, error handling, debugging facilities, and the editor.

LISP, like BASIC, is interpreted. That means that the interpreter is "listening" to the keyboard, waiting for you to enter an executable statement. The 17 "keychords" (combinations of Ctrl

or Alt with another key or keys) provide a variety of support functions, such as invoking the editor or tutorial system, help, and debugging support. One that suggests the power and convenience of a good LISP programming environment is the Alt-L keychord, which prompts for a function name and then displays its argument list. (How often have you been writing a line of code invoking some function and been unable to remember the correct argument sequence? This is likely in LISP, since the standard style uses many short functions.)

Another important part of a good programming environment is error detection and recovery. GCLISP is reasonably competent at error detection but provides minimal recovery capability. Like most of the larger LISP systems after which it is patterned, GCLISP will trap references to "unbound symbols" (variables that have never been assigned a value), arithmetic overflow and underflow errors, type errors (such as attempting to add a character string to a number), attempts to exceed array bounds, and other run-time errors. Once an error has been detected and reported, the system enters a "break level." Again, this is a standard LISP technique—at this point you can enter any executable LISP statement just as you can at the top level, but it is executed in the context of the error (with all the variable values in effect). This facility is useful for displaying the values of variables (for example, the parameters

of the routine executing at the time the error was detected). The Ctrl-B keychord displays the control stack, but unfortunately you cannot move around in the stack and examine locals in different procedure invocations as you can in many LISP systems. GCLISP takes the somewhat unusual but useful tack of displaying the stack by showing the actual LISP forms in evaluation. A sample display is shown in figure 1.

Unfortunately, once you have detected an error in GCLISP and found out why things went wrong, it is impossible to continue. In a few LISP systems, when evaluation stops (because, for example, the program attempts to reference an unbound symbol) you can assign a value on the spot and continue evaluation. In GCLISP, you can assign a value, but the only break level from which you can continue is a user-inserted call to the break function. Once the interpreter detects an error, the only way to restart execution is to abort (return to the top level) and start over.

Error detection and recovery are supplemented in a good LISP programming environment by various debugging support packages. In GCLISP these include a trace facility, step facility, and break function. The trace facility lets you specify the names of functions to be traced. Then each time one of the named functions is entered or exited, that fact is displayed on the screen along with

(continued)

**Table 1: Sample execution times for GCLISP compared with the times for a number of other LISP implementations.** Where two columns are presented, the first is for interpreted code and the second is for compiled code. All times are in milliseconds for a single execution of the named function. Note that the speed measurements are rough and will vary among individual systems.

Operation	GCLISP		muLISP IBM PC	XLISP IBM PC	Franz LISP VAX-11/750		Zetalisp Symbolics 3600	
	PC	AT IBM PC						
Iteration	0.6	1.8	2.1	35	1.0	0.4	0.4	0.004
List create	3.0	9.0	1.5	65	4.2	3.1	1.1	0.3
CADDDR	0.4	1.1	0.6	25	0.7	0.3	0.3	0.005
Structure create	4.0	9.1	3.5	—	6.9	4.2	12.0	0.55
Structure reference	0.6	1.7	0.5	—	1.9	0.9	2.4	0.008
Function call	0.2	0.4	0.1	—	0.7	0.4	0.4	0.006
Closure application	0.4	1.2	—	—	1.9	1.3	0.4	0.09

parameter values (on entry) or returned values (on exit). You can't "conditionally" trace a function in GCLISP; that is, you can't ask to see its execution traced only when some condition is satisfied (e.g., when it is executed from within some other function).

The step facility is nicely implemented. It lets you see each step in the execution of any arbitrary LISP expression. You have two basic options when stepping through a computation. The down-arrow key resumes evaluation and stops at the next level of detail in the current expression. The right-arrow key completes evaluation of the current expression and stops before beginning evaluation of the next expression at the same level. Finally, you can insert the break function at any arbitrary point in a LISP expression. When executed, it interrupts the interpreter and returns control to the console in the same manner as a detected error.

### GMACS EDITOR

Perhaps the most powerful aspect of an integrated LISP environment is the editor. GCLISP provides GMACS, an EMACS-like editor that is fully inte-

grated into the LISP environment. It supports multiple (two) windows (you can cut and paste across windows) and more buffers than I can use, is reasonably quick (although it's not hard to type ahead of it), and does preemptive scrolling.

Most noticeably lacking from GMACS are an undo command and the ability to bind key sequences. If those seem fairly primitive facilities to you, it's likely that your favorite advanced EMACS feature is missing also, but enough of EMACS is there for most EMACS users to feel relatively comfortable. Also, GCLISP comes with all the sources for the editor (in LISP, of course) and describes key bindings in a file called EDCOMTAB.LSP that is fairly easy for a hacker to customize to his or her heart's content.

Most important, GMACS is an integral part of the LISP environment. Besides little features like parentheses balancing, expression indentation, and cursor positioning and delete functions that work for S-expressions (the basic LISP syntactic form), GMACS provides keychords to evaluate function definitions, evaluate

S-expressions, display argument lists and documentation, and macroexpand an expression.

All these features mean an incredibly rapid debug cycle. Suppose, for example, you are debugging and discover that you need to add a function call to function *y* within function *x*. All you do is enter the editor (via a single keychord, Ctrl-E) and edit the change into function *x*. Now suppose that you forgot the calling sequence for function *y*. Just depress the Ctrl-Z-L keychord and enter the name of function *y*. GMACS displays the argument list for function *y* on the screen. Once you have finished editing the definition of function *x*, press Ctrl-Z-C, and the definition is evaluated. Finally, press FI and you are back in the LISP listener, ready to continue debugging. Since the entire system is memory-resident, most of this happens in less time than it took to read this paragraph.

All this is wonderful, but unfortunately the quality of the GMACS implementation is not up to the standard set by the rest of GCLISP. In the version I used (1.0), several annoying bugs occurred in the cursor positioning and display-refresh logic, and the system was slow enough to be occasionally annoying. Also, it takes more than two minutes to initially load the editor from floppy disk.

The most annoying problem is that once I loaded the editor, I had only enough room left on my 512K-byte system to edit one modest-size (about 20K-byte) file. And once the file was loaded, I had no room left to load any LISP programs for debugging. That seriously crimps the utility of GCLISP as a development system. However, there are several alternatives. Apparently, GCLISP can use memory beyond the 640K bytes that MS-DOS supports, although I haven't actually tried this to see if it works. Some microcomputers (the DEC Rainbow and the Wang, for example) are configured to directly support more than 640K bytes. GCLISP will use all available memory in these cases. Finally, you can always reserve 60K to 100K bytes of memory for a separate DOS

```

* (setf b 3)
3
* (+ 1 (+ a b))
ERROR:
Unbound variable: A
1> ^B
(BACKTRACE)
(+ A B)
(+ 1 (+ A B))
NIL
1> (setf a 4)
4
1> (continue)
Can't CONTINUE from this error, use CLEAN-UP-ERROR.

```

Figure 1: A sample error-detection and stack display taken from a GCLISP screen dump. For purposes of clarity, user input appears in color.

REVIEW: GCLISP

partition and use a small stand-alone editor rather than the built-in GMACS. In this case, the interface is through files and you lose the wonderful integrated editing facilities described above, but you still have the GCLISP interpreter and debugging facilities.

**THE TUTORIAL SYSTEM**

To help you learn the language, GCLISP includes San Marco Explorer and Inspector, some of the most extensive and well-executed tutorial material I have seen. The Explorer is an extensive programmed instruction sequence, occupying two entire double-sided disks. It is coordinated with and covers most of the material of Winston and Horn's *LISP*, widely used in university LISP courses and generally acknowledged as one of the best introductory texts. The San Marco Inspector provides dynamic graphic displays of program execution, enabling simple demonstration of program control flow.

In scope alone, the Explorer is quite impressive. The list of topics covered includes some 60 items, or "slide trays," and each of these consists of 10 or more separate screens of material. I cannot imagine a better, more enjoyable, more painless, or more comprehensive introduction to LISP than this tutorial; it definitely sets a new standard for software instructional material. If you complete this program, you will learn at least as much as you would in the average one-semester college introductory course on LISP.

**USES FOR GCLISP**

I can envision three separate uses for GCLISP: training, software development, and application delivery. As a training system, GCLISP is unsurpassed. The tutorial is extensive and extremely well done, and the San Marco Inspector is a wonderfully graphic way to examine control flow. The only flaw is the use of dynamic rather than lexical scoping, and this is an issue only when you use GCLISP as a training device for other Common LISP systems.

Similarly, as an application-delivery

*The tutorial material is extensive and well executed.*

system, GCLISP offers a large subset of Common LISP, a robust implementation, and reasonably fast execution. The availability of streams and windows and the ability to access color graphics, combined with an assembly-language interface, make GCLISP suited for writing high-quality "intelligent" user interfaces, either to other software resident within GCLISP or to software running on other machines.

Unfortunately, GCLISP is somewhat less attractive as a development system. The large amount of memory required by the editor and debugging tools makes it useful only on a 640K-byte or larger system, and the editor's slowness and quirks are occasionally annoying. Also, the lack of ability to inspect the control stack and the lack of error recovery (ability to continue from an error) slow the debugging process. Despite all this, if you have enough memory on your computer, this could be an attractive development system.

**CONCLUSION**

Golden Common LISP attempts, largely successfully, to provide a high-quality Common LISP programming environment on a microcomputer. It is very similar in feel to the larger LISP systems, and I found myself automatically considering it a peer of those systems.

If you are looking for a way to learn LISP or know you want to work in LISP and can't afford a LISP machine, I highly recommend that you look into this product. However, if you intend to use this system for program development, be prepared to load up your machine with as much memory as you can possibly afford, at least 640K bytes. If you do have enough memory (or, even better, an 80286 machine with 1 or 2 megabytes), GCLISP can provide a solid LISP environment. ■

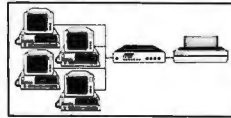
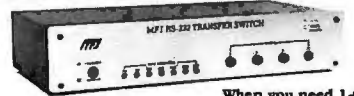
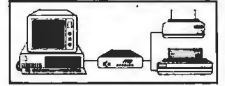
**Switches to make your PCs powerful.**

Reliable and affordable port expansion without memorizing complicated software commands. Switch your PC between peripherals with the push of a button. Is MFJ good? Joe Campbell in his book, *The RS-232 Solution* said, "Switch boxes are sold by many suppliers, but by far the two best values are from MFJ Enterprises." Below are just some of those values.

When you need to switch between two peripherals ... or you need to have two computers share the same peripheral ... MFJ-1240/879.95



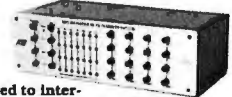
The 1240 has a built-in transmit/receive switch that allows 2-way information flow. LEDs monitor data lines while built-in surge protectors guard them. Can be used as a null modem. MFJ's No. 1 seller!



When you need 1-to-4 computers to share one peripheral or 1-to-4 peripherals to share a common computer ... MFJ-1243/8118.95

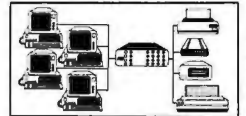
The perfect office switch. Save money. Don't buy extra printers or modems.

Connect 1-to-4 computers to a single printer or let a PC share up to four peripherals. LEDs monitor data lines; surge protectors guard them. Two way communication is allowed.



When you need to interconnect four computers and four peripherals at one time! The MFJ-1294 gives you a computer system ... MFJ-1294/8299.95

With the MFJ-1294 you can create a mini-network of computers and peripherals. All eight devices can be working simultaneously! Think of the production you'll get with the MFJ-1294's 16 possible combinations.



Seven additional models to choose from including MFJ's IBM and Centronics Parallel Switches. All RS-232 switches have RS-232 connectors. LEDs to monitor data lines. MOV surge protectors and transmit/receive buttons that allow 2-way communication.

**And Power Strips to make them safe.**

Your fine computer and peripheral equipment can be damaged by electrical surges much smaller than you've been led to believe. Save them and your valuable data with an MFJ

Power Center. Multi-filters isolate equipment, eliminating noise/hash/interaction; MOVs suppress spikes and surges. These are heavy-duty, commercial quality Power Strips.

MFJ-1107 - 8 sockets: 2 unswitched: 879.95  
MFJ-1108 - 7 sockets: 1 unswitched. Drop-out relay prevents disk drive head from bouncing: 899.95  
MFJ-1109 - like 1107 but intelligent

(switch on the device that's plugged into the control socket and everything else comes on): 8129.95

There are other Switches, Power Centers and Computer Peripheral Products available from MFJ. Call and talk with us about all your computing needs. When you do, ask for our latest catalog. Both the call and catalog are free.

**1-800-647-1800**

For technical/repair information or in Mississippi or outside the Continental United States, please telephone...

**1-(601) 323-5869 or  
telex 53-4590 MFJSTKV**

All MFJ products come with a double guarantee we think is unmatched. Order from MFJ and try any product for 30 days. If it doesn't satisfy your needs, just return it for a full refund less shipping. If you keep it you can be assured of continued service and our One Year Unconditional Guarantee.

Call toll-free 1-800-647-1800 and charge the products you need to your VISA or MasterCard, or send a check or money order, plus \$5.00 shipping, and our shipping department will promptly have your computer peripheral on its way to you.

**MFJ** MFJ Enterprises, Inc.  
921 Louisville Road  
Starkville, MS 39759



## Sequential power-up, surge protection, power-interrupt sensing, and sequential power-down for your microcomputer system in ONE product.

### **SEQUENTIAL PERIPHERAL POWER-UP**

Avoid harmful electrical disturbances that can occur with the simultaneous power-on of your entire computer system from one outlet. Simply plug your computer and peripherals into the System Controller™ and eliminate this problem. The System Controller safely and quickly powers-up and down your system sequentially to manufacturers' recommendations by applying and removing power to its four outlets at 1.5 second intervals. Now your computer and peripherals will receive the precise amount of AC power that they require.

### **EFFECTIVE SURGE PROTECTION**

The Surge Sentry®-protected System Controller also protects your system against power surges, spikes and other irregularities which cause data scrambling, or worse, complete data loss and equipment/component damage.

### **POWER-INTERRUPT SENSING**

System Controller can sense brownout and blackout situations. When they occur, the System Controller will shut off power to the system until electricity is restored and the reset button is pushed.

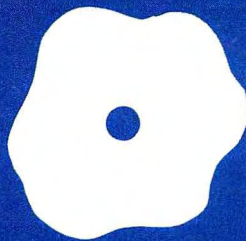
### **DYNATECH—THE LEADER IN ELECTRICAL PROTECTION PRODUCTS**

Like all Dynatech power products, the System Controller has superior engineering and reliability. See our complete line of electrical protection products by Dynatech at your local dealer or call TOLL FREE 1-800-638-9098 for more information. System Controller is UL listed and CSA approved.

***Dynatech***  
COMPUTER POWER, INC.

4744 Scotts Valley Drive  
Scotts Valley, CA 95066  
408/438-5760, 800/638-9098

System Controller is a trademark of Dynatech Computer Power, Inc. Surge Sentry is a registered trademark of Dynatech Computer Power, Inc.



# The Norton Utilities

## Tools for recovering data and managing directories

BY RUBIN RABINOVITZ

**P**eter Norton's data-recovery tool really recovers lost data. I've used it successfully dozens of times. Will it save every lost file? No. Unfortunately, there are some kinds of damage that the Norton Utilities can't repair. Can you tell before buying the program whether it will help you recover a particular file? The answer to this question has to be inconclusive. There are different kinds of lost data, and sometimes, even when you know how the damage occurred, it is difficult to predict whether it can be repaired.

The simplest kind of loss occurs when you delete a file by using the ERASE or DEL commands in DOS. Even though your directory indicates that the file no longer exists, it hasn't really been erased. What's happened is that an instruction prohibiting DOS from writing in certain areas of the disk has been altered. Your data is retained until information is actually written into these sectors. If you change your mind and decide that you need the discarded data after all, the Norton Utilities will reverse the changes made by the ERASE command and your old file will be restored.

Certain types of equipment failures can produce more serious data losses. Every DOS-formatted disk contains hidden files called the boot record and the file allocation table; these, together with the directory, are used for managing the data stored on the rest of the disk. If garbled information is entered into these files—a common cause is a disk drive out of alignment—your data may become inaccessible. But sometimes the data files themselves may survive this damage; if so, you may be able to recover some or all of them.

### RETRIEVING LOST DATA

If you plan to use the Norton file-recovery procedure, you should be careful not to write on a disk with a lost file. You'll risk having new data entered in the sectors containing the file you hope to save. Once the old information has been overwritten in this

way, it can't be recovered.

If you did write on the disk, there's still a chance that the sectors holding the erased file were not the ones that received the new data; this depends on factors like how much free space was on your disk and which version of DOS you're using. So until you actually begin the recovery procedure, you won't know for sure whether the lost file was destroyed. Still, it's best not to take chances. Make it a rule to never write on a disk containing damaged files.

Another good idea is to make a copy of your damaged file whenever possible. If you're working with floppy disks, you should use the DOS DISKCOPY command (as opposed to the COPY \* . \* command); DISKCOPY works by reproducing what's on the source disk exactly, byte by byte, so even deleted data is copied. Carrying out the recovery procedure on a copied version of the damaged file means that if you make a mistake, you'll have a chance to recopy the original and try again.

After taking these precautions, you can begin the file-recovery procedures. In general, for simple problems like unintentionally invoking an ERASE command, you can expect the Norton Utilities to retrieve lost files consistently. When a problem is caused by a current spike, static electricity, or a disk drive out of alignment, it's harder to predict how much of a file can be recovered; this is because so many different varieties of error can occur.

With many types of errors, the Norton Utilities can often help you salvage something. At times you may be able to recover only portions of a file. This is similar to what happens when the CHKDSK procedure in DOS restores only some of the lost clusters (groups of isolated sectors) in a file. In many cases you can save enough of a file to be able to reconstruct the missing portions with little trouble. But for some files, such as those created with spreadsheet programs, even a small amount of data loss can

(continued)

Rubin Rabinovitz (Department of English, Campus Box 226, University of Colorado, Boulder, CO 80309) is a professor of English. He received his doctorate at Columbia University and has reviewed books for the New York Times and New York magazine.

## AT A GLANCE

**Name**

The Norton Utilities (version 3.0)

**Type**

File-recovery and disk-management utilities

**Manufacturer**

Peter Norton  
2210 Wilshire Blvd.  
Santa Monica, CA 90403  
(213) 399-3948

**Format**

One 5¼-inch floppy disk

**Computer**

IBM PC and most compatibles

**Necessary Software**

PC-DOS or MS-DOS

**Documentation**

68-page manual; help screens in the file-recovery program

**Price**

\$99.95; upgrade from an older version, \$25

make a file worthless.

For some other problems, the Norton Utilities won't be of much help. For example, when control information specific to a particular application program is destroyed, the Utilities won't be able to restore it. However, the Norton program does permit you to enter new data directly onto a disk in either hexadecimal or alphanumeric format. Thus, if you know enough about how a program works, you may be able to correct an error by writing in the proper control information.

Even when it's impossible to retrieve a lost file, hope remains in some cases for recovering the information within the file. The Norton Utilities program is often able to display the contents of a damaged file on the screen. What you see is exactly what's on the disk. Your information is there, but not in its familiar format, and it may be intermixed with control characters. Even so, this feature can be a lifesaver when there's important material in a lost file.

To save the data from a lost file, you can print the screen display: The DOS program's PRINT SCREEN command is available when you're using the Norton Utilities. Saving information this way can be bothersome when working with a long file because you'll be printing one screen at a time, together with the rectangular border that surrounds it. A trick I've used is to read the displayed data into a tape recorder. This can be much faster than printing, and it permits you to omit unneeded material or to add comments as you go along.

A program included in the Norton Utilities, Disk Test, lets you discover whether a disk contains damaged files. Though Disk Test seems to duplicate the functions of CHKDSK, it really doesn't. Each program searches for different types of errors. But like CHKDSK, Disk Test can't always recognize damaged files. When I tested some files that were produced with a badly aligned disk drive, Disk Test reported that they were undamaged; but in fact, they had generated DOS error messages

and were in need of repair.

Still, this happened only rarely; in the great majority of trials, the program detected any errors. And for most kinds of lost data, the Norton Utilities is usually of some help. Unless a file is severely damaged, the Norton package usually permits you to recover at least some of its data.

**OTHER UTILITIES**

In addition to the file-recovery and testing routines, the Norton Utilities contains 14 programs for carrying out other useful tasks. Some of these are procedures that you may have wished were included in DOS. For example, once you begin using electronic volume labels, you may decide you want labels on all your disks. With DOS there's no way of adding a label to a disk after it has been formatted. But a Norton program called Volume Label permits you to add labels to untitled disks and to change existing labels.

Similarly, you may wish that DOS had a program for erasing a disk completely (even the FORMAT procedure can leave behind some residual data). The Norton Utilities includes such a program, called Wipe Disk; it writes zeroes into every sector of a disk. A similar operation is performed by the Norton Wipe File program; unlike the DOS ERASE command, it overwrites all the data in a file. These routines are the computer equivalent of a paper shredder. They're mainly useful where sensitive information has to be completely removed.

Another nice Norton program is Text Search, which lets you define a string of characters and search for it in a file or on an entire disk. It works like a word-processing global search, and for this reason it will appeal to people who don't have word-processing programs. But unlike most conventional search programs, the Norton version reads the data in erased files, and you can enter this data into a new file.

If you don't own a word processor, you may also find Line Print useful. It's a utility program that provides

*(continued)*

# PERFORMANCE

## THAT IS OUT OF THIS WORLD...



**\$389<sup>00</sup>**

**MODEL 2000 20MHz  
DUAL TRACE**

**\$549<sup>00</sup>**

**MODEL 3500 35MHz  
DUAL TRACE DELAYED SWEEP**

## ...AT A DOWN TO EARTH PRICE

At last! Truly affordable test equipment with no compromise in design, and features you would expect to find only on oscilloscopes costing hundreds of dollars more! JDR Instruments presents two, new, high-performance models backed by a two year warranty and technical support which is only a phone call away. Perfect for the technician or advanced hobbyist, both models feature Dual Trace capability and a variety of operating and triggering modes, including CH-B Subtract and X-Y operation.

MODEL 2000 has a 20 MHz bandwidth and 20 calibrated sweeps ranging from .2s to .2 $\mu$ s. A convenient built-in component tester provides additional diagnostic power.



INCLUDES TWO HIGH QUALITY  
1x, 10x TEST PROBES

MODEL 3500 features a 35 MHz bandwidth and exceptional 1mV/DIV sensitivity. Delayed sweep and variable holdoff allow stable viewing of complex waveforms.

**ORDER TOLL FREE**  
**800-538-5000**  
**800-662-6279 (CA)**



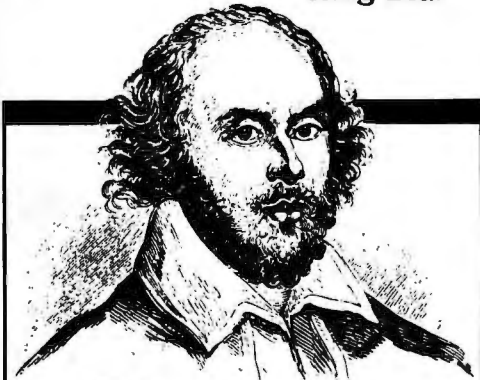
**JDR INSTRUMENTS**  
1224 South Bascom Avenue  
San Jose, California 95128 (408) 995-5430

At Christmas I no more  
desire a rose

Than wish a snow in May's  
new fangled mirth

But like of each thing  
that in season grows

—King Lear



## MacInker

### A Gift For Christmas A Gift For All Seasons

If Shakespeare had had a word processor, he would have consumed about 25 cartridges to run a first draft of his works. At an average cost of \$10/cartridge, the cost is \$250. With MAC INKER he would use one cartridge, his total would be 50 cents in ink, and his print-out quality would be much improved.

And now one UNIVERSAL CARTRIDGE MAC INKER (UC) re-inks all fabric cartridges and one UNIVERSAL SPOOL MAC INKER (US) re-inks all spools. MAC INKER (UC) is \$60. Cartridge drivers are \$8.50 ea. MAC INKER (US) is \$66.95. We still have our first generation, dedicated MAC INKER(s) for most popular printers, with prices starting at \$54.95. You can also use any MAC INKER to create and/or re-ink your own colored cartridges. There are more than 45,000 MAC INKERS in the field in the U.S. and overseas. MAC INKER has been reviewed, approved and flattered in most magazines, and even in the *New York Times* and the *Chicago Sun Times*.



Universal Cartridge Mac Inker

Order toll free 1-800-547-3303  
or ask for free brochure

## Computer Friends

6415 SW Canyon Court, Suite #10  
Portland, OR 97221  
in Oregon and for 24-hour service  
(503) 297-2321 • Telex 4949559CF

## REVIEW: NORTON UTILITIES

some simple formatting and printing options and permits you to add line numbers to documents automatically.

Another series of programs is designed to help you learn about your computer and use it more efficiently. You can test a compatible machine against an IBM Personal Computer, find the addresses in RAM (random-access read/write memory) where application programs are loaded, display a map showing the locations of the files on a disk, read the data in a hidden file, change archive files into read-only files or vice versa, reset screen attributes such as colors and reverse video, or make the computer beep to signal that a command sequence has been executed.

### DIRECTORY MANAGEMENT

Among other inducements to buy the Norton Utilities, even if you don't need it for recovering lost data, are programs for managing directories. One of these programs, Directory Sort, is very useful. It lets you sort by filename or by file extension, by file size, or by the date or the time a file was created. Directory Sort is a great help for locating files quickly and for organizing large directories.

File Find will be welcomed by hard-disk users. It searches through directories and subdirectories for a specified file. File Find permits you to use the wild-card characters \* and ?, letting you search for a range of files with similar names or extensions. List Directories is another Norton program for managing hard-disk directories. It displays all the directories and subdirectories that are contained on a disk.

File Size supplements the information given in DOS directories. When File Size displays dates, it lists the day of the week along with the other information. The display also gives you the amount of space occupied by the data in a file, the amount of space taken up by a file on the disk (the figure for the data plus whatever room may be in partially filled sectors), and the amount of space needed to copy the file onto another disk (this number is necessary when

the sizes of the clusters on two different disks aren't the same size).

### USING THE PROGRAM

Working with most of the smaller Norton programs is easy. The instructions are clear and the command sequences are simple. Learning to use the file-restoration program, however, is somewhat more difficult. Unlike earlier releases of the Norton Utilities, the new version (3.0) has its menus arranged in a tree array. To use a function available in menu 2.3, you start at the main menu, then go to menu 2, then go to menu 2.3. But the manual has no list indicating where each function is located; instead, you're advised to experiment with the program and assured that you'll quickly catch on.

Well, maybe. Although I was familiar with an earlier release of the Utilities, it still took some guesswork to get from one part of the program to another. First-time users of the program—some of them still numb from the shock of a FATAL ERROR message—may not be in the mood for experimenting. Without detailed instructions, they could add to the damage they're trying to fix.

A valuable addition to the manual would be a chart showing the contents of all the file-repair menus and the command keystrokes needed to get from one menu to another. Also, a more detailed set of troubleshooting procedures and a more comprehensive discussion of the causes of data loss would be useful.

In general, I think the Norton Utilities is an excellent set of programs. It provides a good way to learn more about how a computer works and how information is stored on disks. Among the many Norton programs, there are a few that you'll probably use regularly; the rest may initially seem less valuable. But they're like specialized tools: In some situations, you'll find them indispensable. This is certainly true of the Norton data-recovery procedure. Using it once to retrieve a valuable file can make it pay for itself. Not many programs can promise as much. ■





## Pick A Racehorse, A Workhorse, Or Your Choice Of Saddles

VAR's & VAD's now have a choice of PC and AT compatible computers and a complete range of enhancement products all in one place. And you won't be dealing with rookies either. Basic Time has been a computer manufacturer and distributor since 1975. We have the experience and proven ability to offer systems integrators the products and service they need.

**Try Our Workhorse-The BT/XT.** A new standard in price/performance for an 8088 computer. 8 slots, 256k RAM, AT type keyboard, Hercules compatible monochrome monitor and adapter, 20 Meg hard disk, floppy drive, 130 watt power supply, MS-DOS, and full PC compatibility.

external modems. Hard disk storage is simple and reliable with our 20 Mb systems for PC's and BT44 and BT70 Mb drives for AT's. Tape backup systems are available to secure your data too. Need more memory and I/O ports? The BT6Plus and AT4x4Plus multifunction boards give you unrivaled bang for your buck.

### Run With Our Racehorse-The BT/AT.

This 80286 computer with 28ms average access time 44Mb drive runs circles around the IBM™ AT. It's complete with Hercules compatible monochrome monitor (color optional), a fistful of I/O ports, keyboard, 1.2 Mb/360k floppy, and 640k of RAM, MS-DOS and GW-BASIC. All this and more at the lowest price available for an AT compatible\*.



For more details on how your company can offer it's customers more performance while you concentrate on one vendor instead of five, call or write:

Department B  
3350 Scott Blvd.,  
Bldg. 52  
Santa Clara, Ca. 95054

Inside California  
(800) 841-2474

Outside California  
(800) 323-8437

**Your Choice Of Saddles.** Either horse you choose we can outfit you completely. Our HR series monitors support monochrome, color, or EGA adapters. Communication is easy with Basic Time internal or

# basic time

\*Infoworld Sept. 2, 1985, Page 1.

**Engineering  
Excellence**

**CROSSTALK™**  
XVI



THE STATE OF THE ART IN  
DATA COMMUNICATIONS  
SOFTWARE

DESIGNED BY

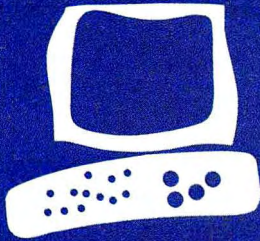
**MICROSTUF®**

CROSSTALK IS A TRADEMARK OF  
MICROSTUF, INC., ATLANTA, GEORGIA

CROSSTALK IS AVAILABLE FOR  
MOST SMALL BUSINESS  
COMPUTERS

DATE

2/16/84



## HyperDrive for the Macintosh

### A class act with caveats

BY GREGG WILLIAMS

**G**eneral Computer Company's HyperDrive isn't much to look at. In fact, the only difference between a HyperDrive-equipped Mac and a normal one is a sticker just below the screen (see photo 1). But that's one of the HyperDrive's best features: There *isn't* anything to look at. It looks like a normal Macintosh, but *inside* is a 10-megabyte (or, in the case of HyperDrive 20, a 20-megabyte) hard disk. A HyperDrive-equipped Mac fits in the same carrying case and still has two free serial ports (many add-on Mac hard disks use one of the two serial ports). As an added bonus, a HyperDrive-equipped Mac uses itself as the start-up disk, eliminating the usual practice of having to start up with a special floppy disk.

The HyperDrive is fast, unobtrusive, and easy to use. Unfortunately, I had some problems that might affect your view of it.

#### INSIDE THE HYPERDRIVE

The HyperDrive is an add-on hard-disk drive installed inside your 512K-byte Macintosh by one of General Computer Company's authorized dealers. Formerly, the company offered its own 512K-byte upgrade; it no longer does. The disk is housed in a shock-mounted case; the dealer also installs one circuit board, an auxiliary power supply, and a small fan (see photo 2). This adds just under 5 pounds to the Mac's weight (just over 5 pounds for the HyperDrive 20).

The HyperDrive with installation costs \$1695 (\$2195 for the HyperDrive 20). GCC provides a 90-day warranty, and the HyperDrive can be serviced by the dealer who installed it or by any authorized Apple dealer (last June, Apple announced that adding a HyperDrive does not void your Mac warranty). You can also purchase a one-year maintenance contract covering the HyperDrive for \$195 (\$250 for the HyperDrive 20).

I found the HyperDrive and the HyperDrive 20 to be identical except for the amount of storage they deliver. From here on, anything I say about the HyperDrive will

refer to both models unless I explicitly indicate the HyperDrive 20.

#### RUNNING THE HYPERDRIVE

A HyperDrive-equipped Mac uses modified software that partitions the hard disk into as many drawers as you want. A drawer is essentially the same as a disk drive; it has its own desktop icon that opens, like a normal Macintosh disk-drive icon, to a window containing its contents. Unlike a normal disk, a drawer can take up to 16 megabytes of disk storage; the only other limitation is in the number of files it can store in one drawer. (The Macintosh, like many other computers, was not designed with hard disks in mind. Vendors of add-on hard disks modify the existing operating system so the hard disk looks like multiple floppy disks. The Macintosh floppy disk contains space for only 128 files, a maximum large enough for the standard 400K-byte 3½-inch floppy disk but not for a larger mass-storage device.)

A HyperDrive drawer can be larger than 400K bytes but still has a natural limitation in the number of files it can hold. GCC has altered the Finder so a drawer can contain up to 128 (normal), 256, or 512 files. A drawer allocates storage from the hard disk in units of 256K bytes—a drawer with just one file in it takes 256K bytes, and a set of files totaling 257K bytes takes 512K bytes.

Because of the way the HyperDrive allocates disk space, drawers have an interesting quirk: The available memory messages in the upper left corner of various drawer windows might be different (they should be the same, since they reflect the amount of memory available on the entire hard disk).

#### THE MANAGER

Just as a normal Macintosh runs faster if you're not using the external drive, the HyperDrive-equipped Mac runs faster if you have fewer drawers on the desktop. You can

(continued)

Gregg Williams is a senior technical editor at BYTE. He can be contacted at POB 372, Hancock, NH 03449.

### AT A GLANCE

**Name**

HyperDrive (or HyperDrive 20)

**Type**

An internal 10-megabyte (or 20-megabyte) hard disk for the Macintosh computer

**Manufacturer**

General Computer Co.  
215 First St.  
Cambridge, MA 02142  
(617) 492-5500

**Software**

Modified System file plus Manager, HyperInstall, Backup, and print-spooling programs

**Price**

\$1695 (\$2195 for HyperDrive 20); optional HyperCare maintenance contract is \$195 (\$250 for HyperDrive 20)

use the Manager program (included with HyperDrive) to open or close drawers. Closed drawers are invisible to the Macintosh; they do not appear on the desktop, nor do they slow start-up and launch times (launch time is the amount of time needed to start a selected program). The Manager gives you a "Drawers" menu that lists all existing drawers. You can check (open) and uncheck (close) a drawer by selecting its name.

With the Manager program, you can also initialize, format, or non-destructively test the hard disk, create and delete drawers, change a drawer's password, and do garbage collection (reclaim fragmented areas of storage too small to use). The Preferences screen lets you modify the HyperDrive's behavior in several ways (see photo 3).

#### THE DRAWERS ACCESSORY

To the Macintosh, the Manager is just another program, and entering and leaving it take time. As a partial, faster substitute, GCC has added a new desk

accessory titled Drawers. When you launch the Drawers accessory, the Mac adds the Drawers menu to the title bar and you can open new drawers, even while you're inside an executing program.

Occasionally, you can't close drawers this way and must do it via the Manager program. This happens when the HyperDrive software sees that a file is still open and might happen when you try to open or close a drawer created with the 256- or 512-file directory.

#### BACKUPS

GCC includes a Backup program that lets you copy files or some or all of the drawers, either to another part of the HyperDrive or to multiple floppy disks. Once you have done that, you can later do an incremental backup on one or more drawers—this is faster because it updates only the data that has changed since the last backup.

However, each incremental backup takes at least one disk, even if you have changed only a few files. This is



Photo 1: A Macintosh computer with a GCC HyperDrive 20 20-megabyte hard disk in it.

wasteful, and you will eventually want to do a complete backup (which will use disks more efficiently).

**PRINT SPOOLER**

The print-spooling utility supplied with the HyperDrive is an innovative and useful program that uses the free space on the hard disk (i.e., disk-storage capacity not used by any open or closed drawer) to spool any output that goes to the printer. All other Mac print spoolers to date print only text files. (Ordinary text spoolers use a small amount of the Mac's memory to store the file in ASCII format and then print it in draft mode. The Mac cannot spare enough memory to save the high-resolution graphics image that it sends to the printer when a document is printed in standard- or high-quality modes, but a HyperDrive-equipped Mac with several unused megabytes of storage can.)

You can install the print-spooling capability by moving the Spooler Install program onto the Startup drawer and launching it; the print-spooling capability is available automatically when you restart the computer until you remove it by running the Spooler Install program again. The feature works well; for example, I started printing a 14-page MacWrite document and found that my Mac was free for other tasks after the printer had produced four pages. (The spooler does not spool everything to disk, only what the printer can't handle; for the first four pages, the Mac was continuously printing the document and saving the rest of it to disk. This is slower than a scheme that would dump everything to disk, but it saves a lot of time.) The spooler continues to print your document, pausing only during times of heavy disk access, even if you leave one application and go to another; however, it does not survive a complete reset or power-down/power-up of the Mac.

**PERFORMANCE**

The more files that are on the desktop, the longer the Mac takes to start  
*(continued)*

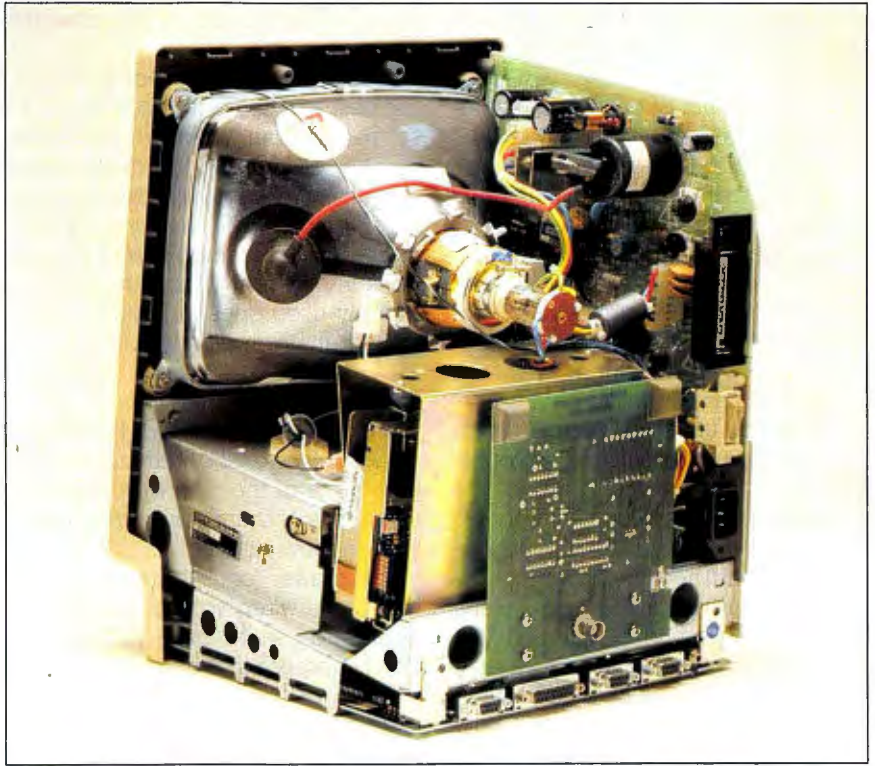


Photo 2: An interior shot of a HyperDrive-equipped Mac. The hard disk is the vertically mounted box. The circuit board in front of the hard disk is not part of the HyperDrive; it is an enhancement that gives the Mac an external video output jack.

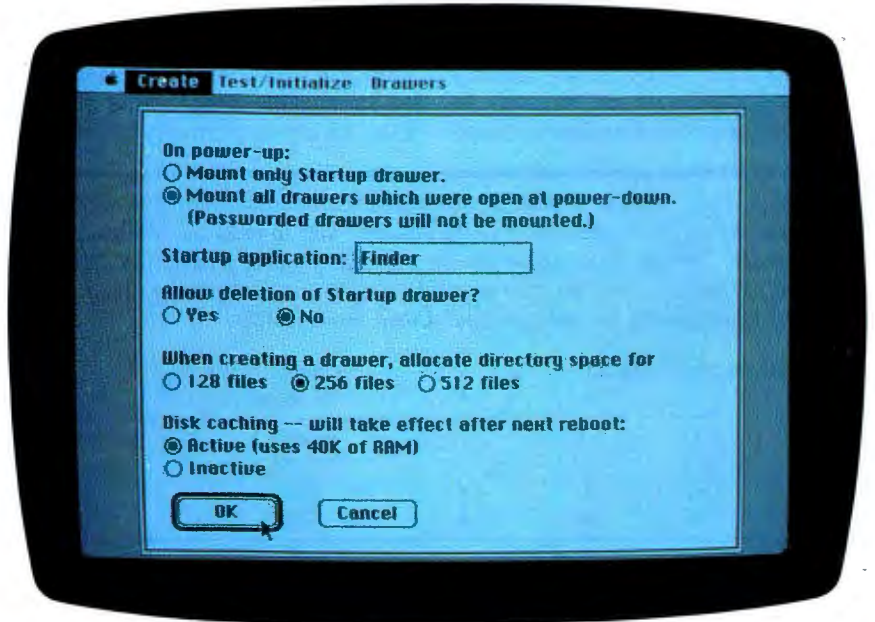


Photo 3: The Preferences screen. This screen allows you to change the way the HyperDrive works.

up or exit from an application (which essentially restarts the system). Surprisingly, the launch time also varies with the amount of data on the desktop. This is Macintosh Finder 4.1 behavior, not HyperDrive behavior. However, the problem is magnified with a HyperDrive because you can have many more files on the desktop at a time.

Table 1 shows the timing results of three operations (initial start-up of disk and launch and exit times for the Manager program) under varying conditions. (The launch and exit times for the Manager are representative of applications in general; I found the respective times for MacPaint, for example, to be within a second of those for Manager.) The table shows that the more files visible on the desktop, the longer the HyperDrive-equipped Mac takes to start the system and leave an application (the time needed to launch an application increases only slightly with the load).

The table also shows that the overhead of an empty drawer (which takes up 4K bytes) is pretty low, and that there is a slight advantage (never more than two seconds) to putting all your files in one drawer instead of several. Note that the drawers in the last example contain less data than the example with four loaded drawers; I could not triple the number of files in the second drawer because

I ran out of space in the drawer's directory.

Because of the preceding results, the best strategy is to place your files so that you can work with the fewest number of drawers and the smallest amount of disk storage visible at one time. In my use of the HyperDrive, I put my more commonly used applications in one drawer and the less frequently used ones in another, and I closed any drawer not in use.

**PROBLEMS**

The add-on nature of the HyperDrive causes occasional odd things to happen, none of them serious. GCC has taken care of them in ways that cause little inconvenience.

The drawer icons become normal disk icons when you return from an application that's on a floppy disk. This is because that disk becomes the start-up disk, and it lacks the drawer icon and a few other things. This is only an annoyance, but you can prevent it by running a supplied Hyper-Install program, which adds the missing elements to the disk.

If you create a drawer and turn the Mac off without putting something in it, you will get a "disk needs minor repairs" alert box the next time you turn on your Mac. Nothing has gone wrong—it's just that the Finder looks for an invisible Desktop file on each disk, which is normally created as

soon as you put one file on it. When it doesn't see it, the Finder gives you the "minor repairs" box and creates the Desktop file when you tell it to go ahead with the repairs. This is a function of the Macintosh Finder program, not the HyperDrive.

**CAVEATS**

I used a 10-megabyte HyperDrive-equipped Mac eight hours a day for two months without a problem. In the month that followed, however, I had one crash that resulted in GCC replacing the unit (GCC said it was a bad disk-controller card), a major software-related problem (somehow the System Folder software got corrupted), and another crash that caused the loss of two drawers. (I use "crash" to denote a system failure that leaves the computer unable to start up from the internal hard disk.) Three times, the fan in the second HyperDrive-equipped Mac made a buzzing sound that went away in about an hour. I will not elaborate on these errors because GCC maintains that it has improved both its software and its method of adding the HyperDrive to a 512K-byte Macintosh.

I received a HyperDrive 20 in late August and used it for about two weeks. In that time, I had several problems of varying severity.

Some 3½-inch floppy disks that usually worked crashed when trans-

Table 1: Event times in seconds on the HyperDrive-equipped Macintosh. The events measured are time to start up (from computer turned on to appearance of the desktop), time to enter the Manager program, and time to exit it and return to the desktop. The top section shows the effect of adding empty drawers (4K bytes each) to the desktop, which is negligible. The middle section shows the effect of adding data to the extra drawers. The bottom section shows the speed advantage of putting approximately the same amount of data in one drawer.

Drawers (K bytes in each)				Total K bytes	Start-up	Launch Manager	Exit Manager
1	2	3	4				
966	1142			2108	27.0	5.7	9.6
966	1142	4		2112	27.4	6.2	9.8
966	1142	4	4	2116	28.0	6.7	9.9
966	1142	4	4	2116	28.0	6.7	9.9
966	1142	1142		3250	33.7	7.6	16.3
966	1142	1142	1142	4392	42.3	7.5	24.3
970	1142			2112	27.7	7.3	9.6
970	2273			3243	31.4	7.4	14.3
970	3026			3996	33.8	7.3	16.7

**REVIEW: HYPERDRIVE**

ferred to the HyperDrive. I eventually discovered that, in almost every case, the solution was to remove the System Folder from that disk so the software would go to the System Folder, as modified for the HyperDrive, in the Startup drawer. Tom Westberg of GCC said that his company now recommends that you put all your applications in the Startup drawer, which would prevent this problem.

One time I was unable to open a drawer, even from the Manager program. Westberg said this stems from a complicated algorithm that manages the hard disk; paradoxically, the problem goes away as you use more and more of the HyperDrive's capacity. Westberg said that it rarely happens, and the system software is always able to open at least three drawers before it happens.

Twice, on entering the Manager program, I was given an alert box telling me that "The HyperDrive has not been formatted properly. The only function you may execute at this point is 'Format.'" (I could also quit.) When I quit the alert box and reentered the Manager program, I did not get this message again (formatting the HyperDrive would have erased everything on the disk). Westberg, who was always very helpful, said he thinks that the spurious alert box was a bug in the software.

My last problem occurred as I was writing this review: The HyperDrive crashed whenever I tried to use the internal or external floppy-disk drive. The hardware was probably not at fault; the drives booted and operated correctly when I caused the Mac to ignore the HyperDrive and use a floppy as the start-up disk. I did not have time to correct this error and sent the HyperDrive back to GCC.

**CONCLUSIONS**

I like the HyperDrive very much, but I can't deny the severity and number of problems I had with it. I might still buy one, but only if my dealer were nearby and he or she reported no problems with previous HyperDrives. ■

**MIDWEST COMPUTER & VIDEO SUPPLY CO.**

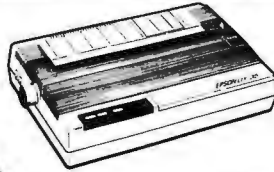
**1-800-527-5274**

IN MISSOURI: 314-423-8300

**BEST PRICES! FASTEST DELIVERY! NO EXTRA FEE TO USE YOUR MASTERCARD OR VISA!**



EPSON  
JVC  
Panasonic  
RCA  
SONY  
SHARP  
HITACHI



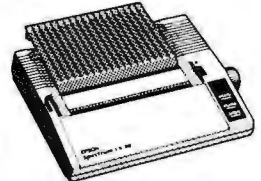
**EPSON DX-35 New Item!**  
**\$ CALL!**

- 35 CPS Letter Quality
- Diablo 630 Compatible

**EPSON LX-80**

- 100 CPS • NLQ Mode

**CALL FOR \$229 HOLIDAY PRICING!**



ALL EPSON PRINTERS HAVE ONE-YEAR WARRANTY



**EPSON**

**FX-85**

- 160 CPS • SelectType • NLQ Mode

**CALL FOR HOLIDAY PRICING \$342**

**We deliver PRODUCT... not promises!**

P.O. BOX 28448 ST. LOUIS, MISSOURI 63146



C.O.D.



**The right place at the right price.**

**Make reservations at any Best Western, see your travel agent, or call 1-800-528-1234.**



**Best Western®**

**WORLDWIDE LODGING**

"World's largest chain of independently owned and operated hotels, motor inns, and resorts"

©1985 Best Western International

# HOW TO GET OVER \$2000 WORTH OF NEW CAPABILITIES FOR YOUR COMMODORE 64™



## FOR \$599\*

The Spartan™ is the Apple™ II+ emulator for your Commodore 64™ that will open up a whole new world of hardware and software for you! Imagine adding these features to your Commodore 64™ for the Spartan™ price of \$599:  Apple™ II+ hardware and software capabilities  64K RAM expansion  four software selectable Commodore 64™ cartridge slots  non-dedicated 8-bit parallel port  standard audio cassette deck capabilities for your C-64™.

The suggested retail value of comparable products offering only these capabilities is over \$2200.00\* — but the Spartan™ gives you much, much more! By building on your investment in your Commodore 64™ — an excellent introductory computer — you create a whole new system with both C-64™ and Apple™ II+ capabilities. There is a whole other world out there! The huge selection of Apple™ II+ hardware and software is now yours to explore! Call toll free for the Spartan™ dealer nearest you.



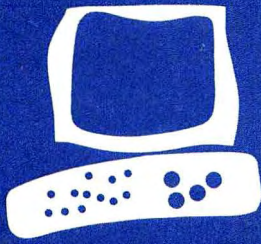
### MIMIC

FOR INFORMATION WRITE:  
MIMIC SYSTEMS  
1112 FORT ST., FL. 6H  
VICTORIA, B.C.  
CANADA V8V 4V2

TO ORDER CALL:  
**1-800-MODULAR**  
(663-8527)

\*All prices quoted are in U.S. funds, freight and taxes not included. Value of components equivalent to the Spartan™ system are quoted from Apple™ II+ CPU and Apple™ II+ single disk drive 1983 list prices, and from current suggested list prices and component specifications of other peripheral manufacturers. Commodore 64™ and Commodore logo are trademarks of Commodore Electronics Ltd. and/or Commodore Business Machines, Inc. Apple™ II+ is a trademark of Apple Computer Inc. Spartan™ is a trademark of Mimic Systems Inc. and has no association with Commodore Electronics or Apple Computer Inc. The Spartan™ is manufactured by Mimic Systems under license granted by ATG Electronics Inc. of Victoria, B.C. Canada.





## Upgrades for the TRS-80 Model 100

**Equipment  
for adding  
versatility and  
convenience**

BY TERRY KEPNER

**T**he Radio Shack Model 100 was the first truly portable computer with built-in software. Because of that, it received rave reviews and gained immense popularity. But it was also criticized because it couldn't be expanded with hardware: It lacked a disk-drive interface and options for increasing the memory, for using a video monitor or larger screen display, and for an expansion box.

But all that has changed. You can now increase the memory capacity to 96K bytes with more software, add disk drives, increase the display to a full 80 characters by 24 lines, and add expansion boxes that include real-world interfaces (analog to digital) for connecting to other equipment.

### MEMORY MODULES

When the Model 100 was introduced, only Radio Shack sold the 8K-byte memory modules. Now six companies sell the chips for considerably less. (See the text box on page 336 for the sources of products mentioned.) These modules are literally a snap to install: Turn off the computer, remove the back, locate the empty RAM (random-access read/write memory) sockets, plug in the 8K-byte chip modules, and reassemble the unit. Any technician can do the job in 15 minutes, and a brave novice can do it almost as quickly.

### MEMORY EXPANSION

The Model 100 gives you 32K bytes of RAM with all the memory sockets filled. The next step in expanding RAM involves the upgrades that use the bus socket located on the bottom of the computer, in the expansion compartment.

PG Design's 32K-byte RAM bank (\$325) plugs into the expansion socket and includes its own battery. It uses CMOS (complementary metal-oxide semiconductor) memory, like the internal RAM, and the inclusion of the battery turns the expansion board into a miniature self-powered bank. The unit can be removed for several weeks

without losing data. Unfortunately, the board also covers up the access to the expansion ROM (read-only memory) socket, so you can't use any other devices while the "memory bank" is installed. Nor can you transfer data between the external bank and the internal memory. In operation you can use either the internal or the external memory; programs can't span the banks (i.e., you can't have a 40K-byte program or data file). A simple one-line BASIC program is used to switch between the two banks.

Cryptronics offers even more convenience with its 96K-byte expansion memory bank (\$425). It fits inside the expansion compartment but doesn't cover the expansion ROM socket. It, too, includes a battery. A program is provided for transferring data from bank to bank.

The next level of memory upgrade is also made by Cryptronics, the PortaPac Z-100 RAM disk. This device plugs into the RS-232C port of the Model 100 and provides storage capacities of 60K bytes (\$325), 120K bytes (\$395), 180K bytes (\$465), and 240K bytes (\$535). Each block of 60K bytes is treated as a "drive." The unit measures 1.75 inches high by 6 inches wide by 10 inches deep and weighs 3.75 pounds (including its internal sealed lead-acid battery). The battery is recharged with an AC adapter while the unit is in use; it powers the RAM disk for 2½ to 4 hours of continuous use or 6 to 20 hours of storage time (depending on the amount of RAM). The PortaPac Z-100 includes operating software in internal ROM and a BASIC program you load into your computer and use to control the unit. The disadvantages of the unit are its short memory retention and its hefty amount of radio frequency interference. Radios and televisions can't operate within about 30 feet of the unit.

### DATA STORAGE

Permanent data storage for the Model 100 was originally limited to cassette tapes. Now

*(continued)*

*Terry Kepner (POB 481, Peterborough, NH 03458) is a freelance writer and programmer. He has been writing about computers since 1979.*

several choices are available: wafer tape, 5¼-inch floppy disks, and 3½-inch disks, with bubble-memory under development.

Holmes Engineering was first on the scene with its wafer-tape drive system, the Portable Micro Drive (PMD) (\$369.50), which operates from the Model 100 RS-232C port. The PMD is about the same size as the Model 100. The drive is battery-powered with an AC adapter/charger and includes its own internal RAM for RAM-disk operation. The wafer tapes are about 20 to 30 times faster than cassette tapes for data saving and loading and

are "endless loop" tapes. Micro wafer tapes come in various sizes from 5 to 50 feet. The PMD treats the tapes as "slow" disk drives, automatically searching for sections large enough to store files. (You don't have to worry about "overwriting" other files or programs; the PMD won't let you unless you specifically tell it to erase a tape file.) Like the PortaPac Z-100, the PMD can store only ASCII (American Standard Code for Information Interchange) files and is controlled primarily through the Model 100 TELCOM program.

Standard disk drives and an 80-

character by 25-line display on a video monitor are available with Radio Shack's Disk/Video Interface (\$799). But this ties you to a desk. If you want portability, you have two choices: the Holmes Engineering Chipmunk and the PICdisc Micro Drive, which both use 3½-inch disks with 360K-byte capacity.

The Chipmunk, available from the Portable Computer Support Group for \$599, is a battery-operated unit with an AC adapter/charger. It measures 5½ inches wide by 2½ inches tall by 7½ inches deep and weighs only 2½

(continued)

## WHERE TO GET UPGRADES

### MEMORY MODULES

**RADIO SHACK/TANDY CORP.**  
1800 One Tandy Center  
Fort Worth, TX 76102  
\$119.95

**PURPLE COMPUTING**  
2068 Ventura Blvd.  
Camarillo, CA 93010  
\$44.95

**CRYPTRONICS INC.**  
11711 Coley River Circle  
Suite 7  
Fountain Valley, CA 92708  
\$29

**PG DESIGN**  
66040 Gratiot  
Richmond, MI 48062  
\$48.50

**ECONOMY COMPUTER CONCEPTS**  
Box 2047  
North Babylon, NY 11703  
\$39

**I.O. DATATECH**  
48-60 38th St.  
Long Island City, NY 11101  
\$69.95

**HOLMES ENGINEERING**  
5175 Green Pine Dr.  
Salt Lake City, UT 84123  
\$49.95

### MEMORY EXPANSION

**PG DESIGN**  
(see address above)

**CRYPTRONICS INC.**  
(see address above)

### DATA STORAGE

Portable Micro Drive  
**HOLMES ENGINEERING**  
(see address above)

Disk/Video Interface  
**RADIO SHACK/TANDY CORP.**  
(see address above)

The Chipmunk  
**PORTABLE COMPUTER SUPPORT GROUP**  
11035 Harry Hines Blvd.  
No. 207  
Dallas, TX 75229

PICdisc Micro Drive  
**PERSONAL INTEGRATED COMPUTERS**  
18013 Skypark Circle  
Suite D  
Irvine, CA 92714

Bubble-memory device  
**SOUNDSIGHT COMMUNICATIONS**  
2807 Pelham Place  
Hollywood, CA 90668

### EXPANSION ROMS

Lucid, Write-ROM  
**PORTABLE COMPUTER SUPPORT GROUP**  
(see address above)

The Ultimate ROM  
**TRAVELING SOFTWARE INC.**  
11050 Fifth Ave. NE  
Seattle, WA 98125

Multiplan  
**RADIO SHACK/TANDY CORP.**  
(see address above)

ROM2  
**POLAR ENGINEERING AND CONSULTING**  
Box 7188  
Nikishka, AK 99635

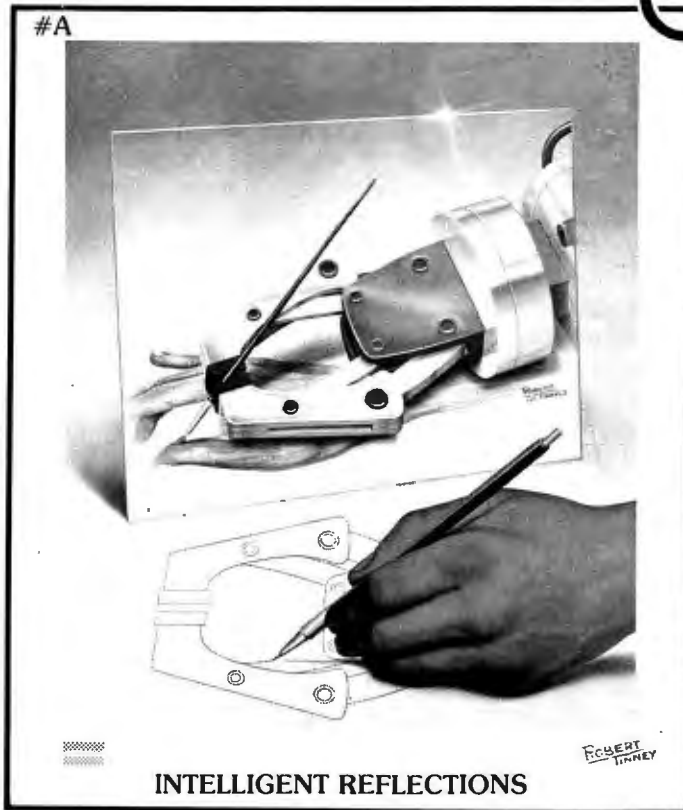
**PERIPHERALS**  
Thinview LCD panel  
**AXONIX**  
417 Wakara Way  
Salt Lake City, UT 84108

PL-1000  
**ELEXOR ASSOCIATES**  
Box 246  
Morris Plains, NJ 07950

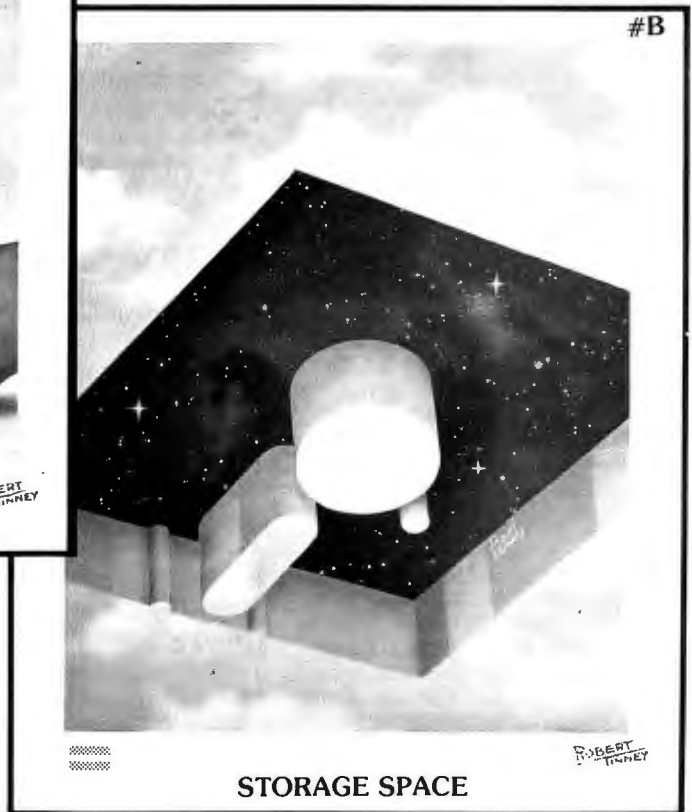
Black Jack modem adapter  
**MICROPERIPHERAL CORP.**  
2565 152nd Ave. NE  
Redmond, WA 98052

# BYTE

# LIMITED EDITION Classics



Beautiful 16" X 20"  
Limited Edition Prints,  
each signed and numbered  
by the Artist.



### Fascinating...And Unique!

The two 1985 Byte covers shown above are now available as 16" X 20" limited edition prints. Each edition is strictly limited to 1000 prints, which are individually inspected, signed and numbered by the artist, Robert Tinney. These excellent reproductions are made from the original paintings (not from transparencies or photos) to ensure accurate color fidelity.

Byte Limited Edition Classics are printed on select 100% cotton fiber stock. This is a museum grade acid free paper, highly resistant to yellowing and cracking; you will be assured of a print which will retain its color and beauty for generations. Accompanying each print is a handsome Certificate of Authenticity, which is also personally signed and numbered by the artist, and which certifies the quality and limited number of the edition.

### Price and Shipping

The price of each Byte Limited Edition Classic is \$55; if two or more prints are ordered, the price of each is only \$45.

Byte Limited Edition Classics are shipped flat, and are guaranteed to arrive undamaged or be immediately replaced. In fact, if for any reason you are not satisfied with your order, you may return it within 30 days for a no questions asked refund. Your prints will be shipped UPS Blue Label (two day delivery), and will usually be shipped within one week of receipt of order.

### Ordering

To order your Byte Limited Edition Classic(s), just clip out and mail the coupon below. If you prefer, you may call in a MasterCard or Visa order to Robert Tinney Graphics, 1-(504)272-7266.

Send me the following print for \$55 (\$45 each for two or more).

Qty.	#	Title	Amount
_____	_____	_____	\$ _____
_____	_____	_____	\$ _____
postage & handling \$4 (\$10 overseas)			\$ _____
<b>Total</b>			<b>\$ _____</b>

Bill my  Visa or  Mastercharge. Exp. Date: \_\_\_\_\_  
Card No. \_\_\_\_\_

I have enclosed check or money order to Robert Tinney Graphics  
 Please just send me your free color brochure.

**Ship To:**  
Name: \_\_\_\_\_  
Address: \_\_\_\_\_  
City: \_\_\_\_\_  
State: \_\_\_\_\_ Zip: \_\_\_\_\_

Mail this coupon to:  
**Robert Tinney Graphics**  
1864 N. Pamela Drive  
Baton Rouge, Louisiana 70815

Visa or MasterCard orders  
**CALL 1-504-272-7266**

# EARTH LAUNCHES NEW STARS

EARTH COMPUTERS launches two of the "Hottest" new stars in the S-100 Universe. Both the **TURBOMASTER 8™** and **TURBOSLAVE I™** are Star performers, featuring high speed Z-80H CPUs.

EARTH's new stars are fully compatible with the Multi-user TurboDOS operating system, and will operate in most S-100 systems, including pre-IEEE 696 systems.

## TURBOMASTER 8

This outstanding new 8-Bit Single Board Computer offers features that are out of this world:

- On-board ST-506 Winchester Controller
- TurboDOS, CP/M, MP/M compatible
- 5-1/4" and 8" Floppy Controller
- Up to 256KB of memory • 2 Serial ports
- 8 MHz, Z-80H CPU • 1 Parallel port

## TURBOSLAVE I

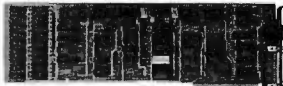


The perfect companion to the **TURBOMASTER 8** or other 8/16-Bit Master processor. This high speed slave utilizes an 8 MHz Z-80H CPU and offers extensive on-board diagnostics... an industry exclusive.

- No paddle boards
- S-100, IEEE 696 compatible
- 128KB of RAM
- 2 RS-232 ports, 50-38.4K Baud
- FIFO communications

EARTH COMPUTERS also manufactures a growing line of PC compatible stellar performers such as:

- **TURBOSLAVE PC™**—an 8 MHz



Z-80 single board slave processor that runs CP/M applications on a PC and is compatible with the TurboDOS multi-user operating system.

- **TURBOACCEL 286™**—a high performance 80286 accelerator that boosts PC performance up to five times.
- **EARTHNET PC™** and **EARTHNET S-100**, the low cost, ARCNET-compatible way to tie PC and S-100 systems together.

To put these stars to work for you, call or write EARTH COMPUTERS. **BE SURE TO ASK ABOUT HOW YOU CAN WIN A FREE Z-80 CO-PROCESSOR BOARD.**

**EARTH COMPUTERS**

"Building Blocks For The Super Micro"

P.O. Box 8067, Fountain Valley, CA 92728  
TELEX: 910 997 6120 EARTH FV  
PHONE: (714) 964-5784

## REVIEW: MODEL 100 UPGRADES

### *PICdisc turns the Model 100 into a CP/M computer.*

pounds. It plugs into the expansion socket on the bottom of the Model 100. You can't use the memory-expansion modules with the Chipmunk plugged in. It uses a small CDOS program to control the unit. The internal batteries provide 2 hours of continuous use (such as a disk data sort) or about 12 hours of intermittent use (loading and saving files).

PICdisc (\$799) is manufactured by Personal Integrated Computers (PIC) and uses a different approach. It includes a 32K-byte RAM bank and turns a Model 100 into a 64K-byte CP/M computer. (You must have a 32K-byte Model 100 to use PICdisc.) The unit attaches directly to the left side of the Model 100 with a special metal mounting plate you bolt to its bottom. The mounting plate holds the drive connector and attaches to the expansion bus with a short cable that runs to the expansion compartment. A plastic lid covers the entire bottom of the computer and the connecting cable to prevent the mounting plate from scratching tabletops.

With the mounting plate in position, the PICdisc drive can be quickly installed or removed without putting stress on the delicate expansion socket of the Model 100. The mounting plate has an expansion connector for the drive. The bottom lid adds only one-quarter inch to the depth of the Model 100. The PICdisc runs for 2½ hours continuously or about 20 hours intermittently.

The disadvantage of the PICdisc is that it completely usurps the computer's ROM operating system and programs, turning the Model 100 into a CP/M computer. Special software automatically saves a RAM image to disk when you boot the PICdisc, so you don't lose the data in memory. (When you exit CP/M, this image is reloaded into your computer.) And

you can pull files out of the RAM image for use in CP/M programs. In other words, PICdisc wasn't designed to complement the Model 100 programs—it was designed to replace the Model 100 ROM.

The advantage of the PICdisc is access to the CP/M system and all the programs available for it. Unfortunately, only PIC supplies the CP/M programs in the 3½-inch format, but the company will transfer programs and files to that format if you supply the original 5¼-inch disk.

The PICdisc system incorporates the T/Maker Integrated Software System, which includes word processing, relational database management, spreadsheet, graphics, and a spelling checker. This almost offsets the disadvantage of losing the Model 100 ROM programs. Once you start using T/Maker, you probably won't notice the loss of the Model 100 native mode.

SoundSight Communications manufactures a bubble-memory expansion device. The device uses bubble-memory modules that are slower than normal RAM but faster than a disk drive, and they never lose stored data until you order it erased. The price runs from \$750 to \$900 for the first 128K bytes, with possible expansion to 512 megabytes.

The bubble-memory unit is a simple bolt-on case that attaches to the bottom of the computer, leaving the expansion compartment door accessible. It makes the Model 100 about one-half inch thicker. Like the Model 100, it's powered by AA batteries.

### **EXPANSION ROMS**

ROMs have advantages over RAM-based programs because they don't require any RAM and you don't have to load them into RAM to use them. Lucid (\$149.95) and Write-ROM (\$149.95) are produced by the Portable Computer Support Group. Lucid is a spreadsheet program that rivals Lotus 1-2-3 in capabilities (except disk I/O routines, of course). Trying to describe all its abilities would require a separate review. Its most unusual

(continued)

# EXECUTIVE PRIVILEGE.

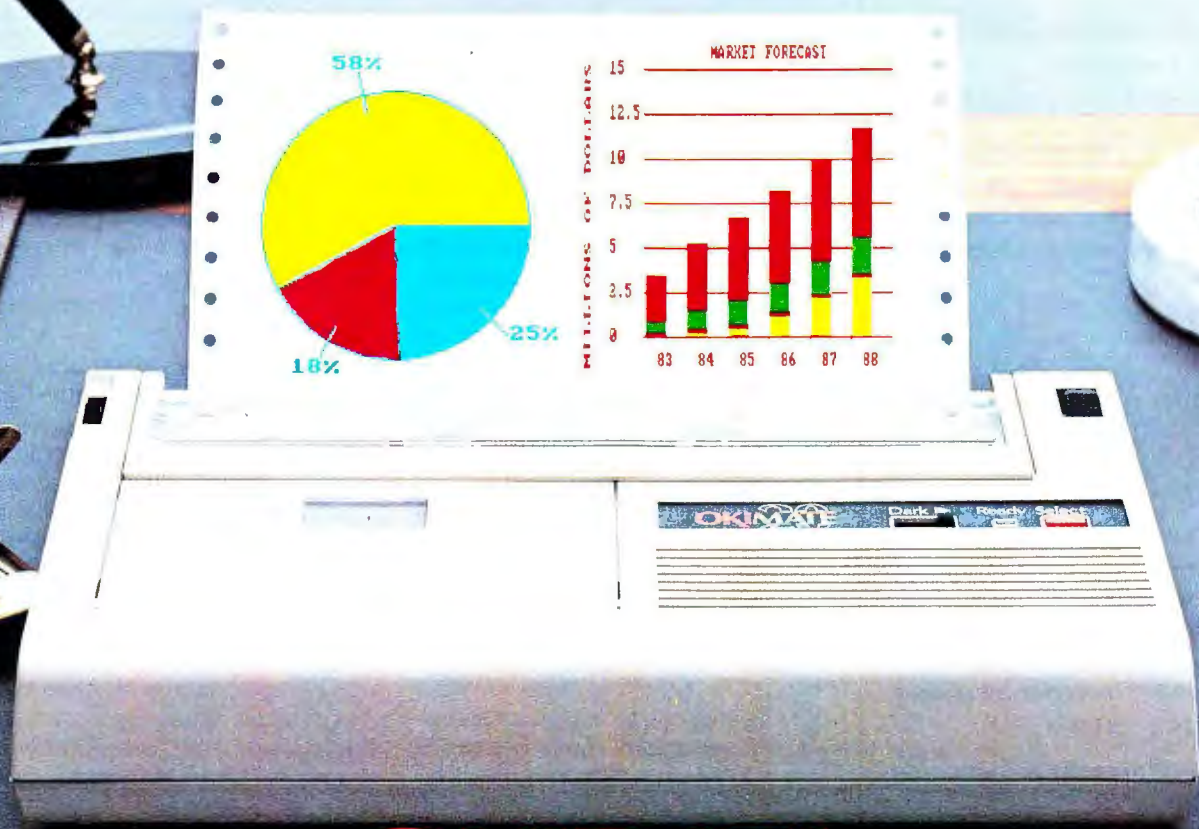
Introducing the \$268 OKIMATE 20 color printer for IBM® and Apple® users.

We admit it—the OKIMATE 20 isn't for everyone. Just IBM and Apple users who like to execute their big ideas with style.

The OKIMATE 20 is a powerful business tool, capable of printing ruthlessly accurate performance charts in over 100 vivid colors. It can paint sales records and forecasts with the same dynamic intensity. Or process your conclusions with crisp, near-letter quality

text. It can even make overhead transparencies to show your recommendations to the entire company. And it's easy enough for a busy executive to operate—everything is included.\*

Rank sure has its privileges. And the new OKIMATE 20 certainly is one. For your nearest Okidata dealer, call 1-800-OKIDATA (in New Jersey 609-235-2600). Mt. Laurel, NJ 08054.



## OKIDATA

an OKI AMERICA company

We put business on paper.

Inquiry 269

\*\$268 is manufacturers suggested retail price. OKIMATE 20 "Plug n Print" package includes black and color ribbon cartridges, paper and two software programs, "Color Screen Print" and "Learn to Print."

The above charts were created with Fast Graphs™ and printed using OKIMATE 20's Color Screen Print program through multiple-passes.

Apple is a registered trademark of Apple Computer, Inc.

IBM is a registered trademark of International Business Machines, Inc.

IBM / PC

# CROSS ASSEMBLERS

*We've been selling these industrial-quality assemblers to the development system market since 1978. They are now available for the IBM PC.*

## FEATURES:

- Fully relocatable
- Separate code, data, stack, memory segments
- Linker included
- Librarian included
- Generate appropriate HEX or S-record formatted object file
- Macro capability
- CPM80, MPM, ISIS versions available
- Conditional assembly
- Cross reference
- Supports manufacturer's mnemonics
- Expanded list of directives
- 1 year free update

**Assemblers now available include:**

Chip	Chip
1802/1805	NSC800
8051	F8, 3870
6500/01/02	Z8
6800/01/02	Z80
6803/08	9900/9995
6804	Z8000
6805	68000
6809	6301
6811	8048/49/50/42
8085	65C02/C102/C112

**Take advantage of leading-edge technology. Get your own Relms assembler today. Use your Mastercard or order by phone: (408) 265-5411**

**Relational Memory Systems, Inc.  
P.O. Box 6719  
San Jose, California 95150  
Telex: 171618**

*Prices subject to change without notice.  
Software distributor inquiries invited.*



## REVIEW: MODEL 100 UPGRADES

feature is that it doesn't require RAM for empty cells; only spreadsheet cells holding data use up memory. Its maximum size is 126 columns by 254 rows.

Write-ROM upgrades the Model 100 by replacing the built-in TEXT program with a more powerful word processor. It has all the features you might expect: margin control, centering, justification, headers, footers, search and replace, and 35 other functions. You can also prepare WordStar-compatible files on it and perform mail-merge functions.

The Ultimate ROM (\$229.95) is a collection of three Traveling Software programs on one plug-in ROM chip. The trio consists of T-base, a relational database manager; Traveling Writer, a text formatter; and Idea!, a thought processor that can organize ideas into outlines. All the programs use a Config file that lets you modify them.

Multiplan (\$149.95) from Radio Shack is the popular spreadsheet program scaled down to the Model 100. Almost all the features, except disk I/O commands, have been reproduced, including template and data portability to other versions of Multiplan. Its size limit is 63 columns by 99 rows.

For the 8085 machine-language programmer there is ROM2 (\$85), a macro assembler/symbolic debugger. The assembler allows macros with symbolic arguments, conditional assembly-code blocks, and label table retention. The debugger allows interactive code patching, interactive code execution, program simulation tracing, single-stepping, breakpoint setting, and other functions. ROM2 is also of interest to BASIC programmers. It includes a renumber utility, lists a RAM directory with file sizes, can copy and compare .DO files, and has a global search-and-replace utility.

## PERIPHERALS

For Model 100 owners unhappy with the laptop's limited display, Axonix has the Thinview LCD panel (\$699). It measures 1¼ inches thick by 6½ inches high by 11¾ inches wide. It's an 80-column by 25-line battery-operated display. The unit plugs into the

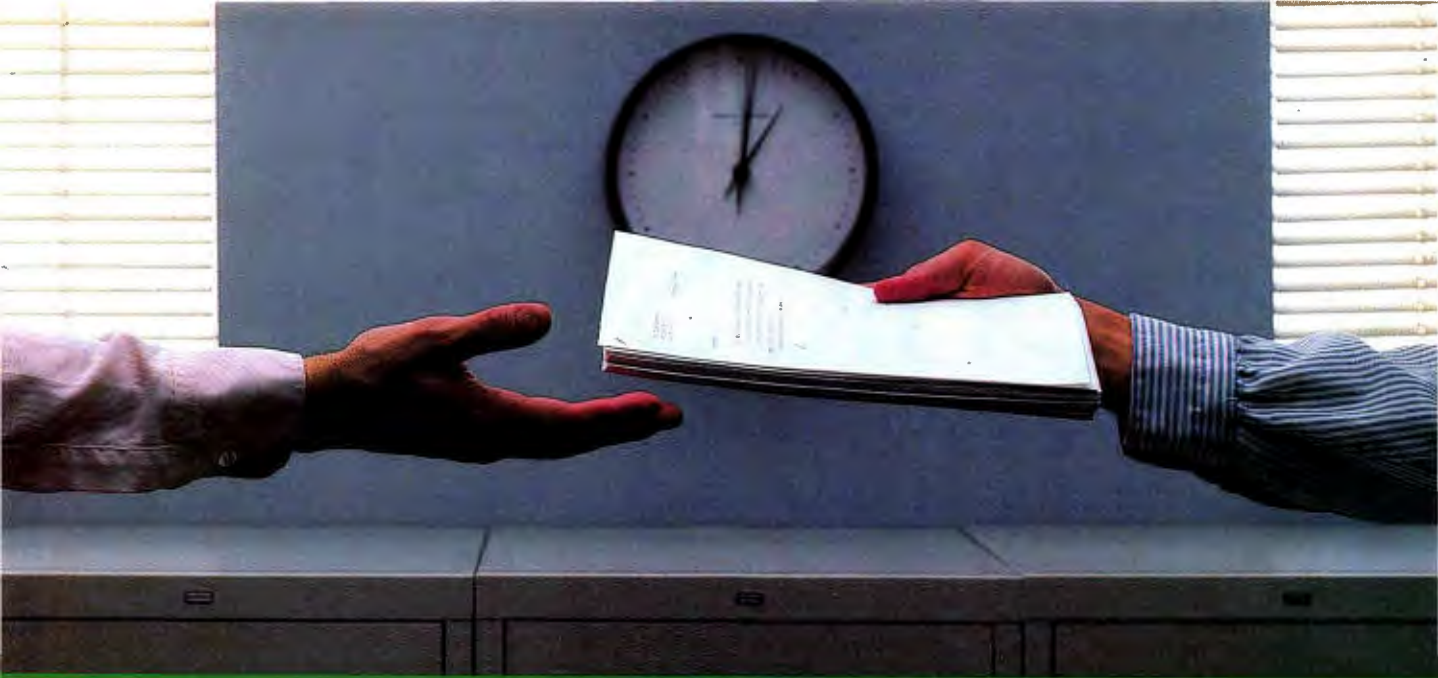
RS-232C port or expansion bus socket and includes driver software that routes the normal LCD input to the Thinview. Weight, including batteries, is less than three pounds. The nicad batteries provide up to 16 hours of continuous use. The display is 640 by 200 pixels for a total of 128,000 addressable pixels. While the unit is normally set for 80 characters, you can get a compressed display of up to 106 characters per line. The Thinview has its own 16K bytes of memory for the display and has scrolling, paging, and cursor-control capability. You can even get up to 64K bytes of programmable memory in the unit.

To connect your Model 100 to the real world, there is the \$549 PL-1000 from Elexor Associates. This RS-232C device has a 16-channel 12-bit analog-to-digital input, a 2-channel digital-to-analog input, 32-bit digital I/O, non-volatile memory, and room for two additional boards in the chassis. Expansion boards currently available handle digital I/O, A/D, timer/counter, triac, optoisolator, relay, battery option, and a direct bus to the Model 100. The unit is only slightly larger than the Model 100.

Finally, if you are frustrated with hotel phone systems that don't give you access to the phone lines (no modular plugs) and don't like the low reliability of the Radio Shack acoustic couplers, the Black Jack modular jack (\$49.95) adapter from Microperipheral Corp. might be just what you want. To use it, you remove the mouthpiece from the telephone, screw in the Black Jack, plug the modular cable into the Black Jack, dial your remote system, and start communicating. The Black Jack circumvents unreliable and noisy acoustic couplers and lets you transmit and receive from phones that don't use the standard modular plugs.

## SUMMARY

The Model 100 has come quite a distance since its introduction. With its current low price and the number of upgrades available, the Model 100 is one of the most versatile laptop computers in the world. ■



## 2400 bps modems: Do you Really need another speed?

- Is the shift from 300 to 1200 bps going to repeat itself at 2400 bps? The answer is both yes and no. There certainly are applications for 2400 bps asynch dial-up modems, but we shouldn't expect 1200 bps to die overnight.
- 2400 bps modems can improve throughput, thereby getting tasks done quicker and more economically. However, 1200 bps has become the virtual standard for professional dial-up communications, and most users are satisfied with it. So why consider a 2400 bps modem at all?
- One reason is flexibility. If the modem you select operates at all three speeds (300, 1200 & 2400) in accordance with accepted industry standards, it will serve virtually all dial-up applications now and in the foreseeable future.
- The modem you select should be the MultiModem224. It is Bell 212A and 103 compatible at 1200 and 300 bps, and CCITT V.22bis compatible at 2400. It is also 100% compatible with the Hayes command set, meaning that it will work with virtually all communications software packages, at all three speeds. Other features include both synchronous and asynchronous operation, full intelligence and a phone number memory.
- The MultiModem224 is available in both desktop and IBM PC™ internal card versions. (There is also a rack-mounted version for central sites.) And as a bonus, we provide free offers from ten of the most popular on-line information services, including CompuServe™, Dow Jones™ and The Source™.
- A 2400/1200/300 bps modem is just a plain good investment. Why not let the MultiModem224 provide your communications for both today and tomorrow?

Inquiry 254 for End-Users. Inquiry 255 for DEALERS ONLY.

For more information, call us toll-free at  
**1-800-328-9717** (in Minnesota, call **1-612-631-3550**).

**MultiTech**  
Systems 

*The right answer every time.*

82 Second Ave. S.E., New Brighton, MN 55112 (612) 631-3550, TWX: 910-563-3610

**MultiTech**  
Systems 

**MultiModem 224**  
2400/1200/300 BPS Intelligent Modem



# Princeton Graphic Systems Number One Again

Sharp resolution, full compatibility, and rugged reliability. That's what you get in every Princeton Graphic Systems monitor. That's why Princeton Graphic Systems is number one in the minds of more and more personal computer owners every year.

Only Princeton Graphic Systems offers a complete family of quality personal computer

displays. Our color and monochrome monitors outperform the competition every time. That's why, for the second year in a row, our HX-12 high resolution color monitor has been voted best in the world.\*

So for the very best in personal computer monitors, pick the company that's number one. Princeton Graphic Systems.

\*PC WORLD Magazine's 1985 World Class Survey.



## PRINCETON™

GRAPHIC SYSTEMS  
AN INTELLIGENT SYSTEMS COMPANY

601 Ewing Street, Bldg. A, Princeton, NJ 08540, (609) 683-1660, Telex: 821402 PGSPRIN, (800) 221-1490 Ext. 704





## The IBM Proprinter

### IBM's replacement for its Graphics Printer

BY RICH MALLOY

**Y**ou've just printed out a three-page letter on fanfold microperforated paper. You remove the perforation strips and separate the pages. The letter looks professionally typed, but now you have to print the address on the envelope. You remove the fanfold paper and insert the envelope, being careful not to catch it on the tractor-feed sprockets. Then you print the envelope and reinsert the fanfold paper. The whole process takes about 20 minutes. You think that there has to be a better way to print envelopes. And you begin to wipe the dust off your neglected typewriter.

The new Proprinter from IBM offers a simple solution. It has a long slot on the front panel into which you can easily insert envelopes and single-sheet paper. The beauty of the design is that you never have to remove the fanfold paper.

The Proprinter has other features, too. It can print at 84 characters per second in draft mode or 27 cps in near-letter-quality (what IBM calls NLQ) mode. It is compatible with the Epson MX-80 and with IBM's previous dot-matrix Graphics Printer, and it costs a fairly reasonable \$549. Unfortunately, the Proprinter is not without its problems.

At first glance, the Proprinter seems a little larger than the Epson MX-80 or FX-80. The control panel is on the left side of the front panel, which makes it easier to see. The on/off switch is on the right side, just where it is on the IBM Personal Computer. It fits attractively on a desk, but note that you will probably have to use it with some type of printer stand.

#### SPEED

The Proprinter is fast but, like most dot-matrix printers, not as fast as advertised. In my tests, the printer produced at an average of 84 cps, a long way from the advertised 200 cps. Actual speeds varied widely from 72 to 115 cps. By comparison, an Epson FX-80 printed at 81 cps in the same test.

In emphasized mode, the Proprinter

slowed to an average of 42 cps, far from the advertised 100 cps. And in NLQ mode, the printer slowed to a moderate but respectable 27 cps, which is the closest of the three modes to its advertised speed, 40 cps.

The Proprinter could have had better results in our benchmark tests but, toward the end of each test, it paused between lines. I repeated the tests with a word-processing program (XyWrite II Plus) and had similar results. According to the optional Proprinter technical reference manual, the printer pauses for "dense patterns" because it thinks the print head is too hot. The manual suggests that you not turn the printer on and off unnecessarily, but I got similar results whether I had just turned the printer on or left it on for a day. The guide to operations, the only manual bundled with the printer, does not explain the problem. The benchmark test is fairly simple (a BASIC program that prints 50 lines of 60 As each) and should not have caused any problems.

#### PRINT QUALITY

The Proprinter's print quality in draft and emphasized modes is almost exactly like that of the Epson MX-80. This is passable, if not aesthetically pleasing.

In NLQ mode, the printer does much better (see figure 1). The characters are distinct and the dots are indiscernible. However, I would have preferred a better typeface: I dislike the sans serif style, the square O, and the house-like A. Also, in draft and emphasized modes, the dot of the *i* is not lined up with the rest of the character. The Proprinter does let you download other characters. I did not try this feature, but it looks fairly straightforward.

#### NOISE

The new ink-jet, thermal-transfer, and laser printers are very quiet. The Proprinter harks back to a noisier time. It seems as loud as any dot-matrix printer I have used.

Also, because of its rather high speed, the

(continued)

Rich Malloy is BYTE's New York editor. He can be reached at BYTE/McGraw-Hill, 43rd Floor, 1221 Avenue of the Americas, New York, NY 10020.

## AT A GLANCE

### Name

IBM Proprinter

### Type

Dot-matrix printer

### Manufacturer

IBM National Distribution  
Division  
1000 Westchester Ave.  
White Plains, NY 10604  
(800) 426-2468

### Features

Draft mode: 200 cps (84 cps actual)  
NLQ mode: 40 cps (27 cps actual)  
Maximum graphics resolution: 240 dots per inch  
Compatible with IBM Graphics Printer and Epson MX-80  
Front slot allows easy insertion of single-sheet paper and envelopes  
Tractor-feed and friction-feed mechanisms

### Options

Serial interface \$99  
5K-byte buffer \$35  
Ribbon cartridge \$9.25  
Technical reference notes \$28

### Documentation

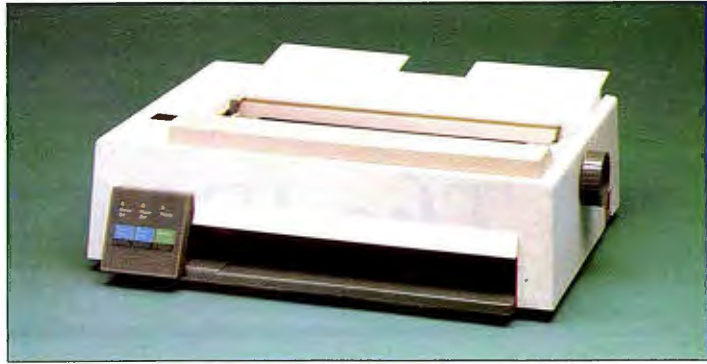
160-page guide to operations

### Warranty

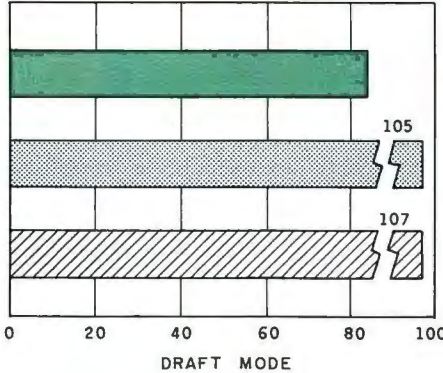
One year

### Price

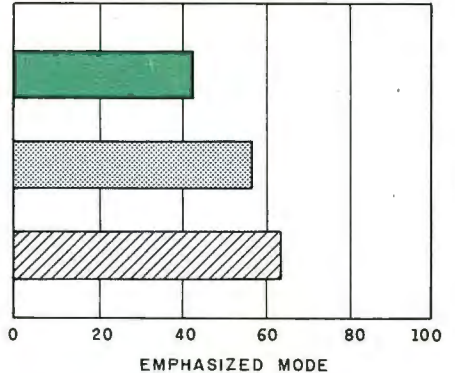
\$549



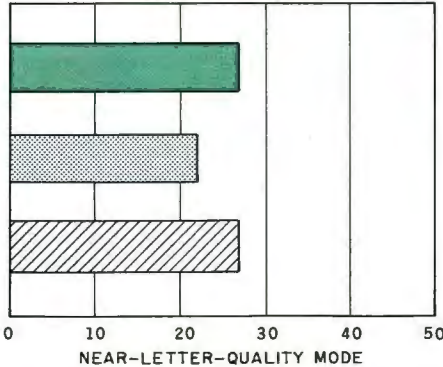
PRINT SPEED (CHARACTERS/SEC)



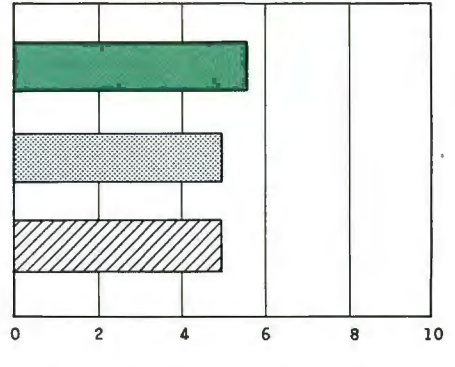
PRINT SPEED (CHARACTERS/SEC)



PRINT SPEED (CHARACTERS/SEC)



LIST PRICE (\$100)



■ IBM PROPRINTER    ■ EPSON FX-80    ■ OKIDATA MICROLINE 92

This is the IBM Proprinter, Emphasized mode

This is the Epson FX-80, draft mode.

This is the Okidata Microline 92 in draft

A comparison of the IBM Proprinter with the Epson FX-80 and the Okidata Microline 92. The print speeds were determined by timing how long it took the printers to print 50 lines of 60 As each. The prices shown are list prices.

The print speeds were determined by timing how long it took the printers to print 50 lines of 60 As each. The prices shown are list prices.

# THE X-10 POWERHOUSE DOES EVERYTHING BUT PUT OUT THE CAT.



Model CP290

## THE X-10 POWERHOUSE INTERFACES WITH YOUR COMPUTER TO CONTROL YOUR HOME...FOR SECURITY, COMFORT AND ENERGY SAVINGS.

This remarkable Interface lets you run your home through your Apple IIe or IIc, Commodore 64 or 128 and a mouse, keyboard or joystick.

When you're away, it makes your home look and sound lived in. When you're home, it can turn off the TV at night and wake you up to stereo and fresh brewed coffee in the morning. It can even turn on your air conditioner and control your heating.

### SPECIAL COLOR GRAPHICS MAKE PROGRAMMING A SNAP.

You simply pick a room from the display screen. Use your mouse, joystick, or keyboard to position graphics of lights or appliances. Then follow on-screen instructions to program any light or appliance to go on or off whenever you choose. You can even control thermostats, light intensity and more.



**THE WAY IT WORKS.** The X-10 Powerhouse Interface is cable-connected to an Apple RS-232 port or a Commodore "User" port and plugged into a standard 110V outlet. After it is programmed, the Interface sends digitally encoded signals through your home wiring to special X-10 Modules. To control a lamp or appliance, you simply plug the electrical device into a Module



and then plug the Module into an outlet. The Interface can control up to 256 Modules throughout your home and won't interfere with normal use of lights and appliances.

There are plug-in Appliance Modules, Lamp Modules, Wall Switch Replacement Modules and Special 220V Modules for heavy duty appliances such as water heaters and room air conditioners. Plus Thermostat Controllers for central heating and air conditioning, Telephone Responders to control your home from any phone, and much more.

**IT WON'T TIE UP YOUR COMPUTER.** Use your computer only for programming. When you're finished, disconnect the Interface from your computer and keep it plugged into any convenient power outlet in your home. It will operate as a stand-alone controller with battery back-up and will run your home automatically.

**SURPRISINGLY INEXPENSIVE.** A Powerhouse System including the Interface, software and connecting cables costs less than \$150. X-10 Modules are less than \$20 each.

**Software for IBM PC and compatibles available soon.**

For the Dealer Nearest You Call: **1-800 526-0027**  
or, write to: X-10 (USA) [in NJ: (201) 784-9700]

185A Legrand Avenue  
Northvale, NJ 07647

**X-10 POWERHOUSE**  
NUMBER ONE IN HOME CONTROL

Apple, Apple IIe and Apple IIc are registered trademarks of Apple Computer, Inc. Commodore 64 and 128 are registered trademarks of Commodore Int'l Ltd. IBM PC is a registered trademark of International Business Machines Corporation.



Draft: ABCDEFGHIJKLMNOPQRSTUVWXYZabcdefghijklmnopqrstuvwxyz01234567  
 Boldface: ABCDEFGHIJKLMNOPQRSTUVWXYZabcdefghijklmnopqrstuvwxyz01234  
 Underlined: ABCDEFGHIJKLMNOPQRSTUVWXYZabcdefghijklmnopqrstuvwxyz012  
 Nonprinting:  
 Compressed: ABCDEFGHIJKLMNOPQRSTUVWXYZabcdefghijklmnopqrstuvwxyz0123456789  
 Superscript: ABCDEFGHIJKLMNOPQRSTUVWXYZabcdefghijklmnopqrstuvwxyz01  
 Subscript: ABCDEFGHIJKLMNOPQRSTUVWXYZabcdefghijklmnopqrstuvwxyz0123

Special accent characters (codes 131-140): åäågëèéíí  
 (selected from character set 2)

Control Codes

- Escape E: Emphasized**
- Escape F: Cancels Emphasized
- Escape G: Double-Strike (near letter qual)
- Escape H: Cancels above
- Escape E & G: Emphasized Double strike**
- Escape F & H: Cancel emphasized double strike
- Escape I ASCII 2: Near Letter Quality
- Escape I ASCII 0: Normal quality
- Escape S ASCII 0: Superscript
- Escape T: Cancels above
- Escape S ASCII 1: Subscript
- Escape T: Cancels above
- Escape "-" ASCII 1: Underline following text
- Escape "-" ASCII 0: Cancel above
- Escape ":" Start 12 characters per inch pitch
- ASCII 18: Start 10 characters per inch pitch
- Escape W ASCII 1: Double-wide pr**
- Escape W ASCII 0: Cancel double-wide printing
- ASCII 15: Condensed printing
- ASCII 18: Cancels above
- ASCII 15 Escape E: Emphasized Condensed printing**
- ASCII 18 Escape F: Cancels Emphasized Condensed printing
- ASCII 15 Escape G: Double strike Condensed printing**
- ASCII 18 Escape H: Cancels Double strike Condensed printing
- Escape ":" Escape G: Start 12 characters per inch pitch, double strike
- ASCII 18 Escape H: Cancel above

Figure 2: Samples of the Proprinter's printing capabilities.



### STATE-OF-THE-ART MAGNETIC MEDIA

#### 5 1/4" DISKETTES



- With Hub Rings
- With Write Protect Tabs
- With Static-Free, Dust-Free Envelopes
- With User ID Labels
- In Factory Sealed Poly Packs

**69¢**


Single Side  
Double Density

**79¢**

Double Side  
Double Density

100% ERROR FREE - LIFETIME WARRANTY  
MEET OR EXCEED APPLICABLE ANSI, ECMA, ISO STANDARDS

Minimum quantity: 50 diskettes. Discount for 300 or more diskettes. Shipping and Handling: \$4.00 per 100 diskettes. Reduced shipping charge for larger quantities. C. O. D. add \$4.00. Cash or certified check. MI residents add 4% sales tax. Prices subject to change without notice.


**Precision Data Products**  
 P.O. Box 8367, Grand Rapids, MI 49508  
 (616) 452-3457 • Michigan 1-800-632-2468  
 Outside Michigan 1-800-258-0028

Inquiry 287

### ATTENTION DEALERS!!

#### IBM Compatible Lowest Prices For Quantity Buys\*

XT 8 Slot 256K Motherboard (ØK)	<b>5-9*</b>
XT 8 Slot 640K Motherboard (ØK)	<b>\$124</b>
Monochrome Graphics Card w/ printer port* (720 x 348 Graphics mode, 64K, can run Lotus)	<b>\$134</b>
384K Multifunction Card (w/cables, software, ØK)	<b>\$ 84</b>
Color Graphics Card	<b>\$ 9</b>
Multi I/O Card	<b>\$ 67</b>
Floppy Controller Card	<b>\$ 97</b>
Cases, Power Supplies, Serial Card, & much more	<b>\$ 37</b>
	<b>Call</b>

#### Supreme Company

1630 Oakland Rd, A 103  
 San Jose, CA 95131  
**408-971-6400 FAX 408-971-6115**  
**TLX 172412 Scam SNJ**

\* For larger orders call for quote

Inquiry 343

### REVIEW: PROPRINTER

*In many ways,  
the IBM Proprinter  
seems to be a clone of  
the Epson FX-80.*

has such a switch, but it is tiny, unlabeled, and hidden deep inside the machine. Second, you should not have to press the Online button before the Line Feed or Form Feed buttons. In order to skip to the next page on the Proprinter, you have to press Online, Form Feed, and Online again. Why not just Form Feed? Almost all printers are set up this way, and I have no idea why. In fact, the only printer I know that has both of the above features is the Texas Instruments Model 855.

#### CONCLUSION

In many ways, the Proprinter seems to be a clone of the Epson FX-80. Its two distinguishing features are its NLQ mode and its slot in the front to allow easy printing on single-sheet paper and envelopes. Unfortunately, the printer has some problems handling fanfold paper, and the NLQ font could have been made more pleasing without much extra work.

The important things to consider in a dot-matrix printer are cost, print quality, speed, noise, compatibility, reliability, and ease of use. The Proprinter has a reasonable price of \$549. An equivalent Epson FX-80 sells for \$499. In terms of print quality, speed, noise, and compatibility, the Proprinter is unexceptional. As for reliability, it is difficult to say much after a short test; the printer seems solidly built and has a one-year warranty, but the jury is still out. The only area where the Proprinter excels is ease of use, and that only because of its front slot. If you will not be using this slot much, I suggest you look around at other dot-matrix printers. However, if you would be using this feature fairly often, I recommend this printer. ■

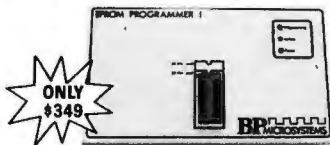
### PC EXPANSIONS

AST SixPakPlus (64k)	\$229
SixPakPlus (384k)	\$259
MegaPlus (64k)	\$269
Advantage (128k)	\$409
Advantage (1.5M)	\$569
I/O Plus	\$129
PCnet - starter kit	\$809
Quadboard (64k)	\$193
Quadboard (384k)	\$229
Quadmeg-AT (128k)	\$319
Quadmeg-AT (2M)	\$529
Quadport-AT	\$105
HERCULES graphics board	\$319
Color Card with PP	\$159
HAYES Modems: 2400	\$call
Smartmodem 1200	\$409
Smartmodem 1200B	\$379
Set of 9 chips (64k)	\$6
256k chips (each)	\$3
8087 chip	\$119
Maynard Disk Controller	\$100
Sandstar Series	\$call
Internal Hard Disks from	\$609
MaynStream tape backup from	\$979
Qume 142A	\$99
Teac FD55B	\$99
Tandon TM100-2	\$109
CDC 9409	\$119
Verbatim Datalife disks (10)	\$20

#### VLM Computer Electronics

10 Park Place • Morristown, NJ 07960  
 (201) 267-3268 Visa, MC, Check or COD.

### EPROM PROGRAMMER



**ONLY \$349**

#### A great value, here's why:

- Programs and reads 2716 through 27513 EPROMs, 2516 through 2564 EPROMs, 52B13 through 52B33 EEPROMs and others to manufacturers' specs
- Programs A suffix and CMOS parts
- Uses fast programming algorithm
- Requires no personality modules
- RS-232 input requires no special software
- Includes communications software for IBM PC and compatibles
- Uses Intel, Motorola, Tektronix and other formats
- Splits files for 16 bit systems
- Gold Textool ZIF socket
- Sturdy Construction
- Full 1 Year Warranty

## BP MICROSYSTEMS

5325 Glenmont, Suite E, Houston, TX 77081  
**(713) 667-1636**

Inquiry 43

## 64K ■ 128K ■ 256K

# DRAMS

## 80287-8 ■ 80287-3

## 8087-3 ■ 8087-2

## 8087-1

### BITTNER



899 SOUTH COAST HIGHWAY  
 LAGUNA BEACH, CA 92651  
**(714) 497-6200**  
 CALL NOW FOR **FREE** CATALOG

Inquiry 35

### Software for Engineers

#### Electronic Circuit Analysis

- Nonlinear transient, DC, AC analysis
  - Worst Case, Monte-Carlo
  - Frequency, time dependent parts
- \$450.**

#### Logic Simulation System

- Full delay analysis (min, max, typical, load dependent)
  - Ability to save simulation results
- \$395.**

Both have:

- Built in editor, fully interactive
- Macros (unlimited)
- Large circuits

For MS-DOS, 192k minimum

**Tatum Labs**  
**33 Main Street**  
**Newtown, CT 06470**  
**(203) 426-2184**

Inquiry 346

An unbelievable number of software companies will try to tell you their word processors are easy to use. But one look at even the simplest command calls their bluff.

The boldface feature, for instance. This "simple" command can require up to six keystrokes on some systems. You could spend months learning to use them. And that's no exaggeration.

Boldfacing with our system requires only one keystroke: *b* to *boldface*. Just as *c* will *copy text*, *d* will *delete* it, and *e* will *end* the edit.

Our system is Final Draft. And we spent months designing it to be the best system on today's market. Best because our edit commands are alphabetically-assigned so that you can remember them easily. Best because we have only 35 commands, not 305. Best because you can learn our system the first day and master it the second.

But let's not distort the facts: Final Draft isn't just simple. It's powerful. Features like the thesaurus, floating footnotes, canned paragraphs and automatic

red-lining are no myth.

There's only one thing about Final Draft that's hard to believe: the price. It's \$395.

So if you're tired of hearing one boldface lie after another, just heed this simple truth: Final Draft is a great word processor.

### **FINAL DRAFT™**

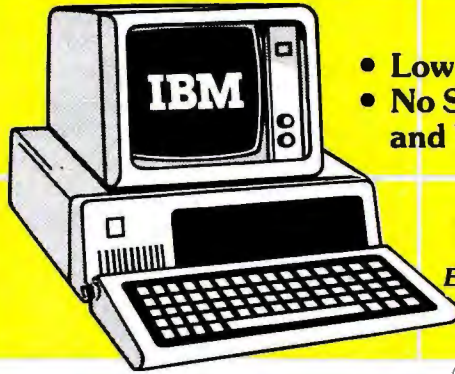
The word processor from CYMA/McGraw-Hill. Call 800-292-CYMA.

Inquiry 94 for End-Users.  
Inquiry 95 for DEALERS ONLY.

# IT'S A BOLDFACE LIE



# Save



- Low Low Prices
- No Surcharge for MasterCard and VISA

**1-800-231-9842**  
WESTERN REGIONAL ORDERS

**1-800-237-4048**  
EASTERN REGIONAL ORDERS

These Fine Corporations, Universities and Companies Put Their Trust In "COMPUTER MART"

ATT	American Savings	University of:
3M	Landmark Mortgage	California
Magnavox	American Nurse Assoc.	Illinois
Eaton	Dun & Bradstreet	New York
Merrill Lynch	U.S. Navy - Army	Colorado State

Put Your Trust In **COMPUTER MART**

### • COMPUTERS •

IBM ENHANCED AT	4928
IBM ENTRY LEVEL AT	3241
IBM PC, 1 DSDD DR, 256K	1702
IBM PC, 2 DSDD DR, 256K	1826
IBM PC, NO DRIVES, 64K	1616
IBM PC, 2 HALF/HYTE	
256K	1702
IBM XT, 1DSDD DR/10MB,	
256K	3355
IBM XT, 1DSDD DR/TA HD,	
256K	2491
COMPAQ, 2 DSDD, 256K	2173
COMPAQ PORTABLE 2	
MODEL 2	5292
COMPAQ DESK PRO	
MODEL 3	3304
COMPAQ DESKPRO	
MODEL 2	2156

### • MONITORS •

AMDEK 300G	119
AMDEK 300A	123
AMDEK 310A	140
AMDEK 600 RGB COLOR	409
AMDEK 710 SUPER HI RES	
COLOR	447
IBM COLOR	616
IBM MONOCHROME	235
PRINCETON MAX-12 E	160
PRINCETON HX-12 RG	
COLOR	446
PRINCETON SR-12	575
PRINCETON HX-12E	
COLOR	510
QUADRAM AMBER-	
CHROME	171
QUADRAM QUADCHROME	
II	426

### • DISPLAY CARDS •

STB SUPER HI RES 400	402
HERCULES COLOR	151
IBM MONOCHROME	218
IBM COLOR	226
EVEREX GRAPHICS EDGE	328
GENOA SPECTRUM	289
TECMAR GRAPHICS	
MASTER	459
PARADISE MODULAR	
GRAPHICS	274

### • BOARDS •

AST SIX PACK PLUS, 64K	223
AST MEGAPLUS, 64K	205
AST MP-2, 64K	228
AST ADVANTAGE, 128K	384
AST I/O PLUS	122
JRAM-2	156
QUADRAM QUADBOARD	
ØK	186
QUADSPRINT	423
TECMAR CAPTAIN, ØK	162
TECMAR FIRST MATE, ØK	200
TECMAR WAVE XT, 64K	187
TECMAR JR CAPTAIN,	
128K	295

### • MODEMS •

HAYES 2400	627
HAYES 300	138
HAYES 300/1200	407
HAYES 1200B	
w/SOFTWARE	346
HAYES 1200B	351
VEN-TEL HALF CARD	374
VEN-TEL 300/1200	
INTERNAL	341

AST REACH HALF CARD	
1200	363

### • PRINTERS •

OKIDATA 83A, WIDE	
CARRIAGE	545
OKIDATA 84P, WIDE	
CARRIAGE	660
OKIDATA 92P	392
OKIDATA 93P, WIDE	
CARRIAGE	597
OKIDATA 2410P	1782
OKIDATA 182	215
OKIDATA 192	376
OKIDATA 182S	259
OKIDATA 184	660
EPSON FX-80 TRACTOR	371
EPSON LX-80	255
EPSON FX-185, WIDE	
CARRIAGE	515
EPSON FX-100, WIDE	
CARRIAGE	531
EPSON JX-80 COLOR	
PRINTER	531
EPSON LQ-1500	
PARALLEL	1002
NEC 2050	694
NEC 3550	1058
NEC 8850	1478
JUKI 6100	362
JUKI 6300	503

### • ACCESSORIES •

OKIDATA 82/92 TRACTOR	44
NEC BI-DIRECTIONAL	
TRACTOR	151
NEC CUT SHEET GUIDE	63
JUKI 6100 BI-DIRECTION	
TRACTOR	105
JUKI 6300 BI-DIRECTION	
TRACTOR	122
MEMORY, 65K CHIPS	8
MEMORY, 256K CHIPS	39
PRINTER CABLE	10
MICROFAZER BUFFER, 8K	131

# Save



## COMPUTER MART

1901 S. TAMiami TRAIL, VENICE, FL 33595  
2820 W. CHARLESTON, LAS VEGAS, NV 89102

Call for non-advertised and lower current prices. IBM is a registered Trademark of International Business Machines. Prices subject to change. We accept all major credit cards, money orders, and personal checks. 2% surcharge for shipping, handling and COD shipments, and purchase orders \$100 minimum. Returns are subject to a 15% restocking fee. All sales final.

**IN FLORIDA CALL 813-493-2736**  
**IN NEVADA CALL 702-877-3988**





## Panasonic's 4-Color Graphic Penwriter

It's an  
electronic  
typewriter,  
a printer,  
and a  
graph maker

BY JON R. EDWARDS

**T**he Panasonic 4-Color Graphic Penwriter, a versatile electronic typewriter and graph maker, has so great a list of "stand-alone" features that it is easy to overlook the RS-232C serial interface that permits the Penwriter to function as a printer. The Penwriter has a built-in graphics package, including column layout and pie, bar, line, and radar graphs. You can easily change colors and select from among two fonts and 10 different character sizes. The list of features also includes vertical printing, a 4K-byte text-memory buffer for editing short documents, and a command mode for composing lines and figures. The printer can also access the command mode, letting you write simple programs to generate printed graphics.

The Penwriter is certainly portable. It can run on batteries, and it measures 14½ by 10½ by 2½ inches and weighs slightly less than 6 pounds (without batteries). A plastic dust cover holds additional pen sets.

The Penwriter uses water-based ballpoint pens to print. Panasonic rates the life of each pen at approximately 40,000 characters. Characters are not as well formed as they are with daisy-wheel printers, however; many of the characters have a dot-matrix appearance, but the printing method does allow a variety of fonts, character sizes, and graphics.

At first glance, the top of the unit appears daunting. The keyboard contains a number of nonstandard keys, and many switches and buttons complicate its appearance. In truth, however, I must admit that I have long disliked DIP (dual in-line package) switches; I prefer to have quick access to every option.

In the upper right-hand area of the keyboard are eight switches and a color-change button. Pressing the color button rotates the pen holder one stage through the cycle of black-red-green-blue. You can set the eight switches for interesting combinations of printing modes and character fonts, sizes, and shapes. You can, for example, choose between italics and a "normal font," select

bold type or underlining, alter the horizontal or vertical size of individual characters (see figure 1), change the line spacing, select one of two available character sets, type or draw in direct mode, or set up the Penwriter as a printer.

Above the keyboard and to the left are five graphics keys (see photo 1). The column-layout function frames information within boxes. Like all the graph functions, however, it does not work in conjunction with software. Rather, you must set up the columns either in direct-printing (DP) mode or in line-by-line (LL) mode. This is perhaps the most severe limitation of the "printer," since the other charts, while able to use data from any other type of graph, are limited to 12 data entries. The appearance of the graphs is impressive (see figure 2). They are available in three sizes, with selective hatching and color, and there's a data-editing feature, but you may miss the ability to tie the functions to spreadsheets.

The keyboard contains several keys common to typewriters but not to computers. These keys handle the setting and releasing of tabs and margins. The character-set selector introduces a range of additional characters, including international symbols. Five accent symbols are designated as dead keys, facilitating their use with other characters. There is, however, no easy way to use these additional keys and features in the printer mode.

### AS A TYPEWRITER

As an electronic typewriter, the Penwriter has four modes. In DP mode, it immediately prints the keys that you press. You can set the margins, use the tab, backspace to move the carriage, and use the margin release to pass the right margin. As with some typewriters, a buzzer sounds to indicate the approaching right margin. The Penwriter can center text, flush text against the right margin, and produce overlays for very distinctive printing (see figure 3).

(continued)

SPACING		HORIZONTAL		
		1	2	3
VERTICAL	1	abcdefg	abcd	abc
	2	abcdefg	abcd	abc
	3	abcdefg	abc	abc

Figure 1: Two of the switches on the Penwriter keyboard control the horizontal and vertical sizes of the characters. The standard line has about 10 characters per inch. Note that the linefeed space is proportional to the vertical size of the character. Other switches change the print color, select among boldface, underlining, and italics, set the line spacing, and put the Penwriter into its printer mode.



Photo 1: The Penwriter's five graphics keys are used for pie charts, bar charts, line graphs, radar graphs, and column layout.

In LL mode, characters are displayed on the 24-character-wide liquid-crystal display (LCD) before they are printed. You can edit the text appearing on the screen with the Backspace or the Forward key. The Delete key erases characters under the screen cursor. You can print vertically in both modes by pressing Code and the V key. When printing vertically, the space bar and the Reverse Index, Index, Return, and Backspace keys adjust the paper, but you cannot set the top margin and tabs.

The command mode accepts and executes graphics commands. You can move the pen; establish an origin; draw lines, dashes, axes, and circles; and set the character size, color, and rotation. You can generate graphics immediately or use the printer, a method that vastly enhances the graphics potential of the Penwriter. One control code (12 hexadecimal) puts the printer into command mode. I was therefore able to use the BASIC LPRINT command to change color, draw circles, and rotate characters. Using several examples in the documentation as a guide, I wrote a short BASIC program (see listing 1) that generates figure 4. I also printed some letterheads.

Pressing the Mode In/Out key enables the fourth mode, text memory. In this mode, the Penwriter can store up to 3310 characters in its memory; you can divide the work space into nine phrase memories. Special keys print the text, search for specified words, delete the contents of a phrase, check the amount of memory available, and shift the cursor left, right, and up or down one line. You can set margins before or after entering text. There is an automatic word-wrap feature.

You can use the Penwriter with batteries or with an external AC power adapter that comes with the unit but does not neatly tuck away inside the dust cover. When the batteries are weak, the LCD begins to flash. With batteries in, or if the AC adapter is continually connected, text memory, graphics data, RS-232C transmission

(continued)



## MAKE THE CONNECTION . . .

Our **Connection** systems will solve your problem of trying to read and write diskettes or tapes from almost any computer system using your PC.

The **Diskette Connection** is a hardware system that enables the IBM PC or compatible to read and write most 8 inch, 5¼ inch, or 3½ inch diskettes.

With our **File Connection** software programs you can transfer data files between most computer systems, including CP/M, DEC, Honeywell, Univac, IBM 3740, S/1, S/3, S/23, S/32, S/34, S/36, and S/38.

Our **Word and Typesetting Connection** programs use IBM standard Document Content Architecture (DCA-RFT) to transfer document files between most word processing and typesetting systems, including Compugraphic MCS, CPT, Displaywriter, OS/6, Multiset, NBI, Quadex, Xerox, and Wang.

Our **Tape Connection** system will read and write IBM or ANSI standard ½ inch 1600 BPI magnetic tape. A full size 2400 foot tape can store a 45 MByte file and be written in 6 minutes.

Since 1982, we have supplied thousands of systems to customers around the world, including IBM, NASA, AT&T, Kodak, and General Motors.

Our specialty is conversion systems and we can provide a solution to your problem. Call us today to discuss your requirements.

*This ad is one of a series featuring NASA missions. For a free poster, send us your written request.*

**Box 1970 Flagstaff, AZ 86002  
(602) 774-5187 Telex 705609**

## AT A GLANCE

### Name

Panasonic 4-Color Graphic Penwriter

### Type

Electronic typewriter, graph maker, and printer

### Manufacturer

Panasonic  
One Panasonic Way  
Secaucus, NJ 07094  
(201) 348-7000

### Size

14½ by 10½ by 2½ inches

### Features

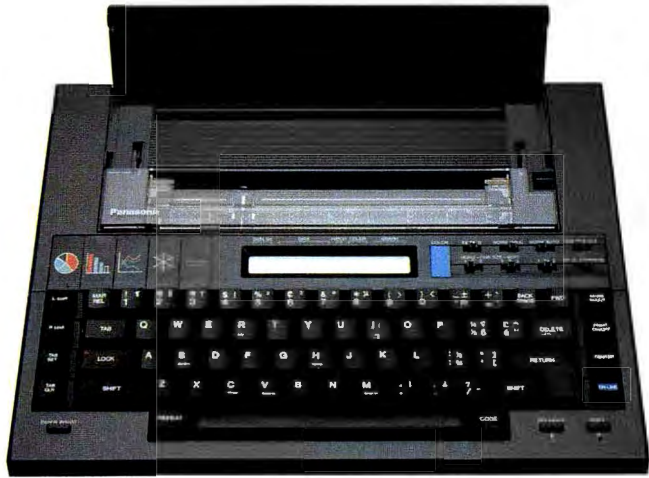
Four water-based ballpoint pens (each has 40,000-character capacity), 24-character LCD, five graphics packages, Courier and italic fonts, boldface, underlining, variable character size, 13 graphics commands, 4K-byte memory buffer, RS-232C interface (receive-only), battery option, 80 characters per line

### Documentation

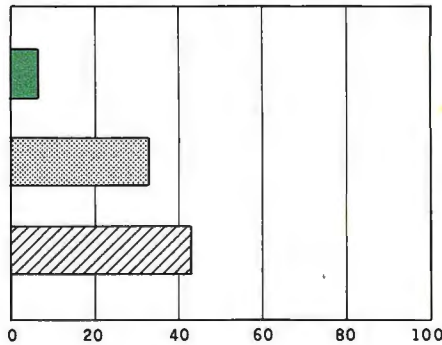
64-page user's manual

### Price

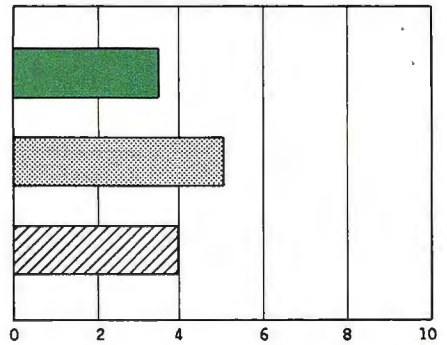
\$350



PRINT SPEED (CHARACTERS/SEC)



LIST PRICE (\$100)



PANASONIC PENWRITER
  EPSON RX-80
  GEMINI-10X

This is the Panasonic 4-Color Graphic Penwri

This is the Epson RX-80 in emphasized mod

This is the Star Gemini-10X This is the St

The Panasonic 4-Color Graphic Penwriter is compared with the Epson RX-80 and the Star Micronics Gemini 10-X in emphasized mode. The pitch for all printers is 10 characters per inch. The print speeds were determined by tim-

ing how long it took the machines to print the Shannon test (573 characters; see "The Art of Benchmarking Printers" by Sergio Mello-Grand in the February 1984 BYTE, page 193). The prices shown are list prices.

format, margins, and tab-setting positions remain in memory. As an extra feature for forgetful battery users, the Penwriter automatically switches off (without harming text memory, etc.) when there has been no input for about 10 minutes. This does not apply when you use the Penwriter as a printer.

Loading paper is a relatively straightforward procedure. Insert the paper into the paper channel, press the Insert key, and the paper moves forward automatically. I miss not having a platen knob to move the paper, however, and I found the paper-release lever, which must be released to adjust the paper, flimsy and far too tiny. It is almost impossible to insert the paper manually by releasing the lever and maneuvering the paper through; you must follow the directions.

The sheet feeder is not intended for continuous paper, and there is no optional tractor-feed mechanism. It would not be easy to use continuous paper. And in ordinary use, metal paper guides that press against the platen tend to perforate the left and right edges of even the thickest paper, distracting from the otherwise fine appearance of the printed output.

**AS A PRINTER**

I hooked the printer to the serial port of an IBM Personal Computer. Before going on line, the printer can accept new values for transmission rate, data length, and automatic linefeed. Once set, the values become defaults. You can also set the switches for color, boldface, underlining, italics, and character size. Alternatively, you can use underlining, boldface, and italics by calling upon the appropriate escape functions cited in the manual. Panasonic claims a printing speed for the Penwriter of 6.5 characters per second (cps). However, using the Shannon test (see "The Art of Benchmarking Printers" by Sergio Mello-Grand in the February 1984 BYTE, page 193), I recorded the speed at 5.7 cps. Printing in boldface or with larger characters visibly slows the machine.

*(continued)*

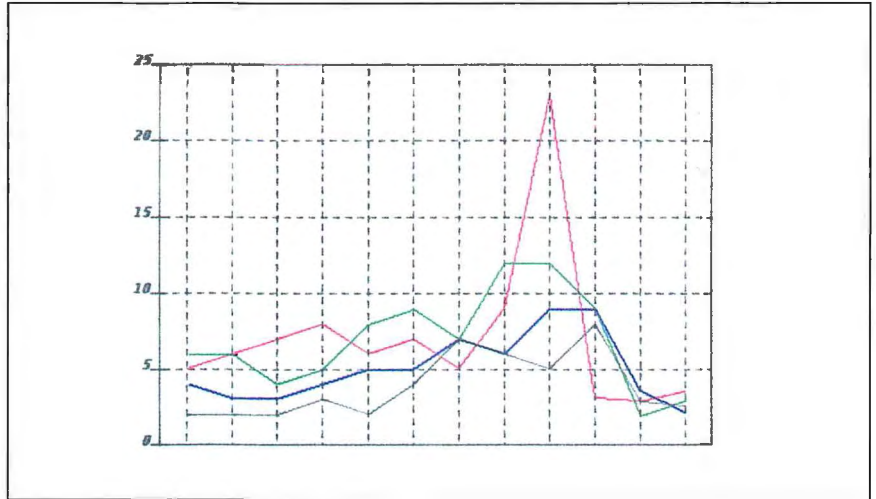


Figure 2: A comparative line graph.

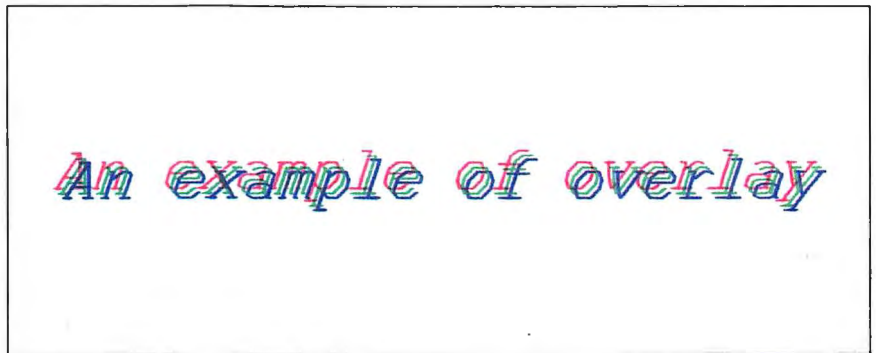


Figure 3: The Penwriter supports overlay printing in its direct-printing mode.

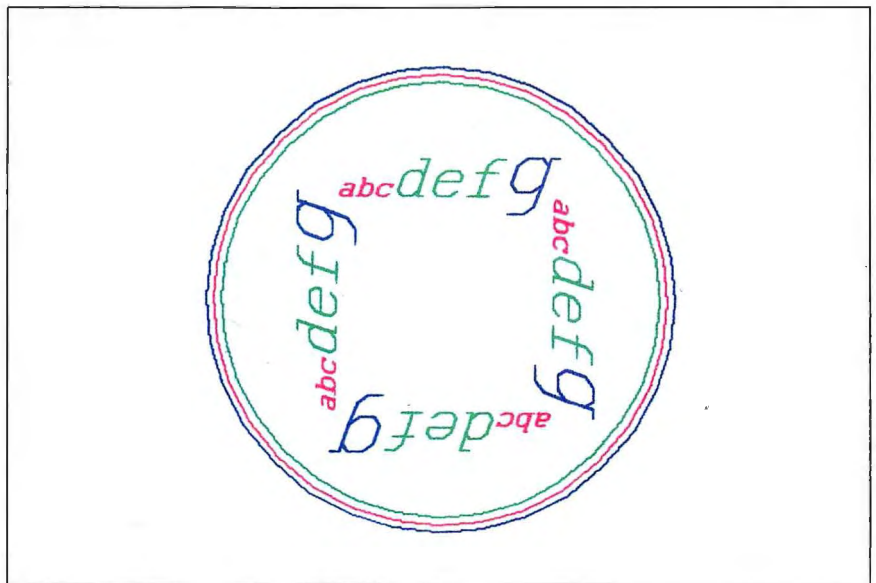


Figure 4: An example of Penwriter graphics.

Listing 1: This program uses the printer in command mode to produce figure 4.

```

10 LPRINT CHR$(18):REM enter command mode
20 LPRINT "r500,0:i":REM initialize origin
30 LPRINT "c3:y150:c2:y145:c1:y140":REM draw circles
35 LPRINT "r-75,75":REM relative move from origin
40 FOR X=0 TO 3
50 LPRINT "q";X:REM print in four directions
60 LPRINT "c1:s1,1:pabc"
70 LPRINT "c2:s2,2:pdef"
80 LPRINT "c3:s3,3:pg"
90 NEXT X
    
```

I recorded the slowest operation, boldface printing of characters three times the standard width and height, at 0.8 cps.

Cables are available to connect the printer to a serial port on an IBM PC, to the superserial card on the Apple, to the VIC1011A on a Commodore, or to the built-in serial port of the Panasonic Sr. Partner RL-H7000.

There is no optional parallel port. The RS-232C port is receive-only; you cannot use the Penwriter as a dumb terminal. Unfortunately, there is no provision to use the 4K-byte buffer as a spooler.

**DOCUMENTATION**

The manual is excellent. Careful, diagramed instructions cover every

aspect of use. There are instructions for replacing batteries and pens and for inserting paper; the manual explains every special key, switch, and printing mode. A section on use as a printer includes pen assignments and control codes.

**SUMMARY**

I enjoyed working with the 4-Color Graphic Penwriter. It combines versatility with a good price, though I remain concerned that some of the plastic components, including the paper guide and the transparent cover over the carriage, are too fragile to hold up under heavy use. I was also distracted by the perforation of the margins. Still, the Penwriter is a good value for people who require its versatility: One moment it's a printer, the next an electric typewriter with memory, and then a fancy printer of graphs and graphics. ■

# DRIVE ENCLOSURES

**FLOPPY**  
8" & 5"

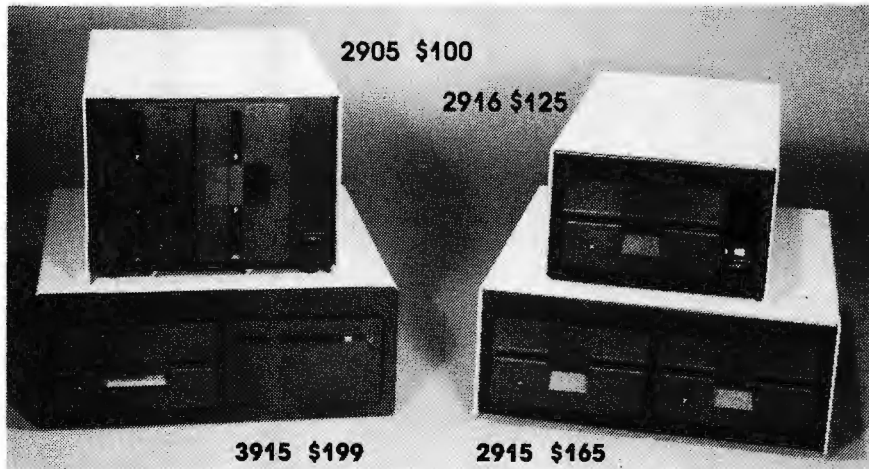
**TAPE**  
5" & 8"

**FLOPPY-WINCHESTER-TAPE**

**FROM \$80<sup>00</sup>**

(Includes Power Supply)

**WINCHESTER**  
5" & 8"



- Desktop & Rack
- Heavy Duty All Metal Cabinet
- Fan & Dust Filter\*
- Hefty Power Supplies
- Full or Slim Drives
- Power Harness From Supply To Drives
- Line Fuse, EMI Filter\*, Detachable Line Cord
- Cabinets & Supplies Available Separately

\* = Most Models (Disk drives not included)

**INTEGRAND**

RESEARCH CORPORATION

8620 Roosevelt Ave./Visalia, CA 93291

209/651-1203

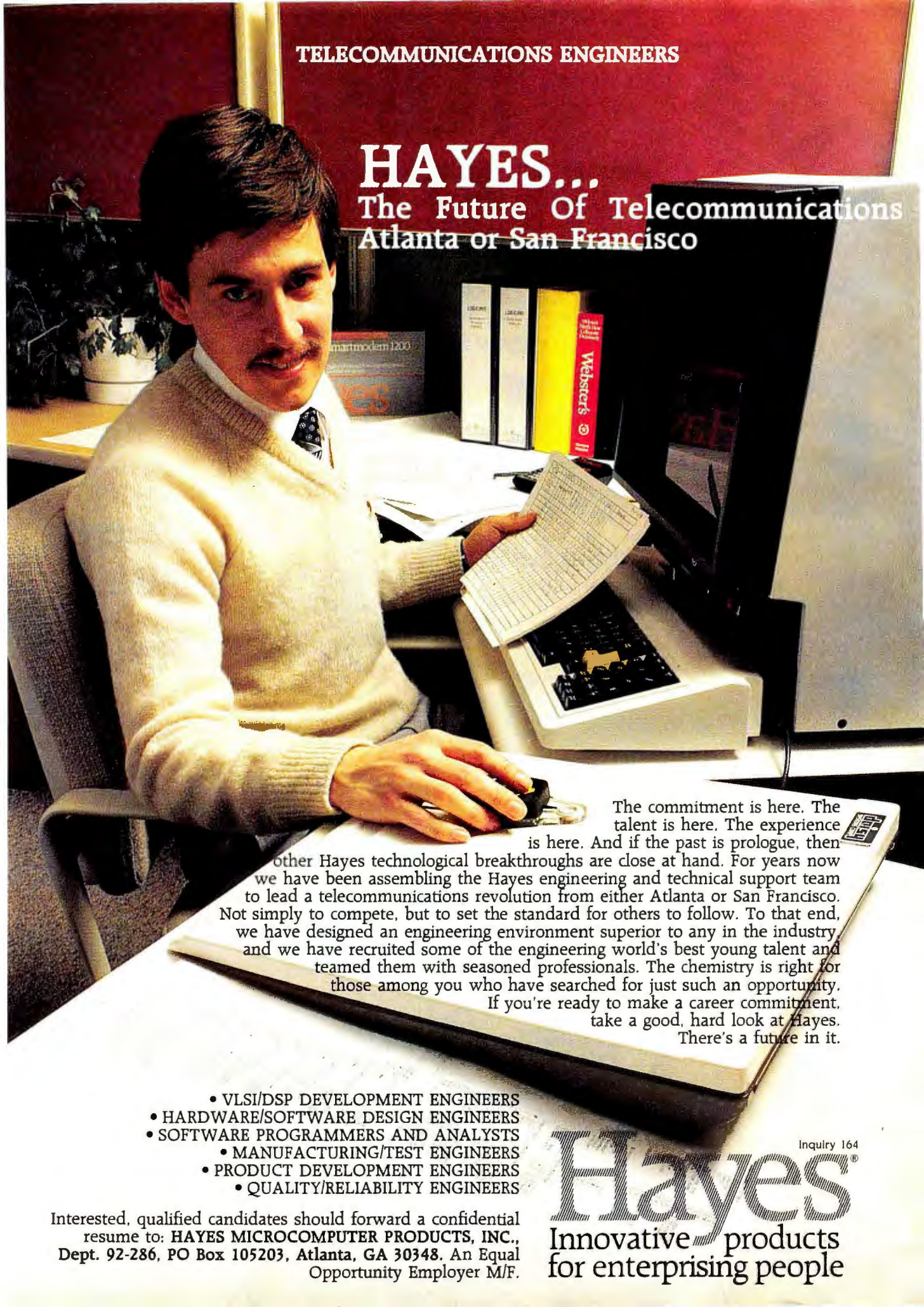
Write or call for our brochure which includes our application note:  
"Making micros, better than any ol' box computer"

32 Page Free Fakt Pakt Catalog

TELECOMMUNICATIONS ENGINEERS

# HAYES...

The Future Of Telecommunications  
Atlanta or San Francisco



The commitment is here. The talent is here. The experience is here. And if the past is prologue, then other Hayes technological breakthroughs are close at hand. For years now we have been assembling the Hayes engineering and technical support team to lead a telecommunications revolution from either Atlanta or San Francisco. Not simply to compete, but to set the standard for others to follow. To that end, we have designed an engineering environment superior to any in the industry, and we have recruited some of the engineering world's best young talent and teamed them with seasoned professionals. The chemistry is right for those among you who have searched for just such an opportunity.

If you're ready to make a career commitment, take a good, hard look at Hayes. There's a future in it.

- VLSI/DSP DEVELOPMENT ENGINEERS
- HARDWARE/SOFTWARE DESIGN ENGINEERS
- SOFTWARE PROGRAMMERS AND ANALYSTS
- MANUFACTURING/TEST ENGINEERS
- PRODUCT DEVELOPMENT ENGINEERS
- QUALITY/RELIABILITY ENGINEERS

Interested, qualified candidates should forward a confidential resume to: HAYES MICROCOMPUTER PRODUCTS, INC., Dept. 92-286, PO Box 105203, Atlanta, GA 30348. An Equal Opportunity Employer M/F.

Inquiry 164

# Hayes®

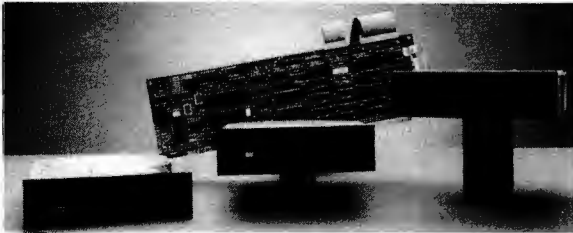
Innovative products  
for enterprising people



# TOP QUALITY

## ENHANCEMENT PRODUCTS

FOR IBM AND COMPATIBLE COMPUTERS

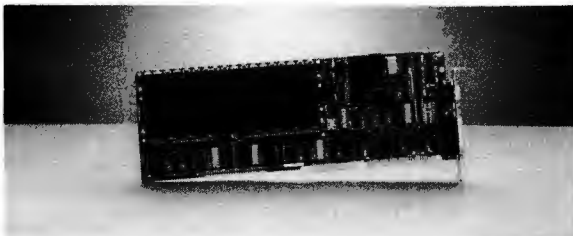


### Hard Disk Subsystems

- 10, 20, 30, 44, 65, 70, 120 MB
- High Performance Models For 286 Class Machines
- Formatted and Tested
- Easy Installation

### Tape Backup Subsystems

- 10 to 60 MB
- Internally Mounted or Free-standing
- High Speed

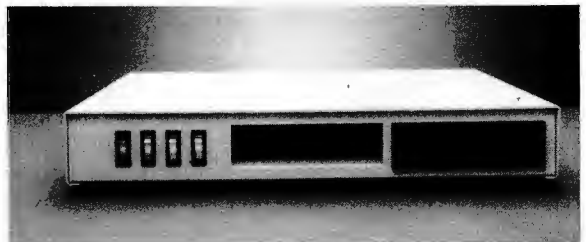


### Expansion Cards

- AT Multifunction
- AT RAM
- Four Function I/O (Short Slot)

### Accessories

- 640K Motherboard Upgrade
- Power Center™ Power Distribution



### WE BACK YOU UP

Specialists In Quality Add-on Products  
And Accessories For IBM, Compaq, AT&T Personal Computers

Our products are now available to dealers through  
MICRO D, PRICE ELECTRONICS, and SOFTSEL.

401 W. Dyer Rd., Santa Ana, CA 92707 • (714) 549-9111

IBM is a trademark of International Business Machines Corp.  
Compaq is a trademark of Compaq Computer Corporation  
AT&T is a trademark of American Telephone and Telegraph



# R·E·V·I·E·W F·E·E·D·B·A·C·K

## OSBORNE 3

I'd like to bring up some features of the Osborne 3 computer not covered by Donna Osgood in her review (September, page 284) and to emphasize others that I feel were covered too briefly. I have owned my Osborne 3 for seven months and have explored many of its limitations and advantages.

I wanted a machine that could support compilers for all the current languages, which meant I needed MS-DOS. I also craved the background print spooler and easy 1200-bps modem support. IBM media compatibility was a feature I desired so I could borrow one of the PC ATs at work for my large jobs. Above all, I wanted to avoid planned obsolescence. Portability was indicated, so I also put battery operation on the wish list. The Osborne 3 was the only machine on the market that met a majority of the criteria on my list.

I purchased my machine with 512K bytes of RAM, a nicad battery, and some free software my dealer threw in. The disk drives are very slow due largely to the lack of a track-zero detector on the Panasonic drives used in the machine; this necessitates a lot of grinding during disk access. So the first piece of software I obtained was a RAM-disk utility—end of that problem.

As I dislike editors that use the screen for anything but text, I haven't experienced the difficulty Osgood discussed in her article. She did neglect to mention the Osborne's auto-cursor mode. In this mode, the 24-line logical screen is auto-scrolled onto the 16-line Osborne LCD so the cursor is always visible. The fast repeat speed of the keys makes it easy to zip the cursor about to see any part of the screen.

Possibly the most unique feature of this machine does not appear in any manual. Since the Osborne runs on any voltage between 12 and 15 volts, I bought a power connector to match the Osborne's, a cigarette lighter plug, and 20 feet of heavy-gauge wire. I can compute anywhere I can drive my car without depleting the Osborne's on-board battery.

Osgood properly emphasized the limitations of the Osborne LCD. While vastly better than the Data General/One or

Kaypro 2000 displays, the contrast is still weak in normal room lighting. This is readily improved with strong over-the-shoulder lighting. The contrast is then entirely acceptable, and I have experienced no eyestrain after lengthy sessions at the machine.

I can easily carry my entire setup in a tote bag, including a tub of 50 disks. My projects on the machine include a quick-and-dirty database program written in Prolog for my Naval Reserve unit, a full relational database system with query language written in C, a set of MS-DOS utilities in C, and the design of an EMACS-like editor system to be written in either muLISP or IQLISP. When Turbo Pascal arrives, I'll probably finish some of the projects left over from my p-System Apple.

Last of all, I'd like to address the inevitable questions about the superiority of the Morrow Pivot and Zenith machines. They are better; for more than double the price, they had better be. And they certainly are not anywhere near double the machine.

ROBERT W. CUNNINGHAM  
San Diego, CA

## PARADISE CARD

I am writing in response to Harry Krause's review of the Paradise Modular Graphics Card (September, page 321). We use the card on IBM PCs with Princeton Graphic Systems MAX-12 amber monitors. We are unable to run programs such as DisplayWrite 2 that default to color mode when a color card is used. Although we turn the contrast and brightness knobs to full intensity, many of the shades representing colors are too dim to be easily read. The MAX-12 has no internal adjustment for intensity. We do not have this problem on IBM monochrome monitors because they have sufficient brightness control to make all shades easily readable.

We have tried using the MODE BW command at the operating-system level prior to running the application programs. This does not solve the problem because it seems that the MODE command operates only on the composite signal produced by the color card, not the RGB signal.

We welcome suggestions from readers on how to solve the problem. Unless a

solution is found, I suggest that users considering purchasing the Paradise Modular Graphics Card first test the card on their systems, using a program that produces text in several colors.

JAY FRANCIS  
Colorado Springs, CO

## JUKI 6100

In response to David Lewiston's letter on the Juki 6100 (August, page 286), I would like to say that I have been using a Juki 6100 for over a year now. The printer has seen fairly heavy use. My setup includes a tractor feed. I have not had the problems that Lewiston describes.

I do have some suggestions based on experience. For the sticking ribbon problem, the only IBM-style ribbons that don't stick are the pink-leader single-strike filament ribbons. The orange-leader ribbons and blue-leader multistrike correctable carbon-film ribbons jam within 8 to 10 pages. While the yellow-leader ribbons don't jam quite that fast, they do shed, so you get tiny black specks all over the paper while the letters fall off the page. I've heard reports that the noncorrecting blue-leader multistrike fabric ribbons also work, but I don't know that from my own experience.

I've run into the take-up problem to an extent. The solution seems to be to wind the ribbon up to the point where the colored leader has gone into the cartridge. Sometimes it does hang up if the leader isn't all the way inside the reel. (Of course, using a ribbon that tends to jam anyway would exacerbate this.)

I don't know what to say about the irregular spacing or the crooked lines. I suggest checking the software for the spacing problem. I had some weird results until I edited my word processor's printer driver a bit. For the slanting lines, try clamping the paper onto the back of the tractor-drive unit as well as the front.

JAMES D. MACDONALD  
Miami, FL ■

REVIEW FEEDBACK is a column of readers' letters. We welcome responses that support or challenge BYTE reviews. Send letters to Review Feedback, BYTE Publications, POB 372, Hancock, NH 03449. Name and address must be on all letters.



# Kernel

---

<b>COMPUTING AT CHAOS MANOR: THE EUROPEAN CONNECTION</b> <i>by Jerry Pournelle</i> .....	363
<b>CHAOS MANOR MAIL</b> <i>conducted by Jerry Pournelle</i> .....	383
<b>BYTE U.K.:</b>	
<b>THE TORCH TRIPLE X</b> <i>by Dick Pountain</i> .....	385
<b>BYTE JAPAN:</b>	
<b>COMPUTING IN TAIWAN</b> <i>by William M. Raike</i> .....	397
<b>ACCORDING TO WEBSTER: MICROCOMPUTER COLOR GRAPHICS—OBSERVATIONS</b> <i>by Bruce Webster</i> .....	405
<b>CIRCUIT CELLAR FEEDBACK</b> <i>conducted by Steve Ciarcia</i> .....	420

---

JERRY AND HIS WIFE recently left Chaos Manor to take a trip to Europe. It proved to be a working vacation because he visited locations to be found in his next novel. But he didn't entirely forget computers, being able to spend a few days at the Swiss Federal Institute of Technology—one of the important centers of the computer revolution. This month's column describes some of the projects taking place there.

In BYTE U.K., Dick describes the new Torch Triple X—a low-cost personal computer that runs UNIX System V and is driven by Motorola's 68010. Dick claims that the Torch Triple X is aimed at the AT&T market (although the Torch is priced lower), but Dick believes Torch may get its most serious competition from Commodore's Amiga.

In July Bill Raike visited Taiwan, where he attended the Computex '85 computer show and checked out the software piracy problem in that country. In this month's BYTE Japan column he discusses several of the products he saw at the show; most of them are IBM PC, PC XT, or PC AT clones. He also describes a pirate software shop he found in Taiwan.

Bruce Webster's column deals almost entirely with the subject of color graphics on microcomputers. He gives a brief survey of the field, describing the graphics systems on some of the popular computers. This includes his opinion on whether or not Apple should come out with a color Macintosh.

MICROSOFT  
P R E S S

## The Classic Returns.

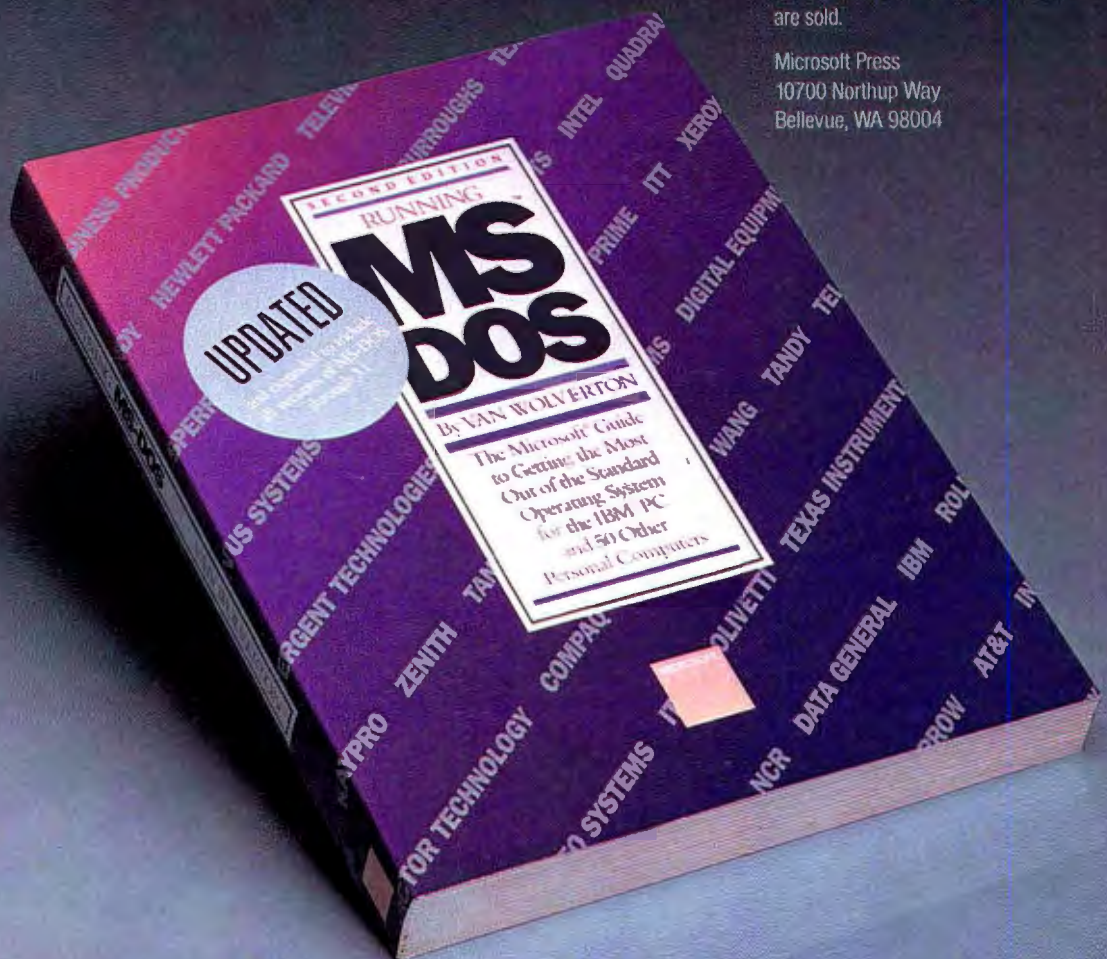
Now... newly updated to include all versions of MS-DOS through 3.1... the 2nd edition of **RUNNING MS-DOS** is your ultimate source-book for mastering the full power of the software that tells your computer how to think. It continues the tradition of the first edition, proclaimed by Jim Seymour of PC Week magazine to be the "Best PC-Related Book of 1984."

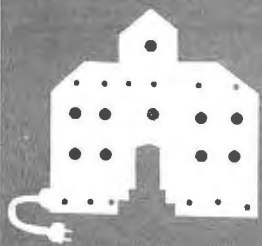
Here is the inside information—directly from the company that developed MS-DOS—that will help you streamline your computer, set up a multi-level filing system, use the MS-DOS text editor, build and sort a miniature database, create customized commands, and manage your monitor, printer, disk drives and modem. Plus new information on using the IBM PC AT's high-capacity diskette drive (MS-DOS 3.0) and using MS-Networks (MS-DOS 3.1).

If you use one of the more than five million personal computers with MS-DOS... then you need **RUNNING MS-DOS**.

\$21.95 wherever books and software are sold.

Microsoft Press  
10700 Northup Way  
Bellevue, WA 98004





# C·O·M·P·U·T·I·N·G A·T· C·H·A·O·S· M·A·N·O·R

## The European Connection

ETH

Lilith

Modems

Percy

Starlet

Purple Computing

Terminals

BY JERRY POURNELLE

I'm starting this in Graz, a city I never even heard of until a few weeks ago. It's in the Steiermark district of southern Austria and is the location of AIMS, the American Institute of Musical Studies. AIMS is a nonprofit organization operating out of Dallas, Texas, that trains American singers for careers in European opera houses, and a very good job it does. My next novel involves intrigue, high tech, and an American coloratura soprano, so this is a working vacation.

We drove in driving rains to Graz from Liechtenstein, a country no one but stamp collectors knew about until a few years ago. It is now a center of high-tech enterprises and, incidentally, the third or fourth wealthiest country per capita in the world: a great location for parts of my novel. The rainstorm, it turned out, was one of the worst they'd had in 20 years. It washed out many of the roads we wanted to take, as well as flooding much of Innsbruck and Salzburg. Getting to Graz was an adventure in itself. After Graz we go to Vienna, then Salzburg, then on a general tour of the Tirol.

If all this sounds like I didn't do much computing at Chaos Manor this month, you're right; even so, there's plenty to report. As part of our travels, I managed to spend a couple of days in Zurich, Switzerland, at the Eidgenossische Technische Hochschule, otherwise known as ETH, the Swiss Federal Institute of Technology. Hochschule sounds like "high school," but don't let that fool you. Einstein taught at ETH; it corresponds closely to MIT or Caltech. Like MIT, ETH has a number of departments. The one of particular interest to me is the Institut fur Informatik, where Professor Niklaus Wirth invented both Pascal and Modula-2.

We were fortunate to be at ETH with Dr. Richard Ohran, whom I've mentioned before in this column. Richard is a former member of the faculty at ETH who now runs the Modula Research Institute, a nonprofit organization founded to help ETH Infor-

matik distribute programs and other public-domain technologies developed by the faculty and students. He also heads the Modula Corporation, a for-profit company that sells a really excellent Modula-2 compiler for the Macintosh. The Modula-2 language is in the public domain, as are most ETH research results; but particular implementations of ETH's work, including Modula-2, are developed and sold by private companies. Ohran's Modula Corporation also manufactures the Lilith computer.

Richard is a good man to have with you on a visit to ETH. Not only did he get his doctorate (with a silver medal) there, but in his earlier stay he was the hardware member of the team that designed the Lilith; now his Modula Corporation in Utah makes all the Liliths used at ETH. They have about 100 of them and want more.

The Lilith is an interesting machine. It was designed to "speak" Modula-2 and use the Modula operating system. This works better than I would have believed. The Lilith compiles and executes Modula-2 programs faster than most machines can run assembly language. The Modula-2 team designed the Lilith that way. The result is unique among higher-level languages: programmers using the Lilith can produce hundreds of lines of bug-free Modula-2 code, corresponding to thousands of lines of assembly-language code, in astonishingly short times. If Modula-2 becomes as important a computer language as I think it will, there should be considerable interest in the Lilith; it's hard to conceive of a better system for developing Modula-2 programs.

Up to now, use of the Lilith has been confined largely to Modula-2 enthusiasts and people at ETH. Not many have been manufactured, and they've been thought too costly for most software developers.

That view may be mistaken. If you intend to write really large programs so that a number of programmers have to work to-

(continued)

Jerry Pournelle holds a doctorate in psychology and is a science-fiction writer who also earns a comfortable living writing about computers present and future.

# "BRIEF, The Programmer's Editor, is simply the best text editor you can buy."

— John Dvorak, InfoWorld, 7/8/85

## Be more productive and avoid frustration with BRIEF.

- A high-level, readable **Macro Programming Language** - allows customization for programming languages . . . Complete, unlimited variables, etc.
  - Edit **multiple files of unlimited size** (2 Meg is OK)
  - Multiple **Windows** on screen with different or same file, fragments, etc.
  - A bona-fide **UNDO** stack (up to 300) of **all operations**: deletions, reading files, search, translate, more
  - Full "**regular expression search**" - wild cards, complex patterns
  - **Reconfigurable keyboard**
  - **Adjustable line length** - up to 512.
  - **Keystroke macros** - for common typing sequences
  - Suspend BRIEF to execute, **exit to DOS** - run another program (like a compiler, dir, XREF, DIFF, or DEBUG) then resume BRIEF session
  - **Compiler-specific** support like auto indent, syntax check, compile within BRIEF
- FREE WITH ORDER:** Best of BRIEF Macros" — includes Fortran, C, Calculator.

Only \$195

Full Refund if not satisfied in 30 days.  
CALL 800-821-2492.

335-B Washington St., Norwell, MA 02061  
617-659-1571

**Solution Systems**

# PROLOG-86™

## Become Familiar in One Evening

Thorough tutorials are designed to help learn the PROLOG language quickly. The interactive PROLOG-86 Interpreter gives immediate feedback. In a few hours you will begin to feel comfortable with it. In a few days you are likely to know enough to modify some of the more sophisticated sample programs.

### Sample Programs are Included like:

- an **EXPERT SYSTEM**
- a **NATURAL LANGUAGE INTERFACE** (it generates a dBASEII "DISPLAY" command)
- a **GAME** (it takes less than 1 page of PROLOG-86)

### PROTOTYPE Ideas and Applications QUICKLY

Serious development of experimental systems and prototypes is practical with the full syntax of PROLOG-86. 1 or 2 pages of PROLOG is often like 10 pages in "C".

**Programming Experience is not required** but a logical mind is. PROLOG-86 supports the de facto STANDARD.

**RECENT IMPROVEMENTS:** Access to MSDOS, on-line help, load Editor.

**AVAILABILITY:** All MSDOS, PCDOS systems.

**FREE with order:** "Best of Prolog-86 Programs"—contest entries include: a primate expert system, an automobile expert system, a blocks world natural language system, etc.

Only  
\$125.

Full refund if not satisfied during first 30 days.

**Solution Systems**

335-B Washington St.,  
Norwell, Mass. 02061  
617-659-1571  
800-821-2492

## CHAOS MANOR

gether, Modula-2 may well be the language of choice. It's structured to make it simple to interface a number of programmer efforts with minimum problems; and the Lilith is a nearly ideal programming tool for producing Modula-2 code.

Ohran's Modula Corporation is going to make it easier to get a Lilith. About the time you read this, it intends to market a version of the Lilith that will work in conjunction with an IBM PC, using the PC's disks, keyboard, and screen. I haven't seen that work yet. I have had a Lilith off and on for more than a year, and it's one of the best software-development tools I've ever had access to. I can write Modula-2 code with the Lilith, then transfer it to the PC by recompiling with the Logitech compiler; the result works fine unless I've used the Lilith's special display capability.

For quick-and-dirty programs, I still use Digital Research's Compiling CBASIC because it's transportable across 8- and 16-bit machines, and I have a pretty good library of CBASIC routines; but I suspect that one day I will convert all my CBASIC stuff to Modula-2. It's not that hard to do. CBASIC is a well-structured language, particularly if you use the "declare" toggle that tells the compiler to treat an undeclared variable as an error. A couple of years ago I'd have thought anyone who deliberately required declaring all variables before using them was crazy, and I probably even said something that silly in print. Ah well, live and learn.

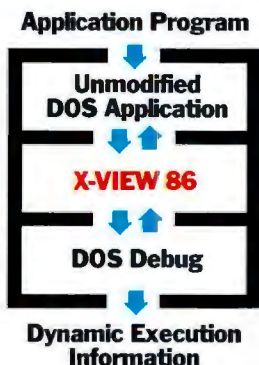
Anyway, I'm hoping that coupling a Lilith system with a PC will make both the Lilith and Modula-2 more widespread and available. ETH has developed some really interesting programs for the Lilith. As I've said before, we won't see software prices really tumble until *lots* of people have good programming environments to work in, and there are as many people trying to write big programs as there are would-be authors of books. Getting the Lilith plus the ETH development approach plus Modula-2 into the hands of U.S. hackers may have a

(continued)

# X-RAY VISION

Get it with X-VIEW 86™

**X-VIEW 86™** analyzes, profiles, and debugs DOS application software — for improved performance on the IBM PC and its compatibles.



## X-VIEW 86 lets you observe the internal operations of DOS application software.

Helps you analyze, debug, test, port, or convert DOS application software — and get faster, more reliable results.

### Real solutions to technical challenges.

Looking for code hot spots?

X-VIEW 86 helps you find them fast.

Irritated by bugs that DEBUG can't reach?

X-VIEW 86 captures them.

Sweating over hardware compatibility issues?

X-VIEW 86 pinpoints the trouble spots.

Struggling with a conversion that just won't work?

X-VIEW 86 breaks the deadlock.

### What X-VIEW 86 does.

X-VIEW 86 saves you hours of time-consuming, tedious work. It automatically collects data on application programs:

- memory map references
- I/O space references
- INT call usage
- instruction set usage
- segment usage data

X-VIEW 86 can interrupt the application program

- on any processor I/O access
- on any processor INT instruction
- on a specified execution path address
- on a specified memory location reference

X-VIEW 86 can also start the application program execution at a specified address. And it displays the results of the analysis on screen.

### Hardware and software requirements.

X-VIEW 86 runs on any member of the IBM PC family — or any operationally-compatible machine that has at least 64 Kbytes of memory. And it's not copy-protected. You use it with PC DOS DEBUG 2.0 or 2.1.

### Exciting — not expensive.

X-VIEW 86 is priced at an affordable \$59.95.

### To order, call 1-800-221-VIEW.

In Texas, call 1-800-233-VIEW.

Then get ready for a whole new outlook on your work.

Inquiry 148



To order X-VIEW 86™ by credit card, call toll free 1-800-221-VIEW. In Texas call 1-800-233-VIEW or send the coupon today.

Customer Service  
McGraw-Hill Inc.  
8111 LBJ Freeway  
Dallas, Texas 75251

X-VIEW 86™ is \$59.95. All orders are subject to acceptance by McGraw-Hill, Inc. Prices are subject to change without notice.

- Check enclosed (Make check payable to McGraw-Hill Inc. Orders paid by check are subject to delay.)
- A.E.  M.C.  VISA  D.C.

Name \_\_\_\_\_  
 Title \_\_\_\_\_  
 Company \_\_\_\_\_  
 Address \_\_\_\_\_  
 City \_\_\_\_\_ State \_\_\_\_\_ Zip \_\_\_\_\_  
 Phone (\_\_\_\_) \_\_\_\_\_  
 Qty \_\_\_\_\_ \$59.95 Amt \_\_\_\_\_  
 Shipping (\$2.00 per copy) Texas sales tax (\$3.67 per copy) \_\_\_\_\_  
 Total \_\_\_\_\_  
 Signature \_\_\_\_\_  
 Name on card \_\_\_\_\_  
 Credit card no. \_\_\_\_\_ Expiration date \_\_\_\_\_

*The Modula system  
is harder to learn  
than Macintosh's,  
but easier to use  
once you've learned it.*

spectacular effect on the computer revolution.

### 32016 SYSTEMS

Another ETH project under Niklaus Wirth's direction is porting the Modula operating system (which the Lilith runs directly) over to computers using the National Semiconductor 32016 chip. The Modula operating system has a number of similarities to the Macintosh system. (No coincidence: both grew out of Alan Kay's work at Xerox. Some time ago, Wirth spent a year's sabbatical at Xerox's Palo Alto Research Center, and he was there again this summer.) The Modula system is somewhat harder to learn than Macintosh's, but in my judgment a lot easier to use once you've learned it. Anyway, ETH has a working experimental Modula system for a 32016 computer.

The 32016 runs at 10 megahertz (MHz), compared to the 6-MHz chips in the Lilith. Hans Eberle, Wirth's assistant for this project, said that he was "surprised that the 32016 is only slightly less fast than the Lilith."

I raised an eyebrow at this. Later, while having dinner with Dr. Ohran, I asked him how this could be. After all, the 32016 runs almost as fast as the 2901 chips in the Lilith.

According to Ohran, it's a matter of design philosophy. The Lilith was intended to run Modula-2. Other computers have to worry about underflow and overflow. There are no such error checks in the Lilith, just as there are no checks for stack overflow. Not only does the Lilith run Modula-2, *it runs nothing else*; there is no assembler, or, put another way, the Modula-2 com-

piler is the Lilith's assembler. Overflow and stack-explosion checks have been shifted to the compiler so that programmers need not keep track of such administrivia.

Moreover, the Lilith's 2901 chip has an obscure data path that gives I/O (input/output) operations direct access to the stack without going through the ALU (arithmetic logic unit). The Lilith fetches instructions about five times faster than any other machine. The result is amazing speed. According to Ohran, since all machines have to fetch instructions, the others have to achieve nearly an order of magnitude speed improvement just to keep up with the Lilith.

I suppose I believe this, but I have no way of checking it out. Steve Ciarcia "speaks solder"; hardware's not my specialty. I do know that I've seen the Lilith do amazing things at blinding speeds, and everyone at ETH prefers the Lilith to just about anything else. Undergraduates in the Institut für Informatik begin with the Apple II and Macintosh; they graduate to the Lilith when they have significant project work to do. There are also VAXes and other minicomputers and mainframe machines at ETH; but the Lilith is everyone's favorite.

Anyway, the 32016 machine running Modula-2 is almost as fast as the Lilith and has better graphics control. They're now building a color Lilith around the 32016.

### SOME STANDARD PROBLEMS

ETH is big on both classics and acronyms: the new 32016 machine will be known as CERES, which stands for "computing engine for research, engineering and science." The bus structure is, according to Eberle, "close to the 32016 and not standard. We need a bus that supports the architecture of the processor. Industry must worry about standards. It is not the concern of ETH."

This pretty well echoes Professor Wirth's often-expressed attitude. ETH has a dual-purpose mission, to work at the frontiers of knowledge and to train students to understand the latest developments in technology. Wirth's

view is that ETH cannot become distracted by the requirement to make its technological achievements conform to industry's needs. It is enough that ETH develop generic technologies; industry must do the rest.

I can understand this view, and I even agree that academics shouldn't need to do industry's work; but sometimes the results are less than optimum. In the long run, the best technology generally wins out. In the short run, though, there can be unfortunate results: witness the proliferation of Pascal dialects and the delays in developing really practical implementations of Modula-2. I'm impressed with what ETH has done with Modula-2 and the Lilith, and I'm in a hurry to see these concepts take their rightful place in the computer revolution.

The good news is that methods for disseminating new developments at ETH are being perfected, such as Wirth's new one-pass Modula-2 compiler that compiles itself in less than five minutes. In the future, it shouldn't take so long to get new developments out of the ivory tower—actually it's granite, but you get the idea—and into the hands of users.

Modula-2 is catching on. Philippe Kahn, whose Turbo Pascal has become something of a standard—they even use it at ETH, where one medical database program for the IBM PC is 3000 lines of Turbo Pascal—has promised Turbo Modula-2 for the PC Real Soon Now, and that should help get some of ETH's programs out to BYTE readers. There are good Modula-2 compilers and Modula operating systems for the Stride family of 68000-based computers. Modula Corporation has MacModula-2. It can't be long before U.S. hackers get some of ETH's marvels in shape for the rest of us.

### MUSIC AND GO

Most technical institutes require a senior thesis project for graduation. At ETH this can result in significant programs. I didn't have time to look at all of the ETH projects—most of the students weren't there anyway, it be-

(continued)



AT&T presents maxims for better international communication.

# Sometimes, it's better to put all your eggs in one basket.



**AT&T International Services offer the strongest, sturdiest basket for your telecommunications needs.**

Because AT&T has a long history of making international connections and developing international services.

AT&T offers a wide range of international services for your company, whether you're involved in manufacturing, distribution, marketing or any other function. AT&T International Long Distance Service, for example, helps your company build better business relationships. AT&T International 800 Service encourages the steady flow of contact between customers, salespersons and suppliers, so you can maintain a competitive edge.

But how do you choose the services that are right for you? It's simple. Just contact your Account Executive or Sales Specialist at AT&T. They're experts in a wide range of businesses, and they can offer you our entire basket to accommodate your needs. Together you and your AT&T representative can tailor services and applications that work for you.

To learn more about AT&T's state-of-the-art telecommunications and the applications they have for your business, please contact your Account Executive at AT&T Communications now. Or call a Sales Specialist at the toll-free number below.

**1 800 222-0400 Ext. 515**



**AT&T**

The right choice.

# WIN A LIFETIME OF HOLIDAYS FROM Holiday Inn®



## Where good service is a way of life.

Bring the game card attached to this ad to any participating Holiday Inn® or Holiday Inn Crowne Plaza® hotel and see if you've already won one of the fabulous prizes described below. While you're there, see for yourself what we mean by good service at Holiday Inn hotels.

**2 Grand Prizes**—A vacation trip for two anywhere in the world, every year for the rest of the winner's life; including Holiday Inn hotel accommodations, air travel, car rental, and spending money, up to a total prize value of \$10,000 per year.

**4 First Prizes**—A vacation trip for two anywhere in North America, including Mexico, the Caribbean, and Canada, every year for the rest of the winner's life; including Holiday Inn hotel accommodations, air travel, car rental, and spending money, up to a total prize value of \$5,000 per year.

**4 Second Prizes**—A vacation trip for two anywhere in the Continental U.S., every year for the rest of the winner's life; including Holiday Inn hotel accommodations, air travel, car rental, and spending money, up to a total prize value of \$2,500 per year.

**10,000 Third Prizes**—\$20 in Holiday Inn Guest Certificates.

### See attached game card for complete rules and details.

If the game card has been removed, you may obtain a free game card by mailing a hand-printed, stamped, self-addressed envelope by December 15, 1985 to: LIFETIME OF HOLIDAYS Card Request, P.O. Box 4520, Westbury, NY 11592. State of Washington residents need not affix postage to self-addressed envelope. Limit one game card per request.

 Holiday Inn®



ing summer—but Hans Hinterberger, the Informatik administrator, arranged for me to see some fascinating ones.

The first was a system in which you can play a musical piece on a standard-keyboard music synthesizer, hearing it as you play it, and then get a written transcription in musical notation. The program also separates voices and does transpositions, which are often necessary but very tedious musical chores. All this appears on the Lilith's screen; then you can use the mouse to change the notes, move things around, and otherwise fuss with the score, after which the final result comes out as hard copy from a laser printer.

This program hasn't been perfected, but it will be published when it's done; the source code should be available from the Modula Research Institute sometime in 1986. I hope U.S. hackers will pick it up where the ETH

faculty and students leave it because there's a crying need for computer assistance for composers.

My friend Robert Bloch (he's often introduced as Robert Bloch author of *Psycho*, all one word) has the rights to do an opera based on *The Phantom of the Opera*. We have introduced him to Dr. Robert Challs, professor of music at Cal State Northridge and composer of *The Thirteen Clocks*, based on James Thurber's modern classic. By me Challs is pretty good; I generally can't stand modern opera, but I like *The Thirteen Clocks*. Anyway, we're hoping that Bloch and Challs can do *Phantom* together. Alas, the expenses of simply getting an opera onto paper, separated into parts with copies for singers and orchestra and conductor, can be staggering. Computers make a writer's life much easier by taking much of the work and expense out of producing manuscripts; I'm sure the

little beasts will have just as profound an effect in the music field.

Another project that fascinates me is a program to help people who play go. Go is a game with only three rules; you can learn it in five minutes. Playing it well, on the other hand, can take a lifetime; it's much more complex than chess.

There is no program that can play a passable game of go. Even mediocre human players invariably win unless the computer is given an enormous handicap. The Japanese hope to produce a go program as part of the Fifth Generation Computer Project, but no one has seen any results yet.

Winning at go requires an appreciation of grand strategy, and the relationships between widely separated activities on the go board are far too subtle to be reduced to rules. How-

(continued)

## a message to our subscribers

From time to time we make the BYTE subscriber list available to other companies who wish to send our subscribers material about their products. We take great care to screen these companies, choosing only those who are reputable, and whose products, services, or information we feel would be of interest to you. Direct mail is an efficient medium for presenting the latest personal computer goods and services to our subscribers.

Many BYTE subscribers appreciate this controlled use of our mailing list, and look forward to finding information of interest to them in the mail. Used are our subscribers' names and addresses only (no other information we may have is ever given).

While we believe the distribution of this information is of benefit to our subscribers, we firmly respect the wishes of any subscriber who does not want to receive such promotional literature. Should you wish to restrict the use of your name, simply send your request to the following address.

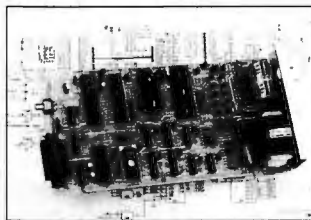
BYTE Publications Inc.  
Attn: Circulation Department,  
70 Main St., Peterborough, NH 03458

### LOW COST UNIVERSAL EPROM, EEPROM, PROM PROGRAMMER

EPROMS : 2516 THRU 2564, 2716 THRU 27613, 27C16 THRU 27C512, 68732 THRU 68766, 67C286  
EEPROMS : 52R13, 52R23, 52R33, 2818A, 2884A, 48Z02  
MICROS : 8741, 8744, 8748(M), 8749(M), 8751, 8755  
PROMS : CY7C 281, 282, 291, 292

#### 1409 BASIC MODEL

NO PERSONALITY MODULES, MENU SELECTION, ONBOARD 110/220V AC POWER SUPPLY, RS232C INTERFACE, XON-XOFF, RTS, CTS, DTR, VERIFY PROGRAM AND BLANK COMMANDS, MANUAL PROGRAMMING WITH LINE EDITING, ACCEPTS ASCII, INTEL, OR MOTOROLA FORMAT, USER FRIENDLY MONITOR FOR I/O DEBUGGING, FAST PROGRAMMING MODE: 27128 UNDER TWO MINUTES, LOW/HIGH BYTE PROGRAMMING FOR 16 BIT BUS, EPROM BYTE, BLOCK, OR CHIP ERASE, UP/DOWN LOAD IN INTEL/MOTOROLA FORMAT, COMPLETE DOCUMENTATION INCLUDING CAD SCHEMATICS, HIGH QUALITY AMP ZIP



#### 1409 KIT PRICING

11A : 8K FIRMWARE PCB, XFORMER . . . \$125  
21 : 11A + 874(X) FAMILY . . . \$150  
31 : 21 + 8751, 8755 + 2" PCB . . . \$200  
12A : 11A + FULL SET OF PARTS . . . \$250  
22 : 21 + FULL SET OF PARTS . . . \$300  
32 : 31 + FULL SET OF PARTS . . . \$400  
13A : 12A ASSEMBLED AND TESTED . . . \$350  
23 : 22 ASSEMBLED AND TESTED . . . \$400

#### 1409C PACKAGED MODEL

BUILT-IN EPROM ERASER, CONDUCTIVE FOAM

STAND ALONE EPROM DUPLICATION GANG PROGRAMMER EXPANSION PORT PAD, ACTIVE SOCKET LED INDICATOR



#### 1409C PRICING

33 : 13A + EPROM DUPLICATION . . . \$650  
34 : 33 + 8744, 8751, 8755 . . . \$800

SOURCE CODE ON PC-DOS DISK . . . \$ 75  
SOFTWARE DRIVERS FOR MOST PCs . . . \$ 35

CALIFORNIA RESIDENTS ADD 8% SALES TAX  
ALL PRICES F.O.B. SAN JOSE, CA  
MASTERCARD AND VISA ACCEPTED

### B&C MICROSYSTEMS

6322 MOJAVE DRIVE, SAN JOSE, CA 95120 TEL: (408) 997-7685 TWX 4995363

# We've been accused of breaking the speed limit.



## You Be The Judge.



Until now, if you wanted true letter quality printing, you needed a daisywheel printer. Then you waited and waited while it plugged along at speeds of about 55 cps.

Now the waiting is over. Because the Genicom 3320 dot

matrix printer offers true letter quality printing at an incredible 180 cps. It's the fastest impact letter quality printer available.

And the Genicom 3320 offers full graphics capability... impossible with a daisywheel.

It also features up to 300 cps data processing, high throughput, heavy duty cycle printing, quiet operation, and Hex dump diagnostics.

Plus the 3320 comes standard with Diablo® 630 and IBM® PC Graphics protocols and works

with most major PC software packages such as Lotus®, Wordstar 2000® and Multimate®.

Call our Toll Free number for all the evidence. You'll find Genicom has five other 3000 models for everything from color printing and bar codes to speeds up to 400 cps.



# GENICOM

## The Printers That Mean Business.

Genicom Corporation, Dept. 315J, Waynesboro, VA 22980. TOLL FREE 1-800-437-7468. In Virginia, call 1-703-949-1170.

Diablo® is a registered trademark of Xerox Corporation. IBM® is a registered trademark of International Business Machines. Lotus® is a registered trademark of Lotus Development. Wordstar 2000® is a registered trademark of Micropro International Corporation. Multimate® is a registered trademark of Multimate International Corporation.

ever, no matter how good you are at go strategy, you must also master the game's tactics, which aren't easy. Mastering them can be tedious. Fortunately, those *can* be reduced to rules that a computer can learn.

At ETH, Anders Kierulf and Jurg Nievergelt have developed what they call a smart go board that has many ways to help go players. It can play *joseki*, which are tactical openings played in one corner. It can analyze certain tactical situations, including *ladders*. Best of all, it can record an entire game as played; then in the replay allow you to do variations and return to the actual position after you investigate alternatives to the real moves. Go has dozens of pieces, all just alike, scattered across the board. The exact position of each and the exact sequence of play are usually critical to the outcome of the game; thus, recording and replaying classic games has always involved a lot of tedious bookkeeping. That capability alone makes the ETH smart go board important.

Both the music and go programs are written in Modula-2. They're designed for the Lilith. I don't know how hard it will be to recompile them for the PC or Macintosh. Anyway, it's pretty certain that Ohran will have versions for his PC-Lilith combination when it comes out.

Music lovers and go players unite: you have nothing to lose but some drudge work...

**DATABASES**

I had a busy time at ETH; after watching the go program (and getting a promise that I'll have a copy for my Lilith Real Soon Now), I met Andreas Diener, a graduate assistant in the group headed by Professor Carl August Zehnder. They have been investigating the implications of having databases available at workstations and developing software that allows selective access and security. For example, you cannot allow casual users access to personnel data; but you might want them to be able to get statistical information about all

(continued)

# Thinking of the C Language?

## THINK COMPUTER INNOVATIONS

### **NEW!** C86 VERSION 2.3 with Source Level Debugging Support

The C language has rapidly become the development language of choice for applications ranging from Operating Systems to Accounting Packages. WHY? Its structured approach and extreme portability make it perfectly suited to today's fast-paced environment.

Of all of the C Compilers available for PC/MSDOS, more programmers choose COMPUTER INNOVATIONS' C86. WHY? Because it's part of a COMPREHENSIVE family of C products with an unparalleled reputation for performance, reliability, and stability.

#### **C86 2.3 C COMPILER**

C for PC/MSDOS began with C86 and today it remains perhaps the most solid, stable C Compiler available. Even competitor's ads show C86 as a consistent top level performer in benchmark testing.

Version 2.3 offers a host of new features including source level debugging support and a 40% boost in compilation speed. Call for complete specifications.

**COST: \$395 UPDATE TO 2.3: \$35 w/old diskettes NOT COPY PROTECTED CALL ABOUT VOLUME DISCOUNTS**

#### **LEARN C INTERACTIVELY WITH INTRODUCING C**

Intimidated by rumors about the difficulty of learning C? Need to train your staff quickly? INTRODUCING C can help. INTRODUCING C combines a thorough, self-paced manual with a unique C interpreter to provide a fast, efficient method of learning C.

Designed for both professional and casual programmers, it provides a comprehensive understanding of important C concepts such as standard K&R syntax and operators, full structures and unions, arrays, pointers, and data types. Requires IBM PC, XT, or AT with one disk drive and 192K bytes of memory.

**COST: \$125 - NOT COPY PROTECTED**

#### **CI PROBE SOURCE DEBUGGER**

Take advantage of C86 2.3 source level debugging support with CI PROBE. Cut down program development time and save money! CI PROBE is highly economical yet has the features of debuggers costing far more.

**COST: \$225 - NOT COPY PROTECTED**

#### **C-TERP C86 COMPATIBLE INTERPRETER**

The C-TERP INTERPRETER is a full K&R implementation that allows you to write code and execute it immediately without the compile and link steps. Once you have your program running with C-TERP you can compile the code (without alterations) with C86 for fast, efficient executable files. C-TERP requires 256K, 512K is recommended.

**COST: C86 version - List Price: \$300, Special Computer Innovations Price \$250. Combined C86 & Lattice version - List Price: \$400, Special Computer Innovations Price \$350.**

#### **Start With Us, Stay With Us**

Computer Innovations offers a complete range of products that let you enter the C environment and create applications with the most advanced set of development tools available. Unparalleled tech support assures that you're always at the height of productivity.

To order call: **800-922-0169**



980 Shrewsbury Ave., Tinton Falls, NJ 07724 • (201) 542-5920

C-TERP is a trademark of Gimple Software. Prices and specifications subject to change without notice.

# THE PROGRAMMER'S SHOP™

helps save time, money and cut frustrations. Compare, evaluate, and find products.

## SERVICES

- Programmer's Referral List
- Compare Products
- Help find a Publisher
- Evaluation Literature FREE
- BULLETIN BOARD - 7PM to 7AM 617-826-4086
- Dealer's Inquire
- Newsletter
- Rush Order
- Over 700 products

## SERVICE: FREE NEWSLETTER

Software development and AI on micros: trends, forecasts, controversies, innovations, and techniques. Plus announcement of 80 NEW tools. CALL for "Newsletter Packet."

## RECENT DISCOVERY

Periscope II symbolic debugger - some source level, 2 screens, interrupt switch \$129

## AI - LISP

GC LISP - "Common", rich, List Our  
 Interpreter - Interactive Tutorial 495 Call  
 Compiler and Interpreter 1190 1090  
 LARGE Model - 2 to 15 meg. 695 649  
 IQ LISP - MacLISP and InterLISP.  
 Well-liked, 1,000K. PC DOS \$149  
 TLC LISP - "LISP-Machine" - like, all  
 RAM, classes, turtle graphics, 8087,  
**compiler.** CPM-86, MSDOS \$235  
 WALTZ LISP - "FRANZ LISP" - like, big  
 nums, debug, CPM-80, MSDOS \$149  
 Others: ExperLISP (\$439), TransLisp-PC  
 (\$75), BYSO (\$125), MuLISP-86 (\$199)

## AI - PROLOG

ARITY PROLOG - full, debug, ASM, C,  
 virtual. **Compiler** \$1950 MSDOS \$495  
 MPROLOG - Rich syntax, editor, segment  
 work space, portable. PC DOS \$725  
 Prolog-86 - Learn Fast. Standard,  
 tutorials, samples MSDOS Call  
 Others: Prolog-1 (\$359), Prolog-2 (\$1895),  
 Prolog V (\$65), V+ (\$95), MicroProlog  
 (\$229), Prof. MicroProlog (\$359).

## Feature

TransLisp-PC - "Common Lisp", tutorial,  
 graphics, 230 functions, samples \$ 75

## MultiLanguage Support

Btrieve/N (\$469), single user \$199  
 Codesifter - executive profiler \$109  
 DoubleDOS - nice, two task \$79  
 LMK Make by Lattice \$159  
 MultiLink - multitasking \$249  
 Panel - Screens, windows \$239

## AI - Expert System Dev't

ExpertEASE - Inductive. PC DOS Call  
 EXSYS - All RAM, Probability. Why.  
 Trees, Solid, files, popular PC DOS \$359  
 INSIGHT 1 - Probabilities, required  
 thresholds, menus, fast PC DOS \$ 95  
 INSIGHT 2 - adds backward, forward, par-  
 titions, dB2, lang. access. PC DOS \$449  
 Others: APES (\$359), Advisor (\$949),  
 ES Construction (\$100), ESP (\$845),  
 Expert Choice (\$449), more.

## Low Cost Languages

BORLAND: Turbo 3.0 \$ 49  
 3.0 with 8087 or BCD \$ 79  
 3.0 with 8087 and BCD \$ 85  
 C/86 by Software Toolworks - Quick \$ 65  
 Introducing C - Step by step training \$109  
 Let's C by Mark Williams \$ 59  
**Modula 2** by ITC - Windows, tight \$ 80  
 PC/Forth by LMI - '83, DOS, ASM \$ 89  
 Prolog-86 - enhanced, DOS, Edit Call  
 Quick BASIC by Microsoft - Compile \$ 79  
 BASICA, Link \$ 85  
 Snobol4+ by Catspaw - Strings \$ 85

## C Support - Systems

C Debug - Source debuggers - by  
 Complete Soft (\$269), MSD (\$149).  
 CPRINT - by ENSCO, thorough \$ 50  
 C Sharp - well supported, Source,  
 realtime, tasks MSDOS \$600  
 C Sprite Debugger by Lattice \$149  
 C ToolSet - DIFF, xref, source \$135  
 Faster C - replace LINK \$ 95  
 PC Lint - full C program checking  
 and big, small model. All C's \$119

Call for a catalog, literature, and solid value

**800-421-8006**

THE PROGRAMMER'S SHOP™

128-B Rockland Street, Hanover, MA 02339

Mass: 800-442-8070 or 617-826-7531 1085

Note: All prices subject to change without notice.  
 Mention this ad. Some prices are specials.



## BACKUP YOUR SOFTWARE WITH LOCKSMITH 6.0™.

Locksmith, the controversial copy program that took the Apple world by storm in 1981, has evolved from a powerful bit-copy programmed into a complete disk utility system, allowing the Apple user to recover crashed disks, restore accidentally deleted files, and perform hardware diagnostics on the disk drive and memory boards. The NEW Locksmith version 6.0 is now available and includes an advanced disk recovery utility, a framing-bit analyzer, an automatic boot tracer, a sector editor, many file utilities, and of course, the most powerful bit-copy program available. A fast disk backup utility copies disks in eight seconds flat. Improvements to Locksmith Programming Language have made it more powerful and easier to use for you to write your own backup and repair procedures. Includes a library disk which contains automatic procedures to copy hundreds of Apple programs.

Locksmith requires no additional hardware, but will use any additional RAM memory that it finds, including RAM boards from Applied Engineering and Checkmate Technology.

**Don't get caught with your hands tied. Order Locksmith 6.0 today.**

Does copy protection  
 have your hands tied?



NEW LOW PRICE \$79.95  
 Registered Locksmith 5.0 owners may upgrade to version 6.0 for \$29.95.  
 Available from your computer dealer or directly from:



Alpha Logic Business Systems, Inc.  
 4119 North Union Road  
 Woodstock, IL 60098  
 (815) 568-5166



© Alpha Logic Business Systems, Inc. 1985  
 Locksmith and Locksmith/PC are registered trademarks of Alpha Logic Business Systems, Inc.

CHAOS MANOR

employees. Of course, a sufficiently clever hacker may be able to ask questions that look as if they're asking for collective data but that actually apply to only one employee, so you want your system to defeat those attempts also.

Zehnder's group has recently released LIDAS (Lilith database system), which includes Modula-R, a database-language extension of Modula-2. The idea is to come up with something compatible with the Lilith and the Modula-2 compiler but adapted to database problems.

One of Wirth's least-known books is also one of his best: it has the unlikely title *Data Structures + Algorithms = Programs*. The database-programming work at ETH reminded me of that book; probably no coincidence.

Part of Diener's Ph.D. thesis is work on GAMBIT (I told you they're big on acronyms), a database-definition tool. LIDAS and GAMBIT are "completed but not exactly commercial," meaning that in keeping with their general philosophy, ETH declines to take responsibility for making these remarkable tools available to the average user; you can get them from ETH for a nominal fee, but it will be some commercial developer's task to reduce them to a publishable package.

I'm sure that will happen. What I saw at ETH was impressive. Here are a bunch of networked machines with what appears to be a common database. Nonprivileged users can work with the database, adding to it and getting information from it, and never even suspect that there are layers of information to which they don't have access. Moreover, you can keep private files whose existence is unknown to other users. The idea is to present private and shared data in an integrated way; and what ETH has done so far beats anything I've ever seen for either micros or minis.

Much of the work at ETH is done in English (even though English is not one of the four official Swiss languages), and Diener's thesis will be written in English and will eventually

(continued)

# A Graphic Declaration of Independence

Graphics can be a tough nut to crack for the applications programmer. Every I/O device, from mice and monitors to printers and plotters has different specifications. Now you can achieve Virtual Device Independence with the GSS family of graphics programming tools.

**GSS-DRIVERS®**

A powerful set of device drivers working with a VDI interface to your application. Allow you to select and control a wide variety of graphic and alphanumeric devices without reprogramming. Generate a standard Virtual Device Metafile (VDM) for graphic data storage.

**GSS® Language Bindings**—The bindings provide an interface between the VDI and the language source.

Language bindings are available for Lattice C and Microsoft Fortran, Assembler, Pascal, and BASIC compiler.

**GSS TOOLKITS®**

**Kernel System**—Linkable subroutine library conforming to ANSI GKS level 2B. Simplifies programming for all graphics applications, including CAD and engineering programs.

**Plotting System**—A library of 2-D plotting functions which make it easy to build charting capabilities into your program. Line, bar, pie, scatter, step, area, etc.

**Metafile Interpreter**—A program module which reads and decodes a graphic data file in the proposed ANSI standard VDM format as generated by GSS-DRIVERS.

GSS, GSS TOOLKIT and GSS DRIVERS are registered trademarks of Graphic Software Systems, Inc. Lifeboat, The Source for Software with Full Support, and Lifeboat logo are trademarks of Lifeboat Associates

For immediate delivery or more information, call: **1-800-847-7078** In NY: **(212) 860-0300**

or write: **LIFEBOAT ASSOCIATES**  
1651 Third Avenue New York, NY 10128



The Source for Software with Full Support™

"Murphy said he'd kill for a Harris-Lanier VIP Classic."

"Justifiable homicide."

**FOR YOUR INFORMATION,  
OUR NAME IS  
HARRIS**

Telephone, dictating and answering machine in one.  
For more on the Harris-Lanier VIP Classic™ call 1-800-241-1706.

**HARRIS LANIER**

TOLL FREE 1-800-848-FAST



WHEN ORDERING  
ASK ABOUT OUR  
**FREE**  
HOLIDAY  
ITEMS.

# NOW GET THE TOP NAME DISKETTES AT THE LOWEST PRICES EVER.

	5.25" SSDD 48 TPI	5.25" DSDD 48 TPI	5.25" DSDD-HD PC/AT	3.5" SSDD	3.5" DSDD
<b>Dysan</b> <sup>®</sup>	\$1.48	\$1.95	\$4.05	\$2.60	\$3.50
<b>Verbatim</b> <sup>®</sup> DataLife.	\$1.38	\$1.74	\$3.65	\$2.48	\$4.00
<b>3M</b>	\$1.34	\$1.65	\$3.75	\$2.29	\$3.55
<b>maxell</b> <sup>®</sup>	\$1.22	\$1.66	\$3.45	\$2.20	\$3.25
<b>XIDEX</b>	\$ .80	\$ .90		\$2.45	

These diskette brands represent the vast majority of all diskette sales. And for good reason. They're simply the highest quality and most reliable diskettes on the market. Now with one simple toll-free call you can buy them at the lowest prices around. So why settle for a brand you never heard of when you can have the best for less?

## TOLL FREE 1-800-848-FAST

### TO ORDER

**PAYMENT:** We accept MasterCard and Visa with no service charge • Bank checks, certified checks and money orders will insure fast delivery • COD — Add \$3.00 - certified, bank check or money order only • Personal checks - we must wait 10 days to clear before shipping • Corporate accounts and purchase orders welcome, subject to credit approval • Prices subject to change without notice.  
**Shipping and Handling** — Standard case lot is 50 diskettes of the same type per case • Add 5% for less than case lot quantities • Minimum order size is \$30.00 • Add 3% (minimum \$3.00), per each 100 or fewer diskettes • Ohio residents add 5.5% for State Sales tax.

**EXPRESS MICRO SUPPLIES INC. • DEPT. L-557 • COLUMBUS, OH 43260**



## CHAOS MANOR

be available with source code through the Modula Research Institute.

### AND YET MORE

There's a lot more happening at ETH. Jurg Nievergelt, Andrea Ventura, and Hans Hinterberger have done some excellent work on using computers to aid in computer science education. Carlo Muller's diploma thesis was Modula-Prolog. Others have cooperated to make it a nearly complete Prolog interpreter (see the theme section of the August BYTE beginning on page 148 for discussions of Prolog), which is written in Modula-2 and is now available for the Lilith, VAXes, and MS-DOS machines. Work on databases, networking, graphics, and man-machine interfacing continues. ETH is one of the important centers of the computer revolution, and we'll continue to hear lots more about it.

### MODEM TROUBLES

I've become addicted to the BYTE Information Exchange, otherwise known as BIX; the thought of a month in Europe without a single BIX fix was upsetting. In my last week back home at Chaos Manor, I tried a number of approaches to ensure overseas communications. Alas, they all came to naught.

Europeans do things differently from the way we do. In the U.S., we operate on credit. Tymnet, for example, is billed to the number you make contact with; the center you reach then bills you, generally through a credit card. In Europe, though, you have to pay in advance. Many post offices in Europe have facilities for connecting you to a European Tymnet gate. You go to the post office, pay your money, and are put into a small booth to use the network; then you get back anything you've overpaid.

Alas, most European networks operate at 300 baud—and Europe's 300-baud modems are not compatible with American modems. Your Tandy Model 100, or the little outside modem that attaches to the NEC PC-8201, won't work through European telephones. You *can*, I am told,

(continued)

# O Say, Can You C?

If you're a serious C programmer, you know that software development is 75% debugging. That's why you should take a look at the *Mark Williams C Programming System*. Besides producing the speediest, densest C code on the market, it includes a unique C source debugger called *csd* to help you C better!

#### MARK WILLIAMS C PROGRAMMING SYSTEM

- *csd* lets you set breakpoints at source level; windowing enables you to view a program output along with source. You can control program execution, display and change variable values, view sequence of function calls.
- Full UNIX compatibility with large library of more than 100 routines, plus support for a wide variety of third-party C utilities.
- Large and small memory models, full 8087 support plus high-speed floating point software emulation.
- One-step compilation produces an executable file with a single command. Options include object file in MWC or MS-DOS formats, or ROMable code.
- Extensive optimization, including peephole and jump optimization and common-code elimination.
- Void and enumerated data types, structured assignments and Berkeley structure rules.
- System includes librarian, assembler, and many useful utilities.

Mark Williams C Programming System and *csd* are trademarks of Mark Williams Co. Lifeboat, The Source for Software with Full Support and Lifeboat logo are trademarks of Lifeboat Associates.

**Call Lifeboat™ for the best in compilers and programming tools for the C development environment.**

For immediate delivery or more information, call

**1-800-847-7078** In NY: **(212) 860-0300**

or write: **LIFEBOAT™ ASSOCIATES**  
1651 Third Avenue New York, NY 10128



The Source for Software  
with Full Support™

"Sure could use some coffee..."



FOR YOUR INFORMATION,  
OUR NAME IS  
**HARRIS**

Telephone, dictating and answering machine in one.  
For more on the Harris-Lanier VIP Classic™ call 1-800-241-1706.



# We've gone to great widths to make you look good.



## Introducing New SIDEWAYS™ Version 3.

Sideways has always been the favorite way to print nearly everything that's too wide for a printer. Not surprising.

It's quick. It's easy. And it makes clean, one-piece printouts as wide as you like. So you get spreadsheets that really spread out. Pert charts that peer far into the future. All kinds of extra-wide reports without staples, glue or tape.

But now Sideways Version 3 goes even further.

### Especially for 1-2-3™ and Symphony.®

Now you can make short work of those wide 1-2-3 spreadsheets. No need to make print files. Just highlight a range and print right from your worksheet file using familiar Lotus-like menus.

Mix bold, underlined and expanded type, all on the same page. Print through or skip over perforations. Make the finest extra-wide printouts this side of typesetting.

Using Symphony? Sideways chimes right in to print any worksheet you've loaded without ever leaving your Symphony session.

### No matter what software you use.

Spreadsheets, databases, word processors, project planners. Whatever you use, you'll get more out of new Sideways.

Choose from nine different type sizes, from "minuscule" to "mammoth." Print bold, underlined or expanded – whatever your software can create. Even foreign language and line-drawing characters. Plus, there are so many ways to adjust margins, spacing and page size, it stretches the imagination.

Sideways Version 3 for the IBM® PC and all popular dot-matrix printers. Available now at computer dealers nationwide. Or directly from Funk Software with your check, Visa or Mastercard.

At just \$69.95 a copy, you'll never want for width again.

### Special upgrade offer!

Just send \$20 along with your current Sideways program disk and manual directly to Funk Software. We'll send you Version 3 right away.



Funk Software, 222 Third Street, Cambridge, MA 02142. Phone (617) 497-6339.

Copyright 1985, Funk Software, Inc. Sideways is a trademark of Funk Software. Lotus, 1-2-3 and Symphony are registered trademarks of Lotus Development Corp.

CHAOS MANOR

rent a Tandy Model 100 that will chew European current and communicate at 300 baud, but so far we haven't been anywhere I could do that.

European 1200-baud systems are the same as ours; and it is possible to connect to a U.S. 1200-baud modem by a direct call to the U.S. Alas, that too has its problems. For one thing, you generally want to go to the post office to make the call. European hotels routinely add about a 400-percent surcharge to overseas calls. (In Vienna, two calls to BYTE and one to California came to \$87 U.S., and they weren't long calls.)

Worse, though, is finding a portable computer with a 1200-baud modem. For some time now I have carried Percy, the NEC PC-8201, on most of my trips, and I've become very fond of him; but there is no 1200-baud modem for Percy. At NCC in Chicago this year, I met some NEC officials who were greatly cooperative about getting me one of the NEC PC-8401 Starlet machines. Starlet comes with an internal 300-baud modem, and there is an external 1200-baud modem available. Alas, the 1200-baud modem does not run on batteries! You have to plug it into 100-volt 60-cycle current. Europe doesn't use 100-volt 60-cycle current, and I was unable to get a reliable power converter. The Starlet and its modem stayed behind after all.

ETH's Institut fur Informatik offered to get me connected to BIX, and I eagerly accepted; then they found out that no one in the Institut knew how to do it. They called the Computing Center, another branch of ETH, which sent around a very friendly chap to help me. It turns out that every ETH terminal has the capability for connecting to the outside world at 1200 baud; you only need a password. Thus, I got a BIX fix courtesy of ETH; otherwise, though, I've remained BIXless and will until we swing through Zurich on our way back to the Frankfurt airport.

**PORTABILITY**

The last time I was in Europe I carried Adelle, the Otrona Attache luggage.

(continued)

**\*SPECIAL**

**MEMORY SOLUTIONS**



**TURBO DRIVE™ SERIES**

High performance, full featured fixed disk kits for:

- IBM PC  IBM PC/XT  IBM PORTABLE PC  AT&T 6300
- AT&T 7300  COMPAQ PORTABLE AND DESKPRO

MODEL <sup>1</sup>	CAPACITY FORMATTED	INTERNAL			EXTERNAL		
		LIST	SPECIAL Qty. 1	SPECIAL Qty. 10	LIST	SPECIAL Qty. 1	SPECIAL Qty. 10
TD8510 <sup>2</sup>	10 MB	\$ 595	\$375	\$350	\$ 895	\$ 560	\$539
TD8520 <sup>2</sup>	20 MB	795	499	475	1095	685	660
TD8533 <sup>2</sup>	33 MB	1595	995	—	1695	1095	—

TURBO DRIVE™ is the only competitive product in this price category which increases hard disk I/O by 50-100% and more over other hard disk subsystems on the market today. And it is as reliable as it is fast with a MTBF of over 14,000 power-on hours!

**FEATURES:**

- 10, 20, & 33 MB Formatted Capabilities (up to 2 drives/66 MB per system)
- 100% Hardware and Software Compatible
- Auto Boot from Fixed Disk
- Head Parking Software
- Simple Installation
- 12-Month Warranty
- Short Slot Controller — Card is 5 1/2" Long
- Drives are Completely Burnt in and Tested With Sophisticated Test Equipment Used by IBM

<sup>1</sup> Standard Subsystems Available

<sup>2</sup> Specify Full or 1/2 Ht. Bezel

<sup>3</sup> Price includes replacement 135W drop in PS for the IBM PC

**MAX DRIVE™ SERIES**

High capacity full height fixed disk upgraded for

- IBM PC/AT and kits for  IBM PC, XT and  compatibles.

**FEATURES:**

- 20 to 330 MB Formatted Capacity
- Utility Software for PC DOS — Utilize up to 10 Vols. or Smaller "Disks". Access Vols. by Password, Read/Write, Inhibit and More.
- Simple Installation
- 12-Month Warranty
- Units are Completely Burnt in and Tested

**From \$795.00**

The TURBO DRIVE™, MAX DRIVE™ & I-8480 Series of disk subsystems represents part of a 10 year corporate commitment to offering higher performance turn-key peripherals at a much lower cost to you than products provided by systems manufacturers. The Turbo Drive™ series offers higher capacities, significantly increased speed, and power efficient components with less heat dissipation causing increased product life and reliability. The MAX DRIVE™ Series provides maximum capacity with maximum price/performance efficiencies. The I-8480™ Series offers an alternative to communications and the benefit of media interchange between most micro, mini and mainframe computers.

\* Limited Time Offer — Sales Direct to Users at Special Price — Free Shipping in Continental U.S. — Expires January 31, 1986. Dealer Inquiries Encouraged — University and Corporate PO's Welcome

**INNOVATIVE**

**Peripheral Technology, Inc.**

2911 Newport Boulevard, Newport Beach, California 92663 • (714)642-7163



**FOR YOUR INFORMATION,  
OUR NAME IS  
HARRIS**

To find out more on how the VIP Classic™ from Harris-Lanier can reduce desktop clutter, call 1-800-241-1706.



# TURBO



Power™

## UTILITIES

FOR

**Turbo Pascal™ PROGRAMMERS**

**Improve Code Performance  
Find Subtle Bugs  
Automate Tedious Tasks**

Supports Turbo Pascal 2.0 & 3.0  
IBM PC/XT/AT & True Compatibles  
PCDOS 2.X & 3.X  
192K RAM DSDD Drive

**If You Really Use Your  
Pascal Compiler You Need  
These Tools!**

- Pretty Printer
- Pascal Structure Analyzer
- Execution Profiler
- Execution Timer

**Advanced Text Processing  
& Command Automation**

- Pattern Replacer
- Difference Finder
- Command Builder
- File Finder
- Super Directory

**Where Else Can You Get  
500K of Integrated, Useful,  
Tested, Fully Documented  
Source Code for \$95?**

- 140 Page Printed User Manual
- Quick Reference Card
- Detailed Programmer's Manual on Disk
- Complete Turbo Pascal Source Code
- 6 Bonus Utilities with Source!
- Tax & U.S. Postage Included
- Executable only version \$55

**MC/Visa Orders TOLL FREE  
(USA) 800-538-8157 x830  
(CAL) 800-672-3470 x830  
Brochures, Questions, PO's  
call 408-378-3672**

**Checks or Money Orders  
TurboPower Software  
478 W. Hamilton Ave., Suite 196  
Campbell, CA 95008 U.S.A.**

INTERNATIONAL REPRESENTATIVES —  
Switzerland: Software Haus 064-512651  
Japan: Southern Pacific Ltd 045-314-9514  
England: The Core Store 0606-45420  
Canada: Software Commodities 416-865-1600  
Holland: SCOS PC-Center 020-106922  
Norway: Polysoft 03-82575  
Turbo Pascal is a Trademark of Borland International

## CHAOS MANOR

The Attache still works fine and has a built-in converter to European power, but it's just too darned heavy, or so I thought as I was packing. It is time, I told myself, to become truly portable.

That, it turns out, is more easily said than done. The HP 110 is portable. I have problems reading its screen, but I could probably live with it. Alas, I couldn't find a reliable way to recharge its batteries on European current; at least, no one I managed to get hold of at Hewlett-Packard could tell me how I could safely do it. The HP 110 I have has about 70K bytes of useful memory; hardly enough for a month's trip, even if I didn't have to worry about power and eyestrain. That eliminated it.

The NEC PC-8401 Starlet was a possibility. The memory problem looked severe at first, but then I found out about Purple Computing's SideStar, which is an external CMOS (complementary metal-oxide semiconductor) RAM (random-access read/write memory) disk that you can plug into the Starlet. Carry two of those and you've got *lots* of reliable memory. Furthermore, it's easy to dump onto any other machine when you return, since the Starlet knows how to connect to disks. Alas, the PC-8401's screen is even more difficult to read than the HP 110's. I was about to bring the Starlet anyway until I found that the modem wouldn't be usable; that was enough to decide against it. I am told that by the time you read this, NEC will have a greatly improved Starlet available, with an easier-to-read screen; but it wasn't available in late July when we caught the plane.

I was getting a little desperate when I found out about Purple Computing's SideCar memory module for the PC-8201. This plugs into the side of the 8201 and provides *four* banks of 32K-byte memory. The 8201 already has two internal 32K-byte banks, all nonvolatile CMOS (low-current) memory backed up with lithium batteries. In addition, I carried a couple of NEC memory cartridges for Percy; the result is that I've done both BYTE and *Popular Computing* columns, kept my

notes, and written two chapters of a novel. I still have plenty of memory space left, and if I start running low, I have the NEC cassette data recorder in my luggage.

Percy's printer is a tiny little thermal affair; it produces a long, skinny output that looks like an adding-machine tape. I'm sure the BYTE people don't much appreciate it and wish I'd carried one of the larger printers, but if they saw my luggage, they'd sympathize. The little NEC printer is a life-saver.

Fair warning about the PC-8201: if you get the printer, order spare paper well in advance. NEC national headquarters had to move heaven and earth to get several rolls to Los Angeles on two days' notice. For some reason, few NEC dealers stock the paper. Secondly, both the NEC printer and data recorder come with Japanese batteries. Throw them away. Don't even attempt to use them. They won't hurt the printer, but if the data recorder has low batteries, it can hang up so badly you have to cold-start the NEC PC-8201, and that loses all your data files, including the one you were trying to save.

Purple Computing sells internal memory chips for the 8201 in addition to SideCar. If you get an 8201—and I'm so happy with mine that it will remain as a truly portable backup no matter what other machine I carry in future—you'll want to deal with Purple.

In addition to slots for additional internal RAM (which you get from Purple), the 8201 has a slot for a ROM (read-only memory) chip. The best one I've seen for that is The Ultimate ROM from Traveling Software. This contains a number of interesting programs, including an idea processor I've used with some success in drafting this column. There's also a good text formatter that works with the TTXpress portable printer, also available from Traveling.

We've used Percy in hotels, in the car, on airplanes, and even at dinner at Schloss St. Rupert in Salzburg—our fellow diners were extremely curious about him. The only problem we've

(continued)

# CHAIRMAN OF THE BOARDS

## THE 2400 bps MODEM FOR IBM-PCs & COMPATIBLES.

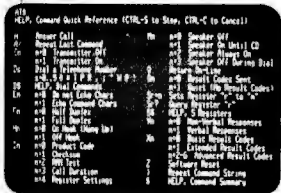
Plug the new USRobotics Microlink 2400™ modem board into any slot in your IBM PC or compatible—to give your computer full 2400 bps data communications capability.

The Microlink 2400 can communicate twice as fast as 1200 bps modems. (It transmits a double-spaced page of text in as little as 7 seconds!) Faster communication means lower phone bills and increased productivity. The modem can even redial busy numbers until it gets through—freeing you for other tasks.



Microlink 2400 displays call status and length on your screen, as well as operational parameters, including the command set and S-register settings. The modem's auto-answer feature automatically adjusts from 2400 bps to 1200 or 300 bps to match the speed of incoming transmissions.

What's more, a powerful equalizer assures peak performance on every call.



Help Screens

The Microlink 2400 is CCITT and Bell compatible, and responds to the full AT command set. You can use it with any of the popular telecommunications software packages including Telpac™ by USRobotics, Crosstalk™, PC Talk™ and Smartcom™. In

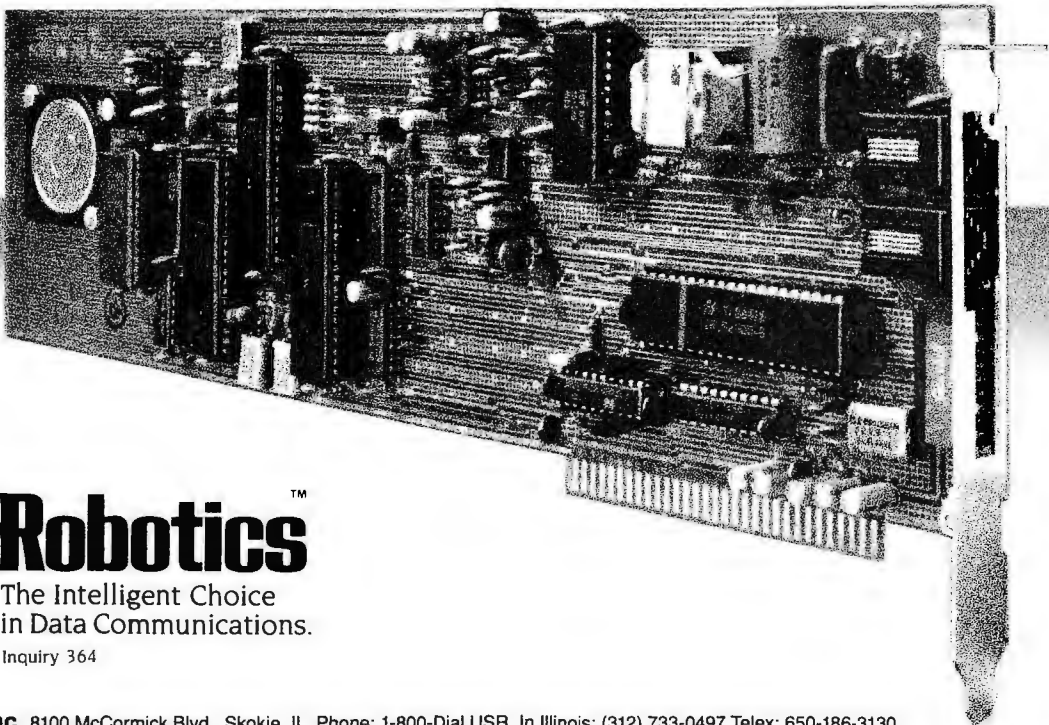
addition to the features you'd expect, our new, improved Telpac enhances Microlink 2400's performance with such features as easy-to-use windows, multilevel security, and log files to monitor your outgoing calls.

Microlink 2400's low chip count results in exceptional reliability — backed by a full 2-year

manufacturer's warranty. But best of all is the price — only \$699! And if you prefer an external modem, our new Courier 2400™ will deliver the same superior performance at the same affordable price. We set out to build the best modems on the market. Now, they're ready. Microlink or Courier. Being faster is important. But being best was our goal.



Courier 2400™



# USRobotics™

The Intelligent Choice  
in Data Communications.

Inquiry 364

had so far is that Mrs. Pournelle often wants to use him the same time I do; Percy is extremely easy to use, and she learned about him in no time. Next time she'll carry her own; Traveling Software has a good deal on 8201s, and I've ordered her one.

**TERMINAL DIFFICULTIES**

My daughter's job keeps her traveling; just now she's in Germany. Some time ago she asked me for an all-purpose computer she could use in various countries. It happened that Viasyn had just brought out the CompuPro 10, otherwise known in these columns as Shirley. Dr. Godbout's people were able to adapt it for European current, and I could get it at a good price, so over it went.

Viasyn didn't make terminals, so we looked about for one that would work in Europe and finally settled on a TeleVideo. Jenny was happy with it until one day it stopped working and a mysterious error appeared on the screen. No manual and no employee of TeleVideo seem able to explain that error message. It happens about 10 seconds after the terminal is turned on.

Jenny is not very computer-experienced, and trying to diagnose by intercontinental telephone is a losing proposition. When I got to her place in Germany, I did some tests: the first was simply to pull the plug from the TeleVideo to the CompuPro computer. Sure enough, the mysterious error message appeared anyway; so it wasn't something like the baud rate or a parity error.

The second thing I did was to connect the PC-8201 in terminal mode to the Shirley using the cable that formerly connected the TeleVideo. We booted Shirley. Everything worked fine. WRITE, WordStar, and SuperCalc all came up as usual. Of course, Shirley wasn't expecting a display 8 lines by 40 characters in size, so things looked a little odd, but otherwise it was all right.

Alas, we've been unable to find anyone in Germany who'll work on the TeleVideo terminal, while sending it back to the States costs money and

**ITEMS  
DISCUSSED**

**AMPRO Z80 MACHINES** . . . Check with  
Disks Plus . . . . . company  
15945 West Pope Blvd.  
Prairie View, IL 60069  
(312) 537-7888

**LILITH COMPUTER** . . . starts at \$13,000  
**MACMODULA-2** . . . . . \$150  
Modula Corporation  
950 North University Ave.  
Provo, UT 84604  
(801) 377-3598

**NEC PC-8201** . . . . . starts at \$399  
**NEC PC-8401 STARLET** starts at \$999  
NEC Home Electronics  
1401 Estes Ave.  
Elk Grove Village, IL 60007  
(312) 228-5900

**SIDECAR** . . . . . starts at \$159  
**SIDESTAR** . . . . . \$399  
Purple Computing  
420 Constitution Ave.  
Camarillo, CA 93010  
(800) 732-5012 (outside California)  
(805) 987-4788 (California)

**THE ULTIMATE ROM** . . . . . \$229.95  
Traveling Software Inc.  
11050 5th Ave. NE  
Seattle, WA 98125  
(800) 343-8080

requires complex paperwork. It looked simpler to buy her a new terminal.

I asked the people at ETH which terminals (for European current) they preferred for beginning students. Seems they'd done a study that indicated Zenith terminals give the most bang for the buck, so long as you take a little care in using them. There are others that stand up to student abuse a bit better, but for a small number of users, they like Zenith.

We've always liked Zenith anyway. When I get home I'll see what I can do; at worst, there's a Zenith outlet in

Zurich. I can send them the money, and maybe somebody can help with the papers for getting it into Germany. Meanwhile, score one more use for Percy.

**WINDING DOWN**

I'm finishing this in the Salzburg Hotel at Zell am See, an Austrian resort town on a lake so clear it rivals Tahoe.

There's a problem about the book of the month: the only computer book I have with me is my own *Adventures in Microland*. Edward Luttwak's *Grand Strategy of the Roman Empire* (Johns Hopkins University Press, 1976) has been a fascinating travel companion as we toured the old Roman forts and bases, but that's a bit specialized. Even as I write this, my wife is giggling over *Deadly Games*, a novel about modern Russia by émigrés Edward Topol and Friedrich Neznansky (Berkeley, 1985), which I also enjoyed, and there's even a little about the primitive computing equipment available to the Moscow police; but I suppose the real book of the month has to be the August BYTE, which I stuffed into my briefcase as I went out the door. I have twice read it cover to cover.

There's a lot to think about in the August BYTE; but my main conclusion is that it will be a while before the new declarative languages take over from the procedural programming languages we have today. Certainly they're not going to have much of an impact on the micro world until we get implementations that work on our machines. ETH's Modula-Prolog for MS-DOS machines is just now becoming available, so maybe that will get interest going in the micro community.

Meanwhile, I can reflect on what I've seen at ETH. When their work with databases becomes widely available, that will be one generic advance. That 3000-line Turbo Pascal program I mentioned earlier is an indexing system for a videodisk of medical data. At NCC in Chicago, I saw a number of videodisk systems and new developments in CD (compact-disk) ROMs. Electronically readable encyclopedias

are already on sale; next will be technical books with inserted *moving* illustrations accompanied by sound. None of this is more than a couple of years in the future—at least for hobbyists. The general public may have to wait longer.

The micro revolution continues, and we're right in the middle of it. I get to see the future before it happens. BYTE readers provide a continuous stream of information and ideas. I love it.

I do apologize for getting so far behind with my correspondence: my staff reports that though I almost caught up after the construction (happily finished), because of this vacation Chaos Manor is once again filled with archaeological layers of unanswered mail. When I get home I'll *read* it all, but realistically it's unlikely that I'll be able to answer more than a tenth of it.

Fortunately, the micro revolution

provides solutions as well as problems: BIX gives me a fighting chance to, if not keep up with correspondence, at least not fall too far behind. Now if I can just persuade people to use BIX instead of the post office. . .

A last-minute bottom line.

First, an apology. In October, I left out the address for Don Castella of Disks Plus, and that's not fair; Don has done a lot of work setting me up an Ampro Little Board system, and he also knows a *lot* about Ciarcia's new small system. I recommend Disks Plus as a good source of inexpensive but powerful integrated hardware/software packages for writers.

Second, an observation. I've read this over, and it's amazing how working on an 8 by 40 screen can affect writing style; the sentences and paragraphs are shorter and choppy than what I usually write on my 16 by

64 system. When I discussed this with BYTE Editor in Chief Phil Lemmons, he wondered if Ogden Nash didn't write on a 2 by 40 machine, while historian Edward Gibbons used an 80 by 2000. . .

This working vacation has been just what I needed, but I'm astonished at how much I miss getting on line with BIX and generally playing about with small computers. I can hardly wait to get back to Chaos Manor, where we have new machines, new software, and mounds of mail. Recall Ogden Nash on sins of omission: "Whee! The next round of unanswered letters is on me. . ." ■

*Jerry Pournelle welcomes readers' comments and opinions. Send a self-addressed, stamped envelope to Jerry Pournelle, c/o BYTE Publications, POB 372, Hancock, NH 03449. Please put your address on the letter as well as on the envelope. Due to the high volume of letters, Jerry cannot guarantee a personal reply.*

# THE \$2995 I<sup>2</sup> DEVELOPMENT SYSTEM

Turns any personal computer into a complete, integrated microprocessor DEVELOPMENT SYSTEM. The control/display program runs under MS-DOS, CP/M, or ISIS, and controls the UDL via an RS-232 port.

ADAPTERS AVAILABLE FOR VAX, APPLE CP/M AND PDP-11



## IN-CIRCUIT EMULATOR

32K bytes of EMULATION ROM (128K max) allows you to make program patches instantly. You can stop the program at break-point, single-step, and display or change registers, ports and memory. The target processor stays in its socket for perfect transparency.

## BUS STATE ANALYZER

Features four-step sequential triggering, selective trace, and pass and delay counters. Symbolic trace disassemblers and debuggers are available for Z-80, NSC-800, 8048, 6301, R65, 6500, 6800, 6801, 6802, 6805, 6809, 8051, 8085, Z-8, 1802, 8088/80188, 8086/80186, and 68000/8.

## EPROM/EEPROM PROGRAMMER

Doubles as a stimulus generator during system checkout. Handles 24 and 28 pin devices up to 27256.

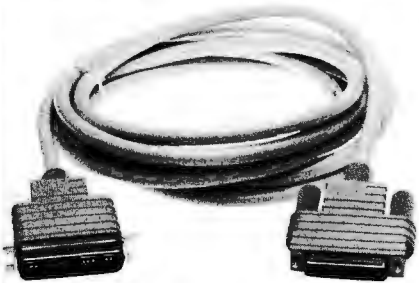
FOR FURTHER INFORMATION  
TELEPHONE JOHN STANLEY

**(415) 361-8883**

OR WRITE:

**ORION INSTRUMENTS, INC.** 702 MARSHALL STREET • SUITE 614 • REDWOOD CITY, CA 94064

# THE ULTIMATE CABLE ASSEMBLY



Patent PND.

## DATA SPEC®

FROM ALLIANCE RESEARCH CORPORATION

20120 Plummer Street  
Chatsworth, CA 91311 • 1-818-993-1202

No More Fumbling with Screwdrivers! Just a twist of the thumb wheel screw heads and the cable is securely screwed into position! No cable looks or works quite like this. DATA SPEC® cable assemblies not only visually enhance your computer equipment, but provide superior quality inside and out.

### FEATURES:

- Gold Plated Pins
- Positive Strain Relief
- Full Shielding (Exceeds F.C.C. EMI/RFI Emission Requirements)
- Large Convenient Thumbscrews (No More Screwdrivers Needed!)
- Exclusive P.D.T. Underhood for Maximum Integrity
- Lifetime Warranty

DATA SPEC® makes cable assemblies to fit any of your interface needs: RS232, Parallel (Centronics), Printers, Modems, Disk Drives, and monitors. For your IBM, Apple, AT&T and other popular PCs. Ask for DATA SPEC® cables at your nearest authorized DATA SPEC® dealer.

USE INQUIRY NUMBERS BELOW

# PRINTER JACK™

## Apple IIc Serial to Parallel Printer Interface



The Printer Jack™ is a device that will enable you to use the Apple IIc, which is not equipped with a parallel port, with any standard parallel printer. The Printer Jack can also be used with other computers with an optional cable. The Printer Jack set, Model A1250 includes: a CPU unit (the big box), a 9V power supply and a 5 pin to a 5 pin cable.

## DATA SPEC®

FROM ALLIANCE RESEARCH CORPORATION

20120 Plummer Street  
Chatsworth, CA 91311 • 1-818-993-1202

USE INQUIRY NUMBERS BELOW

# SURGE PROTECTOR



Power Spikes can occur anywhere! Even in RS232 lines! Stop power spikes with the NEW RS232 Surge Protector from DATA SPEC®. The RS232 Surge Protector will eliminate power spikes and surges generated by static discharges from damaging computers and peripherals. Comes with a Female DB25 on one end and a DB Male on the other end with gold plated pins. All 25 pins are wired through. Ask for the RS232 Surge Protector at your nearest authorized DATA SPEC® dealer.

## DATA SPEC®

FROM ALLIANCE RESEARCH CORPORATION  
20120 Plummer Street  
Chatsworth, CA 91311 • 1-818-993-1202

# RS232 MINI-TESTER



This miniature RS232 tester is designed to monitor RS232 lines. This tester is very useful in diagnosing RS232 communication problems.

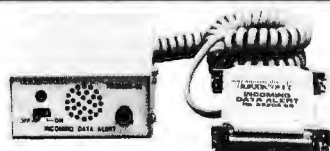
There are 7 different colored LED indicator lights to monitor the following functions: Receive Data (RD), Clear To Send (CTS), Data Terminal Ready (DTR), Request To Transmit Data (TD), Request To Send Data (RTS), Data Set Ready (DSR), and Carrier Detect (CD). Ask for the RS232 Mini Tester at your nearest authorized DATA SPEC® dealer.

## DATA SPEC®

FROM ALLIANCE RESEARCH CORPORATION  
20120 Plummer Street  
Chatsworth, CA 91311 • 1-818-993-1202

USE INQUIRY NUMBERS BELOW

# NO LOST DATA! Even Computer Owners Need Beepers



Have you ever lost data from a modem because you forgot to turn a switch? Now you can be "beeped" and visually alerted with the Incoming Data Alert from DATAS SPEC®.

This device will sound an audible "beep" (for about 15 seconds) and light a red L.E.D. (which stays lit until reset) whenever data is being transmitted through an RS232 line. The Incoming Data Alert monitors pin 3 and can be used between modems and computers and terminals.

## DATA SPEC®

FROM ALLIANCE RESEARCH CORPORATION  
20120 Plummer Street  
Chatsworth, CA 91311 • 1-818-993-1202

USE INQUIRY NUMBERS BELOW

# 25 PIN DATA SWITCH \$59.95



All RS232 25 pin switch boxes are available in these configurations: AB-25, ABC-25 and ABX-25 (Cross Matrix, allows the use of 2 computers and 2 peripherals). Can be switched with IBM PC parallel port, compatibles too!

It's about time you benefit from high performance at affordable prices? Ask for the 25 Pin Data Switches at your nearest authorized DATA SPEC® dealer.

## DATA SPEC®

FROM ALLIANCE RESEARCH CORPORATION  
20120 Plummer Street  
Chatsworth, CA 91311 • 1-818-993-1202

# 36 PIN PARALLEL DATA SWITCH (CENTRONICS TYPE)



These switch boxes also have gold plated pins and have all 36 pins switched. The 36 pin boxes are available in these configurations: AB-36 and ABC-36.

Quality features, outstanding durability and affordable prices! Ask for the 36 Pin Data Switches at your nearest authorized DATA SPEC® dealer.

## DATA SPEC®

FROM ALLIANCE RESEARCH CORPORATION  
20120 Plummer Street  
Chatsworth, CA 91311 • 1-818-993-1202

Inquiry 105 for End-Users. Inquiry 106 for DEALERS ONLY.

# L.E.D. 25 PIN DATA SWITCH BOX



Get all the outstanding features of DATA SPEC's RS232 25 Pin Data Switch Boxes and more with the ABL-25LE. This luxury edition data switch box features 7 L.E.D. indicators (TD, RD, RTS, CTS, DSR, DTR & CD) and gold plated pins.

Ask for the 25 Pin L.E.D. Data Switch Box at your nearest authorized DATA SPEC® dealer.

## DATA SPEC®

FROM ALLIANCE RESEARCH CORPORATION  
20120 Plummer Street  
Chatsworth, CA 91311 • 1-818-993-1202

© Copyright 1985 Alliance Research Corporation



*Editor's note: Due to space limitations, we are able to publish only a sampling of the great amount of mail Jerry receives each month.*

## YET MORE ON COPY PROTECTION

Dear Jerry,

Since I am trying to make a living by selling my thoughts, I am in favor of copyright laws that protect me from being ripped off. And I just met a guy who specializes in pirating programs. He told me he had 13 word processors, 10 spreadsheets, lots of stuff like that, and that he hadn't paid a dime for any of them. As near as I could tell, he'd never used any of them, but that's not the point. He's wrong, and you and I both know it. If he photocopied one of your books and began selling it on street corners, I certainly expect that you'd be irked.

A school principal once asked me to lend him my Wildcard so he could make copies of an expensive program the school system had purchased. They had 28 machines, and the company wanted \$200 for one disk, no backup, for each machine. The school system got a volume discount for the computers but couldn't get one for the software. It's one hell of a moral dilemma for a man who's supposed to set a good example to be, more or less, forced into theft in order to meet his commitment to society. Not only that, it was also a really stupid program, but through some hard-sell method that they used they were able to con the school system into buying it.

An even more ludicrous example of corporate greed was in the papers here recently. Seems a company, I'm not sure which one, was suing a computer store for violating the licensing agreement in using this company's product in training seminars they were conducting teaching businesspeople how to use the product. They evidently were using one program per machine (no hot copies) but were using the same copies for each class of trainees, instead of purchasing a new one for each user. Talk about a case of biting the hand that feeds you.

There's got to be some middle ground somewhere, a place where consumers and producers can fulfill their legitimate needs. I, for one, don't buy a lot of software, mostly because of price, but also because there's a lot of low-quality junk out there. I don't like copy-protected disks because, with my Apple at least, they always seem to mess with the DOS and then, if my drive is a bit off or whatever, I'm stuck with a zapped disk. Besides, nobody can write a perfect program that's perfect for all machines and all users, but maybe I can modify it to do something that the company never thought of. It saves me writing a whole program from scratch and, maybe, opens up a whole new market for you. There's no way I could market it without you knowing it's a variation of your program, and I'm willing to settle for a share of royalties. On the other hand, however, I probably could figure out a way to break your copy protection, but why waste my time? If it's a really good idea, I'm sure that I'm much better off doing the program from scratch and leaving you out in the cold.

Furthermore, if I buy a car and the engine goes bad or I just want to try a different one, I don't have to call the factory for permission to change it. I bought it, and it's mine. If I want to screw up the warranty, that's my business. There's lots of things I've seen that I'd pay \$10 for, but they cost \$29.95. Lots of \$100 programs that I'd give \$50 for. I haven't seen anything that I'd pay \$100 for, but I've seen some stuff that would be worth more if I could mold it to fit my own needs, but I can't because it's on a copy-protected disk and it comes with some kind of stupid licensing agreement that seems to say I've only rented the thing, unless it goes bad, in which case I own it and the guy I rented it from doesn't have any obligation to make it right. Why should I waste my hard-earned money on a deal like that and still not have a program that will do what I want it to do? As for getting a hot copy, why bother? If it's not worth buying, why steal it?

It's time for the honorable people on both sides to get together and set some standards. If you sell me a fair program

at a fair price, I won't let anyone else have a copy of it. If I've got more than one machine, let's talk about a volume discount. It's a lot of hassle for me to copy disks and manuals, but I don't feel I should pay full retail for each and every one of them.

I'll tell you the same thing I told the school principal: You can live in a swamp without crawling in the slime. Those who want to know how to break programs can find out without you compromising your integrity. Keep letting us know about honorable outfits like Borland, and we can deal with them. Despite what the experts say, integrity is more important than packaging. Let the rip-off artists deal with each other, but isolate them; they deserve each other.

Thanks for allowing me to ramble on in this long letter.

BRUCE NATTRASS  
Madison, WI

*Perhaps it's simply because it's traditional, but I see nothing fundamentally wrong with the way copyright protects books: when you buy a book, you own it, but you have no right to sell or give away copies, nor to keep a copy if you dispose of the original. The disabled and educational institutions have certain rights as well.*

*It's illegal but physically possible to borrow books from the library and make copies of them; fortunately, that's pretty difficult. Alas, it's much easier to make copies of software.*

*There's got to be an answer, and let's hope that we find it soon. Thanks for a thoughtful letter.*

Best.—Jerry ■

## HELP NEEDED

The last letter I sent to Swami Shantam Paul was returned "unable to forward." I'd appreciate it if anyone knowing his new address could let me know.

FREE SHIPPING!

No Credit Card Surcharge!

# PC SOURCE

## AST SixPakPlus

w/384K



**\$249**

## STANDARD BRAND PRODUCTS

All Standard Products  
Have A 2 Year Warranty!



## Standard MFC Multifunction Card W/384K

- Parallel Port
- Game Port
- Software
- Memory Expansion
- Clock Calendar
- Serial Port

**\$145**

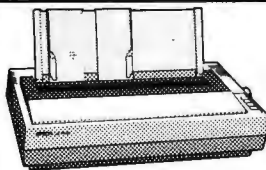
**AST Advantage! W128K... \$399**

## Memory

### 64K Chip Set

9 chips per set,  
1 Yr. Warranty  
Minimum Order 2 Sets... **\$5**

**256K Chip Set**  
9 chips per set,  
1 Yr. Warranty... **\$29**



## EPSON



Number one.  
And built like it.

LX80... **\$229**

FX185... **\$499**

FX85... **\$379**

LQ1500... **\$929**

Printer Cable \$25

W/Parallel Interface

## Intel Math Co-Processor

8087 **\$119**

80287 **\$219**

## Complete Hard Disk Kits for the IBM PC™

✓ Reliable ✓ Full Instructions ✓ 1 Year Warranty

**\$395**  
10 MB

**\$495**  
20 MB

**\$695**  
30 MB

**COMPAQ**

10MB Hard Disk Kit ..... **\$475**

20MB Hard Disk Kit ..... **\$629**



PC's & AT's



**Call For Current Prices...**

## TEAC 55B



Half Height  
Double Sided

**\$95**

## MINUTEMAN™

Total Power Protection!

- Blackouts
- Interruptions
- Brownouts
- Surges
- Spikes
- FMI/RFI Noise

### Minuteman 250

250 watts output  
power capability ..... **\$399**

### Minuteman 500

500 watts output  
power capability... .. **\$549**

## 360K Floppy Drive

for the **IBM** AT™



**\$119** Qty. 5 \$99

W/Mounting Rails

## CORPORATE AND INSTITUTIONAL ACCOUNTS

Our national accounts division is dedicated to providing the prompt professional service required to keep your business running smoothly. We accept P.O.'s on a Net Terms basis, (minimum purchase of \$50) offer same day shipping, free fully insured UPS ground shipment. We offer full-time technical staff to answer any questions that might arise and to make fast repairs if needed. Call our national accounts staff today. We Make Your Job Easier...

### OUR POLICY

We accept Mastercard & Visa (with no Surcharge!), money orders, certified checks, personal checks (allow 10 days for processing), COD (minimum purchase of \$50), Company/Institutional P.O.'s and wire transfers. We do not charge your card until we ship. We pay shipping (UPS ground, fully insured) on orders delivered in continental U.S.A.

Add 6 1/8 sales tax if Texas resident. Prices are subject to change. All equipment carries a new factory warranty. Any return item must be accompanied by a return authorization number.

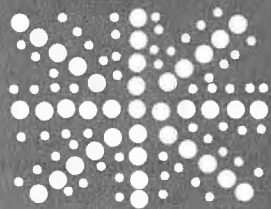
Call Toll Free (800)626-4027 Within Texas (512) 331-6700



Inquiry 68



10904 Marble Road Austin, TX 78750



## The Torch Triple X

A UNIX  
machine for  
a (rumored)  
personal  
computer  
price

BY DICK POUNTAIN

**T**orch Computers Ltd. is one of the more successful British computer manufacturing firms, although it is not well known in the United States. Torch entered the computer business by providing peripherals for the Acorn BBC Micro (see *BYTE U.K.*, September, page 385), a machine that never crossed the Atlantic in large numbers but is the second most popular home computer (after the Sinclair Spectrum) in the U.K.

When Acorn launched the BBC Micro (the Beeb) in 1981, the company promised a series of second processors (including the Z80 and National Semiconductor's 16032) to plug into the machine's high-speed bus, called the Tube. Acorn itself was slow to produce these second processors; and Torch Computers (Torch Computers Ltd., Abberley House, Great Shelford, Cambridge CB2 5LQ) was born to add the Z80 and CP/M capability to the Beeb. After some rather complicated politics, Torch's first product became a whole new computer, containing a BBC motherboard purchased from Acorn and a Z80 running CP/N, Torch's own CP/M-80-compatible operating system. With twin floppy disks, color graphics, and a built-in, post-office-approved modem (at a time when such things were rare), the machine certainly stood out from the throng of "identikit" CP/M boxes that dominated business computing in those days.

Torch went on to produce an add-on box for the Beeb, containing twin floppy-disk drives, a Z80 with its own 64K-byte RAM (random-access read/write memory), and CP/N, which proved to be a considerable success. It provided a relatively low-cost entry into CP/M in much the same way that Apple II Z80 cards did in the U.S.

This line of development—providing expansions to the Beeb, which Acorn had still not delivered—led Torch naturally into UNIX land. Again paralleling Apple in the U.S., the Beeb had found favor in university departments, as well as with the hobbyists, and

these people wanted UNIX.

In 1983, Torch produced another (rather large) add-on box called the Unicorn, which contains both a 68000 and a Z80, runs both Berkeley System III UNIX and CP/N, and uses the Beeb as a color-graphics terminal. Over the intervening years, Torch has extended the Unicorn into a range of stand-alone UNIX personal computers and workstations, all based on the triple-processor architecture, integral communications hardware, networking, and the BBC sound and graphics facilities. As a result, Torch has quietly become one of the larger UNIX vendors in the U.K. (in terms of installed base, if not value), almost unnoticed by the specialist UNIX houses. A recent report on the UNIX marketplace in the U.K. ignored Torch altogether, concentrating on machines that cost more than £15,000.

### THE TRIPLE X

From the earliest days of the company, Torch's designers had been working on a full-fledged UNIX computer, code-named the XXX or Triple X. Their experience with the Unicorn design radically altered this project; they more or less started again from scratch using the latest personal computer technology. Torch now has a product that is to be officially launched in January 1986 at London's "Which Computer" show. The product, a low-cost, mass-producible personal computer running UNIX System V and driven by Motorola's 68010 processor, has retained the Triple X name.

The machine is aimed at the same market as the AT&T UNIX PC, although it will probably be priced substantially lower. (Pricing was not decided at press time, although some adventurous figures being mentioned are nearer to the IBM Personal Computer than to typical UNIX prices.)

The Triple X (see photo 1) machine is a desktop computer with a small footprint—smaller than an IBM PC and about the same size as that of the Apricot from

(continued)

Dick Pountain is a technical author and software consultant living in London, England. He can be contacted c/o BYTE, POB 372, Hancock, NH 03449.

Apricot Inc. The console unit contains a single-board computer with a full megabyte of RAM, a single 720K-byte floppy-disk drive, and a 20-megabyte Winchester drive. A single power cord supplies both the console and display units, and the power switch is software-controlled so that the machine performs an orderly UNIX shutdown before finally removing power.

A tilting, swiveling 10-inch video-display unit sits on top of the console unit. This is a high-resolution color unit, capable of a maximum graphics resolution of 720 by 512 pixels. Torch uses this bit-mapped graphics capability to provide a Macintosh-style user interface to UNIX, complete with windows, icons, and a mouse. The Triple X supports multiple type fonts and laser-printer output, the latter via an integral Ethernet controller.

The Triple X's white injection-molded case permits modular expansion. The console unit is a sandwich

of a base plate, a central rectangular ring, and a lid. The processor and memory motherboard fit into the base, while the central ring contains the disk drives, power supply, and fan. The central ring can be lifted clear for access. You can insert extra stacking rings containing extra drives or other peripherals into the sandwich. Alternatively, you can remove the ring, leaving a diskless workstation. Using the built-in VME bus interface, you can add an extra-deep ring that turns the console into a floor-standing mini-computer-style unit that may contain many VME cards and extra power supplies.

#### HARDWARE DESIGN

The Triple X is designed around the 68010 processor, which runs at 8 MHz, working in conjunction with the 68451 MMU (memory-management unit) and 68450 DMA (direct memory access) controller to support virtual-memory operation in the 1-megabyte

main memory space.

A 6303 single-chip microcomputer with on-chip RAM and ROM (read-only memory) acts as a service processor, which controls the video modes and color palette, a battery-backed clock with some CMOS (complementary metal-oxide semiconductor) setup memory, keyboard and mouse, sound generation, serial communications links, and a 1-MHz peripheral bus. This second processor insulates the devices it controls from the activities of the UNIX system so that, for instance, the mouse can move the screen cursor in real time without interference from UNIX tasks. It also relieves UNIX from any potential video synchronization problems when changing screen modes. The video system has its own separate 64K bytes of RAM, part of which is double-ported to serve as a message-passing area for communications between the 68010 and the service processor.

The service processor conducts power-up diagnostic checks and ascertains what devices exist in the system before it bootstraps the 68010. If an optional on-board modem is present, the service processor can perform remote diagnostics on failure of the main processor.

Despite the lack of any dedicated hardware graphics processor, screen refresh and raster moves (for example, dragging windows or icons) are exceptionally quick; the powerful peripheral chips and service processor appear to leave the 68010 with plenty of steam to perform these chores.

The amount of video memory provided is sufficient to allow 720 by 512 pixels in two colors (1 bit per pixel), 720 by 256 pixels in four colors (2 bits per pixel), or 360 by 256 pixels in 16 colors (4 bits per pixel). The normal operating mode is 720 by 256 pixels, which provides sufficient resolution to produce normal, bold, and italic type styles with excellent clarity on the screen. As on the Macintosh, the choice of a small 10-inch screen format improves the perceived clarity of

*(continued)*



Photo 1: The Torch Triple X microcomputer.

# NEW LANGUAGE BREAKS OLD RULES. GIVES PROGRAMMERS POWER, SPEED AND SIMPLICITY.

Try this remarkable language, PROMAL™, for 30 Days AT NO RISK and...

We think you'll be thrilled with this breakthrough system when you discover its power, ease of use, and dazzling performance on your IBM PC, Apple IIe/IIc, or Commodore 64. But we don't expect you to accept our claims for PROMAL without proof, so we invite you to explore the power of PROMAL on your own during our 30-day trial period.

## Broken Rules

Now that PROMAL 2.0 has broken the rules, a structured language doesn't have to be slow, unwieldy and difficult to use. PROMAL is fast, elegant, and simple.

## What Is PROMAL?

PROMAL stands for PROGRAMMER'S Micro Application Language. But PROMAL is more than a high-level language, it's a total structured programming development system with a fast, one-pass compiler, a versatile full-screen editor, plus an integrated machine-language subroutine library. And for APPLE and Commodore systems it includes a DOS-like system "Executive."

## Better By Design

PROMAL was designed from "scratch" for optimum performance and ease of use on microcomputers. It has a simplified syntax with no awkward terminators

## PROMAL 2.0 FEATURES

### COMPILED LANGUAGE

- Structured indentation syntax
- No line numbers or terminators
- Long variable names (31 characters)
- Global, Local, & Argument variables
- Byte, Word, Integer & Real data types
- Decimal or Hex number types
- Functions & Procedures with passed arguments
- Predefined DATA of any type
- Multi-Dimensional Arrays (any type)
- Strings & pointers
- Control Statements: IF, IF-ELSE, WHILE, FOR, CHOOSE, REPEAT-UNTIL, BREAK, NEXT, INCLUDE, ESCAPE, REFUGE
- Bit-operators, shifts, type casts
- Variables at any memory location
- Simple Machine Language interface
- Recursion supported
- Program chaining and overlays (IMPORT/EXPORT)
- Separate compilation of modules
- Load and run relocatable M/L programs
- Compile errors trapped for Editor

### EXECUTIVE (APPLE II & C64 Only)

- Command driven, with line editing
- Multiple user programs in memory at once
- Function key definitions
- Program abort and pause
- Prior command recall
- I/O Re-direction & batch jobs
- "DOS"-like commands: COPY, RENAME, DELETE, display FILES, TYPE, HELP, etc.
- Memory MAP, SET, and display commands

### EDITOR

- Full-screen, cursor driven
- Function key controlled
- Line insert, delete, search
- String search and replace
- Block copy, move, delete & file read/write operations
- Auto indent, undent support

### LIBRARY

- 50 Resident Machine-language commands
- Call by name with arguments
- String handling (9 routines)
- Re-directable I/O (STDIN & STDOUT)
- Formatted numeric output
- Decimal & Hexadecimal I/O
- Block fill/move/read/write
- Cursor control & line editing
- Data type conversion
- Random number function
- Real function support (in PROMAL): ABS, ATAN, COS, EXP, LOG, LOG10, POWER, SIN, SQRT, TAN
- Modem device support & much more

like ";" or "]" and indentation is part of the syntax, so structuring your code is natural and easy. Just compare PROMAL with BASIC in this example:

Equivalent Program Segments	
<pre> REPEAT   PROMPT AT 5,24, "Add/Chg/Quit?"   IF Reply = 'A'     ADD Item     New.Items = New.Items + 1   ELSE IF Reply = 'C'     CHANGE Item   UNTIL Reply = 'Q'           </pre>	<pre> 11910 REM -----BASIC----- 11920 CL = 5:LN = 24:PRS = "Add/Chg/Quit?" 11925 GOSUB 9490:REM GET REPLY 11930 IF RPS &lt;&gt; "A" THEN 11960 11940 I = IT:GOSUB 10100:REM ADD 11945 NI = NI + 1:GOTO 11920 11950 IF RPS &lt;&gt; "C" THEN 11970 11960 I = IT:GOSUB 6050:REM CHG 11970 IF RPS &lt;&gt; "Q" THEN 11920           </pre>

PROMAL is readable and understandable. You see the logic from the structure. And PROMAL lets you call procedures by name—so no more GOSUBs. But there's more.

## Slick Editor

Editing your source is a snap with the specially-designed and integrated full-screen Editor—it not only helps you structure your program, it even finds compilation errors—automatically.

## Quick Compiler

The compiler is a lightning-fast, one-pass, recursive descent design. On the IBM PC it crunches source to object at 2000 lines per minute, and it's equally impressive on the Apple and C64. And your PROMAL source code is portable from machine to machine. That means your source can be used on all PROMAL target machines.

## Run-Time Speed Demon

PROMAL blows away Apple II and C64 languages from BASIC and PASCAL to FORTH. (Send \$3 for a copy of our full benchmark report.) It's 2000% faster than BASIC. And on a normal IBM PC, the native 8088 code from PROMAL beat Turbo Pascal 3.0 by 10% on the standard sieve benchmark!

## DOS For Those Without

If you don't have a real "DOS," then PROMAL gives you a true operating system environment with the built-in operating system Executive. (See box.)

## Outside Opinion

Naturally we're enthusiastic about PROMAL, but here's what other programmers are saying:

"Excellent... an ideal development system... Well done indeed!"

M. T. V.  
Naperville, Ill.

"I am... so amazed by PROMAL... I cannot believe the high degree of excellence of this entire package."

C. P., Ph.D.  
Ridgeway, New York

"I don't know that I've ever seen a [system] as thoughtfully designed and as skillfully executed as PROMAL. Its logic and ease of programming are truly remarkable. Its speed of execution is phenomenal... congratulations."

E. C. R.  
Alexandria, VA

## Safety In Numbers

SMA, Inc. has been satisfying customers (over 100,000) since 1982 with innovative microcomputer products. Now you can join our thousands of satisfied PROMAL users, by trying it today.

## Try It For 30 Days On Us

Send us some bucks and we'll send you PROMAL on trial for 30 days. If for any reason whatsoever you are not satisfied, just send it back for a quick refund of your purchase price. No questions asked. No risk.

## How To Order.

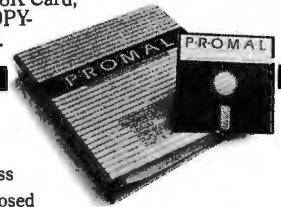
Call TOLL-FREE to order with your credit card or use the handy order form below to send in your check or money-order for your 30-day trial. Don't wait, you deserve the power of PROMAL today!

# 1-800-762-7874

In NC: 919-878-3600

**SMA** Systems Management Associates, Inc.  
3325 Executive Drive, Dept. PB-6  
Raleigh, North Carolina 27609

PROMAL runs on IBM PC/PCjr with 192K, Commodore 64/128, APPLE IIc, or APPLE IIe with 80 Col. 128K Card, and is NOT COPY-PROTECTED.



## Order Form for PROMAL 30-Day Trial!

My system is (check one)  
 IBM PC/100% compatibles     APPLE IIc/IIe  
 COMMODORE 64/128

Please RUSH me:

- PROMAL Developer's System—Compiler, Editor, Library, Demo disk, 280-page manual, (Plus Executive for Apple and C-64) and stand-alone program generation (no royalties).  
\$99.95 + 5.00 Shipping & Handling
- End-User System for Apple IIc/IIe and Commodore 64/128—all features of Developer's Version except stand-alone program generation (Executive needed for program execution)  
\$49.95 + 5.00 Shipping & Handling
- Graphics ToolBox (Apple/C64 only)—20 routines for hi-res graphics: windows, clipping, text-on-graphics using scaled, rotated, user-defined fonts.  
\$29.95 + 2.50 Shipping & Handling

Please charge my  
 Visa  
 MasterCard  
 American Express

My check is enclosed

Card Number \_\_\_\_\_ Exp. Date \_\_\_\_\_

Signature \_\_\_\_\_

Name \_\_\_\_\_

Address \_\_\_\_\_

City \_\_\_\_\_

State \_\_\_\_\_ Zip \_\_\_\_\_

NC residents add 4½% sales tax.  
Foreign orders add \$20.00 additional shipping.



PROMAL is a trademark of Systems Management Associates, Inc. Turbo Pascal is a trademark of Borland International, Inc.

**Color Diskettes BY CentTech**  
The Colorful Solution to Data Organization™

**TIMELESS WARRANTY**  
SS-DD DS-DD

**\*70¢** Color Bulk QTY. 100 **90¢\***

**\*89¢** Color Boxed QTY. 100 **\$1.09\***

**\*99¢** Color Bulk 96 TPI QTY. 100 **\$1.19\***  
**\$2.13\*** DS-HD

IBM PC-AT Compatible Color Bulk  
100% error-free beyond 75% clipping level.  
Available in 13 useful assorted colors.  
\*Copies with W/Tyvek sleeves add 2¢. Label Kit 2¢.  
\*\*Pre-packaged in Plastic Library Case/12. A \$4.95 value case for 20¢ disk extra.

**3M Incredible Price!**

**99¢** LIFETIME WARRANTY DS-DD  
SS-DD **\$1.32**  
5.25" QTY. 5 CASES

**\$1.99** 96 TPI **\$2.39**  
**\$2.25\*** 3-5"/135 TPI **\$2.97\***  
**\$3.13\***

High Density for IBM PC-AT/DS-HD  
3M Headcleaning Kit ..... **\$7.95**  
3M Data Cartridges (DC-1000) . **\$12.60**  
DC-3000XLP ..... **\$19.37**  
DC-600A ..... **\$20.60**  
\*with FREE FLIP'N'FILE.

**Nashua "Boxed" Diskettes**

**LIFETIME WARRANTY**  
SS-DD Lesser qty add 10¢ DS-DD

**77¢** 5.25" QTY. 10 BOXES **89¢**

**\$1.95** 3-5" QTY. 5 BOXES **\$2.65**

Factory fresh in boxes of 10 with Tyvek sleeves, user ID labels, write-protect tabs and reinforced hub ring. **DS-HD \$2.59.**

**wabash® Pinnacle/Data Tech**

**LIFETIME WARRANTY**  
SS-DD DS-DD

**65¢** BOXED 5¼ QTY. 10 BXS **75¢**

**\$1.99** 3-5" 5 BOXES **\$2.39**  
Lesser qty add 10¢ **\$2.24**

High Density for IBM PC-AT DS-HD

**100% Error-Free BULK** By Leading American Media Manufacturer one of the top 2

**LIFETIME WARRANTY**  
SS-DD DS-DD

**55¢** 5.25" QTY. 100 No sleeves/labels **65¢**

**PRINTER RIBBONS** Epson MX 70/80 ..... \$2.68  
Epson MX-100 ..... \$4.08  
Olivetti 90, 82, 83, 92, 93 ..... \$1.36  
Olivetti 84 ..... \$2.95

**DISK STORAGE** Amray Media Mate 50 ..... \$8.75  
Disk Minder II-75 ..... \$9.75  
Micro Disk Minder-36 ..... \$7.75

**PRICE PROMISE:** We will better any lower delivered price on the same products and quantities advertised nationally.

**TERMS:** FREE USE OF VISA AND MASTERCARD. American Express also accepted. Shipping: Add \$3.00 per 100 diskettes or fraction thereof. Other items add \$3.00 for disk storage or headcleaning kit or dozen ribbons or C.O.D. orders. P.O. accepted from recognized institutions and schools on 2%-10 Net 30. Utah residents add 5% sales tax. Minimum order \$30.00.

**TOLL FREE ORDER LINE:**  
**1-800-233-2477**  
INFORMATION AND INQUIRIES:  
**1-801-942-6717**

**Computer Affairs, Inc.** 2028 E. FT. UNION BLVD., 105 SALT LAKE CITY, UTAH 84121  
CALL: 1-800-AFFAIRS  
HOURS: 9AM-6PM M-F (Mtn. Time)

**BYTE U.K.**

*You can select colors interactively with a palette editor, allowing control of red, green, and blue levels.*

the displayed characters.

The color selection is extremely flexible. The physical color palette is a 16 by 8 RAM under the control of the 6303, into which bytes are stored to select the 16 displayable colors. Each palette byte controls the intensities of the red, green, and blue beams in the monitor, with 3 bits each devoted to red and green (eight levels) and 2 bits to blue (four levels). This allows 16 colors to be chosen arbitrarily from a possible 256. There are two logical palettes, *mark* and *flash*, allowing flashing displays that cyclical swap from one to the other.

You can use all 16 colors in screen mode 1 (360 by 256 pixels). In the normal screen mode (720 by 256 pixels), you can only use 4 actual hues, but 16 halftone tints are available if you mix all the pairs; these tints are subtle and show no visible halftone pattern at all. You can select colors interactively with a palette editor, allowing direct control of the red, green, and blue levels, which are displayed as a bar chart. You may alter these levels with the mouse; since changes take effect immediately, you can even use it for color matching.

Communications on the Triple X are handled by two more built-in devices, a Zilog SCC (serial-communications controller) and the Lance Ethernet controller. The back panel provides two serial data channels with D-type connectors. One is configured as RS-423A and the other as X.25, but you may reconfigure them both with software to support high-speed synchronous protocols such as HDLC (high-level data-link control) and SDLC (synchronous data-link control). The

Ethernet controller uses DMA to avoid buffering and can operate concurrently with the central processor.

The detachable keyboard has 10 function keys, a numeric pad, and four cursor-control keys. It uses a layout that is vaguely IBM-like but has superior key placements and sizes (e.g., a huge L-shaped Return key). It is completely *soft*, and you can program any key from the UNIX shell to generate a string.

The mouse is a two-button serial device. On the prototype machine I tested, it plugged into the RS-423A port, but on the production models it will have its own socket.

The main board contains a VME bus interface so that you can use the Triple X as a processor card in VME systems. Torch has prototypes of a 68020 processor board that can use Triple X boards as device controllers in a multiprocessing VME system; the Triple X slave processors write directly into the 68020's memory for fast communication.

**SOFTWARE DESIGN**

The Triple X's operating system is UniPlus + System V, an implementation of UNIX System V from UniSoft Systems, ported for Torch by Root Computers Ltd. of England. It's a complete UNIX implementation with the Berkeley enhancements, Root's enhancements (for unbuffered DMA) disk access and code sharing between processes, and Torch's own extensions to handle a bit-mapped-graphics (rather than a character-oriented) display device.

The Torch MMI (man-machine interface) is mostly built into the UNIX kernel for maximum speed; it never gets swapped out of memory just when you need it. User programs can access the MMI either through direct system calls or through an extensive C library provided with the Triple X.

The interface between UNIX proper and the MMI promotes compatibility with standard UNIX software. UNIX sees a console driver to which it sends a character output stream in the normal fashion, oblivious to the

(continued)

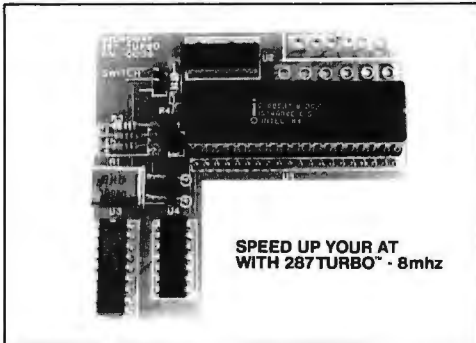
# MICROWAY'S 8087 RUNS 1-2-3™!

MicroWay is the world's leading retailer of 8087s and high performance PC upgrades. We stock a complete selection of 8087s that run at 5 and 8mhz. All of our coprocessors are shipped with a diagnostic disk and the best warranty in the business - one year! We also offer daughterboards for socketless computers such as the NEC PC and PCjr, and a board which increases the clock speed of the 80287 from 4 to 8 mhz. Our NUMBER SMASHER™ includes 512K ram. It will run the IBM PC at clock speeds up to 10mhz and achieves a throughput of .1 megaflops

with 87BASIC/INLINE, Intel Fortran, or Microsoft Fortran. Software reviewers consistently cite MicroWay software as the best in the industry! Our customers frequently write to thank us for recommending the correct software and hardware to meet their specific needs. They also thank us for our same day shipping! In addition to our own products which support the 8087 and 80287, we stock the largest supply of specialized software available anywhere. For information call us at

**617-746-7341**

**FASTBREAK™** . . . MicroWay's software turns on your 8087 during 1-2-3™ execution. Recalculations run up to 36 times faster. When used with the NUMBER SMASHER™ it can provide a total increase in 1-2-3™ execution speed of up to 79 to 1. FASTBREAK provides you with the unique capability for running other programs on top of 1-2-3. These programs can be written in BASIC, PASCAL, Fortran or C and can access the current values in your 1-2-3 worksheet. . . . . \$79  
**FASTBREAK & 640K NUMBER SMASHER . . . \$1099**



## MicroWay® 8087 Support

For the IBM PC, PC XT, PC AT and Compatibles.

**NUMBER SMASHER™** The World's Fastest Accelerator Card for the IBM PC, XT, and Compatibles! Includes an 8086 and 8087 pair tested to 10mhz, and 512K bytes of high speed ram. Compatible with all software, operating systems and hardware! Your program speed is increased by a factor of 2.5 to 4.0. Floating point programs run up to 2.8 times faster on the PC than on an 80287 equipped PC AT . . . . . **\$1049**

**MATRIXPAK™** manages a **MEGABYTE!** Written in assembly language, our runtime package accurately manipulates large matrices at very fast speeds. Includes matrix inversion and the solution of simultaneous linear equations. Callable from MS Fortran 3.3, 87MACRO, and 87BASIC/INLINE . . . . . each **\$150**

**87FFT™** Written in assembly language, performs Forward and Inverse FFTs on real and complex arrays which occupy up to 512K bytes of RAM. Also does convolutions, auto correlations, hamming, complex vector multiplication, and complex to radial conversions. Callable from MS Fortran, 87MACRO, C, TURBO PASCAL or 87BASIC/INLINE . . . . . **\$200**

**87FFT-2™** performs two-dimensional FFTs. Ideal for image processing. Requires 87FFT **\$100**

### GRAPHICS PACKAGES

Grafmatic for Fortran or Pascal. . . . . **\$125**  
 Plotmatic for Grafmatic. . . . . **\$125**  
 MultiHalo (one language) . . . . . **\$189**

**DFixer™** - Eliminates the AT hard disk problem! A disk which thoroughly checks PC or AT hard disks for bad sectors and updates the MS DOS file allocation table accordingly. . . . . **\$149**

**EPSILON™** - our favorite in-house editor lets you simultaneously edit up to 11 source files and concurrently run a compiler or linker. A real timesaver! . . . . . **\$185**

**87BASIC/INLINE™** converts the output of the IBM Basic Compiler into optimized 8087 inline code which executes up to seven times faster than 87BASIC. Supports separately compiled inline subroutines which are located in their own segments and can contain up to 64K bytes of code. This allows programs greater than 128K! Requires the IBM Basic Compiler and Macro Assembler. Includes 87BASIC . . . . . **\$200**

**87BASIC™** includes patches to the IBM Basic Compiler and both runtime libraries for USER TRANSPARENT 8087 support. Provides super fast performance for all numeric operations including trigonometrics, transcendentals, addition, subtraction, multiplication, and division. . . . **\$150**

**87MACRO/DEBUG™** - contains all the pieces needed for writing 8087/80287 assembly code including 8087 macros, object libraries for commonly used functions, including transcendentals, trigonometrics and conversions between strings and real numbers. Our 87DEBUG completes the package . . . . . **\$199**

**OBJ-ASM™** - a multipass object module translator and disassembler. Produces assembly language listings which include public symbols, external symbols, and labels commented with cross references. Ideal for patching object modules for which source is not available . . . . **\$200**

**RTOS - REAL TIME OPERATING SYSTEM**  
 RTOS is a multi-user, multi-tasking real time operating system. It includes a configured version of Intel's iRMX-86, LINK-86, LOC-86, LIB-86, OH-86, and MicroWay's 87DEBUG. Runs on the IBM-PC, XT, PC-AT and COMPAQ. . . . . **\$400**

### INTEL COMPILERS!

FORTTRAN-86. . . . . **\$750**  
 PASCAL-86. . . . . **\$750**  
 PL/M-86. . . . . **\$500**  
 ASM-86. . . . . **\$200**

\*Requires RTOS or iRMX-86. All Intel compiler names and iRMX-86 TM Intel Corp.

**8087 5mhz . . . . . \$109**  
 Including DIAGNOSTICS and one-year warranty For IBM PC and compatibles.

**8087-3 5mhz . . . . . \$175**  
 For the Tandy 1200.

**8087-2 8mhz . . . . . \$175**  
 For Wang, AT&T, DeskPro, NEC, Leading Edge.

**80287-3 5mhz . . . . . \$199**  
 For the IBM PC AT and Compaq DeskPro 286.

**287Turbo™ 8 mhz . . . . . \$395**  
 With Reset Button and Diagnostics.

**64K RAM Set . . . . . \$8**

**256K RAM Set . . . . . \$29**

**256K CMOS RAM Set . . . . . \$39**

**128K RAM Set PC AT . . . . . \$89**

**AST Boards . . . . . CALL**

**JRAM-2™ (ØK) . . . . . \$169**

**JRAM™ AT (ØK) . . . . . \$229**

**JRAM-3™ (128K) . . . . . \$275**

**INTEL ABOVE BOARD . . . . . CALL**

**FORTTRAN, C and BASIC**

Microsoft Fortran Version 3.3 . . . . . **\$229**  
 IBM Professional Fortran. . . . . **545**  
 Ryan-McFarland Fortran . . . . . **399**  
 FORLIB+ or STRINGS and THINGS. . . . . **65**  
 Lattice C or Microsoft C Version 3.0 . . . . . **299**  
 FLOAT87 . . . . . **150**  
 IBM Basic Compiler Version 2.0 . . . . . **445**  
 Microsoft Quick Basic . . . . . **89**  
 Summit BetterBASIC™ . . . . . **175**  
 True Basic. . . . . **105**

### MACRO ASSEMBLERS

IBM Assembler with Librarian V. 2.0 . . . . . **155**  
 Microsoft Assembler Version 3.01 . . . . . **125**

### PASCAL and APL

Microsoft Pascal Version 3.3 . . . . . **199**  
 Borland Turbo with 8087 Support. . . . . **85**  
 STSC APL★PLUS/PC. . . . . **450**  
 STATGRAPHICS. . . . . **595**  
 COSMOS Revelation. . . . . **750**  
 Phoenix Plink86. . . . . **295**  
 SPSS/PC . . . . . **595**

FASTBREAK and NUMBER SMASHER are trademarks of MicroWay, Inc. Lotus and 1-2-3 are trademarks of Lotus Development Corp.

European Customers: Please call MicroWay in London at 01-223-7662.

**MicroWay**

P.O. Box 79  
 Kingston, Mass.  
 02364 USA  
 (617) 746-7341

**The World Leader  
 in 8087 Support!**

very different processing that these characters receive inside the MMI.

Special Triple X features are organized into three categories, in ascending order of complexity, which are invoked by one of three methods: sending control characters, escape sequences, or calls to the ioctl routine. This permits standard UNIX software to use the basic features such as type styles and colors without modification and the others with fairly minor modification.

The MMI is composed of nine manager modules. Eight of them are part of the UNIX kernel: window manager, keyboard and mouse manager, menu manager, font and text manager, graphics manager, event manager, icon manager, and track manager; the desktop manager is a *process* that provides a mouse, window, and icon shell. The experienced user can modify it fairly easily.

In my limited use of the Torch MMI, I found it to be a thorough implementation. It appears at least as "deep" as the Macintosh operating system and goes well beyond it in places. It's constructed on classic Xerox PARC lines, starting from the BitBlt routine that performs basic raster copying, shading, and clipping, although Torch's BitBlt incorporates the handling of color bit planes. All visual objects, from a point up to the whole screen, are represented by *forms*. A form consists of a bit map and the parameters that specify its dimensions and colors. BitBlt manipulates these forms.

The graphics manager, called Torch-Draw, is built on top of BitBlt. It supports line, ellipse, and arc drawing, area fills, rectangle framing, clipping, scrolling, and more. The drawing pen may be any form of arbitrary size, not just a point, and so the placement of

icons and mouse cursors becomes an ordinary act of plotting.

Forms of arbitrary size also represent type fonts, with style (normal, bold, or italic) kept as a separate attribute that you can toggle by sending control codes. Torch has commissioned professional typographers to create a series of ISO (International Standards Organization) fonts with typeset-quality attributes, such as proportional spacing and kerning.

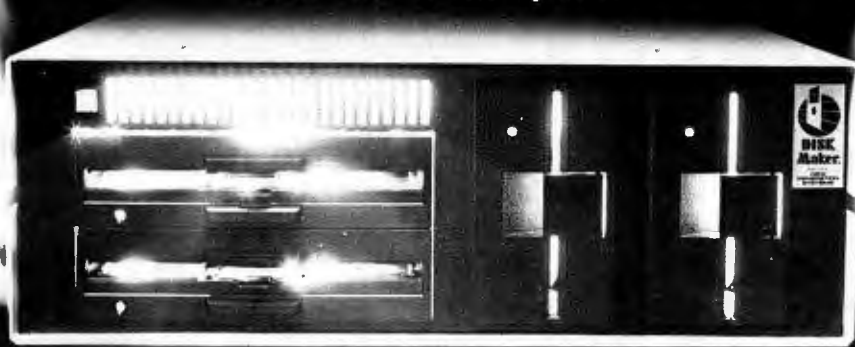
Torch loaned me a preproduction version of the machine on which the lower layers were all in place, but the desktop manager was only partially complete. Therefore, the following description comes partly from direct experience and partly from the programmers' specification documents for yet-to-be-implemented features.

The desktop metaphor is similar to that of the Macintosh (except that it's

(continued)

# The Most Valuable Disk Maker in the Universe

Now with UNIX Option!



## Download fast, read over 200 formats easily, reformat rapidly

The more disk formats you work with, the more our Disk Maker® system saves time and money by reading and/or writing disks in any of over 200 formats. No modems, no patches, no other special software necessary.

Disk Maker II Plus is a complete, stand-alone system featuring both 8" and 5 1/4" disk drives with options for 3 1/2" and IBM PCAT drives—up to 12 total drives. With its 6 MHz processor and RAM memory drive, Disk Maker II Plus is fast! Hardware options include a 15 or 20 Mb hard disk, an 8086 MSDOS coprocessor and memory expansion.

Optional software includes word processor and Compu-graphic typesetter formats and the MicroDrive Tester for drive alignment testing.

Supported with comprehensive manual, 6 month warranty and continuing software update program.

Disk Maker I is an alternative for existing S-100 systems (CompuPro, Zenith Z-100, North Star, etc.) to provide the same functions as Disk Maker II Plus.

Write or call today for information on how Disk Maker® can save you time and money.

Jerry Pournelle wrote about Disk Maker®: "It's easy to install, easy to use, and darned near unique. If you need one, you need it bad." (BYTE, July 1984)

**NEW  
GENERATION  
SYSTEMS**

1800 Michael Faraday Drive, Suite 206, Reston, VA 22090  
(703) 471-5598 Order Line: (800) 368-3359  
Dealer inquiries welcomed.



# BYTE

## 邀請閣下前往中國

## BYTE invites you to China

BYTE—the international standard among microcomputer publications—now invites you beyond the Great Wall. BYTE is the first to deliver your sales message to over 40,000 of China's technically-oriented managers and users.

The Chinese are looking for information, expertise and your products as part of a bold, massive modernization program. And BYTE will be reaching decision makers who have purchasing power.

Sound interesting? Call your BYTE sales representative, today. BYTE means business—worldwide.

*Closing date: Jan. 15, 1986*

*Publishing date: Mid-March 1986*



# BYTE

THE SMALL SYSTEMS JOURNAL

70 Main Street  
Peterborough, NH 03458  
(603) 924-9281



*One feature of the Triple X that appeared novel to me is the superimposition of icons.*

in color); it employs a group of icons presented on the screen that you can drag or click on. The left mouse button selects single icons; the right button, groups of icons.

Files are classified as tools (i.e., executable processes), data, or folders (i.e., UNIX directories). The system provides standard icons to represent these three types. Each directory may contain a file called desktop, so that

many desktops can exist in the system; different users may each have their own. In each folder there may also be a file called icons that allocates user-defined icons (created with a supplied icon editor) to specific files. These override the default icons and display when you open the folder representing the directory. Icon bit maps are named and stored in files in a system directory called /icons; they are allocated to files indirectly, using their names, so that if you modify an icon, the new version automatically replaces every instance of its use.

One feature that appeared novel to me is the superimposition of icons. You can give a data file to a program as an argument by dragging its icon on top of the program icon, an extension of the trash-can usage in previous systems.

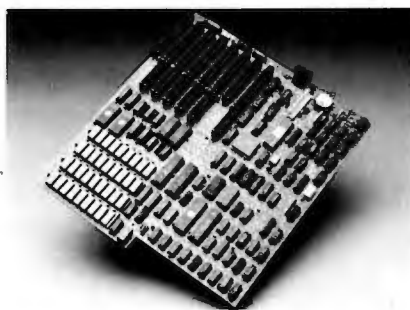
The Triple X supports hierarchical directories in a natural way. Opening

a folder by double clicking creates a new window revealing other folders that you can open. You can only have one folder window active (on top) at one time, but you can have many visible on the screen, and you can bring another one to the top in the usual way by clicking in it. You can drag tool and data icons out of a folder onto the desktop and copy them by dragging them onto another folder. A file dragged to the desktop stays there even when you close its folder, and you should replace it after you're through using it. You can drag data files from the desktop onto tools in other open folders, and certain tools (for example, ls) accept whole folders as arguments. UNIX is a multitasking system; therefore, you can have different processes running in different windows, which means that you can click and activate some kinds of icons

*(continued)*

# SMARTEK 1 MEGA BYTE SYSTEM BOARD

## IBM AT COMPATIBLE CPU MOTHER BOARD



**FEATURES:**

- \* Dual speed 8 MHz or 6 MHz CPU (80286) selectable by software (Optional 9, 10 MHz CPU) selection with standard 6 MHz operation
- \* 1 Mega Byte standard main memory on board, 16 Mega Byte in system in the protected virtual address mode
- \* Multiuser and multitasking operation
- \* Virtual memory and disk capability
- \* 2 sockets for 27256 eprom (SMT Bios will be available with a nominal fee)
- \* 8 I/O expansion slots: 6 with dual 62 pin and 36 pin connectors, 2 with single 62 pin connectors
- \* Socket for 80287 Math processor
- \* CMOS clock and calendar circuit
- \* On board battery backup, no external cable required
- \* External hardware reset capability
- \* Power on LED indicator
- \* NO selection jumper (no headache for system configuration)
- \* 24 bit addressing, 16 bit data path
- \* 16 level interrupt capability
- \* 7 channel direct memory access (DMA)
- \* 3 programmable timers available
- \* Speaker/keyboard connector
- \* Fully assembled and tested board \$995
- \* EASY board with all sockets and components installed except ICs \$495
- \* 90 days warranty, parts and labor

The Smartek 1 Mega Byte System Board has a lot of advantages over the Faraday's A-Tease, ATI-1000, and IBM PC AT boards.

	SMARTEK	FARADAY	ATI	IBM
Memory	1 Mega byte (standard)	640k (standard)	640k (standard)	512k (standard)
Number of ICs	129	154	130	130
Dual Clocks	6 MHz and 8 MHz select (9, 10 MHz opt)	6 MHz only	6 MHz only	6 MHz only
Jumpers option	none	plenty	plenty	1
Battery	on board (serviceable)	external	on board (unserviceable)	external
PCB layers	4	8	4	6
EASY BOARD (Option)	yes	no	no	no
Power on LED	yes	no	no	no
External Reset	yes	no	no	no
Lowest cost	yes	no	no	no

**SMARTEK INC.**

2000 Wyatt Dr. Suite #3, Santa Clara, CA 95054

Telex: 317994

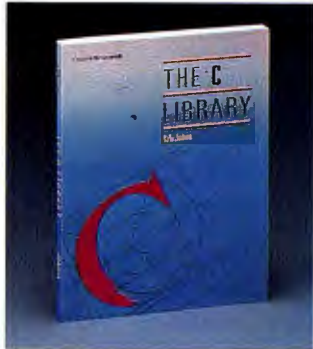
Tel: (408) 988-4112  
(408) 748-8501

OEM, VAR, Dealers and Corporate purchasing discount inquiry invited

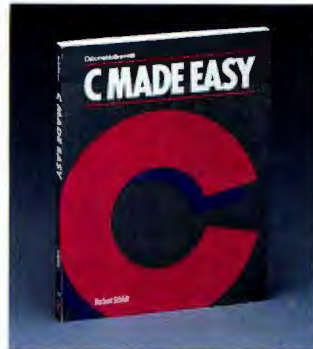
(IBM AT are trademarks of International Business Machines Corporation)

# Frustration Insurance

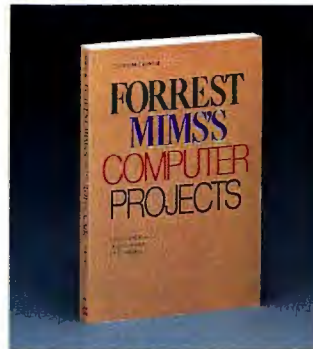
Computer Books from Osborne/McGraw-Hill.



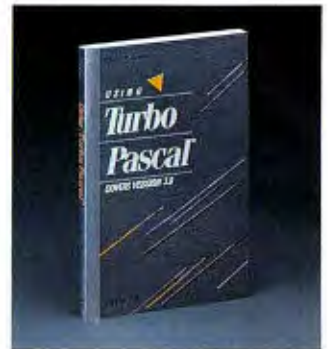
• **The C Library**  
Jamsa  
\$18.95      Order #881110-4  
Experienced C programmers will find over 125 routines ranging from macros to actual UNIX™ utilities. There are tools for string manipulation, pointers, input/output, array manipulation, recursion and more!



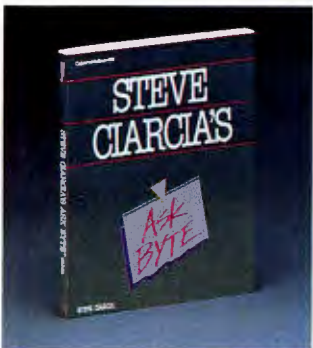
• **C Made Easy**  
Schildt  
\$18.95      Order #881178-3  
Learn C programming in no time at all with this easy-to-use tutorial which introduces general concepts, functions, libraries, disk input/output and a wide range of other facts about the C programming environment and UNIX operating system.



• **Forrest Mims's Computer Projects**  
Mims  
\$14.95      Order #881193-7  
Forrest Mims III, noted author, has amassed a collection of computer projects which include computerized security alarms, psychological testing, experimenting with computer art and how to use your computer as a storage oscilloscope.



• **Using Turbo Pascal™**  
Wood  
\$19.95      Order #881148-1  
Maximize your advanced programming skills with this thorough volume which covers Turbo Pascal, including version 3.0 for the experienced programmer.



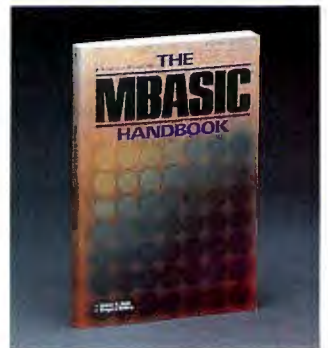
• **Steve Ciarcia's ASK BYTE**  
Ciarcia  
\$14.95      Order #881200-3  
Steve Ciarcia provides insightful solutions to your exasperating hardware and software problems including how to troubleshoot difficulties that affect your peripherals, accessories, and operating systems



• **Advanced Programmer's Guide to UNIX™ System V**  
Thomas, Rogers, and Yates  
\$21.95      Order #881211-9  
C programmers who already know UNIX fundamentals can use this guide to write more effective programs with the software tools in UNIX System V.



• **A User Guide to the UNIX™ System (2nd Edition)**  
Thomas and Yates  
\$18.95      Order # 881109-0  
Now the best-selling **User Guide to the UNIX™ System** has been revised and expanded to cover applications of the UNIX operating system for Bell Laboratories New System V and Berkeley UNIX.



• **The MBASIC Handbook**  
Ettl  
\$18.95      Order #881102-3  
Gain a better understanding of programming while you learn to develop and customize programs with this fundamental guide to Microsoft® BASIC.

Osborne/McGraw-Hill books are available at bookstores and computer stores everywhere. To order any of these titles by mail, complete the coupon and mail to McGraw-Hill, P. O. Box 400, Hightstown, NJ 08520. All orders must be prepaid. Checks, money orders, VISA and MasterCard are acceptable for payment. No postage or handling charges are required, but please include appropriate tax if applicable in your shipping area. All books will be shipped via UPS. Allow 4-6 weeks for delivery. Books will not be delivered to post office boxes. This offer is valid only in the Continental United States and is subject to change without notice.



**Osborne McGraw-Hill**

Inquiry 275

NAME		
ADDRESS		
CITY		
STATE	ZIP	
INDICATE METHOD OF PAYMENT <input type="checkbox"/> CHECK/MONEY ORDER		
<input type="checkbox"/> VISA/EXP DATE _____	<input type="checkbox"/> MASTERCARD/EXP DATE _____	
CARD #		
SIGNATURE		
QTY	ORDER #	PRICE
		SUBTOTAL
		TAX
		TOTAL
<b>McGraw-Hill</b> P. O. Box 400 Hightstown, NJ 08520		

more than one time.

Double clicking to activate icons is more flexible than in previous systems I've seen. The icons file specifies what action, defined by UNIX shell commands, should occur when an icon is double-clicked. There are default actions: no action for a data file and the program name itself for a tool, but you can insert any arbitrarily complex action instead. This file also lets you define some icons as *acceptors* (for example, icons that can receive others as arguments).

The MMI integrates transparently with UNIX, since you can always open a window and issue shell commands in the normal way. But for the non-enthusiast, using icons and pointing is tremendously effective in cushioning you from the brutality of the UNIX user interface. If developers would give sensible names to all the utility programs as well, I would be a com-

plete convert. Since you no longer need to type them, the rationale for monosyllabic monstrosities like *grep* has disappeared.

**CONCLUSIONS**

Even in its prototypical state, the Torch Triple X has a polished and professional design that exploits the latest technology (256K-byte RAMs, etc.) in a way that makes it mass-producible at ordinary desktop computer prices. Handled properly, it could well be the machine that spurs the long-awaited UNIX takeoff. The excellent user interface overcomes most of the objections against UNIX as an operating system for ordinary mortals.

The only remaining question concerns the amount of application software available under UNIX. Here, Torch is taking an active stance. Rather than talking about third-party sup-

port, they have commissioned standard applications, including a word processor and spreadsheet from a London-based UNIX software house, that should fully utilize the advanced user interface.

If the launch price is as low as some of the figures currently circulating suggest, Torch will have no trouble selling the machine to its traditional academic and scientific customers. In pursuing the longer-term goal of selling to the business user, Torch may find the most serious competition coming, paradoxically, from the Commodore Amiga rather than the AT&T UNIX PC, which I think looks rather drab by comparison.

The Triple X is unlikely to be sold in the U.S. by Torch; in fact Torch is looking for a major U.S. company to manufacture it. A deal is close as this column goes to press, so keep an eye open for the announcement. ■

8086  
8088

AMX

8080  
Z80  
6809

Now  
68000

## Real-Time Multitasking Executive

- No royalties
- Source code included
- Fault free operation
- Ideal for process control
- Timing control provided
- Low interrupt overhead
- Inter-task messages

```

graph TD
    UserTasks[User Tasks] --> AMXTaskScheduler[AMX Task Scheduler]
    AMXTaskScheduler --> AMXServiceProcedures[AMX Service Procedures]
    AMXServiceProcedures --> AMXInterruptSupervisor[AMX Interrupt Supervisor]
    AMXInterruptSupervisor --> UserDeviceServiceProcedures[User Device Service Procedures]
    UserDeviceServiceProcedures --> AMXInterruptSupervisor
    AMXInterruptSupervisor --> AMXTaskScheduler
    
```

AMX is TM of KADAK Products Ltd.  
CP/M-80 is TM of Digital Research Corp.  
IBM, PC DOS are TM of IBM Corp.

<ul style="list-style-type: none"> <li>■ Language Interfaces :</li> <li style="padding-left: 20px;">C    Pascal</li> <li style="padding-left: 20px;">PL/M Fortran</li> <li>■ DOS File Access :</li> <li style="padding-left: 20px;">CP/M-80</li> <li style="padding-left: 20px;">IBM PC DOS</li> </ul>	<table style="width: 100%; border-collapse: collapse;"> <tr> <td style="font-weight: bold;">AMX for 8080</td> <td style="font-weight: bold;">\$ 800 US</td> </tr> <tr> <td>8086</td> <td>950</td> </tr> <tr> <td>6809</td> <td>950</td> </tr> <tr> <td>68000</td> <td>1600</td> </tr> <tr> <td>Manual (specify processor)</td> <td>75</td> </tr> </table>	AMX for 8080	\$ 800 US	8086	950	6809	950	68000	1600	Manual (specify processor)	75
AMX for 8080	\$ 800 US										
8086	950										
6809	950										
68000	1600										
Manual (specify processor)	75										

KADAK Products Ltd.

(604) 734-2796  
Telex: 04-55670

206-1847 W. Broadway, Vancouver, B.C., Canada V6J 1Y5

## HARMONY VIDEO & COMPUTERS

2357 CONEY ISLAND AVE., BROOKLYN, NY 11223  
800-VIDEO84 OR 800-441-1144 OR 718-627-1000

	<b>IBM PC</b> \$1349.95 <b>STAR SG10</b> \$197.95	<b>PANASONIC 1091</b> \$221.95 <b>APPLE 2E w/DRIVE</b> \$790.00
--	--	--

"PRINTER SPECIALS"

Brother HR15 XL 307 Brother HR 35 619 Citizen MSP 10 239 Corona Laser 2387 Daisywriter 718 Epson LX80 213 Epson JX80 467 Epson LQ 1500 637 FX 185 328 FX 85 328 HP Laser Jet 2652 Juki 6100 335	NEC 2050 NEC 3550 915 NEC 8850 1317 Okidata 192 323 Okidata 193 484 Okidata 182 219 Okimate 10 115 Olympus 250 Panasonic KXP 1091 222 Panasonic KXP 1090 183 Panasonic KXP 1092 327 Panasonic KXP 1093 390 Panasonic KXP 315 379	Powertype 275 Star SG10 198 Star SG 15 333 Star SD 10 302 Star SD 15 400 Star SR 10 435 Star SR 15 543 Star SB 10 426 Silver Reed Exp 550 354 Silver Reed Exp 500 231 Silver Reed Exp 770 593 Toshiba 1340 515 Toshiba 351 985
--	--	--

# WOW! WOW! WOW!

<b>IBM</b> AT Enhanced 3921 AT Unenhanced 2912 IBM Monitor 208 IBM PC 64K 1349 PC XT 1980 PC XT Clone 1099 IBM Drive 146 AST Six Pack 193 Tail Grass 25 Meg 2392 Quad Board 172 Keytronics 115 Hercules Color 136 Hercules Monochrome 282 Mitsubishi Monochrome 135 Paradise Graphics 239 Paradise 5 Pack 125 STB Graphics -> 2 193 STB R10 + 2 166 STB Mono Board 135 Tecmar Graphics 427 Tecmar Captain 148 Peryat Monocard 137 Bernoulli Box 1822	80287 Chip 182 AST Advantages 354 Everex Edge 260 Everex Magic 164 <b>APPLE</b> 2E w/Disk Drive 790 Addl. Drives from 104 <b>ATARI</b> 130 XE 127 600 XL 75 1027 Printer 159 1050 Drive 129 Indus. Drive 200 <b>MODEMS</b> Hayes 1200 349 Hayes 1200B w/Smartcom 328 Hayes 300 120 Hayes 2400 562 Micromodem 2E 125 Novation J-cat 79 Prometheus 1200 289	<b>MONITORS</b> Amdek 300 Green 104 Amdek 300 Amber 109 310 Amber 129 Color 300 156 Color 500 231 Color 600 364 Color 700 374 Color 710 399 Princeton HX12 390 Princeton Max 12 142 SR 12 536 Taxan 220 219 Taxan 420 370 <b>COMMODORE</b> Commodore 128 251 Commodore 64 130 1451 Disk Drive 155 1702 Monitor 1541 MPS 503 79 Indus. Drive 201 Card cc. Interface 32
---	---	--

800-441-1144

Items reflect cash discount. For your protection we check for stolen credit cards.  
M.C./VISA welcome. Personal checks cause 4 week delay.

# "I Program In BetterBASIC And I Recommend It."

"Lifeboat Associates," has expanded its philosophy of endorsing structured programming languages to include a truly superior product—BetterBASIC. More than just a BASIC, BetterBASIC offers use of the full memory of the computer, true procedures and functions, modularity and more. BetterBASIC has the advantages of the C language on which Lifeboat built its reputation and appeals to the wide audience of programmers who already program in BASIC. I liked BetterBASIC so much, I decided "Lifeboat" should publish it. I program in BetterBASIC and I recommend it."

Dr. Edward Currie, President—Lifeboat Assoc.—New York, NY

**640K** Now you can use the full memory of your PC to develop large programs.

**STRUCTURED** Create well organized programs using procedures and functions that are easily identified and understood and completely reusable in future programs.

**MODULAR** Use procedures and functions grouped together to form "library modules" which are then available to you or anyone else for future use.

**EXTENSIBLE** Create your own BetterBASIC modules which contain BetterBASIC extensions. This feature coupled with the easy-to-use Assembly Language support, makes this an ideal OEM language.

**INTERACTIVE** BetterBASIC acts like an interpreter because it responds to the users' commands in an immediate mode. However each statement is actually compiled as it is entered.

**COMPILED** Each line of the program is compiled as it is entered into the computer's memory rather than interpreted at runtime.

**RUNTIME SYSTEM** The optional Runtime System generates stand alone EXE. files allowing for the distribution of products



written in BetterBASIC with no royalties.

**SUPPORTS** Windows, Graphics, DOS and BIOS ROM calls, Chaining, Overlays, Local and Global Variables, Recursion ... and more.

**BetterBASIC** Runs on IBM PC, XT, AT and all IBM-compatibles. Ask your local dealer for BetterBASIC or call 1-800-225-5800 in Canada call 416-469-5244. Also available for the Tandy 1000, 1200, AND 2000 AT Tandy/Radio Shack stores.

## Summit Software Technology, Inc.™

P.O. Box 99, Babson Park  
Wellesley, MA 02157

### PRICES:

BetterBASIC	\$199
8087/80287 Math Module	\$99
B'Trieve™ Interface	\$99
Runtime System	\$250
Sample Disk with Tutorial	\$10

*Better*  
**BASIC.**

**Because It's The Best.**

MasterCard, Visa, Checks, Money Order, C.O.D. accepted and P.O. on approval.

BetterBASIC is a registered trademark of Summit Software Technology Inc. IBM PC, XT, AT, are registered trademarks of International Business Machines Corp. Tandy is a registered trademark of Tandy Corp. B'trieve is a registered trademark of SoftCraft Inc.

(If you're using BetterBASIC and would like to be featured in one of our ads, please write to the Director of Advertising at Summit.)

# You were smart to buy Turbo Pascal™ back then. Now you'd be smart to sell it.

**AND HERE'S YOUR CHANCE. TRADE IN YOUR TURBO PASCAL AND GET THE MODULA-2 SOFTWARE DEVELOPMENT SYSTEM (M2SDS) FOR JUST \$50.88.**

How can you get the latest in programming efficiency? Simple. Just send us your Turbo Pascal diskette\*—whether it's IBM format or not—and we'll send you M2SDS for just \$50.88. That's \$30 off the regular price.

Why switch? Because Modula-2 was specifically designed by the developer of Pascal, to replace the Pascal language. So you already know the language basics that will help you start programming right away.

And when you combine the power of Modula-2 with all the features of M2SDS, you'll be programming faster than ever—in virtually no time at all.

Just look at all the extras M2SDS includes. And how it outperforms Turbo Pascal in independent studies.

So now that you're wise to Turbo Pascal, why not trade it in? And trade up to the programming efficiency of the future. Get M2SDS for just \$50.88 when you send us your Turbo Pascal diskette. Or, order M2SDS for just \$80.88 without the trade.

Either way, it's one of the smartest moves you can make in programming. And now, it's the best deal going.

*Turbo Pascal is a trademark of Borland International.  
\*Diskette will be destroyed immediately upon receipt, so that your Borland license agreement is not violated.*

	M2SDS	TURBO 3.0
<b>COMPILE SPEED (MIN:SEC)</b>		
30 LINES	0:09.00	0:02.00
360 LINES	0:25.00	0:05.00
<b>EXECUTION SPEED (MIN:SEC)</b>		
SIEVE	0:13.92	0:15.26
FIBONACCI	0:53.49	1:49.74
30X30 MATRIX (8087)	0:08.84	0:19.28
FP OPERATIONS	0:52.12	0:31.75
FP OPERATIONS (8087)	0:01.97	0:06.21
SYNTAX CHECKING EDITOR	YES	NO
MULTIPLE WINDOW EDITING	YES	NO
EDITOR FILESIZE LIMIT	MEMORY SIZE	64K
COMPILER ERROR CALLS EDITOR	YES	YES
LINKER	YES	NO
PRODUCES .EXE FILES	YES	NO
EXECUTABLE CODE SIZE LIMIT	DISK SPACE	64K
DOS ACCESS FROM EDITOR	YES	NO
DOS ACCESS FROM PROGRAMS	YES	LIMITED
8087 SUPPORT STANDARD	YES	NO
COPY-PROTECTED DISK	NO	NO
COST WITH 8087 SUPPORT	\$80.88	\$109.90

Trade in your Turbo Pascal for M2SDS today. Or, order your copy by completing this coupon.

- Enclosed is my Turbo Pascal diskette and a check for \$50.88, plus \$4 shipping and handling.
- Enclosed is my Turbo Pascal diskette. Apply charges to the credit card indicated below.
- Please send me M2SDS for \$80.88, plus \$4 shipping and handling. My check is enclosed.
- Please send me M2SDS for \$80.88. Apply charges to the credit card indicated below.

VISA/MasterCard/American Express.  
(Circle One)

Credit card # \_\_\_\_\_

Expiration Date \_\_\_\_\_

Name \_\_\_\_\_  
(Signature required for credit card orders.)

Address \_\_\_\_\_

City \_\_\_\_\_

State/Zip \_\_\_\_\_

*Price does not include shipping and handling. Texas residents add 6.125% sales tax. International orders add \$30.*

INTERFACE TECHNOLOGIES CORPORATION  
3336 Richmond, Suite 200 Houston, TX 77098

Source: Software Resources, Inc.

Sieve program from BYTE, January 1983.

Fibonacci program from Dr. Dobb's Journal, February 1985.

Matrix program from BYTE, October, 1982.

FP Operations program from BYTE, May 1985.

Turbo Pascal without 8087 uses only 6-byte accuracy for type REAL; M2SDS with or without 8087 uses 8-byte accuracy.

Programs compiled with all checking options on. All tests conducted on a standard IBM-PC/XT with 512K of memory and an 8087 math coprocessor.

 **INTERFACE TECHNOLOGIES**

3336 Richmond Ave., Suite 200  
Houston, Texas 77098

**1-800-922-9049**

(In Texas, call 713/523-8422) Telex: 322127

Modula-2 Bulletin Board: 713/523-7255

# Computing in Taiwan

The Computex '85  
computer show  
and a look at  
software piracy

BY WILLIAM M. RAIKE

**T**his month, BYTE Japan could be called BYTE Asia. The entire BYTE Japan staff (namely, me) selflessly agreed to visit Taiwan for a few days to report on the Computex '85 computer show held there during the week of July 12-18. I also wanted to check out the rumors I've heard concerning software (and hardware) piracy in that country.

It had been three years since I last visited the city of Taipei, one of Asia's premier economic miracles. New construction is erupting everywhere, the air pollution and traffic are even worse than before, the Chinese (and Taiwanese) food is as good as ever, and there are hundreds upon hundreds of small- and medium-size companies turning out high-quality personal computers at incredibly low prices. If you want to buy computer equipment and are planning to visit this part of the world soon, the potential savings on equipment combined with the low cost of travel and lodging might make it worthwhile for you to stop in Taiwan.

## THE SHOW

Computex '85 was held under the auspices of Taiwan's China External Trade Development Council (CETDC) in its huge exhibition hall at the Sungshan domestic airport. The overwhelming majority of exhibitors were offering equipment compatible with the IBM PC or the IBM PC XT computers. As regular BYTE Japan readers know, this situation is completely different from the one in Japan, where IBM PC compatibility isn't even an issue. Most of the computers were straight-out clones, but I saw a number of innovative ideas, including IBM PC- and Apple-compatible portable computers and an interesting new machine based on the 80186 processor.

## ERSO BIOS

How, I wondered, do these small companies manage to legally produce IBM PC-compatible machines without investing large amounts of money to develop their own

BIOS (basic input/output system)—the nuts-and-bolts software that underlies the operating system and lets the machine run? How do they avoid infringement lawsuit problems?

I got an answer I hadn't expected. An organization called ERSO (the Electronics Research and Service Organization, sponsored by the Taiwanese government) has developed its own BIOS, which it claims is acceptable to IBM as noninfringing. For modest fees, small computer manufacturers can obtain licenses for the ERSO BIOS. That way, they avoid the need for large software-development outlays and escape the risk of serious legal entanglements when they attempt to export to the United States, which is clearly their target market.

The same thing could have been done by a private organization, but the Taiwanese government had strong reasons to become involved: It needs to make visible efforts to put a stop to the export of illegal copies of proprietary hardware and software. The ERSO BIOS makes an appealing carrot; the accompanying stick is an apparent determination by the Taiwanese government, at the behest of the CETDC, to prosecute computer pirates. In early June, the Taiwan Supreme Court confirmed jail sentences for three people convicted of selling illegal copies of Apple II manuals and software. Earlier, another manufacturer was sentenced to a year in jail and fined for illegally copying IBM software. Current Taiwanese law calls for a jail sentence of up to five years for manufacturing counterfeit goods and up to one year for selling or exhibiting them.

Another government move to discourage computer pirates becomes evident when you go to the airport to leave the country. Taiwan is one of the few places I've been to that requires a customs inspection for departing passengers. A specific item on the declaration form asks you to list any computer disks, tapes, or other software

(continued)

*William M. Raiké, who has a Ph.D. in applied mathematics from Northwestern University, has taught operations research and computer science in Austin, Texas, and Monterey, California. He holds a patent on a voice scrambler and was formerly an officer of Cryptext Corporation in the U.S. In 1980, he went to Japan looking for 64K-bit RAMs. He has been there ever since as a technical translator and a software developer.*

*He can be contacted c/o BYTE, POB 372, Hancock, NH 03449.*

# If you need easy access to your IBM mainframe, our Emulation Adapters are just the tickets.

With the IBM Enhanced 5250 Emulation Adapter or the IBM 3278/79 Emulation Adapter, you can quickly convert your IBM Personal Computer into an online terminal. Thereby gaining easy access to mainframe data without leaving your desk. And making the transfer of data between PC and mainframe simple.

What's more, you can access programs at the host and run PC programs simultaneously. Switching from one to the other with a simple keystroke sequence.

You can even pick your own printer in most cases: the host's high-speed printer or your own PC's printer.

## Put the power of our most popular mainframes on your desk.

The enhanced 5250 emulation card allows you to access the IBM System/34, 36 or 38 with your PC, PC XT, PC AT or *Portable* PC. (Remote access is available on the System /36 and 38 using appropriate hardware and software.)

And the 3278/79 card lets you and your IBM PC, PC XT or PC AT interact with the IBM 4300, 3081, 3083 or 3090, either local or remote.

**You'll thank us for the memory.**

The 3278/79 card's emulation

control program requires only 23K of memory.

Which means, with our 3278/79 card, you've got more memory left for application programs. And less tied up with housekeeping functions.

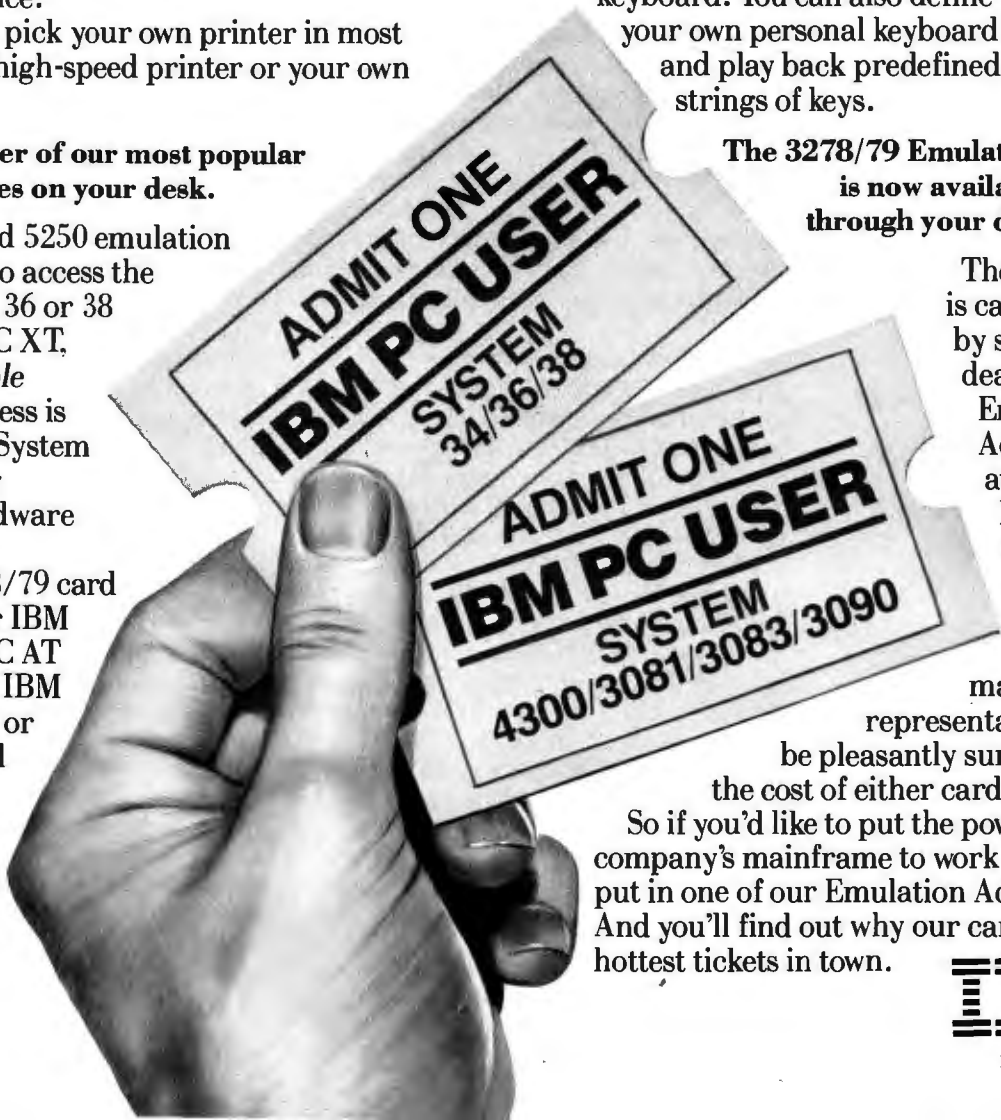
## The key to keyboard familiarity.

The enhanced 5250 card's emulation program lets you define keyboard functions. Default definitions make it easy to map the PC, PC XT, PC AT or *Portable* PC keyboards to the 5291 keyboard. You can also define your own personal keyboard layout and play back predefined strings of keys.

**The 3278/79 Emulation Adapter is now available through your dealer.**

The 5250 card is carried by selected dealers. Both Emulation Adapters are available at IBM Product Centers and through your IBM marketing representative. You'll be pleasantly surprised by the cost of either card.

So if you'd like to put the power of your company's mainframe to work for you, put in one of our Emulation Adapters. And you'll find out why our cards are the hottest tickets in town.



**IBM**



purchased in Taiwan. If the customs inspector finds any software or hardware product in your luggage that doesn't have a seal indicating specific government approval, it will be confiscated.

The ERSO BIOS apparently hasn't discouraged technological competition. Some companies producing IBM-compatible machines have chosen, either independently or in partnership with U.S. firms, to develop their own BIOSes, bypassing the government effort. They claim that their BIOSes are faster than the ERSO version, while maintaining full IBM PC compatibility.

**THE LEO PERSONAL COMPUTER**

One of the most interesting machines at Computex '85 was the LEO AT/XT from First International Computer Inc. (see photo 1). The LEO isn't really an IBM clone, but the company claims that it is fully compatible with the IBM PC XT and has some of the features of the PC AT as well.

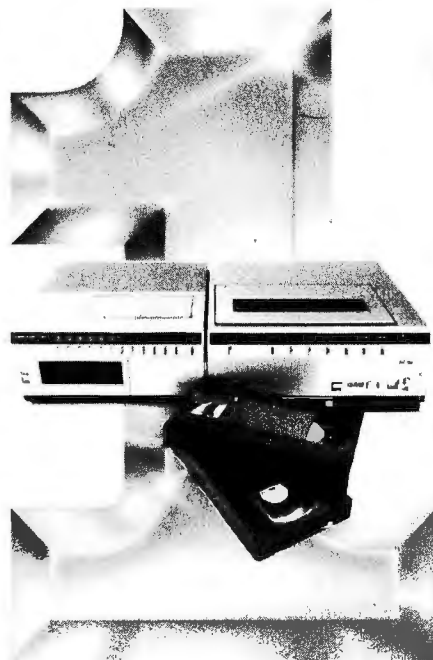
The LEO is based on an 80186 microprocessor (the same type as in

my Fujitsu FM-16 $\beta$  computer) running at 8 MHz; it's supposed to be about three times as fast as the IBM PC XT. It uses some kind of dual-bus architecture; a spokesperson for the company wasn't specific. The LEO has its own BIOS, developed in cooperation with an American company, and First International Computer claims it will run either MS-DOS or PC-DOS as well as Concurrent CP/M-86. I saw it running several popular application software products, including Lotus Development Corporation's 1-2-3.

The LEO comes in three configurations; all have 512K bytes of memory on the main board (you can expand the memory up to 1 megabyte by adding a memory board) and include a keyboard and a color-graphics card as well as a floppy-disk controller, Centronics-compatible printer port, and RS-232C serial interface.

The differences between the three versions involve the disk drives. The top-of-the-line model, the LEO AT/XT-2, includes one 360K-byte floppy-disk drive, one 1.2-megabyte floppy-

*(continued)*



**Number One  
In Performance**

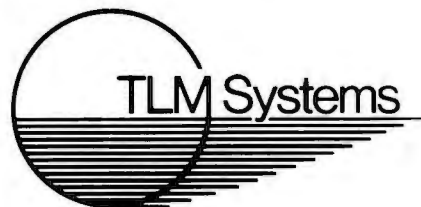
**Hard Disk  
Intelligent  
VCR Backup  
for AT/XT/PC**

**FEATURES**

- High speed microprocessor controlled backup (68008)
- Two channel interface
- Built in LAN channel
- Software control of most VCR functions including Fast Forward, Rewind, and auto backup using VCR timer capabilities
- Economical VHS or Beta formats

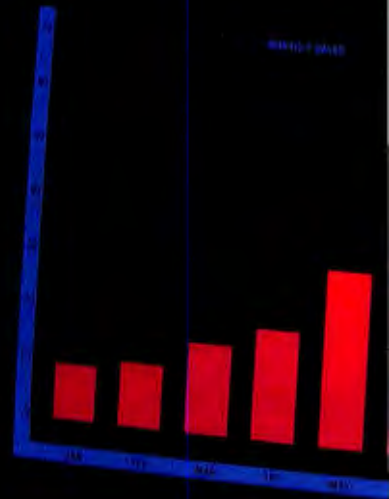


Photo 1: The LEO AT/XT personal computer.



4704 W. JENNIFER, SUITE 105 • FRESNO, CA 93711  
209/276-2345

# BREAD. BOX.



Using good accounting software can help you determine not only where your business stands, but where it's headed.

Of course, when you use great accounting software, the direction becomes quite obvious.

**CYMA**  
McGraw-Hill  
800-292-CYMA

## COMPANIES MENTIONED

**AQUARIUS SYSTEMS INC.**  
394 Keelung Rd. Sec. 1, 6F  
P.O. Box 48-29  
Taipei, Taiwan  
Telephone: (02) 706-9140  
Telex: 13138 AQUOSYS

**AUTOSIM COMPANY LTD.**  
P.O. Box 3-10 Hsichih  
Taipei Hsien Taiwan  
Telephone: (02) 643-1520  
Telex: 32454 AUTOWEB

**FIRST INTERNATIONAL COMPUTER INC.**  
201 Tung Hwa N. Rd., 13F  
Taipei, Taiwan  
Telephone: (02) 715-4473  
Telex: 23056 CHARLENE

**IMC GROUP**  
No. 102, 4F Hao-mei Bldg.  
Nanking E. Rd. Sec. 5

Taipei, Taiwan  
Telephone: (02) 766-1991  
Telex: 25907 JFYWU or 12998 PCDATA

**K.S. BROTHERBOX COMPANY LTD.**  
6F-1 No. 3 Shin Sen N. Rd. Sec. 1  
(or P.O. Box 32-62)  
Taipei, Taiwan  
Telephone: (02) 391-0837  
Telex: 13264 KSBOX

**OST-EMPOR ELECTRONICS COMPANY LTD.**  
No. 12, Alley 16, 7th Fl.  
Lane 12 Sec. 3 Pateh Rd.  
Taipei, Taiwan  
Telephone: (02) 772-6492

**TECA ENGINEERING COMPANY LTD.**  
64 Tunhua N. Rd., 4F  
Taipei, Taiwan  
Telephone: (02) 721-1162  
Telex: 25817 TECACO

disk drive, and a 20-megabyte hard-disk drive with controller. Its price, in U.S. dollars, in quantities up to 11 units, is \$2165. The LEO AT/XT-1 model is the same, except it doesn't include the 1.2-megabyte floppy-disk drive; its price is \$1995. You can also buy a LEO AT/PC model for \$1270; this version comes with two 360K-byte floppy-disk drives, but no hard-disk drive.

A novel feature of the LEO series is that, of the five expansion slots on the main board, two slots accept cards designed for the IBM PC AT and compatibles, while the remaining three slots are IBM PC XT-compatible. Furthermore, the manufacturer says that the LEO can run MS-DOS 3.0. These features really put the LEO into a class somewhere between the IBM PC XT and the PC AT; the availability of an 80286 processor card next year ought to make the machine even more versatile.

### IBM PC XT AND IBM PC AT CLONES EVERYWHERE

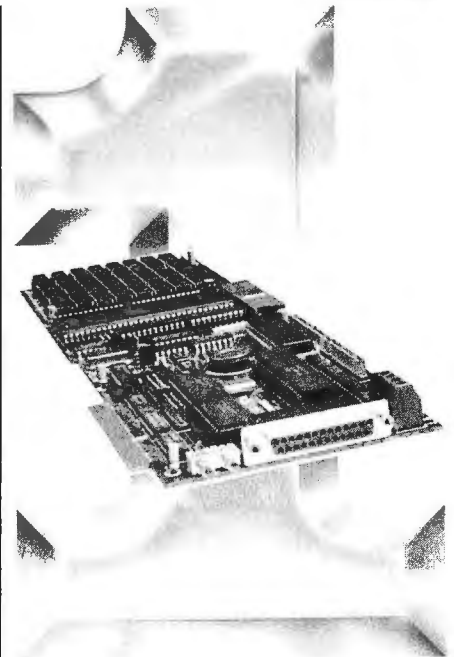
I couldn't even count the companies that were exhibiting look-alikes for the

IBM PC, PC XT, and PC AT. To give you an idea of prices, here are some typical examples.

The model HT-320 computer from OST-EMPOR Electronics Company Ltd. is an IBM PC AT-compatible machine. It includes 640K bytes of memory on the main board, with eight expansion slots, a color-graphics card, keyboard, and a single 1.2-megabyte floppy-disk drive. No hard-disk drive is included. The price for a single unit is \$2050.

TECA Engineering Company Ltd. offers both components and assembled computers in IBM PC-, PC XT- and PC AT-compatible models. The IBM PC-compatible version, with dual floppy-disk drives, 256K bytes of memory on the main board, and a 12-inch monochrome monitor, costs \$747. The IBM PC XT version, including hard-disk drive and controller, sells for \$1100. An IBM PC AT-compatible version, with 512K bytes of memory and an 80286 processor, one 1.2-megabyte floppy-disk drive, and one 20-megabyte hard-disk drive, has a list price of \$2800.

(continued)



## Number One in Performance

# 68010/68000 Coprocessor for IBM/AT/XT/PC-

8/10/12.5mz No Wait States

**\$1395<sup>00</sup> Qty. 1**

#### FEATURES

- 1-2 MB RAM (1MB Standard)
- 16K-64K EPROM
- 2-8 Serial Ports Async/Sync/Bisync Communications
- Battery-backed Real Time Clock
- Battery-backed 2K-8K RAM
- 2 Parallel Ports
- Memory-mapped Dual-port BUS
- 3-9 Users Per Board (3 Standard)
- Up To 16 Boards Per AT/XT/PC
- Can Operate As Standalone Processor

#### SOFTWARE

- OS9 (Powerful UNIX-like Multi-user OS)
- CPM/68K
- Software selectable OS including concurrent PC DOS/OS-9 or CPM/68K operation
- Support Module for IBM Graphics
- High-speed Local/Global Disk Caching
- Basic, Pascal, Fortran, C, and COBOL

IBM is a registered trademark of International Business Machines Corporation. OS/9 is a registered trademark of MicroVare Systems Co. CPM is a registered trademark of Digital Research Corp. MS-DOS is a registered trademark of Microsoft.



4704 W. JENNIFER, SUITE 105 • FRESNO, CA 93711  
209/276-2345

# HIGH PERFORMANCE OUTPUT WAS ONCE A SINGULAR EXPERIENCE.

That experience was the Datasouth DS 180.

The machine so sophisticated, so reliable, that it won international acclaim as the printer demanding people demand.

But those demanding people demanded more. More functions, more applications, the ability to perform more printing tasks.

Our answer was the DS 220. A multi-mode that actually *outperformed* every other matrix printer in its class.

Then, we brought high performance to the personal computer, with our own line of Personal Printers.

Our DaisyWheel 36 brought the Datasouth reputation to daisy-wheel printing.

And our CX and TX models freed once-captive IBM users from the need to buy overpriced IBM printers.

We even improved on the original, with the new DS 180 Plus and the new DS 180DD for demand document applications.

So, what was once a singular experience is now plural: the Datasouth High Performance printer *family*.

IBM is a registered trademark of International Business Machines.



**datasouth**

H I G H P E R F O R M A N C E P R I N T E R S

Datasouth Computer Corporation  
Box 240947 • Charlotte, NC 28224  
704/523-8500 • Tlx 6843018 DASOU UW

AVAILABLE NATIONWIDE  
THROUGH OUR NETWORK OF  
SALES AND SERVICE DISTRIBUTORS

CALL TOLL FREE:  
**1-800-222-4528**  
Ext. 508

The ASI-500 computer from Aquarius Systems Inc. is fully IBM PC XT-compatible and runs the government-developed ERSO BIOS. It has 640K bytes of on-board memory and includes a single 320K-byte floppy-disk drive and a 10-megabyte hard disk. It comes with MS-DOS 2.11, but no monitor or color-graphics board is included. The list price is \$1130. A dual-floppy version with only 128K bytes of memory sells for only \$600.

Autosim Company Ltd. produces the Touch-1 computer, an IBM PC XT-compatible. With 256K bytes of on-board memory, a single 320K-byte floppy-disk drive, and a color-graphics card, it sells for \$395. A slim-type 10-megabyte hard disk and controller will set you back an additional \$550. The best thing about this computer is its keyboard (available separately for \$55); I think its layout and touch are about 100 percent better than that of the standard IBM PC keyboard.

The Kingtech KS-200 portable IBM PC XT-compatible from K.S. Brotherbox Company Ltd. sells for \$750, with 640K bytes of memory, dual 360K-byte floppy-disk drives, and a built-in 9-inch green monitor. Or you can order the KS-200A with a hard-disk drive instead of one of the floppy-disk drives for \$1150. The keyboard is detached and has the standard IBM PC layout.

The IMC JR+ from IMC Group is a laptop portable IBM PC-compatible, but it doesn't have a built-in display. It does have 256K bytes of memory, a color-graphics board, and one built-in 5¼-inch 320K-byte floppy-disk drive. The list price is only \$475. The same company makes a portable IBM PC-compatible machine that includes a 9-inch green monitor and two floppy-disk drives for \$755. It also offers an IBM PC XT-compatible machine with a 10-megabyte hard disk and 256K bytes of memory for \$1055, or with 640K bytes of memory for \$1120. IMC Group uses a proprietary BIOS that was developed in the U.S.

**SOFTWARE PIRACY CLOSE-UP**

Regular readers of this column know that my computer is a Fujitsu FM-16β,

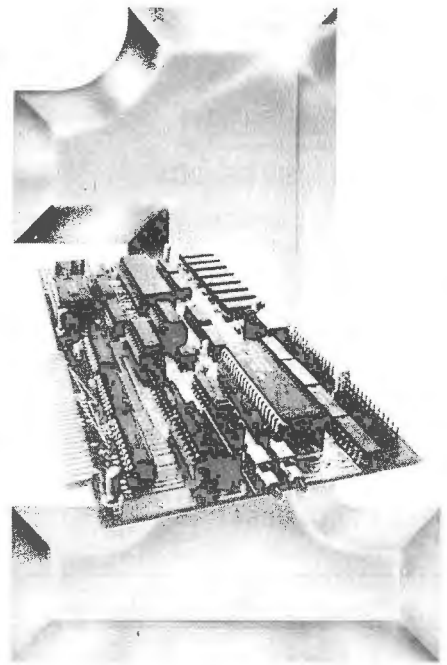
which is not at all IBM PC-compatible. In fact, I run the CP/M-86 operating system, not MS-DOS, so I have no need for IBM PC software. Nevertheless, having heard so many rumors about pirate software shops in Taiwan, I decided to check it out myself.

One shop measured up to my worst expectations. Its catalog consists of a list of over 300 well-known software packages, including Lotus's 1-2-3 and Symphony, Ashton-Tate's Framework, and numerous compilers, spreadsheets, word processors, and other application programs marketed by major companies in the U.S. and throughout the world. The store also offers hundreds of books, including manuals for the software it sells. All of this is illegal, all of it is pirated. The software is sold for \$10 per disk. I asked to see three well-known programs; they were brought out of the storeroom and demonstrated. Not one of the disks had a label from the original manufacturer. Since I was testing three disks, I was offered a discount: three disks for \$20. The salesperson said, "Please wait a moment; we'll copy these right now," and proceeded to do just that. I couldn't resist the temptation to ask, "How is it that you can offer such expensive software for such a low price?" The salesperson confided to me, "I think this is a little bit illegal. You should hide these from Customs when you go to the airport."

Don't write and ask me the address of the shop; with any luck, by the time you read this the Taiwanese government will have closed down the operation. In the meantime, the only thing I can say to U.S. software suppliers is that sending software to Taiwan may be issuing a license to steal. If I were a major software company, I'd consider hiring a permanent representative in Taiwan just to file complaints against software pirates.

**COMING UP**

Next month I'll take a look at new models of the NEC PC-9801 series. I'll also discuss the DynaMac and some software that bridges the East-West language gap. ■



**Number One in Performance**

**Z80H BLUE STREAK™**

**IBM/AT/XT/PC- 8mz No Wait States**

**FEATURES**

- 64K-256K RAM
- 2K-8K EPROM/Static Ram
- 2 Serial Ports  
    Async/Sync/Bisync Communications
- Real Time Clock
- Memory-mapped Dual-port BUS
- On-board/Remote Reset NMI capability
- Up To 32 Boards Per AT/XT/PC
- Can Operate As Standalone Processor
- Less Than Full Size Board  
    (will fit other compatibles.)

**SOFTWARE**

- ZP/M™ CP/M Emulation Software  
    (Supports Most CP/M Software)
- Multiuser Capability if Used As A Slave Processor

IBM is a registered trademark of International Business Machines Corporation. CP/M is a registered trademark of Digital Research Corp.



4704 W. JENNIFER, SUITE 105 • FRESNO, CA 93711  
209/276-2345

# Lycó Computer Marketing & Consultants



**SG-10 .. \$208.00**

## AXIOM SEIKOSHA

GP550AT (Atari).....222  
 GP550CD (C-64).....222  
 GP700AT (Atari).....439  
 GP700AP (Apple).....439  
 ELITE5CD (C-64).....229

## C. ITOH

8510Ap+.....299  
 1550P.....437  
 1550BP.....437  
 1550EP.....437  
 1550BCD.....469  
 F10-40.....859  
 F10-55.....1039  
 7500AP.....204  
 7500AR.....244

## TOSHIBA

P1340.....557  
 P351.....1286

# SAVE ON THESE IN STOCK PRINTERS

## CARDCO

32K BUFFER..(C-64).....59

## CORONA

LP300 Laser Printer.....2686  
 200361 Toner Cartridge...89

## EPSON

FX85 (New).....333  
 LX80.....212  
 FX185 (New).....464  
 LX90 (New).....226  
 SQ2000 (New).....1555  
 JX80.....467  
 Homewriter 10.....193  
 CR-20-Atari.....153  
 CR-220-C-64.....153  
 DX-10 (New).....207  
 DX-20 (New).....237  
 HS-80 (New).....288  
 LO1500P.....975  
 LO1500S.....1039  
 RX-100.....356  
 FX-100+.....CALL

## CITIZEN

MSP-10.....289  
 MSP-15.....358  
 MSP-20.....337  
 MSP-25.....495  
 Sheetldr (10/20).....189  
 Sheetldr (15/25).....199

## OKIDATA

Okimate 10.....179  
 Okimate 20.....CALL  
 182.....214  
 192.....348  
 193.....563  
 92P.....349  
 93P.....565  
 84P.....645  
 92 Imagewriter.....349

\*IBM versions also

## BROTHER

HR-15XL-P.....359  
 HR-15XL-S.....359  
 HR-35P.....839  
 HR-35S.....839  
 2024L-P.....848  
 M1009-P.....189

## JUKI

Juki 6100.....347  
 RS232 Serial Board.....119  
 6100 Tractor.....258  
 6100 Sheet Feeder.....209  
 Juki 6300.....757

## LEGEND

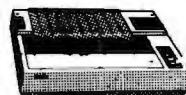
880.....188  
 1080.....222  
 1380.....282  
 1385.....296

## DIGITAL DEVICES

16K BUFFER.....75  
 32K BUFFER.....89  
 64K BUFFER.....125

## DIABLO

D25.....549  
 630API.....1599  
 630ECS.....1759  
 D601F.....2395  
 P2CQ1.....699  
 P38.....1749  
 C150.....999



**1091...\$233.00**

## PANASONIC

1091.....233  
 3131 (NEW).....269  
 1092.....373  
 1093.....426  
 3151 Letter.....426  
 4K Buffer.....65

## SILVER REED

EXP400.....249  
 EXP500.....295  
 EXP550.....399  
 EXP770.....749

## STAR MICRONICS

SG-10.....208  
 SG-15.....373  
 SD-10.....336  
 SD-15.....319  
 SR-10.....442  
 SR-15.....583  
 Powertype.....303  
 SB-10.....CALL  
 SG-10C-64 (NEW).....CALL

## MONITORS

### TAXAN

115 12" Green Composite..CALL  
 116 12" Amber Composite..CALL  
 121 12" Green TTL.....135  
 122 12" Amber TTL.....145  
 220 14" Color Composite.....259  
 410 12" RGB Hi Res IBM.....329  
 420 12" RGB Super Hi IBM.....409  
 440 12" RGB Ultra Hi Res.....555  
 Tilt Stand.....35

### ZENITH

ZVM 122A Amber.....75  
 ZVM 123G Green.....75  
 ZVM 124 Amber IBM.....129  
 ZVM 131 Color.....275  
 ZVM 133 RGB.....389  
 ZVM 135 Composite.....449  
 ZVM 136 Hi Res Color.....589  
 1220. 1239. 1240.....CALL

### TEKNIKA

MJ-10 Composite.....179  
 MJ-22 RGB.....255

### AMDEK

300 Green.....118  
 300 Amber.....128  
 310 Amber IBM.....155  
 Color 300 Audio.....234  
 Color 500 Composite.....369  
 Color 600.....397  
 Color 700.....495  
 Color 710.....569

### PANASONIC

DT13000 13" RGB/Composite.....247  
 DTM140 14" RGB/Composite.....329  
 DT1103 10" RGB Hi Res.....395  
 DTS101 10" Composite.....175  
 DT1000G 10" RGB.....166  
 TX12HP 12" Color.....419  
 TR120M1PA 12" Green.....109  
 TR120MBA 12" Amber.....109  
 TR122M9P 12" Green IBM.....148  
 TR122MYP 12" Amber IBM.....148

### SAKATA

SG 1000 12" Green.....99  
 SA 1000 12" Amber.....109  
 SG 1500 12" Green TTL.....119  
 SA 1500 12" Amber TTL.....129  
 SC 100 13" Color Comp.....209  
 SC 200 13" RGB.....389  
 STS1 Tilt Stand.....29

### NEC

JB-1260 Green.....95  
 JB-1201 Green.....135  
 JC 1215 Color.....235  
 JC 1216 RGB.....375  
 JC 1460 Color.....265  
 JB 1205 Amber.....139

### X-TRON

Comcolor I Composite Green...177

### PRINCETON GRAPHICS

MAX-12 Amber.....185  
 HX-12 RGB.....465  
 SR-12 RGB.....595

## MODEMS

### HAYES

Smartmodem 300.....133  
 Smartmodem 1200.....377  
 Smartmodem 1200B.....347  
 Smartmodem 2400.....598  
 Micromodem II E.....135  
 Westridge (C-64).....59  
 Mitey Mo Modem.....69  
 Compuerve.....19.85

### ANCHOR

Volksmodem.....55  
 Volksmodem 12.....186  
 Mark 12.....229

### RACAL-VADIC

2400PC.....549  
 2400PA.....799  
 2400V.....559  
 1200PC.....329  
 300V.....205  
 300PC.....199  
 George Software.....69

### TELE LEARNING

Total Telecommunications (C-64).....29.95  
 AP-250 (300 Baud Apple).....69.95  
 IB-250 (300 Baud IBM).....69.95

### NOVATION

IBM-300/1200 MS-DOS ext.....319  
 IBM-300/1200 CPM-86 ext.....319  
 IBM 300/1200/2400 ext.....529  
 IBM 300/1200/2400 MS-DOS.....579  
 IBM MS-DOS-int.....325  
 IBM CPM-86 int.....325  
 Macromodem 300/1200.....315  
 Macromodem 300/1200/2400.....585  
 Apple Cat II.....219  
 Upgrade Apple Cat II.....225  
 Cat 300 Acoustic.....139  
 J-Cat RS232.....89

### MICROBITS

1064 Modem.....57

## DRIVES

### INDUS

GT ATARI.....215  
 GT COMMODORE.....235

### COMTEL

Enhancer 2000 (C-64).....179

### TYMAC

MDD-640 3 1/2" Apple Drive 640K.....289

### MSD

SD1 Drive (C-64).....229  
 SD2 Drive (C-64).....469

## DISKETTES

(Box 10)

### DENNISON

ELEPHANT 5 1/4" SSDD.....11.99  
 ELEPHANT 5 1/4" SSDD.....12.99  
 ELEPHANT 5 1/4" DSDD.....14.99  
 PREMIUM 5 1/4" SSDD.....13.99  
 PREMIUM 5 1/4" DSDD.....15.99

### SUNKYONG

SKC 5 1/4" SSDD.....11.99  
 SKC 5 1/4" DSDD.....13.99

### MAXELL

5 1/4" MD1.....13.99  
 5 1/4" MD2.....19.99

### VERBATIM

5 1/4" SSDD.....13.99  
 5 1/4" DSDD.....19.99

### BONUS

5 1/4" SSDD.....9.99  
 5 1/4" DSDD.....12.99

## IBM-PC COMPATIBLE

### \*LOTUS

Lotus 1-2-3.....309.00  
 Symphony.....439.00

### \*QUADRAM

Quad Jr. Exp. Chassis.....519.00  
 Quad Jr. Exp. Memory.....209.00  
 Quad Memory Jr.....209.00

### \*LEADING EDGE

Nutshell.....69.95  
 LEWP Basic.....65.00  
 LEWP Merge Print.....99.00  
 LE Spell Correction.....169.00

### OMEGA

10 Meg Bernoulli Box (IBM).....1899  
 5 Meg Bernoulli Box (MAC).....1499

ITT XTRA XP Personal Computer!  
 \*256K. 2 Drive System.....CALL  
 \*256K. 10 Meg. Hard System.....Call

### AT&T

Safari 7300.....CALL  
 6300.....CALL

### TANDON

\*320K 5 1/4" Drive.....115

### AST

Six Pack Plus 64K.....CALL  
 Mega Plus II 64K.....269  
 Memory 128K (mega).....199  
 Memory 256K (Mega).....335  
 Mono-Graph Plus.....339  
 Advantage-AT-128K.....389

# TOLL FREE 1-800-233-8760



Inquiry 219  
**TO ORDER**



CALL TOLL FREE

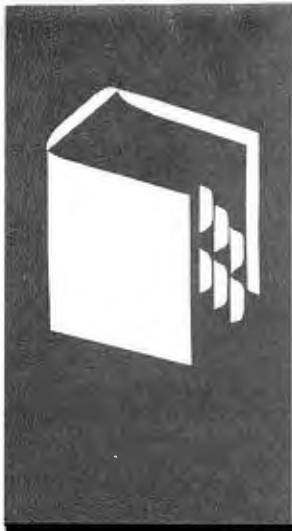
**800-233-8760**

Customer Service 1-717-327-1825 Jersey Shore PA 17740

or send order to  
 Lycó Computer  
 P O Box 5088

### RISK FREE POLICY

In-stock items shipped within 24 hours of order. No deposit on C.O.D. orders. Free shipping on prepaid cash orders within the continental U.S. Volume discounts available. PA residents add sales tax. APO/FPO and international orders add \$5.00 plus 3% for priority mail service. Advertised prices show 4% discount for cash, add 4% for MasterCard or Visa. Personal checks require 4 weeks' clearance before shipping. Ask about UPS Blue and Red label shipping. All merchandise carried under manufacturer's warranty. Free catalog with order. All items subject to change without notice.



# Microcomputer Color Graphics—Observations

Mac Communications

Color Graphics

Atari 520ST

Amiga

SideKick

Mac Books

BY BRUCE WEBSTER

I'm sure most of you haven't the slightest interest in my personal affairs, but I'm about to move to another state, and Jerry Pournelle's appellation for his chaotic home fits my own house (not to mention my life) all too well. As a result, much of the software waiting to be examined waits still, and hardware shipments have stopped altogether until I have a new address at which to receive them. Your patience is requested and appreciated.

Those of you who have written me physical letters deserve a special public apology. From where I am sitting, I can turn my head and see a 2-inch stack of letters awaiting answers, some of which are older than I can comfortably think about. My goal is to answer them before The Big Move next week and thereafter stay on top of things, answering all letters promptly. And, as my friend's grandmother says, if you believe that, I'll tell you another one.

## MAC COMMUNICATIONS SOFTWARE

As you may recall, last month's column was written on the Macintosh for the first time (using Microsoft Word). Well, I'm back on the Compaq this month. Not because of word-processing problems on the Mac; even now, I find myself reaching for the mouse. No, the problem lies with the only telecom program I have for the Mac: MacTerminal. I had a very difficult time doing a simple ASCII upload of my column to BIX (BYTE Information Exchange), mostly due to the lack of a "wait for prompt" feature in MacTerminal. That, of course, was on top of many other deficiencies and proved to be the proverbial backbreaking straw. The real culprits are ASCII Pro and Crosstalk, the two telecom programs I use on the Compaq. Both can do so much that MacTerminal seems primitive by comparison.

After asking around, I've found that the Mac package most often recommended is Red Ryder, a shareware package available through many users groups and bulletin

boards. I hope to have a copy by next month, in which case I'll probably switch back to the Mac for writing. Hayes Smartcom II for the Mac also looks good, although I've heard that it doesn't work well with the Apple modem. You should use a Hayes Smartmodem with it. I'll try to have more detailed reports on both these packages in the next month or so; in the meantime, do *not* buy MacTerminal.

## COLOR GRAPHICS VERSUS MONOCHROME

Many rumors are now surfacing about future Mac products. Supposedly, Apple will be releasing a Big Mac by the time this column sees print; said Mac will reportedly come with 1 megabyte of RAM (random-access read/write memory), the new 128K-byte ROM (read-only memory), and a double-sided (800K bytes) disk drive, all in the standard Mac box. More intriguing is the talk about Carla, a 2-megabyte Mac with dual 68000 processors, slots, and different-size monitors (including a 9- by 12-inch full-page version). And it just possibly may have color output. Of course, rumors and sightings of a color Mac have been around almost as long as the machine itself. Steve Jobs asserted last January that no color Mac would surface for a few years at least, until such time as a color equivalent of the Laser-Writer was feasible. He contended that color wasn't that important and said the Mac community was far better off working toward higher-resolution monochrome display and reproduction.

There haven't been too many issues on which I've agreed with Jobs, but this is one. The following appeared in my review of the Macintosh in the August 1984 issue of BYTE:

"Some criticism has been made about the lack of a color-graphics capability. Frankly, I am unconvinced of its necessity. Most applications I have seen use color graphics as

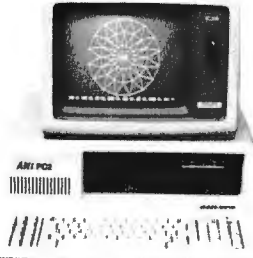
(continued)

Bruce Webster is a consulting editor for BYTE. He can be contacted c/o BYTE, POB 1910, Orem, UT 84057, or on BIX as bwebster.

**A Powerful, Practical Computer  
at an Economical Price...and IBM® XT Compatible**

**ANI PC2**

Your Price **\$995**



**FEATURING**

- 640K 8 Slot Motherboard
- 8088 16 BIT 4.77 MHZ Processor
- 135 Watt Power Supply
- IBM® PC/XT Compatible
- 5150 Compatible Keyboard
- Accessory Slots Compatible with IBM® Plug-in Cards
- Two Toshiba 360 Kb Disk Drives
- 8087 Co-processor (optional)
- PGS MAX 12 Amber Hi-Res Monitor (runs with color card also)
- Warranty: 120 Days Parts and Labor

- 10 MB Hard Disk Subsystem \$395 ■ 20 MB Hard Disk Subsystem \$495
- All other configurations available.

**AlphaNumeric International, Inc.**  
14060 Gannet Street ■ Suite 1-103 ■ Santa Fe Springs, CA 90670

213/921-8689 ■ Telex 181149 West LSA

Dealer Inquiries Invited  
Quotes for large quantities invited.

101

\*IBM is a trademark of International Business Machines

**DESMET C \$150\***  
Macintosh™ Development Package

- Runs on both 128K and 512K Macintosh
- Full K&R Compiler — IEEE Floating Point
- >450 Function Macintosh ROM Library
- Assembler, Linker & Librarian
- >120 Function STUDIO Library
- Machine Code Debugger
- Source Code Editor
- "Shell" interface
- 300 Page manual
- RAM Disk

Published and sold direct to the end-user by:  
**C Ware Corporation**  
P.O. Box C, Sunnyvale, CA 94087  
(408) 720-9696

\*Price includes domestic shipping. Canada \$5. Europe/Asia add \$20. Call to charge by VISA, MC or AMEX. Street address: 505 W. Olive, #767, Sunnyvale, CA 94086.

Macintosh is a trademark licensed to Apple Computer, Inc.

**ACCORDING TO WEBSTER**

*The 68000 processor in the  
Mac has to do everything  
and quickly becomes the  
bottleneck for the system.*

a substitute for detail, and the Mac can give you lots of detail."

Since then, little has happened to change my mind; the Mac, with its square pixels and amazing graphics routines, still has the cleanest, most professional display of any microcomputer I've worked with. But technology is starting to catch up with Apple, and crisp, fast color graphics in equal or higher resolution are showing up on the Atari 520ST, the Amiga, and some of the new graphics boards for the IBM PC. And while these newcomers don't have software libraries anywhere close to the Mac Toolbox, they do have greater hardware support, resulting in very fast display updates. By contrast, the 68000 processor in the Mac has to do everything and quickly becomes the bottleneck for the system.

Still, a monochrome display has many advantages over color graphics. It is usually easier to read than a color display of equal resolution. As Jobs noted, image-manipulation and -reproduction technology (printers, digitizers, etc.) is more advanced for monochrome displays, and "what you see is what you get" displays are easier to support. Monochrome displays require less memory than color displays of equal or even less resolution, something important for a machine (the Mac) still officially limited to 512K bytes. Finally, high-resolution monochrome monitors are cheaper than equivalent-resolution color monitors.

**A BRIEF SURVEY OF GRAPHICS**

The development of graphics technology is itself fascinating. The first real breakthrough was the Apple II, which offered graphics—and color graphics, at that—as a standard feature. I still have the June 1977 issue of BYTE with Apple's first ad in it, and I can still remember the feelings of computer lust it stirred in me. None of the mainframes and minis I was working with at school had color graphics, and here was a microcomputer that could do it all.

Unfortunately, the graphics on the Apple were not particularly easy to use (and still aren't, although they are well documented now, eight years later). The high-resolution graphics mode—280 by 192 pixels (monochrome) or 140 by 129 pixels (six colors)—used a bizarre mapping scheme, reputedly chosen by Steve Wozniak to save a few TTL (transistor-transistor logic) gates in the design. And the display RAM itself was fixed right in the middle of the memory map. This wasn't much of a problem when RAM prices were high—that same ad offers 16K bytes of RAM

(continued)



# What every Apple II+ and IIe user should ask before buying the "Sider" 10 MB hard disk:

When a company offers a superior quality 10 megabyte Winchester hard disk for only \$595, it's bound to raise a few eyebrows... and a lot of questions. The fact is, you're probably already wondering "Can I really get a 10 megabyte hard disk that's *reliable* for only \$595?" The answer is: ABSOLUTELY...when you choose the Sider from First Class Peripherals.

## What's so great about the Sider?

For starters, the Sider lets you boot your *Apple II+* or *IIe* directly off the hard disk—unlike some other Winchester subsystems. Rebooting is also trouble-free. And the disk is partitionable, allowing you to allocate space to four operating systems on the same disk. The Sider supports: Apple DOS 3.3; Pro DOS™; Apple Pascal; and CP/M®.

What's more, a small "footprint" lets you incorporate the compact Sider into your existing computer set-up with ease.

In addition, with the Sider, you not only pay far less for the subsystem, you also save money on installation. Because, unlike other 10 MB systems that require the purchase of expensive "extras," the Sider is *plug and play*. Everything you need is provided, including cables, host adaptor, installation software and manual.

## What makes it so reliable?

To start, the Sider is manufactured, and sold exclusively, by First Class Peripherals, an innovative computer company which is backed by Xebec. The computer industry's leading manufacturer of disk controllers, Xebec has over a decade of experience serving customers like IBM, Toshiba, Texas Instruments and Hewlett Packard. It's this kind of expertise that helps assure the Sider's performance.

Special design features further enhance reliability. The Sider's controller is the field-proven, industry standard Xebec SI410A. And Xebec's 3200 drive tester, the



## "Only \$595?"

October 1, 1985 through December 31, 1985

toughest in the industry, ensures that the Sider will operate reliably. One more assurance of the \$595 Sider's quality: it's UL Approved and FCC Class B rated.

## But why is it only \$595?

You pay less for the Sider than for other 10 MB hard disks simply because you're paying for the superior quality components inside the unit, not for a lot of retail overhead costs. Since First Class Peripherals sells direct, you avoid dealer and dis-

tribution expenses, and pay only for the product.

## What about a guarantee?

Like many experienced Apple users, you may be reluctant to buy a hard disk priced at only \$595 without first seeing for yourself how it performs. That's why First Class Peripherals offers you a reassuring, money-back guarantee that eliminates any risk on your part. Simply order the Sider and use it for 15 days. Then, if you're not entirely satisfied, return it and receive a full refund—no questions asked.

The Sider also comes with a full one-year limited warranty. Plus, there's a convenient, toll-free hotline you can call anytime you have a technical or service question, or need help.

## Don't delay. Order the Sider now.

To receive the Sider 10 megabyte Winchester hard disk subsystem for only \$595, simply order using the coupon below. For faster service, order by phone and charge to your VISA, MasterCard or American Express. (You can also call us if you have any questions or technical concerns about the Sider. We'll see you get the help you need.) Call toll-free:

# 1 800 538-1307

Extension 205

**Yes**, please send me the Sider, including half-height 10 megabyte Winchester hard disk drive, Apple adaptor board, cable, complete installation software and documentation.

I prefer to pay as follows:

- I've enclosed my check or money order for \$595\* + \$15 shipping and handling, payable to First Class Peripherals.
- Please bill the following credit card account for \$595\* + \$15 shipping and handling:
- VISA     MasterCard     American Express

Card # \_\_\_\_\_ Exp. Date \_\_\_\_\_

Signature \_\_\_\_\_  
\*Residents of CA, NV and PA, please add appropriate sales tax.

Name \_\_\_\_\_

Address \_\_\_\_\_

City \_\_\_\_\_

State \_\_\_\_\_ Zip \_\_\_\_\_

Telephone (area code) \_\_\_\_\_

Mail to:

**FIRST CLASS PERIPHERALS** 3579 Highway 50 East  
Carson City, NV 89701  
205

Apple and Pro DOS are trademarks of Apple Computer, Inc. CP/M is a registered trademark of Digital Research, Inc.

# 9-TRACK MAG. TAPE SUBSYSTEM FOR THE IBM PC/XT/AT



**\$4757**

For information interchange, backup and archival storage, IBEX offers a 9-track, IBM format-compatible 1/2" magnetic tape subsystem for the IBM PC, featuring:

- 42 M-Bytes on a single reel.
- IBM format 1600 cpi.
- Software for PC-DOS, MS-DOS.

**IBEX**

**IBEX COMPUTER CORP.**  
20741 Marilla St.  
Chatsworth, CA 91311  
(818) 709-8100  
TWX: 910-493-2071

Write, phone or TWX for information

## COMPETITIVE EDGE

P.O. Box 556 — Plymouth, MI 48170 — 313-451-0665

### Compupro®, LOMAS, EARTH, TELETEK S-100 CIRCUIT BOARDS

CompuPro 286 CPU	\$671.	Lomas 286 8MHz	\$821.	Color Magic 32K	\$556.
CompuPro SPU Z**8MHz	296.	Lomas 8086	420.	Lomas 10MHz 8086	520.
CompuPro 8085/88**	263.	Lomas Octaport** 8 Serial	320.	Lomas 4 serial	200.
CompuPro Disk 1A**	371.	Lomas LDI** 72	206.	Lomas Color Magic** 16K	476.
CompuPro Disk 3**	446.	Lomas 256K Dram	358.	Lomas MSDOS** 2.11	200.
CompuPro Ram 22**	446.	Lomas 512K Dram	448.	CompuPro MDrive H*512K	446.
CompuPro Ram 23**	188.	Lomas Ram 67**	599.	CompuPro I/O 3 8 port	371.
CompuPro Ram 23 128	263.	Lomas Hazitall**	244.	Teletek SBC 1 6MHz 128	375.
CompuPro CPU Z**	189.	Thunder 186**	895.	Turbodos* for Teletek	650.
CompuPro CCP/M*816*	300.	Lomas CCP/M*86**	280.	Lomas 2 Megabyte	
System Support One**	263.	CompuPro I/O 4	245.	Ram-(2048K)	just \$921.
Teletek HD/	375.	Systemmaster II*	795.	Earth Turbomaster	\$795.
Teletek Systemaster*	495.			I.T. 1024x1024 Bnd	\$995.

### Earth Computer TURBO SLAVE 1 8MHz 128K \$395.

Turbo Slave I runs with Teletek, North Star Horizon, Advanced Digital and Others under Turbodos\*\*.

### SYSTEMS

CompuPro 85/88,256K.CDOS, SS1,I/O 4,2-96TPI DRS, 15 Slot	\$3095
CompuPro 85/88,256K.CDOS, SS1,I/O 4,1-96TPI,20MB, 15 Slot	\$4295
CompuPro 286, SPUZ, 40MB, SSI, I/ 3, CDOS, 15 Slot, 30 amp P/S	\$6995
286, 1024K, 20MB, AutoCad 2 System — Ready to Run	\$8395
Lomas 286,1024K,20MB HD,1-5",CDOS, 6 SERIAL, 2 Par, 15 Slot	\$4995
Lomas Thunder 186, 256K, 20 MB HD, 1-5", CDOS, 4 Slot	\$2895
Teletek 8MHz Master, 4-8MHz 128K SLVS, 1-5", 20 MB HD, TDOS	\$4995
AT CLONE, 286, FAST 20 MB HD, enhanced	\$3695

### UPGRADE YOUR IBM® PC\*\*!!

<b>MONITORS</b>	<b>GRAPHIC BOARDS</b>	<b>HARD DRIVE KITS</b>
Amidex 310A	Hercules Monochrome	PC 10MB PC
	\$159	\$299
	Hercules Color Card	PC 21MB PC
	\$159	\$395
Princeton Color HR-12	Tecmar Graphics Master	AT 21MB AT
\$459	\$449	\$795
Princeton Color SR-12	Paradise Graphics	AT 36MB AT
\$649	\$279	\$1295
286 ACCELERATOR	STB Graphx...II	AT 70MB AT
\$895	\$279	\$2295
Turbo Accel-286 8 MHz	Hercules Compatible MONO	AT 80MB AT
\$895	\$135.	\$3295
<b>MULTI-FUNCTION BOARDS</b>	<b>FLOPPY DRIVES</b>	AT 119MB AT
AST 6 Pak 64K	TEAC 1.2MT FD559	\$3595
\$245	\$119	
Quadram Expanded Quadboard OK	Mitsubishi 96 TPI	PC Fly Controller
\$219	\$125	\$60
Tecmar Captain 64K	5" DSDD Color Drvettes	\$ 21
\$189		

### ALL PRICES SUBJECT TO CHANGE AND STOCK ON HAND

CompuPro is a Registered Trademark of Visyn, CPU Z, Disk 1A, Disk 3, Interfacr 3, Interfacr 4, CPU 286, CPU 8085/88, System Support 1, MDRIVE-H, Ram 22, Ram 23 are trademarks or registered trademarks of Visyn. CP/M 2.2, CCP/M, are registered trademarks of Digital Research Inc. MSDOS is a registered trademark of Microsoft, Systemaster & Systemaster II are registered trademarks of Teletek Enterprises. Turbodos is registered trademark of Software 2000. IBM is a registered trademark of International Business Machines. AutoCad 2 is a registered trademark of AutoDesk, Inc.

## ACCORDING TO WEBSTER

for \$600—but once 32K- and 48K-byte systems became popular, the location became one more problem to work around.

The Apple II established built-in color graphics as a standard for personal computers; the Atari 400/800 and the Commodore 64 built upon that standard, adding hardware support, relocatable video RAM, missiles and sprites, and other features. Programmers on these machines had a much easier time of it, and some impressive programs (read: games) were produced. However, because of the cellular nature of the graphics on these systems, most of the programs had a "chunky" look to them and were not as impressive as the most advanced programs (read: games) on the more primitive Apple II. Both machines sold well but, with limited expansion capability, tended to be dead ends for their owners.

When IBM decided to get into the micro world, it wisely followed the example of the Apple II and put expansion slots into the machine. Then, for some incomprehensible reason, the people at IBM did not make graphics a standard part of their system; in fact, they did not even make an ASCII text display a standard feature. Instead, they offered two incompatible display cards: one for monochromatic text display, the other for color text and graphics. And, just to add to the excitement, they designed their cards and monitors such that if you plugged your monochrome monitor into your color card, you stood a good chance of burning out your monitor.

In retrospect, a couple of reasons suggest themselves for this design philosophy, none of them flattering to IBM. Possibly, IBM was unwilling to give its customers a standard graphics capability (or even a standard ASCII display, for crying out loud) but wanted to charge extra for these "options." Or perhaps IBM was somehow afraid that making graphics (especially color graphics) a standard feature would "lower" its system to the level of the Apple/Atari/Commodore computers, which most people viewed as game machines.

Whatever the reasons, the results are obvious today: a wide variety of display cards, with varying levels of compatibility between each other and your software. IBM has gotten right in there with the rest of them, not only offering the monochrome (text) display adapter and the color-graphics card, but also the Extended Graphics Adapter (EGA) and the very expensive Professional Graphics System. And if you want clear, crisp text and color graphics on the same system, be prepared to do some juggling of both software and hardware. (I haven't even mentioned the problems of conflicting parallel ports on different display cards.)

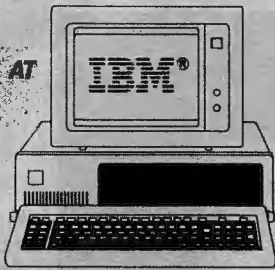
On top of this, the standard IBM graphics aren't very exciting. You have a few different resolutions to choose from; the most common are 640 by 200 pixels (monochrome), 320 by 200 pixels (monochrome), and 320 by 200 pixels (four colors). The RAM-to-display mapping isn't that bad, but the color selection is disappointing: one of

(continued)

# COMPUTER HUT

COMPARE  
OUR  
SERVICE & PRICE!

IBM-PC, XT & AT  
CALL



## COMPAQ®

Portables, Deskpros, 286 Models ... CALL

## ITT

XTRA 2DR, 256K ... \$1395

## DISK DRIVES

Tandon TM100-2 DS/DD ... \$109

TEAC FD 55-B Slimline ... \$115

IBM® drives w/logo ... \$129

## HARD DISKS/TAPE

## ME MAYNARD ELECTRONICS

Hard disks & tape back-ups complete with cont. & cables.

WSO 10, 20, 30 meg from ... \$675

MaynStream Portable tape backup & Portable hard disk systems ... CALL

MEGA Bernoulli 20 Meg ... \$2495

ALLOY full line ... CALL

IRWIN tape backups from ... \$549

## ADD-ON BOARDS

## QUADRAM

Quadboard 0K exp. to 384K ... \$219

Microfazer 64K parallel ... \$229

## AST

SixPak Plus 64K ... \$239

I/O mini Ser Port & Clock ... \$139

Advantage 128K ... \$399

## dca

IRMA board ... \$895

## ORCHID

PCturbo-186 w/128K ... \$625

## HÉRCULES

HiRes Mono Graphics ... \$309

Color Graphics w/par port ... \$175

## PARADISE

Modular Graphics ... \$269

5-Pack 0K exp. to 384K ... \$159

## PERSYST

Mono Card w/par port ... \$189

## TECMAR

Graphics Master ... \$469

Maestro 128K ... \$399

## MODEMS

### Hayes®

Smartmodem 1200 ... \$399

Smartmodem 1200B w/smartcom.ii ... \$369

Smartmodem 2400 ... \$639

### NOVATION

Smart Cat Plus w/MITE ... \$299

## PRINTERS

### EPSON

FX-85, FX-185, LX-80, JX-80, RX-100, LQ-1500,

DX-10, DX-20, HI-80 plotter, HS-80 ink jet —

BEST DEAL — GUARANTEED!

### brother

HR-10 ... \$299 HR-15XL ... \$369

HR-25 ... \$569 HR-35 ... \$749

Twinwriter 5 ... \$899

FACIT ... CALL

hp HEWLETT PACKARD ... CALL

### OKIDATA

182, 192, 93, 193, 84, 2410 . BEST PRICES

### NEC

2050 ... \$699 3550 ... \$1095

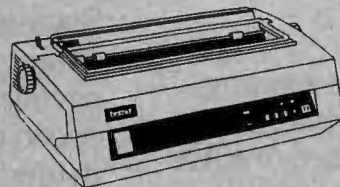
8850 ... \$1549 elf 360 ... \$459

Pinwriter P2 ... \$549 P3 ... \$775

### TOSHIBA

P351 ... \$1195 P1340 ... \$595

## ACCESSORIES . . . . . CALL



## SPECIALS

### PARADISE SYSTEMS

#### MODULAR GRAPHICS CARD

Runs all IBM Color graphics software on IBM Mono & Color Monitors ... \$249

5-PACK w/0K-expandable to 384K, Ser. Port, clock, Ram disk & print spooler ... \$139

ASK ABOUT OUR  
REPAIR SERVICES.

## MONITORS

### AMDEK

Video 300G ... \$129 300A ... \$139

Video 310A ... \$179

### PGS

HX12 ... \$479 HX-12E ... \$559

MAX-12E ... \$189 SR-12 ... \$599



## SOFTWARE

### WORDPROCESSING

MS Word ... \$239 Multimate ... CALL

Volkswriter deluxe ... \$159

PFS: Write ... \$85 WordPerfect ... \$239

WordStar propak ... \$299

Wordstar 2000 ... \$259

### DATABASE / INTEGRATED

dBase III ... CALL Framework ... CALL

Lotus 1-2-3 ... \$299 Symphony ... \$429

Jazz ... CALL

RBase 5000 ... \$369 Cornerstone ... \$299

### BUSINESS / ACCT.

Microsoft Project, Chart ... \$159

Harvard Total Project Mgr ... \$289

PFS: File, Plan, Graph ... \$85

BPI Accounting ... CALL

### UTILITIES / COMPILERS

Sideways ... \$39 Smartcom II ... \$99

Superkey ... \$55 Norton Utilities ... \$65

Sidekick NP ... \$55 Turbo Pascal ... \$49

MS Basic ... \$239 MS Fortran ... \$219

LIFEBOAT Lattice C ... \$299

STARBRIDGE DOS ... \$39

### TRAINING / OTHER

#### ATI TRAINING POWER

Teach yourself: Lotus 1-2-3, dBase III, Multimate, Jazz ... \$49

#### ATI SKILL BUILDER

How to use: PC DOS, IBM PC, Database, Wordprocessing ... \$39

Typing Tutor III ... \$39 Gato ... \$29

Flight Simulator ... \$39

## AND LOTS MORE

ANY PRODUCT NOT  
LISTED? CALL

## EAST COAST

### COMPUTER HUT OF NEW ENGLAND INC.

101 Elm St. Nashua, NH 03060

(603) 889-7625

For Orders Only — (800) 525 5012

## CANADA

### MICROCONTEXT

AUTHORIZED DEALER

4847 Ave Du Parc  
Montreal Que H2V4E7.

(514) 279-4595

## MID-WEST

### COMPUTER HUT INC.

524 S. Hunter  
Wichita, Kansas 67207

(316) 681-2111

For Orders Only — (800) 572 3333

All products usually in stock for immediate shipment and carry full manufacturers' warranty. Price subject to change — this ad prepared two months in advance. We honor personal checks — allow 20 days to clear. COD up to \$500. Visa, MasterCard add 2%. For shipping & insurance add 2% or \$6.00 min. for small items and \$12. min. for monitors, printers, etc. We accept company checks and P.O.'s from Fortune 1000 Companies.

IBM is a trademark of IBM Corp.

Return authorization and order status call information line

Inquiry 75

1285

# HOTLINE

## AT&T'S SMALL BUSINESS CONNECTION.

tailor an equipment and service package that fits your individual needs perfectly.

While you're on the line, you'll learn about AT&T's hot line of products. Like the MERLIN™ Communications System, with features like conference calling, which lets you conduct time-saving meetings over the phone. Or speed dialing, which instantly puts you in touch with key people. Features you can program and reprogram to meet your changing needs.

When it comes to surefire products, there's nothing like our full line of computers, including AT&T's 3B Computers, and our new popular AT&T UNIX™ PC.

The UNIX PC delivers the kind of power, speed and exceptional ease of use few PCs can match. Not to mention AT&T's PC 6300. It's fully compatible with the IBM PC yet twice as fast



Take your pick from our family tree.

Whether you're looking for the ideal telephone system, computer, or FAX machine for your small business, there's a connection.

They're all members of AT&T's Small Business Connection—a full family of products and services

specifically created to help you save time, effort and money.

It's easy to connect with the Small Business Connection. Simply dial 1 800 247-7000, our hotline, and you'll immediately be in touch with a specialist trained to understand the needs of small businesses. A specialist who'll work with you to



Get the total telephone for small business.

# NE



# AT&T GIVES YOU ONE NUMBER TO REMEMBER FOR UNFORGETTABLE PRODUCTS AND SERVICE.



This number connects you to the office in your area.

and more expandable.

You'll also get all the facts on the AT&T FAX 3510D. It's capable of firing sharp, clear copies of letters, charts or photos—across town or across the country—as fast as 20 seconds a page. Plus it's industry compatible, fully portable, and completely automatic.



Send stacks of tracts in a flash with this FAX.

Finally, we'll wrap it all up for you in one of our service packages, like Service-Plus. This allows you to take care of all your communication needs with one call. You can even select one of several financial plans to meet your

cash flow requirements. Best of all, along with everything else comes all the experience, resources and know-how only AT&T can offer.

Use the hotline and call AT&T's Small Business Connection today. Just dial 1 800 247-7000, Ext. 204.

You'll be warmly received.



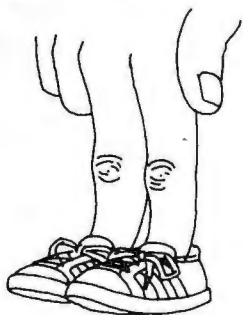
Service-Plus is just one of the plusses.



# AT&T

## The right choice.

# THE ONLY THING YOU NEED NOW IS FASTER FINGERS



## INTRODUCING, SUPERCHARGER™

INCREASE THE SPEED OF YOUR IBM PC AT REASONABLE COST WHILE MAINTAINING HARDWARE/SOFTWARE COMPATIBILITY.

- 100% software/hardware compatible
- A clock controller not a co-processor
- Totally user transparent
- Nearly **doubles** processor speed
- Plug in installation
- Doesn't need an expansion card slot
- Toggle switch for speed change included
- 3" x 5" dimension

**\$279.95 Dealer Inquires Invited**

### DYNATEC SYSTEMS INC.

870 East 9400 South, Ste. 103  
Sandy, UT 84070 (801) 572-6867

## ACCORDING TO WEBSTER

*The IBM PC, XT, and compatibles allow you 640K bytes of user memory, and the display—either text or graphics—doesn't use that up.*

four palettes, each with three fixed colors and one user-selectable (out of a list of 16) background color. However, as with the Apple II, some ingenious programmers have managed to get far more out of the IBM PC than IBM put in. And, of course, there are the advanced and upward-incompatible graphics-display cards.

About the only commendable feature of the separate display cards is that they contain their own display RAM, although the address space had to be allocated within the 8088's 1-megabyte memory map. The IBM PC, XT, and compatibles allow you 640K bytes of user memory, and the display—either text or graphics—doesn't use that up.

Apple's people, in designing the Macintosh, reversed IBM's decisions. They made the Mac a closed box, ignoring the prime reason for the Apple II's continued success despite its close-to-obsolete technology. But they not only made a graphics display standard, they made it the focus of the entire machine. Unlike previous systems that distinguished between text and graphics display, everything on the Mac was done with graphics, including the icon-and-menu-based user interface. Adding the black-on-white display, the square pixels, the graphics routine in ROM, and a much more sensible RAM-to-screen mapping scheme, the result was a machine that looked like the expensive Star systems developed by Xerox, at a fraction of the price.

The graphics display on the Mac is straightforward in how it works. The 512- by 342-pixel image is scanned from left to right, top to bottom, out of the video-RAM area (called the screen buffer), each bit corresponding to one pixel. Unlike most graphics systems, a 0 corresponds to white and a 1 to black. The screen buffer is located near the top of user RAM, automatically adjusting upward for 128K-byte, 512K-byte and 1-megabyte Macs. And, because of the extensive routines in ROM, programmers can and should avoid writing directly into the screen buffer. While many of Apple's claims about the Mac were hyperbolic, the Mac did set a new standard for microcomputer displays. With multiple fonts and styles and Apple printers, the phrase "what you see is what you get," previously applied to margin-justifying word processors, took on a whole new meaning. And for all the criticism of the Mac interface, it has been quickly adapted to new and existing systems, indicating that Apple and Xerox must have done something right.

But graphics displays eat up memory, and the higher

*(continued)*

## maxell.

### New Lower Price! 5¼" Diskettes

MD-1 Single Sided Double Density  
**12.25 box of ten**

MD-2 Double Sided Double Density  
**16.75 box of ten**

MD-2HD High Density  
**36.00 box of ten**

Single Sided 96TPI  
**21.50 box of ten**

Double Sided 96TPI  
**25.50 box of ten**

### 3½" Micro Floppy Disks

MF-1 SS Quad **23.75 box of ten**

MF-2 DS Quad **33.75 box of ten**



#### TERMS:

Visa/Mastercard  
—C.O.D.— Prepaid.  
Allow 10 days for personal/ Company check to clear. Add \$3.00 Shipping. C.O.D. add \$2.00. Texas residents add 5.125% sales tax.



Call for other Maxell Products

1-800-527-1814

(In Texas 1-512-682-7774)

P.O. Box 3424—Edinburg, Texas 78540-3424



You would think when IBM needs EPROM Programmiers they would choose the best and the most expensive. They don't. They only choose the best. GTEK.



MODEL 7956 (w/RS-232 option) ..... \$1099  
 MODEL 7956 (stand alone) ..... \$ 979

GTEK's outstanding Gang Programmer with intelligent algorithm can copy 8 EPROMS at a time! Use the 7956 in a production environment when you need to program a large number of chips. Programs all popular chips through the 27512 EPROMS; supports CMOS EPROMS through the 27C256; supports EEPROMS through the X2864A; supports Intel's 2764A & 27128A chips. The 7956 will also program single chip processors.



MODEL 7228 ..... \$ 599

GTEK's 7228 has all the features of the 7128, plus Intelligent Programming Algorithms! It supports the newest devices available through 512K bits. The 7228 programs 6 times as fast as standard algorithms. It programs the 2764 in one minute! Supports CMOS EPROMS through the 27C256; supports EEPROMS through the X2864A; supports Intel's 2764A & 27128A chips. Supports Tektronics, Intel, Motorola and other formats.



MODEL 7324 ..... \$1499  
 The 7324 has a built-in compiler. It programs all MMI, National and TI 20 & 24 pin PALS. It has non-volatile memory and operates stand-alone or via RS-232.

MODEL 7322 ..... \$1249  
 Same as Model 7324 but operates only via RS-232.

MODEL 7316 ..... \$ 749

This PAL PROGRAMMER programs Series 20 PALS. It has a built-in PALASM compiler.

MODEL 7283 ..... \$1199

This BI-POLAR PROM PROGRAMMER programs all popular BI-POLAR PROMS. It operates stand-alone (for production) or RS-232 (for development).

MODEL 705 ..... \$ 299  
 68705V3, R3, P3 PROGRAMMER.



MODEL 7128 ..... \$ 429  
 The 7128 has the highest performance-to-cost-ratio of any unit. It supports the newest devices available through 256Kbits.

## EPROM, PROM & PAL PROGRAMMERS

— These features are standard from GTEK —

Compatible with all RS-232 serial interface ports • Auto select baud rate • With or without hand-shaking • Bidirectional Xon/Xoff • CTS/DTR supported • Read pin compatible ROMS • No personality modules • Intel, Motorola, MCS86 Hex formats • Split facility for 16 bit data paths • Read program, formatted list commands • Interrupt driven—program and verify real time while sending data • Program single byte block or whole EPROM • Intelligent diagnostics discern bad and/or unerased EPROM • Verify erasure and compare commands • Busy light • Complete with Textool zero insertion force socket and integral 120 VAC power (240 VAC/50Hz available) •

## UTILITY PACKAGES

GTEK's PGX Utility Packages will allow you to specify a range of addresses to send to the programmer, verify erasure and/or set the EPROM type. The PGX Utility Package includes GHGX, a utility used to generate an Intel HEX file.

PALX Utility Package—for use with GTEK's Pal Programmiers—allows transfer of PALASM\* source file or ASCII HEX object code file.

Both utility packages are available for CPM,\* MS-DOS,\* PC-DOS,\* ISIS\* and TRSDOS\* operating systems. Call for pricing.

## CROSS ASSEMBLERS

These assemblers are available to handle the 8748, 8751, Z8, 6502, 68X and other microprocessors. They are available for CPM and MS-DOS computers. When ordering, please specify processor and computer types.

## ACCESSORIES

Model 7128-L1,L2, L2A  
 (OEM Quantity) \$259.

Model 7128-24 ..... \$329.

Cross Assemblers CPM-80 ..... \$200.  
 MSDOS; CPM 86 ..... \$250.

PGX Utilities ..... Call for pricing  
 PALX ..... Call for pricing

Erasers ..... DE4 \$80; PE14T \$129  
 C25 \$349; C50 \$599

U/V Eraser DE-4 ..... \$ 80.

RS-232 Cables ..... \$ 30.

8751 Adapter ..... \$174.

8755 Adapter ..... \$135.

48 Family Adapter ..... \$ 98.

"All you CPM people who wanted to move to IBM, but couldn't... now you can — and bring your CPM software with you!"

From GTEK, the leader in development hardware and software, comes the CPM user's dream.

The majority of advances being made in the computer industry today are being made for PC-DOS and MS-DOS machines.

If you are a CPM user who wanted to convert to these operating systems but didn't because you had to abandon or rewrite your CPM programs, now you can make your move without losing or rewriting a single program!

The dream from GTEK is a package that makes your PC-DOS (IBM PC, XT, AT) or MS-DOS (IBM clones like COMPAQ, Leading Edge, Televideo) machines think they're being run by an 8080 or Z80 microprocessor with CPM!

The GTEK package contains a CPEmulator™ and CPM Conversion Utility that allows you to read and write popular CPM disk formats such as Kaypro and Osborne.

If you've been using CPM on any of these machines you can now move to PC-DOS or MS-DOS operating systems.

Kaypro • Osborne • Heath/Zenith • Radio Shack • Epson • DEC • IBM • Morrow • Xerox • HP • Sanyo • Intertec • Cromenco • Televideo • Compupro.

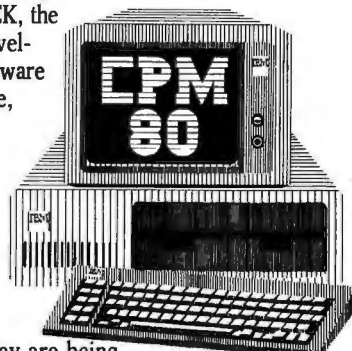
How easy is it to use? Two steps. (1) Use the Conversion Utility to copy the CPM program to an MS-DOS or PC-DOS diskette. (2) Use the Bind Utility to attach the CPEmulator to your program. And that's it. It's ready to run.

You won't see any difference when you run the CPM program! Now all the work you did in CPM is still valuable when you change to your PC-DOS or MS-DOS machine.

And here's the happy ending to the dream. The CPEmulator is just \$199.

Call GTEK's CPM Hotline...

1-601-467-9019



Development Hardware/Software  
 P.O. Box 289, Waveland, MS 39576  
 601/467-8048; telex 315-814 (GTEK UD), INC.

GTEK, PALASM, CPM, MS-DOS, PC-DOS, ISIS, TRSDOS, & CPEmulator are registered trademarks.

**DEALERS WELCOME!!** (103/212A) **ALPHA CONCORD**

**300/1200** bps  
**99% Hayes compatible**

- \* Auto dial, auto answer (tone or pulse)
- \* 8 status indicators & switch selectable
- \* Auto speed selection (0-300, 1200 bps)
- \* Speaker with volume control
- \* Aluminum case, w/adaptor

6 MONTH WARRANTY. ONLY **\$179**

**SEMI-ASSEMBLED MODEM** \*\*\* **\$140**

Modem board completely assembled, tested & guaranteed. 5 minutes assembly.



Add 5% Shipping Charge **MODEM KIT \$120**

**10 DAY MONEY BACK GUARANTEE** (No refund on shipping charge)

---

**AT COMPATIBLE** **MOTHERBOARD**

Replacement & 99% compatible

**XT or APPLE IIe**

**\$175** ea. (tested, guaranteed)

Case ..... \$110  
 Keyboard ..... \$110  
 Printer/RS232 ..... \$120  
 2M expansion card \$call

**AT BAREBOARD \$CALL**

**AT MOTHERBOARD \$900**

**XT KEYBOARD \$70.**

**CONCORD Technology Inc.**  
 Ph. (604) 879-3555 Telex: 04-508393 CONCORD  
 47 W. Broadway, Van., B.C. Canada V5Y 1P1

**BEST PRICES on IBM/APPLE CARDS.**  
 Write for Price List.

**ACCORDING TO WEBSTER**

the resolution, the more memory needed (for the Mac, 22K bytes located at the top of user RAM). Add to that the fact that everything done on the Mac is graphics-based, and Apple should never have released the Mac as a 128K-byte machine incapable of user expansion. Word has it that Jobs was behind both decisions (no slots and small memory size); his departure has apparently made it easier for Apple to pursue developments like the Carla machine. Jobs was also against color graphics for the Mac, and that may be coming as well.

Now, two new systems with advanced built-in color graphics have hit the market. The Atari 520ST uses 32K bytes of user RAM for a display with three different resolutions: 640 by 400 pixels with 2 colors, 640 by 200 pixels with 4 colors, and 320 by 200 pixels with 16 colors. Mapping is fairly simple: Each horizontal group of 16 pixels maps to one, two, or four consecutive 16-bit words, depending upon the resolution currently being used. The result is a 1-, 2-, or 4-bit value used to index a color table holding 2, 4, or 16 values. Each color-table entry is 3 nybbles (12 bits) long, 1 nybble each for red, green, and blue. Only 3 of the 4 bits in each nybble are used, yielding 8 possible values for each color and 512 possible colors. The video RAM can be relocated to anywhere in memory on a 256-byte boundary.

The graphics on the 520ST are impressive, but there are a few problems. Like the Mac, the 520ST has no real hardware support for graphics processing, which means the 68000 must do all the work. And, as with the Mac, the ST's memory cannot be easily expanded, if it can be expanded at all. Also, the video output on the ST can be accepted safely only by an Atari monitor; the ST senses which type of monitor is connected and adjusts the output signal accordingly. Non-Atari monitors run the risk of burnout. (Of course, a standard Mac can't even accept an external monitor.)

This brings us to Commodore's Amiga, which represents the state of the art in microcomputer graphics. Like the ST, the highest resolution is 640 by 400 pixels—but you can use 16 colors instead of just 2 and select from a palette of 4096 colors instead of just 512. Low resolution is 320 by 200 pixels with 32 colors, and there are a few resolutions in between. You can redefine the color table and the horizontal resolution as the beam scans down the screen, giving you the ability to display hundreds of colors simultaneously. Video RAM must be located within the bottom 512K bytes of the memory map. Within there, it is freely relocatable and switchable; scrolling is done by incrementing registers rather than having to actually move data within the RAM. A true bit-plane approach is used, like many graphics systems for minis and mainframes. (See the product preview of the Amiga in the August BYTE [page 83] for more details on how bit planes and playfields work.)

As significant as these features are, the real power of the Amiga lies in the custom graphics hardware that

(continued)

**DISKS & MORE**

**CALL FREE 1-800-328-3472**

All Prices Per Box of 10 — Min. Order 2 Boxes

5 1/4"		3 1/2"		8"	
<b>Diamond™</b>					
SS/DD/RH	\$9.19	SS/	\$20.99	All Diamond Disks Come In A Free Plastic Storage Case	
DS/DD/RH	9.99	DS/	32.99		
High Den	29.99				
<b>Brown®</b>					
SS/DD/RH	11.99	SS/	22.89	Head Cleaning Kits—Clean From 10-260 Times 8.95 to 29.95	
DS/DD/RH	14.99	DS/	34.99		
High Den	31.59				
5 1/4"		3 1/2"		8"	
<b>Maxell®</b>					
SS/DD		SS/	22.89	SS/DD	24.89
SS/DD/RH	12.39	96TPI	21.89	DS/DD	26.89
DS/DD/RH	16.59	DS/	33.89	DS/DD	26.89
High Den	31.69	96TPI	25.89		
<b>3M®</b>					
SS/DD		SS/	22.89	SS/SD	19.89
SS/DD/RH	13.59	96TPI	20.59	SS/DD	23.89
DS/DD/RH	16.69	DS/	35.99	DS/DD	27.89
High Den	31.79	96TPI	25.09		
<b>Ring King Storage Units</b>			<b>3M Data Cartridges</b>		
5 1/4"		3 1/2"		DC-1000 12.61	
15 - 2.00 + .20 ship		20 - 2.50 + .20 ship		DC-300 A	17.85
35 - 5.99 + 2.00 ship		50 - 15.00 + 2.00 ship		DC-300 XLP	19.37
50 - 8.95 + 2.00 ship		8"		DC-600 A	20.60
70 - 15.22 + 2.00 ship		70 - 23.97 + 3.00 ship		Ship 5.00 per 10	

**NORTH HILLS CORP INT'L**  
 3564 Rolling View Dr. White Bear Lake MN 55110  
 1-800-328-3472 MN Call Collect 612-770-0485  
 All Disks Are 100% Certified — Have A Lifetime Warranty.  
 All 8" & 5 1/4" Have Tyvek Envelopes, User Labels, W/P Tabs

TERMS—VISA, MC, Prepaid—MO or Cert. Check, COD Add 3.00  
 SHIPPING— 5 1/4" & 3 1/2" — 3.00 per 100 or Fewer  
 — 8" — 4.00 per 100 or Fewer  
 — Storage Units and Cartridges As Shown

"All Orders Are Shipped In 24 Hrs." "Never Undersold"  
 Prices Subject To Change — Call For Quantity Prices — Min Order 2 Boxes





**Saving over \$800,000 a year in mailing costs made Robert Turley an instant legend at AT&T's American Transtech.** Mr. Turley modestly gives much of the credit to ZIP + 4 codes, the Postal Service's computerized sorting system for First-Class Mail.

"Every month we mail millions of time-sensitive documents on behalf of major corporations. Critical items like dividend checks and stock certificates. By using ZIP + 4 codes, we can mail these documents with the most reliable First-Class Mail service there is.

"The changeover process was surprisingly easy and economical. Our start-up costs were nominal compared to the savings.

"And best of all, most of these savings can be passed on to our customers!"

To find out how ZIP + 4 codes can address the specific needs of your business send in the coupon.

For immediate assistance, or the number of your postal customer service representative, call 1 800 842-9000, ext. 265.

Call or write today. It could be your best chance to become a legend.



**HELPING YOU  
HELP YOUR BUSINESS.**

**With ZIP+4<sup>®</sup> codes  
you can become  
a corporate legend  
like Robert Turley.**

Please check your line of business:

- Insurance,  Banking,  Manufacturing,  
 Securities,  Utilities,  Education,  
 Retail,  Government,  Publishing,  
 Service Company,  Other.

And check your yearly First-Class Mail volume:  Up to 10,000,  10,001-50,000,  
 50,001-100,000,  100,001-1,000,000,  
 1,000,000+

U.S. Postal Service, Regular Mail Services  
P.O. Box 2999  
Washington, D.C. 20013-2999 7K42

Name \_\_\_\_\_

Title \_\_\_\_\_ Company \_\_\_\_\_

Address \_\_\_\_\_

City \_\_\_\_\_

State \_\_\_\_\_ ZIP \_\_\_\_\_



# YOU FORCED US TO MOVE!

...and We Love You For It!



Because of the tremendous response you've given to our FREE OVERNIGHT DELIVERY and \*10 OFF policies, our growth has been phenomenal! Even we did not project how rapidly we would expand. Quite honestly there were times when it seemed like the whole country was trying to place an order...at the same time!

We realize that some of you have had problems getting through (our phones simply could not handle the volume) and, yes, some have even gotten their shipments late (our shipping department has been on a 12 hour schedule)...to those of you, WE APOLOGIZE for the inconvenience and would like to say THANK YOU for your patience.

A one million dollar investment has allowed us to solve these problems...we've just moved into our new World Headquarters, beefed up our sales department, added a spanking new phone system and built a fully automated warehouse.

Oh, sorry, we almost forgot "Harold" (who's extremely fast, but very sensitive) our new 100 terminal computer system. He's designed to speed up order processing to get your shipments out the door...fast. Sorry Harold.

## INTERNATIONAL ORDERS

### EUROPE Announcing Logicsoft Europe!

Our European friends may now order directly through our Amsterdam Distribution Center, which carries the latest factory fresh versions of the most sought after IBM PC software and hardware. Now you can receive your order fast and still take advantage of the incredible savings that only mail order can offer. Please call or telex to confirm pricing & policies. Telex: 10759 Logic NL

Call 020-834864 or mail orders to:  
LOGICSOFT EUROPE BV  
pb 9480, 1006 AL  
AMSTERDAM, HOLLAND

### CANADA

For our Canadian customers we've installed a special local number, 416-283-2354. Now you can get the biggest savings in mail-order for the cost of a local call. Or, if you wish, Telex 286905 Soft UR.

### FAR EAST AND AUSTRALIA

Call 516-249-8440 and ask for our International Department. They're experts on export and you get to take advantage of our great mail order prices. Telex 286905 Soft UR. Please call or telex to confirm pricing & policies.

WE WILL BEAT  
ANY PRICE BY

**\$10**

See Our Card for Details

**FREE**

Overnight Delivery

See Our Card for Details

**EVERYTHING YOU ALWAYS  
WANTED TO KNOW ABOUT  
BEATING A PRICE BUT WERE  
AFRAID TO ASK...**

**or How I Learned To Save Money  
Without Really Trying.**

We know there are still a few of you who have shied away from ordering from us (you know who you are) perhaps thinking our \$10.00 off and FREE overnight policies were a "gimmick" or a "come-on" to pressure you into something.

We'd like to tell you how simple it really is. Just pick up the phone and dial 1-800-645-3491, then tell your sales agent you'd like to beat a price (don't be embarrassed; he's not), the name and date of the publication and who you want us to beat. No gimmick, no come-on, it's that easy.

## CONFUSED OVER ACCOUNTING SYSTEMS?



We don't blame you, that's why we invite you to give us a call. We've evaluated over 50 of them and just because you can save a lot of money buying mail order shouldn't mean you have to sacrifice service...We want to take the time to assist you before you buy. We realize that an accounting system can add up to a sizeable investment and helping you end up with the right package for your money is what doing business is all about.

## ACCOUNTING SYSTEMS

	Information Unlimited (IUS)	Open Systems	Great Plains	Peachtree Series 8	State of The Art	Realworld (MBSI)	BPI
Accounts Payable	*299	*409	*499	*389	*479	*575	*395
Accounts Receivable	*299	*409	*499	*389	*479	*575	*395
Fixed Assets	---	*409	---	*389	---	---	---
General Ledger	*299	*409	*499	*389	*479	*575	*395
Inventory	*299	*409	*499	*389	*479	*575	*539
Job Costing	---	*409	*499	*389	---	---	*539
Material Management	---	*409	---	---	---	---	---
Order Entry/Processing	*299	*409	---	*389	*479	*575	---
Payroll	*365	*409	*499	*389	*479	*575	*395
Report Writer	---	*409	---	---	---	---	---
Sales Invoicing	---	---	---	*389	*479	---	---
Purchase Order Entry	---	409	---	---	---	---	---
TCS Client Ledger System	*1195						

JUST A PARTIAL LISTING OF ACCOUNTING SYSTEMS - CALL TODAY!

# LOGICSOFT®

THE LOGICAL CHOICE  
A Member of the Logic Group



110 Bi-County Blvd., Farmingdale, N.Y. 11735

**1-800-645-3491**

In New York State...516-249-8440 • In Canada...416-283-2354  
Customer Service 1-800-431-9037

See following pages for Software, Hardware, Special Order Dept., Programmers Dept., PC Jr. Corner and our Computer Forms Division.

TEAR AND COMPARE! TEAR AND COMPARE! TEAR AND COMPARE! TEAR AND COMPARE! TEAR AND COMPARE!

**LOGICSOFT** INCREDIBLE  
NEW SERVICE BREAKTHROUGH

# FREE OVERNIGHT DELIVERY!

On Orders Totalling  
over \$100... Shipped  
UPS FREE !!  
Under \$100  
(Within Continental  
U.S.)

VIA...  **Purulator  
courier**

**PLUS...IF YOU CAN FIND A LOWER PRICE**  
**We'll Beat \$10**  
**It By....**

THAT'S RIGHT! OUR LOWEST PRICE GUARANTEE IS STILL EFFECTIVE!  
Tell us the advertiser and price of any software or hardware item on these pages currently advertised in any popular computer publication and we'll beat that price by \$10. This offer does not apply to items under \$100 or where the price is not lower than Logicsoft's. NO DEALER'S PLEASE!

**WORD PROCESSING**

Wordstar 2000	\$259
<b>WORDSTAR 2000 PLUS</b>	<b>305</b>
Wordstar Pro Pac	265
Wordstar Pro Plus	345
<b>WORD PERFECT (New Release)</b>	<b>225</b>
Microsoft Word	235
Spellbinder	Lowest Price
<b>MULTIMATE</b>	<b>249</b>
Volkswriter Deluxe	165
Peachtext 5000	199
Easywriter II/Speller/Mailer	195
Edix & Wordix	255
Finalword	225
Samna III	325
Xy Write II Plus	255
Think Tank	125
pfs: WRITE	85
Wordplus PC with Boss	359

**DATA BASE MANAGEMENT**

<b>KNOWLEDGEMAN</b>	<b>\$259</b>
Cornerstone	Lowest Price
Tim IV	189
R:Base 4000	265
<b>R:BASE 5000</b>	<b>365</b>
DB Master	475
d Base II (New Release)	299
Condor III	349

**SOFTWARE for IBM PC**

**DATA BASE MANAGEMENT (cont.)**

<b>d BASE III</b>	<b>\$369</b>
Clipper (d Base III Compiler)	399
Data Base Manager II (alpha)	175
Infostar plus	159
Friday	169
pfs: file & pfs: report	165
<b>REVELATION</b>	<b>745</b>
Powerbase	255
Personal Pearl	229
Easyfiler	235
Superfile	159
Guru	1695

**INTEGRATED/SPREADSHEETS**

<b>LOTUS 1-2-3 (v 2.0)</b>	<b>\$305</b>
Enable (New Version)	399
Smart Series	579
Ability	339
<b>FRAMEWORK</b>	<b>359</b>
Open Access	395
Electric Desk	229
<b>SYMPHONY (Limited Quantity)</b>	<b>429</b>
Supercalc 3	179
Multiplan	129
TK! Solver	279
pfs: plan	85

**FINANCIAL**

<b>DOLLARS AND SENSE</b>	<b>\$115</b>
--------------------------	--------------

**FINANCIAL (cont.)**

Financier II	115
<b>MANAGING YOUR MONEY</b>	<b>\$119</b>
Home Accountant Plus	99
Howard Tax Preparer	195
Professional Tax Planner	319
Fixed Asset System (BEST)	439
Market Manager Plus (Dow Jones)	179
Market Analyzer (Dow Jones)	269

**GRAPHICS**

<b>CHARTMASTER</b>	<b>\$275</b>
Signmaster	195
BPS Graphics	289
Fast Graphs	265
pfs: graph	85
<b>GRAPHWRITER</b>	<b>319</b>
Graphwriter Combo Pak	485
<b>DIAGRAM MASTER</b>	<b>195</b>
Microsoft Chart	175
<b>ENERGRAPHICS</b>	<b>259</b>
Energraphics with plotter option	325
PC Draw	295
Gem Draw (incl. Desk Top)	95

**PROJECT SCHEDULERS**

<b>MICROSOFT PROJECT</b>	<b>\$165</b>
SuperProject (IUS)	245
<b>HARVARD TOTAL PROJECT MGR.</b>	<b>265</b>
Project Scheduler (Scitor)	245
Project Scheduler 5000 (Scitor)	279

**SOFTWARE UTILITIES for IBM PC**

**WORD PROCESSING**

<b>FANCY FONT</b>	<b>\$159</b>
Wordplus (Oasis)	115
pfs: proof	65
Punctuation & Style	99
Spellix	59
Wordperfect Sorter	75

**DATA BASE**

Quickcode III	\$159
d Graph III	175
d Util III	65
k Graph	175
k Paint	85
k Text	109

**DATA BASE (cont.)**

Clout 2	\$145
Extended Report Writer	119
Sideways	45
<b>GENERAL</b>	
<b>PROKEY 4.0</b>	<b>\$89</b>
Norton Utilities (New Release)	65
<b>SIDEKICK (unprotected)</b>	<b>65</b>

**GENERAL**

<b>CROSSTALK XVI (New Release)</b>	<b>\$115</b>
Smartcom II	109
Sideways	45
Copy II PC	39
<b>DESK ORGANIZER</b>	<b>65</b>

Prices & policies subject to change without notice.

Immediate Replacement on any Defective Product.

\* NO SURCHARGE for VISA or MasterCard. \* No Sales Tax on Orders Outside N.Y. State \* Purchase Orders  
\* Welcomed from Qualified Institutions... NO SURCHARGE! (Please call for price verification) \* Phase add 2%  
for handling and insurance (Int'l orders add'l) \* Payment: MasterCard, VISA, American Exp., C.O.D. Money Order or Check



National Sales  
Hot Line

**1-800-645-3491**

Customer Service 1-800-431-9037

New York State...516-249-8440

Canada.....416-283-2354

Domestic/International Telex...286905 Soft UR

**LOGICSOFT**

THE LOGICAL CHOICE  
A Member of The Logic Group

110 Bi-County Blvd., Farmingdale, N.Y. 11735

SEE OTHER SIDE  
FOR MORE SAVINGS!

**WE WILL BEAT ANY PRICE BY \$10**  
See Other Side for Details

**NEW! Expanded Special Order Dept.**  
We know there are many products that simply cannot be found through mail order. We've solved that problem...just ask for our **SPECIAL ORDER** department...We've got the suppliers ...still at low mail order prices!

**FREE Overnight Delivery**  
See Other Side for Details

**PC JUNIOR CORNER**

**PROGRAMMER'S DEPT.**

SOFTWARE	HARDWARE (Cont.)
Lotus 1-2-3 (White they last!) <b>\$309</b>	Keytronic 5151 Keyboard <b>\$179</b>
Wordstar <b>149</b>	Keytronic 5149 Num. Keypad <b>50</b>
Electric Desk <b>189</b>	Jr. 128K Booster (Microsoft) <b>145</b>
<b>HARDWARE</b>	Quadram Expansion Chassis <b>519</b>
Captain 128K (Tecmar) <b>339</b>	Quadram Exp. Memory <b>235</b>
PC Mouse (Mouse Systems) <b>129</b>	Quadmem Jr. <b>219</b>

**NEW PRODUCTS ADDED DAILY...CALL!**

Concurrent PC DOS (w/windows) <b>\$99</b>	Pascal Compiler (MS) <b>\$245</b>
Pascal MT + (PC DOS) <b>349</b>	C Compiler (MS) <b>305</b>
PL/1 - (DR) <b>489</b>	Microsoft Sort <b>159</b>
Display Manager - (DR) <b>359</b>	Cobol Compiler(MS) <b>479</b>
Access Manager - (DR) <b>269</b>	Business Basic (MS) <b>299</b>
<b>LATTICE C COMPILER 305</b>	<b>FORTRAN COMPILER (MS) 229</b>
C-Food Smorgasbord <b>119</b>	C86 C Compiler (Computer Innovations) <b>345</b>

**GENERAL HARDWARE**

PRINTERS*	MONITORS*	COMMUNICATIONS BOARDS (cont.)	MODEMS (cont.)
<b>DIABLO</b>	<b>AMDEK</b>	AST-3780 <b>749</b>	<b>QUADRAM</b>
36** <b>\$1229</b>	Color 300 <b>\$255</b>	DCA	Asher <b>\$395</b>
D25** <b>619</b>	Color 500 <b>389</b>	IRMA Board <b>\$949</b>	Quadmodem 2000 <b>315</b>
630-ECS** <b>1799</b>	Color 600 <b>479</b>	<b>QUADRAM</b>	Quadmodem 2024 <b>499</b>
<b>EPSON</b>	Color 710 <b>579</b>	Quadlink <b>\$449</b>	Quadmodem 2100 <b>375</b>
LQ1500 <b>\$1199</b>	12" Green 300G <b>135</b>	<b>GRAPHICS BOARDS</b>	Quadmodem 2124 <b>565</b>
Parallel Interface <b>79</b>	12" Amber 300A <b>145</b>	AST	<b>RACAL-VADIC</b>
JX-80 <b>599</b>	12" Amber 310A <b>169</b>	Monograph plus <b>\$425</b>	Maxwell 1200 PC (w/SW) <b>\$239</b>
LX-80** <b>265</b>	<b>PRINCETON GRAPHICS</b>	Preview <b>279</b>	Maxwell 1200 V (w/SW) <b>239</b>
LX-80 Tractor/Feeder <b>30</b>	RGB HX-12 <b>\$489</b>	<b>EVEREX</b>	2400 V <b>435</b>
RX-100 <b>399</b>	RGB SR-12 <b>599</b>	Graphics Edge <b>\$309</b>	<b>VEN-TEL</b>
FX-80 Plus** <b>379</b>	Scan Doubler Board (for SR 12) <b>185</b>	The Edge <b>299</b>	PC Modem Half Card <b>\$379</b>
FX-185 (New)** <b>569</b>	Amber Max-12E <b>185</b>	<b>HERCULES</b>	PC Modem 1200 <b>399</b>
<b>JUKI</b>	<b>QUADRAM</b>	Graphics Card <b>\$299</b>	1200 Plus <b>399</b>
6100 <b>\$439</b>	Quadchrome 12" <b>\$465</b>	Color Card <b>169</b>	<b>BACK-UP DEVICES</b>
6300 <b>799</b>	Quadscreen 17" <b>1595</b>	<b>MA SYSTEMS</b>	<b>ALLOY</b>
<b>MANNESMANN TALLY</b>	Quadchrome II 14" <b>465</b>	Peacock Color Board <b>\$245</b>	PC Quick Tape (60Mb) <b>\$1719</b>
Spirit 80 <b>\$279</b>	Amberchrome 12" <b>165</b>	<b>PARADISE SYSTEMS</b>	<b>SYSGEN</b>
160 <b>579</b>	<b>TAXAN</b>	Multi-Display Card <b>\$215</b>	Image (10Mb) <b>\$835</b>
180 <b>849</b>	100G <b>\$125</b>	Modular Graphics Card <b>289</b>	<b>MOUSE INPUT DEVICES</b>
<b>NEC</b>	105A <b>136</b>	Options A & B <b>Lowest Price</b>	<b>MOUSE SYSTEMS</b>
2030** <b>\$719</b>	121 <b>149</b>	<b>QUADRAM</b>	PC Mouse w/paintbrush <b>\$139</b>
2050** <b>695</b>	122 <b>149</b>	Quadcolor I <b>\$195</b>	<b>MICROSOFT</b>
3530 <b>1329</b>	210 <b>259</b>	Quadcolor II <b>465</b>	Microsoft Mouse (Serial) <b>\$149</b>
3550 <b>1395</b>	420 <b>409</b>	<b>SIGMA</b>	Microsoft Mouse (Buss) <b>139</b>
8850** <b>1949</b>	440 <b>699</b>	Color 400 <b>\$549</b>	<b>SURGE PROTECTORS</b>
Pinwriter P2** <b>675</b>	<b>MULTI-FUNCTION BOARDS</b>	<b>STB</b>	<b>KENSINGTON MICROWARE</b>
Pinwriter P3** <b>695</b>	<b>AST RESEARCH</b>	Graphics Plus II <b>\$315</b>	Master Piece <b>\$115</b>
<b>OKIDATA</b>	Six Pak Plus (64k) <b>\$249</b>	<b>TECMAR</b>	<b>CURTIS</b>
182P <b>\$239</b>	Mega Plus II (64k) <b>275</b>	Graphics Master <b>\$459</b>	Diamond <b>\$39</b>
84-IBM <b>799</b>	Mega Pak (256k) <b>369</b>	<b>TSENG LABORATORIES</b>	Emerald <b>49</b>
192-IBM <b>409</b>	Advantage (128k) <b>429</b>	Ultra Pak <b>\$545</b>	Sapphire <b>59</b>
193P <b>559</b>	I/O PlusII <b>135</b>	<b>MODEMS</b>	Ruby <b>69</b>
2410P <b>2295</b>	<b>ORCHID</b>	<b>HAYES</b>	<b>KEYBOARDS</b>
<b>QUME</b>	Blossom (0-k) <b>\$235</b>	Smartmodem 300 <b>\$205</b>	<b>KEYTRONIC</b>
Sprint 11/40** <b>\$1299</b>	<b>QUADRAM</b>	Smartmodem 1200 <b>445</b>	5150 <b>\$159</b>
Sprint 11/55** <b>1595</b>	Quadboard (64k) <b>\$245</b>	Smartmodem 1200B w/smartcom II <b>349</b>	5151 (Deluxe) <b>175</b>
Sprint 11/90** <b>2199</b>	<b>STB</b>	Smartmodem 2400 <b>719</b>	5152B <b>645</b>
<b>SILVER REED</b>	Super Rio (64k) <b>\$329</b>	<b>NOVATIDN</b>	<b>MEMORY CHIPS</b>
400 <b>\$279</b>	Rio Plus II (64k) <b>259</b>	Access 1-2-3 <b>\$475</b>	64k (200ns) <b>\$35</b>
770 <b>795</b>	Rio Grande <b>375</b>	Smart-Cat Plus (Int.) <b>355</b>	256k (150ns) <b>69</b>
<b>TOSHIBA</b>	Grande Byte <b>275</b>	Professional 2400 <b>689</b>	<b>DISKETTES</b>
P351 Tractor <b>\$165</b>	Chauffeur <b>Lowest Price</b>	<b>PRENTICE</b>	<b>LOGICTRAK 5 1/4"-100% GUARANTEED</b>
P351 <b>1375</b>	<b>TECMAR</b>	Popcom X100 <b>\$379</b>	Double side, double density, 10 per box
1340 <b>539</b>	Captain <b>\$199</b>	Popcom C100 <b>355</b>	20 + boxes <b>per disk \$2.35</b>
<b>CITIZEN</b>	<b>COMMUNICATIONS BOARDS</b>	<b>PROMETHEUS</b>	10-19 boxes <b>per disk \$2.50</b>
MSP10 <b>\$315</b>	AST	Pro-modem 1200 <b>\$375</b>	2-9 boxes <b>per disk \$2.99</b>
MSP15 <b>455</b>	AST-5251-11 <b>\$699</b>	Pro-Modem 1200B <b>319</b>	1 box <b>per disk \$3.99</b>
MSP20 <b>455</b>	AST-SNA <b>699</b>		
MSP25 <b>595</b>	AST-BSC <b>699</b>		

\*Due to weight restrictions, Printers and Monitors are shipped UPS...FREE  
\*\*Parallel interface req...Ask sales agent



National Sales Hot Line

**1-800-645-3491**

Customer Service 1-800-431-9037

New York State..516-249-8440 Canada.....416-283-2354 Domestic/International Telex...286905 Soft UR

**LOGIC SOFT**

THE LOGICAL CHOICE  
A Member of The Logic Group

110 Bi-County Blvd., Farmingdale, N.Y. 11735

TEAR AND COMPARE! TEAR AND COMPARE! TEAR AND COMPARE!

removes much of the burden from the 68000 processor. This includes the Blitter (bit-mapped block-transfer device) and hardware support for sprites and other animation effects. The Amiga also offers a variety of video output signals: NTSC (National Television System Committee) for RF (radio frequency) modulators, composite, and RGB (red-green-blue), both analog and digital. The software for graphics is not as extensive nor as well done as that on the Mac. From what I can tell by the manuals, however, it isn't as restrictive, either. And the memory map is marvelous; the Amiga allows an additional 8 megabytes of RAM to be added via the expansion bus, offering a solution for memory-intensive processes.

**A PARADOX**

Amazing graphics do not a successful computer make, at least not necessarily. The Atari 520ST and the Amiga are both perceived as being glorified game machines because of their powerful color graphics; the comment often heard is, "Who wants business software that runs in color?" Yet color graphics have been pushed for the Mac as a way of penetrating further into the business market. These notions are contradictory but represent the problems that both types of systems face in being accepted outside of the home.

So, back to the original issue: Should Apple come out with a color Mac? I don't think so, since it raises more problems than it solves. Existing software won't be able to take advantage of it; the "color routines" in QuickDraw are very simple and aren't worth a whole lot; it would introduce a whole set of software/hardware-compatibility problems (which Apple will probably have enough of, anyway); without special hardware support, it will just lead to further degradation of performance (though that may be part of the reason for the dual 68000 processors supposedly used in Carla); all the current machines will be left out of the upgrade; and it will make the system more expensive. In short, Apple has a lot to lose and not that much to gain.

**NEW PRODUCTS**

A completely unexpected product—SideKick for the Macintosh—showed up in the mail from Borland International yesterday. It has a wide list of features, like a calendar, notepad, business calculator, simple telecom program, appointment/alarm list, auto-dialer, and so on. Many of these are installed as desk accessories, which is how you access them from within your application. I've run into a few problems (such as the Install program not "seeing" any of the accessories to be installed), and I can't really recommend it until I've had a chance to check it out some more. Look for a follow-up here next month.

Most books about the Macintosh have been useless fluff, at least as far as serious programming goes. The only exception has been the infamous, expensive, and obscure *Inside Macintosh* from Apple. Kathe Spracklen, coauthor of

(continued)

# NEW "EAST COAST" OFFICE

When we opened our second location in Nevada last year we were swamped with calls from our east coast customers asking for a closer location. The word was: "We need faster delivery, too." Well, now it's there. Located as close as possible to all.

**Delaware 1-800-451-1849**

P.O. Box 10247 Wilmington, DE. 19850

We would like to thank each of you sincerely for your patronage. We appreciate your Business

the  
**Diskette  
Connection™**

# DISKETTES

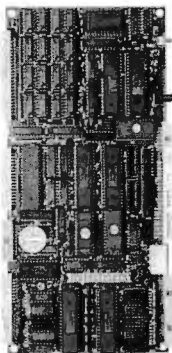
3 Locations for Quick Delivery

<b>Dysan</b> 5 1/4" Disks S-SIDE 1495 D-DEN. 1995 S-SIDE 2595 D-SIDE 3195 HIGH DEN. 4195 3 1/2" Disk S-SIDE 2695 8" Disks S-SIDE 2095 D-SIDE 2295 D-SIDE 2795	<b>maxell</b> 5 1/4" Disks S-SIDE 1245 D-DEN. 1695 S-SIDE 2195 D-SIDE 2595 HIGH DEN. 3695 3 1/2" Disks S-SIDE 2395 D-SIDE 3395 8" Disks S-SIDE 2495 D-SIDE 2695	<b>BONUS</b> Disks-10 pk \$9.95 per box ATHANA MIN 7.95 per box 5" S-SIDE 8.95 per box 5" D-SIDE BULK PACK 50 DISK \$40.00 S-SIDE \$45.00 D-SIDE Media Mate \$8.95 ea +2.00 Shipping	<b>3M</b> 5 1/4" Disks S-SIDE 1425 D-DEN. 1745 S-SIDE 2065 D-SIDE 2575 3 1/2" Disks S-SIDE 2495 8" Disks S-SIDE 1995 D-DEN 2395 D-DEN 2795	<b>Verbatim Datalife</b> 5 1/4" Datalife S-SIDE 1395 D-DEN. 1745 S-SIDE 2165 D-SIDE 2675 3 1/2" Datalife S-SIDE 2395 8" Datalife S-SIDE 1995 D-DEN. 2195 D-DEN. 2495
---	---	--	---	---

Old Reliable  
**Diskette Connection™**  
\* Delaware 1-800-451-1849  
P.O. Box 10247 Wilmington, DE. 19850  
\* Oklahoma 1-800-654-4058  
P.O. Box 1874 Bethany, OK. 73008  
\* Nevada 1-800-621-6221  
P.O. Box 1213 Boulder City, NV. 89005

**TERMS:** Minimum 20 disks or \$35.00 — VISA or MasterCard accepted  
C.O.D. orders add 2.00 for special handling. SHIPPING: 3 1/2" & 5 1/4" Diskettes; Add 3.00 for every 100 Diskettes or any fraction thereof. 8" Diskettes; Add 4.00 for every 100 Diskettes or any fraction thereof. We ship UPS; orders requiring other delivery methods add shipping, plus 2% of total order.

# New OEM SBC



Base model  
Only \$ **250.** 5" x 11"

OEM Discounts Available

## Includes:

- 6 MHz Z80<sup>®</sup> Processor
- 64K DRAM
- Provision for 128K of EPROM or E<sup>2</sup>PROM
- 3 Parallel Ports
- Boot PROM to boot off EPROM, floppy disk or hard disk
- Full Z80 Interrupt Support

## Optional features to choose from:

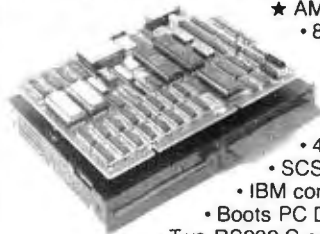
- Floppy Disk Controller 8", 5.25" and 3.5"
- ST-506 Winchester Hard Disk Controller
- 128K or 256K DRAM
- Monochrome or Color CRT Video Controller (Alpha-numerics and Graphics)
- Up to 4 additional Serial Ports
- Up to 2 additional parallel ports with counter-timers
- Buffered Peripheral Expansion Interface
- 50 or 60 Hz operation
- Time-of Day Clock with Battery Back-up

The Megatel Quark<sup>®</sup>400 is a single board computer which allows OEM designers the flexibility of choosing only the features required. Development and system software include fully configured CPM<sup>®</sup> 2.2 operating systems — BASIC and C. All Megatel software includes utilities, drivers and source code. To order or enquire, call us today. Megatel Computer Technologies 150 Turbine Drive, Weston, Ontario M9L 2S2 (416) 745-7214 U.S. Address 1051 Clinton St., Buffalo, N.Y. 14206

Quark is a registered trademark of F. & K. MFG. CO. LTD. Z80 is a registered trademark of Zilog Inc. CPM is a registered trademark of Digital Research Inc.

**megatel**

## IBM PC AT performance! PCjr price!



### ★ AMPRO Little Board/186 \$419

- 8 Mhz 16 Bit 80186 CPU
- 128 512K RAM; 1 MB w add-on board
- 128K EPROM — 2 Byte Wide sockets
- 4 Drive floppy disk controller
- SCSI (SASI) hard disk interface
- IBM compatible ROM-BIOS
- Boots PC DOS 2.x, 3.x
- Two RS232 C serial ports

- Parallel printer port
- Expansion board w/512K RAM, 8087-2, Clock, 2 serial ports, RS422 port

### ★ AMPRO Little Board Plus \$289

- Same as Little Board 186 except 4 Mhz Z80A (8 Bit) CPU, 64K RAM, 4 — 16K EPROM; w/ CP/M 2.2, ZCPR3

### ★ AMPRO Little Board (the original) \$239

- Same as Little Board Plus except no SCSI, 4K EPROM; w/ CP/M 2.2, ZCPR3

- ☆ 25 different enclosures w/power supplies, cables, etc. from \$99
- ☆ Floppy/Winchester drives from \$89
- ☆ XEBEC 4000 OWL 1/2 Ht 10Mb drive w/ integral controller \$595
- ☆ Terminals: Wyse, Qume, Kimtron from \$395
- ☆ Power supplies, cables, connectors in stock

Complete technical support. Assembled systems available. Write or call for free catalog. Most orders shipped same day.

VISA, MasterCard, Money Order, C.O.D. Checks allow two weeks. Purchase orders and bids welcome. Prices F.O.B. Prairie View, IL.

IBM PC AT, PCjr, PC DOS are trademarks of International Business Machines Corporation. XEBEC OWL is a trademark of XEBEC, Inc.

**DISKS PLUS** INC. 15945 West Pope Blvd.  
Prairie View, IL 60069  
(312) 537-7888

## ACCORDING TO WEBSTER

Macintosh Revealed is more  
than 500 pages long, well  
illustrated, and well laid-out, but  
it just doesn't cover  
everything I want it to.

Sargon II, once said that the book "consists of 25 chapters, each one of which requires that you understand the other 24 before reading it," which should give you some idea of what a pain it is to use. But for anyone wanting to do much with the Mac, it was the only real source of information (other than INFO-MAC, MacTutor, and your local Mac users group).

However, some decent books are finally coming out. Most notable is *Macintosh Revealed* by Stephen Chernicoff (Hayden Book Company). Volume 1 (*Unlocking the Toolbox*) has been out for some time. Volume 2 (*Programming with the Toolbox*) has just come out. Each volume costs \$24.95. Chernicoff appears to know what he's talking about, and he does a good job of bringing a newcomer (albeit a dedicated one) up to speed on the Mac.

My two complaints about the book are that it is too short and it costs too much. But that is neither Chernicoff's nor, I think, Hayden's fault; the book is more than 500 pages long, well illustrated, and well laid-out, but it just doesn't cover everything I would like it to. Nor could it possibly. Considering how enormous *Inside Macintosh* is, and yet how tersely it deals with all the aspects of the Mac, I would imagine that a complete treatment of the Macintosh would run a few thousand pages in four volumes. My only real complaint is that *Macintosh Revealed* was not around a year ago.

### IN THE QUEUE

As I said at the start, I have piles of untested (and unopened) software that I need to get to. With luck, I can get settled quickly and get down to some serious work. I'm still coming up to speed on C and have many different C compilers to look at (including Microsoft's new C compiler and a few of the cheap C implementations for MS-DOS). Two new programming languages for the Apple II have shown up: Kyan Pascal and PROMAL. I want to give the ITC Modula-2 Software Development System a real workout, also.

In the meantime, take care, and I'll see you on the bit stream. ■

*I'd like to acknowledge the help of Ryan Gale of Monitor Labs and Andy Jaros and Doug Bell of Oasis Systems in gleaning some of the graphics information about the IBM PC and the Atari 520ST. Thanks, guys.*

# IBM XT COMPATIBLE \$ 1195

## Super XT System Configuration

- 640K RAM Memory
- Two Double-Sided/ Double Density Floppy Drives
- High Resolution TTL Monochrome Monitor & Adaptor (optional Hercules emulation or color graphics)
- Parallel, Serial and Game Ports
- Clock/Calendar (battery-backed)
- Ram Disk and Spooler software
- 135 Watt Power Supply and 8 Expansion Slots
- DOS



Above System With 10 MB Hard Disk...**\$1,695.00**  
 Above System With 20MB Hard Disk...**\$1,895.00**

IBM is a registered trademark of International Business Machines Corp. and PC SOLUTION is a trademark of HI-TEC enterprises, Inc.

### MONITORS



#### MONOCHROME

PC Solution (Xtron) .....	\$125
Taxan 121 (Green) .....	\$155
PGS Max-12 E. ....	\$165

#### COLOR

Quadchrome II .....	\$349
Panasonic CT1300 .....	\$225
Sanyo TV/RGB w/REMOTE .....	\$349
PGS HX-12 .....	\$449
Taxan 640 .....	\$525

### HARD DISK

10MB (int.) w/controller .....	\$395
20MB (int.) w/controller .....	\$495
Teamate 10 MB Removable .....	\$1350
Teamate 20 MB Plus 10 MB removable .....	\$1895

### MONITOR ADAPTORS

Mono or Color without printer port .....	\$99
Mono or Color w/printer port .....	\$149
STB Chaffer (Graphics) .....	\$295
Hercules Color Card .....	\$155
Everex The EDGE .....	\$299
Sigma Color 400 .....	\$479
Mono Graphics Card (Emulates Hercules mono graphics) .....	\$159

### MODEMS

Everex Evercom 1200 Baud(Int) .....	\$195
Hayes 1200 B .....	\$315
Hayes 1200 (Ext) .....	\$375

### ETC...

AST Six pack Plus (w/384K) .....	\$299
AST Advantage for AT .....	Call
Quadram Quad Board 384K .....	\$299
Generic 6 Pack .....	\$175
Multi I/O Card .....	\$165
Floppy Controller .....	\$69
DTC Hard Disk controller .....	\$185
Teac 55BV floppy drive .....	\$99
135 Watt power supply .....	\$99
XT Mother Board .....	\$250
Chassis .....	\$99
5150 Style Keyboard .....	\$99
5151 Style Keyboard .....	\$155
AT Style for XT .....	\$135

All merchandise new  
 We accept MC, Visa, and Choice (add 3%  
 for MC, Visa and Choice)  
 Certified or cashiers check, personal check  
 subject to 14 days clearance time.  
 Minimum \$5.00 shipping charge for first 4 lbs.,  
 \$1.00 additional per lbs. over 4.  
 Maryland & D.C. Residents include 5% Sales  
 Tax.  
 All returns require RMA No. and subject to 15%  
 restocking charge.  
 Advertised prices for mail order only. Retail  
 prices slightly higher.  
 Prices subject to change, and limited to stock on  
 hand. We reserve the right to limit quantities.

### PRINTERS



Panasonic 1091 .....	\$249
Panasonic 1092 .....	\$359
Canon 1080A .....	\$275
Citizen msp10 .....	\$259
Toshiba 1340 .....	\$495
Toshiba P351 .....	\$1095
Silver Reed 770 .....	\$725

Hi-  
 Tec

# COMPUTERS & ELECTRONICS

4263 Howard Avenue • Kensington, Maryland 20895

(301) 564-9500

Conducted by Steve Ciarcia

## TERMINAL-MANAGEMENT PROCESSOR

Dear Steve,

In your January 1984 Circuit Cellar, you explored the NS455A terminal-management processor. I am constructing an NS455A-based school project. Where can I get an NS455A assembler?

Also, could you suggest a design for a single-step switch that would allow me to execute one instruction at a time?

RON SCOTT  
Atlanta, GA

*Jon Elson has written an assembler for the NS455A in Turbo Pascal that should work on any Pascal system. He can be contacted at 819 Marshall Ave., Webster Groves, MO 63119, (314) 962-6103.*

*If National Semiconductor's documentation is correct, there is no way to use a single-step switch on the NS455A. The documentation indicates that the clock must not go below 3 MHz. The correct way to do debugging is to write a debugger/monitor program. You can get control back from a breakpoint with either a hardware interrupt or by placing an MOVBP3 instruction over the breakpoint. Unfortunately, I know of no easy way to debug programs on the 8048 class of computers without extensive hardware support or a development system. The only alternative is trial and error, combined with careful bench-checking of your code. You should also look at the May 2, 1985, issue of EDN for an article on an 8048-family emulator that you can build. (The NS455A is a derivative of the 8048, and this circuit might be adapted for the NS455A.)—Steve*

## SPEECH SYNTHESIS

Dear Steve,

Concerning your article in June 1983, "Use ADPCM for Highly Intelligible Speech Synthesis," I have built the speech-synthesis circuit, and it is operating well with my computer. My hobby is amateur radio, and I am able to use speech synthesis for a radio transceiver with pre-recorded bulletins and news.

Can you help me locate the design of a 64K-byte DRAM system to connect to the Oki speech-synthesis circuit? The

memory should provide about 15 seconds of recorded speech.

JOHN P. SZYKOLUK  
Ste. Anne, Manitoba, Canada

*There are many applications for speech synthesis, and your application is an interesting use of the ADPCM chips.*

*DRAM chips are a good choice for applications where density and power are a concern. One of the disadvantages of using these chips is that they must be refreshed, which necessitates extra circuitry. In your search for a memory system that connects directly to the Oki speech-synthesis circuit, you will probably find that building such a unit is not extremely difficult. In essence, a small computer system is necessary to control the memory.*

*In order to access the memory chips, you need to provide an address where the data will be written to and read from. Also, there must be logic that senses when there is data to be transferred. All this must be accomplished with some sort of sequential logic. In the article, the speech-synthesis circuit was interfaced to a Z80 microprocessor. Many CMOS microcontrollers are available that contain many useful functions. If you don't need all the bells and whistles of these microcontroller chips, you could use a CMOS microprocessor like National Semiconductor's NSC800. This uses the same instruction set as the Z80 and is useful in low-power situations.*

*To achieve 15 seconds of speech, you will need 60K bytes of data memory. This leaves about 4K bytes of directly addressable memory space for your use. That should be plenty of speech memory for this application.*

*The following books may be helpful in designing a microprocessor system: The Z-80 Microcomputer Handbook by William Barden Jr. (Howard W. Sams, 1978) and Build Your Own Z-80 Computer by me (BYTE Books, 1980).—Steve*

## SPEECH-ASSISTED WORKSTATION

Dear Steve,

I am interested in developing a speech-assisted workstation for the blind. Your article describing the SSI263 integrated cir-

cuit looks very useful ("Build a Third-Generation Phonetic Speech Synthesizer," March 1984). The rule-based software allows a level of personality to be integrated into the package (such as pronouncing the user's name correctly).

I would be implementing the system on an MS-DOS machine, the Tandy 1200. I am quite new at microcomputers, and I would appreciate your assistance in running the system in a non-Apple environment. Since Apple and Tandy use different machine languages, a list of the phoneme rules might be sufficient for software conversion. Any ideas on how the board fits into the actual slot would be helpful.

MICHAEL SALSBURG  
West Chester, PA

*There are many useful applications for the SSI263 speech synthesizer. Your application is another example of its usefulness to help disabled individuals.*

*While the Sweet Talker II was designed for the Apple II, the same principles are applicable to any computer. As mentioned in the article, the Apple's address-decoding capability simplifies the task of selecting the board. However, this does not present a major problem for other computers. It simply means that another method of address decoding must be supplied on the actual printed-circuit board.*

*As far as the software is concerned, the same basic commands outlined in the article can be used. While the machine language for your computer is different than that for the Apple II, you should be able to adopt the same ideas. Good luck.*

—Steve ■

*Over the years I have presented many different projects in BYTE. I know many of you have built them and are making use of them in many ways.*

*I am interested in hearing from any of you telling me what you've done with these projects or how you may have been influenced by the basic ideas. Write me at Circuit Cellar Feedback, POB 582, Glastonbury, CT 06033, and fill me in on your applications. All letters and photographs become the property of Steve Ciarcia and cannot be returned.*



# Rome, Italy. Rome, New York.

Who makes more on-time express deliveries to more places around the world than anybody?



DHL Worldwide Express.

From documents to packages. From desk to desk to over 45,000 places in over 150 countries. DHL makes more overseas deliveries from the U.S. than Federal, Emery and Airborne combined. No wonder DHL is now the fastest growing express service in the U.S. In the world of international business, there's only one air express company that's #1. DHL.

**Nobody delivers the whole wide world like DHL.**

# IBM, APPLE, COMPAQ, HP,

CDC 1/2 HT.  
FLOPPY DRIVES **\$69**

IBM PCjr  
WITH COLOR  
MONITOR **\$599**

**FREE EXPRESS-SHIPPING ON ALL ORDERS OVER \$100.00.**

## HARDWARE AST

SIX PACK PLUS \$ 227.00  
AT ADVANTAGE CARD \$ 359.00  
5251 EMULATION CARD \$ 543.50

## QUADRAM

MICROFAZER PAR \$ 204.00  
QUADBOARD 64K \$ 225.00  
QUADMEG-AT \$ 305.00

## KEYTRONIC

5151 KEYBOARD \$ 149.00  
AT PROM KIT \$ 14.95

## COMPUTER ACC.

POWER DIRECTOR \$ 79.00

## MOUSE SYS

MOUSE SYS W/ PAINT \$ 138.00

## PRINTERS

### EPSON

FX-185 \$ 475.00  
FX-85 \$ 269.00  
LQ-1500 \$ 899.00

### STAR MICRONICS

NLQ30 \$ 193.00  
NLQ40 \$ 269.00  
NLQ50 \$ 369.00

### BROTHER

HR-25 \$ 519.00  
HR-35 \$ 892.00  
TWINWRITER \$ 913.00

### HEWLETT PACKARD

LASERJET \$2175.00  
6 PEN PLOTTER \$1375.00  
THINKJET \$ 369.00

**CALL FOR PRICES ON C.I.TOH  
DIABLO, NEC, APPLE, IBM**

## GRAPHICS BDS HERCULES

GRAPHIC CARDS \$ 289.00  
COLOR CARD \$ 145.00

### PARADISE

GRAPHICS CARD \$ 272.00  
MULTIDISPLAY CD \$ 197.00

### PERSYST

COLOR CD/RGB COMP \$ 199.00  
BOB SUPER HI-RES \$ 389.00

### TECMAR

GRAPHICS MSTR BD \$ 445.00

## MONITORS

### PRINCETON GRAPHICS

HX-12 HI RES \$ 543.00  
SR-12 W/DOUBLER \$ 714.00

### ZENITH

AMBER \$ 99.00  
GREEN \$ 99.00

### AMDEK

COLOR 300 \$ 269.00  
COLOR 500 RGB \$ 359.00  
COLOR 710 HI-RES \$ 579.00

### IBM

PROF. GRAPHICS MON \$ 969.00  
ENHANCED GRAPHICS MON \$ 599.00

### DISKS

MAXELL HI-DEN \$ 42.95  
MAXELL DS-DD \$ 19.95  
VERBATIM \$ 21.95

## DISK DRIVES TALLGRASS

TAPE BACKUP 60 MEG \$1511.00  
25 MEG DISK/60 MEG TAPE \$2559.00  
35 MEG DISK/60 MEG TAPE \$3259.00  
80 MEG DISK/60 MEG TAPE \$5359.00

### CONTROL DATA SYSTEMS

18 MEG EXTERNAL HD \$1299.00  
30 MEG EXTERNAL HD \$1559.00  
30 MEG INTERNAL IBM-AT \$1299.00

### IOMEGA

SINGLE 10 MEG HD \$1799.00  
DUAL 10 MEG HD \$2495.00  
CARTRIDGES \$ 43.00

### MOUNTAIN COMPUTER

10 MEG DISK EXTERNAL \$1229.00  
20 MEG DISK EXTERNAL \$1499.00  
35 MEG DISK EXTERNAL \$2229.00  
20 MEG INT HD FOR AT \$ 750.00  
60 MEG EXT. TAPE BU \$1649.00

### PRICE-LINE HARD DRIVES

10 MEG INT W/CONT. \$ 539.00  
20 MEG INT W/CONT \$ 719.00  
40 MEG INT W/CONT \$1190.00

### SHUGART

10 MEG HD W/CONT. \$431.00

**COMPAQ 286  
CALL \$\$\$**

## MODEMS HAYES

SMARTMODEM 300 \$129.00  
SMARTMODEM 1200 \$379.00  
SMARTMODEM 2400 \$614.00

**CALL FOR PRICES ON  
NOVATION, RACAL-VADIC  
VEN-TEL AND OTHERS**

## IBM SPECIAL # 1

IBM, 1-320K DS,DD DISK DRIVE  
10 MEG. HARD DRIVE, AMBER OR  
GREEN MONITOR, 256K, PAR PORT  
PFS. WRITE AND FILE

## IBM SPECIAL # 2

IBM AT-1/20 MEG HARD DRIVE  
1.2 MEG FLOPPY, PAR PORT,  
512K, MONO MONITOR CARD,  
AMBER OR GREEN MONITOR.

**PRECISION DS/DD  
\$9.95 BOX OF 10**

**\$2350.00**

**CALL \$\$\$**

\*NO SURCHARGE FOR CREDIT CARDS, FREE EXPRESS-SHIPPING ON  
ORDERS OF \$100.00. COD'S ACCEPTED.3% ADDED FOR INSURANCE.NO  
MONITORS, COMPUTERS, PRINTERS, PAPER INCLUDED IN EXPRESS-  
SHIPPING.PRICES SUBJECT TO CHANGE WITHOUT NOTICE..VISA, MC,  
AMERICAN EXPRESS ACCEPTED. COMPANY PURCHASE ORDERS ALSO  
ACCEPTED.+IBM IS A REG. TRADE MARK.CALL FOR RMA# ON  
ALL RETURNS.

**ORDER LINE**

**1-800-334-8989**

# WE BEAT ANY ADVERTISED \$.

WE'RE THE NEW KIDS ON THE BLOCK, CHECK US OUT.

## COMPUTERS IBM

PC, 256K, 360K FLOPPY, 10 MEG HD	\$2049.00
PC, 256K, 360K FLOPPY, 1.2 MEG FLOPPY, 10 MEG HD.	\$2299.00
PC, 256K, 360K FLOPPY, 1.2 MEG FLOPPY, 20 MEG HD.	\$2659.00
AT-512K, 1.2 MEG FLOPPY, 360K FLOPPY, 20 MEG HD.	\$3877.00
AT-512K, 1.2 MEG FLOPPY, 360K FLOPPY, 40 MEG HD.	\$4349.00

## COMPAQ

### PORTABLE

256K WITH 2-360K DISK DRIVES	\$1919.00
256K WITH 1-360K FLOPPY AND 10 MEG HD	\$2449.00
256K WITH 1-360K FLOPPY AND 20 MEG HD	\$2639.00

## DESKPRO SYSTEMS

MOD. 2-256K, 2HF/HT	\$1949.00
MOD. 3-256K, 1HF/HT, 10 MEG HD	\$2795.00
MOD. 4-640K, 1HF/HT, 10 MEG HD	\$2949.00

## 286 SYSTEMS

286 PORTABLE, 256K AND 1.2 MEG FLOPPY	\$3299.00
286 PORTABLE, 640K, 1.2 MEG FLOPPY, 20 MEG HD	\$4645.00
286 PORTABLE, 640K, 1.2 MEG FLOPPY, 20 MEG HD B/U	\$5159.00
DSKPRO 286-256K, 1.2 MEG FLOPPY	\$3129.00
DSKPRO 286-512K, 1.2 MEG FLOPPY 30 MEG HD	\$4419.00
DSKPRO 286-512K, 1.2 MEG FLOPPY 30 MEG HD B/U	\$4940.00

IBM PROPRINTER.....CALL  
IBM QUIETWRITER.....CALL  
IBM COLOR JETPTR.....CALL

## SOFTWARE

### WORD PROCESSING

WORDSTAR 2000	\$239.00
WORDSTAR 2000 PLUS	\$289.00
WORDSTAR EASY	\$87.00
SAMNA PLUS	\$299.00
SAMNA III	\$239.00
PFS. WRITE	\$78.00
PFS. REPORT	\$69.00
PERFECT WRITER	\$125.00
WORDPERFECT W/SPELLER	\$211.00
PERSONAL WORDPERFECT	\$85.00
MICROSOFT WORD	\$210.00

### SPREADSHEETS & DATABASES

LOTUS 1-2-3	\$299.00
SYMPHONY	\$429.00
SPELLING CHECKER	\$87.95
TEXT OUTLINER	\$87.95
SPOTLIGHT	\$44.95
DBASE III	\$334.00
FRAMEWORK	\$334.00
SUPERCALC	\$197.00
REFLEX	\$249.00
POWER BASE	\$199.00
R BASE 5000	\$344.00
PERFECT CALC	\$125.00
VISICALC	\$125.00
MULTIPLAN	\$109.00

### FINANCIAL SOFTWARE

HOME ACCOUNTANT	\$84.00
MONOGRAM DOLLARS & SENSE	\$99.00

### ACCOUNTING

BPI GENERAL ACC.	\$297.00
BPI INV. OR JOB CST	\$471.00
BPI A/P OR A/R	\$297.50
FIS 2001 ACC SYS	\$2750.00
GREAT PLAINS GL, AR, AP, INV. OR PAYROLL	\$389.00
SORCIM AR, AP, ORDER ENTRY OR INV.	\$297.00

Price-Line  
Computers, Inc.

**OPEN 6 DAYS/WEEK, MON-SAT.**

**8 A.M.-8 P.M. Pacific Standard Time**

**CALIF. RESIDENTS CALL 1-818-341-9193**

9710 Topanga Canyon Place  
Chatsworth, CA 91311

**REVISED 2nd EDITION**  
**THE MANUAL™**  
 ONLY \$14.95 EACH

**THE MANUAL: LOTUS 1-2-3**

THE MANUAL COVERS ALL THE PROGRAM'S COMMANDS, FUNCTIONS, AND FEATURES IN ALPHABETICAL ORDER.

LOTUS 1-2-3 • SYMPHONY FRAME WORK • dBASE II MULTIPLAN • WORDSTAR APPLE WORKS • JAZZ dBASE III • EXCEL

**ALSO AVAILABLE FROM THE POWER OF BOOKS**

**FROM \$14.95**  
 A SERIES OF HOW TO BOOKS FOR BUSINESS APPLICATIONS

LOTUS 1-2-3\* • SYMPHONY\* FRAME WORK\* • MULTIPLAN\* WORD\* • APPLE WORKS\* CONSTRUCTION MANAGEMENT\* FINANCIAL CALCULATIONS\* SMART SOFTWARE  
 \*ALSO AVAILABLE BOOK WITH DISKETTE

**CALL TOLL FREE 1-800-MANUALS**  
 MIS • 1107 NW 14th • Portland, Oregon 97209  
 Telephone (503) 222-2399

(continued from page 32)

**HOMEBREW CPU**

"EGO: A Homebuilt CPU, Part I: The Software" by Clifford Kelley (September, page 229) was as untimely as all get-out and I loved it!

While attending Hope College as an undergrad, I had the opportunity to construct a 4-bit CPU designed by Dr. Jim VanPutten as a teaching tool for an electronics course. It sprawled across at least eight breadboards (the ones with all the little holes) and took forever to build, but it was invaluable for learning. The innards of the processor, such as a clear distinction of instruction cycles or what it means to "decode an instruction," were indelibly inscribed in my memory. I still have the hand-drawn construction and operation instruction in my desk drawer.

Over the years, it seems BYTE has leaned away from homebrew-type articles. Thank you for making Homebrewing the September theme. For me, the "derived education" Mr. Kelley speaks of has been a continued source of fascination of how simple even the complicated can become.

BRIAN J. MORK  
 Savoy, IL

**AGRICULTURAL PROGRAMS SOUGHT**

I am in the process of compiling public-domain, farm-business-related programs written in BASIC for increasing the productivity of farm-business operation. These programs will be helpful to farmers, universities, and agricultural agents.

In this connection, I would like to request the assistance of readers who might be able to share with me their programs or public-domain programs they have used to realize this valuable project. Proper credit and acknowledgment will be extended to the author and a final complimentary copy of the compilation will be given to those who have shared and donated their work. Write to me at the University of Puerto Rico—Mayaguez Department of Agricultural Engineering, POB 5114, College Station, Mayaguez, PR 00709.

E. J. RAVALO  
 Mayaguez, PR

**STRUCTURING BASIC**

Although Arthur Huston presented some useful ideas on the use of BASIC in his article "Structuring BASIC" (June, page 243), there is, I think, a better way to accomplish the same goals. This is through the use of

a preprocessor to provide structured constructs. For instance, in *Dr. Dobbs's Journal* #88, N. C. Shammass describes NBASIC, a powerful preprocessor for Microsoft BASIC. The enhancements include named subroutines with parameter passing, CASE statements, REPEAT...UNTIL statements, and alphanumeric labels.

The use of the intrinsic WHILE...WEND as well as CASE and REPEAT allows completely structured programming. You need never use GOTO; if you do, however, you can now identify the destination by a label rather than a line number.

Beyond providing the tools for good structured programming, NBASIC makes subroutine libraries a snap to implement. This is so because the subroutines can be named; one need never be concerned with line numbers. Your subroutine library should be created with an ordinary text editor and lines left unnumbered. Your application program should be created similarly; within it you can simply CALL the subroutines by name. Then all you need do is join the two text files, number the lines, and submit them to the preprocessor. These operations are easily done by way of a command-file processor (SUBMIT or EX in CP/M, SUB or ZEX in ZCPR3, or BATCH in MS-DOS). (Since it is not possible to pass command-line arguments, such as a filename, to BASIC programs, for easy command-file execution it is useful to modify NBASIC to read the name of its input file from another file. A short program can then be written in assembly language, Pascal, or C to read the command line and store its argument in this file and then exit or chain to the preprocessor.)

Although the linking, numbering, and preprocessing of a program slows down the development cycle somewhat, the time will be more than made up when it is necessary to modify the program a month or a year later.

On the whole, however, anyone desiring a structured, interpretive language that encourages the construction of reusable code really ought to be using FORTH.

DREAS NIELSEN  
 Corvallis, OR

*Arthur Huston replies:*  
 NBASIC certainly sounds like one of the more powerful BASIC preprocessors on the market, and it would no doubt be an effective tool in writing structured programs. My article, however, was aimed at the legions of programmers who learned Microsoft BASIC when they first bought

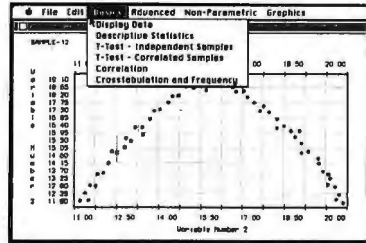
(continued)

BUSINESS • SCIENCE • EDUCATION

# STATISTICAL PACKAGES

data-analysis software from: **StatSoft**  
unbeatable power and flexibility for unbeatable prices!

We developed complete, high-performance statistical packages for all computers:



1. **STATISTICAL SUPPLEMENT FOR LOTUS 1-2-3™** (number one statistical add-on for LOTUS™ and Symphony™, also reads files from many other programs, can be used as a stand-alone statistical package, runs on IBM™ and all compatibles, 256k, 2dd, 8087 support) ..... **\$149**
2. **STATFAST** (the first stand-alone and still the most powerful statistical package developed for the Macintosh™ 128k or 512k, 1dd) ..... **\$119**
3. **APP-STAT** (a complete statistical package for the Apple II™ family of computers, 1dd) ..... **\$99**
4. **PSYCHOSTAT-3** (a complete statistical package, available for Kaypro™ and all CP/M™ computers, 1dd) ..... **\$99**

All of these statistical packages are user friendly and super-easy to use. They include the full range of basic statistical analyses (descriptive statistics, t-tests, correlations, cross-tabulations, nonparametric statistics, and more) and advanced multivariate statistics (multiple regression, multifactor analysis of variance and covariance, repeated measures, contrasts, unbalanced designs, and more). All packages can handle **data files of unlimited size**, include flexible Data Editors, and can access data files from spreadsheets, data-bases, and mainframes. If you are interested in statistical analysis on micro computers, call us! Our technical staff can advise you and recommend the best program for your needs.

*Please add \$5 for shipping and handling. To place your order or talk to our technical staff for more information, call or write:*



**STATSOFT**

2831 EAST 10TH STREET, SUITE 3, TULSA, OK 74104  
(918) 583-4149



LOTUS 1-2-3, Symphony, IBM, Macintosh, Apple II, Kaypro, and CP/M are registered trademarks of respective companies.



**COMPLETE IBM COMPATIBILITY**

**STAY AHEAD OF THE GAME WITH THE LOWEST IN TOWN!**

**TECH PC/AT \$1999**

**PRICE INCLUDES:**

- 6MHZ 80286 CPU
- 512K
- ONE 1.2 MB FLOPPY DRIVE
- 8 EXPANSION SLOTS
- 195 WATT POWER SUPPLY
- COMPLETE MS DOS, PC DOS, XENIX COMPATIBILITY
- RUNS LOTUS 123, DBASE III FRAMEWORK AND ALL OTHER POPULAR AT SOFTWARE.
- ONE YEAR WARRANTY!!

**OPTIONS:**

TECH PC/AT WITH 20MB HARD DISK **\$2499**

TECH PC/AT WITH 20MB HARD DISK, MONOCHROME MONITOR, HERCULES® COMPATIBLE MONO/GRAPHICS CARD **\$2699**

ALSO AVAILABLE WITH 6-8 MHZ SWITCHABLE CPU, TAPE BACKUPS, MODEMS, LARGER HARD DISKS, AND NETWORKING SYSTEMS.

**TECH TURBO PC/XT \$1099**

**PRICE INCLUDES:**

- 4 TO 7 MHZ SOFTWARE SWITCHABLE CPU
- 640K
- TWO 360K DS/DD FLOPPY DISK DRIVES
- 8 EXPANSION SLOTS
- 135 WATT POWER SUPPLY
- ONE YEAR WARRANTY!!

**OPTIONS:**  
TECH TURBO PC/XT WITH 20MB HARD DISK **\$1699**

TECH TURBO PC/XT WITH 20MB HARD DISK, MONOCHROME MONITOR AND HERCULES COMPATIBLE MONO/GRAPHICS CARD **\$1950**

**TECH PC/XT \$799**

**PRICE INCLUDES:**

- 4.77 MHZ CPU
- 256K
- TWO 360K DS/DD FLOPPY DRIVES
- 8 EXPANSION SLOTS
- 135 WATT POWER SUPPLY
- ONE YEAR WARRANTY!!

**OPTIONS:**  
TECH PC/XT WITH 20MB HARD DISK **\$1449**

TECH PC/XT WITH 20MB HARD DISK, MONOCHROME MONITOR, HERCULES COMPATIBLE MONO/GRAPHICS CARD **\$1649**

TELEX: 272006  
Answer Back-TECH  
FAX: 714/556-9325

VISA, MASTERCARGE,  
CHECK ACCEPTED

**TECH PC PERSONAL COMPUTERS**  
**714/754-1170**

2131 S. HATHAWAY, SANTA ANA, CA 92705  
©1985 TECH PC  
\*Hercules is a registered trademark of Hercules Computer Technology.  
\*IBM, IBM PC, XT, and AT are registered trademarks of International Business Machines Corp.

**LETTERS**

Listing 3: A subprogram for random-number generation.

```

;Returns a new ISEED and the
;normalized RAND;
.8087
DSEG SEGMENT PARA
PUBLIC 'DATA'
;Required info for tracing back to
;FORTRAN
DB 'RANDOM'
SP__SAVE DW 0
DD RANDOM
FACTOR DD 69069D
MODULO DD 7FFFFFFFH
DSEG ENDS

CSEG SEGMENT PARA
PUBLIC 'CODE'
ASSUME CS:CSEG,SS:SSEG
;required by callin prog
DW DSEG
RANDOM PROC FAR
PUBLIC RANDOM
;for addressability of DATA seg
MOV AX,DSEG
MOV DS,AX
ASSUME DS:DSEG
MOV SP__SAVE,SP
;computation starts here with 8087
FIELD DWORD PTR
MODULO
FIELD DWORD PTR
FACTOR
;pointer for ISEED
LDS SI,ES:[BX]
FIELD DWORD PTR [SI]
FMUL
FPREM
;return the new ISEED
FIST DWORD PTR [SI]
FDIVB ST,ST(1)
LDS SI,ES:[BX] + 4
;return the normalized RAND
FST DWORD PTR [SI]
;for addressability of DATA seg
MOV AX,DSEG
MOV DS,AX
FWAIT
RET
RANDOM ENDP
CSEG ENDS
SSEG SEGMENT PARA STACK
'STACK'
DB 64 DUP(?)
SSEG ENDS
END

```

their machine and now write useful programs for themselves, their businesses, or their friends. Bringing structure to their programs through techniques rather than expensive add-on products seems a logical next step.

I also never meant that these techniques made BASIC "better" than FORTH or, for that matter, any language. There are thousands of people who program in BASIC because it is free, relatively simple, and accesses all the bells and whistles in their machine (graphics, sound port, etc.). Another alternative would be to buy one of the new versions of BASIC such as True BASIC or Better BASIC.

**RANDOM-NUMBER GENERATION**

The excellent article by Charles A. Whitney ("Generating and Testing Pseudorandom Numbers," October 1984, page 128) is most useful and timely for those who are serious about Monte Carlo programs using small computers. Most software houses supply simple random-number generators for BASIC, but they refuse to include the random-number generators in more advanced languages in order to avoid precisely those pitfalls mentioned

in Whitney's article. Microsoft FORTRAN and IBM Professional FORTRAN are no exceptions. However, if you use the registers with 64 bits or more in a coprocessor such as an 8087, a very simple yet proven random-number generator is possible. One has to use assembly language in order to stay within the 8087 coprocessor until the desired random number is computed.

Listing 3 shows my version of a random-number generator that is a transplantation of RN32 from the venerable CERN Program Library (CERN Division DD, 1211 Geneva 23, Switzerland), which was originally written for 32-bit machines of CDC and IBM mainframes. It employs the linear congruential generator discussed in Whitney's article, with the multiplicative factor of 69069 and initial seed of 65539, and the product is taken modulo (2 to the 31st power). Notice that these selections conform with the rules of thumb in Whitney's article. The current version supplied is in a format to be linked with modules written in IBM Professional FORTRAN and to be invoked by CALL RANDOM(ISEED,RAND).

YUNG KEUN LEE  
Baltimore, MD ■

# Hard to be Humble



*Hayes™ compatible modems—Incompatible price*

**I**t's hard to be humble when IBM™ compatibility, excellent performance, and very low cost are among your products' hallmarks.

Sunnyvale Communications Company introduces the new 1200LC Modem, a true high performance—low cost complete modem unit. Whether you decide on our popular 1200TPC internal card design or its new standalone version you won't be disappointed.

### **IBM™ PC, AT, XT COMPATIBLE**

We include all the hardware and telephone cables needed to allow you to access data bases, send electronic mail, make simple user to user connections, and more!

### **MONEY BACK GUARANTEE!**

At this price you wouldn't expect 1200/300 bps operation, Hayes™ compatibility, auto-dial and answer, auto speed and parity selection, tone or pulse dialing, *and* a built-in call monitoring speaker now would you? At Sunnyvale Communications Company we give you more! Coupled with our two year modem warranty is a 30 day money-back guarantee. Sound better all the time?

Place your order toll-free today, or write to us for more information.

NAME \_\_\_\_\_

ADDRESS \_\_\_\_\_

DAY PHONE \_\_\_\_\_

CHECK ENCLOSED

VISA/ACCT. NO. \_\_\_\_\_

MASTERCARD/ACCT. NO. \_\_\_\_\_

1200LC Modem

1200 TPC Modem Card

SIGNATURE \_\_\_\_\_

California residents add sales tax. All orders add \$4 per modem for shipping and handling. Additional freight charges will be added for Canadian and international orders. No C.O.D.s or purchase orders accepted. Allow four weeks for delivery.

**Sunnyvale  
Communications  
Company**

P.O. Box 3565 • Sunnyvale, CA 94088-3565  
408/752-5095

**800/** 835-9009 in Ca.  
TOLL FREE ORDER LINES  
558-5741 outside Ca.

# ITT INTRODUCES THE FASTEST PC IN THE WORLD. BECAUSE TIME IS MONEY.



The new ITT XTRA™ XP is definitely out to break some speed limits and sound barriers.

Thanks, in part, to the added muscle of an Intel 80286 chip buried deep inside, the ITT XTRA XP runs circles around the competition.

It is, in fact, over three and a half times faster than the IBM XT.

And twenty-five percent faster than the AT on a Lotus recomputation.

And as if speed alone weren't enough, the new

XP actually speaks. And listens.

Using our optional Voice Communications Module, you can duplicate key-strokes with just your voice.

Leaving your hands free to go about their business.

You'll also find an extremely economical 3270 emulation option.

And our optional Integrated Graphics Adapter that displays virtually any program on the market — color or monochrome — on one monitor.

All backed by a world-

wide communications company dedicated to total office communication.

**ITT listens, too.**

Call us at (800) 321-7661, or in California, (800) 368-7300.

Call today. Time is definitely money.

And time is something the XP can save you a lot of.

**ITT**  
PERSONAL COMPUTERS

© 1985, ITT Systems, Inc.  
IBM XT and AT are registered trademarks of International Business Machines. Intel 80286 is a registered trademark of Intel Corporation.



NEW SYSTEMS

**Apple-compatible  
Ace 2000 Series**

The Ace 2000 series, like previous Franklin offerings, is compatible with the Apple II computer family. Franklin claims the 2000 can run 95 percent of the Apple II software.

The Ace 2000 has 128K bytes of memory and a detached keyboard with numeric keypad and user-definable function keys. The computer also has a parallel printer port, 80-column display capability, and a game port with both 9- and 16-pin connectors. The 2000 uses the GTE 65SC02 microprocessor, which allows it to generate the double-high-resolution modes of the Apple IIe and IIc.

The Ace 2000 is available in three versions: the 2200, with two disk drives and a list price of \$999; the 2100, with one drive, for \$849; and the 2000, with no drives, for \$699. An optional high-resolution monochrome monitor (22-MHz bandwidth) is available for \$139. Contact Franklin Computer Corp., Route 73/Haddonfield Rd., Pennsauken, NJ 08110, (609) 488-0666. Inquiry 611.

**SBC88 Development  
and Control System**

The SBC88 from Vesta Technology is a single-board computer based on the 8088 microprocessor. It comes with either two 2K by 8-bit RAM chips or one 8K by 8-bit RAM chip. The 2K version can be expanded to 8K of memory and has an EPROM programmer to burn 2716 EPROMs. The 8K version can be expanded to 32K of memory and has an EPROM programmer to burn 2764 EPROMs.



The Franklin Ace 2200.

Both boards have an RS-232C port and 23 I/O ports, including two 8-bit output ports, two 8-bit input ports, seven individually addressable input ports, and seven high-current output ports. An 8-bit A/D converter provides eight channels for analog input; software routines allow analog output.

Programs for the SBC88 can be written in BASIC or FORTH, downloaded from any terminal via the RS-232C port, and copied from RAM to EPROM using the PROGRAM command. Once this is done the program will execute whenever the system is turned on. The 2K board costs \$279 and the 8K board costs \$319, in-

cluding choice of language/operating system. Contact Vesta Technology Inc., Suite 101, 7100 West 44th Ave., Wheatridge, CO 80033, (303) 422-8088. Inquiry 612.

**Epson's Equity I**

Epson's Equity I is an IBM PC-compatible desktop computer with a keyboard like the PC AT's. Standard features include serial and parallel ports, three expansion slots, 8088 processor, 256K bytes of RAM expandable to 640K, a front-panel power switch, MS-DOS 2.11, and GW-BASIC. It has a socket for an optional 8087 coprocessor.

The Equity I comes in three configurations. With one 360K 5¼-inch floppy-disk drive, it's priced at \$995. With a second disk

drive, it costs \$1295. A version with one floppy-disk drive and a 20-megabyte hard disk is \$2195.

Epson offers as options a 12-inch monochrome monitor (\$149), a 13-inch color monitor (\$549), a monochrome video adapter card (\$129), and a color-graphics adapter card (\$149). The Equity I is designed to use all standard IBM PC expansion hardware and software.

Contact Epson America Inc., 2780 Lomita Blvd., Torrance, CA 90505, (800) 421-5426; in California, (213) 539-9140. Inquiry 613.

**68010 UNIX System**

The microFORCE-1 is a two-user VMEbus system with a five-slot backplane. Four slots are filled with a memory-management board, a memory card, a serial I/O card, and a Winchester/floppy-disk controller, leaving one expansion slot.

The memory-management board, Force's CPU-3VA, has a 68010 microprocessor running UNIX System V 1.0, 32K bytes of static RAM, and a serial port. The system has an MMU bypass option to decrease the execution time of UNIX system calls whenever possible. The DRAM 2.2 memory card comes with 1 megabyte of RAM. Its I/O card has three RS-232C ports, including a printer port and a port for synchronous or asynchronous communication.

The microFORCE-1 comes with one 5¼-inch floppy-disk drive and a 25-megabyte unformatted hard-disk drive. It costs \$5995. Contact Force Computers Inc., 727 University Ave., Los Gatos, CA 95030, (408) 354-3410. Inquiry 614.

(continued)

## PERIPHERALS

**HabaDisk for Atari ST**

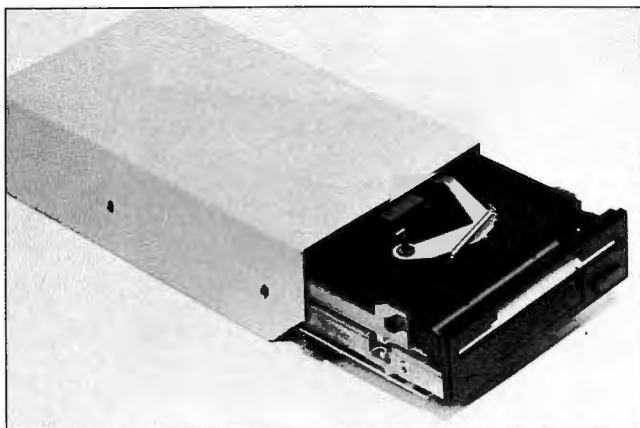
**H**aba Systems' HabaDisk is a 10-megabyte hard-disk expansion for Atari's ST computer, storing as much information as 12 double-sided disks. The HabaDisk includes its own power supply and an interface cable that attaches to the ST's hard-disk port. Haba says the drive is fully compatible with existing Atari ST hardware and software.

The HabaDisk is priced at \$699.95. For more information, contact Haba Systems, 6711 Valjean Ave., Van Nuys, CA 91406, (818) 901-8828. Inquiry 615.

**9-track Tape Drive for IBM PC**

**T**he AN-9800-PC from Acknowledge is a 9-track tape subsystem for the IBM PC and Wang Professional computers. The tape drive allows data to be written to and read from the standard 1/2-inch tape on 7-inch reels used by many mainframe and minicomputer makers, permitting data transfer between microcomputers and mainframes.

Included with the self-loading, self-threading AN-9800-PC is a controller card that occupies a single expansion slot in the IBM PC or Wang PC. The 30-pound drive has a footprint of 9 by 14 inches. The IBM PC-compatible tape-drive system is priced at \$4995, while the Wang PC version is \$5995. An optional carrying case for the tape drive is \$145. Contact Acknowledge Inc., 100 Pennsylvania Ave., Framingham, MA 01701, (617) 620-8843. Inquiry 616.



PKI's *SydeWyndr* external disk drive.

**External Disk Drive for Macintosh**

**S**ydeWyndr is a 3 1/2-inch external disk drive for the Apple Macintosh. It accommodates single-sided microfloppy disks with a capacity of 400K bytes, formatted, and has a transfer rate of 489.6K bits per second.

SydeWyndr weighs 3 1/2 pounds and comes with a case and connecting cable for \$350. Contact PKI Inc., 2539 West 237th St. E., Torrance, CA 90505, (213) 539-2123. Inquiry 617.

**Citizen Daisy-Wheel, Dot-Matrix Printers**

**C**itizen America has introduced two printers, one a daisy-wheel unit, the other a dot-matrix machine.

The Citizen Premiere 35 uses print wheels compatible with the Diablo 630; it can print at 35 characters per second and has a list price of \$599. The printer also has a low operating

noise level of 55 decibels and comes with an 8K-byte buffer. Other features include interchangeable interface cartridges, proportional spacing (selectable by a front-panel switch), and a 12-month warranty.

The Premiere 35 has a push-style tractor-feed mechanism. An optional dual-bin sheet feeder with envelope-feed capability is available for \$400.

The dot-matrix Citizen 120D prints at 120 cps in draft mode. It has a list price of \$249. You can select compatibility with either the IBM Graphics Printer or the Epson FX-80 by throwing a switch. Other features include a 25-cps correspondence-quality mode (selectable with a front-panel switch), a 4K-byte buffer, and a tractor-feed mechanism.

Contact Citizen America Corp., 2425 Colorado Ave., Santa Monica, CA 90404, (213) 453-0614. Inquiry 618.

**GTC Laser Printer**

**G**TC Technologies' Blaser is an 8-page-per-minute laser printer based on Canon's LBP-CX printer

engine. The Blaser emulates the Diablo 630 and NEC Spinwriter printers for text output and the text and graphics images of the IBM Graphics Printer (which was based on Epson's FX-80).

While in the IBM Graphics mode, alphanumeric characters are printed in a Courier font rather than the dot-matrix font, and graphics characters are printed taking advantage of 300-dpi capabilities. Standard graphics are output emulating the Epson's resolution, although additional escape-code sequences enable more advanced graphics features.

Each font includes bold-face, compressed, expanded, superscript, subscript, and combinations of these formats, and all characters can be rotated 90 degrees and printed in landscape mode.

Ten font cartridges are available: American Type-writer, Apollo Proportional, Roman Proportional, Apollo Compressed, Elite, Prestige, Cobra, Courier Italic, Helvetica, and Legal. Each font cartridge is \$99; a four-font cartridge is \$289.

The Blaser includes a switch-selectable serial or parallel interface; both interfaces can be enabled simultaneously using an optional \$499 adapter. A \$699 adapter enables the parallel port plus four additional serial ports. Documents from each computer are buffered in the printer's 64K-byte RAM until earlier tasks are completed.

The Blaser printer has a list price of \$2995. For more information, contact GTC Technologies Inc., 216 West Florence Ave., Inglewood, CA 90301, (213) 673-8422. Inquiry 619.

## ADD-INS

**68020 Development System for IBM PC, XT, AT**

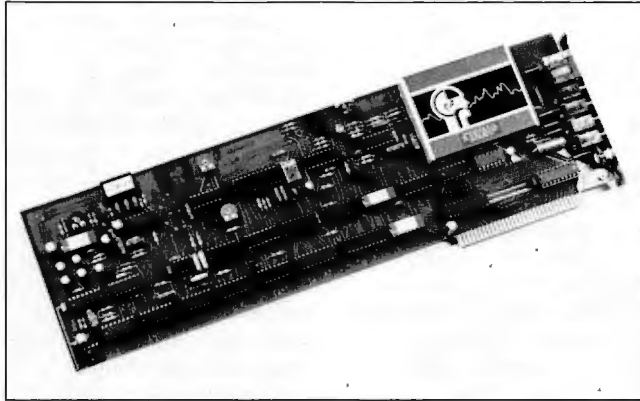
The IBM PC can be used as the basis for a 68020 development system by plugging the Language Resources PC-020 card into one of the PC's long slots and using the accompanying PC-020 software. You can write, assemble, test, and execute 68020 programs entirely within the PC-020/IBM PC system.

The PC-020 card contains a Motorola 68020 32-bit microprocessor, a 68881 FPU math coprocessor, and 1 megabyte of RAM. The RAM can be used as expansion memory by PC-DOS programs.

The development-system software includes a macro assembler, a symbolic debugger, a linker/locator, and documentation. Any executing 68020 program has full access to PC-DOS files. The assembler follows the Motorola assembler style and allows you to employ string macros, conditional assembly, structured control, 68881 instructions, and INCLUDE statements.

Language Resources is also offering C and Pascal compilers for the PC-020. These produce native code and generate full listings containing symbol tables and cross-references. The Pascal compiler is IEEE standard, and the C compiler is a complete Kernighan and Ritchie implementation with System V extensions. Both compilers can handle 16- and 32-bit integers, contain full floating-point support, and have run-time libraries.

The PC-020 costs \$5995 and works with the IBM PC, XT, or AT (and plug-com-



*The CompuFone board from Computalkers Consultants.*

patibles) with a hard disk and PC-DOS (or MS-DOS) 2.0 or higher. The C and Pascal compilers cost \$895 each. Contact Language Resources Inc., 4885 Riverbend Rd., Boulder, CO 80301, (303) 449-6809. Inquiry **620**.

**80287 Card for PC AT**

MicroWay's 287Turbo card includes an 8-MHz Intel 80287 math coprocessor and its own 8-MHz crystal, allowing faster execution of complex math functions than is possible with a standard 6-MHz IBM PC AT. The design of the 80287 allows it to operate at a different clock speed than the main 80286 processor, but the 80287 normally shares the AT's 6-MHz crystal when it is inserted into the AT's coprocessor socket. The 287Turbo board plugs into the same socket but does not use the AT's crystal.

The 287Turbo card is designed so that the 80287-8 and clock crystal can be replaced with faster components when they are made available. A program is included to test all the 80287's functions.

The 287Turbo board is

\$395. Contact MicroWay Inc., POB 79, Kingston, MA 02364, (617) 746-7341. Inquiry **621**.

**Telephone Management for the IBM PC**

The CompuFone board for the IBM PC, XT, and compatibles is a full-length card comprising three subsystems: a digitizer, a Touch-Tone generator/decoder, and a telephone interface.

The speech digitizer works like a solid-state tape recorder. Voice messages can be recorded in RAM or in disk files through telephone or mike-in or line-in jacks using any of five possible bit rates. Speech is encoded using hardware data compression for economical storage: a hard disk is recommended—a 10-megabyte hard disk will hold only 70 minutes of speech. You must also have at least 128K bytes of RAM. Speech output can be transmitted over telephone lines, line-out jacks, or speaker-out jacks.

The Touch-Tone generator will initiate phone calls on either Touch-Tone or rotary (pulse) dial phones. The telephone interface monitors

the call to make sure it has gone through, then relays your recorded voice message. The system can also detect an incoming call, answer with your voice, and record the caller's message.

The Touch-Tone decoder allows you to use any telephone keypad as a remote keyboard for your computer. It is designed to receive commands or enter data sent by the caller.

CompuFone costs \$645; the manual can be ordered separately for \$30. Contact Computalkers Consultants, 1730 21st St., Santa Monica, CA 90404, (213) 828-6546. Inquiry **622**.

**Custom Terminal Design**

The 65/9028 VT is a controller board for a video terminal that emulates ANSI X3.64, DEC VT-52, and Lear Siegler ADM 3A terminals. The 80-column display mode includes a non-scrolling 25th line. Line graphics permit plotting, graphing, and complex forms display. Each of 10 function keys can contain a string of 32 characters. Separate serial communications and printer ports are also supported, and the company says that all polarities of composite and separate video and sync outputs are possible, with 50-Hz or 60-Hz vertical sync.

The 65/9028 VT includes 16K bytes of firmware and 8K of nonvolatile RAM on a single 5- by 6½-inch circuit board. The board is available as an assembled unit for \$239. A kit version is \$199; the bare circuit board with the ROM is \$49. Contact Linger Enterprises Inc., POB 5783, Newport News, VA 23605, (804) 244-3874. Inquiry **623**.

(continued)

## Graphics Software for Apple II Series

**C**hartics is a package of business and scientific graphics routines that runs on all Apple II computers. The software lets you plot arrays of up to 280 variables on two high-resolution pages of video memory.

Charts made with the program can be proportioned to fit into user-defined windows that you can scroll to any location on the screen. A scaling function lets you specify  $x$ -minimum,  $x$ -maximum,  $y$ -minimum, and  $y$ -maximum to plot a chart in oversize or undersize proportions or to display a section of a chart. This feature circumvents problems associated with negative numbers by letting you determine the scale and the part of the chart to be shown.

Chartics can import DIF or ASCII text files, so you can chart data directly from applications programs or from on-line services. It also loads and saves standard Apple binary picture files, so you can incorporate existing digitized images into charts. The program offers 32 colors on color monitors and 8 gray tones on monochrome monitors.

Chartics costs \$250. It requires 64K bytes. Contact American Avicultural Art & Science Inc., 3268 Watson Rd., St. Louis, MO 63139, (314) 645-4431. Inquiry 624.

## Search Program with AI Capability

**C**larity Software has released a data-retrieval program for the IBM PC series that reportedly can search at a rate of 110K

bytes of disk data per minute. Called Logic-Line 1, the program retrieves data from any type of disk-based file. Clarity claims the package can work with document files or database files, regardless of how the data is formatted.

In addition to simple Boolean searches for keywords, Logic-Line 1 can use grammatical techniques based on artificial intelligence to do "fuzzy searches" or cross-searches for data that may not conform to the original keyword criterion but which may be relevant nonetheless.

Logic-Line 1 is written in C and, until the new year, has an introductory price of \$100. Contact Clarity Software, POB 839, Chesterland, OH 44026, (216) 729-1132. Inquiry 626.

## Oscilloscope Package for IBM PC, XT, AT

**S**napshot Storage Scope turns the IBM PC, XT, or AT into a digital oscilloscope and data-acquisition system. The program is capable of digital or analog triggered acquisitions, windowed displays, absolute and relative cursor readouts, time and magnitude readouts, channel labels, and selective recording of data to disk.

With Snapshot, you can acquire and display up to four channels of data at a

selectable sampling rate of less than one sample per minute or as many as 50,000 samples per second. You can analyze the data with a commercial package or with your own program. Data can be displayed graphically or in tables. The display and the stored data files list the number of points collected, date and time, title, duration, and sensitivity of each channel.

Minimum system requirements are a PC or compatible, one double-sided double-density floppy-disk drive, 256K bytes of RAM, PC-DOS 2.0, an IBM color-graphics board or compatible, and a MetraByte or Data Translation analog I/O board. No programming is necessary.

Snapshot sells for \$495 and comes with a 30-day trial period. A demo disk is \$8. Contact HEM Engineering Co., 17025 Crescent Dr., Southfield, MI 48076, (313) 559-5607. Inquiry 625.

## Draw with Perspective

**M**acPerspective is an architectural-rendering program for the Macintosh that lets you construct wire-frame perspective drawings of houses, buildings, or other objects composed primarily of straight lines.

To create a perspective drawing, you specify the

location of the observer and enter  $x$ ,  $y$ , and  $z$ -coordinates of points on the object in either feet and inches or units and decimal units. The computer determines the location of each point as it appears in perspective and draws lines between successive points. (Or you can use the mouse to draw lines between points.) If you change the position of observation, the computer redraws the object as seen from the new viewpoint. The line drawing can then be used as a tracing master from which you can create a finished rendering.

Drawings can be up to 100 inches wide and printed by an Imagewriter or LaserWriter. With a 128K Mac, you can draw figures of up to 1100 points; with a 512K Mac, you can use 1900 points. The package provides a rapid zoom-in/zoom-out capability.

MacPerspective costs \$189. Contact B. Knick Drafting, 313 Marlin Place, Melbourne Beach, FL 32951, (305) 727-8071. Inquiry 627.

## MS-DOS Version of CBC Tools

**M**innow Bear Computers has released an MS-DOS version of its CBC Tools for use with DRI's CBASIC compiler. The supplement is intended to take advantage of the capabilities of MS-DOS 2.0 (the original is comprised primarily of functions portable between CP/M-80, CP/M-86, and MS-DOS). The functions in the supplement were written in assembly language.

CBC Tools for MS-DOS costs \$175. Contact Minnow Bear Computers, POB 2233 Station A, Champaign, IL 61820-8233, (217) 398-6883. Inquiry 628.

### WHERE DO NEW PRODUCT ITEMS COME FROM?

*The new products listed in this section of BYTE are chosen from the thousands of press releases, letters, and telephone calls we receive each month from manufacturers, distributors, designers, and readers. The basic criteria for selection for publication are: (a) does a product match our readers' interests? and (b) is it new or is it simply a reintroduction of an old item? Because of the volume of submissions we must sort through every month, the items we publish are based on vendors' statements and are not individually verified. If you want your product to be considered for publication (at no charge), send full information about it, including its price and an address and telephone number where a reader can get further information, to New Products Editor, BYTE, 425 Battery St., San Francisco, CA 94111.*

# Computers For The Blind

Talking computers give blind and visually impaired people access to electronic information. The question is how and how much?

The answers can be found in "The Second Beginner's Guide to Personal Computers for the Blind and Visually Impaired" published by the National Braille Press. This comprehensive book contains a Buyer's Guide to talking microcomputers and large print display processors. More importantly it includes reviews, written by blind users, of software that works with speech.

Send orders to:

National Braille Press Inc.,  
88 St. Stephen Street, Boston, MA 02115  
(617) 266-6160

NBP is a nonprofit braille printing and publishing house.

## MULTILINGUAL WORD PROCESSING

### Multilingual Column Text

This is multilingual text :

#### French:

La touche Alt est également utilisée avec les touches du clavier numérique pour entrer les caractères qui ne se trouvent pas sur les touches du clavier de type machine à écrire.

#### Greek:

To ΜΗΧΗΡΩΤΗΡ ΣΥΣΤΗΜΕ ΗΜΕ ΗΜΕΣΙΣΚΑ ΕΥΡΩΠΗ ΗΝ ΤΟΥ ΚΡΑΤΟΣ ΚΑΙ ΟΥΧΙΔΕΥΤΙΚΑ ΤΩ ΤΟΥ ΟΙΚΟΝΟΜΟΥ ΕΥΡΩΠΕΙΣΤΗΡΕΙΕ.

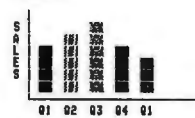
#### Japanese:

ア ア ア ア ア ア ア ア ア ア  
イ イ イ イ イ イ イ イ イ イ  
ウ ウ ウ ウ ウ ウ ウ ウ ウ ウ

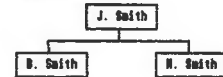
#### German:

Wenn Sie Ihren Text ohne "Pa-pier-Überschneidung", erfassen, berichtigen oder abspeichern möchten brauchen Sie die Hilfe eines Textverarbeitungsprogramms.

### Graphics:



### Organization charts:



### Tables:

Date	Item number	Price
050505	210-0707-000	245.00
050505	540-0707-001	1000.00
050505	200-2000-000	45.00
080505	990-9999-999	1.00
120705	100-1000-100	1999.99

- Up to eight fonts on screen
- Graphics and character modes
- Image based Word processing
- Line graphics and bar charts
- Independent columns
- Real time text dragging
- Typewriter emulation
- Translation to and from ASCII
- Printing to printer or disk
- Comprehensive printer tables
- Numeric tabs and indents
- Headers and footers
- Color support
- Arithmetic calculations on text
- Integrated Communications
- Transmit and receive on disk
- Automatic hyphenation
- Document repagination
- Search and replace
- Context sensitive help
- Easy to use and learn
- In English, French, German
- In Dutch and Greek.
- IBM PC/XT/AT and Compatibles

Only \$259 Incl. Latin and Japanese/Greek font. Junior version \$49.95



### MICRO BUSINESS PRODUCTS

11E Avenue Observatoire  
Brussels, Belgium  
Tel: 375-0953 Tlx: 28340

P.O. Box 630  
Wayne, NJ 07470  
Tel: 201/684-4142

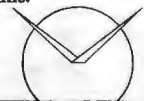


## COMPLETES THE EQUATION FOR COST-EFFECTIVE CIRCUIT SIMULATION

IBM PC plus PSPICE equals precise, mainframe-performance circuit simulation of up to 120 transistors. Design in mere minutes complicated circuits that used to take hours. Check performance under "real" conditions including transient, temperature, and frequency response, without costly breadboarding. "See" troublesome currents and voltages formerly too low to detect. Perfect each circuit without gobbling up expensive mainframe time.

And with PROBE graphics "software oscilloscope," PSPICE/TURBINE hardware accelerator, and user-changeable models options, your PSPICE micro will surpass VAX 11/780 performance at a fraction of the cost.

Affordably priced at \$950.00, PSPICE completes the equation for success. Phone for details.



### MicroSim Corporation

23175 La Cadena Drive  
Laguna Hills, CA 92653  
714/770-3022

VAX is a trademark of Digital Equipment Corporation.  
IBM-PC is a trademark of International Business Machines Corporation.

# THE BUYER'S MART

## A Directory of Products and Services

THE BUYER'S MART is a new monthly advertising section which enables readers to easily locate suppliers by product category. As a unique feature, each BUYER'S MART ad includes a Reader Service number to assist interested readers in requesting information from participating advertisers.

RATES: 1x—\$350 3x—\$325 6x—\$300  
Prepayment must accompany each insertion.

AD FORMAT: Each ad will be designed and typeset by BYTE. Advertisers must

furnish typewritten copy. Ads can include headline (23 characters maximum), descriptive text (250 characters maximum), plus company name, address and telephone number. Do not send logos or camera-ready artwork.

DEADLINE: Ad copy is due 2 months prior to issue date. For example: December issue closes on October 1. Send your copy and payment to THE BUYER'S MART, BYTE magazine, 70 Main Street, Peterborough, NH 03458. For more information call Karen Burgess at BYTE 603-924-9281.

### ACCESSORIES

#### SOFTWARE PACKAGING, DISKS

Cloth binders & slips like IBM's. Vinyl binders, boxes, and folders—many sizes. Disk pages, envelopes, & labels. Low qty. imprinting. Bulk & branded disks. Much More! Low prices. Fast service. Call or write for FREE CATALOG.

**Anthropomorphic Systems Limited**  
376-B East St. Charles Road  
Lombard, IL 60148  
1-800-DEAL-NOW (312) 629-5160

Inquiry 702

### ACCESSORIES

#### VERBATIM DATALIFE

SS/DD 10 PACK IN A PLASTIC BOX

NOW ONLY **\$16.50**

WHILE SUPPLIES LAST  
MASTERCARD AND VISA ACCEPTED

CALL TOLL FREE

**950-1088-78775437**

LOCAL: (313) 363-0100

Inquiry 717.

### BUSINESS OPPORTUNITIES

#### → VIDEO STORES ←

We need ambitious dealers in all U.S. states and Canada to market a powerful system to computerize video tape rental stores.

#### WINCHESTER DATA PRODUCTS INC.

3301-Executive Drive., #204, Raleigh, N.C. 27609  
(919) 872-0995

Inquiry 795.

#### FABRIC DUST COVERS

Heavy polycotton. Six colors. 1000 different covers available for Computers, Printers, Typewriters, etc. PLUS, custom work Monogramming and screen printing available. *In our 4th year of serving you. . .*

#### COVERS UNLIMITED

POB 381076, Germantown, TN 38183-1076  
800-821-7709 or 901-754-4465

Inquiry 721.

#### FREE DISK JACKET SAMPLE

New low-cost DISKAT™ FLOPPY DISK JACKET gives best protection plus way to print and display directory info. Made from heavy-duty antistatic vinyl, the DISKAT™ dual-pocket design stores disk & displays sorted printout of directory data. Send for a FREE sample and software offer.

#### LEINBACH INCORPORATED

P.O. Box 730, Dept. B12, Nyack, NY 10960  
(914) 353-0990

Inquiry 727.

### COMMUNICATIONS

#### SMART ANSWERING MACHINE

SAM transforms your IBM PC into an intelligent phone answering & real-voice messaging center. FEATURES: 999 personal messages, call screening, message forwarding, timed or grouped message delivery, sortable phonebook/autodialer, time/date log, voice prompted remote access, AND MORE!! All hardware & software included. Retail \$295. VISA/MC.

#### DIALECTRON, INC.

2035 California St., Ste #17, Mountain View, CA 94040  
(415) 960-3040

Inquiry 727.

#### LESS NOISE! MORE COOLING!

Stop irritating fan noise & overheating problems with the SILENCER cooling system. It utilizes a super quiet (84% less noise), West German, all metal, 4½" fan. Provides up to 100% more cooling. Mounts on the back of the IBM PC. \$79.95 + \$4 s/h VISA/MC

#### PC COOLING SYSTEMS

31510 Via Ararat Dr., Bonsall, CA 92003  
(619) 723-9513

Inquiry 777.

#### DATA CABLES & PARTS

EIA RS232-C Data Cables - standard, extended distance, RS232-C Teflon Assemblies. Also Centronics (parallel), Coaxial (RG59U, RG62A/U, Dual Wang, Twin-axial), Ethernet, Ribbon, IBM, DEC Compatible cables, AB switches, connector parts, bulk cable; tools & hardware (wall plates). Send for Catalog.

#### Communication Cable Co.

POB 600-B, Wayne, PA 19087  
215-644-1900

Inquiry 715.

### CONTRACTS

#### FOR ENTREPRENEURS

Legal contracts for hardware/software developers. Employee agreement, non-disclosure form, contracts for sale (hardware and/or software), consulting, development, hardware & software maintenance, non-competition, project delivery & more.

#### \$50 Waters Publishing \$50

— 8235 Douglas - Suite 1000 —  
Dallas, TX 75225  
(214) 369-8108

Inquiry 792.

#### FUNKY LOWERCASE?

EPROMS to fix lowercase and provide custom fonts for the following PRINTERS and COMPUTERS:

\*GORILLA/GP-100X/MPS801 **\$14.95\***  
\*Model I/III/4 (video) **\$14.95\***  
\*DMP100/LPVI **\$29.00\***

Send for sample text:

#### THE ELECTRONIC CLOSET

8187 Blakely Court West • Bainbridge Is., WA 98110

Inquiry 734.

#### Self-Inking Printer Ribbon

For users of Okidata and other open spool ribbon printers. Controlled Printout Devices are a new kind of printing ribbon that re-ink themselves, and will last 15 times longer than the ribbon you are now using. For further information please call or write.

#### CONTROLLED PRINTOUT DEVICES, INC.

POB 669, Baldwin Rd., Arden, NC 28704  
(704) 684-9044

Inquiry 719.

### DISK CONVERSION

#### CONVERSION SERVICES

Convert any 9 track magnetic tape to or from over 500 formats including 3½", 5¼", 8" disk formats & word processors. Disk to disk conversions also available. Call for more info. (312) 459-6010

#### Pivar Computing Services, Inc.

★ ★ 47 W. Dundee Road ★ ★  
Wheeling, IL 60090

Inquiry 779.

### BOOKS / DISKS / VIDEOS

#### ATTENTION PROGRAMMERS!!

*Programmers' Handbook of Computer Printer Commands is a must!*  
Programming Codes for 100's of Printers.

- \* 43 Manufacturers \* Daisy & DMP
- \* 272 pgs. in Table Form
- \* Info: Code, Hex/Dec. Equiv., and Description
- \* Dealer Inquiries Invited

TO ORDER CALL OR WRITE:

#### CARDINAL POINT INCORPORATED

P.O. Box 596, Ellettsville, IN 47429  
(812) 876-7811 (M-F 9-5)

Inquiry 713.

#### BLANK FUNCTION KEY TEMPLATES

Write convenient commands next to your function keys on reversible plastic templates. Styles to fit IBM-PC, Compatibles, HP-150, Keytronic 5151, and others. Custom also available.

**\$4.95 Pkg. of 3 (Plus \$1 s&h)**

1-800-231-5413

In CA 1-800-523-5441

Free catalog of other helpful products available by circling number below on inquiry card.

Inquiry 720.

#### INCOMPATIBLE WORD PROCESSORS?

We convert to and from: XEROX, DEC, IBM, LANIER, WANG, PC-DOS, CONVERGENT TECHNOLOGY, WORDSTAR, MULTIMATE, SAMNA ASCII, MICOM.

Also most CP/M systems.

LOWEST PRICES

#### DATA CONVERSION INC.

6310 Caballero Blvd. • Buena Park, CA 90620  
(714) 522-7762 (800) 824-4651 in CA.

Inquiry 724.

## DOCUMENTATION

### Computer Assembly Manuals

**BIG BLUE SEED** for IBM™ BUILDERS: parts list, placement diagrams, instructions for assembling over 55 IBM-compatible bare cards - \$14.95.  
**APPLE SEED II** for APPLE™ BUILDERS: in the style of the **BIG BLUE SEED** with instructions for assembling 70 Apple-compatible bare cards - \$12.95.  
**BOTH ASSEMBLY MANUALS FOR \$25.00**

### NuScope Associates

P.O. Box 790 • Lewiston NY • 14092

Inquiry 775.

## DUPLICATING SERVICES

### WESTERN TRANSDATA, INC.

Why risk duplicating your important programs on your computer, when our equipment is designed solely to duplicate disks & verify their perfection 100%? Over 600 formats. 3 1/2", 5 1/4" & 8". Plus serialization, copy protection, labeling, packaging, shrink-wrapping and fast, personalized service.

### WESTERN TRANSDATA, INC.

1701 E. Edinger Ave. A-7  
 Santa Ana, CA 92705  
 714/547-3383 (collect)

Inquiry 793.

### DUPLICATION SOLUTIONS

We have the answer to your duplication needs, no matter what the volume. We supply auto-loaders, disks, and technical support. We provide copy protection, serialization, package assembly, and distributive shipping.

### MegaSoft

P.O. Box 1143, Freehold, NJ 07728  
 1-800-222-0490 201-462-7628 (in NJ)

Inquiry 762.

## ENTERTAINMENT

### \*\*\* GAMES !!! \*\*\*

Disk full of Public Domain Games for the Apple IIe, IIc, II+. Games like Blackjack, Checkers, Ohello I, Adventure, Asteroyder and much more for \$19.95!!! including shipping.

### Gennaro Conte Associates, Inc.

2522 Holland Ave., Bronx, NY 10467  
 Compuserve ID:74005,1064

Inquiry 740.

## HARDWARE

### PROM/PAL BIPOLAR PROGRAMMER IBM PC

EPROM PROG—\$250, PAL OPTION—\$250,  
 MP OPTION—\$100, BIPOLAR OPTION—\$350  
 •MS-DOS, CP/M-86 Software handles 2716 through 27256  
 EPROM • 16, 20 and 24 pins BI-POLAR PROMS • From MMI,  
 SIG, HAR, TI & AMD • 20 and 24 pins PAL from MMI, AMD,  
 NAT & TI • Also 8741/48/49/51 MP

**Advanced Microcomputer Systems Inc.**  
 2780 S.W. 14th St. • Pompano Beach, FL 33069  
 (305) 975-9515

Inquiry 701.

### APPLE & IBM PERIPHERALS!

FACTORY DIRECT! Ite 64K/80 Column Bd. \$39.  
 II+ /Ite Cooling Fan \$24.95. II+ /Ite Mouse w/SFWR  
 \$49.95. Joystick III w/fire on stick Apple or IBM  
 \$24.95. 10 Ft IBM Parallel Cable \$12.95. RAM Set/9  
 PC-\$5 XT-\$7. Add \$3 Shipping. Write for complete list.

### NEXO DISTRIBUTION

8824 Golf Drive - Spring Valley, CA 92077  
 (619) 589-7928

Inquiry 774.

## HARDWARE

### 8097 PROTOTYPING BOARD

Develop applications for the Intel 8096 Family of Microprocessors with the CSC-8097 Board - the ONLY board available for development with Intel's 8097 16-bit single chip microcontroller. Price: \$750

### Caldwell Systems Corp.

POB 617, San Ramon, CA, 94583  
 415-833-1850

Inquiry 712.

### BDS LASER PRINTER! — \$2,559.00 COMPLETE WITH SOFTWARE!

8 Pages per Minute, 9 Type Fonts, (18 with optional Cartridge), Down-Loadable (Design your own) Fonts, Parallel (Centronics, IEEE-488) and Serial (RS-232C) Interfaces, Landscaping (Graphics Intermixed with Text), Magnification, Sideways Print, and Non-Volatile Memory for Control Features.

### HIGH TECHNOLOGY, INC.

9312 W. 92nd Ave., Westminster, CO 80020  
 (303) 431-7596 VISA and MASTERCARD Accepted!

Inquiry 745.

### TURBOCHARGER FOR IBM

- ✓ Increases processing speed over 300%
- ✓ Full software compatibility with PC and XT
- ✓ Supports Intel 10 MHz 8087 coprocessor

### Everett/Charles® Marketing Services

6101 Cherry Avenue  
 Fontana, CA 92335

800-443-1860 Calif. 909-821-0589

Inquiry 737.

### 1/2 IN. 9 TRACK COUPLER

READ and WRITE 1/2 in. magnetic tape with formatted 9 track drives. Runs all speeds and densities in PC, XT, & AT running MS-DOS or IBM XENIX. Data transfers up to 904K bytes/second. Couplers start at \$880. Complete sub-systems start at \$2995.

### Overland Data, Inc.

5644 Kearny Mesa Rd., Ste. A, San Diego, CA 92111  
 (619)-571-5555 and TELEX 754923 OVERLAND

Inquiry 776.

### • IBM PC XT AT SALE • • COMPAQ CMPTR SALE •

TEAC 588V DISK DRIVE ..... \$ 89.00  
 SEAGATE 10MB w/CNTR. .... \$475.00  
 SEAGATE 20MB w/CNTR. .... \$595.00  
 IRWIN TAPE BACKUP 10 MB HALF HT. .... \$550.00  
 POWER SUPPLY, CABLES, DOS, CARDS ..... LOW  
 CHIPS, MONITORS, KEYBOARDS ..... CALL  
 (213) 770-8186

### MAX GROUP CORP.

17000 S. Vermont Ave., Unit J, Gardena, CA 90247  
 Telex: 5106003099 MAX GROUP LAS

Inquiry 761.

### \$59 CONTROL COMPUTER

6802MPU, 16 line I/O, RAM, EPROM socket, Power Supply 100 lot price, Evaluation unit with test EPROM \$99

### Hawaiian Sky Telescopes

74-5626 Alapa St., Kailua-Kona, HI 96745  
 (808) 326-2190

Inquiry 744.

## HARDWARE

### BUYING A PROGRAMMER?

Information on EPROM programmers for Engineering, Production and Field Service.

Specifications and prices upon request.

### SHERMAN PIRKLE, INC.

617-861-6688

Inquiry 786.

### PCjr ADD-ON DRIVES

Upgrade your PCjr with our user-installed add-on drive system. It includes a replacement disk controller (operates up to 3 drives), a 2 drive cable, external 360K drive(s) & software for operating the extra drives. Prerequisite: DOS 2.1, \$295 (one drive), \$449 (2 drives), \$149 (controller only), \$6 shipping.

Call (505) 282-4182

### J & M Systems, Ltd.

15100-A Central SE, Albuquerque, NM 87123

Inquiry 753.

### E(E)PROM, PROM PROGRAMMER

Program all EPROMS, EEPROMS, microcomputers, zero-power RAMs, 35 nS PROMS for under \$300!

### B & C Microsystems

See our ad on page 369.

Inquiry 704.

### POWERLINE GREMLINS?? POWER FAILURES??

The MEIRICK STANDBY POWER SYSTEM is the TOTAL SOLUTION to your powerline problems.

240 watt system - \$365; 400 watt system - \$495;  
 800 watt system - \$795

### MEIRICK Inc., POWER SYSTEMS DIV.

Box 298, Frisco, CO 80443 303-668-3251

Inquiry 763.

### MULTI-FUNCTION Bd \$189.95

includes 384K of RAM, Serial, Par., Clock, Software  
 256K RAM Card (full) for IBM's ..... 129.95  
 Team 300/1200 modem, int. or ext.,

Hayes Compt. .... 199.95

Radio Shack 64K Color Computer II. .... 149.95

External Drives 5 1/4" for Radio Shack in case 125.95

Epson Printers, Cheap! Call for quotes.

### C.C. Distributing

Memphis, TN 38119 5512 Poplar Ave.  
 901-761-4585

Inquiry 714.

### 100% XT COMPATIBLE \$1395.

The ASCENDANT is 100% compatible with the IBM PC XT and has more standard features than the IBM PC at a lower price. Standard items included are 130 wps serial & parallel interface, two 1/2 height floppy drives, expandable to 512K plus much, much more... 1 year limited warranty. VISA/MC

### IC ELECTRONICS, INC.

2920 Schwartz Rd., Columbus, OH 43232  
 614-236-0108

Inquiry 749.

## PERIODICALS

### DISCOVER ROBOTICS

Robot Experimenter™ magazine shows you how to take the next step in the computer revolution by freeing your computer to roam about the house. REX is designed for both educators and experimenters. Subscribe now to explore the world of tomorrow.

• \$24.00 for 12 issues. MC/VISA/CHECK •

#### Robot Experimenter

POB 458, Peterborough, NH 03458  
603/924-3843

Inquiry 784.

## SOFTWARE/BUSINESS

### DATA ENTRY SYSTEM

Heads-down data entry with two-pass verification for the PC/XT/AT & compatibles. Loaded with features like: Auto dup & skip, verify bypass, range checks, & table lookups. Fully menu driven only \$395. Call for free 30 day trial period.

#### COMPUTER KEYS

6519 193 SW, Lynnwood, WA 98036  
(206) 776-6443

Inquiry 716.

### EXPERT CHOICE®

Designed for today's decision makers—gain the competitive edge. Facilitates complex decisions based on both objective & subjective factors about criteria & alternatives. Uses: procurement, resource allocation, strategic planning, R&D, marketing, finance, employee selection & evaluation. DEMO AVAILABLE \$10.

#### Decision Support Software, Inc.

1300 Vincent Place-Dept. B, McLean, VA 22101  
(703) 442-7900 (800) 388-2022

Inquiry 726.

### ENHANCE YOUR PRINTER!!

Print in a variety of fonts and sizes with your Epson (or compatible) printer. Prints SIDEWAYS too. Great for letters, spreadsheets, . . . even signs and banners! Create your own fonts to print. DigiCon Print Package—\$49.95 (for IBM PC).

#### Digital Concepts, Inc.

P.O. Box 8345, Pittsburgh, PA 15218  
(412) 823-8314

Inquiry 728.

### TAX-PREP™ '85 TRIAL

Multiplan or 1-2-3 users, easily prepare totally professional tax returns. Try TAX-PREP '85 (for 84 returns) thru November for \$15 + 3 s/h and we'll give you \$15 off TAX-PREP '86, avail. in Jan. for \$129.95. YES, it has the features you want!!! FREE info.

#### EZWare Corporation

29 Bala Ave. Dept. G., Bala Cynwyd, PA 19004  
(215) 667-4064

Inquiry 738

### dFELLER Inventory

A business inventory program written in modifiable dBASE source code. The menu-driven program lets you locate items by inventory name or number. It keeps track of reorder points, vendors, average cost, and other info. Requires dBASE II or III. PC-DOS/CPM \$150.

#### Feller Associates

550 CR PPA, Route 3, Ishpeming, MI 49849  
(906) 486-6024

Inquiry 739.

## SOFTWARE/BUSINESS

### LP88-LINEAR PROGRAMMING

A powerful menu-driven system for solving linear programs w/ up to 255 constraints & 2255 variables. Features include interactive & batch operation, spreadsheet-style input & editing, storage of problems & bases, Simplex Algorithm restart, report generator, sensitivity analysis. Req. IBM PC, 192K. \$99 w/8087 support, user's guide. VISA/MC.

#### EASTERN SOFTWARE PRODUCTS INC.

P.O. Box 15328, Alexandria, VA 22309  
(703) 549-5469

Inquiry 732.

### TSA 88-TRANSPORTATION

A GENERAL-PURPOSE system for solving transportation, assignment and transhipment problems. Solves transportation problems with up to 510 origins and/or destinations by applying the Transportation Simplex Algorithm. Menu-driven with features similar to LP88. Requires 192K. \$99 with 8087 support user's guide. VISA/MC.

#### EASTERN SOFTWARE PRODUCTS, INC.

POB 15328, Alexandria, VA 22309  
(703) 549-5469

Inquiry 733.

### WINDOWING FOR dBASE III

dWINDOW™ is a unique utility program (9K) that dramatically enhances the screen presentations of dBASE. By patching itself into memory dWINDOW adds a series of new commands and functions to the dBASE repertoire. THE EFFECT IS SPECTACULAR! \$99 plus shipping.

#### Liberty Bell Publishing

618 NW Glisan, Suite 203, Portland, OR 97209  
(800) 547-3000 (Dept. 604)

Inquiry 760.

### STANDARD FORMS

Easy to use with on screen step by step prompts. Prints data required in proper spaces on any preprinted form that fits in your printer. Free phone support. \$79 (VISA/MC/AMEX). MS-DOS/CPM-80. Other original software. FREE catalogue.

#### MICRO-ART PROGRAMMERS

173 Birch Avenue, Cayucos, CA 93430  
(805) 995-2329 (24 hours)

Inquiry 765.

### TIME & BILLING

400 clients/20 partners/80 job & 40 out of pocket categories/20 areas of practice/fixd fee or hourly/more! Prints billing/statements/aged rec's/more! Free phone support. \$149 (VISA/MC/AMEX). MS-DOS/CPM-80. Other original software. FREE catalogue.

#### MICRO-ART PROGRAMMERS

173 Birch Avenue, Cayucos, CA 93430  
(805) 995-2329 (24 hours)

Inquiry 766.

### PC-Write™ Shareware

Fast, friendly, flexible word processor and text editor for IBM PC. Easy to use. Advanced features like macros, split screen, footnotes, mailmerge. Many good reviews, thousands sold. All software, manual on disk \$10. OK to copy! Register for full manual, support, source \$75.

#### Quicksort (206) 282-0452 Visa/MC

219 First N. #224J, Seattle, WA 98109

Inquiry 782.

## SOFTWARE/BUSINESS

### PC-File III™ Version 4

Search, sort, browse, global changes, macros, mailing labels, format reports with selection & calculations, sub-totals, totals, averages, encryption. Exchange data with 1-2-3, WORD, WordStar. Over 190,000 users. \$59.95 + \$5 s/h. For IBM PC.

#### ButtonWare, Inc.

P.O. Box 5786, Bellevue, WA 98006  
1-800-J-BUTTON

Inquiry 707.

### PC-File/R™

All the power of PC-File III plus: Relational link to other databases, integrated letter writing & mail-merge, context sensitive pop-up help windows. New binary search retrieves data hundreds of times faster. \$149.95 + \$5 s/h.

#### ButtonWare, Inc.

P.O. Box 5786, Bellevue, WA 98006  
1-800-J-BUTTON

Inquiry 708.

### ABACUS

ONLY FROM SUNSOFT . . . Complete Accounting System for \$49.95 plus S&H. SOURCE CODE only \$20 extra!! Complete documentation. Runs on CP/M & PC-DOS systems with CBASIC. 2.5" 5 1/4" DSDD min.

\* completely menu driven  
\* full file maintenance  
\* G/L, A/P, A/R, P/R, C/A

#### SUNSOFT Inc.

P.O. 1168, Marquette, MI 49855  
For orders: 1-800-624-7008 For info.: (906) 226-3370

Inquiry 789.

### EXPENSE MANAGER

Customizable expense data base system and report writer. Produces tax-saving summaries. Analyzes by category, code and date. Manages up to \$1,000,000 and 1,000 accounts! IBM PC/XT/jr 128K or Apple II + /e/c 64K

Only \$39.95 — Money Back Guarantee!!

#### Network Services

1915 Huguenot Road, Richmond, VA 23235  
(804) 379-2253 MC/VISA

Inquiry 773.

### 1985 TAX PREPARATION

Fast, easy to use package prepares and prints 1985 Federal income tax returns using form 1040. Fully interactive, menu driven. Follows IRS forms. Supports 26 forms plus multiples. MS/PC-DOS, 128K; Prof. \$149.00; Pers. \$39.95; VISA/MC (\$5 SH)

#### Dunphy Systems, Inc.

P.O. Box 326, Worthington, OH 43085-0326  
614-459-2349 (orders 800-622-4070; Ill. 800-942-7317)

Inquiry 730.

### FEDERAL TAX SOFTWARE

for individual returns. Print up to 26 forms/schedules using IRS forms or overlays. 3 levels of the program: \$75; \$350 or \$600 in CP/M, MS-DOS, PC-DOS. Demo available thru:

#### 1040 PLUS

6730 E. McDowell #103, Scottsdale, AZ 85257  
(602) 941-3407

Inquiry 700.



# THE BUYER'S MART

## SOFTWARE/BUSINESS

### PC-Type™

Fast, compact, capable & easy! Help panels, hands-on tutorial, macros, multiple-line headings & footings, DOS path support, print spooling, block operations, etc. ASCII files. Install program allows customization. \$59.95 + \$5 s/h. For 128K IBM PC.

**ButtonWare, Inc.**  
P.O. Box 5786, Bellevue, WA 98006  
**1-800-J-BUTTON**

Inquiry 709.

## SOFTWARE/GENERAL

### TURN ON YOUR PRINTER

Eleven printer fonts and printer control menu. Includes Italics, Script, Correspondence. Optional Fonts Scientific, Russian, Greek and Hebrew (\$20@). Okidata 92, 93, Epson FX80, 100, Star Micronics. MS-DOS, CPM-80.®

**CUSTOM CHARACTER SET \$46.50.**  
**WOODSMITH SOFTWARE**  
Rt. 3-Box 550A, Nashville, IN 47448  
**(812) 988-2137**

Inquiry 796.

## SOFTWARE/GRAPHICS

### THE DRAWING TABLET

Draw lines, circles, parallelograms, arcs. Paint with 100 different brush sizes in four shades. Block functions with the ability to replace, overlay, inlay. Save to disk or printer. Store symbols in libraries. Text capability. Only \$49.95 + 3.00 s&h.

**K SOFTWARE HOUSE**  
Rt. 2, Box 83B1 Unionville, TN 37180  
**(615) 294-5090**

Inquiry 755.

### PC-Calc™ Version 3

64 columns x 256 rows, math and stat. functions, horizontal bar graphs, title locking, individually adjustable column widths, IF...THEN, link to other spreadsheets or PC-File databases, much more. Requires 256K IBM PC. \$59.95 + \$5 s/h.

**ButtonWare, Inc.**  
P.O. Box 5786, Bellevue, WA 98006  
**1-800-J-BUTTON**

Inquiry 710.

### WORD IMAGE

Edit 4 files, undo, sub-directory, big files, macros, on-screen attributes, command driven, batch files, search/replace in ranges, help, all printers, manual, fast, MORE. Needs 320KB, PCDOS 2.0+, and 360K disk. Intro: \$50.00, 30-Day trial.

**Software Ideology**  
P.O. Box 305, Brooklyn, N.Y. 11204  
**718-236-3876**

Inquiry 797.

### ATTENTION ENGINEERS

Easy-to-use graphics software for the IBM PC, XT, AT, and compatibles. Full 2-D and 3-D screen graphing capabilities including contours. No programming needed! Interface to pen-plotter.

**OMNILOT (S) .....\$195**  
**OMNILOT (P) .....\$195**  
**BOTH .....\$295**

**MICROCOMPATIBLES**  
301 Prelude Drive ★ Silver Spring, MD 20901  
**(301) 593-0683**

Inquiry 767.

### INCOME TAX SOFTWARE

**TAXWORKS®** software to enter, calculate, and print Federal Form 1040 and 17 supporting schedules. 1985 marks 3rd year of production. 240 programs sold last season. Free phone support. For IBM, MS-DOS, CPM-80. Federal \$400. California \$100. Demo \$25.

**TAXWORKS®**  
881 Alma Real Dr., Suite 2  
Pacific Palisades, CA 90272  
**(213) 459-2746, In Calif. (800) 232-1040™**

Inquiry 746.

### POWERFUL FILE MANAGEMENT

I.D.T.'S FileManager® for people serious about their systems. No kid stuff—only powerful managing tools. File sort, copy, move, delete, search & change attributes. Undelete and clear files.

EDLIN enhancer & batch mode clean up and more. Menu driven.  
**\$34.95** (about 1/3 Norton's) **MC/VISA**  
**INTEGRATED DATA TECHNOLOGY, INC.**  
4775 Bunchberry Lane, Colorado Springs, CO 80917  
**ORDERS: 303-488-2583**

Inquiry 750.

### GRAPHICS PRINTER SUPPORT

AT LAST! Use the *Print* key to make quality scaled B&W or color reproductions of your display on any dot matrix, inkjet, or laser printer. GRAFPLUS supports all versions of PC or MS-DOS with IBM, Tecmar, and Hercules graphics boards. \$59.95.

**Jewell Technologies, Inc.**  
4302 SW Alaska St., Suite 207  
Seattle, WA 98116  
**(206) 937-1081**

Inquiry 752.

## SOFTWARE/GENERAL

### MICRO BEATS RACETRACK!!

Earn profits to afford peripherals and goodies to build the "System of Your Dreams." Dick Mitchell did it. A *Winning Thoroughbred Strategy*, book and software program \$59.95. Book only, \$29.95. Send for literature and review.

**Cynthia Publishing Company**  
4455 Los Feliz Blvd., Suite 1106B  
Los Angeles, California 90027  
**(213) 664-3165**

Inquiry 722.

### US-ATLAS

Geographic locator of 29,000 U.S. cities for IBM-PC & compatibles. Computes Great-Circle distance between points. Draws states with 640 x 200 graphics. Has 9 options. \$39.95 check or m.o. to address below.

**ILLSTON PC-PROGRAMS**  
1930 Hayselton Dr., Jefferson City, MO 65101  
**(314) 635-3417**

Inquiry 748.

### THE DGI TYPE SHOP

Turn your IBM or APPLE computer and HEWLETT-PACKARD plotter into a desktop publishing system. THE DGI TYPE SHOP offers a quick and economical alternative to typesetting - PLOTSETTING. Price \$175. Ten optional fonts that range from a very formal script to Greek - Scientific are available.

**DECISION GRAPHICS, INC.**  
P.O. Box 2776-B, Littleton, Colorado 80161  
**Phone (303) 796-0341**

Inquiry 725.

### MicroGANTT®

Control your project! You describe the work, **MicroGANTT** calculates the schedule and budget. Optimize the schedule interactively. Customize the reports. Sub-tasking, fixed and variable costs, multi-project resource allocation, unlimited size and scope. GANTT, PERT, CPM, DOD-7000. Call or write for free catalog.

**Earth Data Corporation**  
P.O. Box 13188, Richmond, VA 23225  
**(804) 231-0300**

Inquiry 731.

### ESCRIBE EN ESPAÑOL?

Escribién, the first Spanish spelling checker, works with DOS, CPM and most word processors. Features as in best English checkers but designed for Spanish. Includes on-line verb conjugation. Order toll free 1-800-538-8157 (In CA 1-800-672-3470) x806. \$99.95 through 12/85; demo \$14.95.

**Ibersoft Inc.**  
P.O. Box 3455, Trenton, NJ 08619  
**609-890-1496**

Inquiry 747.

## SOFTWARE/LANGUAGES

### CROSS ASSEMBLERS with "UNIVERSAL" LINKER and POWERFUL LIBRARIANS for IBM PC MS-DOS

Full featured for most microprocessors

**ENERTEC, INC.**  
BOX 1312, Lansdale, PA 19446  
**215-362-0966 MC/VISA**

Inquiry 735.

### \*\* THE HYPNOTIST \*\*

with HEART-RATE BIOFEEDBACK PERIPHERAL includes Hypnotism/User's Manual—\$99.95

### \* PERSONALITY ANALYZER \*

Includes: book "PLEASE UNDERSTAND ME" audio tape by IU psychology prof.—\$49.95 for Psychiatrists; School, Marriage & Career Counselors; Psychologists and Self-analysts

**PSYCOM SOFTWARE INTERNATIONAL, INC.**  
2118 Forest Lake Dr., Cintl., OH 45244  
**TELEORDERS 7 DAYS: (513) 474-2188**

Inquiry 780.

### Key Kit The real TIME SAVER

Decrease your work load by placing repeated keystrokes on one key. Works concurrently with your software. Supports block graphics, foreign language letters and math symbols. Customize your software and have things your way. For IBM-PC/XT/AT, \$56.00

**G & S**  
P.O. Box 34, Troy, PA 16947  
**(717) 297-3001**

Inquiry 742.

### BYSO® LISP

for IBM PC

**INTERPRETER \$150**

(includes Visual Syntax®)

**COMPILER \$395**

for stand alone expert systems, etc.

**Levien Instrument Co.**  
POB 31, McDowell, VA 24458  
**(703) 396-3345**

Inquiry 759.

## SOFTWARE/LANGUAGES

### Finally. BSW-Make.

A complete implementation of the Unix "make" facility for MS-DOS. No more recompiling every file in sight after an edit. Just type "make" and BSW-Make automatically builds your product quickly and correctly. BSW-Make supports: • most compilers and assemblers • MS-DOS v2.00 or later • macros for parameterized builds • default rules.

Only \$69.95 postpaid (Mass. residents add 5% sales tax)

#### The Boston Software Works

120 Fulton Street, Boston, MA 02109  
(617) 367-6846

Inquiry 706.

## SOFTWARE/LANGUAGES

### Minnesota SNOBOL4 Language

Powerful string & data handling facilities. Interpreter compatible with mainframe SNOBOL4. 32K strings, 32 bit integers, 8087 for float & large memory model. Sample pgms include ELIZA. For >128K IBM PC/MS DOS or compatible. Authoritative "green" book by Griswold available.  
Guide + 5 1/4" diskette.....\$44.95  
Guide + green book + dkt.....\$59.95  
Green book only.....\$24.95  
Postpaid in USA. In NY add tax. VISA/MC (914) 271-5855

#### BERSTIS INTERNATIONAL

POB 441, Millwood, NY 10520

Inquiry 705.

## SOFTWARE/SCIENTIFIC

### HALLEY'S COMET

KNOW WHEN AND WHERE TO LOOK WITH OR WITHOUT A TELESCOPE!

Provides sky locations of the comet, moon, and major planets for any place and time in 1985-86. Apple, IBM, TRS-80 (I) versions open (in BASIC), with explanatory booklet. \$30 plus s/h and tax in CA. VISA/MC

#### MSAR Software Co.

360 Moore St., Santa Cruz, CA 95060  
To Order Call Now 408-426-7019

Inquiry 770.

## CBTREE FOR C PROGRAMMERS

Provides enhanced file handling calls directly into C programs. Maintains balanced B-trees, supports unlimited number of keys, data records, and key lengths. Fast, Flexible, Efficient. No royalties. Source Code Included.

New Low Price: \$99

#### PEACOCK SYSTEMS, INC.

2009 Hileman Rd., Falls Church, VA 22043  
(703) 893-0118

Inquiry 778.

## UNIVERSAL CROSS-REFERENCER

—WORKS WITH ALL LANGUAGES—  
BASIC, C, Pascal, FORTRAN, COBOL, ASM...  
You name it!

MS/PC-DOS V2+, IBM PC, XT & compatibles  
Unbeatable at \$39.95 + \$3 s/h. MC/VISA/Check

#### DALSOFT SYSTEMS

3565 High Vista, Dept E2  
Dallas, TX 75234 (214) 247-7695

Inquiry 723.

## ► SCIENTIFIC CALCULATOR ◀

Memory resident emulation of the HP-11C plus direct insertion of results in foreground program, graphically presented, decimal, hex, binary, & octal operations, boolean functions and more. Mouse support. 8087 or Standard versions \$49.95 + 3.00 s&h.

#### K SOFTWARE HOUSE

Rt. 2, Box 83B1 Unionville, TN 37180  
(615) 294-5090

Inquiry 756.

## FORTRAN PROGRAMMERS

Discover F77L

A Full FORTRAN 77 Language System for the IBM PC and Compatibles

"THE PROGRAMMER'S FORTRAN"

#### Lahey Computer Systems Inc.

31244 Palos Verdes Dr. West, Suite 243  
Rancho Palos Verdes, CA 90274  
213-541-1200

Inquiry 758.

## SOFTWARE/SCIENTIFIC

### Affordable Engineering Software

CALL or WRITE for FREE CATALOG  
Circuit Analysis • Root Locus • Thermal Analysis • Matrix Manipulation • Signal Processing • Filter Design • Graphics • Text Proofreader

#### BV Engineering

2200 Business Way Suite 207, Riverside, CA 92501  
VISA/MC (714) 781-0252

Inquiry 711.

## SOFTWARE/SYSTEM

### CONFIDENTIAL CRYPTON

Protect Confidentiality

- Encrypt/Decrypt PC Files
- Under Password Control
- With Menu-Driven Software

Only \$35 C.O.D. or VISA/MC  
To order call/write: (206) 842-8196

#### ARCorp

721 Park Ave., Winslow, WA 98110

Inquiry 703.

### Tools for CB80 & CB86

BDOS, DOS, and BIOS calls from CB80 and CB86! CBC Tools includes functions for directory access, string ops, a debugger, radix conversion, command line parsing, quicksorts, bit and byte ops, and much more. Available for CP/M-80, CP/M-86, and PC-DOS for \$180.00.

#### Minnow Bear Computers

POB 2233 Sta. A, Champaign, IL 61820-8233  
(217) 398-6883

Inquiry 772.

## RATS!

RATS is a fast, accurate & complete regression package with unsurpassed POWER. Has both time-series & cross section analysis. Includes Box-Jenkins, logit & probit. Spectral analysis & graphics also available. Requires 256K RAM, IBM PC or compatible. \$200. MC/VISA.

#### VAR Econometrics

P.O. Box 19334, Minneapolis, MN 55419  
(612) 822-9690

Inquiry 790.

## pcSHARE MULTI-USER O/S

pcSHARE allows your IBM-XT/AT or compatible to support up to 5 users running 1-2-3, dBASE, WordStar, etc. on inexpensive serial CRTs. For software developers, pcSHARE efficiently runs compiled Basic, Pascal & C programs with full DOS 3.0 compatible record locking.

#### DIGITROL COMPUTERS INC.

440 Phillip Street  
Waterloo, Ontario, CAN, N2L 5R9  
(519) 884-4541

Inquiry 729.

## LISP for CP/M Z-80

Complete LISP system: list editor, source code library, pretty printer, floating pt math, random access disk i/o, ELIZA. 200+ page manual. Hundreds in use in schools, labs, homes. Most CP/M disk formats. \$54.95 includes USA postage/overseas add \$15.

#### Computing Insights

P.O. Box 4033  
Madison, WI 53711

Inquiry 718.

## PC ARRAY PROCESSING!!!

VECTOR87 has 57 array processor subroutines: FFT (fastest in the world?), convolution, dot product, complex vector operations, random number gen, etc. Up to 18x faster than compiled code. For Pro Fort, IBM/MS Fort/Pascal. Lat C.

All 3 obj libs \$99 US.

#### Vectorplex Data Systems Ltd.

Box 136 Station M, Calgary, Alberta T2P 2H6, Canada  
(403) 248-1250

Inquiry 791.

## DISK DRIVE DIAGNOSTIC

Memory Minder, from J & M Systems, is a disk diagnostic program for the IBM PC, PCjr, & IBM compatibles. It checks your drives for head alignment, spindle speed, hysteresis, azimuth & more. And, you can use Memory Minder to actually align your disk drives! \$99 plus \$4 shipping.

#### J & M Systems, Ltd.

15100-A Central SE, Albuquerque, NM 87123  
(505) 292-4182

Inquiry 754.

## DEVELOP Z-8 APPLICATIONS

Fastest Lowest Cost Route to build robot controllers and industrial automation. Z-8 assembler and reliable cassette storage system gives you the power of Z-8671 BASIC and the speed of assembled machine code.

Z-8613, piggyback PROM, instructions.....\$182  
Recorder.....70  
Assembler.....165

System Boards Available

#### Hasco Technology

9960 Canoga Ave. D3, Chatsworth, CA 91311  
818-709-6268

Inquiry 743.

## PC Matrix Calculator

Matrix power, calculator ease. Interactive. & Programmable. +, -, \*, /, invert, solve = s, eigen, covar, more. AND interactive OLS regression. ASCII, other I/O. EASY. Just type names & operators; it reads files, chks syntax, forms result. opt 8087 \$35.

#### S'Ryt Code Works

2353 Massachusetts Ave. Suite 66  
Cambridge, MA 02140  
617-497-2390

Inquiry 788.

## Symbolic Debugger for Turbo Pascal™

- Set breakpoints at line numbers or procedures
  - Display and modify variables symbolically
  - Fully integrated into Turbo Pascal environment
- Requires Turbo 2.0 or 3.0, IBM PC version.  
Only \$49 plus \$2 S&H.

#### KYDOR COMPUTER SYSTEMS

812 S. Sherman St., Richardson, Texas 75081  
(214) 669-1888

Inquiry 757.

# THE BUYER'S MART

## SOFTWARE/SYSTEM

### MCFORMAT \$50

Don't let DOS waste your disk space! Add up to 50% more hard disk capacity to your IBM PC, XT, AT or 100% compatible by selecting format parameters, including cluster & directory size. Fully DOS compatible (3.0 or 3.1), VISA/MC.

**MICROCOMPUTER CONCEPTS, INC.**  
9715 SE 43 St., Mercer Island, WA 98040  
(800) 722-8066 (206) 236-2300

Inquiry 768.

## SOFTWARE/SYSTEM

### Don't Re-Key - Use PIK'r!

*\*\* The magic micro-mainframe data editor \*\**  
Selectively reformat mainframe ASCII report data into spreadsheets, databases. Lotus, dBASE, Multiplan, Visicalc, word processors. Cut & Paste, edit, merge, transpose. \$95.

**SAMKHYA Corp.**  
47 Sixth St., Suite 3000, POB 142  
Petaluma, CA 94953  
(800) 442-0012 US, (800) 442-5544 CA

Inquiry 785.

## UTILITIES

### THE C UTILITY LIBRARY

Make C program development easy on PC & AT. 300 documented, tested functions: pop-up windows, fast graphics, data-entry, time/date math, much more. SOURCE (95% in C) included. NO ROYALTIES. Most compilers, memory models. \$185.

**Essential Software, Inc.**  
P.O. Box 1003, Maplewood, N.J. 07040  
(914) 782-6605

Inquiry 736.

### LASER TYPOGRAPHY \$495.

Typographic composition software to drive the Corona L300 Laser Printer as a typesetter. H & J 24 proportional space fonts, widths for 78 fonts available. Mix face & point size on any line, multicolumn capability.

**Micro Print-X, Inc.**  
P.O. Box 581, Balingier, TX 76821  
(915) 365-2343 Dealer Inquiries Welcome

Inquiry 769.

### DEMOGRAPHIC DATA BASE

County and city database supplied on 32 IBM PC compatible diskettes. Agriculture, Banking, Crime, Education, Elections, Government, Health, Households, Labor force, Land, Income, Population, Poverty, Services, Weather, and more. \$290.00

**Melissa Data Co.**  
12 Balboa Cooves, Newport Beach, CA 92663  
(714) 650-1000

Inquiry 764.

### DOS PATHING EXTENSION

Give your software the full PATHING capabilities that are missing from the 2.xx and 3.xx versions of MS-DOS and PC-DOS. FULLPATH object license: \$19.95, source license: \$399.95, (+\$5 S/H + 6% in MN). VISA/MC/PO/CHK 30 day money back guarantee.

**P. R. GLASSEL and ASSOCIATES, INC.**  
30255 Fir Trail, Stacy, MN 55079  
612-482-1337

Inquiry 741.

## UTILITIES

### CP/M 2.2 on VAX/VMS

Z80 instruction set emulator runs CP/M™ 2.2 on VAX/VMS™. Supports 64K bytes RAM & 64M bytes disk. Exchange utility transfers files between CP/M and VMS. May access SSSD CP/M diskettes directly via console floppy. \$495 inc CP/M.

**William's Lake Systems**  
8 Saragway Place  
Halifax, Nova Scotia, Canada  
B3P 2N9

Inquiry 794.

### MEDIA MASTER PLUS

READ, WRITE, and FORMAT over 60 CP/M disks and run most CP/M-80 programs on your IBM PC! Two program package includes ZP/EM, a CP/M-80 emulator program that transforms your IBM PC into a 1-2 MHZ CP/M 2.2 computer. \$59.95 + \$3.00 S/H (CA 6%)

**INTERSECTING CONCEPTS, INC.**  
4573 Heatherglen Ct. Ste. 10  
Moorpark, CA 93021  
(805) 529-5073

Inquiry 751.

### TOPVIEW SPOOLER

TVSPOOL is a user-friendly printer spooler for the TopView environment providing: Disk Resident Queue, Page buffer, Banner Processor, Delete After, Multiple Copies, and more. Introductory Price is \$60.00 (Visa/MC)

(714) 261-0440  
**RIX Softworks, Inc.**  
17971-F Skypark Circle, Irvine, CA 92714

Inquiry 783.

### HP LASERJET TYPESETTING

with most popular word processors  
**QROFF \$79.95**  
from

**QCAD SYSTEMS, INC.**  
1164 Hyde Ave., San Jose, CA 95129  
Toll-free 800-538-9797  
In California, call 408-727-6671  
Leaders in software tools

Inquiry 781.

### COPYWRITE

CopyWrite backs up hundreds of the most popular programs for the IBM PC. CopyWrite is revised monthly to keep up with the latest in copy protection, and comes with a trade-in offer. It needs an IBM AT, XT, or PC, 128K and one disk drive, but can use more memory or another drive. \$50 US. Check/Credit Cards.

**QUAD SOFTWARE LIMITED**  
45 Charles St. E. 3rd Fl.  
Toronto, Ontario, Canada M4Y 1S2  
(416) 961-8243

### PACKED UTILITY DISK

HOT FOR  
STUFF \$10 IBM-PC

EXPECT A MIRACLE!

### MICRO TOOLS INC.

POB 357 N. Chili, NY 14514 (716)594-1088  
Circle the Inquiry #771... We'll do the Rest

Inquiry 771.

## Subscription Problems?



### We want to help!

If you have a problem with your BYTE subscription, write us with the details. We'll do our best to set it right. But we must have the name, address, and zip of the subscription (new and old address, if it's a change of address). If the problem involves a payment, be sure to include copies of the credit card statement, or front and back of cancelled checks. Include a "business hours" phone number if possible.

BYTE  
Subscriber Service  
P.O. Box 328  
Hancock, NH 03449

# CCT-4 SYSTEM SERIES

The latest CCT implementation of the new generation Intel 16-Bit Processor technology. This means extreme speed, unequalled power, and the ultimate in reliability, and of course, the innovators at CCT behind it.

This series in the CCT line exploits the speed and power of the Intel 80286 and Zilog Z-80H (8MHz), on the 286Z CPU board. This combination, along with CompuPro DMA controllers and I/O boards, yields a dramatic improvement in system throughput speeds, from basic CP/M operation, up to large powerful multi-user/multi-tasking machines. The CCT-4 represents the most advanced hardware presently available in a microcomputer to run the thousands of CP/M type software programs on the market, and with CONCURRENT DOS 8-16 and the CompuPro PC Graphics board (when available), all software written for the IBM PC machines. This series is for the serious business/scientific user.

**CCT-4A** State-of-the-art power in it's basic form. Consists of CCT-286Z CPU board and CCT-M256 (256K), along with CompuPro: Enclosure 2 Desk (21 slot MF), Disk 1A, System Support 1, Interfacer 4, the CCT-2.4 floppy drive system, and CP/M 8-16, and with SF-200 surge suppressor system. . . . . **\$5,269.00**

**CCT-4B** Single-user/hard disk power. As the 4A, except priced without the CCT-2.4, to add in your choice of CCT hard/floppy combination drive subsystem, at the published pricing. . . . . **\$4,149.00**  
 (Example: CCT-4B Mainframe with CCT-10/1 = \$6,198.00) Plus cost of selected drive subsystem

**CCT-4C** Multi-user/hard disk power. As the 4B, with the CCT-M512 (512K static RAM board) instead of M256; Interfacer 3 instead of Interfacer 4; SF-400 instead of SF-200, plus Concur. DOS 8-16 O.S. (4 to 6 user system) . . . . **\$4,999.00**  
 (Example: CCT-4C Mainframe with CCT-40/1 = \$8,048.00) Plus cost of selected drive subsystem

**Limited Time Offer - FREE 80287 and Supercalc 86 with any CCT-4!**

The above systems include all necessary cabling, assembly, testing, minimum 20 hour burn-in, and the CCT unconditional 12 month direct warranty.

**CCT-M512** WORLD'S TOP SELLING CCT STATIC RAM. IEEE Standard 12MHz. 512K in one slot! — **Special Price: \$799**

**CCT-M256** 256K version of M512 upgradeable to full 512K. Perfect 256K RAM board for any CompuPro system . . . . . **\$439**

**BATTERY BACK-UP ON CCT RAM!**

**HUGE PRICE CUTS!**

**CUSTOM COMPUTER TECHNOLOGY / BOX 4160 / SEDONA, ARIZONA 86340**  
**TOLL FREE ORDERING: 800-222-8686 / For technical support / service: 602-282-6299**

# Compu\$ave

Call Toll Free 1-800-624-8949

IN ARIZONA CALL (602) 967-3532

**COMPUTERS**

- Altos 586-40 Multiuser System. . . . . **5199**
- IBM-PC/2 FDrives/10M HDrive. . . . . **2390**
- Wyse-PC/2 Floppy Drives. . . . . **1159**
- Wyse-XT/1 FDrive/10M HDrive. . . . . **1879**
- Zenith 148 PC/1 Floppy Drive. . . . . **1060**
- Zenith 158 PC/2 Floppy Drives. . . . . **1749**
- Zenith 171 PC Port/2 FDrives. . . . . **1879**
- Compaq/Corona/Eagle/Molecular. **CALL**
- NEC/Sharp/Sperry/Televideo. . . . . **CALL**

FOR AMALGAM AN EPSON POWER SIZE COLOR ONLY \$299

**MODEMS**

- Anchor Volksmodem (Ex). . . . . **55**
- Anchor Signalman Express (Ex). . . . . **235**
- Hayes Smartmodem 300 (Ex). . . . . **128**
- Hayes Smartmodem 1200 (Ex). . . . . **359**
- Hayes Smartmodem 1200B (Int). . . . . **309**
- Micromodem IIE/Soft (Int). . . . . **128**
- Novation Apple Cat II (Int). . . . . **192**
- Novation Half-Card 2400 (Int). . . . . **439**
- Prometheus Promodem 1200 (Ex). . . . . **299**
- Racal-Vadic 1200V W/Soft (Ex). . . . . **209**
- US Robotics Password 1200 (Ex). . . . . **194**
- Ven-Tel PC Modem Half-Card (Int). . . . . **305**
- AT&T/AST/Quobie/Uds/Software. **CALL**

**PRINTERS**

- Abati LQ. . . . . **299** Epson FX85. . . . . **345**
- Citizen MSP10. **248** Epson LX80. . . . . **219**
- Citizen MSP15. **345** Juki 6100. . . . . **345**
- C. Itoh F10-55. **949** Juki 6300. . . . . **665**
- OkidataML182 **215** NEC ELF. . . . . **385**
- OkidataML192 **358** NEC P5. . . . . **965**
- Panasonic1091 **234** Star SG10. . . . . **209**
- Panasonic1092 **348** Star SD10. . . . . **339**
- Televideo 750. **855** Cables 5'. . . . . **17**
- Toshiba P341. **899** Cables 10'. . . . . **19**
- Brother/Diablo/Qume/Sharp. . . . . **CALL**
- Houston And Other Plotters. . . . . **CALL**
- Buffers/Sheet Feeders/Tractors. . . . . **CALL**
- Stands/Switches/Ribbons. . . . . **20% OFF**

**TERMINALS**

- Adds Viewpl+ **419** Qume 101G. . . . . **265**
- Ampex 210. . . . . **365** Qume 119G. . . . . **439**
- Ampex 219. **CALL** Qume 201G. . . . . **519**
- Ampex 230. . . . . **449** Qume 202G. . . . . **589**
- Televideo 914. **539** Qume 211G. . . . . **639**
- Televideo 922. **598** Visual 65. . . . . **489**
- Televideo 955. **449** Wyse 30. . . . . **278**
- Zenith Z-22. . . . . **488** Wyse 50. . . . . **418**
- Zenith Z-29. . . . . **608** Wyse 75. . . . . **558**
- Zenith Z-49. . . . . **859** Wyse 85. . . . . **578**
- Altos/IBM/Liberty/LSI/Samsung. **CALL**

**BOARDS**

- AST Advantage W/128. . . . . **379**
- AST Six Pack Plus W/64K. . . . . **215**
- Hercules Color Card. . . . . **143**
- Hercules Monochrome Graphics. . . . . **289**
- Micro Sci 80/64E (Apple). . . . . **75**
- Orange Buffered Grappler+(Ap). . . . . **139**
- Orange Grappler+ (Apple). . . . . **70**
- Orchid Cram RAM/OK. . . . . **266**
- Orchid PClurbo 186/256K. . . . . **835**
- Paradise Modular Graphics. . . . . **258**
- Paradise Multi-Display. . . . . **192**
- Persyst Short-Port Color Card. . . . . **159**
- Persyst Time-Spectrum/OK. . . . . **189**
- Premier Color-Pack Card. . . . . **115**
- Quadram Quadboard/384K. . . . . **225**
- Quadram Silver Quadboard/OK. . . . . **219**
- STB- Chauffeur. . . . . **249**
- STB Graphics Plus II. . . . . **249**
- Tecmar Graphics Master. . . . . **443**
- Tecmar Maestro AT. . . . . **379**
- ABM/Logicom/Microtek/PGS. . . . . **CALL**
- Practical Peripherals/Thesys. . . . . **CALL**

**DISK DRIVES**

- Gamma/Apple IIE, IIC. . . . . **135**
- Micro Sci A2/Apple II, II+, IIE. . . . . **159**
- Mitsubishi 4851/IBM. . . . . **99**
- Seagate 10M Subsystem/IBM. . . . . **439**
- Seagate 20M Subsystem/IBM. . . . . **539**
- Tandom TM 100-2/IBM. . . . . **99**
- Alloy/Corvus/Maynard/Teac. . . . . **CALL**

**MONITORS**

- Amdek 300. . . . . **116** BUI 1411. . . . . **339**
- Amdek 310A. **139** Taxan 116. . . . . **115**
- Amdek 500. . . . . **245** Taxan 121. . . . . **124**
- Amdek 722. . . . . **489** Taxan 620. . . . . **369**
- PGS HX9. . . . . **415** Taxan 640. . . . . **489**
- PGS HX12. . . . . **432** Wyse 500. . . . . **169**
- PGS MAX12. . . . . **159** Wyse 600. . . . . **519**
- PGS SR12. . . . . **579** Zenith 122. . . . . **82**
- Samsung 1451. **205** Zenith 123. . . . . **79**
- Thomson31021G **139** Zenith 1240. . . . . **169**
- NEC/Panasonic/Roland/Talung. . . . . **CALL**
- Cables/Stands/Interfacer. . . . . **CALL**

COMPARE OUR PRICES FOR MERCHANDISE DELIVERED TO YOUR DOOR. YOU WILL SEE WHY WE HAVE THE REPUTATION FOR QUALITY PRODUCTS AT LOW-LOW PRICES.

**WE ALSO CARRY**

- Maxell Disks MD-1 (Bx). . . . . **18**
- Maxell Disks MD-2 (Bx). . . . . **25**
- Verbatim Disks/SS-DD (Bx). . . . . **18**
- Verbatim Disks/DS/DD (Bx). . . . . **23**
- Verbatim-Bonus Disks/SS-DD (Bx). . . . . **12**
- Verbatim-Bonus Disks/DS-DD (Bx). . . . . **17**
- SOFTWARE**
- Apple / Atari / IBM / Commodore
- Digitizers / Joysticks / Power Supplies
- Chips / Keyboards / Surge Protectors
- Cables / Graphics Tablets / Light Pens

**HOURS: MON - FRI 9AM - 6PM / SAT 9AM - 2PM**

Compu\$ave 1000 S. 19th St. Suite 9 Phoenix, AZ 85040 (602) 967-3532  
 Dept. 1000 601 Major Credit Cards Welcome  
 Prices Represented as Discounts. Minimum Shipping Charge \$4.  
 A Division of Adlanke Corporation

**TOLL-FREE  
ORDERING:  
800-222-8686**

# CCT<sup>®</sup> CUSTOM COMPUTER TECHNOLOGY

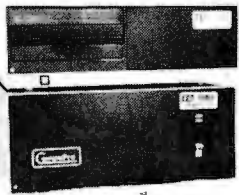
A  
PAT  
MARTINI  
COMPANY

**FOR TECHNICAL SUPPORT/  
SERVICE / IN ARIZONA:  
602-282-6299**

**1 CCT PLAZA — P.O. BOX 4160 — SEDONA, ARIZONA 86340**

Purchase your Hardware and Software directly from an OEM/ Systems Integrator. Take advantage of our buying power! We stock a full line of Board Level Components, Software and Peripherals. Call for your needs. We'll give you the Lowest Prices, and the Technical Support and Know-How we are quickly becoming well-known for. Satisfied Customers Nationwide. The Nation's Custom Systems House for Business, Education and Science. Call for a system quote. CCT implements tomorrow's technology today!<sup>™</sup>

**• FOREMOST QUALITY • ADVANCED SUPPORT • REASONABLE COST •**



### 80286 NOW!

□ **CCT-286Z** is our model designation for the **MI-286** dual processor board from **Macrotech**. It features the super high speed combination of Z-80H and 80286, with provision for the 80287 math chip. Directly replaces 8085/88 and 8086 CPUs running CP/M, MP/M Concurrent DOS, and MS-DOS, at throughput increases of 3X to 5X!

**SPECIAL PRICE - \$795**  
**80287 Option - Installed - \$250**

**SEE THE CCT-4 SERIES  
USING THIS BOARD  
DETAILED ON THE FACING PAGE**

**NOW!  
BATTERY BACK-UP  
ON  
CCT RAM BOARDS!  
VOLATILE PRICES  
CALL FOR QUOTE**

### LIBERTY TERMINALS

• Superior Reliability •  
110-14" GREEN-80/132 Column . . . CLOSE  
110-14" AMBER . . . . . OUT  
200-14" GREEN-80/132 Super Deluxe PRICES  
200-14" AMBER . . . . . CALL!

### OKIDATA PRINTERS - Top Quality

82 - 80 Col . . . CALL 83 - 132 Col . . . CALL  
92 - 80 Col . . . CALL 93 - 132 Col . . . CALL  
84 - 132 Col/200cps—Top of the Line . . . CALL  
For Serial Interfaces . . . . . CALL

**TOSHIBA P351 - 288 CPS/24 PIN - \$1499**

### DIABLO — Letter Quality Series

Model 620 . . \$969 Model 630 . . \$1799  
**WE HAVE ALL SOFTWARE—CALL**

## \$ ACROSS THE BOARD PRICE REDUCTIONS \$

### INDUSTRIAL GRADE **CCT DISK DRIVE SYSTEMS** ROLLS ROYCES OF THE INDUSTRY. SUPERIOR QUALITY **S-100 HARD DISK SUBSYSTEMS**

Professionally engineered ST-506 type systems for the business market S-100 Computer user. Includes industry top quality drives, CompuPro Disk 3 DMA controller, all cabling, A&T, formatted, burned-in. Provisions for up to two hard disks in each system. We include operating system update. CP/M 80, CP/M 86, CP/M 8-16, CCP/M 8-16, CP/M 68K. (1/1 Systems are CCT innovated hard/floppy combinations, with Mitsubishi DSDD 8" drive.) 12 month warranty.

CCT-10 (11 + MEG) . . . . .	\$1499	CCT-10/1 . . . . .	\$2049
CCT-20 (22 + MEG) . . . . .	\$2019	CCT-20/1 . . . . .	\$2569
CCT-40 (36 + MEG) . . . . .	\$2499	CCT-40/1 . . . . .	\$3049
CCT-60 (58 + MEG) . . . . .	\$3699	CCT-60/1 . . . . .	\$4249
CCT-90 (87 + MEG) . . . . .	\$4909	CCT-90/1 . . . . .	\$5459
CCT-125 (123 + MEG) . . . . .	\$6099	CCT-125/1 . . . . .	\$6649

**HOT NEW CCT BOARD PRINTERFACER 1™** - Print buffer I/O Board. Up to 1 Meg. RAM on board. Looks as/works with Interfacer 3/4. Single or Multiuser/Interrupt driven or polled. Super-slick design handles one serial, one parallel, software switchable. Also for Zenith and Alpha. Intro Price — **\$349.**

### FLOPPY SYSTEMS

**CCT-2.4 • Dual 8" DSDD** Mitsubishi 2.4 Megabyte in Extra Heavy horizontal enclosure, all cabling, A&T, Burned in. The fastest system available: . . . . . **\$1229**  
**CCT-5 • 5 1/4" DSDD** IBM Compatible Mitsubishi 360K. Extra Heavy Cabinet removable filter air system, all cabling, A&T, Burned-in. Perfect for our Concurrent DOS Package . **\$399**

**CCT-8/5 • FULL IBM COMPATIBILITY**  
One Mitsubishi 8" DSDD (1.2 Meg)/One 5-1/4" DSDD (360K) IBM Drive  
For Concurrent DOS and PC DOS . . . . . **\$1029**

## ★ SUPER PRICES ★ COMPUPRO COMPONENTS ★ IN STOCK ★

CPU-Z - \$229 • Disk 1A - \$399 • Disk 1A w/CP/M - \$499 • CPU 8086/10 - \$359 • SPU-Z - ?  
CPU 8085/88 - \$229 • CPU 286 - \$849 • CPU 68K - 10Mhz - \$359  
Disk 3 - \$459 • RAM 22 (256K) - ? • RAM 23/64K - \$229/128K - \$299

### SUPER SALE — M-Drive/H - 512K - \$399 / 2 Meg - \$899

Enclosure 2 Desk - \$699/Rack - \$749 • Interfacer 3 - \$409 • Interfacer 4 - \$289 • System Support 1 - \$299  
Concurrent DOS 8-16 (CCTCMX) - \$309 • CP/M 80 (CCTHMX) - \$125 • CP/M 86 (CCTTMX) - \$175  
CP/M 8-16 (CCTTMX) - \$199 • CP/M 68K (CCTCX) - \$279 • Operating System Updates/Remakes - \$30

**16 Bit Upgrade Kit: CP/M 86, RAM 23, System Support 1, Cable \$649 □ CP/M 8-16 - Kit - \$673**

### CCT-1 — ENTRY LEVEL S-100 BUSINESS SYSTEM

- Enclosure 2-Desk-21 Slot Mainframe •
- CPU-Z - 6 Mhz Z-80 CPU Board •
- Disk 1A - DMA Floppy Disk Controller •
- RAM 23 - 64K Static RAM - 12Mhz •
- Interfacer 4 - 3 Serial/2 Parallel I/O •
- CCT-2.4-Dual 8" Mitsubishi DSDD Drive System - 2.4 Megabytes •
- CP/M 80 - 2.2 HMX - CCT Modified •
- All Cabling, Complete CCT Assembly, Testing, and Minimum 20 Hour Burn-in •

**SPECIAL PRICE  
\$3,150**

**RUNS ALL STANDARD 8" CP/M SOFTWARE - INCLUDES OUR EXCLUSIVE 12 MONTH DIRECT WARRANTY**

Prices & availability subject to change. All products new, and carry full manufacturer's warranties. Call for catalog. Free technical help to anyone. All products we sell are CCT individually tested and set up for your system - Plug-In & Go! Arizona residents add sales tax CCT<sup>®</sup> Trademark — Custom Computer Technology; MS-DDS<sup>®</sup> Trademark — Microsoft; IBM<sup>®</sup> Trademark — International Business Machines; CompuPro<sup>®</sup> Trademark — W.J. Godbout; CP/M<sup>®</sup> MP/M<sup>®</sup> Trademarks — Digital Research HERCULES<sup>™</sup> Trademark — Hercules Computer Technology



# SUNTRONICS CO., INC.

12603 Crenshaw Blvd., Hawthorne, CA 90250

1-800-421-5775 (Order Only)

(213) 644-1140 (CA Order & Info)

STORE HOURS

Mon-Fri 9 a.m. to 6 p.m.

Sat 10 a.m. to 5 p.m.

TERMS: VISA MASTERCARD C.O.D. (Cash or Certified Check Required) Check (Allow 2-3 Weeks for Clearing) Shipping & H.C.S. 00 for 3 Lbs. plus 50¢ for each add'l Lb. Calif. residents add Calif. Sales Tax 5% 00 Minimum Order IBM and Apple are registered trademarks of IBM & Apple

## SUN-XT COMPUTER (IBM PC/XT COMPATIBLE)



- RAM EXPANDABLE TO 640 K
- USES MS & PC-DOS OPERATING SYSTEMS
- RUN LOTUS 1-2-3 FLIGHT SIMULATOR SYMPHONY OBASE II & III AUTO CAT, WORD STAR, MULTI PLAN ... ETC. (DOES NOT RUN PROG. REQUIRE ROM BASIC.)

- CPU BOARD W/256 K RAM
- COMPUTER CABINET
- FULL FUNCTION KEYBOARD
- 135 W/POWER SUPPLY
- 2 DSDD DISK DRIVES
- FDC W/CABLE
- TTL MONITOR (AMBER OR GREEN)
- MONOCHROME GRAPHICS CARD W/PARALLEL PRINTER PORT.
- FULLY A & T (MEETS FCC CLASS "A" REG., FOR IND. & BUS. USE)

**ONLY \$895.00**

DEALER & OEM INQUIRIES INVITED!!

### SUN-XT CPU

- 8088 CPU (8087 OPTION)
- RAM EXPANDABLE TO 640K
- FULLY IBM COMPATIBLE
- DIMENSION SAME AS IBM PC/XT
- NO RAM INCLUDED
- 8 EXPANSION SLOTS

**\$175.00**

### FLOPPY DISK CONTROLLER

- STANDARD DOUBLE SIDE DOUBLE DENSITY
- RUN 2 INTERNAL & 2 EXTERNAL
- WITH CABLE

**\$59.00**

### IBM STYLE CABINET

- 8 SLOT BACK PANEL
- COMES WITH MOUNTING BRACKET & HARDWARE
- FITS IBM POWER SUPPLY

**\$59.00**

### COLOR GRAPHIC CARD

- RGB & COMPOSITE VIDEO
- 640 x 200 HIGH-RES
- 320 x 200 LO-RES
- 80 x 25 TEXTMODE
- LIGHT PEN INTERFACE

**\$99.00**

### HIGH RESOLUTION MONOCHROME MONITOR

- 12" AMBER OR GREEN
- 1000 LINES AT CENTER
- 20MHZ BAND WIDTH
- SEPARATE TTL SIGNAL INPUT
- DUAL INTENSITY SIGNAL LEVEL
- HIGH PERFORMANCE SHARP IMAGES

**\$105.00**

### MONOCHROME GRAPHIC CARD

- HIGH-RES CHARACTER 720(H) x 348(V)
- 80 x 25 TEXT MODE
- RUN LOTUS 1-2-3 ETC.
- WITH PARALLEL PRINTER PORT

**\$120.00**

### MULTI-FUNCTION BOARD

- RAM EXPANDABLE TO 384(K)
- SERIAL/PARALLEL PORT
- CLOCK CALENDAR W/BATTERY BACKUP
- GAME PORT
- SPOOL & RAM DISK

**\$129.00**

### MULTI-I/O BOARD

- FLOPPY DISK DRIVE CONTROLLER
- PARALLEL PRINTER PORT
- SERIAL I/O PORT (OPTION DUAL)
- CLOCK CALENDAR W/BATTERY BACKUP
- GAMEPORT

**\$149.00**

### RGB COLOR MONITOR

- 14" DISPLAY DB-9 CONNECTOR
- 640 x 240 HIGH-RES
- 2500 CHARACTERS (80 x 32)
- RGB TTL LEVEL, INTENSITY SIGNAL
- 0.39 mm DOT PITCH
- H-SCANNING 14.5K-17.8KHZ

**\$365.00**

### FULL FUNCTION KEYBOARD

- 83 KEY FULL FUNCTION
- POWER, CAPS, NUM LIGHT INDICATOR
- MECHANICAL TYPE SWITCH
- WITH CABLE

**\$79.00**

### 135W POWER SUPPLY

**\$89.00**

### 150W POWER SUPPLY

**\$109.00**

### 6 OUTLET SURGE SUPPRESSOR (MIDLAND ROSS IND.)

**\$14.50**

### 10MB HARD DISK w/CONT

**\$495.00**

### 20MB HARD DISK w/CONT

**\$595.00**

### ASYNCR B232

**\$59.00**

### PARALLEL PRINTER CARD

**\$39.00**

### TEAC 55B DISK DRIVE

**\$89.00**

### HARD DISK DRIVE CONTROLLER (10MB OR 20MB)

**\$159.00**

### 64K RAM KIT (9 EA)

**\$8.50/KIT**

### 256K RAM KIT (9 EA)

**\$35.00/KIT**

### APPARAT EPROM BLASTER (FOR IBM)

**\$129.00**

### CITIZEN MSP-10 PRINTER

**\$299.00**

### TOSHIBA 1340 PRINTER

**\$599.00**

### DSDD 5 1/4 DISKETTE

**\$12.95/per 10 ea**

### PARALLEL PRINTER CABLE

**\$15.00**

# BYTE CONNECTION INC.

## BOTTOM LINE PRICE BUSTERS! - "Who you gonna call?"

### (714) 778-6496

#### PERSONAL COMPUTERS:

IBM ★ 1 (IBM Compatible), 384K, two 360 floppies, hi-res graphics card monitor and K.B.	\$ 995
IBM ★ II, all the above, w/10MB HD	\$1495
AT & T 6300, 256K, two 360 floppies, AT & T graphics card, monitor and K.B.	\$2222
all the above, w/360 floppy and 20MB HD drive	\$2828
AT & T 7300	CALL
COMPAQ PORTABLE, 640K, 360 floppy, 10MB HD	\$2595
COMPAQ DESK PRO, 640K, two 360 floppies, hi-res graphics card, K.B.	\$2020
all the above w/360 floppy, 10MB HD, 10MB tape b/u	\$3131
with 30MB	\$3636
COMPAQ PORTABLE MODEL 286, 512K, two 1.2 MB floppies	\$3838
above with one 1.2 floppy, 20MB HD	\$4444
COMPAQ DESK PRO MODEL 286, 640K, two 1.2 floppies, hi-res graphics card, monitor and K.B., S.P., C/C	\$3838
above with one 1.2 MB floppy, 20MB HD, 10MB tape b/u	\$4994
above w/30MB HD	\$5353
above w/70MB HD and 60MB tape b/u	\$6969
IBM PC, 256K, two 360 floppies, hi-res graphics card, monitor P., S., C/C, K.B.	\$2099
above w/360 floppy, 10MB HD, 10MB tape b/u	\$3131
IBM PC XT, 640K, 360 floppy, 20MB HD, 10MB tape b/u	\$3663
IBM PC AT, 512K, 1.2 MB floppy, 20MB HD, S., P., C/C, hi-res graphics card, monitor, K.B.	\$4444
IBM PC AT, above with 70MB HD, 60MB tape b/u	\$6969

#### PRINTERS:

ANADIX 9620 - 9752	\$1129 - \$1350
BROTHER DM40 - DH45	\$ 950 - \$1050
CITIZEN MSP15 - 25	\$ 439 - \$ 619
COMREX CR III	\$ 395
DATA PRODUCT 8070 - 8072	\$1750 - \$1850
DATA PRODUCT LINE PRINTERS	CALL
DIABLO P32 - 34LQ	\$ 685 - \$1250
DIABLO AP1 - P38	\$1595 - \$1550
EPSON 85 - 185	\$ 399 - \$ 499
HP LAZERJET	\$2600
HP LAZERJET PLUS	\$3550
NEC 3550 - 8850	\$1050 - \$1350
OKIDATA 192 - 193	\$ 389 - \$ 495
OKIDATA 84 - 2410	\$ 665 - \$1825
PANASONIC 1093	\$ 499
TOSHIBA 1340	\$ 550
TOSHIBA P351	\$1159

#### PLOTTERS & DIGITIZERS:

CALCOMP 1043	CALL
HP 7475	\$1659
HITACHI DIGITIZERS	CALL
H1 DMP 41 - 42	\$2495
H1 DMP 51/52	\$3595
H1 DMP 51 MP-52 MP	\$4995
NICOLET DPX	CALL
ROLAND DPX	\$3850
TI	CALL
10 LINE	\$4095

We carry all name brand MFC, modems, monitors, monitor adapters and software. Call for what is not listed. WE GUARANTEE THAT YOUR CALL WILL NOT BE A WASTE. No charge for testing and configuring systems. Prices and availability subject to change without notice.

**163 West Cerritos Ave., Anaheim, CA 92805**

**(714) 778-6496**

# D & D CHRISTMAS SPECIALS ENSURES A HAPPY NEW YEAR

## SPECIAL #1

### CORONA PORTABLE

- 512K • 2 Drives
- Monitor • Keyboard • DOS

**\$1195**

All Sales Are Warranted for 90 Days, Parts & Labor  
**WE SERVICE WHAT WE SELL!**

## MAIL ORDER AND SAVE

ORDER TOLL FREE (800) 621-0849 ext. 446

## SPECIAL #2

### IBM PC 256K

- Two 360K Drives

ONLY

**\$1529**

## SYSTEMS

### IBM

PC 256K, 1 Drive .....\$1495  
PC 256K, 2 Drives ..... 1529  
XT 256K, 1 Drive ..... 1879  
XT 256K, 1 Drive 1-10 MG 2195

### COMPAQ

Portable, 2 Drives, 256K ..\$1875  
Call on Desk Pro's

### CORONA

Portable .....\$1195  
Desk Top, 2 Drives, 512K  
w/monitor ..... 1399

## MODEMS

### HAYES

Micromodem IIE .....\$ 149  
300 ..... 149  
1200 ..... 389  
1200B IBM Internal ..... 359  
2400 External ..... 639

### PROMETHEUS

Promodem 1200 .....\$ 279  
Promodem 1200A ..... 289  
Promodem 1200B ..... 269  
Promodem 1200MAC .... Call

### ANCHOR

Mark 12 .....\$ 199  
Express ..... 255

## PRINTERS

### EPSON

Call for Best Pricing

### OKIDATA

182, 120 cps .....\$ 218  
183, 120 cps ..... 418  
192, 160 cps, IBM ..... 348  
193, 160 cps, IBM ..... 498  
84, 200 cps, IBM ..... 658  
OKI-MATE 20, Color ..... 118

### TOSHIBA

P1351 ..... Call  
P1340 .....\$ 519  
P351 ..... 1029

### STARMICRONICS

SG10/15 .....\$219/389  
SD10/15 ..... 355/469  
SR10/15 ..... Call

### CITIZEN

MSP-10 .....\$ 249  
MSP-15 ..... 369  
MSP-20 ..... 399  
MSP-25 ..... 539

## DISKETTES

Call for quantity discounts

### PRECISION COPY

SS 100 (Box of 10) .....\$ 17  
DS 100 (Box of 10) ..... 19

### DYSAN

SS 100 (Box of 10) .....\$ 30  
DS 100 (Box of 10) ..... 34

### POLAROID DS/DD

Bulk Disks as low as .....69¢ ea.

## IBM EXTRAS

We carry almost everything for  
PC, AT or XT

Name Brands or Generic

### AST RESEARCH

PC Net II .....\$ 519  
SixPak +, 64K w/Side Kick 209  
Reach w/Crosstalk ..... 329  
Preview Mono Card ..... 239  
Advantage w128K ..... 399

### D & D MEMORY CARD

MF-100+, 64K same as  
SixPak + .....\$ 119

### HERCULES

Color Card w/Printer Port ..\$ 149  
Mono Graphics Card ..... 305

### GOODIES

IBM Printer Cable .....\$ 15  
64K Ram Set of Nine Chips 8  
256K Ram Set of Nine Chips 29  
Power Supply 135 Watts .. 79  
8087 CoProcessor Call for Best Price  
DOS 2.1 ..... 55  
DOS 3.1 ..... 64

## MONITORS

### PRINCETON GRAPHICS

Max 12E .....\$ 159  
HX-9 ..... Call  
HX-12 ..... 429  
SR-12 ..... 569  
Doubler Card ..... 179

### THOMSON

Color Monitor .....\$ 329  
Monochrome Monitor ..... 169

### AMDEK

310A .....\$ 148  
600 ..... 419  
722 ..... 525

## DRIVES

### IBM COMPATIBLE

Teac 55B .....\$ 80  
Mitsubishi 4851 ..... 84  
Tandon TM 100-2 ..... 84  
Seimans DT542 ..... 84  
Panasonic JU455 ..... 84  
In quantities of 2 or more

### TEAC

55B, 320K .....\$ 84  
55GF, 1.2MG for AT .... 179

### WELTEC

AT Compatible 360K ....\$ 109

### IRWIN

10 MG Tape Backup .....\$ 479

### 100% APPLE COMPATIBLE 5 1/4"

525A for Iie and II+ .....\$ 109  
525C for Iic ..... 119

## APPLE EXTRAS

### ALS

Z-Engine 2.2 .....\$ 115  
CPM 3.0 Card ..... 279  
256K Add Ram ..... 149

### ORANGE MICRO

Grappler + .....\$ 78  
Grappler+ Buffered w/16K 145

### MICRO SCI

80 Column Card 64K ....\$ 79

**WE OFFER VOLUME DISCOUNTS! MAKE THAT CALL (800) 621-0849 ext. 446**

## SPECIAL #3

### IBM PC

- Two 1/2 Ht 360K Drives
- 256K • 10 MG Hard Disk Drive
- 120 Day Warranty

**\$1989**

## SPECIAL #4

### MULTIFUNC. CARD FOR IBM

- Serial and Parallel Ports
- Clock/Gameport • Ram disk/  
Printer spool, Software • 1 yr. War.

w/384K only **\$159**

## SPECIAL #5

### INTERNAL HARD DISK FOR IBM

- Seagate w/IBM Controller
- 10 Meg 20 Meg

**\$469 \$569**

## SPECIAL #6

### IBM PC/XT COMPATIBLE

- Two 360K 1/2 Ht Drives
- 256K • 8 Slots • 135 Watts
- 120 Day Warranty

**\$569**

**d&d Discount Computers**

SELLING TO YOU SINCE 1978

### MAIL ORDER:

13324 HAWTHORNE BLVD., SUITE 201  
HAWTHORNE, CA 90250

### ORDER DESK:

Inside California (213) 970-0206

Outside California (800) 621-0849 x446

Hours: Monday—Friday 8 am to 6 pm  
Open Saturdays

WE CARRY TOO MANY ITEMS TO LIST,  
PLEASE CALL FOR A QUOTE ON ANY ITEM.



No Surcharge for Credit Cards

Terms: All merchandise new. We accept MC, Visa, Wire Transfer, C.O.D. (call), Certified Check, P.O.'s from qualified firms. Shipping: minimum 4.00 first 5 pounds. Tax: California residents only add 6 1/2% sales tax. All returns subject to 15% restock fee. Prices Subject to Change.



**FITS IBM PC, XT & AT**

**64-256K PRINTER BUFFER**

- Includes Parallel Printer Port
- One Year Limited Warranty

**64K...\$140**  
(Non-upgradeable)

**64K...\$155**  
(Upgradeable)

**256K...\$180**

TO ORDER CALL  
**800-826-1465**  
**(602) 938-3165**

**Ditron**  
CORPORATION  
4026 W. ST. JOHN  
GLENDALE, AZ 85308

MC/VISA, COD ACCEPTED  
DEALER INQUIRIES WELCOME  
IBM, PC, XT, AT a trademark of IBM CORP.

Inquiry 118

**VT100 \$150\***  
\* plus your

**PC, jr, XT, AT or compatible**

**ZSTEMpc-VT100 Smart Terminal Emulator**  
132-col. by windowing - no addit. hardware  
Double High Double Wide Characters  
Full VT100 line graphics. Smooth scrolling  
2-way file transfers incl. XMODEM and KERMIT  
Full keyboard softkeys/MACROS  
Speeds to 38.4KB. High Throughput  
Color/graphics, monochrome & EGA support  
International Font Support  
Single Key DOS Access

**ZSTEMpc-VT100 \$150. ZSTEMpc-D200 \$125.**  
30 day money back guarantee. MC/VISA.

**KEA SYSTEMS LTD.**  
#412 - 2150 W. Broadway  
Vancouver, B.C. CANADA V6K 4L9  
Support (604) 732-7411  
TELEX 04-352848 VCR

**Orders Toll Free (800) 663-8702**

**Zstem** by **KEA SYSTEMS**

Inquiry 385

**ICs PROMPT DELIVERY!!!**  
SAME DAY SHIPPING (USUALLY)

OUTSIDE OKLAHOMA: NO SALES TAX

V20 CPU J1PD70108D-8	\$16.00
8087-2 Math Coprocessors	140.00
<b>DYNAMIC RAM</b>	
256K 64Kx4 150 ns	\$8.45
256K 256Kx1 120 ns	3.25
256K 256Kx1 150 ns	2.47
128K 128Kx1 120 ns	5.20
64K 16Kx4 150 ns	2.75
64K 64Kx1 150 ns	1.00
<b>EPROM</b>	
27C256 32Kx8 250 ns	\$9.99
27256 32Kx8 250 ns	4.75
27C64 8Kx8 150 ns	3.99
2764 8Kx8 250 ns	2.25
<b>STATIC RAM</b>	
6264LP-15 8Kx8 150 ns	\$3.25

640 Kbyte MOTHERBOARD KITS: IBM PC/XT Zenith 150 & 100. Compact Portable & Plus! \$65.00

QUANTITY ONE PRICES SHOWN  
NEW! 100 ns 256Kx1 D-RAM @ 5.15

OPEN 6 1/2 DAYS: WE CAN SHIP VIA FED-EX ON SAT.

MasterCard VISA or UPS CASH COD  
**Factory New, Prime Parts** **µPoo**  
**MICROPROCESSORS UNLIMITED, INC.**  
24,000 S. Peoria Ave., (918) 267-4961  
BEGGS, OK. 74421

Prices shown above are for Nov. 18, 1985  
Please call for current prices. Prices subject to change. Please inspect tapes or lower prices on some parts due to supply & demand and our changing costs. Shipping & insurance extra. Cash account prices shown. Orders received by 4 PM CST can usually be delivered to you by the next morning, via Federal Express Standard Air or 36.00, or Priority One in \$13.00!

Inquiry 244

**Check your spelling as you type!**

**The Resident Speller™**  
PC Version

- Turn on or off checking with the touch of a key
- Add words to alternate list
- Works with most word processors
- Requires 90K in addition to word processor for 49,000 word dictionary

**The Resident Speller \$99**  
**Demo Disk \$ 2**

**S & K Technology, Dept. G**  
4610 Spotted Oak Woods  
San Antonio, TX 78249  
512-492-3384

Inquiry 316

**Artificial Intelligence on your Commodore or Apple!**

**ADVISOR**, the first low-cost expert system designer brings this new technology to professionals, educators, scientists, and serious hobbyists. **ADVISOR** can reason about uncertain knowledge situations, making it a capable tool for real world applications.

- Super-fast inference engine
- Backward & forward chaining
- 255 If/Then Rules
- 127 Logical Variables
- Interactive, easy to use

Available for the APPLE II® series or C-64/128®, **ADVISOR** comes with manual and sample expert systems.

**ONLY \$99.50**  
Plus \$3.00 Postage and Handling  
(CA RES ADD 6% SALES TAX)  
ALLOW 6-8 WEEKS FOR DELIVERY

**UMI ULTIMATE MEDIA INC.**  
275 Magnolia Ave.  
Larkspur, CA 94939  
For Credit Card Orders, call (415) 924-3644  
DEALER INQUIRIES INVITED

Inquiry 365

**NationServ**  
Online Information Network  
POB #391, Fairfield, IL 62837  
618-847-2291 24hrs @ 300-1200

ONLINE BBS LISTINGS  
JOBSERVICE-NA LISTS  
MESSAGE CENTER-INFO  
PLAY GAMES ONLINE  
SHOPPING MALL - UGS  
CLASSIFIEDS-DNLOADS

\$15/yr-No connect/hourly fee!  
Each 100th membership...free!  
The winner's fee is returned!  
Call and register with SYSOP!  
Limited "guest" access avail!  
Clubs and groups are welcome!  
Fastest growing system in US!

Inquiry 261

**IBM PC/VT220**

- EM220 for IBM PC, XT, AT**
  - VT220, VT102 emulation
  - File Transfer \$149
  - 132 Column modes
  - Color Support
  - Hot Key
- EM4010 for IBM PC, XT, AT**
  - Tektronix 4010 emulation
  - VT220, VT102 emulation \$249
  - Picture files
  - High resolution hardcopy
  - Supports IBM, IBM Enhanced, Hercules, Tecmar and AT&T.

**Diversified Computer Systems, Inc.**  
3775 Iris Ave., Suite 1B  
Boulder, CO 80301  
(303) 447-9251

Trademarks: VT100 - Digital Equipment; IBM PC, XT - IBM Corp.

Inquiry 119

**WHY YOUR FLOPPY DISK SHOULD BE A BASF FLEXY DISK**

- Lifetime warranty.
- Certified 100% error-free.
- Special self-cleaning jacket and unique two-piece liner.
- Center hole more accurate than industry standard.
- Bi-axially oriented polyester substrate.
- Cross-linked oxide coating.
- Double lubrication.

**PLUS BASF Special Offer**  
Call, write or utilize reader service - we'll send you our full-range catalog of computer supplies with a special offer enclosed.

**Simply #1 in Service & Reliability**

**LYBEN COMPUTER SYSTEMS**  
1050 E. Maple Rd.  
Troy, MI 48063  
(313) 589-3440

Inquiry 217

**ChinaStar® II CHINESE WORD PROCESSOR**  
中文文書處理

**\$99.**

- IBM PC, XT, AT, portable or compatible with 256 K RAM
- Multilingual
- 21,000 Traditional or 11,000 Simplified Chinese characters
- Traditional/Simplified file translation program
- Multiple input methods

**JHL JHL RESEARCH, INC.**  
2552 W. Woodland Dr., Anaheim, CA 92801  
(714) 827-7420 Telex: 350481 IBC

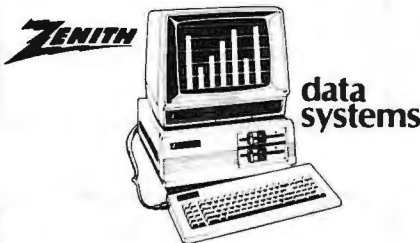
Inquiry 412



## Computer Systems

### VIASYN 816/286-H40 w/256K SPUZ & .5MDrv/H. \$\$ SPECIAL... TOO LOW TO ADVERTISE

VIASYN 816/C2 w/80286, 512K RAM, SPUZ-256, 40Mb H.D., 10Mb Tape, 5 1/4" 96TPI FLPY, CDOS 816/286, NewWord & SuperCalc II \$7,792  
VIASYN CORE SYSTEM w/256K RAM, I/F-4, Syst. Supp. 1, ENCL. 2D, Disk 1A, Disk 3, 5 1/4" FLPY, & 10Mb H.D. Add Your Choice of CPU & Oper. Sys. \$4,198  
VIASYN 816/10-H40 w/Two 5 1/4" FLPY'S \$5,195  
**CALL FOR OTHER SYSTEM CONFIGURATIONS**  
MORROW PIVOT II Portable CALL



data systems

ZENITH Z-158 PC-DESK TOP SYSTEM: 2 DRVS, 320K 2S & 2P Ports w/CLK-CAL/Battery, Includes MS-DOS, & 8 MHz Switch \$1,979  
640K RAM OPTION / 1/2 HT 10Mb TAPE \$99/\$495  
2 FLOPPY & 10Mb Drives / 20Mb Drives \$2,349/\$2,489



ATARI  
Power Without the Price™

"JACKINTOSCH"  
520 ST  
FREE PRINTER!

COLOR SYSTEM 32/16 BIT 68000 CPU, 512K RAM, 500K DRIVE, 4 COLOR GRAPHICS 640X200 RES., MENU DU MOUSE, TOS, BASIC & LOGO SOFTWARE, MUSIC GENERATOR, PARA., SERIAL & JOYSTICK PORTS, CLOCK & TERMINAL EMULATOR \$999.95  
JACKINTOSCH 520ST Monochrome 640x400 \$799.95  
VIP PROFESSIONAL/520ST Same As Lotus 1-2-3 \$170

## PC & AT Multifunction/Slave Bds.

We Have a Good Selection of Multifunction and Memory Boards for PC, XT, AT, JR, AT & T, and PC Portables  
INTEL ABOVE BOARD/AT 128K-4Mb w/Expanded Mem. SW to allow CPU to Address all Avail. Mem. \$459  
STB RIO PLUS II 64K-512K, S.P., CLK \$216  
STB RIO GRANDE/PC-AT 128K, -1.5Mb, 2S, P&G \$319  
TECMAR CAPTAIN UNPOP w/Treasure Chest \$157  
TECMAR EXPANSION CHASSIS With 8 Slots \$675  
TECMAR MAESTRO Unpopulated for IBM-AT \$325  
TECMAR WAVE 64K to 256K Fits XT Short Slot \$179  
ADVANCED DIGITAL PC-SLAVE w/256K, 8MHz 8088 CPU, 2 S Ports, RTNX S/W-For Multi-User PC \$695  
ALLOY PC-SLAVE/16 256K to 768K RAM \$759

## PC Scientific/Industrial Boards

IND.COMP.DESIGNS 1000 w/96TTL I/O Ports \$379  
TECMAR BASE BOARD 96 Digital I/O Lines CALL  
TECMAR DADIO D to A Up to 24 Devices CALL  
TECMAR IEEE-488 Board CALL  
TECMAR LABMASTER CALL

## Power Solutions

PC/XT REPLACEMENT P/S 130/150 WATT \$89/\$99  
SAFT SPS1000VA 1000 WATT/SINE WAVE \$1,095  
SOLA 750/4500 WATT HI-INRUSH UPS \$1,959  
TRIPPLITE ISOBAR Line Suppressor-Filters from \$38  
TRIPPLITE BC-425-FC 425 Watts 15-20 Minutes \$439

## Video/Graphics & Cad

STB GRAPHICS PLUS II & MONO PLUS II \$249/\$169  
STB CHAUFFEUR RGB Port/16 Grey Shades \$279  
TECMAR GRAPHICS MASTER/TENDER \$439/\$189  
ILLUMINATED TECHNOLOGIES AUTOCAD PACKAGE: 8 Color 1024X1024 S-100 Board • Inside Autocad Handbook • Autocad 2 • Mitsubishi 19" 1024X874 RGB Analog Color Monitor • Hitachi Tiger 11"X11" Tablet with 12 Button Cursor \$4,995  
CSD-PC AUTOCAD 2 PACKAGE: 1024X1024 Monochrome Graphics • 15" 1100X1250 Res. \$3,149

## Printers, Plotters & Buffers

**BROTHER CHRISTMAS SPECIALS** CALL  
CITIZEN MSP-15 160/40 CPS 15" Low Profile \$409  
CITIZEN MSP-25 200/50 CPS 15" ULTRA QUIET \$569  
EPSON LX80, RX100+, FX80+, FX100+, LQ1500 CALL  
HOUSTON INST. PLOTTERS & DIGITIZERS CALL  
OBERON OMNI-READER w/PC Software "READS" Text Directly Into Word Processor \$409  
OKIDATA ALL MODELS CALL  
HANZON 12315 64K-256K INTELLIGENT BUFFER SER.-SER., SER.-PAR., PAR.-SER., PAR.- PAR. Computer to Printer Combinations Possible \$259  
JOHNATHAN FREEMAN DESIGNS UNIVERSAL PRT BUFFER S&P In & S&P Out, 64K/256K \$189/\$249  
PRACTICAL PERIPH. MICROBUFFERS CALL

## Mainframe & Drive Enclosures

INTEGRAND 2909 2X8" 1/2 HT Horiz. Stack \$189  
INTEGRAND 2210 w/4 Slots & 5 1/4" Fipy & H.D. \$315  
INTEGRAND Laser Turbo 10 Slots, 2 H.D. 5 1/4" \$498  
JMR POWERPLAY-Side by Side 5 1/4" H.D. with Console and 6 Surge/Noise Protected Outlets \$239  
JMR 1 H5 5 1/4" H.D. PC Style Cabinet \$189  
MPS 5500 5 1/4" H.D. & 1/2 HT FLPY or TAPE \$209  
MPS 10065 "SUPER STRT" 6 Slots & 1.5 H.D./Floppy Drives \$395  
MICROWARE 920004 Dual STD. 5 1/4", PC-Style \$149  
PARA DYNAMICS 2300-G3 2X8" FLPY & 5 H.D. \$395

## Floppy Disk Drives

MITSUBISHI 2894 STD / 2896 1/2 HT 8" \$395/\$369  
MITSUBISHI 4853 / TEAC FD55F 96TPI \$129/\$99  
TEAC FD55B & MITSUBISHI 4851 / SANYO \$88/\$79

## Hard Disk Subsystems

PC-INSIDER/PC-OUTSIDER H.D. SERIES FOR IBM 10 Mb to 116Mb Formatted with Controller & All Cables, Hardware & P/S or PC Style Cabinet CALL  
TECMAR QIC 60 TAPE For PC'S \$1,449  
CALL For DLR &/or QTY. PRICES on HARD DISKS:

## MITSUBISHI Maxtor Seagate MICROPOLIS QUANTUM Amcodyne

S-100 BUS SUBSYSTEMS Supporting Turbodos, Concur. Dos. CP/M 80 & 816 Operating systems CALL  
10Mb TAPE (CompuPro or PC) INT/EXT \$498/\$598

## S-100 Bus Boards

If you purchased before calling us, you probably paid too much! We stock ACKERMAN DIGITAL, ADVANCED DIGITAL, CCS, VIASYN, CROMEMCO, DUAL, ELECTROLOGICS, INTERCONTINENTAL MICRO, KONAN, MULLEN, PICKLES & TROUT, INDUSTRIAL COMPUTER DESIGNS, TARBELL, TECMAR, TRANSEND, VECTOR ELEC.  
A Few Of This Month's SPECIALS Are:  
ACKERMAN MEMORIZER W/O Memory, 64K RAM & EPROM \$211  
ACKERMAN KLUGE CARD A&T \$175  
COMPUPRO/VIASYN RAM16 64K STATIC \$175  
COMPUPRO/VIASYN RAM 22, 256K STATIC \$472  
COMPUPRO/VIASYN RAM 23, 128K STATIC \$229  
DUAL NEW BOARD SPECIALS CALL  
ICD A/D64-100 w/64 Analog Inputs \$225  
MACROTECH 256-ST \$395  
MACROTECH VRAM 512K Static with Battery Back-Up and MDrive/H Capability \$769  
MACROTECH MI-286 80286/Z80H Dual Proc. \$699  
MACROTECH MSR-II 1Mb Dynamic Ram \$825  
MACROTECH MSR-II 2Mb Dynamic Ram \$999  
VECTOR RAM 17 64K Static Ram (VIASYN) Excellent with Z80 CPU'S \$299  
VECTOR INTERFACER I Dual Serial (VIASYN) \$209  
VECTOR INTERFACER II 3 Para., 1 Serial \$229

## Monitors & Terminals

PRINCETON GRAPHICS SR-12 690 X 480 RGB \$609  
TATUNG CM-1322 640X200 RGB Same as IBM \$375  
TATUNG CM-1360 LIKE 1322 w/G-A Switch \$419  
TATUNG CM-1370 720X480 RGB w/GRN Switch, Long Persist Phos. Works w/ STB's SUPER RES 400 \$469  
TATUNG MM-1222G/A Hi-Res 12" TTL(IBM) at \$119/125  
TAXAN MONITORS Call for Low Prices  
TECMAR 640X480 RGB. GRN Switch Long Phos \$519  
ZENITH ZVM123A (Green) / 122A (Amber) \$85/\$89  
LINK 125 Wyse 50 Comp. 14" GRN or AMB w/Higher RES., More Emul's, Selectric K.B., 6 Scroll Rates \$449  
LINK 125/PC w/PC Emulating Video & Keybd CALL

## Modems

HAYES SMART MODEM 1200 / 2400 \$425/\$639  
PRENTICE POPCOM w/PFS Access C150/X150 \$299  
PROMETHEUS PROMODEM 1200 Hayes Compatible w/ Built-In PWR Supply-RS232 Stand Alone Unit \$289  
OPTIONS FOR PROMODEM 1200 ARE:  
PROCESSOR/64K MEMORY/DISPLAY \$75/\$19/\$79  
PROMETHEUS 1200 APL/IBM/MAC \$295/\$265/\$329  
U.S. ROBOTICS COURIER/PASSWORD \$435/\$209  
U.S. ROBOTICS S-100 Board 300/1200 \$319  
U.S. ROBOTICS PC MODEM w/ Telcap Software \$219  
U.S. ROBOTICS PC MULTI-MODEM 256K \$439

## Software • Software • Software

We have Access to all Well Known Brands - ORDER CORRECTLY - SOFTWARE IS NOT RETURNABLE!

## Operating Systems & Utilities

ADVANCED DIGITAL CP/M 3.0 \$290  
COMPUPRO/VIASYN CPM At Affordable Prices  
CROMEMCO 68000 CROMIX \$475  
DIGITAL RESEARCH Complete line up to 35% Off

## Language And Tools

BD SOFTWARE "C" Compiler 8" SS SD 8 BIT \$95  
COMPUTER INNOVATIONS C-86 "C" Compiler \$299  
COMPUIVIEW VEDIT/VEDIT-PLUS \$115/\$169  
DIGITAL RESEARCH Most products in Stock CALL  
LATTICE "C" Compiler \$299  
MICROSOFT Complete Line CALL

## Data Bases & Spreadsheets

ASHTON-TATE dBASE II & III BEST PRICE  
DATAFLEX FILE/RECORD Locking Multi-User CALL  
PFS FILE/REPORT CALL  
ASHTON-TATE Framework CALL  
MDBS Knowledgegeman \$309  
SORCIM SuperCalc-3 Better Than 1-2-3!!! \$209

## Diskettes & Cartridges

3M TAPES 300XL & 600A/1000A In Stock \$29.95/19.95  
DYSAN 3740/20 8" DSDD / 3.5" SSDD \$31/\$29.49  
FUJI 5 1/4" SSDD / 5 1/4" DSDD \$15/\$19  
FUJI FILM FD2D-1024 8" DSDD \$29.95

## Hobby Corner

**SOLD "AS IS" WITH NO RETURNS**  
AMPRO "LITTLE BOARD" (The Original) \$259  
APPLE II INTEGRER BASIC CARD \$59  
CROMEMCO ZPU \$149  
DRI GSX-80 (From CompuPro) \$39  
DRI PASCAL/MT+ \$175  
ELECTROLOGICS QUASI-DISK 2/4Mb CP/M80 RAM DISK with Battery Back-Up \$1,695/\$3,095  
HEURISTICS SPEECH LAB For Speech Recognition 95  
IMSAI P106-6 Kit 2 Sets of 24 PROG. I/O Lines \$149  
IMSAI MIO KIT (Assembled) 2 PAR & 1 SER. \$69  
MICROPRO CalcStar 1.20 8" CP/M \$79  
MICROPRO SuperSort 1.60 8" CP/M \$140  
MICROSOFT MULTIPLAN CP/M80 8" \$117  
MORROW DJDMA-3A w/Software \$195  
MORROW HDCA-3 8 or 14" SA4008 H.D.C. \$195  
MORROW MPZ80 REV. 2 w/DOC. \$195  
NORTH STAR FLOATING POINT BOARD \$189  
PARA DYNAMICS 2508D Like 3510 w/ 8 Slots \$395  
PRAGMATIC DESIGNS PD20MS 8" FUJITSU 20Mb H.D. Subsystem For CompuPro System \$2,495  
PROTEUS ENGINEERING "WRITE" W.P. CP/M 8" \$50  
S.D.S. MPU 100 Z80 CPU KIT \$89  
S.D.S. E-PROM Board #27007 Kit \$49  
SMS STATIC RAM 64K For N.S. Horiz., Etc. \$149  
TEI TFD-O Cabinet For 3 STD 5 1/4" FLY DRVS. \$195





## PORTABLE MEMORY EXPANSIONS

**8K MEMORY MODULES \$29**

For Model 100, NEC PC-8201A & Olivetti M10

**24K MEMORY MODULES \$99**

For Tandy 200

**128K SIDESTAR \$399**

A Ram Disk Cartridge for the NEC Starlet

**128K SIDECAR \$259**

Ram Cartridge for the NEC PC-8201A

**TTXpress 1280 \$99**

Portable Thermal Printer—2.2 lbs., bat. oper.

**FREE SHIPPING IN USA**

(800) 732-5012 (805) 987-4788 (in Calif.)

**PURPLE COMPUTING**  
420 Constitution Ave., Camarillo, CA 93010

VISA/M/C & AMER. EXP.

Inquiry 300



## LIONHEART

BUSINESS & STATISTICAL SOFTWARE

PC/MS-DOS, AMIGA, MACINTOSH  
ATARI 520ST, CP/M, COMMODORE 128

Explanatory books with professional compiled software, the new standard for statistical use. The influential Seybold Report on Professional Computing has this to say about Lionheart "...our sentimental favorite because of its pragmatic approach to the basic statistical concepts... The thinking is that the computer merely facilitates the calculations; the important thing is to be able to formulate a problem correctly and to determine what type of analysis will be most valuable." Let Lionheart help you get ahead of the competition!

- BUSINESS STATISTICS ..... \$145
- EXPERIMENTAL STATISTICS ..... 145
- MULTIVARIATE ANALYSIS ..... 150
- QUALITY CONTROL & INDUSTRIAL EXPERIMENTS ..... 125
- FORECASTING AND TIME-SERIES ..... 145
- SALES AND MARKET FORECASTING ..... 145
- DECISION ANALYSIS TECHNIQUES ..... 110
- LINEAR & NON-LINEAR PROGRAMMING ... 95
- PERT & CRITICAL PATH TECHNIQUES ..... 95
- OPTIMIZATION ..... 110

PC/MS-DOS, Amiga, Macintosh, some CP/M

VISA, MasterCard, AMEX, Check

P.O. Box 379, ALBURG, VT 05440  
(514) 933-4918

Inquiry 210

## I/O Bus for Data Acquisition & Control

now available for IBM PC & Apple II series computer



The Local Applications Bus... 'LAB 40'

In photo are 'LAB 40-PC' generator & 'LAB 40-1' signal acquisition module.

- **Modular approach to data acquisition and control.**  
A 40 conductor ribbon cable bus is generated by a card in the host computer. Up to 8 low cost modules can be located anywhere on a cable up to 100 ft. long. Our LAB 40 generator cards for the IBM PC or Apple II are priced at \$175.
- **Signal Acquisition and Control Module, model 'LAB 40-1'.**  
Features: 8 bit resolution, 4 channels, differential inputs, sampling rate up to 650KHz, software programmable gains and offset, digital output port, low price of \$175. Twelve bit module available.
- **Full featured 'digital oscilloscope' software.**  
Documented and user modify-able. PC version \$175. (Apple II version \$100). Complete data acquisition packages (hardware and software) start at \$450.
- **Development tool.**  
Unique to LAB 40 is its ability to interface directly to microprocessor compatible integrated circuits and hybrids. We encourage users to develop projects and products. LAB 40 is an ideal educational tool.
- **New low cost modules.**  
Twelve bit A/D \$235. Port/Relay Driver \$95. Real Time Clock \$95.

### Computer Continuum

75 Southgate Ave., Suite 6 • Daly City, CA 94015  
(415) 755-1978

## The Truth of the Matter is...

Prevail is a UNIX-based office automation and application development solution which can be shipped to you *today*. If you are looking for office automation software or need a fourth-generation language, look to Prevail—an A.T.&T co-labeled product.

Prevail has seven components which will meet your needs.

- Word Processing
- Spreadsheet
- Database Management System
- Window Manager and User Interface
- Report Writer
- Applications Development Language
- Telecommunications

Prevail is available on AT&T 3B series, AT&T Unix PC Model 7300, NCR Tower, DEC VAX and MicroVax II series, Sun Microsystems computers, and Masscomp computers.



**Inspiration Systems, Inc.**  
400 Cummings Park, Suite 4300  
Woburn, MA 01801  
617/938-1160

Inquiry 181

## ACT 1 A COMPLETE FULLY INTEGRATED ACCOUNTING SYSTEM for PC-DOS\*

A powerful, time proven, (3½ yrs) flexible, w/integrity package including

GENERAL LEDGER  
ACCOUNTS RECEIVABLE  
ORDER ENTRY/INVOICING  
ACCOUNTS PAYABLE  
INVENTORY  
PAYROLL

only **\$99.50**  
plus shipping & handling

**(800) 344-2540**  
7 am to 7 pm MST



**COUGAR MOUNTAIN SOFTWARE**  
2609 Kootenai Box 6886 Boise, Idaho 83707  
\*PC-DOS trademark of IBM

Inquiry 418

## Quelo® 68000 Software Development Tools

**68000/68010 Assembler Package**  
Assembler, linker, object librarian and extensive indexed typeset manuals.  
Conforms to Motorola structured assembler, publication M68KASM[4]. Macros, cross reference and superb load map, 31 character symbols.  
Optimized for CP/M-80, -86, -68K, MS-DOS, PC-DOS. \$ 595  
Portable Source in "C" ..... \$3000

**Lattice® 68000 "C" Cross Compiler and Quelo 68000/68010 Assembler Package**  
Optimized for MS-DOS ..... \$1095

**68200 Assembler Package**  
Optimized for CP/M-80, MS-DOS, PC-DOS ..... \$ 595

**68020 Assembler Package**  
Optimized for CP/M-68K, MS-DOS ..... \$ 750  
Portable Source in "C" ..... \$3500

For more information contact **Quelo Inc.**  
2464 33rd W. Suite #173  
Seattle, WA 98199  
Patrick Adams Phone (206) 285-2528  
COD, Visa, MasterCard Telex II (TWX) 910-333-8171  
CP/M, tm DRI,MS-DOS tm Microsoft, Lattice, tm Lattice Inc.

Inquiry 308

## MAXELL DISKETTE Special Offer



Maxell offers a line of floppy diskettes that come to you certified free of dropouts. Maxell's 5.25" high density MD2 HD for the IBM PC AT and the 3.5" for the MACINTOSH, LISA AND HP PC. Now, when you purchase these diskettes save 5% on 5 boxes or 10% on 10 boxes. Call today for this savings and unbeatable prices on Maxell Diskettes from Computer Products Supply.

Computer Products Supply  
320 N. Madison Ave.  
Los Angeles, CA 90004  
CALL TOLL FREE  
(800) 621-0849 ext. 285  
OR CALL COLLECT  
(213) 664-1144

Inquiry 79

## UNIX, C and UNIX SHELL TRAINING

Asidor Systems Inc. offers four-day workshops in UNIX, C and Shell programming at their Union, NJ office. The following courses are offered:

- C Programming
- Advanced C Programming
- Unix Shell Programming
- Advanced Unix
- UNIX Workshop

For more information, write or call:

**Asidor Systems Inc.**  
2143 Morris Avenue  
Union, New Jersey 07083  
201-687-6780

Inquiry 27

## controls up to 4 motors from any CRT, terminal or computer



### CENTROID STEPPING MOTOR CONTROLLER

- powerful 5 amps/ winding
- acceleration deceleration
- RS232 interface
- 1-4 axis moves

Standard Version with BASIC \$985  
16K BASIC with Battery Backup \$1335  
CNC VERSION \$1950  
Stepping Motor Tips Cookbook \$8  
CNC Manual \$12

**CENTROID (814) 237-4535**  
Box 739, State College, PA 16804

Inquiry 55



**FREE SHIPPING ON ALL SOFTWARE**

# COMPUTERBANC

**Buy 2 of one product and get 5% off (systems excluded)**

**IBM PC AT 20 MB**  
(Seagate model 225)  
512K, serial & parallel  
**\$4299**

**Hard Drives**  
10 MB Internal 459  
10 MB External 639  
20 MB Internal 549  
20 MB External 729

**IBM PC XT**  
10 MB, 256K  
**\$1999**  
256K, 2 drive  
**ITT XTRA**

**AT COMPATIBLES**  
**SPERRY IT 44 MB**  
**\$4399** **CALL**  
**COMPAQ**  
**28630MB**

**EPSON EQUITY I CALL**  
**COMMODORE AMIGA CALL**

**COMPAQ DESK PRO**  
10 MB, 640K  
**\$2499** **\$1495**  
256K, 2 drive  
**ITT XTRA**

\* All systems include monochrome monitor, dos, and parallel port

**IBM SOFTWARE**

LOTUS 123	CALL
SYMPHONY	CALL
ENABLE	389.00
GEN COLLECTION	129.00
ASHTON TATE Framework	379.00
dBASE II	289.00
dBASE III	389.00
CLIPPER dBASE III Compiler	379.00
MULTIMATE	239.00
SOACIM SUPERCALC III	210.00
SUPER PROJECT	210.00
MICROSOFT Multiplan	289.00
Word	159.00
Project	159.00
FOX & GELLER Quickcode	139.00
NOARTON UTILITIES	52.00
TURBO PASCAL ver 3.0	49.00
SUPERKEY	37.00
SIDENICK (unprotected)	46.00
ASCI PRO Comm Software	59.00
CROSSTALK XVI	105.00
PEACHTREE Back to Basics	101.00
IN-HOUSE ACCOUNTANT	89.00
WORD PERFECT	249.00
MICROPRO WordStar Pro	239.00
WordStar 2000 +	316.00
SAMNA PLUS	345.00
WORD III	279.00
ABASE 5000	389.00
PRINTMASTER	35.00
ENERGRAPHICS	169.00
BPI General Accounting	316.00
ALSO HAYDEN, MONOGRAM, BPI, MICROCORAM, NORTON AND MORE	

**IBM HARDWARE**

AST 6 Pock Plus w/384k	250.00
Advantage W/128k	417.00
HERCULES Mono Graphics	319.00

Color Card	159.00
ORCHID Turbo w/256k	599.00
QUADRAM Quadboard O-H	198.00
QuadPort for AT ser & par	115.00
TECHNAR Graphics Master	469.00
STB Aia plus 64K 5 Function	189.00
Rio Grande 3 function for AT	289.00
Graphix Plus	210.00
High Res 400	349.00
Chaffeur monographics	NEW 234.00
PARADISE Modular Graphics Card	CALL
SIGMA High Res Color 400	CALL
IBM Compatible color card	119.00
Multifunction Card 384k s.p.cdk	169.00
Multifunction Card OK-1, 2mb	179.00
Compatible Mono Card w/par	129.00
5151 Compatible Keyboard	129.00
TTL Monitor Amb or Grn	100.00
TALGOASS W/Tape	CALL
IRWIN TAPE DRIVE	499.00
EVEREX TAPE Pc/Xt/AT	CALL
Graphics Edge Card	CALL
RODIME 20MB DRIVE	CALL
TEAC 558V	95.00
IBM 1.2MB FLOPPY	CALL
360K Floppy for AT	115.00
MOUSE SYSTEMS Mouse	139.00
MICROSOFT Mouse	117.00
KORLA KAT	149.00
DISKETTES DS/DD	15.00
ALSO — PERYSVT, PARADISE, TECHNAR, EVEREX AND OTHERS	

**MODEMS**

ANCHOR Express 300/1200	229.00
Volkmodem 1200 (5 yr wrnty)	189.95
Lightning 2400 Baud	CALL
HAYES 1200	379.00
1200B	349.00
2400	CALL
Micromodem //e	CALL
Transet 1000	CALL

PROMETHEUS 1200	293.00
Promodem 1200B	229.00
Promodem 1200A	229.00
Promodem Mac Pac Pac Hit	329.00

**MONITORS**

AMDEK 300A	139.00
310A HI-Res Amber	135.00
COLOR 600 HI-RES RGB	433.00
COLOR 710	474.00
PRINCETON GRAPHICS HX-12	469.00
HX-9	449.00
SA-12	625.00
MAX-12	179.00
TAXAN 121/122	149.00
640 (RGB) 640 x 200 NEW	335.00
630 (RGB) 640 x 400 NEW	399.00
640 (RGB) 720 x 400 NEW	499.00
PANASONIC DT-S101 Color	179.00
DT-H103 10" High Res RGB	349.00
DT-D1300D 13" RGB Color	249.00

**PRINTERS**

BROTHER NEW 1509	345.00
HA-15XL	345.00
HA-25XL	469.00
HA-35XL	699.00
Twinwriter	822.00
EPSON LX-80	225.00
FX-85	345.00
FX-185	485.00
OHMDATA ML-192	373.00
ML-193	522.00
PANASONIC HX-P1091	229.00
HX-P1092	279.00
HX-P1093	399.00
HX-P3131 17 cps LQ	249.00
HX-P3151 22 cps LQ	379.00
TOSHIBA P351 w/tractor	1279.00
STAR MIRACONS SG-10	219.00
CITIZEN MSP-10	266.00
MSP-15	332.00

CANNON Laser Printer	CALL
HOUSTON INSTRUMENTS Plotters	CALL

**APPLE PRODUCTS**

APPLIED ENG. Ramworks 64K	149.00
AST Multi I/O	CALL
MICRO SCI A2 Drive Ite	169.00
Iic compatible drive	139.00
APPLE Compatible Dr (1yr wrnty)	129.00
HABA Mac drive	CALL
MAC Compatible 3 1/2 drive	249.00
BERNOULLI 5MB MAC drive	CALL
MACINTOSH Harddrive	CALL
MACINTOSH Software Jazz	CALL
MICROSOFT Macenhancer	175.00
Softcard II	259.00
Multi-plan //e & Mac	129.00
Basic (Mac)	109.00
ASCII XPRESS (communications)	69.00
THE DESK ORGANIZER (Mac)	133.00
APPLE MOUSE II	129.00
APPLEWORKS	215.00
PRINTSHOP	30.00
HAYES Mach III Joystick	39.00
SYSTEM Saver Fan	69.00
VIDEO 7 Iic Enhancer	99.00
Titan Accelerator	229.00
VIDEX Ultraterm	169.00
APRICORN (Lifetime Warranty)	
Super Serial Imager	69.00
Graphics Interface	59.00
80 Column/64K	59.00
Extend It 64K	39.00
KORLA SpeedKey	39.00
Muppet Keys	39.00
DISKETTES APPLE/MAC	12.00/24.00
APPLE Ite 64k w/80 column	775.00
WE SUPPORT THESE FINE SYSTEMS: APPLE, IBM, COMPAQ, ITT, AND MANY MORE No Charge for Credit Cards	

**Call for complete pricing. Thousands of products available.**



## COMPUTERBANC

16783 Beach Blvd., Huntington Beach, CA 92647  
TELEX #550757 ANSWER BACK—COMPUTER UD  
714/841-6160



No Charge for Credit Cards

Orders Only

800/332-BANC

OUTSIDE CALIFORNIA

Cash prices indicated. All products are in factory sealed packages. We guarantee all items for 30 days. Within this period, defective merchandise returns must be accompanied by AMA number. All other returns will be subject to a 10% restocking fee. For prepaid orders, there will be a 3% shipping charge; 5% for UPS Blue Label; \$5.00 minimum; all orders outside U.S.A. at 15% shipping. California residents add 6% sales tax. Prices subject to change without notice.

© Copyright 1985 COMPUTERBANC, All Rights Reserved.



"KING OF THE ELECTRONICS JUNGLE"  
LEO ELECTRONICS, INC.  
P.O. Box 11307  
TORRANCE, CA 90510-1307  
PHONE 213/212-6133 or  
outside CA: 800/421-9565  
TLX: 291 985 LEO UR FAX: 213/212-6106

WE WILL BEAT ANY PRICE  
ON MEMORY EXPANSION CHIPS

RAMS	EACH	Hard to find "NECESSARY" PARTS FOR IBM OR CLONE	
4125B-15	2.85	8284	4.35
4184-15	.75	8088	4.95
4184-20	.70	8288	6.75
4128-15 (AT)	4.25	8253-5	3.50
81187-3	1.85	8255-5	3.50
*58167	9.00	8259-5	5.50
(real time clock)		8237-5	6.75
		765	7.00

If these prices are not the lowest in this publication, we will beat any legitimate\*\* price.

\*\*Confirmed prime chip pricing on quality merchandise.

**MATH CO-PROCESSORS**

Individually boxed with instruction manual

8087-3	115.00
80287-3	180.00

\*IBM - Trademark of International Business Machines

We stock Republic of China Made and Foreign Orders. Item quantities, terms and conditions. U.S. funds only. Call for C.D.P. California residents add 6% tax. Shipping by UPS. Add \$2.00 for ground and \$3.50 for air. All major credit cards. All parts 100% guaranteed. Price subject to change without notice. \$10 minimum order. CALL FOR VOLUME PRICING.

Inquiry 206

# FAST!!!

SPEED COMPARISON  
CALCULATE 1000 SINES

MICROSPEED II+ - 1.4 SEC.

MICROSPEED II - 2.4 SEC.

APPLESOFT - 26 SEC.

PASCAL - 37 SEC.

TIME 10 20 30 40

Discover why MicroSPEED has set a new standard for microcomputer performance worldwide. This easy-to-use Language System has proven results in the most demanding applications, from the Space Shuttle to medical diagnosis. Hardware & software work together to boost your Apple or Amiga to minicomputer speed (1000-2500% increase).

CALL TOLL-FREE NOW:

## MICROSPEED

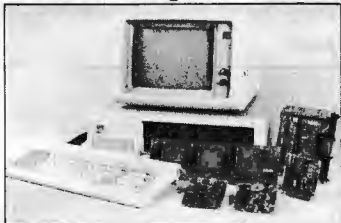
800-272-0777 301-627-6650

or write Applied Informatics, Inc.,

12217 Wheeling Ave., Upper Marlboro, MD 20772

Inquiry 21

## MODULAR DATA ACQUISITION



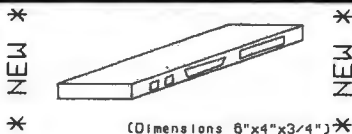
- For IBM & Compatibles
- Flexible and Inexpensive
- Money Back Guarantee
- Free Technical Support

Fast Delivery

**QUA TECH, INC.**

478 E. Exchange St. Akron OH 44304  
(216) 434-3154 TLX: 5101012726

Inquiry 302



(Dimensions 6"x4"x3/4")

BI-DIRECTIONAL SERIAL/PARALLEL CONVERTER

CONVERT YOUR RS232 SERIAL PORT INTO A CENTRONICS PARALLEL PORT, YOUR PARALLEL PORT INTO A RS232 SERIAL PORT, JUST BY MOVING JUMPERS.

NO MORE LIMITATIONS IN YOUR SYSTEM. NOW YOU CAN CONNECT A TERMINAL TO PARALLEL PORT, YOUR PARALLEL PRINTER TO A SERIAL PORT, SERIAL PRINTER TO A PARALLEL PORT, AND MUCH MORE !!!

BAUD RATE AND MODE FULLY SELECTABLE.

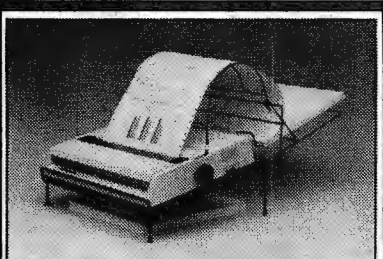
!!! ALL IN ONLY ONE UNIT !!!

ORDER TODAY AT INTRODUCTORY PRICE AT:

INTECTRA INC. - Department 232  
2629 TERMINAL BLU  
MOUNTAIN VIEW - CA - 94043  
(415) 967-8818 - TLX 345545

Introductory price \$ 29.99  
(California residents add 6% tax -  
Bay area residents add 7% tax)

Inquiry 182



## The GRANDSTAND PRINTER STAND AND TRAY

- Folds & Stacks Automatically
- Fits ALL Popular Micro Printers
- Space Saving Operation
- Routes Cables Neatly

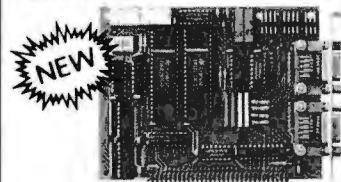


**Grand Union  
Micro Systems**

P.O. Box 1880  
Fallbrook, CA 92028  
(619) 723-0882

Inquiry 156

## RS-422 Communications Board



NEW

- For IBM-PC/AT/XT and compatibles
- Dual RS-422 serial interface
- Programmable to 56k baud
- Differential drivers to 4000 ft.

**\$345.00**

**QUA TECH, INC.**

478 E. Exchange St. Akron OH 44304  
(216) 434-3154 TLX: 5101012726

Inquiry 303

## BULK DISKETTES BY NASHUA



**75¢** each  
Qty. 100

5 1/4" DS/DD with hub ring and Tyvek sleeve, bulk packaged, no labels, factory warranted. Shipping extra. For quantity 50, add 10¢ each.

Get the same low price our high-volume duplication customers get!

CALL TOLL FREE

**1-800-321-4668**

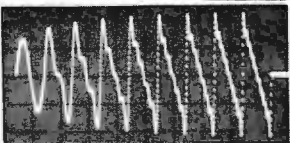
in Colorado, 303-234-0871

VISA, MASTERCARD, OR COD ACCEPTED

**ALF** 1315-F Nelson St.  
Denver, CO 80215

Inquiry 12

## WAVEFORM SYNTHESIZER



- For IBM-PC/XT/AT and compatibles
- Generates user-definable signal
- Up to 2000 points per envelope

**QUA TECH, INC.**

**\$795.00**  
478 E. Exchange St. Akron OH 44304  
(216) 434-3154 TLX: 5101012726

Inquiry 304

NEW!

## The Linker for Turbo Pascal™

Why recompile tested procedures over and over while debugging your Turbo Pascal programs, when TP•Linker™ can instantly link them in—already compiled. TP•Linker turns your compiled Turbo Pascal procedures into compact, linkable external procedures. Linkable procedures use 1/2 the memory as their Turbo Pascal source code. So you can bring them in off disk faster and store more of them on RAM disk. TP•Linker is easy to use, self-documenting, and works from the Turbo Pascal Program Development Environment. An extra bonus—now you can sell procedures written in Turbo Pascal as linkable procedures without having to disclose your source code. Why waste time re-compiling code that you know works? TP•Linker—the ideal upgrade for anyone using Turbo Pascal.

Not copy protected  
TP•Linker for Turbo 2.0, 3.0 \$69  
+ BCD, 8087 \$99  
Add \$5 S+H + \$10 for Overseas. MCA/ISA

A-OK Systems  
816 Easley St., Silver Spring, MD 20910  
301-585-5105 (6)

Turbo Pascal is a trademark of Borland Intl.

Inquiry 3



# FORTRON CORPORATION

3225 SELDON COURT, FREMONT, CA 94538

INFORMATION & CALIF. RESIDENTS

(415) 490-8171

TLX: 559291 FORTRON

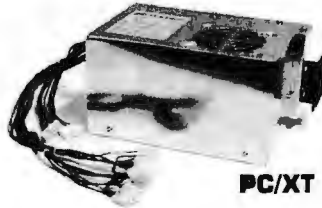
FAX: [415] 490 9156



**When choosing a POWER SUPPLY for your PC, XT, AT or Compatibles please consider this. . .**

"All look-alike supplies come with some type of warranty, only Fortron's power supplies come with a guarantee backed by a full U.L. rating. Your PC represents a substantial investment, it does not make sense to risk costly downtime due to bargain power supplies, when for a few dollars more you can have the confidence of Fortron quality."

**Trust in Fortron quality without compromise.**



**FC 135-40** [140 W. max.] **129<sup>00</sup>**

- For upgrade IBM PC to XT same pin out, same dimension as IBM PC, XT
- or 8 pin output connectors for Faraday CPU board
- With 4 drives connectors
- Low noise DC fan, 110/230 VAC convertible
- Over current, over voltage, short circuit, thermostat protections
- U.L. recognition, one year warranty

**FC 5192** (200 W. max.) **189<sup>00</sup>**

- Identical dimension & pin-out to IBM AT power supply
- Faraday type pin-out available
- W/4 drives connectors
- High air flow, low noise DC fan, 110/230 VAC convertible
- OCP, OVP, short circuit, thermostat protections
- U.L. recognition, one year warranty



**FORTRON-200** (200 W. Uninterruptible Power System for P.C.)

- 115V/230V AC input convertible
- Input current 2.5 amp
- 200W continuous
- 1/2 cycle (typical) transfer time
- Hold-up time from 20 minutes (200W) up to 60 minutes (60W)
- 5.12" x 7.7" x 13.46"



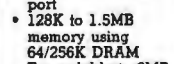
PC/AT

**ORDER TOLL FREE [800] 821-9771**





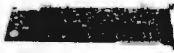
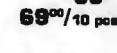
**Attractive Prices for Dealers/OEM's Please Call for Current Prices!**


## COMPUTER CHASSIS & KEYBOARD

<p><b>FC 630</b> <b>78<sup>00</sup></b></p>  <ul style="list-style-type: none"> <li>• For Faraday DTC BRD</li> <li>• Rear side switch</li> <li>• To use FC 130-40 power supply</li> <li>• Complete mounting hardware</li> </ul>	<p><b>FC 630 A2</b> <b>99<sup>00</sup></b></p>  <ul style="list-style-type: none"> <li>• IBM XT identical</li> <li>• To use FC 135-40 power supply</li> <li>• Side switch</li> <li>• Complete mounting parts</li> </ul>	<p><b>FC 630 AT</b> <b>139<sup>00</sup></b></p>  <ul style="list-style-type: none"> <li>• IBM AT identical</li> <li>• Complete mounting hardware</li> <li>• LED lamps, speaker optional</li> </ul>	<p><b>FC 640 Expansion Chassis</b> <b>269<sup>00</sup></b></p>  <p>Ext./Rev. Adaptor <b>179<sup>00</sup></b></p> <ul style="list-style-type: none"> <li>• Comes with 5 slot mother brd., 100 W. power supply, cooling fan</li> <li>• Three 1/2 height drive bracket</li> <li>• Dia. 15 1/4" x 12" x 6 1/4"</li> <li>• Ext./Rev. Adaptor optional</li> </ul>	<p><b>FC 427</b> <b>89<sup>00</sup></b></p>  <ul style="list-style-type: none"> <li>• IBM XT keyboard compatible</li> <li>• Enlarged return key</li> <li>• Light and num. lock keys</li> </ul>	<p><b>FC 527</b> <b>129<sup>00</sup></b></p>  <ul style="list-style-type: none"> <li>• IBM AT keyboard compatible</li> <li>• Enlarged return shift key</li> <li>• Capacitance low profile key switch</li> </ul>
---	---	--	---	--	--

<p><b>FC 230 Floppy Disk Controller</b> <b>59<sup>00</sup></b></p>  <ul style="list-style-type: none"> <li>• Drives 4 x 5 1/4" FDD</li> <li>• IBM compatible</li> <li>• w/cable</li> </ul>	<p><b>FC330 Hard Disk Controller</b> <b>149<sup>00</sup></b></p>  <ul style="list-style-type: none"> <li>• Up to 2 Hard Disk Drives</li> <li>• Fully Buffered I/O Bus</li> <li>• Built-in ECC</li> </ul>	<p><b>CT-6020 Color/Graphic/Printer</b> <b>109<sup>00</sup></b></p>  <ul style="list-style-type: none"> <li>• 80 x 25 Hi-Res</li> <li>• 40 x 25 Low-Res</li> <li>• 320 x 200 Dots</li> <li>• Comp. video output</li> <li>• Light pen conn.</li> </ul>	<p><b>FC940 RS232 /Real Time Clock</b> <b>69<sup>00</sup></b></p>  <p>Clock only <b>59<sup>00</sup></b></p> <ul style="list-style-type: none"> <li>• To 9600 Baud</li> <li>• Battery back-up</li> </ul>	<p><b>FC 830 512K Memory Expansion</b> <b>89<sup>00</sup></b></p>  <p>(8K)</p> <ul style="list-style-type: none"> <li>• From 64K to 512K</li> <li>• Parity-checked memory for error detection</li> </ul>	<p><b>FC 730 AT Multifunction Card for PC-AT</b> <b>249<sup>00</sup></b></p>  <ul style="list-style-type: none"> <li>• Game Port</li> <li>• 2 EIA-RS232C port</li> <li>• Centronics printer port</li> <li>• 128K to 1.5MB memory using 64/256K DRAM</li> <li>• Expandable to 3MB (optional)</li> <li>• Spooler</li> <li>• RAM disk</li> </ul>	<p><b>RS232/Printer Card for PC-AT</b> <b>119<sup>00</sup></b></p>  <ul style="list-style-type: none"> <li>• EIA RS232C port</li> <li>• Centronics parallel port</li> </ul>
--	---	--	--	--	--	--

## Low Low Cost for IBM PC, XT, AT Add-On Cards

<p><b>FC 930 RS232/Parallel Port</b> <b>79<sup>00</sup></b></p>  <ul style="list-style-type: none"> <li>• RS232 serial</li> <li>• Parallel interface</li> </ul>	<p><b>FC 530 Monochrome/Printer</b> <b>99<sup>00</sup></b></p>  <ul style="list-style-type: none"> <li>• 8 x 25 screen</li> <li>• 7 x 9 character</li> <li>• TTL Level of output</li> </ul>	<p><b>CT-6040 Monochrome/Graphic/Printer</b> <b>129<sup>00</sup></b></p>  <ul style="list-style-type: none"> <li>• 80 x 25 text mode</li> <li>• 720 x 348 graphic mode</li> <li>• Runs Lotus 1-2-3</li> <li>• 64K Graphic Display Mem.</li> </ul>	<p><b>FC 730 (CT-6050C) 384K Multifunctions</b> <b>129<sup>00</sup></b></p>  <ul style="list-style-type: none"> <li>• Memory Expansion to 384K</li> <li>• Clock/Calendar</li> <li>• Serial, parallel interface</li> <li>• Game port</li> </ul>	<p><b>Internal Modem</b> <b>179<sup>00</sup></b></p>  <ul style="list-style-type: none"> <li>• Free PC-Talk Software</li> <li>• 300/1200 baud</li> <li>• Auto Busy Redial, Auto Answer</li> <li>• Dual phone jack plus RS232 port</li> </ul>	<p><b>PRINTER</b> <b>99<sup>00</sup></b></p> <p><b>69<sup>00</sup>/10 pcs</b></p>  <ul style="list-style-type: none"> <li>• Thermo</li> <li>• 80 character/line</li> <li>• Battery Back-up</li> <li>• Centronics parallel interface</li> </ul>
---	--	--	--	---	---

<p><b>MONITORS</b></p> <ul style="list-style-type: none"> <li>• w/Swivels</li> <li>• Hi-Res for IBM PC</li> </ul>  <p>12" Green: <b>99<sup>00</sup></b> 12" Amber: <b>109<sup>00</sup></b></p>	<p><b>CABLES</b></p> <ul style="list-style-type: none"> <li>• Hard Disk Drive Cable (34p-34p) <b>19<sup>00</sup></b></li> <li>• Floppy Drive Cable <b>11<sup>00</sup></b></li> <li>• 9 pin D type to 25 pin D type for PCAT <b>19<sup>00</sup></b></li> <li>• Printer cable 25 DB to Centronics <b>19<sup>00</sup></b></li> <li>• RS232 to RS232 cable <b>19<sup>00</sup></b></li> <li>• Power cord w/female socket <b>2<sup>00</sup></b></li> </ul>	<p><b>DRIVES</b></p> <p><b>TEAC 55BV 360K F.D.D.</b> <b>89<sup>00</sup></b></p> <p><b>TEAC 55GV 1.2MB F.D.D. for PC-AT</b> <b>139<sup>00</sup></b></p> <p><b>10MB H.D.D.</b> <b>449<sup>00</sup></b></p> <p><b>20MB H.D.D.</b> <b>559<sup>00</sup></b> (H.D.D. w/cable controller)</p>	<p><b>RAM CHIPS</b></p> <p>64K <b>6<sup>00</sup>/9 pcs.</b></p> <p>256K <b>33<sup>00</sup>/9 pcs.</b></p> <p>128K <b>53<sup>00</sup>/9 set</b> (for PC-AT)</p>	<p><b>TERMS</b></p> <ul style="list-style-type: none"> <li>• Min. shipping &amp; handling \$6.00.</li> <li>• Can be more for actual cost.</li> <li>• CA. Res. add 6.5% tax.</li> <li>• No return merchandise without a RMA No.</li> <li>• Restocking charge 15%.</li> <li>• Prices subject to change w/o notice.</li> </ul>
--	--	--	--	---

## CADD for \$99.95

GENERIC CADD is a sophisticated & easy to use Computer Aided Drafting/Design program for PCs.

### GENERIC CADD Features:

Drawing Layers • Component Libraries  
Component Libraries • User-Defined Fonts  
Video & Digitizer Menus • Color Graphics

### Other Available GENERIC Software:

AUTOCAD™ file conversion for \$24.95  
Dot Matrix printer/plotter option for \$24.95

Call 1-800-228-3601 to order  
No dealer calls, please.

MC, VISA, COD. Add \$3.00 for shipping  
60 day money back guarantee

### GENERIC SOFTWARE

6 Lake Bellevue, Suite 203  
Bellevue, WA 98005  
(206) 462-1944

Inquiry 151

FOR THE BEST OF US ...

## THE CYPHER™

A COMPLETE 68000 & Z80A  
SINGLE BOARD COMPUTER SYSTEM  
WITH ULTRA-HIGH-RES GRAPHICS!!



**FREE** 80000 PIVOTL  
CYPHER-800  
270K-80  
COMPATIBLE

**FREE** 80000 PIVOTL  
CYPHER-800  
270K-80  
COMPATIBLE

**FREE** 80000 PIVOTL  
CYPHER-800  
270K-80  
COMPATIBLE

**FREE** 80000 PIVOTL  
CYPHER-800  
270K-80  
COMPATIBLE

**LOWER PRICED 1 MEGABYTE CYPHER FROM \$899 (100 QUALITY ASSEMBLED WITH:**

- 80000 & Z80A DUAL PROCESSORS BEST OF BOTH WORLDS: OPTIONAL Z801 AND FASTER 80000
- 1 MEGABYTE MEMORY (128K STANDARD)
- DOUBLE DENSITY FLOPPY DISK CONTROLLER w/ 2 5.25 IN. 360 KBYTES
- DMA CONTROLLER FOR FAST IMAGE TRANSFERS TO FROM VIDEO MEMORY AND 80233
- 2 SERIAL PORTS (EPOC)
- 2 BY ADDRESS MANAGEMENT FOR Z80
- 4 LAYER P.C.B. (70% I.C.A.S.)
- 400K EPROM (256K EPROM 3.3 OHM BURN, NOT INCLUDED) COMES WITH CYPHER DOSE RAM DISK. BIOS/ROMS TECHNICALLY AVAILABLE FOR TERMINAL EMULATION AND BIOS FOR ALL CPU MODELS

**ALL ON ONE BOARD!**

- ALL THE HIGH RESOLUTION GRAPHICS: 1024X1024, PROGRAMMABLE UP TO 1024 X 1024 RESOLUTION
- REAL TIME CLOCK (BATTERY BACKED UP)
- TWO CHANNELS FOR DISPLAYS (19 BIT RESOLUTION)
- ANALOG ROBOTICS LAB WORK
- 160 MONITOR TYPES (EXPANDABLE TO 840)
- 4K STATIC RAM (EXPANDABLE TO 80K)
- PROGRAMMABLE BRUSH RATE GENERATOR (80233)
- PARALLEL ASCII IN/OUTBOARD INPUT
- FULL SPEED EXPANSION BUS AND PIVOT HEADER
- BUFFERED BUS

MANUAL AND COMPLETE DOCUMENTATION  
AGENCY/EDUCATION/RESEARCH/INDUSTRY  
COST REDUCED (CALL OR VISIT)  
SERIALIZED CYPHERS (QUALITY CONTROL)  
BURNED EPROMS (256K BURN) BURN  
Z80 AND Z8000 MONITOR CYPHER DOSE™  
RAM, EMULATION, RAM DISK AND MORE

800 EACH  
1000 EACH  
2000 EACH  
3000 EACH

UPON RECEIPT OF THIS AD OR BY TELEPHONE  
ALL ORDERS ARE SUBJECT TO CREDIT REVIEW  
CREDIT SUBJECT TO CREDIT REVIEW SERVICE  
CREDIT & PAYMENT OF CREDIT REVIEW  
CREDIT & PAYMENT OF CREDIT REVIEW

ROTEL COMPUTERS LIMITED  
174 BETTY AVE DRIVE, WILLOWDALE,  
TORONTO, ONTARIO, CANADA M2N 1J8  
(416) 220-4727

Inquiry 253



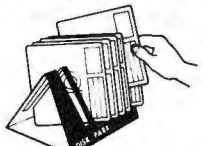
### RS232C IBM PC Compatible Paper Tape Transmitter/Model 612

Stops and starts on character at all speeds,  
uses manual control or X-on, X-off 90-260  
volt, 50-60 Hz power. 50-9600 baud, up to 150  
char/sec synchronous or asynchronous;  
gated internal or external clock, RS 232C,  
current loop or parallel output, reads 5-8 level  
tape, 7-11 frames per character, even or odd  
parity. Desk top or rack mount.

Addmaster Corporation, 415 Junipero Serra  
Drive, San Gabriel, CA 91776, (818) 285-1121,  
Telex 674770 Addmaster SGAB

Inquiry 7

## DISK 7 PARK



- 7 parking lots for your disks while working
- easy to save. easy to get. very useful
- protect disks from damaged
- no more mess on desk
- money back guaranteed

Only \$3.75+\$1.00 shipping  
N.Y. residents add 8% sales tax

sent check to:  
COMET TECHNOLOGY INC.  
68-44 Burns St. Apt. C3  
Forest Hills, N. Y. 11375  
(718) 793-1065

Inquiry 417

## M.A.G.I.C

### INLAB 28 LOGIC/MEMORY PROGRAMMER

It must be magic!  
How else could  
INLAB load all



- Capable of programming hundreds of logic and memory devices!
- Small and portable—less than 26 ounces!
- Inexpensive firmware updating!
- Available with CUPL™ design software!
- Standard RS232 interface!
- EPROM emulation, from 2716 up to 27256 (including CMOS)!

It's no illusion! For only \$1995, we can make a Model 28 appear before your very eyes! Just give us a call at 303/460-0103.

We'd like to do some magic for you!

CUPL is a trademark of Assured Technology, some elements of the Model 28 are manufactured and marketed under license from Digital Media, Inc.

**INLAB INC**  
A Hathaway Company  
2150-1 West 6th Avenue  
Broomfield, CO 80020

Inquiry 180

## 5 1/4" BASF FLEXYDISKS

	10-90	100+
SS / DD Soft	\$ .92 ea.	\$ .89 ea.
DS / DD Soft	\$ 1.02 ea.	\$ .99 ea.
High Density (IBM - AT)	\$ 3.15 ea.	\$ 3.05 ea.
3.5 / SS Micro	\$ 2.10 ea.	\$ 2.05 ea.

In Stock — Immediate Shipment.  
Mastercard, VISA, Check or Money Order.  
Add \$3.00 shipping charges per each 100 or part.  
Add \$2.50 additional for C.O.D. shipments.  
N.J. residents add 6% sales tax.

Data Exchange  
Dept. B, P.O. Box 993  
178 Route 206 South  
Somerville, N.J. 08876  
(201) 874-5050

Inquiry 103

## DYNAMIC RAMS

41256	120ns	\$3.15
✓41256	150ns	\$2.50
4164	120ns	\$0.75
✓4164	150ns	\$0.65
128K	150ns	\$5.50

COPROCESSORS		E. PROMS	
8087-2	\$140.00	27C256	250ns \$12.95
8087-3	\$115.00	27256	250ns \$ 7.25
80287-3	\$195.00	27128	250ns \$ 2.75
		27C64	200ns \$ 4.25
		2764	250ns \$ 1.75
6264LP-15	\$4.50	2732A	250ns \$ 1.80
6116LP-3	\$1.75	8000's	(Parts Available)

## I.C. EXPRESS

15358 Valley Blvd., City of Industry, CA 91746  
(Mon-Fri • 8-5/Sat 9-3)

ORDER  
(818) 369-2688

CALL FOR CURRENT PRICES & VOLUME DISCOUNTS.  
Price Shown for UPS COD Cash • MasterCard/VISA add 3% more.  
Prices are subject to change. Minimum order \$10.00  
California residents must add 8.5% sales tax  
Shipping & Handling: UPS Ground \$5.00 UPS Air \$7.00 (under 1 lb)  
ALL MERCHANDISE IS 100% GUARANTEED.

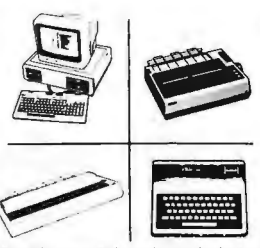
Inquiry 177

## MARYMAC INDUSTRIES INC.

800-231-3680

### Radio Shack® Tandy® Epson Printers

People you Trust to give you the very best!



- Lowest Discount Prices
- Reliable Service
- Quality Products

"World's largest independent authorized computer dealer."

22511 Katy Fwy., Katy (Houston) Texas 77450  
(713) 392-0747 Telex 774132

Inquiry 225

### NO SHIPPING CHARGES ORDER TOLL-FREE 800-824-3432

#### CHRISTMAS SPECIALS DRIVES

TEAC 55B	79.99
TANDON 100-4 (96 T.P.I.)	129.99
EPSON HD860 20 MEG. 1/2 HT. HARD DISK WITH CONTROLLER & CABLES	599.99

**BLUE XTRA**  
• PC/XT Compatible • 8 Slot Motherboard  
• 1-1/2 HT. 360K Floppy • 256K RAM  
• 135W Power Supply • Runs IBM Dos 2.1 or 3.1  
**FULL WARRANTY** 699.99

**MONITORS**  
Princeton Graphics MAX-12-HI-RES Amber with HI-RES Controller Card 299.99  
Princeton Graphics HX-12 RGB with Color Graphics Card 549.99

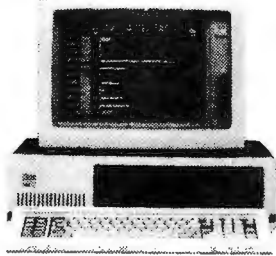
**ADD ON CARDS**  
Multifunction Card w/384K RAM Included. Serial/Parallel Port. Clock/Calendar. Game Port 159.99

**NICORN ELECTRONICS**  
10010 Canoga Ave. Unit B-8 Chatsworth, CA 91311

Minimum order \$10.00 — No shipping charges on prepaid orders — C.O.D. add \$3.00 — UPS Blue add \$3.00 — Calif. residents add 6% sales tax. Personal checks need for clearance VISA - MC

Inquiry 366

# IBM®



**IBM PC, 256K, One Half Height 320K Disk Drive DS/DD, Persyst Color Card With Printer Port, Taxan Green Monitor, DOS 2.1, PLUS a 10MB Hard Disk Sub System All For:**  
**\$2499.**

**IBM PC, 256K, Two Half Height Drives DS/DD, Persyst Color Card With Printer Port, Taxan Green Monitor, DOS 2.1, 130 Watt Power Supply PLUS a 10MB Hard Disk Sub System All For:**  
**\$2799.**

**IBM PC, 256K, Two Half Height Drives DS/DD, Persyst Color Card With Printer Port, Taxan Green Monitor, DOS 2.1, 130 Watt Power Supply, 10MB Hard Disk Sub System, PLUS 10MB Tape Back Up System All For:**  
**\$3299.**

**IBM PC, 256K, Two Half Height Drives DS/DD, Persyst Color Card With Printer Port, Taxan Green Monitor, DOS 2.1, 130 Watt Power Supply, 20MB Hard Disk Sub System All For:**  
**\$3099.**

**IBM PC, 256K, Two Half Height Drives DS/DD, Persyst Color Card With Printer Port, Taxan Green Monitor, DOS 2.1, 130 Watt Power Supply, 20MB Hard Disk Sub System, PLUS 10MB Tape Back Up System All For:**  
**\$3699.**

### MONITORS

AMDEK 300 Green	\$135.00
AMDEK 300 Amber	\$149.00
AMDEK 310 Amber W/TTL Plug	\$185.00
PGS HX-12	\$465.00
PGS MAX-12	\$185.00
PGS SR-12	\$625.00
TAXAN #115 Green Composit	\$125.00
TAXAN #116 Amber Composit	\$135.00
TAXAN #121 Green W/TTL Plug	\$149.00
TAXAN #122 Amber W/TTL Plug	\$159.00
TAXAN #620 COLOR MONITOR	\$449.00
TAXAN #640 COLOR MONITOR	\$569.00
IBM MONOCHROME DISPLAY	\$260.00
IBM COLOR DISPLAY	\$590.00

# COMPAQ®

## COMPAQ® DESKPRO™

CALL  
FOR DIFFERENT  
CONFIGURATIONS

### PRINTERS

NEC PINWRITER 80 COL.	\$599.00
NEC PINWRITER 136 COL.	\$799.00
EPSON LX 80	\$239.00
EPSON FX 85	\$359.00
EPSON FX 185	\$499.00
EPSON RX 100	\$399.00
EPSON JX 80	\$499.00
EPSON LQ 1500	\$895.00
COMREX CR 420	\$1895.00
TOSHIBA 351	\$1199.00
STAR MICRONICS SG 10	\$259.00
STAR MICRONICS SG 15	\$395.00
CITIZEN PRINTER MSP-10	\$325.00
CITIZEN PRINTER MSP-15	\$450.00
CITIZEN PRINTER MSP-20	\$435.00
CITIZEN PRINTER MSP-25	\$599.00
JUKI LQ 6100	\$385.00
JUKI LQ 6300	\$725.00
BROTHER HR-25	\$499.00
BROTHER HR-35	\$775.00
DYNAX DX 15XL	\$365.00
OKIDATA	CALL

## SPECIAL 13" RGB MONITOR FORTIS FC10

**\$299.00**

### MODEMS

HAYES SMART MODEM 1200	\$395.00
HAYES SMART MODEM 300	\$209.00
HAYES 1200B PLUG IN CARD	\$365.00
HAYES 2400 BAUD MODEM	\$699.00
POP COM 1200 EXTERNAL	\$375.00
AST REACH MODEM	\$380.00
QIC MODEM INTERNAL	\$275.00

### DRIVES

TANDON TM-100-2 DS/DD	\$139.00
TOSHIBA SLIMLINE DS/DD	\$120.00
TEAC SLIMLINE DS/DD	\$120.00

### HARD DISKS

10MB SUB SYSTEM INTERNAL	\$595.00
EXTERNAL	\$795.00
20MB SUB SYSTEM INTERNAL	\$875.00
EXTERNAL	\$1050.00
40MB SUB SYSTEM INTERNAL	\$1150.00
EXTERNAL	\$1325.00

### HARD DISKS & TAPE BACK-UP UNITS (EXTERNAL)

10MB HARD DISK W/10MB TAPE BACK UP	\$1250.00
20MB HARD DISK W/10MB TAPE BACK UP	\$1475.00
40MB HARD DISK W/10MB TAPE BACK UP	\$1795.00

# CONQUEST® PC TURBO



**CONQUEST PC TURBO 640K Two Half Height Drives, Floppy Disk Controller 135 Watt Power Supply, Serial Port, Parallel Port (IBM Standard) and Enhanced Keyboard:**

**\$1225.**

Above System With 10MB Internal Hard Disk:

**\$1970.**

With 20MB Internal Hard Disk:

**\$2195.**

With 40MB Internal Hard Disk:

**\$2515.**

Tape Back Up Systems Are Also Available for the Conquest PC Turbo at a reasonable price.

### MULTIFUNCTION BOARDS

AST I/O MINI CARD, 1-SER.	\$145.00
AST SIX PACK 64K, 1-SER., 1-PAR	\$249.00
AST PREVIEW	\$299.00
AST ADVANTAGE CARD 128K FOR AT	\$425.00
ALR CHALLENGER CARD 128K FOR AT	\$395.00
PERSYST COLOR PRINTER ADAPTER	\$179.00
PERSYST MONOCHROME PRINTER ADAPTER	\$189.00
PERSYST BOB CARD	\$395.00
HERCULES COLOR PRINTER ADAPTER	\$179.00
HERCULES GRAPHIC PRINTER ADAPTER	\$299.00
STB GRAPHIC PLUS II	\$325.00
IBM COLOR GRAPHIC ADAPTER	\$225.00
IBM MONO PRINTER ADAPTER	\$230.00
GENOA SPECTRUM GRAPHIC CARD	\$349.00

### GENERAL

MAXELL DISKETTES MD2	\$35.00/box
MAXELL MD2-HDM FOR AT	\$60.00/box
CONTROL DATA DISKETTES	\$24.00
KEYTRONIC KEYBOARD KB 5151	\$169.00

### IBM PC-XT AND PC-AT

Different configurations  
available.

CALL FOR PRICES.

# Microshop

COMPUTER PRODUCTS

(714) 838-7530

2630 Walnut Avenue, Unit C, Tustin, California 92680

# Your System/Controller should fit you like a good suit.



## LET MICROMINT CUSTOM FIT YOU

Whether it's suits or system controllers, you can't buy off the rack when you need a custom fit.

That's why Micromint individualizes its system controllers to meet your particular needs and budget. What's most important to you? Software compatibility? Speed? Everything on one board? Economical computing power?

**#1: "I want software compatibility."**

**Solution:**  
THE SB180  
COMPUTER/CONTROLLER

The SB180, only 4" by 7½", offers a Z80 compatible CPU running at 6MHz, 256K bytes of RAM, up to 32K bytes of ROM, two serial ports, a parallel port, Z80/6800 I/O expansion bus, and an industry standard 765A-compatible disk controller for up to four disk drives — any combinations of 3½", 5¼" or 8" drives. The SB180 is based on the Hitachi HD64180 CPU, a microcoded CMOS chip which provides high performance, reduced system cost, and low power operation while maintaining complete compatibility with the large base of standard CP/M software.

SB180-1 w/BK ROM monitor. . . \$369.00  
SB180-5 w/BK ROM monitor,  
BIOS source and  
Z-system . . . . . \$418.00

**#2: "I need speed."**

**Solution:**  
THE Z8 FORTH  
SYSTEM/CONTROLLER

The Z8 FORTH System/Controller is only 4" by 4½" and includes a custom masked Z8 version of the FORTH

language with a full screen editor, cassette I/O driver primitives, EPROM programmer primitives, and other utility words. It also contains up to 4K bytes of RAM or EPROM, an RS-232 serial port with selectable baud rates, and two parallel ports. Additional Z8 peripheral boards include memory expansion, a smart terminal board, serial and parallel I/O, real time clock an A/D converter, and an EPROM programmer. It's perfect for data reduction and high speed control applications.

BCC21 w/utilities . . . \$225.00

**#3: "Let me have an entire development system on one board."**

**Solution:**  
THE BCC52  
SYSTEM/CONTROLLER

The BCC52 is a new stand alone single board microcomputer which is bus compatible with the Micromint BCC11/BCC21 Z8 System/Controllers and expansion boards. The BCC52 features the Intel 8052AH-BASIC microprocessor which includes a ROM resident 8K byte floating point BASIC inter-



**For a System Controller suited to your needs, give us a call.**

preter with extensions for process control work. It contains sockets for up to 48K bytes of RAM/EPROM, an "intelligent" 2764/128 EPROM programmer, 3 parallel ports, a serial terminal port, and a serial printer port.

BCC52 . . . \$239.00

**#4: "Give me lots of economical computing power."**

**Solution:**  
THE BCC11 BASIC  
SYSTEM/CONTROLLER

The Z8 BASIC System/Controller is nearly identical to the FORTH System/Controller but contains a tiny BASIC interpreter, up to 6K bytes of RAM and EPROM, an RS-232 serial port with switch selectable baud rates, and two parallel ports. Add a power supply and terminal to start programming in BASIC or machine language. Programs can be transferred to 2732 EPROMS with the optional EPROM programmer for auto-start applications. It can also use any of the expansion boards mentioned under the Z8 FORTH System/Controller.

BCC11 . . . \$149.00

Additional information on peripheral boards and OEM pricing is available.

**Order Toll Free**

**1-800-635-3355**

In Connecticut call: 1-871-6170



**MICROMINT, INC.**  
25 Terrace Drive  
Vernon, CT 06066



Merry Christmas from Computer Connection

# We'll Ship Blue Label FREE\*

\*You pay for Ground shipping and we'll ship Blue Label FREE for all orders placed by December 20th

**COMPUTER CONNECTION**  
TOLL FREE ORDER LINE

## PRINTERS

<b>STAR MICRONICS</b>	
SG-10, 120 cps, 2K buffer	\$ 219
SG-15, 120 cps, 2K buffer	375
SD-10, 160 cps, 10" carriage	359
SD-15, 160 cps, Corr. Qual.	469
SR-10, 200 cps, 10" carriage	499
SR-15, 200 cps, w/tractor	599
SB-10 Draft & NLQ 24 wire printhead	625

<b>OKIDATA</b>	
ML182P 120 cps	We
ML182 IBM Graphics Comp	Will
ML182S 10" Carriage	Beat
ML192P, 160 cps	all
ML192 IBM Graphics Comp	Pricing
ML192S, 160 cps	on
ML193P, 160 cps	Oki
ML193 IBM Graphics Comp	Printers
ML193S, 160 cps	with
ML84P, 200 cps	or
ML84 IBM	without
ML84S, 200 cps	IBM
Okimate 20	Rom

<b>EPSON</b>	
LX80, 100 cps, 10" carriage	Call
FX80 +, 160 cps, 10" carriage	Us
RX100, 100 cps, 15" carriage	First
FX100 +, 160 cps, 15" carriage	For
LQ1500 Draft NLQ	Lowest
SO2000, All New	Prices
*We Are An Authorized Dealer	

<b>BROTHER</b>	
HR-25	\$ 422
HR-35	599

<b>DYNAX</b>	
DX15XL, 20 cps By Brother	\$ 329
DH-45 Dual Head, LQ & Dot Matrix	899

<b>JUKI</b>	
6100, L.Q., 18 cps w/proportional spc.	\$ 359
6300 L.Q., 40 cps	675

<b>TOSHIBA</b>	
P1340 P	\$ 525
P1340 S	525
P351 P/S, Faster and More Versatile	1145

<b>PANASONIC</b>	
1091 w/Tractor, 120 cps, 1 yr. war.	\$ 239
1092, 10" carriage, 180 cps	375
1093, 15" carriage, 160 cps	535

## HARD DISK DRIVES

<b>MICRO-SCI</b>	
10 Meg w/cont. formatted for IBM	\$ 399
20 Meg w/cont. formatted for IBM	599

<b>ALPHA OMEGA</b>	
10 Meg w/Controller Card	\$ 499
20 Meg w/Controller Card	629
30 Meg w/Controller Card	999
20 Meg for AT	550
33 Meg for AT	775

## DISK DRIVES

<b>TANDON</b>	
TM100-2 for IBM PC	\$ 85

<b>MITSUBISHI</b>	
1/2 Ht. 360K	\$ 95

<b>TEAC</b>	
55B Double Sided 360K	\$ 84
Quad Density	159

<b>Drives For Apple &amp; Franklin</b>	
<b>MICRO-SCI</b>	
A-2	\$ 149
A.5C for IIC w/cable	155
A.5 1/2 height for IIE	155
Controller Add	55

## PRINTER ACCESSORIES

<b>ORANGE MICRO</b>	
Grappier +	\$ 75
Buffered Grappier +, 16K exp. 64K	150

<b>TOSHIBA</b>	
Bi-Directional Trac. 1351/351	\$ 149/155
Font Disk for Down loading P1351	50

<b>MICROTEK</b>	
Dumpling GX (same as Grappier +)	\$ 65
Dumpling GX w/16K buffer	119
Dumpling GX w/32K buffer	129
Additional Buffering 16K	7

<b>FOURTH DIMENSION</b>	
Par. Card & Cable for Apple	\$ 49

<b>OKIDATA</b>	
Plug and Play for IBM	\$ 49
Tractor for 182 & 192	39

<b>JUKI</b>	
Bi-Direc. Tractor for 6100/6300	\$ 115/125
Serial Interface	65

<b>CABLES</b>	
IBM PC to Parallel Printer	\$ 14
Serial Cable	16
Centronics M/M or M/F	18

## DISPLAY MONITORS

<b>QUAORAM</b>	
Amber chrome IBM compatible	\$ 169

<b>AMDEK</b>	
V300G	\$ 115
V300A	119
V310A for IBM PC	149
Color 300	199
Color 500 Color Composite	319
Color 600 RGB Hi-Res	399
Color 710 Super Hi-Res	545

<b>TAXAN</b>	
IBM Green Monochrome #121	\$ 129
IBM Amber Monochrome #122	139
RGB IBM w/Cable #420	389
RGB Super Hi-Res. #640 Best Buy	489
RGB/Comp. Med. Res. #210	245

<b>PRINCETON GRAPHICS</b>	
HX-12 for use with IBM PC	\$ 435
Max 12E Amber for IBM	169
SR 12 Super Hi-Res	575
Scan Doubler	185

<b>QUIMAX</b>	
PX-4, RGB Hi-Res w/Gr. Text Mode	\$ 410
DM-14 Monochrome for IBM	150

## STOCKING STUFFERS!!

Order NOW for Christmas

<b>RF MODULATOR</b>	<b>SMT 64K/80 COL.</b>
\$14	\$49
<b>IBM PRINTER CABLE</b>	<b>DYNAX DX15XL</b>
\$14	• LQ, 20 cps \$329
<b>AST 6-PAK W/64K</b>	<b>STAR MICRONICS</b>
\$210	• SG10, 120 cps \$219
<b>ANCHOR MARK XII</b>	<b>TEAC 55B</b>
\$209	• 1/2 Height, D/D \$84
<b>IBM DOS 3.1</b>	<b>COMPAQ</b>
\$59	• Port., 2 Dr. & 256K \$1899

"THE COMPANY THAT DELIVERS"

<b>IBM</b>	
IBM Dos 3.1	\$ 59
<b>PARADISE</b>	
Modular Graphics Card	\$ 259
Module A	75
Module B 256K w/C & C.	120
5-Pak same as 6-Pak - Ser. Port	175

<b>64K MEMORY UPGRADE</b>	
64K (9 chips) 200ns & 150ns	\$8.00

<b>HEXACE TECHNOLOGIES</b>	
Hi-Res Color Card for PC, XT, AT	\$ 110

<b>QUADRAM</b>	
Quad Color 1 Board	\$ 179
Exp. Quadboard w/64K & Game Port	199
Quadlink 3000 Run Apple sft on IBM	329

## APPLE & FRANKLIN ACCESSORIES

<b>ACCESSORIES</b>	
Kensington System Saver	\$ 69
Masterpiece Control Unit	99

<b>MICROTEK</b>	
Serial Interface	\$ 75

<b>MICROMAX</b>	
Viewmax 128K extended 80 col. card for Apple IIE w/64K	\$ 99
80 col. card for Apple II & II+	139

<b>VUTEK (2 yr. war.)</b>	
Vutek - CPS Board, RGB & Composite w/Par. & Ser. Ports, 2 Yr. War.	\$ 189
Color Card (Herc. comp.) w/Para.	150
Monographic Card (Herc. comp.)	275

<b>AST RESEARCH</b>	
Six Pak w/64K & Sidekick	\$ 225
Six Pak w/384K & Sidekick	255
Game Port	49

<b>KEYTRONICS</b>	
KB5151	\$ 175

<b>MICROTEK</b>	
Monochrome Text Par. & Ser.	\$ 169
Color Graphics Card	165

<b>TECHMAR</b>	
Graphics Master	\$ 449
256K Memory Upgrade	99

<b>ADVANCED LOGIC SYSTEMS</b>	
Z Engine 2.2	\$ 115

<b>APPLE</b>	
Super Serial Card	\$ 139

<b>SMT</b>	
64K, 80 col. Card, 3 yr. war.	\$ 49

<b>MICRO-SCI</b>	
64K, 80 Col. Card	\$ 79

## PERSONAL SYSTEMS

<b>APPLE</b>	
Professional Sys. incl: Apple IIE w/128K & 80 col., tilt mon., duo disk w/con't kit	\$1339
Apple IIC Lightweight Portable	789

<b>IBM</b>	
IBM PC 64K, 1 Drive	\$1460*
IBM PC, 2 Drives w/256K	1535*
IBM XT, 10 Meg., 360K Dr. w/256K	2399*
IBM XT Bare w/256K & IBM Floppy	1899*

Call About All "AT" Systems  
Call for current IBM prices.

<b>SANYO</b>	
MBC 550-2 w/1, 320K Drive & sftwr.	\$ 750
MBC 555-2 w/2, 320K Drives & more software	899
775 Portable	1795
Serial Port for Sanyo	65

<b>COMPAQ</b>	
256K, w/2 - 320K Drives	\$1899
Desk Top Model 1	1649
Desk Top Model 2	1925
Desk Top Model 3	Call
Desk Top Model 4	Call

We have "286" Ports. & D.P. in stock

<b>WYSE</b>	
1100-1 incl. 256K w/two 360K Drives, 1 par & 2 ser. ports	\$1399
1100-2 incl. 10 meg, 1 floppy, 256K, 1 par. & 2 ser. ports	2599

\*Wyse Monitors & Exp. Chassis Available

## SOFTWARE

<b>LOTUS DEVELOPMENT CORP.</b>	
Lotus 1-2-3	\$ 289
Symphony	420

<b>ASHTON TATE</b>	
D Base II	\$ 299
D Base III	389

<b>PRINTER SWITCH BOX</b>	
<b>EXPONENT</b>	
Centronics Two Switch	\$ 60
Centronics Four Switch	85
Serial Two Switch	45
Serial Four Switch	69

## MODEMS

<b>ANCHOR</b>	
Mark XII	\$ 209
Volkmodem XII	179
Express 1200	265

<b>HAYES MICRO</b>	
300 Baud Smart Modem	\$ 149
1200 Baud Smart Modem	379
1200 B for IBM PC w/SM II	375
2400 Baud Modem	645
Micro Modem IIE	149
Chronograph	189
300 For Apple IIC w/Sftwr	Call

## DISKETTES

<b>PC DISKETTES</b>	
Sgl./Dbl. (Box of 10)	\$ 13
Dbl./Dbl. (Box of 10)	15

<b>COMPUTER CONNECTION</b>	
Dbl./Dbl. (Box of 10)	\$ 16
Sgl./Dbl. w/Disk Container (10)	15
Dbl./Dbl. w/Disk Container	17
Bulk 50 & Up - Dbl./Dbl.	1.35 ea.

## We Stock What We Sell!!

IF YOU SEE IT ADVERTISED FOR LESS, CALL COMPUTER CONNECTION FIRST FOR LOWEST QUOTE!

MAIL ORDER:  
17121 S. Central Avenue, Unit L  
Carson, California 90746



NO SURCHARGE FOR CREDIT CARDS

We accept VISA, MasterCard, COD (w/Deposit), Certified Checks or Wire Transfers. Minimum Shipping Charge \$4.00. Some items subject to back order. California Res. add 6 1/2% Sales Tax. All returns are subject to a 15% restocking charge and must be authorized by store manager within 10 days. Prices subject to change without notice. This Ad supersedes all others.

## ORDER LINE (800) 732-0304

(Outside California)  
(213) 635-2809

(Inside California)  
Mon.-Fri. 7 a.m. to 6 p.m.  
Saturday 11 a.m. to 3 p.m.

## CUSTOMER SERVICE:

(213) 635-5065  
Mon.-Fri. 9 a.m. to 3 p.m.

# Super Disk™ Diskettes

**Now...Diskettes you can swear by, not swear at.**

Lucky for you, the diskette buyer, there are many diskette brands to choose from. Some brands are good, some not as good, and some you wouldn't think of trusting with even one byte of your valuable data. Sadly, some manufacturers have put their profit motive ahead of creating quality products. This has resulted in an abundance of low quality but rather expensive diskettes in the marketplace.

**A NEW COMPANY WAS NEEDED AND STARTED** Fortunately, other people in the diskette industry recognized that making ultra-high quality diskettes required the *best* and newest manufacturing equipment as well as the best people to operate this equipment. Since most manufacturers seemed satisfied to give you only the everyday quality now available, an assemblage of quality conscious individuals decided to start a new company to give you a new and better diskette. They called this product the *Super Disk* diskette, and you're going to love them. Now you have a product you can swear by, not swear at.

## HOW THEY MADE THE BEST DISKETTES EVEN BETTER

The management of *Super Disk* diskettes then hired all the top brains in the diskette industry to make the *Super Disk* product. Then these top bananas (sometimes called floppy freaks) created a new standard of diskette quality and reliability. To learn the "manufacturing secrets" of the top diskette makers, they've also hired the remaining "magnetic media moguls" from competitors around the world. Then all these world class, top-dollar engineers, physicists, research scientists and production experts (if they've missed you, send in your resume to *Super Disk*) were given one directive...to pool all their manufacturing know-how and create a new, better diskette.

## HOW SUPER DISK DISKETTES ARE MANUFACTURED

The *Super Disk* crew then assembled the newest, totally quality monitored, automated production line in the industry. Since the manufacturing equipment at *Super Disk* is new, it's easy for *Super Disk* to consistently make better diskettes. You can always be assured of ultra-tight tolerances and superb dependability when you use *Super Disk* diskettes. If all this manufacturing mumbo-jumbo doesn't impress you, we're sure that at least one of these other benefits from using *Super Disk* diskettes will:

- 1. TOTAL SURFACE TESTING** - For maximum reliability, and to lessen the likelihood of disk errors, all diskettes must be totally surface tested. At *Super Disk*, each diskette is 100% surface tested. *Super Disk* is so picky in their testing, they even test the tracks that are in between the regular tracks.
- 2. COMPLETE LINE OF PRODUCTS** - For a diskette to be useful to you and your computer, it must be compatible physically. *Super Disk* has an entire line of 5 1/4-inch diskettes for your computer.
- 3. SPECIALLY LUBRICATED DISK** - *Super Disk* uses a special oxide lubricant which is added to the base media in the production of their diskettes. This gives you a better disk drive head to media contact and longer head and disk life.
- 4. HIGH TEMPERATURE/LOW-MARRING JACKET** - A unique high temperature and low-marring vinyl jacket allows use of their product where other diskettes won't work. This special jacket is more rigid than other diskettes and helps eliminate dust on the jacket.
- 5. REINFORCED HUB RINGS** - Standard on all *Super Disk* mini-disks, to strengthen the center hub hole. This increases the life of the disk to save you money and increase overall diskette reliability.
- 6. DISK DURABILITY** - *Super Disk* diskettes will beat all industry standards for reliability since they will give you more than 75% of the original signal amplitude remaining even after an average (Weibull B-50) of 30 million passes. They are compatible with all industry specifications as established by ANSI, ECMA, ISO, IBM and JIS.
- 7. CUSTOMER ORIENTED PACKAGING** - All *Super Disk* disks are packaged 10 disks to a carton and 10 cartons to a case. The economy bulk pack is packaged 100 disks to a case without envelopes or labels.
- 8. LIFETIME WARRANTY** - If all else fails, remember, all disks made by *Super Disk* Inc., have a lifetime warranty. If any *Super Disk* diskette fails to meet factory specifications, *Super Disk* Inc. will replace them under the terms of the *Super Disk* warranty.
- 9. SUPERB VALUE** - With *Super Disk*'s automated production line, high-quality, error-free disks are yours without the high cost.

**Order toll free 800-USA-DISK.**

## NOW...NAME BRAND QUALITY AT SUPER CE PRICES

Now, you can buy *Super Disk* brand diskettes directly from Communications Electronics at prices less than "unbranded" generic diskettes. Your data is valuable, so why take chances using a diskette that could be so unreliable that the manufacturer refuses to put their name on it. To save you even more, we also offer *Super Disk* bulk product where 100 diskettes are packed in the same box without envelopes or labels. Since we save packaging costs, these savings are passed on to you. Diskette envelopes are also available from us. These super strong and tear resistant envelopes are only 8¢ each. Use order # EV-5 and specify the quantity of 5 1/4" diskette envelopes that you want.

# 39¢ per disk Quantity One

Our diskettes are packed 10 disks to a carton and 10 cartons to a case. The economy bulk pack is packaged 100 disks to a case without envelopes or labels. For best value, you should order in increments of 100 diskettes. Almost all diskettes are immediately available from *Super Disk*. With our efficient warehouse facilities, your order is normally shipped in less than a day.

SAVE ON SUPER DISK™ DISKETTES Product Description	Part #	Super Disk price per disc (\$)
5 1/4" SSSD Soft Sector w/Hub Ring	6431-BA	0.54
5 1/4" Same as above, but bulk pack w/o envelope	6437-BA	0.39
5 1/4" SSDD Soft Sector w/Hub Ring	6481-BA	0.58
5 1/4" Same as above, but bulk pack w/o envelope	6487-BA	0.43
5 1/4" DSSD Soft Sector w/Hub Ring	6491-BA	0.64
5 1/4" Same as above, but bulk pack w/o envelope	6497-BA	0.49
5 1/4" DSQD Soft Sector w/Hub Ring (96 TPI)	6501-BA	1.49

SSSD = Single Sided Single Density; SSDD = Single Sided Double Density; DSSD = Double Sided Double Density; DSQD = Double Sided Quad Density. TPI = Tracks per inch.

## BUY YOUR DISKETTES FROM CE WITH CONFIDENCE

To get the fastest delivery of your diskettes, phone your order directly to our order desk and charge it to your credit card. Written purchase orders are accepted from approved government agencies and most well rated firms at a 10% surcharge for net 10 billing. For maximum savings, your order should be prepaid. All sales are subject to availability, acceptance and verification. All sales are final. All prices are in U.S. dollars. Prices, terms and specifications are subject to change without notice. Out of stock items may be placed on backorder or substituted for equivalent product unless we are instructed differently. A \$5.00 additional handling fee will be charged for all orders with a merchandise total under \$50.00. All shipments are F.O.B. CE warehouse in Ann Arbor, Michigan. COD terms are available, in U.S. UPS areas for \$5.00 extra, and are payable with cash or certified check. Michigan residents add 4% sales tax.

For shipping charges add \$6.00 per 100 diskettes and/or any fraction of 100 5 1/4-inch diskettes for U.P.S. ground shipping and handling in the continental U.S. For 1,000 or more disks shipped to the continental U.S., shipping charges are \$3.00 per hundred diskettes. UPS 2nd day air rates are three times continental U.S. rates. For Canada, Puerto Rico, Hawaii, Alaska, or APO/FPO delivery, shipping is three times the continental U.S. rate.

**Mail orders to:** Communications Electronics Inc., Box 1045, Ann Arbor, Michigan 48106-1045 U.S.A. If you have a Visa or Master Card, you may call and place a credit card order. Order toll-free in the U.S. Dial 800-USA-DISK. In Canada, order toll-free by calling 800-CA1-DISK. If you are outside the U.S. or in Michigan dial 313-973-8888. Telex anytime 810-223-2422. Order your *Super Disk* diskettes now.

Copyright © 1986 Communications Electronics Inc.

Ad #102585-BA



**Now  
39¢  
a disk**

# DoKay

COMPUTER  
PRODUCTS,  
Inc.

ORDER TOLL FREE

(800)  
538-8800

(CALIFORNIA RESIDENTS)

(800)  
848-8008



## STATIC RAMS

2101	256 x 4	450ns	1.90
2102	1K x 1	450ns	.79
2102L-4	1K x 1	450ns	.99
2102L-2	1K x 1	250ns	1.29
2111	256 x 4	450ns	2.29
2112	256 x 4	450ns	2.29
2114	1K x 4	450ns	.99
2114-25	1K x 4	250ns	1.10
2114L-4	1K x 4	450ns	1.20
2114L-3	1K x 4	300ns	1.30
2114L-2	1K x 4	200ns	1.40
2147	4K x 1	55ns	3.95
5101	256 x 4	450ns	CMOS 3.95
TMS4044-4	4K x 1	450ns	2.95
TMS4044-3	4K x 1	300ns	3.45
TMS4044-2	4K x 1	200ns	3.95
MK4118	1K x 8	250ns	0.95
TMS2018-20	2K x 8	200ns	2.49
TMS2018-15	2K x 8	150ns	2.99
TMS2018-10	2K x 8	100ns	4.49
HMR110-4	2K x 8	200ns	CMOS 2.49
HMR110-3	2K x 8	150ns	CMOS 2.99
HMR110-2	2K x 8	120ns	CMOS 5.49
HMR110LP-4	2K x 8	200ns	CMOS 2.99
HMR110LP-3	2K x 8	150ns	CMOS 3.49
HMR110LP-2	2K x 8	120ns	CMOS 6.49
Z-8132	4K x 8	300ns	29.95
HM0204P-15	8K x 8	150ns	CMOS 5.95
HM0204LP-15	8K x 8	150ns	CMOS 6.95
HM0204LP-12	8K x 8	120ns	CMOS 8.95

## DYNAMIC RAMS

TMS4027	4K x 1	250ns	1.45
UPD411	4K x 1	300ns	1.95
MM5280	4K x 1	300ns	1.95
MK4108	8K x 1	200ns	.49
MM5298	8K x 1	250ns	.49
4110-20	16K x 1	200ns	.79
4110-15	16K x 1	150ns	.99
4110-12	16K x 1	120ns	1.49
2118	16K x 1	150ns	5v 3.95
4184-25	64K x 1	250ns	5v .59
4184-20	64K x 1	200ns	5v .89
4184-15	64K x 1	150ns	5v .79
41268-20	256 x 1	200ns	2.89
41268-15	256 x 1	150ns	2.89

## EPROMS

1702	256 x 8	1 us	3.95
2708	1K x 8	450ns	2.49
2758	1K x 8	450ns	5.00
2718	2K x 8	450ns	5v 2.95
2718-1	2K x 8	350ns	5v 3.95
TMS2518	2K x 8	450ns	5v 3.95
TMS2718	2K x 8	450ns	5v 6.95
TMS2532	4K x 8	450ns	5v 3.95
2732	4K x 8	450ns	5v 2.95
2732 A-4	4K x 8	450ns	21v 2.95
2732 A-25	4K x 8	350ns	21v 3.95
2732 A	4K x 8	250ns	21v 5.95
2732 A-2	4K x 8	200ns	21v 6.95
2764	8K x 8	450ns	5v 3.95
2764-25	8K x 8	250ns	5v 4.95
2764-20	8K x 1	200ns	5v 5.95
TMS2564	8K x 8	450ns	5v 9.95
MC680784	8K x 8	450ns	5v 17.95
MC680786	8K x 8	350ns	5v 19.95
27128-45	16K x 8	450ns	5v 5.99
27128-30	16K x 8	300ns	5v 6.99
27128-25	16K x 8	250ns	5v 8.99
27264-25	32K x 8	250ns	14v 8.95

## 74LS00

74LS00	23.	74LS125	.48	74LS280	.58
74LS01	.24	74LS126	.48	74LS286	.54
74LS02	.24	74LS132	.58	74LS273	1.45
74LS03	.24	74LS133	.58	74LS275	3.30
74LS04	.23	74LS138	.38	74LS279	.48
74LS05	.24	74LS137	.98	74LS280	1.95
74LS08	.27	74LS138	.54	74LS283	.88
74LS09	.28	74LS139	.54	74LS290	.88
74LS10	.24	74LS145	1.15	74LS293	.88
74LS11	.34	74LS147	2.45	74LS295	.98
74LS12	.34	74LS148	1.30	74LS298	.88
74LS13	.44	74LS151	.54	74LS299	1.70
74LS14	.58	74LS153	.54	74LS323	3.45
74LS15	.34	74LS154	1.95	74LS324	1.70
74LS20	.24	74LS155	.88	74LS352	1.25
74LS21	.28	74LS156	.88	74LS353	1.25
74LS22	.24	74LS157	.84	74LS383	1.30
74LS26	.28	74LS158	.58	74LS384	1.90
74LS27	.28	74LS160	.88	74LS395	.48
74LS28	.34	74LS161	.84	74LS386	.48
74LS30	.24	74LS162	.88	74LS387	.44
74LS32	.28	74LS163	.64	74LS388	.44
74LS33	.54	74LS164	.88	74LS373	1.35
74LS37	.34	74LS165	.94	74LS374	1.35
74LS38	.34	74LS166	1.90	74LS377	1.35
74LS40	.24	74LS168	1.70	74LS378	1.13
74LS42	.48	74LS169	1.70	74LS378	1.30
74LS47	.74	74LS170	1.45	74LS385	1.85
74LS48	.74	74LS173	.88	74LS386	.44
74LS49	.74	74LS174	.54	74LS390	1.15
74LS51	.24	74LS175	.54	74LS393	1.15
74LS54	.28	74LS181	2.10	74LS395	1.15
74LS55	.28	74LS189	.80	74LS399	1.45
74LS63	1.20	74LS190	.88	74LS424	2.80
74LS73	.38	74LS191	.88	74LS447	.38
74LS74	.34	74LS192	.78	74LS490	1.80
74LS75	.38	74LS193	.78	74LS624	3.95
74LS76	.38	74LS194	.68	74LS640	2.15
74LS78	.48	74LS195	.68	74LS645	2.15
74LS83	.58	74LS196	.78	74LS668	1.85
74LS85	.68	74LS197	.78	74LS689	1.85
74LS86	.38	74LS221	.88	74LS670	1.45
74LS90	.54	74LS240	.94	74LS674	3.80
74LS91	.88	74LS241	.98	74LS682	3.15
74LS92	.54	74LS242	.98	74LS683	3.15
74LS93	.54	74LS243	.98	74LS684	3.15
74LS95	.74	74LS244	1.25	74LS685	3.15
74LS98	.88	74LS245	1.45	74LS688	2.35
74LS107	.38	74LS247	.74	74LS689	3.15
74LS108	.38	74LS248	.98	74LS783	23.95
74LS112	.38	74LS249	.98	81L895	1.45
74LS113	.38	74LS251	.58	81L895	1.45
74LS114	.38	74LS253	.58	81L897	1.45
74LS122	.44	74LS257	.58	81L898	1.45
74LS123	.78	74LS258	.58	26LS2521	2.75
74LS124	2.95	74LS259	2.70	26LS2569	4.20

We will try to BEAT  
All Competitor's Prices  
CALL for Quote!

## 8000

8031	14.90	8253	6.99
8035	5.99	8263-5	7.99
8039	5.99	8255	4.45
IMB-0060	15.99	8255-5	4.99
IMB-0073	29.99	8267	7.99
8080A	3.99	8267-5	8.99
8085	4.99	8269	8.99
8085A-2	11.99	8269-5	8.99
8088	24.99	8271	88.99
8087-3 (5 MHz)	124.95	8272	19.99
8087-2 (8 MHz)	198.95	8274	28.99
8088	18.99	8275	28.99
8089	58.99	8278	6.99
		8278-5	7.99
		8282	6.45
		8283	6.45
		8284	4.80
		8285	6.45
		8287	6.45
		8288	12.90
		8289	44.90
		8292	12.90

## 8100

8131	2.99	8304	2.99
8155	5.99	8307	2.99
8155-2	7.99	8308	2.99
8168	5.99	8310	3.99
8185	28.99	8311	3.99
8185-2	39.99		

## 8200

8202	23.99	8303	2.99
8205	38.99	8304	1.99
8206	2.99	8307	2.99
8212	1.75	8308	2.99
8214	3.75	8310	3.99
8218	1.75	8311	3.99
8224	2.20		
8228	1.75		
8228	3.45	8741	28.99
8237	12.80	8748	18.99
8237-5	14.80	8749	28.99
8238	4.45	8755	23.99
8243	4.45		
8250	8.99		
8251	3.99	80188-8	89.80
8251A	4.45	89188	89.80

## 8300

8303	2.99	8741	28.99
8304	1.99	8748	18.99
8307	2.99	8749	28.99
8308	2.99	8755	23.99
8310	3.99		
8311	3.99		

## 8700

8741	28.99	80188-8	89.80
8748	18.99	89188	89.80
8749	28.99		
8755	23.99		

## 80000

80188-8	89.80
89188	89.80

THIS IS A SAMPLING  
ONLY . . . CALL WITH  
ALL  
YOUR COMPONENT NEEDS

## CRYSTALS

ALL STANDARD VALUES . . . 1.69  
CRYSTAL CLOCK OSC.  
ALL STANDARD VALUES . . . 4.89

## DIP SWITCHES

4, 5, 6, 7, 8, 10 ALL . . . .79 ea.

## ZIF SOCKETS

14 pin ZIF	4.89
18 pin ZIF	4.89
24 pin ZIF	5.89
28 pin ZIF	6.89
40 pin ZIF	8.89

## ORBITAL SYSTEMS:

### EXTENDED 80-Column Card for APPLE IIe

- 64K to 128K Upgrade
- 2-Year Warranty . . . \$69.95

### Z-80 (CP/M) CARD APPLE II+, IIe†

- Compatible w/all Apple CP/M
- Lifetime Warranty . . . 69.95

## MEG-O-RAM EXPAND DESKTOP SPACE 1 MEGABYTE on APPLEWORKS† APPLE IIe† . . . \$259.00

## APPLE ACCESSORIES

- Parallel Printer Card . . . . . 49.95
- 80-Col. card for Apple II+ . . . 149.95
- 80-Col. card for Apple IIe . . . 129.95
- Serial Card (communication) . . . 69.95
- Cooling Fan . . . . . 38.95
- Power Supply . . . . . 69.95
- Joystick . . . . . 29.95
- Joystick Adapter Apple IIc . . . 14.95
- RF Modulator . . . . . 13.95
- Disk Drive Full Height . . . . . 169.95
- Disk Drive 1/2 Height . . . . . 169.95
- Controller Card . . . . . 49.95
- Apple Paddles . . . . . 5.95
- 16K Card . . . . . 39.95

## ★ BULK DISKETTES ★

- SS/DD . . . . . 25/\$17.25
- DS/DD . . . . . 25/\$19.75
- AT 1/2 disks . . . . . 25/\$50.00
- 3 1/2" disks . . . . . 25/\$50.00

ALL DISKETTES HAVE  
A FULL 1-YEAR WARRANTY

## UV ERASERS

QUV-T8/1 \$49.95  
ECONOMY Model



- Erases 15 EPROMS in 20 minutes
- Plastic Enclosure

DOKAY carries the Full Line  
of LOGICAL DEVICES, Inc.

## MEMORY EXPANSION KIT



41256 150ns  
\$2.89 each!

## APPLE† or IBM† JOYSTICK \$29.95

## ☆ MERCURY MODEMS ☆ For APPLE† and IBM†

HAYES COMPATIBLE MODEM 195.00  
— FULL ONE YEAR WARRANTY —

## ✓ IBM† ACCESSORIES ✓

- 8087-3 (5 MHz) . . . . . 124.95
- 8087-2 (8 MHz) . . . . . 144.95
- TEAC 558 . . . . . 99.95
- TANDON TM100-2 . . . . . 129.95
- 135W XT POWER SUPPLY . . . 99.95
- 512K RAM MEMORY BOARD . . 139.95
- MULTIFUNCTION BOARD  
with 384K RAM . . . . . 179.95

## MACINTOSH† UPGRADE (Parts only)

128K to 512K . . . . . 50.00  
Consists of: 16 41256 150ns  
1 74F253  
17 16 Pin Sockets  
Resistors and Capacitors ALSO INCLUDED

† A TRADEMARK OF APPLE COMPUTER  
‡ A TRADEMARK OF IBM CORPORATION

</

# California Digital

17700 Figueroa Street • Carson, California 90248

**LETTER QUALITY F-10 DAISY WHEEL PRINTER**

**\$429** Quantity Two

Single piece price \$499. But if you have already purchased an F-10 printer from California Digital, we will honor the \$429 price on the second printer.



The TEC F-10 Daisy Wheel printer is the perfect answer to a reasonably priced 40 character word processing printer. While this printer is "extremely" similar to C.Itoh's F-10/40 Starwriter printer. Legal counsel for the C.Itoh Company have advised us that we should refrain from referring to the TEC printer as a Starwriter. This 40 character per second printer auto installs with Wordstar and Perfect Writer. Features extensive built-in word processing functions that allow easy adaptability and reduced software complexity. Industry standard Centronics interface provides instant compatibility with

all computers equipped with a parallel printer port. The TEC F-10 accepts paper up to 15 inches in width. These printers were originally priced to sell at over \$1400. Through a special arrangement California Digital has purchase these units from a major computer manufacturer and is offering these printers at a fraction of their original cost. Options available include sheetfeeder, tractor feed, buffered memory and an assortment of printer cables for a variety of computers.

**5 1/4" DISK DRIVE SALE \$89** Quantity Two

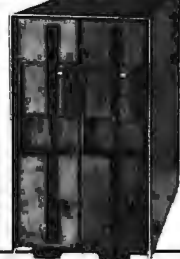
Your Choice any 48 or 96 TPI drive  
**SHUGART • TEAC • QUME**  
**MITSUBISHI • MATSUSHITA**



TEAC FD55B half height	99	89	89
TEAC FD55F 96 TPI, half ht.	119	89	89
TEAC FD55FG for IBM AT	189	179	175
SHUGART SA455 Half Height	99	89	89
SHUGART SA465 1/2 Ht. 96TPI	99	89	89
TANDON 100-2 full height	129	125	119
MITSUBISHI 4851 full height	99	89	89
MITSUBISHI 4853 96/TPI 1/2 Ht.	99	89	89
MITSUBISHI 4854 8" elec.	295	285	275
QUME 142 half height	99	89	89
Switching power supply			49
Installation Kit with manual			10
Dual enclosure for 5 1/4" drives			59
34 pin edge connectors			5
Scotch head cleaning kit			19
Flip & File Storage tubs			15

**DUAL SHUGART SUBSYSTEM \$239**

The dual Shugart subsystem features two SA465 (96 tpi) 5 1/4" double sided disk drives. Also supplied within the subsystem is 50 watt power supply and a shielded signal cable.



**FIVE INCH DOUBLE SIDED DOUBLE DENSITY**

	Each box	10 Boxes	100 Boxes
<b>CAL DIGITAL</b>	CAL-581 CAL-581 N/A	9.95	8.25 7.85
<b>SCOTCH</b>	MMN-7450 MMN-74510 MMN-74516	17.95	17.25 16.75
<b>VERBATIM</b>	VRB-350/01 VRB-350/10 VRB-350/16	17.95	17.25 16.75
<b>MEMOREX</b>	MRX-3481 MRX-3482 MRX-3485	16.95	16.26 15.75
<b>MAXELL</b>	MXL-MD2 MXL-MD2/10 MXL-MD2/16	17.95	17.25 16.75
<b>DYSAN</b>	DYS-104/2D DYS-107/2D DYS-105/2D	42.50	40.50 35.50
<b>DYSAN / 96</b>	DYS-204/2D N/A	49.95	47.95 45.75

Other diskettes available include 3 1/2" and all 8" formats. Please phone for prices.

**QUME \$149**

Eight Inch Single Sided Drives

QUME 841 single side	159	149	call
SHUGART 801R	359	359	354
SIEMENS FDD 100-8	119	115	109

Eight Inch Double Sided Drives

QUME 842 "QUME TRACK 8"	189	179	call
SHUGART SA851R	495	485	475
OLIVETTI double sided	189	179	159
REMEX RFD-4000	179	169	159
MITSUBISHI M2896-63 1/2 Ht.	459	449	409
Dual 8" enclosure with power and fan			259
Switching power supply			89
Installation kit with manual			10

**PLOTTER \$219**

The Comtex Comscriber I is the ideal solution to make short work of translating financial and numeric data into a graphic presentation. Many ready to run programs such as Lotus 1-2-3, Visi-on and Apple business graphics already support this plotter. The Comscriber I features programmable paper sizes up to 8 1/2" by 120 inches, 6 inch per second plot speed and 0.004" step size Easy to implement Centronics interface allows the Comscriber I immediate use with the printer part of most personal computers. The Comscriber I is manufactured for Comtex by the Enter Computer Corporation. The plotter is marketed by Heath Kit and also sold under Enter's own "Sweet P. Label This is your opportunity to purchase a plotter which was originally priced at \$795 for only \$219. Also available is a support package which includes demonstration software, interface cable, a multicolor pen assortment and a variety of paper and transparency material.



**Quick-Link 300 \$59**

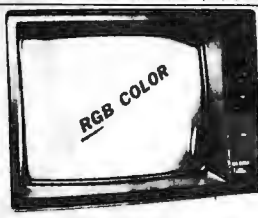
The Quick-Link 300 gives you an instant link to any dial up data base. Such as Dow Jones, Western Union or the Source. The Quick-Link has four user programmable log-on keys, allowing the operator, with only one key stroke, to dial the data base, log-in and give the password. All this information is permanently stored in non-volatile RAM. Features include video output to television or monitor, auto dial, auto-log, full sized keyboard, 300 baud modem and 1200 baud auxiliary printer port. All this is available for only \$59.

**Muppet Learning Keys \$29.95**

The Muppet Learning Keys teaches children, of two years of age and up, the relationship of letters, numbers and color. But even more it teaches the fundamentals of computers. Manufactured by Koala Technologies under license of Jim Henson's Muppets, The Muppet Learning Keys is the ideal Christmas gift for that special child. Learning Keys is currently selling in specialty stores for \$79 but do to a special purchasing arrangement, California Digital is offering this unit at only \$29.95.



**NEC RGB COLOR MONITOR \$219**



The NEC JC-1401D is a 13" medium/high resolution RGB monitor suitable for use with the Sanyo MBC-550/555 or the IBM/PC. The monitor features a resolution of 400 dots by 240 lines. Colors available are Red, Green, Blue, Yellow, Cyan, Magenta, Black and White. The NEC monitor carries the Litton-Monroe label and was originally scheduled for use in their "Office of the Future" equipment. A change in Monroe's marketing strategy has made these units excess inventory which were sold to California Digital. We are offering these "new" RGB monitors at a fraction of their original cost. Sanyo compatible NEC-1401/S; IBM/PC Computer compatible NEC-1401/PC.

## PRINTERS

**MATRIX PRINTERS**

Star Gemini-SG10 120 char/sec.	STR-SG10	299.00
Star Gemini-SG15 100 char./sec. 15" paper.	STR-SG15	389.00
Star Gemini Delta 10, 160 Char/sec	STR-D10	359.00
Citizen MSP/10FT 160 char/sec.	CIT-MSP10	289.00
Toshiba P1351, 192 char/sec. letter quality	TOS-1351	1495.00
Okidata 192A serial & parallel 96" paper	OKI-192A	257.00
Okidata 192A parallel interface, 160 char/sec.	OKI-192A	245.00
Okidata 84P parallel 15" paper	OKI-84P	799.00
Epson LX-80 10" 120 Char/sec.	EPS-LX80	239.00
Epson FX80FT, 10" 160 char./sec. with graphitax	EPS-FX80	389.00
Epson RX100-15" with Graphitax	EPS-RX100	389.00
Epson FX1100FT 15" 150 char./sec with graphitax	EPS-FX100	489.00
Powriter 8510 parallel 96" paper	EPS-LD1500	895.00
Epson LQ1500, 15" correspondence quality	EPS-JX90	519.00
Epson JX90 Color printer	PRO-3510P	329.00
Dataproducts E-600-3, band printer 600 LPM.	DPS-B600	6985.00
Printonix P300 high speed printer, 300 lines per minute.	PTX-P300	3995.00
Printonix P600 ultra high speed 600 lines per minute.	PTX-P600	5795.00

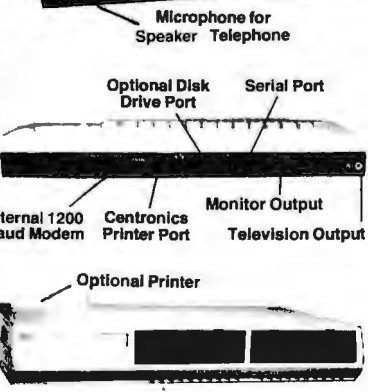
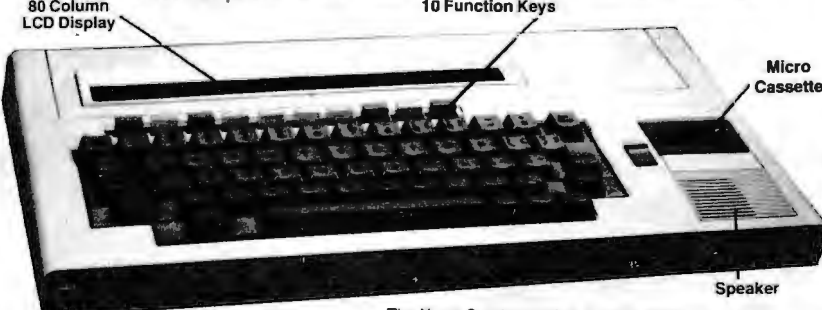
**WORD PROCESSING PRINTERS**

Starwriter F10 parallel, 40 char/sec	PRO-F10P	499.00
NEC8810 55 char/second, serial interface	NEC-8810	1659.00
NEC830 55 char/sec. par1 interface	NEC-830	1659.00
NEC-3550 personal printer designed for the IBM/PC	NEC-3550	1599.00
NEC2050 designed for IBM/PC 20 char/sec. par1	NEC-2050	689.00
Silver Reed EXP500, 14 char/sec. par1 interface	SRD EXP500	219.00
Silver Reed EXP550 17 Char/sec. par1 interface.	SRD-EXP550	429.00
Diablo 630 40 char./sec. serial	DBL-630	1569.00
Diablo 620, proportional spacing, horiz & vert. tab. 20 cps	DBL-620	769.00
Juki 6100, 18 char./sec.	JUK-6100	399.00
Juki 6300, 40 char./sec.	JUK-6300	699.00
Comtex CR2, 3k buffer, proportional spacing, par1.	CRX-CR2P	395.00

# California Digital

17700 Figueroa Street • Carson, California 90248

## XEROX \$299 SUNRISE COMPUTER



The Xerox Sunrise 1810 is by far the best value we have ever seen in a micro computer. This is a self contained battery and AC operated portable. The Sunrise was originally priced at \$2995. Xerox has since elected to drop the computer from their product list. California Digital has purchased all the remaining inventory and is making the unit available at a fraction of its original cost.

This portable features a built in 80 column liquid crystal display, 64K of memory along with both RF monitor and television outputs. The internal 300/1200 baud modem includes an auto dial telephone assembly. The units has both centronics parallel and a serial port programmable to 19,200 baud. The self contained micro cassette is capable of capturing data from the keyboard as well as doubling as an recorder for dictating messages.

An optional dual floppy disk drive module, pictured above, is available for only \$219. Also available, for \$59 is an 80 column printer that mounts in the drive module. The Sunrise features a CP/M operating system which allows the operator to use any CP/M program in Xerox 5 1/4" disk format and over 5000 CP/M programs available in public domain.

We have available a 15 minute tape on the Sunrise Computer. The tape is in VHS format and was produced by Xerox to promote the computer. California Digital is offer the promotional tape at \$15. This will be applied towards purchase price of the Sunrise 1810.



## Eclipse \$179

**DATA PRODUCTS**  
**1200 Baud • Hayes Compatible**

The Eclipse 1200 is the best value we have ever offered in a fully Hayes Compatible modem. The unit incorporates status lamps, speaker, auto dial and many more features into this compact package.

California Digital is so confident of your complete satisfaction that we will allow the return of the Eclipse 1200 and apply the full credit towards the purchase price of any other modem.



**MEMORY & SPECIALTY BOARDS**

Twir-Winchester, floppy and streamer tape	299
AST Six Pack 64K, serial, par'l, clock/clk	223
AST Six Pack as above but 384k/Byte of mem	239
AST Advantage 128K	419
AST I/O plus clock/cal., serial & game port	129
Quadram Quadboard II, 64K memory	379
Quadram QuadLink/Apple files	279
Persytel Time Spectrum card, 64K	239
DigiGraphics Multifunction	219
Titan Tech. PC/Accelerator	499
Hexace RAM card 576K/byte	199
Hexace multifunction	119

**GRAPHIC CARDS**

Hercules Color Card	179
Hercules Graphic Card	319
Persytel 8080 Board super hi-res color.	329
Hexace half slot video card	119
Peacock Color Card, composi/RGB, printer	139
California Comp. SuperVision graphics	379

**INTERNAL MODEMS**

Modtech UltraLink 1200, 202 half duplex	99
Anchor Auto. Signalman Mk16. 300 baud.	49
Prometheus 1200B Internal	279

**HARDWARE**

Tallgrass 60 meg. tape back-up	1459
Kraft IBM JoyStick	36
Microsoft Mouse, serial & paintbrush	145
Mouse Systems PC Mouse	149
8087 co-processor	119
Keytronics 5151 IBM keyboard	199
Belkin A/B switch, par'l or serial	59

**SOFTWARE**

MicroPro WordStar word processing	179
Ashton Tate Framework, spreadsheet+	395
Ashton Tate D/Base III, Data Base Manager	395
Lotus 1-2-3 spreadsheet & more	299
Symphony by Lotus development	419
Redwood Dev. Jr. CAD, plotter	59

## 1200 BAUD MODEMS

**INTELLIGENT MODEM**  
**Mercury 1200**



The Mercury 1200 is our lowest cost Hayes compatible modem. Not a lot of bells and whistles but a good value at only \$175. Manufactured in the United States.

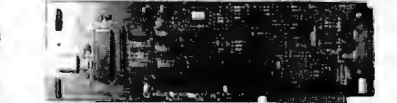


The Universal Data 212A is manufactured for the mini-computer market. This modem is both 300 and 1200 baud auto answer. An industrial quality modem originally priced at \$595. NOT Hayes compatible.



The Team 212A offers all the features of the Hayes Smart Modem 1200 for a fraction of the price. Now is our opportunity to purchase a 1200 baud modem at the price of a 300 baud modem.

## UltraLink 1200



The UltraLink is a 1200 baud HALF DUPLEX bell 202 compatible internal modem card for the IBM/PC. This unit operates full duplex at 300 baud.

The UltraLink adds a voice/data demension to your PC. Manufacturers original suggested price on this modem is \$795. California Digital's price is only \$99.

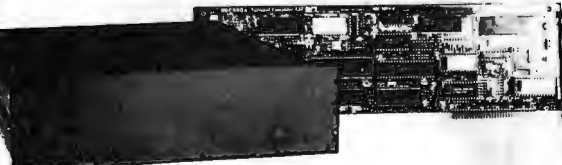
## MODEMS

Eclipse 1200 100% Hayes, with status lamps.	179.00
Universal Data 212LP, 1200 duplex, line powered.	139.00
Universal Data 212A, 300/1200 baud, industrial.	159.00
Universal Data 103JLP, line powered, auto answer.	29.00
Hayes Smartmodem 2400 baud modem	599.00
Fujitsu 2400/1200 baud auto everything.	459.00
Team 1200 Hayes Compatible, 300/1200 baud.	199.00
UltraLink 1200 data and voice on same line.	99.00
CTS 212AH 1200 baud, auto dial	219.00
Terminal software for CTS 212AH	35.00
Prometheus 1200B super features	319.00
Prometheus 1200B internal PC	279.00
Signalman Mark 12, 1200 baud, Hayes compatible.	239.00
Signalman Mark VI, 300 baud internal PC	49.00
Hayes Smart Modem 1200 baud, auto dial	399.00
Hayes 1200B for use with the IBM/PC, 1200 baud.	369.00
Hayes Smartmodem, 300 baud only, auto dial	199.00
Hayes Chronograph, time & date	199.00
Penril 300/1200 industrial quality	395.00
EGP-1200	179.00
UDS-212LP	139.00
UDS-212A	159.00
UDS-103LP	29.00
HYS-2400	599.00
FUJ-1935D	459.00
TEM-SM1200	199.00
UTL-1200A	99.00
CTS-212AH	219.00
CTS-212SFT	35.00
PRM-P1200	319.00
PRM-P1200B	279.00
SGL-MK12	239.00
SGL-MK6	49.00
HYS-212AD	399.00
HYS-1200B	369.00
HYS-103AD	199.00
HYS-CHR232	199.00
PEN-12AD	395.00

## Shugart \$239

10 MEGABYTE WINCHESTER HARD DISK DRIVE

Quantity Two



**Five Inch Winchester Disk Drives**

	each	two+
SHUGART SA712 10 M. Ht.	259	239
SEAGATE ST506 6.7 Meg.	139	129
SEAGATE 225 20 Meg. 1/2 Ht.	389	359
SEAGATE 4026 26 M. 35mS.	859	829
SEAGATE 4051 51 M. 35mS.	1095	1059
FUJITSU 2242 55 M. 35mS.	1799	1729
FUJITSU 2243 86 M. 35mS.	2295	2219
RODIME RD-202E 27 Meg.	759	729
RODIME RD-203E 40 Meg.	995	959
RODIME RD-204E 53 Meg.	1259	1195
CONTROL DATA 94155-86 M.	1629	1779
MAXTOR XT1140 140 Meg.	3379	3295
HONEYWELL 85M. 27 mS.	1795	1695
TOSHIBA MK56 70 M. 30mS.	1789	1729
TANDON 502 10 Meg.	419	379

**Winchester Controllers for IBM/PC**

FALCON FT-HDC half card	189
XEBEC 1220 with floppy controller	269
NATIONAL COMPUTER 5004	159
DTC 6150BX	159
OMTI 5510 half card	189
ADAPTEC 2010A software install	189
WESTERN DIGITAL WD/1002	189

**SCSI/SASI Winchester Controllers**

XEBEC 1410A 5 1/4" foot print	239
OMTI 20L	119

**Winchester Accessories**

Installation Kit with manual	10
Winchester enclosure and supply	139
Dual 20/34 cable set	25
Switching power supply	49

TOLL FREE ORDER LINE  
**(800) 421-5041**

TECHNICAL & CALIFORNIA  
**(213) 217-0500**

Incredible value!

# Nashua™ Diskettes

**LIFETIME WARRANTY!**

**85¢** ea. 5 1/4" SSDD **97¢** ea. 5 1/4" DSDD

These are poly-bagged diskettes packaged with Tyvek sleeves, reinforced hubs, user identification labels and write-protect tabs. NASHUA Corporation is a half-billion dollar corporation and a recognized leader in magnetic media.

**SOFT SECTOR ONLY!** Sold in multiples of 50 only!

**FOR ORDERS ONLY:** 1-800-621-6827  
(In Illinois: 1-312-256-7140)

**INFORMATION & INQUIRIES:** 1-312-256-7140

**HOURS:** 8AM-5PM Central Time, Monday-Friday  
**WE WILL BEAT ANY NATIONALLY ADVERTISED PRICE ON THE SAME PRODUCTS AND QUANTITIES!**

**DISK WORLD!, Inc.**

629 Green Bay Road • Wilmette, Illinois 60091

**DISK WORLD!**

Authorized Distributor **NASHUA MAGNETIC MEDIA**

FANTASTIC LOW PRICES ON

# BASF QUALIMETRIC DISKETTES!

**LIFETIME WARRANTY!**

Buy in bulk and save. 150 to the carton with envelopes, write-protect tabs and user ID labels. Boxed product is the same, except in cardboard boxes of 10.

5.25" SSDD	Qty. 50	Qty. 150
5.25" DSDD	83 ea.	80 ea.
5.25" SSDD-HD	94 ea.	92 ea.
5.25" SSDD-96TPI	2.13 ea.	N/A
5.25" DSDD-96TPI	94 ea.	N/A
3.50 SSDD-135TPI	1.06 ea.	N/A
3.50 DSDD-135TPI	1.84 ea.	1.68 ea.
	2.40 ea.	2.28 ea.

**NOTE:** 3.50" diskettes in Quantity 50 are packed in plastic library cases. That's why they seem to be a better buy. But there are only 5 diskettes to a case...so the bulk diskettes are really a better deal, unless you like expensive little library cases.

**FOR ORDERS ONLY:** 1-800-621-6827  
(In Illinois: 1-312-256-7140)

**INFORMATION & INQUIRIES:** 1-312-256-7140

**HOURS:** 8AM-5PM Central Time, Monday-Friday  
**WE WILL BEAT ANY NATIONALLY ADVERTISED PRICE ON THE SAME PRODUCTS AND QUANTITIES!**

**DISK WORLD!**

Authorized Reseller Information Processing **BASF** Media

# 3M Scotch® DISKETTES

Now, the lowest prices ever on

**LIFETIME WARRANTY!**

The best deal on 3M diskettes you've ever seen! **FREE!** FLIP 'N FILE 15 with every order for 5.25" SSDD and DSDD.



**\$1.36 ea.** ... 5.25" SSDD with FREE Flip 'n File 15  
**\$1.67 ea.** 5.25" DSDD with FREE Flip 'n File 15...

**MINIMUM ORDER: 50 Diskettes**  
(Orders less than 50 are \$1.39 and \$1.70, respectively.)

**100% LIFETIME WARRANTY!**

This is a Super Special Promotion. It was supposed to end May 31, 1985.

But we decided to buy more than 1,000,000 3M diskettes packed in the FREE Flip 'n File 15...and give you the benefits of this terrific value.

One word of warning: this offer is limited only to supplies on hand. Once this inventory is gone, that's it. The prices stay the same...but there's no FREE Flip 'n File.

The last time we ran an offer like this, everything sold out in about six weeks.

So don't wait. Order now.

Other 3M diskettes

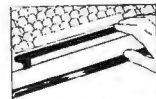
	Qty. 20	Qty. 50
5.25" SSDD-96TPI	\$2.07 ea.	\$2.04 ea.
5.25" DSDD-96TPI	\$2.51 ea.	\$2.48 ea.
5.25" DSDD-HD FOR AT	\$3.18 ea.	\$3.14 ea.
3.50"SSDD-135TPI (Mac)	\$2.29 ea.	\$2.26 ea.

**DATA CARTRIDGES**

100% certified 3M data cartridges

DC-1000	\$12.62 ea.
DC-300XLP	\$19.38 ea.
DC-600A	\$20.61 ea.

Sold in cases of 10 only.  
Add \$5.00 shipping per 10 data cartridges.



**FIRST TOUCH KEYBOARD STRIP**

The best way we've ever seen to avoid static danger. Adheres to the front ledge of your keyboard. Overpriced at \$19.95, so we cut the price to \$10.95 + \$1.50 Shipping.



**A VERY SPECIAL OFFER**  
**3M POST-IT NOTES & DISPENSER**

Suggested Retail: \$20.95. Includes dispenser, 12 pads of 3" x 5" Post-It notes and Pilot Ball Point Pen. Order it with 50 3M diskettes or 10 data cartridges and it's only \$9.75 + \$3.00 Shipping.

**DISK WORLD!**

Authorized Distributor Information Processing Products



# ATHANA DISKETTES

The great unknown!

**79¢** ea. 5 1/4" SSDD **85¢** ea. 5 1/4" DSDD

You've used these diskettes hundreds of times...as copy-protected originals on some of the most popular software packages. They're packed in poly-bags of 25 with Tyvek sleeves, reinforced hubs, user identification labels and write-protect tabs.

**LIFETIME WARRANTY!**

**SOFT SECTOR ONLY!** Sold in multiples of 50 only.

**FOR ORDERS ONLY:** 1-800-621-6827  
(In Illinois: 1-312-256-7140)

**INFORMATION & INQUIRIES:** 1-312-256-7140

**HOURS:** 8AM-5PM Central Time, Monday-Friday  
**WE WILL BEAT ANY NATIONALLY ADVERTISED PRICE ON THE SAME PRODUCTS AND QUANTITIES!**

**DISK WORLD!, Inc.**

629 Green Bay Road • Wilmette, Illinois 60091

**DISK WORLD!**

Authorized Distributor **ATHANA MAGNETIC MEDIA**

# DISK WORLD! Ordering & Shipping Instructions

**Shipping:** 5 1/4" & 3 1/2" DISKETTES—Add \$3.00 per each 100 or fewer diskettes. **Other Items:** Add shipping charges as shown in addition to other shipping charges. **Payment:** VISA and MASTER-CARD accepted. **COD Orders:** Add additional \$5.00 Special Handling charge. **APD, FPO, AK, HI & PR Orders:** Include shipping charges as shown and additional 5% of total order amount to cover PAL and insurance. **Taxes:** Illinois residents only, add 7% sales tax.

Prices subject to change without notice.  
This ad supercedes all other ads.  
Not responsible for typographical errors.  
**MINIMUM TOTAL ORDER: \$35.00**

**FOR ORDERS ONLY:** 1-800-621-6827  
(In Illinois: 1-312-256-7140)

**INFORMATION & INQUIRIES:** 1-312-256-7140

**HOURS:** 8AM-5PM Central Time Monday-Friday

**WE WILL BEAT ANY NATIONALLY ADVERTISED PRICE ON THE SAME PRODUCTS AND QUANTITIES!**

**DISK WORLD!, Inc.**

629 Green Bay Road • Wilmette, Illinois 60091

**DISK WORLD!**

# DISKETTE STORAGE CASES

**AMARAY MEDIA-MATE 50: A REVOLUTION IN DISKETTE STORAGE**

Every once in a while, someone takes the simple and makes it elegant! This unit holds 50 5 1/4" diskettes, has grooves for easy stacking, inside nipples to keep diskettes from slipping and several other features. We like it!

**\$9.69** ea. + \$2.00 Shpng.

**DISKETTE 70 STORAGE: STILL A GREAT BUY.** Dust-free storage for 70 5 1/4" diskettes. Six dividers included. An excellent value.

**\$9.95** + \$3.00 Shpng.



**DISK CADDIES** The original flip-up holder for 10 5 1/4" diskettes. Beige or grey only.

**\$1.65** ea. + 20¢ Shpng.

**FOR ORDERS ONLY:** 1-800-621-6827  
(In Illinois: 1-312-256-7140)

**INFORMATION & INQUIRIES:** 1-312-256-7140

**HOURS:** 8AM-5PM Central Time, Monday-Friday  
**WE WILL BEAT ANY NATIONALLY ADVERTISED PRICE ON THE SAME PRODUCTS AND QUANTITIES!**

**DISK WORLD!, Inc.**

629 Green Bay Road • Wilmette, Illinois 60091

**DISK WORLD!**

The value leader in Computer supplies And accessories.

# PRINTER RIBBONS:

at extraordinary prices!

Brand new ribbons, manufactured to Original Equipment Manufacturer's specifications, in housings. (Not re-inked or spools only.)

**LIFETIME WARRANTY!**

**Epson MX-70/80** . . . \$2.70 ea. + 25¢ Shpng.  
**Epson MX-100** . . . \$4.08 ea. + 25¢ Shpng.  
**Okidata Micro83** . . . \$1.37 ea. + 25¢ Shpng.  
**Okidata Micro84** . . . \$2.98 ea. + 25¢ Shpng.

**FOR ORDERS ONLY:** 1-800-621-6827  
(In Illinois: 1-312-256-7140)

**INFORMATION & INQUIRIES:** 1-312-256-7140

**HOURS:** 8AM-5PM Central Time, Monday-Friday

**WE WILL BEAT ANY NATIONALLY ADVERTISED PRICE ON THE SAME PRODUCTS AND QUANTITIES!**

**DISK WORLD!, Inc.**

629 Green Bay Road • Wilmette, Illinois 60091

**DISK WORLD!**

# What the world really needs is a 69 cent Double Sided, Double Density Diskette with a LIFETIME WARRANTY!

## And DISK WORLD! has it.

### Introducing Super Star Diskettes: the high quality diskette with the lowest price and the best LIFETIME WARRANTY!

In the course of selling more than a million diskettes every month, we've learned something: higher prices don't necessarily mean higher quality.

In fact, we've found that a good diskette manufacturer simply manufactures a good diskette...no matter what they charge for it. (By way of example, consider that none of the brands that we carry has a return rate of greater than 1/1,000th of 1 percent!)

In other words, when people buy a more expensive diskette, they aren't necessarily buying higher quality.

The extra money might be going toward flashier advertising, snazzier packaging or simply higher profits.

But the extra money in a higher price isn't buying better quality.

All of the good manufacturers put out a good diskette. Period.

#### How to cut diskette prices ...without cutting quality.

Now this discovery posed a dilemma: how to cut the price of diskettes without lowering the quality.

There are about 85 companies claiming to be "diskette" manufacturers.

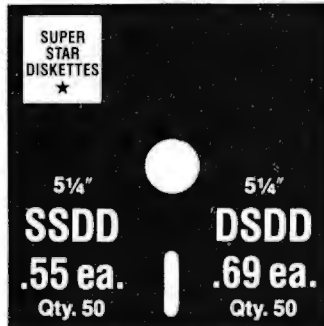
Trouble is, most of them aren't manufacturers. Rather they are fabricators or marketers, taking other company's components, possibly doing one or more steps of the processing themselves and pasting their labels on the finished product.

The new Eastman Kodak diskettes, for example, are one of these. So are IBM 5 1/4" diskettes. Same for DYSAN, Polaroid and many, many other familiar diskette brand names. Each of these diskettes is manufactured in whole or in part by another company!

So, we decided to act just like the big guys. That's how we would cut diskette prices...without lowering the quality.

We would go out and find smaller companies to manufacture a diskette to our specifications...specifications which are higher than most...and simply create our own "name brand" diskette.

Name brand diskettes that offered high quality at low prices.



Super Star diskettes are sold in multiples of 50 only. Diskettes are shipped with white Tyvec sleeves, reinforced hubs, user ID labels and write-protect tabs.

#### Boy, did we get lucky. Our Super Star Diskettes are the same ones you've been using for years...without knowing it.

In our search for the low priced, high quality diskette of our dreams, we found something even more interesting.

We found that there are several manufacturers who don't give a hoot about the consumer market for their diskettes. They don't spend millions of dollars in advertising trying to get you, the computer user, to use their diskettes.

Instead, they concentrate their efforts on turning out the highest quality diskettes they can...because they sell them to the software publishers, computer manufacturers and other folks who (in turn) put their name on them...and sell them for much higher prices to you!

After all, when a software publisher or computer manufacturer or diskette marketer puts their name on a diskette, they want it to work time after time, everytime. (Especially software publishers who have the nasty habit of copy-protecting their originals!)

**Super Star Diskettes. You already know  
how good they are. Now you can buy  
them...cheap.**

Well, that's the story.

Super Star diskettes don't roll off the boat from Pago-Pago or emerge from a basement plant just east of Nowhere.

Super Star diskettes have been around for years...and you've used them for years as copy-protected software originals, unprotected originals. Sometimes, depending on which computer you own, the system master may have been on a Super Star diskette. And maybe more than once, you've bought a box or two or more of Super Star diskettes without knowing it. They just had some "big" company's name on them.

Super Star Diskettes are good. So good that a lot of major software publishers, computer manufacturers and other diskette marketers buy them in the tens or hundreds of thousands.

We buy them in the millions.  
And then we sell them to you.  
Cheap.

#### When every little bit counts, it's Super Star Diskettes.

You've used them a hundred times...under different names.

Now, you can buy the real McCoy, the same diskette that major software publishers, computer manufacturers and diskette marketers buy...and call their own.

We simply charge less.

#### Super Special!

Order 50 Super Star Diskettes and we'll be happy to sell you an Amaray Media-Mate 50 for only \$8.75, shipping included...a lot less than the suggested retail price of \$15.95.



Regular DISK WORLD! price: \$9.69 ea.  
+ \$2.00 Shpng.

#### DISKETTE STORAGE CASES

##### DISK CADDIES

The original flip-up holder for 10 5 1/4" diskettes. Beige or Grey only.

**\$1.65 ea. + .20 Shpng.**



##### DISKETTE 70 STORAGE

Dust-free storage for 70 5 1/4" diskettes. Six dividers included. An excellent value.

**\$9.95 ea. + \$3.00 Shpng.**



#### HOW TO ORDER:

##### ORDERS ONLY:

1-800-621-6827

(In Illinois: 1-312-256-7140)

##### INQUIRIES:

1-312-256-7140

FOR FASTEST SERVICE, USE NO-COST MCI MAIL: Our address is DISKORDER. It's a FREE MCI MAIL letter. No charge to you. (Situation permitting, we'll ship these orders in 24 hours or less.)

**SHIPPING:** 5 1/4" & 3 1/2" DISKETTES—Add \$3.00 per each 100 or fewer diskettes. **OTHER ITEMS:** Add shipping charges as shown in addition to other shipping charges. **PAYMENT:** VISA, MASTERCARD and Prepaid orders accepted. **COD ORDERS:** Add additional \$5.00 special handling charge. **APO, FPO, AK, HI & PR ORDERS:** Include shipping charges as shown and additional 5% of total order amount to cover PAL and insurance. We ship only to United States addresses, except for those listed above. **TAXES:** Illinois residents, add 7% sales tax.

MINIMUM ORDER: \$35.00.

#### The Super Star LIFETIME WARRANTY!

Super Star Diskettes are unconditionally warranted against defects in original material and workmanship so long as owned by the original purchaser. Returns are simple: just send the defective diskettes with proof of purchase, postage-paid by you with a short explanation of the problem, and we'll send you the replacements. (Incidentally, coffee stained diskettes and diskettes with staples driven through them don't qualify as "defective".)

**WE WILL MEET OR BEAT ANY NATIONALLY  
ADVERTISED PRICE  
ON THE SAME PRODUCTS AND QUANTITIES  
SUBJECT TO THE SAME TERMS AND CONDITIONS.**

**HOURS:**  
Human: 8AM-6PM Central Time, Monday through Friday  
Answering Machine: 6PM-8AM, All Times  
MCI MAIL: 24 hours a day.

# DISK WORLD!, INC.

**629 Green Bay Road  
Wilmette, Illinois 60091**

## MAJOR BRAND PRICE BREAKTHRU



Retail Value \$5000

Save up to 60%

**ADVANCED XT**

**ACP PRICE  
NOW ONLY!**

**\$1695.00**

*Monochrome Monitor Included  
10 Mb Hard Disk*

ACP has sold over 2,000 of this system to major customers including Rockwell Int'l, Hughes Aircraft and Emulex Corp. See for yourself why these customers prefer the Advanced XT over the IBM XT.

**BASE SYSTEM CONSISTS OF:**

- 256K Expandable to 640K on the Motherboard.
- (1) 360K DS/DD Floppy Disk
- Serial & Parallel Ports
- Deluxe Keyboard w/LED's
- Mouse with Software
- LCD, Lightpen & RF Ports
- RGB and Mono Ports
- VLSI Circuit Design
- (3) Expansion Slots
- Ergonomic Design & Packaging
- GEM or PC Works Software
- 90 Day Warranty

<b>SYSTEM A</b> <small>(P/N BDACP100)</small>	Base System (See Left)	<b>\$ 995.00</b>
<b>SYSTEM B</b> <small>(P/N BDACP101)</small>	Base System with additional Floppy Disk Drive	<b>\$1099.00</b>
<b>SYSTEM C</b> <small>(P/N BDACP102)</small>	Base System w/12" Grn Monitor w/Tilt & Swivel base and additional Floppy Drive	<b>\$1295.00</b>
<b>SYSTEM D</b> <small>(P/N BDACP103)</small>	Base System w/RGB Color Monitor w/Tilt & Swivel base and additional Floppy Drive	<b>\$1495.00</b>
<b>SYSTEM E</b> <small>(P/N BDACP104)</small>	Base System w/10Mb Hard Disk and Green Monitor with Tilt & Swivel base	<b>\$1695.00</b>
<b>SYSTEM F</b> <small>(P/N BDACP105)</small>	Base System w/10Mb Hard Disk and RGB Color Monitor with Tilt & Swivel base	<b>\$1985.00</b>

**ADVANCED XT ACCESSORIES**

- 6 Slot Expansion Chassis (IBM or IBM Compatible)... **\$399.00**
- LCD Display (80x25) for use with Advanced XT LCD Port.... **\$299.00**
- Monochrome Hi-res text card... **\$9.95**
- Monochrome IBM style Monitor... **\$99.95**
- 256K Upgrade (Uninstalled)... **\$59.95**

- PC DOS 2.1..... **\$65.00**
- GW Basic..... **\$75.00**
- PC Works 1.15 (Touchstone) Regular \$195..... **\$65.00**
- Archive Tape B.U. (ext. 10Mb)... **\$995.00**
- Maintenance Manual..... **\$50.00**
- Technical Reference Manual.... **\$50.00**

**SPECIAL SYSTEM w/Printer**

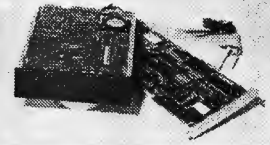
1. System E with Diablo 620 Serial Printer..... **\$1995.00**
2. System F with Diablo 620 Serial Printer..... **\$2285.00**
3. Canon LBP-8A1 IBM compatible laser printer. Purchase for a low price of **\$2895.00** and we will give you System A **FREE!**

**DIABLO 620 DAISYWHEEL PRINTER**

**The Finest Letter Quality Printer at a Spectacular Price. We have sold 1000's. You can have a spare at this price.**



- 620 Serial..... List 1495 **ACP \$395.00**
- 620 API..... List 1695 **ACP 495.00**
- 620 D36..... List 1695 **ACP 550.00**
- F-21 Sheet Feeder. List 895 **ACP 249.00**
- 620 Tractor..... List 395 **ACP 99.00**
- Cable..... **ACP 29.00**
- Serial to Par. 64K Buffer.... **ACP 125.00**



**10 Mb \$399.00**

Shugart SA712 w/Controller & Cables. Ready for Installation in IBM™ PC and Compatibles. (1 Year Warranty)

Shugart SA712 10Mb HD **\$229.00**

Seagate ST225 20Mb HD **419.00**

**PC UPGRADE SPECIAL**

**\$4.95** SET OF (9) 64K RAMS

**\$26.95** SET OF (9) 256K RAMS

**\$5.95** 4128 PIGGYBACK RAM

**1200 Baud Hayes™ Comp. Modem** Short Card by U.S. Robotics with Telpac I Software.

List \$499 **ACP... \$179.00**  
Buy (6)..... **\$159.00**

**10Mb Tape Back-up**



Archive, #1 in tape back-up technology. High speed 10Mb back-up for only

**\$995.00**

**External Box w/Power Supply**

Great for adding Hard Disk to your PC. Same as photo..... **\$179.00**

**DELUXE JOYSTICK**

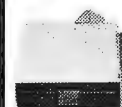
**\$11.95**



Compatible w/Atari 2600, 400, 800, VIC-20/64 and Apple. Apple requires optional cable adaptor. Add **\$2.95**

**APPLE DISK DRIVE**

**\$115.00**



High quality 1/2 high drive for Apple II, II+, IIe or IIc. Apple IIc requires optional cable adaptor. Add **\$10.00**



# Parts

TOLL FREE  
800-854-8230

Calif. Residents

714-558-8813

OUR POLICY

- No surcharge for VISA or Mastercard.
- No sales tax. \*All shipments insured.
- Your card is NOT charged until we ship.
- Same day FEDEX shipment is available.
- Volume purchasing agreements available.
- Government agencies, corporate and Institutional PO's accepted.
- Orders subject to availability.
- All items have manufacturer warranty. Some warranties up to 5 years.
- Pricing subject to change w/o notice.
- Returns or cancellations may be subject to restocking fee.
- ACP Retail Store pricing may vary.
- We are not responsible for typos.

## UPS POWER SUPPLY

Backup Power for your IBM, Apple or Compatible

UPS-PC 200 Watts \$277.00  
UPS-XT 300 Watts 419.00  
UPS-AT 800 Watts 739.00

### A-B PRINTER SWITCH

An AB Switch allows use of two printers with your computer system. We stock over 15 different configurations.

AB Switch (Electronics) \$55.00  
AB Switch (DDB) \$9.00

## COLOR VIDEO CARDS

Plantronics Color Plus \$375.00  
IBM Color Card \$27.00  
IBM Mono Card w/parallel \$216.00  
STB Graphics Plus \$399.00  
Paradise Multitdisplay Card \$345.00  
Everex Graphics Edge \$345.00

## SPECIAL BUY

Sharp 11" Color RGB Monitor  
List \$499.00 ACP \$249.95

## INTERNAL STD-BUS BOARDS

ISB1000 280 CPU \$200 89.95  
ISB1010 486 CPU 200 79.95  
ISB3216 16K CMOS RAM 810 99.95  
ISB3218 16K Static RAM 200 39.95  
ISB3220 16K CMOS RAM 200 119.95  
ISB3300 280 PCI (D ending) 250 79.95  
ISB3331 Universal PCI 210 49.95  
ISB3400 Opto Para. Input 200 119.95  
ISB3400 Pnpay Controller 210 79.95  
ISB4100 64B (DMA) WMI Inter. 255 99.95  
ISB3500 Trac 215 99.95  
ISB3510 Opto-In Input 270 119.95  
ISB3520 SPT Relay 190 89.95  
ISB3600 Arithmetic 375 149.95  
ISB3610 EPROM Programmer 250 99.95  
ISB3700 Sync/Async 245 69.95  
ISB3711 Univ. Sync/Async 315 149.95  
ISB3720 REMADAC 245 99.95  
ISB3800 12 Bit AD 720 299.95

## CAPACITORS

.01uf DIBO BYPASS CAPACITOR 100K/50  
.1 uf DIBO BYPASS CAPACITOR 100K/50  
.1 uf MONOLITHIC CAPACITOR 1001/25  
.1 uf MONOLITHIC CAPACITOR 1001/25

## CORCOM EMI FILTER

STD CORCOM 3 Conductor Filter \$4.50  
Line Cord for above - 8 foot .35  
Line Cord 2 Conductor - 8 foot .35  
Line Cord 3 Conductor - 6 foot .35

## MUFFIN FANS

Over 10,000 in Stock

Twin 4" 7A-300 Fan NEW! 69.95  
Twin 4" 8" Muffin Fan NEW! 89.95  
12VDC Fan NEW! 119.95  
Flower Guards Added 1.49  
Power Cords Added 1.49

## IC SOCKETS

SOLDIERTAIL 1-99 100  
8 Pin STPLP \$ .13 10  
14 Pin STPLP .17 12  
18 Pin STPLP .17 12  
18 Pin STPLP .20 .11  
20 Pin STPLP .28 .28  
22 Pin STPLP .28 .27  
24 Pin STPLP .28 .27  
28 Pin STPLP .38 .38  
30 Pin STPLP .48 .48  
6 Pin STPLP .39 3.25

## WIREWRAP (GOLD)

8 Pin WW/SL \$ 49 8.40  
8 Pin WW/SL \$ 59 8.40  
16 Pin WW/SL \$ 65 8.95  
20 Pin WW/SL \$ 89 9.95  
22 Pin WW/SL \$ 119 1.75  
24 Pin WW/SL \$ 129 1.75  
28 Pin WW/SL \$ 149 1.99  
30 Pin WW/SL \$ 159 1.99  
18 Pin STPLP \$ 1.49 1.99  
24 Pin STPLP \$ 1.75 1.99  
28 Pin STPLP \$ 1.99 1.99

## ICDC CONNECTORS

NOTE: To order insert number of contacts in place of xxx in ACP part number.  
ORDER QUANTITY OF 50pcs (mixed) AND TAKE AN ADDITIONAL 10% OFF.

ICDC TYPE	ACP NO	NUMBER OF CONTACTS	10	20	34	40	50
Solder Header	IDHxS	.79	1.20	1.65	2.10	2.40	3.00
Rt Angle Solder Header	IDHxSR	.79	1.20	1.65	2.10	2.40	3.00
Ribbon Header Socket	ID5xx	.75	.95	1.35	1.60	1.85	2.10
Ribbon Header	IDMxx	—	5.25	5.95	6.75	7.25	8.25
Ribbon Edgecard	IDExx	1.70	2.15	2.50	2.60	3.70	3.95
Wirewrap Header	IDHxW	1.80	2.90	3.75	4.25	4.95	6.50
Rt Angle WW Header	IDHxWR	1.99	3.10	4.10	4.20	4.60	7.15

## EPSON PRINTERS

FX-85 (160cps) \$369.00  
FX-185 (160cps) \$515.00  
LX-80 (100 cps) \$245.00  
LQ-1500 (NLQ) \$899.00  
FX-80 + \$339.00

## DRIVE CABINETS

IBM Style Hard Disk with power supply and fan \$175.00  
Dual Hard Disk w/power sup & fan 200.00  
Dual 5 1/4" Full Height vertical mount 65.00  
8002 8.25 8828 14.80 8875 2.70  
8903 18.95 8840 12.75 8880 6.00  
8908E 9.50 8845 11.95 89047 22.95

## PERYST CARDS

Peryst Mono Combo - NEW! \$335.00  
Peryst Color Combo - NEW! \$335.00  
Peryst Bob Board \$45.00  
Peryst Shortcut Card Call  
Peryst Mini Mono Call  
Peryst +1 Time Spectrum w/4K 179.95  
Peryst 192K Rainbow DEC Card 149.95

## MODERN SPECIAL

Neuge Smartmodem Compatible  
1200 B. External. Sold for \$299  
\$199.00

## TRANSISTORS/DIODES

PN#	QTY	PN#	QTY	PN#	QTY
PH2222A	781.00	PN3904	1181.00	PN2222A	781.00
PN2939A	51.00	PN3906	111.00	PN2939A	51.00
PNW18	31.00	PN3908	21.00	PNW18	31.00
2N2219A	.45	PN3909	21.00	2N2219A	.45
2N2905	.45	PN3910	21.00	2N2905	.45
2N2907	.45	PN3911	21.00	2N2907	.45
2N2908	.45	PN3912	21.00	2N2908	.45
2N3055	.25	PN3913	21.00	2N3055	.25
2N3056	.25	PN3914	21.00	2N3056	.25
2N3057	.25	PN3915	21.00	2N3057	.25
2N3058	.25	PN3916	21.00	2N3058	.25
2N3059	.25	PN3917	21.00	2N3059	.25
2N3060	.25	PN3918	21.00	2N3060	.25
2N3061	.25	PN3919	21.00	2N3061	.25
2N3062	.25	PN3920	21.00	2N3062	.25
2N3063	.25	PN3921	21.00	2N3063	.25
2N3064	.25	PN3922	21.00	2N3064	.25
2N3065	.25	PN3923	21.00	2N3065	.25
2N3066	.25	PN3924	21.00	2N3066	.25
2N3067	.25	PN3925	21.00	2N3067	.25
2N3068	.25	PN3926	21.00	2N3068	.25
2N3069	.25	PN3927	21.00	2N3069	.25
2N3070	.25	PN3928	21.00	2N3070	.25
2N3071	.25	PN3929	21.00	2N3071	.25
2N3072	.25	PN3930	21.00	2N3072	.25
2N3073	.25	PN3931	21.00	2N3073	.25
2N3074	.25	PN3932	21.00	2N3074	.25
2N3075	.25	PN3933	21.00	2N3075	.25
2N3076	.25	PN3934	21.00	2N3076	.25
2N3077	.25	PN3935	21.00	2N3077	.25
2N3078	.25	PN3936	21.00	2N3078	.25
2N3079	.25	PN3937	21.00	2N3079	.25
2N3080	.25	PN3938	21.00	2N3080	.25
2N3081	.25	PN3939	21.00	2N3081	.25
2N3082	.25	PN3940	21.00	2N3082	.25
2N3083	.25	PN3941	21.00	2N3083	.25
2N3084	.25	PN3942	21.00	2N3084	.25
2N3085	.25	PN3943	21.00	2N3085	.25
2N3086	.25	PN3944	21.00	2N3086	.25
2N3087	.25	PN3945	21.00	2N3087	.25
2N3088	.25	PN3946	21.00	2N3088	.25
2N3089	.25	PN3947	21.00	2N3089	.25
2N3090	.25	PN3948	21.00	2N3090	.25
2N3091	.25	PN3949	21.00	2N3091	.25
2N3092	.25	PN3950	21.00	2N3092	.25
2N3093	.25	PN3951	21.00	2N3093	.25
2N3094	.25	PN3952	21.00	2N3094	.25
2N3095	.25	PN3953	21.00	2N3095	.25
2N3096	.25	PN3954	21.00	2N3096	.25
2N3097	.25	PN3955	21.00	2N3097	.25
2N3098	.25	PN3956	21.00	2N3098	.25
2N3099	.25	PN3957	21.00	2N3099	.25
2N3100	.25	PN3958	21.00	2N3100	.25
2N3101	.25	PN3959	21.00	2N3101	.25
2N3102	.25	PN3960	21.00	2N3102	.25
2N3103	.25	PN3961	21.00	2N3103	.25
2N3104	.25	PN3962	21.00	2N3104	.25
2N3105	.25	PN3963	21.00	2N3105	.25
2N3106	.25	PN3964	21.00	2N3106	.25
2N3107	.25	PN3965	21.00	2N3107	.25
2N3108	.25	PN3966	21.00	2N3108	.25
2N3109	.25	PN3967	21.00	2N3109	.25
2N3110	.25	PN3968	21.00	2N3110	.25
2N3111	.25	PN3969	21.00	2N3111	.25
2N3112	.25	PN3970	21.00	2N3112	.25
2N3113	.25	PN3971	21.00	2N3113	.25
2N3114	.25	PN3972	21.00	2N3114	.25
2N3115	.25	PN3973	21.00	2N3115	.25
2N3116	.25	PN3974	21.00	2N3116	.25
2N3117	.25	PN3975	21.00	2N3117	.25
2N3118	.25	PN3976	21.00	2N3118	.25
2N3119	.25	PN3977	21.00	2N3119	.25
2N3120	.25	PN3978	21.00	2N3120	.25
2N3121	.25	PN3979	21.00	2N3121	.25
2N3122	.25	PN3980	21.00	2N3122	.25
2N3123	.25	PN3981	21.00	2N3123	.25
2N3124	.25	PN3982	21.00	2N3124	.25
2N3125	.25	PN3983	21.00	2N3125	.25
2N3126	.25	PN3984	21.00	2N3126	.25
2N3127	.25	PN3985	21.00	2N3127	.25
2N3128	.25	PN3986	21.00	2N3128	.25
2N3129	.25	PN3987	21.00	2N3129	.25
2N3130	.25	PN3988	21.00	2N3130	.25
2N3131	.25	PN3989	21.00	2N3131	.25
2N3132	.25	PN3990	21.00	2N3132	.25
2N3133	.25	PN3991	21.00	2N3133	.25
2N3134	.25	PN3992	21.00	2N3134	.25
2N3135	.25	PN3993	21.00	2N3135	.25
2N3136	.25	PN3994	21.00	2N3136	.25
2N3137	.25	PN3995	21.00	2N3137	.25
2N3138	.25	PN3996	21.00	2N3138	.25
2N3139	.25	PN3997	21.00	2N3139	.25
2N3140	.25	PN3998	21.00	2N3140	.25
2N3141	.25	PN3999	21.00	2N3141	.25
2N3142	.25	PN4000	21.00	2N3142	.25
2N3143	.25	PN4001	21.00	2N3143	.25
2N3144	.25	PN4002	21.00	2N3144	.25
2N3145	.25	PN4003	21.00	2N3145	.25
2N3146	.25	PN4004	21.00	2N3146	.25
2N3147	.25	PN4005	21.00	2N3147	.25
2N3148	.25	PN4006	21.00	2N3148	.25
2N3149	.25	PN4007	21.00	2N3149	.25
2N3150	.25	PN4008	21.00	2N3150	.25
2N3151	.25	PN4009	21.00	2N3151	.25
2N3152	.25	PN4010	21.00	2N3152	.25
2N3153	.25	PN4011	21.00	2N3153	.25
2N3154	.25	PN4012	21.00	2N3154	.25
2N3155	.25	PN4013	21.00	2N3155	.25
2N3156	.25	PN4014	21.00	2N3156	.25
2N3157	.25	PN4015	21.00	2N3157	.25
2N3158	.25	PN4016	21.00	2N3158	.25
2N3159	.25	PN4017	21.00	2N3159	.25
2N3160	.25	PN4018	21.00	2N3160	.25
2N3161	.25	PN4019	21.00	2N3161	.25
2N3162	.25	PN4020	21.00	2N3162	.25
2N3163	.25	PN4021	21.00	2N3163	.25
2N3164	.25	PN4022	21.00	2N3164	.25
2N3165	.25	PN4023	21.00	2N3165	.25
2N3166	.25	PN4024	21.00	2N3166	.25
2N3167	.25	PN4025	21.00	2N3167	.25
2N3168	.25	PN4026	21.00	2N3168	.25
2N3169	.25				

# SUPERIOR QUALITY — AT "PLAIN-WRAP" PRICES

DIAL N FILE -  
BEST BUY\*



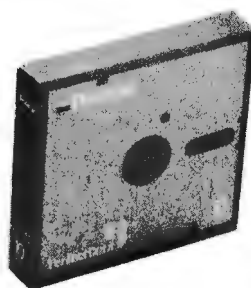
\*A turn of the dial  
displays your diskettes  
in this sturdy  
plastic case.

## ■ Polaroid/PerfectData™

### 5¼" Double Density

As Low As:

# 69¢



### Your Benefits From Polaroid's Superior Quality:

- All disks are soft sectored in packages of 10 with reinforcing hub rings, write protect tabs, and labels
- Available in soft cardboard boxes or plastic Dial N File
- Free data recovery service
- Exceeds all industry standards
- Multi-million piece "Truck-Load" purchase for absolute lowest prices - limited quantity, so hurry
- Unconditional 20 year warranty

Today, the biggest threat to your data is you. Accidents will happen, and before Polaroid came along, they usually resulted in complete data loss.

Polaroid diskettes cannot prevent accidents, but with their free data recovery service, they will prevent loss of data. Simply return your damaged diskette to Polaroid's Data Recovery Center, and they will recover all possible data, tell you what blocks, if any, could not be recovered, and return a new disk to you.

The incredible savings offered by Priority One settles the issue of who gives the best value for your diskette dollar.

### 5¼" Double Density 48 TPI

Double Sided for PC's & Compatibles — Single Sided for Apple & Atari

Part Number	Description	Retail	PRICE PER BOX OF 10 DISKETTES		
			5 - 20	25 - 95	100 or More
BXPOL522DF	Double Sided in Dial N File	\$51.00	<b>\$13.00</b>	<b>\$11.00</b>	<b>\$8.90</b>
BXPOL512	Single Sided	\$35.00	<b>\$10.00</b>	<b>\$ 8.40</b>	<b>\$6.90</b>
BXPOL512DF	Single Sided in Dial N File	\$41.00	<b>\$12.00</b>	<b>\$10.00</b>	<b>\$7.90</b>

### 8" Double Density

Part Number	Retail	5 - 20	25+
SINGLE SIDED:			
BXPOL812	\$45.00	<b>\$15</b>	<b>\$10</b>
DOUBLE SIDED:			
BXPOL822	\$55.00	<b>\$20</b>	<b>\$15</b>

8" Diskettes available only in standard packaging

ALL PRICES ARE PER BOX OF 10 DISKETTES. MINIMUM ORDER IS 5 BOXES; LARGER ORDERS MUST BE IN MULTIPLES OF 5.

IRVINE



18241 Mc Durmott,  
Irvine, CA 92714  
(714)660-1411

**PRIORITY ONE ELECTRONICS®**

Mail Your Order To:

21622 Plummer St., Chatsworth, CA 91311-4194  
RETAIL: (818)709-5464 INDUSTRIAL: (818)709-5111



SAN JOSE

452 W. Trimble Rd.,  
San Jose, CA 95131  
(408)946-7010

MINIMUM PREPAID ORDER 5 BOXES. Terms U.S. VISA, MC, BAC, Check, Money Order, U.S. Funds ONLY. CA residents add 6%, 6½%, or 7% Sales Tax, depending on your local rates. All prices listed are per box of 10 diskettes. UPS shipping charge is \$4.00 for first 10 boxes (100 diskettes), \$2.00 for each additional order of 5 boxes. Credit card orders will be charged appropriate freight. Please include your phone number with your order. Prices good

through December 1985, or as long as supplies last. We are not responsible for typographical errors. PRIORITY ONE ELECTRONICS and PRIORITY 1 ELECTRONICS are registered service marks of the Heath Group, Ltd.



**ORDER TOLL FREE (800)423-5922 (NOW IN CALIF. TOO!!)**

## BAR CODE READER



- IBM PC/XT COMPATIBLE (AND MOST CLONES)
- CONNECTS BETWEEN KEYBOARD AND THE PC
- NO CARD SLOT REQUIRED/SIMPLE INTERCONNECT
- NO CUSTOM SOFTWARE DRIVERS REQUIRED
- HIGH FIRST READ RATE
- READS DOT MATRIX & PRINTED BAR CODE LABELS
- CODE 3 OF 9, INTERLEAVED 2 OF 5, UPC
- AUTOMATIC BAR CODE SELECTION
- AUDIO AND VISUAL INDICATORS
- READS HIGH, MED. AND LOW DENSITY LABELS
- SWITCH SELECTABLE OPTIONS
- SELF-TEST DIAGNOSTICS

**\$495 ea.**

PC/MS DOS BAR CODE PRINTING SOFTWARE \$79 ea.

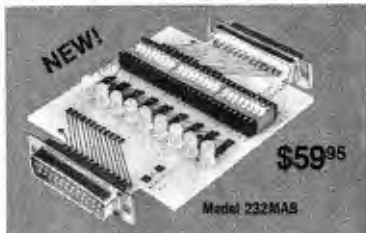
AMERICAN MICROSYSTEMS

P.O. BOX 830551, RICHARDSON, TX. 75080

(817) 834-9659

MASTERCARD AND VISA ACCEPTED

## An RS-232 Break-Out-Box at a Fraction of the Cost.



\$59.95

**RS-232 Multi-Adapter Board:** 9 LED's for signal monitoring. 24 switches to open any line (except line 1). 20 jumper wires allow re-wiring to any configuration. 1 male and 1 female connector. Order direct! Only \$59.95. All cash orders postpaid. (IL res. add 6% sales tax). We Accept MC, Visa. Free illustrated catalog of RS-232 interface and testing equipment. Phone: 815-434-0846. Make checks payable to:

**B & B electronics**  
MANUFACTURING COMPANY  
P.O. Box 1008B, OTTAWA, IL 61350

Inquiry 31

## DOUBLE THE OPTION CAPACITY OF YOUR IBM PERSONAL COMPUTER

### PC-XTRA

- DIRECT EXTENSION OF IBM PC BUS
- NO SOFTWARE CHANGES
- NO HARDWARE MODIFICATION
- STYLING CONSISTENT WITH IBM

Add all these special options that you've been wanting without worrying about filling your plug-in and back panel space



DEALER INQUIRIES INVITED.

\$549.00\* F.O.B. SANTA ANA

\*CALIFORNIA RESIDENTS ADD 6% SALES TAX

P C HORIZONS, INC.

1701 E. Edinger, Ste. A6, Santa Ana, CA 92705

(714) 953-5396

Inquiry 276

## development tools

**C-DOC:** a cross-reference and documentation system, \$275.

**The Program Tuning Kit:** a symbolic execution profiler, \$145.

**The C Browser:** an intelligent code display system, \$125.

All three \$445.

An invaluable suite of tools for C software development under MS-DOS/PC-DOS.

**Figure Flow**

☎ 1800 362 3625

Inquiry 140

## DATAFLEX™

- Multi-user Database!
  - Powerful!
  - Multiple Operating System Compatibility!
  - Attractive Dealer Pricing!
  - Full Dealer Support!
- Dataflex is a trademark of Data Access  
Dealer Inquiries Invited

**COGITATE**

24000 Telegraph Road  
Southfield, Michigan 48034 USA  
(313) 352-2345

Inquiry 64

NEW!



**SafeSkin™**

KEYBOARD PROTECTOR

Remains in place during keyboard use. Prevents damage from liquid spills, dust, ashes, etc. Fits like a second skin, excellent feel. Available for: IBM-PC, AT, Apple (all), Compaq, Model 100, NEC 8201, C64, Zenith 150, DEC, Kaypro and many others. Send \$29.95, check, M.O.. Visa & MC include exp. date. Specify computer type. Dealer inquiries invited. Free brochure avail.

Merritt Computer Products, Inc.  
2925 LBJ Fwy. #180 / Dallas, Texas 75234  
(214) 942-1142

Inquiry 232



## Sure it's insured?

SAFWARE® Insurance provides full replacement of hardware, media and purchased software. As little as \$39/yr. covers:

- Fire • Theft • Power Surges
- Earthquake • Water Damage • Auto Accident

For information or immediate coverage call:

**1-800-848-3469**

In Ohio call 1-614-262-0559

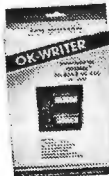
**SAFWARE**

SAFWARE, The Insurance Agency Inc.

Inquiry 321

## OK-WRITER™

LETTER QUALITY



Enhancement for  
Okidata ML824/833A  
Dot Matrix Printers

- Easy to install
- Plug-in module
- Letter Quality: 30 cps
- Draft Quality: 120 cps
- 10, 12, 17 cpi

- Full dot addressable graphics
- Front panel access to all features
- Proportional spacing, bold, double width, underlining, self-test, etc.
- Serial and parallel interfaces retained
- HEX mode; Diagnostic HEX dump
- And many other features

**RAINBOW TECHNOLOGIES, INC.**

17971-E Skypark Circle, Irvine, CA 92714

(714) 261-0228 Telex 386078

UK Distributor: X-DATA (0753) 72331

Inquiry 310

## 5 1/4" 3M FLEXYDISKS

	10-90	100+
SS / DD Soft	\$1.34 ea.	\$1.29 ea.
DS / DD Soft	\$1.63 ea.	\$1.58 ea.

**PLUS—** A \$2.00, 3M Factory Rebate Coupon with each box, along with 3M's big \$30.00 rebate for other 3M products.

**In Stock — Immediate Shipment.**

Mastercard, VISA, Check or Money Order. Add \$3.00 shipping charges per each 100 or part. Add \$2.50 additional for C.O.D. shipments. N.J. residents add 6% sales tax.

**Data Exchange**

Dept. B, P.O. Box 993

178 Route 206 South

Somerville, N.J. 08876

(201) 874-5050

Inquiry 104

**INTEL/LOTUS ABOVE BOARD**  
**4 MEGABYTE**  
**\$349<sup>95</sup>** With 64K Installed for IBM PC

For Your IBM PC		For Your IBM PC-AT	
256K	\$399 <sup>95</sup>	128K	\$529 <sup>95</sup>
512K	\$449 <sup>95</sup>	512K	\$629 <sup>95</sup>
1 MB	\$549 <sup>95</sup>	1 MB	\$729 <sup>95</sup>
2 MB	\$749 <sup>95</sup>	2 MB	\$929 <sup>95</sup>
		4 MB	\$1599 <sup>95</sup>

**TALLTREE JRAM-2/JRAM-3**  
**2 MEGABYTE CARD**  
**\$179<sup>95</sup>** JRAM-2 Without Memory

1 MB JRAM-2	\$399 <sup>95</sup>
2 MB JRAM-2	\$599 <sup>95</sup>
256K JRAM-3	\$329 <sup>95</sup>
1 MB JRAM-3	\$499 <sup>95</sup>
2 MB JRAM-3	\$629 <sup>95</sup>

**Multifunction Cards**  
**For Your IBM PC \$149<sup>95</sup>**

Up to 384K, parallel printer port, RS-232 serial port, game port, clock/calendar, RAM disk/printer buffer software package.

OK JADE Expando RAM	\$299	\$149 <sup>95</sup>
384K JADE Expando RAM	\$649	\$199 <sup>95</sup>

**EXPAND YOUR IBM PC.**  
**IBM PC—XT, IBM PC—AT**

AST Six Pak Plus 64K	\$395	\$249 <sup>95</sup>
AST Six Pak Plus 384K	\$945	\$299 <sup>95</sup>
AST I/O Plus	\$185	\$129 <sup>95</sup>
128K AST Advantage-AT	\$595	\$399 <sup>95</sup>
3.0 MB AST Advantage-AT	\$4145	\$999 <sup>95</sup>
IRMA 3270 Board	\$1195	\$988 <sup>95</sup>

**IBM Video Boards**

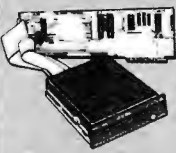
Hercules Color Graphics	\$245	\$189 <sup>95</sup>
Hercules Monochrome Graphics	\$499	\$339 <sup>95</sup>
Tecmar Graphics Master	\$699	\$499 <sup>95</sup>
Paradise Graphics Card	\$395	\$319 <sup>95</sup>
Everex Graphics Edge	\$599	\$349 <sup>95</sup>
JADE RGB w/Parallel Port	\$199	\$99 <sup>95</sup>
JADE RGB w/Parallel & Serial	\$299	\$199 <sup>95</sup>
JADE TTL Monochrome 720x348	\$299	\$149 <sup>95</sup>

# HARD DISK DRIVE SALE!

**135/150 WATT**  
 Drop-in replacement  
**POWER SUPPLY**  
 For your IBM PC

135 Watt	LIST \$199	JADE \$95 <sup>95</sup>
150 Watt	LIST \$249	JADE \$115 <sup>95</sup>

**10 MEGABYTE Hard Disk System**  
**FOR YOUR IBM PC**  
**\$389<sup>95</sup>**



Complete with controller card, data cable, and mounting hardware, totally PC/XT compatible. External model includes cabinet & power supply.

10 MB Internal 1/2 High	LIST \$900	JADE \$389 <sup>95</sup>
20 MB Internal 1/2 High	\$1550	\$489 <sup>95</sup>
33 MB Internal 45 ms	\$2184	\$1229 <sup>95</sup>
20 MB Hi-Speed for AT	\$1250	\$699 <sup>95</sup>
30 MB Hi-Speed for AT	\$1550	\$899 <sup>95</sup>

For external cabinet & power supply add \$199<sup>95</sup>



**High Speed APU Chips**

8087	\$119 <sup>95</sup>	80287	\$199 <sup>95</sup>
------	---------------------	-------	---------------------

**FREE PC PAINTBRUSH W/MICROSOFT Mouse**

Microsoft Mouse, RS-232 Serial	\$199	\$129 <sup>95</sup>
Microsoft Mouse, IBM Bus	\$199	\$129 <sup>95</sup>
PC MOUSE with Pop-ups	\$195	\$139 <sup>95</sup>
PC MOUSE with Paint	\$220	\$159 <sup>95</sup>

**KEYTRONICS**



KB5150 Improved IBM Keyboard	\$209	\$159 <sup>95</sup>
KB5151 Deluxe IBM Keyboard	\$299	\$199 <sup>95</sup>
KB 200 for Apple II+	\$399	\$249 <sup>95</sup>


KB5153, KB5152V also available.

**64K RAM Chip Upgrade Kits \$999**

High speed RAM upgrade kit with FREE parity (error detection) and one year warranty. We ship thousands of these kits to satisfied customers every week.

128K RAM Chip Kit for AT	LIST \$395	JADE \$99 <sup>95</sup>
256K RAM Chip Kit	\$99	\$39 <sup>95</sup>

**TEAC 55B 360K Disk Drive for IBM PC**  
**\$899<sup>95</sup>**



TANDON 100-2, DS, DD	\$299	\$99 <sup>95</sup>
TEAC 55B, DS, DD	\$249	\$89 <sup>95</sup>
TEAC 55F, DS, QD 720K	\$299	\$99 <sup>95</sup>

**High Resolution Video Monitors**



Amdex 300G	LIST \$179	JADE \$139 <sup>95</sup>
Amdex 308A	\$199	\$149 <sup>95</sup>
Amdex 310A	\$230	\$179 <sup>95</sup>
Amdex Color 710	\$799	\$589 <sup>95</sup>
PGS MAX-12E 720 x 350	\$269	\$179 <sup>95</sup>
PGS HX-12 640 x 240	\$699	\$449 <sup>95</sup>
PGS HX-12E 600 x 350	\$785	\$549 <sup>95</sup>
PGS SR-12 720 x 400	\$799	\$629 <sup>95</sup>
PGS Scan-Doubler for SR-12	\$299	\$199 <sup>95</sup>
Taxan 640 Ultra Hi-Res RGB	\$799	\$599 <sup>95</sup>

**JADE 1200 BAUD Modem \$179<sup>95</sup>**

HAYES Smartmodem 1200 Compatible at a fraction of the price. FCC approved.

JADE 1200 Baud External	\$349	\$179 <sup>95</sup>
JADE 2400 Baud External	\$699	\$499 <sup>95</sup>
JADE 1200B Internal	\$349	\$179 <sup>95</sup>

**HAYES Smartmodems**



Sophisticated direct-connect auto-answer/auto dial modem, touch tone or pulse dialing RS-232 interface programmable.

HAYES Smartmodem 2400	\$899	\$629 <sup>95</sup>
HAYES Smartmodem 1200	\$699	\$389 <sup>95</sup>
HAYES 1200B w/o Smartcom II	\$539	\$339 <sup>95</sup>
HAYES 1200B for IBM PC	\$599	\$359 <sup>95</sup>
HAYES Smartmodem 300	\$289	\$169 <sup>95</sup>
HAYES Micromodem IIe	\$299	\$169 <sup>95</sup>
HAYES Smartmodem IIc	\$399	\$169 <sup>95</sup>
Modem Cable	\$35	\$24 <sup>95</sup>

**PROMODEMS As Low As \$149<sup>95</sup>**



ProModem 300c for Apple IIc	\$199	\$149 <sup>95</sup>
ProModem 1200B for IBM PC	\$399	\$289 <sup>95</sup>
ProModem 1200 RS-232	\$495	\$299 <sup>95</sup>
ProModem 1200A for Apple	\$449	\$349 <sup>95</sup>
ProModem 1200 for Macintosh	\$495	\$349 <sup>95</sup>
Alpha/num Display Option	\$99	\$79 <sup>95</sup>
Options Processor	\$99	\$79 <sup>95</sup>
64K Mem Expansion for Above	\$99	\$19 <sup>95</sup>
Modem Cable	\$35	\$24 <sup>95</sup>

**Printers**

**EPSON FX-85 & FX-185, OKIDATA 192 & 193, C. ITOH, CITIZEN, STAR**

**PRICED TOO LOW TO PUBLISH!**

**Call Us Toll Free For The Best Deal In The Country!**

**A-B Printer/Data Switch**

Fully bi-directional switch allows your computer to run either of two printers, or allows two computers to share one printer, standard A-B switch box.

	LIST	JADE
Parallel Printer A-B Switch	\$149	\$69.95
Serial A-B Switch	\$129	\$79.95
Parallel A-B-C-D Switch	\$175	\$99.95
Serial A-B-C-D Switch	\$175	\$99.95
Parallel "X" Switch	\$149	\$89.95
Serial "X" Switch	\$149	\$89.95

**Printer Accessories**

	LIST	JADE
IBM PC Style Cable	\$54	\$19.95
Standard Parallel Cable	\$40	\$19.95
RS-232 Serial Cable	\$30	\$24.95
Ribbons	as low as	\$4.99
Apple IIc/Macintosh Cable	\$39	\$19.95

**ISO-BAR**

These industrial quality ISO-BARs contain surge suppression circuitry and built-in noise filters plus a 15 amp circuit breaker.

	LIST	JADE
6 Socket, 1 Filter ISO-BAR	\$69	\$44.95
4 Socket, 2 Filter ISO-BAR	\$89	\$59.95
8 Socket, 4 Filter ISO-BAR	\$99	\$69.95

**UNINTERRUPTABLE POWER SUPPLY**

Emergency back-up power to save your computer system. A must for every computer system.

200 Watt UPS	\$359	\$269.95
425 Watt UPS	\$539	\$449.95
1000 Watt UPS	\$1179	\$969.95

**Disk Drive for Your Apple IIc**

**\$129<sup>95</sup>**



	LIST	JADE
Disk Drive for Apple IIc	\$249	\$129.95
Parallel Printer Cable for IIc	\$99	\$59.95
Full Height Disk Drive	\$299	\$139.95
Half Height Disk Drive	\$249	\$129.95
ALS Z Engine	\$299	\$145.95
16K RAM Card	\$99	\$39.95
64K 80 Column Card for IIc	\$219	\$119.95
Best 80 ColumnCard II/II+	\$219	\$139.95
Printer Card & Cable	\$109	\$49.95
Fan with Surge Protection	\$99	\$59.95
Grappler Plus	\$175	\$99.95
64K Buffered Grappler+ w/16K	\$275	\$149.95

**Letter Quality Upgrade For Your EPSON RX-80, RX-100, FX-80, FX-100**

Near-Letter-Quality upgrade with front panel font controls for your old printer.

	LIST	JADE
LetterWriter Upgrade	\$79	\$58.95

**MICROFAZER Buffers**

Expandable to 64K (Parallel model expands to 512K)

	LIST	JADE
8K Parallel in/Parallel out	\$169	\$139.95
64K Parallel in/Parallel out	\$225	\$164.95
128K Parallel in/Parallel out	\$445	\$269.95

Your choice: serial in/serial out, parallel in/serial out, serial in/parallel out.

	LIST	JADE	LIST	JADE	
8K	\$199	\$169.95	64K	\$260	\$199.95

**Microbuffers**

Parallel or serial for printers and modems Expands to 256K.

	LIST	JADE
32K Microbuffer	\$299	\$229.95
64K Microbuffer	\$349	\$249.95
64K Add-on Board	\$179	\$149.95

**JADE XPC IBM PC**

- 640K of RAM
- 135 Watt Power Supply
- 8 Expansion Slots
- Deluxe Keyboard
- 90 Day Warranty



- 256K of RAM
- 63 Watt Power Supply
- 5 Expansion Slots
- IBM Keyboard
- 90 Day Warranty

256K of RAM, Two 360K Disk Drives & Disk Controller

**\$995**

**OPTION #1**

256K of RAM  
Two 360K Drives  
Monochrome graphics card  
Amdek 310A

IBM PC \_\_ \$1995  
JADE XPC \$1295

**OPTION #3**

640 K of RAM  
10 Mb of Hard Disk  
One 360K Drive  
130 Watts of Power  
Parallel & Serial Ports  
Color Card  
Taxan RGB Monitor

IBM PC \_\_ \$2995  
JADE XPC \$1995

**\$1695**

**OPTION #2**

256K of RAM  
Two 360K Drives  
Color Graphics Card  
Taxan RGB Monitor

IBM PC \_\_ \$2395  
JADE XPC \$1395

**IBM PC-XT**

- 256K RAM
- 10 Mb Hard Disk
- Mono-Graphics Card
- Parallel Printer Port
- Amdek 310A

**\$2895**

**IBM PC-AT**

- 512K RAM
- 20 Mb 60 ms Hard Disk
- 1.2 Mb Disk Drive
- Parallel Printer Port
- Serial RS-232C Port
- Color Graphics Card
- Taxan Hi-Res Color Monitor

**\$4595**

**Place Orders Toll Free!**



**JADE**

**Computer Products**

Continental U.S.A. (800) 421-5500  
 Inside California (800) 262-1710  
 Los Angeles Area (213) 973-7707

4901 W. Rosecrans Ave. Box 5046 Hawthorne, CA 90251-5046

# TAXAN 415

High Resolution  
Color Monitor

**\$289<sup>95</sup>** LIST PRICE \$699

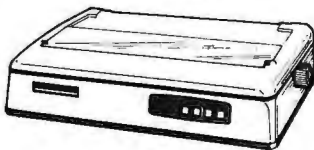
IBM Cable \$1495

- 640 X 262
- 16 Colors
- .38" Dot Pitch
- IBM & Lotus Compatible
- 12" Black Matrix
- 18 MHz Band Width

# Why pay \$1149 for a C. Itoh STARWRITER™ F-10

When our 40 cps letter quality  
daisywheel from the same  
manufacturer is only

**\$499<sup>95</sup>**



\*StarWriter is a Trademark of C. Itoh  
Digital Products, Inc.

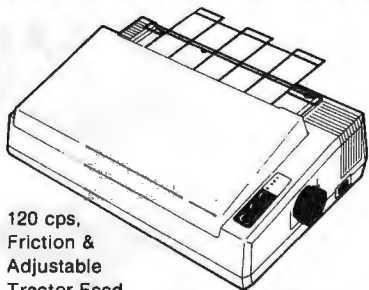
# STREAMING TAPE BACK-UP UNIT

½ Height Unit (Internal Mount)  
File-by-File or Complete Image  
Back-up and Retrieval

**\$399<sup>95</sup>**

Backs up 10 Megabyte/12 Min.

# STAR GEMINI 10-X



120 cps,  
Friction &  
Adjustable  
Tractor Feed  
w/Graphics.  
Limited  
Quantity.

**\$159<sup>95</sup>**

# CANON PRINTERS

160 cps, 23 x 18 NLQ Mode, 2K  
Buffer, Single Sheet & Fan Fold  
Paper, Hi-Res Graphics, Bi-directional/Logic Seeking, Quiet—Less  
Than 60dB

PW-1080A 10" Carriage

**\$199<sup>95</sup>** LIST PRICE \$499

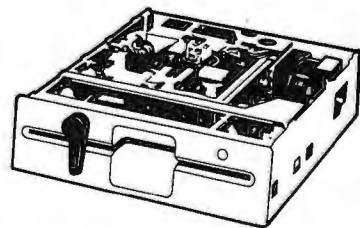
PW-1156A 15" Carriage

**\$299<sup>95</sup>** LIST PRICE \$699

Hurry! Limited quantity—No rain checks!

# 360K DISK DRIVE

Double-Sided, Double-Density

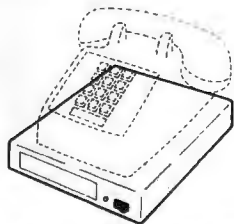


IBM PC, XT or  
Compatibles.

**\$69<sup>95</sup>**

# JADE 1200 BAUD MODEM

HAYES Smartmodem 1200 compatible  
at a fraction of the price. FCC approved.



**\$179<sup>95</sup>**

# TOSHIBA PRINTERS

24 Pin Letter Quality High  
Speed Dot Matrix Printers

P1340 Parallel	\$799	\$599.95
P1340 Serial	\$799	\$599.95
P341 Parallel	\$1299	\$999.95
P341 Parallel/Serial	\$1349	\$1049.95
P351 Parallel	\$1699	\$1099.95
P351 Parallel/Serial	\$1749	\$1149.95

# BERNOULLI BOX

**\$1995**

New Half-Height Drives!

10 Mb Bernoulli Box	\$2295	\$1995
10+10 Bernoulli Box	\$3195	\$2695
20 Mb Bernoulli Box	\$2995	\$2495
20+20 Bernoulli Box	\$4540	\$3495
Controller Card	\$155	\$129
New Plus Card	\$355	\$279
Extra 10 Mb Cartridge	\$79	\$59
Extra 20 Mb Cartridge	\$99	\$69

PLACE ORDERS TOLL FREE! AMERICAN EXPRESS  
Continental U.S.A. Inside California Los Angeles Area  
(800)421-5500 (800)262-1710 (213)973-7707

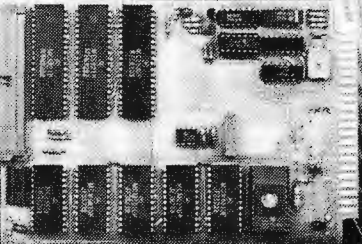
We accept cash, checks, credit cards or purchase orders from qualified firms & institutions  
Minimum prepaid order \$15.00. California residents add 6½% tax. Prices & availability subject  
to change without notice. Shipping & handling charges via UPS Ground 50¢/lb. UPS Air  
\$1.00/lb. Minimum charge \$3.00.

# JADE Computer Products

4901 W. Rosecrans, Box 5046, Hawthorne, CA 90250-5046

# \$91.00

## Single Board Computer



\*\$90 piece price, model MC143 (shown)

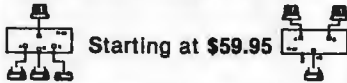
6800 MPU, serial I/O, parallel I/O, RAM, EPROM, 44-pin 4.5" x 6.5" PCB  
**EXPANSION MODULES:** RAM, EPROM, CMOS RAM/battery, analog I/O, serial I/O, parallel I/O, counter/timer, IEEE-488, EPROM programmer, floppy disks, cassette, breadboard, keyboard/display.



Wintek Corp.  
 1801 South Street  
 Lafayette, IN 47904  
 317-742-8428

Inquiry 376

## SAVE TIME AND MONEY WITH LOW COST PI-SWITCH BOXES.



Starting at \$59.95

- Quickly shares your computer among multiple terminals, printers, modems, etc. with just a flick of the wrist.
- Compact black & beige aluminum enclosure features a high quality rotary switch with rear mounted connectors.
- Serial RS-232 Models have fem. 25-Pin Conn. (Lines 1-7 & 20)

PI-02-S switches 2 to 1 ..... \$59.95

PI-03-S switches 3 to 1 ..... \$79.95

PI-05-S switches 5 to 1 ..... \$109.95

- Parallel models have fem. 36-Pin cent. conn.

PI-02-P switches 2 to 1 ..... \$4.95

PI-04-P switches 4 to 1 ..... \$154.95

- Dealers, schools & custom inquiries welcome.
- One Year Warrantee, COD, VISA, M/C.
- Shipping UPS \$2.00/ea. AIR \$4.00/ea.



7301 NW 41 St.  
 MIAMI, FL 33166  
 (305) 592-6092

Inquiry 320

Serial ◀■■■■■■▶ Parallel



## Convert What You Have To What You Want!

- RS232 Serial
- 8 Baud Rates
- Latched Outputs
- Centronics Parallel
- Handshake Signals
- Compact 3 1/2" x 4 1/2" x 1 1/2"

No longer will your peripheral choices be limited by the type of port you have available! Our new High Performance 700 Series Converters provide the missing link. Based on the latest in CMOS technology, these units feature full baud rate selection to 19.2K, with handshake signals to maximize transfer efficiency. Detailed documentation allows simplified installation. Order the Model 770 (Ser/Par) or Model 775 (Par/Ser) Today!

Buffer Products  
 Coming Soon!



only \$89.95

Connector Option \$10.00  
 CA Residents 8% tax  
 UPS Shipping \$3.00

CALL (805) 658-7466 or 658-7467

For FAST Delivery



Inquiry 357

## 5 1/4" FLOPPY MOTORS

Now Buehler OEM replacement spindle motors for all major 5 1/4-inch, full-height floppy disk drives are available for fast delivery. Built to exact OEM size, performance and quality standards. Pulleys included.

For details and prices, contact:

Buehler Services, Inc.  
 P.O. Box A, Hwy 70-E  
 Kinston, NC 28501  
 Phone: 919/522-4300



Inquiry 78

## Maxell Floppy Disks

The Mini-Disks with maximum quality.



Dealer inquiries invited. C.O.D.'s accepted. Call FREE (800) 235-4137.



PACIFIC EXCHANGES  
 100 Foothill Blvd., San Luis  
 San Luis Obispo, CA 93401.  
 In Cal. call (800) 592-5935 or (805) 543-1037.

Inquiry 277

## DATA ACQUISITION TO GO INTERFACE FOR ANY COMPUTER



Connects via RS-232. Built-in BASIC. Stand alone capability. Expandable. Battery Option. Basic system: 16 ch. 12 bit A/D, 2 ch. D/A, 32 bit Digital I/O. Expansion boards available. Direct Bus units for many computers.

SPECIALISTS IN PORTABLE APPLICATIONS  
**(201) 299-1615**

P.O. Box 246, Morris Plains, NJ 07950

# ELEXOR

Inquiry 131

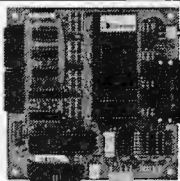
## Osborne

As available only! Very limited quantity.

Important: Always call to check availability before ordering.	To fix yourself, or for parts. Complete, but known not working.	Guaranteed for 30 days. May be new or refurb., depending on avail.	Exch/Repair	Outright
Main Board OS-1	\$79	\$79	\$139	\$299
Main Board Exec.	\$159	\$139	\$299	
Battery Pack, 40 Watt	—	—	\$49	
Double Density Kit **	—	—	\$79	
** Includes board, cable, documentation & disk				
5" CRT (Grn/White)	\$8.95	\$19	\$29	
7" CRT (Amber)	\$19	\$49	\$99	
15" CRT, no case	—	—	\$85	
Drive Analog Card	\$9.95	\$29	\$59	
Drive Mechanism	\$19	\$25	\$59	
Power Supply	\$4.95	\$24	\$29	
Keyboard (No enclos.)	\$9.95	—	\$99	

Shipping charged on all orders

Computer Parts Mart 415-493-5930  
 3200 Park Blvd \* Palo Alto \* CA 94306



NOW WITH 8K RAM FOR THE SAME PRICE

## SIBEC 51 8051/52 DEVELOPMENT BOARD

8051-Based Single-Board Computer with Monitor/Debugger

- 4 28-pin byte-wide sockets; monitor will program EEPROMS.
- Perfect for System Development and Educational Applications



\$335

Binary Technology, Inc.

MAIN ST. • P.O. BOX 67  
 MERIDEN, NH 03770 • 603/469-3232

Inquiry 34

## PC/XT USERS!

- COGTREE Utilities by Cogitate ..... \$129.95
- LYNC by Norton-Lamber.... \$199.95
- DATAFLEX by Data Access...Varies
- RM/COBOL by Ryan/McFarland.....Varies
- Universe by Omnitrend.... \$ 98.50
- Blue MacI by Cogitate.... \$599.00
- CadPower+ by Trilux.....\$995.00
- Softex Teaching Aids.....\$ 95.00
- PrintSet by Cogitate.....\$ 79.95
- CogITAPE by Cogitate.....CALLII
- Anti-Static Products.....Varies
- Uninterruptible Power Backups.....Varies
- TeleVideo Software.....CALLII



"A Higher Form of Software"  
 24000 Telegraph Road  
 Southfield, MI 48034  
 (313) 352-2345/Telex 386581

VISA/MASTERCARD ACCEPTED  
 Dealer Inquiries Welcomed

Inquiry 63

# TERMINAL EMULATION

Softerm PC emulates over 30 popular terminals including the:

- DEC VT102, VT220
- Data General D200, D410
- IBM 3101-20 (block mode)
- Hewlett-Packard 2622A
- Honeywell VIP7801, VIP7803

Guaranteed Compatibility

Call for free product brief  
\$195 MC-VISA-COD  
For the IBM PC/XT/AT, DG1, NEC,  
Wang PC, TI Pro, Gridcase, Tandy

## SEIFTRONICS

3639 New Getwell, Suite 10  
Memphis, TN 38118  
901-683-6850

Inquiry 332

## DISK DUPLICATION

5 1/4" DOUBLE SIDED

\$ .98

3 1/2" SINGLE SIDED

\$ 2.12

PRICES BASED ON RUN SIZE OF 1000

AND **maxell** MEDIA

1-800-222-0490  
201-462-7828 in NJ

**MEGAsoft**

PO BOX 1143 FREEHOLD, N.J. 07728

Inquiry 230

## ROSE ELECTRONICS DATA SWITCHES



SHARE computers, printers, any parallel or serial device  
ELIMINATE cable swapping  
INEXPENSIVE way to network  
COMPATIBLE with all computers.

Businesses, Schools, Homes  
WE ALSO OFFER:  
Data Buffers, Line Drivers, Modems, Protocol Converters, Parallel - Serial Converters, Cables, Computers, Printers, Disk Drives, and more.

**AUTOMATIC - CARETAKER** is ideal for a business or school to share a printer or modem among many computers. Operation is fully automatic with no software required. Parallel or Serial 4 channels - \$295 8 channels - \$395

**MANUAL - HARDSWITCH** is operated with the flip of a switch. 2:2 and 2:4 models allow simultaneous communication.

Serial 1:2 - \$59 1:4 - \$ 99 2:2 - \$109 2:4 - \$169  
Parallel 1:2 - \$79 1:4 - \$139 2:2 - \$119 2:4 - \$199  
LED and spike protection on serial models add \$20.

**CODE ACTIVATED - PORTER** connects one computer to multiple peripherals. A software code selects the peripheral. Parallel or Serial 4 channels - \$295 8 channels - \$395  
Buffer option 64K - \$100 256K - \$250

**REMOTE - TELEPATH** connects multiple computers to multiple peripherals. A selector at each computer or terminal chooses up to 4 peripherals and displays busy status.  
4:4 - \$495 4:8 - \$795 selector - \$39.

Give a Rose to your computer

ROSE ELECTRONICS (713) 240-7673

P.O. BOX 742571

HOUSTON, TX 77274

MC & VISA Accepted  
Dealer Inquiries Invited  
CALL US FOR ALL YOUR INTERFACE NEEDS

Inquiry 315

## NEC PRINTERS

Pinwriter P-2.....\$ 485  
(w/Interface & Tractor)

Pinwriter P-3.....\$ .685  
(w/Interface & Tractor)

Pinwriter P-5.....\$ 925  
(w/Interface & Cut Sheet Guide)

ELF 360, 350.....\$ 380

2010/15/30/50.....\$ 605

3510/15/30/50.....\$ 960

8810/15/30/50.....\$1365

Optional Forms Handling  
Devices.....CALL

QUALITY PRINTERS

8415 Cement City Rd.  
Brooklyn, Michigan 49230  
Phone: 517-592-3749

Inquiry 306

## FREE SOFTWARE FROM THE PUBLIC DOMAIN

User Group Software isn't copyrighted, so no fees to pay! 1000's of CP/M and IBM software programs in .COM and source code to copy yourself! Games, business, utilities! All FREE!

	Rent	Buy
IBMPC-SIG 1-370 Diskettes .....	400.	800.
IBMPC-BLUE 1-116 Diskettes .....	145.	375.
SIG/M UG 1-222 Diskettes .....	130.	625.
CP/M UG 1-92 Diskettes .....	45.	250.
PICO NET 1-34 Diskettes .....	25.	100.
KAYPRO UG 1-39 Diskettes .....	45.	90.
EPSON UG 1-39 Diskettes .....	45.	90.
Commodore CBM 1-28 Diskettes..	25.	65.

Public Domain User Group Catalog Disk \$5 pp.

(payment in advance, please)

Rental is for 7 days after receipt, 3 days grace to return. Use a credit card, no disk deposit.

Shipping, handling & insurance \$9.50 per library.

(619) 941-0925 Orders & Technical (9 to 5)

(619) 727-1015 24 Hr. 3 Min. Info Recording

Have your credit card ready!

National Public Domain Software

1533 Avohill Dr.  
Vista, CA 92083



BBB



AM EX.

Inquiry 239

## ROMDISK

### EPROM DISKETTE AND DISK DRIVE EMULATOR IBM PC\* COMPATIBLES AND APPLE IIe\*

- Diskless control and communications systems
- Dedicated workstations for improved productivity
- Customized, high speed, smart terminal
- Put software in silicon
- Solid state reliability and performance
- Self contained control and EPROM program circuitry
- PC and MS DOS\* compatible

ROMDISK PC-1 (180K) \$495

ROMDISK PC-2 (360K) \$595

ROMDISK A FOR //e (144K) \$349



**CURTIS, INC. 22 Red Fox Road  
St. Paul, MN 55110 612/484-5064**

\*IBM PC and PC DOS is a registered trademark of IBM Corporation. MS DOS is a registered trademark of Microsoft Corporation. Apple //e is a registered trademark of Apple Computer Corporation.

Inquiry 90

## ICs and Disk Drives

- **64K / 128K / 256K**  
O-RAMs at LOW PRICES
- **TEAC FD-55BV** DSDD Disk Drives  
\$85.00 each or  
\$75.50 each for box of 10  
(w/one year factory warranty!)
- **V-20 TURBO CHARGER**  
\* HIGH SPEED—Up to 40% increase!  
\* CMOS—Uses 85% less power!  
\* REPLACES slow 8088 CPU  
\* LOW COST!
- **MEMORY BOARDS**  
\*SIXPAK PLUS w/64K \$230.00  
\*ABM SUPERBOARD w/OK \$150.00  
\*ABM MEM512 w/OK \$100.00  
\*JRAM-2 w/OK \$159.00
- **E-PROM, S-RAM, 6087, and 80287s are IN STOCK**  
CALL US FOR DETAILS!

WARRANTY: All ICs are guaranteed for 180 days from the invoice date on defective items. We will replace them free of charge.

ExcelTec Industries, Inc.

P.O. Box 2205 Silver Spring, MD 20902  
1015 Gayley Ave. #422, Los Angeles, CA 90024

West Coast East Coast

Phone: (213) 208-6942 (301) 933-3523

FAX: (213) 208-6846 (301) 933-3643

OEMs and DEALERS are invited  
CALL US FOR THE LATEST PRICES

Inquiry 413

## ATTENTION BERNOULLI BOXERS Give your OMEGA a Boot!

FIXT/B PLUS for  
IBM AT, XT, PC and compatibles

FIXT/B PLUS gives you the utility of a bootable hard disk while preserving the performance of your Bernoulli Box. You can have it all with FIXT/B PLUS!

### Golden Bow Systems

\$95-\$110  
Add \$3 for shipping/handling  
California residents add 6% sales tax.



3348 Stearns Ave., Suite F  
San Diego, CA 92119  
(619) 298-9349

Inquiry 154

## \*\*\* APPLE IBM \*\*\* PRINTERS—PLOTTERS—MODEMS EXTERNAL PRINTER BUFFER

- 64K RAM
- BUILT-IN MICROPROCESSOR
- WORKS WITH ANY RS232 INTERFACE
- 8 SELECTABLE BAUD RATES
- SEPARATE INPUT AND OUTPUT SPEEDS
- SELECTABLE CHARACTER ATTRIBUTES
- XON/XOFF OR HARDWARE HANDSHAKE
- BUFFER LEVEL AND STATUS DISPLAY
- STANDARD DB25 CONNECTORS
- ACCEPTS ANY DATA FORMAT

PCB, ROM & SCHEMATICS \$75

FULL KIT \$135

ASSEMBLED & TESTED \$185

5-CHANNEL 256K ALSO AVAILABLE

MICRO SYSTEMS DESIGN

PO BOX 1187

LOOMIS, CA 95650

(916) 652-5665

Inquiry 239



# Micro Products International

714/898-0840

# CHRISTMAS SPECIALS

We Cater to IBM™ Dealers  
 \* Hardware \* Software  
 \* Training Tapes \*  
 Call for our Catalog now!

We accept Visa, M/C, Pre-Pay by Check or Money Order. COD's are accepted by Telephone & Mail. COD Terms are Cashier's Check for first time orders over \$1000.  
 Fax: 714/897-3363 Tlx: 887841 XORDATA HTBH

## New Hayes SmartModem Compatible!

Finally a price breakthrough on a Hayes compatible, external 300/1200 baud modem. This low price is without driver software, but if you need it add \$25.00. Call for a 26 page catalog of our special deals. Look in this spot every month for Hot, New items sure to catch your interest.



- Runs the popular Hayes communications software
- FCC approved direct RJ-11 connection
- Phone Cable & power supply one low price
- MOD-8100-00 ..... \$199.00

## IBM PC-XT SELECTRIC KEYBOARDS

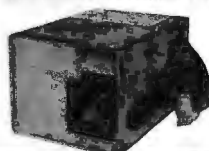
Your volume purchase of these excellent Selectric type keyboards will bring the features you have been wanting down to a price you can't resist. So many features - you'll love it!

- Single key reset
- Separate numeric keypad
- Separate "Arrow" keypad
- Dimple marked "5", F, & J keys



- KEY-1051-00 Selectric ..... \$129.00
- KEY-1050-00 Standard ..... 89.00

## ADD-ON POWER SUPPLIES



Two new, thoroughly tested IBM PC/XT power supplies for your system upgrade. Best price in Byte with ONE YEAR warranty!!

- POW-1040-00 135 watt ..... \$ 99.00
- POW-1044-00 150 watt ..... \$115.00

## IBM TURBO MOTHERBOARD

Micro Products announces a powerful new IBM XT type motherboard. 4 layers for superior reliability & speed. Turbo mode allows 75% higher thru-put by increasing system clock to 7 MHz under software control. Designed to use new 256K RAM chips or 64K chips. 640K memory expansion does not require use of valuable card slots. Many outstanding features combined with our new 7 PAK Multifunction board make previously expensive options standard features at a LOW LOW Cost.

- BOA-6078-00 Supplied with OK ..... \$349.00



## SUPER 12 PAK MULTI-FUNCTION

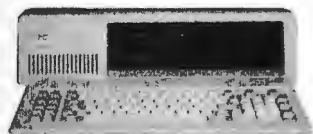
This one is really loaded! Features: One Parallel Port, One RS232-C Serial Port, One Game Port, RealTime Clock / Calendar with Battery Back-up, Expandable to 384K of Parity-checked Memory, Supplied 0K Memory, all cables, PrintSpooler and RAM Disk Software.

- BOA-6335-00 ..... \$129.95
- Additional (9) 64K Memory Chips
- KIT-8000-00 ..... \$ 10.00

## Do it Yourself!

\$1395<sup>00</sup> WOW!

## Add-On H.D. & Tape



## Complete System!

NEW 17,000 in Service!

- ### Features!
- RAM Disk
  - Game Port
  - 640K cpty
  - PrintSpooler
  - Turbo mode!
  - 4.77MHz to 7MHz!
  - Ser, Par
  - Clock



10 Meg H.D. Complete System!  
**\$1995<sup>00</sup>**

20 Meg Color Complete System!  
**\$2550<sup>00</sup>**

40 Meg w/Tape Complete System!  
**\$3035<sup>00</sup>**

- ### Software
- XWORD
  - XBASIC
  - XBASE
  - XCALC
  - XCOM



10 or 20 Megabyte on the top, your choice of Hard Disk on the bottom. Super appearance! Requires one slot in your PC for SASI Interface and an extension connector on the floppy card. Everything else is supplied by us.

- 10 Meg \$1095
- 20 Meg \$1295
- 28 Meg \$1395
- 40 Meg \$1895
- 105 Meg \$4195
- 140 Meg \$4695

## Add-On Hard Disk

Two ways to go. The Internal system is cheaper because it does not need a PIS & Chassis. The same PIS & Chassis can be used for a 10 Meg Tape Back-up on your XT!

- |                     |                       |
|---------------------|-----------------------|
| 10 Megabyte         | 40 Megabyte           |
| \$525 Int/\$695 ext | \$1195 Int/\$1295 ext |
| 20 Megabyte         | 105 Megabyte          |
| \$650 Int/\$795 ext | \$3795 Int/\$3995 ext |
| 28 Megabyte         | 140 Megabyte          |
| \$795 Int/\$895 ext | \$4395 Int/\$4695 ext |

## Add-On 20 Meg Tape



SUB-8300-00 ..... \$595.00

If your IBM-AT needs a little help in the Back-up category, you won't be able to beat this price! Cables, software and everything!

## Check These Standard Features:

- Full-Size, Feather-Touch, Capacitance Keyboard, 10 Function Keys, Calculator-Type Numeric Keypad
- Parallel & Serial I/O • Real Time Clock • Game Port • 2-Slimline 5 1/4" DS/DD 48 TPI 360K Drives
- 8 IBM expansion slots • RAM Disk • Print Spooler • 4 DMA & 3 Timer channels
- Full 640K capacity on-board • 8088 16-bit CPU • Monochrome Video Card
- Up to 32K of EPROM (full 64K supplied) • Supports PC-DOS - MS-DOS - CP/M-86
- Power Supply Hard-Disk-Ready, no need to add-on additional power
- High resolution 12" Monitor, Green Screen, 22 MHz bandwidth

# Not enough room here - Call for Catalog

## PROM LASER

This is the One! Our PROM Burner allows reading, storing-to-disk, recalling, and burning. Hi-speed algorithms burns 2764 in 45 seconds! Also handles 2716, 2732, 27128, 27256. Features: Zero insertion force sockets; On-board Voltage Generator; No interference with normal computer operations.

BOA-8640-00 ..... \$199.00

## We want your DRIVE business!

- |                    |                    |                     |                     |                     |
|--------------------|--------------------|---------------------|---------------------|---------------------|
| Shugart 360K       | TEAC 360K          | NEC 10meg           | Tulln 20meg         | Mentek meg          |
| \$85 <sup>00</sup> | \$95 <sup>00</sup> | \$345 <sup>00</sup> | \$695 <sup>00</sup> | \$495 <sup>00</sup> |

## MISCELLANEOUS \$\$\$ SAVERS

- 7 PAK Multifunction Floppy, RTC, 2 Serial, 1 Parallel, Game, RAM Disk BOA-8250-00 ..... \$189.00
- 64K Memory Chips (9) NEC for IBM KIT-8000-00 ..... \$ 10.00
- 256K DRAM Memory Chips (9) = 256K KIT-9000-00 ..... \$ 45.00
- Add-On Memory, (up to 512K) supplied OK BOA-6350-00 ..... \$ 99.00
- Floppy Controller, Controls up to four drives, 5 1/4" 48/96 TPI BOA-6100-00 ..... \$ 95.00
- Monochrome Graphics Card, (Hercules type) (1-2-3 compatible) 720h x 348v BOA-8150-00 ..... \$175.00
- Color Graphics Card, 320 x 200 Res. Color, 640 x 200 Monochrome BOA-8200-00 ..... \$145.00
- Clock Calendar Board, fits in "short slot" w/battery Back-up BOA-8375-00 ..... \$ 55.00
- Hard Disk Controller, standard ST-508 interface for DOS 2.1 & 3.1 BOA-8060-00 ..... \$155.00
- 300 / 1200 Baud Modem Internal w/PC Talk III Communications Software BOA-8725-00 ..... \$210.00
- Monochrome Monitor, 22MHz bandwidth, composite input or TTL MON-1725-00 Green/Comp 99.00 MON-1700-00 Amber/Comp 104.00 MON-1775-00 Green/TTL 104.00 MON-1750-00 Amber/TTL 109.00

## INTERNATIONAL ORDERS

Micro Products is ready to serve your needs in several countries. Each Office has Sales Literature, Local Pricing, Inventory and Technical Service available to support your needs. There are no problems with U.S. Export Forms.

**USA OFFICE**  
 15392 Assembly Lane, Unit A  
 Huntington Beach, CA 92649  
 Tel: 714/898-0840  
 Tlx: 887841 XORDATA HTBH

**AMSTERDAM OFFICE**  
 Building 70, 4th Floor  
 1117 ZH Schiphol-East  
 Amsterdam, The Netherlands  
 Tel: (020) 45 26 50 - Tlx: 18306

**AUSTRALIAN OFFICE**  
 8 Irwin Street, Bellevue  
 W. Australia 6056  
 Tel: 274-3701

**MARACAIBO OFFICE**  
 Av. 3F Esq. Calle 81  
 Centro Com. Maelga - Local #5  
 Maracaibo, Venezuela 4001-A  
 Tel: 061-913328 - Tlx: 62344 PEMIN

**BOMBAY OFFICE**  
 311 Sindhi Lane  
 Nanubhai Desai Rd.  
 Bombay 400-004 India  
 Tel: 357172 - Tlx: 011-2668

**CANADA OFFICE**  
 264 Principale, St. Blaise,  
 Quebec, Canada J0J 1W0  
 Tel: 541/291-3118

## Now PC-XT in a Kit!

Completely XT Compatible

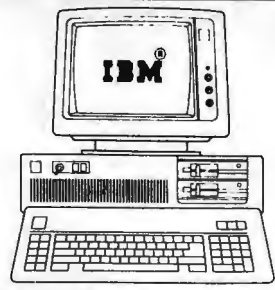
\$1095<sup>00</sup>



Why didn't anybody think of it before? If you have a Phillips screwdriver and 1-2 hours available, SAVE yourself a bundle of MONEY! No where will you beat this deal on a complete 8 slot ready-to-assemble and run XT compatible.

- Cabinet
- 135 watt Power Supply
- Keyboard
- 8 Slot Motherboard
- 256K RAM
- 2-360K Shugart Drives
- Floppy Controller & Cable
- Mono Video Card
- TTL Amber Monitor

<b>IBM PC</b> 256k, 2 floppies	<b>IBM PC 20 + 20</b> 256k, 1 or 2 floppies 20MB HD & 20MB Backup	<b>IBM XT 10 + 10</b> 256k, 1 or 2 floppies 10MB HD & 10MB Backup
<b>IBM PC 10 MB</b> 256k, 1 or 2 floppies	<b>IBM XT</b> 256k, 2 floppies	<b>IBM XT 20 + 20</b> 256k, 1 or 2 floppies 20MB HD & 20MB Backup
<b>IBM PC 20 MB</b> 256k, 1 or 2 floppies	<b>IBM XT 10 MB</b> 256k, 1 or 2 floppies	<b>IBM AT 20 MB</b> 512k, 1 or 2 floppies
<b>IBM PC 30 MB</b> 256k, 1 or 2 floppies	<b>IBM XT 20 MB</b> 256k, 1 or 2 floppies	<b>IBM AT 30 MB</b> 512k, 1 or 2 floppies
<b>IBM PC 10 + 10</b> 256k, 1 or 2 floppies 10MB HD & 10MB Backup	<b>IBM XT 30 MB</b> 256k, 1 or 2 floppies	<b>IBM AT 40 MB</b> 512k, 1 or 2 floppies



**FOR EXTRA SAVINGS**  
Call for the latest prices for your custom configuration. All systems are configured and tested at no extra cost and come only with Compumail's 90 day warranty.

<b>IBM AT 20 + 20</b> 512k, 1 or 2 floppies 20MB HD & 20MB Backup	<b>COMPAQ DESKPRO 10 MB</b> 640k, 1 or 2 floppies	<b>COMPAQ PORTABLE 286</b> Custom Configurations
<b>IBM AT 30 + 60</b> 512k, 1 or 2 floppies 30MB HD & 60MB Backup	<b>COMPAQ DESKPRO 10 + 10</b> 10MB HD & 10MB Backup	<b>COMPAQ DESKPRO 286</b> Custom Configurations
<b>IBM AT 40 + 60</b> 512k, 1 or 2 floppies 40MB HD & 60MB Backup	<b>COMPAQ DESKPRO 20 MB</b> Backup Available	<b>IBM XT COMPATIBLE</b> Custom Configurations
<b>COMPAQ PORTABLE</b> 256k, 1 or 2 floppies	<b>COMPAQ DESKPRO 30 MB</b> Backup Available	<b>IBM AT COMPATIBLE</b> Custom Configurations
<b>COMPAQ PORTABLE 10 MB</b> 256k, 1 or 2 floppies	<b>COMPAQ DESKPRO 40 MB</b> Backup Available	<b>IBM COMPATIBLES ARE YOUR LOW COST ALTERNATIVE</b>

**★ PRICE WAR ★ CALL US LAST WITH YOUR BEST QUOTES ★**

**PRINTERS FLOPPY/HARD DISKS MONITORS MODEMS**

<b>EPSON FX-85 + NLQ</b> ..... \$339 FX-185 + NLQ ..... \$459 Sht Fdr FX-85/FX-185 ..... \$249/\$299 NLQ Upgrade Kit for FX-80/FX-100 ..... CALL LX-80/HI-80/JX-80 ..... \$219/\$359/\$469 Tractor LX-80/FX-80/HI-80 ..... \$50/\$60/\$70 LQ-1500 w/Parallel Module ..... \$889 LQ Tract/Sing/Dual Sht Fdr ..... \$70/\$450/\$750 LX-90 w/Par Interface & Tractor ..... \$279 <b>OKIDATA 192-P/192-IBM</b> ..... \$329 193-P/193-IBM ..... \$459 84-P/84-IBM ..... \$629 93-IBM (White Supplies Last) ..... \$499 <b>TOSHIBA 1340P</b> ..... \$469 ..... 341 ..... CALL <b>TOSHIBA 351-P/S</b> ..... "REDUCED" ..... \$1069 351 Tractor/Sht Fdr ..... \$190/\$790 <b>JUKI 6100/6200/6300</b> ..... \$349/\$549/\$649 6X00 Tractor/Sht Fdr ..... \$150/\$250 5510P (160cps) ..... \$369 ..... 5510 Color Kit ..... \$150 <b>BROTHER HR-15XL</b> ..... \$329 HR-15 Trac. .... \$110 ..... Sht Fdr. .... \$190 HR-15 Keyboard ..... \$160 HR-25P/HR-35P ..... \$439/\$649 HR-25/35 Tractor/Sht Fdr ..... \$120/\$200 2024L LQ/Graphics-24 pin, 160/80 cps. .... \$779 2024L Sht Fdr-Narrow/Wide ..... \$220/\$290 <b>TWINWRITER 5</b> ..... World's First Dot Matrix & Daisy Wheel combined in ONE ..... \$799 TWINWRITER 5 Trac/Sht Fdr ..... \$150/\$250 <b>C. ITOH ProWriter Jr w/NLQ</b> ..... \$219 8510BPI ..... \$309 ..... 8510SECP + NLQ ..... \$379 8510SECP + NLQ ..... \$449 ..... 1550-EP ..... \$429 1550SECP + NLQ ..... \$519 ..... 1550SECP + NLQ ..... \$619 24LQP ..... \$949 ..... A10-30SP ..... \$439 Y10-20P ..... \$379 ..... A10 Tractor ..... \$160 F10-40P ..... \$869 ..... F10-55P ..... \$1069 F10 Tractor/Sht Fdr ..... \$190/\$290 CX-4800P 4 Pen Plotter ..... \$429 <b>QUME LetterPro 20P (20 cps)</b> ..... \$399 20P Trac/Sht Fdr ..... \$150/\$390 SPRINT 1140 + /1155 + ..... \$1299/\$1399 SPRINT Interface Module ..... \$80 SPRINT Trac/Sht Fdr ..... \$210/\$690 <b>PANASONIC KX-P3151 LQ (22cps)</b> ..... \$459 KX-P1090/91/92/93 ..... \$199/\$259/\$369/\$469 <b>STAR Power Type</b> ..... \$349 SG-10/SG-15 (120cps) ..... \$259/\$399 SD-10/SD-15 (160cps) ..... \$369/\$479 SR-10/SR-15 (200cps) ..... \$519/\$619 <b>NEC PINWRITER P-2/P-3</b> ..... \$499/\$699 Sht Fdr for P-2/P-3 ..... \$350/\$420 2050/3550/8850 ..... \$649/\$999/\$1399 SPINWRITER Trac/Sht Fdr ..... \$190/\$790 ELF 360 Par (16cps) ..... \$419 <b>DIABLO Advantage D-25</b> ..... \$499 630 API ..... \$1499 ..... 630 ECS-IBM ..... \$1599 Trac/Mech Single Bin Sht Fdr ..... \$230/\$470 <b>CITIZEN:</b> 18 months manufacturer warranty MSP-10/15 (160/40cps) ..... \$299/\$449 MSP-20/25 (200/50cps) ..... \$439/\$589 Sht Fdr (Specify Model) ..... \$229 <b>LEGEND CP-VII</b> ..... \$899 ..... 1200 ..... \$259 880/1080/1380/1385 ..... \$199/\$219/\$259/\$319 <b>ANAHEIM 9620B/9625B-PLUS</b> ..... \$1199/\$1299 9725B COLOR ..... \$1399 WP6000/DP6500 ..... \$2299/\$2569 <b>HEWLETT PACKARD PRINTERS</b> ..... CALL <b>SILVER REED Daisywheel - Parallel Models</b> 400/500/550/770 ..... \$189/\$269/\$379/\$669 <b>TELEVID 750 Daisywheel-50 cps</b> ..... CALL <b>AB/ABC/ABCD Switch Boxes</b> ..... CALL <b>KENSINGTON Universal Printer Stand</b> ..... \$20 With Printer ..... \$10
---

<b>CDC/MITSUBISHI/PANASONIC/TANDON/TEAC</b> Half HI DSSD ..... "REDUCED" ..... \$79 Free Mounting Kit with 2 Drives <b>CDC/TANDON Full HI DSSD</b> ..... \$99 <b>HARD DISKS for IBM PC/XT</b> 10 MB Int w/Controller ..... "REDUCED" ..... \$399 10 MB Ext w/Controller ..... "REDUCED" ..... \$569 20 MB Int w/Controller ..... "REDUCED" ..... \$469 20 MB Ext w/Controller ..... "REDUCED" ..... \$649 33 MB Int w/Controller ..... "REDUCED" ..... \$999 33 MB Ext w/Controller ..... "REDUCED" ..... \$1199 44 MB Int w/Controller ..... "REDUCED" ..... \$1349 44 MB Ext w/Controller ..... "REDUCED" ..... \$1499 <b>MAYNARD complete line</b> MAYNSTREAM portable tape backup 20MB ..... \$999 MAYNSTREAM portable tape backup 60MB ..... \$1299 <b>HARD DISKS/BACKUP FOR IBM PC AT</b> ..... CALL <b>GENDA GALAXY TAPE BACKUPS</b> 20 MB Int/Ext ..... \$749/\$849 60 MB Int/Ext ..... \$999/\$1099 32 + 60 MB Ext Disk/Backup ..... \$2399 <b>TALL GRASS NEW PC/T FORMAT</b> 25/35 MB w/60 MB Backup ..... \$2599/\$3399 50/80 MB w/60 MB Backup ..... \$4299/\$5499 60 MB Tape Backup only ..... \$1199 Controller, \$140 Cartridge (60 MB) ..... \$40 <b>EVEREX 60MB Tape Backup Int</b> ..... \$899 EVEREX 60MB Tape Backup Ext ..... \$999 EVEREX Expansion Chassis Half Height ..... \$699 EVEREX Expansion Chassis Full Height ..... \$749 <b>INTERDYNE TAPE BACKUP</b> 10 MB Int/Ext ..... "REDUCED" ..... \$369/\$549 20 MB Int/Ext ..... "REDUCED" ..... CALL <b>HARD DISKS/BACKUP FOR COMPAQ</b> ..... CALL <b>BERNOULLI Box by Iomega 10+10</b> ..... CALL Auto Boot also Available <b>BERNOULLI Box by Iomega 20+20</b> ..... CALL <b>POWER SUPPLY 130 Watts</b> ..... \$89 <b>POWER SUPPLY 150 Watts</b> ..... \$99
--

<b>PGS MAX-12/HX-12/HX-12E</b> ..... \$169/\$419/\$499 HX-9/HX-9E/SR-12 ..... \$419/\$499/\$549 SR-12 w/Scan Doubler ..... \$699 SR-12 w/Sigma 400 ..... \$999 <b>TAXAN NEW MONITORS GUARANTEED LOWEST PRICES ON ALL TAXAN MONITORS</b> COLOR 620 4 text modes - 640X262 Res ..... \$199 COLOR 630 4 text modes - 640X400 Res ..... \$299 COLOR 640 Top of the line monitor ..... \$399 COLOR 640 w/TAXAN 555 RGB Card ..... \$749 COLOR 640 w/Persyst BoB Brd ..... \$799 COLOR 640 w/Sigma 400 ..... \$939 <b>AMDEK 300G/300A/310A(M)</b> ..... \$139/\$149/\$159 COLOR 300/500/600 ..... \$239/\$349/\$419 710 ..... \$489 w/Teclar Graphics Master ..... \$899 <b>PGS MD-12 RGB 690x400</b> ..... "BEST" ..... \$399 With Persyst Bob Brd ..... "VALUE" ..... \$699 <b>ROLAND MB-142 14" B/W Reversible</b> ..... \$299 <b>TECMAR Color \$529 w/Graphics Master</b> ..... \$939 <b>SONY TV/RGB Monitor in ONE</b> ..... \$449 <b>TILT/SWIVEL Monitor Pedestal</b> ..... \$20	<b>EasyData 12B 300/1200 Bd Int w/PCTalk III</b> ..... \$199 <b>SmartTEAM 212A 1200 Bd Ext w/o sft</b> ..... \$209 <b>HAYES 1200 B w/SmartCom II</b> ..... \$329 <b>HAYES 1200 Ext. w/o Software</b> ..... \$359 Smartcom II ..... \$89 New 2400 Bd Ext. ..... \$549 <b>HAYES Transet 1000</b> ..... "REDUCED" ..... \$299 <b>POPCOM C-150 Int w/PFS:Access</b> ..... \$289 <b>POPCOM X-150 Ext w/PFS:Access</b> ..... \$299 <b>AST Reach! 1200 Bd short card w/Crosstalk</b> ..... \$329 <b>PROMETHEUS PROMODEM 1200 EXT</b> ..... \$269 Options Processor ..... \$79 w/Modem ..... \$65 Alphanumeric Display ..... \$79 w/Modem ..... \$65 New Comm Buffer for 1200 Ext ..... CALL <b>PROMODEM 1200 B Int w/MITE software</b> ..... \$229 <b>QUADMODEM II shortcard w/Crosstalk XVI</b> ..... \$299 2400 Bd Upgrade Kit for Quadmodem II ..... CALL <b>Ven-Tel Half Card w/Crosstalk XVI</b> ..... \$349 1200 Plus Ext w/o software ..... \$349 <b>BIZCOMP Intellimodem EXT</b> ..... \$319 ST/XL/XT ..... \$289/\$319/\$359 <b>WATSON Integrated Voice Data Modem</b> ..... CALL <b>EVEREX 1200B Internal w/software</b> ..... \$249 <b>U.S. ROBOTICS Complete Line</b> ..... CALL
---	---

**MULTI-FUNCTION CARDS**

<b>AST SIXPAK 64K</b> ..... \$209 ..... 384K ..... \$239 Rampage! ..... CALL Advantage O-K ..... \$379 ..... 128K ..... \$389 <b>ORCHID Blossom O-K</b> ..... \$169 ..... 384K ..... \$199 Conquest for IBM PC/XT (up to 2MB) ..... CALL Cram-RAM for IBM XT short slot (up to 2MB) ..... CALL Eccell for IBM AT (up to 4MB) ..... CALL <b>TECMAR Captain O-K</b> ..... \$169 ..... 384K ..... \$199 MAESTRO AT w/Treasure Chest ..... Best Price <b>INTEL Above Board (up to 4MB)</b> ..... CALL <b>PARADISE 5-Pack O-K</b> ..... \$139 ..... 384K ..... \$169 <b>MF-1DD O-K</b> ..... \$169 ..... 384K ..... \$199 Par. Ser & Game Ports, Clock/Cal <b>QUADBOARD O-K</b> ..... \$189 ..... 384K ..... \$219 Silver Quadboard: O-K to 640k ..... CALL Gold Quadboard: Multifunction & Color ..... CALL Quadmeg-AT (up to 4 MB) ..... CALL Quadport-AT/Expansion Kit ..... CALL <b>INSTALL RAM &amp; test brd for PC/AT</b> ..... \$20/\$40
---

**DISPLAY CARDS**

<b>HERCULES MonoGraphics</b> ..... \$289 ..... Color ..... \$149 <b>HERCULES COMPATIBLE MonoGraphics</b> ..... \$199 <b>EVEREX Graphics Edge</b> ..... \$269 The Edge ..... \$269 <b>AST Preview w/Flight Simulator</b> ..... \$249 <b>PERSYST Short Color/Mini Mono</b> ..... \$159/CALL Color Combo: Multifunction & Color ..... from \$299 Mono Combo: Multifunction & Mono ..... from \$299 <b>PERSYST BoB Board</b> ..... \$339 <b>PERSYST Bob w/TAXAN 640</b> ..... \$799 <b>IBM EGA (Enhanced Color Graphics)</b> ..... \$499 With IBM Enhanced Color Monitor ..... \$1079 <b>Gold Quadboard: Multifunction &amp; Color</b> ..... CALL <b>STB Chaffeur</b> ..... "REDUCED" ..... \$279 <b>PARADISE Modular Brd</b> ..... from \$299 <b>TECMAR Graphics Master</b> ..... \$429 G Master w/TECMAR Color Monitor ..... \$939 G Master w/AMDEK 710 Color Monitor ..... \$899 <b>GENOA Spectrum</b> ..... \$269 <b>MYLEX Chairman</b> ..... \$299 <b>SIGMA COLOR 400 (Specify Monitor)</b> ..... \$479 COLOR 400 w/PGS SR-12 ..... \$999 COLOR 400 w/TAXAN 640 ..... \$939 <b>PERSYST Bob with PGS MD-12 Hi-Res RGB</b> Color Monitor gives 690x400 resolution making this best combination value ..... \$699
--

**CHIPS ETC.**

<b>HIGHEST QUALITY!</b>	<b>Major Brands</b>
<b>64K RAM Set</b> ..... \$7 ..... 10+ Sets ..... \$6 ..... 50+ ..... \$5 <b>128K RAM Set</b> ..... \$35 ..... 10+ Sets ..... \$33 ..... 50+ ..... \$30 <b>256K RAM Set</b> ..... \$30 ..... 10+ Sets ..... \$28 ..... 50+ ..... \$25 <b>8087 Maths Co-Processor</b> ..... Best Price <b>80287-3 for IBM AT</b> ..... "REDUCED" ..... \$239 <b>ORCHID Pcturbo w/128k</b> ..... \$549 Latest Version w/640k ..... \$599 <b>QUADRAM QUADsprint</b> ..... "REDUCED" ..... \$499	<b>MISC. ADD ONS</b> <b>CABLE Parallel, 6 ft.</b> ..... \$20 ..... 10 ft. .... \$25 Serial, 6 ft. .... \$11 Keyboard Extension, 6 ft. .... \$21 <b>ORCHID Pcturbo w/128k</b> ..... \$549 Latest Version w/640k ..... \$599 <b>HAYES Transet 1000</b> ..... "REDUCED" ..... \$299 <b>QUADRAM QUADsprint</b> ..... \$499 <b>MOUSE SYSTEMS PC Mouse w/PC Paint</b> ..... \$129 PC Mouse w/PC Paintbrush ..... \$129 <b>MICROSOFT MOUSE w/PC Paintbrush</b> ..... \$129/\$139 Bus/Serial ..... \$169 <b>KEYTRONIC KB 5151</b> ..... \$169 KB 5153T w/Touch Pad ..... CALL <b>AB/ABC/ABCD Switch Boxes</b> ..... CALL <b>COMPUTER ACCESSORIES P 1-2-3</b> ..... \$299 <b>POWER DIRECTOR P-2 w/5 outlets</b> ..... \$99 <b>POWER DIRECTOR P-12 w/6 outlets</b> ..... \$129 <b>KENSINGTON Master Piece (5 outlets)</b> ..... \$89 <b>KENSINGTON Universal Printer Stand</b> ..... \$21 <b>KENSINGTON Master Piece Plus</b> ..... CALL <b>STANDBY PWR SUPPLY w/surge protection</b> 300 Watts ..... \$339 500 Watts ..... \$599 800 Watts (Sine Wave) ..... \$699 <b>QUADRAM Microtazer Bk</b> ..... \$129 ..... 128k ..... \$149 <b>TILT/SWIVEL Monitor Pedestal</b> ..... \$21 <b>POWER SUPPLY 130 Watts</b> ..... \$89 <b>POWER SUPPLY 150 Watts</b> ..... \$99 <b>EVEREX Expansion Chassis Half Height</b> ..... \$699 <b>EVEREX Expansion Chassis Full Height</b> ..... \$749

**COMPANY POLICY:** Min. order \$100. Prices & availability subject to change. We ship UPS only. Shipping/handling charges vary. Prices reflect cash discount on prepaid orders. Add 1% for COD orders, 3% for MC/VISA & 5% for AMEX. COD requires cashiers check. All merchandise sold is new and all sales are final. Refused shipments subject to 20% charge (Min \$50). Products shipped in factory cartons come with manufacturer warranty. For others, including IBM systems, call tech support for return auth. # for warranty repairs. Non-defective items returned as defective subject to 10% service charge (Min. \$50). Not responsible for hardware or software compatibility of any product. No open acct PO's or foreign orders. No showroom, demonstrations or walk-in sales. Personal or company checks take 3 weeks to clear. FOR ADVANCE PAYMENTS or PICKUP: PLEASE CALL FIRST FOR WORKORDER #.

**COMPU** **805-987-7015**

406-C CONSTITUTION AVE., CAMARILLO, CA 93010 WHEN ORDERING PLEASE REFER TO AD #B80

# Try It. Then Buy It. PC-Write.™

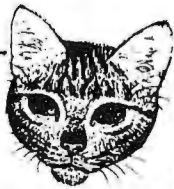
A fast, full-featured word processing package for the unbelievable price of \$10. Complete. You get a manual on disk, mail merge, split screen, keyboard macros, on-screen formatting, full printer support, and more.

Try *PC-Write* for \$10. Then register for \$75 to get:

- latest diskette
- printed manual
- two updates
- phone support
- newsletter

Registration supports our "shareware" concept that keeps our prices low, and allows our development of *PC-Write* enhancements.

Shareware means you can get *PC-Write* from a friend or user group to try, and give away copies yourself. Then register if you like it. No risk!



Byte  
December 85

Now you can use the same editor for all your work, both programs and manuals. Watch for version 2.6 soon.

A perfect Christmas gift!  
We'll send it and include a nice card in your name.

Order *PC-Write* Today.  
Satisfaction Guaranteed.

*Quicksort*™  
(206) 282-0452

219 First N. #224y  
Seattle, WA 98109



Inquiry 426

## EPROM PROGRAMMER



APROTEK 1000  
ONLY  
**\$265.00**

COMPLETE WITH  
PERSONALITY  
MODULE

117 VOLT AC POWER-RS232  
-6 BAUD RATES - HANDSHAKE TO HOST  
**ALLOWS READ, WRITE, VERIFY & COPY**

Comes complete with a CPM, IBM-PC or Apple Driver Program on Disc.

Programs the following 5 Volt 24 or 28 pin devices: 2716 series through 27256, 25xx series, 68764 plus others. Please Specify Personality Module desired with order. Additional Personality Modules only \$15.00 ea. **Full 1 year warranty.**

TO ORDER: CALL 1-800-962-5800 OR WRITE  
APROTEK  
1071-A AVENIDA ACASO Add  
CAMARILLO, CA 93010 \$4.00 Shipping/USA  
Info: (805) 987-2454 VISA or MC Add 3%

Inquiry 24

## M68000 SINGLE BOARD COMPUTER



On board 6-10 MHz CPU, 20K RAM, 32K EPROM, two RS-232, 16-bit port, 5-counter/timers expandable via Memory/FDC Board.

M68K CPU (bare board) ..... \$ 89.95  
M68K CPU A&T (6MHz) ..... \$495.00  
M0512K Memory/FDC (bare board) ..... \$ 89.95  
M0512K Memory/FDC (128K) ..... \$495.00  
FDC/Hard Disk interface option ..... \$150.00  
M68KE Enclosure w/power supply ..... \$249.00  
M68K Monitor EPROM's ..... \$ 95.00  
M68K Macro Cross Assembler ..... \$195.00  
4XFORTH OS w/assembler, editor ..... \$295.00  
CP/M 68K OS w/"C" compiler ..... \$395.00

**EMS** Educational Microcomputer Systems P.O. Box 16115 Irvine, CA 92713 (714) 854-8545

Inquiry 129

## WHOLESALE

AST 6-PACK + 64K ..... \$239  
ANCHOR VOLKSMODEM 12 . . . 164  
AUTOCAD ..... CALL  
(DIGITIZERS, PLOTTERS) PENCEPT, HOUSTON,  
HITACHI, CALCOMP, NICOLET, ENTER, GTCO  
JUKI 6300 ..... 639  
MAC 3.5 FLOPPY DRIVE ..... 279

CALL FOR LATEST PRICE

APPLE	HAYES	PANASONIC
AXIOM	IBM	PARADISE
CITIZEN	JUKI	PRINCETON
C. ITOH	LEGEND	SILVER REED
COMPAC	LOTUS	TAXAN
EPSON	NEC	TOSHIBA
ENTER	NOVATION	VENTEL
GENOA	MICROPRO	ZENITH

Minority Industries VISA

5021 N. 20th St., #10261, Phoenix, AZ 85064

ORDERS ONLY 1-800-428-7979  
OTHER INFORMATION (602) 890-0596

Prices subject to change & reflect cash discount.  
Please add 2% for shipping on most items.

Inquiry 250

## P.D.Q. CABLES

3021 PURDUE ROAD  
DAYTON, OHIO 45420

No higher quality computer cables on the market today!!

METALIZED HOODS  
FULLY SHIELDED  
POSITIVE STRAIN  
RELIEF  
100% GUARANTEED

6' IBM PARALLEL CENTRONICS-----\$17.00  
6' IBM SERIAL PRINTER CABLE-----\$17.00  
6' IBM SERIAL FOR MODEM-----\$17.00  
6' STRAIGHT PARALLEL CENTRONICS--\$18.00  
6' RS232C-----\$17.00

IF THERE IS A CABLE NEEDED, P.D.Q. CAN CONSTRUCT AND GUARANTEE IT!

CALL  
(513) 254-8755

Inquiry 282

## ATTENTION MEGABYTES

Let your PC grow!

Feature for IBM AT, XT and compatibles supports **BIG** disks secures disk data.

Feature operates with AT- and XT-compatible hard disk controllers.

## Golden Bow Systems

\$80.00

Add \$3 for shipping/handling  
California residents add 8% sales tax



3388 Second Ave., Suite F  
San Diego, CA 92103  
(619) 298-9349

Inquiry 155

## Erases Most Eproms in 3 Minutes



ONLY \$34.95

Solid State 2-8 Min.  
Timer Version ..... \$54.95

For all 24 or 28 pin devices—2 at a time.  
90 DAY WARRANTY SHIPPING & HANDLING  
DEALERS WELCOME \$2.50  
AZ RESIDENTS ADD 6% TAX

**WALLING CO.**

4401 S. JUNIPER • TEMPE, AZ 85282 • (602) 838-1277

Inquiry 372

**STATIC RAMS**

2101	256x4	(450ns)	1.95
5101	256x4	(450ns)(CMOS)	3.95
2102L-4	1024x1	(450ns)(LP)	.99
2102L-2	1024x1	(200ns)(LP)	1.45
2112	256x4	(450ns)	2.99
2114	1024x4	(450ns)	.99
2114L-4	1024x4	(450ns)(LP)	1.09
2114L-2	1024x4	(200ns)(LP)	1.49
2114L-15	1024x4	(150ns)(LP)	1.95
TMS4044-4	4096x1	(450ns)	1.95
TMM2016-150	2048x8	(150ns)	1.49
TMM2016-100	2048x8	(100ns)	1.49
HM6116-4	2048x8	(200ns)(CMOS)	1.39
HM6116-3	2048x8	(150ns)(CMOS)	1.49
HM6116LP-4	2048x8	(200ns)(CMOS)(LP)	1.49
HM6116LP-3	2048x8	(150ns)(CMOS)(LP)	1.59
HM6116LP-2	2048x8	(120ns)(CMOS)(LP)	2.95
HM6264P-15	8192x8	(150ns)(CMOS)	3.89
HM6264LP-15	8192x8	(150ns)(CMOS)(LP)	3.95
HM6264LP-12	8192x8	(120ns)(CMOS)(LP)	4.49

LP=Low power

**DYNAMIC RAMS**

4116-250	16384x1	(250ns)	.49
4116-200	16384x1	(200ns)	.69
4116-150	16384x1	(150ns)	.89
4116-120	16384x1	(120ns)	1.49
NK4332	32768x1	(200ns)	6.95
4164-200	65536x1	(200ns)(5V)	.49
4164-150	65536x1	(150ns)(5V)	.69
4164-120	65536x1	(120ns)(5V)	1.95
MCM6665	65536x1	(200ns)(5V)	1.95
TMS4164	65536x1	(150ns)(5V)	1.95
4164-REFRESH	65536x1	(150ns)(5V)(REFRESH)	2.95
TMS4416	16384x4	(150ns)(5V)	4.95
4112-150	131072x1	(150ns)(5V)	5.95
41256-200	262144x1	(200ns)(5V)	2.95
41256-150	262144x1	(150ns)(5V)	2.95

5V=Single 5 Volt Supply

REFRESH=Pin 1 Refresh

★★★★HIGH-TECH★★★★

**NEG V20  $\mu$ PD70108 \$20<sup>95</sup>**

REPLACES 8088 TO SPEED UP IBM PC 10-40%

- \* HIGH-SPEED ADDRESS CALCULATION IN HARDWARE
- \* PIN COMPATIBLE WITH 8088
- \* SUPERSET OF 8086/8088 INSTRUCTION SET
- \* LOW POWER CMOS

★★★★SPOTLIGHT★★★★

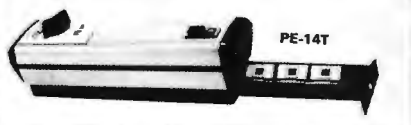
**ORDER TOLL FREE**  
**800-538-5000**  
**800-662-6279 (CA)**



**EPROMS**

2708	1024x8	(450ns)	3.95
2716-6	2048x8	(650ns)	2.29
2716	2048x8	(450ns)(5V)	1.95
2716-1	2048x8	(350ns)(5V)	2.49
TMS2532	4096x8	(450ns)(5V)	3.95
2732	4096x8	(450ns)(5V)	2.29
2732A	4096x8	(50ns)(5V)(21V PGM)	2.69
2732A-2	4096x8	(200ns)(5V)(21V PGM)	3.95
27C64	8192x8	(250ns)(5V)(CMOS)	5.95
2764	8192x8	(450ns)(5V)	1.95
2764-250	8192x8	(250ns)(5V)	2.49
2764-200	8192x8	(200ns)(5V)	3.49
TMS2564	8192x8	(450ns)(5V)	6.95
MCM68766	8192x8	(350ns)(5V)(24 PIN)	17.95
27128	16384x8	(250ns)(5V)	2.79
27C256	32768x8	(250ns)(5V)(CMOS)	12.95
27256	32768x8	(250ns)(5V)	7.49

**SPECTRONICS CORPORATION EPROM ERASERS**



Model	Timer	Capacity Chip	Intensity (uW/Cm <sup>2</sup> )	Unit Price
PE-14	NO	9	8,000	\$83.00
PE-14T	YES	9	8,000	\$119.00
PE-24T	YES	12	9,600	\$175.00

**8000**

8035	1.49
8039	1.95
8080	2.95
8085	2.49
8087-2	139.95
8087	109.00
8088	6.95
8088-2	9.95
8155	2.49
8155-2	3.95
8748	7.95
8755	19.95
80286	129.95
80287	185.00

**6500 1.0 MHz**

6502	2.79
65C02 (CMOS)	12.95
6507	9.95
6520	1.95
6522	4.95
6526	26.95
6532	6.95
6545	6.95
6551	5.95
6561	19.95
6581	34.95

**CRT CONTROLLERS**

6845	4.95
68B45	8.95
6847	11.95
HD46505SP	6.95
MC1372	2.95
8275	26.95
7220	19.95
CRT5027	12.95
CRT5037	9.95
TMS9918A	19.95

**CRYSTALS**

32.768 KHz	.95
1.0 MHz	2.95
1.8432	2.95
2.0	1.95
2.097152	1.95
2.4576	1.95
3.2768	1.95
3.579545	1.95
4.0	1.95
4.032	1.95
5.0	1.95
5.0688	1.95
6.0	1.95
6.144	1.95
6.5536	1.95
8.0	1.95
10.0	1.95
10.738835	1.95
12.0	1.95
14.31818	1.95
15.0	1.95
16.0	1.95
17.430	1.95
18.0	1.95
18.432	1.95
19.0	1.95
22.1184	1.95
24.0	1.95
32.0	1.95

**74LS00**

74LS00	.16
74LS01	.18
74LS02	.17
74LS03	.18
74LS04	.16
74LS05	.18
74LS08	.18
74LS09	.18
74LS10	.16
74LS11	.22
74LS12	.22
74LS13	.26
74LS14	.39
74LS15	.26
74LS20	.17
74LS21	.22
74LS22	.22
74LS27	.23
74LS28	.26
74LS30	.17
74LS32	.18
74LS33	.28
74LS37	.26
74LS38	.26
74LS42	.39
74LS47	.59
74LS48	.69
74LS51	.17
74LS73	.29
74LS74	.24
74LS75	.29
74LS76	.29
74LS83	.49
74LS85	.49
74LS86	.22
74LS90	.39
74LS92	.49
74LS93	.39
74LS95	.49
74LS107	.34
74LS109	.36
74LS112	.29
74LS122	.45
74LS123	.49
74LS124	2.75
74LS125	.39
74LS126	.39
74LS132	.39
74LS133	.49
74LS136	.39
74LS138	.39
74LS139	.39
74LS145	.99
74LS147	.99
74LS148	.99
74LS151	.39
74LS153	.39
74LS154	1.49
74LS155	.59
74LS156	.49
74LS157	.35
74LS158	.29
74LS160	.29
74LS161	.39
74LS162	.49
74LS163	.39
74LS164	.49

**74HC00**

A new family of high speed CMOS logic featuring the speed of low power Schottky (8ns typical gate propagation delay), combined with the advantages of CMOS: very low power consumption, superior noise immunity, and improved output drive.

74HC00	.59
74HC02	.59
74HC04	.59
74HC08	.59
74HC10	.59
74HC14	.79
74HC20	.59
74HC27	.59
74HC30	.59
74HC32	.69
74HC51	.59
74HC74	.75
74HC85	1.35
74HC86	.69
74HC93	1.19
74HC107	.79
74HC109	.79
74HC112	.79
74HC126	1.19
74HC132	1.19
74HC133	.69
74HC138	.99
74HC139	.99

**HIGH SPEED CMOS**

74HC: Operate at CMOS logic levels and are ideal for new, all-CMOS designs.

74HC148	1.19
74HC151	.89
74HC154	2.49
74HC157	.89
74HC168	.95
74HC175	.99
74HC240	1.89
74HC244	1.89
74HC245	1.89
74HC251	.89
74HC259	1.39
74HC273	1.89
74HC293	4.99
74HC368	.99
74HC373	2.29
74HC374	2.29
74HC390	1.39
74HC393	1.39
74HC4017	1.99
74HC4020	1.39
74HC4045	.89
74HC4050	.89

**8200**

8203	29.95
8205	3.29
8212	1.49
8216	1.49
8224	2.25
8237	4.95
8237-5	5.49
8250	6.95
8251	1.69
8251A	1.89
8253	1.89
8253-5	1.95
8255	1.69
8255-5	1.89
8259	1.95
8259-5	2.29
8272	4.95
8279	2.49
8279-5	2.95
8282	3.95
8284	2.95
8286	3.95
8288	4.95

**2.0 MHz**

6502A	2.95
6520A	2.95
6522A	5.95
6532A	11.95
6545A	7.95
6551A	6.95

**DISK CONTROLLERS**

1771	4.95
1791	9.95
1793	9.95
1795	12.95
1797	12.95
2791	19.95
2793	19.95
2797	29.95
6843	19.95
8272	4.95
UPD765	4.95
MB8876	12.95
MB8877	12.95
1691	6.95
2143	6.95

**CRYSTAL OSCILLATORS**

1.0MHz	5.95
1.8432	5.95
2.0	5.95
2.4576	5.95
2.5	4.95
4.0	4.95
5.0688	4.95
6.0	4.95
6.144	4.95
8.0	4.95
10.0	4.95
12.0	4.95
12.480	4.95
15.0	4.95
16.0	4.95
18.432	4.95
20.0	4.95
24.0	4.95

**MISC.**

TMS99531	9.95
TMS99532	19.95
ULN2003	.79
3242	7.95
3341	4.95
MC3470	1.95
MC3480	8.95
MC3487	2.95
11C90	13.95
2513-001 UP	6.95
AY5-2376	11.95
AY5-3600 PRO	11.95

**Z-80**

Z80-CPU 2.5 MHz 1.79

**4.0 MHz**

Z80A-CPU	1.89
Z80A-CTC	1.95
Z80A-DART	5.95
Z80A-DMA	5.95
Z80A-PIO	1.95
Z80A-SIO-0	5.95
Z80A-SIO/1	5.95
Z80A-SIO/2	5.95

**2.0 MHz**

68B00	4.95
68B02	5.95
68B09E	7.95
68B09	7.95
68B21	4.95
68B45	8.95
68B50	3.95
68B54	7.95

**BIT RATE GENERATORS**

MC14411	9.95
BR1941	4.95
4702	9.95
COM8116	8.95
MM5307	4.95

**UARTS**

AYS-1013	3.95
AY3-1015	4.95
TR1602	3.95
2651	4.95
IM6402	6.95
IM6403	9.95
INS8250	6.95

**6.0 MHz**

Z80B-CPU	4.95
Z80B-CTC	8.95
Z80B-PIO	8.95
Z80B-DART	14.95
Z80B-SIO-0	12.95
Z80B-SIO/2	12.95
Z8671 ZILOG	19.95

**CLOCK CIRCUITS**

MM5369	1.95
MM5369-EST	1.95
MM58167	12.95
MM58174	11.95
MSM5832	2.95

**SOUND CHIPS**

76477	3.95
76489	8.95
SSI-263	39.95
AY3-8910	12.95
AY3-8912	12.95
SP1000	39.00

VISIT OUR RETAIL STORE LOCATED AT 1256 SOUTH BASCOM AVENUE IN SAN JOSE

**JDR Microdevices**

1224 S. Bascom Avenue, San Jose, CA 95128

800-538-5000 • 800-662-6279 (CA) • (408) 995-5430

FAX (408) 275-8415 • Telex 171-110

HOURS: M-W-F, 9-5 TU-TH, 9-9 SAT, 10-3  
PLEASE USE YOUR CUSTOMER NUMBER WHEN ORDERING

# PARTIAL LISTING ONLY — CALL FOR A FREE CATALOG

### CMOS

4001	.19	14419	4.95
4011	.19	14433	14.95
4012	.25	4503	4.95
4013	.35	4511	.69
4015	.25	4516	.79
4016	.25	4518	.85
4017	.49	4522	.79
4018	.49	4526	.79
4020	.59	4527	1.95
4021	.69	4528	.79
4024	.49	4529	2.95
4025	.25	4532	1.95
4027	.39	4538	.95
4028	.65	4541	1.29
4035	.69	4553	5.79
4040	.69	4585	.75
4041	.75	4792	12.95
4042	.59	74C00	.29
4043	.85	74C14	.59
4044	.69	74C74	.59
4045	1.98	74C83	1.95
4046	.69	74C85	1.49
4047	.69	74C95	.95
4049	.29	74C150	5.75
4050	.29	74C151	2.25
4051	.69	74C161	.99
4052	.69	74C183	.99
4053	.69	74C184	1.39
4056	2.19	74C192	1.49
4060	.69	74C193	1.49
4068	.29	74C221	1.75
4069	.19	74C240	1.89
4076	.59	74C244	1.89
4077	.29	74C374	1.99
4081	.22	74C905	10.95
4085	.79	74C911	8.95
4086	.89	74C917	8.95
4093	.49	74C922	4.49
4094	2.49	74C923	4.95
14411	9.95	74C926	7.95
14412	6.95	80C97	.95

### 7400/9800

7400	.19	74147	2.49
7402	.19	74148	1.20
7404	.19	74150	1.35
7406	.29	74151	.55
7407	.29	74153	.55
7408	.24	74154	1.49
7410	.29	74155	.75
7411	.25	74157	.55
7414	.49	74159	1.65
7416	.25	74161	.69
7417	.25	74163	.69
7420	.19	74164	.85
7423	.29	74165	.85
7430	.19	74166	1.00
7432	.29	74175	.89
7438	.35	74177	.75
7442	.49	74178	1.15
7445	.69	74181	2.25
7447	.89	74182	.75
7470	.35	74184	2.00
7473	.34	74191	1.15
7474	.33	74192	.79
7475	.45	74194	.85
7476	.35	74196	.75
7483	.50	74197	.75
7485	.59	74199	1.35
7486	.35	74221	1.35
7489	2.15	74244	1.35
7490	.39	74247	1.25
7492	.50	74248	1.85
7493	.35	74249	1.95
7495	.55	74251	.75
7497	2.75	74256	1.35
74100	2.29	74273	1.95
74121	.29	74278	3.11
74123	.49	74367	.65
74125	.45	74368	.65
74141	.65	9368	3.95
74143	5.95	9602	1.50
74144	2.95	9637	2.95
74145	.60	96S02	1.95

### 74S00

74S00	.29	74S163	1.29
74S02	.29	74S168	3.95
74S03	.29	74S174	.79
74S04	.29	74S175	.79
74S05	.29	74S188	1.95
74S06	.35	74S189	1.95
74S10	.29	74S195	1.49
74S15	.35	74S196	1.49
74S20	.29	74S197	1.49
74S32	.35	74S226	3.99
74S37	.69	74S240	1.49
74S38	.69	74S241	1.49
74S74	.49	74S244	1.49
74S85	.95	74S257	.79
74S86	.35	74S253	.79
74S112	.50	74S258	.95
74S124	2.75	74S280	1.95
74S138	.79	74S287	1.69
74S140	.55	74S288	1.69
74S151	.79	74S299	2.95
74S153	.79	74S373	1.69
74S157	.79	74S374	1.69
74S158	.95	74S471	4.95
74S161	1.29	74S571	2.95

### VOLTAGE REGULATORS

#### TO-220 CASE

7805T	.49	7905T	.59
7808T	.49	7908T	.59
7812T	.49	7912T	.59
7815T	.49	7915T	.59

#### TO-3 CASE

7805K	1.39	7905K	1.49
7812K	1.39	7912K	1.49

#### TO-92 CASE

78L05	.49	79L05	.69
78L12	.49	79L12	.69

#### OTHER VOLTAGE REGS

LM323K	5V 3A	TO-3	4.79
LM338K	4.5A	TO-3	3.95
78H05K	5V 5A	TO-3	7.95
78H12K	12V 5A	TO-3	8.95
78P05K	5V 10A	TO-3	14.95

### LINEAR

TLO66	.99	LM733	.98
TLO71	.69	LM741	.29
TLO72	1.09	LM747	.69
TLO74	1.95	LM748	.59
TLO81	.59	MC1330	1.69
TLO82	.95	MC1350	1.19
TLO84	.49	MC1372	6.95
LM301	.34	LM1414	1.59
LM309K	1.25	LM1458	.49
LM311	.59	LM1488	.49
LM311H	.89	LM1489	.49
LM317K	3.49	LM1496	.85
LM317T	.95	LM1812	8.25
LM318	1.49	LM1869	1.95
LM319	1.25	ULN2003	.79
LM320	see 7900	XR2206	3.75
LM322	1.65	XR2211	2.95
LM323K	4.79	XR2240	1.95
LM324	.49	MPQ2907	1.95
LM331	3.95	LM2917	1.95
LM334	1.19	CA3046	.89
LM335	1.40	CA3081	.99
LM336	1.75	CA3082	2.99
LM337K	3.95	CA3086	.80
LM338K	3.95	CA3089	1.95
LM339	.59	CA3130E	.99
LM340	see 7800	CA3146	1.29
LM350T	.40	CA3160	1.19
LF353	.59	MC3470	1.95
LF356	.98	MC3480	8.95
LF357	3.25	RC4553	.69
LM358	.59	LM3900	.49
LM380	.89	LM3909	.98
LM383	1.95	LM3911	2.25
LM386	.89	LM3914	2.39
LM393	.45	MC4024	3.49
LM394H	4.60	MC4044	3.99
TL494	4.20	RC4136	1.25
TL497	3.25	RC4553	.69
NE555	.29	LM13600	1.49
NE556	.49	75107	1.49
NE558	1.29	75110	1.95
NE564	1.95	75150	1.95
LM565	.95	75154	1.95
LM566	1.49	75188	1.25
LM567	.79	75189	1.25
NE570	2.95	75651	.99
NE590	2.50	75452	.39
NE592	.98	75453	.39
LM710	.75	75477	1.29
LM723	.49	75492	.79
H-T0-5 CAN, K-T0-3, T-T0-220			

### IC SOCKETS

#### 8 PIN ST

1.99	500
.13	.11
.15	.12
.17	.13
.20	.18
.23	.27
.30	.27
.39	.37
.40	.32
.49	.39
4.25	CALL

#### 16 PIN ST

.13	.11
.15	.12
.17	.13
.20	.18
.23	.27
.30	.27
.39	.37
.40	.32
.49	.39
4.25	CALL

#### ST-SOLDER TAIL

8 PIN WW	.59	.49
14 PIN WW	.69	.52
16 PIN WW	.69	.58
18 PIN WW	.95	.90
20 PIN WW	1.09	.98
22 PIN WW	1.39	1.28
24 PIN WW	1.49	1.35
28 PIN WW	1.69	1.49
40 PIN WW	1.99	1.80

#### WW-WIREWRAP

16 PIN ZIF	4.95	CALL
24 PIN ZIF	5.95	CALL
28 PIN ZIF	6.95	CALL
40 PIN ZIF	9.95	CALL
ZIF-TEXT TOOL		
(ZERO INSERTION FORCE)		

### EDOCARD CONNECTORS

100 PIN ST	S-100	125	3.95
100 PIN WW	S-100	125	4.95
62 PIN ST	IBM PC	100	1.95
50 PIN ST	APPLE	100	2.95
44 PIN ST	STD	156	1.95
44 PIN WW	STD	156	4.95

### 36 PIN CENTRONICS

ICDCEN36	RIBBON CABLE	6.95
CEN36	SOLDER CUP	4.95
CEN36PC	RT ANGLE PC MOUNT	4.95
	FEMALE	
ICDCEN36/F	RIBBON CABLE	7.95

### INTERSIL

ICL7106	8.95
ICL7107	12.95
ICL7660	2.95
ICL8038	4.95
ICM7207A	5.95
ICM7208	15.95

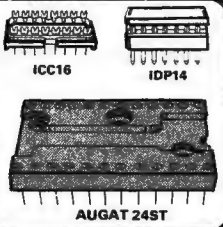
### DATA ACQ INTERFACE

ADC0800	15.55	8T26	1.29
ADC0804	3.49	8T28	1.29
ADC0809	4.49	8T95	.89
ADC0816	14.95	8T96	.89
ADC0817	9.95	8T97	.59
ADC0831	8.95	8T98	.89
DAC0800	4.4C	DM8131	2.95
DAC0806	1.95	DP8304	2.29
DAC0808	2.95	DS8833	2.25
DAC1020	8.25	DS8835	1.99
DAC1022	5.95	DS8836	.99
MC1408L8	2.95	DS8837	1.65

### DIP CONNECTORS

DESCRIPTION	ORDER BY	CONTACTS								
		8	14	16	18	20	22	24	28	40
HIGH RELIABILITY TOOLED ST IC SOCKETS	AUGATxxST	.62	.79	.89	1.09	1.29	1.39	1.49	1.69	2.49
HIGH RELIABILITY TOOLED WW IC SOCKETS	AUGATxxWW	1.30	1.80	2.10	2.40	2.50	2.90	3.16	3.70	5.40
COMPONENT CARRIERS (DIP HEADERS)	ICCxx	.49	.59	.69	.99	.99	.99	.99	1.09	1.49
RIBBON CABLE DIP PLUGS (IC)	IDPxx	---	.95	.95	---	---	---	1.75	---	2.95

FOR ORDERING INSTRUCTIONS SEE D-SUBMINIATURE BELOW



### DIODES/OPTO/TRANSISTORS

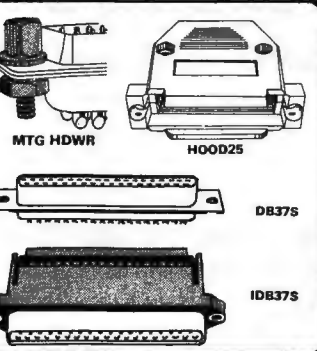
1N751	.25	4N28	.69
1N759	.25	4N27	.69
1N4148	25/1.00	4N28	.69
1N4004	10/1.00	4N33	.69
1N5402	.25	4N37	1.19
KBPO4	.95	MCT-2	.69
KBUS8A	.95	MCT-6	1.29
MDA990-2	.35	TIL-111	.99
N2222	.25	2N3906	.99
PN2222	.10	2N4401	.25
2N2905	.50	2N4402	.25
2N2907	.25	2N4403	.25
2N3055	.79	2N6045	1.75
2N3904	.10	TIP31	.49

### D-SUBMINIATURE

DESCRIPTION	ORDER BY	CONTACTS						
		9	15	19	25	37	50	
SOLDER CUP	MALE	DBxxP	.82	.90	1.25	1.25	1.80	3.48
	FEMALE	DBxxS	.95	1.15	1.50	1.50	2.36	4.32
RIGHT ANGLE PC SOLDER	MALE	DBxxPR	1.20	1.49	---	1.95	2.65	---
	FEMALE	DBxxSR	1.25	1.55	---	2.00	2.79	---
WIRE WRAP	MALE	DBxxPWW	1.69	2.56	---	3.89	5.60	---
	FEMALE	DBxxSWW	2.76	4.27	---	6.84	9.95	---
IDC RIBBON CABLE	MALE	IDBxxP	2.70	2.95	---	3.98	5.70	---
	FEMALE	IDBxxS	2.92	3.20	---	4.33	6.76	---
HOODS	METAL	MHOODxx	1.25	1.25	1.30	1.30	---	---
	GREY	HOODxx	.65	.85	---	.85	.75	.95

ORDERING INSTRUCTIONS: INSERT THE NUMBER OF CONTACTS IN THE POSITION MARKED "x" OF THE "ORDER BY" PART NUMBER LISTED.  
EXAMPLE: A 15 PIN RIGHT ANGLE MALE PC SOLDER WOULD BE DB15PR.

**MOUNTING HARDWARE \$1.00**



### LED DISPLAYS

FND-357(359)	COM CATHODE	.382"	1.25
FND-500(503)	COM CATHODE	.5"	1.49
FND-507(510)	COM CATHODE	.5"	1.49
MAN-72	COM ANODE	.3"	.99
MAN-74	COM CATHODE	.3"	.99
MAN-8940	COM CATHODE	.8"	1.99
TIL-313	COM CATHODE	.3"	.45
HP5082-7760	COM CATHODE	.43"	1.29
TIL-311	4x7 HEX W/LOGIC	.270"	9.95
HP5082-7340	4x7 HEX W/LOGIC	.290"	7.95

### DIFFUSED LEDS

JUMBO RED	T1%	.10	.09
JUMBO GREEN	T1%	.14	.12
JUMBO YELLOW	T1%	.14	.12
MOUNTING HDW	T1%</		

**BARGAIN HUNTERS CORNER**

**IBM COMPATIBLE  
MONOCHROME DISPLAY ADAPTOR**

- 720 x 350 PIXEL SCREEN (80 CHARACTERS x 25 LINES)
- CHARACTER ATTRIBUTES: BLINK, UNDERLINE, REVERSE, VIDEO & INTENSIFIED
- STANDARD TTL OUTPUT
- MADE IN USA BY INTERSIL SYSTEMS
- 90 DAY WARRANTY
- INCLUDES 5 PAGE MANUAL

**\$4995**

NOTE: THE ABOVE CARD DOES NOT INCLUDE A PARALLEL PRINTER PORT. DON'T LET THIS PRICE SCARE YOU. IF YOU PURCHASED THESE FROM AN EXCESS INVENTORY LOT, WE CAN SELL THEM AT AN UNBEAT-OF-PRICE!

**PURCHASE THE ABOVE  
MONOCHROME DISPLAY ADAPTOR  
AND THE  
SAMWOOD MONOCHROME MONITOR**

**FOR ONLY \$13995**

**SPECIALS END 12/31/85**

**SOCKET-WRAP I.D.™**

- SLIPS OVER WIRE WRAP PINS
  - IDENTIFIES PIN NUMBERS ON WRAP SIDE OF BOARD
  - CAN WRITE ON PLASTIC, SUCH AS IC #
- | PINS | PART#     | PCK. OF | PRICE |
|------|-----------|---------|-------|
| 8    | IDWRAP 08 | 10      | 1.95  |
| 14   | IDWRAP 14 | 10      | 1.95  |
| 16   | IDWRAP 16 | 10      | 1.95  |
| 18   | IDWRAP 18 | 5       | 1.95  |
| 20   | IDWRAP 20 | 5       | 1.95  |
| 22   | IDWRAP 22 | 5       | 1.95  |
| 24   | IDWRAP 24 | 5       | 1.95  |
| 28   | IDWRAP 28 | 5       | 1.95  |
| 40   | IDWRAP 40 | 5       | 1.95  |
- PLEASE ORDER BY NUMBER OF PACKAGES (PCK. OF)



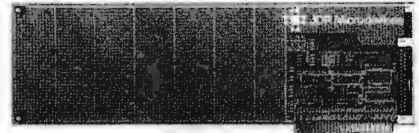
**FRAME STYLE TRANSFORMERS**

12.6V AC CT	2 AMP	5.95
12.6V AC CT	4 AMP	7.95
12.6V AC CT	8 AMP	10.95
25.2V AC CT	2 AMP	7.95

**25 PIN D-SUB GENDER CHANGERS \$7.95**



**WIRE WRAP PROTOTYPE CARDS  
FR-4 EPOXY GLASS LAMINATE  
WITH GOLD-PLATED EDGE-CARD FINGERS**



IBM-PR2

**IBM**

BOTH CARDS HAVE SILK SCREENED LEGENDS AND INCLUDES MOUNTING BRACKET

IBM-PR1 WITH +5V AND GROUND PLANE . . . . . \$27.95  
IBM-PR2 AS ABOVE WITH DECODING LAYOUT . . . . . \$29.95

**S-100**

P100-1 BARE - NO FOIL PADS . . . . . \$15.15  
P100-2 HORIZONTAL BUS . . . . . \$21.80  
P100-3 VERTICAL BUS . . . . . \$21.80  
P100-4 SINGLE FOIL PADS PER HOLE . . . . . \$22.75

**APPLE**

P500-1 BARE - NO FOIL PADS . . . . . \$15.15  
P500-3 HORIZONTAL BUS . . . . . \$22.75  
P500-4 SINGLE FOIL PADS PER HOLE . . . . . \$21.80  
7060-45 FOR APPLE IIe AUX SLOT . . . . . \$30.00

**CAPACITORS**

TANTALUM			
1.0µf	15V .35	.47µf	35V .45
6.8	15V .70	1.0	35V .45
10	15V .80	2.2	35V .65
22	15V 1.35	4.7	35V .85
.22	35V .40	10	35V 1.00

DISC			
10µf	50V .05	.680	50V .05
22	50V .05	.001µf	50V .05
27	50V .05	.0022	50V .05
33	50V .05	.005	50V .05
47	50V .05	.01	50V .07
68	50V .05	.02	50V .07
100	50V .05	.05	50V .07
220	50V .05	.1	12V .10
560	50V .05	.1	50V .12

MONOLITHIC			
.01µf	50V .14	.1µf	50V .18
.047µf	50V .15	.47µf	50V .25

**DATARASE EPROM ERASER \$34.95**

- ERASES TWO EPROMS IN 10 MINUTES
- COMPACT-NO DRAWER
- THIN METAL SHUTTER PREVENTS UV LIGHT FROM ESCAPING



**1/4 WATT RESISTORS**

5% CARBON FILM ALL STANDARD VALUES FROM 1 OHM TO 10 MEG. OHM

10 PCS	same value	.05	100 PCS	same value	.02
50 PCS	same value	.025	1000 PCS	same value	.015

**RESISTOR NETWORKS**

SIP	10 PIN	9 RESISTOR	.69
SIP	8 PIN	7 RESISTOR	.59
DIP	16 PIN	8 RESISTOR	1.09
DIP	16 PIN	15 RESISTOR	1.09
DIP	14 PIN	7 RESISTOR	.99
DIP	14 PIN	13 RESISTOR	.99

**SPECIALS ON BYPASS CAPACITORS**

.01 µf CERAMIC DISC 100/\$5.00  
.01 µf MONOLITHIC 100/\$10.00  
.1 µf CERAMIC DISC 100/\$6.50  
.1 µf MONOLITHIC 100/\$12.50

**SWITCHING POWER SUPPLIES**

**PS-IBM \$99.95**

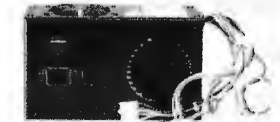
- FOR IBM PC-XT COMPATIBLE
- 130 WATTS
- +5V @ 15A, +12V @ 4.2A
- -5V @ .5A, -12V @ .5A
- ONE YEAR WARRANTY



PS-IBM

**PS-130 \$99.95**

- 130 WATTS
- SWITCH ON REAR
- FOR USE IN OTHER IBM TYPE MACHINES
- 90 DAY WARRANTY



PS-130

**PS-A \$49.95**

- USE TO POWER APPLE TYPE SYSTEMS
- +5V @ 4A, +12V @ 2.5A
- -5V @ .5A, -12V @ .5A
- APPLE POWER CONNECTOR



PS-A

**PS-3 \$39.95**

- AS USED IN APPLE III
- +5V @ 4A, +12V @ 2.5A
- -5V @ .25A, -12V @ .30A
- 15.5" x 4.5" x 2.0", .884 LBS.



PS-3

**PS-ASTEC \$19.95**

- CAN POWER TWO 5 1/4" FDDS
- +5V @ 2.5A, +12V @ 2A
- -12V @ .1A
- +5V @ 5A IF +12V IS NOT USED
- 6.3" x 4.0" x 1.9", 1 LB.



PS-ASTEC

**PS-TDK \$29.95**

- +5V @ 4A, +12V @ 2A
- +12V @ 2.8A, -12V @ .30A
- 6.2" x 7.4" x 1.7", 1.6 LBS.

**NEW BOOKS BY STEVE CIARCIA**

BUILD YOUR OWN Z80 COMPUTER \$19.95  
CIRCUIT CELLAR VOL 1 \$17.95  
CIRCUIT CELLAR VOL 2 \$18.95  
CIRCUIT CELLAR VOL 3 \$18.95  
CIRCUIT CELLAR VOL 4 \$18.95

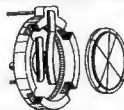
**MICROCOMPUTER HARDWARE HANDBOOK**

FROM ELCOMP \$14.95  
OVER 800 PAGES OF DATA SHEETS ON THE MOST COMMONLY USED ICs. INCLUDES TTL, CMOS, 74LS00, MEMORY, CPUs, MPU SUPPORT. AND MUCH MORE!

**WISH SOLDERLESS BREADBOARDS**

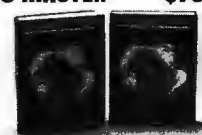
PART NUMBER	DIMENSIONS	DISTRIBUTION STRIP(S)	TIE POINTS	TERMINAL STRIP(S)	TIE POINTS	BINDING POSTS	PRICE
WBU-D	.38 x 6.50"	1	100	—	—	—	2.95
WBU-T	1.38 x 6.50"	—	—	1	630	—	6.95
WBU-204-3	3.94 x 8.45"	1	100	2	1260	2	17.95
WBU-204	5.13 x 8.45"	4	400	2	1260	3	24.95
WBU-206	6.88 x 9.06"	5	500	3	1890	4	29.95
WBU-208	8.25 x 9.45"	7	700	4	2520	4	39.95

**LITHIUM BATTERY AS USED IN CLOCK CIRCUITS**



3 VOLT BATTERY \$3.95  
BATTERY HOLDER \$1.49

**IC MASTER \$79.95**



**THE INDUSTRY STANDARD**

VISIT OUR RETAIL STORE LOCATED AT 1256 SOUTH BASCOM AVENUE IN SAN JOSE



**JDR Microdevices**

1224 S. Bascom Avenue, San Jose, CA 95128  
800-538-5000 • 800-662-6279 (CA) • (408) 995-5430  
FAX (408) 275-8415 • Telex 171-110

**ALL MERCHANDISE 100% GUARANTEED**

HOURS: M-W-F, 9-5 TU-TH, 9-9 SAT, 10-3  
PLEASE USE YOUR CUSTOMER NUMBER WHEN ORDERING

TERMS: Minimum order \$10.00. For shipping and handling include \$2.50 for UPS Ground and \$3.50 for UPS Air. Orders over 1 lb. and foreign orders may require additional shipping charges - please contact our sales department for the amount. CA residents must include applicable sales tax. All merchandise is warranted for 90 days unless otherwise stated. Prices are subject to change without notice. We are not responsible for typographical errors. We reserve the right to limit quantities and to substitute manufacturer. All merchandise subject to prior sale.

# PARTIAL LISTING ONLY — CALL FOR A FREE CATALOG

## BAL PRINTER BUFFERS

- \* FREES COMPUTER FOR OTHER TASKS WHILE PRINTING LONG DOCUMENTS.
- \* STANDALONE DESIGN - WORKS WITH ANY COMPUTER OR PRINTER.
- \* ALL MODELS FEATURE PRINT PAUSE, MEMORY CHECK AND GRAPHICS CAPABILITY.

**SP120P PARALLEL \$139.95**  
 \* 64K UPGRADABLE TO 256K  
 \* LED INDICATOR SHOWS VOLUME OF DATA IN BUFFER

**SP120S RS232 SERIAL \$159.95**  
 \* 64K UPGRADABLE TO 256K  
 \* SIX SELECTABLE BAUD RATES FROM 600B - 19,200B

**SP110 PARALLEL \$249.95**  
 \* 64K UPGRADABLE TO 512K  
 \* SPOOLS OUTPUT OF UP TO THREE COMPUTERS  
 \* LED BARGRAPH DISPLAYS AMOUNT OF DATA IN BUFFER  
 \* RESET FUNCTION CLEARS DATA IN BUFFER  
 \* REPEAT FUNCTION CAN PRODUCE MULTIPLE COPIES OF A DOCUMENT



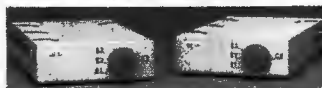
SP120



SP110

## BAL 3-WAY SWITCH BOXES

- \* SERIAL OR PARALLEL
- \* CONNECTS 3 PRINTERS TO 1 COMPUTER OR 3 COMPUTERS TO 1 PRINTER
- \* ALL LINES SWITCHED
- \* HIGH QUALITY ROTARY SWITCH MOUNTED ON PCB
- \* GOLD CONTACTS
- \* STURDY METAL ENCLOSURE



**SWITCH-3P CENTRONICS PARALLEL 99.95**  
**SWITCH-3S RS232 SERIAL 99.95**

## IBM PRINTER CABLE

- \* DB25 TO CENTRONICS
- \* SHIELDED CABLE

**\$9.95**

## JOYSTICKS



**\$7.95**

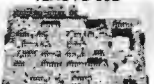
**\$4.95**

## FLOPPY DISK DRIVES

- TEAC**  
**FD-55B 1/2 HEIGHT DS/DD \$89.95**  
**FD-55F 1/2 HEIGHT DS/QUAD \$99.95**
- SHUGART**  
**SA460 5 1/4" (80 TRACK) DS/QUAD \$199.95**
- TANDON**  
**TM100-2 5 1/4" (FOR IBM) DS/DD \$99.95**
- MPI**  
**MPI-B52 5 1/4" (FOR IBM) DS/DD \$89.95**



TEAC FD-55B



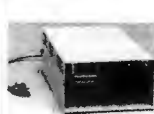
TANDON TM100-2

## SIEMENS 8" DISK DRIVES

- FD100-8 SS/DD SA801R EQUIV. \$119.00**  
**FD200-8 DS/DD SA851R EQUIV. \$159.00**  
**JFORMAT-2 SOFTWARE \$49.95**  
 SUPPORT FOR QUAD DENSITY DRIVES FROM TALL TREE SYSTEMS

## DISK DRIVE CABINETS

- 5 1/4" DRIVE ENCLOSURES**
- CAB-APPLE APPLE TYPE DRIVE CABINET WITHOUT POWER SUPPLY \$24.95**  
**CAB-1FH5 FULL HEIGHT 5 1/4" BEIGE DRIVE CABINET WITH POWER SUPPLY \$69.95**  
**CAB-2SV5 DUAL SLIMLINE 5 1/4" CABINET WITH POWER SUPPLY - VERTICAL MOUNT \$49.95**
- 8 INCH DRIVE ENCLOSURES BY JMR**
- CAB-2SV8 DUAL SLIMLINE 8" DRIVE CABINET WITH POWER SUPPLY - VERTICAL MOUNT \$209.95**  
**CAB-2FH8 DUAL FULL HEIGHT 8" DRIVE CABINET WITH POWER SUPPLY - HORIZONTAL \$219.95**



CAB-1FH5



CAB-2SV5



CAB-2FH8

## NASHUA DISKETTE SPECIALS

**5 1/4" SOFT SECTOR DS/DD WITH HUB RINGS**

**\$9.90 BOX OF 10**  
**89c ea BULK QTY 50**  
**79c ea BULK QTY 250**

NASHUA DISKETTES WERE JUDGED TO HAVE THE HIGHEST POLISH AND RECORDED AMPLITUDE OF ANY DISKETTES TESTED. SEE "COMPARING FLOPPY DISKS", BYTE 9-84.

## DISKETTE FILE

**\$8.95**



HOLDS 70 5 1/4" DISKETTES

## DISKETTES

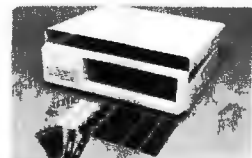
- NASHUA 5 1/4"**  
 DS/DD SOFT SECTOR **\$9.90**  
 DS/QUAD SOFT SECTOR **\$34.95**  
 DS/HIGH DENSITY FOR AT **\$49.95**
- NASHUA 8"**  
 SS/DD SOFT SECTOR **\$27.95**  
 DS/DD SOFT SECTOR **\$34.95**
- NASHUA 3.5"**  
 3.5" SS/DD FOR MACINTOSH **\$32.95**
- VERBATIM 5 1/4"**  
 SS/DD SOFT SECTOR **\$23.95**  
 DS/DD SOFT SECTOR **\$29.95**  
 SS/DD 10 SECTOR HARD **\$23.95**
- N-MD2D \$9.90**  
**N-MD2F \$34.95**  
**N-MD2H \$49.95**
- N-FD1 \$27.95**  
**N-FD2D \$34.95**
- N-3.5SS \$32.95**
- V-MD1D \$23.95**  
**V-MD2D \$29.95**  
**V-MD110D \$23.95**

## IBM STYLE COMPUTER CASE

ATTRACTIVE STEEL CASE, WITH HINGED LID, FITS POPULAR PC/XT COMPATIBLE MOTHER-BOARDS.

- \* SWITCH CUT-OUT ON SIDE FOR PC/XT STYLE POWER SUPPLY
- \* CUT-OUT FOR 8 EXPANSION SLOTS
- \* ALL HARDWARE INCLUDED

**ONLY \$59.95**



## IBM COMPATIBLE KEYBOARDS

- DKM-2000 \$79.95**  
 \* FULLY IBM COMPATIBLE  
 \* 83 KEY WITH CAPACITANCE TYPE SWITCHES  
 \* LED STATUS INDICATORS FOR CAPS, NUMBER LOCK  
 \* AUDIBLE CLICK
- KB-5151 \$89.95**  
 \* ENHANCED IBM COMPATIBLE  
 \* SEPARATE CURSOR AND NUMERIC KEYPADS  
 \* CAPS LOCK & NUMBER LOCK INDICATORS  
 \* IMPROVED KEYBOARD LAYOUT



## EXTENDER CARDS

- IBM-PC \$45.00**  
**IBM-AT \$68.00**  
**APPLE II \$45.00**  
**APPLE IIe \$45.00**  
**MULTIBUS \$86.00**

## POWER STRIPS

- \* UL APPROVED
- \* 15A CIRCUIT BREAKER



**\$12.95**

## KEYBOARD-AP

- \* REPLACEMENT FOR APPLE II KEYBOARD
- \* CAPS LOCK KEY
- \* AUTO-REPEAT
- \* ONE KEY ENTRY OF BASIC OR CP/M COMMANDS



**\$49.95**

## CASE WITH KEYBOARD

FOR APPLE MOTHER-BOARD MODEL KB-1000

- \* USER DEFINED FUNCTION KEYS
- \* NUMERIC KEYPAD WITH CURSOR CONTROL
- \* CAPS LOCK
- \* AUTO-REPEAT



**ONLY \$79.95**

## HIGH QUALITY TEST EQUIPMENT FROM JDR INSTRUMENTS

### 20 MHz DUAL TRACE OSCILLOSCOPE

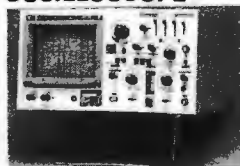
**MODEL 2000 \$389**



- \* BAND WIDTH - DC: TO 20 MHz (-3db)
- \* AC: 10 Hz TO 20MHz (-3db)
- \* SWEEP TIME - .2 μSEC TO .5 SEC/DIV ON 20 RANGES
- \* COMPLETE MANUAL AND HIGH QUALITY HOOK-ON PROBES INCLUDED
- \* INPUT IMPEDANCE: 1 MEG OHM
- \* TV VIDEO SYNC FILTER
- \* X-Y AND Z AXIS OPERATION
- \* 110/220 VOLT OPERATION
- \* COMPONENT TESTER
- \* LP CONSUMPTION - 19 WATTS
- \* BUILT-IN CALIBRATOR
- \* AUTOMATIC OR TRIGGERED TIMEBASE

### 35 MHz DUAL TRACE OSCILLOSCOPE

**MODEL 3500 \$549**



- \* BAND WIDTH - DC: TO 35MHz (-3db)
- \* AC: 10 Hz TO 35MHz (-3db)
- \* SWEEP TIME - .1 μSEC TO .5 SEC/DIV ON 21 RANGES
- \* DELAYED TRIGGER - 100 mSEC TO 1 μSEC WITH INTENSIFIED AND DELAYED MODES
- \* COMPLETE MANUAL AND 1X-10X COMPENSATED HOOK-ON PROBES INCLUDED
- \* VARIABLE HOLD OFF FOR VIEWING COMPLEX WAVES
- \* TV VIDEO SYNC FILTER
- \* TRIGGERING OF CH-A, CH-B, ALTERNATING, LINE OR EXTERNAL
- \* X-Y AND Z AXIS OPERATION

### DIGITAL MULTIMETER PEN MODEL DPM-1000



**\$49.95**

AUTO RANGING, POLARITY AND DECIMAL!

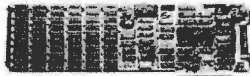
- \* LARGE 3.5" DISPLAY
- \* DATA HOLD SWITCH FREEZES READING
- \* FAST, AUDIBLE CONTINUITY TEST
- \* LOW BATTERY INDICATOR
- \* OVERLOAD PROTECTION
- \* ONLY 1 1/2 x 6 1/4 x 3/4"
- \* DC VOLTS 1mV-500V
- \* AC VOLTS 1mV-500V
- \* .1 OHM - 2 MEG OHM
- \* WEIGHS ONLY 2.3 OUNCES
- \* LOW PARTS COUNT-CUSTOM 80 PIN LSI INSURES RELIABILITY
- \* INCLUDES MANUAL, BATTERIES, HARD CASE, AND ALLIGATOR CLIP

**CALL FOR VOLUME QUOTES**

© COPYRIGHT 1985 JDR MICRODEVICES

## IBM COMPATIBLE INTERFACE CARDS ALL WITH A ONE YEAR WARRANTY

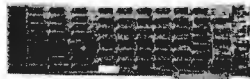
**MULTIFUNCTION CARD \$129.95**  
ALL THE FEATURES OF AST'S 6 PACK PLUS AT HALF THE PRICE



- \* CLOCK/CALENDAR
- \* 0-384K RAM
- \* SERIAL PORT
- \* PARALLEL PORT
- \* GAME PORT
- \* SOFTWARE INCLUDED

PRINTER CABLE \$9.95 64K RAM UPGRADE 9/\$7.11

**COLOR GRAPHICS ADAPTOR \$99.95**  
FULLY COMPATIBLE WITH IBM COLOR CARD



- \* 4 VIDEO INTERFACES: RGB, COMPOSITE COLOR, HI-RES COMPOSITE MONOCHROME, CONNECTOR FOR RF MODULATOR
- \* COLOR GRAPHICS MODE: 320 x 200
- \* MONO GRAPHICS MODE: 640 x 200
- \* LIGHT PEN INTERFACE

**MONOCHROME GRAPHICS CARD \$129.95**  
FULLY COMPATIBLE WITH IBM MONOCHROME ADAPTOR AND HERCULES GRAPHICS CARD



- \* LOTUS COMPATIBLE
- \* TEXT MODE: 80 x 25
- \* GRAPHICS MODE: 720 x 348
- \* PARALLEL PRINTER INTERFACE
- \* OPTIONAL SERIAL PORT

**FLOPPY DISK DRIVE ADAPTOR \$59.95**



- \* INTERFACES UP TO FOUR STANDARD FDDs TO IBM PC OR COMPATIBLES
- \* INCLUDES CABLE FOR TWO INTERNAL DRIVES

**1200 BAUD INTERNAL MODEM FOR IBM**  
INCLUDES PC TALK III COMMUNICATIONS SOFTWARE



- \* HAYES COMPATIBLE
- \* AUTO DIAL/AUTO ANSWER
- \* AUTO RE-DIAL ON BUSY
- \* INCLUDES SERIAL PORT
- \* ONE YEAR WARRANTY

**EASYDATA-12B \$195**

**300 BAUD MODEM FOR APPLE OR IBM**  
CLOSE-OUT SPECIAL NOW ONLY



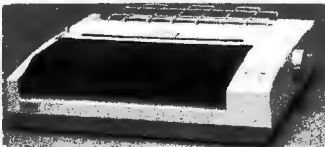
**\$49.95**

INCLUDES ASCII PRO-EZ SOFTWARE (A \$100 VALUE IN ITSELF)

- \* FCC APPROVED
- \* BELL SYSTEMS 103 COMPATIBLE
- \* INCLUDES AC ADAPTOR
- \* AUTO DIAL/AUTO ANSWER
- \* DIRECT CONNECT

CABLE FOR APPLE IIc \$14.95

**100 CPS ESPRIT PRINTER**



**\$149.95**

- \* 9 x 9 DOT MATRIX
- \* 100 CPS - BIDIRECTIONAL
- \* FRICTION AND TRACTOR FEED
- \* PROPORTIONAL SPACING
- \* 80 COLUMN
- \* PARALLEL AND SERIAL INTERFACES
- \* 8 CHARACTER SETS AND GRAPHICS

CABLE TO IBM PC \$9.95  
REPLACEMENT RIBBON CARTRIDGE SZ-44 \$11.95

**PS-IBM 130 WATTS \$99.95**



**TEAC DISK DRIVES FOR IBM PCs**



FD-55B DS/DB \$89.95  
FD-55F DS/QUAD \$89.95

## UNBELIEVABLE MONITOR DEALS



**TAXAN RGB VISION III**  
MODEL 415

- \* 18 MHz BAND WIDTH
- \* 640 x 262 PIXEL RESOLUTION
- \* 16 COLORS WITH INTENSITY CONTROL
- \* 12" BLACK MATRIX
- \* IBM AND LOTUS COMPATIBLE

CABLE FOR IBM \$15.95  
**\$289.95**



**SAKATA COMPOSITE COLOR**  
MODEL SC-100

- \* TOP RATED FOR APPLE
- \* 13" COMPOSITE VIDEO
- \* RESOLUTION: 280H x 300V
- \* INTERNAL AUDIO AMPLIFIER
- \* ONE YEAR WARRANTY

**\$169.95**



**SAMWOO MONOCHROME**  
MODEL DM-216B

- \* PERFECT COSMETIC MATCH FOR IBM PC
- \* IBM COMPATIBLE TTL INPUT
- \* 12" NON-GLARE SCREEN
- \* P39 GREEN PHOSPHOR
- \* HI-RES 22 MHz BAND WIDTH

**\$99.95**

**MONITOR STAND TILTS AND SWIVELS**



**\$12.95**

**APPLE COMPATIBLE INTERFACE CARDS**

EPROM PROGRAMMER \$79.95



MODEL RP525

- \* DUPLICATE OR BURN ANY STANDARD 27xx SERIES EPROM
- \* EASY TO USE MENU-DRIVEN SOFTWARE INCLUDED
- \* MENU SELECTION FOR 2716, 2732, 2732A, 2764 & 27128
- \* HIGH SPEED WRITE ALGORITHM
- \* LED INDICATORS FOR ACTIVITY
- \* NO EXTERNAL POWER SUPPLY REQUIRED
- \* ONE YEAR WARRANTY

16K RAMCARD \$39.95

- \* FULL TWO YEAR WARRANTY
- \* EXPANDS YOUR 48K APPLE TO 64K
- \* USE IN PLACE OF APPLE LANGUAGE CARD

SAVE PC CARD W/ INSTRUCTIONS \$9.95

16 TEST CARD \$89.95

- \* QUICKLY TESTS MANY COMMON ICs
- \* DISPLAYS PASS OR FAIL
- \* ONE YEAR WARRANTY
- \* TESTS: 4000 SERIES CMOS 74HC SERIES CMOS 7400; 74LS, 74L, 74H, 74S, SOME PROMS AND RAMS

**DISK DRIVES**

FOR APPLE COMPUTERS



**BAL-525 \$99.95**

- \* 1/2 HEIGHT ALPS MECHANISM
- \* 100% APPLE COMPATIBLE
- \* FULL 1 YEAR WARRANTY



**BAL-500 \$129.95**

- \* TEAC MECHANISM - DIRECT DRIVE
- \* 100% APPLE COMPATIBLE
- \* FULL 1 YEAR WARRANTY



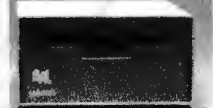
**AP-135 \$129.95**

- \* FULL HT. SHUGART MECHANISM
- \* DIRECT REPLACEMENT FOR APPLE DISK II
- \* SIX MONTH WARRANTY



FOR APPLE IIc  
**AD-3C \$139.95**

- \* 100% APPLE IIc COMPATIBLE, READY TO PLUG IN W/ SHIELDED CABLE & MOLDED 19 PIN CONNECTOR
- \* FAST, RELIABLE SLIMLINE DIRECT DRIVE
- \* SIX MONTH WARRANTY



FOR MACINTOSH  
**MAC 535 \$299.95**

- \* 3.5" ADD-ON DISK DRIVE
- \* 100% MACINTOSH COMPATIBLE
- \* SINGLE SIDED 400K BYTE STORAGE
- \* HIGH RELIABILITY DRIVE FEATURES
- \* AUTO-EJECT MECHANISM
- \* FULL ONE YEAR WARRANTY

**DISK DRIVE ACCESSORIES**

DISK CONTROLLER CARD \$49.95  
APPLE IIc ADAPTOR CABLE \$19.95  
ADAPTS STANDARD APPLE DRIVES FOR USE WITH APPLE IIc

**COMREX CR-1000 DUAL SLIMLINE DISK DRIVE \$199.95**  
FOR APPLE COMPUTERS

- \* SPACE SAVING DESIGN; STACK BETWEEN COMPUTER AND MONITOR
- \* QUIET, RELIABLE 1/2 HEIGHT DRIVES
- \* TOTAL STORAGE CAPACITY: 285K BYTES
- \* AUTO-EJECT MECHANISM
- \* SHIELDED CABLE INCLUDED



INCLUDES CONTROLLER AND DOS 3.3 WITH DISK UTILITIES

ALL MERCHANDISE 100% GUARANTEED

© COPYRIGHT 1985 JDR MICRODEVICES



# U·N·C·L·A·S·S·I·F·I·E·D A·D·S

**NEEDED:** Nonprofit counseling, crisis-intervention, and information and referral service needs tax-deductible donation of Apple II and printer. Will pay shipping. Hotline for Help, 17 Elliot St., Brattleboro, VT 05301.

**NEEDED:** Nonprofit school for emotionally disturbed children seeks tax-deductible donation of Apple computers, peripherals, literature, supplies, etc. Will provide receipts. Dean Esmay, SMA Independence High School, 22700 Richton Square Rd., Richton Park, IL 60471. (312) 481-6091.

**NEEDED:** Nonprofit corporation providing free transportation within the state of Washington to elderly, disadvantaged, or low-income people seeks donation of used radio equipment and two computers. Minuteman Messengers, 636 Burwell, Bremerton, WA 98310. (206) 377-9996.

**WANTED:** Explorers' Post 367, a unit of Boy Scouts of America, seeks tax-deductible donation of computer and peripherals. Will provide receipt. Explorers' Post 367, 539 South Main St., Room 2205, Findlay, OH 45840. (419) 422-2121. ext. 4195.

**WANTED:** Library of the Marine Environmental Sciences Consortium seeks tax-deductible donation of IBM PC or compatible with 256K or 512K bytes of RAM and 360K disk drive(s), 10- to 20-megabyte hard disk, monitor, and dot-matrix printer. MESC, POB 369, Dauphin Island, AL 36528.

**WANTED:** Nonprofit mathematics research association needs new or used 20- to 40-megabyte computer and printer to foster growth regarding conservative and abstract concepts, logic, and the history and future of mathematical sciences. Richard Teter, Paramedics Foundation, POB 5813, Sherman Oaks, CA 91403.

**WANTED:** Nonprofit organization needs low-cost serial I/O interface option for Compugraphic G 7500 typesetter. Offers or any hints are welcome. Missionverlag, D-4812 Bielefeld 11, Mainweg 12, West Germany.

**NEEDED:** Mission organization needs donation of up to five Digital Rainbow 100s, dual disk drive, and LA100 printers for Bible translation and study in Africa. Will pay shipping. Africa Evangelical Fellowship Inc., POB 1679, Bloomfield, NJ 07003. (201) 748-9281.

**WANTED:** Missionary needs donation of PC and public-domain word-processing software for aid to translation of evangelical literature. Ingo Haake, POB 1688, 90000 Porto Alegre, RS, Brazil.

**NEEDED:** Information on NAPLPS or sources to acquire information on this subject. Johann G. Kiermeyer, Hauptstrasse 27, 8425 Neustadt/Donau, West Germany.

**WANTED:** June 1977 BYTE or copy of Dan Fylstra's article "Interfacing the IBM Selectric Keyboard Printer," pages 46-52 and 133-139. Any other information appreciated for this task. Roger G. Smith, Rt. 2, Box 366, Laurel, MS 39440. (601) 428-7484.

**FOR TRADE:** Macintosh public-domain programs. Will share with users groups only. Send newsletter and list of your public-domain files and digitized images. Also, inquire about International Mac User Group Network. John Allen, POB 40045, Portland, OR 97024-0045.

**WANTED:** Persons interested in robotics to form international club with newsletter, etc. Send SASE. The Tlme machine, 30 Melken Court, Baltimore, MD 21236.

**WANTED:** People interested in starting nationwide MC-10/6803/6801 users group and public-domain software exchange. Send SASE. Jon Porter, 6501 Amber Crest, Indianapolis, IN 46220.

**FOR SALE:** CompuPro System B, TeleVideo 950 terminal, extra S-100 bus boards, HP 5 plotter, NEC 7710 letter-quality printer, and more. \$6000 for whole system or will separate. M. D. Schier, 3195 Linwood Ave., Cincinnati, OH 45208. (513) 321-3199.

**FOR SALE:** Rockwell AIM 65 with 4K; \$250. ExpandoRAM with 16K; \$100. Kimsi S-100 expansion board for AIM; \$60. SSM VBIB video board; \$80. Each has documentation. John Ip, 9465 McNaught Rd., Chilliwack, British Columbia V2P 6E9, Canada.

**FOR SALE:** Apple IIe 80-column card with manual. Excellent condition. \$70 or best offer. Michael Smith, D-8 Gatewood, Greenwood, SC 29646.

**FOR SALE:** LDP Lightning One S-100 PC, 10-MHz 8086, 1/2-megabyte RAM, 5-megabyte Winchester, handles three 40-megabyte drives. Will also configure as 8-inch system. S1900. R. Morein, 1570 Arran Way, Dresher, PA 19025. (215) 646-4894.

**WANTED:** Apple II with damaged case or keyboard. Need a working motherboard. Glen Button, POB 536, Cheshire, CT 06410. (203) 272-9251.

**FOR SALE:** 12-inch Sanyo CRT-36 green monochrome monitor with cable. \$100 or best offer. Two TEAC 55B DS/DD disk drives. \$75 each or best offer. Excellent condition. Michael J. Vargo, 2999 Lutheran Rd., Gilbertsville, PA 19525.

**FOR SALE:** ADDS Regent 200 terminal with detachable keyboard. Best offer over \$600. Tony Preston, 119 Hickory Lane, Medford, NJ 08055.

**FOR SALE:** Assembled and tested Slicer single-board computer. 8-MHz 80186, 128K RAM, almost new. \$700. Charles Ng, 49 Showers Dr. #474, Mountain View, CA 94040. (415) 948-5174.

**WANTED:** 15-inch white-on-black Hitachi high-resolution monitor or equivalent. Harry J. Weber, M.D. Route 8, Box 554, Hot Springs, AR 71913. (501) 767-6266.

**FOR SALE:** Olivetti LUC 401, line-control unit, TTY interface, communications interface, RS-232 serial interface, and RS-232 cable. Excellent condition. \$600 (Canadian) or best offer. K. Molohon, POB 562, Sudbury, Ontario P3E 4P8, Canada.

**FOR SALE:** TRS-80 Model 16A with 128K, 68000 board, two 8-inch floppy drives (1.25 megabytes each). \$3000. Ralph Stegner, 66 South Broad St., Fairborn, OH 45324. (513) 878-3447.

**FOR SALE:** Passport Music System with keyboard. Also, Mountain Hardware's Music System with light pen. Brand new. Will sell for dealer cost. Robert M. Reinhart, 4816 North Rutherford, Chicago, IL 60656. (312) 286-6606.

**FOR SALE:** Applied Concepts Morphy Encore chess computer. USCF rating 1800+. \$150. Steve Ferrero, 8601 First Ave., North Bergen, NJ 07047. (201) 869-5351.

**FOR SALE:** CompuPro 8085/88 system with 64K, two 8-inch 600K drives, three serial ports, TeleVideo 910+ CRT, Okidata 82A printer, Mullens I/O, and more. \$3200. Excellent working order. Gary Ragsdale, 8631 Wine Leaf Cove., Germantown, TN 38138. (901) 754-9522.

**FOR SALE:** Apple III with 128K, one external disk, and green-on-green monitor. Mike Ashton, 317 St. Pauls Ave., Jersey City, NJ 07306. (201) 420-0515.

**AVAILABLE:** Public-domain Life, Core War, Line Automation, and Wa-Tor. All written and compiled with Turbo Pascal 3.00 and constantly updated. Source code included. Runs on 64K IBM PC with graphics card. Send SASE. Doug Church, 2112 Noyes St., Evanston, IL 60201.

**FOR SALE:** Xerox 820 board (compatible with Big Board). Includes all sockets, resistors, capacitors, schematics, and assembly instructions. Contains monitor and character set on EPROMs. \$55 or best offer. Gary M. McComas, Route #1, Box 454, West Hamlin, WV 25571. (304) 824-5664.

**FOR SALE:** Complete set of Heathkit H-11 computer manuals, includes schematics and documentation. Make offer. Trade: Have extra January and February 1979 issues of BYTE; need January and February 1977. Will sell/buy if necessary. Luis Mulford, 205 Post Oak, Lake Jackson, TX 77566.

UNCLASSIFIED ADS MUST be noncommercial, from readers who have computer equipment to buy, sell, or trade on a one-time basis. All requests for donated computer equipment must be from nonprofit organizations. Programs to be exchanged must be written by the individual or be in the public domain. Ads must be typed double-spaced, contain 50 words or less, and include full name and address. This is a free service; ads are printed as space permits. BYTE reserves the right to reject any unclassified ad that does not meet these criteria. When you submit your ad (BYTE, Unclassified Ads, POB 372, Hancock, NH 03449), allow at least four months for it to appear.

**FOR SALE:** BYTE: January, February, March, September through December, 1976; January, November, December, 1977; complete 1978; January through October 1979. All for \$60 postpaid. Jeffrey Viola, 16 Temple Ave., Hackensack, NJ 07601.

**FOR SALE:** Inexpensive expansion interface, printer, modem, and disk drive for TRS-80 Model I, Level II. Paul Ngaopravej, 67-01 Woodside Ave., Woodside, NY 11377.

**FOR SALE:** MPX-16 bare board in original sealed envelope, with BIOS and manuals. \$210 including shipping. Merton Bollman, 18002 Atkinson Ave., Torrance, CA 90504.

**FOR SALE:** Zenith Z-90 loaded and Z-37 drives. Morrow MD1-E with MDF70 terminal. Excellent condition. Will consider any reasonable offer. Scott Kudika, 237 Main St., New Kensington, PA 15068. (412) 335-3472 or 337-1717.

**FOR SALE:** Atari 810 disk drive with interface card. \$200 or best offer. Don C. Jacobs, VF-103 MC, FPO New York, NY 09501-6117.

**FOR SALE:** Three Industrial Micro-Systems Model 282 16K static RAM boards. Phantom line, RAM disable, PWR/MWR, and memory-management capability using 450-ns 2114s, with documentation. \$120 each. G. Bober, POB 36428, Grosse Pointe Woods, MI 48236. (313) 884-2133.

**FOR SALE:** Tektronix 4012 with controller and 10-inch diagonal screen. Hazeltine 1421 with keyboard and 12-inch alphanumeric screen. Best offer. Sharon Mott, Great Plains Gasification Associates, POB 1149, Beulah, ND 58523.

**FOR SALE:** 80-column card for the Apple IIe; \$50. Ed Rambeau, 55 West 74th St., New York, NY 10023. (212) 724-0458.

**TRADE:** Will trade my Apple II public-domain software for yours. Send SASE. Dale Flatow, 7684 South Logan Ave., Oak Creek, WI 53154.

**FOR SALE:** DAK Microsystems 6/232, S-100 board with six programmable RS-232 channels plus 16-channel master/slave interrupt controller. Preproduction with full documentation. Best offer over \$175. K. S. Kolberg, 52105B Friars Court, South Bend, IN 46637. (219) 277-6154.

**FOR SALE:** Dual Remex 3/4-height 5-inch fully IBM PC-compatible DS/DD drives in cabinet with power supply. Almost new. Manual included. \$220. Benny Bamgbade, POB 440323, Houston, TX 77244-0323. (713) 550-4651.

**FOR SALE:** Motorola UDS 208 A/B 4800-bps data modem. \$1500 (Canadian). Doug Anderson/Ernie Reimer, 118 Midland St., Winnipeg, Manitoba R3E 2Y6, Canada. (204) 775-8531.

**FOR SALE:** Data General/One with 256K bytes, screen, two 3 1/2-inch drives, printer, internal battery, and carrying bag. \$3500. Michael Balamuth, 300 East Main St., Centerport, NY 11721. (516) 367-8390.

**FOR SALE:** BYTE: 1978-1984 complete, except for February and December 1979 and June 1981. Also November and December 1977. \$30 per year. Martin Evans, 325 East 52nd St., New York, NY 10022. (212) 355-1926.

**FOR SALE:** TI-99/4A. Excellent condition, hardly used. Manuals and cables included. \$45 plus shipping. Anthony Switzer, Rt. 2, Box 254, Campobello, SC 29322. (803) 895-2659.

**FOR SALE:** Kaypro 4 '84 Plus 88. CP/M machine (64K) with factory-installed MS-DOS SWP coprocessor (256K), built-in clock, and 300-bps modem. \$1200 or offer. Eric Hart, 103 McGraw Place, Ithaca, NY 14850. (607) 272-3691.

**FOR SALE:** HP 2116B "mini" computer. In working order, but some assembly may be required. \$200, best offer, or trade. Billy Vitro, 10480 Orange Ave., Cupertino, CA 95014.

**FOR SALE:** Two Visual 50 terminals. Emulate DEC VT52, ADDS Viewpoint, LSI ADM 3A, and Hazeltine Esprit terminals. Nearly new. \$400 each or best offer. Will swap both for one SwTPC 8212 terminal. Dwight Lanpher, Box 472, Northeast Harbor, ME 04662. (207) 276-5350.

**WANTED:** Used IBM PC with dual disk drives, memory expansion (at least 256K), monochrome graphics card, and serial and parallel ports. State price and other details. L. D. Thomas, 104 Birchwood Rd., Baltimore, MD 21228.

## BYTE'S ONGOING MONITOR BOX

ARTICLE#	PAGE	ARTICLE	AUTHOR(S)	ARTICLE#	PAGE	ARTICLE	AUTHOR(S)
1	9	Microbytes	staff	17	239	Common Ground	Hancock
2	37, 429	What's New	staff	18	251	Local Power in a Remote Link	McManis
3	48	Ask BYTE	Ciarcia	19	263	Conversations	Comer, Peterson
4	65	Book Reviews	Vose, Czarnik, Clark	20	273	Cross-System Conferencing with CLACR	Levinson
5	93	Ciarcia's Circuit Cellar: Turnkey Bulletin-Board System	Ciarcia	21	294	The AT&T PC 6300	Troiano
6	106	Programming Project: A SIMPL Compiler, Part I: The Basics	Amsterdam	22	306	The Tandy 200 and the NEC PC-8401A	Krause
7	118	Product Description: The Tandy 600 and the Tandy 3000	Vose	23	317	Golden Common LISP	D'Ambrosio
8	125	English Recognition	Kimbrell	24	323	The Norton Utilities	Rabinovitz
9	145	Scientific Applications Software	Nash	25	329	HyperDrive for the Macintosh	Williams
10	155	Programming Insight: Virtual Fielding in Microsoft BASIC	Currie	26	335	Upgrades for the TRS-80 Model 100	Kepner
11	161	Programming Insight: Travesty with Database	Rubenking	27	343	The IBM Proprinter	Malloy
12	169	An Overview of Conferencing Systems	Meeks	28	351	Panasonic's 4-Color Graphic Penwriter	Edwards
13	187	Conferencing Standards	Palme	29	363	Computing at Chaos Manor: The European Connection	Pournelle
14	195	Database Structure in PortaCOM	Palme	30	385	BYTE U.K.: The Torch Triple X	Pountain
15	203	The Network Application Manager	Flavin, Williford	31	397	BYTE Japan: Computing in Taiwan	Raie
16	221	Storage Architectures	Mayer	32	405	According to Webster: Microcomputer Color Graphics—Observations	Webster

## BOMB Results

### A TECHNICAL EVOLUTION

Mark Garetz, author of "Evolution of the Microprocessor," which appeared in September's 10th Anniversary Section, wins the \$100 bonus. Howard Austerlitz wins \$50 for second place for his theme, "A Parallel-

to-Serial Printer Port Adapter." The columns by Steve Ciarcia and Jerry Pounelle continue in their popularity with readers, as does Robert Kurosaka's Mathematical Recreations.

### BYTE ADVERTISING SALES STAFF:

**Dennis J. Riley, Advertising Sales Manager, 70 Main Street, Peterborough, NH 03458, tel. (603) 924-9281**

#### NEW ENGLAND

ME, NH, VT, MA, RI, EASTERN CANADA  
Paul McPherson Jr. (617) 262-1160  
McGraw-Hill Publications  
575 Boylston Street  
Boston, MA 02116

#### ATLANTIC

NY, NYC, CT, NJ (NORTH)  
Leah G. Rabinowitz (212) 512-2096  
McGraw-Hill Publications  
1221 Avenue of the Americas—  
39th Floor  
New York, NY 10020

Dick McGurk (203) 968-7111  
McGraw-Hill Publications  
Building A—3rd Floor  
777 Long Ridge Road  
Stamford, CT 06902

#### EAST

PA (EAST), NJ (SOUTH),  
MD, VA, W.VA, DE, D.C.  
Daniel Ferro (215) 496-3833  
McGraw-Hill Publications  
Three Parkway  
Philadelphia, PA 19102

#### SOUTHEAST

NC, SC, GA, FL, AL, TN  
Maggie M. Dorvee (404) 252-0626  
McGraw-Hill Publications  
4170 Ashford-Dunwoody Road—  
Suite 420  
Atlanta, GA 30319

#### MIDWEST

IL, MO, KS, IA, ND, SD, MN, WI, NB, IN  
Bob Denmead (312) 751-3740  
McGraw-Hill Publications  
Blair Building  
645 North Michigan Ave.  
Chicago, IL 60611

#### GREAT LAKES, OHIO REGION

MI, OH, PA (ALLEGHENY), KY,  
ONTARIO, CANADA  
Mike Kisseberth (313) 352-9760  
McGraw-Hill Publications  
4000 Town Center—Suite 770  
Southfield, MI 48075

#### SOUTH PACIFIC

SOUTHERN CA, AZ, NM, LAS VEGAS,  
NV  
Jack Anderson (714) 557-6292  
McGraw-Hill Publications  
3001 Red Hill Ave.  
Building #1—Suite 222  
Costa Mesa, CA 92626

Karen Niles (213) 480-5243, 487-1160

McGraw-Hill Publications  
3333 Wilshire Boulevard #407  
Los Angeles, CA 90010

#### NORTH PACIFIC

HI, WA, OR, ID, MT, NORTHERN CA,  
NV (except LAS VEGAS), W. CANADA  
David Jern (415) 362-4600  
McGraw-Hill Publications  
425 Battery Street  
San Francisco, CA 94111

Bill McAfee (415) 964-0624  
McGraw-Hill Publications  
1000 Elwell Court—Suite 225  
Palo Alto, CA 94303

#### SOUTHWEST, ROCKY MOUNTAIN

UT, CO, WY, OK, TX, AR, MS, LA  
(214) 458-2400  
McGraw-Hill Publications  
Prestonwood Tower—Suite 907  
5151 Beltline  
Dallas, TX 75240

#### WEST COAST SURPLUS

**AND RETAIL ACCOUNTS**  
Tom Harvey (805) 964-8577  
3463 State Street—Suite 256  
Santa Barbara, CA 93105

#### The Buyer's Mart

Karen Burgess (603) 924-9281  
BYTE Publications  
70 Main Street  
Peterborough, NH 03458

#### Post Card Mailings

**National**  
Bradley Browne (603) 924-6166  
BYTE Publications  
70 Main Street  
Peterborough, NH 03458

### International Advertising Sales Representatives:

Mr. Hans Csokor  
Publimedia  
Reisnerstrasse 61  
A-1037 Vienna, Austria  
222 75 76 84

Mrs. Gurit Gepner  
McGraw-Hill Publishing Co.  
PO Box 2156  
Bat Yam, 59121 Israel  
3 866 561 321 39

Mr. Fritz Krusebecker  
McGraw-Hill Publishing Co.  
Liebigstrasse 19  
D-6000 Frankfurt/Main 1  
West Germany  
69 72 01 81

Mrs. Maria Sarmiento  
Pedro Teixeira 8, Off. 320  
Iberia Mart 1  
Madrid 4, Spain  
1 45 52 891

Mr. Andrew Karnig  
McGraw-Hill & Associates  
Finnbodavagen  
S-131 31 Nacka, Sweden  
8-44 0005

Mr. Alain Faure  
McGraw-Hill Publishing Co.  
17 rue Georges Bizet  
F 75116 Paris  
France  
(1) 47-20-33-42

Mr. Arthur Scheffer  
McGraw-Hill Publishing Co.  
34 Dover St.  
London W1X 3RA  
England 01 493 1451

Mr. Savio Pesavento  
McGraw-Hill Publishing Co.  
Via Flavio Baracchini 1  
20123 Milan, Italy  
02 86 90 617

Seavex Ltd.  
400 Orchard Road, #10-01  
Singapore 0923  
Republic of Singapore  
Tel: 734-9790  
Telex: RS35539 SEAVEX

Seavex Ltd.  
503 Wilson House  
19-27 Wyndham St.  
Central, Hong Kong  
Tel: 5-260149  
Telex: 60904 SEVEX HX

Hiro Morita  
McGraw-Hill Publishing Co.  
Overseas Corp.  
Room 1528  
Kasumigaseki Bldg.  
3-2-5 Kasumigaseki,  
Chiyoda-Ku  
Tokyo 100, Japan  
3 581 9811

# R.E.A.D.E.R S.E.R.V.I.C.E

Inquiry No.	Page No.	Inquiry No.	Page No.	Inquiry No.	Page No.	Inquiry No.	Page No.
388	208	337	292	140	463	211	416
2	180	73	453	141	407	212	30
3	448	* COMPUTER CONTINUUM	446	142	353	214	211
4	19	74	326	143	353	215	213
5	19	75	409	144	449	216	197
6	68	76	371	145	449	* LOTUS DEVELOPMENT	205
7	450	77	260, 261	146	228	217	444
8	185	398	350	147	147	219	404
9	36	78	467	407	376	220	116, 117
10	36	79	446	150	52	221	424
11	460, 461	80	247	151	450	222	64
411	372	81	247	408	370	223	58
12	448	82	447	152	281	224	59
13	159	83	272	153	168	225	61
14	406	84	414	154	468	226	450
16	82	85	70, 71	155	471	227	7
* AMERICAN MICROSYSTEMS	463	86	70, 71	156	448	228	15
18	259	87	70, 71	157	238	148	365
19	78	88	46, 47	158	413	230	468
20	78	418	446	159	22	231	418
* ANTHRO CORP.	75	89	18	160	394	232	463
21	448	90	468	161	373	233	321
22	285	91	440	162	375	424	433
23	285	92	441	163	377	425	433
24	471	93	54	164	357	234	191
25	50	94	349	399	231	235	92
27	446	95	349	165	87	236	62, 63
* AT&T	312, 313	96	400	166	316	238	469
393	410, 411	97	400	* HEWLETT-PACKARD	253	239	468
* AT&T INFORMATION SYS.	84, 85	98	443	168	255	240	141
* AT&T INTERNATIONAL	367	99	55	170	419	241	141
28	278	389	194	* HOLIDAY INNS INC.	368	242	17
29	200	390	194	172	408	* MICROMINT INC.	452
30	227	102	267	173	207	419	206
31	463	103	450	174	398	243	235
* B&C MICROSYSTEMS	369	104	463	175	72	244	444
32	327	105	382	176	72	* MICRORIM INC.	248, 249
33	23	106	382	177	450	245	451
* BEST WESTERN	333	107	283	178	277	422	433
34	467	108	402	* INFORMATION APPLIANCE	181	423	433
35	348	391	421	180	450	* MICROSOFT CORP.	137
36	300	109	232	404	377	* MICROSOFT CORP.	139
37	CII, 1	110	176	181	446	* MICROSOFT PRESS	362
38	CII, 1	111	266	182	448	246	328
39	39	112	230	183	356	247	250
40	39	113	224	184	149	248	389
41	41	114	412	185	149	133	333
42	41	115	417	* INTERFACE TECH CORP.	396	249	334
43	348	116	418	189	18	250	471
* BUEHLER SERVICES INC.	467	420	458, 459	402	428	251	315
44	51	421	458, 459	403	428	* MIX SOFTWARE	303
46	442	119	444	191	464, 465, 466	252	80
* BYTE MARKETING	391	121	455	192	325	253	450
* BYTE SUBSCRIBER MESSAGE	369	123	412	193	472, 473	254	341
* BYTE SUBSCRIPTION SERVICE	178, 439	394	322	194	474, 475	255	341
* C WARE/DESMET C	406	395	322	195	476	259	468
47	282	125	338	412	444	260	132
48	282	126	338	196	79	261	444
* CALIF. DIGITAL	456, 457	* EASTMAN KODAK CO.	151	197	394	262	45
50	53	128	220	385	444	263	183
51	30	129	471	198	186	264	CIII
* CAPITAL MICRO	286	130	74	200	142, 143	265	35
52	12, 13	131	467	201	142, 143	266	390
53	12, 13	132	229	202	268	* NEWSNET INC.	16
55	446	* EPSON AMERICA	11	203	74	268	122
56	24	* EPSON AMERICA	218, 219	204	162	* NORTH HILLS CORP.	414
57	24	135	43	205	140	269	339
58	177	136	43	206	448	270	4
60	154	137	468	207	373	271	381
61	358	413	374	208	375	275	393
62	275	138	304, 305	209	272	276	463
64	463	414	123	210	446	277	467
63	467					278	73
417	450					279	202
65	454					280	76, 77
* COMPAQ COMPUTER CORP.	152, 153					281	271
67	408					* PC'S LIMITED	471
* COMPUMAIL	470					282	384
369	225					283	471
70	440					284	8
71	157					284	279
72	388					416	121

.....  
 TO GET FURTHER information on the products advertised in BYTE, either pick up your touch-tone telephone and use TIPS (if you are a subscriber), or fill out the reader service card. Either way full instructions are provided following this reader service index which is provided as an additional service by the publisher, who assumes no liability for errors or omissions. \*Correspond directly with company.



# BYTE READER SERVICE



Fill out this coupon carefully. PLEASE PRINT. Requests cannot be honored unless the zip code is included. This card is valid for 6 months from cover date.

Name \_\_\_\_\_ DECEMBER 1985  
 41C5  
 (Title) \_\_\_\_\_ (Company) \_\_\_\_\_  
 Address \_\_\_\_\_ Telephone \_\_\_\_\_  
 City \_\_\_\_\_ State \_\_\_\_\_ Zip \_\_\_\_\_

I purchased this copy by  Subscription  Newsstand, computer store, or bookstore

1 23 45 67 89	111 133 155 177 199	221 243 265 287 309	331 353 375 397 419	441 463 485 507 529	551 573 595 617 639	661 683 705 727 749	771 793
2 24 46 68 90	112 134 156 178 200	222 244 266 288 310	332 354 376 398 420	442 464 486 508 530	552 574 596 618 640	662 684 706 728 750	772 794
3 25 47 69 91	113 135 157 179 201	223 245 267 289 311	333 355 377 399 421	443 465 487 509 531	553 575 597 619 641	663 685 707 729 751	773 795
4 26 48 70 92	114 136 158 180 202	224 246 268 290 312	334 356 378 400 422	444 466 488 510 532	554 576 598 620 642	664 686 708 730 752	774 796
5 27 49 71 93	115 137 159 181 203	225 247 269 291 313	335 357 379 401 423	445 467 489 511 533	555 577 599 621 643	665 687 709 731 753	775 797
6 28 50 72 94	116 138 160 182 204	226 248 270 292 314	336 358 380 402 424	446 468 490 512 534	556 578 600 622 644	666 688 710 732 754	776 798
7 29 51 73 95	117 139 161 183 205	227 249 271 293 315	337 359 381 403 425	447 469 491 513 535	557 579 601 623 645	667 689 711 733 755	777 799
8 30 52 74 96	118 140 162 184 206	228 250 272 294 316	338 360 382 404 426	448 470 492 514 536	558 580 602 624 646	668 690 712 734 756	778 800
9 31 53 75 97	119 141 163 185 207	229 251 273 295 317	339 361 383 405 427	449 471 493 515 537	559 581 603 625 647	669 691 713 735 757	779 801
10 32 54 76 98	120 142 164 186 208	229 251 273 295 317	339 361 383 405 427	449 471 493 515 537	559 581 603 625 647	669 691 713 735 757	779 801
11 33 55 77 99	121 143 165 187 209	231 253 275 297 319	341 363 385 407 429	451 473 495 517 539	561 583 605 627 649	671 693 715 737 759	781 803
12 34 56 78 100	122 144 166 188 210	232 254 276 298 320	342 364 386 408 430	452 474 496 518 540	562 584 606 628 650	672 694 716 738 760	782 804
13 35 57 79 101	123 145 167 189 211	233 255 277 299 321	343 365 387 409 431	453 475 497 519 541	563 585 607 629 651	673 695 717 739 761	783 805
14 36 58 80 102	124 146 168 190 212	234 256 278 300 322	344 366 388 410 432	454 476 498 520 542	564 586 608 630 652	674 696 718 740 762	784 806
15 37 59 81 103	125 147 169 191 213	235 257 279 301 323	345 367 389 411 433	455 477 499 521 543	565 587 609 631 653	675 697 719 741 763	785 807
16 38 60 82 104	126 148 170 192 214	236 258 280 302 324	346 368 390 412 434	456 478 500 522 544	566 588 610 632 654	676 698 720 742 764	786 808
17 39 61 83 105	127 149 171 193 215	237 259 281 303 325	347 369 391 413 435	457 479 501 523 545	567 589 611 633 655	677 699 721 743 765	787 809
18 40 62 84 106	128 150 172 194 216	238 260 282 304 326	348 370 392 414 436	458 480 502 524 546	568 590 612 634 656	678 700 722 744 766	788 810
19 41 63 85 107	129 151 173 195 217	239 261 283 305 327	349 371 393 415 437	459 481 503 525 547	569 591 613 635 657	679 701 723 745 767	789 811
20 42 64 86 108	130 152 174 196 218	240 262 284 306 328	350 372 394 416 438	460 482 504 526 548	570 592 614 636 658	680 702 724 746 768	790 812
21 43 65 87 109	131 153 175 197 219	241 263 285 307 329	351 373 395 417 439	461 483 505 527 549	571 593 615 637 659	681 703 725 747 769	791 813
22 44 66 88 110	132 154 176 198 220	242 264 286 308 330	352 374 396 418 440	462 484 506 528 550	572 594 616 638 660	682 704 726 748 770	792 814

**BYTE's BOMB** is your direct line to the editor's desk. Each month, the two top-rated authors receive bonuses based on your evaluation. First look at the list of this month's articles and corresponding article numbers (located on the page preceding the Reader Service list), then rate each article you've read as **Excellent**, **Good**, **Fair**, or **Poor**, based on your overall impression of the article, by circling the appropriate number in each column below. Your feedback helps us produce the best possible magazine each month.

Article No.	1	2	3	4	5	6	7	8	9	10	11	12	13	14	15	16	17	18	19	20	21	22	23	24	25
Excellent	1	5	9	13	17	21	25	29	33	37	41	45	49	53	57	61	65	69	73	77	81	85	89	93	97
Good	2	6	10	14	18	22	26	30	34	38	42	46	50	54	58	62	66	70	74	78	82	86	90	94	98
Fair	3	7	11	15	19	23	27	31	35	39	43	47	51	55	59	63	67	71	75	79	83	87	91	95	99
Poor	4	8	12	16	20	24	28	32	36	40	44	48	52	56	60	64	68	72	76	80	84	88	92	96	100

Article No.	26	27	28	29	30	31	32	33	34	35	36	37	38	39	40	41	42	43	44	45	46	47	48	49	50
Excellent	101	105	109	113	117	121	125	129	133	137	141	145	149	153	157	161	165	169	173	177	181	185	189	193	197
Good	102	106	110	114	118	122	126	130	134	138	142	146	150	154	158	162	166	170	174	178	182	186	190	194	198
Fair	103	107	111	115	119	123	127	131	135	139	143	147	151	155	159	163	167	171	175	179	183	187	191	195	199
Poor	104	108	112	116	120	124	128	132	136	140	144	148	152	156	160	164	168	172	176	180	184	188	192	196	200

# BYTE READER SERVICE



Fill out this coupon carefully. PLEASE PRINT. Requests cannot be honored unless the zip code is included. This card is valid for 6 months from cover date.

Name \_\_\_\_\_ DECEMBER 1985  
 41C5  
 (Title) \_\_\_\_\_ (Company) \_\_\_\_\_  
 Address \_\_\_\_\_ Telephone \_\_\_\_\_  
 City \_\_\_\_\_ State \_\_\_\_\_ Zip \_\_\_\_\_

I purchased this copy by  Subscription  Newsstand, computer store, or bookstore

1 23 45 67 89	111 133 155 177 199	221 243 265 287 309	331 353 375 397 419	441 463 485 507 529	551 573 595 617 639	661 683 705 727 749	771 793
2 24 46 68 90	112 134 156 178 200	222 244 266 288 310	332 354 376 398 420	442 464 486 508 530	552 574 596 618 640	662 684 706 728 750	772 794
3 25 47 69 91	113 135 157 179 201	223 245 267 289 311	333 355 377 399 421	443 465 487 509 531	553 575 597 619 641	663 685 707 729 751	773 795
4 26 48 70 92	114 136 158 180 202	224 246 268 290 312	334 356 378 400 422	444 466 488 510 532	554 576 598 620 642	664 686 708 730 752	774 796
5 27 49 71 93	115 137 159 181 203	225 247 269 291 313	335 357 379 401 423	445 467 489 511 533	555 577 599 621 643	665 687 709 731 753	775 797
6 28 50 72 94	116 138 160 182 204	226 248 270 292 314	336 358 380 402 424	446 468 490 512 534	556 578 600 622 644	666 688 710 732 754	776 798
7 29 51 73 95	117 139 161 183 205	227 249 271 293 315	337 359 381 403 425	447 469 491 513 535	557 579 601 623 645	667 689 711 733 755	777 799
8 30 52 74 96	118 140 162 184 206	228 250 272 294 316	338 360 382 404 426	448 470 492 514 536	558 580 602 624 646	668 690 712 734 756	778 800
9 31 53 75 97	119 141 163 185 207	229 251 273 295 317	339 361 383 405 427	449 471 493 515 537	559 581 603 625 647	669 691 713 735 757	779 801
10 32 54 76 98	120 142 164 186 208	230 252 274 296 318	340 362 384 406 428	450 472 494 516 538	560 582 604 626 648	670 692 714 736 758	780 802
11 33 55 77 99	121 143 165 187 209	231 253 275 297 319	341 363 385 407 429	451 473 495 517 539	561 583 605 627 649	671 693 715 737 759	781 803
12 34 56 78 100	122 144 166 188 210	232 254 276 298 320	342 364 386 408 430	452 474 496 518 540	562 584 606 628 650	672 694 716 738 760	782 804
13 35 57 79 101	123 145 167 189 211	233 255 277 299 321	343 365 387 409 431	453 475 497 519 541	563 585 607 629 651	673 695 717 739 761	783 805
14 36 58 80 102	124 146 168 190 212	234 256 278 300 322	344 366 388 410 432	454 476 498 520 542	564 586 608 630 652	674 696 718 740 762	784 806
15 37 59 81 103	125 147 169 191 213	235 257 279 301 323	345 367 389 411 433	455 477 499 521 543	565 587 609 631 653	675 697 719 741 763	785 807
16 38 60 82 104	126 148 170 192 214	236 258 280 302 324	346 368 390 412 434	456 478 500 522 544	566 588 610 632 654	676 698 720 742 764	786 808
17 39 61 83 105	127 149 171 193 215	237 259 281 303 325	347 369 391 413 435	457 479 501 523 545	567 589 611 633 655	677 699 721 743 765	787 809
18 40 62 84 106	128 150 172 194 216	238 260 282 304 326	348 370 392 414 436	458 480 502 524 546	568 590 612 634 656	678 700 722 744 766	788 810
19 41 63 85 107	129 151 173 195 217	239 261 283 305 327	349 371 393 415 437	459 481 503 525 547	569 591 613 635 657	679 701 723 745 767	789 811
20 42 64 86 108	130 152 174 196 218	240 262 284 306 328	350 372 394 416 438	460 482 504 526 548	570 592 614 636 658	680 702 724 746 768	790 812
21 43 65 87 109	131 153 175 197 219	241 263 285 307 329	351 373 395 417 439	461 483 505 527 549	571 593 615 637 659	681 703 725 747 769	791 813
22 44 66 88 110	132 154 176 198 220	242 264 286 308 330	352 374 396 418 440	462 484 506 528 550	572 594 616 638 660	682 704 726 748 770	792 814

To get further information on the products advertised in BYTE, fill out the reader service card with your name and address. Then circle the appropriate numbers for the advertisers you select from the list. Add a first-class stamp to the card, then drop it in the mail. Not only do you gain information, but our advertisers are encouraged to use the marketplace provided by BYTE. This helps us bring you a bigger BYTE. The index is provided as an additional service by the publisher, who assumes no liability for errors or omissions.

PLACE  
POSTAGE  
HERE

**BYTE**

READER SERVICE  
PO BOX 298  
DALTON, MA 01227-0298  
USA

PLACE  
POSTAGE  
HERE

**BYTE**

READER SERVICE  
PO BOX 298  
DALTON, MA 01227-0298  
USA

# BYTE



## SUBSCRIPTIONS

41C5

For a subscription to BYTE, please complete this card.

Name \_\_\_\_\_

Address \_\_\_\_\_

City \_\_\_\_\_

State \_\_\_\_\_ Zip \_\_\_\_\_ Country \_\_\_\_\_

Card No. \_\_\_\_\_

Expiration date \_\_\_\_\_

Four digits above name—Master Charge only \_\_\_\_\_

Signature \_\_\_\_\_ Date \_\_\_\_\_

Please allow eight weeks for processing. Thank you.

USA

Canada  
Mexico

- |                                  |                               |                               |
|----------------------------------|-------------------------------|-------------------------------|
| <input type="checkbox"/> 1 year  | <input type="checkbox"/> \$21 | <input type="checkbox"/> \$23 |
| <input type="checkbox"/> 2 years | <input type="checkbox"/> \$38 | <input type="checkbox"/> \$42 |
| <input type="checkbox"/> 3 years | <input type="checkbox"/> \$55 | <input type="checkbox"/> \$61 |

- \$69. Europe (air delivery) payment enclosed  
 \$37 Worldwide (surface mail) payment enclosed

(Air mail rates available upon request)

Please remit in US funds drawn on a US bank. Thank you.

- Check enclosed (Bonus: |North American only| one EXTRA issue—receive 13 issues for 1 price of



- Bill me (North America only)

# BYTE



## SUBSCRIPTIONS

41C5

For a subscription to BYTE, please complete this card.

Name \_\_\_\_\_

Address \_\_\_\_\_

City \_\_\_\_\_

State \_\_\_\_\_ Zip \_\_\_\_\_ Country \_\_\_\_\_

Card No. \_\_\_\_\_

Expiration date \_\_\_\_\_

Four digits above name—Master Charge only \_\_\_\_\_

Signature \_\_\_\_\_ Date \_\_\_\_\_

Please allow eight weeks for processing. Thank you.

USA

Canada  
Mexico

- |                                  |                               |                               |
|----------------------------------|-------------------------------|-------------------------------|
| <input type="checkbox"/> 1 year  | <input type="checkbox"/> \$21 | <input type="checkbox"/> \$23 |
| <input type="checkbox"/> 2 years | <input type="checkbox"/> \$38 | <input type="checkbox"/> \$42 |
| <input type="checkbox"/> 3 years | <input type="checkbox"/> \$55 | <input type="checkbox"/> \$61 |

- \$69. Europe (air delivery) payment enclosed  
 \$37 Worldwide (surface mail) payment enclosed

(Air mail rates available upon request)

Please remit in US funds drawn on a US bank. Thank you.

- Check enclosed (Bonus: |North American only| one EXTRA issue—receive 13 issues for 1 price of



- Bill me (North America only)

*Note our special offer!  
Send cash with your order  
and receive 13 issues  
for the price of 12 for  
each year you subscribe.  
(North America only, please.)*

## Don't Miss An Issue!

### Have BYTE delivered to your door.

Each month BYTE will bring you the latest in microcomputer technology.

DISCOVER and IMPLEMENT new ideas. Don't miss the original information presented in the pages of BYTE.

With BYTE you'll always be among the first to know about the important breakthroughs, worthwhile new equipment, and innovative projects in the world of computing.

CHALLENGE US to deliver the very best idea in microcomputers and advanced technology to you. Return the attached card today!

Subscribe to BYTE—the world's leading computer magazine

PLACE  
POSTAGE  
HERE

**BYTE** SUBSCRIPTIONS

PO Box 597  
Martinsville, NJ 08836-0597  
USA

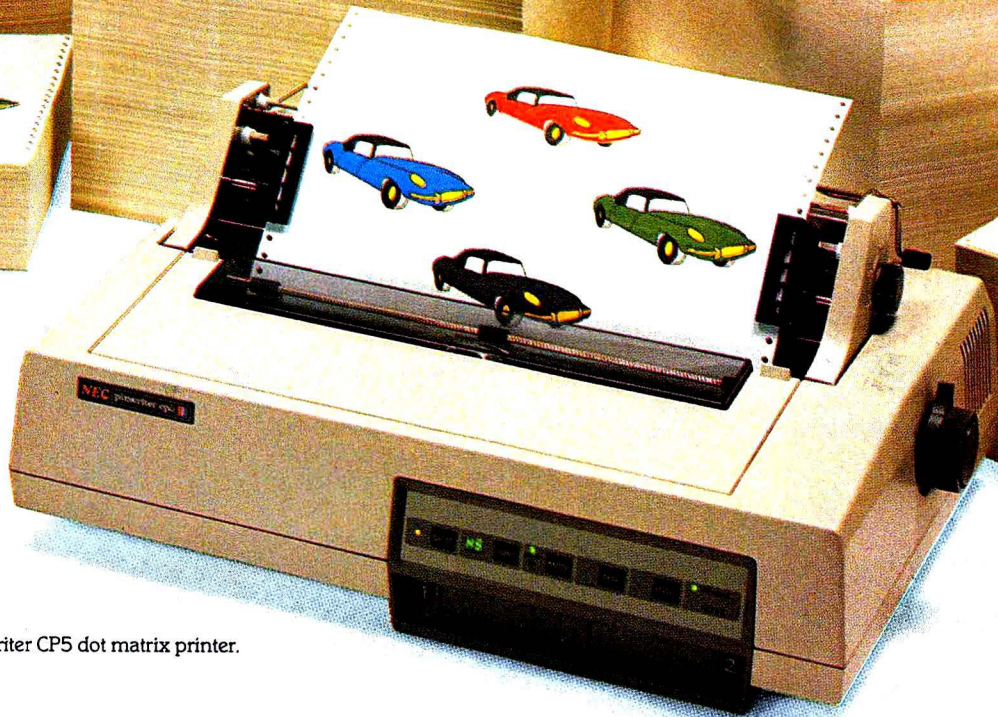
PLACE  
POSTAGE  
HERE

**BYTE** SUBSCRIPTIONS

PO Box 597  
Martinsville, NJ 08836-0597  
USA



# THIS NEC PRINTER CAN MANUFACTURE 2 MILLION CARS WITHOUT A REPAIR.



Color Pinwriter CP5 dot matrix printer.

To build 2 million of these cars requires printing more than 25 billion dots. And that's how many our new Pinwriter™ P5 printer can print before you have to think about a repair.

This NEC printer is not an exception. In fact, any NEC printer can run an average of 5 years in normal use before it needs a repair.

Such reliability doesn't come easy. Every NEC printer is built on a highly automated assembly line. From the most advanced components in the industry. Then it's subjected to some of the most demanding tests ever devised for printers.

Reliability is not the only thing this NEC printer has going. It's also the quietest dot matrix printer in its class. And it has the finest graphics resolution, plus more built-in true fonts. And it's the fastest multi-speed 24-pin dot matrix printer available.

Now don't you wish NEC also made cars?

Check out a new Pinwriter P5 at your nearest NEC dealer. Or for more information, call 1-800-343-4418 (in MA 617-264-8635). Or write: NEC Information Systems, Dept. 1610, 1414 Massachusetts Ave., Boxborough, MA 01719.

**NEC PRINTERS. THEY ONLY STOP WHEN YOU WANT THEM TO.**

**NEC**  
NEC Information Systems, Inc.

# TANDY... Clearly Superior™

**Tandy 2000® Computer-Aided Design Systems combine minicomputer-quality graphics with PC affordability.**

With a Tandy 2000 and Computer-Aided Design (CAD) software, you can get highly sophisticated, reproduction-quality drawings, graphs and illustrations that you'd expect from a very expensive, dedicated drafting system.

The Tandy 2000's high resolution graphics let you create razor-sharp diagrams, charts and graphs in a brilliant array of colors. The precision drafting

and design functions that used to be available only on main-frame or minicomputers can now be yours for less than \$7,000, including software.

And along with improving the productivity of your design staff, you can use the Tandy 2000 for word processing, accounting, spreadsheets and many other business applications.

Look to us for total support, too. Over 1200 Radio Shack

Computer Centers offer leasing plans, software and accessories: And almost 60 Area Training and Support Operations Centers offer such services as installation, new user orientation and training.

CAD doesn't have to be expensive, and it isn't with Tandy computers. Ask for a demonstration at the Radio Shack Computer Center nearest you. The Tandy 2000 is Clearly Superior!



Available at over 1200  
Radio Shack Computer Centers and at  
participating Radio Shack stores and dealers.

**Radio Shack®**  
**COMPUTER CENTERS**  
A DIVISION OF TANDY CORPORATION

Prices apply at Radio Shack Computer Centers  
and participating stores and dealers.

Inquiry 309