

\$3.50

JULY 1986

JULY 1986 VOL. 11, NO. 7

\$3.50 IN UNITED STATES
\$4.25 IN CANADA / £1.75 IN U.K.
A MCGRAW-HILL PUBLICATION
0360-5280

BYTE

THE SMALL SYSTEMS JOURNAL®

Engineer's Toolbox



A single company has revolutionized the business of language, the language of business, and created the exciting new world of electronic reference works—Borland!

Which isn't bad for a 3-year-old. Turbo Pascal,[®] our first product, now has more than half a million users, and has become a world-wide standard. And that was just the beginning.

Since then, the Turbo Pascal family has grown to a family of 9, and today we're announcing our second language, Turbo Prolog,[™] the natural language of Artificial Intelligence.

We've also introduced amazing business productivity tools like SideKick,[™] Traveling SideKick,[™] Reflex, The Analyst,[™] and SuperKey.[™]

We broke new ground in 1985 with Turbo Lightning.[™] It includes the Random House[®] dictionary and thesaurus. Turbo Lightning is the forerunner of a complete electronic reference library, newly joined by the Word Wizard,[™] which solves the unsolvable twists, and boggles and challenges your mind. Word Wizard



also includes Turbo Pascal source code so you can figure out how the Turbo Lightning access system works.

And here is a brief synopsis of current offerings from the Borland library of history-making software . . .

Turbo Pascal[®] 3.0

The fastest Pascal compiler, plus an integrated programming environment. Includes a free MicroCalc[™] spreadsheet, and 1,200 lines of annotated source code, ready to compile and run. Minimum memory: 128K.

Turbo Tutor[™]

Takes you from basic right through advanced programming concepts and techniques. Includes 300-page tutorial and source code for every example used in the reference manual. Minimum memory: 128K.

Turbo Graphics Toolbox[™]

Lets you create high-resolution graphics. Includes tools for complex business graphics, easy windowing, and storing screen images to memory. Complete with source code on disk, ready to compile. Minimum memory: 192K.

Turbo Database Toolbox[™]

Perfect complement to Turbo Pascal. Contains complete library of Pascal procedures that allows you to search and sort data and build powerful database applications. Minimum memory: 128K.

Turbo Editor Toolbox[™] **NEW!**

It's all you need to build your own text editor or word processor. Provides all the routines—you decide which features you want. Source code included. Also includes the MicroStar[™] text editor with pull-down menus and windowing. Interfaces directly with Turbo Lightning to let you spell-check your MicroStar files. Minimum memory: 192K.

Turbo GameWorks[™] **NEW!**

Reveals the secrets and strategies of game theory. Includes source code so you can write your own games. Gives you ready-to-play Chess, Bridge, and Go-Moku, an ancient Japanese game that will provide hours of fascinating diversion. Even if you don't want to write your own games, it's a terrific value. Minimum memory: 192K.

NEW! NEW! NEW!



Turbo Prolog[™]

The natural language of Artificial Intelligence, Turbo Prolog is our second language and the latest product in the Borland software library. Turbo Prolog is a fifth-generation language, and probably the most powerful programming language ever conceived. Includes a 200-page reference manual and free GeoBase,[™] a natural query language database with commented source code on disk, ready to compile. It's all you need to know about Artificial Intelligence at a Humanly Intelligent price. Minimum memory: 384K.



Turbo Lightning[™]

An electronic reference library which includes the 80,000-word Random House Concise Dictionary and the 50,000-word Random House Thesaurus. Checks your spelling as you type. Gives you instant synonyms. Leads the revolutionary way in electronic publishing. Minimum memory: 256K.



SuperKey[™]

Amazing keyboard enhancer for your IBM PC. With easy-to-write macros that can turn 1,000 keystrokes into 1. Also includes powerful encryption technology that keeps confidential files confidential, locks your keyboard with secret password protection. (Because of encryption technology, SuperKey is under a US Government export ban.) Minimum memory: 128K.



SideKick[™]

Powerful desktop management program. #1 best-seller for the IBM[®] PC. Includes notepad, calculator, appointment scheduler, telephone directory and autodialer, and ASCII table. RAM-resident, it's always there to help, and stays in the background while you run other programs. One keystroke activates it. Minimum memory: 128K.



Reflex, The Analyst[™]

Unique, easy-to-use database management and analysis. Shows your spreadsheet data from 1-2-3[®] dBase,[™] and others in five graphic forms—including bar charts, pie charts, scatter plots, line graphs, and stacked bar charts. Answers What If? questions. Minimum memory: 384K.

NEW!



Word Wizard[™]

Intriguing new addition to the Turbo Lightning Library.[™] Solves unsolvable crosswords, and challenges your word skills and ability to break codes and ciphers. Scrambles, twists, turns, and boggles your mind. Includes Turbo Pascal source code and all the technical information you'll need to figure out the "nuts and bolts" of the Turbo Lightning access system. Minimum memory: 256K.



Traveling SideKick[™] **NEW!**

BinderWare[™] that includes an organizer, a binder, a software program, and a report generator that picks your SideKick's electronic brain, then prints out your appointments, daily/weekly/monthly/yearly calendar, phone lists, mailing labels, or whatever else you need when you're away from your desk. It's the smart new way to take your computer with you without taking your computer with you. Minimum memory: 256K.

Special Prices!

You can save even more—through September 1, 1986.

- Turbo Jumbo Pack—six Turbo products for only \$245.00: Turbo Pascal, Turbo Tutor, Turbo Graphics, Turbo Database Toolbox, Turbo Editor Toolbox, and Turbo GameWorks.
- SideKick and Traveling SideKick for only \$125.00.
- SideKick and Traveling SideKick and SuperKey, for only \$175.00.
- Turbo Lightning and Word Wizard for only \$149.95.

Step-by-step tutorial, demo programs with source code included!

And now Borland introduces Turbo Prolog, the natural language of Artificial Intelligence.

Prolog is probably the most powerful computer programming language ever conceived, which is why we've made it our *second* language—and "turbocharged" it to create Turbo Prolog.*

Our new Turbo Prolog brings supercomputer power to your IBM® PC and introduces you step-by-step to the fascinating new world of **Artificial Intelligence**. And does all this for an astounding \$99.95.

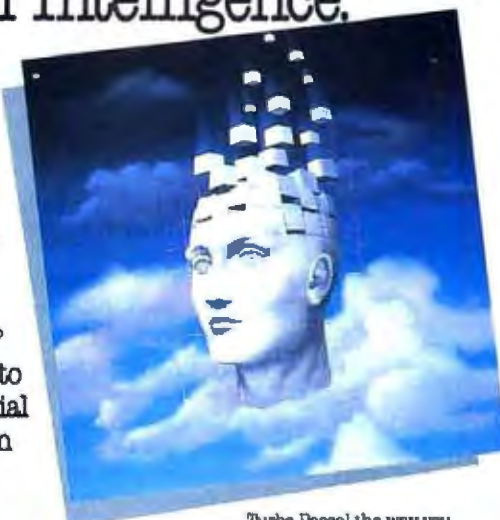

Turbo Prolog is to Prolog what Turbo Pascal® is to Pascal!

Our Turbo Pascal astonished everyone who thought of Pascal as "just another language." We changed all that—and now Turbo Pascal is the de facto worldwide standard, with hundreds of thousands of enthusiasts and users in universities, research centers, schools, and with professional programmers, students, and hobbyists.

You can expect at least the same impact from Turbo Prolog, because while Turbo Prolog is the most revolutionary and natural programming language, it is also a complete development environment—just like Turbo Pascal.

Turbo Prolog radically alters and dramatically improves the brave new world of artificial intelligence—and invites you into that fascinating universe for a humanly intelligent \$99.95.

Even if you've never programmed before, our free tutorial will get you started right away

You'll get started right away because we have included a complete step-by-step tutorial as part of the 200-page Turbo Prolog Reference Manual. Our tutorial will take you by the hand and teach you everything you're likely to need to know about Turbo Prolog and artificial intelligence.

For example: once you've completed the tutorial, you'll be able to design your own expert systems utilizing Turbo Prolog's powerful problem-solving capabilities.

Think of Turbo Prolog as a high-speed electronic detective. First, you feed it information and teach it rules. Then Turbo Prolog "thinks" the problem through and comes up with all the reasonable answers—almost instantly.

If you think that this is amazing, you just need to remember that Turbo Prolog is a 6th-generation language—and the kind of language that 21st century computers will use routinely. In fact, you can compare Turbo Prolog to

Turbo Pascal the way you could compare Turbo Pascal to machine language.

You get the complete Turbo Prolog programming system for only \$99.95

You get a complete Turbo Prolog development system including:

- The lightning-fast Turbo Prolog incremental compiler and the interactive Turbo Prolog editor.
- The 200-page reference manual which includes the step-by-step Turbo Prolog tutorial.
- The free GeoBase™ natural query language database including commented source code on disk—ready to compile. GeoBase is a complete database designed and developed around U.S. geography. It includes cities, mountains, rivers, and highways, and comes complete with natural query language. Use GeoBase immediately "as is," or modify it to fit your own interests.

So don't delay—don't waste a second—get Turbo Prolog now. \$99.95 is an amazingly small price to pay to become an immediate authority—an instant expert on artificial intelligence! The 21st century is only one phone call away.

YES! I want the best

Turbo Prolog at only: **\$99.95**

To order by phone, or for a dealer nearest you, call **(800) 255-8000** in CA call (800) 742-1133

Compiler	Product	Price	Unit
—	Turbo Prolog†	\$99.95	\$
—	Turbo Pascal 3.0	\$69.95	\$
—	Turbo Pascal w/IBM711	\$109.90	\$
—	Turbo Pascal w/BCD11	\$109.90	\$
—	Turbo Pascal w/IBM7, BCD11	\$124.95	\$
—	Turbo Database Toolbox	\$54.95	\$
—	Turbo Graphics Toolbox†	\$54.95	\$
—	Turbo Tutor	\$54.95	\$
—	Turbo Editor Toolbox†	\$69.95	\$
—	Turbo GameWorks†	\$69.95	\$
—	Turbo Lightning†	\$99.95	\$
—	Word Wizard†	\$69.95	\$
—	Palmt. The Analyst†	\$149.95	\$
—	Sidelock†	\$84.95	\$
—	Traveling Sidelock†	\$69.95	\$
—	SuperKey†	\$69.95	\$
—	Turbo Lightning Word Wizard†	\$149.95	\$
—	Sidelock Traveling Sidelock†	\$125.00	\$
—	Sidelock SuperKey Traveling Sidelock†	\$175.00	\$
—	Turbo Jumbo Pack†	\$245.00	\$
—	Outside USA add \$10 per copy CA and MA res. add sales tax		\$
—	Amount enclosed		\$

Prices include shipping to all US cities.
Carefully describe your computer system:
Mine is: 8-bit 16-bit
I use: PC-DOS MS-DOS CP/M-80 CP/M-86
My computer's name and model is: _____
The disk size I use is: 3 1/2" 5 1/4" 8"
Payment: VISA MC Bank Draft Check
Credit card expiration date: ____/____/____
Case # _____

NOT COPY PROTECTED AP15
****60-DAY MONEY-BACK GUARANTEE**

Name: _____
Shipping Address: _____
City: _____
State: _____ Zip: _____

Telephone: _____
CCOs and purchase orders **WILL NOT** be accepted by Borland.
Outside USA mails payment by credit card or International Postal Money Order.
*Limited Time Offer until September 1, 1986
**YES, if within 60 days of purchase this product does not perform in accordance with our claims, call our customer service department and we will gladly arrange a refund.
†IBM PC, AT, XT, PCX, and true compatibles. PC-DOS (MS-DOS) 2.0 or later. Turbo Graphics requires IBM CGA, Hercules Monochrome Card or compatible.
‡116 of only.

Turbo Prolog 1.0 Technical Specifications
Programming System Features
Compiler: Incremental compiler generating native in-line code and linkable object modules. The linking format is compatible with the PC-DOS linker. Large memory model support. Compiles over 2500 lines per minute on a standard IBM PC.
Interactive Editor: The system includes a powerful interactive full-screen text editor. If the compiler detects an error, the editor automatically positions the cursor appropriately in the source code. At run time, Turbo Prolog programs can call the editor, and view the running program's source code.
Type System: A flexible object-oriented type system is supported.
Windowing Support: The system supports both graphic and text windows.
Input/Output: Full I/O facilities, including formatted I/O, streams, and random access files.
Numeric Ranges: integers -32767 to 32767, Reals: 1E-307 to 1E+308
Debugging: Complete built-in trace debugging capabilities allowing step-by-step debugging of programs.



4585 SCOTT'S VALLEY DRIVE
SCOTT'S VALLEY, CA 95066
(408) 438-8400 TELEX 172373

Other Borland Products include Turbo Pascal, Turbo Tutor, Turbo Lightning, Turbo Database Toolbox, Turbo Graphics Toolbox, Turbo Editor Toolbox, Turbo GameWorks, SuperKey, Sidelock, SideKick, The Macintosh Office Manager, Reflex, The Analyst, and Traveling Sidelock—all of which are registered trademarks or trademarks of Borland International, Inc. or Borland/Analyst, Inc. Turbo Prolog and GeoBase are trademarks and Turbo Pascal is a registered trademark of Borland International Inc. IBM and AT are registered trademarks of International Business Machines Corp. Copyright 1986 Borland International Inc. 11622

Inquiry 45 for End-Users. Inquiry 46 for DEALERS ONLY.



C·O·N·T·E·N·T·S



82



162

FEATURES

- INTRODUCTION** 82
- CIARCIA'S CIRCUIT CELLAR: PARALLEL INTERFACING: A TUTORIAL DISCUSSION, PART 1: BASICS**
by Steve Ciarcia 85
Steve reintroduces parallel interfacing, concentrating on application examples.
- PROGRAMMING PROJECT: BUILD A SPREADSHEET PROGRAM** by Jonathan Amsterdam 96
Some interesting design considerations make for a challenging project.
- PROGRAMMING INSIGHT: ANAGRAM SOLVING IN PASCAL** by Bob Keefer 113
How do you turn *excitation* into *intoxicate*? ANAGRAM.PAS uses a probability table.
- THE DEFINICON 68020 COPROCESSOR, PART 1: THE HARDWARE AND OPERATING SYSTEM**
by Trevor Marshall, Christopher Jones, and Sigi Kluger 120
This plug-in board provides 32-bit computing power and math processing for IBM PCs and compatibles.
- ENGINEERING ON A MICRO** by Chris Pedicini 145
A walk through Truss2, a BASIC program that assists engineers in the designing of truss-type structures.

THEME: ENGINEER'S TOOLBOX

- INTRODUCTION** 162
- SIMULATING CIRCUITS**
- COMPUTER CIRCUIT SIMULATION** by Wolfram Blume 165
An introduction to the problems inherent in circuit modeling, including linearizing nonlinear elements and solving large simultaneous equations.
- ANALOG CIRCUIT ANALYSIS** by David McNeill 170
Based on the circuit analysis program SPICE, this modeling and simulation routine runs on a Commodore 64.
- AN 8031 IN-CIRCUIT EMULATOR** by George Dinuiddie 181
An emulator that can help you debug assembly language programs.
- STRUCTURAL ANALYSIS** by Robert W. Johnson and Fernando G. Loygorri 199
This finite-element method works on an IBM PC.
- STRESS ANALYSIS** by D. Lee Petersen and Steven L. Crouch 219
A technique for stress analysis using a coupled boundary-element/finite-difference method.
- A MATERIAL SELECTION PROGRAM** by Brother Tom Sawyer and Michael Pecht 235
You can weight options and do "what if" searches with this program written in Turbo Pascal.
- SMALL-SCALE ENGINEERING APPLICATIONS** by J. Neil Stone 253
With these two programs, you can estimate critical properties and liquid viscosities and build a database for physical property estimation.

REVIEWS

- INTRODUCTION** 264
- REVIEWER'S NOTEBOOK** by Jon Edwards 267
- THE COMMODORE 128 PERSONAL COMPUTER SYSTEM** by William Wiese Jr. 269
A machine with 128K bytes of RAM, two microprocessors, and a C-64 mode.

BYTE (ISSN 0160-5280) is published monthly with one extra issue per year by McGraw-Hill Inc. Founder: James H. McGraw (1860-1948). Executive, editorial, circulation, and advertising offices: One Phoenix Mill Lane, Peterborough, NH 03458, phone (603) 924-9281. Office hours: Mon-Thur 8:30 AM - 4:30 PM, Friday 8:30 AM - 1:00 PM, Eastern Time. Address subscriptions to BYTE Subscriptions, PO Box 590, Martinsville, NH 08836. Postmaster: send address changes, USPS Form 3579, undeliverable copies, and fulfillment questions to BYTE Subscriptions, PO Box 596, Martinsville, NH 08836. Second-class postage paid at Peterborough, NH 03458 and additional mailing offices. Postage paid at Winnipeg, Manitoba. Registration number 9321. Subscriptions are \$21 for one year, \$38 for two years, and \$55 for three years in the USA and its possessions. In Canada and Mexico: \$23 for one year, \$42 for two years, \$61 for three years. \$69 for one year air delivery to Europe. 17,100 yen for one year surface delivery to Japan, \$37 surface delivery elsewhere. Air delivery to selected areas at additional rates upon request. Single copy price is \$3.50 in the USA and its possessions, \$4.25 in Canada and Mexico, \$4.50 in Europe, and \$5 elsewhere. Foreign subscriptions and sales should be remitted in United States funds drawn on a U.S. bank. Please allow six to eight weeks for delivery of first issue. Printed in the United States of America.

THE ITT XTRA XP <i>by John D. Unger</i>	281
An IBM PC AT clone capable of operating even faster than the AT.	
THE CONQUEST TURBO PC <i>by John D. Unger</i>	289
An IBM PC XT compatible that is hardware-switchable between 4.77 MHz and 8 MHz.	
BYSO LISP AND WALTZ LISP <i>by William Wong</i>	293
Two implementations of LISP with different levels of functionality and support.	
EXPEROPS5 <i>by William Jacobs</i>	297
A version of the OPS5 programming language designed for the Macintosh.	
FIVE LABORATORY INTERFACING PACKAGES <i>by Patricia Wirth and Lincoln E. Ford</i>	303
A look at five software packages for running A/D boards.	
THE IBM WHEELPRINTER E <i>by Robert D. Swearingin</i>	315
A no-nonsense daisy-wheel printer that delivers high-quality output	
REVIEW FEEDBACK	319
Readers respond to previous reviews.	

KERNEL

INTRODUCTION	322
COMPUTING AT CHAOS MANOR: TRAVELING COMPUTERS <i>by Jerry Pournelle</i>	325
Lapboard computers and new products make portable computing easier.	
ACCORDING TO WEBSTER: PROGRAMMING TOOLS <i>by Bruce Webster</i>	347
A small segment of the software industry has turned into a significant market.	
BYTE U.K.: PERSONAL SUPERCOMPUTERS <i>by Dick Pountain</i>	363
Dick gives an update on the Transputer and describes the Computing Surface.	
BYTE JAPAN: A JAPANESE COMDEX AND MORE <i>by William M. Raiké</i>	371
Besides Japan's COMDEX, Bill looks at new NECs and Oki's laptop	
APPLICATIONS ONLY: CHEAP STUFF <i>by Ezra Shapiro</i>	381
Is it worth overlooking flaws to get inexpensive software?	

BEST OF BIX

AMIGA	393	IBM PC AND COMPATIBLES	403
ATARI ST	397	MACINTOSH	407

EDITORIAL:			
BIX UPDATE	6	BOOK REVIEWS	63
MICROBYTES	9	EVENT QUEUE	78
LETTERS	14	CHAOS MANOR MAIL	391
WHAT'S NEW	29	DISKS AND DOWNLOADS	459
CLUBS AND NEWSLETTERS	48	THE CAUZIN SOFTSTRIP	460
FIXES AND UPDATES	49	BYTE'S ONGOING MONITOR BOX.	
ASK BYTE	50	BOMB RESULTS	462
CIRCUIT CELLAR FEEDBACK	54	READER SERVICE	463

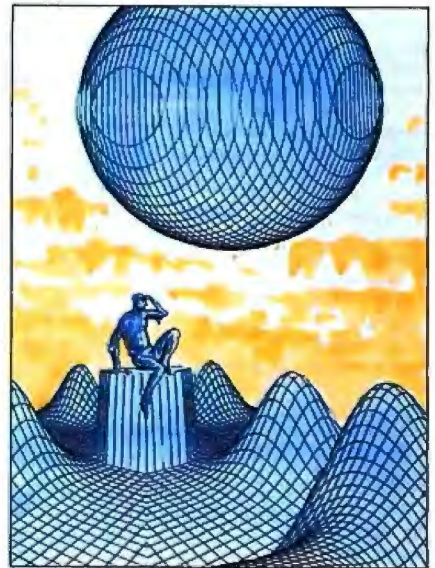

264



322

Address editorial correspondence to: Editor, BYTE, One Phoenix Mill Lane, Peterborough, NH 03458. Unacceptable manuscripts will be returned if accompanied by sufficient postage. Not responsible for lost manuscripts or photos. Opinions expressed by the authors are not necessarily those of BYTE. Copyright © 1986 by McGraw-Hill Inc. All rights reserved. Trademark registered in the United States Patent and Trademark Office. Where necessary, permission is granted by the copyright owner for libraries and others registered with the Copyright Clearance Center (CCC) to photocopy any article herein for the flat fee of \$1.50 per copy of the article or any part thereof. Correspondence and payment should be sent directly to the CCC, 29 Congress St., Salem, MA 01970. Special ISSN 0160-5280/86. \$1.50. Copying done for other than personal or internal reference use without the permission of McGraw-Hill Inc. is prohibited. Requests for special permission or bulk orders should be addressed to the publisher. BYTE is available in microform from University Microfilms International, 300 North Zeeb Rd., Dept. PR, Ann Arbor, MI 48106 or 1A Bedford Row, Dept. PR, London WC1R 4EJ England.  Subscription questions or problems should be addressed to: BYTE Subscriber Service, One Phoenix Mill Lane, Peterborough, NH 03458

BYTE

SENIOR VICE PRESIDENT/PUBLISHER
HARRY L. BROWN
EDITOR IN CHIEF
PHILIP LEMMONS

BIX

MANAGING EDITOR, BYTE
GENE SMARTE

ASSISTANT MANAGING EDITOR

GLENN HARTWIG
CONSULTING EDITORS
STEVE CIARCIA
JERRY POURNELLE
BRUCE WEBSTER

SENIOR TECHNICAL EDITORS

G. MICHAEL VOSE, *Themes*
GREGG WILLIAMS, *Features*

TECHNICAL EDITORS

DENNIS ALLEN
JON R. EDWARDS, *Reviews*
RICHARD GREHAM
KEN SHELDON
GEORGE STEWART
JANE MORRILL TAZELAAR
TOM THOMPSON
CHARLES D. WESTON
EVA WHITE
STANLEY WZOLA

ASSOCIATE TECHNICAL EDITORS

CURTIS FRANKLIN, Jr., *Best of BIX*
MARGARET COOK GURNEY, *Book Reviews*
BRENDA McLAUGHLIN, *Applications Software Reviews*,
San Francisco

COPY EDITORS

BUD SADLER, *Chief*
FAITH HANSON
NANCY HAYES
CATHY KINGERY
PAULA NOONAN
JOAN VIGNEAU ROY
WARREN WILLIAMSON
JUDY WINKLER

ASSISTANTS

PEGGY DUNHAM, *Office Manager*
MARTHA HICKS
JUNE N. SHELDON

NEWS AND TECHNOLOGY

EZRA SHAPIRO, *Bureau Chief, San Francisco*
CINDY KIDDOO, *Editorial Assistant, San Francisco*
RICH MALLOY, *Senior Technical Editor, New York*
PHILLIP ROBINSON, *Senior Technical Editor, San Mateo*

ASSOCIATE NEWS EDITORS

DENNIS BARKER, *Microbytes*
CATHRYN BASKIN, *What's New*
ANNE FISCHER LENT, *What's New*

CONTRIBUTING EDITORS

JONATHAN AMSTERDAM, *programming projects*
MARK DAHMEKE, *video, operating systems*
MARK HAAS, *at large*
RIK JADRNICEK, *CAD, graphics, spreadsheets*
ROBERT T. KUROSAKA, *mathematical recreations*
PHIL LOPICCOLO, *computers in medicine*
ALASTAIR J. W. MAYER, *software*
ALAN R. MILLER, *languages and engineering*
DICK POUNTAIN, *U.K.*
ROGER POWELL, *computers and music*
WILLIAM M. RAKE, *Japan*

ART

NANCY RICE, *Art Director*
IAN MULLER, *Art Assistant*
ALAN EASTON, *Drafting*

PRODUCTION

DAVID R. ANDERSON, *Production Director*
DENISE CHARTRAND
MICHAEL J. LONSKY
VIRGINIA REARDON

TYPOGRAPHY

SHERRY MCCARTHY, *Chief Typographer*
LEN LORETTE
DONNA SWEENEY

PLANNING AND DEVELOPMENT/PUBLIC RELATIONS

(603-924-7255)
MICHELE P. VERVILLE, *Manager*
FAITH KLUNTZ, *Copyrights Coordinator*

FINANCIAL SERVICES

PHILIP L. PENNY, *Director of Finance and Services*
KENNETH A. KING, *Business Manager*
CHRISTINE LEE, *Assistant*
VICKI WESTON, *Accounting Manager*
LINDA SHORT, *D/P Manager*
EDSON WARE, *Credit*
MARILYN HAIGH
DIANE HENRY
VERN ROCKWELL
JOANN WALTER

PUBLISHER'S ASSISTANT

BEVERLY JACKSON

EXECUTIVE EDITOR, BIX
GEORGE BOND

SENIOR EDITOR

DAVID BETZ
ASSOCIATE EDITORS
TONY LOCKWOOD
DONNA OSGOOD, *San Francisco*

BUSINESS AND MARKETING

DOUG WEBSTER, *Director*, (603) 924-9027
PATRICIA BAUSUM, *Secretary*
BRIAN WARNOCK, *Customer Service*
DENISE A. GREENE, *Customer Service*
TAMMY BURGESS, *Customer Credit and Billing*

TECHNOLOGY

CLAYTON LISLÉ, *Director, Business Systems Technology*, MHSI
BILL GARRISON, *Business Systems Analyst*
JACK REILLY, *Business Systems Analyst*
LINDA WOLFF, *Senior Business Systems Analyst*

ADVERTISING SALES

DENNIS J. RILEY, *Director of Sales and Marketing*
SANDRA FOSTER, *Administrative Assistant*

ADVERTISING/PRODUCTION (603-924-6448)

LISA WOZMAK, *Supervisor*
ROBERT D. HANNINGS, *Senior Account Coordinator*
MARION CARLSON
KAREN CILLEY
LYDA CLARK
MICHELE JACKSON
WAI CHIU LI, *Quality Control Manager*
JULIE MURPHREE, *Advertising/Production Coordinator*

MARKETING COMMUNICATIONS

HORACE T. HOWLAND, *Director* (603-924-3424)
VICKI REYNOLDS, *Marketing Production Manager*
LISA JO STEINER, *Marketing Assistant*
STEPHANIE WARNESKY, *Marketing Art Director*
SHARON PRICE, *Assistant Art Director*
WILBUR S. WATSON, *Operations Manager, Exhibits*

RESEARCH

PATRICIA AKERLEY, *Research Manager*
JULIE PERRON, *Market Research Analyst*
CYNTHIA DAMATO SANDS, *Reader Service Coordinator*

CIRCULATION (800-258-5485)

ANDREW JACKSON, *Subscriptions Manager*
LAURIE SEAMANS, *Assistant Manager*
SUSAN BOYD
MARY EMERSON
LOUISE MENEGUS
AGNES E. PERRY
JENNIFER PRICE
JAMES BINGHAM, *Single-Copy Sales Manager*
CATHY A. RUTHERFORD, *Assistant Manager*
CLAUDETTE CARSWELL
KAREN DESROCHES

PERSONNEL

CHERYL HURD, *Office Manager*
PATRICIA BURKE, *Personnel Coordinator*

BUILDING SERVICES/TRAFFIC

ANTHONY BENNETT, *Building Services Manager*
BRIAN HIGGINS
MARK MONKTON

RECEPTIONIST

DONNA HEALEY

Officers of McGraw-Hill Information Systems Company: President: Richard B. Miller, Executive Vice Presidents: Frederick P. Jannott, Construction Information Group; Russell C. White, Computers and Communications Information Group; J. Thomas Ryan, Marketing and International. Senior Vice Presidents: Francis A. Shinal, Controller; Robert C. Violette, Manufacturing and Technology. Senior Vice Presidents and Publishers: Laurence Altman, Electronics Week; Harry L. Brown, BYTE; David J. McGrath, Construction Publications, Group Vice President; Peter B. McCuen, Communications Information, Vice President; Fred O. Jensen, Planning and Development.

Officers of McGraw-Hill, Inc.: Harold W. McGraw, Jr., Chairman; Joseph L. Dionne, President and Chief Executive Officer; Robert N. Landes, Executive Vice President and Secretary; Walter D. Serwaika, Executive Vice President and Chief Financial Officer; Shel F. Asen, Senior Vice President, Manufacturing; Robert I. Bahash, Senior Vice President, Finance and Manufacturing; Ralph R. Schulz, Senior Vice President, Editorial; George R. Elstinger, Vice President, Circulation; Ralph I. Webb, Vice President and Treasurer.

BYTE **BYTE** and The Small Systems Journal are registered trademarks of McGraw-Hill Inc.

EDITORIAL AND BUSINESS OFFICE: One Phoenix Mill Lane, Peterborough, New Hampshire 03458, (603) 924-9281. West Coast Offices: McGraw-Hill, 425 Battery St., San Francisco, CA 94111, (415) 362-4600. McGraw-Hill, 951 Mariner's Island Blvd., San Mateo, CA 94404, (415) 349-4100. New York Editorial Office: 1221 Avenue of the Americas, New York, NY 10020, (212) 512-2000.

Circuit-Board-Artwork Software for the Design Engineer in a Hurry

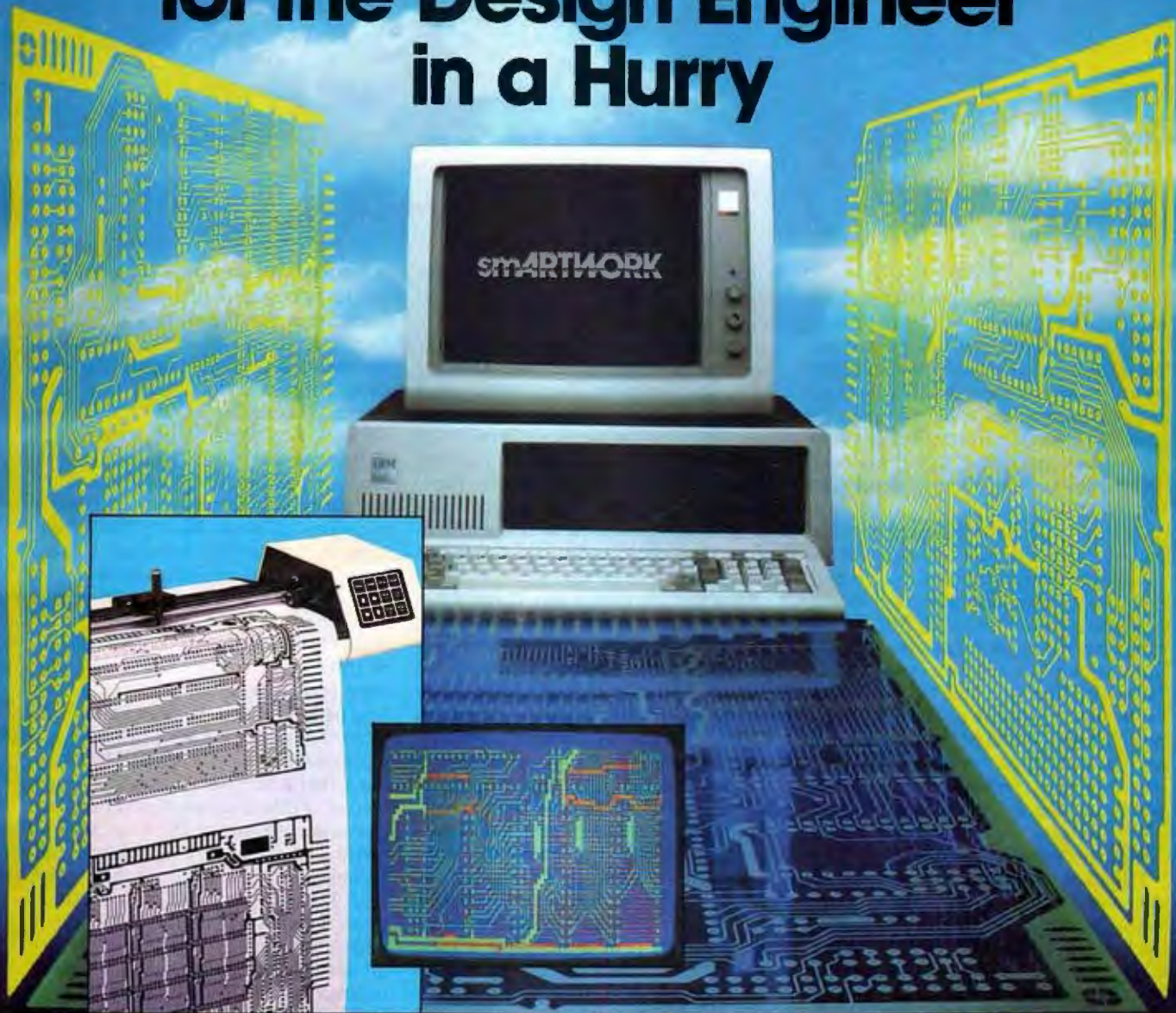

For only \$895, smARTWORK® lets the design engineer create and revise printed-circuit-board artwork on the IBM Personal Computer. You keep complete control over your circuit-board artwork — from start to finish.

Forget the tedium of taping it yourself or waiting for a technician, draftsman, or the CAD department to get to your project.

smARTWORK® is the only low-cost printed-circuit-board artwork editor with all these advantages:

- Complete interactive control over placement and routing
- Quick correction and revision
- Production-quality 2X artwork from a pen-and-ink plotter
- Prototype-quality 2X artwork from a dot-matrix printer

- Easy to learn and operate, yet capable of sophisticated layouts
- Single-sided and double-sided printed circuit boards up to 10 x 16 inches
- Multicolor or black-and-white display

System Requirements:

- IBM Personal Computer, XT, or AT with 256K RAM, 2 disk drives, and DOS Version 2.0 or later
- IBM Color/Graphics Adapter with RGB color or black-and-white monitor
- IBM Graphics Printer or Epson FX/MX/RX series dot-matrix printer
- Houston Instrument DMP-41 pen-and-ink plotter
- Optional Microsoft Mouse

The Smart Buy

At \$895, smARTWORK® is proven, convenient, fast, and a sound value. Call us today. And put it to work for yourself next week.



Wintek Corporation Inquiry 385
1801 South Street
Lafayette, IN 47904-2993
Telephone: (317) 742-8428
Telex: 70-9079 WINTERK CORP UD

In Europe contact: RIVA Terminals Limited,
Woking, Surrey GU21 5JY ENGLAND,
Telephone: 04862-71001, Telex: 859502

*smARTWORK®, "Wintek" and the Wintek logo are registered trademarks of Wintek Corporation.

BIX UPDATE

The BYTE Information Exchange—BIX—is entering its ninth month as a commercial venture. After more than a year of testing software and hardware, BIX was born as a business on November 1, 1985. In the ensuing months, we have learned a lot about what works and what doesn't work in electronic publishing. More important, we have learned a lot about what you want and don't want.

One thing we have discovered is that you are very interested in news of the microcomputing community. As an experiment, we took the idea behind our monthly Microbytes section in the front of the magazine and applied it as a daily on-line news service. The first item in Microbytes Daily appeared, with little fanfare, on BIX on January 17. It was an instant hit and quickly became one of the busiest areas on BIX. Since then, we have added hundreds of news items from around the world. Incidentally, Microbytes Daily is also available through McGraw-Hill's X*PRESS cable TV service.

This effort is coordinated by Glenn Hartwig and Dennis Barker here in Peterborough, who work regularly with BYTE staffers Rich Malloy in New York City and Ezra Shapiro, Phillip Robinson, and Brenda McLaughlin in the Bay Area. They also work with correspondents David Needle in the Bay Area and Lynne Nadeau in New England and contributing editors Dick Pountain in London and William M. Raika in Tokyo.

At crunch times, other members of the BYTE staff pitch in to be sure we get good coverage of important events. Primarily, this means trade shows and conferences, but they also play key roles at other times. For example, in mid-May Bob Pariseau posted a "first contribution as a 'civilian'" on BIX late one Wednesday afternoon. He had, Pariseau said, been laid off from his job as Commodore-Amiga's vice president of software development. BYTE Senior Editor Gregg Williams quickly got on the phone to one of his contacts, Commodore-Amiga General Manager Jay Miner, and was able to confirm that some Amiga software people had been laid off. A short confirming note was placed in the Amiga conference that afternoon, and the infor-

mation gathered was passed on to the Microbytes Daily staff, who got a full report posted the next day.

Less flashy but just as important has been the help given Microbytes Daily by BYTE staff members during shows and conferences. Some of the first items to appear were from the MacWorld Expo in San Francisco. Other events reported as they happened were the Hannover Faire, Winter and Spring COMDEX, Microsoft's CD-ROM conference, the West Coast Computer Faire, and the National Computer Conference.

Most of these events were covered in a more-or-less conventional way, with reporters filing stories about what *they* thought was important or interesting. We now are beginning to experiment with a new way of reporting shows—interactive coverage, to give us a chance to find out what *you* think is important or interesting.

Larry King, Dr. Ruth, and a horde of other talk-show hosts have been practicing interactive entertainment, if not news, for years. Television has flirted with interactive pseudonews through 900-number call-in voting—"Who is right in the *Tonight Show* flap: Johnny or Joan?"; "Did President Reagan act properly in the Libyan crisis?"; and so on. In some instances, viewers have been able to phone in questions to interview shows. But interactive coverage of news is a new concept. There has been little real interaction between reporter and reader.

We are changing this. Before the National Computer Conference began last month, we established a special area on BIX where members could leave requests for us to collect information *they* were interested in at the show. Our people added these requests to the lists of information they were collecting and posted reports on-line, while the show was still going on.

We want to do more of this and are interested in your reactions and suggestions. You can send them to me on BIX (mail to gbond) or as paper mail to our Peterborough address (One Phoenix Mill Lane, Peterborough, NH 03458).

Your participation on BIX has shown us that you are interested in more than microcomputers. When the space shuttle *Challenger* exploded, many of you turned

immediately to the Space conference on BIX for information and discussion. Participation in that already busy conference mushroomed and stayed high throughout the investigation of the tragedy. The same thing happened during the Chernobyl reactor disaster. The modest activity level of our Soviets conference spontaneously shot up as you sought a place to get information and exchange opinions about nuclear energy, Soviet policy, and the implications of events in the Ukraine and Moscow. We want to encourage this airing of opinion on current events and again welcome your suggestions and criticisms.

BIX is not all news, of course. It is the electronic component of BYTE, and many of BYTE's features appear there before they appear in print. Columnists Jerry Pournelle, Bruce Webster, and Ezra Shapiro all post their work on BIX several weeks before it is published in BYTE. An expanded What's New section is a regular feature of BIX. Many product reviews that get squeezed out of BYTE because of space limitations now appear on BIX. Technical information from the Amiga, Atari, IBM, and Macintosh conferences appears regularly here as the Best of BIX (it begins on page 393 of this issue). An ever-growing Listings area includes programs referred to in BYTE articles and a large collection of public domain software. But most important, BIX is the more than 180 conferences where you, our readers, share your information and opinions with each other.

—George Bond
Executive Editor

Joining BIX

You can join BIX literally within the next few minutes. More information about BIX—including detailed log-on instructions—is found on pages 378 and 379 of this issue. If you can't join now but are interested in BIX, circle number 450 on the reader service card.

If you have additional questions, write to BIX, One Phoenix Mill Lane, Peterborough, NH 03458, or call (603) 924-9281 from 8:30 a.m. to 4:30 p.m., weekdays, eastern time. We look forward to seeing you soon on BIX.

Massively Parallel Machine Breaks BIPS Barrier

Thinking Machines Corp. (Cambridge, MA) has introduced commercially a massively parallel computer containing more than 65,000 individual processors. The company says its Connection Machine can handle vast quantities of data at speeds exceeding one billion instructions per second.

Each of the custom processors, which compute simultaneously, has its own memory. The company says that the processors function at the level of the data itself, and that the processors are linked by the machine into patterns matching the structure of the problem being solved. When a problem has more data elements than the machine has processors, the chips act as virtual processors. (Each chip has 4096 bits of memory.) Thinking Machines says its system can handle as many as 1 million virtual processors.

The Connection Machine housing looks like eight black cubes, four on the bottom and four on top (it stands about five feet tall). It comes in two configurations: The model that contains 65,536 processors is selling for \$3 million; the model with 16,384 processors is \$1 million.

Who's buying the BIPS machines? The Artificial Intelligence Laboratory at MIT, the Media Laboratory at MIT, the Department of Computer Science at Yale, Perkin-Elmer, and the U.S. government's Defense Advanced Research Project Agency.

As the debut of the Connection Machine indicates, performance capabilities are going up. Way up. Now, Culler Scientific Systems (Santa Barbara, California) says it's bringing the costs of such performance down to "less than \$6000 per MIPS."

At the National Computer Graphics Association show, Culler demonstrated its Personal Supercomputer (PSC), reportedly capable of handling 18 million instructions per second. The machine costs \$98,500 (although the price of a complete system would be higher because you need to hook the PSC to a workstation). At the NCGA convention, Culler had the PSC functioning as a compute server for a Sun workstation network.

Zenith Develops Flat-Face CRT; Claims Tube Improves Resolution, Eliminates Glare

Zenith Electronics Corp. (Chicago) has developed a new cathode ray tube with a perfectly flat faceplate that the company says is glare-free and provides better resolution and better color fidelity than CRT units now in use. Zenith scientists discussed the "flat tension mask" (FTM) tube at the Society for Information Display's annual symposium, which was held in San Diego.

According to Zenith the ultrahigh-resolution FTM tube offers higher brightness and increased contrast ratio compared to conventional displays. Because the flat tube face doesn't reflect ambient light, unlike a convex face, it is free of glare and reflections, the company says.

Like a conventional color CRT, the FTM tube uses a shadow mask, a thin sheet of metal with thousands of perforations. This mask helps direct beams from the tube's electron gun to the screen, where they excite RGB phosphors and create the video image. In Zenith's FTM, the shadow mask is stretched flat and tense directly behind the tube's flat glass faceplate. Unlike the mask in typical CRT displays, the FTM mask doesn't move, even at high brightness levels that can cause discolored images ("doming") in conventional tubes. The square-cornered FTM display gives text and graphics a more natural look, a Zenith spokesperson said, "as if you were looking at a sheet of paper."

Zenith is initially selling a 14-inch hi-res version of the FTM unit to OEMs. Pilot production has begun, and shipments are expected to start next year.

Ancient Greeks on CD-ROM Disks

Researchers at Brown University have undertaken the Homeric process of transferring approximately 250 megabytes of classical Greek literature to a single CD-ROM disk. The disk

(continued)

will also include approximately 150 megabytes of index. According to Paul Kahn, an applications specialist at the university, Greek scholars will soon be able to find, for example, every occurrence of a particular word in the work of an ancient author.

The text-retrieval system is being designed for the IBM RT PC, a RISC-based computer. The Greek text will be handled by the Interleaf document-processing system for the RT, which is being modified for the ancient Greek alphabet.

To facilitate access to the system, a terminal program is being written for the Macintosh computer. This program will allow the Mac to function as a terminal on the UNIX-based RT and to display the Greek text accurately.

The massive library of literature currently resides on nine-track tapes and is available from the University of California at Irvine. The collection reportedly includes all known works by 178 authors, from the time of Homer to approximately 600 A.D. The CD-ROM system is slated to be completed this summer.

COMDEX Briefly: Sidecar, OS-9, Imagnet

Commodore (West Chester, PA), which had one of the most crowded booths at COMDEX/Spring in Atlanta, prominently displayed Sidecar, its IBM PC-compatibility add-on box for the Amiga. The new peripheral is about the size of a shoebox and attaches to the Amiga expansion bus. The unit reportedly contains an 8088 microprocessor running at the same speed as that of the IBM PC, a socket for an 8087, a single 5¼-inch floppy disk drive, and three IBM expansion slots. The emulator also contains 256K bytes of memory, which is expandable to 512K. Commodore said Sidecar would be available in the fall for a price that would be "substantially under \$1000."

Microtrends (Schaumburg, IL) introduced versions of OS-9, a multiuser, multitasking operating system, for the Atari ST, the Macintosh, and the Amiga. Specified by Philips and Sony as the operating system for their CDI (Compact Disk Interactive) standard for CD players, OS-9 can provide multiuser capabilities, allowing several users to access one CD-ROM drive. The operating system, originally developed by Microware Systems for the Motorola 6809, is similar to UNIX but smaller and less complex.

BMB Compuscience Canada (Milton, Ontario) announced a network called Imagnet that connects IBM PCs with Atari 520STs. The network costs \$900 for the first IBM PC, which functions as the file server, \$800 for each additional PC, and \$500 for each ST. Transmission rate is 2 megabits per second. The company said Imagnet will be available this month.

NANOBYTES

Baseball fans at Philadelphia's Veterans Stadium this season can check out the graphics capabilities of **Commodore's** Amiga. The computer is linked to the 42-foot-wide Phanavision scoreboard. Images are being created with the computer, a video digitizer, a Kurta graphics tablet, and various software, including Aegis Animator, Aegis Images, and Electronic Arts' DeluxePaint. . . . Researchers at **Rensselaer Polytechnic Institute** (Troy, NY) are working with semiconductor materials from chemical compounds, including gallium arsenide, cadmium telluride, and mercury cadmium telluride. Potential applications: optical sensors and optical integrated circuits. . . . **Steve Gibson**, developer of the Gibson Light Pen, has developed a RAM-resident program to smooth the display of PC- and MS-DOS data or text packages. According to Gibson, his \$39 Flickerfree scrolls full screens, whereas the standard IBM PC BIOS makes programs account for individual line feeds when scrolling. You can phone Gibson at (714) 854-1520. . . . **Chips and Technologies** (Milpitas, CA) has a 10-MHz version of its PC AT CHIPSet; the speedier chips could mean AT work-alikes faster than the original. . . . **Stanford University** researchers are using a Macintosh and a 700-line BASIC program to simulate the fabrication of composite materials. Professor Alan Miller says he chose the Mac because its "graphics commands were very accessible." . . . **Applied Reasoning Corp.** (Cambridge, MA) reports it's working on a 16-MHz 80386 coprocessor board for the IBM PC and compatibles; availability depends on when Intel begins volume shipment of its chip. . . . State rankings compiled by the American Electronics Association show that **California** leads the nation in electronics employment with 598,000 workers. Another AEA study says that graduates with B.S. degrees will enter the working world with an average salary of \$28,300. . . . **Symbolics Inc.** (Concord, MA) rolled out a machine the company says makes symbolic processing more accessible to mainstream users; the 3610AE delivery system (\$31,500 in volume) executes software applications written on larger computers. . . . **Addison-Wesley** (San Francisco) has published *The Amiga Hardware Reference Manual* and *The Amiga Intuition Reference Manual*, reportedly available in bookstores selling technical texts. Addison-Wesley said two volumes about the Amiga ROM kernel will be in stores before you read this.

We invented the modem that makes fewer demands on your PC.

The Ven-Tel Half Card™ modem. All the power and speed of our regular modems, but with some major advantages for people who demand versatility from their PC.

Regular modems plug into one of your computer's full-size slots. Just like expansion boards—color boards, graphics cards and memory expanders.

The Ven-Tel Half Card modem is different. It plugs into a short slot, freeing up a long slot so your PC can handle an additional function. And while other modems have about 300 components, ours has 70.

So it not only demands less space from your computer—it also demands less power and generates less heat. Your PC

stays cool and stress-free.

Competitively priced, the Half Card modem is available in both 1200 baud and 2400 baud speeds. And it's backed by Ven-Tel's free *five-year* warranty. No other major manufacturer even comes close.

If you make a lot of demands on your PC... demand the less-demanding modem: The Ven-Tel PC Modem Half Card.



Ven-Tel
Modems

Our free 24-page booklet, "How To Select The Correct Modem," contains specific information about our full line of modems. To request your copy, call 800-538-5121. In California, call 408-727-5721.
Inquiry 373 for End-Users. Inquiry 374 for DEALERS ONLY.

Introducing Six Finally, Performance

WordStar: Write a letter while running up to eight other applications.

MS-DOS File
Send print output directly to printer

Quarterly Sales Report -- First Quarter, 1986

REGION	MANAGER	QMS	TRUCKS	TOTAL
Region 1	Linda Stevens	872	532	1,404
Region 2	Sam Newton	528	488	1,016
Region 3	Salyn Bergman	671	653	1,324
Region 4	Paula Blackdale	852	437	1,289
Region 5	Mike Duffy	821	433	1,254
Region 6	Sam Evans	549	378	927
Region 7	Jack Miller	438	299	737
Region 8	Harvey Adams	798	335	1,133
Region 9	Rob Robinson	928	338	1,266
Region 10	Al Stone	897	587	1,484
Region 11	Robin Taylor	855	484	1,339
Region 12	Bruce Anderson	763	495	1,258
Region 13	Wesley Becker	628	422	1,050
Region 14	Erny Bradley	825	583	1,408
Region 15	Sam Swellman	935	535	1,470
Region 16	Polly Cooper	628	489	1,117

44 Apr 16, 09:28 PM

Lotus 1-2-3: All releases of 1-2-3 run in SixPakPremium's DESQview™ windows.

MS-DOS File
Send print output directly to printer

MS-DOS File
Send print output directly to printer

SYMBOL	PRICE	PERCENT	DATE	TIME	MARKET
IBM	120.00	0.00	4/15/86	11:00	110
MSFT	32.00	0.00	4/15/86	11:00	110
DISC	18.00	0.00	4/15/86	11:00	110
INTL	25.00	0.00	4/15/86	11:00	110
AMT	28.00	0.00	4/15/86	11:00	110
TRW	35.00	0.00	4/15/86	11:00	110
GM	22.00	0.00	4/15/86	11:00	110
CVX	30.00	0.00	4/15/86	11:00	110
DUK	20.00	0.00	4/15/86	11:00	110
WAL	15.00	0.00	4/15/86	11:00	110
AT	18.00	0.00	4/15/86	11:00	110
SL	25.00	0.00	4/15/86	11:00	110
W	12.00	0.00	4/15/86	11:00	110
AMZN	10.00	0.00	4/15/86	11:00	110
GO	15.00	0.00	4/15/86	11:00	110
MS	20.00	0.00	4/15/86	11:00	110
IBM	120.00	0.00	4/15/86	11:00	110
MSFT	32.00	0.00	4/15/86	11:00	110
DISC	18.00	0.00	4/15/86	11:00	110
INTL	25.00	0.00	4/15/86	11:00	110
AMT	28.00	0.00	4/15/86	11:00	110
TRW	35.00	0.00	4/15/86	11:00	110
GM	22.00	0.00	4/15/86	11:00	110
CVX	30.00	0.00	4/15/86	11:00	110
DUK	20.00	0.00	4/15/86	11:00	110
WAL	15.00	0.00	4/15/86	11:00	110
AT	18.00	0.00	4/15/86	11:00	110
SL	25.00	0.00	4/15/86	11:00	110
W	12.00	0.00	4/15/86	11:00	110
AMZN	10.00	0.00	4/15/86	11:00	110
GO	15.00	0.00	4/15/86	11:00	110
MS	20.00	0.00	4/15/86	11:00	110

Dow Jones: Monitor on-line stock quotations while working on other projects.

Dear Mr. Aurilio,

Thank you for inquiring about our new multitasking multitasking solution, SixPakPremium.

With SixPakPremium and DESQview 1.0's easy to use up to 9 large programs on your PC - at once. DESQview will allow you to run virtually all popular programs, such as Lotus 1-2-3, concurrently, in "windows". Also, DESQview requires absolutely no re-writing of your favorite software: it runs both conventional and our expanded memory programs simply and easily.

The SixPakPremium is superior to other multitasking products because it provides both conventional memory up to 640K, and advanced expanded memory all the way up to 2 MB. With four SixPakPremium boards, your PC can have up to 8 MB of expanded memory.

The SixPakPremium also offers all of the features you've come to expect from IBM's popular multitasking products -- a parallel port, 2 serial ports, a game port, a clock/calendar, and IBM's standard 3-year warranty.



SixPakPremium and DESQview trademarks of AST Research, Inc. IBM logo is a trademark of International Business Machines Corp. Lotus 1-2-3 is a registered trademark of Lotus Development Corp. DESQview is a trademark of Charles G. Evans Systems. WordStar is a registered trademark of Micro International Corp. DRAM II and DRAM III are trademarks of IBM Corp. All other trademarks are the property of their respective owners. Copyright © 1986, AST Research, Inc. All rights reserved.

Maxell Corp. of America, 60 Oxford Drive, Moonachie, NJ 07074



maxell[®]
FLOPPY DISKS
THE GOLD STANDARD

Before you invest in a DEC*VT240 terminal, consider the software alternative.

Stop and think about what you really need: A text terminal. Tektronix* graphics. ReGIS* graphics. File transfer capabilities. Communications.

Purchasing a state-of-the-art terminal may be one option, but Persoft has a smarter solution—**SmarTerm® 240**, the ultimate in terminal emulation software.

SmarTerm can do everything the state-of-the-art terminal can do—and more. That's why we call it **state-of-the-smart**.

With SmarTerm 240, the emulation is so exact you'll forget you're using a PC. It features superior text emulation, ReGIS graphics, Tektronix graphics, outstanding communications and file transfer capabilities.

You also get on-line help screens, remappable keyboard layouts and programmable softkeys which can simplify your most frequently performed tasks. You can even customize your own menus!

And because SmarTerm runs on your PC, you've always got a wealth of computing power right at your fingertips.

All SmarTerm products are backed by Persoft's strong technical support network. It's a service you expect from the industry leader in terminal emulation software.

No matter which terminal you're currently using—Data General Dasher* D400, Tektronix 4010/4014, DEC VT100, VT125, VT220 or even the new VT240,



SmarTerm has a state-of-the-smart solution for you.

To find out more about the SmarTerm family of terminal emulation software, see your local dealer. Or contact: Persoft, Inc.
2740 Ski Lane
Madison, WI 53713
(608) 273-6000 – Telex 759491

STATE OF THE ART

VS

STATE OF THE SMART

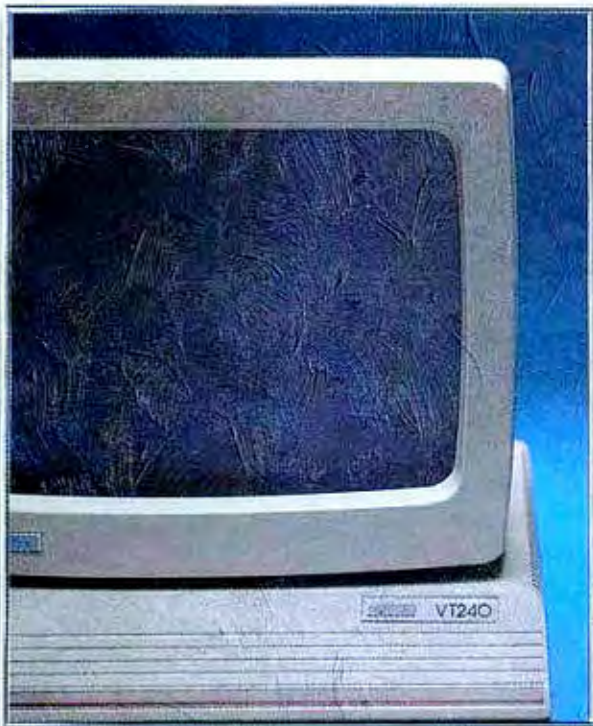

*SmarTerm is a registered trademark of Persoft, Inc. *DEC, VT and ReGIS are trademarks of Digital Equipment Corp. *DASHER is a registered trademark of Data General Corp. *Tektronix is a registered trademark of Tektronix, Inc. © Persoft, Inc., 1985. All rights reserved.

persoft

Inquiry 281

PakPremium™ Exceeds Demand.

Also Compatible With
Original IBM® PCs & XT's

THE AST
PREMIUM
SERIES™



SideKick™ Keep track of schedules with popular desktop management programs.



dBASE II®/dBASE III® Use any release of this popular data base to sort files while working on other applications.

SixPakPremium, the new generation multifunction board designed for new generation IBM XT's, is here! Now one person and one PC have the power to meet the demands of business. AST's newest solution for new XT's, existing PCs, XT's and compatibles, SixPakPremium offers all the popular multifunction features plus two megabytes of expanded memory and the powerful software to use it.

Premium Performance. Now, run up to nine applications simultaneously. Sort a data base, write a letter, calculate a spreadsheet, monitor stock quotations and print labels...all at the same time...on the same PC! And, our windows let you view applications instantly.



SixPakPremium is fully compatible with all current PC applications, including expanded memory applications such as Lotus 1-2-3 Release 2.0. And DESQview, our multitasking/windowing environment is compatible with more than 200 of the most popular packages.

Premium Features. SixPakPremium offers up to two megabytes of expanded memory, two serial ports, parallel port, game port, battery-backed clock/calendar, DESQview and SuperPak™ utilities.

Premium Quality. As the leader in PC enhancement, with over a million products shipped, AST is known worldwide for its highly reliable products.

Make The Premium Choice. For performance that exceeds demand, call our Customer Information Center (714) 863-1333. Or send the coupon to AST Research, Inc., 2121 Alton Avenue, Irvine, CA 92714.

AST
RESEARCH INC.

Yes, I want to learn more about Premium Performance. Please send me your special SixPakPremium information package today!

Name _____

Title _____

Company _____

Address _____

City _____ State _____ Zip _____

Phone (____) _____

Inquiry 29 for End-Users. Inquiry 30 for DEALERS ONLY.

INTERNATIONAL GRAPHICS STANDARDS

We are becoming increasingly aware of the possibility that ISO TC97/SC21/WG2 may approve graphics standards which are conflicting, competing, and incompatible. It is our understanding that formal standards-development activities are intended to harmonize and stabilize both the technology and the marketplace. Competing alternative standards introduce additional conflict rather than cooperative solutions. We acknowledge that strict compatibility between standards is not always possible; nevertheless, it is vital that the results of our work be readily understandable and easily perceived as belonging to the same family. Different standards in the family produced by WG2 should fulfill clearly defined roles, providing an easy choice between different standards. This implies that, for example, at the same functional level, it should be easy to migrate users of computer graphics from systems of lower capabilities to systems of higher functionality, in particular from GKS (Graphical Kernel System) to PHIGS (Programmer's Hierarchical Interactive Graphics Standard).

Recent reporting in the trade press demonstrates conclusively that PHIGS is perceived as an alternative to GKS instead of being a functional outgrowth of it.

We therefore ask for your assistance and support in providing one family of graphics standards. We believe that with only minor technical changes, PHIGS could be presented as an evolutionary step forward for the family of graphics standards, in which GKS was the first to be adopted.

If PHIGS continues to develop and be perceived as an alternative to GKS, the spirit of international cooperation within ISO TC97/SC21/WG2 will be compromised. This will have an impact on other WG2 standards and could preclude the potential positive effect of genuine international enthusiasm and cooperation.

The adoption of GKS by ISO has resulted in significant worldwide investment. If an alternative, competing standard is approved, this will serve to compromise those investments as well as to damage the credibility of ISO within the international graphics vendor community. If no

compatibility is achieved, this will also cause unnecessary additional costs.

We therefore urge that the progression of PHIGS within ANSI be frozen until international consensus is achieved. This would allow synchronization with the international processing. We assure you our cooperation in achieving this goal in the shortest time possible.

A. DUCROT

*French Representative to
ISO TC97/SC21/WG2*

J. ENCARNAÇÃO

*Member of the DIN
Steering Committee*

G. ENDERLE

German Representative to WG2

W. HERZNER

Austrian Representative to WG2

J. SCHÖNHUT

Convenor of ISO TC97/SC21/WG2

P. TEN HAGEN

Dutch Representative to WG2

STANDARDIZING ANSI C

After reading Steve Hersee and Dan Knopoff's article "An ANSI Standard for the C Language" (March), I would like to offer my humble suggestions in light of the following observations:

1. C is already very standard, based on the K&R publication and the AT&T implementation, except for operating system differences, which are generally hidden in standard library procedures. This fact is evident in the limited scope of the ANSI proposal.

2. An attempt to "wrest C away from the developers and implementors" may be unfair to K&R and AT&T, since they gave us not only a standard language, but also a relatively standard operating system, UNIX.

3. Asking the apparently disparate group of "developers and implementors" of the X3J11 Committee to generate a language standard is like asking a group of feudal warlords to propose a common government.

Let's hope that the X3J11 Committee understands that standardization requires both a desire for uniformity as well as a commitment to underlying principle, giv-

ing the ANSI C proposal a better chance than ANSI FORTRAN.

G. A. YOUNG
Yardley, PA

RUNGE-KUTTA SUBROUTINE

Out of curiosity, I coded the machine epsilon routine as given by Benku Thomas ("The Runge-Kutta Methods," April) in two different languages on our Prime 750. I was especially careful to code them as close to identical as possible. Upon running them, I was surprised to find two different results. My PL/I version returned 1.192092E-07 and the FORTRAN-77, 7.105427E-14. It became clear that the difference was due to the use of floating-point hardware on the Prime. The PL/I result is 2^{-23} . Since the mantissa for this data type is 23 bits wide, this is the proper result. (Purists would say 2^{-22} is the correct result, but factors of 2 are not guaranteed anyway.) The FORTRAN result is 2^{-47} , corresponding to the width of a double-precision (REAL*8) number. Our floating-point hardware is double precision. The FORTRAN compiler has left intermediate results in the floating-point registers, thus producing false accuracy.

This result is not unique to the Prime, however. Sliding over to the IBM PC AT, I found machine epsilon to be 2^{-64} , the width of the mantissa on the 80287. I therefore propose the following subroutines to calculate the machine epsilon:

```

Subroutine Epsilon
C
Real*4 Eps, Temp
External Null
C
Eps = 1.0
    
```

(continued)

LETTERS POLICY: To be considered for publication, a letter must be typed double-spaced on one side of the paper and must include your name and address. Comments and ideas should be expressed as clearly and concisely as possible. Listings and tables may be printed along with a letter if they are short and legible.

Because BYTE receives hundreds of letters each month, not all of them can be published. Letters will not be returned to authors. Generally, it takes four months from the time BYTE receives a letter until it is published.

LOOKING FOR THE BEST VALUE IN PC/AT COMPATIBLES?



INTRODUCING THE \$1495 A★STAR™

Looking for a lower priced, higher quality PC/AT compatible than our new A★Star™ is like looking for a needle in a haystack. You're more apt to come up with a case of hayfever.

A★Star gives you features you won't get from any other vendor. Not IBM. Not Compaq. Not even those foreign manufacturers. Features like a 220 watt power supply, eight available expansion slots and "network ready" multi-user operation. All for only \$1495. And that price includes a 1.2MB diskette drive, 512KB memory, a fixed disk/diskette drive controller, a tactile feedback keyboard (you'll love it!) and a 6/8MHz switch/software selectable 80286 CPU.

Best of all, A★Star is quality built right here in America by Wells American Corporation - an American Stock Exchange manufacturer. So now you

can buy with confidence from a vendor you can trust, just like you've trusted IBM. And you'll get a genuine, top quality product (not a cheap imitation) for a price even less than those "questionable" mail order clones. And if that's not enough, it's all money-back guaranteed!

The \$1495 Wells American A★Star.™



A PC/AT FOR ONLY \$1495? THAT'S NOTHING TO SNEEZE AT!

(Hurry! This offer is limited.)

- I'm tired of sneezing! Have someone call me immediately to take my order.
- A★Star sounds terrific. Tell me more.

Name: _____

Company: _____

Phone: _____

Address: _____

City: _____

State: _____ Zip: _____

 **Wells American**
803/796-7800-TWX 510-601-2645
Sunset Boulevard • West Columbia, SC 29169

ANTHROCART.™

MOBILE...

A key reason why people like the AnthroCart. Share your hardware. Move it around. Take it room to room or floor to floor.

AnthroCart. High-tech furniture for high-tech equipment. Space saver. Compact. Rugged.

The AnthroCart is designed to move. Designed so your workspace is as slick as your hardware.

Call us: 800-325-3841



*Supports up to 150 lbs.
All steel frame construction
5 1/4 square foot footprint*



**Anthro Corporation
Technology Furniture**
3221 NW Yeon St.
Portland, OR 97210

Anthro Corporation is a wholly owned subsidiary of Tektronix, Inc. Anthro is a registered trademark of Anthro Corporation.

LETTERS

```
C
10 Eps = Eps/2.0
    Temp = Eps + 1.0
    Call Null
    If (Temp .GT. 1.0) Goto 10
C
    Write( , ) ' Eps' , Eps
    Return
    End
C
C
    Subroutine Null
    Return
    End
```

On all machines I am familiar with, a call to a subroutine forces the storage of intermediate results, since registers may be changed in the subroutine. The use of the variable Temp before the subroutine call ensures that things don't get back into the wider registers before the comparison is done. This new routine returns the more reasonable ≈ 23 bits on all my machines.

MIKE UTTORMARK
Ithaca, NY

BEST OF BIX

I wish to thank you for adding "Best of BIX" to the editorial content of BYTE. I am a charter subscriber to BYTE, and derived a significant amount of immediately useful information from the earlier issues. In recent years the shift in editorial content has transformed BYTE (for me) into an excellent reference source for many high-level topics. I would like more hardware topics in BYTE, but you probably have a good balance for your readership.

You may be interested in the special attraction "Best of BIX" has for a dedicated hardware hacker whose major programming interest is assembly language. I always choose computing hardware based on which microcomputer is used. My current target is the 68000, so the BIX interchanges on Atari, Mac, and Amiga give me valuable insights to these three candidates. I'm sure that whatever choice I make will be much more informed as a result of having this resource. I wish also to praise "According to Webster." This series is surpassed only by Pournelle and Ciarcia in my interest and enjoyment. Ciarcia is a crackerjack hardware guru, and, after reading Pournelle's science fiction, I will read anything he writes.

RALPH TENNY
Richardson, TX

CUTTING COMPILE TIMES

Recently, I needed to compile very large Pascal programs on my 5-year-old Apple II+. Using the units offered by the Apple's
(continued)

New! Windows-Compatible In-a-Vision 1.1

FREE Microsoft Windows!
Limited Offer

Complex Drawing Made Easy

We created In-a-Vision just for you. The engineer who needs more productive drafting support. The designer who needs versatility for alternate ideas or quick revisions. The architect who needs to manage a variety of working drawings. And the businessman who needs first-class presentation materials as well as detailed flow charts and organization charts.

Point. Click. Draw.

Now all you do to create complex technical drawings, systems designs, blueprints, diagrams, illustrations, and proposals is point, click and draw. With In-a-Vision's mouse support, windowing, icons,

and pull-down menus, you produce drawings more quickly, accurately and efficiently than ever before. In-a-Vision's advanced technology includes many features not found on comparable systems costing thousands more. For example, you can pan around in a user-definable drawing space up to 68" x 68" and zoom in on specific areas for

greater detail. Scale, rotate and dimension symbols, fill an area with your choices of pre-defined colors and patterns, as well as draw lines with multiple styles and widths. Other features include overlays, predefined and user-definable page sizes, rulers, grids, and templates to speed popular applications.

Multi-tasking in a PC-based CAD system.

In-a-Vision uses multi-tasking to enable you to continue drawing while printing hard copies or edit multiple drawings simultaneously.

FREE Microsoft Windows from MICROGRAFX!*

If you purchase In-a-Vision directly from MICROGRAFX, we'll give you a free retail copy of Microsoft Windows so you can use In-a-Vision as part of a fully integrated working environment. Move instantly from In-a-Vision to other applications and back ... cut and paste text and drawings

between applications ... and more!

We're confident you'll agree — In-a-Vision will make your complex drawing tasks simple and make you more productive. Satisfaction guaranteed.

TO ORDER CALL: 800-272-3729

Demo disk* or brochure available to qualified customers. In Texas or for customer support, call

(214) 234-1769.

MICROGRAFX, Inc., 1820 North Greenville Avenue, Richardson, Texas 75081.

MICROGRAFX®
The Picture of Success.

Inquiry 238

(Most popular graphics cards, plotters, and printers supported)
Microsoft Windows-compatible. Call for specific operating environment requirements.

* Demo requires MS Windows. Full demonstration system for users without Windows available for \$49.00.

In-a-Vision and MICROGRAFX are trademarks of MICROGRAFX, Inc.

Microsoft is a trademark of Microsoft, Inc.

INTRODUCING

SafetyNet™

From The Creators of *PushMinder™*

Revolutionary New File Recovery System
For the IBM PC and Compatibles

49⁹⁵ plus \$5 shipping
and handling

Accidental File erasure is no trivial matter! There are two kinds of users - those who have accidentally erased an important file, and those who will

SafetyNet™ is a file recovery program designed to recover those files or sub directories of files which have been accidentally erased. Unlike programs such as Norton's UnErase, *SafetyNet™* is a preventive measure rather than an attempt to cure the problem after-the-fact.

Recent surveys have revealed that, on the average, 3.6 persons have access to each computer used in corporate America. It might be four or five days before the victim discovers that their files are no longer available. With that many people utilizing the computer (or a single user who stays on his computer two or more hours per day), there are two chances that a utility such as Norton's UnErase will recover the missing file(s) - slim and none! It is highly likely that the file's space will have been overwritten in the interim (an impossibility with *SafetyNet™*).

It is our belief that when one has accidentally erased a file their anxiety is high - and that's not the time to learn a new technology. With some utility's multi-layered menus, and the admonition that their system doesn't always work, anxiety becomes near panic and increases chances for additional operator error causing loss of the vital information forever!

SafetyNet™ requires the user to do three things: 1) Type "SN" at the > prompt, 2) Mark the files presented on the screen, 3) Press the Enter Key. That's it! No need to know about sectors, clusters, bits or bytes. No requirement to replace the first letter of each previously erased file - a simple, foolproof manner to end the panic which comes when files are accidentally erased.

SafetyNet™ works first time, every time. Regardless of the time span between the actual erasure and discovery, there is no danger that the allocated file space will be overwritten, thus rendering the recovery doubtful or impossible. *SafetyNet™* - a Space-Age utility with a no nonsense user interface.

To order, call toll free (800) 628-2828 ext. 555 or contact:



WESTLAKE DATA CORPORATION

P.O. Box 1711

(512) 474-4666

Austin, Texas 78767

DON'T BOOT UP WITHOUT US!

UCSD Pascal, my system is quite capable of compiling large programs, but the cost is very long compile times and disks which run continuously for minutes at a time. I decided to either upgrade my Apple II+ or get a more powerful machine. After almost giving up and buying a Leading Edge, I discovered that Apple's new Pascal 1.3 and Memory Expansion Card can be very useful in this area.

Because it was almost impossible to find any technical information on this configuration, with Apple's "authorized" sales centers totally ignorant about the matter, I wish to pass on what I have learned to my fellow BYTE readers.

Pascal 1.3 is available from Apple on a trade-in basis if you have Pascal 1.1. The cost is \$125, compared to the normal retail of \$250.

If your system consists of two 5¼-inch disk drives then Pascal 1.3 is not worth the cost. Pascal 1.3 uses more memory than 1.1, so you must almost always use the compiler's swapping option. On a disk system this is intolerably slow. For example, a 399-line program that compiles in 1 minute, 30 seconds under Pascal 1.1 (with-out swapping) requires 2:35 under Pascal 1.3 because swapping must be invoked. Swapping means that the disk drive with the compiler runs almost continuously, and the compilation is much slower.

In conjunction with the Apple II Memory Expansion Card, however, Pascal 1.3 may be worth considering. Pascal 1.3, unlike earlier versions, can use the MEC like a disk drive; it does not, however, use the additional memory as it would use the additional 64K bytes on the 128K Apple IIe. By putting the compiler and source file on this "RAM disk," the program mentioned above compiles in 1:23, with swapping, for a net improvement in compile time.

The big improvement, however, comes when you wish to compile large programs that are broken up into Pascal Units. Units require the swapping option in both versions, and swapping and reading in units used by other units is painfully slow in a two-disk configuration in either version. For example, a 590-line program that uses 9 units and requires swapping takes 3:09 using the disks, and one disk runs continuously. With the compiler and source on the MEC, however, the time is reduced to 1:21, and no disk runs at all.

One can get excellent system performance by putting the editor, filer, system syntax, compiler, and linker files, as well as the program source, on the MEC. You must, however, rename the editor and filer files on the boot disk to force the system to access these files on the MEC. I cheat

(continued)



THE GREAT ESCAPE!

FROM IVORY TOWERS AND
COLD COMPUTER ROOMS TO
THE WARMTH OF YOUR OFFICE.

Artificial intelligence for business
has arrived in a revolutionary new
product . . . Guru.

At last, artificial intelligence designed especially for business! Guru brings together expert system capabilities of artificial intelligence, the productivity of familiar business computing tools and the ease of communicating with your computer using menus, commands or plain English. All available in a single, integrated program.

Guru works like human experts, considering uncertainties, reasoning through forward and backward chaining, asking for more information when needed, and explaining its recommendations.

Guru's expert system works hand-in-hand with all the familiar business computing tools like spreadsheets, statistical analysis, business graphics and a programming language, always available for both expert consultation and your everyday business computing needs.

Best of all, you won't need to learn LISP or PROLOG or buy fancy computers . . . Guru runs on your PC and communicates in plain English! Guru is artificial intelligence that means business.

For more information, call or write Micro Data Base Systems, Inc./Marketing & Sales, P.O. Box 248, Lafayette, IN, 47902, 317/463-2581, Telex 209147 ISE UR.

GURU™

ARTIFICIAL INTELLIGENCE THAT MEANS BUSINESS.

Inquiry 231

by booting the system, transferring the above-mentioned files onto the RAM disk, setting the default disk to the RAM disk, then inserting a boot disk identical to the original but with the appropriate files renamed.

An additional speed advantage occurs in running programs that rely heavily on overlays (non-resident segments); one program took 6:25 using disks and 2:20 on the RAM disk.

A very useful enhancement on version

1.3 permits the user to assign the boot disk to the RAM disk. As it is, the system still insists that the System.Pascal file be on the boot disk, and if one invokes swapping (at the command level, not the compiler option), all swapping is done on the boot disk, which, once again, gets the disks running, slowing things down and making an unnecessary clatter.

One problem I have found is that if the version 1.3 compiler aborts due to stack overflow (which it will without swapping),

some pointer or other is not reset when the system is rebooted, and the compiler will overflow almost immediately. You have to turn off power to reset the system properly. (I haven't bothered to see if 1.1 contains this flaw.) A system crash and reboot does not destroy what is on the RAM disk, but cycling the power obviously does; thus, the above-mentioned problem can be costly in terms of lost work.

In summary, the Pascal 1.3/Memory Extension Card configuration is a good way to upgrade an older 64K Apple for those interested in Pascal. It offers good system response and compile times on complex projects. I bought my MEC with 512K bytes of memory for \$300, and the Pascal 1.3 upgrade for \$125. While I still own a 64K machine, I can compile and run very large programs in a reasonable amount of time.

PHILIP MAHLER
Carlisle, MA

Why buy 3
packages to get
a complete
multi-user
dBASE* System?



After all, FoxBASE is a compiler, an interpreter and a multi-user dBASE system all in one. That means single vendor support and no problems with product incompatibility.

Not only that, FoxBASE actually outperforms dBASE and other dBASE compiler products: its program execution speed is far superior to the competition and its compiler runs up to 60 times faster than other compilers. And FoxBASE is available

FoxBASE™
does it better.
For less.



\$995

for the widest variety of machines and operating systems.

In addition, FoxBASE is interactive and 100% dBASE compatible (including full macro usage). The only thing you won't get is all those annoying dBASE bugs!

Best of all, FoxBASE costs less than half the other packages.

So call (419) 874-0162 now, and ask for a copy of our comparative analysis (including benchmarks). After all . . .

Nothing Runs Like a Fox.

FoxBASE™ 

Fox Software, Inc.
27475 Holiday Lane, Poyrysburg, OH 43551
(419) 874-0162

LOCK UP DIRECTORIES

I enjoyed reading "Making UNIX Secure" by Alan Filipki and James Hanko (April). It was very informative, and the authors were quite thorough in pointing out some of the obscure tricks that can be used to breach security, such as the use of terminal page mode buffering (terminals with programmable answer-back messages suffer the same weakness). However, I feel the authors should have emphasized more strongly the importance of write-protecting directories.

To protect a file from attacks, it is not sufficient to write-protect only the file itself; one must also protect the directory in which it resides. Operations such as file renaming and removing require write permission only on the directory containing the filename, and not on the file itself.

Consider the following scenario: the password file, `/etc/passwd`, is write-protected, but a user has write permission on the `/etc` directory. The user can simply rename (`mv`) the password file and install his or her own. The user can then become superuser, remove his or her password file, reinstall the old one, and wreak havoc. Similarly, if the `/etc` directory is write-protected but the root directory is writable, the user can substitute a dummy `/etc` directory, containing a dummy password file, for the real one. Thus, the only way to ensure the password file is safe from attack is to write-protect the file and all directories leading to it.

Such holes in the security of a system may seem quite obvious and unlikely to occur, but it is surprising to find that there are systems out there that are so vulnerable to attack. The preceding trick is one

(continued)

THE NO FRILLS PLOTTER

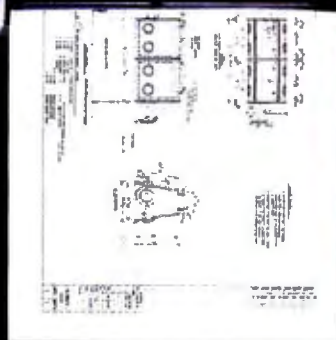

Enter the world of professional CAD applications with Houston Instrument's low cost DMP-41/42 series plotters. These single-pen plotters give you the features you need—C and D size plots, extensive software compatibility, and proven reliability—for a very affordable no frills price of \$3295.*

The DMP-41/42 series' large C and D size formats are ideal for a wide range of CAD applications, from architectural elevations to assembly drawings. And a .005 inch resolution ensures crisp drawings on a variety of media—paper, matte film, or vellum.

Inquiry 168

With the DMP-41/42 series, you can choose from an impressive selection of off-the-shelf graphics software packages such as VersaCAD, AutoCAD, and CADKEY. Or, by using Houston Instrument's popular DM/PL™ language, you can create your own custom software and be assured of upward compatibility with Houston Instrument's entire line of plotters.

The DMP-41/42 series. The plotters that offer superb reliability, comprehensive graphics capabilities, and a no frills price. The proven performers for low-cost CAD.

For more information, call

1-800-531-5205 (512-835-0900 if in Texas), or write Houston Instrument, 8500 Cameron Road, Austin, Texas 78753. In Europe, contact Houston Instrument, Belgium NV., Rochesterlaan 6, 8240 Gistel, Belgium. Tel.: 32-(0)59-277445. Tlx.: 846-81399.

*U.S. suggested retail price. Pricing subject to change.
DM/PL is a trademark of Houston Instrument.

houston instrument

A Division of **AMETEK**

JULY 1986 • BYTE 21

I had to resort to when I was called in to "repair" the password file on a demo system, where the superuser password had been changed by a user and subsequently forgotten. I then took it upon myself to lecture the owners of the system on the importance of maintaining proper security. The security mechanisms provided by UNIX won't help anyone if they are not used correctly.

GILBERT DETILLIEUX
President, Info West
Winnipeg, Manitoba
Canada

"LOOK AND FEEL" ISN'T EVERYTHING IN THIS CASE

James E. Bransfield's letter in the April BYTE (page 14) applauding Apple's "victory" over DRI by no means represents the thoughtful opinion of all of the computer law community. Indeed, the letter sounds more like a brief written in support of Apple's position than a reasoned exposition of a difficult issue.

All of the cases cited by Bransfield are inappropriate in some critically important way. For example, in *SAS Institute, Inc. v. S&H Computer Systems, Inc.*, 605 F. Supp. 816 (M.D.

Tenn. 1985), the defendants took much more than just the "look and feel" of SAS's product. They licensed a copy with the express purpose of adapting it to run on a VAX. They used SAS's source code to design and write their own program. The facts of this and the other cases on which Mr. Bransfield relies hardly support his contention that all the defendants did was to misappropriate a "look and feel."

The Supreme Court of the United States has stated many times that ideas themselves are not copyrightable; only the expression of an idea can be copyrighted. Courts have often had trouble determining where the idea ends and its expression begins, but the distinction must remain. In my opinion, Apple has tried to appropriate an idea (and someone else's idea at that) to itself and extend the law of copyright beyond its constitutional bounds.

If Apple's screen design was sufficiently unique, then it could have been copyrighted in its own right as an audiovisual work. If the screen design was so trivial as not to warrant a copyright, then Apple should not be permitted to gain legal protection for it through the back door by

claiming such protection through the copyright on the software which produces the design.

If DRI truly misappropriated Apple's software, then they should be made to pay. But if they did not, then we, the computer users, should not be made to pay by allowing Apple to usurp through force that to which it has no legal right.

MICHAEL GEMIGNANI
Muncie, IN

I wish to point out that if you accept James E. Bransfield's comments as an authoritative statement of the law without qualification, then you are doing your readers a grave disservice. It is apparent from the marked bias of his comments that either he has not done his research carefully or he is intentionally providing only one very selective view of the cases and concepts related to this area of litigation. I would like to balance that view.

I have been following with interest the articles, editorials, letters, and news concerning the issue of visual copyrights and software "clones" in both your magazine and periodicals such as *InfoWorld*. This area

(continued)

MERCEDES-BENZ EUROPEAN DELIVERY: ADD PLEASURE, SUBTRACT EXPENSE.



Send coupon to:
Mercedes-Benz of North America, Inc.
Marketing Communications Division
One Mercedes Drive, Montvale, NJ 07645



Name _____

Address _____

City _____

State _____ Zip _____

© 1986 Mercedes-Benz of N.A., Inc., Montvale, NJ.

MHJU86-5

Plan to make European delivery of a new Mercedes-Benz part of your 1986 European vacation plans. Select any 1986 gasoline or diesel model,* pick it up at the factory European Delivery Center—and embark on a deluxe driving vacation. Avoiding costly rentals while saving on the price of your new Mercedes-Benz. Send coupon for a free European Delivery brochure today.

*Subject to availability.

NOW YOU CAN TAKE IT WITH YOU WHEN YOU GO

TECH PC Portable computers are designed for travel. Each unit is housed in an attractive yet functional case designed to allow maximal expandability with minimal difficulty. The units can be configured to be as powerful as any desktop and yet have the mobility of a fully portable unit. These units are truly designed to meet the needs of the individual on the go.

The TECH PC/XT PORTABLE weighs in at less than 40 pounds and is ideal for the individual who has limited desk space or the business executive who is often traveling.

Like our TECH PC DESKTOPS, the TECH PC PORTABLES run all software designed for the IBM PC, and compatibles, such as: dBase III, Lotus 123, Symphony, Wordstar, Wordperfect, Framework, programs based on MS-DOS, PC-DOS, PICK, CP/M86, and UCSD p-system operating systems.



TECH PC PORTABLE COMPUTERS are available now in 4 different base models:

TECH PC/XT PORTABLE\$ 999

Options:

Tech Turbo PC/XT Portable with 20 MB Hard Disk\$1499

Tech Turbo PC/XT Portable with 1200 Baud Internal Hayes Compatible Modem and 20 MB Hard Disk\$1699

TECH TURBO PC/XT PORTABLE ...\$1095

Options:

Tech Turbo PC/XT Portable with 20 MB Hard Disk\$1595

Tech Turbo PC/XT Portable with 1200 Baud Internal Hayes Compatible Modem and 20 MB Hard Disk\$1795

TECH PC/AT PORTABLE\$1999

Options:

Tech PC/XT Portable with 20 MB Hard Disk\$2299

Tech PC/XT Portable with 1200 Baud Internal Hayes Compatible Modem and 20 MB Hard Disk\$2499

TECH TURBO PC/AT PORTABLE ...\$2099

Options:

Tech PC/XT Portable with 20 MB Hard Disk\$2399

Tech PC/XT Portable with 1200 Baud Internal Hayes Compatible Modem and 20 MB Hard Disk\$2599

All TECH PC PORTABLES available with tape backups, hard disks up to 280 megabytes, networking systems, and hundreds of other hardware and software accessories.

TECH PERSONAL COMPUTERS is a full service manufacturer of Micro Computer Products and offers a complete line of Desktop, Portables and Multi-User Computer Systems as well as an accessory line of over one hundred enhancement products. **TECH PERSONAL COMPUTERS** are all backed by a full one year warranty with additional maintenance coverage and extended maintenance contracts available through Mohawk Data Sciences. For more information concerning hundreds of MDS Service Centers throughout the United States, contact **TECH PERSONAL COMPUTERS** at (714) 754-1170.



TECH PC

714/754-1170

2131 S. Hathaway, Santa Ana, California 92705

TELEX: 272006 Answer Back-TECH FAX: 714/556-8325

Inquiry 353 for End-Users. Inquiry 354 for DEALERS ONLY.

of controversy is not only unsettled in the user community, it is also unsettled in the law. The issue is not terribly complex technically, which is unusual when one is presented with a legal problem involving computers, but it is very complex legally. Copyrights and intellectual property rights in general are not easily understood. Also, since software is not only a written work but is also a functional artifact of man's intelligence, copyrights are not very well tailored to meet the needs of protecting

both developers and users of microcomputer software.

Copyrights do not protect ideas. (Although Broderbund's attorney seems to think so... see *InfoWorld's* "'Look and Feel' Discussed as Major Copyright Issue," 11 November 1985, page 13.) Copyrights protect the expression of an idea. The idea need not be original, only the method of expressing it. The idea must be "fixed in a tangible medium of expression." This includes written on paper, recorded on

magnetic disks, chiseled on stone tablets, etc. When the author has complied with all of the requirements of the copyright laws, the holder of the copyright is protected from an unauthorized person making a copy of the work. The ideas themselves are not protected from copying, only the author's particular expression of them. Works directly derived from that expression of ideas are also prohibited.

In order to prove that someone has infringed upon the rights of the copyright holder, one normally must show access to the copyrighted work and a substantial similarity between the copy and the original. This is where many of the problems of copyrights and computers crop up. There was at one time a significant doubt that the copyright laws actually protected the object code of a functioning program. The copyright act was amended to make that protection clear. While that doubt existed, many software companies, particularly games producers, copyrighted the screen displays of their programs to prevent piracy of their products. This way, at least, a large portion of the work was protected. Such graphic and visual screens could be protected in the same way video images (TV programs, films, etc.) are protected. With the explicit recognition by Congress and the courts of copyright protection for both source and object code—which, of course, includes the screen information—the practice of copyrighting the screen displays or attract modes of games was no longer important. However, the idea of preventing the copying of such "screens" is obviously once again becoming important to many people.

In addition to the *Apple v. DRI* case, the controversy between MicroStuf and SoftKlone over the Crosstalk clone *Mirror* is an obvious example of this concern. I can easily see why companies that produce expensive but popular software would be interested in legal methods to stop people from using the unreasonably large profit margin of their product to cut them out of a part of their market share. In producing a product that does not have any connection with the actual code of the popular program but has similar appearance, identical command sets, and perhaps improved features for a more reasonable price, the competition can often capture a large portion of the market that would otherwise belong to the first company by default. One might take note that Borland International doesn't have much of a problem with this phenomenon.

While I agree with Mr. Bransfield's analysis that the protection of the source
(continued on page 387)

If you can't share files on your network, you're using the wrong file manager.



Be connected. Btrieve.®

Networks can solve problems. But running a single-user file manager can create new ones: Lost updates. Garbled data. Trashed files.

Btrieve® /N offers safe multi-user file management that protects your data when sharing files. And eliminates the need to rewrite your application for LANs. Btrieve/N sets the file management standard for the industry's most popular networks, as well as XENIX and other multi-user systems.

Fast. Btrieve/N is fast, too. It's written in assembly language especially for the IBM PC. And based on b-tree file indexing, for access speed that won't degrade as your database grows.

Automatic file recovery. Btrieve/N provides automatic file recovery after a system crash. Your Btrieve data al-

ways comes back intact.

Fully-relational data management. SoftCraft's entire family of products gives you a complete, fully-relational database management system. Rtrieve™/N adds report writing capabilities. Xtrieve™/N speeds users through database queries with interactive menus.

For professional programmers. Btrieve/N is the fast, reliable answer for all your application development in BASIC, Pascal, COBOL, C, FORTRAN and APL. With Btrieve/N, you can develop better network applications. And solve problems, not create new ones.

SC SoftCraft Inc.

P.O. Box 9802 #917 Austin, Texas 78766
(512) 346-8380 Telex 358 200

Suggested retail prices: Btrieve, \$245; Btrieve/N, \$595; Xtrieve, \$245; Xtrieve/N, \$595; Rtrieve, \$145; Rtrieve/N, \$345. Requires PC-DOS or MS-DOS 1.X, 2.X, or 3.X. NO ROYALTIES.

High-Speed Animation on Your IBM PC!

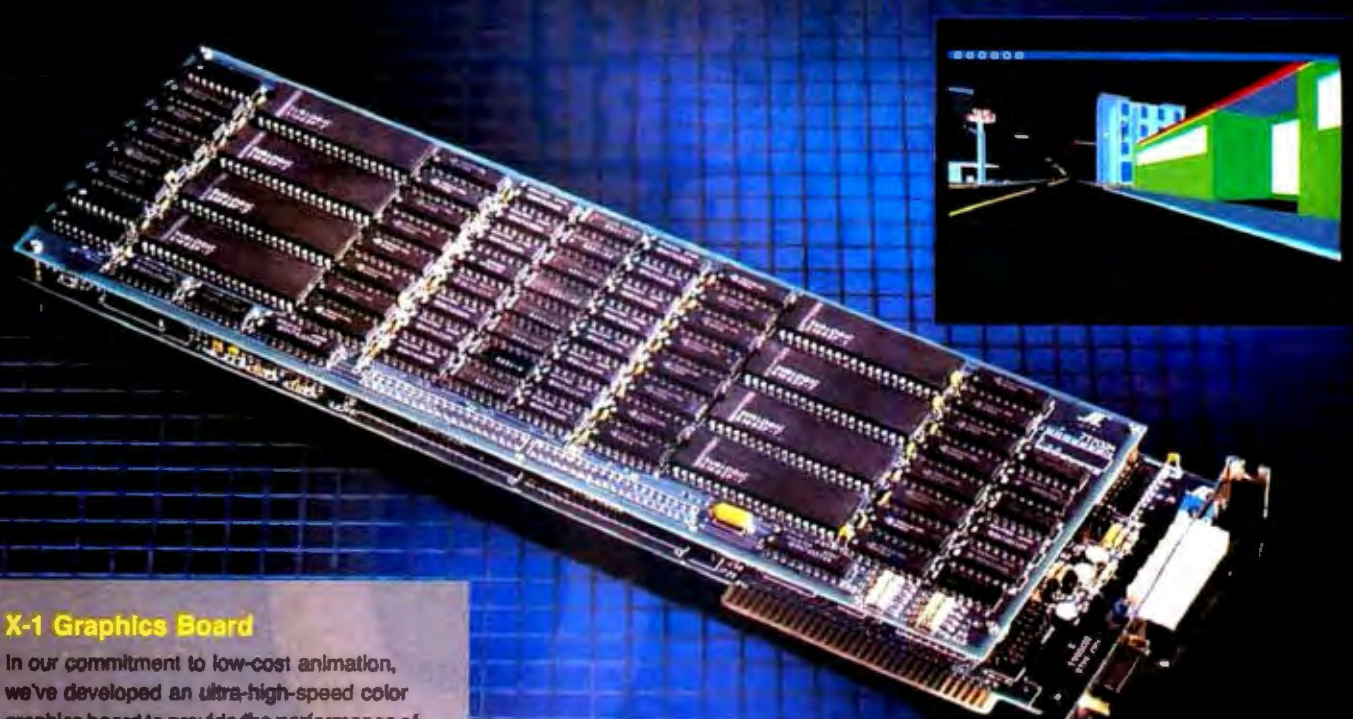
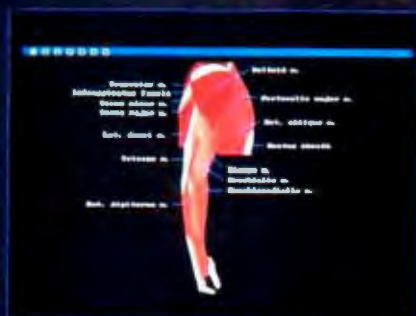

X-1 Graphics Board

In our commitment to low-cost animation, we've developed an ultra-high-speed color graphics board to provide the performance of expensive dedicated graphics systems on an inexpensive, user-friendly IBM PC. This board's 400-million bits-per-second color-fill rate offers animation speeds never before available on a PC plug-in board (the X-1 is 10 times as fast as any other PC graphics card we've seen). The low-cost, high-performance X-1 Graphics Board opens up entirely new applications for microcomputer-based graphics.

3D Graphics Software for use with the Standard IBM Color/Graphics Adapter or X-1 Graphics Board

Our 3D Graphics software, the graphic drivers behind Jet and Microsoft Flight

Simulator, opens up new worlds of 3D and 2D animation. The program works with both the IBM Color/Graphics Adapter and the X-1 Graphics Board, so you can update your hardware at any time and maintain software compatibility.

Specs: The X-1 Graphics Board is available for \$2990 and requires an IBM PC or PC-compatible computer with minimum 128K RAM, PC-DOS or MS-DOS Version 2.0 or newer, and an X-1 compatible RGB display monitor.

The 3D Graphics software is available for \$995, and requires an IBM PC or PC-compatible computer with minimum 256K RAM, PC-DOS or MS-DOS Version 2.0 or newer, and either an IBM Color/Graphics Adapter or the X-1 Graphics Board.



See your dealer for details and a special hardware/software demonstration, or call SubLOGIC directly for more information.

IBM is a registered trademark of International Business Machines Corp.

subLOGIC
 Corporation
 713 Edgebrook Drive
 Champaign IL 61820
 (317) 251-6482 Telex: 296985

Order Line: (800) 637-8853

Inquiry 339

**YOUR
COMPUTER LANGUAGE
IS QUIETLY
BREEDING REAL BATS
IN YOUR
BELFRY.**



WE'RE OUT TO SAVE ONE MILLION FRUSTRATED PROGRAMMERS

You're on a roll, really pumped, writing the best code you have ever written and then—AAARGHHH!

Freeze dried in your tracks because the language you're using just won't let you achieve what you can conceive.

And you wanted to be a programmer.

So your choices are:

1) write around the problem by creating six pages of emetic code...

2) leave out that incredible idea that really puts your stamp of excellence on this program or...

3) get yourself a world class headache (or a stroke) by dropping into assembler.

Whatever you choose, by now you feel the language is out to get you—because it is.

Sure, no language is perfect, but you have to wonder, "Am I getting all I deserve?"

And, like money, you'll never have enough.

Pretty dismal, huh?

We thought so, too.

So we did something about it.

We call it CLARION.

You'll call it incredible.

With CLARION you can write, compile, run and debug complex applications in a New York afternoon.

Even if you're in Savannah.

It gives you the power and speed to create screens, windows and reports of such richness and clarity you would never attempt them with any other language.

Because YOU would have to write the code.

With CLARION you simply design the screens using our SCREENER utility and then CLARION writes the source code AND compiles it for you.

In seconds.

Likewise, you can use REPORTER to create reports. Remember, only CLARION can recompile and display a screen or report layout for modification.

And with no time wasted.

All the power and facilities you need to write great programs, faster

than you ever dreamed of.

Programs that are easy to use.

Programs that are a pleasure to write.

And to you that means true satisfaction.

You've coveted those nifty pop-up help windows some major applications feature. But you can't afford the time and energy it takes to write them into your programs.

That's the way it used to be.

So we fixed that, too.

CLARION HELPER is an interactive utility that let's you design the most effective pop-up help screens that you can imagine. And they're "context sensitive," meaning you can have help for every field in your application.

Unlike the other micro languages, CLARION provides declarations, procedures and functions to process

dates, strings, screens, reports, indexed files, DOS files and memory tables.

Imagine making source program changes with the CLARION EDITOR. A single keystroke terminates the EDITOR, loads the COMPILER, compiles the program, loads the PROCESSOR and executes the program. It's that easy!

Our data management capabilities are phenomenal. CLARION files permit any number of composite keys which are updated dynamically.

A file may have as many keys as it needs. Each key may be composed of any fields in any order. And key files are updated whenever the value of the key changes.

Like SCREENER and REPORTER, CLARION's FILER utility also has a piece of the CLARION COMPILER. To create a new file, you name the Source Module. Then you name the Statement Label of a file structure within it.

FILER will also automatically rebuild existing files to match a changed file structure. It creates a new record for every existing record, copying the existing fields and initializing new ones.

Sounds pretty complicated, huh?

Not with CLARION's documentation and on-line help screens. If you are currently competent in Basic, Pascal or "C" you can be writing CLARION applications

in a day. In two days you won't believe the eloquence of your CLARION programs.

Okay, now for the best part of all. You can say it in CLARION for \$295.00—complete. All you need is an IBM® PC, XT, AT or true compatible, with 320 KB of memory and a hard disk drive.

And we'll allow a full 30 day evaluation period. If you're not satisfied with CLARION, simply return it in its original condition for a full refund.

If you're not ready to take advantage of this no-risk opportunity, ask for our detailed 16 page color brochure. It vividly illustrates the elegance of CLARION. Consider it a preview of programming in the fast lane.

Either way, the call's a freebie.



SAY IT IN

CLARION™

DEPT. A1BY/2

1-800-354-5444



BARRINGTON SYSTEMS, INC. • P.O. BOX 5580 • POMPANO BEACH, FL 33074 • 305/785-4555

IBM® is a registered trademark of International Business Machines Corporation. CLARION™ is a trademark of Barrington Systems, Inc. ©1986 Barrington Systems.

MORE USERS FOR YOUR PC

Advanced Digital's PC-Slave is the solution to your multi-user or local area network problems.



Just plug Advanced Digital's PC-Slave board into your PC expansion slot, a connecting cable, a low-cost dumb terminal or a PC look-alike terminal and you're in business. As many as 31 low-cost workstations may be added to your IBM-PC, AT, XT, and the compatibles. Share a common data base without loss of speed or efficiency since each PC-Slave has its own 8088 CPU, 256-768K RAM dedicated to each user. Advanced Digital provides additional software which supports File & Record locking and print spooling. Advanced Digital's slave concept provides the best multi-user PC system available today! For the location of the dealer nearest you contact:

Advanced Digital Corporation
5432 Production Drive
Huntington Beach, CA 92649
(714) 891-4004 / (800) 251-1801
Telex 183210 ADVANCED HTBH

 **ADVANCED
DIGITAL
CORPORATION**

Advanced Digital U.K. Ltd.
27 Princes Street, Hanover Square
London W1R8NO-United Kingdom
(01) 409-0077 (01) 409-3351
TLX 265840 FINEST

Regional Distributors: In California, Thomas Data Systems, Inc. (213) 214-4681;
In Ontario, Canada, B&L (416) 299-7680; In Australia, Archives Computers (03) 699-8377; In New York, Quinn Data (914) 939-0002

Inquiry 2 for End-Users. Inquiry 3 for DEALERS ONLY.

TeleVideo's \$2995 AT Compatible

TeleVideo Systems introduced the TeleCAT-286, an IBM PC AT-compatible computer priced at \$2995. Designed primarily as a single-user computer rather than a multiuser system or file server, the TeleCAT-286 is 28 percent smaller than the IBM PC AT, the company says, and uses custom-designed chips that reduce the number of components on the system board.

The TeleCAT-286 runs on an Intel 80286 microprocessor operating at 6 or 8 MHz and comes with 512K bytes of RAM that can be expanded to 1 megabyte on the main board. Equipped to hold three internal storage devices, the base model has a 1.2-megabyte 5¼-inch floppy disk drive and a 20-megabyte hard disk drive. The system comes with an AT-compatible keyboard as well as a 14-inch, tiltable monochrome monitor with a graphics resolution of 640 by 400 or 640 by 200 pixels. Other features include one serial and one parallel port and five AT-compatible expansion slots, two of which are occupied by video driver and disk controller cards.

The TeleCAT-286 can be connected to a TeleVideo Personal Mini network file server, as well as to some PC networks. Besides running PC AT software, the new TeleVideo machine can take PC AT and PC XT expansion boards. A system with a 30-megabyte hard disk drive costs \$3495. MS-



The TeleCAT-286, an AT-compatible computer from TeleVideo.

DOS 3.1 and GW-BASIC 3.1 sell for \$85. For more information, contact TeleVideo Systems Inc., 1170 Morse Ave., Sunnyvale, CA 94086, (408) 745-7760. Inquiry 550.

Modeling/Analysis Package for IBM PCs

Pacific Crest Software likens its modeling and analysis program, Point Five, to a word processor for numbers. At its basic level, the package is similar to a programmable calculator; it has 150 mathematical, financial, statistical, and data-manipulation functions.

The program displays a split screen. In the lower part, the "Scratchpad," you

enter functions and formulas. When you press Enter, the software executes the commands and then shows the results in the top part of the screen. Simple commands convert the results from numerical to graphic form. The data and the programs written to manipulate the data are saved separately. Pacific Crest says this makes it easy to analyze the same sets of data with different methods or develop applications that can be applied to different data sets for recurring calculations.

Point Five runs on IBM PCs and compatibles that have at least 256K of memory and two floppy disk drives. It requires MS-DOS 2.0 or later and can be used with an IBM- or Hercules-compatible graphics card and the 8087 coprocessor.

Point Five costs \$195; site licenses are available. Contact Pacific Crest Software, 887 Northwest Grant Ave., Box 2098, Corvallis, OR 97339, (503) 754-1067. Inquiry 551.

Portable Unit Has Printer, Smart Keyboard

Datavue, Quadram Corp.'s offshoot that specializes in portable computers, introduced its FreeStyle system, which includes a new portable daisy-wheel printer and an "intelligent" keyboard. The 6-pound battery-powered printer, called the WriteStyle, is reported to print at 14 characters per second.

The 3-pound keyboard, called the KeyStyle 80, features its own Z80 processor, 96K bytes of memory, word processing and communications software, and an 80-column by 8-line LCD. The KeyStyle 80 also has an infrared link that can connect with either the WriteStyle printer or the Datavue 25, Datavue's portable IBM PC-compatible computer.

The WriteStyle has a list price of \$349. The KeyStyle 80 keyboard costs \$349. Both products will sell together for \$599. An optional modem is available for the keyboard. Contact Datavue, One Quad Way, Norcross, GA 30093-2919, (404) 564-5668. Inquiry 552.

(continued)

Program Helps Word Processors Print Math Expressions

Technical Support Software has developed a program that enables many word processors to print mathematical and scientific expressions within documents. One of the key features of EXACT (expression and character typography) is a split-screen editing space you can use without exiting your text program.

EXACT loads into RAM before your word processor. At any time, you can call up the split screen. You type EXACT commands in the bottom half, and the program flashes the math expressions in the top half in a "what you see is what you get" fashion. Expressions can be edited by changing command lines. Radicals, fractions, brackets, and tables change automatically when you alter the material they contain. When you return to your word processor, you place the cursor where the expression belongs in the document. When you tell your text package to print, EXACT scans the print stream, finds its commands, and sends a graphics image to the printer to draw the expression.

The software has 20 fonts with more than 1000 symbols and characters, a font editor, a complete Greek set, script and italics, and automatic selection of smaller characters for superscripts and subscripts.

TSSI says its typesetting package works with XyWrite II Plus, WordStar, Volkswriter, Word, Final Word, Easy Writer, Perfect Writer, WordPerfect, DisplayWrite 2 and 3, and several other word processors. EXACT runs under MS-DOS 2.0 or later and requires 128K of memory and a color or monochrome graphics card.



TSSI's EXACT enables word processors to print math expressions.



WordTech's dBaseXL has a "tutor" to help construct commands.

Drivers are available for dot-matrix and laser printers. EXACT costs \$475; a demo costs \$5. Contact Technical Support Software Inc., 72 Kent St., Brookline, MA 02146, (617) 734-4130. Inquiry 553.

Low-Cost Database Works with dBASE III Plus

WordTech Systems is selling a database management system it says is fully compatible with Ashton-Tate's dBASE III Plus. Called dBaseXL, the \$169 sys-

tem uses the same data and index files as dBASE III Plus; supports the same syntax, reports, and format files; and provides networking capability.

With dBaseXL, you can have as many as ten files open simultaneously, each with seven open index files. The package has two levels of context-related on-line help. Initial versions run under MS- and PC-DOS 2.0 or later. The program needs 192K of RAM clear of the operating system or device drivers. Contact WordTech Systems Inc., P.O. Box 1747, Orinda, CA 94563, (415) 254-0900. Inquiry 554.

Color Ink-Jet Printer Uses Plastic Ink

Howtek has developed a color ink-jet printer, the PixelMaster, that uses 32 ink jets to produce what the firm calls "near offset quality" printing. The \$2995 device provides raised text and color graphics output with a resolution of 240 by 240 dots per inch on standard 8½-by-11-inch paper.

The PixelMaster is distinguished from other color printers in its use of solid plastic ink, which is designed to minimize, if not eliminate, the problems of smudging and clogging that often occur with traditional water- or oil-based ink-jet printers. In the PixelMaster, plastic ink from a crayon-like rod is melted, allowing the ink to be sprayed as a liquid that solidifies instantly on contact with the paper.

The printer's proprietary Thermo-jet ink jets use four basic colors: magenta, yellow, cyan, and black. It's capable of producing over 250,000 shades of color, the firm claims, and has 20 black ink jets for printing text at a rate of about 30 seconds per page. The PixelMaster also has 16 fonts contained in plug-in ROM cartridges and can reproduce images entered into computers from optical and image scanners.

The printer is designed as a freestanding floor model and is expected to ship this September. Parallel and serial interfaces will be available, according to a company spokesman, who also said that the firm is currently negotiating with other vendors to sell the machine. For more information, contact Howtek Inc., 21 Park Ave., Hudson, NH 03051, (603) 882-5200. Inquiry 555.

(continued)

You need Borland's Traveling SideKick because wherever you go, there's work to be done

Traveling SideKick™ is the only personal organizer developed from and designed for the Computer Age.

An electronic leap ahead of traditional diaries, day-timers and organizers, Traveling SideKick is BinderWare™ that includes a software program, a report generator, reference materials, maps, addresses, appointments, telephone numbers, calendars, customer lists, travel itineraries, a calculator, and much much more.

You need Traveling SideKick because it is the new Computer Age way to take all your facts, files and figures with you wherever you go—whether you're taking work home or heading out across America and the world.

Traveling SideKick is your SideKick's sidekick

More than half a million of you already know how indispensable SideKick, the RAM-resident desktop manager, is on your IBM® PC (So do many Macintosh™ owners who are now using our SideKick/Mac version). While SideKick enjoys the rank of #1 best seller for the IBM PC, it can

What's inside your Traveling SideKick



TABLET OF EXTRA FORMS: IN POCKET ON BACK FLAP FOR USE IN ANY OF THE ORGANIZER SECTIONS.

ADDRESS BOOK SECTION: PREPRINTED ADDRESS FORMS WITH TABBED DIVIDERS FOR EASY REFERENCE.

MISCELLANEOUS SECTION: TO STORE ALL EXTRA PREPRINTED FORMS AND COMMONLY USED RECORDS.

ROLLER BALLPOINT PEN: BLACK FOR THE PEN FLAP FOR EASY ACCESS.

REFERENCE SECTION: CONCERNING MAPS THAT SHOW AREA CODES AND TIME ZONES, TOLL FREE NUMBERS FOR TRAVEL, ACCOMMODATIONS, AIR TRAVEL, CONVERSION CHARTS.

FINANCE SECTION: MULTI USE LOGBOOK FORMS, RECEIPT LOG AND STORAGE ENVELOPE, CREDIT CARD INFORMATION.

CALENDAR SECTION: YEARLY, MONTHLY, WEEKLY, AND DAILY ENGENDERING CALENDARS SUPPLEMENT THOSE YOU PRINT OUT WITH TRAVELING SIDEKICK.

PENDING SECTION: A "TO BE COMPLETED" SECTION FOR CLARIFY PROJECTS, MEETINGS, NOTES, ETC.

CALCULATOR: IN ONE OF TWO BUSINESS-CARD-SIZE STORAGE POCKETS.

TRAVELING SIDEKICK SOFTWARE: GENERATES, UPDATES, AND PRINTS YOUR ADDRESSES AND CALENDAR FILES.

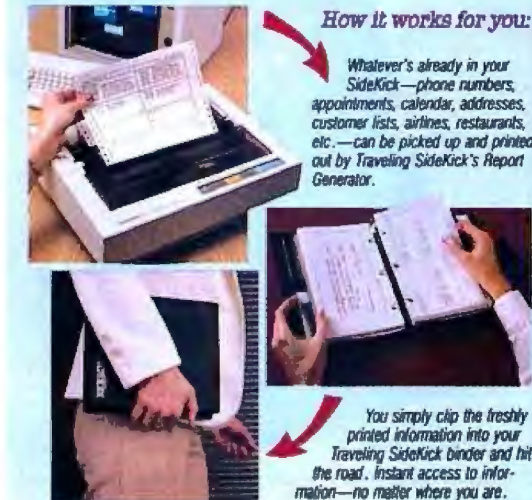

How it works for you:

Whatever's already in your SideKick—phone numbers, appointments, calendar, addresses, customer lists, airlines, restaurants, etc.—can be picked up and printed out by Traveling SideKick's Report Generator.

You simply clip the freshly printed information into your Traveling SideKick binder and hit the road. Instant access to information—no matter where you are.

Naturally, you can add new information/files/data to your SideKick as it occurs. Traveling SideKick instantly incorporates all changes and updates. Traveling SideKick will also sort your address files by name, zip code, or company name. It prints mailing labels and other information selectively, and will search your files for existing addresses and appointments.

only go where your computer goes—so if your computer stays in your office or den, so does SideKick. Traveling SideKick changes all that.

For a limited time, Traveling SideKick is only \$69.95

Until September 1, 1986, you can get Traveling SideKick for

just \$69.95—which is tremendous short-term and long-term value. Short-term because it solves immediate problems at a very low price, and long-term because Traveling SideKick works this year, next year, and all the "next years" after that. (Unlike old-fashioned daytime organizers, electronic organizers and calendars aren't obsolete at the end of the year.)

Special Offer: Get both SideKick and Traveling SideKick for only \$125.00

You probably already have SideKick, but in case you don't, we're offering you both SideKick and Traveling SideKick for only \$125.00. (SideKick alone is usually \$64.95. Add that to Traveling SideKick's \$69.95, and you're looking at \$154.90—which you don't have to look at, because you get \$29.90 off when you buy both.) Whichever way you buy, you're getting our 60-day money-back guarantee** and making a highly organized and productive step into modern business life.

Traveling SideKick is an organizer, a binder, a software program and a report generator that picks your SideKick's brain, then prints out your appointments, daily, weekly, monthly, or yearly calendar, your phone lists, and mailing labels, itinerary, or whatever else you need.

YES!

I want the best

Rush me Traveling SideKick at:

\$69.95*

Or both Traveling SideKick & SideKick at \$125.00.*

To order by phone, or for a dealer near you, call (800) 255-8008 in CA call (800) 742-1133

Send me _____ Traveling SideKick(s) at \$ _____

Send me _____ of both SideKick(s) at \$ _____

Outside USA add \$10 per copy

CA and MA res. add sales tax \$ _____

Amount enclosed \$ _____

Prices include shipping to all U.S. cities

Payment: VISA MC Bank Draft Check

Credit card expiration date _____

Card # _____



4585 SCOTT'S VALLEY DRIVE
SCOTT'S VALLEY, CA 95066
(408) 438-8400 TELEK 172373

Borland products include Turbo Pascal, Turbo Database Toolbox, Turbo Lighting, Turbo Graphics Toolbox, Turbo Tutor, Turbo GameWorks, Turbo Editor Toolbox, Reflex, The Analyst, SideKick, SideKick, The Macintosh Office Manager, Traveling SideKick, and SuperKey—all of which are trademarks or registered trademarks of Borland International, Inc. or Borland/Analytics, Inc. Copyright 1989 Borland International 89-1045D

Inquiry 47 for End-Users. Inquiry 48 for DEALERS ONLY



Toshiba's Portable AT Compatible

Toshiba America introduced its T3100 portable computer, which is compatible with the IBM PC AT and features a gas-plasma display and built-in hard disk drive.

Priced at \$4499, the 15-pound portable runs on an 8-MHz 80286 processor and comes with 640K bytes of memory, expandable to 1.6 megabytes with an optional 1-megabyte add-on board. The computer has a 720K-byte 3½-inch floppy drive, an internal 10-megabyte hard disk drive, and an optional 5¼-inch floppy drive.

The portable's fold-up gas-plasma screen displays 80 characters by 25 lines with a resolution of 640 by 400 pixels. Compatible with software written for the IBM Color Graphics Adapter, the computer is equipped with an interface for an RGB color monitor and parallel and serial ports.

Options include an internal Hayes-compatible 1200-bps modem and an expansion chassis with five full-length IBM PC-compatible slots that plugs into a bus on the back of the computer. Among the other options are an external 15-key numeric keypad and PC Floppy Link (\$99), a half-length interface card and cable for IBM PC and XT compatibles that enables you to use those computers' drives as external drives for the portable. According to the company, a version of PC Floppy Link for the IBM PC AT and compatibles will be available soon. Prices for other options had not been established as of this writing.

Toshiba says it will begin shipping the T3100 this month. It will be bundled with MS-DOS 2.11, GW-BASIC, a power cord, and a



Toshiba's T3100, a portable with a gas-plasma display and internal hard disk drive.

carrying case. Contact Toshiba America Inc., Information Systems Division, 2441 Michelle Dr., Tustin, CA 92680, (800) 457-7777; in California, (714) 730-5000. Inquiry 556.

LCD Panel Links with Projector

Sayett Technology introduced a projection system that weds LCD technology to an overhead projector. The Sayett System 10 uses a standard LCD panel that you connect to a computer and place on the glass plate of an overhead projector. Instead of taking light in and reflecting it out as LCDs normally do, the system passes the light through to the overhead projector.

The system includes an electronic control board and an LCD panel that allows for the projection of digitized text or graphics generated from an IBM PC or compatible. A standard 9-pin RGB port on the computer (or a modem for remote presentation) is required for connecting the Sayett system, which supports output in monochrome or one tinted color.

The \$1200 system will include a graphics presentation program called Show Partner (from Brightbill-Roberts in Syracuse, New York) that can be used to develop slideshow-like presentations of graphic and textual material in a pre-timed sequence. Show Partner can be used to create original graphics or incorporate images from other programs that can then be shown on the Sayett unit. A standard 5¼-inch disk can store "several hundred image cells," according to the company.

Sayett Technology, a wholly owned subsidiary of Eastman Kodak, says the system should be available this month. Contact Sayett Technology, 1133 Mt. Read Blvd., Rochester, NY 14606, (716) 458-0177. Inquiry 557.

Amiga Database

Transtime Technologies has developed a database software package for Commodore's Amiga. Datamat is a relational database

program written in C with an interface that uses English-language menu selections. It incorporates the major features of high-end DBMSs, the company says, and also provides statistical functions.

Using Datamat, you build the database with a data dictionary that contains facilities for adding, modifying, listing, calculating, and shifting variables, as well as for extracting variables from existing dictionaries. The program also has math functions, sort and merge capabilities, user-definable procedures, multilevel passwords, database scanning, and one-step data conversion. A single query can have as many as 26 selection criteria.

The suggested price for Datamat is \$350. In addition to running on the Amiga, it runs on MS-DOS, ZDOS, XENIX, and UNIX machines. Contact Transtime Technologies Corp., 797 Sheridan Dr., Tonawanda, NY 14150, (716) 874-2010. Inquiry 558.

Iomega Develops 20-megabyte Floppy Drive

Iomega, maker of the Bernoulli Box line of high-density floppy disk drives, announced a 5¼-inch half-height drive that can store 21.4 megabytes of data. The new drive uses a special floppy disk enclosed in a hard plastic case. The medium—the plastic substrate and magnetic coating—is similar to that of a standard floppy disk.

The drive, called the Beta 20, will be sold only to OEMs. In quantities of 10,000 units, the drive will have a price of \$370 and is slated to be available in the third quarter of this year. A controller, which can work

(continued)

Why running your business without Borland's Reflex and the new Reflex Workshop is an act of blind faith

Running a successful business isn't something you can do with your eyes shut, but no matter what business you're in, Reflex™ and the new Reflex Workshop™ give you all the tools and views to see what all the numbers look like.

Using Lotus 1-2-3™ or dBASE™ without Reflex is like driving at night without lights

Products such as 1-2-3 or dBASE can do the numbers for you, but you may still not get the picture—simply because they can't show you analytical graphs and pictures of your data, nor can they analyze and summarize all the information you manipulate like Reflex can.



The best just got better. Introducing Reflex 1.1 **NEW!**

The new Reflex 1.1 with extended memory support allows you to manage huge databases of up to 8 megabytes of RAM, 32,000 records, and 260 fields per record with the now-legendary "Reflex Lightning Speed." Furthermore, Reflex 1.1 with its VGA support displays 40 lines of information in its spreadsheet-style List View, compared to less than 26 lines displayed by traditional spreadsheets.

Reflex gives you five graphic ways of looking at your data, five different ways of analyzing your information.

The FORM VIEW lets you build and examine your database

The LIST VIEW lets you put data in tabular list form just like a spreadsheet

The REPORT VIEW allows you to generate everything from making labels to sophisticated reports. You can use database files created with Reflex or transferred from 1-2-3, dBASE, PFS FILE, and other applications

The GRAPH VIEW gives you instant interactive graphic representations

The CROSTAB VIEW gives you amazing "cross-referenced" pictures of the links and relationships hidden in your data.

SPECIAL OFFER!

If you already bought Reflex 1.0, get Reflex 1.1 and the Reflex Workshop for only \$59.95

Because you bought Reflex from us, you're "our kind of people." And since we're not the "take-the-money-and-run" kind of company, you can upgrade to Reflex 1.1 and the Reflex Workshop for only \$59.95. If you prefer to simply upgrade to Reflex 1.1, you can do that for only \$10.

SPECIAL OFFER!

*You get Reflex 1.1 and the Reflex Workshop for only \$199.95**

Sold separately, the new Reflex Workshop is \$69.95 and Reflex is \$149.95, totaling \$219.90—but you can get them both for a limited time only, at an amazing \$199.95. So act now, rush to your nearest dealer, call us, or clip the coupon and put Reflex 1.1 and the Reflex Workshop to work for you right away!

NEW! Introducing the Reflex Workshop Only \$69.95

A major addition to Reflex, the new Reflex Workshop gives you a wide range of analytical tools written for specific applications. You can use these tools "as is" or modify them to suit your analytical and business needs. What you have to work with right away are 25 different tools:

For Finance/Accounting:

- Business Expense Tracking
- Petty Cash Tracking
- Line of Credit Tracking & Analysis
- Accounts Receivable Tracking & Aging Analysis
- Purchase Order Entry & Analysis
- Purchase Order Tracking System
- Leasing Inventory Management
- Asset Inventory Tracking
- Cash Management Trial Balance

For Administration:

- Membership Dues Tracking and Analysis
- Mail List
- Time Management
- Appointment Scheduling
- Applicant Tracking & Inquiry System
- Facilities Planning

For Sales & Marketing:

- Sales Lead Tracking & Analysis
- Store Check Inventory Analysis
- Sales Analysis
- Trend Analysis
- Research Questionnaire Analysis

For Production and Operations:

- Manufacturing Quality Assurance Tracking
- Assembly Repair Turnaround Tracking
- Commercial Real Estate Tracking & Analysis
- Project Scheduling
- Product Cost Analysis and Control



4585 SCOTT'S VALLEY DRIVE
SCOTT'S VALLEY, CA 95066
(408) 438-8400 TELEX 172373

Borland products include Turbo Pascal, Turbo Prolog, Turbo Database ToolBox, Turbo Lightning, Turbo Graphics Toolbox, Turbo Tutor, Turbo GameWorks, Turbo Editor Toolbox, Word Wizard, Reflex, The Analyst, Reflex Workshop, SideKick, SideKick, The Macintosh Office Manager, Traveling SideKick, and SuperKey—of which are trademarks or registered trademarks of Borland International, Inc. or Borland/Analytica, Inc. Reflex and Reflex Workshop are trademarks of Borland/Analytica, Inc. dBASE is a registered trademark of Ashton-Tate. Lotus 1-2-3 is a registered trademark of Lotus Development Corp. Above Board is a trademark of Inter Corp. RAMPage is a registered trademark of AST Research Corp. Liberty is a trademark of Quadram Corp. Hercules is a trademark of Hercules Computer Tech. PFS File is a registered trademark of Software Publishing Corp. IBM is a registered trademark of International Business Machines Corp. Copyright 1986 Borland International BI-1052

Inquiry 49 for End-Users. Inquiry 50 for DEALERS ONLY

“ The best database around... at any price.
Jean Lockwood,
Computer Retail News

Everyone agrees that Reflex is the best-looking database they've ever seen.

Adam B. Green, InfoWorld

Reflex excels as an analytical tool... this program can become everyman's database manager.

Frank J. Dertler, PC Magazine

Borland has done it again.

Sheldon L. Richman,
Washington Post **”**

YES! I want the best

Send me Reflex and Reflex Workshop at

\$199.95*

To order by phone, or for a dealer nearest you, call (800) 255-8008 in CA call (800) 742-1133

- ___ Reflex/Workshop(s) at \$199.95 \$ _____
- ___ Reflex at \$149.95 \$ _____
- ___ Workshop at \$69.95 \$ _____
- ___ Upgrade to 1.1 and Workshop at \$59.95 \$ _____
- ___ Upgrade to 1.1 at \$10.00 \$ _____

(You must return your disks)
Outside USA add \$10 per copy
CA and MA res. add sales tax \$ _____
Amount enclosed \$ _____
Prices include shipping to all U.S. cities
*You must have an IBM or true compatible running DOS 2.0 or later
My computer's name and model is: _____

The disk size I use is: 3 1/2" 5 1/4"
Payment: VISA MC Bank Draft Check
Credit card expiration date: ___/___/___
Card # _____

NOT COPY PROTECTED R15
****60-DAY MONEY-BACK GUARANTEE**

Name: _____
Shipping Address: _____
City: _____
State: _____ Zip: _____

Telephone: _____
CODs and purchase orders WILL NOT be accepted by Borland. Outside USA make payment by credit card or International Postal Money Order.

*Limited time offer until September 1, 1986
**YES, if within 60 days of purchase this product does not perform in accordance with our claims, call our customer service department and we will gladly arrange a refund.

Minimum System Requirements:
384K—Runs on IBM PC, AT, XT, and true compatibles. IBM Color Graphics Adapter, Hercules Monochrome Graphics Card or equivalent.

Reflex works with Intel's Above Board AT and Above Board/PC, AST's RAMPage and RAMPage AT, Quadram's Liberty-PC and Liberty AT, Tecmar's 640 Plus, IBM's EGA and 3270/PC, AT&T's 6300, and many others.



Copyright 1986. Unpublished Material. Program property of Borland/Analytica, Inc. 4585 Scotts Valley Road, Scotts Valley, CA 95066. Unauthorized use, public domain distribution is strictly prohibited by Federal Law.

with up to two drives, costs an additional \$180. Contact Iomega Corp., Holly Pond Plaza, 1281 Main St., Stamford, CT 06902. (203) 359-9858. Inquiry 559.

Page Scanners for Text and Images

Vision Research announced a 300-dots-per-inch scanner that comes with image- and text-editing software and an interface board for IBM PCs and compatibles. The \$2495 Desktop Page Composition System digitizes an 8½-by-11-inch page in 7 seconds. The scanner has four contrast levels, accepts gray-scale or color originals, and can create halftones by dithering. Scanned images are stored in the MegaBuffer interface board, which provides 1.3 megabytes of RAM, enabling you to pan and zoom to any section of an image.

The MegaScan software lets you merge ASCII text with scanned images or documents. The software provides six zoom levels and enables you to edit individual pixels. It includes such capabilities as move, copy, scale, rotate, reverse, lighten, and vertical flip. An optional memory-resident program, called MegaFreeze, lets you transfer a screen image from an application program to a document you're working on and can capture up to 64 screens per document.

The system runs on an IBM PC, XT, AT, or compatible with 512K bytes of RAM and an IBM Color Graphics Adapter or equivalent. Contact Vision Research, 1590 Old Oakland Rd., Suite B-112, San Jose, CA 95131, (408) 298-8700. Inquiry 560.

Datacopy's JetReader scanner provides optical character recognition and



ITT's XTRA XL, a multiuser computer that runs DOS and Xenix.

image processing. The Jet-Reader comes with an interface board and Datacopy's OCR software and Word Image Processing System (WIPS) software. Prices for the system start at \$2950.

The scanner has an automatic paper feed and accepts a stack of up to ten sheets of paper. For images, its scan rates are about 43 seconds per page at 300 dots per inch and 28 seconds at 200 dpi. The scanner typically takes about a minute, the company says, to scan and convert a page of text into ASCII code.

The OCR software can read 12 typefaces; the optional OCR Plus package can be trained to recognize other typefaces. The WIPS software provides image scanner control, image manipulation, file management, image display, and hard-copy output. It lets you integrate images into documents prepared with standard word processors and provides editing capabilities such as scaling, rotation, cropping, and zoom. The optional WIPS Editor package (\$245) enables you to edit images at the level of individual pixels.

A second model, the Jet-Reader Plus, includes the OCR Plus software and sells for \$3250. Contact Datacopy, 1215 Terra Bella Ave., Mountain View, CA 94043, (415) 965-7900. Inquiry 561.

ITT's XTRA XL Runs DOS and XENIX

ITT introduced the XTRA XL computer, which is based on Intel's 80286 and runs both DOS and XENIX. The XTRA XL has a mass storage capacity of 144 megabytes and a reported average hard disk access time of 28 milliseconds.

The machine also features 8-MHz zero-wait-state memory, dynamic disk I/O caching, and an 8-MHz 80186-based communications coprocessor. An 80287 math coprocessor is an option. Depending on model, other standard features include 640K bytes or 1.6 megabytes of RAM, a 1.2-megabyte floppy disk, and a 40- or 72-megabyte hard disk. Multiuser configurations come with a 60-megabyte streaming tape backup unit and can handle as many as four coprocessor boards.

The XTRA XL comes in four models. Models I and II can be used as LAN servers. Models II and III can be used as multiuser systems. The LAN server configurations use ITT DOS 3.1, which eliminates the 32-megabyte disk partition requirement, the company says. The multiuser machines run ITT's XENIX System V, licensed from The Santa Cruz Operation and developed by Microsoft.

System prices begin at \$5299 for a Model I with 640K bytes of RAM, a 1.2-megabyte floppy disk, and a 40-megabyte hard disk. Contact ITT Information Systems, 2350 Cume Dr., San Jose, CA 95131, (800) 321-7661; in California, (800) 368-7300. Inquiry 562.

C for Atari ST

Mark Williams Company's C Programming System for the Atari ST features a complete implementation of Kernighan and Ritchie (plus recent extensions to the language) and UNIX-compatible libraries. Along with utilities such as make, diff, cmp, sort, wc, and egrep, the package provides an interface to GEM's AES and VDI libraries, an assembler, a loader, and an archiver.

A shell provides a UNIX-like environment and supports I/O redirection, pipes, variable substitutions, history substitutions, and path search capabilities. The full-screen editor is based on EMACS.

The C Programming System for the ST costs \$179.95. It requires two double-sided floppy disk drives (or one floppy and one hard disk). Contact Mark Williams Co., 1430 West Wrightwood Ave., Chicago, IL 60614, (312) 472-6659. Inquiry 563.

(continued)

Turbo Pascal® Source Code Included

Borland's new Turbo Editor Toolbox, "Best of the Year" award winner, lets you build your own word processor for only \$69.95!

Turbo Editor Toolbox™ lets you build the best of all word processors into your own word processor. All the modules, techniques, instructions, and Turbo Pascal source code are at your fingertips. You'll quickly learn how to integrate editor procedures and functions into your programs, or you can use Turbo Editor Toolbox "as is," because it has everything.



How to turn good stuff into great stuff—maybe even green stuff!

With your new Turbo Editor Toolbox, you can make WordStar® behave like MultiMate™. You can support windows just like Microsoft's® Word. And do it as fast as WordPerfect® does it. In other words, you can do what they should have done. You just go in there, tinker, fiddle, fool around, and come up with your own version—which will be the best word processor you've never seen before. (And if you want to sell it, go for it; we're not the kind of company that'll send bean-counters and ambulance-chasers after you for royalties.)

How to do windows without jamming your fingers back in your wallet

State-of-the-art "windowing" techniques are part of our new Turbo Editor's repertoire. Sophisticated but easy-to-learn techniques let you design your word processor to show several documents—or several parts of the same document—all at once.

Turbo Editor Toolbox lets you open the windows you want—wherever you want them—at a price that won't make you want to jump out of them.

You get a lightning-fast editor, innumerable features, and a 60-day money-back guarantee** for only \$69.95

For only \$69.95, you can build your own word processor and make it do whatever you want it to do. This already popular new program is just one more way that Borland helps you help yourself. So call us or the dealer nearest you. All the telephone numbers and ordering information are in the adjacent coupon.

You get Turbo Pascal source code and everything you need to build your own word processor

The modules, the manual, ready-to-compile source code, and a full-featured word processor called MicroStar™, which we probably ought to sell separately because it's an excellent text editor. But anyway, you get it free as part of our new Turbo Editor Toolbox. (Maybe this is why Jerry Pournelle of BYTE magazine recently wrote that "Borland International is a public benefactor. The company continues to pour out good, well-documented products at reasonable prices.") Your free MicroStar includes a complete pull-down menu user interface which you can use "as is," or you can modify it for inclusion in your Turbo Pascal programs.

As well as MicroStar, you also get a complete editor ready to include in your programs. Windows, block commands, and memory-mapped screen routines come with it.

Standard Turbo Editor Toolbox features include:

- Wordwrap
- UNDO last change
- Auto-indent
- Find & Find/Replace with options
- Set left and right margins
- Block mark, move and copy
- Tab, insert and overstrike modes, centering, etc.
- Multiple windows
- Multitasking
- RAM-based editor
- Paging, scrolling and text display



Vive la différence

4585 SCOTT'S VALLEY DRIVE
SCOTT'S VALLEY, CA 95066
(408) 438-8400 TELEX 172373

Borland products include Turbo Pascal, Turbo Prolog, Turbo Database Toolbox, Turbo Lightning, Turbo Graphic Toolbox, Turbo Teller, Turbo GameWorks, Turbo Editor Toolbox, Word Wizard, Relax, The Analyst, SideKick, SideKick, The Macintosh Office Manager, Traveling SideKick, and SuperKey—all of which are trademarks or registered trademarks of Borland International, Inc. or Borland Analytica, Inc.

MicroStar is a trademark of Borland International, Inc. WordStar is a registered trademark of MicroPro International Corp. MultiMate is a trademark of MultiMate International Corp. Microsoft is a registered trademark of Microsoft Corp. WordPerfect is a registered trademark of Software Systems International. Copyright 1986 Borland International 01-1055

Inquiry 51 for End-Users. Inquiry 52 for DEALERS ONLY

“The new Turbo Editor Toolbox is the Turbo Pascal source code to just about anything you ever wanted a PC-compatible text editor to do, along with a really excellent book of instructions on what text editors are and how to use the Toolbox to build a custom text editor... you can't afford to be without this.”

Jerry Pournelle, BYTE Magazine, discussing Turbo Editor Toolbox, to which he gave his "Best Of The Year" Award

”

YES! I want the best

Rush me Turbo Editor Toolbox at:

\$69.95

To order by phone, or for a dealer near you, call **(800) 255-8008** in CA call (800) 742-1133

Send me _____ Turbo Editor Toolboxes at \$ _____
 Outside USA add \$10 per copy
 CA and MA res. add sales tax \$ _____
 Amount enclosed \$ _____
 Prices include shipping to all U.S. cities
 Payment: VISA MC Bank Draft Check
 Credit card expiration date ____/____
 Card # _____

(You must have an IBM or true compatible having DOS 2.0 or later)

My computer's name and model is: _____

The disk size I use is: 3 1/2" 5 1/4" TE15

**NOT COPY PROTECTED
60-DAY MONEY-BACK GUARANTEE

Name: _____

Shipping Address: _____

City: _____

State: _____ Zip: _____

Telephone: _____

CCDs and purchase orders WILL NOT be accepted by Borland. Outside USA make payment by credit card or International Postal Money Order.

**YES, if within 60 days of purchase this product does not perform in accordance with our claims, please call our customer service department and we will gladly arrange a refund.

(Minimum System Requirements: 152K Plus on IBM PC, XT, AT, PCjr, and true compatibles)



SYSTEMS

AT Compatibles Run at 10 and 12 MHz

PC's Limited has introduced the 286¹⁰ and 286¹² computers, which are compatible with the IBM PC AT and run at 10 and 12 MHz, respectively. Both computers come with 1 megabyte of RAM on the motherboard, six AT-compatible expansion slots, and two PC-compatible slots. Both can hold three half-height or a full- and a half-height drive and come with a 1.2-megabyte floppy drive, a dual floppy and hard disk controller, and an AT-compatible keyboard.

The base model of the 286¹⁰ sells for \$2295; the 286¹² sells for \$2695. Contact PC's Limited, 1611 Headway Circle, Building Three, Austin, TX 78754, (512) 339-6800. Inquiry 564.

Compucorp Workstations

Compucorp announced two Connection workstations that both have one 20-megabyte hard disk drive and one 360K-byte floppy disk drive, a motherboard with 640K bytes of RAM, two serial and two parallel ports, a keyboard, a monitor, and the capacity for up to four internal drives.

The Connection 16 has a 16-bit 8088 processor. The Connection 32 has two processors: an 8088 and a National Semiconductor 32-bit 32032, which run MS-DOS and XENIX, respectively. The 32's two processors can work concurrently and allow for data transfer. The 32 also comes with XENIX software and features a database management system with word-processing, spreadsheet, and database functions.



Panasonic's Business Partner 286.

Connection workstations can be networked with like machines as well as other IBM PC compatibles.

The 16-bit system costs \$3595. The 32-bit system, including XENIX and MS-DOS, costs \$4995. Contact Compucorp, 2211 Michigan Ave., Santa Monica, CA 90404, (213) 829-7453. Inquiry 565.

Two Panasonic Computers

Two desktop personal computers, the Business Partner and the Business Partner 286, have been introduced by Panasonic. Both systems have four slots for half-height hard disk drives or tape backup systems and come with a keyboard but not a monitor.

The Business Partner, which is compatible with the IBM PC, runs on a 4.77- or 7.16-MHz 8086-2 processor and has six expansion slots. It comes with 256K bytes of RAM expandable to 640K. A unit with a single 5¼-inch 360K-byte floppy disk drive is priced at \$1295. A

machine with two floppy drives costs \$1495.

The Business Partner 286 is compatible with the IBM PC AT and has five AT-compatible and five PC-compatible expansion slots. The computer has an 80286 processor that can run at 6 or 8 MHz and 512K bytes of RAM expandable to more than 1 megabyte. With a single 5¼-inch 1.2-megabyte floppy disk drive, the Business Partner 286 costs \$2795.

Contact Panasonic, One Panasonic Way, Secaucus, NJ 07094, (201) 348-7000, 348-7000. Inquiry 566.

PC Designs' Turbo AT

The PC Designs' Turbo AT is an IBM PC AT compatible that runs on an 8-MHz 80286 microprocessor. Standard features include a monochrome graphics card, a high-resolution

monochrome monitor, two serial and two parallel ports, an AT-compatible keyboard, and 1 megabyte of on-board RAM. The computer also has five 16-bit expansion slots, one 8-bit slot, a clock/calendar with battery backup, and a controller for two floppy and two hard disk drives.

The Turbo AT offers a choice of a 360K-byte or a 1.2-megabyte floppy disk drive. Other options include a math coprocessor, second floppy drive, hard disk drives, and 20-, 60-, and 100-megabyte streaming tape backups.

The Turbo AT is priced at \$1995. Contact PC Designs Inc., 5837 South Garnett, Tulsa, OK 74146, (918) 252-5550. Inquiry 567.

Franklin's First PC Compatible

Franklin Computer, long known for its series of Apple-compatible computers, announced its first IBM PC compatible. Called the PC-8000, it runs on a 4.77-MHz 8088 processor and comes with 512K bytes of RAM and two half-height 5¼-inch floppy disk drives. Of the machine's four expansion slots, three are filled with a disk controller card, a parallel/serial interface card, and a video adapter card that's compatible with IBM's Color Graphics Adapter.

Either a monochrome or RGB monitor (not included in the base price) can be connected to the computer.

The PC-8000 costs \$995 and should be available in August. Contact Franklin Computer Corp., Route 73 and Haddonfield Rd., Pennsauken, NJ 08110, (609) 488-0666. Inquiry 568.

(continued)

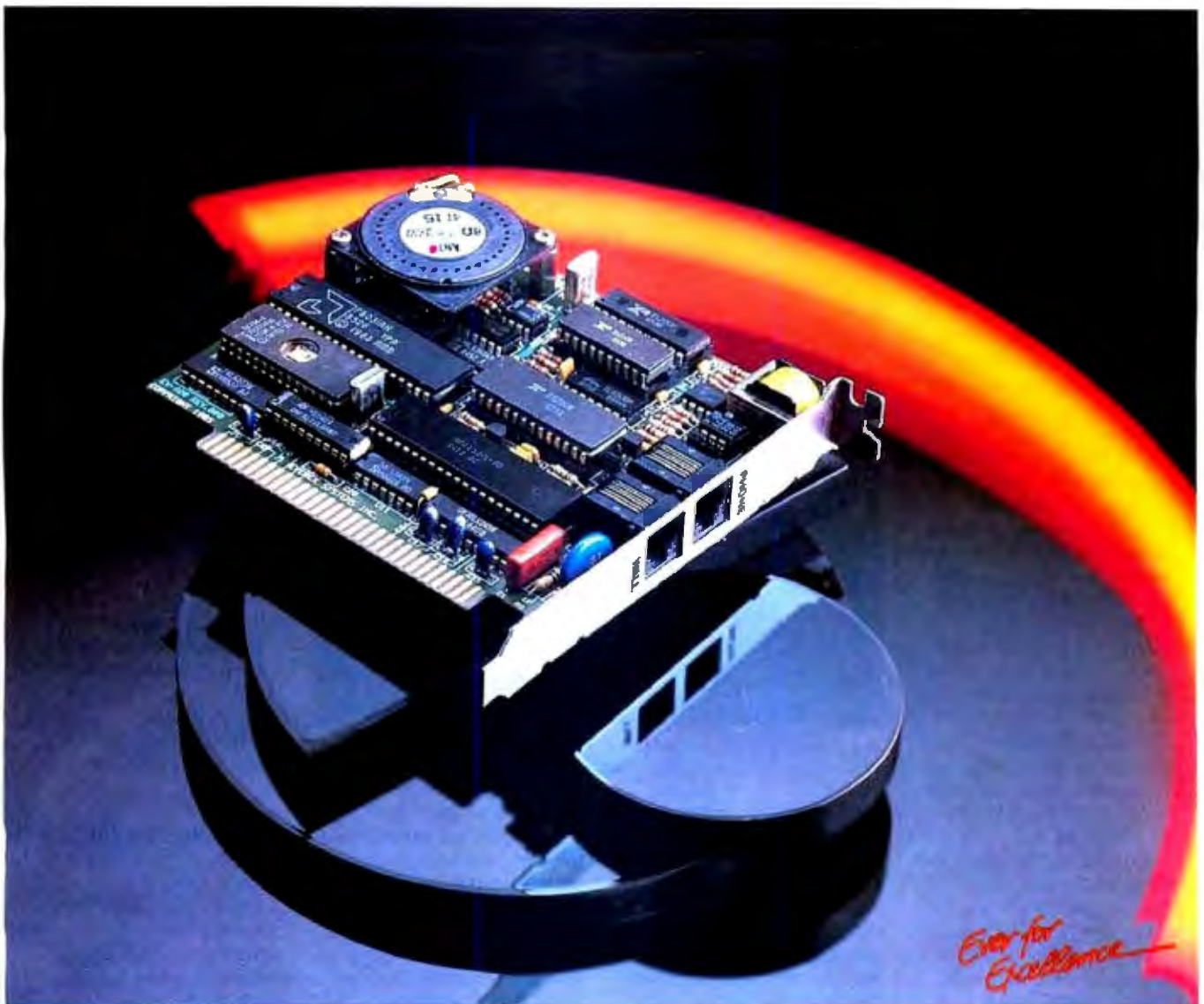

Evercom™ ... 1200 baud, \$249

Now the EVEREX Evercom modem is available on a half-size card, perfect for the short slots in the IBM XT, Portable, and many compatibles. EVEREX has combined innovative engineering and technology to produce a quality

Hayes-compatible 1200 baud modem that out performs the competition at a lower price. EVEREX engineering is the key ingredient that delivers QUALITY and FEATURES without sacrificing PRICE.

Compatibility Guaranteed!!

The Evercom short card modem is guaranteed to be compatible with the Hayes 1200B or your money back for the first 30 day evaluation period.

Call today for dealer pricing and start getting EVEREX VALUE... QUALITY and FEATURES at the LOWEST POSSIBLE PRICE. Why settle for less?

1-800-821-0806

in California

1-800-821-0807

EVEREX
EVER for EXcellence

48431 Milmont Dr. Fremont CA 94539
(415) 498-1111

Before you buy a modem, check these features:

	EVEREX EVERCOM	HAYES NEW 1200B
• Automatic dialing, answering, and redialing	YES	YES
• Half-size card	YES	YES
• Call progress monitoring	YES	YES
• Works in short slot of XT and PC Jr.	YES	NO
• Automatic data-to-voice transition	YES	NO
• Reports serial port speed mismatch	YES	NO
• Detects receiver off-hook	YES	NO
• Configurable from COM1 - COM4	YES	NO
• Supports 132 columns	YES	NO
• Communications software included	YES	\$80 extra
• List Price	\$249	\$489

Evercom is a trademark of Everex Systems, Inc. IBM PC and XT are registered trademarks of International Business Machines Corp.

Hayes 1200B is a trademark of Hayes Microcomputer Products Inc.

Inquiry 133 for End-Users. Inquiry 134 for DEALERS ONLY

JULY 1986 • BYTE 37

PERIPHERALS

Ink-Jet Printer Weighs 4 Pounds

Designed for use with portable computers, a 4-pound ink-jet printer called the Diconix 150 operates at 150 characters per second in draft mode and can produce near-letter-quality text as well as italic, emphasized, and other print styles. The printer, which measures about 2 by 6½ by 11 inches, connects to computers through a standard parallel port. The device emulates the IBM Proprinter or Epson FX and will print on single sheets of paper, continuous-feed paper, and transparencies.

Priced at \$479, the Diconix 150 works with replaceable ink-jet cartridges (\$9.95). Its C-size batteries are contained inside the platen, and it's supplied with an AC power adapter. A serial version of the printer and a variety of color ink-jet cartridges will be available. Contact Diconix Inc., 3100 Research Blvd., P.O. Box 3100, Dayton, OH 45420, (513) 259-3100. Inquiry 569.

EPROM Burner

Hippopotamus Software announced an EPROM burner that works with the IBM PC and compatibles, Atari ST, and Commodore Amiga. The burner lets you read, verify, modify, and burn most popular EPROMs.

No personality modules are required for the different EPROM types. The system controls the burn voltage levels required by different chips and changes pin-outs on the zero insertion force socket to accommodate 2764-, 27128-, 27256-, and 27512-type EPROM chips. The software enables you to edit the EPROM's contents and to read or write files in

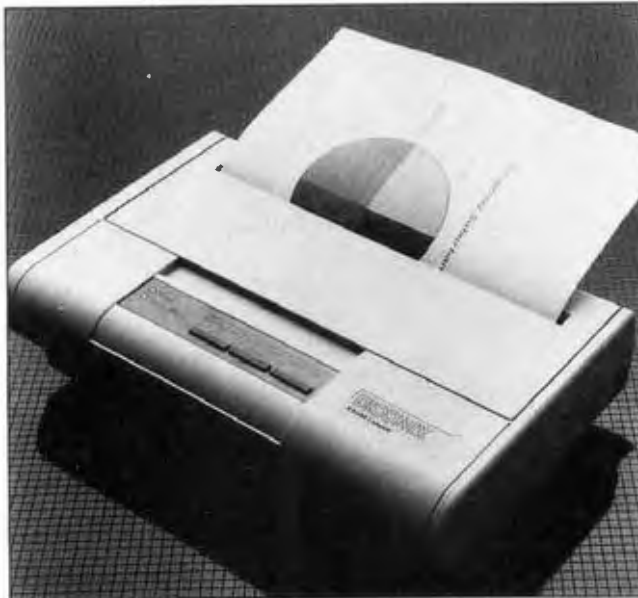

The Diconix 150, a portable ink-jet printer.

binary, Intel, or Motorola formats.

To install the burner you connect it to an 8-bit parallel printer port. All necessary voltages are generated by the wall-plug transformer that comes with the unit. The burner costs \$139.95 for the Atari ST and \$199.95 for the IBM PC and Amiga. Contact Hippopotamus Software Inc., 985 University Ave., Suite 12, Los Gatos, CA 95030. (408) 395-3190. Inquiry 570.

Optical Disk Drive from N/Hance

The N/Hance 525, an optical disk drive from N/Hance Systems, provides 230 megabytes of formatted storage for IBM PCs and compatibles. The drive comes with a 5¼-inch optical disk, a short-slot controller card, and device driver software. The system is priced at \$3495.

The drive's data transfer

rate is 2.5 megabits per second; its average access time, the company says, is comparable to that of a hard disk drive. You can use the drive externally with its own power supply or mount it inside the computer. An optional \$1000 software package lets you index and search for up to 1 million words. Contact N/Hance Systems, 908R Providence Highway, Dedham, MA 02026. (617) 461-1970. Inquiry 571.

Tape Backup for Apples

The B-Sider is a tape backup system that works with either the 10-megabyte Sider or 20-megabyte Sider II hard disk drives for the Apple IIe and II+. The tape drive uses a 20-megabyte streaming cassette tape and attaches to the same host adapter that the hard disk drives use. Contact First Class Peripherals, 3579 Highway 50 E, Carson City, NV 89701, (800) 538-1307. Inquiry 572.

Two Megabytes for the Amiga

Comspec Communications of Canada announced the Microshare AX 2000, a 2-megabyte RAM expansion unit for the Commodore Amiga that you install in the expansion port on the right of the system unit. Other peripherals that you might want to install in the Amiga's expansion port can be installed in the AX 2000's port.

The AX 2000 sells for \$1079 in the U.S. (\$1307.95 in Canada). Contact Comspec Communications Inc., 153 Bridgeland Ave., Unit 5, Toronto, Ontario M6A 2Y6, Canada. (416) 787-0617. Inquiry 573.

Digitizing Tablet

Jandel Scientific has released the Sigma-Scan, a digitizing tablet and software designed for digitizing and measuring areas on photomicrographs, x-rays, maps, strip charts, and other two-dimensional surfaces. The 12- by 12-inch tablet can measure areas, distances, perimeters, curved lines, angles, and slopes. It can make object counts and determine *x,y* coordinates.

The software lets you perform statistical analysis on the data, including means, standard deviation, correlations, t-test, transforms, linear regression, and screen plots. You can save data on disk in ASCII or DIF files and use it in other applications programs. The unit will also work with user-written BASIC programs.

The system retails for \$1195 and works with IBM PCs and compatibles. Contact Jandel Scientific, 2656 Bridgeway, Sausalito, CA 94965. (415) 331-3022. Inquiry 574.

(continued)

Clipper is the fastest dBase III and dBase III Plus™ compiler available. Nothing else comes close. When performance counts, experts rely on Clipper for more speed, more power, and more creative freedom. You can, too. Call for details.

- * Clipper compiled programs run 2 to 20 times faster
- * No royalties...no runtime fees.
- * Source code security.
- * User defined functions.
- * Arrays.
- * Simple menu commands.
- * Context sensitive help can be included with programs.
- * More fields, more memory variables.
- * Call C and Assembly programs.
- * Complete debugging facilities.
- * Multiple file relationships.
- * IBM PC, XT, AT, 3270 compatible™.
- * Multi-user capability.

Clipper™

CLIPPER. THE dBASE COMPILER.
A WINNING PERFORMANCE EVERY TIME.



Nantucket™

Nantucket Corporation
5995 South Sepulveda Boulevard
Culver City, California 90230
(213) 390-7923
Outside California call toll-free:
1-800-251-8438

dBase, dBase III, and dBase III Plus are trademarks of Ashton-Tate, Inc.
IBM PC, XT, AT, and 3270 are trademarks of International Business Machines Corporation.
Clipper and Nantucket are trademarks of Nantucket Corporation.

ADD-INS

Speaker-independent Voice Recognition

Votan has announced a speech-recognition add-on board for the IBM PC and compatibles that doesn't require training for a specific voice. This Speaker Independent Recognition (SIR) system recognizes digits, yes and no, and customized vocabularies. The board also provides continuous speech recognition in speaker-dependent mode, can perform all of its functions over the telephone, and offers digital recording and playback of speech.

Votan sells an optional telephone interface that includes auto-dial, auto-answer, call progress monitoring, and Touch Tone sending and receiving functions. The telephone management capability lets you set up your PC to handle background answering of the phone with stored templates for general or privileged caller responses.

The SIR card sells for \$1350. An optional telephone interface costs \$350. Contact Votan, 4487 Technology Dr., Fremont, CA 94538, (415) 490-7600. Inquiry 575.

Coprocessor Plus Expanded Memory

The Number Smasher/ECM, a coprocessor board from MicroWay, offers up to 1 megabyte of extended memory and a 9.54- or 12-MHz math coprocessor. The board runs in two modes. In the first, you can boot DOS with 512K to 704K bytes of memory. The memory above 640K that does not conflict with existing hardware can be turned on using switches for use as a RAM disk, print spooler, or disk cache.



The Memek board adds graphics and memory to IBM PCs.

In the second mode, you can configure the board with the optional Mega-switch MMU and Megabank software so that a megabyte of memory is available for DOS applications. Software that does not write directly to the screen will work in this mode, which the company calls Extended Conventional Memory. The company will also offer drivers for programs such as 1-2-3, SideKick, and others that write directly to the screen.

The Number Smasher with 512K bytes costs \$599. Options include a 12-MHz clock, real-time clock/calendar, and reset switch (\$149); a 12-MHz 8087 coprocessor (\$250); and the Megaswitch MMU (\$100). Contact MicroWay, P.O. Box 79, Kingston, MA 02364, (617) 746-7341. Inquiry 576.

68020 Board for IBM PCs

The OT 20x is a 68020 upgrade for IBM PCs and compatibles. The multi-user, multitasking board replaces the computer's motherboard and runs the OS-9/68K operating system.

The basic system includes a 12.5-MHz 68020 micropro-

cessor, 2 megabytes of RAM, one parallel port, four serial ports, a real-time clock with battery backup, and room for additional ROM. Also, six full-size expansion cards with 2 megabytes of RAM and four serial ports each can be added, which allows for a total of 14 megabytes of RAM and up to 28 users.

The price for the basic board with 2 megabytes of RAM is \$2995. For more information, contact Frank Hogg Laboratory Inc., 770 James St., Syracuse, NY 13203, (315) 474-7856. Inquiry 577.

Logic Analyzer on a Board

The Logic-20 from Bitwise Designs is a 20-MHz logic analyzer that plugs into a single slot in an IBM PC. The company says the board is capable of a 2-nanosecond setup time and, with the use of the optional Doubler Board, is capable of 40-MHz sampling over eight channels with a 512-word memory depth.

The pods that are standard with the analyzer provide 16 channels of sampling; the standard sampling rate is 20 MHz with a minimum period of 50 ns.

The trace size is 16 bits by 256 words and is expandable to 64 bits. Samples can be made synchronously with an external clock for state analysis or asynchronously with an internal variable-speed clock for timing analysis. The board's software enables you to specify trace type, label data points, and display the data in timing diagrams or state tables.

The Logic-20 is priced at \$1495. The optional pod is \$225. Contact Bitwise Designs Inc., 1223 Peoples Ave., Troy, NY 12180, (518) 274-0755. Inquiry 578.

More Boards in One

Boca Research's Memek is a multifunction display board for the IBM PC, XT, and compatibles that includes a color graphics adapter, monochrome graphics adapter, and up to 2 megabytes of expanded (EMS) memory. The board's VLSI chips emulate Hercules Graphics and Plantronics color adapters as well as IBM Color Graphics and Monochrome Display adapters.

Other features include a serial and parallel port, installation and diagnostic software, and RAM disk and print spooler utilities. A game port and clock/calendar are optional. You install the board in one slot in the PC or XT; no switches or jumpers need be set.

The price of the basic board with 256K bytes of RAM is \$645. A 1-megabyte board costs \$795, and an additional 1-megabyte board costs \$345. Contact Boca Research Inc., 6401 Congress Ave., Boca Raton, FL 33431, (305) 997-6227. Inquiry 595.

(continued)

This is the Modula-2 compiler everybody's been waiting for...

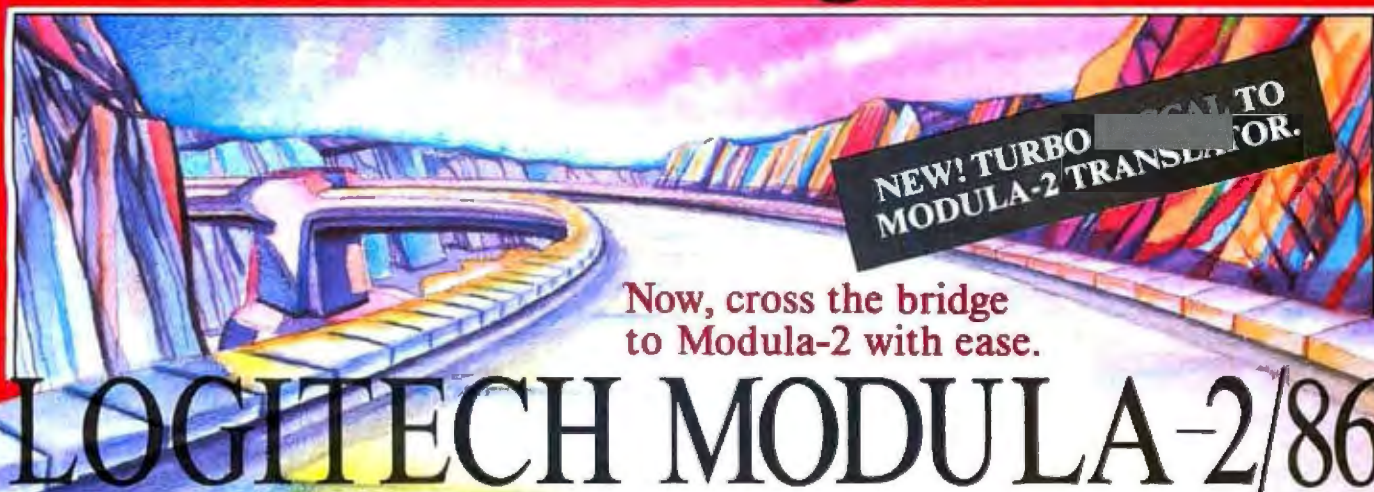

Now, cross the bridge to Modula-2 with ease.

LOGITECH MODULA-2/86

This is Modula-2 at its *absolute* best. It's a fully integrated development environment that takes into account what you need as a programmer. Without leaving the Editor, you can call the compiler, linker and utilities.

With Logitech's Modula-2, you'll have the ability to edit several files at once, comparing, window to window, various code modules. You can even move from window to window compiling, linking, debugging and running.

The compiler has the kind of power and room to breathe that you really need in today's complex applications. It is as *easy* to use as Turbo Pascal, without your programs being limited to 64K of code.

At your command will be the libraries of modules that make Modula-2 a programmer's dream. It has essentially the same structure as Pascal with the major addition of a library organization of code modules that allow you to put together programs on a solid, block-by-block, foundation of proven code.

Whether you're working with a module of your own making, or one of the many in our library, you'll find the system by which each module is identified, described and stored an organizational masterpiece. And that's at the heart of Modula-2.

Underneath the sophisticated system is a Modula-2 compiler that is the result of years of development and proven use in industry. We run on the Vax*, and we run on the IBM PC. And the code is portable—from one to the other.

Best of all... you can have it right now!

Logitech Modula-2/86 Complete with Editor, Run Time System, Linker, Cursor-positioning debugger, 8087 Software Emulation, BCD module. Logitech's extended library. Utility to generate standard .EXE files, Turbo Pascal (and standard Pascal, too) to Modula-2 translator (included without charge until 8/1/86), and much, much more!

Logitech Modula-2/86 with 8087 support Even if you haven't yet gotten an 8087 co-processor, you can still use this version.

Logitech Modula-2/86 Plus For machines with 512K or more. Takes advantage of the larger memory to increase compilation speed by 50%! Supports 80186 and 80286 as well as 8086 and 8088. Includes 8087 and 80287 support, too.

Window Package Now you can build true windowing into your Modula-2/86 code with ease, too. Very powerful and very full, yet only 15K in size. Features virtual screens, color support, overlapping windows and a variety of borders.

Run Time Debugger (source level) Much more powerful than just a symbolic RTD. Display source code, data, procedure call chain and raw memory. Set break points, assign values to variables, pinpoint and identify bugs in your source. The ultimate professional's tool!

Utilities Package Features a post-mortem debugger for static debugging. If a program you've written crashes at run time, the situation is frozen, and you can pinpoint, in source, the cause of the error and the data at that moment. Also includes a disassembler, a cross reference utility and a "version" utility that allows conditional compilation.

Make Utility Automatically selects modules affected by code changes for quick and minimal re-compilation and relinking. Even figures out dependencies for you.

Library Sources Source code for our major library modules is now available for customization or exemplification.

ROM Package If you need to produce rommable code, call our 800 number for further information on this package.

To place an order call our special toll free number

800-231-7717

in California

800-552-8885

Special offer until 8/1/86!

includes

Free! \$49.95 value Turbo Pascal translator! Now, you can take your library with you!

\$89

Yes, I'd like to take the next logical step in programming. Please send my copy of Logitech Modula-2/86 to the following address:

VISA MasterCard Check Enclosed

Card Number _____ Expiration Date _____

Signature _____

Name _____

Address _____

City _____

State _____ Zip _____ Phone (____) _____

Here's the configuration I'd like: And include the indicated items:

- | | |
|---|--|
| <input type="checkbox"/> Logitech Modula-2/86 \$89 | <input type="checkbox"/> Window Package \$49 |
| <input type="checkbox"/> Logitech Modula-2/86 \$129 with 8087 support | <input type="checkbox"/> Run Time Debugger \$69 (source level) |
| <input type="checkbox"/> Logitech Modula-2/86 Plus \$189 | <input type="checkbox"/> Utilities Package \$49 |
| <input type="checkbox"/> Please add \$6.50 for shipping and handling. | <input type="checkbox"/> Make Utility \$29 |
| | <input type="checkbox"/> Library Sources \$99 |

Total enclosed \$ _____

(California residents, please add applicable sales tax)

 LOGITECH

LOGITECH, Inc.
805 Veterans Boulevard
Redwood City, California 94063
Telephone (415) 365-9852

For European pricing please contact

LOGITECH SA
Box 32, CH-1143 Apples, Switzerland
Telephone 41 (21) 774545

Please call our 800 line for: Information on our *VAX version Site License and University Discounts Dealer and Distributor information

Quartet for Modula-2 Programmers

Star Value Software has released four software-development tools for Modula-2 programmers.

TEXTIO, a display and printer library, offers pop-up windows, foreign representations of numbers and dates, and interconnecting line-drawing routines.

GRAPHIX is an interface to MetaWindow, a graphics package from MetaGraphics that features dynamic hardware determination, hardware independence, and local virtual coordinates systems.

MAKE is designed to help you find modules that need recompiling and relinking after you've been editing.

XREF is a cross-reference tool that can process a list of source files (DEF or MOD or both) to clarify module relationships. It prints the line number and module name for each identifier reference.

All four tools are sold separately. TEXTIO and GRAPHIX cost \$79 each; MAKE and XREF, \$59 each. Contact Star Value Software, 12218 Scribe Dr., Austin, TX 78759, (512) 837-5498. Inquiry 579.

System-Generation Facility

Tominy's MACH 1 PAD (Professional Application Developer) for IBM PCs and compatibles is a single-user system-generation facility the company says is designed for "serious" programmers working on business applications. Components include a relational DBMS, a fourth-generation language called LOGIC, a program generator, an automatic screen editor, and a query/report generator. The environment also con-

tains 80 utilities.

Among MACH 1 PAD's other features are menu and screen painting, program framing, interactive test facilities, on-line help, and global directories.

PAD requires PC-DOS 2.1 or later, 128K of memory, and at least 8 megabytes of disk storage. The system is upwardly compatible with Tominy's MACH 1 for multi-user micros, mainframes, and minis. It sells for \$199.95. Contact the MACH 1 PAD Division at Tominy Inc., 4221 Malsbary Rd., Cincinnati, OH 45242, (800) 543-8628; in Ohio, (800) 445-1737 or (513) 984-6605. Inquiry 580.

Program Converter

Metamorphosis is a program designed to facilitate the transformation of any syntactically reducible character-oriented file to any other form and maintain the synonymy. Shannon Associates says its product will translate any source program from one language to another, any language to C, and will also perform dialect conversions.

You can use Metamorphosis to implement compilers, assemblers, macro processors, and query-language processors; reformat character-oriented database files; and analyze grammars, natural languages, sequential and parallel procedures, and computational signatures.

Metamorphosis runs on the IBM PC and compatibles with 384K of RAM, two 360K floppy disk drives, and MS- or PC-DOS 2.0 or later. It costs \$387. Contact J. H. Shannon Associates Inc., P. O. Box 597, Chapel Hill, NC 27514, (919) 929-6863. Inquiry 581.

Amiga FORTRAN 77 Compiler

Absoft Corporation, which developed Microsoft's FORTRAN compiler for the Macintosh, has adapted that compiler to run on the Commodore Amiga. AC/FORTRAN is an ANSI FORTRAN 77 compiler that comes with a full-screen source-level symbolic debugger, linker, library manager, IEEE single- and double-precision floating-point software, VAX extensions, and C interface. Additional development tools are support of overlays and virtual arrays, as well as dynamic linking of programs at run time.

The disk-based compiler takes only 46K of RAM. Because Microsoft's FORTRAN compiler for the Mac is a version of AC/FORTRAN, programs written with the Microsoft package can be ported directly to the Amiga, Absoft says.

AC/FORTRAN for the Amiga costs \$295. Contact Absoft Corp., 4268 North Woodward, Royal Oak, MI 48072, (313) 549-7111. Inquiry 582.

Multuser OS Designed for Intel 80286

THEOS 286-Virtual, a multiuser, multitasking operating system designed for Intel's 80286 chip in protected virtual address mode, can address as much as 16 megabytes of real memory space. Using an 8-MHz 80286, the system can support 14 to 20 users.

The OS provides security features that prevent someone from crashing a system or writing over files.

The 16-bit operating system appears just like its counterpart for Intel's 8086/8088/80186 chips (THEOS 86), but it executes instruc-

tions two to three times faster, according to THEOS Software.

The company has also developed a program that runs MS-DOS packages in a multiuser environment under 286-V. THEOS says THEO-DOS enables standard MS-DOS programs and single applications under Microsoft Compiled BASIC to run without modification under 286-V; the programs, however, must be hardware-independent, and software that's copy-protected or requires a key disk will not work in the multiuser mode.

THEOS 286-V is available for the IBM PC AT and compatibles; the Altos 886, 1086, and 2086; and the Third Coast Technologies 286V Supermicro. It costs \$695 (\$895 for high-end machines). THEO-DOS costs \$250, or you can get it bundled with THEOS 286-V at a starting price of \$845. Contact THEOS Software Corp., 201 Lafayette Circle, Suite 100, Lafayette, CA 94549-4370, (415) 283-4290. Inquiry 583.

BASIC Subprograms for Macintosh

Cut & Paste BASIC—Overview Library is a collection of subprograms you can incorporate into your own applications. The subprograms use generic calling conventions. Library categories include data manipulation, math routines, finance, decision management, statistics, and cryptology. Each subprogram comes with an example you can run to demonstrate it.

Cut & Paste BASIC for the Macintosh costs \$24.95. Contact Technisoft Engineering, P.O. Box 563, Bremerton, WA 98310, (206) 598-4177. Inquiry 584.

(continued)

NEW RELEASE
EVEN MORE FEATURES

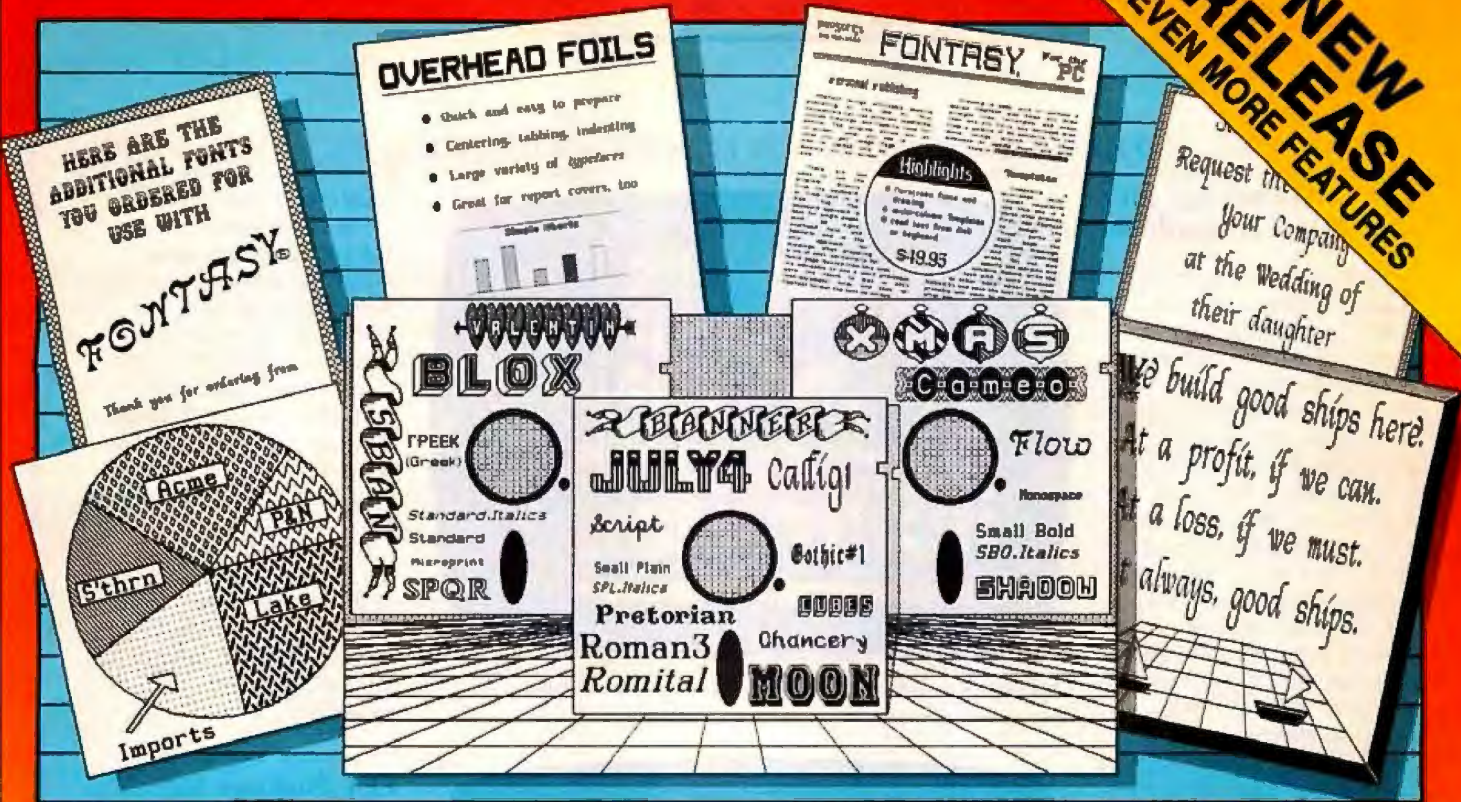

Fontasy printed all of these.

See What You Can Do With

Presentations! Newsletters! Flyers! Signs! Overhead Foils! Invitations! Menus! Logos! Announcements! Banners! Layouts! When you need a goodlooking visual quickly you need FONTASY — superb typefaces and simple drawing in one easy-to-use package.

FONTASY gives you a “what-you-see-is-what-you-get” picture, as you type and draw on the graphics screen of your IBM-PC. You can create a page at a time, see a mini-picture of that page, print it, and save it on disk. Page size is limited only by memory, not by screen size.

Features

Proportional space, justify, kern, bold face, rearrange, magnify, black/white reversal, rotate, mirror image, lines, rectangles, ovals, draw, fill in, undo (and un undo), on line help, 200-page book, and easy control from keyboard or mouse. Corporate licenses available.

Fonts, fonts, and more fonts! We have over 275 typefaces in our growing library, and will be happy to send you free print samples on request.

When you deal directly with the manufacturer (that's us), you pay rock-bottom distributor prices. If you order FONTASY now, we will give you 28 fonts (a \$50 value) at no extra charge. With so many features at such a low price, FONTASY belongs in your software library even if you already have a “font” program.

Inquiry 287

FONTASY®

\$69⁹⁵

Includes 28 Fonts and free ClipArt

Equipment Needed

IBM-PC, XT, AT, or true compatible (Compaq, etc.) with IBM or Hercules graphics adapter and graphics monitor. 256K memory needed for partial pages, 448-640K recommended for full pages. Dot-matrix printer. Mouse optional. MS-DOS 2.00 or above.

FONTASY supports: IBM graphics printer, Proprinter, Epson FX, JX, LX, MX, RX, and LQ-1500; C. Itoh 8510, 1550, 1570, Pro-writer-Jr, H-P LaserJet, ThinkJet; Microline 92, 93; Gemini 10X, 15X; Radio Shack DMP 105-430, 2100; Toshiba 351, 1340-1351; Star; and most Epson-compatibles.

Money-Back Guarantee

Fontasy is not copy-protected and has a 30-day money back guarantee. So, take advantage of our breakthrough price and order now TOLL FREE:

1-800-824-7888, operator 669 (ORDERS ONLY)

For further information and same day shipping, call: (818) 765-4444

PROSOFT®

7248 Bellaire Ave., Box 560
No. Hollywood, CA 91603-0560

FONTASY \$69.95

Tax _____
Shipping _____
Total _____

Name _____ Company _____
Address _____ Telephone _____
City, State, ZIP _____
Visa/MC _____ Exp. Date _____
Computer _____ Memory _____ Printer _____

Terms: M/C, Visa, checks. Please add \$3.00 shipping and handling in U.S. or Canada. \$20.00 overseas. \$2.00 for C.O.D. and sales tax in Calif.

CAE/CAD Package for IBM PCs, Compatibles

EE Designer consists of three integrated programs for schematic design, circuit simulation, and layout of printed circuit boards. The software lets you position component elements, lines, and graphics shapes using a mouse, keyboard, or digitizer pad. You can take schematic symbols from a library that comes with the package or make your own.

A schematic-capture module maintains connectivity between components and symbols in the database. Another program moves design data to a disk file; you can then use the information for circuit simulation, reports, and input to the physical layout module. The circuit-simulation module contains 150 common TTL and CMOS devices. The simulator lets you enable any subset of the circuit you're analyzing. Schematics can be sent to a dot-matrix printer or plotter.

EE Designer runs on IBM PCs and compatibles with 512K of memory, an IBM color adapter or equivalent or a hi-res Tecmar Graphics Master color card, and input and output devices. The program costs \$975. Contact Visionics Corp., 1284 Geneva Dr., Sunnyvale, CA 94089, (408) 745-1551. Inquiry 585.

PC XT, AT Package for Finite-Element Analysis

Brooks Scientific offers an equation solver for finite-element analysis on an IBM PC, XT, or AT. The size of the problems it can tackle is limited only by hardware, the company says.

PCTRAN Plus uses an "out of core" approach coupled with a bandwidth optimiza-

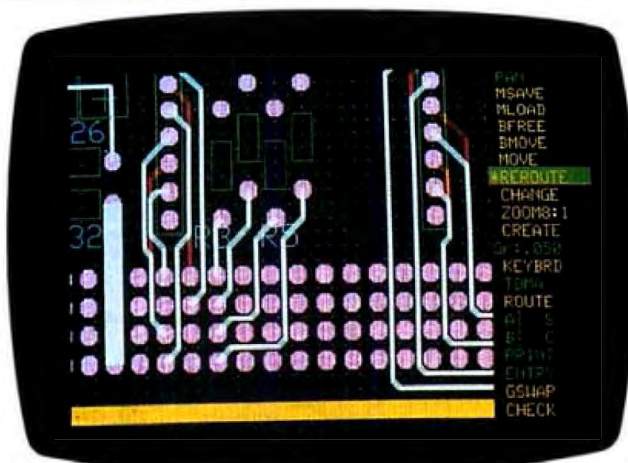

EE Designer, software for drawing and simulating circuit boards.

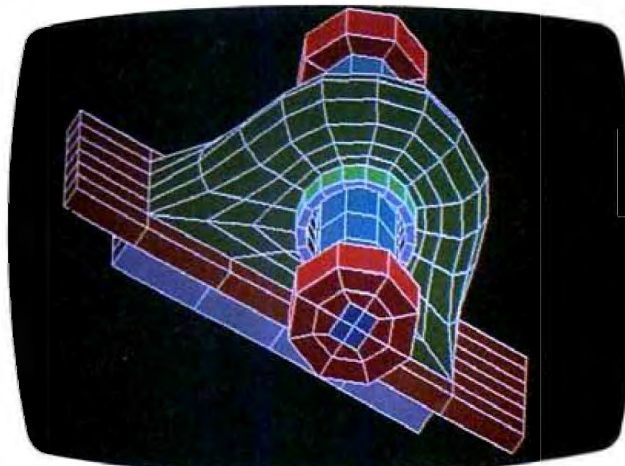

Model analysis with PCTRAN Plus.

tion routine for solving problems. The package can also solve extremely large 3-D solid models by transferring preprocessing files to mainframe FEA programs for analysis. Small- to medium-size FEA models can be built with a fine element mesh. Brooks Scientific says there's no limit to the number of nodes, elements, constraints, forces, and degrees of freedom in an analysis with PCTRAN Plus.

The software runs on the IBM PC XT and AT or compatibles with 512K of RAM, a floating-point math chip,

and a graphics display card. PCTRAN Plus prices start at \$1295. Contact Brooks Scientific Inc., 55 Wheeler St., Cambridge, MA 02138, (617) 491-9220. Inquiry 586.

Mac Package Captures Schematics

McNet turns a Macintosh into a workstation for digital logic design. The program includes a tool for schematic entry, a net list and parts list generator, and a component library. Argus says the package is intended to relieve engineers of

repetitive design tasks.

The schematic-capture software provides commands for copying, moving, rubberbanding, undoing, and selecting by area. An automatic bus function features bus-rip, bus-ripper numberer, bus width tracker, and bus name tracker. You need to name only the bus signals entering or leaving the design page.

McNet runs on a 512K Mac or Mac Plus. It costs \$150. Contact Argus Software, Musgrove Bldg., 2 Elm Square, Andover, MA 01810, (617) 475-8952. Inquiry 587.

FFT Package for IBM PCs

Snap-FFT converts time-domain data acquired with HEM's Snapshot Storage Scope (see What's New, December 1985, page 432) to the frequency domain using a fast Fourier transform algorithm. Like Snapshot, Snap-FFT is menu-driven and requires no programming.

The analysis package calculates amplitude and phase for four channels of data and takes the amplitude ratio of any two sets of channels. It also takes the difference in phase angle to determine phase lag. Data output can be tabular or graphic and shown on the screen, stored on disk, or printed.

Snap-FFT runs on the IBM PC, XT, AT, or compatibles with 256K of RAM, an IBM or comparable graphics adapter, a monochrome monitor with graphics capability, and a DS/DD floppy disk or hard disk. It costs \$295. Contact HEM Data Corp., 17025 Crescent Dr., Southfield, MI 48076, (313) 559-5607.

Inquiry 588.

(continued)

CAD MADE EASY WITH EASYCAD.



Have you looked into a CAD system? And said "no" because of the cost? Or the lack of time to learn it? Then look again. Look to EasyCAD.

EasyCAD is a powerful CAD program designed especially for your IBM PC or compatible system. And it turns you into an expert in 24 hours or less for under \$500! Think of it. You'll be operating a highly productive CAD work station in hours. Instead of months.

To learn more about EasyCAD and its professional performance features, send for details today! Or pick up a brochure at your computer dealer.

And then take it easy.

Inquiry 347



Please send me complete details on EasyCAD.

T & W SYSTEMS, INC.
7372 Prince Drive
Huntington Beach, CA 92647

**EASY
CAD**
IT'S A SNAP!

NAME _____

POSITION _____

ADDRESS _____

CITY _____

COMPANY NAME _____

ZIP _____

PHONE _____

Communications Tools for Commodore Amiga

ATalk, a communications and terminal program for the Commodore Amiga, lets you send files using Kermit and XMODEM (Amiga loadable files are stripped of extra data sent by XMODEM programs), exchange ASCII data with systems that don't support advanced protocols, and set parameters. A script language called Dial-A-Talk, coupled with a phone-number directory, lets you log on automatically through Tymnet, Telenet, or Uninet. The software also provides full ANSI terminal emulation, with options for resizable and full-screen windows.

The program, which is not copy-protected, sells for \$49.95. Contact Felsina Software, 3175 South Hoover St., #275, Los Angeles, CA 90007, (213) 747-8498. Inquiry 589.

Spreadsheet Functions in an APL Environment

STSC's APL*Plus PC Spreadsheet Manager lets you enter and examine data in an APL environment and move data between APL workspaces and Lotus or ASCII files. APL spreadsheets can consist of character and numeric data. The package's editor is similar to that of a spreadsheet program. You can execute and store APL formulas for cells or ranges of cells, and you can sort columns or rows.

The Spreadsheet Manager incorporates direct import and export facilities for non-APL data formats. Data from Lotus spreadsheets or ASCII files can be transferred into APL variables or an APL spreadsheet file.

To use the program, you need STSC's APL*Plus PC System (release 5 or later), an IBM PC or true compatible, and at least 384K of RAM (more memory is recommended for working with large files). The Spreadsheet Manager works with Lotus 1-2-3 releases 1, 1A, and 2 and Symphony releases 1.0 and 1.1. It retails for \$195. Contact STSC Inc., 2115 East Jefferson St., Rockville, MD 20852, (800) 592-0050; in Maryland or Canada, (301) 984-5123. Inquiry 590.

Four for ST Line

Solid Applications is offering four programs for the Atari 520ST and 1040ST.

STKey is memory-resident software for programming function keys; programming can be done from within an application. STKey costs \$29.95.

DiskMenu, an archive and backup utility, provides a means of backing up a hard disk to a floppy disk. It comes with a tool for verifying disk directories and allocation tables. DiskMenu costs \$49.95.

PCalc is a calculator package that can record, to disk or printer, any calculations performed. Simple programs can be set up in conjunction with STKey. PCalc lists for \$29.95.

And PCommand, a command-line interface to TOS, supplies a command and

batch-file facility compatible with PC-DOS. It can run TOS and GEM applications. It sells for \$39.95. Contact Solid Applications Inc., 1333 Moon Dr., Yardley, PA 19067, (215) 736-2449. Inquiry 591.

Bulletin Board for Commodore 64/128

Blue Board, a bulletin-board system for the Commodore 64 or 128 (in C-64 mode) from SOTA Computing Systems, supports more than 200 on-line messages (maximum 1023 characters), as many as 220 users, and 25 sysop-definable subboards. It also provides "Scribbles," little subboards that can handle messages of 80 characters or less. The company says the software is designed to give the sysop total control; the operator can reconfigure most operational characteristics, including connect time, access levels, user IDs, and mail editing. The program is written in machine language.

Blue Board requires a disk drive (Commodore 1541 or equivalent) and a 300-bps auto-answer modem (C-1650 or comparable unit). It's priced at \$69.95. Contact SOTA Computing Systems Ltd., 213-1080 Broughton St., Vancouver, British Columbia V6G 2A8, Canada (604) 688-5009. You can check out a system demo by dialing (604) 683-1914. Inquiry 592.

WHERE DO NEW PRODUCT ITEMS COME FROM?

The new products listed in this section of BYTE are chosen from the thousands of press releases, letters, and telephone calls we receive each month from manufacturers, distributors, designers, and readers. The basic criteria for selection for publication are: (a) does a product match our readers' interests? and (b) is it new or is it simply a reintroduction of an old item? Because of the volume of submissions we must sort through every month, the items we publish are based on vendors' statements and are not individually verified. If you want your product to be considered for publication (at no charge), send full information about it, including its price and an address and telephone number where a reader can get further information, to New Products Editor, BYTE, One Phoenix Mill Lane, Peterborough, NH 03458.

Mac HFS Accessory Bypasses Finder

PBI Software has developed a desk accessory for the Macintosh Hierarchical File System that's designed to provide quick access to files without going to the Finder. From within an application, you can use the program to locate files and the folders they're in by date or by partial/matching name. After finding a file, HFS Locator Plus can show information about it or delete, rename, move, or copy it.

HFS Locator Plus is compatible with all programs using the HFS format. The software costs \$24.95. Contact PBI Software Inc., 1111 Triton Dr., Foster City, CA 94404, (415) 379-8765. Inquiry 593.

Telecommunications Package for Apple IIe/IIc

CommWorks, a telecommunications program for the Apple IIe and IIc, uses the AppleWorks file-folder format and features a text editor that can handle any ProDOS files (up to 35K), an automatic log-on facility, and on-line utilities that let you format disks and make sub-directories. You can define and save communications parameters and define as many as 18 sets of macros in each communications file.

The software supports ProDOS/AppleWorks and XMODEM file transfers. CommWorks functions with any Hayes (including the 2400-bps model), Apple, or Novation AppleCat modem. It runs on a IIe (with extended 80-column card and 128K) or IIc and costs \$95. Contact PBI Software Inc., 1111 Triton Dr., Foster City, CA 94404, (415) 349-8765. Inquiry 594.

Dac-Easy Accounting "Best Software Value"

InfoWorld
1985 "Product of the Year" Awards



"Trendsetting Accounting Product of the Year"

PC World
December, 1985

100,000 and more every day. That's how many smart buyers have already streamlined their accounting with the fastest-selling, most highly praised accounting package ever introduced.

Dac-Easy offers seven full feature accounting modules in a perfectly integrated package, with instant access to:

- General Ledger
- Accounts Receivable
- Accounts Payable
- Forecasting
- Inventory
- Purchase Order
- Billing

You can generate over 300 reports from 80 different routines. And best of all, Dac-Easy Accounting can be used to manage either service- or product-based businesses.

Now the Dac-Easy Series expands with the addition of the widely acclaimed Dac-Easy Payroll and Dac-Easy Word. Dac-Easy Accounting and Payroll are even more powerful and flexible with the company of Dac-Easy Mate and Dac-Easy Port. Also new for 1986 are Dac-Easy Accounting Tutor and Dac-Easy Payroll Tutor.

The best-selling business solution is now complete. Read what the experts say. Compare power, features, ease of use and price. Then join more than 100,000 people who have said "Yes!" to Dac-Easy.

All the Dac-Easy products are non-copy protected, fully documented, and come with a 30-day money back guarantee.

30-day money back guarantee

Dac Software offers an unconditional guarantee on all Dac-Easy products (less shipping charges). There is a \$10 restocking fee if the disk seal is broken. This guarantee is available on all products bought directly from Dac Software.

Minimum Hardware Requirements:

IBM or other compatibles, 256K memory, two disk drives, MS-DOS, PC-DOS 2.0 or later, 132 column printer in compressed mode, color or monochrome monitor.

MS-DOS is a trademark of MicroSoft Corp. IBM and PC-DOS 2.0 are registered trademarks of International Business Machines Corp.

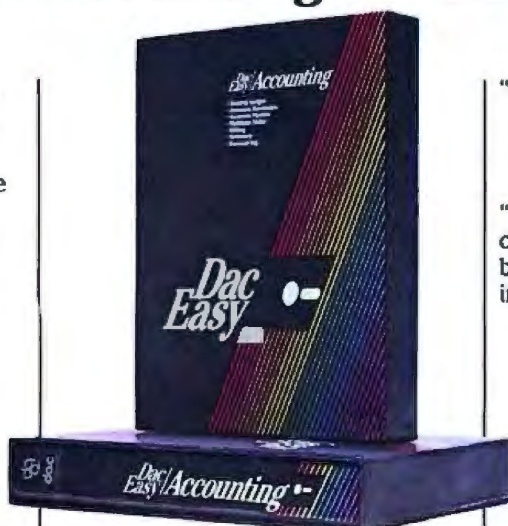

\$69.95

NEW!

Dac Easy Payroll \$49.95

The best in personnel and payroll processing. Automatic tax calculations for all 50 states. Tremendous report features. Multi-departments, after-the-fact payroll, interfaces with Dac-Easy Accounting or can stand alone.

Dac Easy Word \$49.95

Powerful, easy and flexible. Includes 70,000 word spell checker, mail merge, windows for up to four documents, cut and paste, search, word-breaking, word count, and much more.

Dac Easy Mate \$39.95

The perfect companion to our best-selling accounting and payroll programs. Add the Dac Road Map, calculator, color or intensity selection, macros, print to screen option, and file windowing. Dac-Easy Mate makes your accounting fun.

Dac Easy Port \$29.95

A great program that sends your accounting and payroll files to your favorite spreadsheet. Pick from your customer, vendor, chart of account, inventory, or employee files. Select ranges and select individual fields. Fast, easy operation.

Dac Easy Accounting Tutor \$19.95

Dac Easy Payroll Tutor \$19.95

These two programs make accounting and payroll a snap to learn. Can be used by the beginner or by the current user as a handy, stand-alone supplement to the user's manual.

"Dac-Easy is a genuinely amazing deal."

PC Magazine
October 15, 1985
"Editor's Choice"

"I've never before in a review come right out and told readers to buy a product, but I'm doing it now. Dac-Easy is an incredible value."

PC Week
August 27, 1985

Call toll free or return coupon below today

1-800-992-7779

Ask for Operator #828

In Texas or
for more information call
214-458-0038

TELEX: 5106000715 dac software

dac software, inc.
4801 Spring Valley Rd., Bldg. 110-B
Dallas, TX 75244

Please rush me the following products:

Product	#Copies	Price	Total
DAC-EASY ACCOUNTING	_____	\$69.95	_____
DAC-EASY PAYROLL	_____	\$49.95	_____
DAC-EASY WORD	_____	\$49.95	_____
DAC-EASY MATE	_____	\$39.95	_____
DAC-EASY PORT	_____	\$29.95	_____
ACCOUNTING TUTOR	_____	\$19.95	_____
PAYROLL TUTOR	_____	\$19.95	_____

Add Shipping Charge \$7.50

Texas Residents Add Sales Tax (6 1/2%) _____

TOTAL _____

- Check Money Order
 AMEX VISA MASTERCARD

Account # _____

Expires _____

Name _____

Company _____

Street Address _____

City _____

State _____ Zip _____

Phone _____

Computer brand _____

Signature _____

#828

CALL 1-800-992-7779 FOR
IMMEDIATE RESPONSE

NOW LEASE OR PURCHASE SYSTEMS FROM LOGICSOFT.

THE ECONOMY AND FLEXIBILITY OF A LOGICLEASE.

High tech without high cost. Outstanding flexibility. Plus substantial tax benefits. Logicsoft's new leasing program gives you them all and much more. Lease the computer system you need now for 36 months (customized lease programs also available) at one of our low, low rates. At the end of the term, you can purchase the system for only 10% of the original purchase price. Or negotiate a lease extension. Give Logicsoft a call. **We'll process your lease application in 24 hours.** And deliver your system within three days. First and last lease payments required in advance. Lease proposals subject to credit approval. Rates based on current cost of funds.

FREE 90-DAY, ON-SITE SERVICE ON ALL SYSTEMS.

Whether you lease or purchase a system from Logicsoft, you get a unique bonus: *a free 90-day, on-site system hardware service contract.* We've contracted with one of the nation's largest and most respected independent computer maintenance firms to provide you free service in most metropolitan areas. If a problem arises, it will be corrected quickly and efficiently. *At your facility. And at no additional cost to you.* There's no inconvenience of transporting your system to and from a service center. Wherever you are. Whatever the problem. Expert assistance is only a phone call away.

LOGICSOFT®

110 Bi-County Blvd., Dept. 543
Farmingdale, NY 11735
CANADA: 416-283-2354
Domestic/Int'l Telex
286905 SoftUR

To order or receive technical assistance, call our National Hotline:

1-800-645-3491

Customer Service: 1-800-431-9037
NY STATE: 1-800-235-6142 (516) 249-8440
FAX # 516-249-5289

Circle #400 on reader service card.

EUROPE: 020-83 48 64
Telex: 10759 Logic NL
Mail orders to:
LOGICSOFT EUROPE BV
pb 9460, 1006 AL Amsterdam, Holland

NOBODY DELIVERS LIKE LOGICSOFT.



**FREE OVERNIGHT
DELIVERY**

**LOWEST PRICE
GUARANTEE**

**TOLL-FREE
CUSTOMER SERVICE**

Buy it today, use it tomorrow!

Only Logicsoft ships your order the same day via overnight courier.* Free.

Nobody beats Logicsoft prices.

In fact, if you find a lower price (advertised or a bonafide quote) on any of the hundreds of products we stock, we'll beat it by \$10.† Our Corporate Accounts Program offers attractive volume discounts. Credit cards and PO's accepted.

Outstanding customer service and technical support.

It's only a toll-free phone call away. Another reason why Logicsoft is a major hardware and software supplier to over 50,000 companies, including over 90% of the Fortune 1000.

See inside for the lowest prices on over 800 products for IBM-PC's and compatibles.

LOGICSOFT®

To order or receive technical assistance, call our National Hotline:

1-800-645-3491

Customer Service: 1-800-431-9037

NY STATE: 1-800-235-6442 (516) 249-8440

FAX# 516-249-5289

*Applies to order totaling over \$100. If under \$100, shipped UPS—FREE (Within Cont. U.S.) Due to weight restrictions, printers and monitors are also shipped UPS—FREE. †This offer does not apply to items under \$100, American Express or Terms orders. In these instances, we will meet any lower price. We reserve the right to request a current written price quote.

SHIPPING NOW !!!

SHIPPING NOW !!! SHIPPING NOW !!! SHIPPING NOW !!! SHIPPING NOW !!! SHIPPING NOW !!!

SHIPPING NOW !!! SHIPPING NOW !!! SHIPPING NOW !!! SHIPPING NOW !!! SHIPPING NOW !!!



The power of dBASE III for the Macintosh has arrived!!!

This new software product, named dMac III, is fully compatible with dBASE III and is three times faster.

dMac III features a powerful programming language that offers its owners the ability to develop professional business applications for the Macintosh.

In addition, you can transfer your dBASE III applications and databases to the Macintosh where dMac III will allow you to use them without modification.

Of course you can use dMac III along with the other popular Macintosh software products such as Microsoft WORD and Microsoft FILE.

As a dMac III owner you get the best of both worlds. All of the features of the most popular programmable database for the IBM PC plus the user friendliness of Apple's Macintosh.

To order dMac III contact:

FORMAT SOFTWARE
11770 BERNARDO PLAZA CT.
SAN DIEGO, CA 92128
(619) 487-6946

Macintosh is a trademark of Apple Computer

dBASE III is a trademark of Ashton-Tate
IBM PC is a trademark of IBM
Microsoft WORD and Microsoft FILE are trademarks of Microsoft
dMac III is a trademark of FORMAT Software

CLUBS AND NEWSLETTERS

WESTERN INDIANA COMMODORE USERS (WICU), P.O. Box 1898, Terre Haute, IN 47808. Newsletter, BBS at (812) 232-0313, monthly meetings, public domain software. Dues: \$12 annually.

INDEPENDENT COMPUTER CONSULTANTS ASSOCIATION (ICCA), Phoenix Chapter, P.O. Box 32115, Phoenix, AZ 85064, (602) 962-8010. Newsletter: \$20 per year. Membership and monthly meetings: \$50 per year.

NEC PC-8000 USERS GROUP, David Clark, 18 Provence St., MacGregor, Queensland 4109, Australia. Meetings, newsletter, public domain software library.

BAY AREA VICTOR-GROUP, M. J. Knobelsdorf, P.O. Box 50893, Palo Alto, CA 94303, (415) 820-5622. Newsletter, public domain library, meetings, and BBS.

SPE MICROCOMP NEWS, P.O. Box 833836, Richardson, TX 75083-3836, (214) 669-3377. Bimonthly newsletter published by the Society of Petroleum Engineers.

CLEVELAND AREA AMIGA USERS' GROUP, 3715 Townley Rd., Shaker Heights, OH 44122, (216) 295-1624. Meetings, public domain software library, and BBS. Membership fee: \$30.

ENABLE USERS GROUP, 38 Glen Dr., Mill Valley, CA 94941. Meetings, newsletter. Membership: \$5 sign-up fee; \$20 annual dues.

SOUTH SHORE PORTABLE COMPUTER USERS GROUP (SSPCUG), Andrew Moore, P.O. Box 121, North Quincy, MA 02171, (617) 479-9208, evenings. Public domain software library, newsletter.

PROFESSIONAL COMPUTER CLUB EUROPE, Merle Spongberg, Box 6, Goerresstr. 10, D-6904 Eppelheim, Germany. Monthly meetings and newsletter for professional users of IBM PC-DOS and CP/M.

QL USERS AND TINKERERS ASSOCIATION (QUANTA), Brian Pain, 24 Oxford St., Stony Stratford, Milton Keynes MK11 1JU, England. Open to all Sinclair QL users. Monthly newsletter.

HANDS ON!, Technical Education Research Centers, 1696 Massachusetts Ave., Cambridge, MA 02138. \$10 contribution requested for newsletter.

OMNIMUG, Dan Shafer, 1220 Edgewood Rd., Redwood City, CA 94062, (415) 361-8562. For users of Omnis-3 and Omnis-3-based applications. Newsletter, public domain disk exchange, referral service. Dues: \$36 per year.

COMMODORE HARDWARE USER'S GROUP (CHUG), 1322 Fairview Dr., Greenfield, IN 46140. Includes a SIG for Amiga Computer Enthusiasts (ACE), meetings, newsletter. BBS at (317) 898-5027.

WASHINGTON AREA RAINBOW USERS GROUP (WARUG), P.O. Box 1940, Vienna, VA 22180. Monthly newsletter. BBS at (703) 359-6549. Dues: \$16.

ADAM & EVE APPLE USERS' GROUP, P.O. Box 5344, Madison, WI 53705, (608) 255-1856. Monthly newsletter, public domain library, meetings, SIGs, 24-hour BBS at (608) 255-2755. \$15 annual dues.

NATIONAL X/LISA USERS GROUP, P.O. Box 450676, Miami, FL 33145-0676. Free membership, semiannual newsletter. BBS at (305) 445-6481.

THE BOSTON COMPUTER SOCIETY'S ATARI ST USERS GROUP, One Center Plaza, Boston, MA 02108, (617) 296-8286. Bimonthly newsletter (*J-BUG*), regular meetings, public domain disks.

MAINE MACINTOSH OWNERS & OPERATORS SOCIETY (MMOOS), Mike Roderick, Pickard Theater, Bowdoin College, Brunswick, ME 04011, (207) 725-8731, ext. 5344. Meetings twice a month, newsletter, library, discounts, BBS at (207) 725-8456. Dues: \$40 annually.

CLUBS AND NEWSLETTERS is an acknowledgment of new clubs and newsletters received at BYTE. Allow at least four months for your club's mention to appear. Send information to BYTE, Clubs and Newsletters, One Phoenix Mill Lane, Peterborough, NH 03458.



Leading Edge Model D

- 256K Memory • Two 360K Half/Height Floppy Drives • Four Expansion Slots • Keyboard • Text Display Card • High-Resolution Monochrome Monitor • One Parallel And Serial Port • Color option available

• Purchase Price: \$1,375

Lease For **\$59** per month

New IBM AT—30 Mb

- 8 MHz • 512K • 30 Mb Hard Drive (Full Height, w/controller) • 1.2 Mb Half/Height Floppy • Eight Expansion Slots • IBM Enhanced PC Keyboard • Serial/Parallel Adapter • Free 90-Day, On-Site Service Contract • Color or Monochrome Monitor Available as Option

• Purchase Price: \$4,299

Lease For **\$167** per month

New IBM XT—20 Mb

- 512K • 20 Mb Hard Drive • 360K Floppy Drive Half Height • Eight Expansion Slots • IBM Enhanced PC Keyboard • Asynchronous Communications Adapter • Free 90-Day, On-Site Service Contract • Color or Monochrome Monitor Available as Option

• Purchase Price: \$2,369

Lease For **\$99** per month



New Compaq Deskpro 286—30 Mb

- 512K RAM Memory • 80286 Based CPU • One 30Mb Hard Drive (w/controller) • One 1.2 Mb Half/Height Floppy Drive • Eight Expansion Slots • Compaq Keyboard • Graphics Card • One parallel port • Free 90 Day On-Site Service Contract • Color or Monochrome available as option

• Purchase Price: \$3,899

Lease For **\$154** per month

New Compaq Deskpro 20Mb

- 640K RAM Memory • One 20Mb Hard Drive (w/Controller) • One 360K Floppy Drive • Eight Expansion Slots • Compaq Keyboard • Graphics Card • One Parallel port • Asynchronous Communications/Clock Board • Free 90-Day, On-Site Service Contract • Color or Monochrome Monitor Available as option

• Purchase Price: \$2,319

Lease For **\$99** per month

New Compaq Portable II 20Mb

- 640K RAM Memory • 80286 Based CPU • One 20Mb Half/Height Hard Drive (w/controller) • One 360K one-third Height Floppy Drive • Two Expansion Slots • Compaq II Keyboard • Text/Graphics Display Card • 9" Text/Graphics Monochrome Monitor • One Serial and Parallel Port • Free 90-Day, On-Site Service Contract

• Purchase Price: \$3,899

Lease For **\$154** per month

New Compaq Portable 286—20Mb

- 640K RAM Memory • 80286 Based CPU • One 20Mb Hard Drive (w/controller) • One 1.2 Mb Half/Height Floppy Drive • Five Expansion Slots • Compaq Keyboard • Graphics Display Card • 9" Text/Graphics Monochrome Monitor • One Parallel Port • Free 90-Day, On-Site Service

• Purchase Price: \$4,269

Lease For **\$169** per month

AT&T 6300 Total Business System

- 256K RAM Memory, Expandable to 640K On Mother Board • One 10 Mb Half/Height Hard Drive (w/Controller) • One 360K Floppy Drive • Seven Expansion Slots • AT&T Keyboard • High-Resolution Graphics Card • High-Resolution Monochrome Graphics Monitor • Serial & Parallel Ports • Toshiba P-351 Printer And Cable • Software Bundle (dBase III Plus, Lotus 1-2-3, Word Perfect, SideKick, G.W. Basic and MS-DOS) • Free 90-Day, On-Site Service Contract

• Purchase Price: \$4,247

Lease For **\$167** per month

100% Burn-In and Testing.

All systems undergo a 48-hour configuration, testing and burn-in period. We configure system boards, set DIP switches, format hard drives, perform memory diagnostics and check system with monitor.

AND A HUGE SELECTION OF PERIPHERALS.

PRINTERS*

EPSON	
LQ 800	\$579
LQ 1000	759
RX-100	365
FX-85	399
FX-286	589
JUKI	
6100	359
6300	699
NEC	
8800	1045
Pinwriter P-5	Low Price Call!
Pinwriter P-6	485
Pinwriter P-7	619

MANNESMAN TALLY

MT-86	499
-------------	-----

OKIDATA

182 Plug & Play	224
192 Plug & Play	349
193 Plug & Play	545
2410 P Plug & Play	1759

PANASONIC

KX 1091	255
KX 1595	Low Price Call!

TOSHIBA

P 321	469
P 341	795
P 351	999

CITIZEN

MSP 10	259
MSP 15	369
MSP 20	339
MSP 25	519
Premier 35	479

LASER PRINTERS*

CANON	
Laser Printer	\$1995

HEWLETT PACKARD

Laser Printer	2579
Laser Printer Plus	3399

PLOTTERS*

HEWLETT PACKARD	
7475A	1699

HOUSTON INSTRUMENTS

DMP 40	875
DMP 41	2699
DMP 42	2699
DMP 51	3999
DMP 52	3999

MONITORS*

AMDEK	
Color 600	\$389
Color 722	509
Color 725	Low Price Call!
12" Green 300 G	125
12" Amber 300 A	135
12" Amber 310 A	149
NEC	
JC-1401P 3A	
Multi-sync color	
w/swivel base	569
IBM	
Color Monitor	545

Monochrome Monitor ..	225
Enhanced Color Display ..	679
PRINCETON GRAPHICS	
RGB HX-12	419
RGB HX-12E	535
RGB SR-12	569
RGB SR-12P	625
Amber Max 12	165
QUADRAM	
Amberchrome 12"	145
Quadchrome	499
TAXAN	
122	145
620	415
640	535

MULTI-FUNCTION BOARDS

AST RESEARCH	
Six Pack Premium	\$389
Six Pack Plus (384K)	239
Rampage w/128K	329
Rampage (AT) w/512K	459
Advantage (128K)	389
I/O Mini Half Card	119
I/O Plus II	129

EVEREX	
Magic Card II w/384K ..	199

TECMAR

Captain (384K)	229
----------------------	-----

QUADRAM

Quadboard (384K)	269
Silverboard	225
Goldboard	399
Liberty (AT) w/128K	315

INTEL

Above Board (PC)	275
Above Board (AT)	439
Above Board (PS) 64K ..	319
Above Board (PS) AT ..	
256K	429
8087 Math	
Co-Processor	129
80287 Math	
Co-Processor	215

GRAPHICS BOARDS

AST	
Preview	\$249
EVEREX	
Graphics Edge	249
The Edge	239

HERCULES

Monochrome Graphics ..	
Card	299
Color Card	155

PARADISE SYSTEMS

Multi-Display Card	189
Modular Graphics Card ..	219
Color/Mono	139

QUADRAM

EGA Plus Graphics	389
-------------------------	-----

SIGMA

Color 400 (Princeton) ..	489
--------------------------	-----

STB

Chaufeur	255
Graphics Plus II	229
EGA Plus	329

TECMAR

Graphics Master	419
-----------------------	-----

COMMUNICATIONS BOARDS

AST	
5251-11	\$645
DCA	
IRMA Board	839

MODEMS

AST	
Reach 1200 Half Card ..	\$345
EVEREX	
Evercom II	149
HAYES	
Smartmodem 300	145
Smartmodem 1200	389
Smartmodem 1200 B	
w/Smartcom II	359
Smartmodem 2400	599
Smartmodem 2400B	
w/Smartcom II	559

PROMETHEUS

Pro-modem 1200	289
----------------------	-----

Pro-modem 1200 B	
------------------------	--

w/software	239
------------------	-----

QUADRAM

Quadmodem Series	
------------------------	--

.....	Low Price Call!
-------	------------------------

VEN-TEL

PC Modem 1200 Half	
--------------------------	--

Card	375
------------	-----

1200 Plus	339
-----------------	-----

PC Modem 2400 Half	
--------------------------	--

Card	499
------------	-----

MOUSE INPUT DEVICES

MOUSE SYSTEMS

PC Mouse w/DR	
---------------------	--

Halo 2	\$135
--------------	-------

MICROSOFT

Microsoft Mouse (Serial) ..	135
-----------------------------	-----

Microsoft Mouse (Buss) ..	125
---------------------------	-----

SURGE PROTECTORS

KENSINGTON MICROWARE

Masterpiece	\$ 95
-------------------	-------

Masterpiece Plus	119
------------------------	-----

CURTIS

Diamond	39
---------------	----

Emerald	45
---------------	----

Ruby	59
------------	----

KEYBOARDS

KEYTRONIC

5151 (Deluxe)	169
---------------------	-----

5153 (w/touch Pad)	289
--------------------------	-----

3270 PC	Low Price Call!
---------------	------------------------

Keytronic Jr. 5151	169
--------------------------	-----

MEMORY STORAGE

IOMEGA

Bernoulli Box	
---------------------	--

(10 + 10)	\$2349
-----------------	--------

Bernoulli Box	
---------------------	--

(20 Mb)	2299
---------------	------

Bernoulli Box	
---------------------	--

(20 + 20)	3299
-----------------	------

HARD DISK DRIVES

MOUNTAIN COMPUTER

Hard Drive Card	
-----------------------	--

(20 Mb)	975
---------------	-----

Hard Drive Card (30Mb) ..	
---------------------------	--

.....	Low Price Call!
-------	------------------------

PRIAM CORP

60 Mb Internal Hard Drive ..	
------------------------------	--

.....	1489
-------	------

Innerspace ID 40Mb	1299
--------------------------	------

PLUS+

Hard Card	
-----------------	--

10 Mb	\$699
-------------	-------

TALLGRASS TECHNOLOGY

Tc 5525i 25 Mb Int	849
--------------------------	-----

SEAGATE

10 Mb ½ Ht Int	465
----------------------	-----

20 Mb ½ Ht Int	525
----------------------	-----

20 Mb Full Ht (AT)	675
--------------------------	-----

30 Mb Full Ht (AT)	789
--------------------------	-----

40 Mb Full Ht (AT)	899
--------------------------	-----

60 Mb Full Ht (AT)	
--------------------------	--

.....	Low Price Call!
-------	------------------------

CORE

20 Mb Int (AT)	1435
----------------------	------

30 Mb Int (AT)	1795
----------------------	------

40 Mb Int (AT)	2325
----------------------	------

72 Mb Int. (AT)	3999
-----------------------	------

CARTRIDGE TAPE BACK-UP

EVEREX

Excel Stream 20 Mb Int ..	639
---------------------------	-----

Excel Stream 60 Mb Int ..	799
---------------------------	-----

Excel Stream 60 Mb Ext ..	929
---------------------------	-----

IRWIN

Irwin 110 10 Mb Int	499
---------------------------	-----

20 Mb Int.	645
-----------------	-----

20 Mb 325 (AT) Ext. D ..	799
--------------------------	-----

MAYNARD ELECTRONICS

Maynstream 20 Ext	999
-------------------------	-----

Maynstream At-20 Int	799
----------------------------	-----

SYSGEN

Image Tape Backup	
-------------------------	--

10 Mb Int	835
-----------------	-----

Image Tape Backup	
-------------------------	--

20 Mb Int	599
-----------------	-----

Image Tape Backup	
-------------------------	--

20 Mb Ext	699
-----------------	-----

TECMAR

QIC 60 AT	1250
-----------------	------

QIC 60 Ext Tape	
-----------------------	--

Backup	1599
--------------	------

CORE

60 Mb Ext	1599
-----------------	------

FLOPPY DISK DRIVES

Panasonic 360 K	
-----------------------	--

½ Ht.	\$119
------------	-------

Tandon TM-100 360 K	
---------------------------	--

F/Ht	125
------------	-----

Tandon TM-100 360K ½ Ht ..	119
----------------------------	-----

Toshiba 360 K ½ Ht	115
--------------------------	-----

BACK UP POWER SUPPLIES

DATA SHIELD

200 Wt (PC)	\$249
-------------------	-------

300 Wt (XT)	359
-------------------	-----

500 Wt (AT)	569
-------------------	-----

800 Wt (AT)	655
-------------------	-----

*Due to weight restrictions, Printers and Monitors are shipped UPS—free. **Parallel interface req. Ask sales agent. All prices and policies subject to change without notice.

CAN'T FIND IT? ASK FOR OUR SPECIAL ORDER DEPT.

There's a good chance we do carry the product (we're adding new ones every day). Or, we can get it for you from one of our suppliers—still at our low direct-to-you prices.

LOGICSOFT ALSO OFFERS SOFTWARE FOR VIRTUALLY EVERY IBM PC APPLICATION...

WORD PROCESSING		Revelation 495	Quickcode for 1-2-3 95	PROJECT MANAGEMENT	
DISPLAY WRITE III .. \$369	REFLEX 59	Think Tank 109	GRAPHICS		HARVARD TOTAL \$279
Easy Writer II 199	Q & A 229		CHARTMASTER \$209	MICROSOFT PROJECT 229	Project Manager Workbench
MICROSOFT WORD ... 229	DATA BASE MGMT.ADD-ONS		Diagram Master 195 Low Price Call!	
MULTIMATE 229	Clipper (D Base) \$359		Energraphics 169	SUPER PROJECT PLUS 259	Timeline 259
MULTIMATE	Clout 2 (R:Base) 139		Gem Draw 159	FINANCIAL	
ADVANTAGE 279	DB III Compiler (Wordtech)		Graph Writer 219	MANAGING YOUR	
Office Writer 245 Low Price Call!		Harvard Presentation ... 299	MONEY \$105	
Pfs: Write 85	Ext. Report Writer (R:Base)		MICROSOFT CHART .. 179	Dollars N' Sense 109	
Samna III 295 99		PC Draw 209	ACCOUNTING	
VOLKSWRITER 3 149	Quickcode III (D Base) .. 149		Pfs: Graph 85	BPI from \$319	
WORD PERFECT 209	Quickreport (D Base) ... 139		Sign Master 149	COMPUTER ASSOCIATES	
Wordstar 179				(Formerly IUS) ... from 319	
Wordstar Pro Pak 239	SPREADSHEETS/		CAD/CAM	CPA + (GNP) 429	
WORDSTAR 2000 249	INTEGRATED		Auto CAD \$829	Great Plains from 449	
Wordstar 2000 Plus 295	Ability \$ 75		Pro Design II 239	Open Systems from 319	
XY WRITE III 239	Enable 339		PLOTTERS AVAIL.		State of the Art Mas from 579
	FRAMEWORK II 389		See hardware listings		TCS Client Write Up 895
	Javelin 579		LANGUAGES		Real World from 529
	LOTUS 1-2-3 315		Business Basic (MS) ... \$309	MISC/UTILITIES	
	Multiplan 119		C COMPILER (MS) 239	COPY II PC \$ 35	
	Supercalc III 199		COBOL COMPILER	Crosstalk XVI 99	
	SYMPHONY 439		(MS) 395	FAST BACK 99	
			Fortran Compiler (MS) .. 219	Microsoft Windows 65	
DATABASE MANAGEMENT	SPREADSHEET ADD-ONS		Lattice C Compiler 269	NORTON UTILITIES ... 55	
Cornerstone \$ 85	LOTUS REPORT		MACRO ASSEMBLER	Prokey 4.0 79	
d Base II 279	WRITER \$109		(MS) 99	Remote 105	
d BASE III PLUS 395	Cambridge Spreadsheet		Pascal Compiler (MS) ... 185	RESIDENT 75	
Knowledge Man 2 299	Analyst 119		Quick Basic (MS) 69	SIDEKICK 49	
Paradox 519	Sideways 45		TURBO PASCAL 45	Superkey 45	
Pfs: File 85	Spreadsheet Auditor ... 109				
Pfs: Report 79					
Powerbase 209					
R:BASE 5000 339					

OVER 200 OTHER SOFTWARE TITLES IN STOCK AT LOW DISCOUNT PRICES.

#1 Rated productivity software.

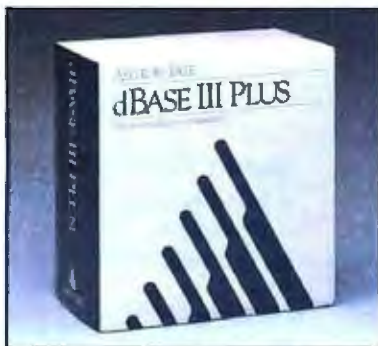

dBase III Plus \$395

Add-Ons for dBase III Plus

Clipper

dBase III compiler. \$359

Quickcode III

Quickcode III reduces programming time by over 70%. \$149

Quickreport

The most powerful report writer for dBase III. \$139



LOTUS 1-2-3 \$315

Add-Ons for LOTUS 1-2-3

Sideways

Sideways lets you create extra wide printouts of reports without staples, glue or tape. \$45

Spreadsheet Auditor

The most powerful error trapping program available. (Includes side print utility.) \$109

LOTUS 1-2-3 Report Writer

Now you can format your own reports, forms and mailings from 1-2-3 files. \$109



Word Perfect \$209

Add-Ons for Word Perfect

Turbo Lightning

Random House Thesaurus & Spell-checker. \$59

Punctuation & Style

Helps improve the quality of your writing. \$75

Fancy Font

Lets you use multiple fonts to enhance the appearance of your letters & reports. \$145

INTRODUCING LOGICWARE. FULLY COMPATIBLE COMPUTER PRODUCTS.

**5-Year Unconditional Warranty • Made in U.S.A.
Immediate Replacement or Repair Policy • Low Power Consumption**

Now Logicsoft gives you a logical choice.

We're manufacturing a complete line of computer products called LogicWare. They're fully compatible with major manufacturers.

The boards pictured here are part of a vast array of ultra-reliable computer products.

We save you money—not by using inexpensive labor or parts—but through state-of-the-art technology, which reduces part requirements and increases reliability. Each product has a 5-year unconditional warranty plus our immediate replace or repair policy.

LogicWare. It's the logical way to get high quality without paying high prices.



AST Compatible AT Multifunction Board w/128K—\$229

- Expandable to 2 Megabytes on Board • Install Either 64K or 256K Chips to Customize the Memory to your Existing Memory Configuration • Software RAM Disk • Printer Spooler/Buffer • One Parallel Port • Two Serial Ports • Game Port



Hercules Compatible Monochrome Graphics Board—\$119

- 720 × 348 Pixel Graphics • Parallel Printer Port • Lotus 1-2-3 Compatible • TTL Monochrome Output • ATD Software Supplied For Direct Emulation of Hercules Graphics Card • Low Power Consumption



AST Compatible Six Function Card w/384K—\$159

- One Parallel Port • One Serial Port • One Game Port • Clock Calendar • 384K RAM Memory • Low Power Consumption • Software • Printer/Spooler Buffer



AST Compatible 576K RAM Board Half Card with 64K—\$69

- Expandable to 576K • Supports 64K or 256K Memory Chips • Fits in Short Slot • Low Power Consumption • Clock Calendar Option loaded w/384K \$135 loaded w/576K \$149



Hercules Compatible Color Graphics Board—\$99

- 320 × 200 Color Pixels • 640 × 200 Monograph Pixels • Parallel Printer Port • Low Power Consumption • Fits in Short Slot • Will Drive a Medium Resolution Color & Monochrome Monitor

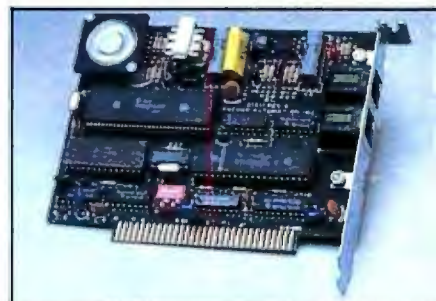

Hayes 1200 B Compatible Half Card Modem w/Software—\$149

- 300/1200 Baud • Bell 103/212A Compatible • Auto Dial/Auto Answer • Pulse or Touch Tone Dialing • Full or Half Duplex Operation • Fits in Short Slot • Low Power Consumption

Hayes 2400B Compatible Half Card Modem w/Software—\$299

LOGICSOFT

To order or receive technical assistance, call our National Hotline:

1-800-645-3491

Customer Service: 1-800-431-9037
NY STATE: 1-800-235-6442 (516) 249-8440
FAX # 516-249-5289

EUROPE: 020-83 48 64
Telex: 10759 Logic NL
Mail orders to:
LOGICSOFT EUROPE BV
pb 9460, 1006 AL Amsterdam, Holland

110 Bi-County Blvd., Dept. 543
Farmingdale, NY 11735
CANADA: 416-283-2354
Domestic/Int'l Telex
286905 SoftUR



No surcharge for MasterCard, VISA, American Express, C.O.D., money order, check or PO's (please call for price verification) • No sales tax on orders shipped outside N.Y. State • Please add 2% for insurance and handling (\$3.00 minimum) (int'l orders add) • We do not bill until we ship. All products covered by mlg's warranty. Defective merchandise may be returned for repair or exchange. We do not guarantee compatibility. Any goods returned for credit are subject to a 15% restocking charge. All prices and policies subject to change without notice.

Circle #400 on reader service card.

FIXES AND UPDATES

FIXES

Improving the Runge-Kutta BASIC Program

Several readers wrote to David M. Leo about the fourth-order Runge-Kutta BASIC program accompanying his "Response of a System to Complex Driving Forces" (listing A on page 197 of the April issue). He agrees with J. C. Sprott, of Madison, Wisconsin, that the variable COUNT should be reset to zero after each time step. This is done most simply by adding:

```
285 COUNT = 0
```

Mr. Leo noted the step was deleted unintentionally while removing the plotting statements from the program. "I didn't catch the omission since the error in peak amplitude was small," he said.

The program can be further improved, as suggested by John McCoy of Sam

Houston State University, by changing four other statements. First, rewrite line 230 like this:

```
230 COUNT = COUNT + 1:ON COUNT  
GOTO 240,260,270,280
```

And then, in lines 250, 260, and 270, IF ... THEN 210 can be shortened to GOTO 210.

More on Runge-Kutta

Benku Thomas, author of "The Runge-Kutta Methods" (April), writes to inform us of errors in his article.

In tables 7 and 8, which are labeled "Absolute Global Errors," the negative signs should not appear on the global errors ob-

tained using the RKG method.

In the algorithm in figure 3, the condition in step 8 should be: for $|x| \neq 0$.

The Real Price of GCLISP 286 Developer

We erred by \$800 in a What's New description of the GCLISP 286 Developer from Gold Hill Computers (April, page

387). The real price is \$1195, not \$1995. Our apologies to the company.

For more information on the package,

contact Gold Hill Computers Inc., 163 Harvard Ave., Cambridge, MA 02139, (617) 492-2071.

UPDATE

Author Adapts Navigation Program to Run on IBM PC

Frederic N. Rounds reports that since his article "Navigation: Putting the Micro-computer to Work at Sea" appeared in our March 1985 issue, he has received hundreds of letters from people, many of

whom were interested in an IBM PC version of the Sunfix program listing, which was written for the TRS-80.

Well, sailors. Mr. Rounds has adapted Sunfix for the IBM PC. He has also rewrit-

ten the user interface for greater suitability on small boats. The new version is available on disk for \$19.95. You can order it from the author at 894 Persimmon Ave., Sunnyvale, CA 94087.

BYTE'S BITS

Italy Calling

Organizers of the Second International Joint Conference on Theory and Practice of Software Development (TAPSOFT) have put out a call for papers. The conference consists of three events.

The Colloquium on Trees in Algebra and Programming (CAAP '87). Topics include formal languages and automata, semantics of sequential and concurrent programs, theory of data structures and databases, and formal specification of software systems.

The Colloquium on Functional and Logic Programming and Specifications (CFLP). Topics include logic of programming, programming language notions, and practical development of applications.

The Advanced Seminar on Foundations of Innovative Software Development focuses on new directions in software development.

Deadline for submission of drafts is September 1. Papers for CAAP should go to Professor Ugo Montanari, Dipartimento di Informatica Università di Pisa, Corso Italia 40 I-56100 Pisa, Italy. Papers for CFLP should be sent to Professor Giorgio Levi at the same address. For information about the conference, write to Dr. Pierpaolo Degano, also at that address.

TAPSOFT '87 is scheduled for March 23-27, 1987, in the city with the leaning tower.

Do-It-Yourself Compaq Upgrade

Applied Foresight is selling a 57-page report that's supposed to help Compaq computer owners upgrade their machines. Written by R. H. Martin, "Upgrading Your Compaq Plus or Portable with 20-40 MB Disk Space & A 640K Motherboard" is reportedly based on real updates of those machines. Martin notes that the upgrade is a complex job because of "portability constraints, the 120-watt power supply, ... and the limited number of slots available." The report costs \$17.50 in the U.S. and Canada, and \$30 everywhere else. You can order it by sending the money to Applied Foresight Inc., P.O. Box 20607, Bloomington, MN 55420.

Conducted by Steve Ciarcia

CROSS ASSEMBLER

Dear Steve,

I am desperately in need of an Intel 8051 microcontroller cross assembler, written in any high-level language. Where can I possibly get one?

CLAUDIO ROLAND SONNENBURG
São José dos Campos, Brazil

I don't know of anyone supplying cross assemblers in a high-level language. By this I mean source code to be compiled on your computer. Cross compilers that will run on most MS-DOS or CP/M systems are available from

Avocet Systems Inc.
P.O. Box 490-B7
Rockport, ME 04856
(207) 236-9055

Another source for cross compilers that will run on some UNIX and PCOS systems in addition to MS-DOS and CP/M is

2500 AD Software Inc.
17200 East Ohio Dr.
Aurora, CO 80017
(303) 369-5001

If you are using a minicomputer or a mainframe, you might be able to obtain the cross assembler you need from the computer's manufacturer.—Steve

IMAGE BUFFER

Dear Steve,

The articles in the November 1985 BYTE on the state of image processing reminded me of an integrated circuit I've heard about. It is a high-density serial image buffer. Is such a memory chip available? If so, where can I get it?

GREG SMITH
Florissant, MO

Texas Instruments manufactures a line of video RAM chips similar to what you describe. These are dual-port memory chips with a built-in high-speed serial buffer (shift register) capable of speeds up to 150 megahertz. One port is sequential access, connected to the serial buffer; the other port is random access. The usual method of using this chip in video applications is to input the data through the random access port and output it to

the video controller through the sequential access port. These chips, known as the TMS4161 family, are available in modules of 64K by 4 or 5 bits, 256K by 4 or 5 bits, and 64K by 1 bit. Contact Texas Instruments at P.O. Box 809066, Dallas, TX 75240, for more information and data sheets.

NEC manufactures a similar series of chips. Its address for technical data is NEC Electronics Inc., 401 Ellis St., P.O. Box 7241, Mountain View, CA 94039-9978.
—Steve

OPERATING SYSTEMS

Dear Steve,

I recently started a project to design and build a computer based on the 68000 microprocessor. I have almost finished construction, and I've already built a serial EPROM programmer as shown in your February 1985 article. My plan is to put my bootstrap loader and monitor in EPROM and then use this to install a serious operating system. I'd like to use one of the more advanced systems, perhaps one of the many UNIX derivatives. However, I have already contacted several manufacturers, including Microware and Digital Research, and was told that they sell only to OEMs. Writing to magazine advertisers offering operating systems with their systems proved fruitless as well. No one will sell me a single copy that I could install myself. Can you give me some sources? What are the chances of successfully converting a system configured for a Cromemco or a CompuPro computer?

JIM CASTLEBERRY
Windermere, FL

It seems that most companies that catered to the hobbyist market now find they can't make a profit that way. One obvious problem is that if you buy an unconfigured operating system, the company must also deliver enough source code to enable you to configure it to your system. Ads from a few companies indicate that they might sell single copies.

Oasys (60 Aberdeen Ave., Cambridge, MA 02138, (617) 491-4180) sells lots of compilers, interpreters, and programing tools. The company also lists oper-

ating system kernels in its ads.

I know you contacted Microware Systems Corporation (1866 Northwest 114th St., Des Moines, IA 50322, (515) 224-1929), but its current advertising mentions a PortPak that lets you configure Microware's OS-9 to custom systems. Maybe this company will tell you where to buy a copy if it doesn't sell direct to the public.

Another possibility is presented in the article "A Simple Multitasking Operating System for Real Time Applications" by Nicholas Turner in the January 1986 issue of Dr. Dobbs' Journal. Contact Turner at

Terra Nova Communications
10 McGranahan Court
Boulder Creek, CA 95006
(408) 338-9510

You could probably adapt an operating system like CP/M-68K from Cromemco or CompuPro (Viasyn) if they deliver the BDOS source code. CP/M was designed to be easy to configure to most systems, and I assume CP/M-68K is written with the same philosophy. Without the source code, however, it would be nearly impossible to get it running on a foreign system.—Steve

SANYO SOFTWARE

Dear Steve,

I bought a Sanyo MBC 555-2 about a year ago and have been extremely dis-

(continued)

IN ASK BYTE, Steve Ciarcia answers questions on any area of microcomputing. The most representative questions received each month will be answered and published. Do you have a nagging problem? Send your inquiry to

Ask BYTE
c/o Steve Ciarcia
P.O. Box 582
Glastonbury, CT 06033

Due to the high volume of inquiries, personal replies cannot be given. All letters and photographs become the property of Steve Ciarcia and cannot be returned. Be sure to include "Ask BYTE" in the address.

The Ask BYTE staff includes manager Harv Weiner and researchers Eric Albert, Bill Curlew, Ken Davidson, Jeannette Dojan, Ion Elson, Roger James, Frank Kuechmann, Dave Lundberg, Edward Nisley, Dick Sawyer, Andy Siska, and Robert Stek.

MARK WILLIAMS' C PROGRAMMING SYSTEM

**Those who insist on C compiler performance
are very big on Mark Williams.**

And the compiler is just part of our total C Programming System.

**NEW 3.0
ENHANCEMENTS**

These and other powerful utilities now *included* in the C Programming System:

- **make:** compiles only what's necessary from multiple modules, a powerful programming discipline
- **diff:** identifies differences between two files
- **m4:** macroprocessor expression editing and substitution
- **egrep:** extended pattern search
- **MicroEMACS:** full screen editor with source

COMPILER FEATURES

- Runs under MS-DOS
- Full Kernighan & Ritchie C with recent extensions including void and enum
- Register variables for fast, compact code
- Full UNIX™ compatibility and complete libraries
- Large and small memory models
- MS-DOS linker compatibility
- 8087 Support
- One-step compiling
- English error messages
- ROMable code
- Linker, assembler, archiver
- Extensive third party library support

csd C SOURCE DEBUGGER

- Debugs at C source level without assembly language
- Separate evaluation, source, program and history windows
- Can execute any C expression
- Capabilities of a C interpreter, but runs in real time
- Set trace points on any statement or variable

Mark Williams' C compiler has earned a place in some very big companies for some very good reasons: it proves the benchmarks right with the speed, code density, consistent performance and expert support required in professional development environments.

But a total development tool shouldn't stop with compiling. Or go on and on with extras that add up and up.

Only Mark Williams' C Programming Systems *includes* the csd C Source Debugger with true source level debugging to speed your programming job.

And only Mark Williams' new 3.0 version *includes* utilities like "make" to make quick work of even the largest projects.

From source code to final product, only one takes you all the way: Mark Williams' C Programming System. All for only \$495. Ask about our 60-day money back guarantee when you call

1-800-692-1700 to order today.*

You'll be big on the total C Programming system from Mark Williams, too.

 **Mark
Williams
Company**

1430 West Wrightwood
Chicago, Illinois 60614

© 1985 Mark Williams Company
UNIX is a registered trademark of Bell Labs.

*In Illinois call 312-472-6659.

satisfied with its performance. I upgraded it to 256K bytes and have two double-sided disk drives. Its IBM PC compatibility is relatively poor. As far as I'm concerned, it has not fulfilled the advertising claims of the company.

I have had a difficult time finding any software that will run on it, especially software involving graphics. I was aware of problems with graphics compatibility at the time I purchased the machine, but I assumed there would be Sanyo software available to offset the shortcoming. That idea has since been proven wrong. The only IBM software I have been able to run without a hitch is Turbo Pascal.

Can you suggest a solution to my problem? How can I make the MBC 555-2 more PC compatible, and where can I find software to run on it? I have heard of a video RAM board that will produce IBM graphics; is it all it's cracked up to be? I would appreciate any comments or suggestions you might have.

VAUGHN S. BURCH
Lancaster, CA

There probably isn't much you can do in a general way to make your MBC 555-2

more compatible with software written for the IBM PC. Computer Shopper magazine runs a monthly column, "The Silver Box" by Richard Fujita, on the Sanyo, and you may find some tips there that will help you locate compatible software. Another suggestion is users groups. I found two Sanyo groups in California in the current issue of Computer Shopper:

*Sanyo-PC-Hacker/Newsletter
12450 Skyline Blvd.
Woodside, CA 94062*

*Sanyo User Group SFBA
c/o Valcon
1260 Westwood St.
Redwood City, CA 94061*

—Steve

HIGH-DECIBEL FANS

Dear Steve,

A source of constant annoyance to me is the loudness of the fan on my Heath/Zenith Z-110. Loud noise close to the operator can cause stress and hearing loss. It definitely makes concentration more difficult for me. Availability of quieter machines should discourage future sales

of loud machines, despite their other good qualities. Decibel volume is not mentioned in BYTE's hardware reviews. I suggest that this information be included in reviews.

The Z-110's fan, which is part of the power supply, seems intended to cool only the power supply; convection should take care of the circuit boards. A power source located at some distance from the operator (outside the computer housing) could be baffled or enclosed to minimize noise.

Why don't designers use these general principles: A small fan has to run fast to do the job that could be done at a lower speed and hence more quietly by a fan with a larger blade diameter; those annoying ceiling fans and kitchen range-hood fans come to mind as analogies. If direction is changed 90 degrees, the sound required loses half its volume.

JAY H. BECKERMAN
Fort Lauderdale, FL

I, too, am annoyed by the loud fans on some computers. Several factors should be considered when selecting a fan. Fans with the same airflow rating have
(continued)

Now works with DOS 3 DEBUG! **X-VIEW 86™**

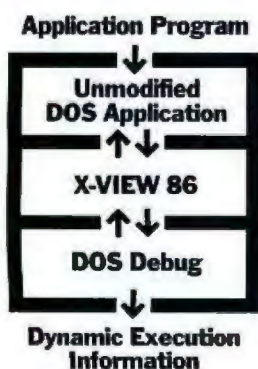

X-VIEW 86 profiles the execution of DOS software, and displays information needed to improve program performance, identify compatibility issues, and pinpoint conversion problems.

Profiles DOS application software and solves problems Debug can't touch.

X-VIEW 86 is a DOS software X-ray machine. X-VIEW 86 monitors internal software operations during execution to help you debug, test, port, or convert programs. X-VIEW 86 adds new features to Debug to profile either your own applications software or top-sellers like 1-2-3®. You get fast, reliable results.

Real solutions to technical challenges.

- Save hours of time-consuming, tedious work using data from X-VIEW 86's built-in reports that identify:
- Execution hotspots
 - Segment usage
 - Memory map references
 - Interrupt calls
 - I/O port references
 - I/O port references
 - Interrupt calls
 - I/O port references
 - Interrupt calls
 - Instruction set usage
 - Memory data references

Hardware and software requirements.

X-VIEW 86 runs on the IBM PC and compatibles with DOS Debug 2.x or 3.x. Even if you use a different debugger, X-VIEW 86 turns Debug into your program profiler. And it's not copy protected.

Priced at an affordable \$59.95.

Get a whole new outlook on your work with X-VIEW 86. We've made it easy. Order today by calling 1-800-221-VIEW (in Texas, or outside the U.S., call 1-214-437-7411). We accept Visa, MC, DC, and AmEx cards. Or order by writing to: McGraw-Hill CCIG Software, 8111 LBJ Freeway, Dallas, Texas 75251. X-VIEW 86 is just \$59.95 plus sales tax and \$3.00 shipping (\$9.00 outside the U.S.). Be sure to include credit card number and expiration date with mail orders. Orders paid by check are subject to delay. To order call

1-800-221-VIEW

McGraw-Hill CCIG Software

8111 LBJ Freeway, Dallas, Texas 75251

X-VIEW 86 is a trademark of McGraw-Hill, Inc.; IBM is a registered trademark of International Business Machines; 1-2-3 is a registered trademark of Lotus Development Corporation.

Mark Williams

Now the biggest name
in C compilers comes in a size
everybody can afford.

Let's C™
\$75

Introducing Mark Williams' \$75 C compiler: Want to explore C programming for the first time? Or just on your own time? Now you can do it in a big way without spending that way. With Let's C.

This is no little beginner's model. Let's C is a powerful programming tool, packed with all the essentials of the famous Mark Williams C Programming System. The one chosen by Intel, DEC, Wang and thousands of professional programmers. The one that wins the benchmarks and the reviewers' praise:

Mark Williams Let's C

- For the IBM-PC and MS-DOS
- Fast compact code plus register variables
- Full Kernighan & Ritchie C and extensions
- Full UNIX™ compatibility and complete libraries
- Small memory model
- Many powerful utilities including linker, assembler, archiver, cc one-step compiling, egrep, pr, tail, wc
- MicroEMACS full screen editor with source
- Supported by dozens of third party libraries
- Upgradeable to C Programming System for large scale applications development

Let's C Benchmark Done on an IBM-PC/XT, no 8087.
Program: Floating Point from BYTE, August, 1983.

Exec Time in Seconds

Let's C	134.20
MS 3.0	347.45

"Let's C is a thoroughly professional C environment loaded with tools and programming utilities. It is also another fine Mark Williams Co. product."
—Christopher Skelly, Computer Language Magazine, Feb. 1986

And now for more big news. Get our revolutionary csd C Source

Debugger for just \$75, too. You can breeze through debugging at the C source level ignoring clunky assembler code.

Affordable, powerful, debuggable. Mark Williams Let's C is the big name C compiler at a price you can handle. Get your hands on it now.

Use this coupon or charge by calling toll-free:
1-800-MWC-1700. In Ill. call 312-472-6659.

ORDER NOW! 60-DAY MONEY BACK GUARANTEE!

Mark Williams Let's C

Please send me:

_____ copies of Let's C and _____ copies of csd (C Source Debugger) at \$75 each. (Ill. residents add 7% sales tax.)

Check Money Order Visa, MasterCard or American Express

Name _____

Address _____

City _____ State _____ Zip _____

Card # _____ Exp. Date _____

Signature _____ BY076



Mark Williams Company

1430 West Wrightwood
Chicago, Illinois 60614

Inquiry 221

markedly different amounts of noise, and fans in each standard physical size (boxer, miniboxer, sprite, etc.) trade airflow for silence. In many cases, computer fans are overspecified, and a quieter whisper-type fan can be substituted.

The reduced airflow can be compensated for by putting internal baffles in the computer to ensure that fan air gets to the components rather than passing the nonelectronic areas of the cabinet. These baffles can be made of cardboard and

are taped inside the computer with duct tape or a similar material. The most annoying part of some axial-flow fan noise is the high-frequency noise peaks produced by the blades crossing the motor supports. Centrifugal or tangential blowers are free from these peak frequencies and produce only white noise. This is much less annoying than the whine of a fan. These blowers are usually larger than a fan, but since you are already considering external devices, you

should look at them.

Other solutions include replacing the fan with a larger boxer-size fan of the whisper type. These rotate at about half the speed of smaller fans and yet produce higher airflow. Adding a speed control to the fan allows the speed to be reduced until an acceptable combination of airflow and noise is achieved.—Steve

RGB TO RF

Dear Steve,

Is there a relatively inexpensive device or kit available that converts the RGB output of the IBM PC color card to an RF signal so that the PC's color graphics can be displayed on an ordinary color TV set?

I know there are modulators to translate the composite video output of the color card to an RF signal that will produce graphics in shades of gray on TV sets, so it seems that people would also be interested in a device for translating RGB output to an RF signal.

RONALD PANNATONI
Morristown, NJ

The composite video signal put out by the IBM PC Graphics Adapter Card contains color information, not just gray scale. If you modulate this signal and send it to a color TV, you get a color picture. Modulators, such as the ones sold by Radio Shack and some computer stores, will do the job for you.

The picture produced is satisfactory for noncritical graphics applications like games and marginal for text at 40 characters per line. Text at 80 characters per line is readable on a black-and-white TV but shimmers awfully on a color TV.
—Steve ■

**CIRCUIT CELLAR
FEEDBACK**

CLOCKS

Dear Steve,

As a result of reading your book *Build Your Own Z-80 Computer*, I have a few questions regarding microprocessor clock frequencies.

When using a Z80, which calls for a 2.5-megahertz clock, how close do you have to be to that frequency? I have noticed that Z80As used in Sinclair computers are operated at 3.25 MHz, yet the Z80A is listed as a 4-MHz CPU. Is there ever a situation when the CPU should be operated at its listed frequency? What is

(continued)

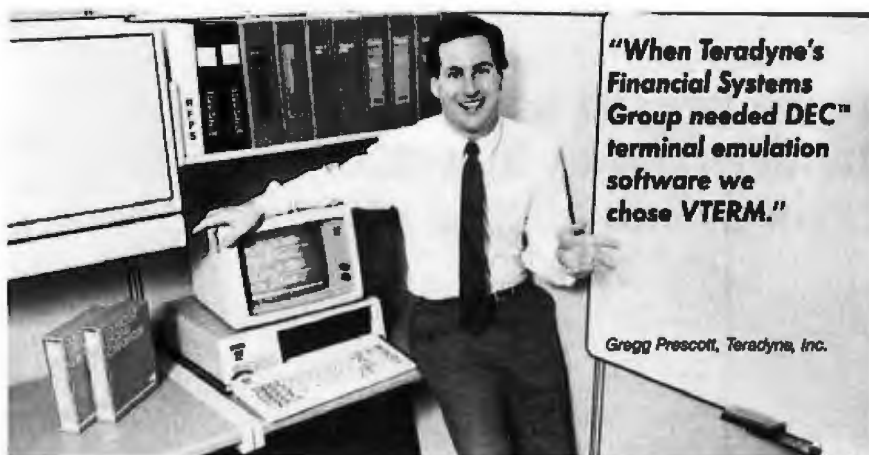

"When Teradyne's Financial Systems Group needed DEC™ terminal emulation software we chose VTERM."

Gregg Prescott, Teradyne, Inc.

**VTERM/220
Quality makes
all other DEC
terminal
emulators
obsolete**

Over 35,000 demanding professionals, like Teradyne's Gregg Prescott, have recognized VTERM's superior quality. Now this same VTERM quality is available in Coefficient's powerful new emulator, VTERM/220.

Features include:

- Plug compatible VT220 emulation with 132-column support and optional Tektronix™ 4010/4014 graphics.
- Extensive file transfer system offering KERMIT, XMODEM and our

VTRANS protocol with VMS™, RSX11 M/M+,™ RSTS/E™ and UNIX™ software.

- Host data capture on PC with conversion to Lotus® 1-2-3® Symphony® and dBase®
- "Hot Key" toggle between host session and PC DOS.

Call us today at 212-777-6707 ext. 158.



Coefficient

The Leader in DEC Emulation Software
Coefficient Systems Corporation
611 Broadway, New York, N.Y. 10012

Trademarks DEC, VMS, RSTS/E, RSX11 M/M+, Digital Equipment Corp.; Tektronix, Tektronix, Inc.; Lotus, 1-2-3, Symphony, Lotus Development Corp.; dBase, Ashton-Tate; UNIX, AT&T, Bell Laboratories

Our Software Isn't Cheap. Just Inexpensive.

- Full-featured word processing**
- Split Screen
 - On-line Help
 - Restore Deleted Text
 - File Conversion
 - Automatic Backup
 - Extensive Printer Support
 - Easy-to-use manual

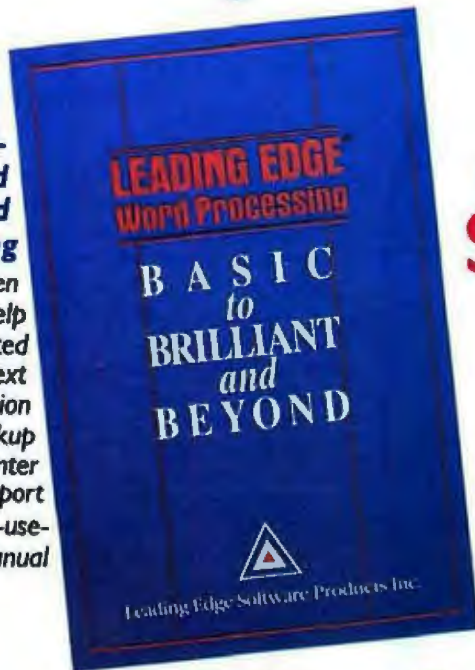

IBM-
Compatible
\$99⁰⁰
Together



- Professional-level Spreadsheet**
- Reads and Writes 1-2-3[®] files directly
 - 255 by 8192 Worksheet Area
 - 15 Types of Graphs
 - 2 and 3 Dimensional Graphs
 - No Copy Protection

Very Inexpensive.

Even though you can buy both Leading Edge[®] Word Processing and the Twin[™] Spreadsheet for a total of \$99, it's not cheap software.

If you don't believe it, read the PC Magazine in which Leading Edge Word Processing was named "Editor's Choice." After that, ask an experienced spreadsheet user if he or she can tell the difference between the Twin[™] and Lotus 1-2-3[®]— which retails at \$495.

And if you still don't believe that the only thing cheap about our software is its price, then pick up the phone and place an order. Our software speaks best for itself.

But do it before you consider any other software. You can't afford not to.

Call 1-800-343-3436 for a dealer near you or to order direct.
In MA call (617) 449-4655.

Call Today Hours: Sunday 1PM-6PM, Monday-Saturday 9AM-8PM



Leading Edge Software Products, Inc.
21 Highland Circle Needham Heights MA 02194
1-800-343-3436 in MA (617) 449-4655

Yes! I'll take a Very Inexpensive Deal! Please rush me ___ sets of Leading Edge Word Processing and the TWIN NAD-7

Name _____
Address _____
City _____
State _____ Zip _____
Telephone _____

System Requirements IBM PC, XT, AT and Compatibles. 256K RAM (LEWP) 384K RAM (TWIN) PC DOS 2.0 or greater Graphics card optional

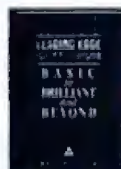

Price Includes Shipping
to all U.S. Cities

\$99⁰⁰
together



Subtotal _____

Mass. Residents Add 5% _____

Amount Enclosed _____

Circle Payment Money Order

SUNDA 10-5 **PROMPT DELIVERY**

PRINTERS		COMPUTERS	
Brother HR15-XL	275.00	IBM PC	\$1199.00
Brother HR-25	419.99	256K 2 Floppies	
Brother HR-35	629.99	Mono Mon. w/ Card	
Brother M-1109	189.99	219.99	
Brother M-1509	In Stock	333.99	
Brother Twinkwriter 5	225.99	669.99	
Citizen MSP-10	339.99	Call	
Citizen Homewriter 10	349.99	459.99	
Epson FX-45	379.00	559.99	
Epson FX-85	369.00		
Epson LX-800	In Stock		
HP Think Jet	374.99		
HP Pro Printer	455.00		
IBM 6100	219.99		
Mac EPI 350	189.99		
Okidata 192	225.00		
Okidata 193	239.99		
Okidata 610	429.99		
Panas. KXP-1090			
Panas. KXP-1091			
Panas. KXP-1092			
Panas. KXP-1592			

COMMODORE		MONITORS	
Comm. 129	218.99	Amtek 310-A	144.99
Comm. 1571	289.99	NEC Multi-Sync	324.99
		In Stock	399.99
		NEC MX 12	149.99
		PGS MAX 12	409.95
		Toson 630	469.95
		Toson 640	

MODEMS	
Hayes 1200B	322.00
Hayes 1200	347.00

APPLE IIc	
With Monitor	Call
NEC PC 8401	Call
TOSHIBA LAP TOP	\$1349.99
SANYO MBC-555	\$624.99
SPERRY PC II	\$1499.00

GUARANTEED LOWEST PRICES
COMPUTER: 1-800-874-1235
VIDEO: 1-800-223-6779
S'nW ELECTRONICS & APPLIANCES
 633 Bedford Ave. Bklyn, NY 11211

TOLL FREE OUT OF N.Y. IN N.Y. CALL (718) 237-2828

Hours: Mon-Thurs 9-6, Fri-Sat 10-5, Sun-Closed

• Credit Card Accounts charges at time of order • Add ships, hand, ins. to charge without notice • No responsible for transportation errors

CIARCIA FEEDBACK

the clock signal used for, besides operating the CPU and synchronizing peripherals?

CORTNEY E. SMITH
Tuba City, AZ

Crystal specifications for a microprocessor or microcontroller chip are maximum values. The Z80A, listed as a 4-MHz device, can be used with a crystal or other oscillator whose value is less than or equal to 4 MHz. Many system designers use a higher-value crystal frequency and divide it down to the required value. For example, a 12-MHz crystal oscillator may be divided down to 4 MHz through a couple of flip-flops connected as a divide-by-three circuit. The resultant 4-MHz signal can then be used to drive a Z80A.

Typically, oscillator frequencies are based on system performance requirements, the microprocessor or microcontroller being used in the design, and other devices on the board that require an oscillator. Keeping these considerations in mind, a designer will often use a device at its listed frequency—it is most common.

The clock signal found in all microprocessor and microcontroller applications is required to time events in the CPU, for example, instruction fetches, decodes, and operations. The clock is also responsible for generating device-select pulses (based on the microcomputer's output on the address bus) and reading and writing information from and to peripheral devices like memories, I/O ports, etc. A whole number used for the clock frequency (i.e., 4 MHz) simplifies timing calculations but is not essential.—Steve

ATARI SOFTWARE

Dear Steve,

I read your article in the June 1982 BYTE about building an interface for the VP-1000 videodisc player. I enjoyed it a great deal, except that I'm not quite good enough to write the software required for the less hardware-intensive version. Do you know of any such software written for the Atari 800? I have versions of Dragon's Lair and Space Ace that I would like to re-write with the controller in software.

HARRY BROWN
Las Vegas, NV

An Atari version of this software is probably out there somewhere, but I am unaware of anyone who has written the code. I can give you some basic guidelines to help you write the code yourself, but I suggest that you use the interface

(continued)

DataSaver⁴⁰⁰
Standby UPS

Power protection for the most powerful micro-computer systems with peripherals is here, now, with the 400 Watt DataSaver. Protect your investment in application software and hardware with reliable, continuous power. 90 and 200 Watt capacities and international models are also available.

Cuesta Systems Corporation
3440 Roberto Court
San Luis Obispo, CA 93401
TLX: 4949381 CUESTA

©1985, Made in U.S.A.
Write or call 805/541-4160
Dealer, O.E.M. inquiries invited

HERE'S 7 REASONS WHY MICRO MART IS AMERICA'S PC SPECIALIST!

1 LOW PRICES. Micro Mart specializes in giving you the best value on all your PC product needs.

2 QUALITY PRODUCTS. We've got a huge selection of national brand name products. Computer systems, printers, peripherals, and more!

3 FULL SERVICE SALES. Our friendly, knowledgeable sales staff will help you

choose the right product at the right price.

4 COMPLETE TECHNICAL SUPPORT. For pre-sale or post-sale advice, give us a call. We're here to help.

5 CUSTOMER SATISFACTION. It's made us famous. Drop in at one of our many store locations or give us a call today.

Shop us today and save on these specials...

6 ProLine XT – A complete system for only \$995!

Here's a system value that can't be beat. Features full PC compatibility. 640K RAM memory. One 360K half height floppy drive. Six expansion slots.

Monochrome graphics card and monitor.

Printer and communications ports. Clock/calendar. Game port.

MS DOS with GW BASIC. Enhanced IBM-style keyboard.

UL and FCC approved. Full 1 year parts exclusive warranty.

All systems built and tested! Call for custom configurations!



FREE!

With the purchase of our ProLine XT

This complete accessory pack: 10 pk. DS/DD Maxell Diskettes. SRW Media Storage Case. Six-outlet Curtis power strip with surge protection. Texwipe PC careware kit with antistatic solution and CRT cleaning fluid and wipes. Perfect Data 5¼" drive head cleaning kit. ProLine XT dust cover. Total Retail Value – \$89.95!

7 American AT – Powerful AT performance for only \$2,289!

All the speed and power

you need. Features full

PC compatibility. 512K

RAM memory. One 1.2

Megabyte floppy drive.

Eight expansion slots.

Monochrome

graphics card

and monitor.

Printer port.

Clock/calendar.

MS DOS.

UL and FCC

approved. 90 day exclusive warranty.

All systems built and tested! Call for custom configurations!



FREE!

With the purchase of our American AT

This complete accessory pack: 10 pk. tpi quad density Maxell Diskettes. SRW Media Storage Case. Six-outlet Curtis power strip with surge protection. Texwipe PC careware kit with antistatic solution and CRT cleaning fluid and wipes. Perfect Data 5¼" drive head cleaning kit. American AT dust cover. Total Retail Value – \$99.95!

(404) 449-8089

Orders Only **1-800-241-8149**

MICRO MART

America's PC Specialist

LOOKING FOR "NET" RESULTS?

EARTH COMPUTERS

has the
solution
to your
Networking
problems.



EARTHNET-PC.™

EARTHNET-PC is the most flexible networking card on the market. It has been designed for high performance and maximum functionality.

EARTHNET-PC is fully compatible with SMC networking cards and runs popular networking software such as NOVELL's NETWARE, ViaNet, and TurboDOS, all of which support the new LAN Standard and DOS 3.1 record locking.

EARTHNET-PC's 5-1/2 inch card fits in any short slot of an IBM-PC/XT or compatible system and uses advanced Token-Passing technology. Data transfers are made at 2.5 Megabytes per second.



YOU CAN STOP SEARCHING...EARTHNET-PC IS THE SOLUTION TO YOUR NETWORKING PROBLEMS! Order your EARTH-NET-PC today! Call EARTH COMPUTERS, the company that's setting the standard for LAN standards.

ATTENTION DEALERS! If you've been searching for ways to increase your NETWORKING profits, call EARTH COMPUTERS and find out about our attractive, profit-generating dealer program.

EARTHNET-PC is a trademark of EARTH COMPUTERS
NETWARE is a trademark of Novell
ViaNet is a trademark of Vlanetix, Inc.
TurboDOS is a trademark of Software 2000
IBM-PC/XT is a trademark of International Business Machines, Inc.



EARTH COMPUTERS

P.O. Box 8067, Fountain Valley, CA 92728
TELEX: 910 997 6120 EARTH FV

(714) 964-5784

Ask about EARTH COMPUTERS' other fine PC and S-100 compatible products.

CIARCIA FEEDBACK

Listing 1: A BASIC program to control a VP-1000 videodisc player.

```
10 GOSUB 1000
20 GOSUB 1000
30 GOSUB 2000
40 X=PEEK (memory loc)
50 IF (X AND 16)=16 THEN GOSUB 2000 ELSE GOSUB 1000
60 IF (X AND 8)=8 THEN GOSUB 2000 ELSE GOSUB 1000
70 IF (X AND 4)=4 THEN GOSUB 2000 ELSE GOSUB 1000
80 IF (X AND 2)=2 THEN GOSUB 2000 ELSE GOSUB 1000
90 IF (X AND 1)=1 THEN GOSUB 2000 ELSE GOSUB 1000
100 GOSUB 1000
110 GOSUB 1000
120 END
1000 OUT port #,0:FOR CT=1 TO determined value: NEXT CT
1001 RETURN
2000 OUT port #,1:FOR CT=1 TO (determined value*2):NEXT CT
2001 RETURN
```

version in figure 5 of the article, as this will make the project easier to understand. We are causing the interface to output the pulse train in time with the serial output of the computer. That is, the output timing of the serial bits, and therefore their value to the videodisc, is totally controlled by the computer program.

The software flowchart of figure 6 (left side) shows the concept. Essentially, this will be a subroutine to pass values placed in memory by the application program to the interface. As explained in the article, you will need to send 10 bits to the machine, the first three always having the values 0, 0, and 1, and the last two always being 0. If the application program formats the five remaining bits into a stored byte in memory, you have all you need to begin.

Simply put, the routine needs only to send an OUT instruction to the desired port address (the data sent is irrelevant), wait either 1.05 milliseconds (in case data bit=1) or 2.1 ms (in case data bit=0), send the OUT instruction again, wait the appropriate time as determined by the bit value, and so on until the cycle has been completed 10 times. In BASIC, the routine might look like the program in listing 1.

The only remaining problem would be to assign the value to the FOR...NEXT loops. You could determine this using the timer found in your computer; just write a short program that prints real time, goes to a FOR...NEXT loop in which you vary the end value to vary the delay, then prints real time again. Since the value you are looking for is in the neighborhood of 0.10 second, this should help you find a value sufficiently close for this application.

I have shown what is obviously an overly simplified, inefficient approach. However, my aim was to provide enough explanation of the concept so you can easily adapt the premise to your machine. The totally software-dependent approach is not easily undertaken unless you are comfortable with assembly language programming, but the concepts shown here can be applied to that project as well.

I hope this has been some help to you. Good luck on your project.—Steve ■

Between Circuit Cellar Feedback, personal questions, and Ask BYTE, I receive hundreds of letters each month. As you might have noticed, in Ask BYTE I have listed my own paid staff. We answer many more letters than you see published, and it often takes a lot of research.

If you would like to share the knowledge you have on microcomputer hardware with other BYTE readers, joining the Circuit Cellar/Ask BYTE staff would give you the opportunity. We're looking for additional researchers to answer letters and gather Circuit Cellar project material.

If you're interested, let us hear from you. Send a short letter describing your areas of interest and qualifications to Steve Ciarcia, P.O. Box 582, Glastonbury, CT 06033.

Over the years I have presented many different projects in BYTE. I know many of you have built them and are making use of them in many ways.

I am interested in hearing from any of you telling me what you've done with these projects or how you may have been influenced by the basic ideas. Write me at Circuit Cellar Feedback, P.O. Box 582, Glastonbury, CT 06033, and fill me in on your applications. All letters and photographs become the property of Steve Ciarcia and cannot be returned.

News about the Microsoft Language Family

Microsoft® muMATH™ used as a tool for teaching college calculus

In the fall of 1985, Cornell University began using Microsoft muMATH in its sophomore level math course that is taught to over 500 students. Professor Richard H. Rand and his colleagues at Cornell have developed a series of computer lessons that introduce the students to the power of computer algebra. Dr. Rand says that without a powerful product like muMATH, "... the point of the problem can be lost in the detail of the solution." Microsoft muMATH makes it possible to ... "assign 'tough' homework problems and to reinforce and clarify the mathematical principles with practice on the computer."

The lessons involving muMATH include (a) an introduction to its symbolic capabilities, (b) solving differential equations, (c) computing Fourier series coefficients, (d) computing eigenvalues and eigenvectors, and (e) deriving Laplace's equation in orthogonal curvilinear coordinate systems. For additional information, see "Teaching Engineering Analysis Using Symbolic Algebra and Calculus," *Engineering Education*, November 1985.

Microsoft muMATH is a symbolic algebra manipulation system. Calculations in typical scientific and engineering languages are arithmetic evaluations, requiring variables to have known values before they can be used. In contrast, calculations in muMATH are algebraic evaluations, performed symbolically. "?" prompts the user for an input. "@" identifies the answer determined by muMATH. The example shows how intermediate muMATH results can be used in later calculations.

```
A> MUSIMP MATSOL
? LOAD (CALCULUS);
? E1:EXPAND ((107-4 X^2 Y)^3);
@: 1225043-137388 Y X^2+5136 Y^2 X^4-64 Y^3 X^6
? E2: DIF (LN COS(A Z^2),Z);
@: -2 A Z SIN (A Z^2)/COS(A Z^2)
? E1+E2;
@: 1225043-2 A Z SIN (A Z^2)/COS(A Z^2)-137388 Y X^2+5136 Y^2 X^4-64 Y^3 X^6
```

T.N.T. Software Develops Low Cost—High Function Applications in Microsoft QuickBASIC

Bruce Tonkin, president, says, "I wrote MY WORD!, a complete word processor with mail merge, macros, undelete, sort, calculator, and device-independent I/O, using the Microsoft QuickBASIC Compiler. I think Microsoft QuickBASIC is the best available language for any product needing dynamic character string operations. The new structured language features make for efficient, modular, and exceptionally readable code. Also, the Microsoft QuickBASIC Compiler takes advantage of the full capabilities of the latest versions of DOS. This increased efficiency can make the difference between a mediocre product and a good one, or between a good product and an outstanding one. I want to sell the best software I can. That's why I use Microsoft QuickBASIC."

T.N.T. Software also distributes a spelling checker and sort utility routines written in Microsoft QuickBASIC. Source code is available.

For more information on the products and features discussed in the Newsletter,
write to: Microsoft Languages Newsletter
 16011 NE 36th Way, Box 97017, Redmond, WA 98073-9717
Or phone:
 (800) 426-9400. In Washington State and Alaska,
 call (206) 882-8088. In Canada, call (416) 673-7638.

Latest DOS Versions:

Microsoft C Compiler	3.00
Microsoft COBOL	2.10
Microsoft FORTRAN	3.31
Microsoft Macro Assembler	4.00
Microsoft Pascal	3.31
Microsoft QuickBASIC	1.02

Microsoft is a registered trademark of Microsoft Corporation.
 IBM is a registered trademark of International Business Machines Corporation.
 muMATH is a trademark of The Soft Warehouse.

AT LEAST FIVE MORE REASONS TO DUMP YOUR OLD PRINTER.

1986, 19 1989,

If you think your old PC printer is worth keeping, think ahead.

Can you depend on it to run five or more years without fail?

Not likely. Which is why you'll especially like the new Alps P2000™ Dot Matrix Printer.

It's not a bit like your old printer. Or most new printers, for that matter.



In fact, with normal care, it'll take you through 1990 and beyond without a single breakdown.

You see, the P2000 is solidly built with precision parts throughout. Even its print head (often the first thing to go in a printer) has a life span of over 200 million characters.

But you'll appreciate it for a lot more than its reliability.

For one thing, it's incredibly fast.

87, 1988, 1990, 199

It prints drafts at 250 characters per second (cps). Memos at 125 cps. And near letter quality documents at 50 cps.

For another thing, it's truly versatile. It prints everything from letters and graphics to 16-inch-wide spreadsheets.

In a variety of type fonts and sizes.

What's more, its paper-saving push/pull tractor feed makes printing forms a snap.

And naturally, it's compatible with all the most popular business software and PCs.

For our brochure and the name of our dealer nearest you, please call (800) 828-ALPS. In California, (800) 257-7872.

The Alps P2000.

There simply aren't many things you can expect to outlast it.

Except, of course, the company that created it.

ALPS
AMERICA

**ORDER
LINE
800-354-7330**

LOWEST PRICES NO SURCHARGE ON BANK CARDS SILICON SPECIALTIES

ZENITH COMPUTERS
Always the
lowest prices.
Call us for
a quote.

HARDWARE

Model	Price
Anodex All Models	Save
Brother All Models	Save
Canon Laser Printer	\$2099
Citizen MSP-10	\$255
MSP-15	\$349
MSP-20	\$319
MSP-25	\$485
Premier 35	\$409
Datasouth All Printer Models	Save
Diablo D-25	\$489
635	\$1035
Other Printer Models	Save

EPSON	
All Printer Models	Save
6100	\$349
6300	\$669
NEC	
3510, 3550, 3515, 3530	\$729
8810, 8830, 8850	\$1039
PS, P6, P7	Save
EH 360	\$379
EH 370	\$379

OKIDATA	
All Printer Models	Save
Panasonic 1080	\$219
1091	\$235
1092	\$309
1092	\$429
KXP3151	\$399

STAR MICRONICS	
All Printer Models	Save

Model	Price
Silver Reed EXP400 Parallel	\$179
EXP550 Parallel or Serial	\$409
EXP800 Parallel or Serial	\$619
Toshiba 321	Save
P351 Parallel & Serial	\$969

TOSHIBA	
321 Parallel	Save
321 Serial	Save
341 Parallel	\$829
341 Serial & Parallel	\$879
351 Serial & Parallel	\$985

DISKETTES	
Maxell MD-2 Plastic Box (Qty 100)	\$125
Sony MD/2 (Qty 100)	\$119

MONITORS	
Amdex All Monitors	Save
NEC All Monitors	Save
Princeton Graphics	Save
Zenith All Models	Save

VIDEO TERMINALS	
Qume QVT Green 101	\$299
QVT Amber 101	\$314
Wyse 30	\$299
50	\$419
75	\$559
Wyse 85	\$859
Wyse 350	\$455
Zenith Z-22	\$559
Z-29A	Save
Z-49	Save

SOFTWARE

TRAINING	
Flight Simulator	\$28
Typing Instructor	\$28
Typing Tutor III	\$28

INTEGRATIVE SOFTWARE	
Encore I.1	Save
Framework II	Save
Smart Software System	\$399
Symphony	Save

GRAPHICS	
Chartmaster	\$205
Diagram Master	\$189
Energraphics	\$159
In-A-Vision	\$249
Microsoft Bus Mouse w/PC Paintbrush 3.0	\$107
Microsoft Chart	\$164
Microsoft Serial Mouse	\$119
Newsroom	\$32
PC Mouse w/Point Plus	\$115
PPS Graph	\$76
Printmaster	\$30
Sigmastar	\$134
Turbo Graphic Tool Box	\$30

UTILITIES	
Copy II Mac	\$19
Magic Works	\$45
Pro Print w/ cables	\$56
Sidick w/Phone Link	\$56
Smooth Talker	\$49

SPREADSHEETS	
Chart	\$69
Click On	\$44
Multiplex	\$108

TRAINING	
MasterType	\$28
Mind Probe	\$26
Typing Instructor	\$25
Typing Tutor III	\$33

COMMUNICATIONS	
Smartcom II	\$83

UTILITIES/COMMUNICATIONS	
Copy II Plus	\$19
Pin Point	\$35
Sideways	\$30
Turbo Pascal (Rep. c/y/m)	\$35
CrossTalk	\$94

TRAINING	
FT Sim II	\$32
Typing Tutor II	\$29

DATA BASE MANAGEMENT	
PPS: File	\$68
PPS: Report	\$68

COMMUNICATIONS	
CompuServe Starter Kit	Best Price
CrossTalk XVI	\$92
MS Access 1.01	\$139
Remote	\$92
Smartcom II	\$83

UTILITIES	
Copy II PC	\$19
1 Disk	\$47
Fastback	\$87
Norton Utilities 3.1	\$48
Sidick	\$30
Sidick (Unprotected)	\$47
Sidick--Superkey (Bundle)	\$85
Sideways 3.1	\$34
Superkey	\$39
Traveling Sidick	\$39

PROJECT MANAGEMENT	
Harvard Total Project Manager	\$262
Microsoft Project	\$219
Super Project Plus	Save
Timeline 2.0	\$219

DATA BASE MANAGERS	
Business File Vision	\$199
File Manager	\$96
I Know It's Here Somewhere	\$33
Microsoft File	\$108
Overviews 2.0	\$144
Think Tank 512	\$96

LANGUAGES	
Basic 2.0	\$84
Corsolet C w/FP (New Ver.)	\$255
Microsoft Fortran	\$165
Microsoft Logo	\$69

MONEY MANAGEMENT	
Dollars & Sense	\$78
Dollars & Sense Forecast Module	\$38
Mac Home Accountant	\$50

WORD PROCESSORS	
Bank Street Writer	\$39
Bank Street Speller	\$39
PPS: Write	\$68
Think Tank	\$75
Word Perfect	\$79
Wordstar Professional (Rep. c/y/m)	\$259

SPREADSHEETS	
Supercalc 3A	\$98
PPS: Plan	\$68
Multiplex	\$55

MODEMS	
AT&T 4000 External	\$309
Anchor Automation Anchor Express	\$235

HAYES	
All Modems	Save
Prometheus All Models	Save
US Robotics Courier 2400	\$389
Password 1200	\$180
MicroLink 2400	\$379

COMPUTERS	
Zenith Computer Products	
SAVE Up to 50%	
Z-158 All Models	Save
Z-158 All Models	Save
Z-148 All Models	Save
Z-171	Save
Z-200	Save

PANASONIC	
Sc Partner Dual Drive	\$1380
Exec. Partner Dual Drive	\$2129

TOSHIBA	
T-1100	\$1389

WYSE	
Wyse pc 1100-1	\$979
Wyse pc 1100-20	\$1339

WORD PROCESSORS	
Leading Edge Word Processor	\$48
Leading Edge W/P w/Spell & Mail	\$82
Lightning	\$55
Microsoft Word 3.0	\$219
Multimate 3.3	Save
PPS: Write w/Spell Checker	\$76
Wordstar Pro Pack	\$233

LANGUAGES	
C Compiler (Microsoft)	\$219
Fortran Compiler (Microsoft)	\$195
Lattice C Compiler	\$242
Macro Assembler (Microsoft)	\$84
Pascal Compiler (Microsoft)	\$166
Quick Basic	\$53
Run C Interpreter	\$82
Turbo Pascal 3.0	\$38
Turbo Database Tool Box	\$30

ACCOUNTING	
Palcant G/L	\$74
Palcant A/P	\$74
Palcant A/R	\$74
Peachtree G/L	\$84
Peachtree A/R	\$84
Peachtree A/P	\$84
Rags to Riches-3 Pack (G/L, A/R, A/R)	\$247

ACCESSORIES	
Mac Tote Carrying Case	\$56
MacVision	\$166
MacPad (by Moxtek)	\$7
Printer Ribbon	\$6
The Easel	\$12
Pocket Pack	\$9

DISKETTES	
SONY Disks (10 Pack) 5.5	\$18
SONY Disks (10 Pack) D.S.	\$27

GRAPHICS	
Clip Art #1	\$16
Clip Art #2	\$21
Newsroom	\$32
PPS: Graph	\$68
Printshop	\$29
Printshop Companion	\$23

MONEY MANAGEMENT	
Dollars & Sense	\$68
Managing your money	Save

DISK DRIVES	
Alpha Omega Turbo 10	\$379
Turbo 20	\$439
Turbo 30	\$569
Imago	Save
Barnwell Boxes for IBM	Save
Barnwell Boxes for Macintosh	Save
Paradise Macintosh Hard Disk	Save
Seagate 20 meg w/Western I/O	\$409

BOARDS	
AST Advantage	\$389
Rampage PC	\$299
Six Pack Plus	\$159
Hercules Color Card	\$149
Graphic Card	\$305
Intel	
Above Board	Save
Maynard Hardware	\$549
Paradise Modeler Graphic 06-1	\$239
Plus Pak	\$115
Quadram	
Gold & Silver Boards	Save
Quadlink	\$329
Quad EGA+	\$365
Tec. Mac Graphics Master	\$269
Coplin No Memory	\$169

PLOTTERS	
Epson H6-80	Save

KEYBOARDS	
Keytronic 5151	\$159

SPREADSHEETS	
Lotus 1-2-3	Save
Multiplex	\$108
Spreadsheet Auditor 2.0	\$82
VP Planner	\$49

MONEY MANAGEMENT	
Dollars & Sense w/Forecast	\$94
Tobias Managing Your Money	Save

DATA BASE MANAGEMENT	
Clipper	\$359
dBase III Plus	Save
Extended Report Writer	\$74
Knowledgebase II	\$279
Nuhwell 2.0	\$59
PPS: File	\$76
PPS: Report	\$67
Quickcode	\$138
QuickReport	\$138
Raffles	Save
Think Tank	\$92

WORD PROCESSORS	
Hayden Speller	\$45
Microsoft Word	\$108
MacSpell Plus	\$53
Mac Lightning	\$49

INTEGRATED SOFTWARE	
Helix 2.0	\$212
Microsoft Excel	\$219

GRAPHICS	
Accessory Pack I	\$22
Click Art	\$28
Mac Draft	\$159
Mac Pic #1 & 2	\$28
Mac The Knife II	\$28
Ready Set Go 2.1	\$96
Video Works	\$55

Product shipped in factory cartons with manufacturer's warranty. Please add \$10.00 per order for UPS shipping. Prices & availability subject to change without notice. Send cashier's check or money order...all other checks will delay shipping two weeks.

Inquiry 309 for MS DOS Products. Inquiry 310 for all others.

SILICON SPECIALTIES
2034 WEST SOUTHERN
MESA, ARIZONA 85202
602-969-0909

Money either of these creditable.

CVS-484

BOOK REVIEWS

DIFFERENTIAL AND
DIFFERENCE EQUATIONS
THROUGH COMPUTER
EXPERIMENTS
Hüseyin Koçak
Springer-Verlag
New York: 1986
224 pages, \$44 including disk

THE C WIZARD'S
PROGRAMMING
REFERENCE
W. David Schwaderer
John Wiley & Sons
New York: 1985
200 pages, \$19.95

INTRODUCTION TO
MACHINE AND
ASSEMBLY LANGUAGE
PROGRAMMING
Philip J. Gust
Prentice-Hall
Englewood Cliffs, NJ: 1986
421 pages, \$39.95

DIFFERENTIAL AND
DIFFERENCE EQUATIONS
THROUGH COMPUTER
EXPERIMENTS
Reviewed by Mark Bridger

Anyone with an IBM PC-compatible computer and a color board and an interest in differential or difference equations should buy Hüseyin Koçak's *Differential and Difference Equations Through Computer Experiments*. Both the book and its accompanying software are of the highest quality in terms of mathematical taste, pedagogical usefulness, and professional programming technique. The package provides the software and explanation necessary to study equations approachable only by experts just a few years ago.

THE SOFTWARE

At the heart of Professor Koçak's package is a program called Phaser, an "Animator/Simulator for Dynamical



Systems." Phaser enables you to enter a system of differential equations or to choose an equation from a fairly extensive library of interesting and important ones. Phaser can then draw the vector field of the system and draw one or more orbits through initial points you select. Furthermore, the screen can be split and different views can be simultaneously plotted in the top and bottom halves. For example, the top half might contain the plot of the orbit, while the bottom shows the plot of one of the variables versus time. Another possibility is to have one window show the vector field, the axes, and the orbits, while the other shows actual numerical values for the variables.

This, however, is just the beginning. Many useful systems are at least three-dimensional (satellites, for example). Their orbits can be quite complicated, involving elaborate spiralings and oscillations through

space. Phaser provides three-dimensional perspective and three axes for reference. You can rotate the entire plot around one or more axes to obtain better views of the orbits; the perspective viewpoint can also be changed.

Phaser also provides the option of displaying the Poincaré plane/map. Here, you select a plane in three-space, with one side determined as "up," the other "down." As an orbit is being drawn—in the top window, for instance—it may encounter the plane. If it encounters it while crossing from up to down, a point is drawn on the plane, which may be shown in the bottom window. A down-to-up encounter results in nothing being drawn. To make things clearer, the section of the orbit lying "above" the plane

(continued)

PROLOG APPLIED!

The FIRST Interactive Prolog for the IBM and Macintosh.

PROLOG/i

A new enhanced Interactive Prolog for MS-DOS. Upwardly compatible with PROLOG V and V-plus. **\$69⁹⁵**

PROLOG/m

Prolog for the Macintosh! Edinburgh syntax. Floating point, math functions. **\$99⁹⁵**

THREE GREAT APPLICATIONS

READY TO RUN
NO PROGRAMMING
EXPERIENCE NECESSARY.

NFL X-pert **\$49⁹⁵**

Expert system for professional football handicapping.

TOOLBOX **\$29⁹⁵**

Including subroutines that speed and compress list handling, searches, sorts, reversal algorithms.

TOYBOX **\$29⁹⁵**

A collection of games and puzzles that make learning Prolog fun.

MIX AND MATCH FOR ADDED SAVINGS

	PROLOG/i	PROLOG/m	*SAVE*
Interpreter plus...			
Toolbox or Toybox	\$ 79.95	\$109.95	\$20
Toolbox and Toolbox	99.95	129.95	30
NFL X-pert	99.95	129.95	20
NFL X-pert and Toolbox and Toybox	119.95	149.95	30
BUY ALL 4 AND SAVE \$50	129.95	159.95	50
Applications Only			
Toolbox and Toybox	\$49.95		
NFL X-pert and Toolbox or Toybox	69.95		
BUY ALL 3 AND SAVE \$20	89.95		

COMPATIBILITY

Applications fully compatible with Prolog compilers and interpreters with Edinburgh syntax.



CHALCEDONY SOFTWARE, INC.

System Requirements
PC-DOS/MS-DOS
Ver. 2.0 or later
256K RAM
512 Macintosh

5580 LA JOLLA BLVD.
SUITE 126 D
LA JOLLA, CA
92037
(619) 483-8513

PHONE ORDERS: 1-800-621-0852 EXT 468

PAYMENT ENCLOSED \$ _____ PROLOG/i **\$89.95**
CA residents add 6% sales tax PROLOG/m **99.95**
 CHARGE MY. MasterCard Visa *If you own PROLOG V or PROLOG V-plus, call for upgrade information*

Card No _____ Exp Date _____

Signature _____ **SHIPPING:**
\$ 5.00 US
7.50 Canada
10.00 Caribean, Hawaii Air
20.00 Overseas Air

Mr /Mrs /Ms _____ (please print full name)
Address _____ *COD Orders Not Accepted*
City /State /Zip _____ *15 day check clearance*

Not Copy Protected



is drawn in one color, while that below is drawn in another color. The Poincare plane turns out to have theoretical use in studying differential equations. Starting with a point on the plane, you can construct an orbit passing through it, hence a sequence of points, as described above, where that orbit encounters the plane. The nature of this sequence provides information about the orbit.

For complicated systems, the computation of solutions involves a lot of number crunching. Phaser comes with two versions: one that requires the 8087 numeric data-processing chip and one that doesn't. It is substantially faster to work with the 8087 version. Users should also be warned that Phaser will run only on a PC equipped with the IBM color graphics adapter. Clones of this board may cause problems.

Phaser also lets you study difference equations. Briefly stated, a difference equation is a way of getting a sequence of points, where each successive point is obtained from the previous one by applying a fixed formula. You might write $New\ Point = f(Old\ Point)$. The properties of the sequence of points so obtained shed light on the function f . You will encounter phenomena such as "fixed points" P where $f(P) = P$, or "cycles" where $f(P_1) = P_2$, $f(P_2) = P_3$, ... $f(P_n) = P_1$. Differential and difference equations are related in many ways: The sequence of points provided by the Poincare plane's intersection with an orbit is only one example. Much of the terminology and many of the concepts are similar. Starting with a given point and applying f over and over produces the "orbit" of P . As an aid in visualization, Phaser provides "stair-step" plots of the orbits. These display the graph of f and the line $y=x$ and compute the orbit by alternately moving vertically to the graph and horizontally to the line.

There are two very interesting questions you can ask about difference and differential equations. The first is, If two initial points are close together, are their orbits necessarily close together? This is especially interesting in studying what happens to orbits as time becomes infinite. The second question is, What happens to the solutions of an equation if some of its parameters (e.g., coefficients or exponents) are changed slightly? Study of this "bifurcation" question leads to very important applications to the study of pattern and shape formation in nature.

HARD COPY

The book begins with three chapters explaining the various topics I've mentioned. It is not a textbook, but it does review some of the theory from a modern and geometrical point of view. (Its elementary material is geared to the same audience as William E. Boyce and Richard C. Di Prima's *Elementary Differential Equations*, 3rd ed., John Wiley & Sons, 1977.)

The middle third of the book contains detailed instructions for using the Phaser program. This is extremely well-written documentation, with keystroke-by-keystroke descriptions of actual plots, demonstrating many changes of windows and viewpoints.

The final section of the book, nearly 100 pages, is

(continued)



TOMCAT 3200-AT MODEL III

- CPU INTEL 80286 6/8MHz
- RAM 512KB on Mother Board
- 2 X 1.2MB (360KB) Floppy Drives
- Floppy and Hard Disk Controller Card
- Turbo Display Color/Monochrome Card
- 1 Serial and 1 Parallel Card
- AT Keyboard
- Monochrome Display Monitor
- User's Manual & Technical Reference
- System Utility Disk (Setup, Diagnostic)

TOMCAT 3200-AT MODEL II (Hard Disk System 20MB) \$2,495



● OEM Acceptable ● Dealer Inquiry "Welcome"



TOMCAT CORPORATION

Suite 304 9820 Del Amo Blvd., Torrance, CA 90503
TEL: (213) 542-8846 FAX: (213) 214-0276

TOMCAT COMPUTER Inc.

Yaguchi Bldg., 3-6-4 Nishiwaseda Shinjuku-ku, TOKYO
TEL: (03) 208-2511 TELEX: J28984 FAX: (03) 208-2662

devoted to descriptions of each of the equations in Phaser's basic library. These vary from the simplest linear systems encountered in an introductory course to systems that are the subject of current research. Attractors and "strange" attractors are pointed out, and each example is accompanied by actual reproductions of phaser plots and references to the literature. My only complaint is that these descriptions are little more than thumbnail sketches. The differential-equations beginner might want a few specific hints on how to get more informative plots, while the more advanced user might enjoy more background and mathematical "gossip."

The Phaser program contains a very useful feature that enables you to create lessons and slide shows. As each plot is created, all the data needed to recreate it can be stored in a disk file. Data for successive plots can be appended to this file. At any point you can retrieve this file and display the plots automatically by consecutively pressing the space bar. This is an excellent way of preparing a demonstration or an exercise for students.

The best teaching aids are tools that enable students to discover mathematics by experimentation. Furthermore, these tools must be powerful enough to solve interesting problems. Ideally, they should be useful and interesting to the introductory student as well as the researcher. Finally, they should be reasonably priced. This package fulfills all these requirements.

Mark Bridger is associate professor of mathematics at Northeastern University (Boston, MA 02115).

THE C WIZARD'S PROGRAMMING REFERENCE

Reviewed by John D. Unger

The *C Wizard's Programming Reference* by W. David Schwaderer is not the sort of book you'd read during the evening in front of a fireplace, but you may want it nearby when you're writing C-language programs, especially if you are exploring some of the more esoteric features of C. It is the kind of book that should be included with every C compiler because it is a comprehensive reference guide to the usage and syntax of the language.

PORTABILITY A PLUS

This book will not teach you how to program in C, but it can make you a better C programmer. It contains few examples of complete C programs. Most of the source code that is included consists of program fragments used to provide examples to key points in the text. Basically, the book is written for intermediate and advanced C programmers. The author's approach assumes a fairly thorough understanding of C syntax, and he uses programming jargon frequently and without reference to explanatory material. It is a book to have ready when you are in the midst of writing a program and suddenly decide that you need a feature of C that you don't understand well or have never attempted to use before. The author

(continued)

A MEGABYTE FOR DOS!

MicroWay is the world's leading retailer of 8087s and high performance PC upgrades. We stock a complete selection of 8087s that run from 5 to 12 MHz. All of our coprocessors are shipped with a diagnostic disk and the best warranty in the business - one year! We also offer daughterboards for socketless computers (NEC PC) and 287Turbo which increases the clock speed of the 80287 from 4 to 10 MHz. Our NUMBER SMASHER/ECM™ runs at 12 MHz with a megabyte of RAM and achieves a throughput of .1 megaflops with 87BASIC/INLINE, Intel For-

tran, or Microsoft Fortran. Software reviewers consistently cite MicroWay software and 8087 expertise as the best in the industry! Our customers frequently write to thank us for recommending the correct software and hardware to meet their specific needs. They also thank us for our same-day shipping! In addition to our own products which support the 8087 and 80287, we stock the largest supply of specialized software available. For more information call us at

617-746-7341

NUMBER SMASHER/ECM™ THE FASTEST ACCELERATOR CARD AVAILABLE

gives you 12 MHz speed in two modes: 704K or one megabyte of "Extended Conventional Memory." MEGASWITCH MMU and MegaDOS software make it possible to run DOS applications with up to 1015K using PC compilers, AutoCAD and Lotus 1-2-3. Does not require EMS software. Totally compatible from \$599 to \$1098
Optional 8087-12..... \$295

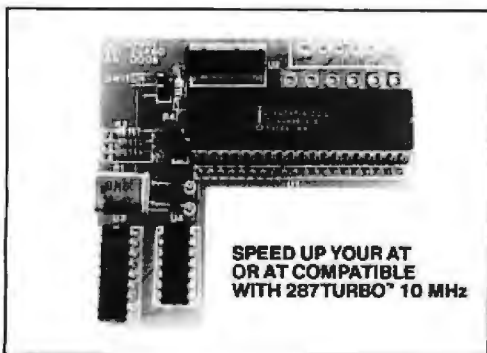

MicroWay® 8087 Support

For the IBM PC, PC XT, PC AT and Compatibles.

87SFL™ MicroWay's Scientific Function Library contains 170 scientific and engineering functions. Callable from most 8087 compatible compilers ... First Language \$250; Additional \$100.

A2D-160™ MicroWay's Data Acquisition Board performs 160,000 12 bit Analog to Digital conversions per second! Includes software drivers. The fastest 12 bit A to D board available. For the IBM PC XT and compatibles. \$1295

MATRIXPAK™ manages a MEGABYTE! Written in assembly language, our runtime package accurately manipulates large matrices at very fast speeds. Includes matrix inversion and the solution of simultaneous linear equations. Callable from RM or MS Fortran, MS Assembler, or 87BASIC/INLINE. each \$99

87FFT™ Written in assembly language, performs Forward and Inverse FFTs on real and complex arrays which occupy up to 512 Kbytes of RAM. Also does convolutions, auto correlations, hamming, complex vector multiplication, and complex to radial conversions. Callable from most 8087 compatible compilers. \$200

87FFT-2™ performs two-dimensional FFTs. Ideal for image processing. Requires 87FFT \$100

MICROWAY UDI runs RTOS or RMX compilers under DOS \$300

FASTBREAK™ employs the 8087 to increase the speed of Lotus 1-2-3™ Version 1A or 1A* by up to 36:1 \$79

FASTPAK™ includes FASTBREAK software and a 5 MHz 8087 chip. \$179

87Verify™ For users who have to be absolutely sure of their results! This background task periodically performs an 8087 accuracy and stress test. \$49

INTEL ABOVE BOARD CALL
JRAM, AST, MAYNARD CALL
RM, IBM, MS Fortran CALL

MegaPage™ Our Intel-Lotus EMS memory card. The only EMS board which comes with two megabytes of cool-running, low power drain CMOS RAM installed. Includes RAM disk, print spooler, disk cache, and EMS drivers. For the IBM PC, XT and compatibles. \$549

MegaPage AT/ECC™ EMS card for the PC AT and compatibles includes Error Correction Circuitry. With ECC, 11 RAM chips cover 256K so the user never encounters RAM errors. With 1 megabyte CMOS \$799; with 3 megabytes CMOS \$1295. Optional serial/parallel daughterboard. \$95.

DFixer™ Our disk utility which thoroughly checks PC or AT hard disks for bad sectors and updates the MS DOS file allocation table accordingly. Solves the AT hard disk problem! ... \$149

DOptimizer™ Optimizes the way your hard disk or floppy stores its files. Speeds up accesses by recombining fragmented files. \$49

DCache™ Our disk caching software speeds up your I/O by storing repetitively used tracks in memory. The amount of memory used can be selected in 64 Kbyte banks. \$49

87MACRO/DEBUG™ Contains all the pieces needed for writing 8087/80287 assembly code & MicroWay's 87DEBUG debugger \$199

OBJ-ASM™ A multipass object module translator and disassembler. Produces assembly language listings which include public symbols, external symbols and labels commented with cross references. Ideal for patching object modules for which source is not available. \$200

87BASIC™ includes patches to the IBM BASIC or MS Quick BASIC Compiler for USER TRANSPARENT 8087 support. Provides super fast performance for all numeric operations including trigonometrics, transcendentals, addition, subtraction, multiplication, and division. each \$150

87BASIC/INLINE™ converts the output of the IBM BASIC Compiler into optimized 8087 inline code which executes up to seven times faster than 87BASIC. Supports separately compiled inline subroutines which are located in their own segments and can contain up to 64 Kbytes of code. This allows programs greater than 128K! Requires the IBM BASIC Compiler Version 1 and a Macro Assembler. Includes 87BASIC ... \$200
In London, please phone 223-7762

8087 UPGRADES

All MicroWay 8087s include a one year warranty, complete MicroWay Test Program and accurate installation instructions.

8087 5 MHz..... \$109
For the IBM PC, XT and compatibles.

8087-2 8 MHz..... \$149
For Wang, AT&T, DeskPro, NEC, Leading Edge.

80287-3 5 MHz..... \$179
For the IBM PC AT and 286 compatibles.

80287-6 6 MHz..... \$229
For 8 MHz AT compatibles

80287-8 8 MHz..... \$295
For the 8 MHz 80286 accelerator cards.

NEC V20, V30..... \$16, \$30

64K RAM Set 150ns..... \$10

256K RAM Set 150ns..... \$34

256K RAM Set 120ns..... \$39

128K RAM Set PC AT..... \$49

287Turbo™ 10 MHz If you own an AT, Deskpro 286 or AT compatible, this is the card you need to get reasonable numeric performance. It plugs into your 80287 socket and includes a specially driven 10 MHz 80287. The card comes in three configurations. The IBM AT version includes a hardware RESET button \$450

287Turbo 8 MHz..... \$369

87/88Turbo™ is a stubby card which includes a clock calendar and a speed controller which changes the speed of your motherboard from 4.77 to 7.4 MHz. Its use requires your PC to have a socketed 8284. Typical speed increase is 1.6 to 2.0. The card overcomes slow hardware by slowing up only when such devices are accessed and running at full speed otherwise \$149
Optional 8087-2 \$149

286TurboCache™ This new MicroWay accelerator uses 8K of cache memory and 80286/80287 processors to provide an average speed increase of 3:1 for most programs. Call for specifications and benchmarks \$595

Call for our complete catalog of software which supports the 8087.

MicroWay P.O. Box 79
Kingston, Mass.
02364 USA
(617) 746-7341

IBM XT 512K Floppy.....\$1988	ZENITH 148.....\$1098
IBM XT 512K 20 Meg Hd.....\$2488	ZENITH 158.....\$1598
IBM AT 512K Floppy.....\$3288	ZENITH 177.....\$1888
IBM AT 512K Floppy 20 Meg Hd.....\$3788	ZENITH 200 AT.....\$2888
512K (OK) Memory Card.....\$ 48	20 MEG Seagate Hd w/Cnt.....\$ 448
384K (OK) XT Minif. Card.....\$ 98	10 MEG Irwin Tape Back-Up.....\$ 448

MONITORS

• AMDEK 310 AMBR.....\$143**
• AMDEK 500 COLOR.....\$388**
• AMDEK 722 COLOR HI RES.....\$488**
• AMDEK 725 COLOR HI RES.....\$536**
• AMDEK 730.....\$688**
• IBM COLOR.....\$599**
• IBM TTL GREEN.....\$249**
• NEC MULTISYNC RGB.....\$588**
• PRINCETON HS-12.....\$466**
• ROLAND HI RES COLOR.....\$347**
• SAMSUNG AMBER COMP.....\$ 78**
• SAMSUNG GREEN COMP.....\$ 78**
• SAMSUNG TTL.....\$ 98**
• SONY ULTRA COLOR 12".....\$467**
• SONY HI RES COLOR 13".....\$445**
• SONY COLOR 1311 TV.....\$467**
• TAXAN GREEN 115 COMP.....\$119**
• TAXAN AMBER 116 COMP.....\$119**
• TAXAN GREEN 121(TTL).....\$137**
• TAXAN 620 RGB COLOR.....\$358**
• TAXAN 630 COLOR MTR.....\$487**
• TAXAN 640 COLOR MTR.....\$517**
• ZNTH ZVM1220 AMB COM.....\$ 98**
• ZNTH ZVM122A AMB COM.....\$ 88**
• ZNTH ZVM1230 GRN COM.....\$ 98**
• ZNTH ZVM1240 AMB (TTL).....\$142**
• OTHER MONITORS.....CALL

PRINTERS

• JUKI 6100.....\$ 348**
• JUKI 6300.....\$ 698**
• BROTHER M-1509.....\$ 388**
• CITIZEN 120D.....\$ 175**
• CITIZEN MSP-10.....\$ 248**
• CITIZEN MSP-15.....\$ 398**
• CITIZEN MSP-20.....\$ 438**
• CITIZEN MSP-25.....\$ 498**
• CITIZEN 35 LO.....\$ 418**
• CITIZEN 120D.....\$ 177**
• EPSON LX-80.....\$ 218**
• EPSON FX-85.....\$ 388**
• EPSON FX-286.....\$ 518**
• OKIDATA 182.....\$ 207**
• OKIDATA 192.....\$ 368**
• OKIDATA 193.....\$ 498**
• SEIMENS PT 88.....\$ 488**
• STAR POWER TYPE-LO.....\$ 318**
• STAR NX-10.....\$ 288**
• STAR SG-15.....\$ 388**
• STAR SD-10.....\$ 369**
• STAR SD-15.....\$ 459**
• STAR SR-10.....\$ 498**
• STAR SR-15.....\$ 599**
• HP LASER JET.....\$2588**
• DARYS LASER (CANNON).....\$2588**
• CORONA LASER.....\$2294**

SUPER SPC-AT

TOTALLY IBM AT HARDWARE & SOFTWARE COMPATIBLE

MOTHER BOARD	DRIVE	FORMATTED	ACCESS	
80286 MICROPROCESSOR	MFG	CAPACITY	SPEED	PRICE
80287 COPROCESSOR (OPTIONAL)				
512K STANDARD MEMORY				
8-1/10 EXPANSION SLOTS				
ONLY (OK).....\$588	SEAGATE	21	65	\$ 448
• SUPER AT KEYBOARD.....\$ 89	SEA/CDC*	21	40	\$ 688
• SUPER AT CASE.....\$ 89	SEA/CDC*	30	40	\$ 845
• SUPER AT 200 WATT	CDC	40	28	\$1145
POWER SUPPLY.....\$149	SEAGATE	40	40	\$ 988
• 2.5M MULTI-FUNCTION	CDC	50	28	\$1399
CARD (OK).....\$198	CDC	70	28	\$1598

SUPER COMPATIBLE PC-XT MOTHERBOARD

TOTALLY IBM XT HARDWARE & SOFTWARE COMPATIBLE

• 640K MOTHER BOARD (OK).....\$108	SPECIAL THIS MONTH ONLY!
• MONOCHROME GRAPHIC	5150 KEYBOARD.....\$54.00
• PRINTER CARD.....\$ 98	5151 KEYBOARD.....\$88.00
• MULTI I/O CARD.....\$108	XT CASE (Flip Top).....\$28.00
• PARALLEL PRINTER CARD.....\$ 28	135 WATT XT
• SERIAL CARD.....\$ 38	POWER SUPPLY.....\$78.00
• GAME PORT ADAPTER.....\$ 19	
• EPROM WRITER CARD.....\$108	

DISK DRIVE

1/2 HEIGHT DISK DRIVE (2 +, 2E).....\$11500
1/2 HEIGHT 2C DISK DRIVE.....\$15900

**NEW!!
INTELLIGENT
EPROM
WRITER**

CAN BURN 2716, 2732(A), 2764, 27128, 27256 Vpp AUTOMATIC SET TO 25V, 21V, OR 12.5V FAST SPEED. ONLY 50 SECONDS FOR 2764 CAN COPY. VERIFY, READ FROM DISK FILE, OR EPROM FULL CP/M UTILITY PROGRAMS SUPPORT FOR DEVELOPMENT ONLY.....\$16900

★ APPLE COMPATIBLE PRODUCTS ★

• APL II+ Compatible Mother Board.....\$228	• PRINTER CABLES.....\$ 13
• APL II+ Compatible 80 Column Card w/64K Memory.....\$ 48	• 80 COLUMN CARD FOR II +\$ 42
• APL II+ Case, Keyboard w/Keypad.....\$119	• Disk Controller Card II + or IIe.....\$ 39
• SS SERIAL CARD.....\$ 68	• 16K Memory/Language Card.....\$ 29
• APL II+ Replacement Keyboard.....\$ 58	• Joystick II + or IIe.....\$ 15
• APL IIe Replacement Case.....\$ 58	• Fancy Joystick II + or IIe.....\$ 19
• Power Supply (replacement II + or IIe).....\$ 39	• Half Height Disk Drives II + or IIe.....\$118
• APL II+ Detachable Keyboard w/Keypad.....\$ 99	• IIe Drives.....\$138
• APL II+ Compatible Mother Board.....\$189	• Super Cooling Fans II + or IIe.....\$ 24
• APL II+ Replacement Case.....\$ 38	• APL Video 7 RGB.....\$158
• APL II+ Replacement Keyboard.....\$ 38	
• APL II+ External Keyboard.....\$ 79	
• APL II+ Functional, Numerical Keypad & Case.....\$ 79	
• EPROM Writer Card.....\$ 38	
• Z-80 CP/M CARD.....\$ 68	
• GRAPPLER Compatible Printer Card.....\$ 39	



2c CASE & KEYBOARD w/KEYPAD

MAIL TO BTE Computers, Inc.

14644 N. CAVE CREEK #6 • PHOENIX, AZ 85022
OR P.O. BOX 30705C • PHOENIX, AZ 85046-0705 • PHONE (602) 867-8962
MASTER CHARGE, VISA, ARE WELCOME. (3.9% C.O.D.) \$5.00 MINIMUM SHIPPING & HANDLING
NOT RESPONSIBLE FOR TYPOGRAPHICAL ERRORS. ALL PRODUCTS SUBJECT TO
AVAILABILITY OR STOCK ON HAND. ALL PRICES ARE SUBJECT TO CHANGE WITHOUT NOTICE!
ALL SALES ARE CASH DISCOUNT PRICES! REFUNDS ARE CREDITED ONLY!

Call TOLL FREE 1-800-233-6035 For Orders Only

emphasizes using C to write source code that is as portable as possible. He demonstrates how to avoid syntax that is permissible but not robust.

Schwaderer uses the proposed ANSI X3J11 standards as the criteria for defining usage. What this means is that the book describes the language with some extensions that are not considered in the standard developed in Brian W. Kernighan and Dennis M. Ritchie's *The C Programming Language* (Prentice-Hall, 1978). Therefore, in many ways this reference book is more up to date than other books in its description of the C language as it is implemented on the most recent versions of C compilers used on microcomputers. The author is careful to point out which proposed ANSI standards are not in general use, and he states in the preface that your compiler must remain your definitive description of the language.

A NEW REFERENCE

It is in his explanations of the more difficult to understand areas of C that the author shines. The sections on library functions related to file I/O, structures and unions, and pointers are clear and complete.

The relationship between arrays and pointers is particularly important to programmers trying to get the most out of the C language. Schwaderer offers good examples of equivalent expressions for multidimensioned arrays and their members by using traditional subscript nomenclature as well as pointer variables.

Many books on C tend to give only brief treatment to the C preprocessor and its directives. Although the preprocessor is not technically part of the C language, all the compilers I have used include such a capability. Taking advantage of C's preprocessor can add a lot to your programming capability, and *The C Wizard's Programming Reference* stands out by giving a complete description of the preprocessor directives. The code fragments used as examples in this section were particularly valuable to me because it seemed that time and again I would look at an example and find myself thinking, "Gee, that's a clever way to handle that problem or to write code that makes the program truly portable."

As befits a useful reference book, both the table of contents and the index are detailed and comprehensive and make it easy to find specific sections that deal with particular aspects of the C language. A valuable asset to this book's utility as a reference is the presence of a removable, double-page-size, light cardboard reference card in the back of the book. The card contains a well-organized and complete summary of all of C's main features. As is true with any reference-type text, a certain amount of redundancy creeps in: I counted at least five separate places in the book where the author warns the reader about confusing the = and == operators.

BEYOND APPEARANCES

The author's style is generally terse and to the point, an acceptable approach to a reference-type text. But it does make the reading seem dry and academic. I do not want

(continued)

Unitex AT™

\$1,695

Unitex PC™

\$595

FREE SHIPPING

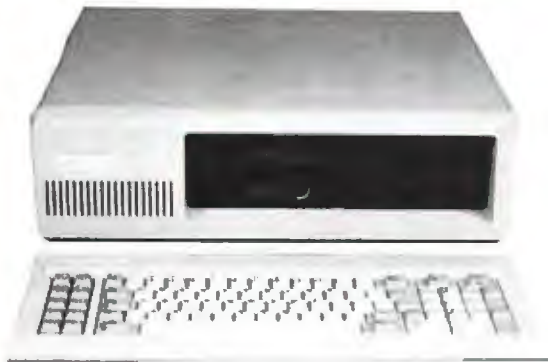

UNITEX PC™

- * System Board Expandable to 640K
- * 256k Random Access Memory
- * 8 Expansion Slots
- * 360k Floppy Disk Drive
- * 135 Watt Power Supply
- * 5150 Type Keyboard
- * Runs IBM PC Software
- * One Year Warranty*

Same System Plus 10 MB Hard Disk

\$995

\$595

UNITEX AT™ \$1,695

- * System Board Expandable to 1024K
- * 512k Random Access Memory
- * 1.2 MB High Capacity Floppy Disk Drive
- * Combined Floppy and Hard Disk Controller
- * 230 Watt Power Supply
- * Battery Backup Clock/Calendar
- * AT Keyboard

UNITEX TURBO™ \$695

- * System Board Expandable to 640K
- * Keyboard Selectable 4.77Mhz and 8 Mhz Speeds
- * 256K Random Access Memory
- * 360K Floppy Disk Drive
- * 135 Watt Power Supply
- * 5150 Type Keyboard

UNITEX CO.

1002 El Camino Real Los Altos, CA 94022

1-800-426-5916

Inside California: 1-415-957-6465

IBM PC, XT, AT are trademarks of IBM Corp.

United Warranty

* Free shipping via UPS (outside of Continental United States). Limited warranty on parts (no on-site service charges).

AT prices subject to change without notice.

Company price reserves subject to a 15% resocking charge.

AT LAST: Professional Typesetting Capability For PC Users

With **PC \TeX** [™] — the best-selling full implementation of Professor Don Knuth's revolutionary typesetting program **\TeX** .

FINEST Typeset Quality Printing From:

dot matrix laser phototypesetter

$$\sum_{i=1}^{\infty} \frac{1}{i} \begin{pmatrix} a_{11} & \dots & a_{1n} \\ a_{21} & \dots & a_{2n} \\ \vdots & \ddots & \vdots \\ a_{m1} & \dots & a_{mn} \end{pmatrix} \int_{-\infty}^{\infty} e^{-x^2} dx$$

WIDEST Range Of Output Device Drivers:

- Epson FX, LQ
- Toshiba
- Corona LP-300*
- Screen preview, with EGA or Hercules card
- HP LaserJet*
- Apple LaserWriter
- APS-5 phototypesetter

MOST COMPLETE Product Offering:

PC \TeX (not copy protected) includes the following:

- Our specially written *PC \TeX Manual*, which enables you to start using \TeX right away.
- Custom "macro packages" that provide formats for letters, manuals, technical documents, etc.
- The *L \TeX* document preparation system, a full-featured macro package for preparing articles, books, reports, etc., and *L \TeX User's Manual*.
- *A \mathcal{M} S- \TeX* , developed by the *Amer. Math. Society* for professional mathematical typesetting.

Site licenses, volume discounts, and interfaces to PC Paintbrush, PC Palette, FancyFont and Fontrix are also available.

PRICED FROM ONLY \$249.00!

(Printer drivers and interfaces additional.)

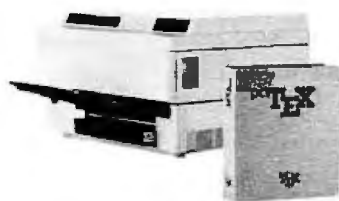

Laser printer,
fonts & software
from \$2995.00

For IBM PC/XT, AT or compatible, DOS 2.0 or higher, and 512K RAM. Hard disk required for printer drivers and fonts.
*HP LaserJet and Corona require additional interface boards.

For more information call or write:

Personal \TeX , Inc.

20 Sunnyside, Suite H, Mill Valley, CA 94941 (415) 388-8853

This ad, with space for the photograph, produced by PC \TeX . Typeset on the Epson FX80, the Corona LP-300 laser printer, and the Autologic APS-5 phototypesetter.

\TeX is a trademark of the American Mathematical Society. Manufacturers' product names are trademarks of individual manufacturers.

BOOK REVIEWS

to give the impression, however, that Schwaderer's treatment of the subject matter is not thorough.

Some relatively minor things detract from what the author is trying to say. For example, while reading through the book, I was frequently distracted by references to figures (usually fragments of source code) that appeared on a subsequent page and occasionally after the next major subject heading. Also, the figures in the book appear to have been constructed on a word processor screen using normal ASCII characters instead of having been drafted. As a result, some of the figures have an amateur look and are harder to read.

The book's layout, lightweight stock, and coil binding all detract from its overall appearance, usability, and longevity. Fortunately, however, the book's content represents a much better value than first appearances would lead you to believe.

John D. Unger (P. O. Box 95, Hamilton, VA 22068) is a geophysicist for the U.S. government who uses computers to study the structure of the earth's crust in earthquake-prone regions.

INTRODUCTION TO MACHINE AND ASSEMBLY LANGUAGE PROGRAMMING

Reviewed by Larry G. Clark

In *Introduction to Machine and Assembly Language Programming* by Philip Gust provides virtual machine simulators to assist the student. A simulator is provided for two machines (one uses a 16-bit word, the other a 32-bit word) so that you can immediately evaluate examples given in the text. Assemblers are provided for both machines as well. The assemblers and simulators are written in standard Pascal syntax to minimize the effort needed to adapt them to your compiler. The source code is listed in an appendix and is also available on an optional disk. The largest of five programs occupies about 40K bytes when the include files are taken into account.

Instructors will find these training aids versatile because they won't succumb to hardware obsolescence. When your software is upgraded, you simply recompile the programs on the new machine, and class continues. If you want to add new mnemonics, you have the source code to the assembler and can make the modifications yourself.

EFFICIENT INSTRUCTIONS

Gust uses a simple instruction set for his first model, a 16-bit machine with one accumulator. Twelve instruction types, such as LOAD, ADD, and MUL, work with the direct, indexed, indirect, and immediate addressing modes. The instructions are quickly explained so that you can begin immediately with examples that are always short and to the point. Don't let the small instruction set mislead you; Gust demonstrates a wide range of assembly language programming methods, such as loops, procedures, arrays, parameter passing by value and reference, and the use of pointers. Examples are given in Pascal source code

(continued)

The New \$119 SummaMouse.[™]

The power and reliability of an electronic mouse, for about 1/2 the cost.

Our new all electronic, optical mouse is an amazing engineering feat.

No Mouse is smarter.

SummaMouse comes with built-in microprocessor controls and Microsoft® emulator driver/menu software to help you get maximum performance from both your mouse and your computer.

Cursor movement, windowing and interaction with spreadsheet, graphics, general business and other software applications is a snap. For more sophisticated applications like CAD and workstation graphics,

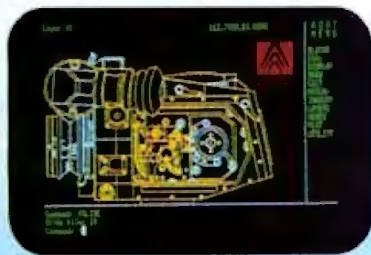

Two-way communication aids in the performance of sophisticated graphics.

SummaMouse offers diagnostics and full, two-way communications so you can program our mouse to perform complicated tasks.

Our electronic technology delivers 100 times the reliability of mechanical mice.

Mechanical MTBF* 1,500 hrs.

*Mean Time Between Failure

No mouse is more reliable.

Unlike mechanical mice which are susceptible to wear and damage, our electronic technology delivers 150,000 hours of maintenance-free performance. That's 100 times greater than the industry standard.

No mouse is mightier.

Summa-Mouse offers a high resolution of 100 lines per inch for smooth cursor control and performance; 3 action keys to program up to 6 functions; variable baud rates from 1200 to 19,200 BPS and Auto-Baud plus compatibility with over 200 leading graphics and windowing software programs, including IBM® Drawing Assistant® and Top View,™ AutoCAD,™ VersaCAD™ and CADKEY;™ DR™ Series; Dr. Halo II;™ GEM™ Series; GSS™ Series; Imigit;™ Lotus 1-2-3® and VisiCalc;® Microsoft® Windows and Microsoft applications; PC™ Series; and major word processing programs.

Electronic MTBF* 150,000 hrs.



Compatible with over 200 leading software programs.

All this for only \$119.

That's about half the price of other electronic mice and of mechanical mice which can't come close to the performance of SummaMouse.

Why mickey mouse around with a more costly, less useful mouse. Contact your dealer or Summagraphics today for more information about SummaMouse.

Or complete and return the coupon below.



NEW SUMMAMOUSE

Please send me more information.

User GEM Dealer

Application type?: _____

Name _____

Title _____

Company _____

Address _____

City _____

State _____ Zip _____

Mail to: Summagraphics Corporation,
777 State St. Ext., Fairfield, CT 06430
(203) 384-1344

Summagraphics[®]

CORPORATION



TELECAT 286

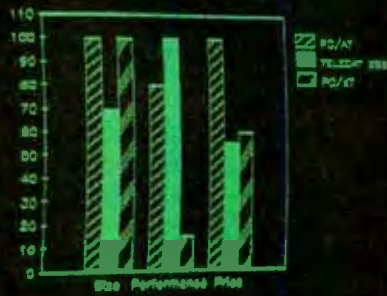

TeleVideo

TeleVideo

AT performance at an XT price. Introducing the TeleCAT-286. \$2995. Complete.

With TeleVideo, you always settle for more.

Up till now, with a mid-range budget, you had to settle for mid-range performance. And a mid-range set of features.

But not anymore. Because now, there's the new TeleCAT-286™ from TeleVideo. An IBM AT-compatible machine that lets you settle for an entirely new concept in medium-priced PCs: more.

More Performance.

The TeleCAT-286 retails for \$2995, roughly the same as a comparably-equipped IBM XT. But the similarity ends there. Instead of starting you off with a stripped-down box, we've loaded up the TeleCAT-286 with everything you need. Like a 20MB hard disk. A 1.2MB floppy. An Intel 80286 CPU that runs at either 6 or 8 MHz clock

28% Smaller Footprint:

What you do with the extra desk space is up to you, but as you can see here, the TeleCAT-286 gives you a lot more of it than the IBM AT.

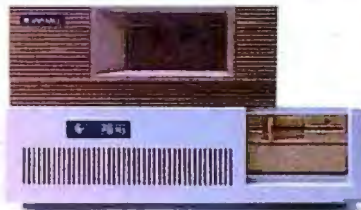

speed. There's even a high-resolution monitor for text and graphics.

To make even better use of internal space, we socketed the TeleCAT-286 for one MB of RAM, and also included serial and parallel ports on the motherboard. As a result, we can still

give you three extra expansion slots.

More Productivity.

Using our experience in building terminals and systems for 750,000 users worldwide, we've designed a machine that's the last word in ergonomics. With

LEDs On Locking Keys:

For maximum visibility, we put our LEDs right on top of the three critical locking keys, so they won't get covered up by overlays.



sculptured keycaps on a high-quality keyboard. LEDs on the three critical locking keys. And a footprint that's 28% smaller than the IBM AT's. So you get more of your desk back, too.

Find Out Even More: 1 (800) TELECAT.

There's a whole lot more we could tell you about the TeleCAT-286. But it's an even better idea to get your hands on it. So call us at 1 (800) TELECAT, Dept. 208, and we'll tell you the nearest place you can try one.

The TeleCAT-286. Our 20MB version is \$2995; 30MB, \$3495. For high performance at a low price, don't settle for less.

 **TeleVideo®**
Settle for more.

TeleVideo Systems, Inc. 1170 Morse Avenue
Sunnyvale, California 94088-3568 • (408) 745-7760

©1986 TeleVideo Systems, Inc. IBM is a registered trademark of International Business Machines, Inc. Screen graphics by Chartmaster ©Decision Resources, Inc.

DeSmet C

now with 32-Bit Pointer Option

C88.....still \$109

The editors' choice for fast compilation and execution. The **price/performance winner** in all major C benchmarks since 1983. Includes Compiler, Assembler, Binder, Librarian, Execution Profiler and Full Screen Editor. Supports both disk and memory resident Overlays. Contains both 8087 and Software floating point support. Full STDIO library.

Large Case Option.....\$50

Makes a great C Compiler even better. Adds 32-Bit Pointers to C88 so you can utilize all of your PC. Groups scalar and static data for fast access. Supports the D88 debugger.

D88.....\$50

Gain most of the benefits of an interpreter while losing none of the run-time speed of the C88 compiler. Display C source and variable contents during execution. Set breakpoints by function name or line number. Examine and set variables by name using C expressions.

order direct from:

C Ware Corporation

505 W. Olive, Suite 767, Sunnyvale, CA 94086 U.S.A.
(408) 720-9696 — Telex: 358185
We accept VISA, MasterCard & American Express

alongside the assembly listing so that readers can better understand the algorithm. The author assumes you've had no more than a basic introduction to Pascal; a knowledge of any language would help you to understand the examples. Gust drops the Pascal examples after you've had time to become proficient at reading assembly code.

Examples demonstrate how to minimize the number of instructions used in branching and looping. Important concepts, such as arithmetic and logical negation, are introduced that reduce the number of branch test instructions. The author also shows a compact arrangement of instructions to minimize the instruction count. But Gust disappointed me by not explaining how the initializer section, code body, and exit test arrangement were developed. However, his examples are consistently written and easy to understand.

FOR loops are written in assembly language using the precalculated "trip count" and "index" methods and are accompanied by an explanation of the circumstances that determine which method should be used. The WHILE... ENDWHILE and REPEAT...UNTIL loops are coded as well. These examples expose the student to the tasks that a compiler must perform and therefore serve as an introduction to later course work in computer science.

Array manipulations are programmed in both one and two dimensions using both the row- and column-major formats. A good explanation of the "base-offset" address calculation model used in address calculations is an excellent programming tool whose use is reinforced frequently.

STACKS AND RECURSION

Limitations imposed by the 16-bit machine's return address storage method are alleviated by introducing a 32-bit machine. This second machine is much more powerful, with multiple registers that can serve as indexes, accumulators, stack pointers, and a set of 30 instructions with six basic addressing modes. As with the 16-bit machine, the author first gives an invaluable explanation of data flow inside the imaginary machine as instructions are executed. Short examples of the assembler's syntax are provided as well. Register management is then introduced to show you how to use the wealth of power that eight 32-bit registers offer. Even though the 32-bit machine readily supports separate data and return stacks, Gust demonstrates how to use the return stack to pass data while holding return addresses. He presents several examples of recursion before going on to bit-manipulation techniques.

Floating-point formats and floating-point algorithms give the reader a basic exposure to the concepts behind this aspect of programming. Although Gust shies away from a full discussion in this introductory text, he does mention advanced topics such as how to control rounding error. One point that was not explained regards format conversion between base 10 and base 2 floating-point formats. The topic was instead deferred to a homework question in the next chapter on character conversion and string manipulation. Incidentally, the author's treatment of strings

(continued)

MAX IBM® AT COMPATIBILITY

SHUTTLE-AT BOARD

- 80286 CPU at 6, 8, 10 MHz
- Upgradable to 1 megabyte
- 1 parallel, 4 serial ports on board
- 4 models (S-286, TS-286, C-286, TC-286)
- Legal and true compatible BIOS

OEM QUANTITY PRICE
\$595.00



EGA BOARD

- 256K on board
- Parallel port on board
- Adapts to EGA, Monochrome, RGB monitors
- 640 x 350 pels (64 colors)
- Less than half the cost for IBM® EGA from **\$295.00**

BIOS CONTRACT AT, XT, PC, EGA available to manufacturers
IBM, AT are trademarks of International Business Machines Corporation



IBS Corporation—professional quality and support
2700 E. Imperial Hwy., Bldg. A., Brea, CA 92621
To order an evaluation call: (714) 579-0680, 579-0691,
579-0692. TLX: 753197, & FAX (714) 579-0695.

BEYOND THUNDERSTONE

Consolidated Diesel, CDC, Crown Zellerbach, David Sarnoff Research Center, RCA Labs, Dunn & Bradstreet Computing Services, Inc., EG&G Washington, Defense Systems Division, Procter & Gamble, Riverview

Hospital, St. Mary's County Mental Health, Saskatchewan Economic Development and Trade (Canada), St. Joseph's Hospital, Tektronix, Texas Instruments, TWA, The Pentagon, US Attorney General, US Geological Survey, Aerospace Corporation, Aramco (Saudi Arabia), Arthur Andersen, AT&T Information Systems, Board of Trade of the City of Chicago, Boeing Aerospace Co., Canadian Dept. of Defense, Chevron Research, Ciba-Geigy, CIGNA, USG, Collins General Aviation Div., Ford, Foxboro, General Electric, Hamilton-Avnet, Hewlett-Packard, Informatics, Institute of Gas Technology, Lawrence Livermore Labs, Liberty Mutual Insurance Company, Monsanto, Northrop Corporation

Hospital, St. Mary's County Mental Health, Saskatchewan Economic Development and Trade (Canada), St. Joseph's Hospital, Tektronix, Texas Instruments, TWA, The Pentagon, US Attorney General, US Geological Survey, Aerospace Corporation, Aramco (Saudi Arabia), Arthur Andersen, AT&T Information Systems, Board of Trade of the City of Chicago, Boeing Aerospace Co., Canadian Dept. of Defense, Chevron Research, Ciba-Geigy, CIGNA, USG, Collins General Aviation Div., Ford, Foxboro, General Electric, Hamilton-Avnet, Hewlett-Packard, Informatics, Institute of Gas Technology, Lawrence Livermore Labs, Liberty Mutual Insurance Company, Monsanto, Northrop Corporation

PC MAGAZINE said **LOGIC-LINE™** ". . . comes closer to achieving its lofty aims than most other PC programs that claim to possess intelligence." * What if you could do lightning-fast data retrieval, as well as find possible points of logical correlation and inference from text and even numeric data? We'd like to show you the most remarkable AI software ever made available for the PC.

WHAT IF YOU AND YOUR PC . . . ?

- **Accountants:** What if you could instantly search through all client tax returns, to test uniformity or solve a current problem?
- **Attorneys:** What if you could zap-search all your depositions, not only for obvious references but for possible inconsistencies?
- **Sales managers:** What if you could download selected customer reports from your corporate mainframe to your PC, and project patterns and interrelationships?
- **Doctors:** Without pretagging or reengineering your existing patient history database, what if you could query for possible correlations between symptoms and other factors, such as age, race, seasons, etc.?
- **Administrators:** What if your PC could verify the consistency of all contracts?
- **Multinationals:** What if you could verify the accuracy of translations between all Romance and Slavic languages, or add new phonetic-based languages to your system?
- **Writers:** What if you could thoroughly analyze the style and thinking patterns of your own favorite authors, and then use your system to compare whether or not you could duplicate style and thought processes?
- **Entrepreneurs:** After obtaining specific time-series data from an information-retrieval service, such as Dialog, what if you could instantly, irrespective of the data presentation format, correlate it with possible patterns in commodity/stock prices and even speeches by federal policymakers?
- **AI professionals:** What if you could search and correlate possibilities for conversion of any machine-readable data into meta-rules for input into currently available expert system building tools, the best being from Teknowledge, in Palo Alto, CA?
- **Information analysts (spook shops):** What if your PC could mine raw field data to distill intrinsic patterns and correlate them with already-verified data?

THE BOTTOM LINE

In short, what if you could treat any text file as if it were a customized expert system? What if you could sift through numeric data for inferences and correlations? What if you could cross-correlate files written in different languages? Or add new phonetic-based languages? All on your PC? Soon to be available on the VAX (naturally at different prices)?

In less than a year, LOGIC-LINE software has become a unique piece of artillery for the data-cracking arsenal. If you are competing against some of the people listed around this ad, you should seriously consider a modest investment in advanced AI technology. Those Thunderstone customers surround more than just this ad.

Your bottom line is your bottom line.

HOW LOGIC-LINE WORKS

LOGIC-LINE can do direct retrieval of data, or locate points of union within the content of data. Its pedigree goes clear back to some of the earliest work done by Norbert Weiner at MIT, and by Alan Turing in the UK.

In a text search, LOGIC-LINE connects text references to search requests by first discarding certain noise words and then looking for patterns among key words.

This is substantially beyond the type of searching your standard word processor can do. What further distinguishes this from routine text searching is LOGIC-LINE's *content analysis* of the meaningful data.

LOGIC-LINE performs a proprietary mathematical transformation on the text, bypassing the need for a dictionary and the need to understand linguistics. The heuristics are controlled by the human, who rejects and discards posed inferences, or who accepts and thereby causes "matches" to be stored in an aggregate file.

Most common text-retrieval systems achieve speed by building *hashed* files that are significantly larger than the original. This defeats the purpose of using micros for retrieval. LOGIC-LINE searches progressively faster, because it condenses the initial file being searched into a significantly smaller *hash* file, which is then the object of future searches.

Thus, because *content-based* retrieval is LOGIC-LINE's strong suit, it gives you the opportunity to do automatic correlation of numeric data, as well as text.

MATHEMATICS TRANSCENDS THE VON NEUMANN MECHANISM

It's long been the fear of particle physicists that wave mechanics took a wrong turn somewhere, and that we missed an obvious solution to the relationship between light, gravity and magnetism. LOGIC-LINE is proof that the AI community took an analogously wrong turn nearly forty years ago.

During World War II, the usefulness of a given computing engine was proportional to its speed in calculating an artillery trajectory. Importance was also placed on using mathematical methods to break enemy codes.

Later, when computing power was no longer at a premium, the "soft" sciences took over language research, abandoning content analysis as well as inference tracking through mathematics and pattern recognition.

Thus, LOGIC-LINE is *evolutionary*, only appearing revolutionary when compared to the most recent AI developments. Mainstream AI just took an unfortunate turn at a critical point in history. But the world is once again ruled by disciplined mathematicians, not by effete linguists peddling *geekware*.

IMMEDIATE DELIVERY. MONEY-BACK GUARANTEE.

LOGIC-LINE can grow as you need its capabilities. For English-language text work, LOGIC-LINE 1 is only \$90. Add numeric manipulation for an additional \$35, and you have LOGIC-LINE 2 for \$125. Add multiple-language capability for another \$25 and you have LOGIC-LINE 3 for \$150. The products are not copy protected and may be returned within thirty days for replacement or refund. Upgrades from one LOGIC-LINE product to another are the difference in price, plus a \$5 handling fee on all orders.

You're going to hear much of Thunderstone in the months to come. You're also going to hear howling, since we seem to have had the same general effect on the *AI Establishment* as a full moon on a werewolf. Alas, our brand of straight talk does set the soft sciences and pseudointelligencia to shrieking in the night. But what can we say, except that the emperor is stark naked and should stop all that prancing around.

What's beyond Thunderstone? Probably 3-dimensional pattern recognition and packaged logical cloning of great thinkers.

In the mean time, we trust you will be most satisfied to experience LOGIC-LINE, from Thunderstone.

Please send me the following:

- LOGIC-LINE 1, the text-only version: \$90
 - LOGIC-LINE 2, for text and numeric work: \$125
 - LOGIC-LINE 3, for text/numeric/multi-lingual work: \$150
 - The LOGIC-LINE disk tutorial for \$20
 - COMPREHENSION™ an expert system for diagnosing and remedying problem-analysis/information-skills weakness: \$50
 - ASSIMILATION™ a CAI program which teaches problem analysis and accelerated learning techniques: \$75
- US residents should include \$5 for handling and shipping, while international orders should include \$25. Ohio residents please include 5% sales tax.

\$ _____ Total amount enclosed/authorized.

- My check is enclosed.
- Please bill my VISA/ MASTERCARD.

Card number _____
 Expires _____ Signature _____
 Date _____ Print your name _____
 Title _____ Phone _____
 Company _____
 Street address _____
 City _____ State _____ Zip _____

THUNDERSTONE™

Lightningsmiths of the New AI Establishment

P.O. Box 839 • Chesterland, OH 44026
 Call 216/449-6104 for more information, or 800/621-5839 (800/972-5855 in Illinois) to order.

*January 14, 1986, page 140. Copyright © 1986 by Thunderstone. LOGIC-LINE 1™ LOGIC-LINE 2™ LOGIC-LINE 3™ COMPREHENSION™ and ASSIMILATION™ are trademarks of Thunderstone, a division of Expansion Programs International, and require a 128K IBM PC or compatible with at least one diskette drive and run under MS/DOS 2.1 and up. TRBA Adv.

ONE SIMPLE QUESTION CAN MAKE YOUR PC CLONE A GOOD INVESTMENT. . .

Is the power supply a FORTRON®?

Your PC represents a substantial investment. It does not make sense to risk costly downtime or system failure due to the use of a so called "BARGAIN" power supply.

At Fortron we insist on quality and reliability that is what earned us a full U.L. rating, and why we feel confidence in offering our warranty, as well as technical support.

Invest in the best and you will be delighted at how little it cost to be powered by FORTRON®

**PROFITABLE DISCOUNT PRICES
FOR DEALERS & SYSTEM
INTEGRATORS AVAILABLE!**



**FC 5192
PC AT (200W)
\$189.00**

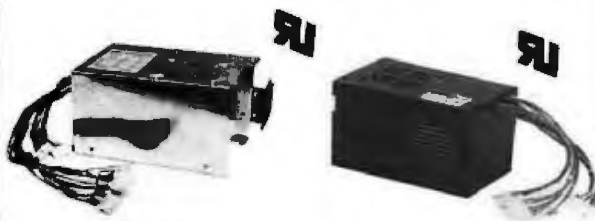

**PC XT
SIDE SWITCH
150W MAX.
\$129.00**

**PC XT
REAR SWITCH (130W)
\$109.00**

- U.L. recognized, file #E-101115(s)
- Meet European safety spec.
- 115/230 AC convertible
- Low noise DC fan
- Good for up-grading PC or replacement to original PC power supply
- OVP, OCP, short circuit protection
- IBM® standard pin-out or Faraday Type pin-out selectable
- 100% 24 hrs burn-in, 100% pre-shipment test. One full year warranty.
- Meet FCC class B.

FORTRON **ORDERS ONLY: (800) 821-9771**
3225 SELDON CT. IN CALIF.: (415) 490-8171
FREMONT, CA 94538 **TELEX: 559291 FORTRON U.D.**

BOOK REVIEWS

is straightforward and carefully avoids algorithms that are dependent upon the character code being used. Character packing, string concatenation, and character-to-number conversion techniques are demonstrated.

A short chapter on machine I/O discusses keyboard and display communications so that the reader can evaluate a sample program that simulates a four-function calculator. Disk I/O is discussed in an elementary manner that includes sample assembly language program code. Interrupts are briefly mentioned as a useful tool in doing I/O.

A discussion of multiple-precision arithmetic is not possible because neither of the virtual machine models offers a carry or overflow flag. This is the only major omission I found.

I had to complete this review without spending a lot of time with an executable copy of the assemblers and emulators. Because a disk with simulator and assembly language programs in Pascal for the IBM PC (for an additional \$24.95; ISBN 0-13-486432-8) arrived at the last minute, I did take a little time for a cursory examination.

I could not resist adapting the one-address assembler to my Turbo Pascal compiler's syntax to learn what must be done to get the software running. I had to change a few conflicting keywords and remove the only GOTO statement used. Instructions on how to prepare the source for compilation is given in the appendix and involves merging text files. Though I was largely successful, the assembler recognized mnemonics but not pseudo op codes. I may have induced this problem by making keyword changes. I was rewarded with a compiled program that occupied about 25K bytes. Although I have not tried the other three programs, I am reasonably confident that my compiler will compile them also. I do, however, have reservations about assembling large examples, as the assembler may demand more dynamic storage than Turbo Pascal can provide.

SUMMARY

The author clearly explains assembly language programming using basic instruction types. The virtual machine models use simplified yet capable and realistic instruction sets to confirm that many instructions go unused because they are seldom needed. The instruction count reduction also allows the reader more time for learning programming techniques by requiring less time to learn how they operate. Although he does not address interrupts or hardware details, I still recommend that the book be considered for use in engineering courses where assembly language programming is taught.

This book provides more than just an explanation of assembly language programming; it offers an introductory glimpse of more advanced programming challenges. Gust introduces programming functions such as variable storage allocation and describes simple aspects of code generator optimization. ■

Larry G. Clark (8103 Thorneadow Dr., Hixson, TN 37343) works as an electrical systems engineer and teaches after hours at Chattanooga State College. His interests include computer language development, control applications, and robotics.

Powerful MS-DOS™ Software.

For the IBM®-PC, XT, AT & others with generic MS-DOS/PC-DOS 2.0 or higher.

Not copy
protected!

Only **\$39.95** Each!

UTAH COBOL™

Whether student, teacher or professional programmer, this is the one you've heard so much about.

- It's easy to use. Compiles 5000 statements on a 128K machine.
- 170 clear error messages, i.e. DATA-NAME IS MISSING OR MISPELLED.
- Distribute your object code programs royalty free.
- Small object code programs conserve disk space.
- Fast compile times to increase programmer productivity. Over 25 times faster than one compiler costing \$995!
- You get a diskette and 213-page manual with lots of examples and 16 complete COBOL source code programs. **\$39.95.**

Also available: COBOL Application Packages, Book 1 **\$9.95.**

UTAH PASCAL™

- 14-digit precision, BCD math, no round-off errors with decimal arithmetic for business and floating point + 63 - 64 for scientific.
- A very nice TRACE style debugging.
- Arrays up to 8 dimensions and 64K strings.
- External procedures and functions with dynamic auto-loading.
- One-step compile, no assembly or link required.
- You get a 132-page manual and diskette. **\$39.95**

UTAH PILOT™

- Perfect for industrial training, office training, drill and testing, virtually all programmed instruction, word puzzle games, and data entry facilitated by prompts.
- John Starkweather, Ph.D., the inventor of the PILOT language, has added a built-in full-screen text editor, and much more.
- Meets all PILOT-73 standards for full compatibility with older versions.
- You get a diskette, 125-page manual and ten useful sample programs. **\$39.95.**

Also still available for 8-bit machines with CP/M® is our world famous Nevada Software Series used by 50,000 customers in 40 countries. These include Nevada COBOL, Nevada FORTRAN, Nevada PASCAL, Nevada PILOT, Nevada BASIC and Nevada EDIT. **\$39.95** each.

Satisfaction guaranteed. If for any reason you're not completely satisfied, just return the package within 15 days in good condition, and we'll refund your money.

IBM is a registered trademark of International Business Machines Corp. CP/M is a registered trademark of Digital Research. MS is a trademark of Microsoft Corp. © 1985 Ellis Computing, Inc.

UTAH FORTRAN™

- FORTRAN IV based upon ANSI-66 standards.
- Very fast compile times and easy to use.
- IF .. THEN .. ELSE constructs.
- Chaining with blank and named common.
- Copy statement.
- ENCODE and DECODE.
- Free-format input and output.
- A very nice TRACE style debugging.
- 150 English language error messages.
- You get a diskette, and 223-page manual. **\$39.95**

UTAH EDIT™

- A character-oriented full-screen video display text editor designed specifically to create COBOL, FORTRAN and PASCAL programs.
- Only requires 15K disk space so it can fit on the same disk as your compilers.
- Completely customizable tab stops, default file type, keyboard control key layout and CRT by menu selection.
- Diskette comes with easy to read 58-page manual. **\$39.95.**

UTAH BASIC™

- This interpreter has a built-in full-screen editor.
- Single- and Multi-line user definable functions.
- BCD Math- no round-off errors.
- Full Matrix operations.
- You get 220-page manual and diskette. **\$39.95.**

Handling/Shipping: No shipping charge within US. Overseas add \$10 for first package, \$5 each additional. Checks must be in US Dollars, drawn on a US bank.

Utah Software requires 128K RAM and PC-DOS or MS-DOS 2.0 or higher.

HOW TO ORDER. Send check or money order to Ellis Computing, Inc. with VISA or MASTERCARD order by phone. Sorry no COD's.



Ellis Computing, Inc.
5655 Riggins Court, Suite 10
Reno, Nevada 89502
Phone (702) 827-3030

SINCE 1977  

ELLIS COMPUTING™

E·V·E·N·T Q·U·E·U·E

July 1986

NETWORKING IBM PERSONAL COMPUTERS AND COMPATIBLES. Dallas, TX, and Salt Lake City, UT. Center for Advanced Professional Education, 1820 East Garry St., Suite 110, Santa Ana, CA 92705. (714) 261-0240. July

ROCKY MOUNTAIN INSTITUTE OF SOFTWARE ENGINEERING 1986 SUMMER PROGRAM. Boulder, CO. rMise, P.O. Box 3521, Boulder, CO 80303. (303) 499-4782. July

UNDERSTANDING AND USING THE IBM PC XT & PC AT, various sites throughout the U.S. The American Institute Inc., Carnegie Building, 55 Main St., Madison, NJ 07940. (800) 822-2473; in New Jersey, (201) 966-1134. July

SUMMER INSTITUTE IN COMPUTER SCIENCE. Tyngsboro, MA. Wang Institute of Graduate Studies, Tyng Rd., Tyngsboro, MA 01879. (617) 649-9731. July-August

TELECOM PACIFIC '86: ASIAN REALITIES FOR USERS AND SERVICE PROVIDERS. Hong Kong. Pacific Telecommunications Council, 1110 University Ave., Suite 308, Honolulu, HI 96826. (808) 941-3789. July 3-4

AUSGRAPH 86: INTERNATIONAL COMPUTER GRAPHICS CONFERENCE & EXHIBITION. Sydney, Australia. Ausgraph 86 Secretariat, P.O. Box 29, Parkville, Victoria 3052, Australia, telephone: (03) 387 9955; Telex: AA 33761. July 7-11

SIMULATION TECHNIQUES FOR PERSONAL COMPUTERS.

Washington, DC. Continuing Engineering Education Program, George Washington University, Washington, DC 20052. (800) 424-9773; in DC, (202) 676-6106; in Canada, (800) 535-4567. July 7-11

PC EXPO. Jacob K. Javits Convention Center, New York, NY. PC Expo, 333 Sylvan Ave., Englewood Cliffs, NJ 07632. (201) 569-8542. July 9-11

CRITERIA FOR NEW PRODUCT SUCCESS. Madison, WI. Gregg Johnson, Department of Engineering Professional Development, University of Wisconsin-Madison, 432 North Lake St., Madison, WI 53706. (800) 262-6243; in Wisconsin, (800) 362-3020. July 10-11

DBASE III BY ADAM GREEN. Seattle, WA. Software Institute of America Inc., 8 Windsor St., Andover, MA 01810. (617) 470-3880. July 14-17

THE STEPS CONFERENCE: SOFTWARE TRENDS FOR EXECUTIVE PLANNING AND STRATEGY. Boston, MA. Software Institute of America Inc., 8 Windsor St., Andover, MA 01810. (617) 470-3880. July 14-17

GOVERNMENT COMPUTER EXPO86. Sheraton Washington Hotel, Washington, DC. Government Computer Expo86, 1620 Elton Rd., Silver Spring, MD 20903. (301) 445-4400. July 14-18

DESIGNING EFFECTIVE MANUALS: STANDARDS AND PROCEDURES/GRAPHICS. New York, NY. Comtech Services Inc., 133 South Van Gordon St., Suite 206, Denver, CO 80228. (303) 986-9534. July 14-18

BUYING AND SELLING RIGHTS TO SOFTWARE, HARDWARE, AND SERVICES. Anaheim, CA. Data-Tech Institute, Lakeview Plaza, P.O. Box 2429, Clifton, NJ 07015. (201) 478-5400. July 15

1986 ASME INTERNATIONAL COMPUTERS IN ENGINEERING CONFERENCE AND EXHIBITION. Hyatt Regency Hotel, Chicago, IL. American Society of Mechanical Engineers, 345 East 47th St., New York, NY 10017. (212) 705-7788. July 20-24

INTRODUCTION TO LOCAL AREA NETWORKS. Washington, DC. Chip Blouin, Continuing Engineering Education, George Washington University, Washington, DC 20052. (800) 424-9773; in DC, (202) 676-6106; in Canada, (800) 535-4567. July 21-22

HANDS-ON TROUBLESHOOTING. Washington, DC. The American Institute Inc., Carnegie Building, 55 Main St., Madison, NJ 07940. (201) 966-1134. July 21-23

SYMSAC '86: THE 1986 ACM-SIGSAM SYMPOSIUM ON SYMBOLIC AND ALGEBRAIC COMPUTATION. University of Waterloo, Ontario.

Canada. Prof. Richard Fateman, EECS Dept., 573 Evans Hall, University of California, Berkeley, CA 94720. (415) 642-1879. July 21-23

FOURTH INTERNATIONAL CONFERENCE: THE FUTURE OF OPTICAL MEMORY TECHNOLOGY. Hyatt on Union Square, San Francisco, CA. Technology Opportunity Conference, P.O. Box 14817, San Francisco, CA 94114-0817. (415) 626-1133. July 22-24

MICROCOMPUTER-BASED COMPUTER-AIDED DESIGN DRAFTING. Worcester, MA. Kathy Shaw, Office of Continuing Education, Higgins House, Worcester Polytechnic Institute, Worcester, MA 01609. (617) 793-5517. July 24-25

PERSONAL COMPUTER INTERFACING FOR SCIENTIFIC INSTRUMENT AUTOMATION. Blacksburg, VA. Dr. Linda Leffel, C.E.C., Virginia Polytechnic Institute and State University, Blacksburg, VA 24061. (703) 961-4848. July 24-26

SCSC '86: 1986 SUMMER COMPUTER SIMULATION CONFERENCE. MGM Grand Hotel, Reno, NV. The Society for Computer Simulation, P.O. Box 17900, San Diego, CA 92117. (619) 277-3888. July 28-30

TEACHING COMPUTERS AND THE HUMANITIES COURSES. Poughkeepsie, NY. Elle Gohl, Workshop Coordinator, Department of Computer Science, Box 252, Vassar College, Poughkeepsie, NY 12601. (914) 452-7000, ext. 2430. July 31-August 2 ■

IF YOU WANT your organization's public activities listed in BYTE's Event Queue, we need to know about them at least four months in advance. Send information about computer conferences, seminars, workshops, and courses to BYTE, Event Queue, One Phoenix Mill Lane, Peterborough, NH 03458.

NORTHEASTERN *Software* TURBO 286™

7 Trap Falls Rd.
Shelton, Connecticut 06484

AT LAST, A
FASTER PC
AT A BETTER
PRICE!

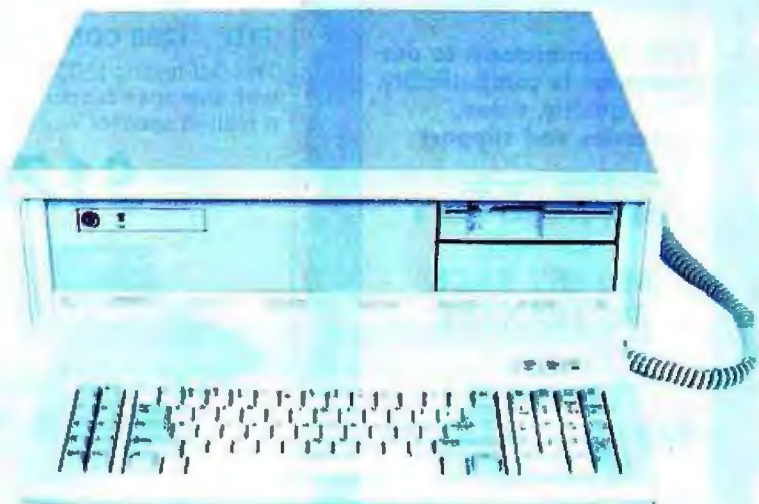

- RUNS ALL MAJOR SOFTWARE WRITTEN FOR THE IBM PC,™ AT,™ AND COMPATIBLES.
- 8 MHZ SYSTEM UNIT (6 MHZ SYSTEM UNIT ALSO AVAILABLE)
- 640 KB MOTHER BOARD INSTALLED AND TESTED.
- 1.2 MB AND 360 KB FLOPPY DISK DRIVE. (PRODUCED BY MAJOR INDUSTRY MANUFACTURERS)

- AT STYLE KEYBOARD.
- 200 WATT POWER SUPPLY.
- 8 EXPANSION SLOTS
- MS DOS 3.1™ USERS MANUAL, AND 2 YEAR LIMITED WARRANTY INCLUDED.
- TWO SERIALS AND ONE PARALLEL PORT
- CLOCK/CALENDAR WITH BATTERY BACKUP
- COMBINED FLOPPY/HARD DRIVE CONTROLLER CARD

OVER 30% FASTER
THAN THE IBM PC-AT™

\$1945.00

**CALL TOLL FREE
1-800-382-2242
CONNECTICUT ORDERS
CALL 203-929-8522
IN CANADA
1-800-843-0074**

SIMPLY THE BEST

Northeastern Software Turbo 286 is a trademark of Northeastern Software.
IBM PC, AT are trademarks of IBM Corporation.

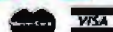

WITH PURCHASE RECEIVE AN ADDITIONAL 2% DISCOUNT ON ANYTHING ELSE WE SELL FOR A FULL YEAR.

Simply put: **THE™** highest quality and best value in computer products anywhere.

THE™ commitment to our customers is compatibility, quality, value, service and support

THE™ backs every product with a **45 DAY MONEY BACK GUARANTEE**

and a **FULL 1 YEAR PARTS AND LABOR WARRANTY**

THE™ MULTI 384

This multi-function card features 0-384K memory, a parallel printer port, a serial port for communications, a clock/calendar with battery backup, and a software bonus that includes RAMdisk and other utilities. Retail Price \$155.00

\$72.00*

Special Wholesale Price



BEST BUY

Functional Clone of AST™ SixPackPlus

THE™ COLOR CARD

100% compatible with the IBM™ colorcard with display modes of 80x25 alphanumeric and 320x200 graphic. Retail Price \$105.00

Special Wholesale Price **\$60.00***

THE™ 576K MEMORY +

Supports 0-576K of available memory and is compatible with all IBM™ PC's. Retail Price \$86.00

Special Wholesale Price **\$37.00***

THE™ PRINTERFACE

Supports all text and graphics features and is fully compatible with third party software. Retail Price \$29.00

Special Wholesale Price **\$18.50***

THE™ MODEMS

100% Hayes compatible

THE™ 1200 COM EXTERNAL

This self-testing 1200 BPS modem comes with auto answer, auto dial, auto redial and a built-in speaker. Retail Price \$275.00

Special Wholesale Price

\$129.00*



THE™ 1200 COM INTERNAL

Features auto answer, dial and redial, with a built-in speaker, RS 232-C serial port and PC Talk III. Retail Price \$255.00*

Special Wholesale Price

\$119.00*

THE™ 2400 COM EXTERNAL

Eight times the speed of a 300 BPS unit makes this 2400 Baud modem truly affordable, and we've made it truly compatible. With auto answer, auto dial, auto redial, and a built-in speaker with volume control. Retail Price \$519.00

Special Wholesale Price

\$277.00*

THE™ H720 MONO

This monochrome graphics card with printer port features 100% IBM™ and Hercules™ compatibility, at a fraction of their prices. Retail Price \$155.00

\$73.00*

Special Wholesale Price



BEST BUY

Functional Clone of Hercules Graphics Card



THE™ 20MB HARD DISK

Featuring a 20MB half height IBM™ PC compatible internal disk drive, controller card, connecting cables and installation manual. Retail Price \$675.00*

Special Wholesale Price

\$395.00*

THE™ MULTI I/O

Feature for feature, **THE™** matches the AST™ I/O+ and comes up a winner, with serial/parallel and game ports standard, (a second serial port optional), a clock/calendar, RAMdisk and print spooler. Retail Price \$110.00

\$60.00*

Special Wholesale Price



BEST BUY

Functional Clone of AST™ I/O+

THE™ 2MB RAM

This Intel™ spec board will give you up to 2MB's of expanded memory. Enough to run memory intensive software such as Framework, Symphony and Microsoft™ Windows. Retail Price \$225.00

Special Wholesale Price

\$129.00*

THE™ EGA PLUS

With 256K and parallel port is ideal for high resolution graphics display of Microsoft Windows,™ AutoCAD,™ and other graphic software. IBM™ EGA compatible. Retail Price \$485.00

Special Wholesale Price

\$240.00*

*All Items Subject to Availability—Members Pay 8% Over Wholesale Prices Plus Shipping

Thompson, Harriman and Edwards Computer

THE™

Thompson, Harriman and Edwards
Computer Products Company Ltd.

THE™ PC + COMPUTER

THE™ PC + is compatible with all business, professional and personal software written for the IBM™ PC. It will also enhance your productivity with its ability to switch to an 8 megahertz clock rate, enabling you to run your software twice as fast as the IBM™ PC. THE™ PC + also comes standard with an "AT" style keyboard, correcting the inefficiencies found by IBM™ on their regular PC keyboard. 640K standard on the mother board will allow you to run memory intensive programs such as Lotus 1-2-3, DBase III and Framework without adding extra memory cards. Plenty of power, with a 135 Watt source and lots of room for expansion with 8 card slots is also standard. Base unit includes: 640K RAM, Computer with One 360K 5¼" Floppy Drive, Dual Turbo Clock Speed, 8 Expansion Slots, 135 Watt Power Supply, "AT" Style Keyboard, Full 1 Year Warranty and 45 Day Money Back Guarantee!

Retail Price \$829.00

Special Wholesale Price

\$469.00*

(Monitor Not Included)

All THE products in this special sale are offered thru

PC Network

*All prices in this ad are wholesale - PC Network Members pay wholesale + 8% and shipping.

CALL TOLL FREE B3N6

(800) 621-SAVE

In Illinois (312) 280-0002

**THE MOST INCREDIBLE
LIMITED TIME OFFER IN
COMPUTER HISTORY, FROM
THE™ and PC NETWORK...**

THE™ PC➤

**640K RAM,
IBM™ PC
compatible,
360K 5.25"
Disk Drive,
Turbo Speed,
"AT" Style
Keyboard**

Special Wholesale Price

\$469.00*

™ - Registered Trademarks of IBM/AST Research/Microsoft/Herodes/Heyes

Products Company Ltd.

Dealer Inquiries Call THE™ at (312) 642-9626
319 West Ontario Street, Chicago, Illinois 60610

COMPLETE SYSTEMS

(Optional local warranty service available in most major metro areas)

IBM PC BASE SYSTEM

IBM PC w/256K
Floppy Drive Controller
2 Double Sided Double
Density Disk Drives
Mix and Match with
your Favorite Monitor
and Printer!

\$1,159.00*

CUSTOM
CONFIGURATIONS
WELCOME



IBM PC HARD DISK SYSTEM

IBM PC w/256K
Floppy Drive Controller
1 Double Sided Double
Density Disk Drive
Half Height Hard Disk

w/20MB
\$1,499.00*

CALL FOR
LATEST IBM
ANNOUNCEMENTS

PORTABLE HARD DISK SYSTEM

256K/1 Floppy/Hard Disk



\$1,999.00* w/20MB
call for 10MB

COMPAQ™

DESKPRO SYSTEM

256K CPU/1 Floppy/Hard Disk



\$1,805.00* w/10MB
\$1,835.00* w/20MB

APPLE IIc



APPLE IIe



MACINTOSH SYSTEMS



Prices Too Low To Print!

64K IBM PC MEMORY EXPANSION KITS

Quantity Discounts Available.
Guaranteed for Life!



Set of 9 Chips **\$9.00***

DISKETTES

Guaranteed for Life!

Brand name diskettes
with 100% success rate
on all IBM models of 5.25
or 3.5 inch floppy disks.

5 1/4" DS/DD
\$8.95*
Bx. 10 Bx. 50
ea. **.59***

5 1/4" SS/DD
\$7.95*
Bx. 10 Bx. 50
ea. **.47***

3 1/2" SS/DD
Bx. 10
\$15.95*
Free Flip
& File Case

1/2 HEIGHT DS/DD DISK DRIVES



The Network buys direct and makes fantastic deals with manufacturers like MPI/Tandon/CDC/Shugart/Qume/TEAC and others to bring you fantastic prices on Name Brand drives for your PC/AT/XT/jr or Compatible.

\$85.00*
Quantity Discounts Available

INTERNAL PC HARD DISK

Low Power/Automatic Boot. Works on standard PC's and Compatibles. Includes drive/controller/cables/mounting hardware and instructions.

Full one year warranty!



10MB **\$340.00***
20MB **\$395.00***
Quantity Discount Available



\$262.00*



\$180.00* ea.

*Members pay 8% above this wholesale price plus shipping.

CALL TOLL FREE 1-800-621-S-A-V-E (orders and memberships)

In Illinois call (312) 280-0002 Validation code: B376

Customer Service and Order Status (312) 280-1567

TM & R—Registered trademarks of IBM/COMPAQ/APPLE/AST Research/LOTUS/MultiMate Int./JOMEGA. Inquiry 277

PC NETWORK

SEE WHY OVER 150,000 HAVE JOINED
MAKING US THE NATION'S #1 SOURCE
FOR EVERYTHING IN COMPUTING

- **Our 600 Page Wholesale Catalog**
Over 30,000 products priced at Wholesale + 8%. Anything you will ever need at a Consistent low price...
- **Quarterly Catalog Updates**
Your Catalog is never obsolete! Keep on top of the newest products and latest price changes.
- **The Printout**
Our newsletter gives you fantastic specials along with unbiased analysis of new products and industry trends.
- **10 Day Returns on any Hardware!**
If you don't like any hardware product—for any reason—return it for a refund.
- **1000 + Title Rental Library**
14 to 30 day rentals on over 1000 different titles. Try before you buy!!
- **Size, Strength and Stability**
The Network has over 150 employees, 45,000 square feet of office and warehouse space, inventory valued in excess of \$15,000,000 and is ranked the largest computer product supplier in the nation! Our commitment is to serve our customers and our 90% repeat business rate is proof!!
- **OnLine™ Bulletin Board**
Download "Freeware" from the nation's largest single concentration of Public Domain software available! Get tied into the nation's largest technical information network! Place orders, get tech support or contact customer service from the Network's OnLine, "not just a bulletin board but a complete customer information network."

CALL TOLL FREE
1-800-621-S-A-V-E

(Orders—Membership and Advice!)
In Illinois call (312) 280-0002

Your Membership Validation Number B376

You can validate your membership number and, if you wish, place your first money-saving order over the phone by using your VISA, MASTERCARD or AMERICAN EXPRESS. Our knowledgeable sales consultants are on duty Mon.-Fri. 8:00 AM to 7:00 PM, SAT. 9:00 AM to 5:00 PM CST.

PERSONAL COMPUTER NETWORK
320 West Ohio
Chicago, Illinois 60610

Call now...Join the PC NETWORK and start saving today!
Customer Service and Order Status (312) 280-1567
8:30 AM to 4:30 PM, Mon.-Fri. CST



PC NETWORK • MEMBERSHIP APPLICATION

YES! Please enroll me as a member in the PC Network™ and send my catalog featuring thousands of computer products, all at just 8% above DEALER WHOLESALE PRICES. I will also periodically receive "THE PRINTOUT," a special up-date on merchandise at prices BELOW even those in my wholesale catalog, and all the other exclusive, money-saving services available to Members.

376

I am under no obligation to buy anything. My complete satisfaction is guaranteed. Please check (✓) all boxes that apply:

- Basic Membership**
with optional 14 Day Evaluation.
- One-year membership for \$8
- Two-year membership for \$15 (Save \$1)
- Business Software Evaluation Library for \$25 add'l. per year—with 14-day returns
- Games Software Evaluation Library for \$10 add'l. per year
- Bill my credit card. VISA MasterCard American Express
- Special V.L.P. Membership**
with optional 30 Day Evaluation.
- One-year membership for \$15
- Two-year membership for \$25 (Save \$5)
- BOTH Business and Game Software Evaluation Libraries for \$30 add'l. per year—with 30 day returns
- *VLP members may receive advance notice on limited quantity merchandise specials

Account Number:

Exp. Date _____
mo. year

Check or money order enclosed for \$_____

Name _____

Address _____

City _____ State _____ Zip _____

Telephone () _____

My computer(s) is: IBM PC IBM-XT IBM-AT Apple II
 Macintosh Other _____

Signature _____
(Signature required to validate membership)

Features

CIARCIA'S CIRCUIT CELLAR: PARALLEL INTERFACING: A TUTORIAL DISCUSSION, PART I: BASICS by Steve Ciarcia	85
PROGRAMMING PROJECT: BUILD A SPREADSHEET PROGRAM by Jonathan Amsterdam	96
PROGRAMMING INSIGHT: ANAGRAM SOLVING IN PASCAL by Bob Keefer	113
THE DEFINICON 68020 COPROCESSOR PART I: THE HARDWARE AND OPERATING SYSTEM by Trevor Marshall, Christopher Jones, and Sigi Kluger	120
ENGINEERING ON A MICRO by Chris Pedicini	145

EVERY ONCE IN A WHILE, Steve Ciarcia forsakes the construction of a hot new device and returns to basic electronics. This month is one of those occasions. Steve believes it is important to provide basic knowledge for newcomers, and the subject for the next two months is parallel interfacing. This month's article is primarily introductory in nature but also includes application examples that might be of value to knowledgeable experimenters.

Jonathan Amsterdam's Programming Project, "Build a Spreadsheet Program," describes four implementations of a spreadsheet program written in Modula-2. The construction of a spreadsheet raises some interesting issues in the design of data structures. The designer of a spreadsheet program faces two especially difficult problems: dependency maintenance and size. These issues make for a challenging project.

If you've ever delighted in turning *excitation* into *intoxicate*, you'll be interested in "Anagram Solving in Pascal" by Bob Keefer. This Programming Insight discusses how to use a probability table to decipher anagrams. Poet John Dryden called the practice "the torturing of one poor word ten thousand ways."

Next, Trevor Marshall, Christopher Jones, and Sigi Kluger look at the hardware and operating system of the Definicon 68020 Coprocessor in the first part of a two-part article. BYTE readers first learned of Definicon Systems Inc. with the introduction of the company's DSI-32 coprocessor board (August 1985 BYTE). This board plugged into an IBM PC slot and featured a National Semiconductor 32032 microprocessor with floating-point unit, memory management chip, and 256K bytes to 1 megabyte of RAM. Now, by special arrangement with BYTE, Definicon has designed a Motorola 68020-based version of this board, allowing 68020 hardware and software development on the IBM PC, XT, AT, and compatibles at an affordable price. The board includes the MC68020 processor and the 68881 floating-point chip, and it will accommodate the 68851 PMMU (paged-memory-management unit) when it becomes available. It contains 1 megabyte of fast RAM.

The last feature in our lineup is related to this month's Engineer's Toolbox theme. In "Engineering on a Micro," Chris Pedicini takes us on a walking tour of Truss2, a BASIC program that helps engineers in the design of truss-type structures.

Now with
Freelance™



VideoShow MAKES Presentations

With VideoShow you'll make the best presentations of your career.

VideoShow is the only complete hardware and software presentation system available today. VideoShow:

Makes Your Presentations Powerful

Use 1000 colors to brighten your images... hundreds more than with any other PC-based system. Plus 5 times better resolution. Add VideoShow's dynamic visual effects and you are guaranteed high impact and professional quality.

Makes Presentations Easy

Select from a variety of software, and use your IBM® PC or compatible to create or update any chart, graph, diagram, or illustration in minutes. Even if you've never used a computer before and

can't draw a straight line. All you do is fill in the blanks.

Makes Any Kind of Presentation

VideoShow lets you use any color monitor or video projector. Plus, you can get slides, overheads, or hardcopy. All in 1000 brilliant colors.

VideoShow Makes Sense

At \$3150* it pays for itself after just a few presentations. And you get the superior quality previously available only from expensive services.

VideoShow Puts You in Control

No longer will your presentations be a terrific struggle. They'll just be terrific!

Find out about it. Call 1-800-556-1234, Ext. 234. In Calif., call 1-800-441-2345, Ext. 234.

VideoShow™
from General Parametrics, Berkeley, CA



*Suggested retail price for VideoShow 150.
IBM is a registered trademark of International Business Machines Corporation.

PARALLEL INTERFACING: A TUTORIAL DISCUSSION PART 1: BASICS

BY STEVE CIARCIA

*An introductory article concentrating on
non-LSI chip parallel interfacing*



Recently I was thumbing through some of my old articles. The reason wasn't nostalgia; instead, I was doing a historical review of the topics. It's too easy to fall into the newest and best craze all the time, so I have to be continually aware that I allocate a portion of my projects to basic electronics.

While an IBM PC bus-compatible image-enhanced Doppler radar interface might make a wonderful Circuit Cellar project, some converts to our electronic religion wouldn't have the slightest idea what I'm talking about. It has been a long time since I've presented anything specifically about parallel interfacing. During the intervening time, I've published many schematics incorporating the same—as well as more sophisticated—circuitry as what I'm about to describe.

Unfortunately, it is often difficult to absorb basic concepts from nonspecific presentations. Before subjecting you to more mad scientist projects, like those planned for the fall, I thought I'd take a quick break and reintroduce parallel interfacing. Rather than making it a pure introductory-level article, however, I'll concentrate on application examples that might be of value to knowledgeable experimenters as well.

Beyond a fast review of TTL connection

basics and MSI/SSI-level parallel I/O port circuits, I'll include the specialized interface devices that are now more cost-effective to use and discuss the differences among them. I hope that you'll then know when to use a parallel input/output or a peripheral interface adapter.

This month's article is primarily introductory in nature and concentrates on non-LSI chip parallel interfacing. The circuit examples include a parallel keyboard and a Centronics printer interface. Next month, I'll describe the various PIAs and programmable peripheral interfaces in general use. Specific circuit examples include an LSI version of the same keyboard and printer interface and a dual PIA card for the Apple II, configured for control and analog data acquisition.

THE BASICS

A typical microcomputer system may have components from several different logic families: Microprocessors and interface adapters are often NMOS or the newer CMOS, which contains both negative-

(continued)

Steve Ciarcia (pronounced "see-ARE-see-ah") is an electronics engineer and computer consultant with experience in process control, digital design, nuclear instrumentation, and product development. The author of several books on electronics, you can write to him at P.O. Box 582, Glastonbury, CT 06033.

channel and positive-channel transistors and consumes significantly less power.

Most of the better-known microprocessors are NMOS: 8080A, 8086, 6502, 6809, and others. Some newer

ones are CMOS: 65C02, 68020, HD64180, 80C85, and others. The gates, latches, and buffers—the "glue" in most systems—are usually from the TTL family because it can effectively drive the high capacitance of a typical microcomputer system bus.

TOTEM-POLE OUTPUT

Several subfamilies are found within the TTL family: LS, or low-power Schottky; S, or Schottky; F, or fast; ALS, or advanced low-power Schottky; and others. Various types of these circuits are equipped with totem-pole, open-collector, or three-state outputs.

The totem-pole output is the standard type, found in most gate, counter, multiplexer, and decoder chips. Its name derives from the fact that it consists of two transistors (or sometimes Darlington pairs of transistors) stacked one atop the other, like a totem pole. The output is located between the two transistors. When the upper transistor is on, the output is high; when the lower transistor is on, the output is low. Figure 1a shows the circuit diagram for a typical totem-pole output. One advantage of this output is that the low driving-source impedance enables it to drive highly capacitive loads without significantly degrading switching times.

The rest of the circuitry in the IC is designed so that both transistors in the totem pole are not on at the same time, except during transitions between logic levels. During transitions, the transistors are on simultaneously for a very brief period of time. When that happens, a direct connection is made, via the transistors, between ground and +5 volts. The result is TTL's notorious *noise spike*. This is why all those noise-decoupling capacitors are needed with TTL logic.

Photo 1 shows an abnormal pulse produced by such a noise spike. Photo 2 shows jitter on the leading edge of a TTL pulse, another symptom of poor noise decoupling.

OPEN-COLLECTOR OUTPUT

We sometimes might want to connect the outputs of two or more circuits together, such as when several system components are driving a common data bus. This can be accomplished through the use of open-collector or three-state outputs.

Figure 1b shows a typical open-collector output: It is the same as figure 1a except that the upper transistor in the totem pole is missing, and the collector of the lower transistor is open, that is, unconnected to anything except the output pin. Because no active circuit elements are con-

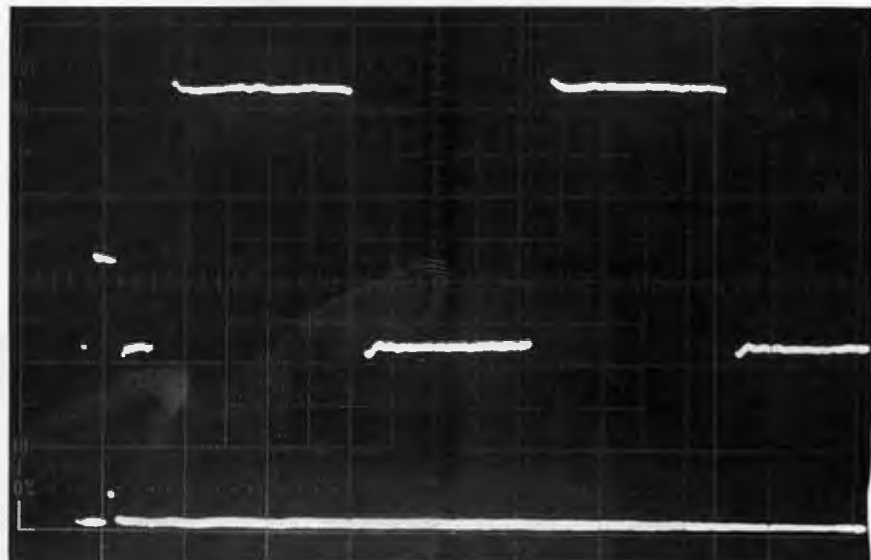
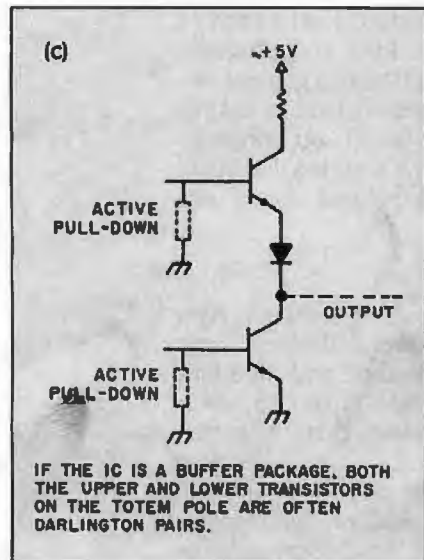
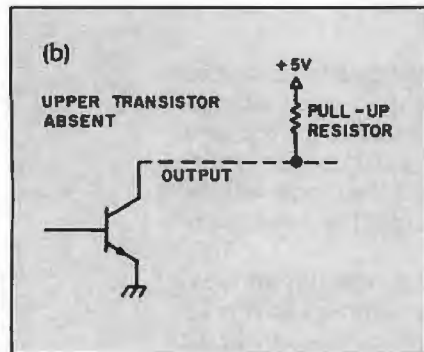
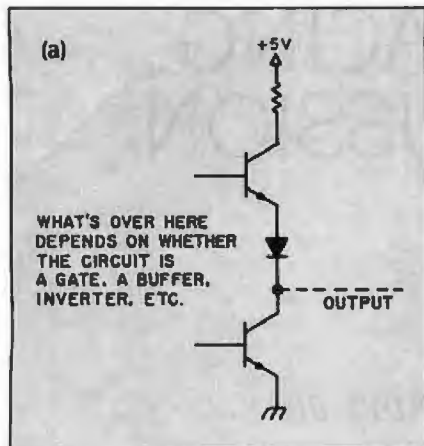

Figure 1: (a) Totem-pole output; (b) open-collector output; (c) three-state output.

Photo 1: At the extreme left of the upper scope trace is an abnormal pulse produced by the positive-going noise spike shown immediately below. (Photo courtesy of Tektronix Inc.)

necting the output with the positive supply, this type of output can go high only if something external, usually a pull-up resistor, forces it there.

While open-collector outputs permit many circuit elements to be bused together, the lack of active components on the "high" side generally degrades the switching time. Use of the pull-up resistor also results in leakage currents through that resistor. Switching time can be improved by reducing the value of the resistor, but this approach increases the leakage currents.

THREE-STATE OUTPUT

The third common output option is shown in figure 1c: three-state (or tri-state). This type of output behaves like a normal totem-pole output when the active pull-down circuits are "off." When the pull-downs are "on," both the upper and lower output transistors are off, their bases held near ground. The output is now in its third, high-impedance, state.

This type of output combines the high switching speed of the totem-pole output with the common-bus capability of the open-collector output. There is a possibility that the totem-pole output will consist of Darlington pairs rather than single transistors, especially if the logic element is a buffer or line driver.

Open-collector and three-state outputs are most commonly used when many outputs are bused together, like the data and control buses of a microcomputer system. In photo 3, the fainter trace is a single abnormal pulse produced by bus contention. Two three-state circuits are simultaneously active on the bus, one attempting to switch high, and the other attempting to switch low.

PARALLEL KEYBOARD INTERFACE

A microcomputer frequently consists of a microprocessor, memory (both RAM and ROM/EPROM), I/O peripheral devices like disk drives and printers, and the miscellaneous components needed to "glue" (or interface) everything else in the system together so they can communicate with each other. In the discussion that follows, handshaking refers to the ability of the microprocessor and the

peripheral device to coordinate data transfers by signaling each other that an action is completed.

A good example of an essential hardware interface is the connection of a keyboard to a microcomputer bus. For the purposes of this part of the discussion, I am using memory-mapped input. When a microprocessor with separate ports for input and output, like the Z80, is used, input and output can be either through directly

addressed ports or "mapped" into available memory space.

Figure 2a shows how a typical parallel ASCII keyboard might be connected. A 74LS138 three-line-to-eight-line decoder, IC1, is partially enabled by a three-input (74LS10) NAND gate, IC2a, whose inputs are connected to address lines A15, A14, and A13 on the bus. An active-high system clock signal drives G1, pin 6.

(continued)

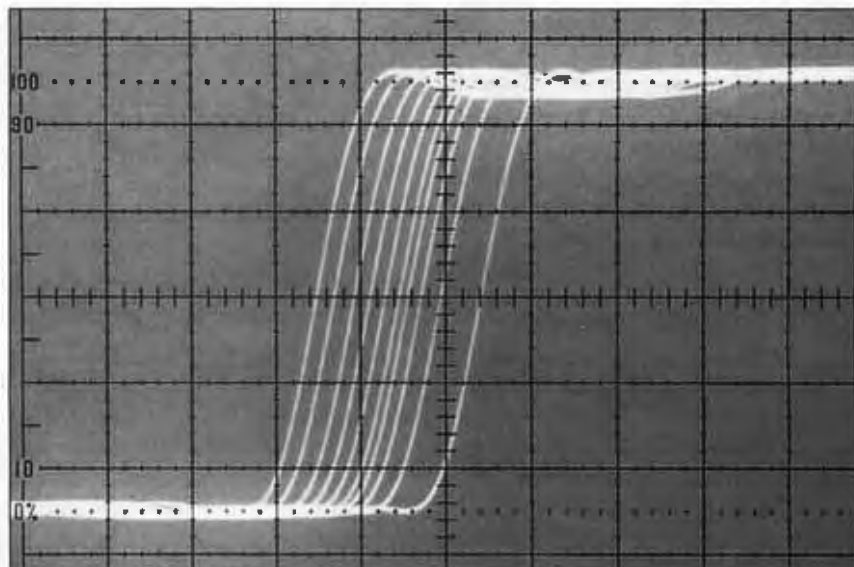

Photo 2: Jitter on the leading edge of a pulse caused by poor noise decoupling. (Photo courtesy of Tektronix Inc.)

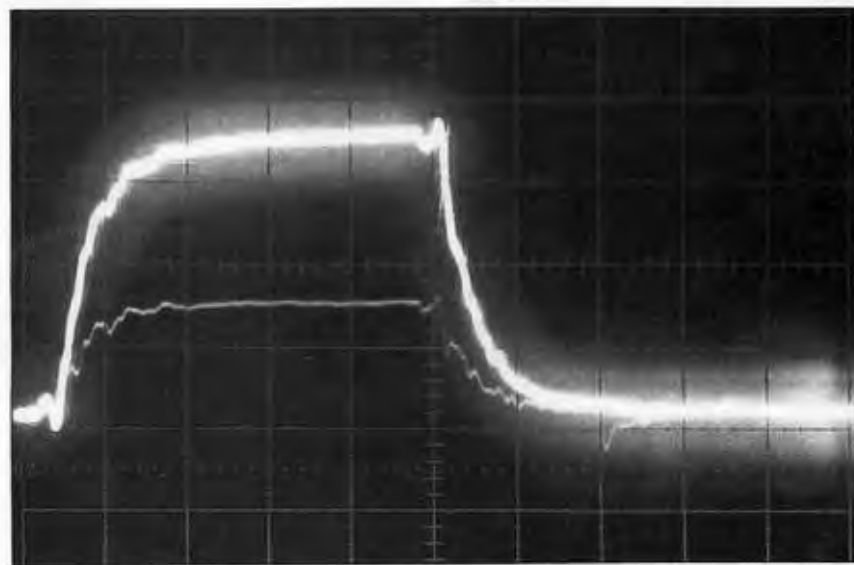

Photo 3: The fainter trace is a single abnormal pulse produced by bus contention between two three-state circuits; one is attempting to switch high, and the other is attempting to switch low. (Photo courtesy of Tektronix Inc.)

With the three address inputs of IC1 attached to address lines A12, A11, and A10, the decoder will divide the top 8K bytes of a 64K-byte address range into eight 1K-byte blocks. We can further divide one of these 1K-byte ranges into eight 128-byte blocks by adding a second 74LS138 decoder, IC3. One of IC3's decoded outputs is used in conjunction with inverter IC5a (74LS04 or 74LS05, typically) and OR gate IC6a (74LS32) to gate the keyboard data, latched by the keyboard data, latched by the keyboard

clocks a 74LS74 latch, IC7a, setting its "Q" output high. The "Q" output is buffered and connected to the high bit (D7) of the data bus. The microprocessor determines whether or not a key has been pressed by reading one of the 128 addresses decoded by output Y0 of the decoder.

The microprocessor reads the address, then tests the high bit to see if it is set. If the high bit is not set, the keyboard is read again. When the microprocessor determines that a key has been pressed, it clears the high bit by referencing one of the addresses decoded by output Y1 of the decoder. Output Y1 clears the 74LS74 latch that drives the high bit.

In 6502 assembly language, the process might look like the segment shown in listing 1. What is shown there is an example of polled input. The microprocessor polls the keyboard to determine if any new data is available.

An alternative method is interrupt-driven input, where the microprocessor is interrupted by the keyboard when new data is available. Figure 3 shows the circuit in figure 2a modified for an interrupt-driven input. The only change is the addition of a 74LS05 open-collector inverter, which drives

Listing 1: An example of polled input.

```

FETCH LDA KEYBD    ; read keyboard address
BPL FETCH          ; high bit clear, read keyboard again
AND #$7f           ; mask high bit, low ASCII now in A-REG
BIT CLEAR          ; clear the high bit by resetting latch
    
```

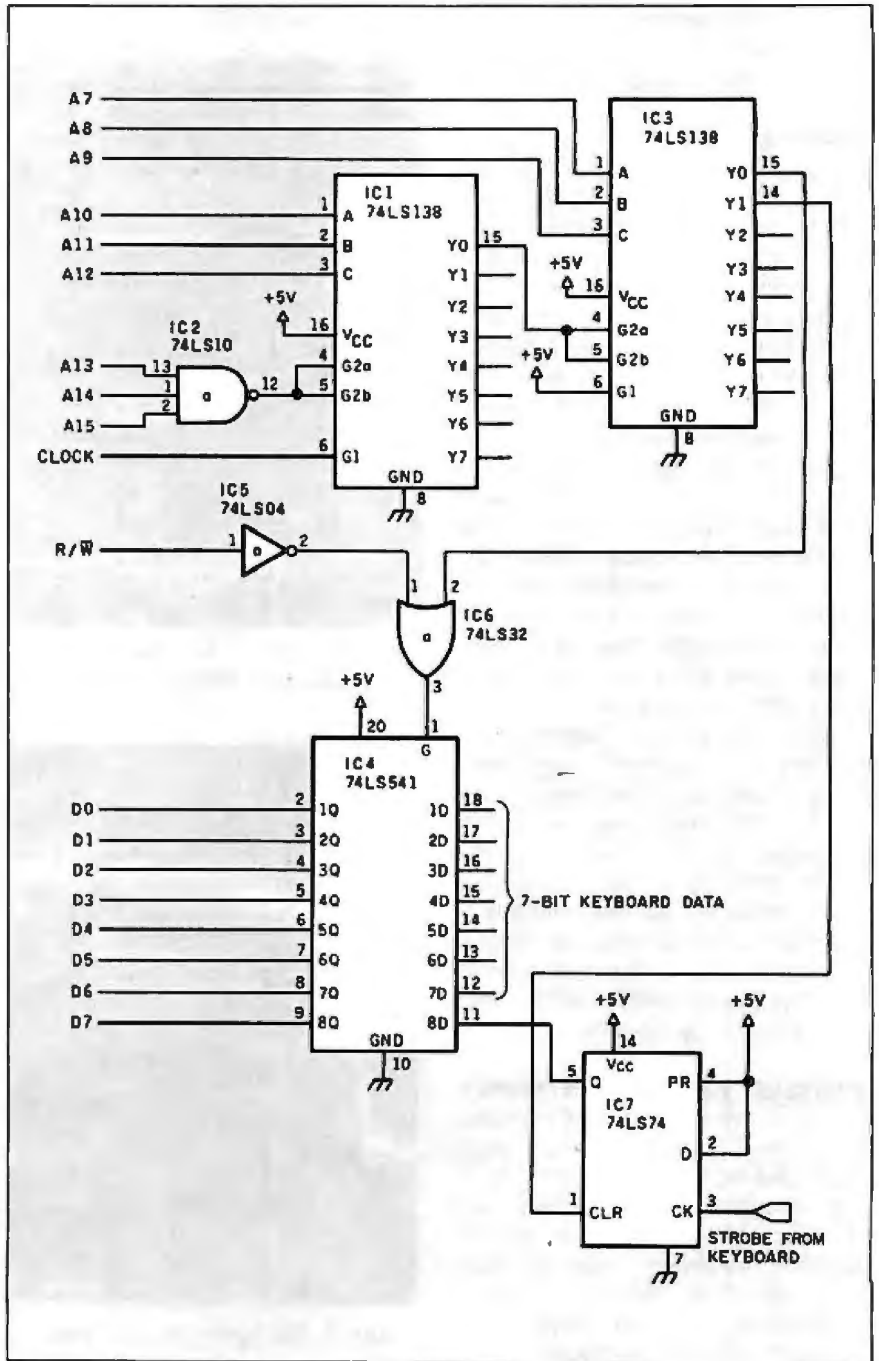

Figure 2: (a) Keyboard buffer input using buffer package (74LS541);

the interrupt input of the microprocessor. The inverter's input is controlled by the "Q" output of IC7a. This inverter and IC5a can be from the same package, in which case a pull-up resistor, typically 2 to 3 kilohms, should be added to the output of IC5a. For simplicity, we'll assume that the microprocessor has a single active-low interrupt input that is shared

by many interrupt sources, each of which drives it with an open-collector output. (A discussion of how various microprocessors and operating systems handle interrupts could fill a large book.)

Note that the high bit is still controlled by the latch. This is so the microprocessor can determine that the keyboard is the source of the in-

terrupt by polling. The 6502 assembly language code for doing this might be similar to that shown in listing 1.

PARALLEL PRINTER INTERFACE

Another common peripheral interface is for a Centronics-protocol parallel printer. We can add this capability to the circuit in figures 2 and 3 by making the additions shown in figure 4. Although this protocol has no formal specification, the timing diagrams in the documentation for the Centronics 737 printer call for data to be stable for a minimum of 1 microsecond, then a minimum 1-microsecond-wide active-low DATA strobe is sent from the computer to the printer. The output data must remain stable for a minimum of 1 microsecond after the rising edge of the DATA strobe.

When the printer is ready for more data, it sends a minimum 1-microsecond active-low ACKnowledge strobe to the computer. Although additional signals are defined by the protocol (BUSY, DEMAND, ON-LINE, etc.), they aren't often used for interfacing printers with microcomputers. The interface was developed by Centronics for interfacing printers with larger computers before the micro-computer as we know it today even existed. The large number of signals defined allowed relatively easy interfacing to a wide variety of equipment. Most of these signals, however, are not needed for a usable microcomputer interface.

In the circuit of figure 4, the rising edge of the Y2 output of decoder IC3 clocks a 74ALS574 latch, IC9, and triggers IC10a, half of a dual one-shot. IC10a generates an output pulse 1 microsecond wide. The trailing edge of IC10a's output triggers IC10b, which provides the active-low DATA strobe to the printer.

If we need to be able to poll the printer port to determine if it is the source of an active interrupt, IC7b is clocked by the ACK from the printer. It drives IC5c, which generates an interrupt signaling that the printer is ready for more data. IC7b also drives the input of IC11a, a 74LS125 three-state buffer enabled by one of the decoded outputs of IC3.

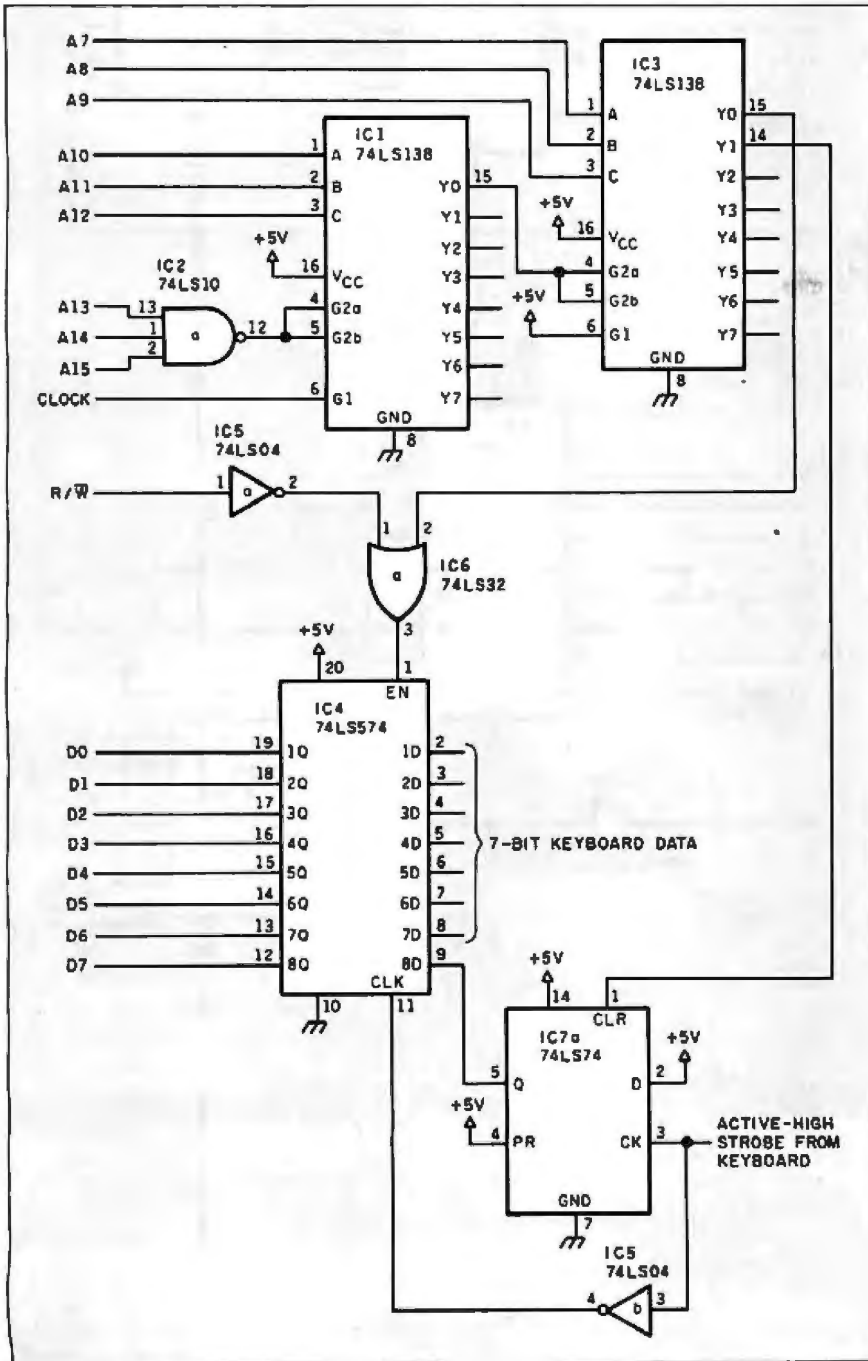

(b) keyboard input using octal latch package (74ALS574).

(continued)

We can eliminate interrupt generation by using polled output.

IC1a's output drives the high bit on the data bus. The microprocessor can poll the address of IC1a to determine whether the printer is the source of an interrupt. IC7b is reset, and the interrupt thus cleared, by another of IC3's decoded outputs.

We could also eliminate the interrupt generation, and IC7b, by using polled rather than interrupt-driven output. In general, multitasking systems use interrupt-driven I/O, while single-tasking systems will frequently rely on polled I/O.

The interfaces just described use memory-mapped I/O address decoding. (Each output of IC3 is active for a range of 128 addresses rather than a single address. It is seldom necessary to completely decode unique addresses for I/O functions.) Some microprocessors, like the Z80 and the newer HD64180, have I/O "ports" whose locations are not part of the microprocessor's defined memory range but instead lie within a special I/O-only addressable space.

The Z80 accesses 64K (65,536) bytes of memory plus 65,536 I/O ports. The HD64180 accesses 512K bytes of memory plus 65,536 I/O ports. Both can use either the ports or memory-mapped locations for communications with the outside world. Other microprocessors, like the 6502 and 6809, lack the I/O-specific addressing and must perform all I/O within the bounds of the 64K-byte memory-mapped address range.

Figure 5 shows the printer output port on the SB180 system described in the September and October 1985 Circuit Cellar project. The SB180 uses a 74LS374 octal latch for data output and the two "D" latches from a 74LS74 package to coordinate handshaking, and it uses an output port rather than memory mapping. The hardware differences between it and the interface described in figure 4 dic-

(continued)

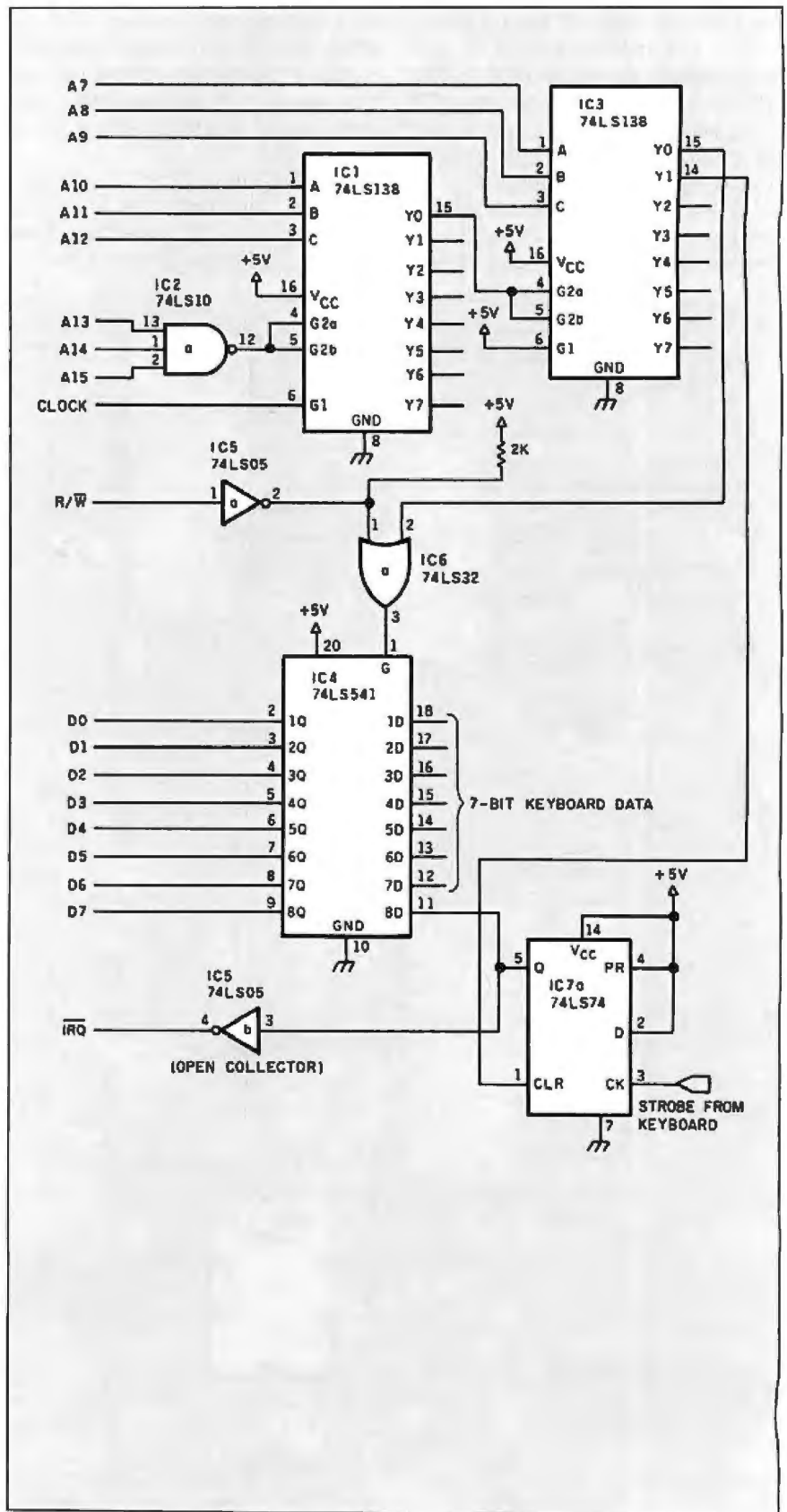

Figure 3: Interrupt-driven keyboard input using buffer (74LS541).

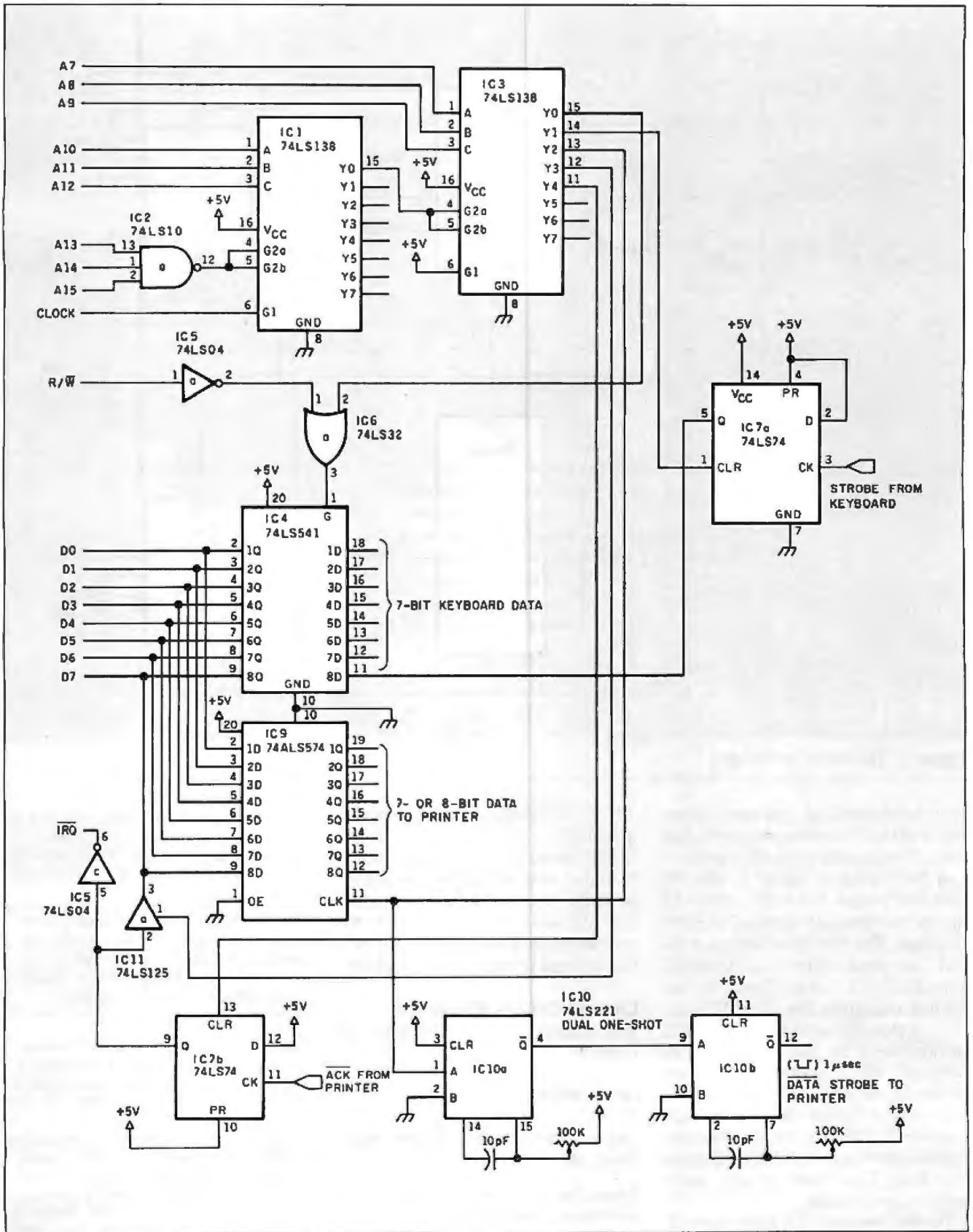

Figure 4: Keyboard and printer using 74ALS574 octal latch.

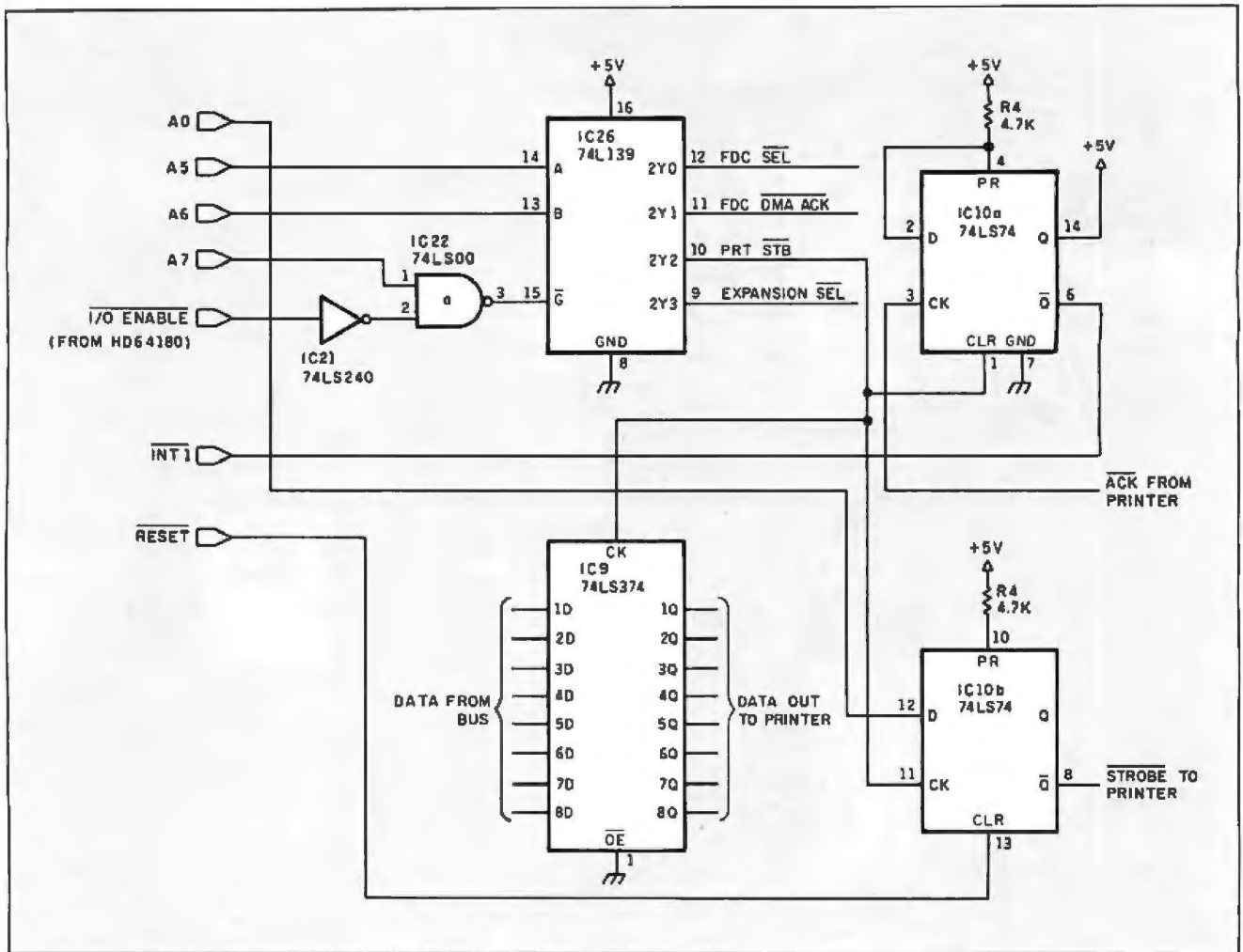

Figure 5: The SBI80 printer port.

tate corresponding software differences when controlling the ports, but there is relatively little difference.

In the circuit in figure 5, the I/O ENABLE strobe from the HD64180 package drives inverter IC21, from a 74LS240 package. The inverter's output controls one input of the 74LS00 NAND gate, IC22. IC22's other input is connected to address line A7. IC22's output controls the (active low) ENABLE of decoder IC26, half of a 74LS139 package. IC26's address inputs are driven by A6 and A5.

The effect is that when A7 is high and the I/O STROBE low, the decoder divides the upper 128 I/O addresses into four 32-address groups, each with its own strobe.

The strobe active for addresses C0 through DF is the PRINTER strobe. The PRINTER strobe resets IC10a, a

74LS74 clocked latch, and clocks IC9, a 74LS374 octal latch, and IC10b. Address line A0 drives the data input of IC10 and determines the level of the STROBE (active low) to the printer. The ACK (active low) strobe from the printer clocks IC10a, generating INT1 (active low) to the microprocessor.

CIRCUIT CELLAR FEEDBACK

This month's feedback begins on page 54.

NEXT MONTH

I'll discuss some of the more specialized components and their application. ■

Special thanks to Frank Kuechmann for his contributions to this project.

There is an on-line Circuit Cellar bulletin board system that supports past and pres-

ent projects. You are invited to call and exchange ideas and comments with other Circuit Cellar supporters. The 300/1200-bps BBS is on-line 24 hours a day at (203) 871-1988.

To be included on the Circuit Cellar mailing list and receive periodic project updates and support materials, please circle 100 on the Reader Service inquiry card at the back of the magazine.

Editor's Note: Steve often refers to previous Circuit Cellar articles. Most of these past articles are available in book form from BYTE Books, McGraw-Hill Book Company, P.O. Box 400, Hightstown, NJ 08250.

Circuit Cellar, Volume I covers articles in BYTE from September 1977 through November 1978. *Volume II* covers December 1978 through June 1980. *Volume III* covers July 1980 through December 1981. *Volume IV* covers January 1982 through June 1983. *Volume V* covers July 1983 through December 1984.



640 x 350 16 COLOR



EGA PAINT



GEM



FLIGHT SIMULATOR



PAINT BRUSH



Auto CAD

NO MORE Low-End Graphics Adapters.

Why Settle for Less?

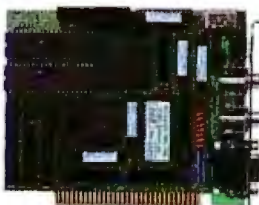

IBM sets the standards for Monochrome, Color/Graphics and the Enhanced Graphics Adapter. Hercules sets the Monochrome

Graphics standard. And the MegaGraph-Plus simply redefines the standard for what the Graphics Adapter is supposed to be: Monochrome text, Hercules graphics, color graphics, enhanced graphics. And most importantly . . . No software driver patches required.

Fully Compatible

You can run almost all software from your early investment. Including Flight Simulator, Pin Ball, Jet and Lotus 1-2-3 Version 1A.

And it will still run all the business software packages written for IBM Enhanced Graphics Adapter (EGA). Examples include Auto CAD, IBM Drawing Assistant, Gem Draw, Microsoft Window, Word & Chart, Lotus 1-2-3 and Symphony, Dr. Halo, PC Paint Brush, EGA-Paint and many, many more.

ATTronics is dedicated to the technical excellence of computing devices. To find out more about ATTronics and our super-high performance ATI-1000 & ATI 2000 AT system compatible boards call or write:

IBM, Hercules, Flight Simulator, Pin Ball, Jet, Lotus 1-2-3 Version 1A, Auto CAD, Gem Draw, Window, Word & Chart, Symphony, Dr. Halo, PC Paint Brush, EGA Paint, Quadram and STB EGA+ are all registered trademarks of their respective companies.

Features

	ATTronics MegaGraph +	Quadram EGA +	IBM EGA	STB EGA +
Half size, fits in any slot of PC/XT/AT	X	X		
EGA compatible	X	X	X	X
CGA compatible	X	(1)	(2)	(2)
MDA compatible	X	X	X	X
Chip count	24	29	86	40
Hercules compatible 720 x 348 graphics	X	X		
No Software Patches required	X		X	X
Boot from:				
- Flight Simulator	X			
- Pin Ball	X			
- Jet	X			
Runs Lotus 1-2-3 version 1A:				
- Hercules mode	X	(1)		
- Color mode	X	(1)		
Two Video Jacks	X	X	X	
Display Memory	256K	256K	64K	256K
Light Pen connector	X	X	X	X
List Price	\$549	\$599	\$624	\$595

(1) Needs software driver patches.

(2) Compatible only to the BIOS level, but not the hardware level. Will not be compatible with most games software



ATTronics International Inc.
491 Valley Way
Milpitas, CA 95035
(408) 943-6629 TLX: 510-600-6093

Mega Graph PLUS

Inquiry 32

The database used now be used

Introducing dBASE III PLUS™

The PLUS stands for all the improvements we've made to the world's number one selling database management software.

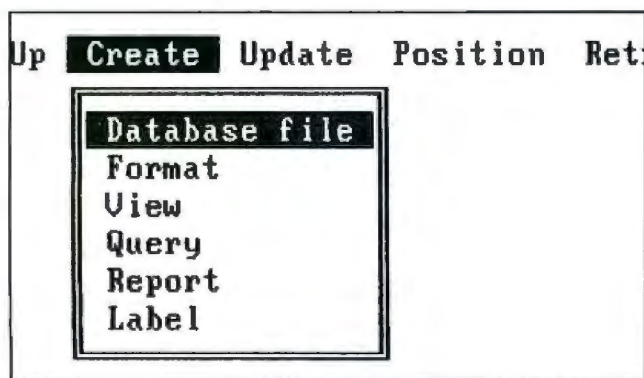

The Assistant helps beginning users accomplish day-to-day data management tasks without programming.

Mind you, dBASE III PLUS still has the powerful dBASE programming language, dot prompt, and all the features that have made dBASE III the standard of the industry.

We've simply raised the standard.

And just as dBASE III introduced more power to the people, our new dBASE III PLUS introduces more people to the power.

People who aren't all that crazy about programming, for example.

The Assistant feature in dBASE III PLUS now provides them with new easy-to-use pull-down menus for creating, using and modifying multiple databases.

So now anyone who can manage a simple cursor can manage day-to-day data management tasks. Without programming.

And by using our new Screen Painter,

anyone can create custom screens. Without programming.

Or using View, access related information in several databases at one time. Without programming.

With Advanced Query System, another new non-programming feature, any user can build complex queries just by selecting from the dBASE III PLUS pull-down menus.

For rapidly creating entire programs, there's even a new Applications Generator.

And for all those who wish to learn to program, the Assistant can be of further assistance. By teaching you programming commands as you go along. Without disrupting your work flow.

These are only a few of the dBASE III PLUS features that can help new users quickly get up to speed. And experienced users quickly increase their speed. (Sorting, for example, is up to two times faster and indexing up to ten times faster than dBASE III.)

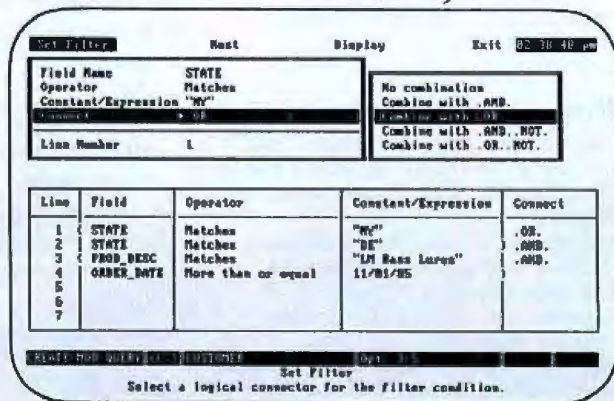

Advanced Query System lets you set up and answer complex queries without programming.

by more people can by more people.

And it's the fastest way to network those users, too. Because now, true multi-user capabilities for local area networking are built right in.

dBASE III PLUS can also help put developers in the fast lane. With a new Data Catalog and more than 50 new commands and functions. Plus code encryption and linking, improved debugging aids, assembly language calls and much more.

For the name of the Ashton-Tate® dealer nearest you,* call 800-437-4329, Extension 0282**

And get your hands on dBASE III PLUS. It's the software more people can look forward to using. Inquiry 28

*Upgrades are available to all dBASE III owners. **In Colorado call (303) 759-4900, Extension 0282. Requires IBM® PC or 100% compatible. Trademarks/owners: Ashton-Tate, dBASE III PLUS/Ashton-Tate; IBM/International Business Machines Corp. © Ashton-Tate. All rights reserved. 1986.

ASHTON·TATE

dBASE III PLUS

The data management standard.



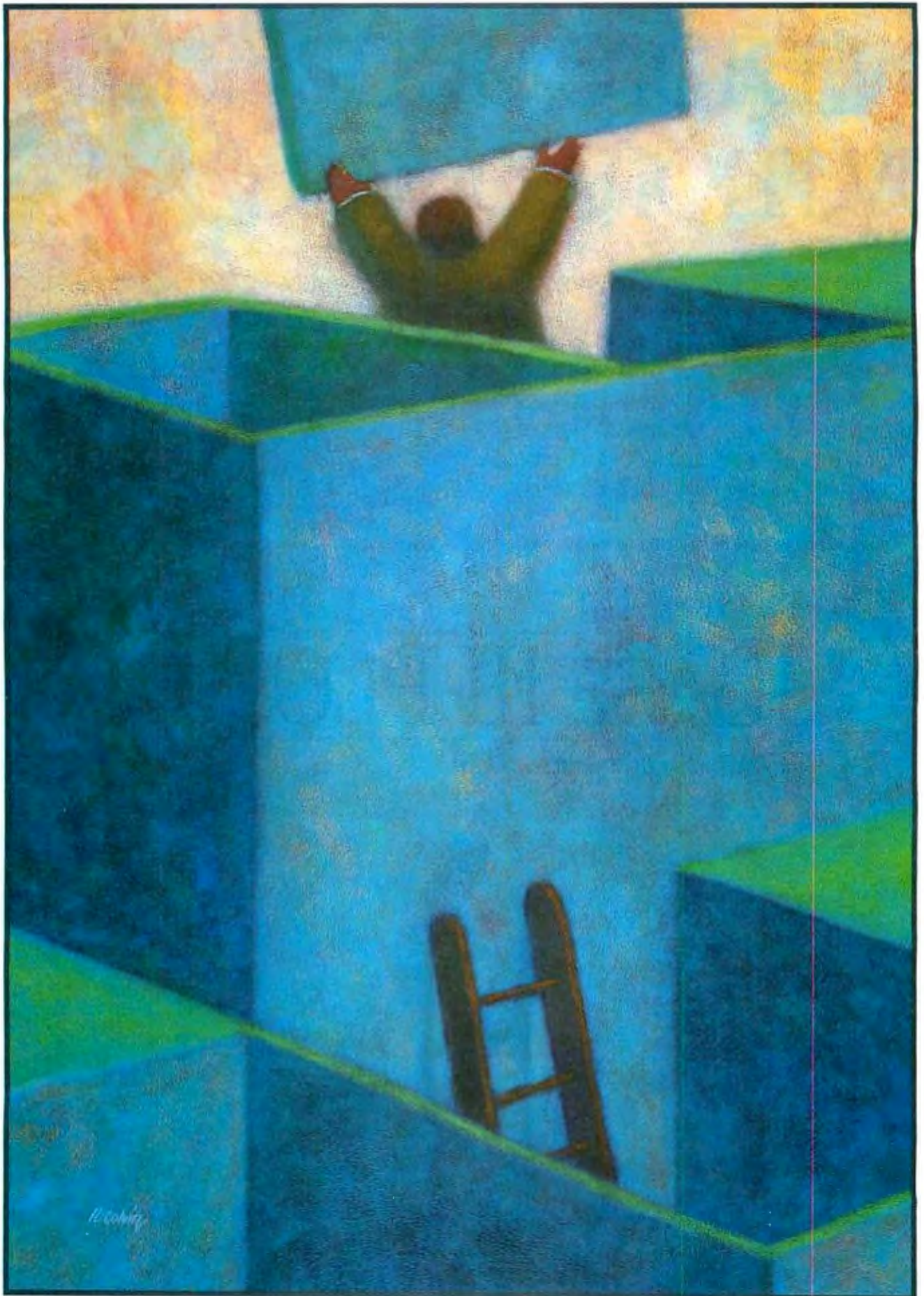

BUILD A SPREADSHEET PROGRAM

BY JONATHAN AMSTERDAM

Four implementations of a spreadsheet in Modula-2

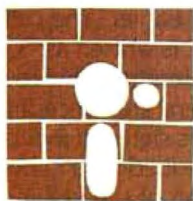

The construction of a spreadsheet program raises some interesting issues in the design of data structures. These issues make for a challenging Programming

Project. A spreadsheet is, of course, a program that provides you with a large grid of cells into which you can stuff numbers and formulas. A cell that contains a number causes the program to display that number; a cell that contains a formula causes the program to display the formula's value and automatically recalculate the formula whenever any cell on which it depends is changed.

A spreadsheet, then, is a special case of what we might call a dependency maintainer: It keeps track of dependencies between cells, and it updates affected cells whenever data is changed. In a spreadsheet, a formula that mentions cell A sets up a dependency between cell A and the cell containing the formula, cell B. Whenever A changes, the spreadsheet recalculates the formula and updates B's value. But that dependency goes only one way—when B changes, A is not affected.

I go into this detail because dependency maintenance is one of two difficult problems one faces when designing a spreadsheet. The second problem is size. Spread-

sheet users want bigger and bigger spreadsheets, and the designer must aim to please.

For this project, I've written a spreadsheet program on an Apple Macintosh in Modula-2. [Editor's note: The source code for this spreadsheet is available in a variety of formats. See pages 459-461 for details.]

USING THE SPREADSHEET

The user interface to my spreadsheet program is far from being the state of the art. In fact, it is downright primitive. The screen of my spreadsheet is divided into four sections (see figure 1). The top line of the screen is reserved for messages the spreadsheet displays. The second line displays the formula contained in the current cell. The third line displays the row and column of the current cell and is where you enter commands.

The command structure of the spreadsheet is simple. Each command begins with a single letter. The V command is used to enter a value into the current cell. Entering "V3.14" will put 3.14 into the current cell. You can also use a formula with the V command: V2.67+ 0.47 will give you the same result as entering V3.14. Similarly, the F

(continued)

Jonathan Amsterdam is a graduate student at the Massachusetts Institute of Technology Artificial Intelligence Laboratory. He can be reached at 1643 Cambridge St. #34, Cambridge, MA 02138.

I haven't provided commands for saving, restoring, or printing a spreadsheet.

command is used for entering a formula into the current cell.

Since the F and V commands access only the current cell, it's important to be able to choose the current cell. You can do this in two ways. Typing U, D, L, or R will change the coordinates of the current cell to reflect a relative move of up, down, left, or right from the present current cell. For example, if the coordinates of the current cell are row 3, column 5, entering U will cause the cell at row 2, column 5, to become the current cell. Another way to choose the current cell is to enter a cell's coordinates directly. To choose the cell at row 3, column 5, for example, you enter "[3,5]."

When the spreadsheet starts up, the upper left-hand corner of the display contains cell [1,1]. You can set a new

corner with the N command. For example, "N[90,217]" will put cell [90,217] in the upper left-hand corner, with cell [90,218] to its right, and so on.

Another command, C, lets you copy the current cell's contents (both formula and value) to another cell. For example, "C[2,17]" will copy the current cell to cell [2,17].

All the columns of my spreadsheet have the same width. You can change the column width by using the W command. For example, "W18" sets the width to 18 spaces. If a number is too large to fit in a column, it's truncated.

You can also change the precision (number of decimal places) displayed with the P command, and you can clear the contents of the entire spreadsheet by entering K (for "Klear"; a misspelling forced by my choice of C for "Copy").

Finally, three important commands complete the set. The A command sets the spreadsheet on automatic, which is the default mode: Any change to a cell immediately causes a recalculation of the spreadsheet. The M (for manual) command turns off the automatic mode, requiring you

to give the explicit command "!" each time you want to recalculate.

I haven't provided commands for saving, restoring, or printing a spreadsheet. Such features should not be difficult to add, but they are outside the scope of this article.

SPECIFYING FORMULAS

The simplicity of commands also carries over to formulas. A formula in the spreadsheet can contain numbers, references to cells, the four standard arithmetic operators, relational operators, and conditional expressions. The syntax of formulas is most easily explained by examples. A formula like $1+3*4/5$ represents the obvious mathematical expression. All standard precedence rules are obeyed, so the program would first multiply 3 by 4, divide by 5, and then add 1.

References to cells can be absolute or relative. An absolute reference looks just like the cell references mentioned earlier: The cell at row 3, column 8, is written as [3,8]. In a relative cell reference, the row and column numbers are preceded by a plus or a minus sign and indicate the amount to be added to or subtracted from the position of the cell in which the formula resides. So, for example, if a formula in cell [3,8] includes the reference [+3,-1], the referenced cell is [6,7]. If the referenced cell is on either the same row or column, a signed 0 can be used. For example, the formula that adds the two cells stacked directly above the formula cell is [-1,+0] + [-2,+0]; using -0 instead of +0 would work just as well. Also, you can combine the relative and absolute notations in a single cell reference; the cell that is three rows down from the formula cell's row and in column 12, for example, is referenced [+3,12].

You can compare cell values using the IF expression and relational operators. An IF expression consists of the word IF followed by a condition and two other expressions, separated by commas. If the condition is true, the first expression is evaluated; if false, the second. An IF expression might be used to prevent division by 0: A formula that computes the ratio of cell [1,2] to [1,3] when [1,3] is non-zero, but displays 0 otherwise, could

Syntax Error: [1,1]+											
[1,1]+											
[6,2]											
	1	2	3	4	5	6	7	8	9	10	11
1	1	10	20								
2	2										
3	3										
4	4										
5	10	\$\$SYN									
6											
7											
8											
9											
10											
11											
12											
13											
14											
15											
16											

Figure 1: The screen of the spreadsheet consists of four major components. At the top is a line reserved for messages displayed by the spreadsheet program. Beneath that, a line displays the formula contained in the current cell. The third line displays the row and column of the current cell. The fourth and largest component is the spreadsheet proper—the grid of cells.

be written as $IF [1,3] = 0, 0, [1,2]/[1,3]$. Also, IF expressions can be nested. For example, if you want to display a different value depending upon whether cell [1,1] is negative, 0, or positive, you could write $IF [1,1] < 0, -1, IF [1,1] > 0, 1, 0$. This formula results in -1 if [1,1] is negative, 1 if the cell is positive, and 0 if the cell is 0.

Although only a few constructs are contained in the formula language, they interact in a regular way to produce a surprising variety of expressions. An IF expression can appear as an operand, as in $3 * IF [1,1] > 0, 1, 0$. This will yield 3 if [1,1] is greater than 0 and 0 if it isn't. Relational expressions yield 1 if they are true and 0 if false, so the above could be expressed more concisely as $3 * ([1,1] > 0)$. The parentheses are necessary to ensure that the relational expression is evaluated before the multiplication.

This regularity breaks down in one important place, however. Although it would be useful to allow cell references like [2,3], [1], such expressions are disallowed: A cell reference can contain only constants, optionally preceded by plus or minus.

IMPLEMENTATION

I now want to consider the uninteresting parts of the spreadsheet program, namely, everything but the spreadsheet data structure itself. Most of these—the input of commands, the handling of the display, and so on—are too straightforward to deserve mention, but I would like to discuss a couple of important points. The first has to do with formulas. Ideally, the parsing of a formula should be separated from its evaluation, as it has been in my earlier projects ("Context-Free Parsing of Arithmetic Expressions," August 1985; "A SIMPL Compiler, Part 1: The Basics," December 1985). The parser should produce a parse tree, which is then interpreted by an evaluator. The problem in doing that for a spreadsheet is space: a parse tree occupies considerably more storage than the equivalent string. In my spreadsheet, formulas are represented as strings, and the parser and evaluator are combined into one program. This arrangement

(continued)

C the Advantage.

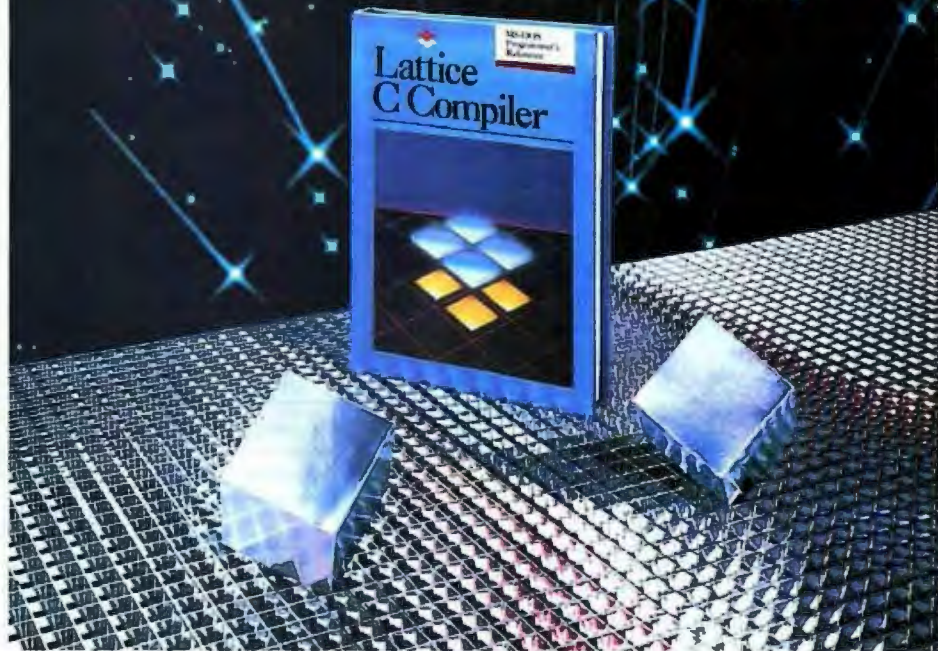

Introducing the Lattice[®] MS-DOS C Compiler, Version 3.

There's never been a better time to buy Lattice C. Professional programmers the world over have made Lattice C the standard compiler for serious MS-DOS programming. Now Version 3 offers even more of the features that have made our previous versions so popular. Our new compiler features include:

ANSI language constructs including, *unsigned* as a modifier, *void* data type, *enum* data type, structure assignments, structure arguments, structure returns, and argument type checking.

The compiler also contains better aliasing algorithms, more efficient code generation, and more flexible segmentation, in-line 8087 code generation, and 80186/80286 code generation.

The library contains more than 200 new functions, including: ANSI/UNIX/XENIX compatibility; extended support for MS-DOS; extended support for networking including file sharing, file locking, and I/O redirection; and flexible error handling via user traps and exits. Plus the library has also been re-engineered to produce much smaller executables.

Try the new Version 3 C Compiler from Lattice. Because C-ing is believing.



Lattice, Incorporated
P.O. Box 3702
Glen Ellyn, IL 60138
312/858-7950 TWX 910-291-2190

INTERNATIONAL SALES OFFICES:
Benelux: Ines Datacom (32) 2-720-51-61
Japan: Lifeboat Inc. (03)293-4711
England: Roundhill (0672)54675
France: SFL (1)46-66-11-55
Germany: (49)7841/4500 (49)8946/13290

slows down and complicates things, but in a spreadsheet, saving space is paramount.

On a related note, the formulas are not stored in fixed-length character arrays. Since the length of a cell's formula can vary considerably, this too would be wasteful. Instead, I used Modula-2's `ALLOCATE` procedure to apportion just enough storage to hold the string, plus one additional byte to hold an ASCII NUL character (ASCII value 0) to mark the end of the string. My spreadsheet's formula data type is actually a pointer to such a variable-length piece of storage.

The other consideration concerns the division between the spreadsheet proper—the part of the program that deals with manipulating and changing cells—and the rest of the program. The spreadsheet data structure is not directly visible to the rest of the program and can be accessed only by a few well-defined procedures.

ABSTRACT DATA TYPE

The heart of any spreadsheet program is, of course, the spreadsheet itself—the data structure containing the cells. From now on, I'll use the term "spreadsheet" for the data structure and "spreadsheet program" to refer to the entire program. We can view a spreadsheet as a kind of data type, like an integer or a set, and we can separate the implementation of the data type from its specification, or abstract description of its behavior. The other parts of the spreadsheet program can access the spreadsheet only by using the operations defined in the specification.

My spreadsheet allows the following operations. The `init` procedure should be called once before any other action is taken; it initializes the spreadsheet. The procedures `getValue` and `getFormula` take a row and column number and return either the value or the formula of the cell at that row and column. The `setValue` procedure takes a row, column, and value and sets the cell's value; likewise `setFormula`. The `set` procedures also redisplay the specified cell. If the spreadsheet is on automatic, they will redisplay any cells whose values are affected.

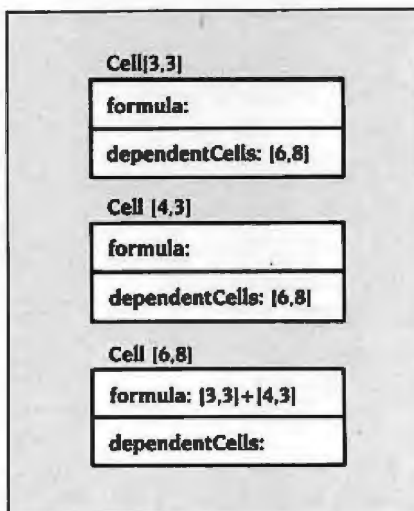

Figure 2: *Dependency maintenance. The references in cell [6,8]'s formula to cells [3,3] and [4,3] make [6,8] a dependent cell of both [3,3] and [4,3].*

You can set the recalculation mode of the spreadsheet with `setManual` and `setAutomatic`, and you can recalculate the entire spreadsheet with `recalculate`, which redisplay the changed cells. The procedures `maxRow` and `maxColumn` return the largest row and column that the spreadsheet allows (the minimum row and column are both 1). The `clearAll` procedure frees all storage associated with the spreadsheet and empties all the cells.

Each cell has a status that indicates whether the cell is empty, contains a valid value, or contains an erroneous value. A cell can contain an erroneous value if its formula does something wrong. For instance, a cell whose formula causes a division by 0 will have a status of `DivByZero`; a cell whose formula references a cell off the spreadsheet will have a status of `RangeError`. The status of a cell can be obtained by calling the `status` procedure with the cell's row and column. Since the procedures `getValue`, `setValue`, `getFormula`, `setFormula`, and `status` can be called with row and column values that are off the spreadsheet, a variable, `operationStatus`, is provided to determine if these operations were successful. The variable is set to `OK` if the operation was successful or to `RangeError` if the row and column values indexed a cell out-

side the bounds of the spreadsheet.

It's important to keep in mind that the procedures and variable I've described are the only interfaces to the spreadsheet from the rest of the program. Without using the interfaces, the program cannot manipulate the spreadsheet data structure or even a cell. This allows the implementer (that is, me) a great deal of freedom, which I have exploited by designing four very different but interchangeable implementations of the spreadsheet program.

NAIVE IMPLEMENTATION

In the first implementation, a cell is a record containing a value, a formula, and a status, and the spreadsheet is represented as a two-dimensional array of cells. A global Boolean variable indicates whether the spreadsheet is in manual or automatic mode. Getting and setting values and formulas are straightforward operations. In automatic mode, the setting procedures force the entire spreadsheet to be recalculated; in manual mode, the `recalculate` procedure is called when you enter "!".

This implementation isn't bad, but I find it unsatisfactory for two reasons. First, it limits the size of the spreadsheet to a fixed, and fairly small, number of rows and columns. Second, it performs poorly in automatic mode, because a change to even a single cell will force every cell in the sheet to be recalculated. If you were using a sheet with many filled cells, the delay in automatic mode would become intolerable, and you'd almost certainly switch to manual. That's too bad, because one of the great beauties of the spreadsheet idea is the ability to see your changes take effect instantly.

DEPENDENCY IMPLEMENTATION

Since a spreadsheet is a dependency maintainer, my second implementation remedies the recalculation problem by taking the dependencies seriously. This implementation keeps track of dependencies between cells, so when a cell is changed, the program need recalculate the formulas for only those cells that depend on the changed cell.

PROGRAMMING PROJECT

This implementation uses the same data structures as the first but adds a new field to the cell record, dependentCells. Each cell's dependentCells field contains a linked list of the row and column numbers of those cells that depend on the cell. Initially, the dependentCells field of each cell contains an empty list. When a formula is entered into a cell via setFormula, the formula is scanned for references to other cells, and those cells' dependentCells lists are updated accordingly. For instance, if the formula [3.3]+[4.3] is entered into cell [6.8], a record containing the numbers 6 and 8 is added to the dependentCells lists of cells [3.3] and [4.3] (see figure 2).

When a cell's value is changed, each cell on its dependentCells list is recalculated. Each recalculated cell may itself have dependent cells, which must be recalculated as well. The process is most simply coded as the recursive procedure recal, shown in listing 1.

It is important to note that this procedure, while much quicker than recalculating the entire spreadsheet, will handle some things differently. Say you have a dependency loop: Cell A depends on cell B, which depends on A. If the entire sheet is recalculated, row by row (or column by column), A and B will change once at most. But recal will change one, then the other, then the first, then the second, and so on, until the machine's stack blows. You could fix this looping problem by associating with each cell a Boolean value that is cleared before recalcula-

tion begins, set when the cell is recalculated, and tested before recalculating a cell to see if it was done already.

Looping can be a useful tool, however. Putting the formula "IF [1.1] = 10, 10, [1.1]+1" in cell [1.1] and setting the cell to 0 will display the numbers 1 through 10 in [1.1] and then stop. Once you can do controlled loops like this, a whole gamut of programming techniques are available. Since looping is sometimes useful and sometimes not, it might be wise to provide an option to turn it on or off. My spreadsheet combines this option with the automatic/manual feature. Automatic recalculation uses the dependency scheme and can loop, but when the spreadsheet's automatic mode is turned off, the program recalculates each cell (as in the first implementation) and will never loop.

Remember that expressions inside cell brackets, like [2.3], 1], are not allowed. This is because the dependency-based recalculation scheme breaks down. A little reflection shows why. If a cell contained this formula, on which cells does it become a dependent? Presumably, it is the cell whose row is the value of [2.3] and whose column is 1. But which cell this is depends on the value of cell [2.3], which can itself change. The simple dependency-tracking scheme I discussed above will no longer suffice.

My solution to the problem is to banish all such "indirect" cell references. If you really want them (and 1

(continued)

Listing 1: This recursive procedure recalculates a cell's formula. If the result differs from the current value of that cell, the procedure writes the new value and updates all other affected cells.

Procedure recal. Takes as input row and column numbers of a cell to recalculate

Begin

If the cell contains a valid formula, then

Evaluate the formula;

If the formula results in a value or status that differ from what the cell currently contains, then

Update the cell's value and status;

Display the cell;

For each row and column number on the cell's dependentCells list,

Call recal with that row and column

End

Vantex Professional Word Processor

\$49.95

EXTRA FAST • FEATURE RICH

General: Document based • Unlimited document size • Integrated spelling-checker (with suggestions) using an updatable 90,000 word dictionary • True split-screen • Flexible main-edit screen: invoke or dismiss, in any combination, the Command Line, Tab Line, text borders, and Information Line. Change the onscreen left and right margins. • Eight sorted directory-list formats (with one-letter commands to load, copy, delete, and search) • 30 user-settable defaults (blinking or non-blinking cursor, automatic backup, automatic timed save, etc.) • Macros (700 keystrokes per set) • Automatic ASCII import and export (makes for a solid program editor)

Entering Text: Distinction between paragraph and line (lines may be 255 wide) • No-hassles insert mode • Both ordinary and "magic diamond" cursor movement • Automatic paragraph reform • Decimal, right-justify, and begin-column tabs (storable in document) • Set boldface, underline, superscript, subscript, italics, and strike-through (unrestricted overlap)

Manipulating Text: Highlighted block-mode. Move and copy (with repetition, and across split-screen), delete, sort (by number or alpha), print, and quality (bold, underline, etc., upper-case, etc.) • Flexible column manipulations (move, copy, delete, fill) • Full backwards-forwards search-replace (case, word) singly or globally (plus special functions to search for format-objects, excessive paragraph-blanks, etc.)

Printing: Preview page-breaks before printing (visible, scrollable, hard and soft page-breaks) • Super-easy format-control screen (automatic storage anywhere into document of automatically spelled-out format-objects) • Valuable format-control features include margins, justification, microjustification, single, double or triple line spacing, "rows needed"; paragraph indents, padding and split-minimum, line headings and centering, row numbering, selectable strike-through and hard-blank characters, multiple headers and footers with variables for page-number (Arabic, letter, Roman), document, dates and time • Full widow-orphan control, including tables • Controllable print-queue • Multiple printers and ports • Edit while printing • Integrated Mail Merge • Selective page print • Drivers for Epson, Diablo 630, and other popular printers. Complete instructions allow the user to create new drivers or modify old ones.

Miscellaneous: Redefinable keys • DOS-pathname support • Context-sensitive Help • Word, character, keystroke counts • Balance parentheses and brackets • Documentation fields • Document-summary utility • Word frequencies • Printed manual • Not copy protected

Minimum requirements: IBM PC/XT/AT or true compatible, monochrome or color, one disk drive, 256K and DOS 2.0 or 2.1 (or 320K and DOS 3.X)

\$49.95 Introductory Offer
Add \$5.50 Shipping & Handling
N.J. Residents add 6% Sales Tax

Send orders to/or call

VANTEX DATA SYSTEMS

P.O. Box 507, Chatham, N.J. 07928

Call 1-800-524-2838

In New Jersey call 1-201-635-5686



Vantex is a registered trademark of Vantex Corporation. Dollar is a registered trademark of Vantex Corporation. IBM is a registered trademark of International Business Machines.

don't dispute that they can be useful), you have a couple of choices. One is to elaborate the dependency scheme to handle the problem. In addition to the usual dependency, there would be a second, indirect, dependency. Say that the formula $[(2.2),1]$ was put in cell $[9,9]$, and the current value of $[2,2]$ is 5. We would put $[9,9]$ on the dependentCells list of $[5,1]$, as before, and we would also put $[9,9]$ on a different list in cell $[2,2]$. A change to $[5,1]$ is handled as before, but a change to $[2,2]$ requires more work. If $[2,2]$ is changed from 5 to 6, $[9,9]$ must be deleted from the dependentCells list of $[5,1]$ and added to that of $[6,1]$; then the value of $[9,9]$ must be updated to reflect $[6,1]$. Such a complicated procedure could probably be made to work, but it is not clear that the benefits outweigh the costs, both in programming effort and run-time efficiency.

A simpler way to handle indirect cell references is to keep track of all cells whose formulas contain indirect references and recalculate these cells whenever any change to the spreadsheet is made. If indirect references aren't used too frequently, this method should be a reasonable compromise between total recalculation and carefully maintained dependencies.

SPARSE IMPLEMENTATION

Now let's consider spreadsheet size—remember, spreadsheets never seem to be big enough. My third implementation provides a spreadsheet of arbitrary size. Actually, the size is limited by the largest value of Modula-2's CARDINAL data type, which in the implementation I use is about 65,000; so my spreadsheet has 65,000 rows and 65,000 columns. But you could use any integer type—say a 32-bit in-

teger, allowing spreadsheets 4 billion square—with no fundamental change to the spreadsheet program.

Of course, these numbers indicate only the largest legal row and column numbers of the data structure; I certainly don't claim that you could fill all the cells of such a gargantuan sheet. That is a matter of memory, and the issue then becomes one of memory management. Only portions of the spreadsheet will actually exist at any given time—those cells that are occupied. Empty cells need not take up space; that is, any portions of a data structure whose behavior is constant need not be explicitly represented.

We could just allocate enough of the upper left-hand corner of the spreadsheet to contain the user's work. But doing so will cramp the user, who might, after all, want to use cells $[1,1]$ and $[65000,65000]$ simultaneously. To support such a sparsely populated spreadsheet we could use linked lists of cells, creating a cell only when actually needed. For efficient access, the cells should be linked both horizontally and vertically. But since that adds up to two pointers for every cell—a significant overhead—it might be wiser to allocate cells in groups, or chunks as I call them, and link the chunks together. That is how my third implementation works. Each cell contains a value, a formula, a status, and a list of dependent cells, just as used earlier.

A cell chunk is a 10 by 10 array of cells (you could make it larger or smaller), with two numbers indicating the starting row and column of the chunk and two pointers, one to the chunk below and one to the chunk on the right. True, using cell chunks means that space will be allocated for some empty cells; but I am banking on the assumption that cells tend to be used in clusters rather than spread out randomly on the sheet. If they are used in clusters, the cell-chunk implementation will waste little space. If they are used randomly, cell chunks will prove to be inefficient.

Initially, only a single chunk spanning rows and columns 1 through 10 is present. By convention, a cell chunk's starting row and column are

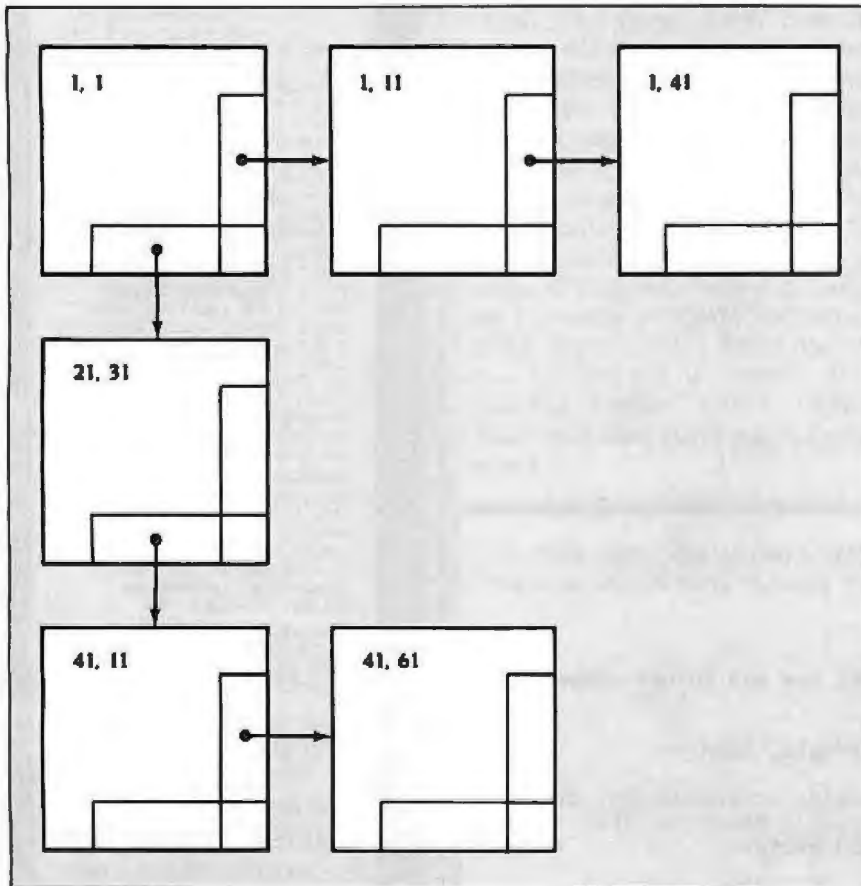

Figure 3: The data structure of the sparse implementation uses 10-row by 10-column chunks of spreadsheet cells. The numbers inside the boxes represent possible starting coordinates (row and column).

always multiples of 10, plus 1. When a cell's formula or value is set, the program first checks to see if the cell is on an existing chunk. If so, the operation proceeds as usual. If not, a new chunk is created, its starting row and column are set to 1 plus the nearest multiples of 10 just below the row and column of the cell being accessed, and the chunk is linked into the data structure in the appropriate place. A cell whose chunk has not been created is an empty cell, so any attempt to examine its contents (via status, getValue, or getFormula) returns just what you would get with an existing empty cell. There's no need to create a cell chunk in such a case.

The chunks could be linked together into a single list, but it's more efficient to use two dimensions. All chunks with the same starting row are linked horizontally, from lowest to highest. The lowest chunk of each row—the chunk with the lowest starting column—is linked to the row below. To find a cell, we first search down until the appropriate row is found, then across until we hit the correct column. The data structure is illustrated in figure 3. It is faster to search a two-dimensional list than a one-dimensional list. When searching for the row, we can skip over whole chunks that we would otherwise have to examine.

When the spreadsheet is cleared, the storage for the cell chunks can be deallocated. If my spreadsheet program allowed clearing of individual cells or groups of cells, such operations could check to see if any cell chunks were thereby rendered blank and could free them.

THE VIRTUAL SPREADSHEET

The sparse implementation does a nice job of giving the illusion of a mammoth spreadsheet while using a much smaller amount of memory, but it still falls quite short of the ideal. To give you an idea of the ratio of memory to spreadsheet size, my spreadsheet allows 65,000² (or about 4 billion) cells; but even with a conservative 8 bytes per cell, 1 megabyte of RAM can hold only about 256,000

(continued)

Teach your old word processor the newest tricks

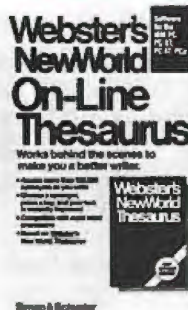

"Truly amazing... outclasses every other program of its type." —John C. Dvorak, *S.F. Examiner*

Feature for feature, Webster's New World® On-Line Thesaurus leaves the competition at a loss for words. With 20,000 root words, 120,000 synonyms, 500,000 replacement alternatives, and much more (see our comparison chart below)—Webster's New World® On-Line Thesaurus guarantees that you'll never be without the right word again. For the IBM PC, XT, AT and PCjr. \$69.95



The phenomenal software that catches complicated yet common misspellings—like "fenomenal." Just type in a word the way you think it sounds, like "potenshal," and the Spelling Checker automatically corrects it for you. Think of the potential that gives you! No wonder *PC Magazine* hails it as "the knock-down, drag-out, clear-cut winner!" (Editor's Choice 1985) For the IBM PC, XT, AT, PCjr and Apple II+, IIe, and IIc. \$59.95

LOOK HOW WE COMPARE:

WEBSTER'S NEW WORLD® ON-LINE THESAURUS			
	Webster's New World	Turbo Lightning	Random House Reference Set
Root word entries	20,000	5,000	5,000
Root words + derivatives	64,000	5,000	5,000
Number of synonyms	120,000	50,000	50,000
Replacement alternatives	500,000	50,000	50,000
Word processors supported	33	11	14
Resident RAM required	44K	64K min.	24K min.
Disk space required (full dictionary)	360K	160K	208K
Find synonyms for synonyms repeatedly	y	n	n
Undo synonym replacement	y	n	n
Backtrack through selections	y	n	n
Note pad	y	n	n
Multiple on-screen synonym pages	y	n	n
Edit synonym before insertion	y	n	n
WEBSTER'S NEW WORLD® SPELLING CHECKER			
	Webster's New World IBM, Apple	Turbo Lightning IBM	Random House Reference Set IBM
Ram Resident	n	y	y
# of words	114,000	83,000	50,000 or 80,000
Help windows	y	y	n
Browseable dictionary	y	n	y
Catches:			
Phonetic misspellings			
You type: FENOMENAL	PHENOMENAL	FELLOWMEN	FEMININE

SIMON & SCHUSTER COMPUTER SOFTWARE

To order call: 1-800-624-0023 (National) 1-800-624-0024 (In N.J.)

WEBSTER'S NEW WORLD®
When Every Word Counts™

maxell.

DISKETTES

3 1/2"	SS/DD	MF1-DD	\$25.50
	DS/DD	MF2-DD	41.75
5 1/4"	SS/DD	MD1-D	15.50
	DS/DD	MD2-D	22.50
	DS/HD	MD2-HD	43.75
8"	SS/DD	FD1	41.00
	DS/DD	FD2	44.10

DURACELL

DURACELL

ALKALINE BATTERIES

D Size—2 Pack	2.18
C Size—2 Pack	2.18
AA Size—2 Pack	1.56
AA Size—4 Pack	2.76
9 Volt—2 Pack	3.71

NI-CAD RECHARGEABLE

D Size—2 Pack	6.95
C Size—2 Pack	6.95
AA Size—2 Pack	5.52
AAA Size—2 Pack	6.95
9 Volt—Carded	6.95

CALCULATOR/PHOTO/ELECTRONIC

PX13B	1.35 VOLT MERCURY	1.37
PX28B	6.0 VOLT SILVER OXIDE	6.44
PX28LB	6.0 VOLT LITHIUM	4.62
PX625B	1.35 VOLT MERCURY	1.37
PX675B	1.35 VOLT MERCURY	1.30

PRINTER RIBBONS

APPLE	IMAGEWRITER	5.87
BROTHER	EM-1, EM-2, HR-1	4.81
DIABLO	HYTYPE II	3.83
	620	5.87
	P31/S31	7.18
EPSON	FX/MX/RX 70/80	4.64
	FX/MX/RX-100	7.62
IBM	5152 PC	4.64

PRINT WHEELS - PLASTIC

DIABLO	COURIER 10	4.58
	PICA 10	4.58
	ELITE 12	4.58
	PRESTIGE ELITE 12	4.58

PRINTWHEELS-METAL

DIABLO	PICA 10	35.73
	ELITE 12	35.73

SMA KEYBOARD TEMPLATES

KEYTRONICS 5151

LOK-123	LOTUS 1-2-3	11.78
DIBK-310	D BASE III +	11.78
DWK-300	DISPLAYWRITE III	11.78
MWK-300	MICROSOFT WORD1.78	
MWK-330	MULTIMATE	11.78
WPK-410	WORD PERFECT	11.78
WSK-100	WORD STAR	11.78
PCK-001	DO-IT-YOURSELF	11.78

SOFTWARE SPECIAL

WORD PERFECT 4.1

State-of-the-art program for word processing that utilizes the full power of your personal computer. Word perfect not only promises, but delivers, everything you hoped for in a good word processor. Its use of function keys allows you to create, edit and print almost effortlessly. The text on your screen looks like the printed document. Margins, page length and spacing can be changed at any time. Special features include: footnotes, headers, math, text columns, spelling checker and merge.

SPECIAL PRICE: \$189.00

ASK FOR CUSTOM PRINTED

FORMS

OPEN ACCOUNTS WELCOME
UPS, COURIER AND FEDERAL EXPRESS
F.O.B. PHILADELPHIA, PA
PRICES SUBJECT TO CHANGE



H&S ELECTRONICS™

1205 SOUTH SECOND STREET

PHILADELPHIA, PA 19147-5403

DIRECT TOLL-FREE NUMBER

ORDERS ONLY

(800) 448-3472 Ext. 100

QUESTIONS

(215) 627-7271

(215) 467-4689

PROGRAMMING PROJECT

cells. The ratio is about 1 to 32,000. We can improve the situation somewhat by providing a further illusion: splitting the available memory between RAM and disk. This technique is not new to anyone familiar with virtual memory, in which a large address space is used by shuffling fixed-size pages of memory words between disk and memory. A virtual spreadsheet uses the same techniques, but it does so at the level of the cell, not the memory word.

Can a virtual spreadsheet be implemented efficiently? Efficiency is partly a matter of technology. I certainly wouldn't recommend using floppy disks for secondary storage, but a fast hard disk might be reasonable. More important, the success of virtual memory depends on the principle of locality of reference: The observation that memory accesses occurring at about the same time tend to reference memory locations that are close to each other. A program that observes the principle of locality will, at any given time, access mostly those pages that are already in memory; therefore, disk traffic is low, and performance is only slightly worse than if the entire address space were present in RAM.

One lesson from virtual memory does not apply here: It was quickly learned that hardware support is essential for virtual memory, because every memory access involves a translation from a virtual address to the corresponding physical address. Translating every address in software is just too slow. But in a virtual spreadsheet, the references of interest are not to memory words, but to spreadsheet cells, and the references occur much less frequently—a reference to a single cell might involve a hundred memory references. It is at least plausible, then, that a purely software approach will do.

Surprisingly little of the sparse implementation has to be changed to accommodate the virtual-memory scheme. Initially, things proceed as before, with new chunks being allocated as required. Eventually a time will come when there is not enough memory to allocate a chunk. In the sparse implementation, the

program says "Out of memory" and leaves it at that. In the virtual implementation, however, a three-step process takes place. First, one of the existing cell chunks is chosen to be removed from memory. Second, the chunk is written to the disk. Finally, its memory is released, to be reallocated for the new chunk. When a chunk whose contents are on the disk is referenced, the chunk is read back into memory, possibly causing another chunk to be written to disk.

A few details are left to be attended to. First is the matter of tracking the locations of all the chunks. Actually, only the chunk's array of cells is written to the disk and freed. The other fields of the chunk, like the starting row and column and the pointers to other chunks, are kept in memory. Additional fields in the chunk provide the necessary bookkeeping information. One such field is `diskAddress`. It contains the location on the disk where the chunk's cell array is located. (The `diskAddress` field of a newly allocated chunk is empty.) When the chunk is first written to disk, it is assigned a disk address. Another new field, `inMemory`, contains a Boolean value that indicates whether or not the chunk's cell array is in memory or on the disk.

Since part of a chunk is never deallocated once the chunk is allocated, the danger exists that memory can be filled if many chunks are created, even if the chunks' cell arrays are all on disk. For our purposes here, my solution to this problem is to ignore it. The "immortal" part of each chunk is a very small 26 bytes, so it will take very many of them to fill memory.

How do we choose which chunk to discard from memory when the inevitable time comes? One idea is to throw out the chunk that was referenced least recently, that is, furthest in the past. As a matter of fact, this so-called least recently used, or LRU, policy works quite well.

True virtual-memory implementations use an approximation to LRU for efficiency reasons, but for our purposes the additional overhead is negligible, so we might as well implement it in full. A counter, `touchCount`,

(continued)

SAVE BIG ON 1200 AND 2400 BAUD MODEMS

Now you can save big by purchasing a modem for your personal computer DIRECT.

Sunnyvale Communications Company has acquired a wide range of products that will enable your computer to communicate with the outside world. These products are of outstanding quality and value.

Check these features:

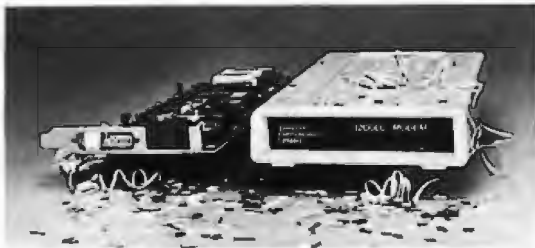

1200 LC \$199

- Hayes™ command compatible
- 1200/300/110 bps
- Auto dial, Auto answer
- Built-in speaker
- RS-232 to any computer

1200 TPC \$129

- Hayes™ command compatible
- 1200/300/110 bps
- Auto dial, Auto answer
- IBM™ internal
- Built-in speaker
- Software included

CALL TODAY!

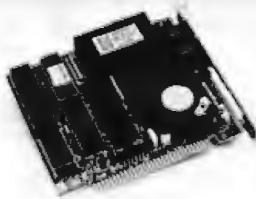

1200 SPC \$175

- Hayes™ command compatible
- 1200/300/110 bps
- Half-slot size
- Auto dial, Auto answer
- Built-in speaker
- Built-in diagnostics

Hayes is a registered trademark of Hayes Microcomputer Products, Inc. IBM is a registered trademark of International Business Machines Corp. Apple and Mac are registered trademarks of Apple Computer, Inc. Crosstalk is a trademark of Microstat, Inc.

NEW!
FASTER!



2400 \$495

- Hayes™ command compatible
- 2400/1200/300 bps
- Auto dial, Auto answer
- Synch or Asynch operation
- Originate and Answer buttons
- Built-in speaker

LIMITED
OFFER!

MacModem 1200LC \$229

- Mac™ compatible standalone
- Hayes™ command compatible
- 1200/300/110 bps
- Auto dial, Auto answer
- Built-in speaker
- Mac modem cable included

MIRROR \$40

- Crosstalk™-like software
- Multi-tasking
- Menu-screen command structure



SC

Sunnyvale
Communications
Company

1398 Borregas Avenue
Sunnyvale, CA 94088-3565
408/752-5095

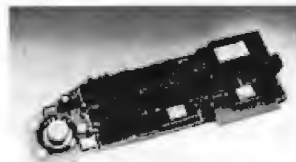

AppleMate 1200 \$199

- Apple™ II, II+, IIe internal
- Hayes™ command compatible
- 1200/300/110 bps
- Auto dial, Auto answer
- Built-in speaker
- Super serial card equivalent
- Built-in terminal software

ORDER FORM

SC

Sunnyvale
Communications
Company

NAME _____

ADDRESS _____

DAY PHONE _____

CHECK ENCLOSED

VISA

MASTERCARD

SIGNATURE _____

ACCT NO _____

California residents add sales tax. All USA orders add \$4 per modem for shipping and handling (Canadian orders add \$10 per modem—international orders extra). No C.O.D.'s or purchase orders accepted.

____ TPC ____ LC ____ SPC
____ MAC-LC ____ 2400
____ AppleMate ____ MIRROR

Subtotal \$ _____
Subtotal \$ _____
Subtotal \$ _____
Handling \$ _____
TOTAL \$ _____

EXP. DATE _____

800

408/752-5095
835-9009 in CA
558-5741 outside CA

The last piece of the virtual spreadsheet algorithm is a simple optimization.

is initialized to 0 and incremented on every cell reference. A field of each chunk, `touchedLast`, is assigned the value of `touchCount` when a cell in the chunk is referenced. The chunk with the lowest counter value is the one least recently used. For instance, say there are two chunks, A and B, and `touchCount` is initially 0. When a cell in chunk A is referenced, the counter is incremented to 1, and that value is stored in A's `touchedLast` field. Then one of B's cells is referenced. Again, `touchCount` is incremented, and its new value, 2, is stored in B's `touchedLast` field. A search for the chunk with the lowest-valued `touchedLast` field will yield A, which is indeed the least recently referenced chunk.

It's possible for `touchCount` to overflow. The simplest solution to the problem is to check for overflow and set the counter and all the chunks' `touchedLast` fields to 0 when it happens. We thus lose the information about which chunk was the least recently accessed, but that's not a problem; nothing will go fatally wrong if we pick some other chunk to get rid of instead. It is only for efficiency that we strive to pick the least recently used chunk.

The last piece of the virtual spreadsheet algorithm is a simple optimization. Each chunk has a Boolean field called `dirty`, which is set to true if any cell in that chunk is changed while that chunk is in memory. The first time the chunk is to be written to disk, the chunk is written regardless of the value of the `dirty` field. But on subsequent write attempts, the `dirty` field is checked. If the value is false, the chunk's contents do not differ from the version already on disk, so there

is no need to write its cells to disk. This optimization is easy to implement and can greatly improve the performance of the algorithm.

Now everything is in place for a detailed description of what happens when a cell is referenced. Two procedures are used to reference cells. The `getCell` procedure returns the cell at a given row and column, and the `setCell` procedure sets the contents of a cell at a given row and column. The procedures work similarly. First, the cell chunk containing the desired cell is searched for. If it doesn't exist and the cell is being set, the cell chunk is created; this action may involve some other cell chunk being written to disk if there's not enough memory. If the desired cell chunk doesn't exist and the cell is being read, there's no need to create the chunk; instead, `getCell` just returns an empty cell.

If the cell chunk is found, the next question is whether its cell array is in memory; this is easily answered by looking at the chunk's `inMemory` field. If it isn't in memory, it is read in from the disk, using the chunk's `diskAddress` field. Reading this chunk in may cause another chunk to be written out. Once the chunk is in memory, the access can proceed. The cell's contents are read or written, `touchCount` is incremented, and its value is stored in that chunk's `touchedLast` field. Also, `setCell` sets the chunk's `dirty` field to true.

So far, I've ignored the low-level details involved in writing and reading cell arrays from disk. In standard virtual-memory systems, the problem is easy because pages are a single fixed size, which is a multiple of a disk sector's size. A page's disk address is just the address of a sector on the disk, and reading or writing a page involves transferring one or more contiguous sectors between disk and memory. Our cell arrays, however, are not of fixed size. Of course, they always contain a fixed number of cells; but cells can differ in size because both formulas and lists of dependent cells can be of different lengths. This wouldn't be so bad, but what really causes trouble is that a cell's size can change; the user can add or change a cell's formula or by

changing another cell's formula affect this cell's dependency list. A problem occurs when we try to write a cell array whose size has changed back to the place on the disk from whence it came. If the cell array has shrunk, we will have some wasted space left over on the disk when we are done writing. What's worse, if the cell array has grown, it won't fit in the original space.

This problem indicates the disk-storage-allocation scheme used for fixed-size pages won't work for our variable-size cell arrays. A simple solution would be to determine the maximum size of a cell array and pretend that cell arrays were really fixed-size objects of that size. But that won't work for our application. Since a cell can theoretically have every other cell in the spreadsheet as a dependent, there is no reasonable upper bound on the size of a cell and, therefore, on the size of a cell array.

A more sophisticated storage-allocation scheme is necessary. The scheme should conserve disk space, but it also must be fast since we don't want to keep the user waiting. The scheme I use takes its inspiration from the design of a typical file system. File systems have to allocate disk space for variable-size files. In a typical file system, the disk is divided into fixed-length segments called sectors. A file always occupies an integral number of sectors, but it may not occupy contiguous sectors. Each sector points to the next sector in the file. The disk's directory contains, for each file on the disk, the number of its first sector. The directory also contains the number of the first free sector on the disk, that sector contains the number of the second free sector, and so on. The free sectors form a linked list on the disk, as do the sectors for each file.

My method is similar, but I've tried to minimize the number of disk accesses required to read or write a cell array by keeping more information in memory. I use a single file I call the scratch file to hold all the cell arrays that are written to disk. Initially, the file is empty; as cell arrays are written, it grows.

In my scheme, a disk address is an array of sector numbers. The size of

(continued)

Computer Friends Buffers, the new generation.

MAC MASTER™

Universal Buffer & Printer Controller.



LOOK!

Let Mac Master be your

1. Buffer and free your Computer Memory
2. Printer Controller. Mac Master stores/recalls all the fonts and commands of any printer you connect to it.
3. Auxiliary Memory. Mac Master stores/recalls files, logos, graphic symbols, etc.

Plus multiple copy capability, memory and copy no. display, pause and bypass option, and more. Available in parallel or serial.

64K **\$299⁰⁰** — 256K **\$450⁰⁰**
 1 MEG **\$700⁰⁰** Shipping **\$4⁰⁰ U.S.**

PROTEUS™

Double Buffer & Data Switch (Parallel).



Connect 2 printers or other parallel peripherals to PROTEUS and you will have:

1. Buffer on Port 1 and 2.
2. Switching capability (manual or via software).
3. Multiple Copy capability on both ports.

PROTEUS 64K — **\$199⁰⁰**

Shipping
\$4⁰⁰ U.S.

PROTEUS 256K — **\$299⁰⁰**

Mac Master and/or Proteus are easily installed and can be used immediately. 12 Months Warranty.

UNIVERSAL

MAC INKER™

Re-ink your Fabric Ribbons automatically for less than 5 cents.

Extremely simple operation. We support any fabric cartridge. The Universal Cartridge MAC INKER is \$68.50. The Universal Spool MAC INKER is \$66.95. Our lubricated, dot matrix ink (\$3.00/bottle) yields a darker print than most new ribbons. Estimated no. of re-inkings per avge. cartridge 60-100. MAC INKER has been reviewed, approved and flattered in most magazines, even in the New York Times and the Chicago Sun Times.



\$68.50

Shipping
\$3.00 U.S.

(Universal w/C. Itoh Prowriter Cartridge).

Over 50,000 MAC INKERS in the field as of Jan. 15, 1986.

RE-INK IN COLOR TOO

We have colored or un-inked cartridges or reloads for most popular printers. Colors: Brown, Blue, Red, Green, Yellow, Purple. Please inquire.

MERCURY MODEM

Really 100% Hayes® Smartmodem Compatible. ■ 300/1200 Baud Speed. ■ Auto answer, Auto dial, Auto speed selection. ■ Audio monitor w/Volume Control. ■ Front Panel lights. ■ Excellent Manual. ■ 18 months warranty.

\$205⁰⁰

Includes power supply and telephone cable. Computer to Modem cable \$15.00. Shipping \$4.00



*Hayes is a trademark of Hayes Microproducts

mac-the-ripper™

Perforation Eliminating Machine.

Tears off the perforations from computer paper. Feed in the first sheet of the stack and let mac-the-ripper do the rest. Eliminates tedium and can pay for itself promptly in saved personnel time.



\$49⁰⁰

Shipping
\$5.00 U.S.

DATA SWITCHES

All types, all lines switched, all metal, heavy duty switch, elegant design, best value for money.

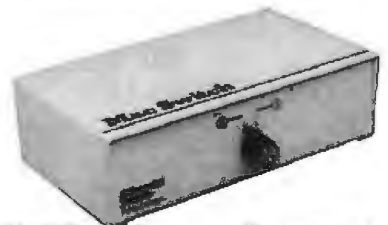

2 Ports Parallel or Serial

\$ 75⁰⁰

4 Ports Parallel or Serial

\$150⁰⁰

2 Computers/
2 Printers Par. or Ser.

\$150⁰⁰

We have cables too. Please inquire or specify at time of order.

Order Toll Free.

Call or Write for free brochure.

1-800-547-3303

In Oregon 503-297-2321 (24 hours line)

Computer Friends®

6415 SW Canyon Ct., #10
Portland OR 97221
telex 4949559

AT ONLY 80K... IT'S A WHOLE NEW BALLGAME!

Now, you can have it all... *all the software you need resident in RAM and plenty of memory to spare!* Because if you've got a hard disk, RAM disk or extended memory, Homebase now sets up a data space to swap data out when you call up one of Homebase's features. It's simple, very powerful and very sophisticated. And it allows us to give you the kind of Homebase you've been asking for... one that needs less than 80K!

In February, PC Magazine said, "Homebase is so elegant that it has one up on SideKick. One way to look at it is to say that Borland's product is a first generation organizer, while Amber's is second or third generation. This is one of those rare software offerings you have to see to believe. Each of Homebase's services could make it in the marketplace as a full featured stand alone product." And that was before we reduced the impact on RAM from 176K to 80K (and added a voice autodialer and an online editor!)

Imagine all these features, with so little overhead:

Type-Ahead Keyboard Buffer

... User definable size, accepts control characters.

Online Editor

... Open a notepad, or edit a text file.

Autodialers

... (voice and data)

ASCII Table

... and Homebase allows you to add any other table you'd like, easily.

Quickterm Terminal

... Now, you'll have the ability to set up your computer to answer the modem and receive Electronic mail in the background while you're working in another application. You'll even be able to bring up Lotus while you're online!

Hit Alt Shift Q and jump right into the terminal no matter what other software you're running or plan to run while you're online. Includes Autodialer that saves and implements entire configurations. Scroll-back, X Modem file transfer and more.

On-Line Context-Sensitive Help Calculator

... handles formulas, simple and complex math. Onscreen tape keeps track for you, converts between hex and dec, adding machine mode... and much more. Variable window displays up to 26 variable values at once.

Multiple Calendars... a system so powerful that it can keep track of a whole office, or a busy individual. Daily, weekly and monthly... you can track appointments and business expenses... even set alarms that show text from appointment slots. (alarm now automatically re-sets at re-boot.) Includes full search facility and coupled, daily to-do list.

Online Databases... both free-form and structured databases available at the touch of a hotkey. The template maker allows you to create structured entry forms for your Homebase databases in minutes and the full search facilities let you manipulate the data easily.

Phone Message Pads... just like the paper ones, but searchable, sortable and printable.

On-Screen Clock

Cut and Paste

Screen Saver

Mobile Homebase... Homebase's Report Generator sorts, composes and prints information from your Homebase databases and calendars to clip into your appointment book when you're on the road. In addition, it can print out mailing labels, continuous form Rolodex™ cards... it can even do mail merge.

DOS Services... View up to four directories onscreen at once, copy or erase groups of related or unrelated files, view and even edit ASCII files... and lots more. Create, delete and move between subdirectories visually.

Phone Directory... you can search, sort, Autodial from and even print your phone directory.

Available at better dealers... worldwide.

PC Magazine
Top Software
Product of the Year!

\$69.95

\$29.95 Homebase
Updates

Send in your original
Homebase masters.

SAFE!!!

Homebase Version 2.0 is compatible with most popular software, including Lotus, Word, DBase III+, WordStar 2000, and peripherals such as the Hercules monographic card, and EGA.

Call Toll Free

800-538-8157 ext. 824

Please enclose cheque or money order or...

Visa MasterCard American Express

Card # _____

Exp. date _____

Homebase \$69.95* per copy (Not copy-protected)

SideKick Trade In \$49.95

Homebase Update \$29.95

Please add \$5 shipping and handling CA residents add 6% sales tax.

30 day money-back guarantee.

Amount enclosed \$ _____

For the IBM PC, XT, AT and compatibles.

Name _____

Address _____

City _____ State _____ Zip _____

Phone: (Home) _____ Phone: (Office) _____ Ext. _____

Dealer, distributor and corporate quantity discounts phone: 408-896-1883

*Orders outside the U.S., please add \$20 shipping and handling. (U.S. funds, please)

SideKick is a trademark of Borland International. Microsoft Word is a trademark of Microsoft. WordStar 2000 is a trademark of MicroPro. Lotus 1-2-3 is a trademark of Lotus Corporation. dBase III+ is a trademark of Ashton-Tate.

Inquiry 16 for End-Users. Inquiry 17 for DEALERS ONLY.

This Is One Time
IBM's Size Is Not
An Advantage.

TOSHIBA

T1100PLUS



When it comes to a portable computer, smaller is better.

That's one reason the new dual disk drive Toshiba T1100 PLUS has it all over the IBM PC¹ Convertible.

But our new portable PC is not only smaller than the IBM. It's also lighter. And more powerful.

How much smaller? A full 20%. And theirs weighs 12.2 pounds. Ours is under 10 pounds.

And with theirs, if you want serial and parallel ports or a CRT port, you have to add add-ons.

Which makes it even bigger and heavier. And more expensive.

With the T1100 PLUS, the serial, the parallel and the CRT ports are standard built-in features. Simple mathematics tells you which portable is more portable. And more affordable.

WE TAKE THE PORTABLE PC TO A HIGHER POWER.

Before we go any further, we have to tell you there is one thing about the T1100 PLUS that's bigger than the IBM portable. It's maximum memory capacity. Ours is 640K of RAM. Theirs is only 512K of RAM.

Now we can tell you that the T1100 PLUS is faster than the IBM. Our 80C86 microprocessor lets you zip through work at twice the speed.

ANOTHER CLEAR ADVANTAGE.

The Toshiba T1100 PLUS uses a high-contrast, high-resolution LCD display screen. It shows 25 lines by 80 characters of text with 640 x 200 resolution, tilts to any convenient viewing angle and folds flat when you use a CRT monitor.

The IBM portable also uses an LCD display screen. But it doesn't have

as much contrast. It doesn't tilt to as many convenient angles. And you have to pull it off to hook up another monitor.

ONE MORE THING THAT MAKES US EXCEPTIONAL.

Of course, the Toshiba T1100 PLUS is fully IBM-compatible. So you can run popular software like Lotus 1-2-3², WordStar³ and dBASE III⁴.

And, as we mentioned, it has two built-in 720K 3.5" disk drives. It also has an optional 1200-baud Hayes⁵-compatible internal modem and runs on built-in rechargeable batteries. Just like the IBM portable.

But should either stop running, only Toshiba guarantees you overnight delivery of a replacement while yours is being fixed. It's all part of our "Exceptional Care" program.

To find out more about the T1100 PLUS, call 1-800-457-7777 for the name of the authorized Toshiba dealer near you. And see why being small is going to make us one of the biggest things in PCs.

In Touch with Tomorrow

TOSHIBA

TOSHIBA AMERICA, INC. Information Systems Division
Inquiry 368

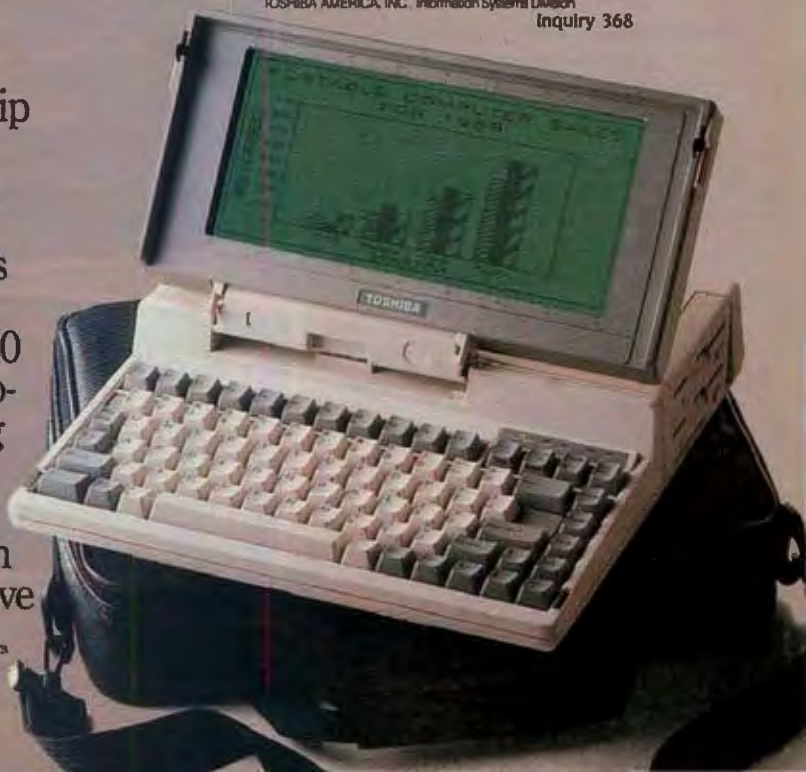

1. IBM and IBM PC Convertible are registered trademarks of International Business Machines Corporation. 2. Lotus 1-2-3 is a registered trademark of Lotus Development Corporation. 3. WordStar is a registered trademark of Micropro. 4. dBASE III is a registered trademark of Ashton-Tate. 5. Hayes is a registered trademark of Hayes Corporation.

Get the Picture with COLORPHOTOBASE

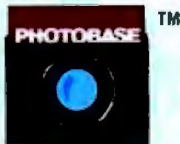

PHOTOBASE is a software package that works with data base management systems such as: dBase II*, R:Base 4000* and the IBM Filing Assistant*.



PC-EYE is a high speed, high resolution video digitizer board that lets you capture anything you can see.

Now you can open up a whole new dimension in data base applications by merging real-life color pictures with popular data base management systems. Pictures of people, products, diagrams, maps, company logos — whatever you want to photograph — can be integrated with your data base. Consider these typical applications:

Security — verify those employees who have authorized clearance to limited access areas. A data base containing employee pictures and personnel records can be searched and displayed for visual verification.

Real Estate — add pictures of houses to on-line real estate listings for faster property identification and improved sales presentations.

Electronic Cataloging — pictures of products can be combined with a data base system containing product specifications, pricing, availability and much more.

Medical Files — Existing data base systems containing patient histories can incorporate pictures of x-rays, cell slides and external body disorders. The ability to visually inspect previous medical problems of patients can greatly enhance the speed and accuracy of future diagnosis.

Customers, distributors and sales personnel can quickly search data and view the resulting product/picture information on one screen. Files can be updated easily, quickly.

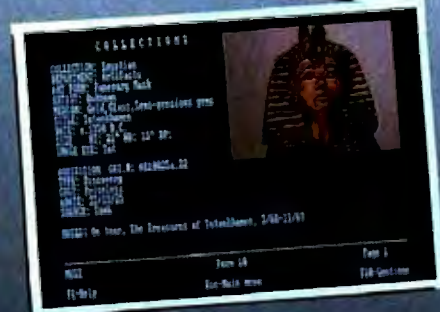
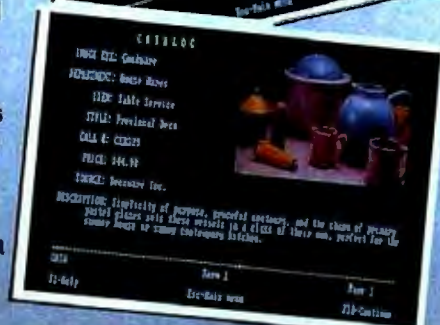
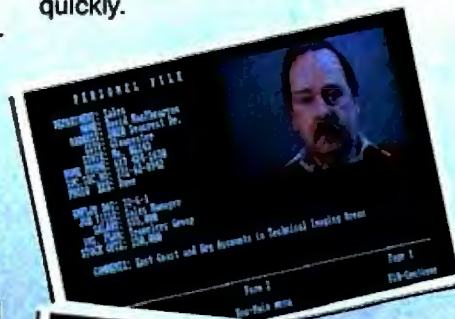

It's Easy

With a simple keystroke, pop-out of your data base system and into the PHOTOBASE menu. Capture images of text, photos, artwork and 3-dimensional objects with an ordinary video camera and our high resolution PC-EYE™ video digitizer. Pop back into your data base system and add the picture name to your data base like you would any other piece of information. The full functionality of the data base system is preserved, but the resulting display is text and picture information on one screen.

Pictures are displayed in the upper right quadrant of the screen or at a full screen resolution of 320 x 200 with 256 optimized colors. Screen display can alternate with text, images, or both simultaneously viewed.

Call or write and we will send you information on PHOTOBASE, PC-EYE, compatible cameras and other imaging equipment in the Chorus Family of products.

**(603) 424-2900 or
1-800-OCHORUS.**

TM PHOTOBASE and PC-EYE are trademarks of CHORUS Data Systems.

*dBase II is a trademark of Ashton-Tate; R-Base 4000 is a trademark of Microrim, Inc.; IBM Filing Assistant is a trademark of International Business Machines Corporation.

CHORUS

ANAGRAM SOLVING IN PASCAL

BY BOB KEEFER

*Use a probability table
to decipher anagrams*

THE JOY OF ANAGRAMMING is the joy of language itself. Although English poet John Dryden called the practice "the torturing of one poor word ten thousand ways," people have been rearranging the letters of words at least since ancient Greek times, and very likely since the first alphabet was devised. Some anagrammatists work for the sheer pleasure of seeing *intoxicate* turn into *excitation*. Others have gone from lofty *heights* to the very *highest*, seeking religious meaning in the mysterious transposition of one word into another.

Part of the pleasure comes from the jolt of recognition when a word is anagrammed. Even short words have an astounding number of possibilities. The number of permutations of a word N letters long is N factorial, so that a five-letter word has 5!, or 120 possible anagrams. An eight-letter word has 40,320, and a ten-letter word has more than 3.6 million. Nevertheless, the human eye can look at *anagrams* and easily see *ars magna*—the great art.

Can a microcomputer be programmed to do the same thing? A

February 1984 BYTE article ("Deciphering Word Games" by Mark C. Worley) outlined a BASIC program that generates all permutations of words up to six letters long and displays them on the screen. At that point, it's up to the operator to pick the English words out from the non-sense combinations.

My program, ANAGRAM.PAS, goes a step further. [Editor's note: ANAGRAM.PAS and SETPROB.PAS (mentioned later) are available in a variety of formats. See pages 459-461 for details.] Written in Turbo Pascal, the program generates all possible permutations of words up to ten letters long (it can do even longer words, but the program would take a very long time to run). Then, using a surprisingly mechanical method, it tries to solve the anagram—that is, to pick out the English among the random nonsense. The program doesn't, however, look words up in a dictionary; that would, after all, be cheating. What it does instead is evaluate the probability that each of the three-letter combinations, or trigrams, that make up the permutations could occur in normal English.

The method is based on the fact that in English, as in any other language, certain patterns of letters are more likely to occur than others (see "A Travesty Generator for Micros" by Hugh Kenner and Joseph O'Rourke, November 1984 BYTE). A basic example is that *q* is almost invariably followed by *u*. In a more typical case, it is easy to determine that *th* is frequently followed by *e*, *a*, *i*, or *o*, more rarely by *u*, and almost never by *p* or *z*.

This property allows your computer to evaluate the likelihood that any given combination of letters is an English word and not nonsense. For example, you can permute the letters *d*, *g*, and *o*, into six arrangements:

DGO
DOG
GDO
GOD
OGD
ODG

When you put these trigrams in order

(continued)

Bob Keefer (35995 East Wills Rd., Creswell, OR 97426) is a feature writer for The Register-Guard in Eugene, Oregon.

of their likely appearance in English, the two words *god* and *dog* rise to the top:

- GOD
- DOG
- ODG
- GDO
- DGO
- OGD

This is exactly what ANAGRAM.PAS does. Given a list of letters in any order—including an English word—it produces every permutation of those letters. Then it scores each permutation by totaling the probabilities of the trigrams that make up the permutation. Finally, the program prints out the top 15 scorers, presumably including any English words buried among the nonsense permutations. Table 1 shows the results of entering the letters *claaps*, which ANAGRAM.PAS unravels to *pascal* on line 4.

But where does ANAGRAM.PAS look up the probabilities? That's where a second program comes in.

SETPROB.PAS

SETPROB.PAS creates a probability table for ANAGRAM.PAS by reading natural English text from a disk file and counting the occurrences of each trigram. The results are tabulated in a three-dimensional array, Probability[X,Y,Z], which is then stored in a disk file (PROB.DAT) for use by ANAGRAM.PAS.

Probability[X,Y,Z] is a big array. With each dimension extending for 27 units—26 letters plus the blank space—it has 19,683 elements. In a Turbo Pascal integer array, which requires 2 bytes per element, that's 40K

bytes for the probability table alone. Using Turbo Pascal on my 64K-byte Osborne 1 means the program cannot be compiled and run in memory but must be compiled into a command file (.COM) and run without the Turbo Pascal system.

I ran SETPROB.PAS on several chapters of an unfinished novel, since that was the largest chunk of text I had sitting around on floppy disks. The English text was about 35,000 words. A bit of experimentation showed that the performance of ANAGRAM.PAS improved dramatically, at first, as more text was digested into the probability table. When the table included the results of reading about half the text, though, the program's performance seemed to top out. It may be that adding English text from a source other than my own hand would once again broaden the program's horizons; I haven't yet tried this.

To use SETPROB.PAS on more than one text file, such as separate chapters contained on more than one disk, you must alter the procedure ZeroProb so that instead of setting the array elements in Probability[X,Y,Z] to zero at the beginning of the program, it reads in existing results from the file PROB.DAT. Notes in the program listing show how to do this easily.

SETPROB.PAS treats everything that is not a letter as a blank space and turns all letters into capitals. Then it collapses strings of blanks into single blanks before evaluating the characters of the trigram (Ch1, Ch2, Ch3) and incrementing the appropriate array element in Probability[X,Y,Z]. A procedure called ScaleProb makes sure that the highest value in the ar-

ray never exceeds Pascal's maximum integer value, 32,767.

An interesting feature of ANAGRAM.PAS is that probability tables can easily be generated for different languages. When I used SETPROB.PAS to create a probability table for Latin by counting a 300-word excerpt from Cicero, *ourti* no longer unscrambled to *trout*, as it does when the table is based on English text, but to *tutor*, a good Latin word. Similarly, *eeuna* unscrambled to *neque*, the Latin word for *nor*, and not *queen*, as it would in English.

ANAGRAM.PAS

ANAGRAM.PAS contains two Pascal procedures of interest. *Permute*, a recursive procedure, generates all possible permutations of the string obtained by procedure *GetInput*. I must admit I was stumped for a long time by the problem of generating permutations of a word of any length without resorting to an endless number of nested for loops; I finally stumbled across the solution in Charles Seiter and Robert Weiss's *Pascal for BASIC Programmers* (Addison-Wesley, 1983) and have borrowed their general structure for *Permute*. To them, thanks.

The second procedure, *Score*, is incorporated into *Permute*. It consults the probability table to look up the relative likelihood of each trigram making up the word. A space is added to the beginning and ending of each permutation before scoring because the blank space is the most frequently appearing character in English text, and its location, marking the beginning and ending of words, is accordingly significant. The total probability for each permutation is stored in the variable *Total*, which is then compared to the list of winners kept by procedure *KeepScore* in the array *ScoreBoard*. If the new total is higher than any score on the *ScoreBoard* array, *Total* and the string *WordToScore* are plugged into place and the rest of the contenders are shuffled down one slot in the ranking.

The one refinement I have made to the basic scoring method is that an anagram's score is cut in half for every

(continued)

Table 1: In a typical run, ANAGRAM.PAS unscrambles a group of letters and finds, on line 4, the word "pascal." The number to the right of the word shows relative probability.

Enter word: <i>claaps</i>	1	CASPAL	539	9	PLASAC	358
	2	SACLAP	481	10	LASPAC	351
	3	SAPACL	458	11	CASLAP	346
	4	PASCAL	452	12	PLACAS	337
	5	CASPLA	418	13	SAPLAC	332
	6	SPACAL	388	14	PASLAC	331
	7	CALAPS	372	15	PACLAS	328
	8	CAPALS	358			

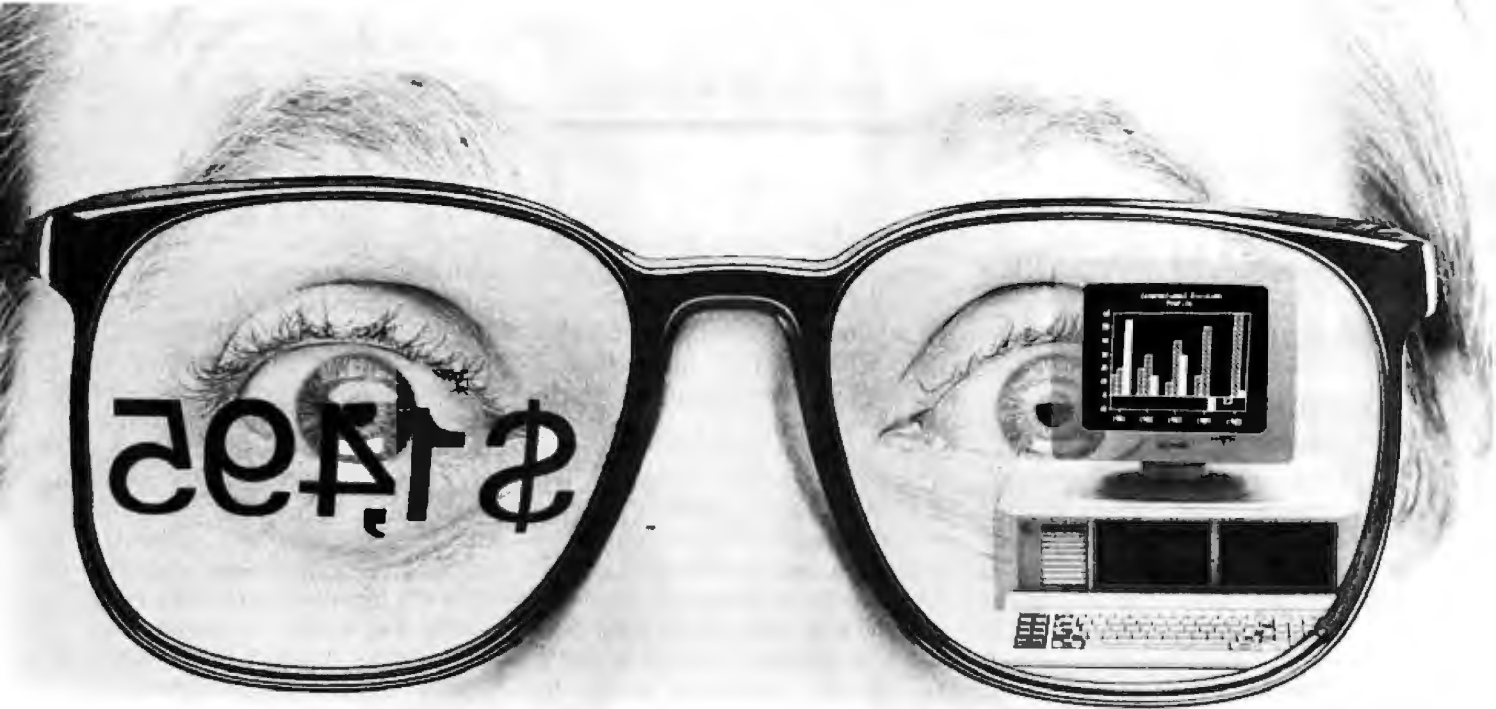

When your eyes are bigger than your budget

Do you need a personal computer, but your budget winces at the cost? Are you considering a big name computer with a big price? Or a no-name brand that will give you less?

Look at Cordata's affordable PCs and ATs.

You see...Cordata (formerly Corona Data Systems) has been providing the best value in PCs right from the beginning.

Check out our desktop PC400. Only \$1495, complete.

- Big 14" screen — easy-to-read, sharp characters, built-in graphics.
- Full size system — lots of room for growth.
- Big memory (512K) — plenty to meet today's software demands.
- Software included — *spreadsheet, word processing, database and communications integrated software (Electric Desk)*. Also MS-DOS, BASIC and start-up tutorials.
- Nationwide service by Xerox.

Cordata means value for your computer dollar. We bring seasoned expertise to every product and a track record of meeting the needs of PC users.

For the Cordata dealer nearest you call (800) 621-6746. In California call (805) 495-5800. In Canada call (604) 984-0641.

Ask for an
EYES-ON DEMONSTRATION.

Join the
cordata Corps™
and get more!

CORDATA, INC., 279 E. Hillcrest Drive, Thousand Oaks, CA 91320
Telex: 050-2696270. In Europe, The Netherlands 030-40-18111

Inquiry 99

 **cordata**
formerly corona
data systems, inc.

ANAGRAM.PAS does not handle very long anagrams well.

trigram it contains with a zero probability. This prevents an anagram made up of both a very likely trigram, such as *she*, and an impossible one, such as *dqt*, from scoring well and overwhelming other possibilities. This is handled in the procedure *Score* by the variable *Unlikelihood*, which counts the number of zero-probability trigrams.

PERFORMANCE

How well does ANAGRAM.PAS work? That depends on the length of the word. To establish some kind of standard for performance while testing the program, I drew up a list of 70 common words, including 20 four-, five-, and six-letter words and 10 seven-letter words. The program was declared to have solved the anagram if the original word appeared anywhere in the list of 15 top choices.

At its best, ANAGRAM.PAS "solved" all 20 of the four-letter words, 16 of the five-letter words, 9 of the six-letter words, and 6 of the seven-letter

words. Table 2 shows a list of the 70 test words and the rank number each received during one run of the program. Overall, then, it appears that ANAGRAM.PAS will unscramble a four- or five-letter word about 90 percent of the time. That is, of course, little to boast of for four-letter words, which have only 24 anagrams. But five-letter words have 120 possible combinations, and it is sometimes startling to watch the program flash the correct unscrambled word on the screen a few seconds after you have typed in its letters in random order. For six- and seven-letter words, the success rate falls to slightly more than 50 percent. Eight-, nine- and ten-letter words take quite a long time to compute (my Osborne takes about 20 minutes for eight letters and 30 hours for ten letters), and I've not tried enough of them to be able to generalize. The success rate is undoubtedly quite low.

I've tried various methods for improving the program's performance—jiggling the way in which the Unlikelihood factor is calculated, for example, or the amount of text used to establish the probability table. My conclusion is that the basic method is sound, and extra bells and whistles only get in the way, except for the simple

rescoring of words containing zero-probability trigrams. The best way to improve performance would undoubtedly be to count the probability of four- or five-letter segments instead of three-letter segments. The size of such a probability table, though, would exceed the memory of most microcomputers. While it is possible to write a program that would score anagrams without a probability table, less memory-intensive algorithms run very much slower and would be ungainly for words longer than five or six letters, which ANAGRAM.PAS already solves fairly well.

One area that might bear examination is elimination of extremely high probabilities from the existing table. The occurrence of *th* is so common, for example, that any time a word contains both *t* and *h*, those permutations containing the diphthong *th* score extremely high and wipe out all other possibilities. Thus *heater* is lost, in favor of such nonsense as *therea*, *eareth*, and *eather*. It may be that massaging the probability table to temper extremes would produce better results.

One thing that ANAGRAM.PAS does not do well at all is handle very long anagrams, such as full sentences. This could be another problem for further study. Lengthy anagrams are not only possible for humans to solve, but they have at times been the occasion of considerable intellectual passion. During the seventeenth century, perhaps the heyday of anagramming, a hermit of St. Paul named Nieszporkowitz produced more than 3000 metrical anagrams of the "Angelic Salutation" in the Gospel According to St. Luke: *Ave Maria, gratia plena, Dominus tecum*. ("Hail Mary, full of grace, the Lord is with you.") One example is *Virgo serena, pia, munda et immaculata*. ("Virgin serene, pious, elegant and immaculate.") Not to be outdone, the Belgian abbot Lucas de Vriese turned out 3100, with apparently few repetitions. It would take ANAGRAM.PAS about 7.8×10^{24} years to compute and score its favorite 15 anagrams of the Angelic Salutation. That is about 5×10^{14} times the estimated age of the universe. ■

Table 2: Seventy common English words and the probability rank each received from ANAGRAM.PAS. An asterisk indicates a rank higher than 15, meaning the program did not solve the anagram. Of course, the probability rank will vary depending on the text you use in calculating the probability of trigrams.

FOUR	2	TROUT	2	SEXTET	*	TERRIER	2
WITH	1	STORE	1	BANANA	12	COUNTRY	1
THEY	1	BREAD	12	FRIEND	11	BISCUIT	*
BOAT	3	STEAM	7	VOLUME	10	SPEAKER	6
SHIP	5	HORSE	13	DONKEY	*	PICTURE	*
CORE	1	NUTTY	5	FLOWER	4	COCONUT	*
HATE	6	AWFUL	15	SKATER	*	BELIEVE	1
SKIN	1	CREEP	*	BORING	4	ARCHERY	*
KIND	1	ADOBE	*	ACTION	*	CALVARY	1
LOVE	1	CREAM	13	INDIAN	1	LIZARDS	3
SING	1	SKIPS	*	PENCIL	*		
CRAM	4	NEEDY	14	NAUSEA	*		
JAZZ	1	PLATE	2	ALIGHT	*		
ZERO	10	QUEEN	2	ENGINE	*		
EXAM	1	PIZZA	8	CORRAL	2		
PAIR	4	ZILCH	*	DIMPLE	2		
QUIT	1	JELLO	4	GANTRY	*		
SKIM	5	CLOCK	2	STREET	*		
OBOE	6	HAPPY	1	ARTIST	*		
SPRY	1	SHAPE	15	BANGLE	10		

PRINTER SHARING AND PRINT BUFFERING ALL IN ONE VERSATILE UNIT

Print Master from BayTech is an intelligent printer controller that connects between your computers and printers. It allows you to share one printer automatically, contend for multiple printers automatically, or switch between several printers by sending a simple code. Plus, Print Master's built-in buffer spools data until your printer can receive it.



A VERY FLEXIBLE PRINTER SHARER

You configure Print Master's ports for any combination of printers and computers by answering questions from the easy-to-follow menus. For example, with the ten-port Print Master, nine computers can share one printer, eight computers can share two printers, seven computers can share three printers, and so on, to one computer which can share nine printers. You can also menu-select these features: the baud rate, word size, stop bits, parity, and XON/OFF handshaking; the disconnect time-out; and form feeds. Ports may be configured individually to translate for printers and computers using different configurations. All changes you make are saved in non-volatile memory.

PRINT MASTER'S BUFFER KEEPS YOU WORKING

Since Print Master can accept data faster than your printer, you can dump a print job into Print Master's 512K buffer and then go on to another project. All connected users can send data to this common pool buffer, and they can be doing it at the same time, even if no printer is available. Data is stored in the buffer until it can be sent on a first-in-first-out basis to

the selected printer. If you need more memory, Print Master is optionally available with one megabyte buffer.

CONTROL PRINT OUTPUT FROM YOUR COMPUTER

If several users are sharing one printer, printer sharing is completely automatic. There are no codes to send. You simply perform your normal print operation. If you are sharing several identical printers, connection is also

automatic. Again, you perform your normal print operation and are connected to the next available printer on a first-come-first-serve basis. Print Master will send data to all printers simultaneously to keep your printers running at full capacity.

If you are sharing several different printers, such as a letter printer, a laser-jet and a plotter, you do your normal print routine but insert a short printer select code (which you can define yourself) as the first characters of your data. The data is then routed to the selected printer. It's that easy.

CHOOSE SERIAL OR PARALLEL MODELS

706A (6 parallel ports), \$795.
706C (6 serial ports), \$795.
706D (4 parallel/2 serial), \$795.
708D (6 parallel/2 serial), \$895.
708C (8 serial ports), \$895.
710C (10 serial ports), \$995.
Additional 500K buffer, \$249.

Want more details? Call or write BayTech at P.O. Box 387, Bay Saint Louis, MS 39520. Telex 910-333-1618. Phone 601-467-8231 or

800-523-2702

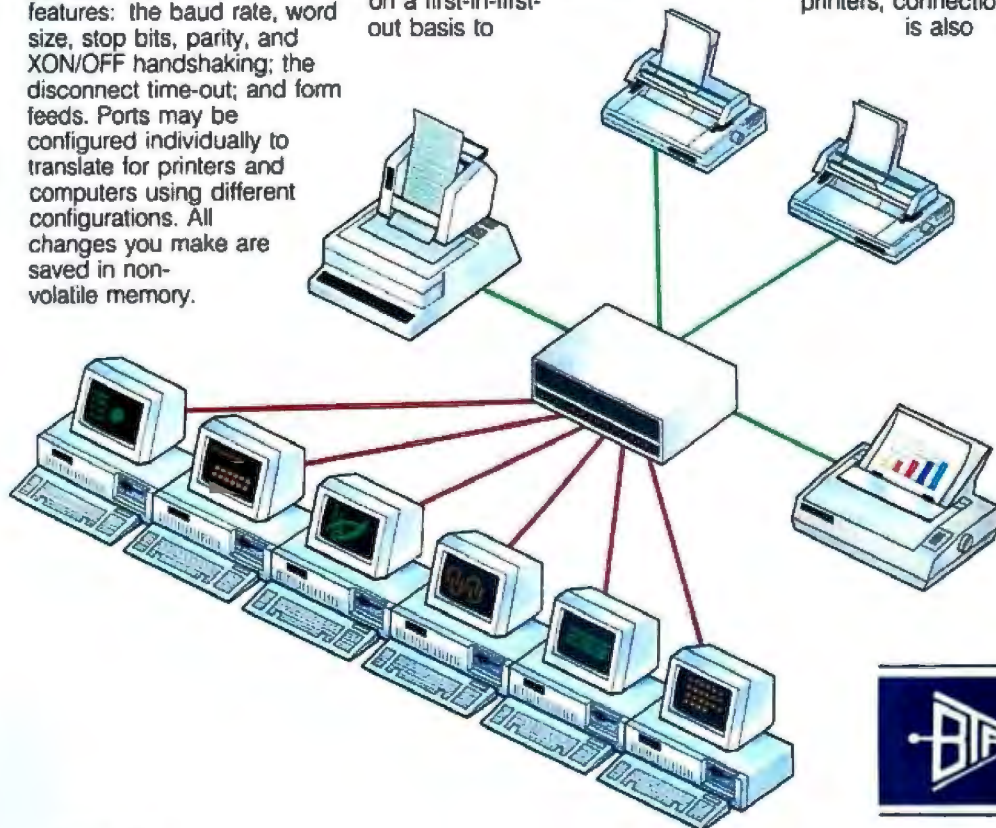

TABLE 1
COMPARISON CHART
RELATIVE RANK OF WP PACKAGES

FEATURE	WORDSTAR 2000 PLUS REL 2	MICROSOFT WORD VERS. 2.0	WORD PERFECT VERS 4.1	MULTIMATE ADVANTAGE VERS 3.5	DISPLAY- WRITE 3 VERS 1.0
Installation	1	2	3	1	4
Documentation	1	2	2	2	3
Ease of Learning	1	2	3	1	4
Functionality	1	2	2	3	2
Performance	2	2	1	3	3
Document Control	1	3	2	4	1
Text Control	1	3	2	4	2
Page Control	2	1	3	2	2
Micro Editing	2	1	2	3	3
Global Control	1	2	1	3	3
Page Layout	2	1	3	2	1
Printing	3	3	2	3	4
Advanced Features	1	2	1	2	3
Writing Aids	3	3	1	3	4
Printers/Fonts Supported	1	3	3	3	2
Connectability	1	4	3	3	5

Note: The comparison numbers represent the relative ranking of each package compared to the others. The package with the highest ranking is given a 1. If packages rank equally, they are assigned the same ranking number.

Source: InfoCorp

SINK YOUR TEETH INTO THIS.

Introducing WordStar® 2000 Plus Release 2, the new and improved software that topped InfoCorp's chart of word processing packages.

We could make all kinds of claims about our new WordStar 2000 Plus Release 2.

About its commonsense commands. Tutorials for easy training. Direct Lotus® file input. Extensive printer support. DCA connectivity. LANs and site licensing options.

That would be easy to do.

But we decided to let the experts do the talking.

In a comparative report—the report containing the chart to the left—Robert Lefkowitz of InfoCorp said:



"WS 2000+ emerges as a clear winner in overall applicability. InfoCorp believes WS 2000+ would appeal to the largest number and widest variety of users. Its layered functionality, ease of learning, and excellent

communications features make it ideal for corporate users, ranging from secretaries to clerks to managers to executives."

And, after reviewing WordStar 2000 Plus Release 2 alongside MultiMate™ Advantage™ and IBM®'s

DisplayWrite® 3, International Data Corporation's Jim Chapman concluded:

"WordStar 2000 is our favorite—for ease of learning, ease of use... and for well-conceived and helpful documentation."

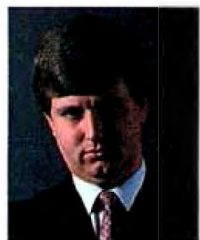

Now we don't expect you to take these opinions as gospel.

Because when it comes to knowing your company's word processing needs, you're the expert who really matters.

So evaluate our product yourself.

See your local MicroPro dealer today. Or call 800-227-6703 (800-632-7979 in California) for the dealer nearest you. Put WordStar 2000 Plus Release 2 to the test and see how it measures up to the advance reviews.

We believe it'll be time well spent. For you and your company.

If you'd like the complete InfoCorp and IDC reports, we'll be happy to send them to you. Just fill out the coupon below and mail it to us, or call 800-443-0100 x. 547.



WORDSTAR®
2000
RELEASE 2™

Powerful word processing has never been easier.™

MicroPro International, Industry Analyst Reports
P.O. Box 57135, Hayward, CA 94545

Yes, I'd like copies of the InfoCorp and IDC Reports on WordStar 2000 Plus Release 2. Please send them to me right away.

Name _____

Title _____

Company _____

Address _____

State _____ Zip _____

Phone (_____) _____

Lotus and IBM DisplayWrite 3 are registered trademarks of Lotus Development Corporation and IBM Corporation, respectively. MultiMate and Advantage are trademarks of MultiMate Corporation. Current WordStar 2000 owners can update to WordStar 2000 Release 2 by calling MicroPro Customer Update 800-433-0100 x 265. 8805M 2/86

THE DEFINICON 68020 COPROCESSOR

*A plug-in board that
provides 32-bit
computing power and
math processing for
16-bit machines*

Have you ever wished that your personal computer had the speed of a VAX or that the number 64K had never existed? Well, the Motorola 68020 32-bit microprocessor has the computing power to come close to fulfilling both those dreams. BYTE has arranged for Definicon Systems to design a special version of its 68020-based scientific microcomputer system that allows 68020 hardware and software development at a price all can afford. (See the text box "How to Get Your DSI-020 Coprocessor Sys-

Trevor Marshall, Christopher Jones, and Sigi Kluger are engineers with Definicon Systems Inc. They can be contacted at 31324 Via Colinas #108/9, Westlake Village, CA 91362.

tem" on page 122 for complete information.)

The DSI-020 is a coprocessor board (see photo 1) that uses the 12.5-megahertz versions of the 68020 CPU and the 68881 FPU (floating-point unit). Provision has been made for the addition of the 68851 PMMU (paged-memory-management unit) when it becomes available. The board has 1 megabyte of high-speed parity-checked dynamic RAM that requires only one CPU wait state to operate correctly. There are two high-speed (38,400 bps) serial ports (figure 1) and an interrupt-driven timer to ease the task of porting UNIX.

All the facilities of a host IBM PC or compatible are available to the coprocessor, including networking and access to any other peripherals connected to the PC's bus. System calls for full bit-mapped graphics are provided in the kernel. All BDOS and BIOS software interrupts in the PC are available to the 68020 programmer.

OVERVIEW

The DSI-020 board is composed of a number of relatively independent functional blocks. The CPU cluster (figure 2) consists of the 68020, 68881, and 68851. The 32-bit bus ad-

dress decoding circuitry is shown in figure 3 and includes the FPU20 and DEC20 PALs, the HOLD20 bus request arbiter PAL, the 32-bit bus DMA sequencer (74F161) and DPORT20 PAL, the DSACK20 PAL, and the BE20 byte enable PAL (figure 4). The DSACK20 PALs main function is to provide signals to the 68020 to indicate that a memory access cycle is complete and whether the size of the transfer was 8, 16, or 32 bits.

A delay line and associated headers delay the CPU's address strobe (AS) signal long enough for all the decoding to have been completed before the $\overline{\text{RASIN}}$ signal is generated to initiate the DP8409 dynamic RAM controller's access cycle. The DP8409 (figure 5) directly drives the multiplexed address and $\overline{\text{RAS}}$ lines of the RAMs. The $\overline{\text{CAS}}$ signal is multiplexed with the Byte Enable signals before being applied to the RAM array, shown in figure 6. The refresh counter is driven from the CPU's clock oscillator, divided by 128. The DP8409 attempts to do a hidden refresh, but if this is not possible, a refresh request ($\overline{\text{RFIO}}$) will be sent to the HOLD20 PAL every 10.24 microseconds. When this is acknowledged (with $\overline{\text{RFSHACK}}$) the DP8409 will perform a $\overline{\text{RAS ONLY}}$ refresh cycle.

Hidden refreshes occur whenever any device other than the RAM itself is addressed. In particular, accesses to the 68881 will cause a hidden refresh to occur. This considerably reduces any overhead that might otherwise be incurred using this DMA refresh technique.

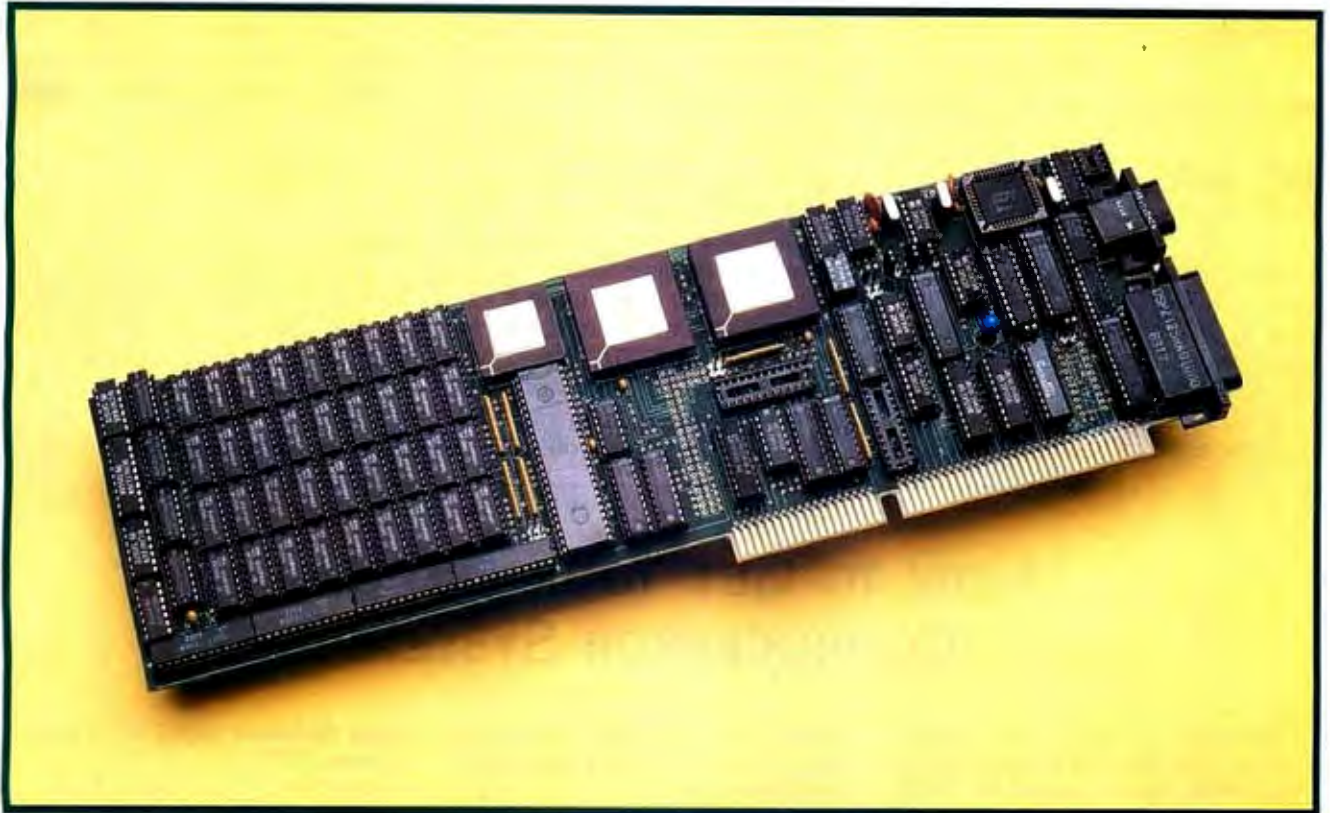

Photo 1: The Definicon DSI-020 board with 68020 CPU, 68881 FPU, and 1 megabyte of memory. A 68851 PMMU is shown with this board although it is not commercially available at this time.

The parity error signal generated as shown in figure 7 is latched and can be read by the host PC at bit 0 of the BFLAGS port (see table 1 and figure 4). Pulse the Refresh Inhibit line (RFSHINH) briefly to reset this latch.

THE 68851 PMMU

The principal function of the PMMU is the translation of logical addresses from the software running in the CPU to physical addresses within the range of the available hardware facilities. This allows programs to run at addresses that are not available in physical memory. An operating system that swaps infrequently used memory blocks to disk and so enlarges the effective addressing range of programs is called a virtual memory system (VMS). Although Definicon has written a VMS for the DSI-32, the kernel for the DSI-020 does not yet

implement virtual memory. The mapping from logical to physical addresses is stored in tables (in memory) that the PMMU can search. It has an internal cache so that the most recently used translation table entries are available without the necessity for an additional bus cycle. The PMMU implements a hierarchical protection mechanism with up to eight access levels. It also provides a breakpoint acknowledge facility to support the 68020 breakpoint instructions.

The 68851 internally decodes its own chip select function.

THE 68881 COPROCESSOR

The 68881 is the first high-speed floating-point accelerator from Motorola. It is addressed when the 68020 places 111 on its status lines (FC0, FC1, and FC2), 0010 on lines A19 through A16, and 001 on lines A15 through A13

and performs a memory cycle. The special coding on the status lines indicates, however, that the cycle is actually for the coprocessor interface. Chip select for the 68881 is derived in the FPU20 PAL.

The major feature of the 68881 is that many frequently used mathematical functions have been microcoded into the silicon. This considerably enhances the performance of the 68020/68881 combination on engineering and scientific computations. It also accounts for its deceptively high performance on some function-sensitive benchmarks, such as the Savage benchmark (*Dr. Dobbs' Journal*, March 1984, page 92).

THE HOST PC BUS INTERFACE

The IBM PC XT bus was designed as a single master bus, so there is no

(continued)

*The 8088 is used
to relieve the 68020
coprocessor of
many disk and console
I/O tasks.*

method for a slave coprocessor to take control of the bus, tell the 8088 CPU to go to sleep, and drive the peripherals directly. The XT relies on the 8088's DMA controller to take back control of the bus every 15 microseconds or so to perform a

dynamic RAM refresh cycle. This forces a coprocessor system such as the DSI-020 either to replace the 8088 or to work in close cooperation with it.

With the design of the PC AT, provision was made for a slave processor to control the bus (via the DRQ and MASTER signals), but a limitation of 15 microseconds remains on the total length of time a slave can keep control before memory refresh fails! This limit obviously makes it very difficult to provide safe direct disk or other stream I/O tasks even using these newer capabilities. It is for these reasons that the DSI-020 is designed to transfer data 1 byte (or word) at a time to the host environment.

During the design of the DSI-32

(August 1985 BYTE, page 120) we found that the total replacement of the 8088 was relatively inefficient and that it is capable of relieving the coprocessor of many of the tedious disk and console I/O tasks. The DSI-020 follows the same design criteria. The MS-DOS system on either a PC AT or a PC XT is used to provide file I/O, networking, and other peripheral tasks, allowing the 68020 kernel to concentrate on the things it does best. The kernel provides the interface and translation between the UNIX-derived 68020 system software and the facilities provided by MS-DOS itself. We allowed the optional use of the 16-bit data transfer facility of the new AT bus. The majority of the improvement resulting from the use of

HOW TO GET YOUR DSI-020 COPROCESSOR SYSTEM

Definicon Systems will provide the elements of the DSI-020 system at the following special prices for BYTE readers.

Note: These special prices have been provided by Definicon, reducing its margins to a bare minimum. In particular, no margin has been allowed for accounting overhead and so *no purchase orders* can be accepted for these special BYTE products.

Terms of payment are VISA/MasterCard/American Express only. There is a 30-day, no-questions-asked, money-back guarantee. Goods must be returned in "as new" condition in original packaging for full credit.

Software support available for all products is limited to a diagnosis and correction of your software problem. Under no circumstances will Definicon's technical support team attempt to teach you to program in any of these languages!

The DSI-020 has been tested in almost all the machines compatible with the IBM XT and AT. If it does not work in yours, Definicon reserves the right either to correct the problem (if it is with the DSI-020) or refund your money.

Although the DSI-020 will operate in

a system with only floppy disks, a fixed disk is essential for meaningful program development.

DSI-020 basic hardware: \$995

1 megabyte of RAM, 12.5-MHz 68020, and 12.5-MHz 68881

No parity chips or serial ports
MS-DOS interface software, simplified assembler, linker, and assembly-level debugger

The DSI-020 hardware is supplied fully assembled and tested.

Optional hardware upgrade: \$99

Chips for the two serial ports, parity-detection circuitry, and the serial number EEPROM

Supplied fully tested if ordered at the same time as the basic hardware.

SVS Library Manager: \$49

Forms object modules into libraries that can be searched by the linker rather than included as a whole.

QUELO Macro Assembler and Utilities: \$155

SVS BASIC PLUS: \$169

BASIC language interpreter similar to DEC's BASIC PLUS language

Living Software BASIC to C Converter: \$299

Includes run-time package compiled for compatibility with either SVS C or LLL C.

SVS C: \$349

Kernighan and Ritchie definition with most UNIX extensions

LLL C: \$349

Kernighan and Ritchie definition with most UNIX extensions

LLL PASCAL: \$399

ANSI level 1 PASCAL

SVS PASCAL: \$399

ANSI level 0 PASCAL plus extensions

SVS FORTRAN: \$459

ANSI FORTRAN-77 language with extensions

All the above items may be ordered only directly from

Definicon Systems Inc.
31324 Via Colinas #108
Westlake Village, CA 91362
(818) 889-1646

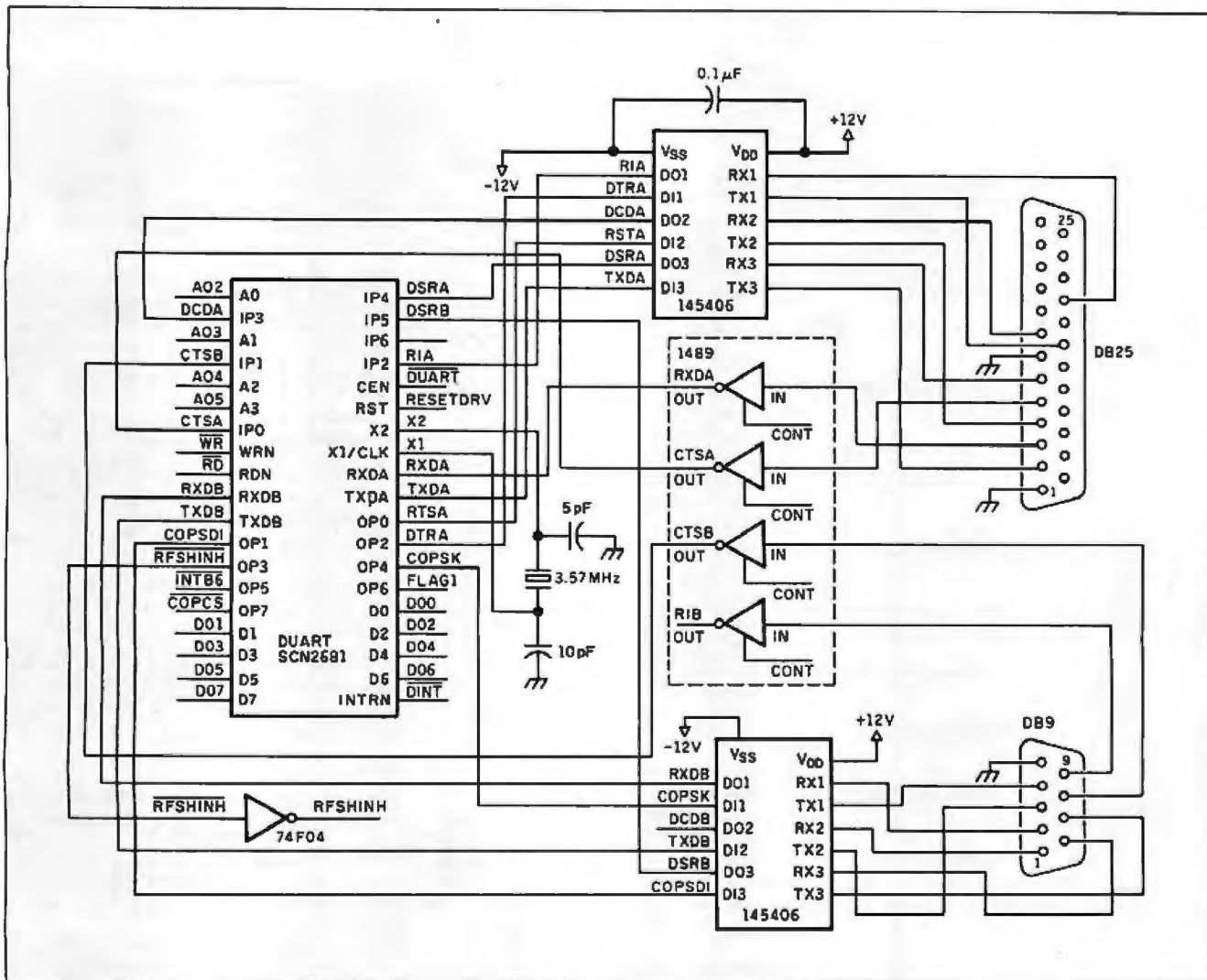

Figure 1: DUART and RS-232C drivers.

an AT host comes, however, from the faster disk subsystem and not from the wider bus.

The DSI-020 automatically senses whether a PC XT 8-bit bus or a PC AT 16-bit bus is available and adjusts to either 8- or 16-bit transfers as appropriate. When an XT is sensed, by the absence of a ground level on pin D18 of the interface (figure 8), the 74HCT245 buffer (figure 9) connects the top half of the 16-bit bus to the lower half of the bus so that the XT can see it. When an AT bus is present, the DSI-020 will assert MEMCST6 to the host whenever it is addressed at an even boundary. This conditions the AT for a possible 16-bit data transfer. If for some reason you are using an XT work-alike in which the 18-pin AT

connector fingers are physically obstructed by components on the motherboard, it is possible to have the extra connector removed.

A jumper block has been provided to disable the AT sensing circuitry. This allows the use of the DSI-020 in an AT using the XT bus mode.

THE DMA CYCLE

When the 68020 kernel wants the 8088/286 to perform a task, it asserts interrupt 2 (optionally INT 7). The 8088/286 addresses the card. The AT20 PAL (figure 4) generates a RAMSEL signal, which in turn generates an IOCHRDY signal to the host. This forces the 8088/286 to wait until the 68020's 32-bit bus becomes available. The DPORT20 also issues the

HOLD86 request to the HOLD20 PAL. This PAL arbitrates the DMA request with refresh requests from the dynamic RAM controller and produces a BUS REQUEST (BR) to the 68020. On seeing this request the 68020 waits until it has completed the current 32-bit bus cycle and then releases its bus and asserts BUS GRANT (BG). The HOLD20 PAL then issues HLDA86, which releases the 74F161A DMA sequencer. The DPORT20 PAL then takes over the 32-bit bus and generates signals that simulate some of the control signals normally generated by the 68020. The dynamic RAM controller responds to these signals, placing the required byte (or word) of data on the 32-bit

(continued)

DEFINICON 68020 COPROCESSOR

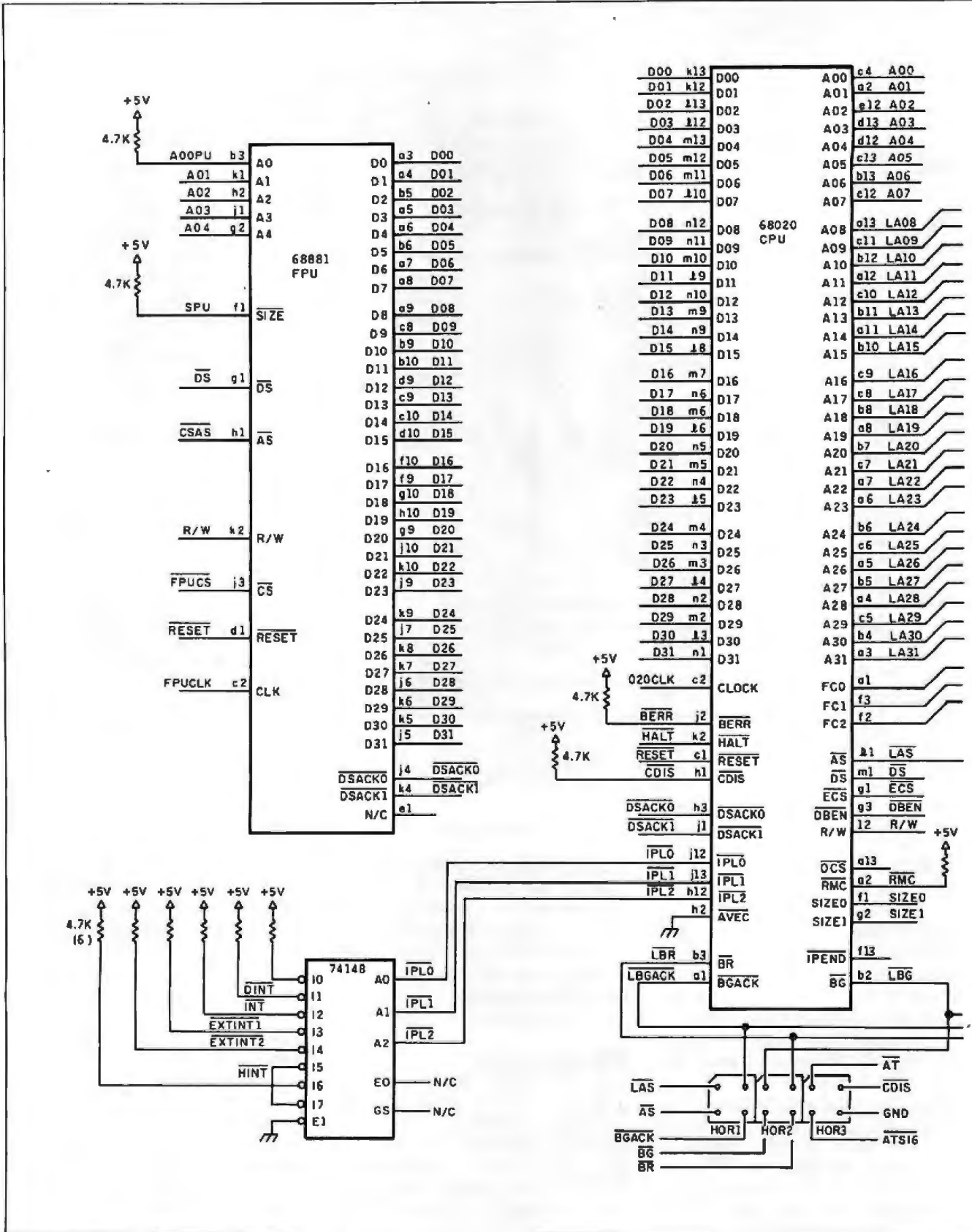
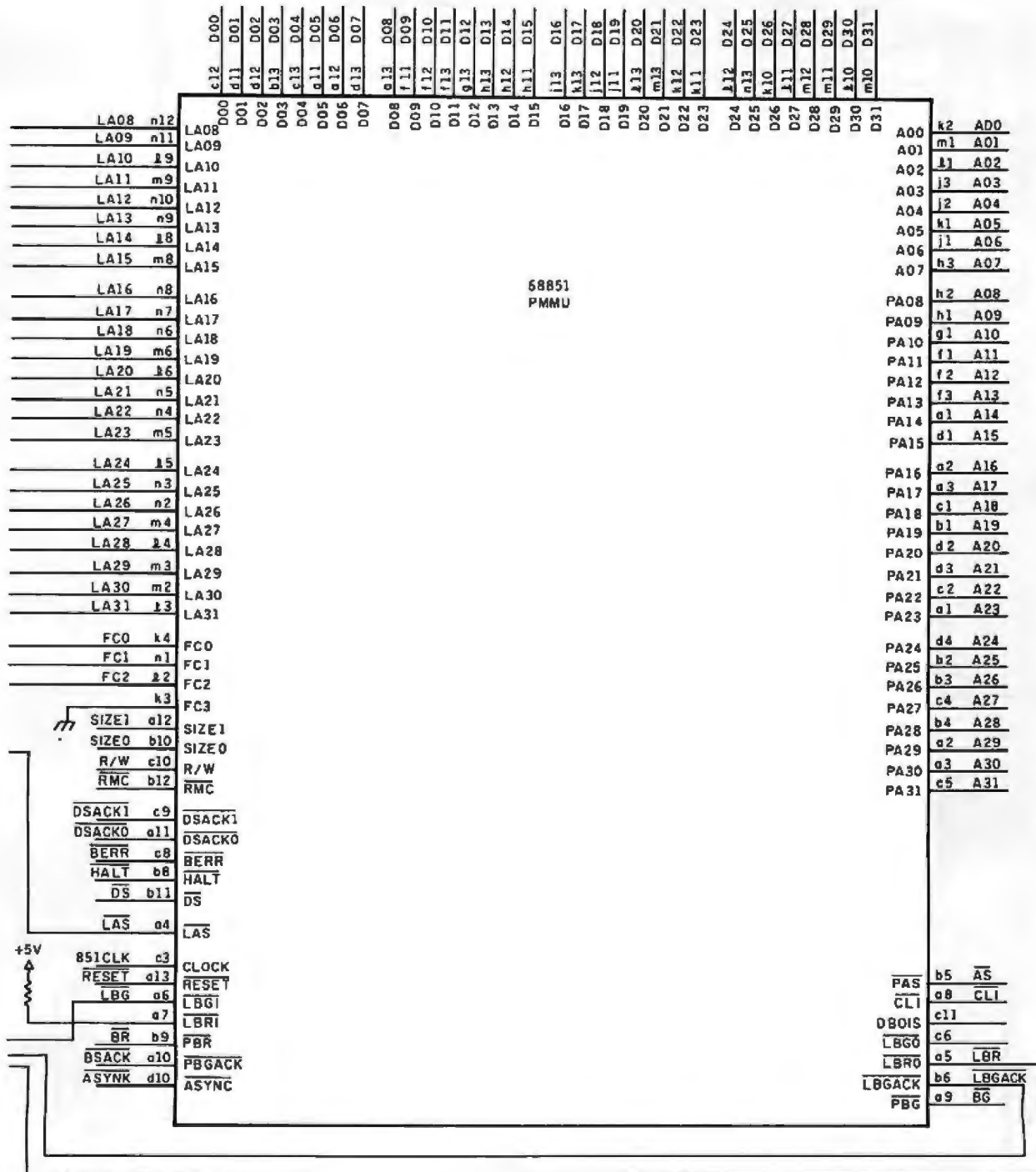
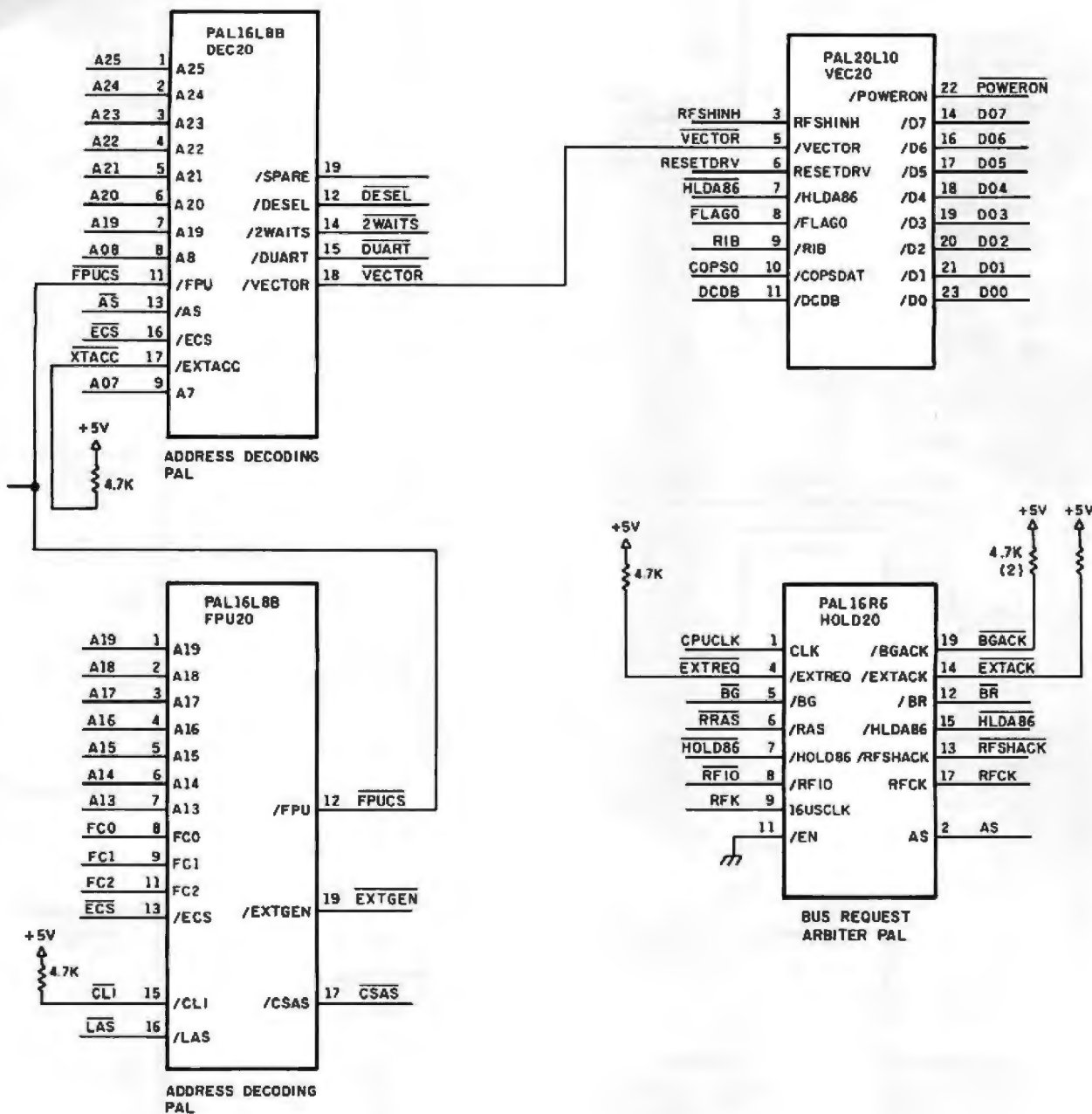

Figure 2: The CPU, floating-point (FPU), and paged-memory-management (PMMU) processors.

DEFINICON 68020 COPROCESSOR



DEFINICON 68020 COPROCESSOR



DEFINICON 68020 COPROCESSOR

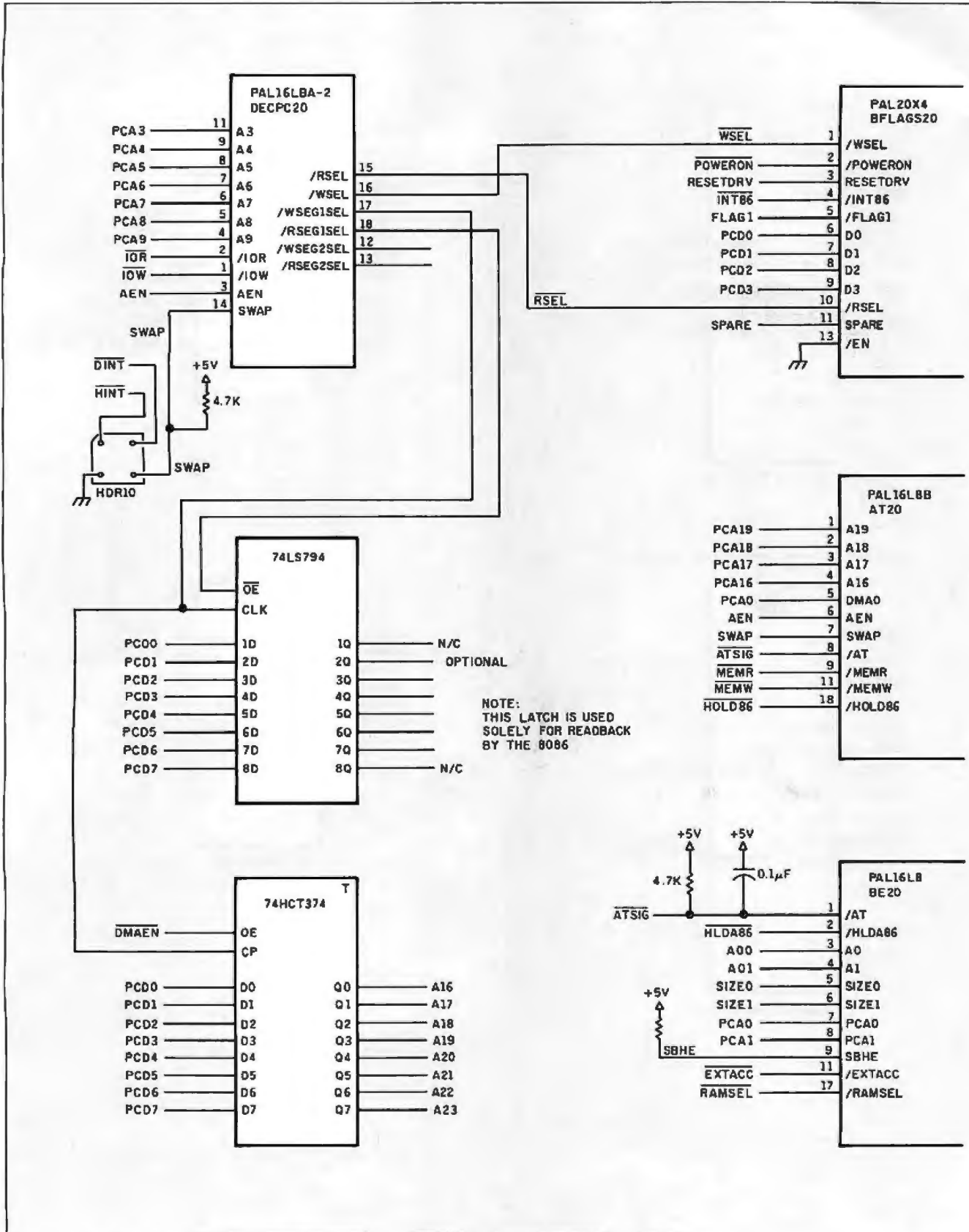

Figure 4: PC interface circuitry and PALs.

DEFINICON 68020 COPROCESSOR

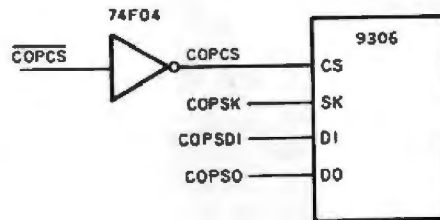
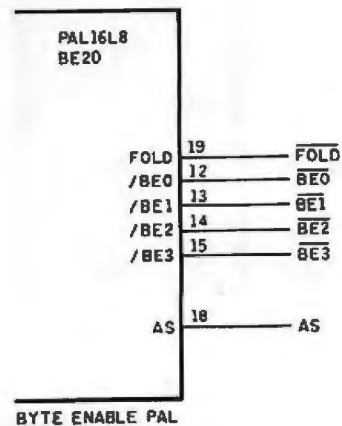
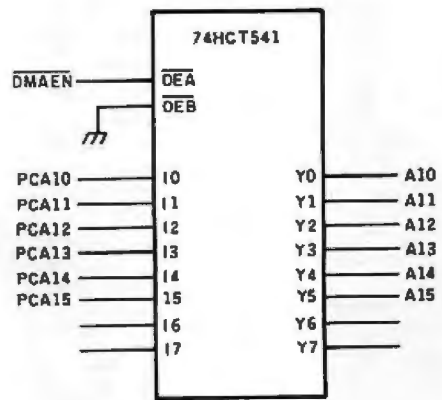
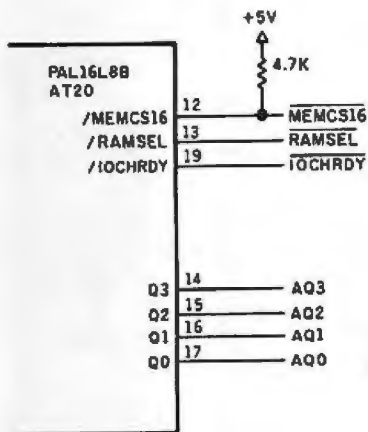
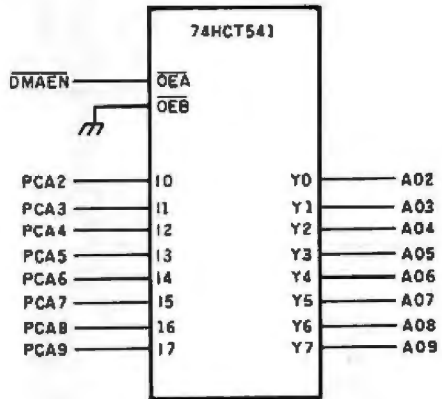
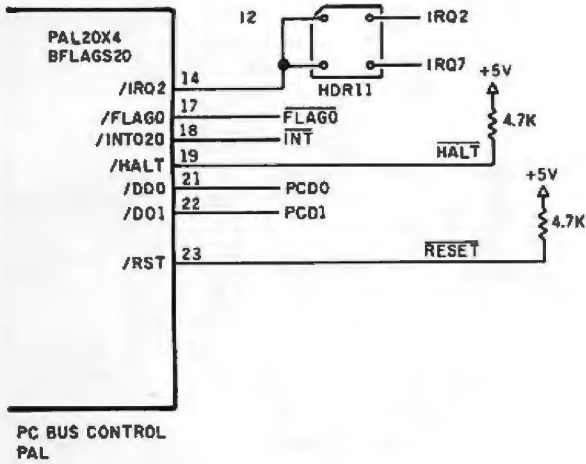
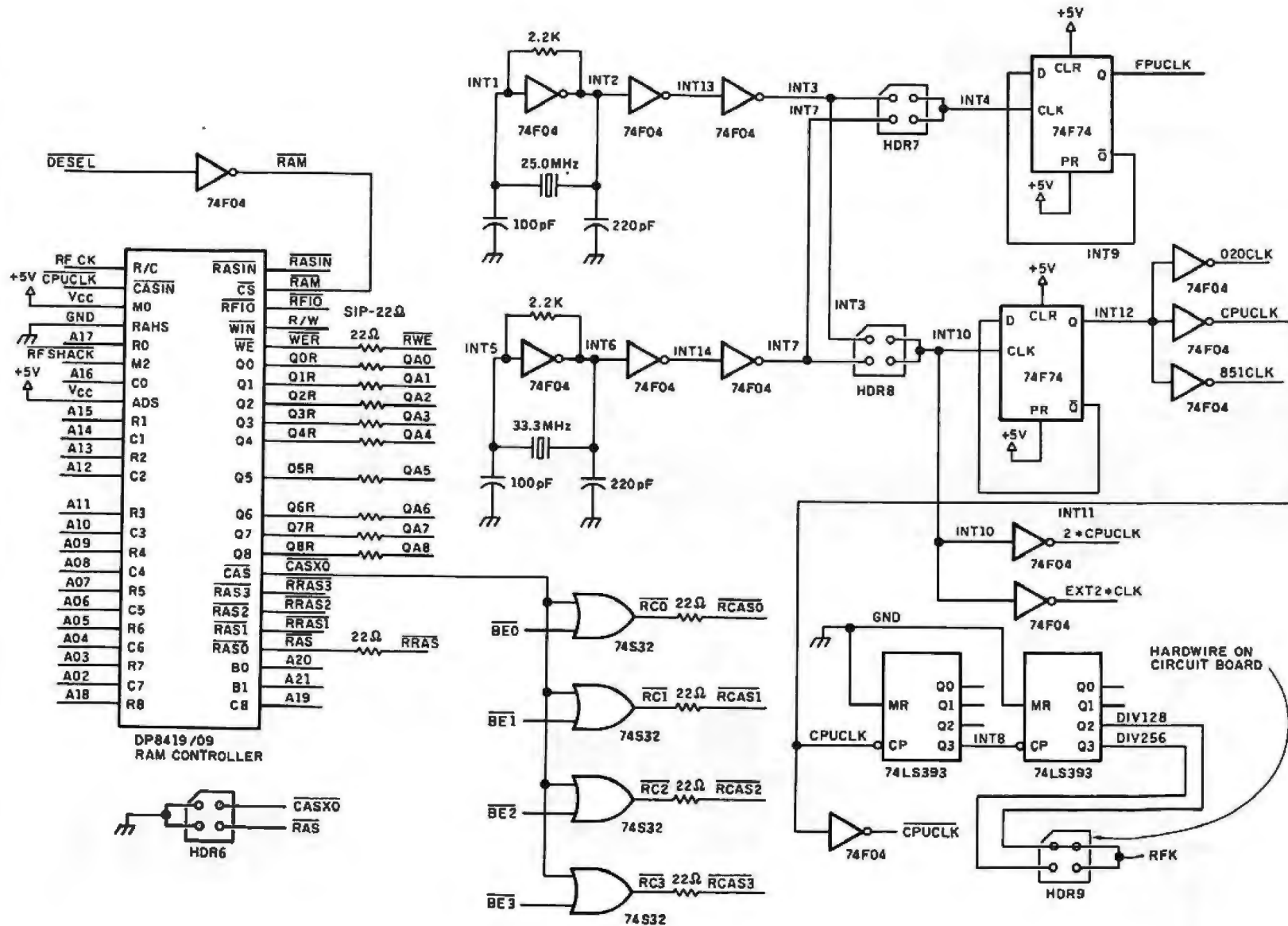

Figure 5: RAM controller circuitry.



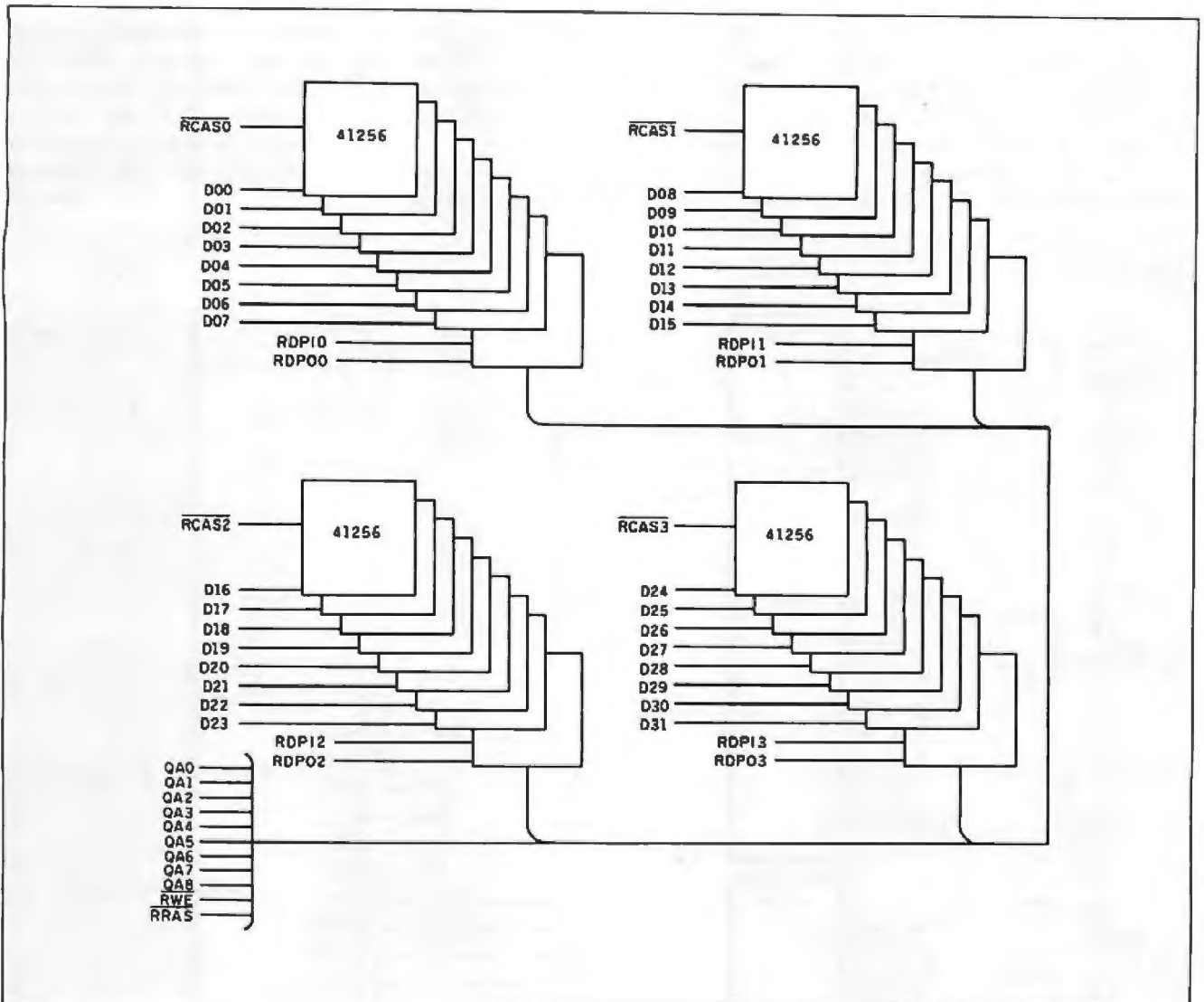

Figure 6: Memory array.

bus so that it can be read by the host computer's data bus.

Despite the number of discrete operations during a DMA transfer, the entire cycle is usually performed in less than a microsecond. Since the 68020 continues to process instructions within its cache, DMA transfers usually do not significantly affect execution speed. This allows a graphics application to continuously update the display adapter's screen without slowing the formation of the next image.

WHY INTEL DOESN'T TALK TO MOTOROLA

A major difficulty arises when interfacing an Intel-like processor (such as

the 8088 or 80286) with any of the Motorola processors. The Intel architecture defines that, starting at the base address (usually 0) the first byte (at address offset 0) holds data bits 0-7 (see table 2), the second byte (at address offset 1) holds data bits 8-15, and the third and fourth bytes hold data bits 16-31.

Motorola, however, has defined that the first byte holds bits 24-31 and so on in exactly the reverse order. This has the advantage that when you examine a hexadecimal dump of Motorola memory the data is exactly as you read it, the most significant byte first, least significant last, and no mental reordering of bytes is necessary. The disadvantage is, of course, that

the DSI-020 design had to provide for this byte reordering, so that data from the PC's screen or disk files would appear to the 68020 rearranged in the correct byte order.

This feature is provided within the hardware design, as software fixes proved far too slow for disk I/O. If you look carefully at figure 4, you will note that A0 and A1, the two least significant (LS) address lines, are not used directly but go to a PAL, the Byte Enable (BE20) PAL, before they interface with any of the memory or peripherals. In addition, PCA0 and PCA1, the LS address lines from the PC, also go to this PAL. Table 2 gives the design equations for this PAL. It can

(continued)

be seen that it takes the lower address lines, the HLDA86 signal (to indicate if the cycle is a processor cycle or a DMA cycle), and the SIZE outputs from the processor and decodes them to four independent Byte Enable outputs (BE0-BE3). These are

used to enable the appropriate data lines to the data bus. If a full 32-bit word is being fetched by the CPU, all four will be active; if only 8 bits, then only one will be active.

One incompatibility still exists, however. If a WORD WRITE is performed

by an IBM PC XT into the DMA memory, the least significant and most significant bytes will be swapped. Consequently, you must be careful to use byte data transfers or remember to reverse the order of the bytes over

(continued)

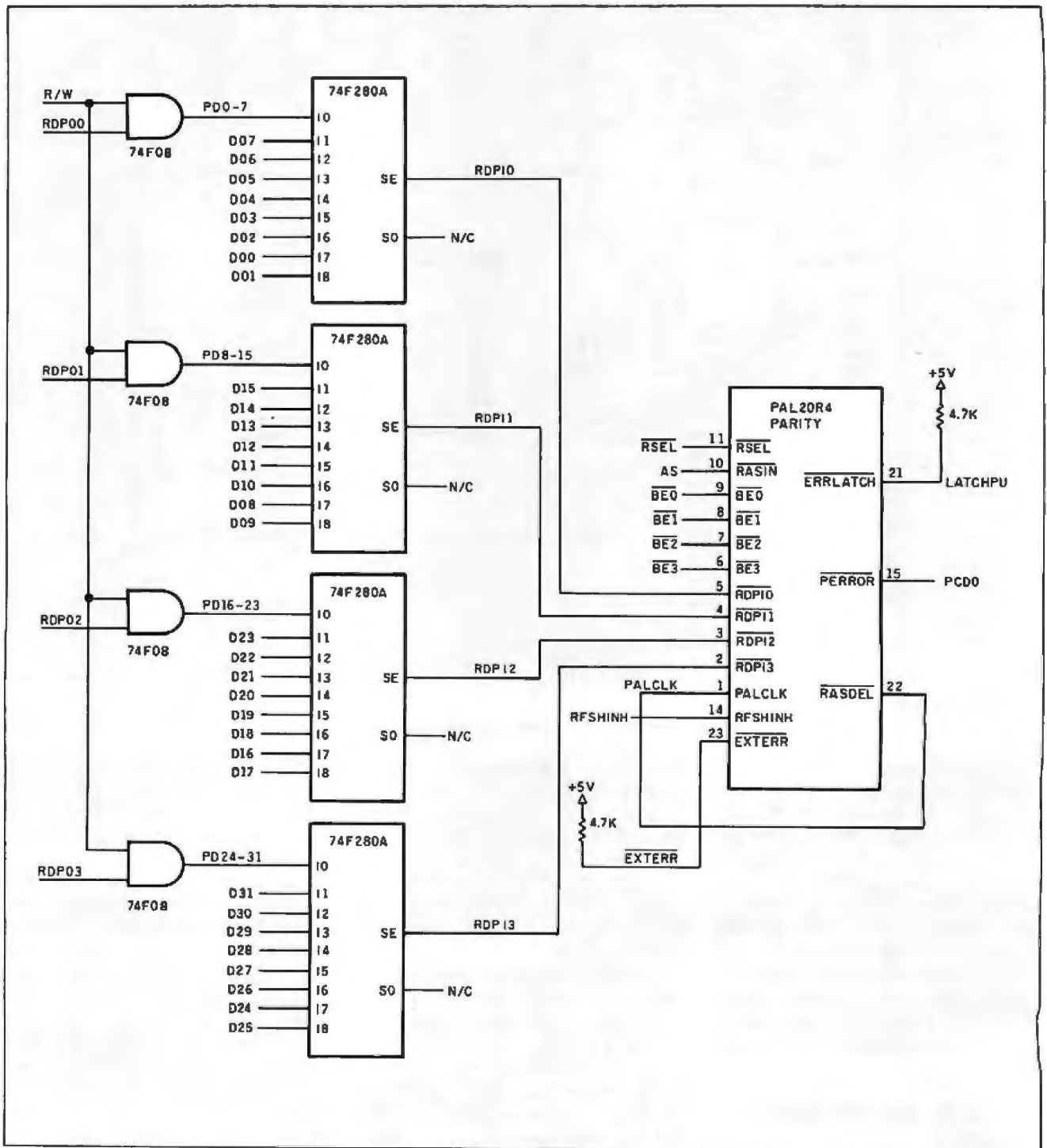

Figure 7: Parity generation and detection circuits.



Western Computer 286 Turbo™

Standard Features

- IBM PC/AT Compatible with 512K RAM
- Up to 1 Megabyte of system memory on the main board
- Switch selectable 8 or 10 MHz operation with one wait state on memory access (80286-10)
- One parallel port/one serial port and Clock/Calendar on main board
- Optional Serial Port on board
- Mass storage options from 20 to 140 Megabyte Hard Disk Drives and 20 to 60 Megabyte tape backup systems
- EGA video options available for CAD/CAM, word processing, etc. . . .
- One year factory warranty

Western Computer has high quality computers at very competitive quantity pricing.

Western Computer XT Turbo™

Standard Features

- IBM PC/XT compatible with 640K RAM on main board
- 4.77 or 8 MHz operation (CPU board made in U.S.A.)
- Two 360K Floppy Disk Drives
- Hercules compatible monochrome graphics controller (720 x 350) or IBM compatible color graphics adapter (320 x 200 - four colors or 640 x 200 - two colors) and parallel printer port
- Monochrome monitor (Composite or TTL input)
- IBM PC/AT style keyboard
- Various hard disk drive and tape backup options available
- One Year Factory Warranty



Western Computer

17781 MITCHELL STREET
IRVINE, CA 92714 U.S.A.
PHONE (714) 553-1611
Customer Service Only
(714) 553-1705
TELEX 756 731 - Answer Back
WESTERN COMP
FAX (714) 553-1705

Western Computer

"For High Technology and Performance"

European Head Office

BELECTRONIC SA,
RUE CENTRALE 43
CH-1880-BEX, SWITZERLAND
PHONE (025) 631250
TELEX 456 168
Answer Back BELE CH.

Table 1: DSI-020's memory-addressing technique.

The DSI-020's memory is all available to the host 8088/286. It appears as a 64K-byte "window" that can be steered through the 16-megabyte total address space by latching a "segment select" value at the segment port.

There are two distinct address spaces at which DSI-020 can be operated:

HDR10 position	Memory Base	Segment Port	BFLAGS Port
Ground	E0000 Hex	160 Hex	150 Hex
V _{cc}	D0000 Hex	2B0 Hex	2A0 Hex

Use the ground position for XT clones only, the V_{cc} position can be used with either XT or AT clones.

The BFLAGS control port is used for PC bus I/O control.

When READ by the PC:

Bit 0, if low, indicates that a parity error has occurred.

Bit 1 is a copy of the FLAG1 output of the DUART.

When WRITTEN by the PC (all outputs to the 68020 are latched)

Bit 0, when high, asserts HALT to the 68020.

Bit 1, when high, asserts INTO20 to the 68020.

Bit 2, when high, resets the 68020.

Bit 3 is FLAG0, which may be read by the VEC20 PAL.

A number of status bits can be read from the VEC20 PAL:

Bit 0 is used by diagnostics to check the state of the Refresh Inhibit signal.

Bit 1 shows the state of the RS-232C RIB signal.

Bit 2 reads the data from the COPS EEPROM serial number chip.

Bit 3 shows the state of the RS-232C DCDB signal.

Bit 4 allows the 68020 to read the FLAG0 signal from the 8086.

PC Scheme— a simple, modern LISP for under \$100.

Texas Instruments presents PC Scheme, the \$95* solution to your symbolic processing needs.

Whether you're an experienced LISP user, or just beginning to discover the power of symbolic programming languages, PC Scheme is the right product for you. It runs on IBM® Personal Computers, as well as the TI Professional Computer family, including the Business-Pro™ computer.

Powerful features include an optimizing incremental compiler for ease of programming and fast execution; an EMACS-like editor; extensions for debugging, graphics, and windowing; DOS-CALL capability; and a programming system for the development of object-oriented

applications—all designed to work efficiently on personal computers.

To order, or for more information, call toll-free:

1-800-527-3500

*Suggested list price.

Business-Pro is a trademark of Texas Instruments Incorporated. IBM is a registered trademark of International Business Machines Corporation.

**TEXAS
INSTRUMENTS**

Creating useful products
and services for you.

©1986 TI 261765-02

Two great reasons to buy Turbo Pascal™

System Builder™ \$99⁹⁵ and Report Builder™ \$75⁰⁰

From the Designer Series™ by Royal American Technologies.

Now, experience the magic of 5th generation software.

It's a state-of-the-art program generator that automatically builds a relational database application for you in just seconds. You just paint your screen and datafile layouts.

SO EASY... Ideal for entry level "coders" to produce relational database systems without coding. (Entry level guide with sample On-disk systems is provided.)
SO POWERFUL... it provides programming professionals with more flexibility and horsepower than any development tool on the market (guide is provided.)



REPORT BUILDER CYCLE:

- Key in the report parameters on screen
- Print your listings
 - New report format for reference
 - Report element layout
- Key in the report data elements on screen
- Report Builder automatically writes the program code and links it to your datafile
- Print your listing
 - Report program source code listings
- Compile the report builder code using the Turbo Pascal™ compiler
- Attach the new report module to your system menu

SYSTEM BUILDER CYCLE:

- Paint the menu screens
- Paint the application screens
- Define the datafile(s) on the screen
- System Builder automatically writes the program code and combines the datafiles into a relational database
- Print your listings
 - Program source code listing
 - Datafile layouts
 - Self-documenting program (includes screen schematics)
- Compile the System Builder code using Turbo Pascal™ compiler
- Start using the completed system

*System Builder will generate 2,000 lines of program code in approximately 6 seconds.

REPORT BUILDER FEATURES:

- Automatically generates Indented, Structured Source Code ready for compiling Turbo Pascal (no programming needed)
- Automatically interfaces to a maximum of 16 Datafiles created with System Builder
- Supports Global Parameters such as Headings, Footers, Lines Per Page, Print Size and Ad Hoc Sorting
- Produces reports containing an unlimited number of Sub-Headings, Sub-Totals and Totals
- Page breaks on Sub-Totals
- Report Builder will generate Report Programs which can contain Report Elements not just restricted to Data Elements. Reports can also include Text Strings, Variables or Computed expressions containing references from up to 16 Datafiles
- Use range input screens produced by System Builder to allow End Users to select portions of a report as needed (i.e. specific account ranges can be requested)
- Produces standalone Report Modules
- Easy-to-use Interface Program to access dBase Files

SYSTEM BUILDER FEATURES:

- Automatically generates Indented, Structured, Copy Book Source Code ready for compiling with Turbo Pascal (no programming needed)
- Paint Application and Menu screens using Keyboard or Microsoft Mouse™
- Finished Application screens all use System Builder's In-Line machine code for exceptional speed
- Use fully prompted Screen Guidance Templates™ to define up to 16 Datafiles per application, each record having an Unlimited Number of fields
- Define up to 16 Index Keys per application database
- Paint functions include:
 - Center, copy, move, delete, insert or restore a line, Go straight from screen to screen with one keystroke
 - Cut and paste blocks of text screen to screen
 - Draw and erase boxes, Define colors and intensities
 - Access special graphic characters and character fill
- Supports an unlimited number of memory variables
- File Recovery Program Generator to make fixing of corrupted datafiles an automatic process
- Automatically modifies datafiles without loss of data when adding/deleting a field
- Menu Generator with unlimited Sub-Menu levels
- Experienced developers can modify the System Builder
- Develop systems for Floppy or Hard Disk
- Modify System Builder's output code to include External Procedures, Functions and Inline Code
- Easy-to-use Interface to access ASCII and dBase Files

SYSTEM BUILDER PERFORMANCE (Typical 10 screen 8 file/index application)

TASK	SYSTEM BUILDER	DBASE III™
Planning and Design	60 minutes	60 minutes
Screen Painting	15 minutes	3 hours
Programming	2 minutes	10 hours
Elapsed time to completed system	1 hour and 17 minutes	14 hours

VARS, System Integrators and Dealers, let's work together. Your inquiries are always welcome. (415) 397-7500.

"I think it's wonderful... prospective buyers should seriously consider DESIGNER even before dBASE III."

*Mr. Greg Weale
Corporate Accounts Manager,
Computerland*

"We used DESIGNER last year to program a major application. It saved our programmers so much time. We now use DESIGNER instead of dBASE III as our development standard!"

*Mr. Peter Barge, Director
Services Division, Horwath & Horwath*

"DESIGNER has resulted in significant time savings... We use it on classical database applications!"

*Mr. Andy Rudevics, Director
Andrasoft Corporation*

Royal American Technologies
201 Sansome, Suite 500
San Francisco, CA 94104

(800)654-7766
California (800)851-2555
Ask for Operator 105.

Please rush me: _____ copies of SYSTEM BUILDER at \$99.95 per copy; _____ copies of REPORT BUILDER at \$75.00 per copy. I've enclosed \$5.00 for postage and handling. California residents add 6% sales tax.

Name _____

Address _____

City _____

State _____ Zip _____

Phone _____

Payment: Check Money Order

Cashiers Check AMEX

VISA MASTERCARD

Expiration date _____

Card Number _____

Signature _____

30-Day Money-Back Guarantee. Not copy protected. \$10 restocking fee if envelope is opened.

System Requirements—System Builder/Report Builder, IBM PC/XT/AT™, or similar, with minimum 256K RAM, dual floppy drives, or hard disk, color or monochrome monitor, MS™ or PC DOS™ version 2.0 or later, Turbo Pascal Version 2.0 or later (Normal, BCD or 8087 versions).

™Trademarks of International Business Machines Corp.

™Trademark of Microsoft Corp.

™Turbo Pascal is a registered trademark of Borland International.

™dBASE is a registered trademark of Ashton-Tate.

ROYAL AMERICAN Technologies Corporation™

The 68020 coprocessor runs UNIX software tools without a UNIX kernel.

tained by a word transfer when writing PC interface software for the DSI-020.

THE BIDIRECTIONAL LATCHES
The 68020 instruction cycles are very much faster than those of the 8088/

286. This means that at the end of a bus cycle, after the 68020 has been released from the DMA task, the PC bus interface still requires the DMA data to be valid. Thus, on a PC bus READ cycle, the DMA data byte has to be latched while RAM data is valid so that it can be made available to the host asynchronously. This is the function of the 74HCT646 latches (see figure 9).

The RASIN (strobe) signal is activated by the DPORT20 PAL at the end of the DMA cycle to latch the data. The RAM array is further stabilized by filter capacitors on the board (figure 10). When the PC writes to the

DSI-020, the latches remain transparent for the total cycle, however.

THE OPERATING SYSTEM

The basic operating system for programming or operating the DSI-020 is MS-DOS (or PC-DOS). Definicon has implemented an interface between the 8088/80286 and the 68020 that allows the 68020 to run UNIX-quality development tools without requiring either a UNIX kernel or a UNIX file system. The system calls are accessed via the 68020 TRAP #14 instruction. The text box "DSI-020 Kernel Functions" on page 142 provides a list of

(continued)

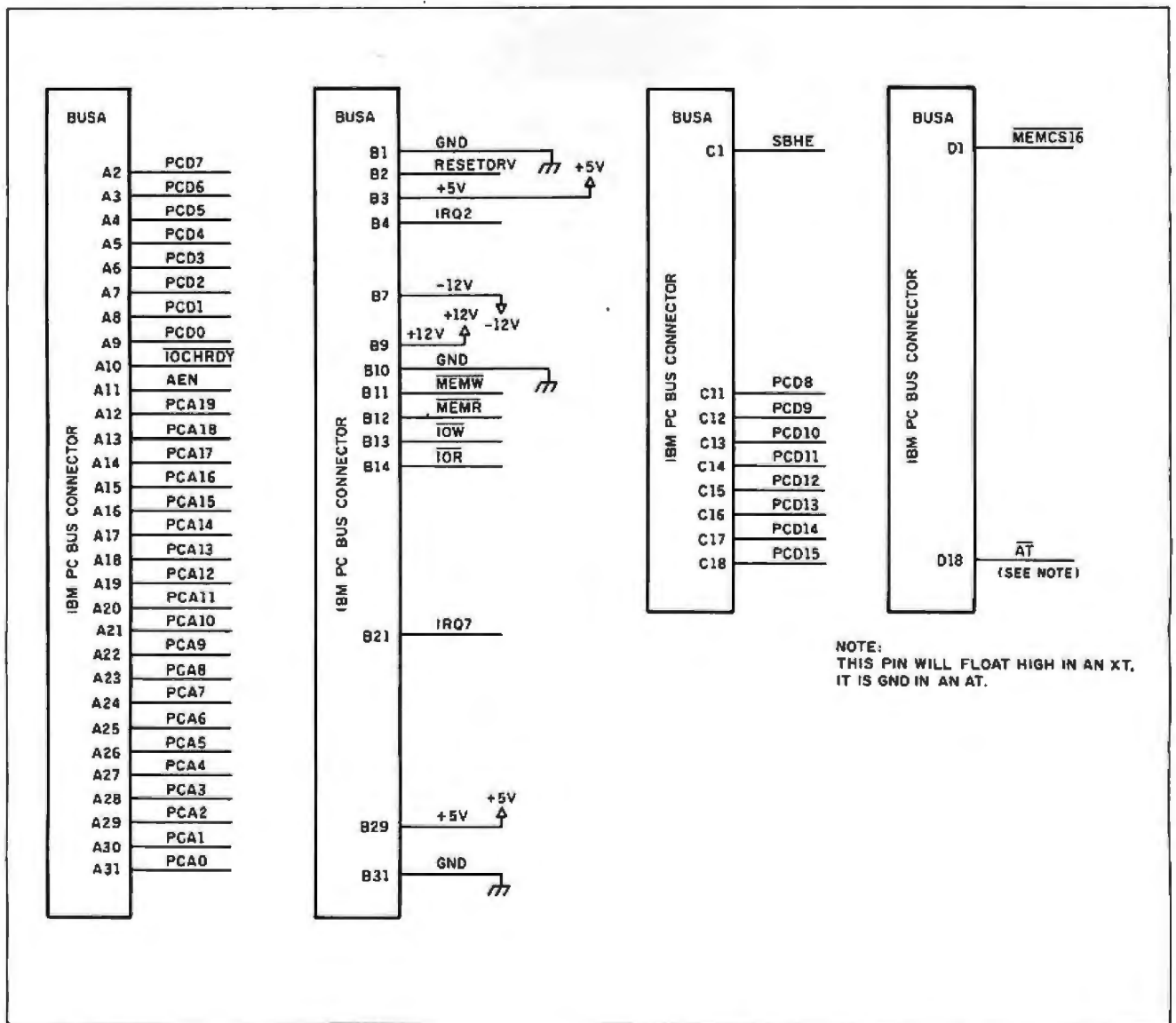
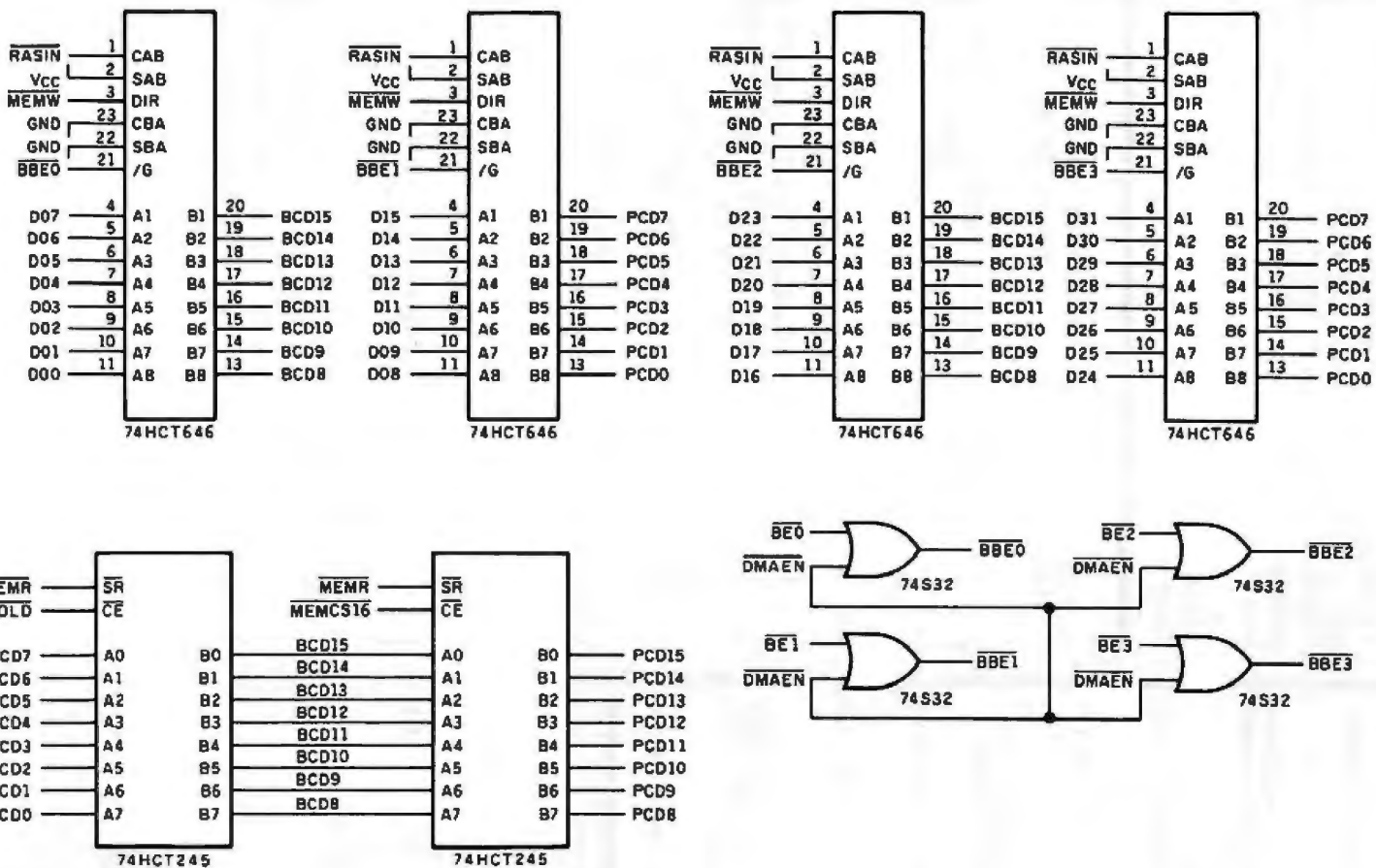

Figure 8: PC bus connections.

Figure 9: PC bus interface latches.



MetaComCo™ Languages

Atari ST™ • Amiga™ • QL™

LATTICE® C

The well known LATTICE® C compiler, full featured portable implementation.

MCC™ PASCAL

An ISO/ANSI standard Pascal. A fast single pass compiler, ideal for commercial, educational and personal use.

MCC™ ASSEMBLER

A professional standard macro assembler with many powerful features.

CAMBRIDGE LISP

LISP interpreter/compiler providing a complete LISP development environment.

BCPL

A powerful compiler offering the convenience of a high level language with the flexibility of an assembler.

APL

Keyword and symbolic versions of this important language from MicroAPL.

MCC™ BASIC

68000 BASIC interpreters and compilers from MetaComCo.

MENU +™

An easy to use program environment with pull-down menus. Menu+ comes free with Atari software. Upgrades ready for registered users.

TOOLKIT

Provides useful tools and utilities. From the people who wrote AmigaDOS.

Product	Atari™ ST	Commodore™ Amiga	Sinclair™ QL
Lattice C	\$149.95	\$149.95	\$129.95
Pascal	\$99.95	\$99.95	\$99.95
Assembler	\$79.95	*	\$49.95
Lisp	TBA	\$199.95	\$79.95
BCPL	TBA	TBA	\$79.95
APL	\$199.95	TBA	\$129.95
Basic	†	*	—
MENU+	\$29.95	TBA	—
TOOLKIT	TBA	\$49.95	—

* = available from Commodore

† = available from Atari

Cambridge LISP is available for CP/M-68K™

QL Lisp includes Interpreter only



The Quality Source for 68000 Software
5353 #E Scotts Valley Dr., Scotts Valley, CA 95066

Contact your local dealer or call:

Tel: US 800-AKA-META

Cal 800-GET-META, Eur (UK) 44-272-426781

Telex (UK) 444874 METACO G

Add 6.5% tax if CA resident.

Lattice is a registered trademark of Lattice Inc.
Amiga and AmigaDOS is a trademark of Commodore-Amiga Inc.
Atari ST is a registered trademark of Atari Inc.
CP/M-68K is a trademark of Digital Research Inc.

DEFINICON 68020 COPROCESSOR

the available system calls. Note that functions 5 through 15 emulate the basic UNIX I/O system. Thus, STDIN (the keyboard) is treated as a FILE with a handle of 0, while STDOUT (the CRT) is addressed as a FILE with a handle of 1. These functions cannot interfere with the operation of the host PC, and it is recommended that you use them in preference to the enhanced interface calls (1,16-25). These enhanced calls, if invoked with

faulty syntax, are sufficiently powerful to interfere with the operation of the MS-DOS system itself.

Note that any peripheral available to the host CPU is also available to the 68020. Bit-mapped graphics adapters are programmed directly using functions 16 through 19, networking is implicitly supported by the DOS file system, and specialized peripherals, such as A/D converters, can be accessed

(continued)

Table 2: Comparison of Motorola and Intel memory arrangement and the hardware logic interface required for translating the data.

	ADDRESS 0	ADDRESS 1	ADDRESS 2	ADDRESS 3
	LSB ... MSB	LSB ... MSB	LSB ... MSB	LSB ... MSB
INTEL DATA BITS	D0 ... D7	D8 ... D15	D16 ... D23	D24 ... D31
MOTOROLA DATA BITS	D24 ... D31	D16 ... D23	D8 ... D15	D0 ... D7
BYTE ENABLE	BE3	BE2	BE1	BE0

	ADDRESS 0	ADDRESS 1	ADDRESS 2	ADDRESS 3
	LSB ... MSB	LSB ... MSB	LSB ... MSB	LSB ... MSB
INTEL DATA BITS	D0 ... D7	D8 ... D15	D16 ... D23	D24 ... D31
MOTOROLA DATA BITS	D24 ... D31	D16 ... D23	D8 ... D15	D0 ... D7
BYTE ENABLE	BE3	BE2	BE1	BE0

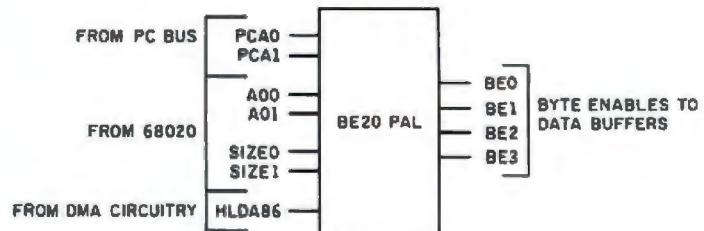

PAL EQUATIONS:

BE0 = $\overline{HLDA86} \cdot \overline{PCA0} \cdot \overline{PCA1}$:This is the PC bus decode term
 + $\overline{HLDA86} \cdot \overline{A00} \cdot \overline{SIZE0} \cdot \overline{SIZE1}$:These next four implement the decode
 + $\overline{HLDA86} \cdot \overline{SIZE0} \cdot \overline{SIZE1}$:schematic from page 5-17 of the
 + $\overline{HLDA86} \cdot \overline{A00} \cdot \overline{A01}$:Motorola MC68020 User's Manual.
 + $\overline{HLDA86} \cdot \overline{A01} \cdot \overline{SIZE1}$

BE1 = $\overline{HLDA86} \cdot \overline{PCA1} \cdot \overline{PCA0}$:The remaining equations are
 + $\overline{HLDA86} \cdot \overline{A00} \cdot \overline{A01}$:constructed in a similar fashion.
 + $\overline{HLDA86} \cdot \overline{A01} \cdot \overline{SIZE0} \cdot \overline{SIZE1}$
 + $\overline{HLDA86} \cdot \overline{A01} \cdot \overline{SIZE0} \cdot \overline{SIZE1}$
 + $\overline{HLDA86} \cdot \overline{SIZE0} \cdot \overline{A00} \cdot \overline{A01}$

BE2 = $\overline{HLDA86} \cdot \overline{PCA0} \cdot \overline{PCA1}$
 + $\overline{HLDA86} \cdot \overline{SIZE0} \cdot \overline{A01}$
 + $\overline{HLDA86} \cdot \overline{A01} \cdot \overline{A00}$
 + $\overline{HLDA86} \cdot \overline{SIZE1} \cdot \overline{A01}$

BE3 = $\overline{HLDA86} \cdot \overline{PCA0} \cdot \overline{PCA1}$
 + $\overline{HLDA86} \cdot \overline{A00} \cdot \overline{A01}$



The C for Microcomputers

PC-DOS, MS-DOS, CP/M-86, Macintosh, Amiga, Apple II, CP/M-80, Radio Shack, Commodore, XENIX, ROM, and Cross Development systems

MS-DOS, PC-DOS, CP/M-86, XENIX, 8086/80x86 ROM

Manx Aztec C86

"A compiler that has many strengths ... quite valuable for serious work"

Computer Language review, February 1985

Great Code: Manx Aztec C86 generates fast executing compact code. The benchmark results below are from a study conducted by Manx. The Dhrystone benchmark (CACM 10/84 27:10 p1018) measures performance for a systems software instruction mix. The results are without register variables. With register variables, Manx, Microsoft, and Mark Williams run proportionately faster, Lattice and Computer Innovations show no improvement.

	Execution Time	Code Size	Compile/Link Time
Dhrystone Benchmark			
Manx Aztec C86 3.3	34 secs	5,760	93 secs
Microsoft C 3.0	34 secs	7,146	119 secs
Optimized C86 2.20J	53 secs	11,009	172 secs
Mark Williams 2.0	56 secs	12,980	113 secs
Lattice 2.14	89 secs	20,404	117 secs

Great Features: Manx Aztec C86 is bundled with a powerful array of well documented productivity tools, library routines and features.

Optimized C compiler	Symbolic Debugger
AS86 Macro Assembler	LN86 Overlay Linker
80186/80286 Support	Librarian
8087/80287 Sensing Lib	Profiler
Extensive UNIX Library	DOS, Screen, & Graphics Lib
Large Memory Model	Intel Object Option
Z (v) Source Editor -c	CP/M-86 Library -c
ROM Support Package -c	INTEL HEX Utility -c
Library Source Code -c	Mixed memory models -c
MAKE, DIFF, and GREP -c	Source Debugger -c
One year of updates -c	CP/M-86 Library -c

Manx offers two commercial development systems, Aztec C86-c and Aztec C86-d. Items marked -c are special features of the Aztec C86-c system.

Aztec C86-c Commercial System	\$499
Aztec C86-d Developer's System	\$299
Aztec C86-p Personal System	\$199
Aztec C86-a Apprentice System	\$49

All systems are upgradable by paying the difference in price plus \$10.

Third Party Software: There are a number of high quality support packages for Manx Aztec C86 for screen management, graphics, database management, and software development.

C-tree \$395	Greenleaf \$185
PHACT \$250	PC-lint \$98
HALO \$250	Amber Windows \$59
PRE-C \$395	Windows for C \$195
WindScreen \$149	FirstTime \$295
SunScreen \$99	C Util Lib \$185
PANEL \$295	Plink-86 \$395

MACINTOSH, AMIGA, XENIX, CP/M-68K, 68k ROM

Manx Aztec C68k

"Library handling is very flexible ... documentation is excellent ... the shell a pleasure to work in ... blows away the competition for pure compile speed ... an excellent effort."

Computer Language review, April 1985

Aztec C68k is the most widely used commercial C compiler for the Macintosh. Its quality, performance, and completeness place Manx Aztec C68k in a position beyond comparison. It is available in several upgradable versions.

Optimized C Macro Assembler	Creates Clickable Applications
Overlay Linker	Mouse Enhanced SHELL
Resource Compiler	Easy Access to Mac Toolbox
Debuggers	UNIX Library Functions
Librarian	Terminal Emulator (Source)
Source Editor	Clear Detailed Documentation
MacRam Disk -c	C-Stuff Library
Library Source -c	UniTools (vi,make,diff,grep) -c
	One Year of Updates -c

Items marked -c are available only in the Manx Aztec C86-c system. Other features are in both the Aztec C86-d and Aztec C86-c systems.

Aztec C68k-c Commercial System	\$499
Aztec C68k-d Developer's System	\$299
Aztec C68k-p Personal System	\$199
C-tree database (source)	\$399

AMIGA, CP/M-68k, 68k UNIX call

Apple II, Commodore, 65xx, 65C02 ROM

Manx Aztec C65

"The AZTEC C system is one of the finest software packages I have seen"

NIBBLE review, July 1984

A vast amount of business, consumer, and educational software is implemented in Manx Aztec C65. The quality and comprehensiveness of this system is competitive with 16 bit C systems. The system includes a full optimized C compiler, 6502 assembler, linkage editor, UNIX library, screen and graphics libraries, shell, and much more. The Apple II version runs under DOS 3.3, and ProDOS, Cross versions are available.

The Aztec C65-c/128 Commodore system runs under the C128 CP/M environment and generates programs for the C64, C128, and CP/M environments. Call for prices and availability of Apprentice, Personal and Developer versions for the Commodore 64 and 128 machines.

Aztec C65-c ProDOS & DOS 3.3	\$399
Aztec C65-d Apple DOS 3.3	\$199
Aztec C65-p Apple Personal system	\$99
Aztec C65-a for learning C	\$49
Aztec C65-c/128 C64, C128, CP/M	\$399

Distribution of Manx Aztec C

In the USA, Manx Software Systems is the sole and exclusive distributor of Aztec C. Any telephone or mail order sales other than through Manx are unauthorized.

Manx Cross Development Systems

Cross developed programs are edited, compiled, assembled, and linked on one machine (the HOST) and transferred to another machine (the TARGET) for execution. This method is useful where the target machine is slower or more limited than the HOST. Manx cross compilers are used heavily to develop software for business, consumer, scientific, industrial, research, and educational applications.

HOSTS: VAX UNIX (\$3000), PDP11 UNIX (\$2000), MS-DOS (\$750), CP/M (\$750), MACINTOSH (\$750), CP/M-68k (\$750), XENIX (\$750).

TARGETS: MS-DOS, CP/M-86, Macintosh, CP/M-68k, CP/M-80, TRS-80 3 & 4, Apple II, Commodore C64, 8086/80x86 ROM, 68xxx ROM, 8080/8085/Z80 ROM, 65xxx ROM.

The first TARGET is included in the price of the HOST system. Additional TARGETS are \$300 to \$500 (non VAX) or \$1000 (VAX).

Call Manx for information on cross development to the 68000, 65816, Amiga, C128, CP/M-68k, VRTX, and others.

CP/M, Radio Shack, 8080/8085/Z80 ROM

Manx Aztec CII

"I've had a lot of experience with different C compilers, but the Aztec C80 Compiler and Professional Development System is the best I've seen."

80-Micro, December, 1984, John B. Harrell III

Aztec C II-c (CP/M & ROM)	\$349
Aztec C II-d (CP/M)	\$199
C-tree database (source)	\$399
Aztec C80-c (TRS-80 3 & 4)	\$299
Aztec C80-d (TRS-80 3 & 4)	\$199

How To Become an Aztec C User

To become an Aztec C user call 1-800-221-0440 or call 1-800-832-9273 (800-TEC WARE). In NJ or outside the USA call 201-530-7997. Orders can also be released to 4995812.

Payment can be by check, COD, American Express, VISA, Master Card, or Net 30 to qualified customers.

Orders can also be mailed to Manx Software Systems, Box 55, Shrewsbury, NJ 07701.

How To Get More Information

To get more information on Manx Aztec C and related products, call 1-800-221-0440, or 201-530-7997, or write to Manx Software Systems.

30 Day Guarantee

Any Manx Aztec C development system can be returned within 30 days for a refund if it fails to meet your needs. The only restrictions are that the original purchase must be directly from Manx, shipped within the USA, and the package must be in resalable condition. Returned items must be received by Manx within 30 days. A small restocking fee may be required.

Discounts

There are special discounts available to professors, students, and consultants. A discount is also available on a "trade in" basis for users of competing systems. Call for information.

Inquiry 217

MANX

To order or for information call:

800-221-0440

DRIVE INN

Enclosures
& power
supplies for
**FLOPPY,
WINCHESTER,
TAPE DRIVES,
SINGLE
BOARD
COMPUTERS
&
\$-100
SYSTEMS.**

8 inch
5 inch
3 inch

**CUSTOMIZING
AVAILABLE**

Call or write
for free
catalogs
and
application
assistance

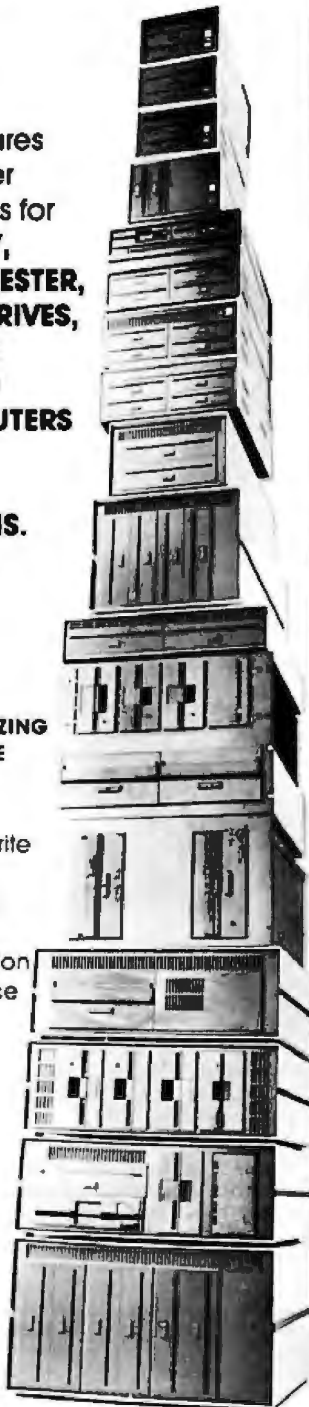

INTEGRAND

RESEARCH CORPORATION
8620 Roosevelt Ave. • Visalia, CA 93291
209/651-1203

TELEX 5106012830 (INTEGRAND UD)
EZLINK 62926572

We accept BankAmericard/VISA
and MasterCard

DEFINICON 68020 COPROCESSOR

using the I/O facilities (functions 20 and 21). In addition, any MS-DOS program that installs itself as an 8088/80286 interrupt process can be accessed via function 25. Most mice and many hardware drivers can be accessed in this way. COM1:, COM2:, and PRN: are accessed by opening files called COM1, COM2, or PRN.

Next month the DSI-020 software support will be discussed in detail.

PERFORMANCE

While almost every reader took the trouble to look at the benchmarks

published in the DSI-32 article, apparently only a handful actually believed we had not specifically made them up to favor the 32032! Consequently, the benchmark used to characterize the DSI-020 performance was not written by Definicon. This program is generally regarded as an "industry-standard" benchmark. This has the added advantage that you will be able to find a plethora of data tabulating the relative performance of other computers. Also, a special 16.7-MHz version of the DSI-020 was assem-

(continued)

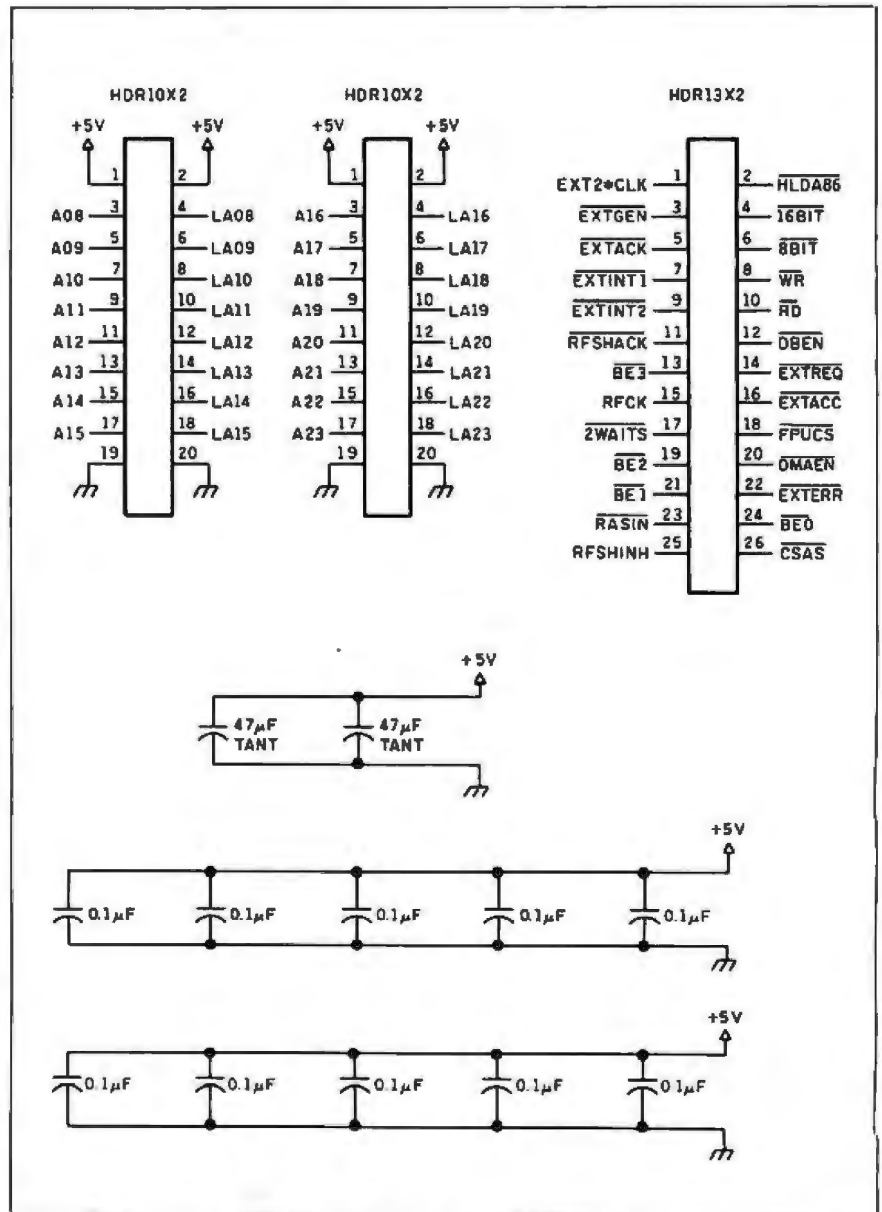

Figure 10: Headers and filter capacitors for the DSI-020.

CAD — \$299 !

Finally you can get a complete CAD package at a reasonable price! For only \$299, ProDesign II provides the advanced features you get on CAD systems costing thousands of dollars. But there is another, very important reason you should get ProDesign II. ProDesign II is very unique among CAD packages. It is easy to learn and use. When we call ProDesign II "The Easy to Use CAD System", we're not joking. You will be productive with ProDesign II in an hour or two instead of a week or two.

What else does ProDesign II offer? Compatibility. Compatibility with over 100 printers. Compatibility with over 50 plotters. Compatibility with most graphics adapters, digitizing tablets, and mice. Compatibility with most display adapters. Compatibility with any software that can produce HP plotter commands. Compatibility with mainframe CAD systems (IGES). All at no extra charge!

What additional hardware do you need? None! An IBM PC compatible and 512K RAM is all you

need. ProDesign II produces high resolution drawings on your dot matrix printer—better than .005" resolution on an IBM/Epson compatible printer. In fact, the drawings on this page were printed on a \$299 dot matrix printer! You don't have to get a mouse or digitizing tablet. ProDesign II is designed for easy and efficient keyboard use. You won't even need a math coprocessor, although it is supported. From a small drawing on a dot matrix printer to an E-Size drawing on a large plotter, ProDesign II is the one to use!

ProDesign II
Affordable, Compatible, and Usable!

Where can you get ProDesign II?
See your local computer dealer, or contact
American Small Business Computers

**118 South Mill
Pryor, OK 74361
(918) 825-4844**

Inquiry 24

IN GERMANY CALL 69-295111

F-18 HORNET DRAWN USING PRODESIGN II

- | | |
|-----------------------------------|-----------------------------------|
| 01. RADAR | 60. AFTERBURNER NOZZLE ACTUATORS |
| 02. FOUR ROTARY CANNON | 61. MOVING TAILPLANE |
| 03. AMMUNITION MAGAZINE | 62. TAILPLANE PIVOT MOUNTING |
| 04. WINGROOTS | 63. TAILPLANE HYDRAULIC ACTUATOR |
| 05. INSTRUMENT PANEL | 64. TURBOFAN ENGINE |
| 06. HEAD-UP DISPLAY | 65. AILERON HYDRAULIC ACTUATOR |
| 07. COCKPIT | 66. WING FOLD ACTUATOR |
| 08. EJECTION SEAT | 67. OVERBURNER AIR-TO-AIR MISSILE |
| 09. OVERSEAT EQUIPMENT | 68. LEADING FLAP ACTUATOR |
| 10. SECOND SEAT BRACE | 69. WING TANK |
| 11. LEADING EDGE DUCT EXTENSION | 70. LEADING FLAP DRIVE SHAFT |
| 12. FUEL/AIR TANKS | 71. EQUIPMENT GEARBOX |
| 13. LEADING EDGE FLAP | 72. AUXILIARY POWER TUBING |
| 14. WING TANK | 73. Oiler Landing Gear |
| 15. OVERBURNER AIR-TO-AIR MISSILE | 74. OVERBURNER AIR-TO-AIR MISSILE |
| 16. MISSILE LAUNCH RAIL | 75. LEADING FLAP DRIVE MOTOR |
| 17. NAVIGATION LIGHT | 76. MAIN RETRACT ACTUATOR |
| 18. WING FOLD WING JOINT | 77. FORWARD RETRACT ACTUATOR |
| 19. AILERON | 78. LIQUID BYPASS CONVERTER |
| 20. FLAP VANE | 79. BRANDING LADDER |
| 21. FLAP | 80. FORWARD LANDING GEAR |
| 22. HYDRAULIC RESERVOIR | 81. CATAPULT LAUNCH STRAP |
| 23. STROBE LIGHT | 82. CONTROL COLUMN |
| 24. RUBBER HYDRAULIC ACTUATOR | 83. RUBBER PEDALS |
| 25. NAVIGATION LIGHT | 84. AMMUNITION FEED CHUTE |
| 26. RADAR WARNING ANTENNA | 85. GUNLE OF ATTACK SENSOR |
| 27. FUEL JETTISON | 86. PILOT HEAD |
| 28. MOVING TAILPLANE | 87. FORMATION LIGHTING STRIP |
| 29. EEC ANTENNA | 88. RADAR EQUIPMENT BAY |
| 30. RADAR WARNING ANTENNA | 89. FORWARD EEC ANTENNA |
| 31. PROBABLY LIGHTING STRIP | 90. RADAR PIVOT MOUNTING |
| 32. AFTERBURNER NOZZLE | 91. RADAR SCANNER |

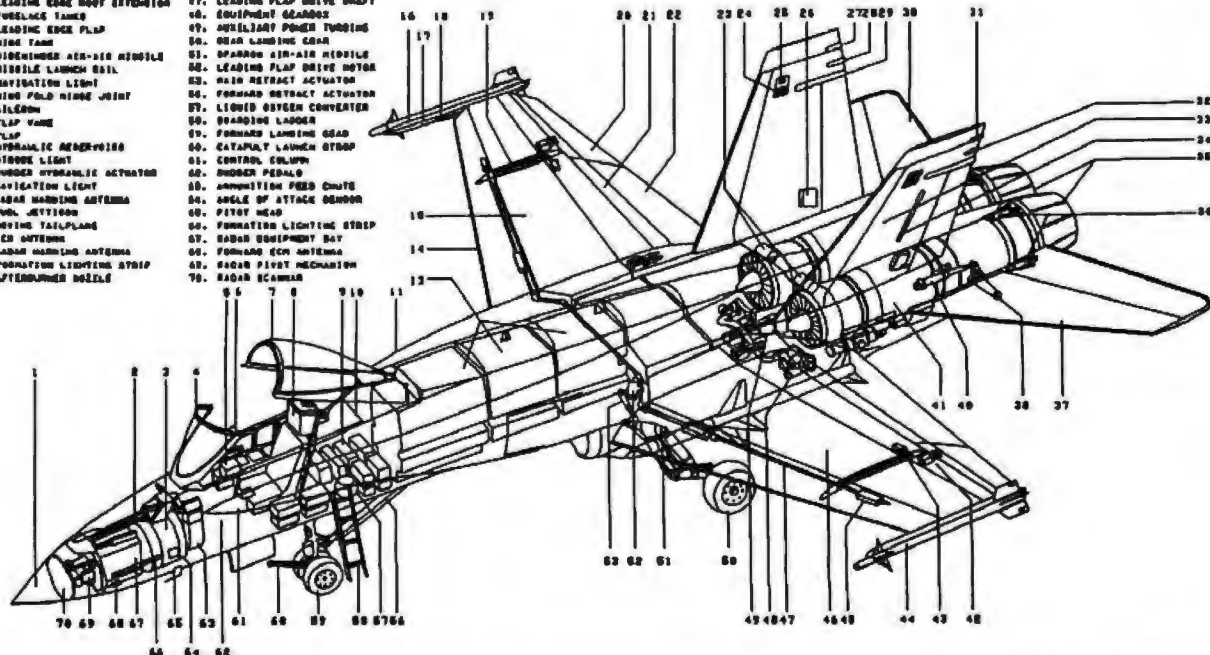

DSI-020 KERNEL FUNCTIONS

Register D0 is always used to communicate the function code to the kernel and will not be listed in the "entry parameters."

A suffix of .L, .W, or .B after a register shows the data size expected by the kernel.

The "no error" status code returned in D0 is 0000.

Address registers are always passed as 32-bit values.

FUNCTION 1—BDOS CALL

Used to communicate an MS-DOS system request (INT 21H) to the host. This function should be used only by experienced programmers.

Entry parameters: A0 DX argument
D1.B BDOS function code (AH argument)

Return parameter: D0.B AL return code, if any, else undefined

This function was implemented for system software development. BDOS functions that allow multibyte I/O (such as string in/out and file I/O operations) will not work properly if crossing 64K page boundaries.

FUNCTION 5—OPEN FILE

Entry parameters: A0 pointer to ASCIIZ filename with optional MS-DOS path specification
D1.W open mode, one of:

0 = read file
1 = write file
2 = read and write

Return parameters: D0.W file ID (handle), or FFFF = error and
D1.W error code

FUNCTION 6—CLOSE FILE

Entry parameter: D1.W file handle
Return parameters: D0.W status. If error,
D1.W error code

FUNCTION 7—CREATE FILE

Entry parameter: A0 pointer to ASCIIZ filename
Return parameters: D0.W file handle, or
FFFF = error and
D1.W error code

FUNCTION 8—READ FILE

Entry parameters: D1.W file handle
A0 disk transfer address (DTA)
D2.L number of bytes to read
Return parameters: D0.L actual number of bytes read, or
0000 = error and
D1.W error code

FUNCTION 9—WRITE FILE

Entry parameters: D1.W file handle
A0 DTA
D2.L number of bytes to write
Return parameters: D0.L actual number of bytes written,
or 0000 = error and
D1.L error code

FUNCTION 10—DELETE FILE (UNLINK)

Entry parameter: A0 pointer to ASCIIZ filename
Return parameters: D0.W status (0000 = file deleted) or
D1.W error code

FUNCTION 11—RENAME FILE

Entry parameters: A0 pointer to old ASCIIZ filename
A1 pointer to new ASCIIZ filename
Return parameters: D0.W status (0000 = file renamed) or
D1.W error code

FUNCTION 12—SEEK TO BYTE IN FILE

Entry parameters: D1.W file handle
D2.L byte to seek to
D3.W base, one of:
0 = from beginning of file
1 = from current location of FP
2 = from EOF
Return parameters: D0.L current position, or
FFFFFFFF = error and
D1.W error code

FUNCTION 13—DETERMINE CURRENT BYTE OFFSET

Entry parameter: D1.W file handle
Return parameters: D0.L current position from BOF, or
FFFFFFFF = error and
D1.W error code

FUNCTION 14—GET COMMAND LINE ARGUMENTS

Entry parameter: none
Return parameters: D0.W number of commands
A0.L pointer to array of pointers to arguments

FUNCTION 15—TERMINATE

Entry parameter: none
Return parameter: none (does not return)

FUNCTION 16—MOVE MEMORY BLOCK FROM 8086

Entry parameters: A0 source address in 8086 space
(20 significant bits)

A1 destination address in 68020 space

D1.L word count

Return parameter: none (memory is moved)

FUNCTION 17—MOVE MEMORY BLOCK TO 8086

Entry parameters: A0 source address in 68020 space

A1 destination address in 8086 space
(20 significant bits)

D1.L word count

Return parameter: none (memory is moved)

FUNCTION 18—MOVE MEMORY FROM 8086 (BACKGROUND)

Same as function 16, except that function call does not wait for completion before returning.

FUNCTION 19—MOVE MEMORY TO 8086 (BACKGROUND)

Same as function 17, except that function call does not wait for completion before returning.

FUNCTION 20—READ 8086 PORT

Entry parameter: D1.W 8086 port address

Return parameter: D0.B value read from port

FUNCTION 21—WRITE 8086 PORT

Entry parameters: D1.W 8086 port address

D2.B byte to be output

Return parameter: none

FUNCTION 23—ALLOCATE 8086 MEMORY

Entry parameter: D1.L number of bytes to allocate

Return value: D0.L pointer:
high word = DS
low word = OFFSET
00000000 if no memory available

FUNCTION 24—DEALLOCATE 8086 MEMORY

Entry parameter: D1.L pointer (DS:OFFSET) to RAM

Return value: none

FUNCTION 25—EXECUTE 8086 INTERRUPT

Entry parameters: D1.B interrupt vector number

A0 pointer to register structure
Sequence: DX, CX, BX, AX

Return value: Register structure filled with result

FUNCTION 27—GET SYSTEM DATE

Entry parameter: none

Return value: D0.L bits:
31..16 year (1980 base)
15..08 month
07..00 day

FUNCTION 28—GET SYSTEM TIME

Entry parameter: none

Return value: D0.L bits:
31..24 hour
23..16 minute
15..08 second
07..00 1/100

FUNCTION 29—CHAIN TO PROGRAM (EXEC I)

Entry parameters: A0 pointer to full command line

A1 desired load address

Return value: none — new program is loaded and executed if it is a valid .E20 file

FUNCTION 30—GET/SET RS-232C CONTROLS

This function is used to control the on-board DUART.

Entry parameters: D1.B 00=get controls, FF=set controls

D2.B 00=set stop bits

01=set parity

02=set character length

03=set baud rate

D3.L set value and port

bits 23..16 = logical port number

bits 07..00 = value

Return value:

D0.L controls if get, error if set

bits 19..18 = number of stop bits

bits 17..16 = parity (0=N, 1=

1-EVEN, 2-ODD)

bits 15..08 = character length

bits 07..00 = baud rate

FUNCTION 31—INPUT CHARACTER

This function inputs a byte from the local DUART.

Entry parameter: D1.B logical port number

Return value: D0.W status word:

bit 15 set if no character available

bits 8..0 contain character if bit

15=0

FUNCTION 32—OUTPUT CHARACTER

This function outputs a character to the local DUART.

Entry parameter: D1.B character to be output

Return value: none (character is output, waiting if necessary)

FUNCTION 33—GET BOARD SERIAL NUMBER

Entry parameter: none

Return value: D0.L board serial number

All functions listed are subject to change due to improvements or bug fixes at any time without notice. Type the file IO-READ.ME on your distribution disk for the latest definitions.

Table 3: DSI-020 Whetstone benchmarks.

1. Single-Precision Whetstones

Performance is quoted as the number of Whetstones per second

DSI-020 12.5 MHz	DSI-020 16.7 MHz	IBM PC RT	VAX-11/780
770K	1028K	200K	1152K

2. Double-Precision Whetstones

Performance is quoted as the number of Whetstones per second

DSI-020 12.5 MHz	DSI-020 16.7 MHz	IBM PC RT	VAX-11/780
676K	902K	185K	798K

Note: All machines have floating-point hardware or coprocessors.

(February 1976, pages 47-49). This version was translated to FORTRAN by D. Frank in 1979. Both single- and double-precision results are given. The Whetstone tests mathematical functions such as LOG and EXP in addition to linear arithmetic. Table 3 shows the results obtained with the DSI-020 at 12.5 MHz and 16.7 MHz, the IBM PC RT, and a VAX-11/780.

You can draw your own conclusion from the data presented in table 3, but one thing is clear: The days when a desktop microcomputer could be regarded as a development tool with limited capability are gone. The question that must be asked now is "how much further can technology go?" A VAX-11/780 dissipates about 6 kilowatts of electricity and requires a small army of technicians to service it. The DSI-020 dissipates 10 watts, and its peripherals and operating procedures (MS-DOS) can be comprehended and serviced by most all the population. Time alone will tell. ■

bled to show the peak performance currently available using the 68020 microcomputer family. Although the chip set made available by Motorola is a 12.5-MHz version, it is our experience that the careful hacker will note the additional crystal oscillator on the

schematic and hone his system's performance to the limit. One tip: You will need to use 100-nanosecond RAM and carefully watch the FPU's operation at these faster speeds, however.

The Whetstone benchmark first appeared in ALGOL in *Computer Journal*

Eighth Annual Conference and Exposition

INTERACTIVE VIDEODISC

In Education and Training

August 20-22, 1986
J. W. Marriott Hotel
Washington, D. C.
Presentations Cover:

- Current Applications
- Emerging Technology
- Methodology Implementation
- Learner Productivity Improvement

Pre-conference tutorials are scheduled for August 18 and 19.

Included among exhibitors:

- | | |
|------------|----------------------------|
| 3M | New Media Graphics |
| DEC | Online Computer Systems |
| NCR | MetaMedia Systems |
| WICAT | Applied Science Associates |
| Pioneer | GWF Associates |
| Sony | Creativision |
| U.S. Video | LaserVideo |

For further information contact::

SALT Society for Applied Learning Technology
50 Culpeper Street, Dept. B
Warrenton, Virginia 22186
703-347-0055
Outside Virginia call toll free: 1-800-457-6812

Special Purchase
LAP COMPUTER
FULL FACTORY WARRANTY



BUILT IN 300 BAUD MODEM
Built in speed dial, buffer to Lates Terminal Emulation in Commodore with Personal or Macintosh Computer

IT'S A HANDS FREE PHONE
Comes with Rechargeable Batteries and Charger. Options Available: Serial or Parallel Port, Workstation Printer

workSlate
BY CONVENTION TECHNOLOGIES

THE MOST PORTABLE TERMINAL

OUR BEST PRICE EVER \$295.00 ORIGINALLY \$1195.00

INCLUDES FREE SOFTWARE WORTH \$88.00
Information and Consultant Services Software

OTHER SOFTWARE PACKAGES	WITH PURCHASE ONLY
Call Management	\$15.00
Project Management	\$15.00
Inventory Management	\$15.00
Marketing Management	\$15.00
Time Management	\$15.00
Travel	\$15.00
Accounting	\$15.00
Mail Merge	\$15.00
Integration Services	\$15.00
Label Makers	\$15.00
Portable Database	\$15.00

The state of the art computer comes with two instructional cassettes that take you through the learning process. This means a woman voice tells you which keys to press as you are learning to manipulate information on the screen. This computer also has built-in keyboards that let you work in its services like Dow Jones/News Retrieval, The Source, MCI Mail, and many other services, including thousands of electronic business cards. • **Screen:** 8" x 11" x 1" • **3.5 in. floppy:** LCD, 45 characters per line, 16 lines. **Power:** NiCad rechargeable battery. **AC:** adapter/recharger for 400 alkaline batteries. **Software:** Built-in word processing, Financial analysis, phone, calendar and communications management. **Internal Memory:** up to 12.8K • 11 people. **Microcassette:** store up to 10 worksheets of 45 minutes of audio extension.

15 Day Money Back Guarantee

CEC
1205 S. Amphlett Blvd #3
San Mateo, CA 94402
415042-4058
600728-3411

ENGINEERING ON A MICRO

A bridge-truss analysis program in BASIC

Computer-aided engineering is not an application you would normally consider for the microcomputer. That's because most computer programs for analyzing stress, temperature, and so on, are based on matrix techniques such as the finite-element (FE)

method. Typically, FE-method techniques require a lot of memory and high computational speed to be effective. Fortunately, the advent of 16- and 32-bit-based microcomputers has increased the operating speed and memory capability of home systems to the point that small FE-method packages are now practical for the home computer.

In this article I will discuss the basis for the method and give the source code for a BASIC program that effectively analyzes pin-jointed trusses. This program, called Truss2, can assist engineers in the design of truss-type structures, as well as provide an excellent basis for understanding the FE method. (See the text box "Finite-Element Analysis Primer" on page 148 for information on the finite-element method.) [Editor's note: The source code listing for TRUSS2.BAS is available in a variety of formats. See pages 459-461 for details. It runs on an IBM Personal Computer with 128K bytes of memory, a graphics board, and BASICA.]

Truss2 can solve some practical problems in the interpretive BASIC version presented here, and if it's compiled, it can solve larger problems. Table 1 shows maximum program limits. The program is completely menu-driven, with all node, element, and load data entered through self-contained spreadsheets. Finally, Truss2 includes plotting options for displaying the truss geometry in both its original and deflected shapes.

(continued)

Chris Pedicini (1139 Highland Ave., Brunswick, OH 44212), a mechanical engineer, works at Union Carbide Corporation. He uses computers for design and analysis as well as personal enjoyment.



The hardware requirements for this program are an IBM PC compatible with at least one floppy disk drive, an operating system with advanced BASIC (BASICA), a color graphics board, a printer, and 128K bytes of memory. Using the compiled version to improve the solution speed and truss size increases the minimum memory requirement to 192K bytes.

USING THE TRUSS ANALYSIS PROGRAM

You use Truss2 in the same way that many FE analysis programs are used. First, define the structure that you wish to analyze, and then assign the node and element numbers. We will use the truss shown in figure B in the text box on page 148 in order to demonstrate the program.

Begin by entering the Data Editor

menu and key in the node, element, and load data. I designed the editor to support the PgUp, PgDn, Home, End, and the arrow keys to simplify cursor positioning for large data fields. The procedure for changing an existing value or entering a new value is the same: Position the cursor over the item to be changed, enter a new value, and press Return. To delete an entry, position the cursor in the row you want to delete and press the F1 function key. The entire row will be deleted and the data display shifted. Note that you will not be able to position the cursor more than one row past the last element.

Photos 1a, 1b, and 1c contain screen images of the node, element, and load data editors as you would see them. Once the node, element, and load data have been satisfactorily

entered, the control parameters that govern the problem are entered in the Control Cards menu. These parameters include title, date, and the elastic modulus and design strength of the material. I use a format that allows you to change one or all of the control parameters without having to go through the list sequentially. Position the cursor in the line of the item that you wish to change and enter the new value. Press the Return key to terminate the entry and log in the new value. Note that the elastic modulus and design strength are assigned default values of 30,000,000 and 30,000 pounds per square inch, respectively.

Before you analyze the problem, you should enter the Plot menu and check the geometry. Any node or element data that is in error should be apparent in the original geometry plot (see photo 2). Some of the features that you may want to explore are zoom, node numbering, and element numbering. Labeling the nodes in a plot is a good way to verify the points at which to apply the loads. If everything looks satisfactory, you solve for the displacements at each node and the stresses in the individual bars by returning to the main menu and selecting the analysis option.

The program results are shown in table 2, along with the theoretical results. You can see that the finite-element solution is exact in this case. This means that the element-stiffness matrix that we wrote for the truss element is in fact equal to the stiffness of the element. If we were to develop different elements for other two- or three-dimensional problems, this might not be true. Perhaps more interesting than the tabular results is the overall behavior of the structure. This is visualized by entering the Graphics menu and plotting out the distorted structure with an exaggeration ratio of 30, as shown in photo 3. We get more information by making a stress plot of the structure. The stress plot puts a solid rectangle through any element that has exceeded our design stress. This is an excellent method for checking the overall design strength against the actual stress in the structure.

The real advantage of the FE

Table 1: Maximum program limits for the Truss2 analysis program in interpretive and compiled BASIC.

	Interpretive version	Compiled version
Number of nodes	100	150
Number of elements	100	150
Number of materials	1	1
Number of loads	100	150
Maximum bandwidth	25	30



Photo 1a: Data entry and modification is done through the node, element, and load screen editors. Pictured is a screen image of the node editor.

method becomes evident when you begin to analyze the "what ifs" of an engineering situation. For instance, what if the loads are 10,000 pounds instead of 8000 pounds? To analyze this situation you need only go to the *data editor*, alter the loads, and instruct the computer to recalculate the deflections and stresses (see photo 4). This is much simpler than the classical

analysis in which you would have to re-solve the entire truss.

PROGRAM DESCRIPTION

Truss2 requires approximately 32K bytes of memory for the source code and about another 30K for variable storage. We add to this the 20K overhead from DOS 2.0 and get a 128K-

(continued)



Photo 1b: A screen image of the element editor.



Photo 1c: A screen image of the load editor with data for the truss shown in figure B.

Data Acquisition

Point and click your way to data acquisition with the GW Instruments MacADIOS™ and the Apple® Macintosh™ computer.

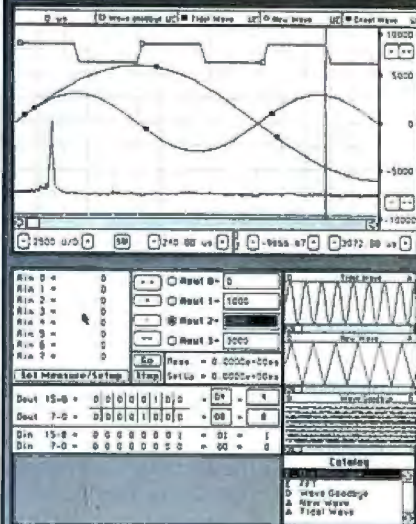

Hardware

- 4 Voltage outputs
- 8 Voltage inputs
- 16 digital in and out
- Timer and clock
- 20 KHz sample rate

Software

- Speech Analysis
- Oscilloscope
- XY Recorder
- Spectrum Analyzer
- MacADIOS Manager™
- Control from BASIC
- Control from C
- Sonogram
- Spectrogram

Send \$10 for a demonstration diskette and documentation. Call or write for a free brochure.



GW Instruments

PO Box 547 • Cambridge, MA 02142
(617) 577-1524

FINITE-ELEMENT ANALYSIS PRIMER

The finite-element (FE) method is a numerical technique for solving partial differential equations by converting them into a set of simultaneous linear equations and applying appropriate boundary conditions. The basic concept of the method is that any continuous quantity—such as temperature or displacement—can be approximated by a discrete model composed of a set of piecewise continuous functions (see figure A). These functions are defined using the values of the continuous quantity at a finite number of points in the domain called *nodes*.

The primary advantage of FE over other numerical methods is that once the programming is done for one category of problems, all problems of that class can be analyzed with no further programming. Thus, the technique is virtually independent of the particular geometry and load conditions. The FE method has the additional advantage that different classes of problems can be analyzed using very similar programs. Although I have covered only simple two-dimensional truss-type problems, this program could form the building block for a larger program capable of handling planar, axisymmetric, or three-dimensional structures.

FE-method terminology can be better understood using the example shown in figure B. Here we have a truss that has been subdivided into regions called *elements*. Points where the regions interconnect are called *nodes*, and the displacements of these points are the unknowns for which we must solve. These elements, called *truss elements*, are defined by the two endpoints (nodes) and a cross section, which is constant within an element but can vary from element to element.

Once we have divided the structure into nodes and elements, we must determine the stiffness matrix for the element before the structure can be analyzed. This is more easily understood if each of the legs in the truss is envisioned to be a spring with varying stiffness. The truss element can be considered to be a very stiff spring governed by equation $F = kX$. In this equation, we see that the displacement

(X) of the two node points is related to the force (F) necessary to produce this displacement by the element-stiffness matrix (K). The order of each of the matrices can be determined by the number of degrees of freedom (DOF) in the element. In this case, we have four DOF, X_i , Y_i , X_j , Y_j , and thus

the force and displacement matrices are each 4 by 1 vectors. This means that the stiffness matrix that relates the corresponding force and displacement components must be a 4 by 4 matrix. There are several methods of obtaining the stiffness of this matrix, the simplest being to consider small x and

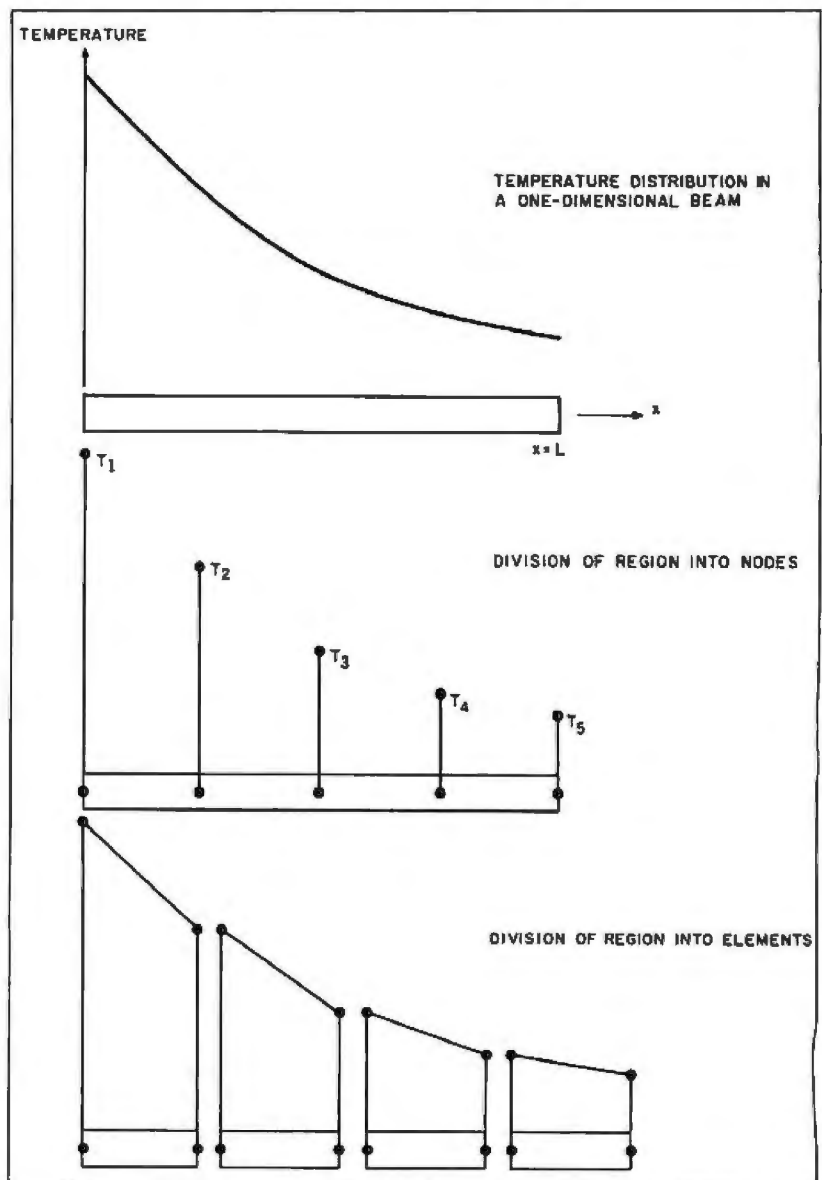

Figure A: Heat distribution in a beam showing the true response and the finite-element approximation at the nodes.

y displacements at each node. This leads to internal forces in the element that must be balanced by the external forces as shown in figure B. By using the equation $F = kX$ and multiplying it by the rotation of the element and the displacement of each of the nodes, we equate this to the vector of external forces and solve for the stiffness matrix K . The rotation of the matrix must be considered because it controls the direction of the resulting force vector. Typically, this is built into the stiffness matrix: $K \times T \times U = F$, where T = rotation matrix and U = displacement matrix. And the equation

$$K = \frac{AE}{L}$$

where A = member area, E = elastic modulus, and L = length, gives the element stiffness for an arbitrary truss element at any orientation.

The next step is to assemble this collection of element-stiffness matrices in an orderly fashion such that we have a mathematical model that represents the stiffness matrix of the complete structure. This is referred to as the global-stiffness matrix. (See figure C.) The key to developing the global-stiffness matrix is determining the location of the element stiffness inside the global stiffness. This is done by considering the DOF that the element affects. All that is necessary is to expand the element-stiffness matrix (using zeros) until it is the size of the global-stiffness matrix. This allows us to add the element-stiffness matrix to the global stiffness and thus build the complete global-stiffness matrix.

Two observations can be made about a correctly constructed global-stiffness matrix. First, it is symmetrical about the principal diagonal; second, a large portion of the matrix is filled with zeros. This is referred to as a banded symmetric matrix, and it is typical of the FE method. The banded matrix structure is a consequence of individual nodal displacements that are affected only by the elements that intersect at those nodes. To optimize the storage requirements of the global-stiffness matrix, we store the elements of the

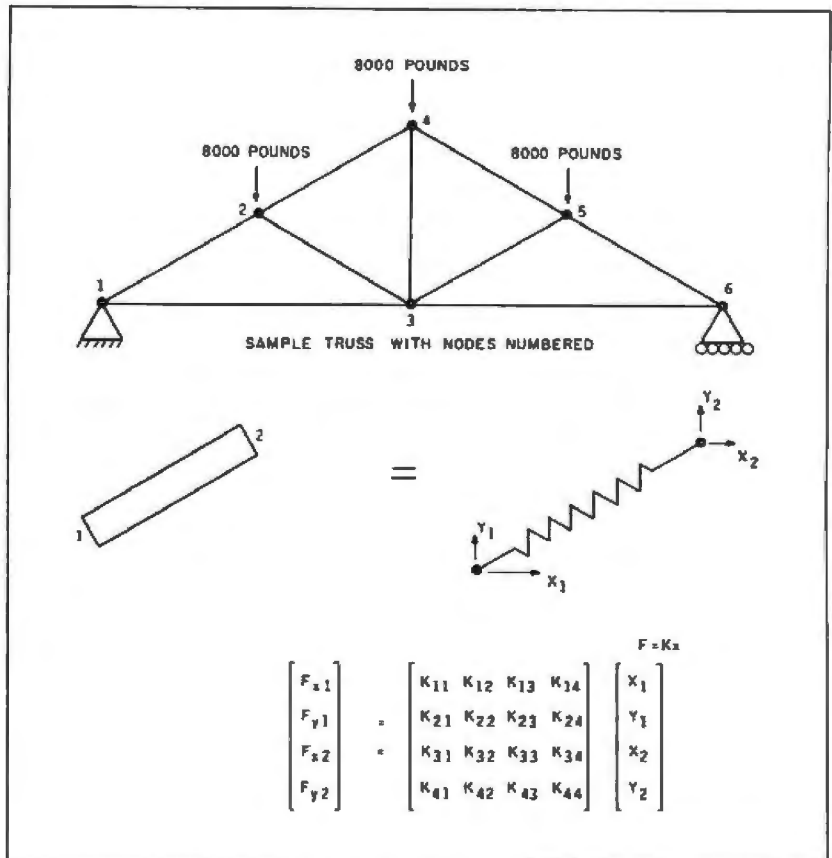

Figure B: Example of a truss that has been subdivided into nodes and elements. The basic equivalence between a truss element and a stiff spring is shown.

matrix in a rectangular array. This array will have a length equal to the number of degrees of freedom and a width equal to the *bandwidth*, or the number of nonzero columns in the array (see figure C). To further reduce the storage requirements of the global-stiffness matrix, we number the truss nodes to minimize the bandwidth. Generally, this consists of numbering the structure across its minimum dimension. For plane trusses, the bandwidth is given by two times the absolute value of the maximum node difference in an element plus 2.

To complete the definition of the problem, we must construct the force vector (F) from the load conditions. There are two types of loads that we impose on our structure: The first are

simple forces in either the x or y directions, and the second are prescribed x and/or y displacements at certain nodes. The latter type of load fixes the displacements at the nodes to the desired value and is called a *fixity*. Fixities allow us to put supports in our structure without having to calculate their reactions. Therefore, we do not need to worry about the actual balance of external forces to prevent the entire structure from moving rigidly. Rigid body displacements allow for non-unique solutions to the structure displacements. Typically, we impose both forces and fixities on the structure.

In the case of force loadings, we can construct F by adding the forces acting on a particular node to the corre-

(continued)

sponding element in the force vector. For example, a force on node i in the x direction would correspond to location $2 \times (i-1)$ in the F vector.

The next requirement is to force certain nodes to have specified displacements (e.g., if a member of a truss is attached to the ground, then we want a zero displacement). This is done by multiplying the diagonal associated with the node in the global-stiffness matrix by a number that is large in comparison to the other entries in the matrix. The corresponding element in F must be multiplied by the same large number and the desired displacement. This forces the particular node to have the desired displacement value because all other entries in that row or equation are insignificant by comparison.

When we are finished assembling the matrix, we have a set of coupled algebraic equations in which the displacements of the nodal coordinates are the unknowns, the stiffness of the structure

is given by a collection of element stiffnesses, and the loads are given by the force vector. This completes the assembly of the set of equations that govern the response of the structure to the load scheme. Once the global-stiffness matrix and the load matrix have been set up in this manner, they are solved using the Gaussian elimination technique. Because the global-stiffness matrix is stored in a rectangular (as opposed to square) array, the method must be modified. Detailed information on the application of Gaussian elimination to banded matrices can be found in references 1 and 2. Solving the matrix equation $F=KX$ for the displacements of the nodes and applying the following two definitions from strength of materials

$$\epsilon = \frac{dl}{L} \text{ (axial strain definition)}$$

$$\sigma = E \times \epsilon \text{ (Hooke's law)}$$

allows us to determine the strain and the stress in each element. The axial

strain definition basically states that the strain in an element is equal to its change in length divided by its original length. Hooke's law is a relation that is valid for most materials if the yield stress is not exceeded. This completes our discussion of the fundamentals of finite-element analysis programming, but we need to touch on two additional themes to complete our story.

The first of these is called *preprocessing* and governs the method of getting the node and element data into the computer. It is easy to see how this could get out of hand for even medium-size problems of 500 nodes and 500 elements. Moreover, because of the tedium involved with typing in a data file of this size, it is one of the biggest sources for error in an analysis. The second area is called *postprocessing*, and it follows the FE-method analysis. Typically, FE-method analysis gives us results that are a localized description of the deflection and stresses in the structures, in other words, the stresses and displacements of the individual elements and nodes. Usually we are interested in the overall behavior of the structure, which can be difficult to interpret from the discrete behavior. Postprocessors have been written that graphically display the distorted structure on the screen. To clarify the results, the deflections can be magnified to exaggerate the structural response, or the plot can be enhanced through the use of color-coded stress fields.

CONCLUSION

In summary, the five basic steps of any FE-method analysis program are

1. Divide the structure into elements and nodes.
2. Determine the stiffness of each element.
3. Assemble the element stiffnesses into a global-stiffness matrix that represents the stiffness of the entire structure.
4. Solve the resulting set of equations with the given load system for the displacements of each node.
5. Use the displacements to calculate the stresses in the members.

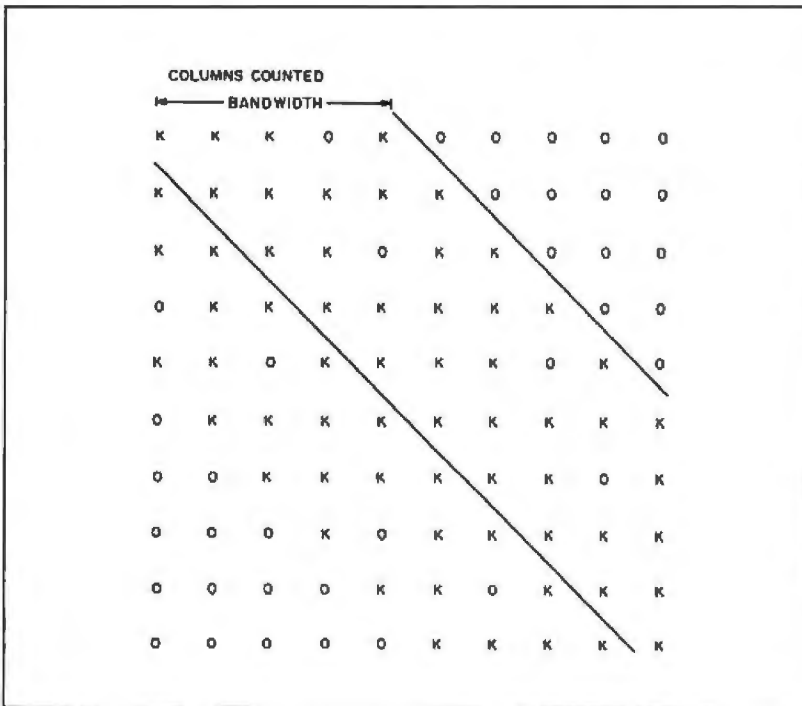
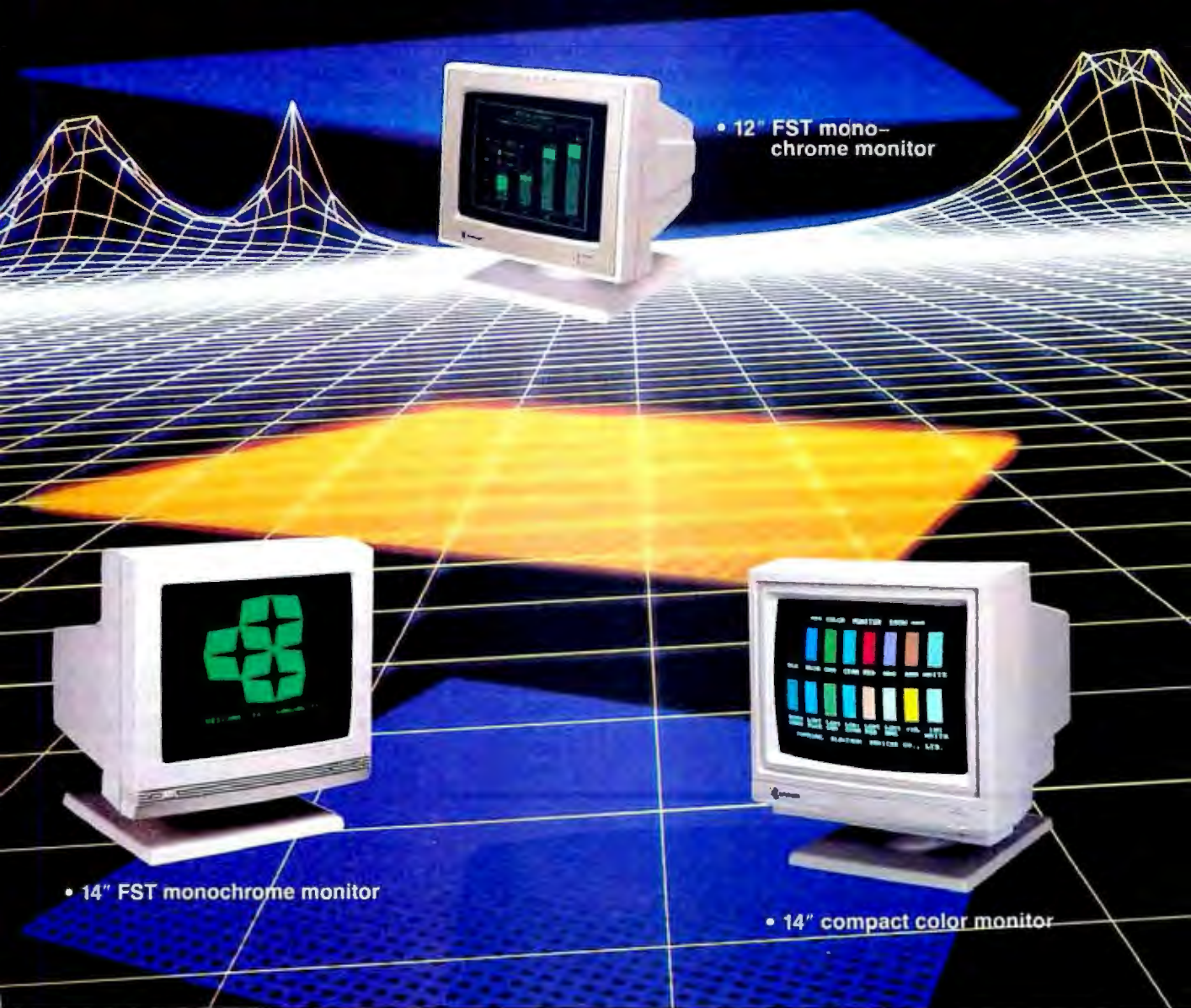

Figure C: Global-stiffness matrix for a structure. Notice the symmetry around the main diagonal.

SAMSUNG ELECTRON DEVICES PRESENTS THREE INNOVATIONS



• 12" FST mono-chrome monitor

• 14" FST monochrome monitor

• 14" compact color monitor

Keeping pace with your customers' needs and the technological future, Samsung Electron Devices now offers three improved Standard Monitors that will provide more functional screen space and truer color values at more competitive prices than ever before. We are pleased to present the following advanced models:

- 14" compact color monitor with 16-color display, at a new competitive price. Compatible with IBM systems.

- 14" FST monochrome monitor with new high resolution flat screen and compact design. Compatible with IBM and Apple systems.
- 12" FST monochrome monitor with the same advanced features as above.

These products represent the same high quality that has enhanced our reputation for eight years in monitor business.

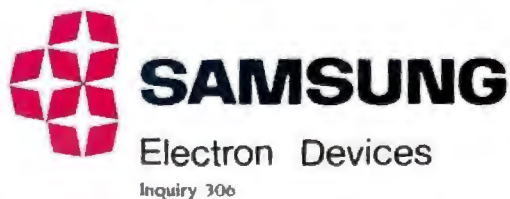

Inquiry 306

byte minimum memory requirement for the interpretive BASIC version. To take full advantage of the program, however, Truss2 should be compiled. This will increase the execution speed of the program five to ten times. It also increases the minimum memory requirement to 192K bytes.

At the start of this project, I wrote out the minimum specifications that the program should meet. These design criteria also helped define the basic program menus, which include

1. A method of entering and editing the nodes, elements, and loads with minimal difficulty.
2. A graphic representation of both the input data and the results to verify the input data and speed interpretation of the results.

3. A file management section to allow the storage and retrieval of the data and results (the Get/Save/Delete menu). This also allows the deletion of any file from within the program to make room on the disk.

4. An analysis of the truss and printing of the results.
5. A user-friendly design.
6. Structured programming throughout to increase program readability.

Truss2 has extensive comments that make it easier to follow. Unfortunately, using REM statements in interpretive BASIC chews up memory. While this is usually not important in small programs, it does affect us because Microsoft BASIC has a maximum address space of 64K bytes. For this reason, the variable definitions are

broken out into table 3, instead of being included as comments in the source code.

Lines 10-576 are devoted to initializing the variables and establishing the program limits. Lines 180-270 contain the graphic representations of the digits 0-9, respectively, for use in labeling nodes and elements in the graphics screen. The reason for this will become apparent later. Lines 370-400 include the information for the various menus in the program.

The first requirement was to write a user-friendly I/O section that would handle data that is being entered and edited. Because there are three separate data sets to handle with this routine, I wrote an interactive full-screen editor contained in lines 960-3050. It is controlled through the use of the array ID and the variables NCUR, NLMT, and K. The editor performs three basic functions: cursor positioning, data entry, and data deletion. The determination of which function to perform is made in lines 1070-1130. Cursor positioning is accounted for in lines 1140-1280. The method for scrolling the current information on the screen is worth mentioning. If the new position requires moving the existing information up or down one line on the screen, you directly access the screen buffer through the use of the PEEK and POKE commands (see lines 2390-2630). This is done instead of simply printing the data for speed. In the interpretive version presented here, it makes no difference. However, the compiled program updates the screen more quickly (two to three times as fast) using PEEK and POKE as opposed to printing the data. Deleting data is done in lines 1870-2120 by removing an element in the appropriate array. Once the element has been deleted, the current page of data is reprinted, and control is returned to lines 1080-1130. Data editing and entry is done in lines 1330-1560. The screen is updated once data has been entered via lines 2650-2790, and control is once again transferred to lines 1080-1130.

The next requirement involved writing a graphic display routine for drawing both the original and distorted

(continued)

Table 2: Theoretical results compared to program output.

Element number	Theoretical stress	Stress by Truss2
1	24000	24000.0
2	-22360	-22361.0
3	-22360	-22361.0
4	-22360	-22361.0
5	26667	26667.0
6	-22360	-22361.0
7	-22360	-22361.0
8	-22360	-22361.0
9	24000	24000.0

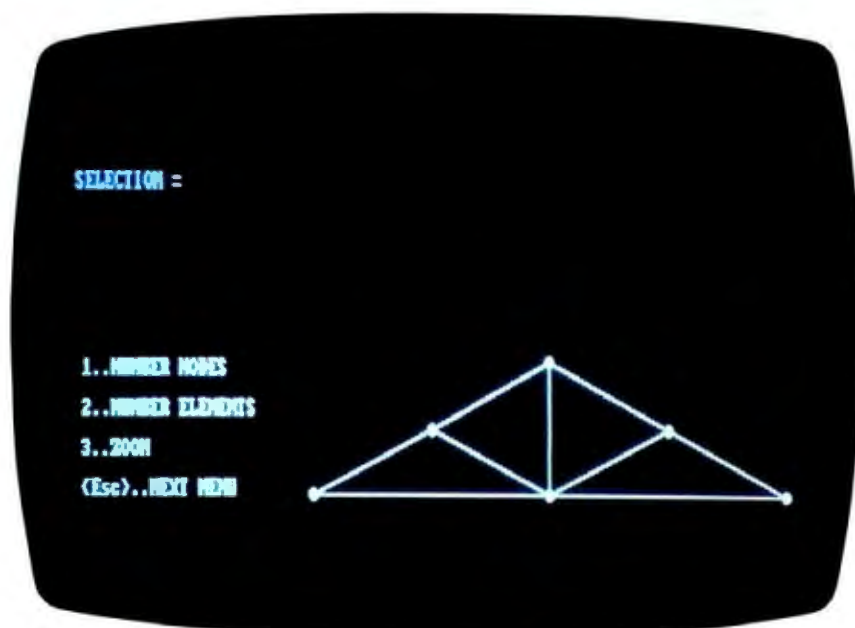

Photo 2: Graphic display of the truss data, using the Plot menu.

We Dared To Go Beyond RAM.

FEATURES

THE CACHE BOARD

Intelligent host adapter interface for hard disk drive.

COMPATIBILITY

Apple II+, IIe and IIe enhanced systems. Most SCSI hard disk drives.

KEY FEATURES

Cache Memory-replaces mechanical disk access with electronic data transfer.

Z-80 processor-Maintains 256K of "most frequently accessed data" in real cache memory. Automatic save function minimizes data loss.

DMA-Transfers data faster than RAM. Cuts booting time in half.

SUPER CHARGE YOUR SIDER

Specific testing with Sider hard drive resulted in not only substantially faster data accessing but also improved performance of the drive itself.

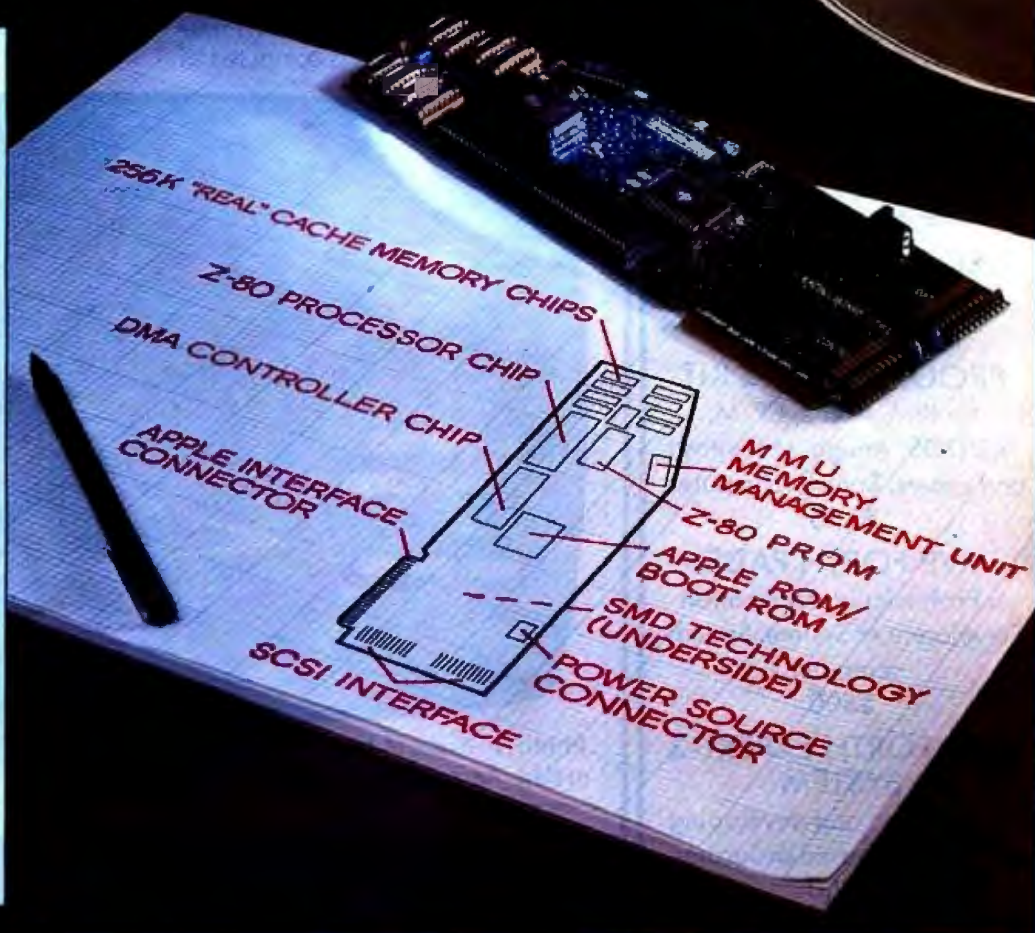

ATTENTION APPLE II USERS:

The Cache Board is an *intelligent* host adapter interface for hard disk drives.

KACHE BOARD DEVELOPMENT

It took over two years of research and development, and long hours of testing to make this product a reality. Ohio Kache Systems dared to go beyond RAM to bring hard disk users a new standard in performance — The Kache Board.

SUPERIOR TO RAM

It's superior to RAM disk, thanks to the use of Cache Memory, Direct Memory Access (DMA), and an on-board microprocessor. When you combine these features with the performance of hard disk drives, you're looking at an overall 25%-30% decrease in access time and the virtual memory environment of a minicomputer such as the VAX.

OKS, Kache Board and the OKS logo are trademarks of Ohio Kache Systems, Inc.

Apple is a registered trademark of Apple Computers, Inc.

IBM is a registered trademark of International Business Machines, Inc.

Sider is a trademark of First Class Peripherals, Inc.

VAX is a trademark of Digital Equipment Corp.

KACHE BOARD PERFORMANCE

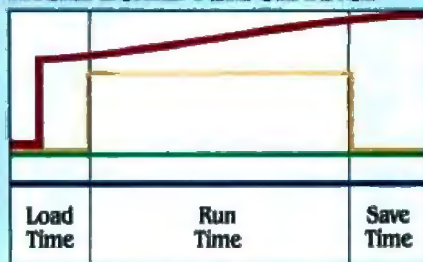

- Kache Board Performance
- RAM Performance
- Apple Performance with Hard Disk Drive
- Apple Performance

CONTINUOUSLY INCREASING PERFORMANCE

As more data files reside in Cache, the performance of the Kache Board continues to improve beyond that of RAM disk. An increasing number of disk access requests are replaced by electronic data transfer from "real" cache memory (see graph above).

AVAILABLE SOON

Available soon: Kache Boards for IBM and IBM compatible systems.

DIRECT FROM DEVELOPER

The Kache Board is available exclusively from Ohio Kache Systems on a direct mail basis only. For more information on the Kache Board write for our free brochure. Or call us toll free at:

1-800-338-0050

We think you'll be as excited about this new product as we are!



Ohio Kache Systems Corp.
4166 Little York Road
Dayton, Ohio 45414-2566
513-890-3913

© Ohio Kache Systems is a developer of computer enhancement products.

FORTH

The computer language for
increased...
EFFICIENCY
reduced.....
MEMORY
higher.....
SPEED

MVP-FORTH SOFTWARE

Stable...Transportable...
Public Domain...Tools

**MVP-FORTH
PROGRAMMER'S KIT**
for IBM, Apple, CP/M,
MS/DOS, Amiga, Macintosh
and others. Specify computer.
\$175

MVP-FORTH PADS,
a Professional Application
Development System. Specify
computer.
\$500

**MVP-FORTH EXPERT-2
SYSTEM**
for learning and developing
knowledge based programs.
\$100

Word/Kalc,
a word processor and
calculator system for IBM.
\$150

Largest selection of FORTH
books: manuals, source listings,
software, development systems
and expert systems.

Credit Card Order Number:
800-321-4103
(In California 800-468-4103)

Send for your
**FREE
FORTH
CATALOG**

**MOUNTAIN VIEW
PRESS**
PO BOX 4656
Mountain View, CA 94040

structure (see lines 3460-4710). Graphically displaying the data not only simplifies data verification and interpretation, but it also makes the program easier to use. In any graphic display, the scaling factors need to be determined as shown in lines 3580-3677. The scale factor is computed by

finding the minimum and maximum values for both the x and y axes and mapping those values onto the screen limits. In our case, the mapping takes place in the rectangle delimited by coordinates (200,10)-(620,190) on the IBM high-resolution screen. To keep
(continued)

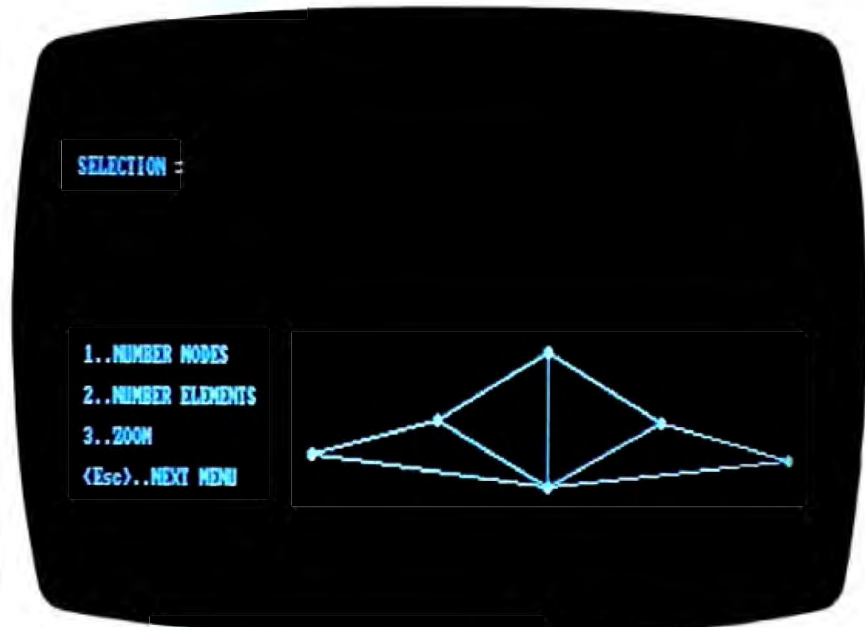

Photo 3: A plot of the overall behavior of the truss with 8000-pound loads applied. An exaggeration ratio of 30 was used.

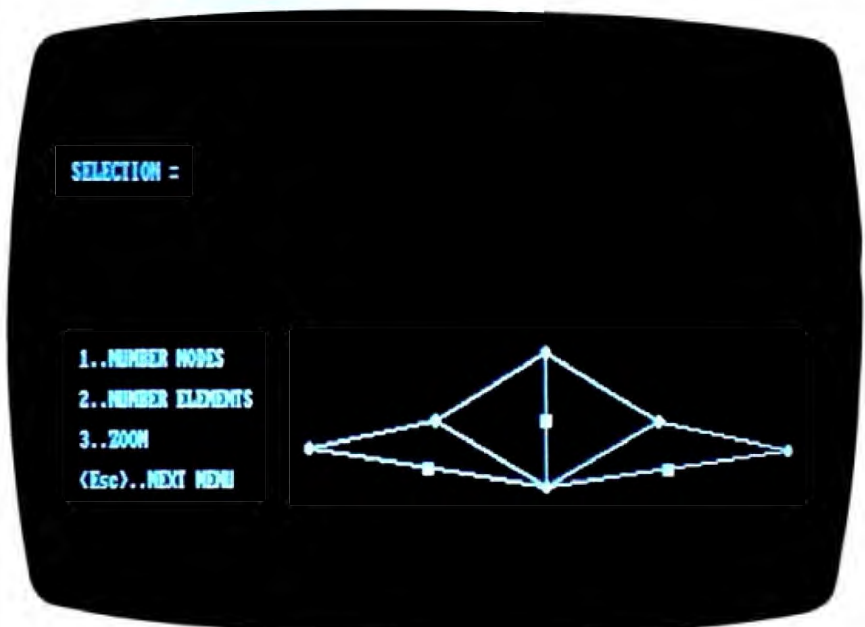

Photo 4: The same truss plotted with 10,000-pound loads and an exaggeration ratio of 30. Rectangles have been placed by the program through members that exceed the design stress.

Orchid's TurboEGA™

The world's fastest EGA



**FREE
MS WINDOWS™**



TurboEGA

Introducing the only Enhanced Graphics Adapter with Pcturbo™ speed.

The experts agree: the EGA is the breathtaking new graphics standard, but the sophisticated software written for it places a big burden on the PC's processing speed. Beautiful graphics, crisp text, but too slow.

Everyone else rushed their EGAs to the market, but Orchid Technology took the time to do it right. Orchid's TurboEGA™, from the inventors of PC TurboProcessing, packs a high-speed Turbo and an EGA into one slot, for the world's fastest EGA.

Graphics with Speed

TurboEGA makes IBM PCs and XT's run faster than an AT. It brings dazzling speed to sluggish graphics programs. All types of software run faster, so you finish more quickly. Transparent to the user, you won't know it's there until you see its speed.

We are so confident that our TurboEGA is the ultimate graphics card that we decided to give away a free copy of Microsoft's Windows™ with each TurboEGA*. Even Microsoft recommends that you run Windows on an AT. Now Orchid's TurboEGA gives you AT speed so XT users can use this number one windowing software at the speed they demand.

The Complete Solution

Only Orchid puts this much performance into one slot and comes fully loaded with 256K of RAM, so there's no hidden cost. TurboEGA is the complete graphics solution.

Pick up the phone and find out how you can have the EGA the competition wishes they had: Orchid's TurboEGA, the world's fastest.

If you have an AT or a system with 80286 speed, ask about the Orchid EGA™—four graphic-card compatibility in one slot.

Features:

- Powered by 7.2MHz 80286
- Optional 5 or 8MHz 80287
- 256K of on-board RAM
- Four graphics modes: EGA, CGA, MDA, Hercules
- Supports the long list of EGA software:
 - Microsoft Windows & Word
 - Lotus 1-2-3 & Symphony
 - Topview
 - Framework
 - Chart-Master
 - AutoCAD
 - PC Paint Plus
 - and more...



47790 Westinghouse Dr.
Fremont, CA 94536
415/490-8586
Tlx: 709289

TurboEGA, OrchidEGA, and Pcturbo and trademarks of Orchid Technology. Microsoft Windows is a trademark of the Microsoft Corporation. All other product names are trademarks of their manufacturers. CGA screen by PC Paint Plus.

Inquiry 265 for End-Users. Inquiry 266 for DEALERS ONLY

*Offer good only on TurboEGA purchases until July 31, 1986. Please allow two weeks for delivery.

TRUSS PROGRAM

the x and y axes in scale, the smallest of the scale factors computed from

$$XSCALE = 210/(XMAX - XMIN)$$

$$YSCALE = 180/(YMAX - YMIN)$$

should be used. WINDOW or VIEW statements were not used because they are not supported by the BASIC compiler.

The routine for labeling the nodes and elements (see lines 3960-4370) uses the PUT and GET commands coupled with the array NUM(I,J). This allows us to put the node and element numbers beginning at any pixel on the IBM graphics screen and thus avoid the 80-column by 25-row limitation for printing data. A zoom routine is included that allows you to box in a particular area on the screen and then remap it to the physical screen limits. This is accomplished by taking the two entered cursor locations and using them to define the minimum and maximum values for the scale determination.

Printing or listing the data is covered

in lines 31000-32280. This routine allows us to list the data on the line printer or the screen. This was done by opening the line printer or the screen as a file and printing the data to it. I chose to monitor the keyboard for an entry rather than trap a key as a way of stopping the printout. This allows you to optimize the compiled code in regard to both execution speed and size. Physically trapping keys in the compiled mode forces the compiler to put an extra 2 bytes of code for each line in the program. These 2 bytes cause the IBM PC to check for an interrupt before each line of code, thus slowing down execution speed. I felt that the additional programming required by taking this route was offset by its advantages.

The last menu in our program governs disk I/O functions (lines 5600-6170). These allow us to save, retrieve, and delete files from within Truss2. All disk I/O is done in ASCII files, allowing you to export or import compati-

(continued)

Table 3: Definitions for the commonly used variables.

Variable	Definition
MBW	Maximum bandwidth
MAXEL	Maximum number of elements
MAXNP	Maximum number of nodes
MAXLD	Maximum number of loads
BW	Problem bandwidth
NUMNP	Number of node points in the problem
NUMEL	Number of elements in the problem
NLOAD	Number of loads in the problem
MENU\$(5,7)	Character array of menu entries. Five menus with a maximum of seven entries per menu. The first one is the title.
NCON(*,1)	Node number 1 for element *
NCON(*,2)	Node number 2 for element *
AR(*)	Section area for element *
XNOD(*)	x coordinate of node *
YNOD(*)	y coordinate of node *
ILOAD(*,1)	Node number for load number *
ILOAD(*,2)	Code value of load number *
RLOAD(*)	Load exerted for load number *
EKEY(1)	Elastic modulus of material
EKEY(2)	Design strength of material
A(200,30)	Global-stiffness matrix
B(200)	Force matrix also stores displacements at the end of an analysis.
STR(*)	Stress in element *
BK(4,4)	Element-stiffness matrix
NCUR	Current number of entries in editor
NLMT	Maximum number of entries in editor
ID(K,*)	Editor control variables

Advanced Authorized Dealers

(Eastern U.S.)

Aardwolf Microsystems
217 East 85th, Suite 102
New York, NY 10028
212/538-7840

Advanced Information Systems, Inc.
1336 Edna S.E.
Grand Rapids, MI 49507
616/243-1312

Corporate Micros, Inc.
333 West 52nd St., Suite 1204
New York, NY 10019
212/315-2853

Crest Systems, Inc.
2101 Magnolia Ave., Suite 208
Birmingham, AL 35205
205/328-4882

Fast Forward, Inc.
129 Adams Street
Louisville, KY 40206
502/589-0301

ICS Software
P.O.C. 359015
Brooklyn, NY 11235
718/743-4050

INACOMP Computer Centers
700 Remington Road
Schaumburg, IL 60195
312/519-1900

Micro City Computers
110 West 31st Street
New York, NY 10001
212/563-6110

Mitech Corporation
#1 Perimeter Park South, Suite 335-S
Birmingham, AL 35243
205/967-0605

Modular Management Systems, Inc.
451 Bloomfield Ave.
Caldwell, NJ 07008
201/228-3838

National AI Lab, Inc.
1800 Century Blvd., Suite 770
Atlanta, GA 30345
404/633-3900

Network Data Systems, Inc.
3419 Pierson Place
Flushing, MI 48433
313/732-6340

**PRISM Computer & Consulting
Services, Inc.**
2100 Riverchase Center, Suite 420
Birmingham, AL 35244
205/988-5111

Southeastern Systems, Inc.
619 East Price Ave., Suite #12
Gastonia, NC 28054
704/866-8048

TRIMARC Systems, Inc.
11716 Parklawn Drive
Rockville, MD 20852
301/231-4991

Open Computer Systems
4701 N.W. 72nd Avenue
Miami, FL 33166
305/594-2980



**THE
SOFTWARE
LINK, INC.**

To Over 30,000 Installations, MultiLink[®] MEANS Multi-User.

At over 30,000 sites, as many as one-quarter of a million users tap into the power of MultiLink[®] Advanced everyday.

Since 1981, they've come to rely on our multi-tasking, multi-user system for compatibility with their favorite software, and the ability to share disks, files, printers, and programs in a true PC-DOS environment.

From the largest of the Fortune 500 to the smallest in small business, MultiLink[®] has provided a cost-effective multi-user solution that's available from no one else.

MultiLink[®] Means Cost-Effective Timesharing on a PC. MultiLink[®] Advanced utilizes the principle of timesharing by sharing a central PC's peripherals, files, and processor time among nine users. Up to eight inexpensive terminals can be connected to a single non-dedicated IBM PC, XT, AT or 100% compatible using standard RS-232 ports. Each terminal effectively emulates a PC having up to 512K RAM.

PC-Shadow[™] Workstations, shown below, even have an AT look-alike, as well as work-alike, keyboard, display, and serial port. In addition, password-protected remote access via modem can be made with either dumb terminals or PCs running our terminal emulation software.

MultiLink[®] Means PC-DOS Compatibility with a Software-Driven System. Lotus 1-2-3, Symphony, WordStar, dBASE III, & Multimate are just a sampling of the wide variety of PC-DOS software that's fully compatible.

Our software-driven system is also IBM NETBIOS compatible, so programs that are written for IBM's Token Ring will run on our multi-user system, as well.

MultiLink[®] Means Multi-User to Leading Computer Publications. Whether you read *PC Magazine*, "MultiLink[®] Advanced delivers on...convenience, speed, and flexibility," or *InfoWorld*, "If you want a low-cost multiuser system with up to eight terminals, MultiLink[®] Advanced is worth a serious look," it becomes clear that MultiLink[®] Advanced is a formidable contender in the multi-user marketplace.

See What MultiLink[®] Can Mean to You. Learn, firsthand, how our multi-user system can benefit your company. Call The Software Link TODAY for complete information and the authorized dealer nearest you. MultiLink[®] Advanced is \$495 and comes with a money-back guarantee.

MultiLink[®] is a registered trademark of The Software Link, Inc. MultiLink[®] Advanced & PC-Shadow[™] are trademarks of The Software Link, Inc. IBM PC, XT, AT, PC-DOS, Token Ring, & NETBIOS are trademarks of IBM Corp. WordStar, dBASE III, Multimate, Lotus 1-2-3 & Symphony are trademarks of MicroPro, Ashton-Tate, Multimate International & Lotus Development Corp. respectively

MultiLink[®] ADVANCED



THE SOFTWARE LINK, INC.

8601 Dunwoody Place, Suite 632, Atlanta, GA 30338 Telex 4996147 SWLINK

CALL: 404/998-0700

Dealer Inquiries Invited

THE SOFTWARE LINK, INC./CANADA

250 Cochrane Drive, Suite 12, Markham, Ontario L3R 6B7

CALL: 416/477-5480

Inquiry 320



System: IBM

Lotus

ble files from other programs. In order to obtain a "neat" directory listing, I use the third screen on the IBM PC to accept the regular directory listing and export it to the first screen.

The heart of the program that does the calculation is contained in lines 10000-10980. Lines 10700-10980 form the element stiffness for a beam element. Lines 10220-10290 impose the loads and fixities, and the actual

solution of the banded matrix takes place in lines 10300-10560. The stresses are then calculated in lines 10580-10690.

Lines 20000-30000 contain a number of general-purpose routines that can be merged into any program. A brief list of these routines and their functions follows:

20000-20180 Reset the screen, turn

off the function keys, and print copyright notice.

- 21000-21230 String input and conversion module.
- 22000-22230 Trap and print runtime errors for disk and printer.
- 23000-23380 Determine the directory for path name and list on screen.
- 24000-24100 Exit the program and return to DOS.
- 25000-25270 Print out menu options and accept entry.
- 26000-26090 Print an error message contained in MSGS onto the screen.
- 26100-26520 Routine to permit changing the drive or directory.

Why your next generation of products should use our 5th generation tools.

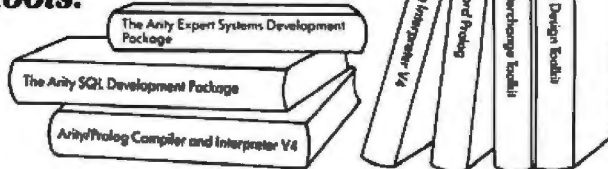

Arity's integrated family of programming tools allows you to combine software written in Arity/Prolog, the best of the fifth generation languages, with Arity SQL, the best of the fourth generation languages, and with conventional third generation languages such as C or assembly language to build your smarter application.

You can use Arity/Prolog to build expert systems using the Arity Expert Systems Development Package. Or to build natural language frontends. Or to build intelligent information management systems. Arity/Prolog lets you build advanced technology into your vertical applications package.

And more...

That's not the whole story. Arity's products are all designed to be fast, powerful, serious. Each of our products contains unexpected bonuses. Such as one gigabyte virtual database integrated into Arity/Prolog. The most powerful of its kind on a PC.

Quality first. Then price.

In order to be the best, we had to prove it to our customers. Our tradition of quality software design is reflected in every product we sell. Quality first. Then price. And we always provide the best in customer support.

Our products are not copy protected. We do not charge royalties. We offer generous educational and quantity discounts. And we have a 30 day money back guarantee.

Try us to know that we keep our promise on commitment to quality and reliability. Try us by using our electronic bulletin board at 617-369-5622 or call us by telephone—you can reach us at 617-371-2422.

Or fill in this coupon. Whether you order today or not, let us send you full descriptions of our integrated family of Arity products.

arity

We design and distribute high quality, serious application software for the IBM PC, XT, AT and all MS-DOS compatibles.

Please complete this form to place your order and/or request detailed information.

	Quantity	Info only
Arity/Prolog Compiler and Interpreter V4	\$795.00	_____
Arity/Prolog Interpreter V4	\$350.00	_____
Arity Standard Prolog	\$ 95.00	_____
Arity SQL Development Package	\$295.00	_____
Arity Expert System Development Package	\$295.00	_____
Arity Screen Design Toolkit	\$ 49.95	_____
Arity File Interchange Toolkit	\$ 49.95	_____
TOTAL AMOUNT (MA residents add 5% sales tax)(These prices include shipping to all U.S. cities)	\$ _____	_____

Name _____
 Shipping Address _____
 City/State/Zip _____ Telephone _____
 Payment: Check PO AMEX VISA MC
 Card # _____ Exp. date _____
 Signature _____

ARITY CORPORATION
358 BAKER AVENUE • CONCORD, MA 01742



ADVANCED FEATURES

The program is purposely limited to demonstrate the principles of the method and provide something that could run under IBM interpretive BASIC. The following suggestions are offered in case you want to expand or tailor the program to a specific application:

1. Check the truss elements for buckling in the event that they are long and slender.
2. Look at the effect of temperature changes in the truss on the stresses and displacements.
3. Expand the program to handle different types of elements such as plane elements, three-dimensional elements, or plates.
4. Display the resulting stresses in color fields using the medium-resolution color graphics mode. ■

[Editor's note: The author has copies of both the source and compiled code available on disk to interested readers. The price is \$30. Please respond to Chris Pedicini, 1139 Highland Ave., Brunswick, OH 44212.]

REFERENCES

1. Bowes, William H., and Leslie T. Russell. *Stress Analysis by the Finite Element Method for Practicing Engineers*. Lexington, MA: Lexington Books, 1975.
2. Segerlind, Larry J. *Applied Finite Element Analysis*. New York: John Wiley & Sons, 1976.

Inquiry 139 for End-Users.
 Inquiry 140 for DEALERS ONLY. →

For \$295 you can draw your own conclusions.

Drafix 1. The first high performance CAD software everyone can afford.

Low-cost, high performance computer-aided design & drafting (CAD) software is finally available for use on your PC.

There's never been a professional CAD package so complete at such a low cost.

Drafix 1 from Foresight Resources.

Only \$295.

Powerful, full-featured second generation CAD software.

Drafix 1 offers all of the capabilities you expect to find in packages costing \$2,000 or more.

This is not simply a souped-up paint package. Drafix 1 is a breakthrough in design that organizes sophisticated CAD functions into smooth, fast operations. All of the drawing, designing and editing functions that designers demand from a serious CAD tool are included in Drafix 1.

A breakthrough in screen design and visual user interface.

Drafix 1 features the best organized screen design ever devised. Very simply, it displays all the information you need, all of the time.

The entire menu hierarchy is displayed constantly. There's no need to memorize commands or search for menus.

Snap-mode options are continually shown on the left screen border and can be selected "on the fly" by either pointer device or a single keystroke. Roll-down screens provide quick access to the virtually unlimited drawing, display and editing options.

And it's all controlled by a versatile three-button mouse, or digitizer, with on-screen prompts so each button function is clearly defined.

AutoCAD[®] compatible for easy expansion.

If you or someone in your company already uses AutoCAD, Drafix 1 offers an inexpensive way to add to your capability.

The optional Drafix 1/AutoCAD file exchange utility permits transfer of drawings between Drafix 1 and AutoCAD.

It's the perfect, low-cost alternative for increasing your drafting and design capacity.

Unbelievable low bundle prices.

To get you up and running we offer two special hardware bundles — all the equipment you need at prices you won't believe.

Get Drafix 1 with your choice of Torrington's Manager Mouse or the LOGIMOUSE[™] C7 for just \$395.00. Or get Drafix 1 with the SummaSketch 12" x 12" digitizer tablet with stylus for just \$650.00.

Order today. Take advantage of our 30-day, money back guarantee.

We're so certain you'll like the performance and versatility of Drafix 1 you're welcome to try it risk free for 30 days. If you're not completely satisfied, return it to us for a full refund.

Find out just how good CAD software can be. For only \$295.00.

Use our toll-free number and any major credit card to order your copy of Drafix 1 today.

SPECIFICATIONS

Code capabilities
Lattice "C" language
Auto graphics
Floating point package
Compass/cursor support
PC-DOS/MS-DOS 2.1 or later

Basic 1 Features

Items
Lines
Plines
Arcs & circles
Node text
Polygons & shapes
Symmetrical & nested

Item attributes

16 pen colors
255 layers
8 Linetypes
12 text fonts
30 Pl marker types

Screen Display

Zoom/Full
8-Scan View
Slide overview
Grid on/off

Metric & English Standards

Engineering (decimals/fractional)
Architectural (ft in)

Project drawing info.

Variable input
Keyboard and cursor
Absolute, Relative, Polar

Snap Modes

Endpoint
Midpoint
Intersection
On axis
Quadrant
Tangent
Arc center

Transfer/Copy

Move
Rotate
Scale
Mirror
Align

Modify/Edit

Attributes
Break/Join
Fillet/Chamfer
Trim
Stretch
Erase
Explode symbols & polygons
Merge
Reface
Merge
Reopen select
Workgroup

Auto including, polygon 3D

Auto Dimensions

Linear Horizontal/Aligned
Angular
Diameter
Leader/Notes
Dimension
Chain & Baseline

Check calculations

Coordinates
Distances & angle
Area & perimeter
Item Massing

Hardware

Computer
IBM PC, XT, AT and compatibles
MS-DOS Plus
2MB

System Requirements

— 512K RAM
— RS-232C Comm. port
— Mouse or Digitizer
— Coprocessor recommended

Graphics Display Boards

IBM CGA/EGA and compatibles
Resolves and a wide range of graphics boards

Digitizers & Locators

Appropriate locator devices supported
All popular plotters ("C" and "E" size paper option available)

Printers

All popular laser and dot matrix printers supported

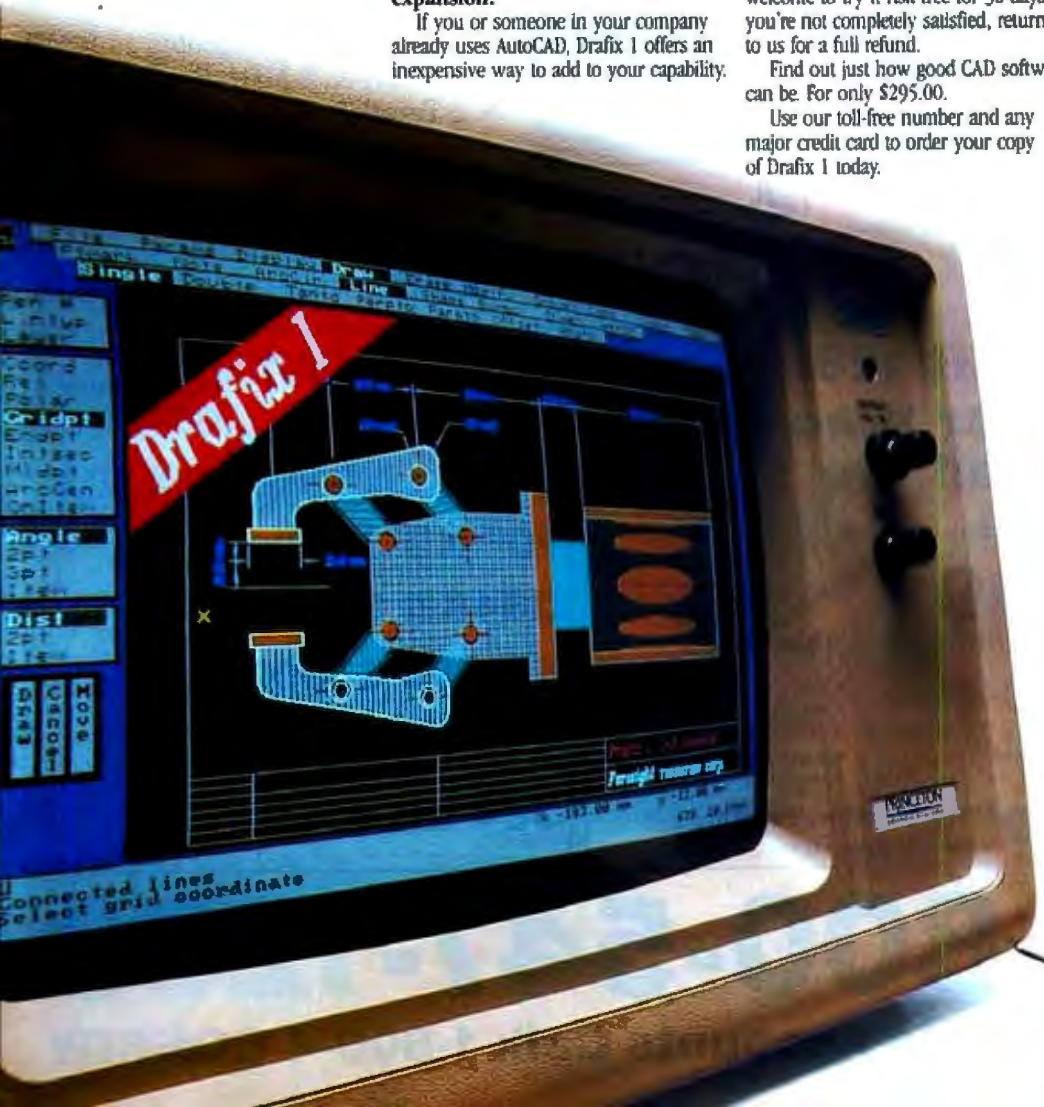

Order Now! Call Toll-Free!
1-800-231-8574,
Ext. 150

- Drafix 1 CAD Package \$295
- Drafix 1 with Mouse \$395
- Torrington _____
- LOGIMOUSE _____
- Drafix 1 with SummaSketch tablet \$650
- AutoCAD File Exchange Utility \$ 95

Dealer inquiries welcome
Check, money order, Visa and MasterCard accepted

FORESIGHT
RESOURCES CORP.
932 Massachusetts
Lawrence, KS 66044
913/841-1121

AutoCAD is a trademark of Autodesk, Inc.
IBM PC/XT/AT are trademarks of the IBM Corp.
SummaSketch is a trademark of Summagraphics Inc.
Manager Mouse is a trademark of Torrington Company.



Low Prices Are Only

Compare our prices, products and service

DATABASE SYSTEMS

- 8399. ASHTON-TATE dBase III+ BORLAND
- 95. Reflex MICRORIM
- 379. R-Base 5000 NANTUCKET
- 369. Clipper PAPERBACK
- 65. VP Info

WORD PROCESSING

- 839. DAC Easy Word LIVING VIDEOTEXT
- 59. Ready
- 109. Think Tank MICROSOFT
- 245. Word MICROPRO
- 79. Easy
- 179. WordStar 3.3
- 249. WordStar Professional
- 295. WordStar 2000+ MULTIMATE
- 69. Just Write
- 229. Multimate
- 245. Executive
- 289. Advantage SSI (Satellite)
- 69. The Library
- 235. WordPerfect 4.1

SPREADSHEETS

- LOTUS
- 8339. 1-2-3 MICROSOFT
- 124. Multiplan PAPERBACK
- 65. VP Planner

INTEGRATED PACKAGES

- ASHTON-TATE Framework II
- LOTUS
- 459. Symphony MICROSOFT
- 65. Windows SOFTWARE PUBLISHING
- 75. Report
- 84. File, Write, Graph, Access or Plan QUARTERDECK
- 65. Desqview

ACCOUNTING

- BPI
- 8325. GL, AR, AP or Payroll DAC
- 39. Easy Payroll
- 55. Easy Accounting EVERGREEN
- 165. One-Write-Plus REAL WORLD
- 339. GL, AR, AP, PR, Inv or Payroll

PERSONAL FINANCE

- MECA
- 85. Managing The Market
- 109. Managing Your Money MONOGRAM
- 109. Dollars & Sense SIMON & SCHUSTER
- 55. J. K. Lasser Money Manager TIMEWORKS
- 75. Personal Financial Planner

CAD SYSTEMS

- AMERICAN SMALL BUSINESS
- 8185. Pro Design I FORESIGHT RESOURCES
- 239. Drafix I
- GENERIC SOFTWARE
- 119. Generic CAD With Dot Plot

COMMUNICATIONS

- HAYES
- 89. Smartcom II MICROSOFT
- 169. Access MICROSTUF
- 105. Crosstalk
- 165. Transporter VM
- 95. Relay
- 135. Relay Gold

UTILITIES

- ALPHA SOFTWARE
- 57. Keyworks AMBER
- 40. Homebase BORLAND
- 46. Superkeys
- 52. Sidekick (copiable) CENTRAL POINT
- 23. Copy II PC
- 23. PC Tools
- 81. PC Option Board FIFTH GENERATION
- 105. Fastback FINOT GROUP
- 64. Keep Track FUNK
- 39. Sideways NORTON
- 59. Utilities ROESOFT
- 83. Prokey

PROGRAMMING LANGUAGES

- BORLAND
- 22. Turbo Tutor
- 32. Turbo Toolbox
- 35. Turbo Graphix Toolbox
- 40. Editor Toolbox
- 46. Word Wizard
- 46. Turbo Pascal
- 46. Traveling Sidekick
- 59. Turbo New Pack
- 63. Turbo Prolog
- 65. Turbo Lightning
- 79. Turbo Pascal w/8087 & BCD
- 78. Traveling Sidekick Combo
- 155. Jumbo Pack MICROSOFT
- 99. Macro Assembler
- 199. Pascal Compiler
- 275. C Compiler
- 229. Fortran Compiler

GRAPHICS

- DECISION RESOURCES
- 155. Sign Master
- 209. Diagram Master
- 235. Chartmaster
- 245. Map Master GRAPHICS COMMUNICATION
- 215. Freelance
- 329. Graphwriter Combo MICROGRAFX
- 109. Draw
- 115. Windows Draw (Req. Windows)
- 229. PC Draw
- 275. In-A-Vision MICROSOFT
- 199. Chart

- Business Accounts Program
- Second Day Air Shipping
- Toll Free Technical Support

ORDERING INFORMATION

- Most orders shipped second day air.
 - Shipping Charges:
 - US & Puerto Rico — 3% (\$6 minimum)
 - APO, FPO — US rate PLUS \$5
 - Canada — 12% (\$15 minimum)
 - Foreign — 18% (\$25 minimum)
 - Heavy items may require additional shipping charges.
 - Prices reflect a 3% discount for Conroy-LaPointe Credit Card or cash. Add 3% for other credit card purchases.
 - Customer Service: (503) 620-9877
- PRICES AND AVAILABILITY SUBJECT TO CHANGE WITHOUT NOTICE

IBM PC/AT Compatible

\$2599



- 512K RAM Expandable to 5 MB
- 6, 7.16, & 8 MHz Processor
- 1 Parallel & 2 Serial Ports
- 8 Expansion Slots
- Clock/Calendar
- Hard Disk Systems Available

SPERRY PC/IT

\$2899 With Mono Card & Monitor

LASER 128:
Better than Apple
at half the price.

\$499

With Monitor & Cable

- 128K RAM, 32K ROM
- 65C02 CPU
- 5¼" Floppy Drive, Internal
- 1 Expansion Slot, 1Ie
- 1 Parallel & 2 Serial Ports
- External Drive Port
- Numeric Keypad
- 4 Cursor & 10 Function Keys
- Supports Double Hi Res
- Mouse/Joystick Port

\$949 With Monitor, Printer, 2nd Floppy Drive, Cables



MAGNUM MEMORY & MULTIFUNCTION BOARDS

PC MASTERCARD™

"0" KB \$139 • Expandable to 1.5 MB

384KB \$189 • Serial Port

1.5 MB \$339 • Parallel Port

ECONORAM™

384 KB \$109 • Short Card

• 1 Year Limited Warranty

To Order:

1-800-547-1289

Business Accounts Call: 1-800-4-CONROY

In Oregon: 1-800-451-5151
Hours: 6-6 Pacific
Mon-Fri, 8-4 Sat

Part Of The Story . . .

with anyone's . . . mail order or retail.

- Full Product Warranties
- Conroy-LaPointe Credit Card
- Products For Apple & Mac

BUSINESS ACCOUNTS

Not just for business, but for schools, government agencies, and other institutions. In addition to our regular low prices, wide selection and professional service, we now accept purchase orders from organizations who qualify. To receive an application, just call 1-800-4-CONROY (or 503-684-7261 in Oregon).

MAGNUM

XT/MARK 2™

\$1295

With
Monitor &
Video Card



The complete IBM compatible.

- Mono Graphics Card And Monitor
- 640K RAM On Motherboard
- Dual 360K Floppy Drives
- Dual Speed 4.77 & 8 MHz Processor
- 135 Watt Power Supply
- Selectric, PC/AT Style Keyboard
- Parallel Printer Port
- 2 Serial Ports
- 5 Slots & Clock/Calendar
- MS-DOS 2.11
- Warranty: 1 Year Parts, 90 Days Labor

EGA System

\$1375 Special

- Magnum XT/Mark 2 With 640K & 2 Half Height Floppy Drives
- EGA Compatible Color Graphics Card
- 3% Off Any EGA Compatible Color Monitor We Carry

MEMORY CHIPS & COPROCESSORS

- RAM CHIPS**
- 8 13. 64K, 200 NS Kits
 - 14. 64K, 150 NS Kits
 - 39. 256K Kits
 - 48. 128K Kits for AT
- HAUPPAGE**
- 119. 8087 Chip
 - 175. 8087-2 Chip
 - 229. 80287 Fast 5 for AT
 - 349. 80287 Fast 8 for AT

EXPANSION BOARDS

- AST**
- 8275. SixPak Plus, 384K
 - 339. Rampage for PC
 - 399. SixPak Premium
 - 495. Rampage for AT
- INTEL**
- CALL Above Board 64K For PC
 - CALL Above Board 128K for AT
- MAGNUM**
- 99. EconoRAM 384K
 - 139. PC MasterCard No RAM
 - 189. PC MasterCard 384K
 - 325. PC MasterCard 1.5 MB
- ORCHID**
- 279. Conquest No RAM
- TALLTREE**
- 269. JRAM 3, 256K EM5 Board, PC
 - 279. JRAM AT3, No RAM for AT

VIDEO BOARDS

- EVEREX**
- 8265. The Edge
- HERCULES**
- 159. Color Graphics
 - 309. Graphics Card
- ORCHID**
- CALL Turbo EGA
- QUADRAM**
- 419. Quad EGA+ Board
- STB**
- 379. EGA Plus
- VIDEO 7**
- 185. Mono Graphics Adapter
 - 399. VEGA Board

INPUT DEVICES & DIGITIZERS

- KEYTRONICS**
- 185. KB 5151 Keyboard
 - 319. KB 5153 Keyboard
- MICROSOFT**
- 129. Mouse
 - 139. Serial Mouse
- MOUSE SYSTEMS**
- 129. Mouse With Software & PC Paint

DRIVES & TAPE BACKUPS

- CDC Floppy Drives**
- 8 99. Half Height 360K
 - 119. Full Height 360K
- IRWIN**
- 539. 10 MB Tape Backup Kit
- MOUNTAIN**
- 875. 20 meg DriveCard Hard Disk
- SILICON VALLEY COMPUTER**
- 599. Goldcard 21 MB Hard Disk Card
- SEAGATE Hard Drives**
- 489. 20 MB for PC
 - 649. 20 MB for AT
 - 789. 30 MB for AT
- SYSGEN**
- 1085. 60 MB Internal Tape Backup
 - 1150. 60 MB External Tape Backup
 - 1225. 20 MB Hard Disk, 20 MB Tape (PC)
 - 1999. 30 MB Hard Disk, 60 MB Tape (AT)
- TEAC Floppy Drives**
- 109. 55-BV Half Height 360K
- TOSHIBA**
- 115. 360K Floppy Drive For AT
 - 169. 1.2 MB Drive For AT

MODEMS

- EVEREX**
- 8159. 1200 Baud Internal
- HAYES**
- 419. 1200 External
 - 379. 1200B Internal
 - 629. 2400 External
 - 579. 2400B Internal
- CONROY-LAPOINTE**
- 185. 1200B Internal w/Software
 - 195. 1200 External w/Software
 - 389. 2400B Internal w/Software

PRINTERS & PLOTTERS

- CANON**
- 2199. Laser Printer A1-P
- EPSON**
- 389. FX 85 160 cps, 32 NLQ
 - 419. HI 80 Plotter
 - 589. FX 286 200 cps, 40 NLQ
 - 649. LQ 800 180 cps, 60 LQ
 - 795. LQ 1000 180 cps, 60 LQ, 15"
 - 995. LQ 1500 200 cps, 67 LQ, 15"
- OKIDATA**
- CALL 182 S or P, 192 S or P, 193, 292, 293
- PANASONIC**
- 275. P1091 120 cps,
 - 439. P3151 Daisywheel

MONITORS

- AMDEK**
- 8125. 300G 12" Green Composite
 - 135. 300A 12" Amber Composite
 - 159. 310A 12" Amber TTL
- Color 600**
- 549. Color 722
 - 609. Color 725
 - 795. Color 730
- NEC**
- 599. JC 1401P3A Multisynch
- PRINCETON**
- 179. MAX 12 12" Amber TTL
 - 459. HX-12 12" Color RGB
 - 559. HX 12e RGB for IBM-EGA
 - 599. SR-12 Hi Res RGB

POWER & SURGE PROTECTION

- CONROY-LAPOINTE**
- 8 83. 130 Watt Power Supply
- CURTIS Surge Suppressors**
- 30. Diamond, 6 outlets
 - 35. Emerald, 6 outlets, 6 cord
 - 47. Sapphire, 3 outlets, RFI filter
 - 55. Ruby, 6 outlets, cord, RFI Filter
- KENSINGTON**
- 92. Masterpiece
 - 129. Masterpiece Plus

DISKETTES & ACCESSORIES

- CONROY-LAPOINTE DISKETTES**
- 8 16. DS/DD 10
 - 119. DS/DD 100
 - 29. DS/HD 10 for AT
 - 279. DS/HD 100 for AT
- FUJI**
- 19. DS/DD 10
 - 39. DS/HD 10 For AT
- GENERIC DISKETTES**
- 11. DS/DD 10
 - 89. DS/DD 100
 - 28. DS/HD 10 for AT
- DYSAN**
- 29. DS/DD 10
- MAXELL**
- 18. DS/DD 10
 - 34. DS/HD 10 for AT

Conroy • LaPointe Inc.

Inquiry 96 for Apple. Inquiry 97 for IBM Peripherals. Inquiry 98 for all others.

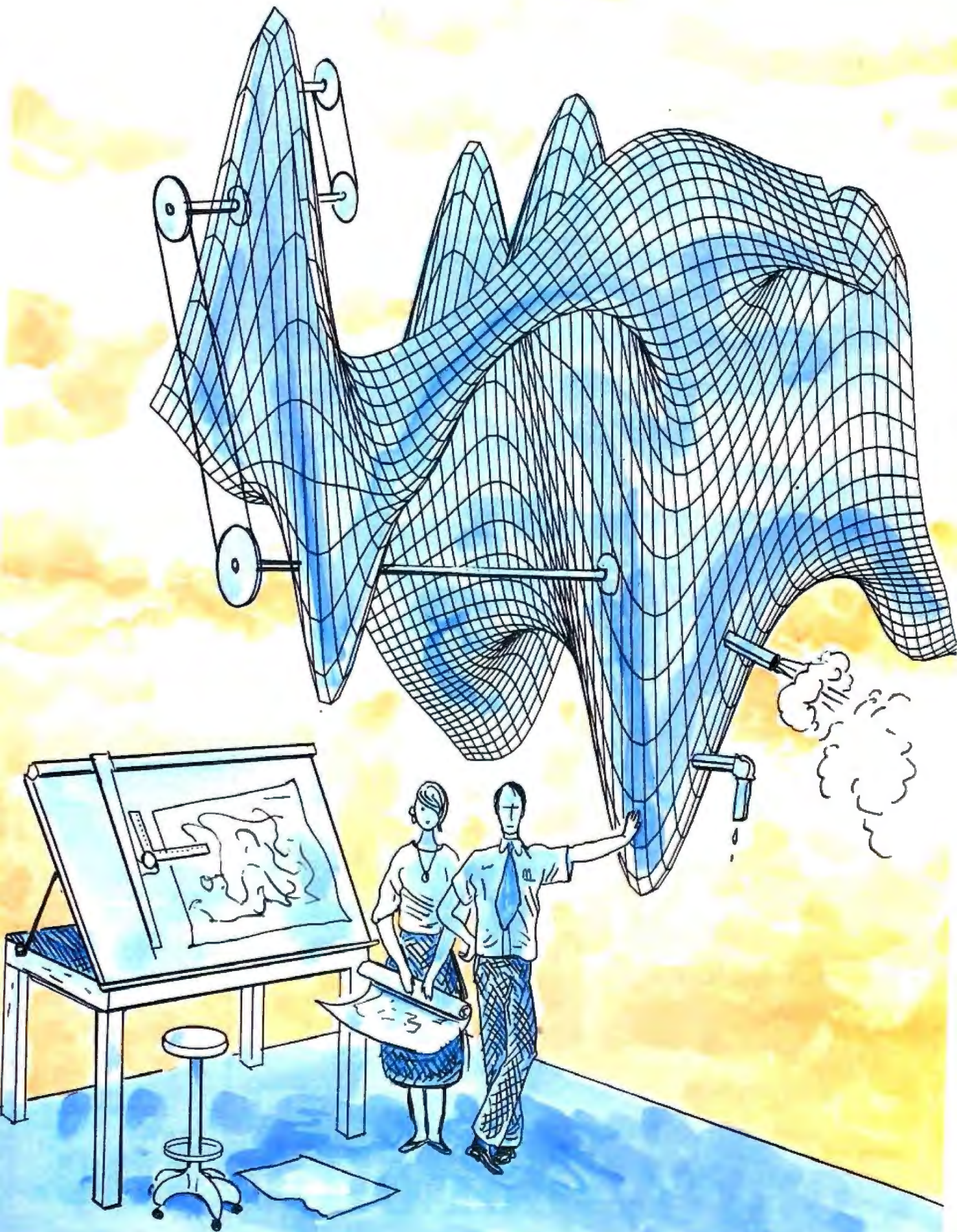

Engineer's Toolbox

SIMULATING CIRCUITS	
COMPUTER CIRCUIT SIMULATION <i>by Wolfram Blume</i>	165
ANALOG CIRCUIT ANALYSIS <i>by David McNeill</i>	170
AN 8031 IN-CIRCUIT EMULATOR <i>by George Dinwiddie</i>	181
STRUCTURAL ANALYSIS <i>by Robert W. Johnson and Fernando G. Loygorri</i>	199
STRESS ANALYSIS <i>by D. Lee Petersen and Steven L. Crouch</i> ..	219
A MATERIAL SELECTION PROGRAM <i>by Brother Tom Sawyer and Michael Pecht</i>	235
SMALL-SCALE ENGINEERING APPLICATIONS <i>by J. Neil Stone</i>	253

ONE OF THE REASONS that engineering and science advance exponentially is the availability of new tools that shorten the time required to accomplish fundamental tasks. Improved tools allow engineers to build many new technologies, including more advanced tools!

Our theme articles this month give a peek inside the toolbox of a mythical mega-engineer—a person building a microprocessor-controlled drawbridge that uses the latest in strong but lightweight materials. Our "meganeer" needs to analyze analog circuits to design the motor controls for the drawbridge; emulate an 8031 controller to design the controller board for sensing approaching vessels and activating the bridge; perform structural and stress tests on the bridge superstructure design; determine the critical properties of the space-age materials to be used in this bridge; and, finally, select the most cost-effective materials for constructing the finished design.

Our fictitious meganeer has plenty of help in his toolbox in the form of micro-computer software to perform many of these tasks. This software has been placed into the public domain and is available in a variety of formats (see pages 459–461).

The modeling and simulation of analog circuits has been possible on main-frame computers for some time with a program called SPICE. David McNeill has reproduced the functionality of SPICE in a program that runs on a Commodore 64. McNeill's article follows a lucid explanation of the theory of circuit-modeling programs by Wolfram Blume.

Next, George Dinwiddie explains a monitor board that permits in-circuit emulation of an Intel 8031 microcontroller. Using Dinwiddie's hardware and software, engineers can substantially cut the time it takes to debug an 8031 application.

Our thematic engineer is building only an imaginary bridge—but he still wants to know under what conditions it might collapse. Robert W. Johnson and Fernando G. Loygorri offer some help with an IBM PC structural analysis program that employs the finite-element method.

Our meganeer does not want to stop with structural analysis, so D. Lee Petersen and Steven L. Crouch offer an article and program on stress analysis using a boundary-element/finite-difference method, a technique that should prove useful to any physical scientist who needs to find numerical solutions to problems approaching infinity.

To select the best (and cheapest) materials to build the imaginary bridge, our engineer can use the sophisticated material selection program by Brother Tom Sawyer and Michael Pecht. Finally, J. Neil Stone provides help for our dauntless bridge designer with programs to determine the critical properties of unusual or new substances.

Armed with this megabyte of software, BYTE's intrepid, nonexistent engineer can now more easily solve a multitude of engineering problems. We've purposefully not given him much computer-aided design/engineering help—reserving a look into that burgeoning realm for an upcoming theme.

We hope you will also find these tools useful.

—G. Michael Vose, Senior Technical Editor/Themes

Microprocessor Development Dreams Come True!

On-Line Help menus,
Command Glossary,
and Word List.

Windows can be used
to view source files,
previous traces,
and more.

Symbol translation
or source code
line display.

Screen displays scroll off
into history buffer –
can be viewed later.

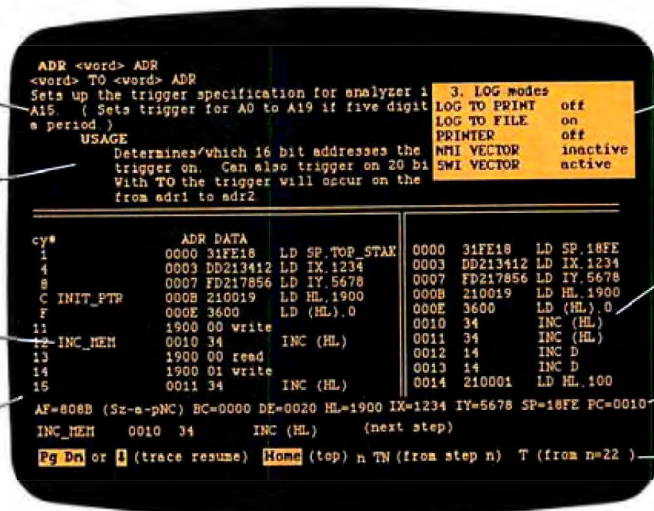

Pop-up Mode
Selection panel
called by soft key.

Disassembly of code
in memory can be
compared with trace in
adjacent window.

Symbolic debug
register display.

Context sensitive
prompt line.

NEW UniLab II™: FOUR INSTRUMENTS IN ONE!

Here are all the development tools you ever dreamed of integrated into one PC-controlled system:

- An Advanced 48-Channel Bus State Analyzer
- An 8/16-Bit Universal Emulator
- A Built-In EPROM Programmer
- An Input Stimulus Generator

The synergy of these instruments that were designed together to work together saves you time and money. All UniLab II commands and menus are seamlessly integrated into a single, super-efficient working environment.

An Integrated Software Environment, too!

Imagine being able to split your screen and look at real-time program traces and the source code that produced them at the same time! Then go to the On-Line Help or pop-up Mode Panels instantly.

If you see something on a trace that doesn't look like last time, you can hold it in one window while you scroll back through your previous displays.

If you set a breakpoint and single-step you can then go back to using the analyzer without missing a beat. You can even execute a DOS batch file from UniLab to edit, assemble, and link, then automatically load the new program and symbol table. UniLab uses the full power of the PC.

Find bugs fast with Hardware-assisted Debugging

The traditional way to look for bugs is to single-step through suspect parts of the code until you catch it in the act. This requires a lot of guessing and wasted time.

With UniLab's built-in analyzer you eliminate the guesswork. Just describe the bug symptom as a trigger, and let the UniLab hardware search

for it as your program runs in real time. UniLab will show you a trace of the program steps leading up to the symptom, almost like magic.

A friendly user interface

UniLab lets you use commands or menus – or a mixture of both. An on-line manual, soft-key help screens, a glossary of commands and their parameters, with full-screen writeups are also at the ready.

Reconfigure for any 8 or 16-bit processor in seconds

Thanks to our unique approach to emulation, changes between processor types require only cable and diskette changes. At last count, we specifically support over 120 micro-processors.

Bonus! The built-in EPROM Programmer and Stimulus Generator are simply icing on the cake.

Affordable capability

How much does all this superior capability cost? A lot less than our less able competitors, and probably a lot less than you expect. Our products are sold with a Money Back Guarantee, and our crack team of Applications Engineers is standing by if you need help. Get the full story on the amazing UniLab II and how it can liberate your development projects, today.

ACTION COUPON

Send me info on UniLab II and your No-Risk 10-Day Evaluation!

Name: _____ Title: _____

Company: _____

Address: _____

City: _____

State/ZIP: _____

Tel.: _____ Ext. _____

UniLab II™

Universal Development Laboratory



Orion Instruments, Inc.

ORION

702 Marshall Street
Redwood City, California 94063

CALL TOLL FREE: 1-800-254-8500

In California (415) 361-8883

SIMULATING CIRCUITS

Circuit modeling programs have replaced "breadboards" as the building blocks of circuit design and development. With these programs, engineers can simulate a circuit, substitute components, vary parameters such as voltage and current in discrete time increments, and observe the changes at every point in the circuit. This capability represents an enormous savings in development

time and effort.

The articles that follow present two approaches to the modeling of electrical circuits. The first, "Computer Circuit Simulation" by Wolfram Blume, is an introduction to the problems inherent in circuit modeling, such as linearizing nonlinear elements like diodes and transistors and solving the large simultaneous equations involved in circuit computa-

tions. The second article, "Analog Circuit Analysis" by David McNeill, describes the author's efforts in developing a set of circuit simulation programs for the Commodore 64, based on algorithms used in the SPICE simulation program of Dr. Laurence Nagel of the University of California.

—Charles Weston
Technical Editor

COMPUTER CIRCUIT SIMULATION

Circuit modeling programs make breadboards obsolete

BY WOLFRAM BLUME

COMPUTER SIMULATION is an important tool for circuit design engineers. The means for testing out ideas and checking a design has traditionally been the "breadboard" (a test circuit built on the workbench).

Computer simulation does the

Wolfram Blume is president of MicroSim Corporation, which manufactures and markets the PSPICE analog simulation program. He can be contacted at MicroSim Corp., 23175 La Cadena Dr., Laguna Hills, CA 92653.

same job. It lets designers check out ideas while designing the circuit. Simulation programs also check the final design before it is released for production.

ANALOG CIRCUITS

The goal of a simulation program is to calculate the voltage at each node and the current through each device of the circuit. We will first want to calculate these values at the circuit's steady state (bias point). Using the

steady-state data, we are then able to calculate the circuit voltages and currents as functions of time and frequency.

Most analog circuit simulators in use today are based on the program SPICE (Simulation Program for Integrated Circuit Engineering), which was developed at the University of California at Berkeley in the early 1970s. SPICE included several advances over earlier simulators, such as a "sparse matrix" data structure.

DATA STRUCTURE

Suppose we want to analyze the circuit shown in figure 1. Including ground, it has three nodes: 0, 1, and 2. The goal is to find the voltage at each node and the current through each device. For now, we will try to find the steady-state, or bias point, solution.

To analyze this circuit using a program we need a somewhat different approach than we would take in

(continued)

As a rule, any non-linear circuit has a linear equivalent, but only for one set of node voltages.

analyzing it by hand. Our approach is known as the nodal analysis method. We will set up a vector that lists the total current being pumped into each node by current sources. For all nodes that are not attached to a current source (such as node 2) this sum will be 0 (since electrical charge cannot be created or destroyed). For node 1 this will be -0.1 , since the current source I_1 is driving 0.1 amp into node 1.

For node 0 this will be $+0.1$, since I_1 is pulling 0.1 amp out of node 0. This vector, I in figure 2, describes the input to the circuit. The current sources are the stimuli that drive the circuit. Note that the vector I has the same number of elements as the number of nodes in the circuit.

Next we need a vector that describes the response of the circuit to I . This vector, V in figure 2, is a list of the voltages at each node. V is the vector we want to find.

Finally, we need a description of how V relates to I . This is provided by the conductance matrix, G (figure 2). G describes how current flows in elements that are not current sources. In our example, the currents through resistors $R1$ and $R2$ are proportional to the voltages across them. The term of G at row i and column j specifies how much current will flow away from

node i if the voltage at node j were increased by 1 volt and the voltages at all the other nodes were held constant. This may seem like a peculiar way of thinking about the circuit, but it has the great advantage that

$$I = G \times V$$

Note that each term in G is the sum of the contributions of the relevant circuit elements. So, knowing which devices in the circuit are connected to which nodes, our program can build G in a straightforward way. G has the same number of rows and the same number of columns as there are nodes in the circuit. Now that I is known and G is known, we can solve for V and get the set of node voltages we are after.

Even in this small example, it is obvious that most of the terms of G will be 0. This becomes even more true as the circuit gets larger. In typical circuits of 30 or 40 transistors, over 90 percent of the terms in G will be 0. G is therefore referred to as a "sparse matrix."

Circuits of this size also typically have 100 to 150 nodes. Since the number of elements in G is n^2 (n = number of nodes) it becomes clear that we must take advantage of all those 0 terms in G or its size will get out of hand. We do this by storing only the nonzero terms of G and a list of pointers to those terms. This process complicates the algorithms, but it is necessary in order to simulate realistic circuits.

SOLVING THE CIRCUIT EQUATIONS

Now that we have established a data structure, we can proceed to analyze the circuit. There are three levels of analysis:

1. Solving a linear circuit by Gaussian elimination or LU factorization.
2. Solving a nonlinear circuit by repeatedly linearizing the circuit and using (1).
3. Solving a time-varying circuit by repeatedly converting the circuit to a nonlinear, non-time-varying circuit and using (2).

Calculating the circuit's response with respect to frequency is a special case of (1).

SOLVING A LINEAR CIRCUIT

Our example circuit (figure 1) is linear and does not vary with time. A linear circuit is composed of linear elements (those elements whose currents are proportional to the voltages within the circuit). For example, resistors are linear because the current through them is proportional to the voltage across their terminals. Ideal amplifiers are also linear because their output is proportional to their input.

Since our system is described by the matrix equation $I = G \times V$, we can use the standard methods for solving systems of linear equations. The two most common methods are Gaussian elimination and LU factorization. Both methods take about the same amount of computer time given one G and one I , but LU factorization has the advantage of being much faster given one G and several different I 's. SPICE uses LU factorization.

Here is a brief overview of LU factorization: The idea is to split G into two matrices, L and U , which multiplied will give G .

$$G = L \times U$$

Therefore,

$$I = L \times U \times V$$

(continued)

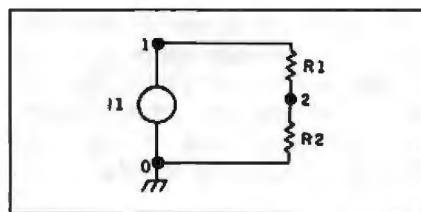
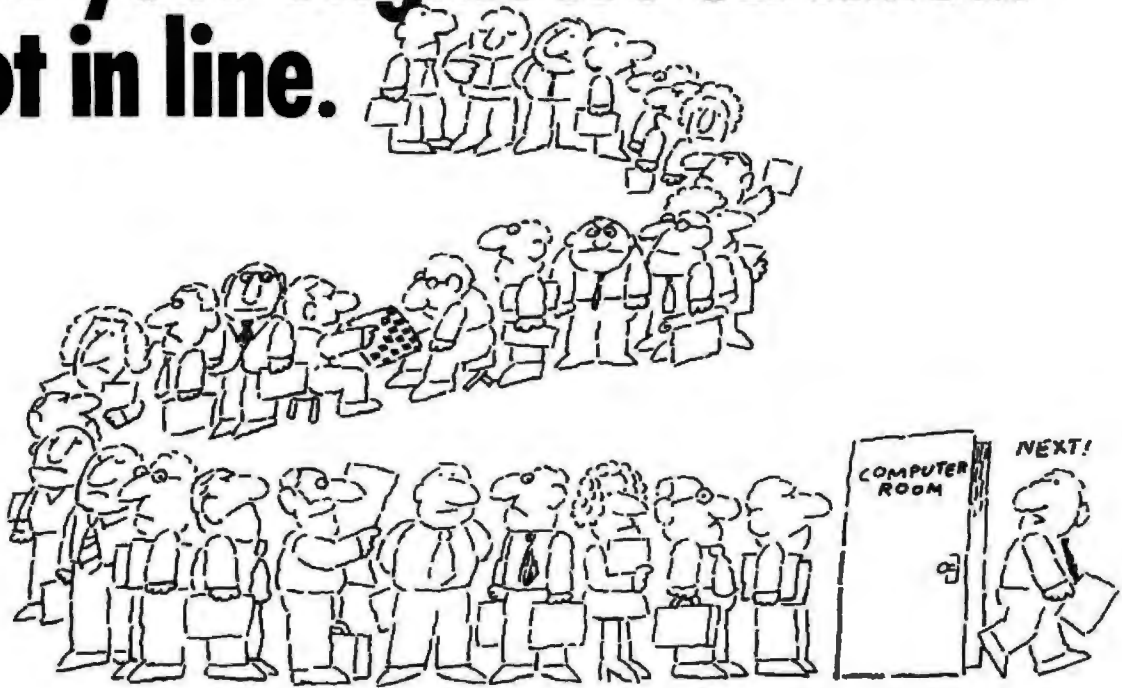

Figure 1: A simple three-node circuit consisting of two resistors and a current source.

$$\begin{pmatrix} -I_1 \\ +I_1 \\ 0 \end{pmatrix} = \begin{pmatrix} \frac{1}{R2} & -\frac{1}{R2} & 0 \\ \frac{1}{R2} & \frac{1}{R2} + \frac{1}{R1} & -\frac{1}{R1} \\ 0 & -\frac{1}{R1} & \frac{1}{R1} \end{pmatrix} \begin{pmatrix} V_0 \\ V_1 \\ V_2 \end{pmatrix}$$

Figure 2: The conductance matrix for the circuit shown in figure 1.

MICRO CAP and MICRO LOGIC put your engineers on line... not in line.



MY OWN WORKSTATION

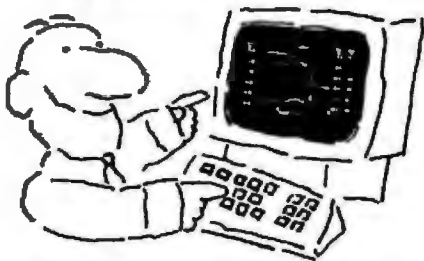

How many long unproductive hours have you spent "in line" for your simulation? Well, no more. MICROCAP and MICROLOGIC can put you on line by turning your PC into a productive and cost-effective engineering workstation.

Both of these sophisticated engineering tools provide you with quick and efficient solutions to your simulation problems. And here's how.

MICROCAP: Your Analog Solution

MICROCAP is an interactive analog circuit drawing and simulation system. It allows you to sketch a circuit diagram right on the CRT screen, then run an AC, DC, or Transient analysis. While providing you with libraries for defined models of bipolar and MOS devices, Opamps, transformers, diodes, and much more, MICROCAP also includes features not even found in SPICE.

MICROCAP II lets you be even more productive. As an advanced version, it employs sparse matrix techniques for faster simulation speed and larger net-

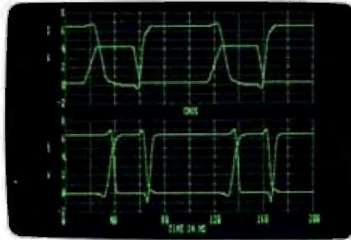

"Typical MICROCAP Transient Analysis"

works. In addition, you get even more advanced device models, worst case capabilities, temperature stepping, Fourier analysis, and macro capability.

MICROLOGIC: Your Digital Solution

MICROLOGIC provides you with a similar interactive drawing and analysis environment for digital work. Using standard PC hardware, you can create logic diagrams of up to 9 pages with each containing up to 200 gates. The system automatically creates the netlist required for a timing simulation and will handle networks of up to 1800 gates. It provides you with libraries for 36 user-defined basic gate types, 36 data channels of 256 bits each, 10 user-defined clock waveforms, and up to 50 macros in each network. MICROLOGIC produces high-resolution timing diagrams showing selected waveforms and associated delays, glitches, and spikes—just like the real thing.

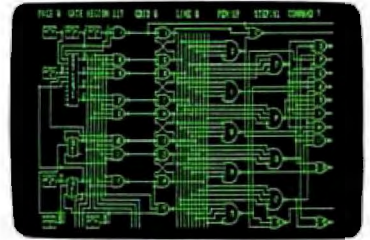

"Typical MICROLOGIC Diagram"

Reviewers Love These Solutions

Regarding MICROCAP... "A highly recommended analog design program" (PC Tech Journal 3/84). "A valuable tool for circuit designers" (Personal Software Magazine 11/83).

Regarding MICROLOGIC... "An efficient design system that does what it is supposed to do at a reasonable price" (Byte 4/84).

MICROCAP and MICROLOGIC are available for the Apple II (64k), IBM PC (128k), and HP-150 computers and priced at \$475 and \$450 respectively. Demo versions are available for \$75.

MICROCAP II is available for the Macintosh, IBM PC (256k), and HP-150 systems and is priced at \$895. Demo versions are available for \$100.

Demo prices are credited to the purchase price of the actual system.

Now, to get on line, call or write today!

Spectrum Software

1021 S. Wolfe Road, Dept. B
Sunnyvale, CA 94087
(408) 738-4387

Inquiry 331

L is lower triangular and U is upper triangular, as shown in figure 3.

An important feature of LU factorization is that for any G there is only one pair of L and U that have this structure. It is also true that the process of splitting G into L and U uses the major part of the computation time in this method.

Once L and U are found, their triangular structure (all 0s above or below the diagonal) allows the program to quickly calculate V from I. Since most of the time is spent finding L and U, we can find the solutions for several I's almost as quickly as for one.

SOLVING A NONLINEAR CIRCUIT

Now that we have a method to solve linear circuits, we can use it to find the solution for nonlinear circuits. The idea here is to use our last guess at V to linearize the circuit. Then, using our method for solving linear circuits, we can calculate a new guess for V. Hopefully, after a few iterations, successive guesses of V will converge to the correct answer.

How can we convert a nonlinear circuit into a linear one? By converting each nonlinear element into its linear equivalent. For instance, we can replace the diode in the circuit shown in figure 4 with a current source and a conductor.

The current through a diode is given by

$$I_d = I_s \times (e^{V/V_T} - 1)$$

At a given voltage V across the diode we can replace the diode with a cur-

rent source whose current is

$$I_{eq} = I_d - V \times G_{eq}$$

in parallel with a conductor whose conductance is

$$d(I_d)/dV = I_d/V.$$

Note that the equivalent current and conductance change with the voltage V across the diode. This is true of diodes and of nonlinear elements in general. As a rule, any nonlinear circuit has a linear equivalent, but only for one set of node voltages. As soon as the node voltages change, we must "linearize" the circuit again.

Our algorithm for solving nonlinear circuits now looks like this:

1. Pick an initial guess for the node voltages V. Set $V_{old} = V$.
2. Using the node voltages V, calculate the linear equivalent circuit and fill in the terms for the circuit matrix G and the current vector I.
3. Using the LU method, solve the circuit for a new set of node voltages V.
4. If V is close enough to V_{old} :
 - 4a. Stop. We are done.
 - Else:
 - 4b. Set $V_{old} = V$.
 - Go back to step 2.

SOLVING TIME-VARYING CIRCUITS

So far the circuits we have considered have not varied with time. That is, neither the sources nor the other elements change with time. Capacitors have been treated as open circuits, and inductors have been treated

as short circuits. This means that the solution, V, does not vary with time either. So far, we have been solving for the steady-state, or bias point, solution.

To accommodate time, we need to add time-varying sources and we need to handle capacitors and inductors. The first objective is easily done. We just allow the value of a source to be a function of time, such as a sine wave, pulse, square wave, etc.

The second objective is done in a way similar to the technique for solving a nonlinear circuit using the method for solving a linear one. We will replace each capacitor and inductor by equivalent circuit elements. Our algorithm for simulating the circuit now looks like this:

1. Use the nonlinear circuit method above to calculate the bias point of the circuit.
2. Set Time = 0. Set TimeStep to a small positive number.
3. Set all sources to their values at time = Time + TimeStep.
4. Using TimeStep and the past values of V, replace each capacitor and inductor by its equivalent circuit.
5. Use the nonlinear circuit method above to calculate V for time = Time + TimeStep. Use V from time = Time as the initial guess for time = Time + TimeStep.
6. Set Time = Time + TimeStep. Update TimeStep based on error-estimation formulas.
7. If Time = > final time requested for simulation:

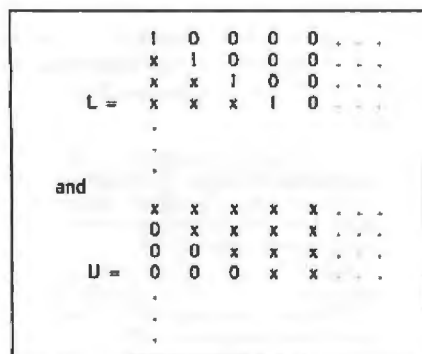

Figure 3: A typical LU-factorization matrix. Note that L has 1s on the diagonal and 0s above the diagonal, and U has 0s below the diagonal.

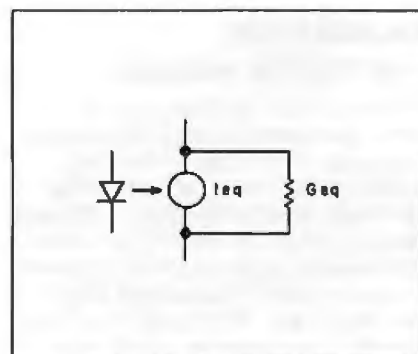

Figure 4: A diode and its linear equivalent circuit, a current source and a conductor.

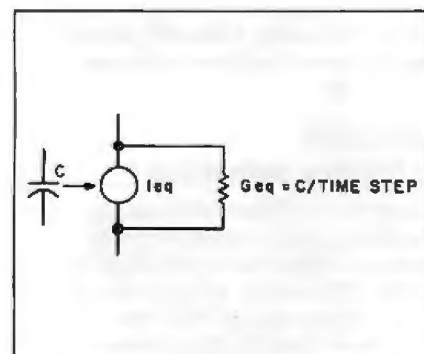

Figure 5: A capacitor and its linear equivalent circuit, a conductance and a current source in parallel. The size of the time step is varied as simulation proceeds.

7a. Stop. We are done.

Else:

7b. Go to step 3.

Replacing the capacitors and inductors by equivalent circuit elements is possible because we know the size of the time step and the past values of each element's charge or current. For example, a capacitor is converted into a current source with a conductance in parallel as shown in figure 5.

The size of the time step is changed as the simulation proceeds. We could use a fixed time step, but this would waste computer time. We need to use a step small enough to accurately calculate those areas where things are changing rapidly (such small steps would be wasted during times when nothing was changing). By changing the step size based on the activity of the circuit, we can use a fine step size where it is needed and a coarser step size otherwise.

CALCULATING FREQUENCY RESPONSE

The response of the circuit to different frequencies is calculated in a way very similar to solving a linear circuit. The difference is that the voltages, currents, and conductances now have real and imaginary parts instead of just real parts. The circuit algorithm now looks like this:

1. Use the nonlinear circuit method previously mentioned to calculate the bias point.
2. Set Frequency = beginning frequency.
3. Linearize the circuit using V calculated in step 1. Fill in terms, both real and imaginary parts, for I and G. Fill in the terms for capacitors and inductors as well. These are implemented as conductances, with imaginary values dependent upon Frequency.
4. Using the LU method, solve for V. V will have real and imaginary parts.
5. Set Frequency to the next frequency. If Frequency > ending frequency:

5a. Stop. We are done.

Else:

5b. Go to step 3.

DISPLAYING RESULTS

Personal computers are well suited for displaying results. Because they are

interactive and have graphics widely available, they are a natural for conveniently displaying the results of a simulation. Although SPICE does not provide for an interactive display of the results, this can easily be added.

The approach I followed is to store all the node voltages and all the device currents at each step of the simulation (e.g., at each time or fre-

quency). These are stored in a binary data file. The display software is a separate program that implements a virtual-memory scheme to allow the data file to be larger than the computer's RAM.

Besides drawing voltages and currents it is very convenient also to be able to draw expressions. For example, by multiplying a voltage and a

(continued)

Don't get burned by surge protection alone.

Now get **total** power protection... for as little as \$139... with the Personal Computer Line Tamer™ Power Conditioner.

Why risk any power trouble?

You will if you buy just a surge protector. Transients and spikes cause less than half of all power problems. Overvoltages, brownouts and just plain power noise can mess up your system just as badly—and they're much more frequent. Only Line Tamer's ferro-resonant technology protects you from any conceivable power problem, short of a blackout

Line Tamers have protected the big boys for years, on all the big mainframes and minis. Those guys would laugh at surge suppression alone.



Choose from 150, 300, 450, or 600 VA models for the Line Tamer that's right for you.

Does it make sense to you to be half safe... especially when so few dollars are involved?

You won't find this total power protection from anyone else at anywhere near the price, so contact us for complete specifications and the dealer nearest you.

SHAPE THE CLEAN POWER SOURCE
MAGNETRONICS INC.

901 DuPage Avenue, Lombard, IL 60148
Phone 1 312 620-8394 • TWX 910-991-2352



current we can display instantaneous power.

COMMENTS

Analog circuit simulation makes heavy use of floating-point arithmetic. For accurate results, double-precision (64-bit) numbers must be used for the V, I, and G terms. As a result, it is necessary to have a floating-point coprocessor, such as the Intel 8087, in the computer. It improves run time by a factor of 15 in a typical circuit. In other words, without a floating-point coprocessor the simulation will be too slow to be useful.

Another requirement is RAM. Typical analog simulations are of circuits with 30 to 40 transistors. This requires about 100K bytes of RAM. Paging to

and from disk would make the simulation intolerably slow. The program code itself takes up several hundred kilobytes of space, depending on how sophisticated the transistor models are and how many kinds of analyses are implemented. Therefore, to run a reasonable simulation, a machine with 512K bytes or more of RAM is needed.

Both these requirements are readily met by an IBM PC XT with 640K bytes and the 8087 coprocessor, which can simulate circuits of up to about 120 transistors. Calculating the time-varying response of a 30-transistor circuit takes about 12 minutes. Once the simulation is done, waveforms can be displayed almost instantly. ■

Editor's note: If you are interested in the concepts and algorithms of circuit simulation, the author strongly recommends that you read "SPICE: A Computer Program to Simulate Semiconductor Circuits" by Laurence W. Nagel.

You can obtain a copy of this document (Memorandum No. ERL-M520) by sending a check for \$20 made out to: Regents of the University of California. Send check to Ms. Deborah Dunster, EECS Industrial Liaison Program, 457 Cory Hall, University of California, Berkeley, CA 94720.

The document is Dr. Nagel's Ph.D. thesis and contains an excellent discussion of the various algorithms in SPICE. He covers the material in this article in more detail and also provides discussions of alternative algorithms and the reasons for selecting those that finally went into SPICE.

ANALOG CIRCUIT ANALYSIS

*An analog circuit modeling
and simulation program
for the Commodore 64*

BY DAVID MCNEILL

OF THE THREE GOALS that I wanted to accomplish with this project, the main one was to produce a program like the circuit analysis program SPICE for my Commodore 64. My second goal was to better understand how transistor models worked and how to incorporate these models into the nonlinear algorithms used by SPICE to solve electronic circuits. My third goal was to fit the program into the memory space of the Commodore 64 and make it run at a reasonable speed.

My circuit analysis package is com-

David McNeill is an electronics engineer who works for Tektronix in Beaverton, Oregon. He can be contacted at 11739 SW Beaverton-Hillsdale Hwy, #164, Beaverton, OR 97005.

posed of three programs: a preprocessor and editor program, the AC analysis program, and the DC analysis program. To perform a circuit analysis, you first load the preprocessor and editor program used for entering the circuit description. Then, using a chaining technique, you can jump between all three programs to run the different analyses.

You can model 12 devices with the programs: resistors, inductors, capacitors, independent voltage sources, independent current sources, voltage-controlled current sources, diodes, bipolar transistors (*nnp* and *ppp*), field-effect transistors (*n*-channel and *p*-channel), and operational amplifiers.

The programs allow you to sweep various parameters and print voltages, currents, impedances, or gains as the

output variables. For example, in the model for the bipolar transistor, you can specify forward and reverse beta, Early voltage, reverse saturation current, junction capacitances, and transit times as parameters.

PROGRAM DESIGN PHILOSOPHY

When I developed these programs, I decided to have as many model parameters as possible to better describe the device and produce more accurate data. Although this increased the complexity of the programs and tended to reduce the size of circuits that could be analyzed, I preferred to have programs that could better model actual transistors rather than analyze larger circuits with less accuracy. I felt that the limitation on running large circuits would be the speed of analysis rather than the amount of memory available.

The heart of the analysis programs is a routine that solves a set of linear equations. These equations arise from performing Kirchhoff's current equation at every node in the circuit. (Kirchhoff's current law states that the sum of all the instantaneous currents flowing toward a given node is equal to the sum of all the instantaneous currents flowing away from that node.)

For simple circuit elements such as resistors, voltage sources, and current sources, the formulation of the set of

(continued)

There's a lot we can tell you about InfoMaster®—the revolutionary new business information service from Western Union that puts over 700 databases at your fingertips. All through a single source.

But, frankly, our claims may sound too good to be true. That's why we want you to experience InfoMaster firsthand.

You'll see alternatives from a wider perspective. Feel really prepared.

InfoMaster delivers the vital business information you want, in minutes—not days. So you spend less time looking for information...and have more time to think about it.

This can make a big difference in your reports, presentations, recommendations, decisions. Not to mention your career.

Experience how easy it is to use.

InfoMaster eliminates the obstacles that have prevented you from taking advantage of electronic information services in the past.

Try it. There's no computerese. No commands to learn. No training needed. All it takes is simple English phrases.

You don't even have to know which database to choose. InfoMaster acts as your guide...leading you there, one easy step at a time. There's even free on-line assistance from a specialist, 24 hours a day. So you're never alone.

One more thing. You can use InfoMaster with any PC or terminal. No advanced communications software is needed.

Fact is, whatever business you are in, we've got the information you need: corporate descriptions, census data, market assessments, legal references, financial statements and analyses, government documents, the world's major trade and technical publications, newspapers, business magazines—and more.

Sample the world's largest electronic information source.

Right now. FREE.

But don't take our word for it. Call now for your complimentary password. Then get on-line and experience InfoMaster FREE.

1-800-247-1373

Dept. 509

InfoMaster®

western union

equations is straightforward, and since the equations in the set are all linear, they can be solved using standard numerical techniques such as Gaussian elimination or LU decomposition. The solution to this set of equations gives the voltage at each node in the circuit.

An element such as a diode, however, is not as easy to model because the relationship between the current through and the voltage across the diode is not linear but exponential. Because of this, we cannot directly assemble and solve a set of equations and arrive at the correct answer.

MODELING NONLINEAR ELEMENTS

To solve this problem, two things must be done. One is to somehow modify the diode to make it appear linear. If it were linear, then we could formulate a set of equations that could be solved directly.

The second thing that must be done is to create an iterative process where we progressively change the linear diode that we created so that it will come closer and closer to the actual diode that exists in the circuit. As our model of the diode becomes better, the solutions to the set of equations will also get closer and closer to the

actual answer. This second process is the program algorithm that controls the whole sequence of solving the set of equations, updating the linear diode, checking for convergence to a correct answer, and then repeating the procedure.

There are several crucial parts to this algorithm that can mean either success or total disaster. Due to the exponential nature of the diode equation, it is very easy to cause an overflow on the computer. Because of this, a good algorithm for clamping and limiting the exponential function was needed.

Figure 1 shows a simple resistor/diode circuit with a graph showing the load line for each element. The solution to this circuit is the point where the two lines intersect, which is at this time unknown. To start the analysis, we first make a guess at the voltage across the diode and pick this point on the diode curve. We can then linearize the diode by drawing a straight line through this point that is tangent to the diode curve, as shown in figure 2.

Notice that we now have two straight lines that intersect close to the actual intersection of the resistor and diode line. The point where the two straight lines intersect is found by

the solution of two simultaneous equations. This solution then becomes an approximation of the actual answer. Although I've shown this graphically, the mathematical approach would be to perform a Taylor's series expansion on the diode equation (see figure 3).

Notice that in the resulting equation, shown in figure 3, we can identify two elements: a constant current source and a conductance. This equation is simply the equation of the straight line that was drawn through the point that we first guessed at on the diode curve.

The important point here is that we have been able to model the diode with two simple linear elements: a resistor and a current source. We now have a circuit that is composed entirely of linear elements. We can use the Gaussian elimination technique to calculate the point of intersection of the two straight lines. At this point we have an answer that is an approximation of the actual answer.

In the next phase we repeat the process and gradually improve the model of the diode so that the answers that are computed each time become closer and closer to the actual answer.

THE LINEARIZATION ALGORITHM

Figure 4a is a flow diagram of the algorithm used to perform this iterative process for the diode. Figure 4b is a graphic description of the iterative process of the linearization algorithm. The first step is to check to see if the program has changed the temperature (such as in a temperature sweep analysis). If the temperature has been changed, the value of the reverse saturation current I_s must be recomputed, since it is temperature-dependent. Next, the program calculates and stores the value of the voltage across the diode that resulted from the last iteration.

The program then checks to make sure that if this value of voltage is used, the exponential function will not overflow. If overflow is possible, the program then clamps the voltage appropriately. Next, the program checks to see if this is the first iteration, and if so, guesses at a starting point for

(continued)

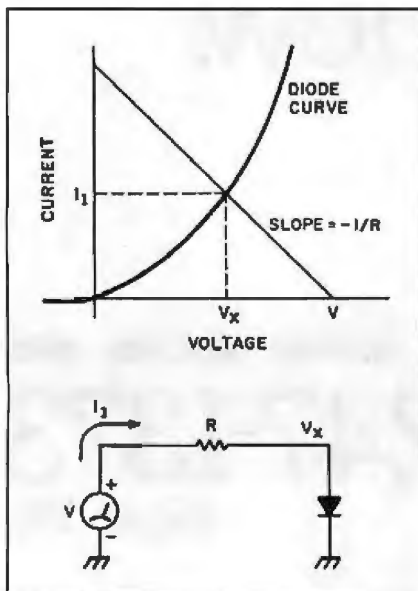

Figure 1: This graph shows the load lines for the resistor and diode in the inset circuit.

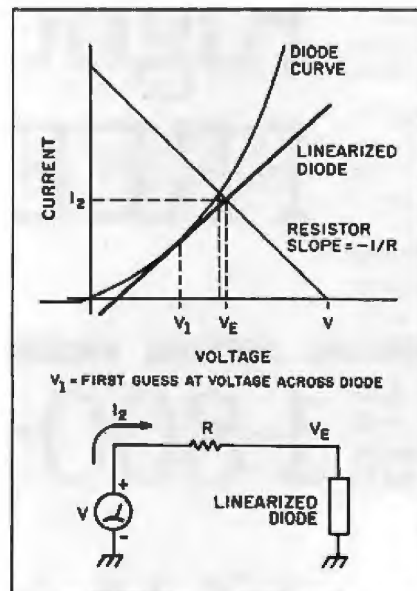

Figure 2: This graph shows the resistor load line, the diode curve, and the linearized diode load line.

American XTsr.™

THE IBM XT® COMPATIBLE WITH 60% MORE SPEED



HIGHLIGHTS INCLUDE:

- 640K-bytes RAM on a four layer high reliability motherboard
- 2 Megabytes of expanded memory on the American Above-Function Card™
- Turbo speed 4.77 to 7.37 MHz selectable without power down
- High Performance, high speed 8088-2 microprocessor
- Eight expansion slots; power-on auto self-test of system components
- Two 360K-byte DS/DD diskette drives
- 20M-byte hard disk drive
- 10M-byte formatted tape back-up included
- Serial, parallel, game ports, graphics card and real-time clock
- American Mouse™ with American Paintbrush™ for CGA and EGA graphics
- MS-DOS 2.11 and Macro-Assembler software included
- 1 year limited warranty covering parts & labor

Salesman Incentive Program Available
FREE American Paintbrush Software.

AMERICAN XTsr.™ PERFECT SYSTEM

MAXIMIZE EXPANSION SLOT USAGE WITH THE AMERICAN ABOVE- FUNCTION CARD!

- Increase memory to 2 Megabytes RAM
- Based on Lotus®, Intel® and Microsoft® specifications
- Serial, parallel and game ports and real-time clock
- One year limited warranty



AMERICAN ABOVE-FUNCTION CARD™

Authorized Distributor and Service Center:

PC Land, Inc.
Tustin, CA (714) 730-6723
Micro Configuration East, Inc.
Brooklyn, NY (718) 941-2512
Computer Peripheral Warehouse, Inc.
Deerfield Beach, FL (305) 481-2170
CPU Distributor
Burnsville, MN (612) 894-9153
Columbia Data Systems, Inc.
Columbia, TN (615) 381-4850
Imagine Computers
Golds, CA (800) 344-2964

D.L. MacNeil
Elk Grove, IL (312) 952-8300
The Super Source
Norcross, GA (404) 441-3451
Power House Sales
Sioux Falls, SD (605) 335-7161
NC Automation
Dallas, TX (214) 986-1151
Omega Data
Hillsboro, OR (503) 640-3995
Microsil
Oklahoma City, OK (405) 767-4354

Computer Wholesalers
Lincoln, NE (402) 466-1892
Computer Professionals
Lakewood, CO (303) 232-4009
Omega Data
Kirkland, WA (206) 823-6768
California Micro, Inc.
Los Angeles, CA (800) 782-6500
Mid America
Carmel, IN (317) 848-3101
Patis Sud Electronique Composants
Paris, France (1) 89.20.06.98
Inter-Micro Distributor, Inc.
Alberta, Canada (403) 436-6393

Manufactured by:

American

COMPUTER & PERIPHERAL, INC.

2720 Croddy Way, Santa Ana, CA 92704
Tel: (714) 545-2004 • Fax: (714) 545-2146

Inquiry 20 for End-Users Inquiry 21 for DEALERS ONLY

By performing a Taylor's series expansion on the diode equation about an operating point, V_0 , you are able to estimate the current in the diode for any voltage, V .

Diode equation: $I_{D_0} = I_s (e^{V_0/V_T} - 1)$

Taylor's series expansion equation: $f(x) = f(a) + f'(a)(x-a)$
(first two terms)

First compute the derivative:

$$f'(a) \rightarrow f'(V_0) = \frac{\partial I_{D_0}}{\partial V_0} = \frac{\partial}{\partial V_0} (I_s (e^{V_0/V_T} - 1)) = \frac{I_s}{V_T} e^{V_0/V_T}$$

Since this is a conductance, let $\frac{I_s}{V_T} e^{V_0/V_T} = G_{M_0}$

Plugging into the expansion equation:

$$I_D(V) = I_s (e^{V/V_T} - 1) + G_{M_0}(V - V_0)$$

$$I_D(V) = I_{D_0} + G_{M_0}V - G_{M_0}V_0$$

This equation represents a current source and a conductance:

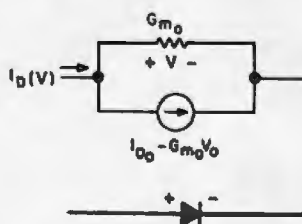

This model then becomes the approximation for the diode:

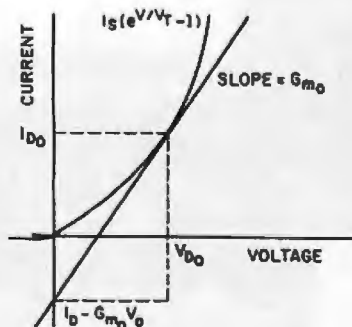

Figure 3: A Taylor's series expansion of the diode equation. The graph now represents the diode as a constant current source and a conductance.

the voltage across the diode. (The value used is the point on the exponential curve that has the minimum radius of curvature.) This point is called the critical voltage.

The next section is very important. Here the program tries to estimate the next voltage to use to linearize the diode. The goal here is to progressively move closer to the actual voltage that is across the diode. The process of determining the next voltage must be done carefully because it is easy to pick a voltage that will make this process diverge so that it can't converge to an answer.

In this algorithm there are two ways of selecting the next voltage to use. When we solve a set of equations with the Gaussian elimination routine, we have calculated a voltage value that is an estimate of the actual voltage across the diode. We can now use this calculated voltage as the starting point for the next guess. This first method of estimating the voltage is called "iterating on the voltage."

Another way of determining the starting point for the next iteration is to determine the value of current flowing in the diode at the point that the Gaussian routine indicated as the solution. Then, with this value of current, the corresponding voltage across the diode is calculated using the diode equation, and this voltage is then used as the starting point for the next guess. This method is called "iterating on the current."

This method of alternating between voltage and current is illustrated in figure 4b. The algorithm says that if the last voltage computed across the diode is greater than the critical voltage, iterate on the current; if the voltage across the diode is less than the critical voltage, then iterate on the voltage.

I found that using this algorithm helped tremendously in reducing the number of iterations it took to converge to the correct answer. It also helped prevent the iteration process from diverging, especially when I had a circuit where a transistor was in the off region of operation or was saturated.

At this point, I have determined a voltage across the diode either

through assigning a value to it or by calculating a new value by iterating on the voltage or current. I now take this voltage and insert it into the equations for linearizing the diode and calculate the values for the conductance and current source for the diode model.

Now I use Kirchhoff's current law to create a set of linear, simultaneous equations based on these new values. The Gaussian elimination program is again used to solve the equations, and, based on the results, the entire process is repeated to converge on the correct answer.

MODELING TRANSISTORS

The algorithm described above is the procedure I used to convert a diode into linear components so that I could solve a circuit as if it contained only linear elements. Since diodes are integral parts of the bipolar and junction FET (field-effect transistor) models, I used this same algorithm for modeling both of these devices.

For the bipolar transistor, I started with the nonlinear hybrid- π model as shown in figure 5. I chose this model because it simulates all four regions of transistor operation. Using this model, I performed the same steps that I did to linearize the diode. However, because the defining equations have dependent values and are functions of two variables, the linearization process is a little more difficult.

Figure 6 shows the linearized hybrid- π model. This model results from performing a Taylor's series expansion on the equations defining each element of the nonlinear hybrid- π model. The resulting expansion equation was then arranged so that its parts represented a controlled current source, a constant current source, and/or a conductance.

Next, the nonlinear components in the hybrid- π model were replaced with these linear components. The iteration process is the same as with the diode. Once the terminal voltages are determined (from the last iteration), those voltages are inserted into the equations in figure 6, and the resulting values are used to compute (using Kirchhoff's current law) the

(continued)

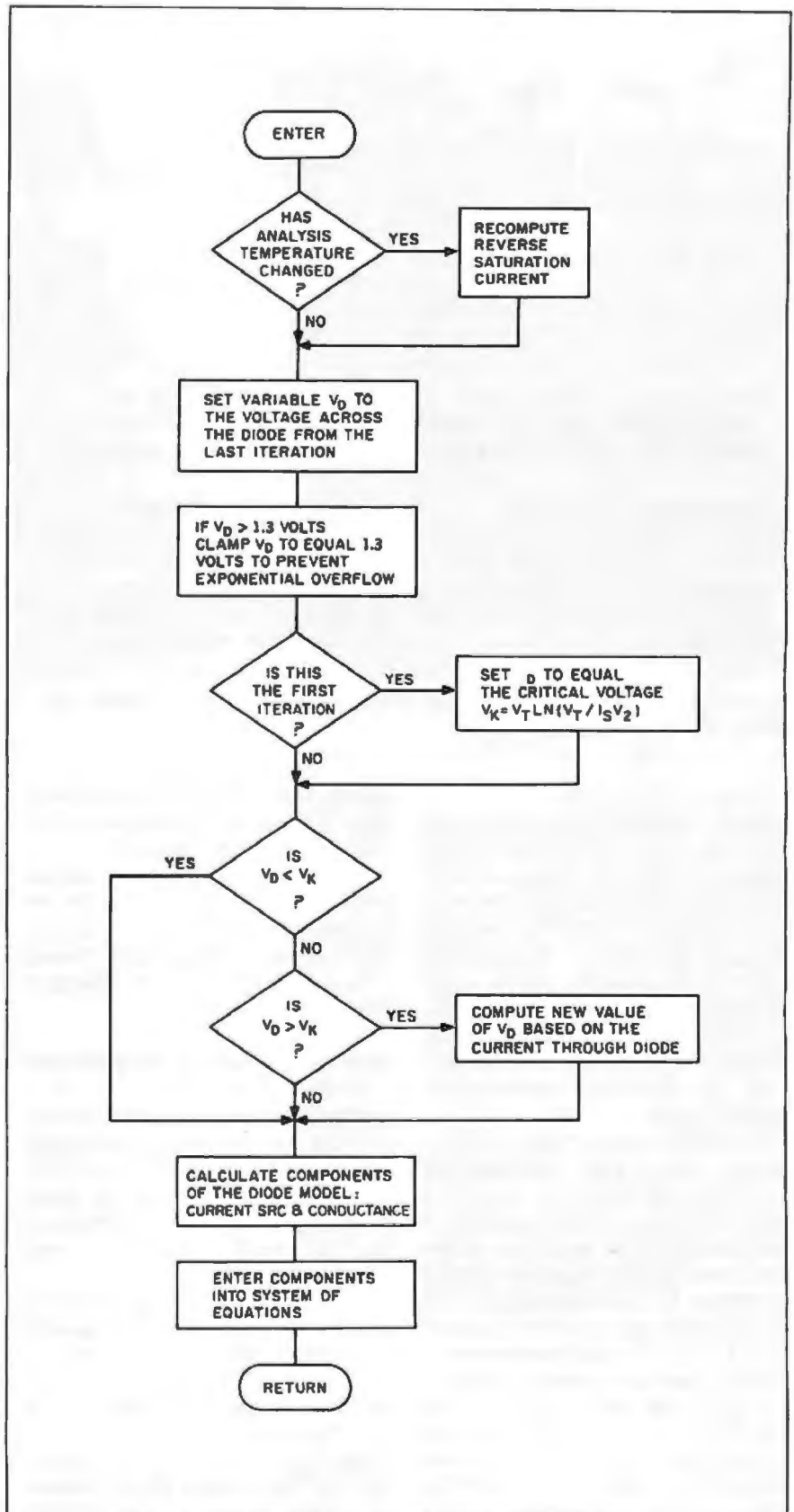
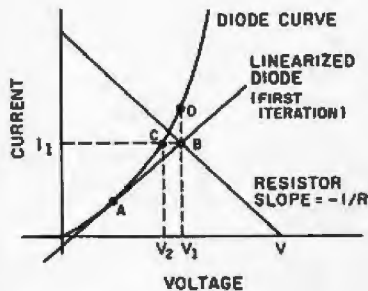

Figure 4a: The flow chart of the algorithm used to find the diode operating point.



After the first iteration, point B is the solution given from the simultaneous equation solution routine. To compute the next voltage to use for the next iteration, use either of two methods:

I. Iterate on the Voltage

Proceed vertically from point B to point D. This voltage, V_1 , is then the point that is used to linearize the diode for the next iteration.

II. Iterate on the Current

Proceed horizontally from point B to point C. From the current at this point, I_1 , compute voltage V_2 , used to linearize the diode for the next iteration.

Figure 4b: This graph shows the process of iterating alternately on the voltage and current values from previous iterations.

solution for this circuit.

When I was troubleshooting my algorithms, I found that the number of iterations it takes to converge on a circuit with a turned-off transistor could be drastically reduced if, on the first iteration, that transistor was analyzed as if it were out of the circuit. Then, on the second iteration, the transistor is analyzed as usual. Of course, this requires that you know the transistor is off, but usually that information is already known.

The SPICE program does this in a different way. SPICE removes the turned-off transistor from the circuit and computes an operating point. Then the transistor is put back in the circuit and another operating point is computed for the final answer. My technique of turning off the transistor for only the first iteration seemed to work fine and saved many iterations.

Trying to get all of this to work together on the Commodore 64 was the real challenge. When the Commodore 64 is powered up, only 38,911 bytes of memory are available to hold the program and variables. It was important to keep the size of the pro-

grams small to leave memory available to hold circuit descriptions and arrays for solving the circuit.

Each circuit requires an approximate square matrix equal to the number of nodes in the circuit plus the number of independent voltage sources. This array is by far the largest consumer of memory.

IMPLEMENTING THE ALGORITHMS

I decided it was best to have three separate programs to handle the AC analysis, DC analysis, and editing functions. I felt that even though this would be less convenient than having one larger program, I could make up for it by being able to analyze reasonable-size circuits.

Each program has a chaining feature that allows you to automatically load and run any of the other two programs. Each program can create a disk file that can be read and used by the other programs. For example, the preprocessor program will create a disk file that contains all the information about a circuit in a form that the AC and DC analysis routines can use.

One method I used to allow analyz-

ing larger circuits was to dynamically allocate memory according to the size of the circuit. After loading one of the analysis programs, a fixed amount of memory remains to hold a circuit description and the array used to solve the circuit. If this memory were divided into two areas, one to hold the circuit description and the other to hold the main array, it is possible to have a circuit that would need more memory than allocated in one area but would use up only half of the other memory area.

In this case, there would be physically enough memory to work, but it is arranged such that it won't work. To prevent this, I dynamically allocate the memory for the circuit description and arrays as it is being loaded by the analysis program. A disadvantage to this is that I don't know the exact size of a circuit that can be analyzed, since it depends on the size of the circuit description. However, an advantage is that a wider variety of circuits can be analyzed, and available memory is used more efficiently.

Another technique that I used to help conserve memory was to use a utility program that went through the BASIC program and removed all remarks and would crunch up to 255 BASIC tokens on a single line. This made the program incapable of being edited, but it saved an average of 3.3K bytes of memory for each program and made a slight improvement in the speed of operation.

Despite all these attempts, the program still ran too slow. Analyzing the 741 op-amp circuit (26 nodes and 23 transistors) with the DC analysis program was taking about an hour and 20 minutes to compute the operating point. After doing some investigation, I found that the two bottlenecks were the Gaussian elimination routine and the routine used to clear the contents of the main array used by the Gaussian elimination routine. So my next major project was to write these routines in machine language.

Since I had the locations of the floating-point routines used by the operating system available, I fortunately did not have to create those routines myself. Within the Gaussian elimination routine, the subroutine

that performed partial pivoting was the big bottleneck. The partial-pivoting routine is used during the elimination procedure to place, on the diagonal of the matrix, the largest number for a particular column. This ensures maximum accuracy during the elimination process. Placing the largest number on the diagonal involved checking the values on the column below the diagonal and then interchanging the elements of two rows when a number was found.

This interchanging procedure can take a long time. I tried using a permutation vector to act as an index for each row. Then, instead of interchanging every element, only the indexes to the rows are interchanged. This is a good idea, but when implemented in BASIC there was not a very significant improvement in speed for the size of arrays that I was using. However, when I wrote the whole routine in machine language, I did use a permutation vector since it was simple to implement.

I think one of the major improvements I was able to make in the performance of the Gaussian elimination routine was in the speed of accessing the elements of the array. The Commodore 64 operating system stores arrays in column-major form. So to access, for instance, the element in column 6 and row 3, the formula used

to calculate the address of that element would be

$$\text{ADDRESS} = \text{STARTING ADDRESS} + (\text{COLUMN\#} \cdot (\text{TOTAL \# ROWS}) + \text{ROW\#}) \cdot 5$$

The number 5 comes from the fact that each floating-point number uses 5 bytes. This formula indicates that every time you want to access any element of an array, you have to perform two multiplications and two additions. To get around this, I decided to set up two tables to assist in accessing elements. The first table consists of the addresses of the zeroth element of each column. The second table is a list of constants that are multiples of 5, starting with 0.

Then, to access the element at column 6 and row 3, I would index into the sixth entry of the first table to get the address of the zeroth element of column 6. Next, I would index into the third element of the second table and obtain 15. This would be added to the number I obtained from the first table to yield the final address of the element that I was searching for. The advantage of this method is that the indexing operation can be done by using the indirect-indexing commands of the 6502 instruction set, and beyond that only a simple 16-bit addition operation is required.

Of course to set up the first table re-

By rewriting the whole BASIC indexing routine in machine language I was able to increase its speed by a factor of 50.

quires a loop of multiplications to be performed. To get around this, I made the following improvement. The first time an array is solved using the Gaussian elimination routine, I find the starting address for the array and save its value. Then, the first table described above is created and the actual elimination process begins.

The next time the array is to be solved (as on the second iteration), I find the starting address of the array and compare it with the previous starting address. If they are the same, I skip the construction of the first table and proceed directly with the elimination process.

The routine that replaces the contents of the main array with 0s in preparation for the next iteration can

(continued)

Nonlinear Hybrid- π Model with Early Voltage Effect

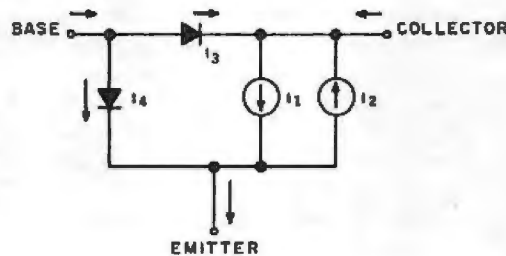

$$I_1 = I_S (e^{qV_{BE}/KT} - 1) (1 - \frac{V_{BC}}{V_A})$$

$$I_3 = I_S (e^{qV_{BC}/KT} - 1) (1/B_R)$$

$$I_2 = I_S (e^{qV_{BC}/KT} - 1) (1 - \frac{V_{BC}}{V_A})$$

$$I_4 = I_S (e^{qV_{BE}/KT} - 1) (1/B_F)$$

where:

B_R = reverse beta

B_F = forward beta

V_A = Early voltage

Figure 5: The nonlinear hybrid- π model of the transistor.

EVERYTHING SYMPHONY WAS SUPPOSED TO BE.

**AVAILABLE NOW
ONLY \$84.95
WITH A 60-DAY
MONEY BACK
GUARANTEE**

In One Totally Integrated Package:

- Word Processing With Spell Checker
- Communications
- Spreadsheet
- Database
- Graphs

- Extremely easy to learn and use
- Data is interchangeable with all modules and other products
- Windows allow quick movement between tasks
- Four background, one foreground mode. Can print on two printers or plotters and two communication devices (modem and main-frame direct connection) all at the same time.
- Artificial Intelligence features reduce the number of keystrokes required to perform tasks
- Upgradable software and data to UNIX and XENIX

- **Package contains:** one plastic box, one illustrated reference manual, one program disk, one sample diskette, keycaps and user support plan
- **System Requirements:** IBM PC or compatibles, 512K, two 360K diskette drives, color or mono display
- Twenty-four hour Hotline Support (optional)



Multiple windows allow quick movement between tasks.

Colorful graphic representations

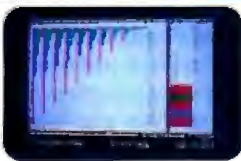

What the experts say:

"I can safely say that I have yet to come across a package which demonstrates such functionality combined with such an innovative approach to the man-machine interface. ABLE are to be congratulated on producing a product which achieves a very high standard of excellence."

—Michael D. Bove, DATA GENERAL

"The best multi-purpose product I have evaluated. Multi-tasking works great, able to print, make an on-line connection and edit a document at the same time."

—Robert Lawrence, ITT INFORMATION SYSTEMS

A B L E

International

ABLE Int'l is a longtime, innovative supplier of software for micro and minicomputers.

301 North Main Street
Pueblo, Colorado 81003 USA
Telephone 303-544-9600, Telex 650-2154286

ABLE *One*

To order, call 1-800-826-1907.
In Colorado call 1-800-826-4784.
Order 24 hrs. a day

60-Day Money Back Guarantee*
These prices include shipping to all U.S. cities. All foreign orders add \$10 per product ordered.

Not copy-protected \$84.95
(CO res. add \$5.52 tax per copy)
Quantity: _____ at \$84.95
Amount: CO res. 6 1/2% tax
Payment: VISA MC BankDraft
Check AmEx Diner's
Credit Card Exp. Date: _____
Card #: _____

Name: _____

Shipping address: _____

City: _____

State: _____

Zip: _____

Telephone: _____

CO's and Purchase Orders WILL NOT be accepted by ABLE. Colorado residents add 6 1/2% sales tax. Outside USA add \$10 and make payment by bank draft, payable in US dollars drawn on a US Bank.
*If you find that this product does not perform to your satisfaction within 60 days of purchase, call our Customer Service Dept. and we will gladly arrange for a refund.



HOW PEOPLE WITH COMMON INTERESTS FIND AN INTERESTING COMMON GROUND.

Presenting CompuServe Forums. Where people from all over get together, without even leaving home.

Now thanks to CompuServe Forums, computer owners are sharing common interests by talking to each other through their computer keyboards. *Software users, computer enthusiasts, ham operators, french cooks, fire fighters, science fiction lovers and other special interest groups* are already in touch, online.

Because when you subscribe to CompuServe, you're able to reach people who want to talk about the things you do. As many people as you like. For as long as you like. Whenever you wish.

Join a conversation already in

progress or start one on your own. Ask questions. And get answers.

All it takes is a modem, most any personal computer and CompuServe.

Forum members across the country are as close as a local phone call.

You can go online with just a local call in most major metropolitan areas. And normal usage fees for weekday nights and weekends are just 10¢ a minute

Of special interest to all Forum participants is software that's FREE for the taking.

Public domain software. For all sorts of activities, from games to business programs. And it's just as easy to copy a piece of software as it is to participate in a Forum.

Become a CompuServe subscriber and get a \$25 Usage Credit to start you off.

Becoming a subscriber is as easy as contacting your local computer dealer. Or you can call us and order direct. Suggested retail price is \$39.95.

And if you'd want more information about CompuServe, we'll be happy to send you a free brochure. Because with all that CompuServe offers—we think it's in your best interest.

CompuServe®

Information Services, P.O. Box 20212,
5000 Arlington Centre Blvd., Columbus, OH 43220

800-848-8199

In Ohio, call 614-457-0802

An H&R Block Company

AN 8031 IN-CIRCUIT EMULATOR

BY GEORGE DINWIDDIE

*Build this emulator and avoid
debugging headaches*

DEBUGGING A microprocessor-based program in assembly language can be difficult for a home engineer. The equipment to aid such a task—logic analyzers and emulators—is usually incredibly expensive. Even a large company might not be able to afford the thousands of dollars needed for an emulator because of the processor-specific nature of the tool. Such was the case when I was developing firmware for an embedded processor controlling a commercial product. The processor in use was an Intel 8031, and at that time, only Intel had an emulator for it. Obviously, Intel wanted a lot of money for the emulator. Worse, it needed a new microprocessor development system to host it.

My alternative was to edit, assemble, burn EPROMs, trace the execution using a logic analyzer, and deduce where the code was going wrong. Once I found a bug, I usually had to start over at the edit step before I could hunt for the next one. This was a slow process.

A BETTER WAY

It didn't take me long to become frustrated with this method. There *had*

to be a better way. At the suggestion of a microprocessor guru, I decided to build a monitor. Because the product hardware was mostly developed, I designed the monitor board so that it could function as an emulator—plugging into the processor socket of the application hardware.

The primary benefit of my monitor is that it gives you the ability to patch errors without repeating the edit, assemble, burn EPROM cycle. Sometimes a patch alters only a byte or two, but more often than not it involves a jump to an unused section of RAM where a hand-assembled routine is inserted.

Another handy debugging tool is the monitor's breakpoint capability. While the breakpoint in my monitor is extremely limited and simple, it does provide a way to verify which path of a conditional jump was taken without having to resort to the logic analyzer. Furthermore, you can check the actual values in variables and internal registers instead of deducing them from external behavior.

Another technique I found helpful was to insert temporary test patches that displayed the value of some variable each time through a loop.

This was accomplished by calling monitor subroutines via a convenient jump table provided at the start of the monitor. This technique was at the expense of real-time operation, but it provided insights into the dynamics of the software that were unobtainable by any other means.

I also included some basic but necessary functions that let you initialize memory, copy a block of memory, compare two blocks of memory, and perform a hexadecimal dump on a block of memory. Of course, I had to provide commands to edit the contents of memory and to execute instructions starting at any arbitrary location. Finally, I added some convenience commands to display the command syntax and the locations in the jump table and to perform hexadecimal arithmetic.

THE PROCESSOR

The Intel 8031 single-chip microcomputer is the ROM-less version of the

(continued)

George Dinwiddie (13808 Wayside Dr., Clarksville, MD 21029) is a software engineer for Mitron Systems Corp. He is currently working on his M.S. degree in computer science.

Listing 1: The code for performing ASCII-hexadecimal to binary conversion.

```

06E8 9430      SUBB   A,#'0'
06ED 4017      JC     BAD           ; ACC < '0'
06EF 940A      SUBB   A,#10
06F1 5005      JNC   $+7           ; ACC > '9'
06F3 240A      ADD   A,#10 ;RESTORE
06F5 020704    LJMP  GOOD          ; '0' <= ACC <= '9'

06F8 2403      ADD   A,#('0'+10-'A'+10) ;CORRECT FOR (-'0'-10)
                                & MAP 'A' INTO 10

06FA 20E709    JB    ACC.7,BAD     ; '9' < ACC < 'A'
06FD C3        CLR   C
06FE 9410      SUBB   A,#16
0700 5004      JNC   BAD           ; ACC > 'F'
0702 2410      ADD   A,#16
0704 C3        GOOD: CLR   C
0705 22        RET
0706 D3        BAD:  SETB  C
0707 22        RET
    
```

8051, the high end of Intel's 8-bit microcontrollers. It has five interrupts—two external inputs, two hardware timers, and one hardware asynchronous serial port (UART). It sports a 16-bit external address bus and 16 bidirectional I/O lines. The processor has three separate memory spaces—a 64K-byte program memory space, a 64K-byte external data memory space, and 128 bytes of internal RAM. The 8031 even features a hardware multiply and divide.

While this processor has a lot of speed and power, it has its share of problems, too. The architecture is

accumulator-based. This means a lot of processing time and bytes of code are used to load and store the accumulator. The instruction set is highly irregular. For example, the only compare instruction is a compare-and-jump-if-not-equal. To do a compare-and-jump-if-equal requires an exclusive-or, a subtract, or a jump-around-a-jump. A jump-less-than or a jump-greater-than also involves extra work. You can see some of the problems this causes in the ASCII-hexadecimal to binary conversion in listing 1. The instruction set also has few instructions that are capable of

accessing the two large external memory spaces.

THE EMULATOR BOARD HARDWARE

The hardware design of the emulator board is straightforward. Figures 1a and 1b show the schematic diagram. It features 4K bytes of monitor EPROM, 8K bytes of application EPROM space, and 8K bytes of emulation RAM. With the current prices for larger memories it would make more sense to use 8K by 8 monitor and application EPROM

(continued)

You already own a computer that can talk. Now let it. Meet the Votrax Family of Voice Products.

- ★ **P.C. DialLog**
Televoicemail management system
Digitizes your voice
Saves and sends voice messages
Auto answer/Auto dial
Call store and forward
Message distribution
P.C. to P.C. communication
For IBM-PC, XT, AT and compatibles
- ★ **Votalker IB & AP**
Board level speech synthesizers
Unlimited vocabulary
Text-to-speech software
Voice mode selection switch
Speech filter selection switch
For IBM-PC, XT, AT and compatibles
For Apple II, IIE, II Plus and compatibles
- ★ **SC-01-SC-02**
Phonetic speech synthesizer chips
Unlimited vocabulary

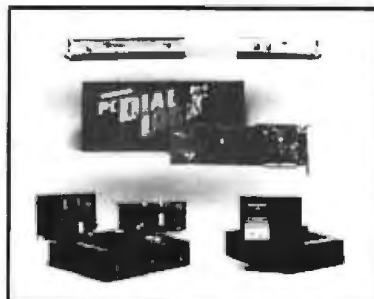

Now you can upgrade almost any personal computer and make it more powerful than ever, by giving it the power of speech.

- ★ **P.S.S. & T.N.T.**
Stand-alone speech synthesizers
Unlimited vocabulary
Text-to-speech
Parallel/RS-232 compatible
Exception word table
On-board music chip
Adaptable to most computers
- ★ **Votalker C-84**
Plug in speech synthesizer
Unlimited vocabulary
Text-to-speech
Rate, volume and pitch control
Three speaking modes
Free trivia game
For Commodore C-64/128
- ★ **Software Developers Welcome**
- ★ **Dealers and Distributors Welcome**



1394 Franklin, Troy, Michigan 48063
1-800-821-1399
In Michigan 313-569-0341
For a voice demonstration call
313-569-2326

COMMUNICATE BETWEEN COMPUTERS...

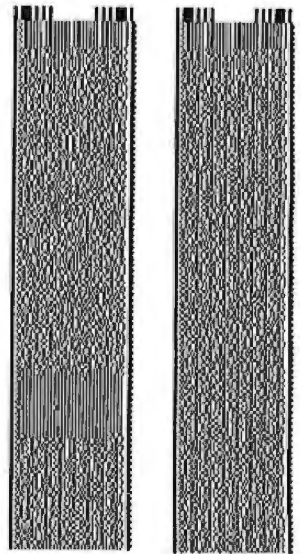

RED2BLUE.COM
Conversion Program

READTHIS.TXT
INSTRUCTIONS

ON PAPER



Use Mac or Apple files on a PC? Difficult? Not with the revolutionary Cauzin Softstrip™ System. With it you can easily move data between incompatible computers. Transfer ASCII or binary, word processing, data base or spreadsheet files. Mac to PC. PC to Mac. Apple to PC. And back again.

Picture a complete system. One that provides a simple and reliable way to distribute and retrieve information. Anything you can put on a magnetic disk, you can put on a Softstrip data strip. Facts. Figures. Software programs. Video games. Product demonstrations. Sheet music. And the list goes on.

A new industry standard, Softstrip technology, has rapidly changed the shape of computer software. You've probably already noticed the change on the pages of leading magazines. Data Based Advisor. MACazine. Nibble mac. MacUser. // Computing. Keyboards Computers & Software. These are just some of the growing ranks of publications featuring programs and data editorially in a form you can scan right into your computer — without typing!

But that's just the beginning of the Softstrip story and the real art of stripping . . .

How can you take a MacWrite file and read it into a PC word processor?

- Save your MacWrite 4.5 file as a "text" file.
- Print your file as strips using STRIPPER™.
- Read the strips into the PC with the Softstrip reader.
- Follow directions contained in READTHIS.TXT (strip above, right).
- Run "RED2BLUE" (strip above, left) and it's ready to use as a word processing file!

TECH SPECS

The Reader is lightweight and portable. It comes complete with all the software and cables you should need to connect it to your PC; Apple II series; or Macintosh computer. It has its own power supply and connects to standard RS232 ports (or to the Apple //e cassette port).

ALL YOU NEED TO START STRIPPING . . . besides your computer, a Softstrip reader, and STRIPPER™ (the "make-it-yourself Softstrip data strip program"):

FOR IBM PC or 100% COMPATIBLE OWNERS
Epson RX or FX printer
Printer interface card

FOR APPLE II OWNERS
Epson RX or FX printer, or
Apple Imagewriter I or II, and
Super Serial™ card (built into Apple //c), or
Grappler™ graphics card, or
Dumping™ graphics card.

FOR MACINTOSH OWNERS
Apple Imagewriter I or II

You can buy the Softstrip System for only \$199.95 (STRIPPER™ is only \$19.95 and an extra accessory kit is also only \$19.95) at all better computer stores. For the one nearest you, or to order direct, (if there is no dealer in your area) call: 1-800-533-7323 in Connecticut: 203-573-0150.

Dumping is a trademark of Microsoft, Inc.
Grappler is a trademark of Omega Micro, Inc.
Super is a registered trademark of Super America, Inc.
Macintosh is a trademark of Microsoft Corporation,
and is licensed to Apple Computer, Inc.
Apple is a registered trademark and
Imagewriter, Super Writer II, and Super Serial Card are trademarks
of Apple Computer, Inc.

IBM is a registered trademark of
International Business Machines Corporation.
Stripper and STRIPPER are trademarks of
Cauzin Systems, Inc.

Cauzin Systems, Inc.
835 South Main St., Waterbury, CT 06706

JULY 1986 • BYTE 183

AN 8031 EMULATOR

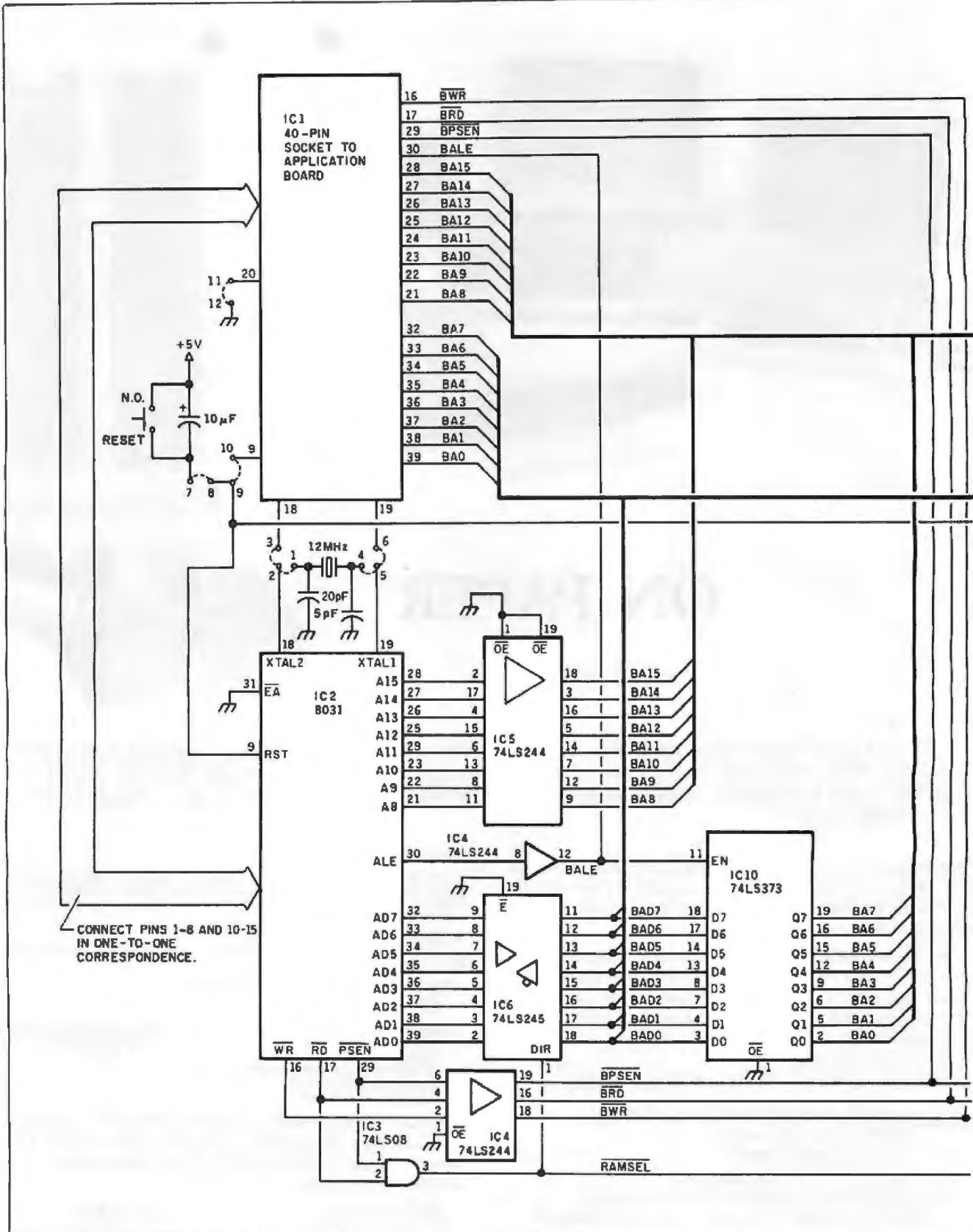
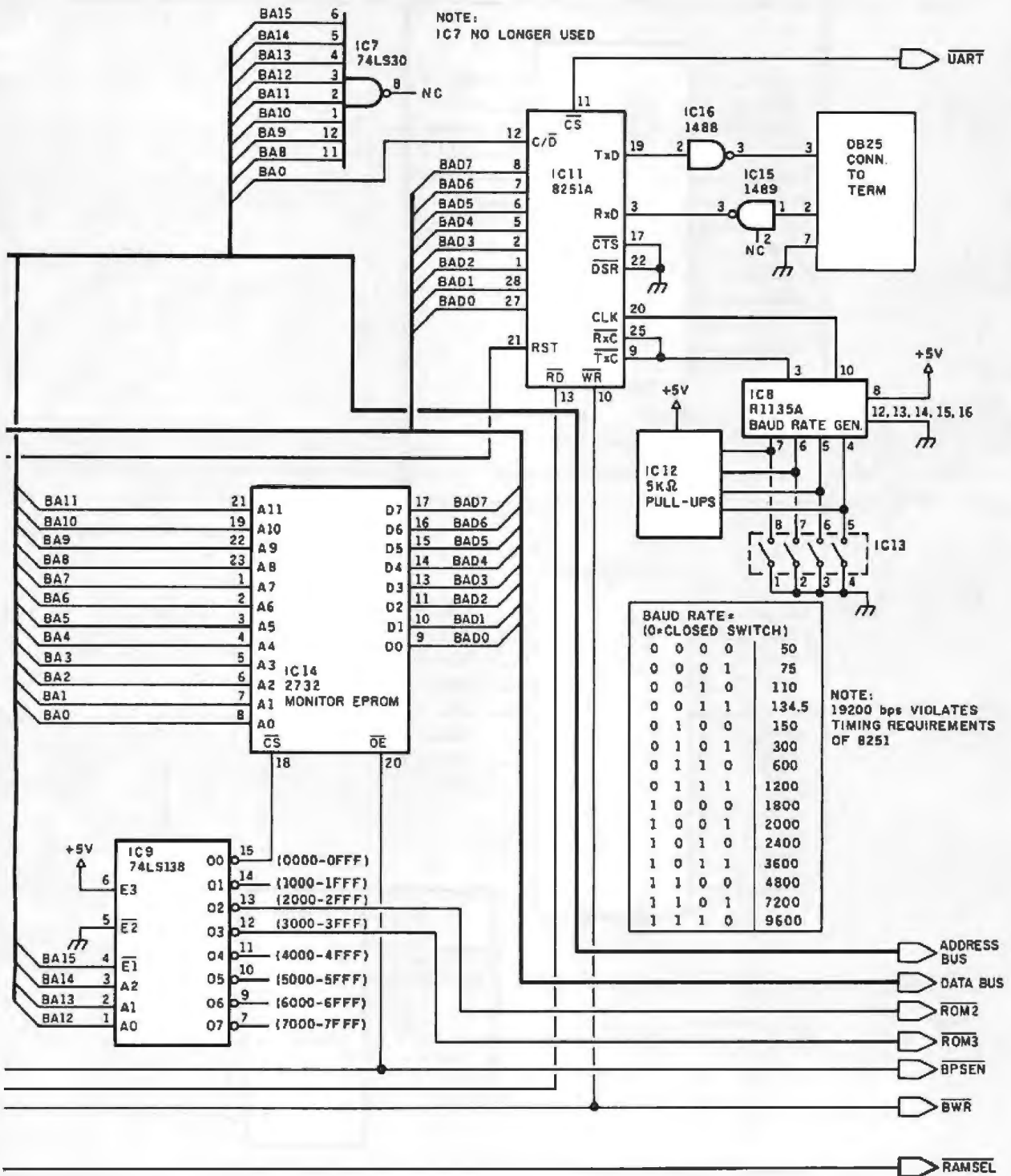

Figure 1a: Schematic of the 8031 emulator board, showing the central processor, UART, and address-decoding circuitry.

AN 8031 EMULATOR



AN 8031 EMULATOR

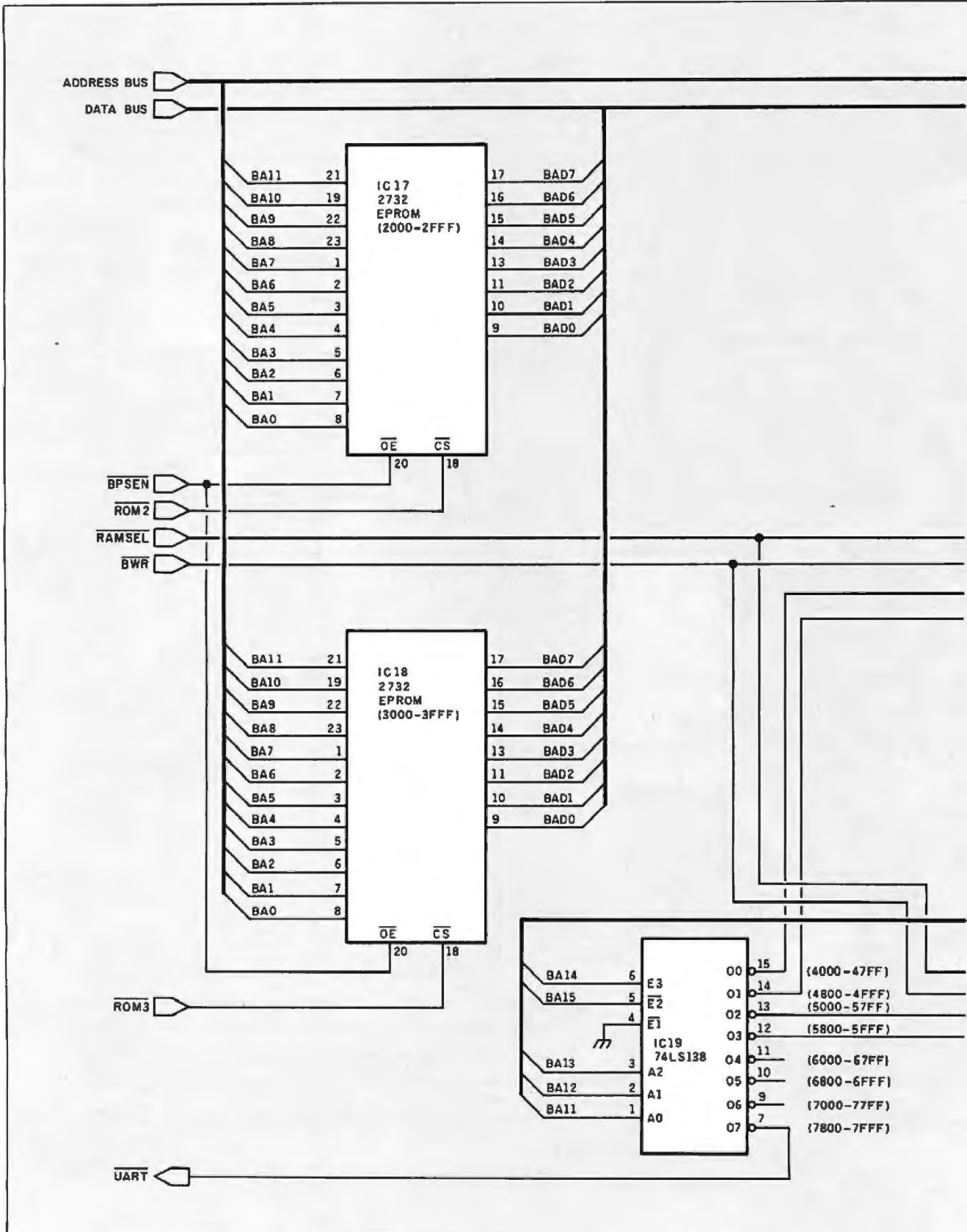
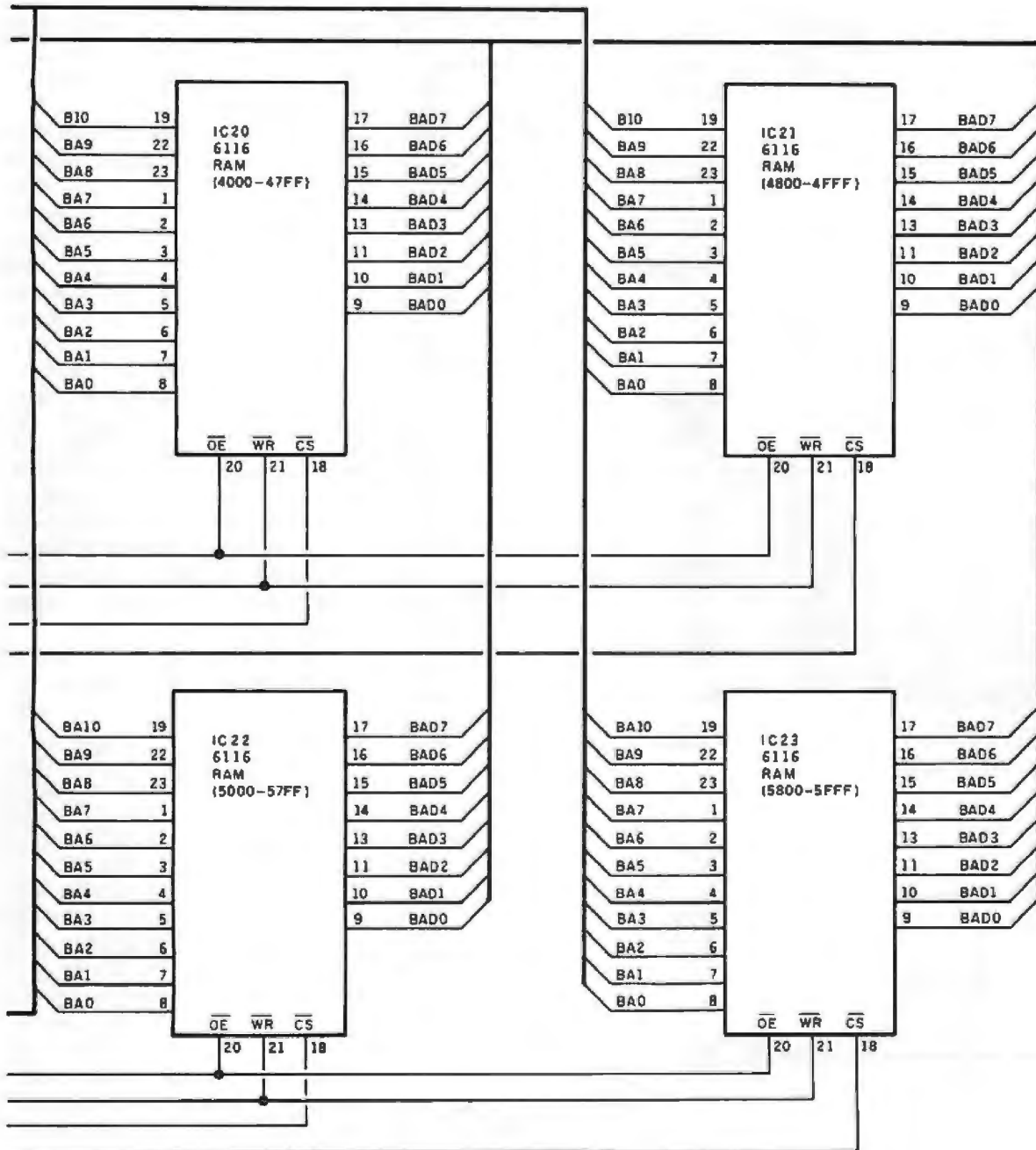

Figure 1b: Schematic of the 8031's ROM and RAM circuitry.

AN 8031 EMULATOR



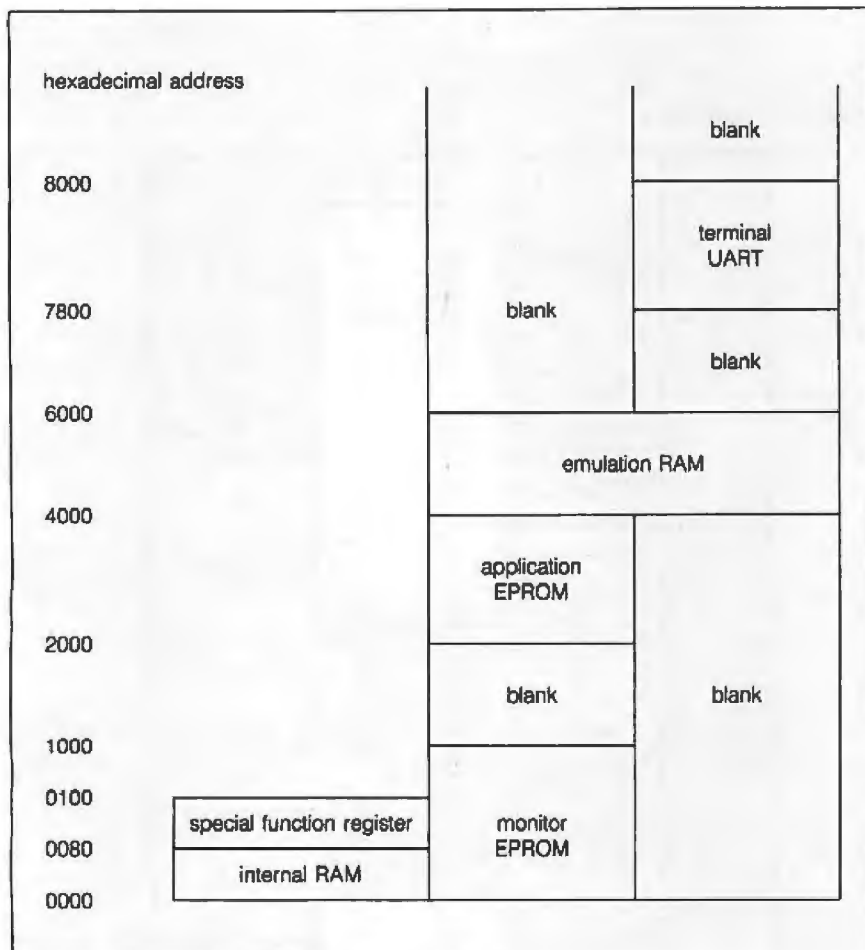

Figure 2: The emulator board's memory map.

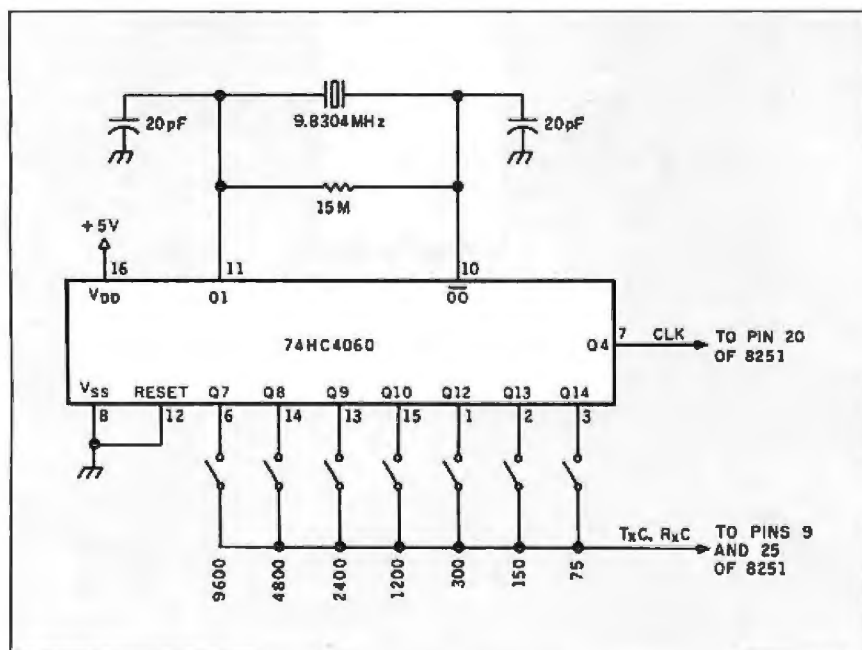

Figure 3: Alternate circuit for generating baud-rate clock signal.

chips and an 8K by 8 emulation RAM chip. When this circuit was first designed, however, an 8K by 8 static RAM chip cost approximately \$50. Using the larger memory chip could save one 74LS138 address-decoder chip, not to mention the additional sockets and wiring.

The 8031's separate external program and data memories pose a problem in the design of the emulator. The monitor and application EPROMS are in the program memory—that's easy enough. The RAM, however, must be in the data memory because the 8031 has no instructions for writing to the program memory. On the other hand, the purpose of the emulation RAM is to allow you to alter the executed code. Therefore, the RAM must also be part of the program memory so that instruction fetches may access it. The solution, of course, is to map the RAM into both memory spaces. The signal RAMSEL is true if PSEN is true or if RD is true. Figure 2 shows a memory map of the emulator board.

I tried to tie up as few of the resources of the processor as possible. The exception to this is the large amount of external memory space used. The project that prompted this monitor used very little external memory, but it did use the internal UART. Therefore, I included an 8251 USART for communicating with the terminal rather than the internal UART of the 8031. Clocks for the 8251 are provided by a Motorola K1135A dual baud-rate generator. The K1135A contains both a crystal oscillator and two divider chains in one 18-pin dual in-line package. If you are unable to find a K1135A, you can substitute the alternate circuit, shown in figure 3, that uses a 74HC4060 oscillator/divider chip.

The address, data, and control signals are buffered to allow for the extra loads placed on them by circuitry on the monitor board. If these signals are also buffered on the target board, it may cause excessive propagation delays. If necessary, replace one set of buffers with jumpers. Jumpers are also provided to choose either the on-board crystal or an external clock

(continued)

Your first color monitor should be good enough to be your last.

NEC introduces the only color monitor you need. Superb resolution plus MultiSync for across-the-board compatibility with all three PC graphics boards made by IBM,® for business graphics, CAD/CAM, computer art, and text.

Now there's one high resolution color monitor that does things your way. The MultiSync™ monitor from NEC. It gives you the best color resolution available at the price.



- Compatibility with the IBM Professional Graphics Adapter, the IBM Enhanced Graphics Adapter, and the IBM Color Graphics Adapter.

Compatibility with the IBM® Enhanced Graphics Adapter Board



- MultiSync, the NEC feature that automatically adjusts to color adapter board scanning frequencies from 15.75 KHz to 35 KHz—suggesting the possibility that the MultiSync monitor might be compatible with all color graphics boards that are fully compatible with the IBM PC, PC/XT, and PC/AT, now and in the future.

- Full implementation of high resolution graphics software for business and other applications, now and in the future.

- And color capability limited only by the board being used.

See Things Our Way

Until now, you had to choose different color monitors for

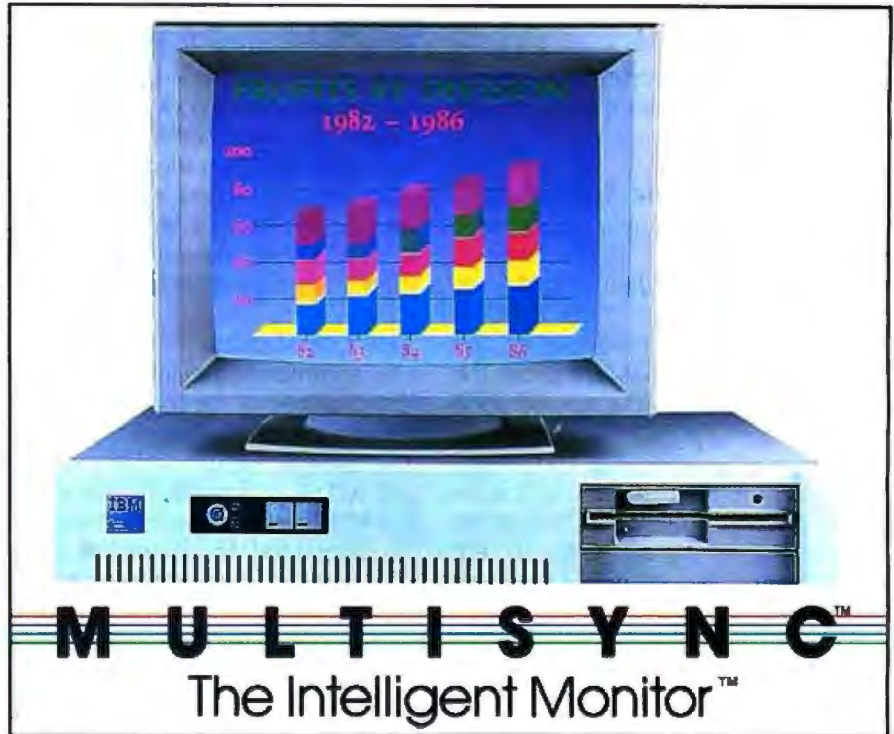

compatibility with all three PC color graphics boards made by IBM. With so many board and monitor configurations, folks didn't know which way to look.

The new MultiSync color monitor gives you unique compatibility. As well as TTL and analog color. With 7 switchable text colors. And resolution up to maximum 800 horizontal dots and maximum 560 vertical lines, on a large, 13" diagonal viewing area.

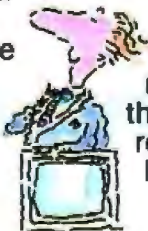

All that, priced at just \$799. All from NEC, a name respected around the world for advanced, reliable products backed by nationwide service.

Compatibility with the IBM® Professional Graphics Adapter Board



It's the one color monitor that does everything your way.

Compatibility with the IBM® Color Graphics Adapter Board



But why talk more about it? Visit your nearest dealer and see a graphic demonstration of the new NEC MultiSync monitor's capabilities. Then draw your own conclusions.

For information dial
1-800-447-4700

NEC HOME ELECTRONICS (U.S.A.) Inc.
Personal Computer Division
1401 Estes Avenue
Elk Grove Village, IL 60007



from whatever application board you are using the emulator with. Similarly, there is a jumper selection enabling the on-board reset button, the application board reset, or both. Another jumper allows connecting or isolating the grounds between the target and emulator boards.

OPERATION OF THE SOFTWARE

First, edit and assemble your source code. Program the object code in EPROMs and plug them into the application code space. Note that the code will be executed out of the emulator board's RAM. Therefore, the origin statement in the source code should specify 4000 hexadecimal, the start of RAM, rather than 2000 hexadecimal, the start of the application EPROM. The interrupt vectors in the monitor EPROM all jump to the equivalent offset in the RAM space, allowing use of all the interrupts with only a slight additional latency. The reset vector, however, jumps to the

monitor initialization code. This scheme allows the application EPROMs, burned for development purposes, to be used in the final project in some cases. In the products I developed with the aid of this monitor, the memory decoding was incomplete. The same EPROM was addressed at 4000 hexadecimal and 000 hexadecimal. [Editor's note: The source code for the author's monitor program, UGHBUG.ASM, is available in a variety of formats. See pages 459-461 for details.]

THE COMMANDS

The commands are invoked by the first character of the command name. There are a few exceptions to this rule. The internal varieties of the DUMP and ALTER commands (which access the 8031's internal memory) have an "I" appended to distinguish them from their external equivalents. The HEXMATH command is invoked with a number sign (#). All numeric values are expressed in hexadecimal. If you

mistype an address or a data value, just keep typing. The monitor accepts the last four digits entered for address values and the last two for data values. You need not type leading zeros unless you're covering up a mistake. To cancel a command that you've started to type, just type any illegal character. To abort a command that outputs to the screen, merely type any character. These rules are consistent for all the commands.

The first command needed in any debugging session is the COPY command. Copy the application code from the EPROM to the RAM. Be sure not to overwrite the last 9 bytes of RAM; these are used by the breakpoint routine.

Next, use the VERIFY command to make sure the transfer was successful. VERIFY indicates agreement between two blocks of memory by doing nothing. Any differences are displayed. (I never got around to adding a memory test. With only four RAM chips it



A Personal Language

When it comes to problem solving, the APL*PLUS System is the undisputed leader.

That's because the APL*PLUS System works with you. It goes far beyond what application software like Lotus® or dBASE® could possibly ever offer. And, it won't tie you down with the details of standard programming languages.

The APL*PLUS System is a personal language, with productivity features that help you concentrate on getting answers,

rather than struggle with intricate calculations and modeling.

With it you can manipulate tables of numbers as easily as single numbers and get quick results from your computer using short, simple statements.

When you've reached the limits of other packages, move up to the APL*PLUS System. It's a powerful and flexible tool that grows with you as your needs become more sophisticated. With over 200 built-in

applications—like graphics, report formatting and communications—you have all the tools at your fingertips to quickly and easily solve those seemingly impossible problems.

Best of all, the APL*PLUS System interfaces well with software packages you're already using—like databases, spreadsheets, and graphics packages. The APL*PLUS System also makes it easy to link those packages that aren't

didn't seem worth the effort. Usually, corrupted memory was the result of stack overflow or some other errant code.) Always VERIFY the damages after your code goes into the weeds.

Run your code using the GO command. If you do not specify an address, execution will restart at the breakpoint. (I'll talk more about breakpoints later.) Although the most likely starting place is 4000 hexadecimal—the reset vector of the application code—you can GO to any address in the program memory.

I had to resort to some tricks in my monitor's code. The 8031 does have an indexed jump instruction, JMP @A+DPTR. Unfortunately, the data pointer is only easily loaded by a constant—a variable must be loaded a byte at a time—and the accumulator is only 8 bits. Besides that, I wanted to be able to restore the data pointer and the accumulator when resuming after a breakpoint. The simple solution, shown in listing 2, is to push the

address onto the stack and execute a return-from-subroutine instruction.

Before running your code you may want to set a breakpoint. The BREAK routine requires a little explanation. Many processors have a single-byte software-interrupt instruction that can be used for breaking back to the monitor. This single byte may be substituted for the first byte of any instruction. When the software interrupt is executed, it transfers control to a breakpoint routine. The 8031 lacks such an instruction; you have to use a long jump instruction, which is 3 bytes long. The break address must be aligned with the first byte of an instruction so that it will be executed and not treated as data.

First you want to save the original instructions. Because an 8031 instruction may be 1, 2, or 3 bytes long, inserting the 3-byte jump instruction at a given point in the code may clobber a sequence of 3, 4, or 5 bytes of code. The number of bytes affected

is the optional final parameter of the break command; 3 is the most convenient value and is the default. This parameter is stored at the location BYTENUM, and the bytes of code are stored in the following 5 bytes (padded with NOP instructions if necessary). Following this, the next 3 bytes of RAM are filled with a jump instruction to the location following the code that was copied, that is, BYTENUM bytes after the break address. After all this is done, a jump-to-the-breakpoint-routine instruction is written at the break address. When execution reaches the break address, control passes to the breakpoint routine. The breakpoint routine saves the registers that are treated as volatile memory and displays the values that they contained.

A GO command without a starting address resumes from the break address. First it restores the saved registers and executes the saved code.

(continued)

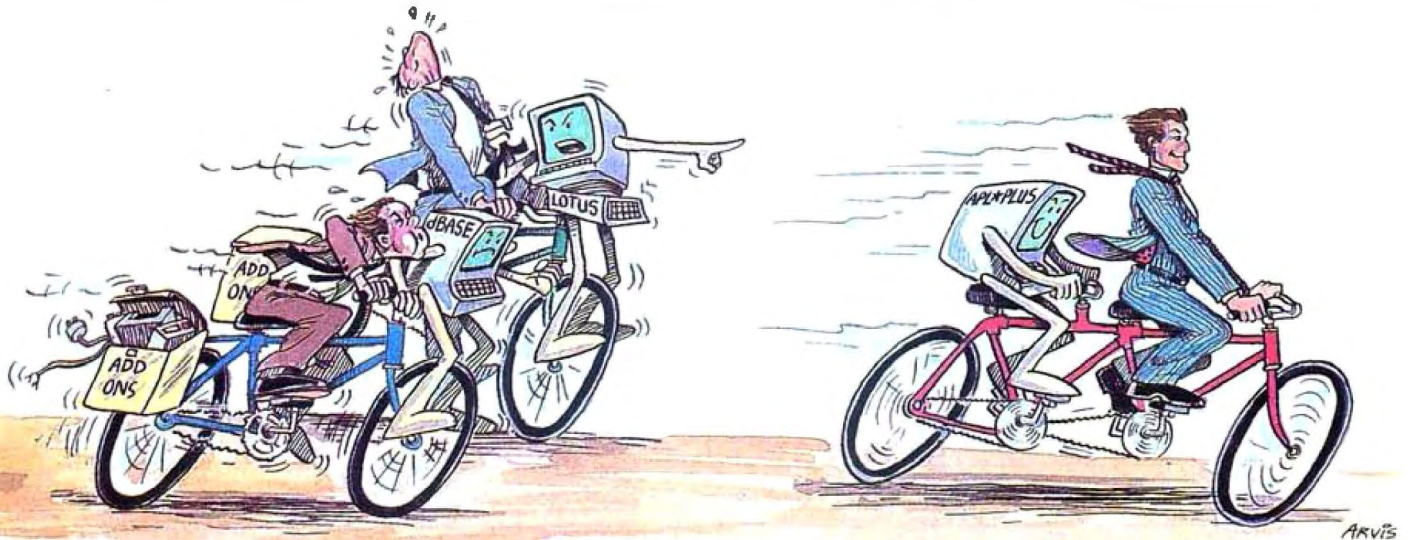

The APL★PLUS® System and You.

currently talking with each other.

With all this problem-solving power, it's no wonder STSC's APL★PLUS System is the personal choice of so many business professionals—financial planners, business analysts, actuaries, scientists, mathematicians, engineers, statisticians, and consultants. Especially since the APL★PLUS System is available on a full range of computers from desktops to mainframes.

Put the power, speed, and flexibility of the APL★PLUS System to work for you. See your local dealer today to get your APL★PLUS System. If they don't have it, refer them to STSC or call STSC toll-free, (800) 592-0050. In Maryland or Canada, (301) 964-5123.

Available nationally through Softset, Micro Central, and distributors worldwide. Dealer inquiries welcome.

Problem-Solving at the Speed of Thought

STSC STSC, Inc.
2115 East Jefferson St.
Rockville, MD 20852

APL★PLUS is a service mark and trademark of STSC, Inc. PLUS★WARE is a trademark of STSC, Inc. Lotus and dBASE are registered trademarks of Lotus Development Corporation and Ashton-Tate, respectively.

A PLUS★WARE™ PRODUCT

©1986 STSC, Inc.

and then it jumps back to the application code following the break address. If you execute the breakpoint routine, you should reset the board before attempting to initiate a GO command to a starting address. This will recover the 5 bytes of stack space used to store the volatile registers.

The code saved at location BYTE-NUM+1 is restored to its original location when a new break address is entered or if the BREAK command is invoked without a new address. You should do this before a reset because the initialization code clears BYTE-NUM and the following locations.

The DUMP command comes in two flavors, internal and external. The external version does a memory dump

of the program memory in hexadecimal, showing the ASCII translation to the right (see figure 4). If no ending address is specified, OFFFH is assumed. A DUMP may be interrupted, as can any command that writes to the screen, by typing any key.

The internal DUMP command is similar but dumps the internal RAM and the special function registers. No ASCII translation is shown since it is unlikely to find ASCII strings in internal memory. The special function registers are indicated symbolically in addition to their addresses. This is shown in figure 5.

The ALTER command also comes in two flavors. The external version displays the current byte from program

memory followed by a dash. If you enter a hexadecimal value, that value will be inserted at that location in external data memory. A space or a carriage return leaves the location unchanged and displays the next byte (carriage return puts you on a new line, space leaves you on the current line). A period or a backspace backs up the displayed byte by one location. Any other nonhexadecimal character cancels the command. Remember that the RAM on the monitor board is mapped to both the program memory and the data memory. The ALTER command writes to data memory because there is no way to write to program memory. It is frequently convenient to use the ALTER command to check code, hitting carriage return after each instruction for readability.

The internal form of the ALTER command accesses the 8031's internal RAM. As in the DUMP command, when you reach the special function registers (locations above 7F hexadecimal) the name of the register is displayed.

(continued)

Listing 2: The author's solution to the 8031's lack of an indexed jump instruction.

```

060F          GXXXX:
060F C049      PUSH    LOBYTE
0611 C048      PUSH    HIBYTE
0613 22       RET
    
```

```

UGH:d 23 00b1
  0  1  2  3  4  5  6  7  8  9  A  B  C  D  E  F
0020          02 40 23 02 00 F5 02 00 F8 02 06 B3 02
0030 06 C6 02 06 F0 02 07 20 02 07 48 02 07 C9 02 06
0040 07 02 06 C0 02 07 6C 02 07 69 02 07 A7 02 07 A1
0050 02 08 16 02 07 70 02 06 AD 02 07 BD 02 07 AF 02
0060 07 EA 02 05 91 0D 0A 55 67 68 62 75 67 20 4D 43
0070 53 2D 35 31 20 6D 6F 6E 69 74 6F 72 2C 20 76 65
0080 72 73 69 6F 6E 20 31 2E 30 30 0D 0A 63 6F 70 79
0090 72 69 67 68 74 20 31 39 38 36 20 62 79 20 47 65
00A0 6F 72 67 65 20 44 69 6E 77 69 64 64 69 65 2E 0A
00B0 04 75
UGH:
    .ef.. .....
    ..... ..H.....
    .....l. .l.....
    .....P.....
    .....U ghbug MC
    S-51 mon itor, ve
    rsion 1. 00..copy
    right 19 86 by Ge
    orge Din widdle..
    .u
    
```

Figure 4: Sample output of the external version of the DUMP command.

```

UGH:d1 69
  0  1  2  3  4  5  6  7  8  9  A  B  C  D  E  F
60          9E AC C9 1C CE CC E4
70 88 90 80 30 02 20 88 A2 DF 9B EC E4 BB 46 E6 E4

80=P0 :55 81=SP :52 82=DPL :69 83=DPH :08 87=PCON:7F 88=TCON:00
89=TMOD:00 8A=TL0 :00 8B=TL1 :00 8C=TH0 :00 8D=TH1 :00 90=P1 :FF
98=SCON:00 99=SBUF:00 A0=P2 :08 A8=IE :60 B0=P3 :FF B8=IP :E0
D0=PSW :20 E0=ACC :01 F0=B :0D
UGH:
    
```

Figure 5: Sample output of the internal version of the DUMP command.

INTRODUCING FUJITSU'S DX FAMILY OF PRINTERS

TAKING PC PRODUCTIVITY TO NEW HEIGHTS

Choose the 80-column DX2100, or the 136-column DX2200. For sheer print volume, these Fujitsu printers can't be topped. At 110 lines per minute, their throughput is almost double that of most major competitors.

The built-in bi-directional tractor speeds paper handling too. Just flick a switch to go from continuous forms to single-sheet feeding, without removing cumbersome optional tractors or tractor paper.

The well-designed operator panel gives you fast, convenient control of all printer functions, and enables you to identify error conditions quickly.

DX printers won't distract you from your work either—thanks to their quiet operation at less than 55 dBA.

And in addition to fast spread sheets, Fujitsu's DX printers produce near-letter-quality print and excellent graphics. They'll grow with your needs, too. Upgrading to color, or changing your system interface, is as easy as plugging in a new module.

You can put these fine printers to work for a lot less than you might expect. And it costs next to nothing to keep them working. They come with a superb reliability rating of 6000 hours MTBF, and a full one-year warranty.

For more information about the new Fujitsu DX family of printers, call Fujitsu America, Peripheral Products Division, at (800) 626-4686. Get the personal printers that really produce.

WE'RE DEVELOPING TECHNOLOGY FOR YOU.



FUJITSU AMERICA

Inquiry 148



1	Exxon
2	General Motors
3	Mobil
4	Ford Motor
5	IBM
6	Texaco
7	E.I. du Pont
8	Standard Oil (Ind.)
9	Standard Oil of Cal.
10	General Electric
11	Gulf Oil
12	Atlantic Richfield
13	Shell Oil
14	Occidental Petroleum
15	U.S. Steel
16	Phillips Petroleum
17	Sun

27
million
Americans
can't read.
And guess
who pays
the price.

Every year, functional illiteracy costs American business billions.

But your company can fight back...by joining your local community's fight against illiteracy. Call the Coalition for Literacy at toll-free **1-800-228-8813** and find out how.

You may find it's the greatest cost-saving measure your company has ever taken.

**A literate
America is a
good investment.**

Ad Council Coalition for Literacy

Both the DUMP and ALTER commands use the SFR table (special function registers table—it can be found near the end of the monitor's source code listing) to access these registers. The special function registers cannot be accessed indirectly, and the memory space they occupy is sparsely populated. The SFR table provides a solution to both of these problems. Each table entry is 11 bytes long. The first 5 bytes give the symbolic name of the register. At an offset of five is a subroutine to read the register. Within this subroutine, at an offset of six, is the hexadecimal address of the register. Eight bytes from the start of each entry is a subroutine to alter the contents of the register. Some registers, such as the stack pointer, would crash the system if they were altered, so these entries return an error flag instead. Some registers, such as the accumulator, are treated as volatile by the monitor. You can alter them, but the monitor makes no attempt to preserve the contents of these registers.

The MODIFY command allows you to enter information into external data memory as characters instead of hexadecimal values. There are only two special characters to remember within this command. A backspace backs up the address pointer to allow the correction of mistakes. An EOT (Control-D) terminates the command. There is no internal version of the MODIFY command since it seems unlikely that the limited internal RAM would be used for storing strings.

The INSERT command fills a selected block of external RAM with a single hexadecimal byte. I used INSERT rather than FILL because I intended to add a FIND command.

The final three commands, HELP, JUMPTABLE, and HEXMATH, are conveniences. HELP displays the syntax of the commands and JUMPTABLE displays the entry points to the utility subroutines. HEXMATH, invoked by #, performs both addition and subtraction in hexadecimal. This is convenient for calculating relative jumps.

Some people might consider these last commands to be insignificant, but I disagree. It takes a short time to forget the command syntax. The HELP

command also makes this tool easily available to others. The JUMPTABLE command allowed me to create test patches easily. Before I added this command I was constantly searching for the monitor program listing to look up the jump-table addresses. The HEXMATH is a cheap convenience—convenient to include when compared with the trouble caused by missing a jump target by 1 byte. Even simple software such as this should attempt to be as helpful as possible—there are better ways to spend time.

CONCLUSION

In this article, I have focused on one particular implementation of a debug monitor. If you are using a different processor it is well worth the effort to create your own. In addition to the debugging help, writing a monitor is a good exercise. It helps you to become familiar with a new instruction set.

Build your monitor one function at a time. First start with displaying a sign-on message. Then accept input and echo it back to the screen. Once you have the terminal interface working, add the more basic commands such as DUMP and ALTER. At this point you will have tools to aid you in developing the rest of the code.

It took me two weeks to develop the hardware and enough of the software to start using my new tool to develop application code. A year later I was still adding features and refining functions. Every minute I spent working on the monitor was quickly repaid in time saved. In the first week I used it, I accomplished six weeks of debugging measured by my previous standards.

What features would I like to add to this or any other monitor? A LOAD command to download a hexfile directly to RAM would be first choice. A FIND or SEARCH command to pick out variable-length byte sequences would be nice. A disassembler and single-line assembler would be a great help. These two are big jobs, though. I got to be pretty good at patching code with hand assembly, but I was doing it every day. The list of features could go on and on. A monitor is never finished until you quit using it. ■

Special thanks to Jim Gaudreault.

The big news in Toshiba 3-in-One technology is small.



Toshiba's 3-in-One™ printer technology gives you speed, letter-quality type and high-resolution graphics. All in one highly reliable machine. Which may be why more people choose Toshiba 24-pin printers than any other.

And now you can get this proven technology in a compact-size printer, the P321. At a compact price.

The P321 uses the same Toshiba-developed 24-pin print head that has set the standard for the industry. It produces letter-quality documents at 72 CPS, draft quality at 216 CPS and accurate, dot-addressable graphics. And our print head lasts twice as long in the process.

Toshiba P351 compatibility and Qume Sprint 11 emulation plus a wide selection of plug-in type fonts are

standard features on the P321. And you can get IBM Graphics Printer emulation and downloadable type fonts on diskette as options.

All these features and options in such a compact size and price and IBM-compatibility make the P321 a perfect mid-priced business printer to use with your PC.

If you need to do full-size spreadsheets, the Toshiba P341 is the way to go. It has the same capabilities and features as the P321 but adds a wide carriage which easily accommodates spreadsheets. You can also add a bidirectional tractor feed or electronic integrated sheet feeder.

For the name of the authorized Toshiba dealer near you, call 1-800-457-7777.

In Touch with Tomorrow

TOSHIBA

TOSHIBA AMERICA, INC., Information Systems Division

**TO ORDER
CALL TOLL FREE
1-800-233-8950
DEPARTMENT A107**

OR MAIL YOUR ORDER TO:

**COMPUTER MAIL ORDER
Department A107
477 E. Third Street
Williamsport, PA 17701**



POLICY Inquiry 86

Add 3% (Minimum \$7.00) shipping and handling. Larger shipments may require additional charges. Personal and company checks require 3 weeks to clear. For faster delivery use your credit card or send cashier's check or bank money order. Pennsylvania residents add 6% sales tax. All prices are subject to change and all items are subject to availability. Defective software will be replaced with the same item only. Hardware will be repaired or replaced at our discretion within the terms and limits of the manufacturer's warranty. We cannot guarantee compatibility. All sales are final and returned shipments are subject to a restocking fee.

**EDUCATIONAL INSTITUTIONS
CALL TOLL FREE
1-800-221-4283**

**CUSTOMER SERVICE
& TECHNICAL SUPPORT
1-717-327-1450**

CANADIAN ORDERS

1-800-268-3974

Ontario/Quebec

1-416-828-0866

In Toronto

1-800-268-4559

Other Provinces

TELEX: 06-218960

2505 Dunwin Drive,
Mississauga, Ontario
Canada L5L1T1

All prices shown are for U.S.A. orders. Call the Canadian Office for Canadian prices.

THE CMO ADVANTAGE

- Next day shipping on all in-stock items.
- Free easy access order inquiry.
- Orders from outside Pennsylvania save state sales tax.
- Free technical support from our factory trained technicians.
- There is no limit and no deposit on C.O.D. orders.
- There is no extra charge for using your Visa or MasterCard and your card is not charged until we ship.
- No waiting period for cashier's checks.
- We accept purchase orders from qualified corporations. Subject to approval.
- Educational discounts available to qualified institutions. (See the toll free educational phone number above.)
- FREE CATALOG MEMBERSHIP

ATARI	
65XE (64K).....	\$89.99
130XE (128K).....	\$139.00
520ST (512K).....	\$369.00

520ST Monochrome System

- 520ST with modulator
- disk drive
- mouse
- logo
- Basic
- 1st Word
- monochrome monitor

LOW, LOW SYSTEM PRICE
\$649.00

520ST Color System

- 520ST with modulator
- disk drive
- mouse
- logo
- Basic
- 1st Word
- color monitor

LOW, LOW SYSTEM PRICE
\$799.00

800XL 64K.....	\$68.99
1010 Recorder.....	\$49.99
1050 Disk Drive.....	\$149.00
1020 Printer.....	\$29.99
1027 Letter Quality Printer.....	\$129.00
1030 Direct Connect Modem.....	\$59.99
Comrex 220 Atari.....	\$89.99

APPLE	
APPLE IIe.....	CALL
APPLE IIc.....	CALL
IIc LCD Display.....	\$329.00

COMMODORE	
Amiga Package	
• 512K	• 2 Drive
• RGB Monitor.....	\$1599.00
C64 Package	
• C64	• C1541
• Taxan 220.....	\$499.00
C128 Package	
• C128	• C1571
• NAP8582 Monitor.....	\$779.00
C128 Computer.....	\$269.00
C1571 (Disk Drive for C128).....	\$249.00
C1902 (RGB 13" Monitor for C128).....	CALL
C1670 (Modem for C128).....	\$179.00
C1530 Datasette.....	\$39.99
C1680 Auto Modem.....	\$59.99
DPS 1101 Daisy Printer.....	\$339.00
Comrex 220 (C64 Interface).....	\$89.99
Xetec SuperGraphix 6K.....	\$69.99

PORTABLE COMPUTERS

NEC	
PC-8010 LS.....	\$699.00
PC-8201 Portable Computer.....	\$339.00
PC-8231 Disk Drive.....	\$599.00
PC-8221A Thermal Printers.....	\$149.00
PC-8281A Data Recorder.....	\$99.99
PC-8201-06 8K RAM.....	\$59.99

SHARP	
PC-1350.....	\$149.00
PC-1261.....	\$149.00
PC-1500A.....	\$169.00
PC-1250A.....	\$99.99
CE-125 Printer/Cassette.....	\$129.00
CE-150 Color Printer Cassette.....	\$149.00
CE-161 16K RAM.....	\$129.00

HEWLETT PACKARD	
41CV.....	\$139.00
41CX.....	\$199.00
HP 11C.....	\$49.99
HP 12C.....	\$75.99
HP 15C.....	\$75.99
HP 16C.....	\$89.99
HPIL Module.....	\$96.99
HPIL Cassette or Printer.....	\$359.99
Card Reader.....	\$143.99
Extended Function Module.....	\$63.99
Time Module.....	\$63.99

We stock the full line of HP calculator products

ACCESSORIES

AMARAY	
80 Column Printer Stand.....	\$14.99

CURTIS	
Side Mount SS-1.....	\$19.99
Side Mount AT SS-2.....	\$34.99
Universal Stand SS-3.....	\$19.99
Diamond SP-1.....	\$29.99
Emerald SP-2.....	\$39.99
Sapphire SPF-1.....	\$49.99
Ruby SPF-2.....	\$59.99
Universal Printer Stand.....	\$14.99
Static Mat.....	\$29.99

DATA SHIELD	
300 Watt Backup.....	\$379.00
500 Watt Backup.....	\$589.00
Turbo 350 Watt Backup.....	\$449.00
P125 Power Director.....	\$99.99
P150 Power Director w/Modem.....	\$119.00

KENSINGTON	
Master Piece.....	\$99.99
Master Piece +.....	\$119.00

KEYTRONICS	
KB5150/KB5151/KB5151Jr.....	CALL
KB5152B/KB5153/KB5149Jr.....	CALL

MEMORY CHIPS	
4184 RAM Chips..... (ea.)	\$1.99
128 RAM Chips..... (ea.)	\$12.99
256 RAM Chips..... (ea.)	\$10.99

Polaroid	
Palette.....	\$1399.00
Power Processor.....	\$229.00
Illuminated Slide Mounter.....	\$39.99
Polacolor 2 Pack Ilim.....	\$18.99

DISKETTES

Dennison	
Elephant 5 1/4" SS/SD.....	\$9.99
Elephant 5 1/4" SS/DD.....	\$11.99
Elephant 5 1/4" DS/DD.....	\$14.99
Elephant Premium DS/DD(50).....	\$69.99
Elephant 3 1/2" SS/DD.....	\$24.99

IBM	
5 1/4" DS/DD floppy disks (Box of 10).....	\$26.99

GENERIC	
DS/DD w/Flip'n'File 10.....	\$11.99

maxell	
3 1/2" SS/DD (10).....	\$18.99
3 1/2" 5 pack SS/DD/Case.....	\$9.99
3 1/2" DS/DD (10).....	\$29.99
5 1/4" MD-1 SS/SD (10).....	\$11.99
5 1/4" MD-2 DS/DD (10).....	\$16.99
5 1/4" MD-2-HD for AT (10).....	\$29.99

Verbatim.	
5 1/4" SS/DD.....	\$12.99
5 1/4" DS/DD.....	\$24.99
Disk Analyzer.....	\$24.99

DISK HOLDERS	
AMARAY	
50 Disk Tub 5 1/4".....	\$9.99
30 Disk Tub 3 1/2".....	\$9.99

INNOVATIVE CONCEPTS	
Flip'n File 10.....	\$24.99
Flip'n File 50.....	\$14.99
Flip'n File 50 w/lock.....	\$19.99
Flip'n File Data Case.....	\$9.99

ANCHOR	
Volksmodem.....	\$59.99
Volksmodem 300/1200.....	\$189.00
Signalman Express.....	\$259.00
Lightning 2400 Baud.....	\$399.00
Express (PC Halfcard).....	\$189.00
6480 (64/128) 300/1200 Baud.....	\$139.00
520 1200 BPS.....	\$149.00

AST	
Reach 1200 Baud Half Card.....	\$399.00

DIGITAL DEVICES	
AT300 - 300 Baud (Atari).....	\$99.99

EVEREX	
1200 Baud Internal (IBM/PC).....	\$179.00

Hayes	
Smartmodem 300.....	\$139.00
Smartmodem 1200.....	\$389.00
Smartmodem 1200B.....	\$359.00
Smartmodem 2400.....	\$599.00
Micromodem IIe.....	\$149.00
Smart Com II.....	\$89.99
Chronograph.....	\$199.00
Transet 1000.....	\$309.00

Novation	
Smart Cat Plus.....	\$299.00
J-Cat.....	\$99.99
Novation 2400.....	\$499.00
Apple Cat II.....	\$219.00
212 Apple Cat II.....	\$379.00
Apple Cat 212 Upgrade.....	\$229.00

QUADRAM	
Quadmodem II	
300/1200.....	\$339.00
300/1200/2400.....	\$499.00

SUPRA	
MPP-1064 AD/AA (C-64).....	\$59.99

DRIVES

IOMEGA	
A110H Single 10.....	CALL
A210H 10 + 10.....	CALL
A120H Single 20.....	CALL
A220H 20 + 20.....	CALL
Save on 10 & 20 Cartr.....	CALL

TALLGRASS	
25, 35, 50, 80 meg (PC)	
.....from \$1299.00	

IRWIN	
Tape Backup.....	CALL

EVEREX CORE	
60 Meg Internal Backup System.....	\$799.00

MOUNTAIN	
AT20-AT72MB.....	CALL

PRIAM	
Hard Card 20.....	CALL

RACORE	
40, 60 MB Inner Space.....	CALL
Shared Data.....	CALL
Shared Space.....	CALL

RACORE	
1500 Expansion Chassis.....	\$379.00
1500 Chassis w/DMA.....	\$429.00
2101 256K Memory.....	\$179.00
2103 512K Memory.....	\$199.00

CMS	
10 Meg with controller.....	\$399.00
20 Meg with controller.....	\$499.00
Rambo-AT.....	\$229.00

ALLIED TECHNOLOGY	
Apple II, II+, IIe 1/2 height.....	\$109.00

INDUS	
Atari GT.....	\$199.00
C-64 /128 GT.....	\$199.00

MSD	
SD1 C-64 Single.....	\$219.00
SD2 C-64 Dual.....	\$469.00

TANDON	
320K 5 1/4" (PC).....	\$119.00

TEAC	
320K 5 1/4".....	\$119.00

SOFTWARE FOR IBM

ANSA SOFTWARE	
Paradox.....	\$499.00
ASHTON-TATE	
Framework II.....	\$389.00
dBase III Plus.....	\$389.00
BATTERIES INCLUDED	
Isgur Portfolio.....	\$159.00
BORLAND	
Lightening.....	\$59.99
Sidkick (unprotected).....	\$57.99
Reflex.....	\$59.99
Travelling Sidkick.....	\$44.99
Turbo Prolog.....	\$64.99
CENTRAL POINT	
Copy II PC-Backup.....	\$29.99
PC Option Board.....	\$84.99
DECISION RESOURCES	
Chartmaster.....	\$229.00
Signmaster.....	\$159.00
Diagram Master.....	\$209.00
FIFTH GENERATION	
Fast Back.....	\$99.99
FUNK SOFTWARE	
Sideways.....	\$44.99
HARVARD SOFTWARE INC.	
Total Project Manager.....	\$269.00
Presentation Graphics.....	\$239.00
LIFETREE	
Volkswriter III.....	\$159.00
LIVING VIDEOTEXT	
Think Tank.....	\$109.00
Ready.....	\$64.99
LOTUS	
Symphony.....	CALL
1-2-3 Version 2.....	CALL
MECA SOFTWARE	
Managing Your Money 2.0.....	\$99.99
Manage Your Market.....	\$89.99
MICROPRO	
Easy.....	\$94.99
WordStar 2000.....	\$239.00
WordStar 2000 +.....	\$289.00
WordStar Pro. w/GL Demo.....	\$189.00
MICROIM SOFTWARE	
R:Base 4000.....	\$249.00
R:Base 5000.....	\$359.00
Clout 2.0.....	\$129.00
MICROSOFT	
Fight Simulator.....	\$34.99
MultiPlan.....	\$129.00
Word.....	\$249.00
Mouse.....	\$139.00
MICROSTUF	
Crosstalk XVI.....	\$89.99
Crosstalk Mark IV.....	\$149.00
Remote.....	\$89.99
MULTIMATE	
Multi Mate Word Proc.....	\$219.00
Advantage.....	\$289.00
On File.....	\$89.99
Just Write.....	\$89.99
NOUNEMON	
Intuit.....	\$69.99
NORTON	
Norton Utilities 3.1.....	\$57.99
ONE STEP	
Golf's Best.....	\$34.99
PFS: IBM	
Proof.....	\$59.99
File/Graph.....	(ea.) \$84.99
Report.....	\$74.99
Write/Proof Combo.....	\$84.99
PROFESSIONAL SOFTWARE	
Write-N-Spell.....	\$89.99
THE SOFTWARE GROUP	
Enable.....	\$329.00
SATELLITE SYSTEMS	
Word Perfect 4.1.....	\$219.00
SORCIMUIS	
Accounting	
API/AR/GU/INV/OE.....	(ea.) \$299.00
SuperCalc III.....	\$199.00
EasyWriter II System.....	\$239.00
Super Project.....	\$199.00
SUBLOGIC	
Jel.....	\$37.99

PRINTERS

Canon	
A40,A50,A55.....	CALL
LBP-8A1 Laser.....	CALL
CITIZEN	
MSP-10 (80 col.).....	\$279.00
MSP-15 (132 col.).....	\$389.00
MSP-20 (80 col.).....	\$349.00
MSP-25 (132 col.).....	\$509.00
C. ITOH	
Prowriter 1550P.....	\$349.00
Starwriter 10-30.....	\$399.00
3500 Tri Printer.....	\$1499.00
corona	
Lazer LP-300.....	\$2799.00
DIABLO	
D25 Daisywheel.....	\$549.00
635 Daisywheel.....	\$1099.00
D80IF Daisywheel.....	CALL
daisywriter	
2000.....	\$899.00
EPSON	
Homewriter 10, LX-80.....	CALL
FX-85, FX-286, RX-100.....	CALL
DX-10, DX-20, DX-35.....	CALL
SO-2000, Hi-80, HS-80, AP-80.....	CALL
LO-800, LQ-1000.....	CALL
JUKI	
6000 Letter Quality.....	CALL
6100 Letter Quality.....	CALL
6200 Letter Quality.....	CALL
6300 Letter Quality.....	CALL
6500 Letter Quality.....	CALL
5510 Dot Matrix Color.....	CALL
LEGEND	
808 Dot Matrix 100 cps.....	\$179.00
1080 Dot Matrix 100 cps.....	\$259.00
1380 Dot Matrix 130 cps.....	\$289.00
1385 Dot Matrix 165 cps.....	\$339.00
NEC	
3000 Series.....	\$779.00
8000 Series.....	\$1099.00
ELF 350.....	\$399.00
P560, P660, P760.....	CALL
OKIDATA	
182, 183, 192, 193, 2410, 84.....	CALL
Okimate 10 (Specify C64/Atari).....	\$189.00
Okimate 20(IBM), 282, 283.....	CALL
Panasonic	
KX1080.....	NEW
KX1091.....	\$269.00
KX1092.....	\$389.00
KX1592.....	\$469.00
KX1595.....	\$659.00
QUADRAM	
Quadjet.....	\$389.00
Quad Laser.....	CALL
SILVER-REED	
500 Letter Quality.....	\$219.00
550 Letter Quality.....	\$299.00
800 Letter Quality.....	\$699.00
star	
SG-10C (C64 Interface).....	CALL
SB/SD/NX/SR Series.....	CALL
Powertype Letter Quality.....	CALL
Texas Instruments	
Ti850.....	\$529.00
Ti855.....	\$639.00
Ti865.....	\$799.00
TOSHIBA	
P321 (80 column).....	\$499.00
P341 (132 column).....	\$799.00
P351 (132 column).....	\$1049.00

MULTIFUNCTION CARDS

RamVantage.....	AST	\$349.00
Rampage-PC.....		\$379.00
Rampage-AT.....	CALL	
Six Pack Plus.....		\$229.00
I/O Plus II.....		\$139.00
Advantage-AT.....		\$369.00
Preview Mono.....		\$299.00
PC Net Cards.....		\$379.00
5251/11 On-line.....		\$669.00
5251/12 Remote.....		\$579.00
5251/11 Plus.....		\$719.00
dea		
IRMA 3270.....		\$879.00
IRMA Print.....		\$999.00
IRMA Smart Alec.....		\$779.00
SEVEREX		
Edge Card.....		\$259.00
Graphics Edge.....		\$219.00
Magic Card II.....		\$159.00
Magic Card I.....		\$99.99
HERCULES		
Graphics.....		\$299.00
Color.....		\$159.00
IBM Associates		
IDEA 5251.....		\$549.00
INTEL		
PCNC8087 5MHz.....		CALL
PCNC8087-2 8 MHz.....	CALL	
PCNC80287 8 MHz.....	FOR	
1010 PC-Above Board.....	YOUR	
1110 PS-Above Board.....	PC	
2010 AT-Above Board.....		
MYLEX		
The Chairman.....		\$439.00
PARADISE		
Color/Mono Card.....		\$149.00
Modular Graphics Card.....		\$199.00
Multi Display Card.....		\$199.00
Five Pack C, S, 0-384K.....		\$99.99
High Res Mono.....		\$169.00
PERSYST		
Bob Board.....		\$359.00
QUADRAM		
Quadport-AT.....		\$119.00
Liberty-AT (128K).....		\$349.00
The Gold Quadboard.....		\$449.00
The Silver Quadboard.....		\$239.00
Expanded Quadboard.....		\$179.00
Liberty.....		\$309.00
QuadSpring.....		\$499.00
QuadLink.....		\$399.00
QuadColor.....		\$199.00
Quadboard-AT.....		\$399.00
8600 E.G.A. card.....		\$399.00
STB		
EGA Plus.....		\$379.00
TECMAR		
Captain - 84.....		\$199.00
Graphics Master.....		\$469.00
VIDEO-7		
EGA.....		\$399.00
INTERFACES		
AST		
Multi I/O (Apple II).....		\$149.00
DIGITAL DEVICES		
Ape Face (Atari).....		\$49.99
U-Print A (Atari).....		\$54.99
U-A16/Buffer (Atari).....		\$74.99
U-Call Interface (Atari).....		\$39.99
U-Print C (C64).....		\$49.99
P-16 Print Buffer.....		\$74.99
U-Print 16 apple lic.....		\$89.99
MICRO R & D		
Apple IIc Parallel.....		\$49.99
Kaypro 2000 Parallel.....		\$49.99
C64/128.....		\$59.99
Orange Mikro		
Grappler CD (C64).....		\$89.99
Grappler Plus (Ite, Iic).....		\$89.99
Grappler C (Iic).....		\$89.99
Grappler 16K (Ite, II+).....		\$139.00
PARADISE		
Graphicard.....		\$69.99
Serial Card.....		\$99.99
Microbuffer II+ 64K.....		\$169.00
QUADRAM		
Microfazer.....		from \$139.00
Elazer (Epson).....		from \$79.99

IBM Inquiry 86

IBM PC SYSTEMS
Configured to your specifications.
Call for Best Price!

IBM-PC, IBM-XT, IBM-AT	
Safari (7300).....	CALL
6300.....	CALL
corona	
PPC400 Dual Portable.....	\$1289.00
PPCXT 10 meg Portable.....	\$1889.00
PC40022 Dual Desktop.....	\$1389.00
PC400-HD2 10 meg.....	\$1889.00
ITT	
ITT X-TRA	
256K, 2 Drive System.....	CALL
256K, 10 meg Hard Drive System.....	CALL
XP5, 20 meg.....	CALL
KAYPRO	
KP-2000 Portable.....	CALL
Kaypro PC.....	CALL
SANYO	
MBC 650-2, MBC 655-2, MBC 675 Portable, MBC 6775, MBC 680 Desktop.....	CALL
SPERRY	
Sperry-AT.....	as low as \$1749.00
Sperry-IT.....	as low as \$2699.00
Call for Specific Configuration!	
All Models.....	
ZILUM	
PC-138 Series, PC-148 Series, PC-158 Series, PC-160 Series, PC-171 Series, AT-200 Series.....	CALL
MONITORS	
AMDEK	
Video 300 Green.....	\$119.00
Video 300A Amber.....	\$129.00
Video 310A Amber TTL.....	\$159.00
Color 600 Hi-Res. RGB.....	\$399.00
Color 722 Dual Mode.....	\$529.00
Color 725.....	CALL
Color 730.....	CALL
MAGNAVOX	
8562 RGB/Composite.....	\$279.00
613 TTL Green.....	\$99.99
623 TTL Amber.....	\$99.99
NEC	
JB1205A.....	\$79.99
JB1270G/1275A.....	(ea.) \$99.99
JB1280G TTL Green.....	\$129.00
JB1295A TTL Amber.....	\$129.00
JC1401 Multi Sync RGB.....	CALL
PRINCETON	
MAX-12 Amber.....	\$179.00
HX-9 9" RGB.....	\$489.00
HX-9E Enhanced.....	\$519.00
HX-12 12" RGB.....	\$489.00
HX-12E Enhanced.....	\$559.00
SR-12 Hi-Res.....	\$599.00
SR-12P Professional.....	\$699.00
QUADRAM	
8400 Quadchrome I.....	\$499.00
8410 Quadchrome II.....	\$339.00
8420 Amberchrome.....	\$179.00
8500 Quad Screen.....	\$1449.00
TAXAN	
115 12" Green.....	\$119.00
116 12" Amber.....	\$129.00
121 TTL Green.....	\$139.00
122 TTL Amber.....	\$148.00
220 14" Color Composite.....	\$179.00
820 640x200 RGB.....	\$439.00
630 640x200 RGB.....	\$489.00
640 720x400 RGB.....	\$539.00
ZILUM	
ZVM 1220 Amber.....	\$99.99
ZVM 1230 Green.....	\$99.99
ZVM 1240 IBM Amber.....	\$149.00
ZVM 135 RGB.....	\$459.00
ZVM 1330 RGB.....	\$459.00
ZVM 1380 RGB.....	CALL
ZVM 1380 E G Comp.....	CALL

COMPUTER MAIL ORDER

1-800-233-8950

DEPT. A107

Actually, we give you two things free.
Our source code. And your freedom.

Just buy part or all of our excellent integrated business accounting system, the SBT Database Accounting Library.

We'll give you our source code absolutely free.

Which, in turn, gives you the freedom to customize our software to fit your business needs.

Say, for instance, you want to change the way a management report is formatted. Our free source code enables you to change it.

What's more, the change will be quick and simple because our software is written in easy-to-use dBASE.

In fact, the entire SBT Database Accounting Library runs with dBASE III or dBASE II,* so you get the power and flexibility of those best-selling programs. Plus the freedom to use any computer that runs dBASE.

The SBT Database Accounting Library.
Great software and freedom. All in the same box.

Call today for our demo disk and brochure.
(415) 331-9900.

THE SBT DATABASE ACCOUNTING LIBRARY.

dProfessional	Time & Billing	\$395
dOrder	Sales Order processing	\$195
dInvoice	Billing/Inventory Control	\$195
dStatement	Accounts Receivable	\$ 95
dPurchase	Purchase Order	\$195
dPayable	Accounts Payable	\$295
dPayroll	Payroll/Labor	\$395
dLedger	General Ledger/Finance	\$395
dAssets	Asset/Depreciation	\$295
dProject	Project/Job Accounting	\$395
dBackup	Menu/Backup	\$ 65



Three Harbor Drive
Sausalito, CA 94965
(415) 331-9900

Call today for the name of the SBT consultant
in your area.

Free source code in every box.



Compiled and Multi-User versions also available. dBASE III and dBASE II are registered trademarks of Ashton-Tate, Inc. Copyright 1985, SBT Corporation.

STRUCTURAL ANALYSIS

BY ROBERT W. JOHNSON AND FERNANDO G. LOYGORRI

This finite-element method works on an IBM PC

THE FINITE-ELEMENT method is one of many attempts by scientists to reduce the complexity of some real-life problems to manageable proportions in order to analyze them. The ultimate goal of the different numerical procedures developed over the years is to find the solution to a complicated problem by solving a simpler one that closely represents the actual problem.

For example, you may replace the elusive task of geometrically computing the length of an irregular figure's perimeter by calculating the perimeter of a polygon with a large number of sides (see figure 1). As you increase the number of the polygon's sides, its perimeter's approximation of that of the irregular figure improves until, with infinite sides, the perimeter of the polygon becomes equal to that of the original figure.

SIMPLIFY, SIMPLIFY

The simplifications used in this attempt fall into two separate categories, physical and mathematical. The finite-difference method and the least-squares approximation represent the group of mathematical simplifications used to reduce the complexity of

equations. The finite-difference method replaces the derivatives in differential equations and boundary conditions with difference equations. If you carry this method far enough, you get surprisingly good results.

The finite-element method is an example of a physical simplification. The equations are left alone, but you reduce the complexity of the part by replacing it with a model made up of a finite number of discrete pieces called elements—similar to the sides of the polygon in figure 1. These elements are interconnected at a number of points called nodes. The behavior of the elements approximates that of the continuous subject.

Finite-element-analysis procedures that require extensive mathematical calculations have been around a long time. Prior to the availability of sophisticated computers, these procedures were impractical and not widely used. Finite-element analysis enjoyed successful, if limited, use on mainframe computers, but it became a practical everyday tool within the reach of the average engineer with the explosion of microcomputer availability.

Of course, there is a catch: You can reduce the complexity of analyzing

some phenomena, but the solution loses precision in the process. If you study a simplified approximation of the real problem, the solution will also be an approximation.

In structural analysis, this is not a costly trade-off. After all, prior to the finite-element methods, the solutions for complex structures were limited to approximations that, even with very sophisticated mathematics, seldom matched the actual structure. Engineers used conservative assumptions to account for this lack of analysis capability.

THE FINITE-ELEMENT METHOD

Although finite-element analysis started as a tool for engineers who

(continued)

Robert W. Johnson, who has 20 years' experience as a structural engineer, works on stress analysis for Boeing in Renton, Washington. He has a B.S. in aero and astro engineering from the University of Washington.

Fernando G. Loygorri is also a structural engineer at Boeing. A native of Spain, he has an M.S. in aerospace engineering from the University of Madrid. Both authors can be contacted at Microstress Corp., 10950 Forest Ave. S, Seattle, WA 98178.

perform aircraft structural analysis, it has been widely applied to solving other types of engineering problems such as fluid dynamics, heat transfer, and soil mechanics. Other less common applications include the biological sciences, where finite elements have been used to determine stresses in the eyeballs and bones, to study the lubrication of natural joints, and to study the motion of blood cells in capillary blood vessels.

The nature of the finite-element method makes it useful to engineers and scientists faced with three different types of problems:

1. equilibrium analyses, like the static solution of the loads and deformation of a structure;
2. eigenvalue analyses, like those you would use in determining the natural frequencies of a structure; and
3. transient analyses, like those found in structural dynamics.

The finite-element solution doesn't consider the effect that deflections have on a structure's ability to carry loads. For example, a thin flat plate under pressure loading with the

edges fixed would show large deflections due to plate bending. These deflections, in reality, would result in the "membrane" characteristics of the plate being loaded. The finite-element method considers only the initial shape of the model. Therefore, no membrane loads are calculated in the plate; this results in no tensile stresses in the model plate elements.

In spite of this obvious limitation, the finite-element stiffness solution is the most common method of stress analysis for complex structures in use today. Most structures do not have large deflections that alter the stiffness characteristics of their elements.

You can account for the effect of the loads on the deflected geometry—if deflections are large—if you solve the problem for a fraction of the total load. Then you add the resulting structure deformation to the geometry of the previous solution to calculate the next increment of loading. The solution is built up by adding the incremental-solution deflections, stresses, and internal loads until you have accounted for the total applied load. The resulting stresses and loads

represent the large-deflection solution to the problem you modeled. You must take care in unique cases like the pressurized flat-plate model to keep the load increments small enough to prevent an excessive build-up of error.

The finite-element solution of a statically loaded structure is reasonably complete in that all internal forces (loads and stresses) are solved as well as all deflections. The deflections are most useful as a way to visualize the structure's performance.

The degree of refinement of the finite-element grid—the element size—is a function of the level of detail required in the solution results. For example, the method can analyze a pin-jointed bar element. In this case, the only possible deformation is the extension or contraction of the bar length. It is a natural assumption that the length increases or decreases linearly along the bar. If the area of the bar is constant, or no analysis of the bar will be done from the element's internal data, then this idealization is adequate for the rest of the model. If stresses along a bar that varies in area are required, then you must model the bar with a number of elements.

Elements interact with each other only through a limited set of points called nodes. The multiple node interactions are mathematically represented by a system of simultaneous equations. In the case of structural analysis, this system expresses the relationships between applied loads and restraints on one side of the equation and the deformed state of the structure on the other side. You can represent the system of simultaneous equations in matrix form as $\{F\} = \{K\} \{u\}$, where $\{F\}$ is a vector representing the applied forces and reactions, $\{K\}$ is the matrix of coefficients, called the stiffness matrix, of the model, and $\{u\}$ is a vector representing the displacements of all the nodes in the system.

THE STIFFNESS MATRIX

The values of the stiffness matrix depend only on the geometry of the problem and the basic assumptions made about the behavior of the ele-

(continued)

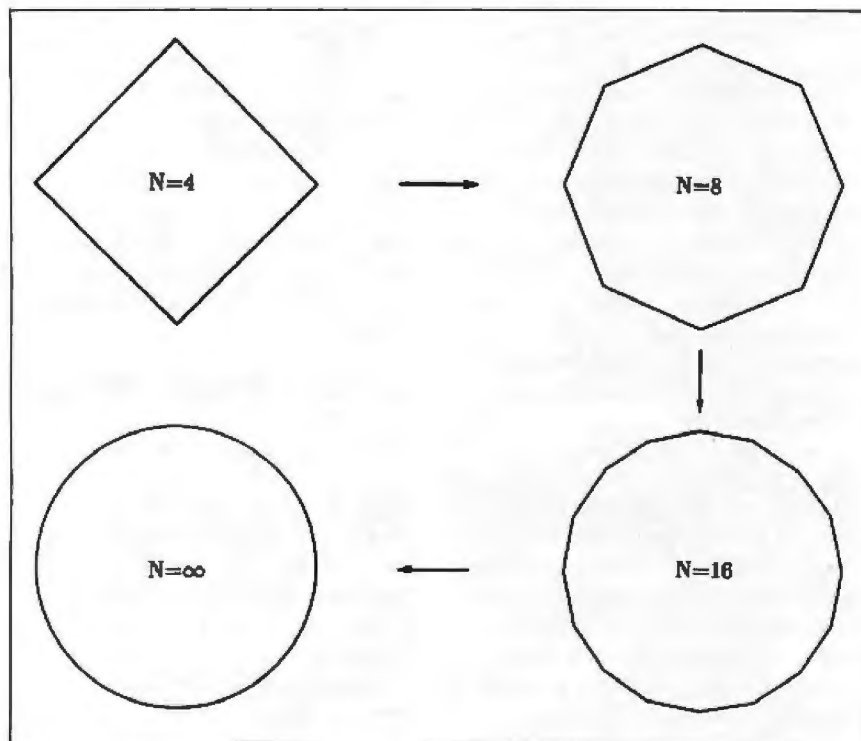
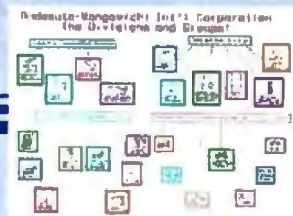
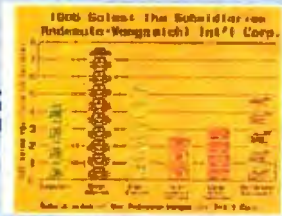
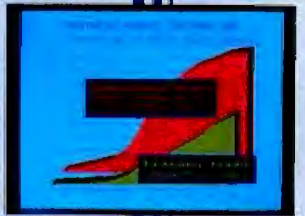

Figure 1: A polygon approximation of the circumference of a circle where N is equal to the number of sides the polygon has.



Until today,
you needed a
Charting program,
a Drawing program,
and a
Presentation program.
NOW ALL YOU NEED IS



ENERGRAPHICS 2.0



EnerGraphics 2.0 simply outperforms the competition. Whether you're making charts for a presentation, analyzing data, making maps, flow charts or creating almost any type of graphic, you'll find the capability with EnerGraphics 2.0.

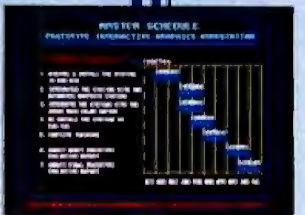

EnerGraphics 2.0 is easy to use too, because a mouse has been added. Now with mere pushes of a button, stunning charts and drawings are easily created. Help screens are also available, plus, new documentation with a quick-tip book that makes EnerGraphics 2.0 a breeze to use.

So, if you want this kind of performance and capability which can be used by anyone, the simple choice is EnerGraphics 2.0.

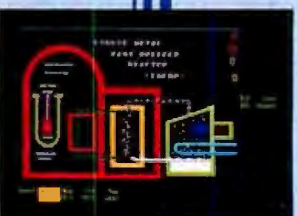
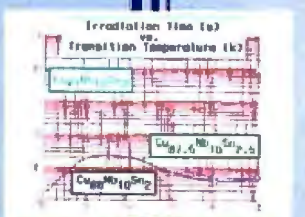

Write for more information and a dealer near you or call **800-325-0174**.

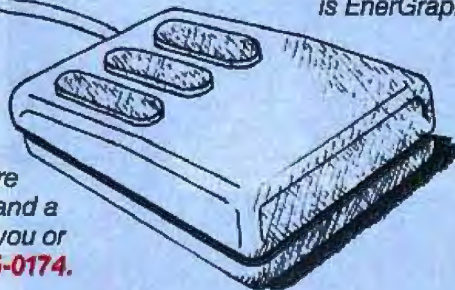

ENERTRONICS

ments. The goal is to determine the deformed state of the model $\{u\}$:

$$\{u\} = \{K\}^{-1}\{F\}$$

Determining the inverse of a matrix, $\{K\}^{-1}$, requires a lot of calculations.

The stiffness matrix represents the effects that loads or restraints applied

to the model at each individual node have over all the nodes in the model. Loads and restraints or displacements may occur at every node in different directions, called degrees of freedom.

Since the finite element performs almost exactly as any linear elastic material would, complex effects such

as "shear lag" (changes in load distribution due to structural deflections along the axis of a member) are included in this approach.

SHEAR LAG

A simple example of shear lag would be a stiffened panel with a large load applied on the end of the central stiffener (see photo 1). An inexperienced analyst may have difficulty estimating the shear reaction of the central member into the skin plates. The term shear lag is used to explain why the shear flows are much higher near the applied load than a linear shear reaction over its length.

There is a significant difference between the shear-lag deflections that are included and the flat-plate membrane deflections that are excluded. In shear lag, the applied loads and the element-stiffness values are in the same direction, where the membrane stiffnesses for the flat plate are oriented at 90 degrees, relative to the applied pressure loading. The stiffnesses at 90 degrees to the applied loads are not a load path and are not included in the finite-element-method solutions. The plate-bending stiffness is in the same direction as the pressure loading and is the only stiffness used to react to the pressure loads in that solution.

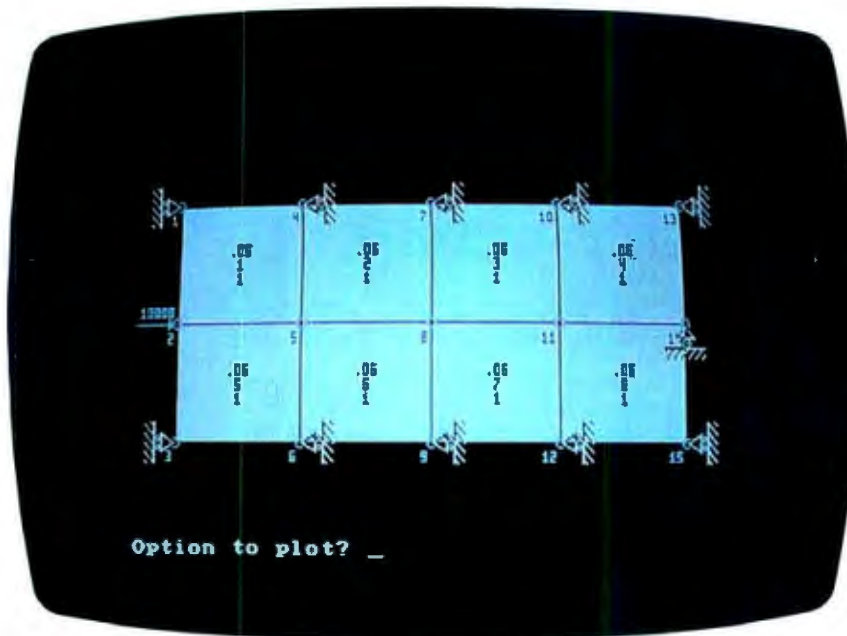

Photo 1: Plot of the stiffened panel with a 10,000-pound load on the central stiffener, drawn by the SAFEPL0T.EXE program.



Photo 2: The lug model with the plates, beams, and loads shown.

THE LUG MODEL

Other problems such as fittings, or lugs, have stumped the most sophisticated solutions due to the complex shapes involved in most practical problems. The two-dimensional finite-element problem is most dramatically illustrated by the solution of the lug shown in photo 2. This problem combines the classical lug solution with oblique loading and structural bending, the latter of which is due to the location of the attachment-bolt reactions at the ends of the fitting and the bearing-loads distribution from the central bolt on the lug itself.

To represent the bolt bearing on the lug, you use a series of radial beam members extending from the central loaded node to the inner surface of the lug bore. You run the finite-element analysis and check the

(continued)

For you, good is just not good enough.

For serious programmers, good isn't good enough. You need the best ... the best tools, the best advice and the best support.

At Lifeboat, we've been selling to programmers since 1976, so we know quality when we see it. And we're committed to a full-service program that goes beyond just selling you the best software at competitive prices. Our expert staff can help you decide which programs are best for your needs and provide you with all the technical support you may require. You can rely on Lifeboat for the complete solution to your programming needs.

LANGUAGES

Lattice C New 3.0 Version

The best selling C Compiler has been upgraded to give you more functions and features. Lattice C 3.0 contains 200 new library functions, better code generation, support for new data types (void, enum, unsigned char, unsigned long), support for the 80186/80286 instruction set and the ability to generate in-line 8087/80287 instructions. Lattice C is the C Compiler for professional developers.

RUN/C—The C Interpreter Upgraded Version

Learn C the natural way with RUN/C. The user interface is similar to BASIC with easy familiar commands. The new 2.0 version of RUN/C comes with a full-screen editor and other enhancements.

RUN/C Professional New

All RUN/C's capabilities plus powerful features for program development. Load your favorite object libraries with RUN/C Professional. Contains a full-screen editor and source code debugging facilities.

Mark Williams C Programming System

A complete C development environment.

Pro Pascal

A truly standard Pascal. Produces fast, tight code with plenty of compile time options and simple one-line commands.

BetterBASIC New Version

Now you can program in BASIC and use the full memory of your PC, create structured programs using functions and procedures, make your own library modules and more. Now compatible with Microsoft BASIC.

LANGUAGE UTILITIES

Plink86 Plus

An overlay linkage editor for linking 8086/8088 object modules. Supports an unlimited size file, unlimited number of modules and up to 4095 hierarchical overlays stacked as many as 32 levels deep. Plink86 Plus contains new features for memory caching, library allocation, file merging and overlay reloading.

Pfix86 Plus

A symbolic and source level advanced debugger for programming professionals.

C-SPRITE

Symbolic debugging at both source level and machine level. Monitor your program by setting breakpoints, examining registers and variables, or single-stepping through code. Handle a set of commands as a macro. C-SPRITE and the Lattice C Compiler are a natural pair for program development and debugging.

BASTOC

A BASIC to C translator for the BASIC programmer who wants to upgrade to C.

EDITORS

LSE

A powerful yet inexpensive full-screen editor designed for efficiency and ease of use. Its speed is optimized by writing directly to video memory. The Lattice Screen Editor provides a multi-window environment, ability to reprogram keys, support for keyboard macros, an undo command, an error tracking mode, on-line help and more.

VEDIT Plus

A full-screen text editor for program development and word processing. It contains powerful features including use of macros, on-line help facility, paragraph formatting, and file comparison.

Pmate

The programmer's editor with an extensive macro command language. Compile in the background while you continue to edit files.

EMACS

Customizable editor including windowing, multi-tasking and special modes for C and Pascal.

FUNCTIONS

C-Food Smorgasbord

Library of time saving utility functions including a BCD package, an IBM PC BIOS interface, level 0 I/O functions, a terminal independence package and more.

Essential C Utility Library

Over 300 functions, with special attention given to screen handling, windows and business graphics. Source code is included.

PforCe Brand New

An optimized library of an impressive 400 plus functions and subsystems. Included is a window management system with overlapping or tiled windows and a database system with B-tree file structure. Several pre-coded screens including "Lotus" style are supplied. And there's much more! Routines for interrupt driven communications, background tasks, and string/table parsing, along with functions for field/screen editing and validation are all part of this superbly written and documented software. Complete source code is included.

The Greenleaf Comm Library

A library of over 120 communication routines. Contains functions to create interrupt driven routines or perform direct I/O to multiple Comm Ports. Its strengths are in asynchronous communications, interrupt mode, modem control, XMODEM, XON/XOFF and flow control. Interfaces with Lattice, Microsoft, Wizard, Desmet, CI86, Aztec and Mark Williams C compilers.

The Greenleaf Functions

A mature library of over 200 functions. Version 3.0 offers all new indexed documentation, with an abundance of examples. Source code included.

GRAPHICS and SCREEN DESIGN

GSS*CGI GRAPHICS New

The GSS Computer Graphics Interface is designed for creating high performance graphics-based applications. GSS*CGI speeds up application development and provides compatibility with a wide range of peripherals. It's the only CGI implementation that provides true device-independence for both raster and vector graphics. Language bindings are available to support development of GSS*CGI based applications using Lattice C, Microsoft C, FORTRAN, Pascal, BASIC Compiler and Macro Assembler. Products in the GSS*CGI GRAPHICS line include the GSS Graphics Development Toolkit, the GSS Kernel System, the GSS Plotting System and the GSS Metafile Interpreter.

Essential Graphics New

A brand new graphics library for C programmers with the emphasis placed on ease of use and portability. No royalties.

Multi-Halo

Library of over 200 graphics functions, supporting all of the popular graphics boards.

Panel

A powerful tool for interactive screen design.

For more information on these and other products in our complete line call:

1-800-847-7078 In NY: 914-332-1875

LIFEBOAT

The Full-Service Source for Programming Software.

INTERNATIONAL SALES OFFICES

Australia: Fagan Microprocessor Assoc. Phone: (01) 3699-9899
Canada: Scantel Systems Phone: (416) 449-9252
England: Grey Matter Ltd. Phone: (44) 364-53499
Italy: Lifeboat Assoc., S.p.A. Phone: (02) 656-841
Japan: Lifeboat Japan Phone: (03) 293-4711
Spain: Micronet, S.A. Phone: (34) 1-457-5056
The Netherlands: GIGA Computer Products Phone: (31) 10-771846
SCOS Automation BV Phone: (31) 20-106922

Lifeboat
55 South Broadway
Tarrytown, NY 10591

Inquiry 206

The names of products listed are generally the trademarks of the owners of the products.

© 1986 Lifeboat Associates

resulting loads in these beam members for tension values. The bolt can transmit only bearing loads—beam-compression values—to the lug material since the lug and bolt are separate parts. Then you divide the area values of those beam members in tension by 10,000 to reduce the tension values to an insignificant magnitude and rerun the solution. This procedure is convenient on personal computers since solution turnaround is fast and full-screen editors let you review the significant model data without waiting for a printout.

Figure 2 shows the location and value of the maximum stress in the lug as a function of load-application angle. We obtained these results by changing the applied load and the orientation of the reduced beam

areas in the central-bolt idealization and rerunning the solution. We made these changes to the lug model with an editor, saved the resulting models for each loading on the computer's hard disk, and then ran the series of jobs in batch mode.

This example illustrates the real value of the finite-element solution as a tool for understanding how structures perform. Since the complete solution—stresses and deflections—is available, you can derive a "picture" of the part's stress distribution from the solution data, much as you would use a photostress model to visualize the stress distribution in real parts.

PROBLEMS

The main problem with a finite-element-analysis program for micro-

computers is the efficient use of the memory that is available on the machine. Memory usage is such an important issue because even modest-size finite-element models require relatively large amounts of storage space.

The analysis of a model involves solving a system of simultaneous equations. All the coefficients must be stored adequately in the computer memory while the solution is in progress. The matrix solutions require a very large storage volume. There is one equation for each independent displacement in the model, which is referred to as a degree of freedom. In a two-dimensional model with in-plane loads, there are three degrees of freedom per node, because each node may independently translate in two orthogonal directions in the plane of the model, and it may also rotate within the plane. In a three-dimensional model, there are six degrees of freedom per node, three translations, and three rotations.

A moderate-size model may contain around 100 nodes, for example. Therefore, the system of simultaneous equations to be solved will contain $3 \times 100 = 300$ equations for a two-dimensional model, or $6 \times 100 = 600$ equations for a three-dimensional model. Obviously, this method would be totally impractical if computers were not available.

The storage problem comes up when you realize that the matrix $\{K\}$ in the 100-node two-dimensional example contains $300 \times 300 = 90,000$ terms, or in the 100-node three-dimensional example contains $600 \times 600 = 360,000$ terms. Obviously, it is impossible to store that many numbers in the main memory of an IBM PC.

To get around such a seemingly unsolvable problem, you must take advantage of the particular characteristics of the system that you need to solve. The theory shows that the matrix $\{K\}$ is always symmetric; that is, all the matrix terms above the principal diagonal (top left to bottom right) are just a mirror image of the matrix terms located below that diagonal. By not storing the redun-

(continued)

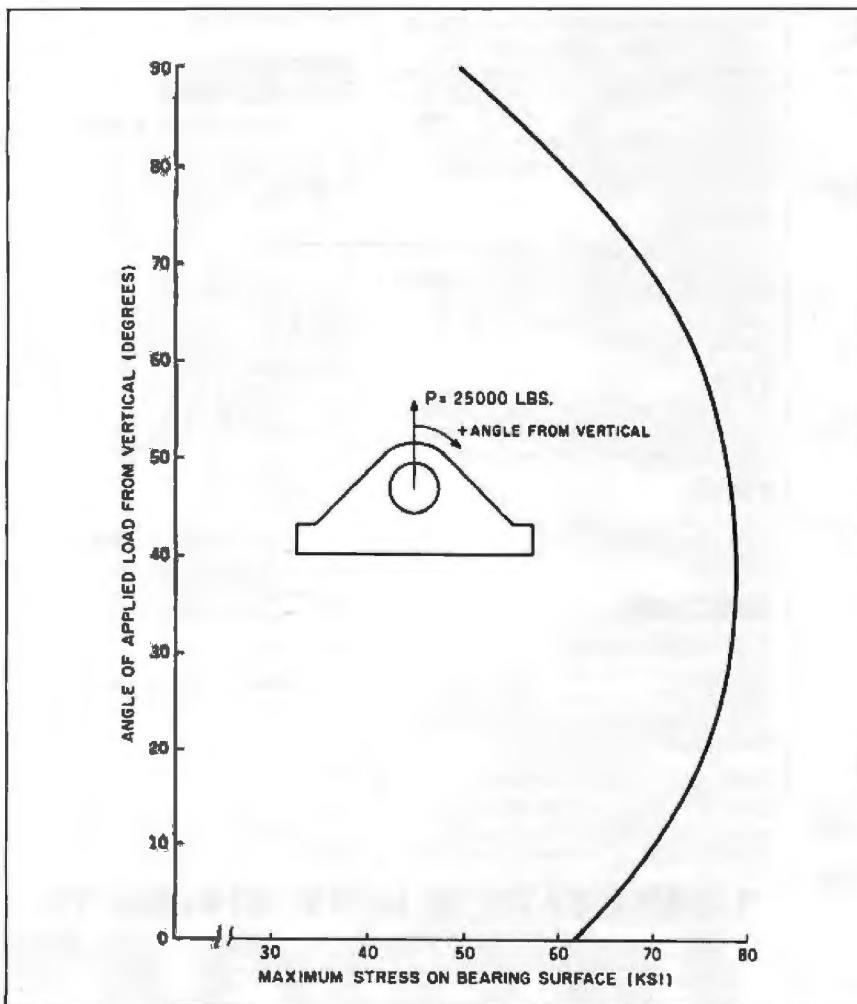

Figure 2: A plot of the variation of the location of maximum stress in the lug against the angle of applied load.

“I can’t, I’m wearing magnetic underwear.”

—Computer backup excuse #685

Doing computer backup really gets under people’s skin.

They’ll do anything to get out of doing it, because backing up is so utterly boring.

But not doing it can definitely be a matter of getting your education at the college of hard knocks.

We’re reminded of the PhD candidate in biology who did hunger research for his doctoral thesis without backing it up.

He had data from a year’s worth of injecting and weighing rats stored on the disk. The computer crashed, the rat data was erased from memory,

and he had it to do all over.

Back to the rat race.

So do your backup. Floppies if you don’t have much memory. Or, if you have 5 to 10 Mbytes or over, on data cartridge—a 3M developed technology whose time has come.

For example, the space-saving 3M DC 2000 data cartridge holds 40 Mbytes

of information. You’d need 80 floppies to store that much. And it can fit in your breast pocket.

To read more true-to-life “horror stories” of people who didn’t back up, ask your computer products dealer for our leaflet “Horror Stories.”

And you can forget about the polarity of your skivvies.

When you
run out of
excuses.™





**The Most Accurate 20MHz
Logic Analyzer Available.
For Only \$1,495.**

*Only with the Logic-20
Only from BitWise Designs*

The true criterion of a logic analyzer's accuracy is not its sample speed, but its set-up time — that period of time prior to the clock edge in which it cannot accurately sample data.

With a set-up time of only 2 ns., the Logic-20 from BitWise Designs blows away its nearest 20 MHz competitors — which are totally unreliable for a monstrous 25 ns. before the clock edge.

The Logic-20 is a single IBM PC (or compatible) expansion card, offering 16 channels of 20 MHz sampling with less than one ns. channel-to-channel skew. Optionally, for those with unusually fast sampling speed applications, the Doubler™ pod is available that allows 40 MHz sampling over eight channels.

And because the Logic-20 is an add on to your personal computer, you can have it right on your

desktop when you need it. You can interrupt development at any time to use your PC to write a memo or document your progress, and then go right back to where you left off. All in your office, all right at your desk.

Need to know more about logic analyzer accuracy or the Logic-20?



Logic That Makes Sense

1223 PEOPLES AVE.
TROY • NY • 12180
518 • 274 • 0755

IBM and IBM PC are trademarks of International Business Machines Corporation.
Logic-20 is a trademark of BitWise Designs, Inc.

*To store a complete
triangular submatrix
would be inefficient
because the matrix is
usually heavily banded.*

dant terms, the storage needs are reduced by almost half.

Still, to store a complete triangular submatrix would be very inefficient because the matrix is usually very heavily banded. In other words, the nonzero terms are clustered in a band located along the principal diagonal. Outside the band, all the terms are zero; if you know this, you don't need to store them.

BANDING

The matrix is banded because each node is connected to a relatively small number of other nodes through the model elements. The terms corresponding to the nodal connections that are *not* made have a value of zero so the matrix is sparsely filled. If all nodes are numbered so that the connections are made between nodes with close numeric identifiers, the nonzero terms in $\{K\}$ will form a narrow band.

In a well-ordered model the bandwidth is easily as low as 25 to 30 percent of the total number of degrees of freedom, reducing the storage needs significantly. For example, the stiffness matrix of a 100-node three-dimensional model with a half bandwidth of 16 nodes contains approximately 57,000 nonzero and non-redundant terms, down 84 percent from the total original value of 360,000.

Once the stiffness matrix has been shrunk as much as possible, we need to find the best way to keep it in the computer's memory. Because the bandwidth of the model is variable, we use a single-dimension array (vector). This is done by appending each line to the end of the previous one.

(continued)

jc lips

The Word is Out...

It's going to break your heart if you already own a PC.

JC LIPS provides a new experience in personal computing. Our third generation personal computer brings you technological advancement and features which have not been possible in the past. It runs all popular IBM PC software 2 to 4 times faster than other compatibles. It will impress you with unsurpassed performance and cool reliability. Best of all, it is available to you at an affordable price.

JC LIPS features the advanced-technology CMOS NEC V40 processor running at 8 MHz with an equivalent throughput of at least 9.5 MHz. The systemboard has 256K of RAM, expandable to 640K, a built-in floppy disk controller, a socket for a high speed floating point processor, and 8 I/O expansion slots. Also included as standard on systems are 360K floppy disk(s), a serial interface, a parallel printer interface, a battery backed-up clock, a keyboard, and a 135 Watt power supply, capable of handling all of this plus any accessories you may add later.

JC LIPS' display system includes a quality 14" high resolution monochrome monitor, with a dark

background non-glare screen and a tilt and swivel base for easy viewing. The multi-function display card provides an IBM PC compatible interface for a monochrome display with Hercules compatible graphics or a RGB color graphics display.

JC LIPS is also available with high speed 20 MB hard disk with 2K cache buffer memory controller, Enhanced Color Graphics display adapter, high resolution RGB color monitor, local area networking controller, and more. These options can be added at any time, and with the features we supply as standard, it will be a difficult system to outgrow.

NOW *the word is out.* Another superb product is available from the high-performance, multi-user systems company, JC Information Systems.



JC INFORMATION SYSTEMS

161 Whitney Place
Fremont, CA 94539
(415) 659-8440 TWX 910-381-7041

MICROSAFE 2-D AND 3-D

The Microsafe series of finite-element-analysis programs are best suited to the analysis of static structures using linearly elastic materials. Microsafe performs the type of solution that resolves equilibrium problems, like the static solution of the loads and deformation of a structure.

SOLVING A MODEL

To solve a structural model with Microsafe, you need to create a file with all the information you need to define the model. You can use any text editor or word processor capable of creating an ASCII character file with no special control characters. You write the parameters of the model (node coordinates, beam areas, plate thicknesses, loads, etc.) in the file, separated by blanks. To save future relearning time, we have included the ability to write notes to ourselves on any line in the file or after the data on the line. Many models are made by editing previous ones such as beam, fitting, or frame models to create those for similar structures. Also, if very unique modeling characteristics are used, a note may be included for future reference. Listing A shows a portion of an actual file including optional English notes.

Once you have created the file, you

should verify it by running it through the graphics module. The program will read the model file and perform an exhaustive validity check. If it finds an error, the program reports all the information available: location, type of error, and reason why that information cannot be accepted. For example, if you incorrectly define the thickness of a plate, the program indicates that the thickness specified doesn't fall within acceptable bounds; it states what those bounds are; and arrows point to the incorrect entry, so you don't have to search the whole line to find the error. Other errors are handled similarly (see photo A).

You may graphically review the entire model, including all the properties, to make sure it matches the intended model. The system does not require any special graphics hardware, only the standard IBM Color Graphics Adapter and a graphics monitor. A zoom feature was added to overcome the rather obvious resolution problems with small details in these monitors. For execution speed, all the graphics routines were written in assembly language.

The solution module also checks the model so you don't necessarily need the graphics module. When solving big models, the computer seems to be

"dead" for long periods of time, so we added progression bars to keep track of its progress. Thus, the program indicates how far the task is away from completion. The solution module reports the displacements, element-corner forces, internal-node and element stresses, and the reactions at the restrained nodes.

We have also included a table not usually found in finite-element programs—residual loads at free nodes. In a balanced model the force contributions of all the elements connected to a given free node should cancel out, and the residual load should be zero. But we found that if the model is poorly designed (with sudden large changes in properties instead of realistically gradual changes, for example), the residual loads quickly become nonzero in the ill-conditioned area. To identify this situation—if it occurs—we included the residual-loads table as a post-processing aid.

IN TWO DIMENSIONS

The two-dimensional Microsafe program allows models with up to 400 nodes, 500 plates, 600 beams, and 60 fasteners and allows plotting of all elements and properties (data values). All solutions are run in memory and require a minimum of 448K available bytes. The 8087 is used if available. Because the stiffness matrix is stored in banded form, models with a high bandwidth require extra memory; up to 704K may be used if available.

The examples shown requiring two-dimensional solutions correspond to the Microsafe 2-D solution program. There is also a plotting program that is used to check out the model data prior to the solution. Use of this program before the solution program will ensure correct results with fewer solution iterations.

IN THREE DIMENSIONS

The example shown in figure A is representative of the type of problem solved by the three-dimensional program. This problem represents the outboard-wing panel of an aircraft with six ribs, a rear spar, a main box spar, and both upper and lower surface skins.

The three-dimensional stiffness matrix is much bigger than the stiffness



Photo A: Microsafe error-diagnostics format.

Listing A: PUNCH.INP: sample input file for Microsafe 2-D program with examples of optional notes and comments to explain data.

```

This file demonstrates the mixture of text (notes) and input data
allowed in the Microsafe Program Series. The data for the program is
contained on the lines that contain a slash character. All lines
without a slash and any characters following the slash are ignored by
the program.
15 / # of nodes
1 / # of materials
4 / # of beams
8 / # of plates
0 / # of fasteners
1 / # of loaded nodes
11 / # of imposed restraints
1 0.0 10.0 / node-# x-coordinate y-coordinate
2 0.0 0.0 /
3 0.0 -10.0 /
4 10.0 10.0 /
5 10.0 0.0 /
6 10.0 -10.0 /
7 20.0 10.0 /
8 20.0 0.0 /
9 20.0 -10.0 /
10 30.0 10.0 /
11 30.0 0.0 /
12 30.0 -10.0 /
13 40.0 10.0 /
14 40.0 0.0 /
15 40.0 -10.0 /
1 10.3E6 0.33 / material-# Young's-modulus Poisson's-ratio
1 2 5 0.5 0.1 1 0.0 0.0 / beam# node1 node2 area inertia material# Q1 Q2
2 5 8 0.5 0.1 1 0.0 0.0 /
3 8 11 0.5 0.1 1 0.0 0.0 /
4 11 14 0.5 0.1 1 0.0 0.0 /
1 2 5 4 1 .06 1 / plate# node1 node2 node3 node4 thickness material#
2 5 8 7 4 0.06 1 /
3 8 11 10 7 0.06 1 /
4 11 14 13 10 0.06 1 /
5 3 6 5 2 0.06 1 /
6 6 9 8 5 0.06 1 /
7 9 12 11 8 0.06 1 /
8 12 15 14 11 0.06 1 /
2 1000. 0.0 0.0 / node # load-x load-y moment
1 1 0.0 / node-# restrained-freedom-# imposed-deflection
3 1 0.0 /
4 1 0.0 /
6 1 0.0 /
7 1 0.0 /
9 1 0.0 /
10 1 0.0 /
12 1 0.0 /
13 1 0.0 /
14 2 0.0 /never remove this node-used to eliminate freebody translation
15 1 0.0 /
1 -> restrain x-direction
2 -> restrain y-direction
3 -> restrain rotation

```

matrix for plane models, typically by a factor of four. Thus, Microsafe 3-D uses as much memory as is available up to 704K bytes before it starts to off-load data to a spill file. This program makes the faster hard disks really attractive. Microsafe 3-D uses disk drives like virtual memory, that is, as slow emulators for RAM. (We are in the process of extending the Microsafe 2-D program to include this feature as well.)

The plotting portion of the three-dimensional analysis program is under development. The rest of the three-dimensional analysis program and all other programs in this article are complete and have undergone extensive testing and use.

AVAILABILITY

[Editor's note: Microsafe 2-D is available as SAFE2SOL.FOR and SAFE2SUB.FOR in

a variety of formats (see pages 459-461 for details), for use with the Microsoft FORTRAN Compiler version 3.2. A library, SAFE2D.LIB, is included that contains the assembled machine language routines. These routines allow character handling and other facilities not included in MS-FORTRAN and must be used with the compiled .OBJ files at link time. The libraries required for linking are SAFE2D.LIB plus the Microsoft FORTRAN (continued)

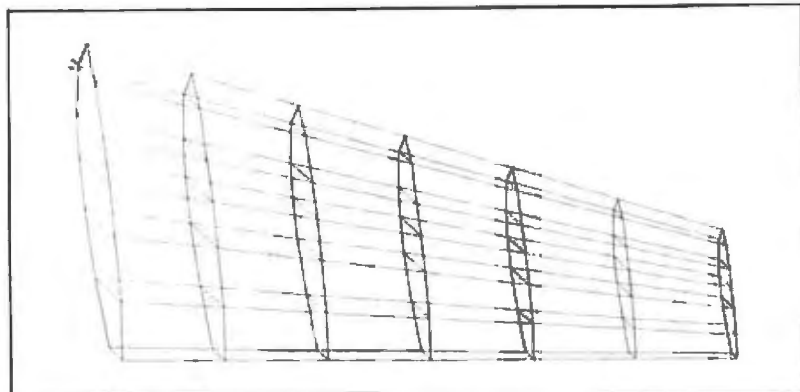

Figure A: Plot of wing model using printer-graphics routine.

libraries MATH.LIB, FORTRAN.LIB, and DOS2FOR.LIB. Instructions for running Microsafe 2-D can be found in BROCHURE.DOC. Two input files are available: LJG.INP and PUNCH.INP. And the assembly language routines are available in source code also: ASCSTR.ASM, CHKDUP.ASM, CHOPWR.ASM, CONFRM.ASM, CONSTR.ASM, DATE.ASM, DEFDRV.ASM, DELFIL.ASM, DSKFRE.ASM, DSKSPC.ASM, ENDSTR.ASM, EXPSTR.ASM, FILSTR.ASM, INTSGN.ASM, LENSTR.ASM, LOCSTR.ASM, LOGPSL.ASM, LWCSTR.ASM, MEMAVA.ASM, MODSTR.ASM, MOVSTR.ASM, PACER.ASM, PAKSTR.ASM, RESSTR.ASM, SETSTR.ASM, SIZFIL.ASM, SIZSTR.ASM, TIME.ASM, and UPCSTR.ASM.]

Microsafe 2-D and 3-D are shareware

products. If you don't know anyone you can get an evaluation copy from, you can obtain executable versions of either of the programs from Microstress Corp. (10950 Forest Ave. S, Seattle, WA 98178) for \$10 to cover the cost of the disks and postage. The disks include an abbreviated manual and numerous examples.

You may evaluate the programs at length, trying them on problems that represent the type of designs that you will actually use them for. Only after you determine that the program serves your particular needs do you purchase either program for \$75. In return you will receive the complete typeset manuals, including the latest program release and notification of future updates.

To determine the location i corresponding to row r and column c , you need a simple computation: $i = (r-1) \times b + c$, where b is the bandwidth of the model.

FOOLING THE SYSTEM

A dilemma arises when selecting the size of the vector because our programs are written in Microsoft FORTRAN (see the text box, "Microsafe 2-D and 3-D" on page 208), and the language forces you to fix the dimensions of each array in the program. If the value you select is too high, the program will not run on machines with a small amount of memory because these machines have no virtual-memory facilities with which to swap portions of the array to disk storage. On the other hand, if the number you pick is low enough to ac-

commodate everybody, then the programs will not use all the memory available in computers that have plenty of it—a very sloppy approach.

We decided to play tricks on the operating system. At run time an MS-FORTRAN program has the code loaded in low memory and the data areas loaded immediately on top of it. The last data blocks to be loaded are the common blocks and, for some reason, the named common blocks are sorted in reverse alphabetical order. Free memory is located after the last common block, starting at segment HIMEM as reported by the linker (see listing 1).

The last common block is the only one that you can expand, without clobbering something of value, to the top of the memory physically present in the machine and known to the

operating system. By putting the $\{K\}$ array in a common block named, for example, AAAAAA, you can dynamically allocate memory to it at run time.

You can determine the location of "top of memory" with a simple routine that examines the data area. The number of elements that will fit in memory is determined by subtracting the address of the first element of the array from top of memory (see listing 2). If you dimension the array at compile time with 8200 elements, it will span more than one segment, so that MS-FORTRAN will generate the proper code when calculating the array indexes.

You can successfully apply this method to most programs that require some degree of dynamic run-time allocation of memory. Unfortunately, it works only for one single array and does nothing to solve the problem of not having enough RAM. Also, it prevents using the program in a multitasking environment.

When the different methods of reducing storage needs still leave a stiffness matrix too big to fit in RAM, it is time to think about extending the amount of memory available to the program. One way of doing it is to use the disk drives as a (slow) emulator for RAM in a mechanism, sometimes called "virtual memory," that is the reverse image of the popular RAM disk, which uses RAM to emulate a disk drive.

The first step in setting up the virtual-memory mechanism is to determine how much space you need on the disk and create a random access file of the proper size. After that, every time an element of the stiffness matrix needs to be accessed (read or written), the program will have to check whether it resides in RAM or in the disk file and act accordingly.

Because disk access is slow compared with memory access, you should minimize the number of disk accesses you use throughout the program. Careful examination of the way the stiffness equations are solved pays off in solution-time savings.

The solution of the system is pro-

(continued)

STRUCTURAL ANALYSIS

Listing 1: The linker listing showing the location of free memory that starts at segment HIMEM, after the last common block.

Start	Stop	Length	Name	Class	
00000H	072C9H	072CAH	SAFES_	CODE	-----
072CAH	0B3B2H	040E9H	PARSF_	CODE	
0B3C0H	0B914H	00555H	CSLOGD	CODE	
0B920H	0B947H	00028H	CSDSKS	CODE	
0B950H	0B977H	00028H	CSUPCS	CODE	
0B980H	0B9D3H	00054H	CSCONS	CODE	
0B9E0H	0BA00H	00021H	CSSETS	CODE	
0BA10H	0BA42H	00033H	CSMEMA	CODE	
0BA50H	0BA75H	00026H	CSEXPS	CODE	
.	
.	
.	
14AADH	15498H	009ECH	MATHCODE	CODE	
154A0H	154D3H	00034H	INTRQ7	CODE	
154E0H	15677H	00198H	OEMR87	CODE	
15680H	15864H	001E5H	INTRQ7	CODE	
15870H	15870H	00000H	HEAP	MEMORY	-----
15870H	15870H	00000H	MEMORY	MEMORY	-----
15870H	15A6FH	00200H	STACK	STACK	
15A70H	232C7H	0D858H	DATA	DATA	
232C8H	232D0H	00009H	EINQQQ	DATA	
232E0H	2331FH	00040H	COMADS	COMADS	
23320H	24993H	01674H	CONST	CONST	
24994H	249C3H	00030H	TRANS	CONST	
249D0H	249DFH	00010H	SIZEBW\$A	\$\$SIZEBW	
249E0H	2BF4FH	07570H	PLATES\$A	\$\$PLATES	
2BF50H	2BF7FH	00030H	GLOBAL\$A	\$\$GLOBAL	
2BF80H	2E4FFH	02580H	FORCES\$A	\$\$FORCES	
2E500H	2E59FH	000A0H	FILENM\$A	\$\$FILENM	
2E5A0H	2E5AFH	00010H	DSKROM\$A	\$\$DSKROM	
2E5B0H	2F23FH	00C90H	COORDI\$A	\$\$COORDI	
2F240H	3F23FH	10000H	AAAAAA\$A	\$\$AAAAAA	
3F240H	3F27FH	00040H	AAAAAA\$B	\$\$AAAAAA	
3F280H	3F280H	00000H	HIMEM	HIMEM	
Origin	Group				-----
0E15:0	CGROUP				
149D:0	DGROUP				

Program code area

Data segment area

Common blocks

High memory: expandable dynamically

Program entry point at 0E2D:0029

Listing 2: MEMAVA.ASM, a routine that determines the number of elements that will fit in the remaining memory.

```
TITLE MEMAVA - FUNCTION TO DETERMINE HOW MUCH MEMORY CAN BE ADDED
PAGE ,132
```

```
; (C) Copyright by Microstress Corporation 1985, 1986
; Written by Fernando Garcia-Loygorri
```

```
COMMENT *
MEMAVA is a routine designed to be called from FORTRAN as a function
to determine how much memory is available to the last common block as
dynamic memory.
```

```
Made of use:
                size = MEMAVA (var)
```

```
where
var = variable name of the last array in the last common block.
size = name of the 4-byte Integer variable receiving the return
value.
```

(continued)

STRUCTURAL ANALYSIS

```

*
SUBTTL FORMAL DECLARATIONS
PAGE

csmemo SEGMENT 'CODE'
      ASSUME CS:csmemo

SUBTTL MEMAVA - EXECUTABLE CODE
PAGE

PUBLIC MEMAVA
memova PROC FAR

      PUSH BP                      ; Save registers.
      MOV BP,SP
      PUSH DS

; Get total amount of room in machine.
      mov ax,40h                   ; Point to the location in memory where
      mov ds,ax                   ; DOS keeps the total amount of memory:
      mov bx,13h                  ; Segment 40h, offset 13h-14h.
      mov ax,[bx]                 ; Get number of K in AX.
      mov cl,6                    ; Multiply by 64 to get total number
      shl ax,cl                   ; of paragraphs (groups of 16 bits).

; Get address of parameter from program.
      LDS BX,DWORD PTR [BP+6]     ; Address of the parameter.
      mov dx,ds                   ; Store the segment to add later.
      mov cl,4                    ; Divide by 16 to get the number of
      shr bx,cl                   ; paragraphs in the offset.
      inc bx                      ; Increment for the one partially used.
      add dx,bx                   ; Add it to the segment.
      sub ax,dx                   ; Subtract it from the total.

; Convert to words in DX:AX because that is where FORTRAN expects the return of
; a 4-byte integer.
      push ax                     ; Save it for later.
      mov cl,13                   ; Set to isolate top 3 bits.
      shr ax,cl                   ; Isolate them by shifting.
      mov dx,ax                   ; Move them to DX.
      pop ax                      ; Recover it.
      mov cl,3                    ; Multiply by 8 (words/paragraph) by
      shl ax,cl                   ; shifting 3 places.

; Everything done except housekeeping.
      POP DS                      ; Recover the registers saved.
      MOV SP,BP
      POP BP
      RET 4                       ; Discard the input parameter.

memova ENDP
csmemo ENDS

END

```

Listing 3: An example of the method used to read elements from the disk one matrix line at a time, process all the terms in that line, and return the values to the disk file in one loop of code.

```

C
C
C Check if the degree of freedom "i" is in RAM or in disk.
C
C      longl = maxban * j + longi
C      if (longl .lt. ibuf1) then
C
C It is in RAM: Copy pointer only.
C
C

```

(continued)



With the IBM System/36 PC, you can run your business from here.



This surprisingly small IBM System/36 PC has the power to keep any size business moving. At a surprisingly small price.

Connect the System/36 PC to your IBM Personal Computer, and you have the power to build your fortune without spending one.

And you also have a system that's part of the System/36 — IBM's most popular multi-user computer family. Which gives any business access to the broad range of System/36 software as well as PC software.

The basic System/36 PC, a processor and a personal computer, easily operates as a standalone system in a small business. Or ties a department in a larger organization together by connecting a combination of IBM PCs, System/36 terminals or compatible printers. So you can share information and resources.

And yet, with all that power, the System/36 PC processor is so small, it fits under your desk, on top, or next to it. Wherever you put it, you can run a successful business from the best position.

For a free brochure on the IBM System/36 PC, or for information on product availability from participating Authorized IBM PC Dealers, Value Added Dealers or IBM Product Centers, call 1 800 IBM-2468, ext. 104/LD. Or call your marketing representative. And be sure to ask about IBM Credit Corporation financing.

IBM[®]

Inquiry 173

```

        longn = longl
    else
C
C It is in disk: Calculate offset in disk, ...
C
        longn = ibuf2
        locatn = longl - ibuf1
C
C ... update pointer and check whether the operation was successful ...
C
        call movpfl (lhandl , locatn , lerror)
        if (lerror .ne. 0) call vmmerr
C
C ... and move an entire stiffness matrix line to the RAM buffer area,
C making sure that all the elements were read.
C
        call readfl (stmtrx(ibuf2) , maxban , lhandl , lerror)
        if (lerror .ne. -1) call vmmerr
    endif
C
C Operate over each individual element in the line corresponding to
C d.o.f. "l".
C
    DO 1130 k = j+1 , lenhbw
        stmtrx(longn) = stmtrx(longn) - ratio * stmtrx(longn - 1 + k)
        longn = longn + 1
1130    CONTINUE
C
C If the d.o.f. "l" resides in disk...
C
        if (longl .ge. lbuf1) then
C
C ... point to its location in the file, ...
C
            locatn=longl-lbuf1
            call movpfl (lhandl,locatn,lerror)
            if (lerror .ne. 0) call vmmerr
C
C ... and save to file the changes made to the buffer area values.
C
            call writfl (stmtrx(lbuf2),maxban,lhandl,lerror)
            if (lerror .ne. 0) call vmmerr
        endif
        .
        .
        .
        .
    
```

Table 1: Comparison of execution times for Microsafe 2-D and 3-D programs. (Times given are from the IBM PC's internal clock.)

Performance of Microstress Finite-Element-Analysis Programs
on IBM PC Machines

Finite-Element Model	# Nodes	# Beams	# Plates	# Fasteners	Solution Type	Solution Times in Sec.		
						PC	PC XT 8087	PC AT 80287
Splice	30	0	16	3	2D-Double	96	47	16
Apframe	98	159	50	0	2D-Double	479	256	83
Lug	247	24	222	0	2D-Single	2500	792	320
Wing	91	36	132	0	3D	12278	2429	1090

2D-Single refers to the single-precision version of Microsafe 2-D.
 2D-Double refers to the double-precision version of Microsafe 2-D.
 3D-Double refers to the three-dimensional Microsafe 3-D.

Time savings also result due to the simplicity of the finite-element model.

grammed by executing a series of nested loops that sweep through the lines and columns of the stiffness matrix. That is, the elements of a line are needed sequentially, and thus it saves time to read them from disk one entire line of the matrix at a time, process all the terms in that line, and then return all the values to the disk file in a single code loop. Listing 3 shows an actual example of this method.

TIME AND TIME AGAIN

The time savings involved are significant, because instead of making $2 \times b$ disk accesses per line (where b is the bandwidth of the stiffness matrix), the program makes only two. The efficiency of the method increases dramatically in models with a large bandwidth, which happen to be the ones most in need of a virtual-memory mechanism, nicely proving their mutual support.

The use of microcomputers produces significant time savings. While sophisticated mainframe computers can solve problems more quickly than microcomputers can, you must usually wait for the results to be available in printouts or plots while the job goes through batch processing. The actual results may not be available to the engineer for hours or days. IBM PCs run the solutions for two-dimensional problems, like the one in this article, in a few minutes, and the results are available immediately. Of course, an 8087 coprocessor or an IBM PC AT with an 80287 coprocessor would cut execution times by a factor of from 3 to 11 (see table 1).

Time savings also result due to the simplicity of the finite-element model. It is straightforward to construct and once it is complete, you can calculate many load conditions with very little additional work. ■



Let Lab Boss™ turn your IBM PC into a powerful instrument controller.

You can spend thousands of dollars for a dedicated instrument controller. Or a few hundred for a controller that's dedicated to you and your IBM PC.

Lab Boss™ from National Instruments puts you and your IBM PC (or compatible) firmly in charge of GPIB instruments. From sophisticated laboratory equipment, like digitizing oscilloscopes and spectrometers, to standard printers, plotters, tape drives and more. At data transfer speeds

that are the highest in the industry.

And Lab Boss products offer a direct data link from your measuring equipment to a full range of analysis software, including RS/1, Lotus 1-2-3, and Symphony. So you can easily report your findings on the same system you used for

instrument control, data acquisition and analysis. Try that on a dedicated controller! So — you want to be the boss? Call National Instruments. 800/531-4742.



NATIONAL INSTRUMENTS
12109 Technology Blvd.
Austin, TX 78727 512/250-9119



Ada just moved into a smaller place.

We have some very good news for you.

You can now get a validated, full Ada[®] compiler for the IBM[®] PC AT. From the people who designed the Ada language. For just \$3,000.

Which means you and your company can now program in Ada without tying up a big, expensive computer.

And you should program in Ada. And not just because the DoD says so.



1432 Main Street, Waltham, MA 02154

- Send me more information about the Alsys PC AT Ada compiler.
- Send me more information about Ada.

Name _____

Title _____

Company _____

Address _____

City _____ State _____ Zip _____

Telephone _____

The DoD mandates Ada for their software principally because Ada is considerably easier and less expensive to maintain.

Does more reliable and easier to maintain code sound attractive to you? If not, just look at how your programmers are spending 80% of their time.

People who know Ada are calling it "the only logical language for



Ada & 4-MB of memory* for the price of 4-MB of memory.

the eighties and nineties." The point is, they're not thinking of

Ada as "the DoD language." It's simply because Ada supports good, solid software engineering practice.

And now you can try full Ada programming for less than the cost of a two week training program.

The Alsys™ Ada compiler for the PC AT is not only validated, it's actually written in Ada. And produces code so efficient it executes faster than C or Pascal on tested benchmarks.

And if that's not enough, the Alsys PC AT Ada compiler runs in protected mode. So you can use the full amount of memory available to the PC AT. This means you can run a program using

up to 16 megabytes of memory for code and data without worrying about DOS, overlays and all that stuff.

Lastly, this compiler comes with a 4-megabyte memory upgrade board. That, by itself, is worth the price of admission.

At this point, we suspect you might be tempted to pull out a credit card and give us a call.

Or at least fill out the coupon.

Write: Alsys, Inc., 1432 Main Street, Waltham, MA 02154, U.S.A., Telephone: (617) 890-0030, Telex: 948536.

In France: Alsys, S.A., 29, Avenue de Versailles, 78170 La Celle St. Cloud, France, Telephone: 33(1)3918 12 44, Telex: 697569.

In England: Alsys, Ltd., Partridge Hse, Newtown Road, Henley-on-Thames, Oxon RG9 1EN, England, Telephone: 44 (491) 579090, Telex: 846508.



Knowledge is good. Especially when it's free.



Ada® is a registered trademark of the U.S. Government (Ada Joint Program Office). IBM® and PC AT are registered trademarks of International Business Machines Corporation. Alsys™ is a trademark, service mark, and trade name of Alsys S.A. *Memory board manufactured by Profit Systems, Inc.

Our guarantee is useless.

Our monitors are engineered to give you trouble-free performance for years. And while every Tatung monitor comes with a guarantee, we're confident that's the one feature you'll never have to use. Write, or call toll free, for complete information about Tatung Monitors. We'll respond quickly. Guaranteed.

This is the Tatung CM1380... a 13" RrGgBbl Super High Resolution monitor. It features a 64 color display with 640 x 350 lines of resolution; 22KHz/15KHz dual frequency.



TATUNG

Inquiry 348 for End-Users.
Inquiry 349 for DEALERS ONLY.

Tatung Co. of America, Inc., 2850 El Presidio St., Long Beach, CA 90810 Toll Free: 1-800-421-2929 (Outside CA)/(213) 979-7055 (In CA)
In Northern CA Call: Tatung Science and Technology, Inc., 708 Charcot Ave., San Jose, CA 95131 (408) 435-0140
Tatung Co. of America, Inc. is a subsidiary of Tatung Co., Taipei, R.O.C.

STRESS ANALYSIS

BY D. LEE PETERSEN AND STEVEN L. CROUCH

A coupled boundary-element/finite-difference method

OUR TECHNIQUE for stress analysis of underground mine layouts uses two different methods for solving the governing differential equations. The boundary-element method is used to determine the far-field stresses and displacements, and the finite-difference method is used to determine the near-field stresses and displacements. Although our specific area of discussion is stress analysis, this technique should be of interest to anyone working in the physical sciences who must obtain numerical solutions to problems in infinite or semi-infinite regions.

Within the field of mining engineering, you must design an underground mine to ensure safe and stable conditions for extracting the valuable ores. The geometry of a typical coal mine is illustrated in figure 1. The coal seam in our example is located some distance below the earth's surface (500 feet is typical) and has a thickness adequate for excavation equipment (7 feet, for example). A regular pattern of tunnels is excavated in the seam, and the excavated coal is transported to the surface for processing and use.

Prior to excavation, the full weight

of the overburden rocks rests on the coal seam. At a depth of 500 feet, the vertical stress resulting from the overburden rocks would be approximately 500 pounds per square inch. Upon excavation of the tunnels, the coal remaining in the seam must support the overburden. The average vertical stress acting on the remaining seam increases in direct proportion to the amount of coal excavated. For example, if 50 percent of the seam were excavated, the average vertical stress would increase to 1000 psi. Stress concentrations in the coal seam and nearby rocks cause localized stresses to be higher than the average stress in some areas and lower in others. Clearly, you must limit the proportion of coal that is excavated to prevent unsafe conditions. Stress-analysis techniques allow the design engineer to determine the stress concentration percentages. For further discussion of mine design techniques, see reference 1.

METHODOLOGY

In designing an underground coal mine, the mining engineer must select the dimensions of the mine layout

(e.g., pillar width, pillar height, tunnel width) and any man-made support or reinforcement required. In a wider context, design of any engineered structure involves the assessment of two factors—the forces acting on the structure and the ability of the structure to carry those forces. In the simplest case, the forces on a structure may be known and fixed, while in more complex situations, the forces depend on the response of the structure. The action of the forces is to deform the structure and yield a new distribution of stress and displacement within it. The stresses and displacements must be controlled within specific limits that are based on experience with the material that makes up the structure.

(continued)

D. Lee Petersen (3343 44th Ave. S, Minneapolis, MN 55406) is currently completing a Ph.D. in geo-engineering at the University of Minnesota and is working as an underground construction consultant.

Steven L. Crouch (Department of Civil and Mineral Engineering, University of Minnesota, Minneapolis, MN 55455) is a professor in geo-engineering at the University of Minnesota and a consultant in rock mechanics. He has a Ph.D. in mineral engineering.

The analysis of stresses and displacements must consider applied forces, the geometry of the structure, and the mechanical properties of the material. In the terminology of differential equations, it is a *boundary-value* problem. That is, we know the values of forces, or displacements, on the boundaries, and we would like to determine the internal stresses and

displacements that result.

A variety of differential equations must be solved for specific boundary-value problems. There are three common techniques to do this—direct solution by mathematical analysis, experimental methods such as photoelasticity, and approximate solutions obtained by numerical methods. With the widespread use of computers, nu-

merical techniques have become increasingly popular, with many stress-analysis computer programs now being available for microcomputers. In general, numerical techniques allow stress analysis of complex geometries and material response that is beyond the scope of the analytical and experimental methods. (Reference 2 is a good source of information on numerical techniques applied to problems in the geosciences.)

RATIONALE FOR A HYBRID MODEL

The coal-mine stress-analysis problem in our example requires a numerical technique to achieve adequate results. Having selected numerical techniques in general, you must now select a specific numerical model. You can choose from distinct categories of continuum models: differential methods such as the finite-element (FE) or finite-difference (FD) methods; integral methods such as the direct-boundary integral-equation method (BIEM); or one of the indirect methods, fictitious-stress (FS) or displacement-discontinuity (DD) (see reference 3). Each method has specific advantages and disadvantages; the best choice depends on the characteristics of the physical problem to be modeled.

With the differential methods, you subdivide the region to be modeled into elements, or zones, the fineness of the mesh depending on the scale of the problem and the local accuracy required. In contrast, the integral methods require that only the boundaries of the region be subdivided.

You can apply all five of the methods mentioned above to the coal-mine geometry in our example. Figure 2 illustrates the use of either the FE or FD methods for a simple two-tunnel geometry (figure 2a). In figure 2b, the coal pillar and adjacent roof and floor rocks have been subdivided into elements. One vertical and one horizontal line of symmetry have been used in preparing the mesh. The FE and FD methods have been widely applied to mining geometries such as this because these methods can deal with different rock materials within the region, including

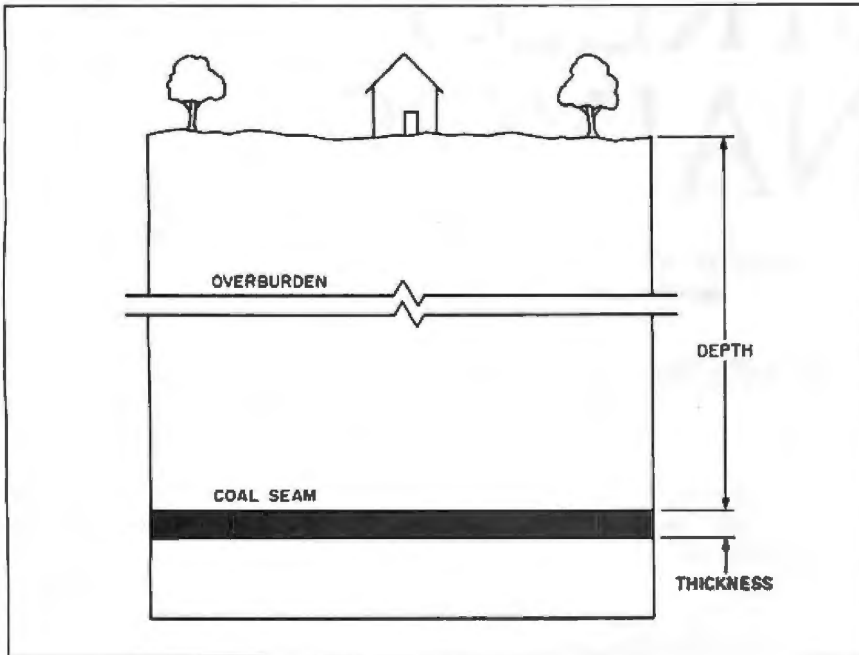

Figure 1: The geometry of a typical coal mine.

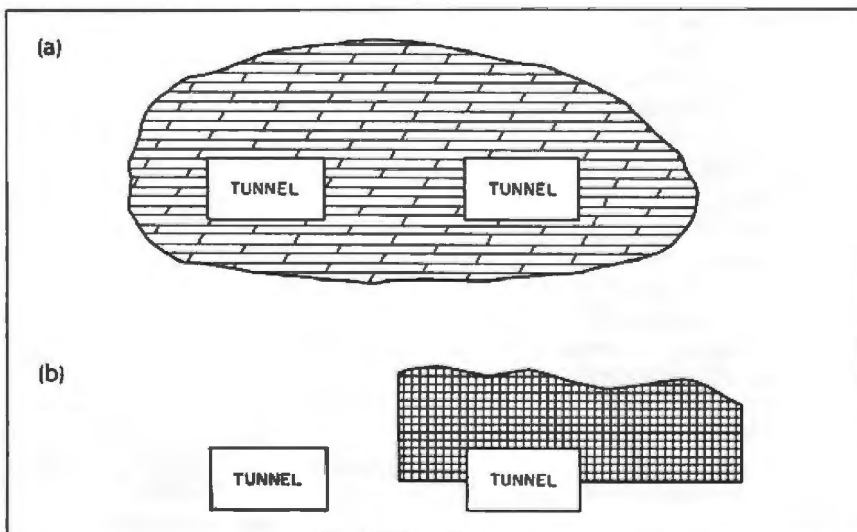

Figure 2: An illustration of either FE or FD methods for a single coal-mine geometry; (a) shows a simple two-tunnel one-pillar problem; (b) displays the FE or FD mesh that subdivides the coal pillar and adjacent roof and floor rocks into elements.

nonlinear or inelastic rock behavior. However, there is commonly a practical limitation on the number of elements allowed by a specific program, so you must set an arbitrary limit on the size of the modeled region. The differential methods are most appropriate for the stress analysis of a single tunnel or an extensive array of tunnels.

Figure 3 illustrates application of the BIEM method to the two-tunnel geometry. The boundary of each excavated tunnel is subdivided into elements, the number of which depends on the computer program and the local accuracy required. Figure 3 shows a typical element size for this problem. The lines of symmetry used in developing the FE or FD mesh could have been used to reduce the number of boundary elements.

The BIEM and FS methods have been used to model coal-mine problems as well, although not as extensively as the FE or FD methods. Both techniques have the advantage of representing an infinite region automatically; you don't have to place arbitrary limits on the region modeled. However, the BIEM and FS methods are normally limited to homogeneous, elastic materials.

You can use the DD method in two different modes for the stress analysis of a coal-mine layout. First, you can use it, as the BIEM and FS methods were used, to outline each excavation with elements. This approach, however, offers no advantage over the BIEM or FS methods. Second, you can use the DD method in the "seam-element" mode. In this mode, you use a single DD element to represent both the upper and lower surfaces of the coal seam (see figure 4). Such an approach loses detail within the seam pillars because it ignores their height, but it allows you to model a large-scale mine geometry economically. The seam-element mode of DD modeling is not appropriate if you need detailed knowledge of the stresses and displacements within pillars. For problems on a larger scale, where the relative displacements between the upper and lower seam surfaces control the stress distribution away from the excavation, you can

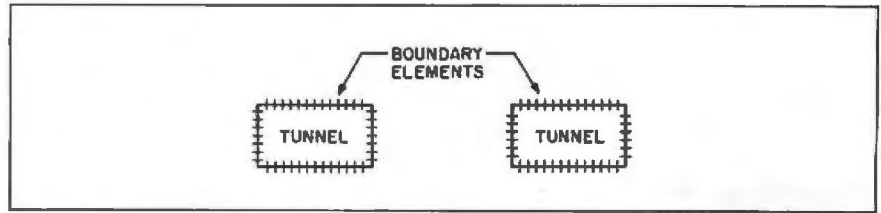

Figure 3: A BIEM representation of the two-tunnel geometry.

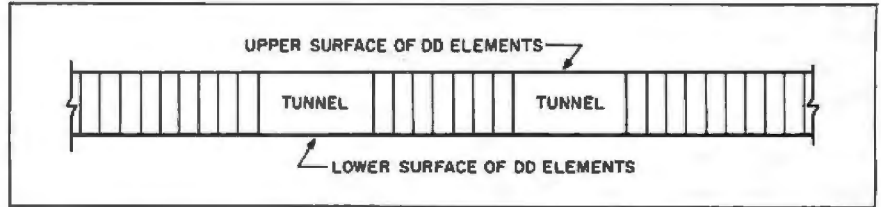

Figure 4: A DD representation in seam-element mode. A single DD element is used for both the upper and lower surfaces of the coal seam.

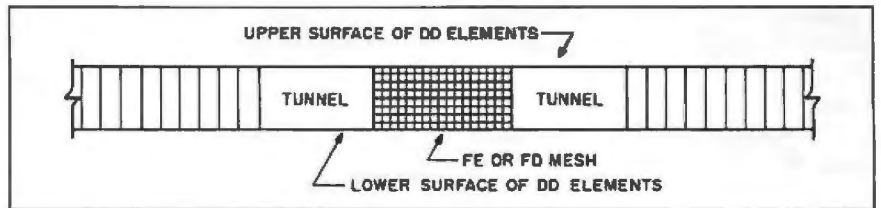

Figure 5: A representation of the hybrid DD/FD model.

use the seam-element mode and ignore the thickness of the seam.

Development of the hybrid model arose due to the limitation of the seam-element DD approach. Seam elements use a rough approximation for mine pillars that yields little more than the average vertical stress acting on the seam. To overcome this limitation, the DD method, which economically represents the rock materials away from the seam, was coupled with one of the differential methods used to represent the pillars (see figure 5). The coal pillars are subdivided in the same manner as in figure 3, and single DD elements are used to represent both seam surfaces along the entire portion of the seam. (The portion of the physical problem represented by the FE or FD method is not limited to the coal pillar; the FD mesh may extend into the roof and floor rocks as desired.) With the hybrid model, the extent of the region represented by the differential method is smaller for a given problem, and the correct boundary con-

ditions are achieved over the height of the pillars. The relative economy of the DD seam method is maintained, but you can determine detailed pillar-stress distributions and incorporate inhomogeneous and nonlinear material behavior into the FE/FD region where such behavior is most important and most likely to occur.

The FD method was selected for coupling with DD seam elements to create the hybrid model. This choice, while somewhat arbitrary, was primarily based on the relatively simple input and small memory needs of the FD method. And, although both the FE and FD methods can model nonlinear material behavior, modifications to the FD method to accommodate such behavior are relatively simple.

THE HYBRID COMPUTER MODEL

The DD and FD methods are based on the same three governing equations common to all boundary-value

(continued)

problems in solid mechanics: the differential equations of motion (based on Newton's second law), a constitutive law that relates strains to stresses, and a kinematics law that defines strains in terms of displacements. In this article we will discuss only two-dimensional plane strain problems of isotropic, linear elasticity. As a result, the governing equations are simplified, and a specific constitutive law—Hooke's law—is used (see the text box "The Governing Equations" on page 230). Our model of the mining problem is called quasi-static: Although the physical problem changes with time, those changes are sufficiently slow that you can neglect inertial effects. Nevertheless, for reasons that will become apparent, we will use the equations of motion (rather than the equations of equilibrium) to formulate the FD method. The DD method, on the other hand, uses the equations of equilibrium. At this point, therefore, the formulations of the DD and FD methods diverge.

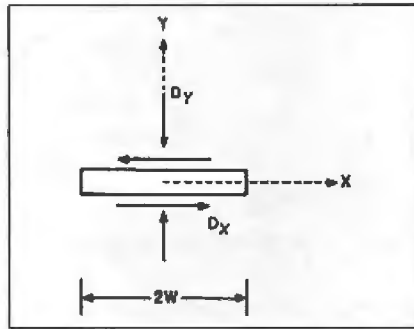

Figure 6: A single DD element of length $2W$, such as a line crack in the body.

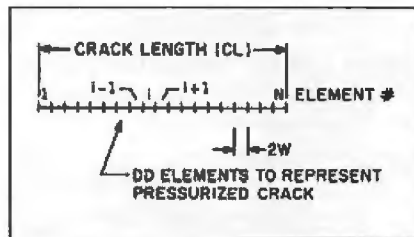

Figure 7: A DD representation of a pressurized crack divided into N boundary elements of uniform length $2W$.

FORMULATION OF THE DD MODEL

Development of the DD model involves considerable mathematical analysis. This analysis yields equations for the three stresses and two displacements at any point in an elastic body due to the influence of a DD element located at the origin of the coordinate system (see reference 3, page 81). Figure 6 illustrates such an element; you can think of it as a line crack existing in the body. If you consider the displacements on the top and bottom surfaces of the element, you will find that the displacements "jump," or are discontinuous, across the crack. The values by which they jump are called the displacement discontinuities and are given the symbols D_x and D_y .

The equations for the stresses and displacements resulting from a DD element with components D_x and D_y are a powerful stress-analysis tool. To illustrate, let's develop a simple computer program (based on only one of the stress equations) that provides a numerical solution to the problem of a pressurized crack in an elastic body. From a physical viewpoint, you expect

that a crack will expand or open if it is pressurized; the numerical model allows you to calculate the shape of the crack as a function of the pressure, the crack length, and the elastic properties of the host material. The problem of a pressurized crack is numerically similar to the coal-seam stress-analysis problem, and you can easily extend the computer program to solve simple seam problems.

You divide the pressurized crack into N boundary elements of uniform length $2W$ (see figure 7), each of which has constant, but at this point unknown, D_x and D_y values. From the symmetry of the crack in the y direction you can conclude that all D_x components are zero. You specify an internal pressure P for the crack that must be met at the midpoint of each boundary element.

To complete the computer model, you select the DD-element stress equation that calculates the vertical normal stress (σ_{yy}) at a point as a function of the D_y component of the element (see reference 3). You can simplify the original equation because you require all elements to lie in a

straight line and have the same length. If the elements are numbered 1 through N from left to right, then the stress at the i th element as a function of the D_y component at the j th element is

$$\sigma_{yy} = \frac{-G}{\pi W(1-\nu)} \frac{1}{4(j-i)^2-1} D_y^j$$

where G and ν are the shear modulus and Poisson's ratio of the elastic body. You must add the influence of all N elements to determine the total stress at element i , which you require to be P :

$$\sigma_{yy}^i = P = \sum_{j=1}^N \bar{A}^j D_y^j$$

where:

$$\bar{A}^j = \frac{-G}{\pi W(1-\nu)} \frac{1}{4(j-i)^2-1}$$

The second of these three equations defines a system of N linear algebraic equations, where P and the \bar{A} coefficients are known and the D_y components are unknown.

Listing 1 contains PCRACK.BAS, a Microsoft BASIC program that uses the above formulation to solve the pressurized-crack problem. [Editor's note: PCRACK.BAS is available in source code in a variety of formats. See pages 459-461 for details.] The input data is the crack length and pressure, element size, and material properties of the elastic body. Lines 1000 to 1210 give usage notes, define array sizes, read model-definition data, and initialize constants. Lines 1220 to 1270 set up the $DY(I)$ and $A(I,J)$ arrays; line 1250 evaluates the third equation above. Note that we have not used an array for the crack pressure, P . In the pressurized-crack problem, all elements have the same pressure P , so you don't need an array. In the coupled DD/FD model, however, each element will have a different P and therefore must be stored in an array.

Lines 1290 to 1470 solve the system of equations using the Gauss-Seidel method with overrelaxation (see reference 4). The Gauss-Seidel method is an iterative technique for solving systems of equations in which successively better estimates for the

(continued)

STRESS ANALYSIS

Listing 1: PCRAK.BAS. a Microsoft BASIC program using the DD method to solve the pressurized-crack problem.

```

1000 REM -----
1010 REM          PROGRAM PCRAK
1020 REM -----
1030 REM          PROGRAM USAGE NOTES
1040 REM          (1) USE CONSISTENT PHYSICAL UNITS
1050 REM          (2) NUMBER OF ELEMENTS <= 30
1060 REM -----
1070 DEFINT I-N
1080 OPTION BASE 1
1090 DIM A(30,30),DY(30)
1100 REM ----- READ BASIC MODEL PARAMETERS
1110 INPUT "CRACK PRESSURE, CRACK LENGTH, NUMBER OF ELEMENTS";P,CL,N
1120 W=CL/(2!*N)
1130 INPUT "MATERIAL PROPERTIES - G,PR";G,PR
1140 REM ----- SET CONSTANTS
1150 PI=3.14159
1160 CON=-G/(PI*W*(1!-PR))
1170 REM ----- GAUSS-SEIDEL ITERATION PARAMETERS
1180 TOL= .00001
1190 ITMAX=2*N
1200 OMEGA=1.3
1210 REM ----- INITIALIZE DY AND COMPUTE A MATRIX
1220 FOR I=1 TO N
1230   DY(I)=0!
1240   FOR J=1 TO N
1250     A(I,J)=CON/(4!*(J-I)^2 - 1!)
1260   NEXT J
1270 NEXT I
1280 REM ----- SOLVE EQUATIONS BY GAUSS-SEIDEL ITERATION
1290 FOR NUM = 1 TO ITMAX
1300   ERRMAX=0!
1310   FOR I=1 TO N
1320     TEMP=0!
1330     FOR J=1 TO N
1340       TEMP=TEMP+A(I,J)*DY(J)
1350     NEXT J
1360     TEMP=(P-TEMP)/A(I,I)
1370     DY(I)=DY(I)+OMEGA*TEMP
1380     ERRI=ABS(TEMP)
1390     IF ERRI > ERRMAX THEN ERRMAX=ERRI
1400   NEXT I
1410   IF ERRMAX <= TOL THEN GOTO 1460
1420   PRINT USING"ITERATION, MAXIMUM ITERATE ## #.#####":NUM;ERRMAX
1430 NEXT NUM
1440 PRINT "ITERATION PROCESS DID NOT CONVERGE AFTER";ITMAX;" ITERATIONS!"
1450 STOP
1460 REM ----- PRINT RESULTS
1470 PRINT "ELEM CRACK OPENING CRACK OPENING COMPUTED STRESS"
1480 PRINT "      (NUMERICAL)      (ANALYTICAL)"
1490 DELB=CL/N
1500 X=-(CL+DELB)/2!
1510 B=CL/2
1520 CON=2!*(1!-PR)*P*B/G
1530 FOR I = 1 TO N
1540   SIGYY=0!
1550   FOR J = 1 TO N
1560     SIGYY=SIGYY+A(I,J)*DY(J)
1570   NEXT J
1580   X=X+DELB
1590   DD=CON*SQR(1!-(X^2/B^2))
1600 PRINT USING" ## ##.#### ##.#### ##.#### ##.####.##":I;DY(I);DD;SIGYY
1610 NEXT I
1620 END

```

unknowns are calculated. In the pressurized-crack problem, we could have used a direct method of solution, such as Gaussian elimination. However, the iterative Gauss-Seidel procedure is important to the coupled DD/FD model, and we have chosen it here to illustrate its use. The boundary condition P is applied in line 1360, and the new $DY(I)$ estimate is calculated in line 1370.

In the coupled model, the P values for each element may change from step to step. With a direct method of solution such as Gaussian elimination, you would have to solve the equations from scratch each time a P value changed. However, the Gauss-Seidel method allows the P value for each element to change (see line 1360). The $DY(I)$ values from the previous solution are good estimates for the

new solution if the changes in P are small, so you need relatively few iterations to achieve a new solution.

Lines 1480 through 1620 print, for each element, the computed value of DY , the analytic solution for the displacement discontinuity (obtained from a well-known formula), and the stress computed from the second equation. (The last quantity provides a check on the accuracy of the numerical solution, because the stress at each element should be equal to P .) We recommend that you run the program for different numbers of elements to determine when you achieve adequate agreement with the analytic solution.

FORMULATION OF THE FD MODEL

The FD model, in this case, has closer ties to the physical problem and the governing equations than does the DD model. You apply the equations, with little modification, directly to a mesh of zones and grid points established in the body to be modeled. An explicit, or "time-marching," solution scheme is used, although the time variable has no relevance in the final solution to the problem.

Figure 8a illustrates a portion of a typical FD mesh that consists of arbitrary quadrilaterals (zones) with a grid point at each zone corner. Stresses are associated with the centroids of zones, while displacements, velocities, and accelerations are associated with grid points. The elastic properties of the body are assigned to zones, but the mass of the body is assumed to be concentrated at the grid points.

Both the differential equations of motion and the definitions of strains in terms of displacements contain partial derivatives. Although there are no functions to differentiate, there are function values (stresses, strains, and displacements) at the zone centroids and grid points. You can estimate a partial derivative by summing, for each side of a polygon, the average function value times geometric properties of the polygon side. Using this approximation, all partial derivatives in the governing equations are re-

(continued)

Cut 'n Paste 'n Print PC

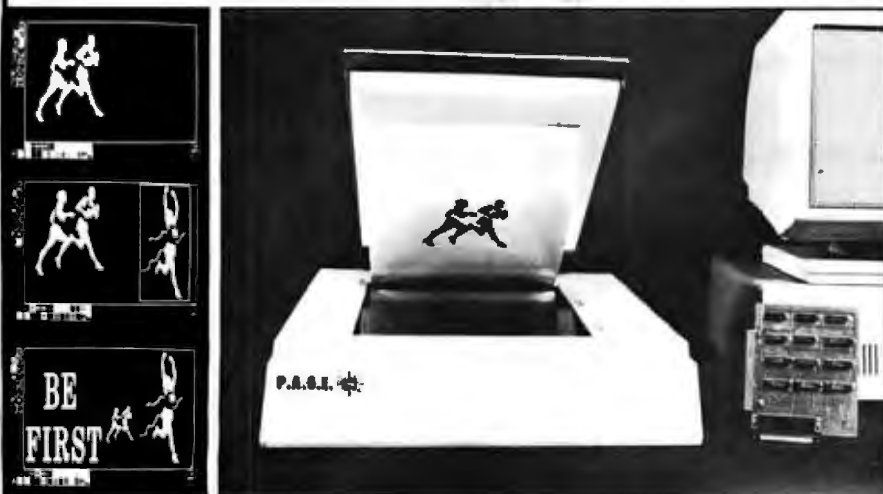

New P.A.G.E. Scanner gives your blind PC the eyes it needs.

Introducing the missing link. The big leap that gives your PC the eyes it needs to capture and enhance existing artwork.

The new P.A.G.E. Scanner takes any photo, flat art, magazine or book and converts them into digitized images. Now you can turn, invert, enlarge, reduce, mirror and even reverse any image, with resolution to 300, 240, 180 or 100 dots per inch, matching laser printer quality.

The possibilities for image manipulation are incredible. There's a zoom feature for fat bit (single pixel) editing, even at a maximum resolution of 90,000 dp sq in.

Hardware Features

- Scans to four resolutions, 100, 180, 240 or 300 dpi.
- Line or halftone.
- Flat bed—easy manipulation of originals.
- Scans books and other dimensional objects.
- 1/2-card interface for IBM PC™, XT™, AT™ and compatibles.
- Compatible with most graphics cards.
- Compatible with most pointing devices.
- Compact and lightweight—15"W x 19"D x 5"H.

- Compatible with most popular dot matrix and laser printers.
- Data file compression saves valuable disk space.
- Runs in virtual page to maximize memory.
- Requires 256K minimum; 640K for high resolution.

Software Features

- Icon driven.
- 20 fonts with text manipulation.
- Grids, filled and unfilled circles, ellipses and boxes, pencil and airbrush, scissors, draw, paint, cut and paste and rubberstamp.
- And even an undo function to instantly correct slip ups.

P.A.G.E. SCANNER

complete with interface, software, cables and user guide.

Just **\$2,995⁰⁰**

Financing available to qualified buyers. Terms: Major credit cards, checks or money orders. Add sales tax in N.J. Order yours now and give your blind PC the eyes it needs. Call (201) 647-3578 ext. 30. Or send your order to:

P.A.G.E.
Printing And Graphic Enhancement
150 Mt. Bethel Road, Dept. B1
Warren, NJ 07060





Remember the first time you upgraded your color graphics hardware? The thrill is still the same.

The discovery of color graphics. As a child, it was a significant event. As a business person, it will change the way you use your personal computer.

Genoa Systems proudly introduces a new and colorful technology for the PC called Spectra EGA. The Enhanced Graphics Adapter that lets you rediscover the benefits, and the thrill, of color graphics on your PC.

An EGA with a better vision.

EGA compatibility is an art that only Spectra has mastered. And, while other EGA hardware is incompatible with current industry standards, Spectra EGA fully supports hardware and software designed for the IBM Enhanced Graphics Adapter, Color Graphics Adapter and Monochrome Graphics Adapter. *And* the Hercules Board.

This means that you don't have to wait around for new

software updates in order to begin enjoying your EGA today.

A lot more than just pretty pictures.

The first thing you'll rediscover with your Spectra EGA is color. There is a whole lot more than ever before. Sixty-four separate colors, in fact, from which any sixteen can be displayed at once.

Next, you'll notice a higher resolution in both text and graphics modes.

The real fun comes in putting the board to work. You'll see soft scrolling, panning and windowing that was never before possible on a PC. And the flicker-free display will allow you to regulate these movements at any speed, or in any direction.

There are 512 characters carried in Spectra's memory that can all

be displayed at once. Which is twice as many as previously possible on a PC.

And if you wish to use other characters, or even create your own alternate character set, Spectra will support those, too.

More colorful features.

Each Spectra EGA comes fully equipped with a parallel printer port, light pen interface and 256K RAM on the single board. This is especially good news because a full 256K RAM is needed to run most popular graphics software effectively.

One thrilling price.

Perhaps the best news is Spectra's price.

Upon first glance you may find that the Spectra EGA and the IBM EGA seem to be very closely priced. But look again. Because the standard IBM EGA only comes with 64K RAM, whereas Spectra EGA comes with a full 256K.

Now, you may purchase the extra memory board you'll need from IBM at an additional cost of about 70-80 percent. Or you can buy Spectra EGA from Genoa...and rediscover the thrill of a bargain.



Spectra Enhanced Graphics Adapter

To find out more about Spectra, or a qualified Genoa distributor near you, call 408-945-9720. Or write to Genoa Systems Corporation, 73 E. Trimble Road, San Jose, CA 95131.

Spectra EGA from Genoa. Evolution in color graphics.

Genoa
We make PCs better.

Inquiry 150 for End-Users.
Inquiry 151 for DEALERS ONLY.

placed by sums of stress or displacement values times the geometric properties of the FD mesh.

The calculation sequence consists of repeatedly applying the governing equations while updating the stress and displacement components of the mesh after each calculation. Each iteration begins by applying the equation of motion. The sequence assumes that you will use sufficiently small time steps so that the stresses remain constant during this portion of the calculation. For each grid point, stresses from adjacent zones are summed to determine the out-of-balance forces, which cause the grid point to accelerate according to its mass (Newton's second law). The ac-

celeration is integrated twice in time to achieve first, the new grid-point velocity (by multiplying by the time step), and then, the new displacement. Next, you assume that all velocities and displacements are constant, and, using the definition of strain in terms of displacement, calculate new strains for each zone. Finally, the strains are used, via the constitutive law, to calculate new stresses. The entire calculation process then repeats, starting with the equations of motion.

Figure 8b illustrates this FD calculation sequence. Due to the nature of the algorithm, the equations-of-motion calculations for the grid points are entirely independent of the strain-and-constitutive-law calculations for

the zones. Boundary conditions are applied either during the equations-of-motion calculation (if displacement conditions are specified) or during the constitutive-law calculation (if stress conditions are specified). This independence of the two phases of the FD calculation is important to the FD-to-DD linkage.

Other calculations also occur during each cycle. The grid-point velocities must be damped to remove mechanical energy from the system so that a quasi-static solution is achieved. And the mesh geometry must be periodically updated if the grid-point displacements are sufficiently large to cause significant changes in the geometric properties of the mesh.

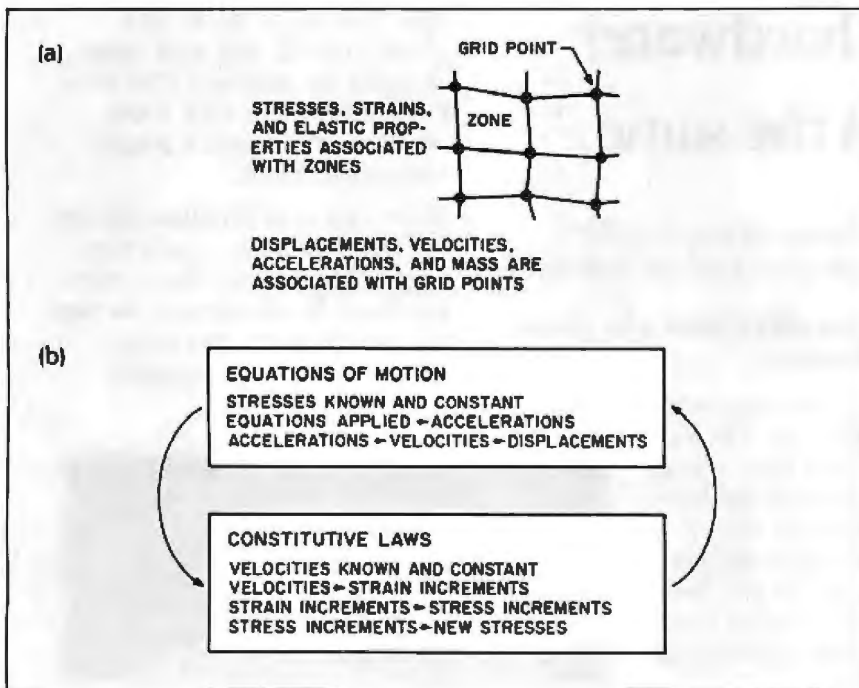

Figure 8: Details of the FD method; (a) shows a portion of a typical FD mesh consisting of arbitrary zones with a grid point at each corner; (b) illustrates the FD calculation sequence.

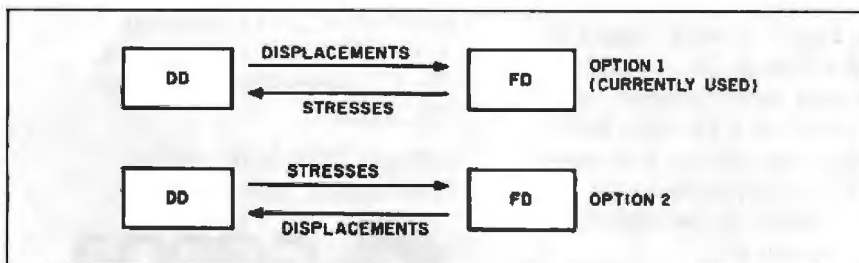

Figure 9: Coupling options for the hybrid DD/FD model.

COUPLING THE MODELS

As shown in figure 5, the hybrid DD/FD model is achieved by linking an FD model of a pillar region between the surfaces of a seam modeled by DD elements. At the contacts between the two regions, you must ensure that the stresses and displacements are continuous, as they are in the physical problem. This continuity requirement provides boundary conditions for both constituent parts of the hybrid model.

Because both the DD and the FD models use iterative methods of solution, it is relatively easy to couple them. You use the results from an iteration of the DD model as boundary conditions for the FD model. Iteration of the FD model then provides boundary conditions for the DD model, and so on. There are two alternatives for the linking procedure, both illustrated in figure 9.

With the first option, the DD model cycles through one or more iterations of the Gauss-Seidel solution procedure yielding new displacement-discontinuity components for each element. These DD components are converted to displacements and applied as boundary conditions to the FD model grid points that are linked to DD elements. The FD calculation procedure executes one or more cycles causing deformation of the mesh and new stresses in each of the

(continued)

THIRD GENERATION PROGRAMMERS FROM GTEK

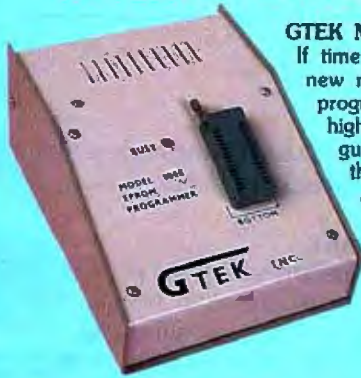

GTEK MODEL 9000 (E)EPROM/MPU PROGRAMMER
If time is money, then let us save some for you. The new model 9000, using its quick pulse algorithms, can program a 2764 in 10 seconds. The 9000 offers higher performance than the competition has even begun to think about. Baud rates to 57,600. Supports thru 512K standard, 8 meg worldwide parts with adapter, Cypress proms, mpu's. NO personality modules. As with our other programmers, RS-232, ASCII data formats, and flexible handshaking make the model 9000 compatible with virtually any computer. Introductory price \$749.

MODEL 7228 (E)EPROM/MPU PROGRAMMER The standard by which other programmers are judged. With thousands in the field, the time proven 7228 has become our most popular programmer. Intelligent algorithms standard. Programs a 2764 in one minute. Supports devices thru 512K, mpu's, eeproms, cmos. NO personality modules. Price \$599



MODEL 7956 GANG (E)EPROM/MPU PROGRAMMER

The 7956 can program eight 2764's in one minute using intelligent algorithms. Standard support thru 512K, eeproms, cmos, mpu's. A must for production environments. Available in stand alone only configuration for \$979 or with RS-232 interface for \$1099

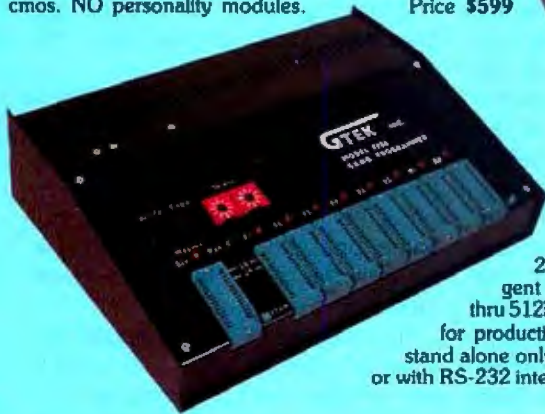

MODEL 7128 (E)EPROM/MPU PROGRAMMER The programmer that won't die. Thousands manufactured since 1982. Supports thru 256K. **PRICE REDUCED** to \$389 including free PGX communications software, a \$95 value.

MODEL 705 Motorola 68705 family programmer. Transfers object code to 28 and 40 pin mpu's. Single key stroke operation. \$299

MODEL 7324 PAL PROGRAMMER The 7324 has a built-in compiler. It supports 20 and 24 pin pals by MMI, NATIONAL, and TI, including the new shared product parts 20S10, 20RS10, 20RS8, 20RS4. It operates stand alone or via RS-232 with PALX communications package. Functionally tests parts after programming and securing. External compilers are supported thru JEDEC and AHS object formats. \$1499

MODEL 7322 Same as 7324 but no stand alone capability. \$1249

UTILITY PACKAGES

PGMX High Speed Communications Package. For IBM PC, AT and compatibles. Bi-directional data rates to a scorching 57600 bps. Provides flexible manipulation of Intel Hex files, both 8 and 16 bit formats, and binary files. Use with model 9000. \$149

PGX Utility Package. For PC DOS, CPM, TRSDOS, ISIS, MSDOS. Use with 9000, 7956, 7228, 7128. \$95

PALX Utility Package. Provides communication, download of Palasm source, JEDEC and AHS object files to models 7324, 7322, 7316 pal programmers. \$95

CROSS ASSEMBLERS and SIMULATORS

You name the cpu, we've got the assembler. Simulators allow target software development and testing on your computer. Versions available for PC DOS, MSDOS, CPM. . Start at \$200

ERASERS—We stock both Ultra Violet

Products and Spectronics for your selection.

MODEL	CHIPS	TIMER	LAMP	PRICE
DE4	8	N	Tube	\$80
PE14T	9	Y	Tube	\$139
C25	25	Y	Grid	\$349
C50	50	Y	Grid	\$599

ACCESSORIES

CABLES—serial \$30, parallel \$30, custom Call For Quote
MODEL 481/482/483 8048 family adapters \$98
MODEL 511/512 8051 family adapter \$174
MODEL 755/756 8755 adapter ... \$135

SPECIAL REQUIREMENTS? Call Us For A Quote On Custom OEM Programmers.

Run CPM Software
on Your IBM
or IBM
Compatible



If you are a CPM user who wants to convert to MSDOS or PC DOS or a PC user who would like access to the thousands of CPM programs in existence, here is the perfect solution to the problem: CPEmulator from GTEK.

CPEmulator is the only field proven emulator which emulates the complete Z-80 instruction set. Terminal attribute emulation is Televideo, Lear Siegler, or the AMSI standard. CPM .COM programs reside under PC DOS and are executable under PC DOS as well as 8086 programs.

Comes complete with COPYCPM, a disk conversion utility which allows transferring data and programs to and from 54 different CPM disk formats. Free CPM utility programs are also included.

Need speed? CPEmulators Speed Kit includes NEC V20 processor. (8080 opcodes only)

CPEmulator Z80 emulator	\$199
CPEmulator 8080 emulator w/V20	\$199
Both versions	\$298

Call GTEK's CPM Hotline 1-601-467-9019

The Printing Solution: Model 8014 Programmable Printer Switch



Finally a way to have as many parallel printers as you need even when you only have one parallel port. With GTEK's programmable parallel switch, you can expand as you require. Perfect for networks.

With the spooling version, you can allocate available memory to fit your requirements, get multiple copies and more.

Both use ordinary IBM type parallel printer cables, expand one port to four, and may be cascaded in Star or Daisy Chain configurations for as many ports as desired. The desired port is selected with a simple escape sequence. For networks, previous selected port is saved on Port Stack and returned to with Return Escape Sequence. Complete with power supply.

Model 8014 Four port programmable switch	PRICE REDUCED \$199
Model 8014-128K spool memory ...	\$339
Model 8014-256K spool memory ...	\$399

GTEK

Development Hardware/Software
P.O. Box 289, Waveland, MS 39576 U.S.A.
601/467-8048; telex 315-814 (GTEK UD), INC.

GTEK, PALASM, CPM, MS-DOS, PC-DOS, ISIS, TRSDOS, & CPEmulator are registered trademarks.

zones. The stresses in the zones adjacent to the DD seam surfaces are converted to the form needed by the DD model and used as new boundary conditions—new P values in analogy to the pressurized-crack program. The DD model then cycles through one or more Gauss-Seidel iterations to start the overall procedure again. With this approach, the DD model provides displacement boundary conditions to the FD model, which in turn provides stress boundary conditions to the DD model.

With the second option, you need a different formulation of the DD model, one in which the displacement-discontinuity components are the known quantities, and the stress conditions at each element are the unknowns. Each iteration of the Gauss-Seidel procedure yields new estimates of each element's stress components, which are applied to the DD seam surfaces. Again, one or more cycles through the FD solution procedure are performed causing deformation of the mesh and new displacements at each of the grid points. The displacements at grid points linked to DD elements are used as boundary conditions for the DD model, and one or more Gauss-Seidel iterations are performed again. With this approach option, the DD model provides stress boundary conditions to the FD model, which in turn provides displacement boundary conditions to the DD model.

We have chosen the first option, with the DD model providing displacement boundary conditions, and the FD model returning stress boundary conditions because it uses the common "seam-element" formulation of the DD model. However, applying displacement boundary conditions to the FD model (as we have formulated it) leads to numerical problems in some instances. It is possible to sub-

tract out the errors by performing correction calculations every several cycles through the FD sequence.

A HYBRID MODEL EXAMPLE

Let's return to the coal-mine-seam example and apply the hybrid DD/FD model to a real problem. We will model the simple two-tunnel, one-pillar geometry of figure 2a, with the pillar represented by an FD mesh. Figure 5 illustrates how the seam surfaces and pillar were subdivided into DD elements and FD zones. There were 72 DD elements placed along the seam surfaces, and the pillar was divided into a 6 by 12 FD grid. Although the problem is symmetric about the vertical centerline of the pillar, the full problem was modeled. Note that the seam elements are extended past the tunnels on each side; enough elements must be provided so that the last element on each side has nearly zero closure (relative movement between the top and bottom of the seam) in the final solution. Standard DD seam elements have been used to represent the unmined portions of the seam outside the tunnels.

Figure 10 shows the results of the DD/FD calculation, a plot of the DD/FD mesh showing the deformed shape of the pillar and seam. The deformations have been enlarged to accentuate the deformed shape. The greatest deformation occurs in the tunnels, where the seam surfaces have undergone significant closure. Note also that the pillar has compressed vertically and, due to the Poisson effect, expanded laterally.

The results shown in figure 10 indicate that the coupled DD/FD model gives detailed information within the pillar, as desired, while automatically incorporating the elastic response of the surrounding rock mass. The model exploits the advantages of

both the DD and FD methods, without the drawbacks of either.

SUMMARY

The stress analysis of the geometries found in underground mining engineering is a relatively narrow application, but the nature of the problem that led us to develop the hybrid computer model is common to other disciplines in the physical sciences. Hybrid boundary-element/finite-element programs are reported in the technical literature of mechanical engineering, rock mechanics, soil mechanics, and groundwater mechanics.

Our technique is unique in that it uses one of the indirect boundary-element methods coupled with an explicit differential method. This approach offers particular advantages in some phases of this problem, particularly the seam-element representation of the DD method.

The coupled DD/FD computer program is relatively small and quick to run, if you restrict problems to a single, planar seam divided into elements of uniform size. One version of the coupled program, written in FORTRAN and incorporating all the features described in this article, fits easily into the 95K bytes of available RAM on a 128K-byte CP/M-86 system. This microcomputer version of the program allows 200 DD elements and 200 FD zones. Problems such as the example above run in under an hour on this system with no 8087 chip. Significantly larger problems run much faster on the newer microcomputers.

The real payoff of the coupled model occurs in problems more complex than our example, specifically two- and three-dimensional problems in which rock failure occurs. Solving two-dimensional, nonlinear problems using FE techniques alone typically

(continued)

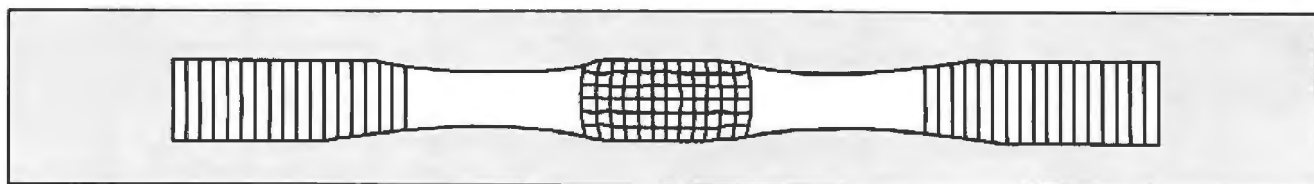

Figure 10: A plot of the results of the hybrid DD/FD model.

A CROSSTALK[®]

Klone FOR \$49⁹⁵

The Closer You Look, the Better We Look!



FEATURING
Foreground/Background Communications

MIRROR is the mirror image of Crosstalk XVI V3.6, the industry standard in data communications software for small business computers. **MIRROR**'s design closely reflects Crosstalk XVI's menus, commands and features. In fact, if you have used Crosstalk XVI before, you will feel right at home with **MIRROR**. The only thing you will not find reflected in **MIRROR** is Crosstalk XVI's \$195.00 price. Because we control the reflection, **MIRROR** costs only \$49.95.

If you are new to data communications, it makes sense to go with the industry standard in data communications software, but why pay the industry standard price. **MIRROR** lets you have the industry standard at 1/4 the price. If you or your company have already standardized on Crosstalk XVI, then consider **MIRROR** for future purchases and upgrades, you'll realize significant savings, without sacrificing on quality, standardization or features.

MIRROR™ WILBOLS

**THE RIGHT DATA COMMUNICATIONS
 CHOICE FOR ANY USER!**



1210 East Park Avenue
 Tallahassee, Florida 32301
 For Information Call
 1-904-878-8568
 TLX 6714280 KLON

\$49.95

Site Licensing Available
 60 Day Money back Guarantee
 NO! Copy Protected

**For New Users,
 MIRROR Provides:**

- Menu/Command Driven
- Complete Crosstalk XVI V3.6 Compatibility
- New User Script File (Enables you to sign-on to your favorite online service in minutes)
- Auto-dial/Auto-answer
- Alphabetized Help-Command Summary
- Money Saving Offers From Online Information Services

**For Experienced Data Communications
 Users, MIRROR Provides:**

- Complete Background Operation (concurrent operation/memory resident)
- Programmable Script/Command Language (Crosstalk XVI V3.6 compatible with extensions)
- Extended Error-checking Protocol Support (XMODEM-single, XMODEM-multi-file, Crosstalk, HAYES and KERMIT)
- Integrated Wordstar-like Text Editor
- Multiple Terminal Emulations (VT-100/52, IBM 3101, Televideo 912C/920/925, TI 940, ADDS Viewpoint, ADM-3A)
- Enhanced Individualized Password Protection

To Order Call Toll-Free

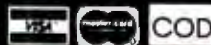

National
1-800-538-8157
 Ext. 848

California
1-800-672-3470
 Ext. 848

\$49.95, plus \$5.00 postage/handling (\$8.00 for COD orders) ea.

Florida residents must add 5% sales tax
 Overseas orders: Add \$18.00 for shipping.

MIRROR is available for the IBM PC/XT/AT and compatibles and requires MS-DOS 3.0 or higher.

MIRROR, KlonWare and SoftKlone are trademarks of SoftKlone Distributing Corporation. Crosstalk XVI and Microstuff are registered trademarks of Microstuff, Inc., WILBOLS is a registered trademark of Hayes Microcomputer Products, Inc., Wordstar is a registered trademark of Micropro International.

DISTRIBUTED IN CANADA BY:
 Saragway Software Distributors
 121 Avenue Road, Suite 202
 Toronto, Ontario, M5R 2G3
 Ph: (416) 923-1500

C & PASCAL PROGRAMMERS

Blaise Computing provides a broad range of programming tools for Pascal and C programmers, with libraries designed for serious software development. You get carefully crafted code that can be easily modified to grow with your changing needs. Our packages are shipped complete with comprehensive manuals, sample programs and source code.

C TOOLS PLUS

\$175.00

NEW! Full spectrum of general-purpose utility functions; windows that can be stacked, removed, and accept user input; interrupt service routines for resident applications; screen handling including EGA 43-line text mode support and direct screen access; string functions; and DOS file handling.

PASCAL TOOLS/TOOLS 2

\$175.00

Expanded string and screen handling; graphics routines; easy creation of program interfaces; memory management; general program control; and DOS file support.

VIEW MANAGER

\$275.00

Complete screen management; paint data entry screens; screens can be managed by your application program; block mode data entry or field-by-field control. Specify C or IBM/MS-Pascal.

ASYNCH MANAGER

\$175.00

Full featured asynchronous communications library providing interrupt driven support for the COM ports; I/O buffers up to 64K; XON/XOFF protocol; baud rates up to 9600; modem control and XMODEM file transfer. Specify C or IBM/MS-Pascal.

Turbo POWER TOOLS PLUS

\$99.95

NEW! Expanded string support; extended screen and window management including EGA support; pop-up menus; memory management; execute any program from within Turbo Pascal; interrupt service routine support allowing you to write memory resident programs; schedulable intervention code.

Turbo ASYNCH PLUS

\$99.95

Complete asynchronous communications library providing interrupt driven support for the COM ports; I/O buffers up to 64K; XON/XOFF protocol; and baud rates up to 9600.

RUNOFF

\$49.95

NEW! Text formatter written especially for programmers; flexible printer control; user-defined variables; index generation; and general macro facility. Crafted in Turbo Pascal.

EXEC

\$95.00

Program chaining executive. Chain one program from another even if the programs are in different languages. Shared data areas can be specified.

ORDER TOLL-FREE 800-227-8087!



BLAISE COMPUTING INC.

2560 Ninth Street, Suite 316 Berkeley, CA 94710 (415) 540-5441

STRESS ANALYSIS

THE GOVERNING EQUATIONS

The governing equations for two-dimensional isotropic plane-strain problems in linear elasticity fall into three groups: equations of motion based on Newton's second law, defini-

tion of the strain components in terms of displacements, and Hooke's law. The following sets of equations adopt the solid-mechanics sign convention with tensile stresses taken as positive.

Equations of motion:

$$\frac{\partial \sigma_{xx}}{\partial x} + \frac{\partial \sigma_{xy}}{\partial y} + \beta_x = m \ddot{u}_x$$

$$\frac{\partial \sigma_{xy}}{\partial x} + \frac{\partial \sigma_{yy}}{\partial y} + \beta_y = m \ddot{u}_y$$

Strain components:

$$e_{xx} = \frac{\partial u_x}{\partial x}$$

$$e_{yy} = \frac{\partial u_y}{\partial y}$$

$$e_{xy} = \frac{1}{2} \left(\frac{\partial u_x}{\partial y} + \frac{\partial u_y}{\partial x} \right)$$

Hooke's law:

$$\sigma_{xx} = 2G \left[e_{xx} + \frac{\nu}{1-2\nu} (e_{xx} + e_{yy}) \right]$$

$$\sigma_{yy} = 2G \left[e_{yy} + \frac{\nu}{1-2\nu} (e_{xx} + e_{yy}) \right]$$

$$\sigma_{xz} = \frac{2G\nu}{1-2\nu} (e_{xx} + e_{yy})$$

$$\sigma_{xy} = 2G e_{xy}$$

Notation:

$\sigma_{xx}, \sigma_{yy}, \sigma_{zz}, \sigma_{xy}$ = stress components

β_x, β_y = body-force components (gravity)

m = mass

u_x, u_y = displacements

e_{xx}, e_{yy}, e_{xy} = strain components

G, ν = elastic constants: shear modulus, Poisson's ratio

\ddot{u}_x, \ddot{u}_y = accelerations

$\frac{\partial}{\partial y}, \frac{\partial}{\partial x}$ = mathematical notation indicating partial derivatives

requires much greater computer resources than problems in which the rock remains elastic, because you need a more extensive mesh, you must follow the excavation sequence closely, and the calculation sequence is more complex. In contrast, our hybrid model solves such two-dimensional problems with only slightly more computer run time than the elastic version. Work is currently under way to expand the model to three dimensions and to include nonlinear material response in the FD region. ■

ACKNOWLEDGMENT

Lee Petersen's research in hybrid computer models is supported by a fellowship

from the United States Bureau of Mines Mineral Institutes Program, Title III, Office of Surface Mining. This program is administered at the University of Minnesota through the Mineral Resources Research Center.

REFERENCES

1. Brady, B. G. H., and E. T. Brown. *Rock Mechanics for Underground Mining*. London: George Allen and Unwin, 1985.
2. Desai, C. S., and J. T. Christian. *Numerical Methods in Geotechnical Engineering*. New York: McGraw-Hill, 1977.
3. Crouch, S. L., and A. M. Starfield. *Boundary Element Methods in Solid Mechanics*. London: George Allen and Unwin, 1983.
4. Carnahan, B., H. A. Luther, and J. O. Wilkes. *Applied Numerical Methods*. New York: Wiley, 1969.



**NEW! FROM
BLAISE
COMPUTING**

Today's programmers need more than yesterday's tools. Requirements such as removable windows and "sidekickable" pop-up utilities are changing the face of program design. You need to filter interrupts so that other resident programs still work. You need the ability to switch between multiple display pages and monitors. Today's technical demands are almost endless, but C TOOLS PLUS gives you what you need.



SOLID LIBRARY SUPPORT

Blaise Computing offers you solid library support that can meet all your demands and more. C TOOLS PLUS embodies the full spectrum of general-purpose utility functions that are critical to today's applications.

Here's just part of the PLUS in C TOOLS PLUS:

- ◆ C TOOLS and C TOOLS 2 compatibility—two packages that receive rave reviews for quality, organization, usability and documentation.
- ◆ FULL SOURCE CODE

Inquiry 43 for End-Users. Inquiry 44 for DEALERS ONLY.

C Tools Plus™

For The Programmer Whose Alphabet Begins & Ends With "C"



- ◆ WINDOWS that are stackable, removable, that support word wrap and that can accept user input.
- ◆ INTERRUPT SERVICE ROUTINE support for truly flexible, robust and polite resident applications.
- ◆ MULTIPLE monitor and display support, including EGA 43-line mode.
- ◆ FAST DIRECT VIDEO ACCESS for efficiency that will not constrain good program design.
- ◆ DOCUMENTATION, TECHNICAL SUPPORT and attention to detail that have distinguished Blaise Computing products over the years.

C TOOLS PLUS supports the Microsoft (and IBM) 3.00 and Lattice 3.00 C compilers and is just \$175.00.

*Also Available Are:
C VIEW MANAGER — A kit for building data entry screens and menus. Begin by designing on-screen what the operator will see; call upon our library functions from your program to display the screens and retrieve the data. Just \$275, including all library source code.*

C ASYNCH MANAGER — provides the crucial core of hardware interrupt support needed to build applications that communicate. It

also includes the "XMODEM" file-transfer protocol and support for Hayes-compatible modems. All source code is included for \$175. C TOOLS & C TOOLS 2—an indispensable combination still available at a low price of \$175, including all source code. See review in PC Tech Journal, 6/85.

BLAISE COMPUTING INC.
2560 Ninth Street, Suite 316 Berkeley, CA 94710 (415) 540-5441
ORDER TOLL-FREE 800-227-8087!

YES, send me the PLUS I need! Enclosed is \$_____ for C TOOLS PLUS. (CA residents add 6 1/2% Sales Tax. All domestic orders add \$10.00 for Federal Express shipping.)

Name: _____ Phone: (____) _____

Shipping Address: _____ State: _____ Zip: _____

City: _____ Exp. Date: _____

VISA or MC #: _____



no other printer is th

Add up everything that's up front:

No other letter-quality printer is this easy, this fast and this good—all three at once! If you thought that was impossible, you were right...up until Star created the new NB-15!

It makes everything so easy for you. Because everything's where you want it. Right at your fingertips. Up front. On the front panel.

And we mean everything: You can select from 3 font styles, 4 print pitches, 2 print modes, and 8 form lengths—19 functions in all. And you can choose additional font cartridges, too.

There's also an exclusive software override. Full software compatibility.

And IBM®-PC compatibility, of course.

Both tractor and single sheet feeds are standard. And there are optional automatic sheet feeders, single and dual bin. With button-control paper alignment right up front, too.



is up front with you.

Best of all, the NB-15™ gives you all this with 24-wire quality printing. All at top speeds of 300 cps draft and a full 100 cps with true letter quality.

Plus a 16K buffer. That's all the memory you could hope for.

The all-new NB-15 business printer. The newest and brightest Star has just come out at a dealer near you. And it's already out in front!

***In front with
quality up front.***

***The new
Star NB-15***



star
micronics



NOTHING DOWN.

Even the best of personal computers can have a bad day. Blackouts happen. Usually at the worst possible time.

But power interruptions don't need to be business interruptions. And lost power shouldn't result in lost data. Not with the POWERMAKER® Micro UPS from Topaz.

Designed specifically for hard disc and critical-use business systems, Powermaker Micro UPS ensures a continuous supply of smooth sine wave power even during

a total blackout.

And there's more. Powermaker Micro UPS also removes spikes and other error-producing transients from incoming power, protecting your PC's sensitive circuitry.

So, if your PC needs a little help once in a while, give it Powermaker Micro UPS protection. For nothing down. Call us today at (619) 279-0831, or contact your local Square D distributor.

TOPAZ®

A Subsidiary of Square D Company

A MATERIAL SELECTION PROGRAM

BY BROTHER TOM SAWYER AND MICHAEL PECHT

You can weight options and do "what if" searches

MSP IS A microcomputer-based, public domain, material selection program that aids an engineer in designing a product by providing an easy method of finding the proper materials for its construction. MSP searches a database and produces a ranked list of materials based on weighted search criteria. [Editors note: MSP.PAS, SRCHFOR.PAS, and WTRANK.PAS are available in Turbo Pascal source code in a variety of formats. See pages 459-461 for full details.]

A DIFFICULT DECISION

The choice of materials to be used in the construction of an engineering product generally depends on four broad material categories: function, appearance, manufacture, and cost. Each of these can be divided into sub-categories, or attributes. The function of a product places certain constraints on the materials that compose it. They must withstand its stresses, deformations, environmental conditions, and possible misuses. In addition, reliability and safety conditions must be satisfied. The appearance or quality of the product relates not only to

its polishability, paintability, and texture, but also to its corrosion resistance, fading properties, and smell. Manufacturing methods determine how the product material will be formed into the desired shape (e.g., molding, extrusion, machining) while meeting the tolerances imposed by the designer. Cost includes the price of the raw material, the cost of forming the material into the product, and other costs, such as welding or hardening, which are directly related to the material's characteristics.

Material selection is usually a difficult decision task for three primary reasons. First, you must examine a large amount of data. For metals alone, more than 100,000 materials with over 80 attributes (fundamental properties) can be identified. The addition of plastics, ceramics, and composites increases this list considerably. Second, data originates from a diversity of disciplines, including electrical, chemical, mechanical, and civil engineering, as well as the human factors and economics areas. A complete spectrum of attribute data for a particular material rarely resides in a

single reference book, and some data may not exist at all. Third, every material possesses a combination of often conflicting attributes. For example, a high-strength material is typically more difficult to machine and more costly than one of lesser strength. Finding a material that satisfies a variety of such requirements is a very time-consuming task.

Often an engineer will choose a proven material because there isn't time to consider alternatives. The computer can help to overcome this difficulty because it can search a data-

(continued)

Brother Tom Sawyer, CSC, is a Holy Cross Brother who teaches computer programming at Bishop McNamara High School (6800 Marlboro Pike, Forestville, MD 20747). He has a B.S. in chemistry from the University of Notre Dame and an M.A. in chemistry education from the University of Maryland.

Michael Pecht is an assistant professor in the Mechanical Engineering Department (University of Maryland, College Park, MD 20742). He has an M.S. in electrical and computer engineering and a Ph.D. in engineering mechanics from the University of Wisconsin at Madison.

base and compare properties more quickly than we can. This is especially true if the list of materials is large or if you want a material that meets a number of criteria at the same time (e.g., hardness, weldability, tensile strength, machinability, and availability).

THE PROGRAMMING MODEL

MSP looks through a data table for materials that meet certain criteria. First it looks for materials that are within a desired range of values. For example, if the material must have good machinability, all of the "good, very good, and best" materials are selected from the list. For numerical data, typically only the one or two most significant digits are examined to select a group of likely candidates. You then examine that group of materials for other desired properties (in any order) and generate a new list. This process continues until a few materials emerge. Finally, you can establish varying degrees of importance for the desired properties. For example, if cost is critical, you should give it more weight in the selection process than other properties.

MSP has the following characteristics:

- You can search for discrete values or values in a given range.
- You can assign a relative importance to each desired attribute.
- It handles descriptive as well as numerical data.
- Selected materials are ranked ac-

ording to the search criteria.

- It works with multiple, dissimilar databases.
- It does not require the use of special languages or codes.
- It records the search criteria you impose.
- It runs on a microcomputer with a single floppy disk.

MSP was developed jointly by a programmer and an engineer. Both Turbo and UCSD versions of Pascal met our requirements, but we finally chose Turbo because it compiles into native code and thus requires no system files in order to run.

The most immediate programming problem encountered was the variety of data types used for engineering materials. There are numerical types like strength and hardness, descriptive types like weldability and machinability, and discrete types such as whether the material class is aluminum, steel, or cobalt. Pascal's RECORD type allows you to put these into a single structure but requires that you declare the structure beforehand. The use of a strongly typed language like Pascal led us to store the data descriptors and categories as strings of characters to serve only as menu labels. The actual value of a given descriptor comes from its position in the qualifier list; that is, data is stored apart from the descriptors as a scalar, or ordinal, type.

For example, assume that a material has a hardness of 142 on the Brinell scale and you want to put that data

in its data record. The Hardness menu categories are character strings that are displayed as in table 1. You enter the letter C, which is then translated into a scalar matching that letter's position in the menu. The program then places the scalar into the material's data record. During a search, you select all materials with a hardness in the range 120 through 179 by pressing the letter C. The actual value 142 is not in the database because the program "sees" only scalar values that correspond to the string descriptors in the menu.

The decision to reduce numerical data to ranges of values is consistent with our intent to reduce the number of acceptable materials to a manageable size. It is a trade-off that produces some desirable results. The first is a compact database. An array of 32 scalars (one for each attribute), each able to differentiate 16 categories, occupies only 32 bytes of storage. Compact data files mean faster search times, especially when accessing a floppy disk drive. Second, you can create any type of data category, providing a truly customized database. Third, data entry and searching are accomplished by entering single letters. You don't need to learn any special codes or procedural languages. The loss of numerical values and thus the inability of the program to calculate derived categories was outweighed by the advantages of compact data, fast searching, and ease of use.

DATA STRUCTURES

Attributes and Qualifiers. Attributes are the properties such as hardness, tensile strength, cost, and machinability that differentiate materials. Qualifiers are the subdivisions of a particular attribute. For example, you can subdivide the cost attribute into the qualifiers very low, low, average, high, and very high. A qualifier for hardness could be 120 through 179 or above 600.

The descriptors for each attribute and its corresponding qualifiers are stored in a record that has the structure shown in listing 1. The numbers of attributes [0..31] and qualifiers

(continued)

Table 1: Typical menus showing the different types of data that can be entered into MSP. Column a shows the Hardness menu, column b the Machinability menu, and column c the Metal's Class menu.

(a) Hardness (Brinell) (numerical continuum)	(b) Machinability (descriptive continuum)	(c) Metal's Class (discrete values)
A: 0 - 59	A: poor	A: alloy
B: 60 - 119	B: fair	B: aluminum
C: 120 - 179	C: good	C: carbon
D: 180 - 239	D: very good	D: cast iron
E: 240 - 299	E: best	E: cobalt
F: 300 - 359		F: copper
G: 360 - 419		G: nickel
H: 420 - 479		H: stainless
I: 480 - 539		I: misc.
J: 540 - 600		



The one videodisc player that won't box you in.

The Sony LDP-2000. The one and only videodisc player with the total flexibility you've been looking for. All other videodisc players limit your ability to expand. What you see is what you get. But the Sony LDP-2000 is amazingly expandable.

The LDP-2000 is the foundation of the Sony Intelligent Video™ System. It enables you to choose from five configurations to fit your application. And when your needs change, simply add the boards you need internally. The footprint always stays the same.

The LDP-2000 will work with *any* computer. It has two external interfaces: an RS-232C and an optional IEEE-488 parallel interface for high-speed digital data transmission. It can also control up to 14 players through one communication bus.

You can take the LDP-2000 anywhere with confidence because of its Automatic Optical Block

Lock—turn off the power and the optical block locks, eliminating potential damage in shipment.

Then there's the Still Frame Audio capability for over 15 hours of compressed digital audio per videodisc side. The LDP-2000 also decodes up to 221 megabytes of digital data from the videodisc, making it a data disk and videodisc in one.

And the LDP-2000's access speed is really impressive: under 1.5 seconds from frame 1 to frame 54,000.

Of course, the LDP-2000 is an integral part of the Sony View System, the only totally integrated intelligent video system.

But if all you need now is a videodisc player, remember Sony's is the only one that won't box you in.

For more information or to arrange a demonstration, write to: Sony Information Center, Dept. A, P.O. Box 6185, Union, N.J. 07083.

SONY
VIDEO COMMUNICATIONS

[0..10] were selected as reasonable limits. The qualifier range could be [0..15] without requiring additional memory, but we didn't see the need for that many categories. The string lengths of 20 and 10 were chosen for the attribute and qualifier names, respectively, because the lengths seem reasonable and they fit evenly on an 80-column screen or printer.

Each database has a file that may contain up to 32 attribute records that form its menus. Record 0 is used to store the file's name and the actual number of attributes it uses. The `atnum` field of record 0 is used as the upper limit for some of the program's FOR..DO loops. A zero in that field indicates that the menus have not been created. The `qlnum` field of each attribute contains the number of

menu items, or qualifiers, for that item. A zero indicates no data. The array of attribute records occupies 4K bytes of memory.

Data Records. The data for a particular material resides in a RECORD that contains a character index (`fid`), a record number (`inum`) to locate the item in the file, and the name of the material (`iname`). The character index is included to allow the program to work with items from different databases simultaneously.

The record also contains an array of scalars. Each index corresponds to an attribute of the material, and the scalar at that index is the qualifier's location in the menu. If a material has a hardness in the range 120 through 179, then the fifth array element, `idata[5]`, the one that corresponds to

hardness, will contain the value D2, the third qualifier in the menu. The value NUL represents no data, and D0 through D9 correspond to menu positions 1 through 10, respectively. The declarations relating to data items are shown in listing 2.

The scalar identifiers (NUL, D0, D1, etc.) can be expressed as the subrange [0..10] because scalars are represented internally as integers. Using different identifiers helps in range and type checking. Record 0 contains the database name and the total number of records in the data file. The program stores data records in an array that requires 5.5K bytes for each 100 items. `Rankitemrec` is used by the program's search option. It is a slightly larger array (5.6K bytes per 100 items) because of the additional field (`rank`) that is the cumulative rank of the item.

Listing 1: The structure of the record containing the descriptors and corresponding qualifiers for each attribute.

```
attrrec = RECORD           {an attribute's record}
  atnum : 0..31;           {attribute's number}
  atname: STRING[20];     {name of the particular attribute}
  qlnum : 0..10;          {index of the last qualifier}
  quals : ARRAY[0..10] of STRING[10] {label for each qualifier}
END;
```

Listing 2: The declarations for the various data items.

```
TYPE
  attrdata = (NUL,D0,D1,D2,D3,D4,D5,D6,D7,D8,D9);
             {scalar marks position of a qualifier in a given menu}

  itemrec = RECORD        {record for a particular data item}
    fid : CHAR;           {database identifier}
    inum : INTEGER;       {the record number of the item}
    iname : STRING[20];   {name of the item}
    idata : ARRAY[0..30] of attrdata
  END;

  rankitemrec = RECORD   {used in the ranking segment}
    rank : INTEGER;
    irec : itemrec
  END;
```

Listing 3: The declaration for the FINAMES.DTA file's records.

```
Finamrec = RECORD
  id : CHAR;              {letter identifier for the database}
  rtnam : STRING[6];     {the rootname of the database}
  name : STRING[20]      {database name, as seen by you}
END;
```

DISK FILES

Each time you create a database, MSP constructs the rootname, a string of the first six (or fewer) nonspace characters of the filename. (The program requires nonspace characters since Turbo Pascal removes spaces from filenames.) You use the rootname to check for duplicate files and to create names for the attribute and item files associated with a given database. The attribute file is given the name `rootname.AT.DTA`, and the item file is called `rootname.IM.DTA`. After the program verifies that the database's rootname is unique, it creates the attribute and item files and initializes each with an empty record. The rootnames and actual names you see are stored in a file called `FINAMES.DTA`. The declaration for this file's records is shown in listing 3.

The character field `id` serves as the menu option for file selection and as the identifier for items in the database. When you select an option that requires opening files, the program reads `FINAMES.DTA` and creates a menu using the character ID with the actual filename listed next to it. After you select a letter from the menu, the program passes the rootname to a procedure that opens the appropriate files. The procedure also checks the status of the database before allow-

(continued)

Push Back
The Envelope:
**10/6
& 12.5 MHz**
AT Compatibility

IBM obviously positioned the AT as the hub of the microcomputer network. ACS has included what IBM left out.

SPEED The ET-286 nearly doubles the clock speed of the AT at 10 MHz and we are already 12.5 MHz capable. With access to 4 Megabytes of on-board memory via a 5MHz DMA bus, the ET-286 bypasses additional wait states required to maintain compatibility with expansion bus memory. With memory intensive network software like Unix and Xenix, this becomes critical. Naturally, the ET-286 toggles from HyperSpeed at 10MHz to 100% 6MHz compatibility for those applications that demand it.

COMMUNICATIONS The ET-286 plus is designed with communications in mind. There are three on-board serial ports that are configurable as either RS-422 or RS-232 depending on your application. 2 parallel ports further extend your communications ability. And there are still 8 expansion slots for additional I/O.

AN ACCESSIBLE SOURCE Part of the success of the ACS-1000 and our other products is the availability of our people. We provide the support that OEM's need in order to win major contracts — engineering support, competitive pricing, even specialized packaging. Service is the key issue in the information marketplace and we provide the kind of service and reliability that you can only find in an American made product.

ACS MS-DOS 3.2 We want to help you compete. That's why we have licensed MS-DOS 3.2 and GW Basic 3.2 and made them available in OEM packages at OEM prices.

Even with all these features, the ET-286 plus is available in OEM quantities for under \$1,000. For more information, call or write:

ACS International, Inc.
2105 Luna Rd., Suite 330
Carrollton, Texas 75006

214-247-5151
TELEX: 709748 ACS UD

ACS-1000
IBM XT Compatible

ET-286 Plus
IBM AT Compatible

ACS-1000

- 8 Or 4.77 MHz
- Up to 1 Meg Memory
- 2 Serial Ports
- 1 Parallel Port
- On Board Disk Controller
- On-Board Clock/Calendar

ET-286 plus

- 10/6 & 12.5MHz
- Up to 4 Meg Memory
- 3 Serial Ports
- 2 Parallel Ports
- 8 Expansion Slots
- 5 MHz DMA
- On-Board Clock/Calendar

NOW AVAILABLE:

- Optional 10 MHz Co-processor
- ACS MS-DOS 3.2
- GW Basic 3.2

A HERITAGE OF EXCELLENCE In any marketplace one product stands out as the pinnacle of performance and value. In the PC/XT marketplace, that product is the ACS-1000: 4.77 or 8 MHz operation, 1 Megabyte memory, built in communications, built in floppy disk controllers, even a SASI interface—all packaged on a single board and priced competitively with the merely compatible.

Building on the heritage of the ACS-1000, the ET-286 plus brings the same standards of excellence to the AT marketplace.

ACS

Inquiry 411

IBM, UNIX and XENIX are trademarks of IBM, AT&T and Microsoft respectively

ing its files to be used. For example, if you want to search for a material, the program will check to make sure that the attribute file contains menus and that the item file contains data. This method of selecting a database (file) is consistent with the user interface in the rest of the program, and it avoids prompts such as "type in the filename."

After each selection, the record Trackrec is created and stored in the file TEMPFILE.DTA. The contents of this file are output as a heading for each ranked list so you see not only a list of materials but also the criteria that were used to produce that list. You could use TEMPFILE.DTA to return to previous ranked lists, but this is not a part of MSP's present version.

The file is active only during the selection process. It is erased when you exit that section of the program. The declaration for Trackrec is shown in listing 4.

MSP's disk and memory requirements are minimal. Three databases of 1000 items each and the program will fit on a 360K-byte floppy disk with some room to spare. The program is 28K bytes long plus a 10K-byte library segment added by the Turbo compiler to produce a .COM file. Program data storage is a constant 5K bytes plus about 6K bytes for each 100 materials. You can control file buffer memory if you open only one file at a time and close it after you put the data into an array. TEMPFILE.DTA is, however, kept open during the selection segment. In Turbo Pascal a declared, unopened file requires only 48 bytes of memory. Table 2 contains a summary of MSP's file types and their sizes.

Listing 4: The declaration for Trackrec.

```
Trackrec = RECORD
  nofitems : INTEGER; {number of items found in search}
  atnum : attrnum; {number of the attribute selected}
  atrbute : attrdata; {scalar value of attr. qualifier}
  selection : CHAR; {code for selection range <=,+,>=}
  atname : attrib; {name of the attribute selected}
  qualname : quallab {name of the qualifier selected}
END;
```

Table 2: Summary of file types used in MSP and the disk space each requires.

Diskfile Name	Program Identifier	Type	Size
FINAMES.DTA	Nfile	FILE OF finamrec	29 bytes/record
rootnameAT.DTA	Afile	FILE OF attrrec	4K bytes
rootnameIM.DTA	Ifile	FILE OF itemrec	6K /100 records
TEMPFILE.DTA	Tfile	FILE OF trackrec	32 bytes/record

PROGRAM OPERATION

The main menu for MSP (see photo 1) shows the five operations it performs. The "remove a data base" option deletes the attribute and item files and removes the database name from FINAMES.DTA. You must enter the word "Yes" before the option is carried out in order to prevent accidental loss of a database. The "system overview" option defines the terms attribute, qualifier, pivot, and relative importance as they are used in the program. MSP comes with a working database of 288 metals. It is a good idea to use the program with the accompanying data before trying to build a database of your own.

Create a new data base. This option allows you to build a customized database shell; that is, you can create all of the menus that drive the program. You need to plan ahead in order to get the most out of the database you are creating. You must decide on the best way to arrange the materials' attributes, and you must look through the data to determine the range of possible values the program might encounter.

We have identified in table 1 three types of data descriptors that you

(continued)

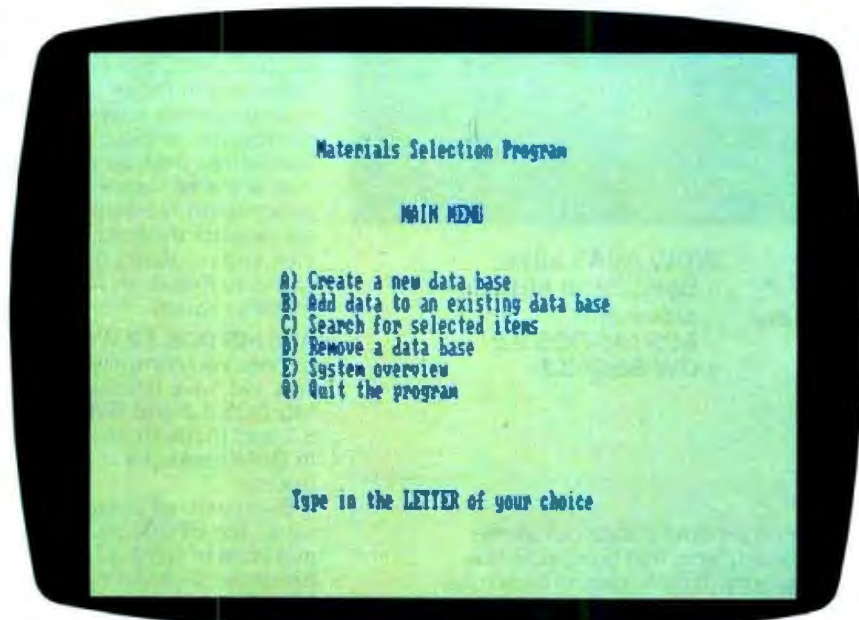

Photo 1: MSP's main menu. The choices are written to reflect the user's point of view and do not use words like "files" and "records."



C FEVER *catch it!*

It's becoming an epidemic... everyone is switching to C! First there were a few hackers, then came the college students, next the major software houses, and now the rest of the programming world. Programmers everywhere are infected with the desire for SPEED, POWER, and PORTABILITY.

It's time to face the inevitable. You're going to catch the fever too! When you do, give us a call. We've got the best cure—an illustrated guide to the C language, plus a complete program development system. Everything you need to master the C programming language... all at a price that's less than the cost of a book!

But don't let this price fool you. Our system is powerful; it compiles twice as fast as the others, is completely standard, and it's very easy to use. Most C compilers are designed for wizards. We have designed ours for you!

- What do you get for a mere \$39.95?
- A 450 page book filled with sample programs, plus...
- A fast, standard, full featured C compiler that supports all data types and the latest features like bit fields, enumerations, structure assignment, and passing/returning structures.
- A linker that loads separately compiled files, searches libraries, and builds an executable program.
- An extensive library of more than 75 functions (including the standard C functions and the computer specific functions that provide direct access to the operating system and BIOS).
- A debugger and assembler to help you write your programs for minimal space or maximum speed.

Works on all MSDOS/PCDOS and all CP/M 286 COMPUTERS! (Not Copy Protected!)

The Powerful Mke
C COMPILER
Harnesses the Power of the C Language with this full featured Compiler
JDC

Incredible Value
\$39.95
AT ONLY With 30 Day
Money-Back Guarantee

Operators are standing by... Please use this Number for ORDERS ONLY!

CALL TOLL FREE FOR RUSH ORDER DELIVERY!
1-800-523-9520

IN TEXAS, PLEASE CALL TOLL FREE 1-800-822-4070

For Technical Support Please call 1-214-783-6001

MIX Software, Inc. / 2116 E. Arapaho / Suite 363 / Richardson, Texas 75081

Or contact our Worldwide Distributors direct in:

Canada: Saragay Software 1-416-923-1500 Switzerland: DMB Communication CH-1-825-53-29
Australia: Techflow 047-586924 France: Info/Tech 1-43-44-06-48

Split Screen Text Editor

an Incredible Value **\$29.95**
AT ONLY (Not Copy Protected! Works on all MSDOS/PCDOS and CP/M 286 Computers)

Our high powered editor is great for editing high level languages. It works just like Micropro's Wordstar, but macros allow you to create your own custom editor, and the split-screen feature lets you edit two files at the same time.



The MSDOS/PCDOS version is loaded with special features:

- Execute any DOS command or RUN other programs from the editor.
- Quickly edit files as large as 300,000 characters
- Compile MIX C programs directly from memory. The editor automatically positions the cursor to the first error in your program.

ASM UTILITY
an Incredible Value **\$10**
AT ONLY

Call assembly language routines from your C programs. The ASM utility works with Microsoft's MASM or M80 assembler. Macros make it easy! Works just as if you were calling a C function, and you can even call C functions from assembly language. Lots of useful assembly language functions are included as examples.

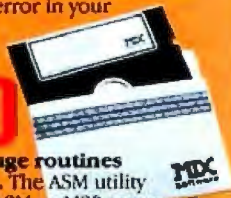

RUSH REPLY ORDER FORM!

SPECIAL OFFER!

Buy both for an even greater value!

SAVE \$14.95 Off Our Regular List Price!

Limited Time Only **\$54.95**
C Compiler & Text Editor

Please check method of payment:
 Check Money Order MasterCard/VISA
Your Card #: _____

Expires: _____

Shipping Charges: (No charge for ASM Utility)

In the U.S.A.: Add \$5.00 per Order.

In CANADA: Add \$10.00 per Order.

OVERSEAS: Add \$10.00 per Text Editor. Add \$20.00 per C Compiler. Add \$30.00 for combined C Compiler and Text Editor.

Operating System: (Check one)

- CP/M 286 MSDOS/PCDOS

Specify Your Computer Name: _____

Specify Disk Format: _____

NAME: _____

Telephone A/C (_____) _____

Street: _____

City: _____

State: _____

Country: _____ ZIP: _____

MIX software 2116 East Arapaho Suite 363 Richardson, Texas, 75081

Ask about our Volume Discounts! Call 1-214-783-6001

Description	Quantity	PRICE	Total Order
Split-Screen Text Editor	_____	\$29.95	\$ _____
C Compiler	_____	\$39.95	\$ _____
C and Text Editor (Special)	_____	\$54.95	\$ _____
ASM Utility	_____	\$10.00	\$ _____
Texas Residents Add 6.125% Sales TAX		\$ _____	\$ _____
Shipping Charges (See at Right)		\$ _____	\$ _____
TOTAL OF YOUR ORDER:		\$ _____	\$ _____

might encounter in a metals database: numerical continuum, descriptive continuum, and discrete values. You can list data that lies on a continuum in either increasing or decreasing order since the search function has the option of going either way. Note that the program "sees" only character strings. You can subdivide the data range in any way you wish since MSP gives no numerical significance to qualifiers. For example, assume that the tensile strengths of the materials to be put in the database are in the range 0 to 300 KSI (kilograms per square inch), but the ones of most interest have values between 90 and 200. Rather than divide the attribute into 10 equal qualifiers, each with a range of 30 KSI, you could use an arrangement like the one shown in table 3 to focus on the "interesting" materials.

You have ample opportunity to edit the qualifier string inputs. However, once you have saved them to the disk, you cannot edit them further because the program stores the data values for each material as a position in a given menu. If you altered the menu, the data might no longer fit the descriptor. When you complete this database-creation section of the program, you have a customized database shell. The attribute and qualifier descriptors

Table 3: Sample menu showing how an attribute can be subdivided into unequal ranges in order to focus on materials that are of interest to the user.

Tensile Strength KSI	
A:	below 85
B:	85 - 99
C:	100 - 114
D:	115 - 129
E:	130 - 159
F:	160 - 174
G:	175 - 189
H:	190 - 204
I:	205 - 249
J:	250 +

now become the menus that the next two parts of the program will use.

Add data to an existing data base. The task of data entry, or building the database, is now simply entering data from a table. The only string input for an item is its name. Once you type this in and verify it, you will see the menus created earlier, and you simply press the letter of the qualifier that best suits the item. The following example shows how the data-input section of the program operates. The descriptors used to create the shell are shown as menus, one for each attribute. The Machinability menu is shown in table 1. If you press the letter C on this menu, the program

assigns the scalar value D2 to the eighth element in the attribute array (itemrec.idata[8]), the one that corresponds to machinability. If there is no data for a particular attribute, you press the letter X to assign the scalar NUL to the array element. The menu, letter choice process continues until you have entered all the attributes. You are then shown the list of attributes with the qualifier descriptors that were selected for the material, and you may change any or all of them using single-letter input. MSP gives a null response to choices that are outside the legal range. A null response means that rather than giving you irritating beeps or error messages, invalid input is simply ignored. In the few instances that require a warning or explanation, it is given with a minimum of fanfare.

The default mode for Turbo Pascal keyboard input is buffered, which means that whatever you type is not processed until the Return character is received. Since most of MSP uses only single-letter input, having to press the Enter key after each letter would interfere with the flow of the program. Therefore, we used the `{SB-}` compiler option to suppress input buffering. The keyboard is ignored until the program encounters a READ statement. However, the buf-

(continued)

WHAT'S NEXT?

A new version of MSP is in the works. It includes some new data types and some additional procedures. It will look the same to the user but will allow more flexibility in representing data.

One feature the new MSP will have is multiple qualifiers for a single attribute. This will be implemented as an array of sets rather than scalars. By using the IN operator, or intersection, the presence of one or more qualifiers can be tested. However, unlike scalars, sets are not ordered. To maintain the ability to test ranges of values, it will be necessary to manipulate the bits in the set's memory location. Turbo Pascal allows direct memory access of variables as well as the inclusion of

assembly language code in the Pascal source code. Thus, a comparison set for a range of values can be formed by setting the appropriate bits in memory, and an ordinal value can be produced by testing the location of a bit within the set.

Another new feature will be the ability to record and manipulate numerical data. You will be able to type in a numerical value for a qualifier, and the program will store that value in a file as well as record its location in the present relative scale. This will require number-to-string conversion as well as an additional reference pointer from the MSP item file to the numerical-value file. The presence of numerical data will permit you to calculate other

values not in the database. We also plan to have the program adjust the qualifier ranges as more numerical data is added. The program will look at the range of values, divide it into categories, and store these in the item file as members of a set. You will be able to override this self-adjusting-database feature if unequal ranges of values are desired.

The new version of MSP will address the problem of unifying numerical and descriptive categories, both of which are common and important in engineering specifications for material selection. The range-search feature of the present MSP will remain; however, a numerical element will be integrated into it.

COMPUTER WAREHOUSE

CALL TOLL FREE 1-800-528-1054

FREE FEDERAL EXPRESS
Air Express Shipping
See Details Below

HARDWARE

BEST PRICES

NOW

No Charge for Bank Cards

PRINTERS

Anadex All Models	Call
Brother All Models	Call
Cannon Laser Printer	\$1949
Citizen MSP-10	\$250
MSP-15	\$349
MSP-20	\$315
MSP-25	\$485
Premier 35	\$409
Datasouth All Printer Models	Call
Diablo D-25	\$489
635	\$1035
Other Printer Models	Call

EPSON

All Printer Models Call

Fujitsu	Call
Juki	
6100	\$349
6300	\$669
NEC	
3510, 3550, 3515, 3530	\$729
8810, 8830, 8850	\$1039
P5, P6, P7	Call
EII 380	\$379
EII 370	\$379

OKIDATA

All Printer Models Call

Panasonic 1080	\$199
1091	\$239
1092	\$309
1592	\$425
KXP3151	\$399

STAR MICRONICS

All Printer Models Call

Toshiba 321 Parallel & Serial	\$449
341	\$769
P351 Parallel & Serial	\$969

MONITORS

Amdex All Monitors	Call
NEC All Monitors	Call
Princeton Graphics	Call
Zenith All Models	Call

VIDEO TERMINALS

Qume QVT Green 101	\$299
QVT Amber 101	\$314
Wyse 30	\$299
50	\$419
75	\$559
Wyse 85	\$439
Wyse 350	\$859
Zenith Z-22	\$455
Z-20A	\$859
Z-49	Call

MODEMS

AT&T	
4000 External	\$309
Anchor Automation	
Anchor Express	\$235

HAYES

All Modems Call

Prometheus All Models	Call
US Robotics Courier 2400	\$379
Password 1200	\$180
Microlink 2400	\$379

DISK DRIVES

Alpha Omega Turbo 10	\$379
Turbo 20	\$439
Turbo 30	\$569
Iomega Bernoulli 10 meg	\$1269
Bernoulli 20 meg	\$1789
Bernoulli 40 meg	\$2549
Paradise Macintosh Hard Disk	\$609
Seagate 20 meg w/Western I/O	\$409

COMPUTERS

PANASONIC	
St. Partner Dual Drive	\$1395
Exec. Partner Dual Drive	\$2129
TOSHIBA	
T-1100	\$1399
WYSE	
Wyse pc 1100-1	\$979
Wyse pc 1100-20	\$1539

Zenith Computer Products
SAVE up to 50%
All Models Call

DISKETTES

Maxell MD-2 Plastic Box (Qty 100)	\$125
Sony MD/2 (Qty 100)	\$119

BOARDS

AST Advantage	\$329
Rampage PC	\$295
Six Pack Plus	\$159
Hercules Color Card	\$149
Graphic Card	\$305
Intel	
Above Boards	Call
Maynard Hardcard	\$549
Paradise Modular Graphic 06-1	\$239
Five Pak	\$115
Quadram	
Gold & Silver Boards	Call
Quadlink	\$329
Quad EGA+	\$385
Two Mar Graphics Master	\$269
Captain No Memory	\$159

PLOTTERS

Epson Hi-80	Call
-------------	------

KEYBOARDS

Keytronics 5151	\$159
-----------------	-------

COPIERS

Canon «PC»

Canon PC-10	\$509
Canon PC-14	\$649
Canon PC-20	\$719
Canon PC-25	\$939

XEROX

1020 w/Toner	\$1099
--------------	--------

SANYO

SFT 600	Call
---------	------



SOFTWARE

IBM PC and 100% Compatibles

TRAINING

Flight Simulator	\$28
PC Logo	\$75
Typing Instructor	\$28
Typing Tutor III	\$28

LANGUAGES

C Compiler (Microsoft)	\$219
Fortran Compiler (Microsoft)	\$195
Lattice C Compiler	\$242
Macro Assembler (Microsoft)	\$84
Pascal Compiler (Microsoft)	\$166
Quick Basic	\$55
Run C Interpreter	\$82
Turbo Pascal 3.0	\$38
Turbo Database Tool Box	\$30

PROJECT MANAGEMENT

Harvard Total Project Manager	\$262
Microsoft Project	\$219
Super Project Plus	Call
Timeline 2.0	\$219

COMMUNICATIONS

CompuServe Starter Kit	Best Price
Crosstalk XVI	\$92
MS Access 1.01	\$139
PFS Access	\$76
Remote	\$92
Smartcom II	\$83

INTEGRATIVE SOFTWARE

Enable 1.1	Call
Framework II	Call
Smart Software System	Best Price
Symphony	Call

GRAPHICS

Chartmaster	\$205
Diagram Master	\$189
Energraphics	\$189
Energraphics w/Plotter Option	\$205
In-A-Vision	\$249

Microsoft Buss Mouse	\$107
w/PC Paintbrush 3.0	
Microsoft Chart	\$164
Microsoft Serial Mouse	\$119
Newroom	\$32
PC Draw	\$199
PC Draw Light Pen	\$102
PC Mouse w/Dr. Halo II	\$104
PC Paint w/Mouse	\$115
PFS Graph	\$76
Printmaster	\$30
Sigmastar	\$134
Turbo Graphix Tool Box	\$30

WORD PROCESSORS

Leading Edge Word Processor	\$48
Leading Edge W/P w/Spell & Mail	\$82
Lightning	\$55
Microsoft Word 2.01	\$219
Multimate 3.3	\$203
PFS: Write w/Spell Checker	\$76
Wordstar w/Tutor	\$178
Wordstar Pro Pack	\$233

Word Perfect (Ver.4.1) \$196
Wordstar 2000 2.0 \$233
Wordstar 2000 + 2.0 \$278

UTILITIES

Copy II PC	\$19
1 DIR	\$47
Fastback	\$87
Norton Utilities 3.1	\$48
Printworks	\$36
Sidclick	\$30
Sidclick (Unprotected)	\$47
Sidclick - Supedkey (Bundle)	\$85
Sideways 3.1	\$34
Superkey	\$39

SPREADSHEETS

Lobus 1-2-3	Call
Multiplan	\$168
Spreadsheet Auditor 2.0	\$82
VP Planner	\$49

Supercalc 3(Ver.2.1) Call

MONEY MANAGEMENT

Dollars & Sense w/Forecast	\$94
Tobias Managing Your Money	Call

DATA BASE MANAGEMENT

Clipper	\$339
Cornerstone	\$67
dBase II	Call
dBase III Plus	Call
Extended Report Writer	\$74
KnowledgeMan II	\$279
KnowledgeMan Upgrade Kit	\$145
Nutshell 2.0	\$59
PFS: File	\$76
PFS: Report	\$67
Quickcode	\$138
QuickReport	\$138
Reflex	Call
Think Tank	\$92

R:Base 5000 \$319

Many other titles available.

We do not guarantee computer compatibility.

Inquiry 89 for MS DOS Products. Inquiry 90 for all others.

COMPUTER WAREHOUSE

Order Line: 1-800-528-1054
Order Processing: 602-224-9345
2222 E. Indian School Rd.
Phoenix, Arizona 85016
602-954-6109

Store Hours: Mon-Fri 10-5:30
Saturday 9-1
Order Line Hours: Mon-Fri 7-5:30
Saturday 9-1
Order Processing Hours: Mon-Fri 10-3

Product shipped in factory cartons with manufacturer's warranty. Please add \$6.00 per order for UPS ground shipping on orders up to 10 lbs. Orders 10 lbs and under you pay for ground service, receive air service at no extra charge. Available on orders 11-30 lbs. \$17 for air service. Prices & availability subject to change without notice. Send cashier's check or money order...all other checks will delay shipping two weeks.





Photo 2: Attribute menu for the metals database that accompanies the MSP program.

fer is useful for string input since it allows you to use the Backspace character. Thus, MSP uses the statement `READLN(con,input string)` to get attribute and qualifier names. The console specification provides buffered input.

When you exit the add-data section, the program appends the new data to the existing item file and updates record 0 so that it contains the total number of items in the file. It is advisable to protect your data by exiting this section every once in a while so that the program will write the data to the disk.

Search for selected items. Material selection is the central function of MSP. You select an attribute and then choose its relative importance, minimum acceptable value (pivot), and finally the range of desired values. For example, the menu choices in photo 2 are used to produce a ranked list of materials based on weighted options. First, you choose an attribute to be the basis of the selection—normally the most desired attribute. Assume that you press the letter H for Machinability. Next, you select the relative importance of the attribute. We included this feature because all attributes may not be equally important in selecting a material. You may want a high-strength material with good machinability but wish to give more weight to the latter. The program converts the choice of relative importance ("least" to "greatest") into a weighting factor (10 to 50) that is used in the ranking formula. That is, if you select B or "high" importance, the weighting factor will be 40.

The third step is to specify the minimum acceptable value, or pivot, for the search. For example, if the machinability must be at least "good," the C qualifier becomes the pivot. Last, you select the range of acceptable values. The pivot value may be "good," but values of "very good" and "best" are also acceptable; thus, you would choose the range option that includes qualifiers from "good" to "best" (also C). For discrete qualifiers like the metal's class, you ordinarily choose the qualifier equal to the pivot. The range-selection menu

Listing 5: Procedures to search the data array in the program for values that match the user's specifications.

```

PROCEDURE Searchfor(VAR It:ranktable; atr:attrnum;
    atr:attrdata; fnam:stri; selcode:CHAR;
    VAR Zflag:flag);
{Get data from file or from ranktable.}
{It[0] used to pass values to output.}
VAR
    memsrch : BOOLEAN;
    J,ent,last : INTEGER;
    Itrec : itemrec;
    tempatr : attrdata;
    Itfile:Ifile;

PROCEDURE Checkrec(VAR cnt:INTEGER);
{look for data in It or on disk}
{changes It and uses selcode,tempatr,atr,memsrch, and }}
VAR
    match : BOOLEAN;
BEGIN
    match := FALSE;
    CASE selcode OF
        'A' : IF tempatr <= atr THEN match := TRUE;
        'B' : IF tempatr = atr THEN match := TRUE;
        'C' : IF tempatr >= atr THEN match := TRUE
    END; {case}
    IF (memsrch) AND (tempatr = NUL) THEN
        match := TRUE;           {Include no-data items}
    IF match THEN
        BEGIN
            cnt := cnt + 1;
            IF memsrch THEN      {data is in It}
                It[cnt] := It[J]
            ELSE                  {data is on disk}
                BEGIN

```

(continued)

shows the importance of the pivot in the search. It also shows how you can include continuous values whether they are listed in increasing or decreasing order. The program converts the range selection into a character and passes it to the search procedure (see listing 5) as selcode. In our example, the program looks for all metals that have a machinability value of greater than or equal to D2. The first time through, the program does a sequential search of the file root-namelm.DTA on the disk. On subsequent passes, the program performs the search on the data in the array ranktable.

The scalars NUL through D9 are ordinal, meaning that each has an integer value based on its position in the declaration. The ORD function converts a scalar to an integer and thus allows you to use the difference in position in a numerical expression. Listing 6 shows the entire weighting and ranking procedure. In our example, the pivot value is D2, which makes the base value equal to 3 (baseval := ORD(D2)). A material with a machinability value of D4 produces an attribute value of 5 (atrval := ORD(D4)). A "high" relative importance translates to a weighting factor (wt) of 40. Qualifier lists are not all the same length so the difference in two values is made proportional by dividing it by the list size (qln). We made the weighting factors multiples of 10 in order to convert the ratio to whole numbers. In our example, the formula becomes

$$It[J].rating := It[J].rating + \text{ROUND}(40 * \text{ABS}(3 - 5)/5)$$

Note that if a qualifier equals the pivot value, the rating is 0. This is reasonable since the pivot is the minimum acceptable value. The formula shows that the greater the weighting factor, the larger the final rating. It is also clear that the farther a value is from the pivot, the greater the rating it receives. That's why only those values greater than zero (NUL) are ranked; otherwise, a NUL would produce the greatest difference and therefore a higher rank.

The value of the Boolean wtit is
(continued)

```

        It[cnt].rating := 0;      {initialize rating}
        It[cnt].item := itrec
    END
    END {if match}
END; {Checkrec}

BEGIN {Searchfor}
cnt := 0;
Zflag := 0;                      {assume no data is present}
last := It[0].item.inum;
IF last = 0 THEN                  {search disk file}
    BEGIN
        memsrch := FALSE;
        ASSIGN(itfile,fnam);
        RESET(itfile);
        READ(itfile,itrec);
        It[0].item.iname := itrec.iname; {data base name}
        WHILE NOT EOF(itfile) DO
            BEGIN
                READ(itfile,itrec);
                tempatr := itrec.ldata[atn];
                Checkrec(cnt);
            END;
        CLOSE(itfile);
        IF cnt = 0 THEN Zflag := -1 {No items found in database}
    END {last=0}
ELSE                               {search array It}
    BEGIN
        memsrch := TRUE;
        FOR J := 1 TO last DO
            BEGIN
                tempatr := It[J].item.ldata[atn];
                Checkrec(cnt)
            END;
        IF cnt = 0 THEN
            Zflag := 1 {No items in It fit the new constraint}
        END; {else}
        It[0].item.ldata[0] := atr; {desired qualifier value}
        IF Zflag <> 1 THEN {change item count. New list or no}
            {items in data base}
            IT[0].item.inum := cnt
    END; {Searchfor}

```

Listing 6: The procedures that weight and rank the data items.

```

PROCEDURE Wtandrank(VAR It:Ranktable; atn:attrnum;
    atr:attrdata; qln:qualnum ;wt:INTEGER; wtit:BOOLEAN);
VAR
    J,last,baseval,atrval : INTEGER;

PROCEDURE Ranklist(VAR It:Ranktable; last:INTEGER);
VAR
    {selection sort by decreasing rating}
    J,K,hdx : INTEGER;
    switch : BOOLEAN;
    high : rankitemrec;
BEGIN
    FOR J := 1 TO last-1 DO
        BEGIN
            switch := FALSE;
            high := It[J]; hdx := J;
            FOR K := J + 1 TO last DO
                IF It[K].rating > high.rating THEN
                    BEGIN
                        switch := TRUE;
                        high := It[K];
                        hdx := K
                    END
                END
            END
        END
    END

```

(continued)

```

        END; {If}
        IF switch THEN {must switch places}
        BEGIN
            It[hdx] := It[J];
            It[J] := high
        END
    END {for J}
END; {Ranklist}

BEGIN {Wtandrank}
baseval := ORD(atr);
last := It[0].item.inum; {# of items in array}
FOR J := 1 TO last DO
BEGIN
    atrval := ORD(It[J].item.ldata[atn]);
    IF (wtit) AND (atrval > 0) THEN
        It[J].rating := It[J].rating +
            ROUND(wt*ABS(baseval-atrval)/qin)
    END;
    IF wtit THEN
        Ranklist(It, last)
    END;
END; {Wtandrank}

```

to the pivot. This includes the NUL value since it is the lowest in rank. Since your first choice is generally the attribute that is most critical, we assumed that items with no data on that attribute should not be included unless you ask for them to be. On subsequent searches, no-data items are accepted because a material may contain other desirable properties. NUL items are not rated, so they will migrate to the bottom of the list unless they rank high in some other property.

After each search, the program tells you the number of items found and gives you the option of getting a ranked list on the screen or printer. If you don't want a list, the program shows you the attribute menu so you can make any further choices. If the ranked list is output (see photo 3), you can then get a listing of the data values for those materials. The selection, relative importance, pivot, and range options are repeated as often as you wish. Once you generate a new list, the former one is lost unless the new selection produces no items (zflag = 1). In that case, the former list is preserved. The search time for 280 records is about 6 seconds on a floppy disk and 1 or 2 seconds on a hard disk. Once the data is in memory, the search time is reduced to a second or less.

OTHER PROGRAM CHARACTERISTICS

MSP uses parameter passing extensively. This reduces memory requirements and has helped in revisions because the parameter declarations show which variables are affected by each procedure. Comments are added to note exceptions. Global variables have been kept to a minimum (32 bytes). In many cases, parameter values are passed in element 0 of the table arrays. Since these parameters are invisible, comments are made to indicate which values are in which fields of the record arrays.

To further reduce memory requirements, you can declare each of the four major procedures as OVERLAY PROCEDURE. This allows all four to use an amount of memory equal to

(continued)



Photo 3: Sample of a ranked listing produced by MSP.

passed from another procedure and is true unless you have selected an attribute for the second time. It ensures that an attribute is weighted only once during a search even though it may be selected more than once, perhaps to narrow down a large list. Once the program calculates the rating, it sorts the array on this number. This is a selection, or push-down, sort. It was chosen because the list may already be in the desired

order (a worst case for Quicksort), and if so, less movement of variables is required. The Boolean switch was included to prevent switching a value that is already in place. The procedure Wtandrank takes about a second for 280 items. Since this is a tolerable pause, a more code-intensive sort like Quicksort was unnecessary.

We decided to exclude items with no data on the first pass unless you select those values less than or equal

Choose your own colors with **COLOR COMMANDER™** pushbutton color control center

The first peripheral of its kind



Suggested User Price \$359.00

16 color choices with your present color board and software

This exciting new peripheral expands the limited palette offered by your software or the IBM RGB color graphics system, to provide an *unrestricted choice* of the 16 IBM colors... and lets you see your changes as you go.

Just push two buttons, and COLOR COMMANDER changes any color your software has chosen to your choice of the 16 IBM colors. Relieve eye strain on monochrome programs; change white-on-black to a more legible black-on-white, or a soothing yellow-on-blue. On color programs, change dull to vibrant, repetition to variety. See your changes as you go, compare colors before-and-after, and re-do until you're satisfied.

The amazing new COLOR COMMANDER is easy to install and to use... and you'll use it constantly, to avoid eye-strain, and to make hard copies in the new colors. It simply hooks up between your IBM PC/XT/AT or compatible and the digital RGB color monitor, without requiring access into the computer. It electronically recodes the graphics adapter color information, pixel by pixel, and can change colors with *any* PC software, including PC Paint, Graphics Partner, Lotus 1-2-3, Wordstar, and even high-resolution CAE/CAD programs. You can use it with your screen shooter, plotter, color printer or film recorder.

Ask to try the revolutionary new COLOR COMMANDER wherever computer products are sold. Or write for free descriptive literature. But do it today and start getting the most from your color graphics system tomorrow.

Inquiry 401 for End-Users. Inquiry 402 for DEALERS ONLY.

PERMA POWER Electronics Inc.

5601 West Howard Avenue • Chicago, Illinois 60648
Telephone (312) 647-9414

* PC Paint is a trademark of Mouse Systems Corporation; Graphics Partner is a trademark of Bright Bill Roberts and Company, Ltd; Lotus and 1-2-3 are trademarks of Lotus Development Corporation, Wordstar is a registered trademark of MicroPro Corporation, IBM is a registered trademark of International Business Machines Corporation.



1. Bring improvement, excitement and imagination to multi-color graphics

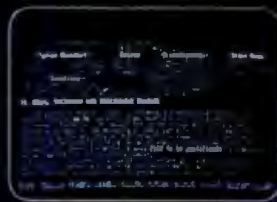

2. Add color to monochrome programs—even in high resolution—for improved legibility, less eye-strain

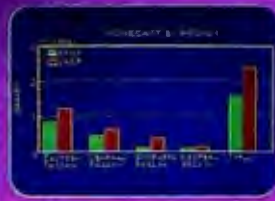
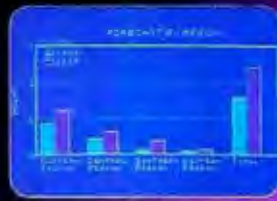

3. Add interest and variety to charts and graphs

Attention all FX80, FX100, JX, & RX owners:
**You already own half of
 a great printer**



Now
 Only
\$79.95

Now for \$79.95 you can own the rest. You see, today's new dot matrix printers offer a lot more.

Like an NLQ mode that makes their letters print almost as sharp as a daisy wheel. And font switching at the touch of a button —

in over 160 styles. But now, a Dots-Perfect upgrade kit can make your printer work like the new models in minutes. At a fraction of their cost.

Call now and use your Visa or Master Card. Don't replace your printer, upgrade it!

1-800-368-7737

In California: 1-800-831-9772

g Sample of letter with Dots-Perfect

Dots-Perfect

Sample of letter without Dots-Perfect

Dresselhaus



EPSON is a trademark of EPSON America, Inc.

837 E. Alosta Ave., Glendora, CA 91740 Tel: (818) 914-5831
 An upgrade kit for EPSON FX, JX and RX printers

**POWERFUL INCIRCUIT EMULATION,
 Priced Within Your Budget. THAT'S NICE!™**

**Get 95% of what you get from the Big Guys,
 For 10% of the cost.**

You get full-speed, real-time execution. Operates up to 10 MHz with 16 hardware break-points, 8K bytes of overlay RAM, histogramming and up and down loading of S-record files.

Designed for system development, troubleshooting, debugging or testing in the lab, field, or at home, NICE 68000 simply plugs into the target μ P socket and any RS-232 terminal or terminal emulator.

Send check, money order, or VISA/MASTERCARD to NICE, 215 Fourier Ave., Fremont, CA 94539; CODs accepted.

*Other NICE emulators are available for the 280, 8088, 8085 and NSC800 starting at \$550.00.

At \$1795.00* NICE 68000 offers the best emulator price/performance.



For information, call 800-NICOLET (800 642-6538) or 415 490-8300 (in California).

NICE Nicolet

NICE is a trademark of Nicolet. 280 is a trademark of Zilog, Inc.

the size of the largest one since only one procedure is resident in memory at a time. The program is structured so that overlays can be used without frequent disk-to-memory swapping. The first few procedures, labeled as utilities, should not be declared as overlays because they are called frequently, and this swapping would cause unnecessary delays. Using overlays reduces the memory that the program occupies by about half.

IN THE FINAL ANALYSIS

The decision to treat attribute descriptors as character strings led to a program that can be tailored to meet your specific needs. The menus are familiar to you because you created them to fit your data and your needs. Further, you can put any kind of data into the database, and you can specify any kind of attribute.

MSP works best as a means to reduce the search list to a manageable size using any number of constraints. It allows you to weight options and is very useful if you want to do a "what if" search. The current version of the program also has limitations: Attribute and qualifier labels cannot be changed once they are stored; data items cannot be deleted and may have only one qualifier; and finally, no derived qualifiers can be calculated from the data. (See the text box "What's Next?" on page 242.) Still, MSP allows you to create a custom database, and with a little practice it is not difficult to construct one from a table of values in a handbook. ■

BIBLIOGRAPHY

- Crane, F. A. A., and J. A. Charles. *Selection and Use of Engineering Materials*. London: Butterworths, 1984.
- John, V. B. *Introduction to Engineering Materials*. New York: Macmillan, 1983.
- Pecht, M., T. Sawyer, G. Dieter, and Y. Pan. "MSP: A Materials Selection Program." In *Proceedings: ASEE Computer Aided Engineering* vol. 2 1985
- Sharp, M. I. *Engineering Materials. Selection and Value Analysis*. London: Butterworths, 1966
- Weiss, V., and D. W. Ahs. "Materials Selection With Logic Programming." 29th National Symposium of the Society for Advanced Material and Process Engineering, Nevada, April 3-5, 1984

A DECADE OF SERVICE

TURBO XT

Dual Spd CPU,
2-FD, 640K
Gm Monitor,
complete



\$995

AT&T*† 6300

2-FD, 256K,
Keyboard, AT&T
Hi-Res Mono
Monitor



\$1,795

IBM* PC

2-FD, Graphics
mono monitor,
256K, list 2810

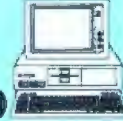

\$1,579

IBM* AT-Enhanced

20-Megabyte Hard
Disk, 1.2-MB FD,
512K, Keyboard,
Amber Monitor



\$3,995

**Complete systems
shipped overnight.**

SOFTWARE

ANDREW TOBIAS MANAGING
YOUR MONEY **\$129**
ASHTON TATE FRAMEWORK II **call**
ASHTON TATE dBASEIII plus **call**
BORLAND SIDEKICK **\$39**
BORLAND TURBO PASCAL **\$45**
BORLAND TURBO LIGHTNING **\$45**
BORLAND SUPERKEY **\$35**
BORLAND REFLEX **\$59**
CLIPPER dBASE COMPILER **call**
COMPUTER ASSOCIATES
IUS Acctg Series from **\$299**
DECISION RESOURCES
CHARTMASTER **\$239**
DECISION RESOURCES
SIGNMASTER **\$189**
DECISION RESOURCES
DIAGRAMMASTER **\$259**
DIGITAL RESEARCH GEM
DRAW/COLLECTION **call**
DIGITAL RESEARCH
GEM COLLECTION **call**
FUNK SOFTWARE SIDEWAYS **\$48**
HARVARD TOTAL PROJECT
MANAGER **call**
HAYES SMARTCOM II **\$89**
IBM DISPLAYWRITER III **\$369**
LATTICE C-COMPILER **\$298**
LIFETREE VOLKSWRITER
DELUXE **call**
MICROSOFT WINDOWS **\$179**
MICROSOFT WORD **call**
MICROSTUFF XTALK XVI **\$99**
MULTIMATE latest **call**
MULTIMATE ADVANTAGE **call**
NORTON UTILITIES **\$59**
OPEN SYSTEMS ACCOUNTING
SERIES **call**
ROSESOFT PROKEY **\$99**
SATELLITE SOFTWARE
WORDPERFECT 4.1 **call**
SOFTWARE PUBLISHING CO.
PFS SERIES from **\$79**
SORCIM SUPERCALC III **\$197**

MASS STORAGE

floppy drives
MITSUBISHI 1/2ht 360k
(bl/gry) **\$98**
MITSUBISHI 1/2ht
1.2 mb (gry) **\$147**
TANDON TM100-2 **\$125**
TOSHIBA 1/2 ht. **call**

internal hard drives
All hard drives complete with
controllers, mounting hardware &
instructions. All are formatted,
tested & have 1 year warranty.

SEAGATE 10MB **\$449**
SEAGATE 20 MB **\$499**
SEAGATE 30 MB **call**
SEAGATE 20 MB for AT **\$689**
SEAGATE 30 MB for AT **\$796**
PRIAM 40MB/60MB **\$1395/1595**
PRIAM 40MB/60MB
for AT **\$1425/1625**

disk cards
HARDCARD
10MB/20MB **\$625/895**
CMS 10MB/20MB **call**
MOUNTAIN 10MB/20MB **call**

disk subsystems
BERNOULLI BOX 20MB/40 MB
\$2695/3595
SYSGEN FLATPACK **call**
TALLGRASS all models **call**

tape drives
IRWIN 10MB/20MB inter. **call**
IRWIN 10MB/20MB exter. **call**
TALLGRASS 4060 **call**

BOARDS

multifunction
QUADRAM QUADPORT AT **\$119**
QUADRAM LIBERTY **call**
QUADRAM EMS + **call**
AST SIXPAK 384k **\$288**
AST RAMPAGE XT/AT **call**
QUADRAM QUADBOARD
384k **call; new low, low price**
THEYS FASTCARD V OK **NEW!**
RAM BOARD 384k half card **\$169**

video/graphics
AST PREVIEW **\$289**
HERCULES COLOR **\$188**
HERCULES GRAPHICS **\$319**
IBM COLOR **\$198**
IBM MONOCHROME **\$198**
QUADRAM EGA + **\$399**
QUADRAM QUADCOLOR I
COLOR CARD w/par. **call**
MONOCHROME GRAPHICS
Herc comp. **\$198**

network
ORCHID PCNET **call**
QUADRAM QUADNET IX **call**

emulation
AST 5251 mod 11/12 **call**
DCA IRMA **call**

MONITORS

monochrome
AMDEK 310a **\$168**
IBM MONOCHROME **\$224**
PRINCETON MAX 12 **\$178**
QUADRAM AMBERCHROME **\$166**

color
AMDEK 600/772 **call/\$528**
IBM ENHANCED COLOR **\$594**
PRINCETON
HX12/H12E **\$436/\$526**
QUADRAM QUADCHROME II **call**
QUADRAM ENHANCED Color **NEW!**

MODEMS

HAYES 1200/1200B **\$398/329**
HAYES 2400/2400B **\$596/526**
US ROBOTICS PASSPORT
1200/2400 **call**
1200 BAUD EXTERNAL MODEM **\$196**
VENTEL 1200 w/XTALK **call**

SUPPLY HOUSE

PC MART DISKETTES box **\$18**
case **\$159**
VERBATIM DISKETTES box **\$28**
case **\$258**

Specialists in complete computer
systems for business applications.

PRINTERS

dot matrix
BROTHER HR1509 **\$398**
EPSON LX-80 **call**
EPSON FX-85/FX-286 **call**
EPSON LQ-800/LQ-1000 **call**
IBM PROPRINTER **\$425**
OKIDATA 182 **\$268**
OKIDATA 192/193 **\$399/545**
OKIDATA 2410 **call**
TOSHIBA 321 **call**
TOSHIBA 341/351 **\$859/1159**

laser/letter quality
BROTHER HR15 **\$198**
BROTHER HR25/HR35 **\$568/798**
CORONA LP300 **\$2995**
EPSON DX20/DX35 **call**
IBM QUIETWRITER II **\$1259**
QUADRAM QUADLASER **in stock!**

plotters
HOUSTON INSTRUMENTS **call**
all models available
for quick delivery

MISCELLANEOUS

MOUSESYSTEMS PC
MOUSE w/PAINT **\$159**
MICROSOFT MOUSE
serial/bus **\$129**
KEYTRONICS
5151/5153 **call**
AT Keyboard **\$149**
QUADRAM MICROFAZER 8k **\$129**
QUADRAM MICROFAZER II **NEW!**
TRIPPLITE ISOBAR from **\$45**
TRIPPLITE UPS 400w/800w **call**
CURTIS PROTECTORS from **\$29**

CHIPS

64k/128k/256k **call for
market price**
8087/80287 **call for
market price**

*Registered Trademark

†Some systems available to qualified accounts only.

PC MART™

Personal Computer Centers

1485 Northeast Express NE • Atlanta, GA 30329

Visit our showrooms in Atlanta, Charlotte, Durham and Raleigh

SALES • SERVICE • FINANCING • DELIVERY • SUPPORT

1-800-241-0286

ORDERS

1-404-634-5995

INFORMATION



**Smart.
Friendly
enough to
work with you;
powerful
enough to
work with
other
applications.**



The difference is friendliness.

Writing should be easy.

It should be easy to edit your words. Change typestyles. Check spelling. Move paragraphs. Include charts. Combine documents. Maybe even share your work with

others in the office.

So why isn't it? Probably because you aren't writing with The Smart Word Processor.

Only Smart has 5 built-in "Confidence Levels," so that everyone in your

office can work at their best speed.

Only Smart lets you select commands from either plain-English menus, or easy-to-remember Quick Keys.

Only Smart can keep dozens of docu-



The difference is more than friendliness.

	Microsoft		
	Smart	Word	WordPerfect
• Integrates w/Data Base and Spreadsheet	Yes	No	No
• Graphics Merge w/Word Wrap	Yes	No	No
• Password Protection with Full Data Encryption	Yes	No	Yes
• Math Capabilities	Yes	No	Yes
• Custom Font Designer	Yes	No	No
• Programming Language	Yes	No	No
• Built-in Communications	Yes	No	No
List Prices:			
single-user	\$395	\$ 450	\$495
3 user-LAN	795	1,195	995

Ask for a Smart Demo-Pack.

Now for just \$19.95, you can experience the complete Smart System on your single-user PC or on up to three LAN workstations.

Your Demo-Pack includes all of Smart's powerful features, along with a complete set of disk tutorials. To order, just call toll-free 800-438-7627 and ask for Dept. BW (in Canada or Kansas call 913-492-3800).

Once you see the difference, you'll get Smart.

ments in memory. So you can open windows into several, or simultaneously view different parts of the same one.

Only Smart gives you asynchronous communications, a programming language, password protection, a fully integrated Spellchecker, and unlimited mul-

tiuser growth — all built in.

And only Smart integrates perfectly with a whole family of powerful applications: you can mail-merge with The Smart Data Base Manager, pull numbers from The Smart Spreadsheet, or wrap text around charts from Smart Business Graphics.



The Smart Word Processor

© 1986 Innovative Software, Inc.

Pick a card and get \$50.00

Putting your money on a Hercules™ Graphics Card or a Hercules Color Card has always been a safe bet.

After all, Hercules is the industry standard in high resolution graphics hardware. And we back each of our cards with a full two-year warranty.

Which explains why we've already sold more than 500,000 cards to owners of IBM® PCs, XT's, AT's and many compatibles.

But there are still some people out there who have yet to buy a Hercules card.

So we're sweetening the pot.

Between now and August 31, when you buy a Hercules Graphics Card or a Hercules Color Card,



we'll send you a check for \$50.00.

See your local Hercules dealer. When you've made your best deal, ask him for one of our rebate applications and send it in with your Purchaser Registration Card and dated sales receipt.

We'll pay off in short order.

Your Hercules card, on the other hand, will pay off for a lot longer than that.

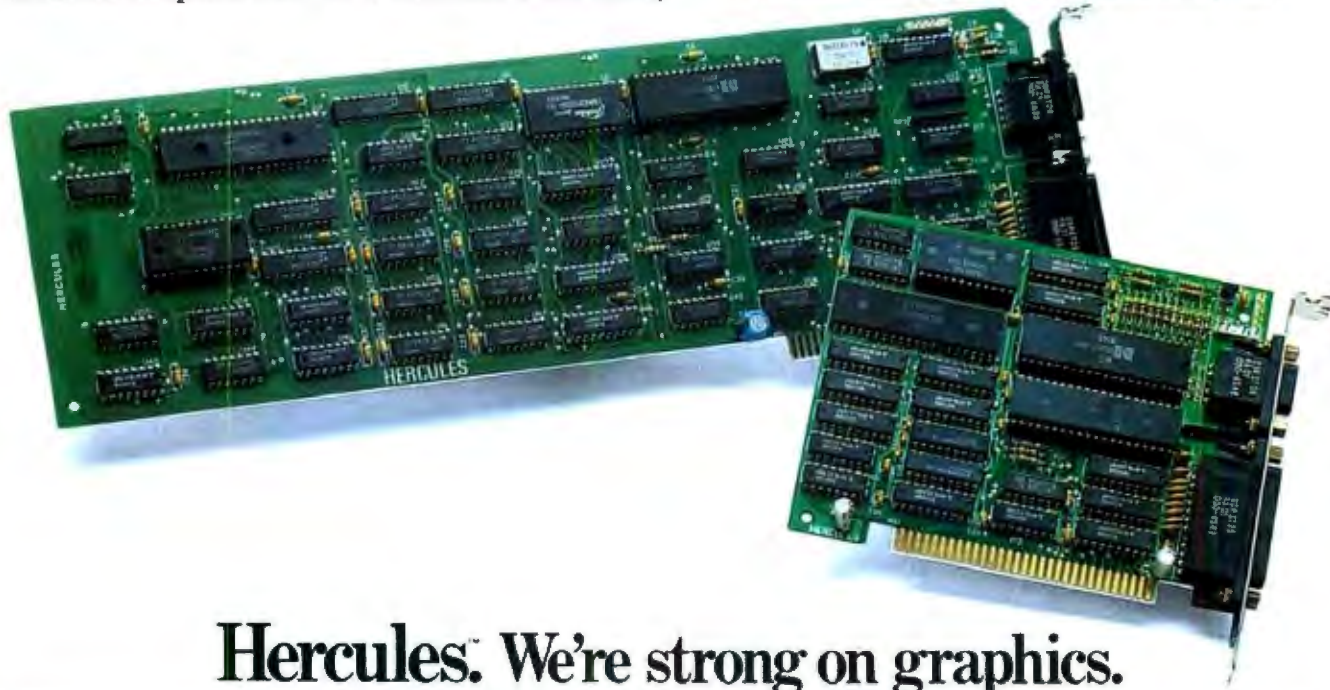

Hercules. We're strong on graphics.

Trademarks/Owners: Hercules/Hercules Computer Technology; IBM/IBM. Offer valid in the United States, U.S. Territories and Canada from May 1 through August 31, 1986. Rebate application, accompanied by Purchaser Registration Card and dated sales receipt must be sent to Hercules Rebate Offer, PROMARK Depot, P.O. Box 3947, Milford, CT 06461-0397 no later than September 15, 1986. Applications received after that date will not be honored. Rebate will be paid in the same currency in which the card was purchased. Offer void where prohibited, taxed or restricted. Dealers are not eligible to claim rebate. Offer limited to one rebate per product serial number and original Purchaser Registration Card. Each rebate must be applied for on an individual basis. Other application constitutes fraud. Rebate offer applies to Hercules Graphics Card (model GB102) and Hercules Color Card (model GB200). Other Hercules products are not eligible. Allow 6-8 weeks for redemption. For additional information in the United States call (800) 532-0600 ext. 708. In Canada call (800) 323-0601 ext. 708.

SMALL-SCALE ENGINEERING APPLICATIONS

BY J. NEIL STONE

*Estimate critical properties and liquid viscosities,
and build a database for physical property estimation*

ALMOST ALL chemical engineering design calculations require a knowledge of the physical properties of substances you handle. Pressure-drop calculations require the density and viscosity; heat-transfer estimates need thermal conductivity and specific heat; absorbers and distillation designs use diffusivity, surface tension, and vapor pressure.

Such physical properties for most pure substances are available in reference books, but it often happens that the substance you're interested in is the one missing from the books on your shelf. Moreover, few chemical engineering designs relate only to pure substances—most involve mixtures, of which there are an almost unlimited number whose properties are not tabulated anywhere.

For these reasons, chemical engineers need to estimate the physical properties of pure substances and mixtures, preferably from a minimum amount of data. For each property, numerous estimating methods have been proposed. Many of these methods are based on the theory of corresponding states, which requires

a knowledge of the critical temperature, critical pressure, critical volume, and acentric factor—collectively known as the critical properties—of the substance. The critical properties of many common substances have been experimentally determined and are readily available, but measuring the critical properties for unusual or new substances is not simple.

I've written two programs, CRITICAL/BAS and VISC/BAS, in TRS-80 BASIC for estimating all physical properties. [Editor's note: The TRS-80 BASIC programs CRITICAL/BAS and VISC/BAS and BASICA programs CRITIBM.BAS and VISCIBM.BAS are available in a variety of formats. See page 459-461 for full details.] CRITICAL/BAS estimates the critical properties of pure substances, and VISC/BAS estimates the viscosities of pure liquids and mixtures. Although the programs work independently, it is my intention eventually to make the various property routines accessible through one central program, as shown in figure 1. To some extent, in fact, the two programs are already linked via a database of critical and fundamental prop-

erties that is established and accessible by each of the program modules.

A great deal of research effort has been expended over the years in developing and improving various techniques for property estimation. For example, the well-known text *The Properties of Gases and Liquids* by R. C. Reid and T. K. Sherwood is a compendium of these methods, and it is quite common to find as many as five or more different methods for estimating any one property. To simplify the use of the programs, I've selected one or two methods that provide reasonable accuracy for a wide range of classes of substances and require only readily available data.

For example, the critical property estimation method I use is that of Rummens and Rajan. This method requires knowledge of the material's molecular weight, density, normal

(continued)

J. Neil Stone is chief engineer of Ledge Engineering Inc. (179 Lansdowne Ave., Kingsville, Ontario N9Y 3J2, Canada) and a consultant who specializes in pollution control for steel and metal-processing industries.

boiling point, and one other vapor pressure value. This information is usually readily available or can be measured.

PROGRAM PHILOSOPHY

Before I wrote the programs, however, I had to consider the philosophy of engineering programs. Many commercial engineering programs and trade publications that cover the subject tend to concentrate on the so-called big applications—multicomponent distillations, flow networks, and heat exchanger design. Such a narrow focus is natural, as these types of applications have an obvious payoff, which justifies the often high price of the software. In practice, though, most engineers more often do small, one-shot calculations and therefore need small, one-shot applications programs.

The advantages are easy to count. Most obviously, these programs take only a few seconds to do calculations that would take a much longer time if done manually. In addition to reducing drudgery, the programs improve accuracy, because once the program is proven, the chances of a calculation error are minimal. Such programs also eliminate transcription of intermediate data and results—a fruitful source of mistakes. And they can easi-

ly print out the input data and results. Most important, though, they provide a standard method of calculation, ready to use, without the need to research the literature.

But engineering work is by nature varied, and a particular calculation may only be required at infrequent intervals. So the potential problem of a one-shot application program that you might use, say, only once every three months is that you might spend more time reading the software manual than using the program.

When I'm in the middle of an engineering job, the last thing I want to do is to read a software manual, learn obscure commands, or program the application. What I do want is to load the program and use it, get the results printed out, and carry on with the job at hand. I may also want to perform several calculations using similar input data to determine the effect of different parameters on the design or to get results for a range of parameters.

As a result, I expect several features in a specific-purpose engineering program. An opening screen display, for example, should give the source of the method, its range of applicability, and input data required. Data entry should be screen-oriented with easy modification of data items, and I expect the ability to enter data in any

commonly used system of units. Printouts should be dated and properly identified with associated input data. Also important is the ability to easily return to the input screen and edit the original input data for a new run. Finally, the program should save the input data and results to a disk file for use in other programs.

The bottom line is that programs must respond to the usage pattern of the engineer. There is nothing more frustrating than being in mid-calculation and thinking, "If only I could . . ."

But program features alone aren't enough. Equally important to an engineer is the technical documentation that is specific to the application (not the hardware or software). While it is fairly easy to check that a word processor or spreadsheet program is working correctly by running a test case, the same cannot be said of engineering calculation programs.

There are usually several accepted methods of calculating any given parameter, each of which gives similar but not identical results. Thus, the only way you can evaluate a new program is by reviewing the method used to determine if it is appropriate to your design conditions. To allow this, the program writer must document the source of the method used, the

(continued)

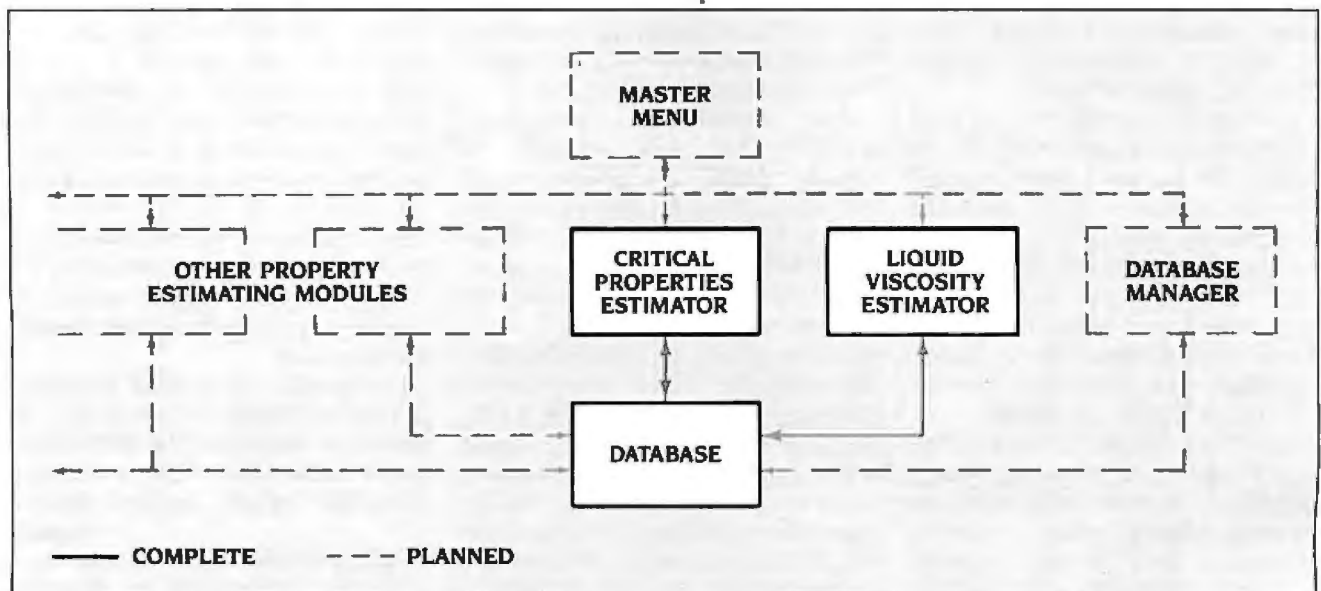

Figure 1: The programs that estimate critical properties and liquid viscosities generate and use a shared database that can also be accessed by future program modules. A database manager module could be added to make maintaining the database easy.

State of the Smart.

SmarTEAM 2400

- Bell 103/212A, CCITT V.22, V.22 bis (V.21 optional)
- Auto speed selection (300, 1200 or 2400)
- Auto answer, auto dial (tone or pulse)
- Hayes compatible
- Call progress detection (dial tone, ringing, busy)
- Speaker with volume control
- 8 LED status indicators
- 6 self test modes
- 2 YEAR WARRANTY



SmarTEAM 2400B

Short card version of SmarTEAM 2400 for IBM PC, XT, AT and compatibles. Communication software included.



SmarTEAM 1200AT (BELL)

100% compatible with Hayes 1200 plus full call progress detection (dial tone, ringing, busy). 300, 1200 full duplex.



SmarTEAM 1200BH (BELL)

Half card for IBM PC, XT, AT and compatibles. Communication software included. 300, 1200 full duplex.



SmarTEAM 1200CT (CCITT)

300, 1200bps full duplex Hayes commands compatible.



HEAD OFFICE:
TEAM TECHNOLOGY INC.
10F, 270, NANKING E. RD., SEC. 3, TAIPEI,
TAIWAN, R. O. C.
TLX: 19725 PÉTRCHEN ATTN TEAM
TEL: (02) 7414270, FAX: (02) 771-2985

U.S. SALES & SERVICE

**MORRISON
& DEMPSEY
COMMUNICATIONS**

19209 Parthenia St Ste D
Northridge, CA 91324
TEL: (818) 993-0195
FAX: (818) 993-7209
TLX: 325524 MODEM NTGE

SINGAPORE:

PET Computers Service (S) Pte Ltd.
Tel: 5331313

HONG KONG:

RAINBOW COMPUTER PERIPHERALS
Tel: 3-7281819

SOUTH AFRICA:

SPARTAN MICRO MANAGEMENT
Tel: (011) 788-5177

CANADA

BUDGETRON INC.
1320 Shawson Drive Unit 1
Mississauga, Ontario
Canada L4W 1C3
TEL: (416) 6737800
TLX: 06-968080

- ★ Hayes is a registered trademark of Hayes Microcomputer Products, Inc.
- ★ IBM PC XT AT are registered trademarks of International Business Machines Corp.
- ★ MITE is a registered trademark of MYCROFT LABS INC.

UNLOCK™ Removes Copy Protection

RUNS YOUR SOFTWARE ON ANY HARD DISK

Guaranteed to work only with programs below:

UNlock ALBUM "A"
\$49.95 (Plus \$4 ship/handling. Foreign orders \$10)

- LOTUS 1-2-3™ (1.A, 1.A', 2.0)
- dBASE III™ (1.0, 1.1, 1.2 & PLUS)
- FRAMEWORK™ (1.0, 1.1, 1.1)
- SYSTAT™ (1.3 & 2.0)
- SPOTLIGHT™ (1.0 & 1.1)
- GRAPHWRITER™ (4.3 & 4.31)
- REALIA COBOL™ (1.2, 2.0)

UNlock ALBUM "B"
\$49.95 (Plus \$4 ship/handling. Foreign orders \$10)

- SYMPHONY™ (1.1)
- CLIPPER™ (Winter '84, Summer '85)
- ELECTRIC DESK™ (1.04)
- DOUBLEDOS™
- MANAGING YOUR MONEY™ (1.5 & 1.51)
- smARTWORK™ (1.0 REV 8 thru 10)
- DATA BASE MANAGER II™ (2.0, 2.02)

UNlock ALBUM "C"
\$49.95 (Plus \$4 ship/handling. Foreign orders \$10)

- MICROSOFT WORD™ (1.5, 2.0, 2.01)
- MULTILINK ADVANCE™ (3.02 & 3.03)
- IBM WRITING ASSISTANT™ (1.01)
- LOTUS 1-2-3 REPORT WRITER™ (1.0)
- PARADOX™ (1.0)
- PFS ACCESS™ (1984 Edition)
- THINKTANK™ (2.0)

"Best of UNlock" ALBUM "D"
\$74.95 (Plus \$4 ship/handling. Foreign orders \$10)

- MICROSOFT WORD™ (1.5, 2.0, 2.01)
- dBase III™ (1.0, 1.1, 1.2 & PLUS)
- LOTUS 1-2-3™ (1.A & 1.A', 2.0)
- SYMPHONY™ (1.1)
- FRAMEWORK™ (1.0, 1.1, 1.1)
- CLIPPER™ (Winter '84, Summer '85)
- MULTILINK ADVANCE™ (3.02 & 3.03)

- Produce non-protected DOS copies from popular software programs
- For IBM® PC, XT, AT, compatibles

TranSec UNlock is a unique software copying disk that removes copy protection, providing standard non-protected DOS copies. UNlock runs on IBM® PC, XT, AT, and compatibles with at least 256K (or more required for some programs), DOS 2.1 or higher.

BACKUP COPIES. UNlock safely and easily makes backup copies.

RUN ON HARD DISK. Programs load faster, use less disk space and work with any hard disk, including Bernoulli Boxes. No longer do you need the original in drive "A".

RUN ON RAM DISK. UNlock is the only software that can run copy protected software on a RAM disk or micro-floppy.

EASY TO USE. 1) Type UNlock. 2) Select program destination. 3) Insert program disk.

SAFE ORIGINAL. UNlock does not alter your original distribution disk. UNlock works by creating a copy of your distribution disk on a hard or floppy disk. It then removes copy protection from the copy!

Choice of the Critics!

BYTE "UNlock 4.7 defeats the latest Prolok and SuperLock type of copy protection schema. It's menu-driven and works fine on the programs it's supposed to work on: Lotus 1-2-3, dBase III, Framework, Symphony, Paradox, and several others."

Jerry Pournelle, BYTE, Feb. '86

PERSONAL COMPUTING "UNlock has two particularly endearing characteristics: it works, and works simply. I was able to quickly produce unprotected copies of Lotus 1-2-3 release 2, Symphony 1.1, Microsoft Word 2.0, dBase III 1.1, and Framework II. These copies performed flawlessly, as did copies of these copies."

Christopher O'Malley, PERSONAL COMPUTING, April '86

NEW! SPECIAL OFFER
"Best of UNLOCK"

ORDER BY TELEPHONE TODAY!
1-305-474-7548



TRANSEC UNLOCK™

TranSec Systems, Inc., 1802-200 North University Drive, Plantation, FL 33322

Trademarks are the sole property of their respective owners. • UNlock is For Use Only to Improve the Useability of Legally Acquired and Operated Software.

SMALL-SCALE APPLICATIONS

procedure followed, and any assumptions the programmer made.

That documentation is not easily included in the program itself, as the information is often difficult to display and takes up disk space. Moreover, a printed manual lets you refer to the information at any time while the program is running. Therefore, separate, hard-copy, detailed technical documentation is essential for engineering programs.

WHAT MY PROGRAMS DO

The first program, CRITICAL/BAS, is a very simple, single-purpose linear program. After the introductory text, you enter the project title, date, and substance name, and then the program displays a data-entry screen. Once the data is entered, the program calculates the critical properties—this takes a few seconds because the method involves estimating the critical temperature, then iterating until the calculated and estimated values agree. After the calculation, the results are displayed for review, and you can choose to print the results, save the data to disk, or do a new calculation.

The second program, VISC/BAS, is somewhat more complex, involving three separate but interlinked branches. The main menu offers two pure-component viscosity estimating methods and one method for mixtures. The two pure-component methods—one for nonassociating compounds and the other for associating compounds—operate alike. After you enter the name of the substance, the program checks the database for the critical and fundamental properties and displays a data-entry screen that includes the data found in the database. You may then edit that data and add any necessary data that's not already in the database.

The program calculates the basic parameters for estimating viscosity and then prompts for the temperature—either a single temperature or a range and interval, in which case the viscosity for the range will be tabulated. In either case, the results are displayed, and you can then print them, calculate the same substance at another temperature or range, or cal-



SMALL-SCALE APPLICATIONS

culate for a different substance using the same procedure.

In the case of mixture viscosity, a multicolumn data-entry format is provided for the viscosity, percent composition, and molecular weight of up to 10 components. The viscosity data for some or all of the components may be omitted, in which case the program will call the estimating routine to determine these values. After you have entered the data, the viscosity of the mixture is calculated and displayed on the screen, and you can choose to print the results, calculate a mixture made of the same materials, or calculate a different mixture.

To make data entry easy, both programs use a full-screen data input format based on a concept originally published and placed in the public domain by L. E. Sparks. I have refined the method and added features to suit my way of working and programming, and I think it is the best data-entry format for engineering programs.

The screen is divided into three areas—a single line of title at the top, up to 11 lines of data entry in the center, and two lines of prompt at the bottom. The layout I use is designed to fit the 16-line display of my TRS-80 Model III—with a 24-line display up to 19 lines of data can be accommodated. Data is entered opposite descriptive text for each entry, and the routine lets you modify or correct an entry as necessary. Having all the input data on the screen at once makes it easy to check for inconsistencies and detect incorrect values.

Both programs have the same structure, and that allows me to keep a set of all the utility subroutines to use as a starting point for each new application I write. This not only speeds up the programming, but also maintains a standard operator interface and variable names. Thus, each program responds in a similar way, and there is no need to puzzle over the expected response when running an unfamiliar or little-used program. And because the variables are standard, I can easily integrate my programs.

Only slightly over 10 percent of the

(continued)

PCEASY™ Simplifies Finding Your Files

EXPANDS FILE NAME CAPABILITY TO 32 CHARACTERS

- **Automatically translates PCEASY file names to DOS file names**
- **Commands and DOS both run faster**
- **Easy menu access to application programs**

TranSec PCEASY is a new easy-to-use software file management system that organizes your files, simplifies DOS and speeds up your IBM® PC, XT, AT or compatibles (DOS 2.1 or higher, 256K or larger, and hard disk required).

FILE LIKE YOU THINK. The heart of the PCEASY system is its expanded 32 character capability to name your files naturally, the way you think. Eliminated are the maze of DOS standard 8 character limit half-forgotten or cryptic file names.

With PCEASY you can use easily remembered names, plain words, even dates, to name your files. You can also name file "folders" to place reports, letters, spreadsheets, programs, or whatever, in their own logical, easy to find location.

SIMPLE FILE ACCESS. To access a file, you don't have to type the name again. All you do is select the file you want and PCEASY immediately finds it for you. PCEASY file names work with nearly any application program (including Lotus 1-2-3™, Symphony™, dBase III™, Framework™, etc.) because they are converted to standard DOS file names... automatically.

FAST MENU ACCESS. To access a file, you don't have to type the name again. All you do is select the file you want and PCEASY immediately finds it for you.

COMPUTERS WORK FASTER. Commands are performed faster and DOS runs more efficiently. An expanded "type ahead" buffer keeps the system speedy.

EASY TO USE. PCEASY prompts you through DOS commands and on-line help is always available. No need to learn a lot of new complicated commands and extra keystrokes.

Order Today for the EASY Life
\$74.95 ea.
(PLUS \$5.00 SHIP/HDL; FOREIGN ORDERS \$15.00)



TranSec Systems, Inc., 1802-200 North University Drive, Plantation, FL 33322

Trademarks are the sole property of their respective owners.



STANDARD DOS SCREEN with maze of hard to remember and confusing file names, because you are limited to 8 characters.



PCEASY FILES MENU features an expanded 32 character capability to name your files with easily remembered names, plain words...even dates. Select the file you want and PCEASY finds it for you fast!



PCEASY PROGRAM MENU features quick, easy, automatic menu access to your application program and DOS operating commands. Select function you want... PCEASY does the rest.

ORDER TODAY BY TELEPHONE!

1-305-474-7548



NOT COPY PROTECTED

There is no point in cluttering the database by saving estimated properties, as they are usually temperature- or pressure-dependent.

program lines are involved in the actual manipulation of numbers. Thus there is little need for clever algorithms and mathematical techniques, and, in fact, the essential math of these programs consists of evaluating a sequence of mathematical expressions. While the math is what makes the program so much faster than manual calculations, it's the I/O that makes the program convenient to use. And that's why I chose to write the programs in BASIC.

If I can reduce an hour of manual calculations to 5 seconds, there is little incentive to use a more difficult or more complex programming language to complete the calculations in 0.5 seconds. Also, tidy screen formatting for data entry and hard-copy output are major factors in making an engineering program useful. None of the other popular languages has any-

where near the ease of handling these matters that BASIC has. In fact, most other languages are either still in the dark ages of batch input (not much use for an interactive program), or they provide minimal I/O facilities. Of course, routines can be written in languages to provide screen and printer formatting, but that's just additional complication and work. Besides, BASIC's math capabilities provide the accuracy needed in most routine engineering calculations and convenient error-trapping procedures.

GENERATING THE DATABASE

The database that links the two programs contains critical and certain fundamental properties for various substances. Table 1 shows the structure of each record. The fundamental properties in the record were chosen because they are used in predicting others. A spare field of 60 bytes is provided in each record of the database, so you can add other fundamental properties you frequently use. However, there is no point in cluttering up the database by saving estimated properties, as they are usually temperature-dependent or pressure-dependent, and it is unlikely that the same result at the same conditions will be required in the future.

Both programs let you generate your own database that contains the specific substances you most often

use. (Listing 1 shows the database generation and retrieval subroutine in VISC/BAS.) Random access files are most suitable for saving this type of information, so that new program modules can be created to rewrite specific records without rewriting the whole file. However, there's no need for any tricky pointers or sorting since most chemical engineers are interested in only 50 to 100 substances. To save search time, though, I use alphabetic subfiles, in which all substances with names starting with *H*, for example, are saved in the file HCRIT/DAT, and those starting with *S* in SCRIT/DAT. In this way, each file has only a few entries, and data retrieval is fast. The field lengths are chosen to give a record length of 128 bytes, so as to pack two records to a sector on a TRS-80-formatted disk.

The database generation and retrieval routine checks if a specified substance is already in the database and, if it is, loads the data into the program. First, the subroutine at line 8780 is called to generate an uppercase version (YH)—to avoid problems with mixed cases—of the substance name (YB), and then the appropriate subfile is opened (line 8670) and searched for the substance name (line 8720).

If the substance is found, the data is retrieved (lines 8590–8620); otherwise, the record counter (line 8750) stops at the end of the file so that a subroutine can save the new data (line 8850). In the case of VISC/BAS, the substance's freezing point is saved for future use, but the boiling point is not used, so a blank has to be saved in this field. Since reading empty fields and attempting to convert those fields into numeric variables results in a small garbage value, the program purges them (line 8630). Also, each module can update existing files with data generated by that module. In this way, each module of the program contributes a share to the database that's used by all modules.

CONVERTING TO BASICA

The programs are written in TRS-80 Model III BASIC. Since we have MS-DOS machines in my company, I

(continued)

Table 1: The database is made up of 128-byte records containing the fundamental and critical properties that are used in predicting other properties. The 60-byte spare field allows you to add other fundamental properties as needed without rebuilding the database.

Item	Type	Field length (in bytes)
Substance name	string	32
Molecular weight	single-precision	4
Boiling point, °C	single-precision	4
Critical temperature, K	single-precision	4
Critical press, atm	single-precision	4
Critical volume, cc/g.mol	single-precision	4
Acentric factor	single-precision	4
Density, g/cc	single-precision	4
Temperature of density measure, °C	single-precision	4
Freezing point, °C	single-precision	4
Spare field		60
Total record		128

LOOKING FOR ANSWERS? ASK STEVE CIARCIA

CIARCIA FANS WON'T WANT TO MISS THIS BOOK!

"No one is better at explaining the intricacies of all the technologies associated with micro-computers."

—Philip Lemmons

**STEVE CIARCIA'S
ASK BYTE**
by Steve Ciarcia
\$14.95, paperback,
323 pages.

Written by the celebrated author of two popular columns that appear monthly in *BYTE*, "Ciarcia's Circuit Cellar" and "Ask *BYTE*."

Ciarcia's insightful answers help you troubleshoot problems with

- Sound
- Communications
- Display and Video
- Memory
- Hardware
- Software
- Operating Systems
- Peripherals

Most of this material has never been published before!

You'll have a greater understanding and appreciation of computing with Ciarcia's ingenious ideas.



- Osborne/McGraw-Hill books are available at bookstores and computer stores everywhere.
- To order *Steve Ciarcia's Ask BYTE* by mail, complete the coupon and mail to:
- Osborne/McGraw-Hill
P.O. Box 400
Hightstown, NJ, 08520
- All orders must be prepaid and should include local tax.
- Checks, money orders, VISA and MasterCard are acceptable for payment.
- No postage or handling charges are required.

This order is subject to acceptance by McGraw-Hill. Offer is good only in the U.S.A.

STEVE CIARCIA'S ASK BYTE 0-07-881200-3

_____ # of copies at \$14.95 plus tax.



NAME _____

ADDRESS _____

(Please, no P.O. Box)

CITY _____

STATE _____

ZIP _____

INDICATE METHOD OF PAYMENT

CHECK/MONEY ORDER

VISA/EXP. DATE _____

MASTERCARD/EXP. DATE _____

CARD # _____

SIGNATURE _____

Clip and send to Osborne/McGraw-Hill, P.O. Box 400, Hightstown, NJ 08520.

42-Q-004-7000-1

usually do a conversion to BASICA. The BASICA versions of CRITICAL/BAS and VISC/BAS are CRITIBM.BAS and VISCIBM.BAS, respectively, and are also available via BYTenet Listings and in other formats.

Listing 1: Both the critical properties estimator and the liquid viscosities estimator programs include similar database generation and retrieval routines. This listing is the routine from the TRS-80 program VISC/BAS.

```

8540 REM Read data from file
8550 CLS
8560 PRINT"Checking disk for data..."
8570 GOSUB 8780:GOSUB 8670:GOSUB 8720
8580 IF N>LOF(1)/LF THEN 8650
8590 A(2,KS)=CVS(MF$):A(2,KS+1)=CVS(TF$)
8600 A(2,KS+2)=CVS(PF$):A(2,KS+3)=CVS(VF$)
8610 A(2,KS+4)=CVS(WF$):A(2,KS+5)=CVS(DF$)
8620 A(2,KS+6)=CVS(SF$):A(2,KS+7)=CVS(FF$)
8630 FOR J=1 TO 7:IF ABS(A(2,KS+J))<C3 THEN A(2,KS+J)=0
8640 NEXT
8650 RETURN
8660 REM Open file for crit data
8670 Y=LEFT$(YH,1)+"CRIT/DAT"
8680 OPEN"R",1,Y,128
8690 FIELD 1,32 AS NF$,4 AS MF$,4 AS BF$,4 AS TF$,4 AS PF$,
4 AS VF$,4 AS WF$,4 AS DF$,4 AS SF$,4 AS FF$,60 AS XF$
8700 RETURN
8710 REM Find if name in record
8720 N=1
8730 GET 1,N
8740 J=LEN(YH):K=LEN(NF$):IF LEFT$(NF$,J)=YH THEN IF
RIGHT$(NF$,K-J)=STRING$(K-J," ") THEN 8760
8750 N=N+1:IF N<=LOF(1)/LF THEN 8730
8760 RETURN
8770 REM Convert name to caps
8780 YH=YB
8790 FOR J=1 TO LEN(YB)
8800 K=ASC(MID$(YB,J))
8810 IF K>96 AND K<123 THEN YL=CHR$(K-32):MID$(YH,J)=YL
8820 NEXT
8830 RETURN
8840 REM Write data to disk
8850 IF N<=LOF(1)/LF THEN LSET FF$=MK$(A(2,KS+7)):
GOTO 8920
8860 LSET NF$=YH
8870 LSET MF$=MK$(A(2,KS)):LSET TF$=MK$(A(2,KS+1))
8880 LSET PF$=MK$(A(2,KS+2)):LSET VF$=MK$(A(2,KS+3))
8890 LSET WF$=MK$(A(2,KS+4)):LSET DF$=MK$(A(2,KS+5))
8900 LSET SF$=MK$(A(2,KS+6)):LSET FF$=MK$(A(2,KS+7))
8910 LSET BF$=""
8920 PUT 1,N
8930 CLOSE 1
8940 RETURN

```

Listing 2: To make conversion between BASICA and TRS-80 BASIC easy, the programs include the lines below that define the parameters of the two different displays and a function that converts values in BASICA LOCATE statements to acceptable values for TRS-80 BASIC PRINT@ statements.

```

200 NS=64:NR=16:LF=1 'screen parameters for TRS80
210 'NS=80:NR=24:LF=128 'screen parameters for 80x24 (IBM)
220 DEF FN LC(J,K)=(J-1)*NS+K-1

```

To make conversion easier, I incorporated a few additional items into the TRS-80 program, as shown in listing 2. These lines define three parameters that differ between various computers—the number of columns on the video (NS), the number of rows on the video (NR), and the conversion factor from LOF to record number (LF)—on the TRS-80 the LOF is returned in records, in BASICA it is returned in bytes. In addition, a function is defined that takes a row and column number, as in the BASICA LOCATE statement, and converts it to a value for a TRS-80 BASIC PRINT@ statement.

Most screen displays in the program are set up in terms of these variables and function so that, when converting to BASICA, all you do is replace the PRINT@ statements with LOCATE(.): PRINT using the same parameters. Other changes needed for the conversion besides the PRINT statements include a more complex statement to decode the cursor arrow input for the IBM PC.

But whether you use a TRS-80 or an IBM PC, I hope you will find my programs helpful in creating your small-scale engineering applications. From an engineering standpoint, the value of these and similar programs comes not from complex math routines or innovative algorithms used in the calculations, but from relatively simple but tedious math in a flexible and convenient package that an engineer can pick up after a period of disuse and put to work immediately. ■

BIBLIOGRAPHY

- Danner, R. P. and T. E. Daubert, eds. *Data Prediction Manual*. American Institute of Chemical Engineering, 1983.
- Przedzicki, J. W., and T. Sridhar. "Prediction of Liquid Viscosities." *American Institute of Chemical Engineers Journal*, vol. 31, no. 2, 1985.
- Reid, R. C., and T. K. Sherwood. *The Properties of Gases and Liquids*, 2nd ed. New York: McGraw-Hill, 1966.
- Rummens, F. H. A., and S. Rajan. "A Numerical Technique for the Estimation of Critical Constants and of Lennard-Jones (12-6) Parameters." *Canadian Journal of Chemical Engineering*, vol. 57, 1979.
- Sparks, L. E. "Data Entry Program for the TRS-80 Model I." *Access*, vol. 1, no. 4, 1982.

DON'T LOOK FOR PRODUCTIVITY IN A PRODUCT.

The purchase of a data base system should be the beginning of a relationship.

That relationship should include planned product upgrades, experienced technical support, vertical application templates, informational seminars, training programs, user groups, newsletters, special marketing programs... and much, much more.

Demand a Relationship

At Software Solutions, the relationship begins as soon as you contact us. We'll help you find answers to your questions about DataEase™—or about any information management issue.

The product evaluator at

Manufacturer's Hanover Trust summed up the experience of tens of thousands of users by calling DataEase "the most impressive productivity tool I have seen."

When you talk to us, ask for our sample diskette. See for yourself why *Data Based Advisor* points to DataEase as "the easiest to understand and use full-featured data base program," calling it "a program which could easily set the industry standard."

Discover us. Find out how important the company behind the product can be.

Send information and a free DATAEASE BYT7/86 sample diskette for my PC (check one):

IBM WANG DEC TI

Include materials relating to:

Corporate Client Retailer
 MIS/DP/IC Professional VAD
 Other _____

Name: _____

Title: _____ Phone: _____

Company: _____

Street: _____

City: _____ State: _____ Zip: _____

Mail to:
Software Solutions, Inc. Telex: 703972
12 Cambridge Drive 800-243-5123
Trumbull, CT 06611

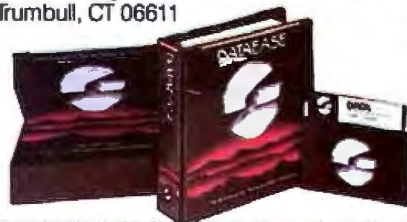

Software Solutions. Get into a relationship that works for you.

Canada
Computerlinks, Toronto, Ontario; (416) 231-1270

United Kingdom
Sapphire Systems, Essex; 01-554-0582

West Germany, Austria
M&T Software Verlag, Munich, 089-4613-0

Scandinavia
West Soft A/S, Alesund, Norway; (47) 71-46166

Switzerland, France
Softsource, S.A. 1209 Geneva, Switzerland; 985152&985-153

The new Diconix 150. At under four pounds,
It's the one PC printer you can



you can even carry it under your arm.
take lightly. Anywhere.



DICONIX

A Kodak Company

3100 Research Boulevard
Dayton, Ohio 45420
(513) 259-3437

Inquiry 113

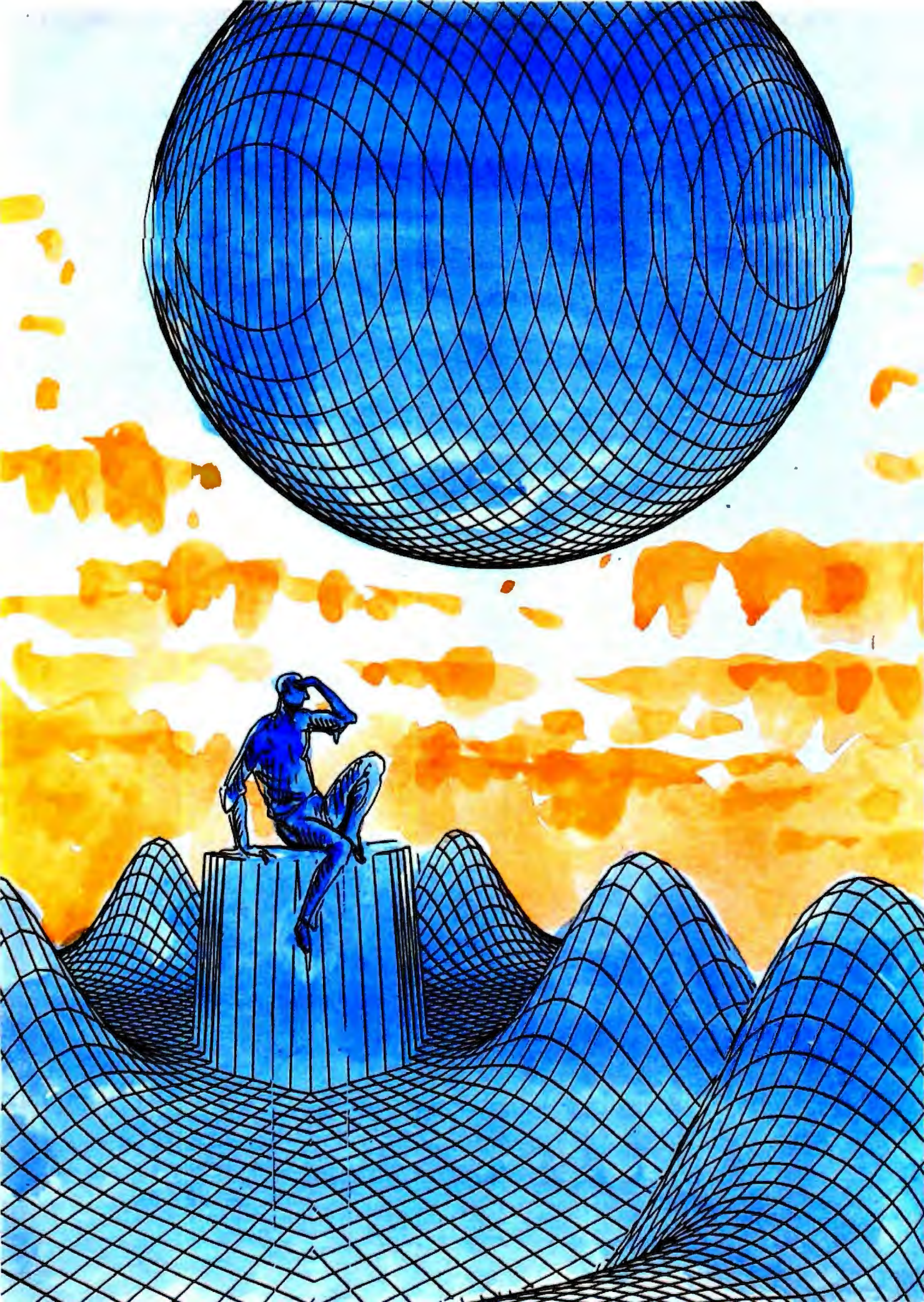

Reviews

REVIEWER'S NOTEBOOK <i>by Ion Edwards</i>	267
THE COMMODORE 128 PERSONAL COMPUTER SYSTEM <i>by William Wiese Jr.</i>	269
THE ITT XTRA XP <i>by John D. Unger</i>	281
THE CONQUEST TURBO PC <i>by John D. Unger</i>	289
BYSO LISP AND WALTZ LISP <i>by William Wong</i>	293
EXPEROPS5 <i>by William Jacobs</i>	297
FIVE LABORATORY INTERFACING PACKAGES <i>by Patricia Wirth and Lincoln E. Ford</i>	303
THE IBM WHEELPRINTER E <i>by Robert D. Swearingin</i>	315
REVIEW FEEDBACK	319

THE COMMODORE 128 is three computers in one. It has a Z80 for CP/M, a Commodore 64 mode, and a C-128 mode that provides 80-column RGB text output and uses an 8502 processor, switchable between 1 and 2 MHz. William Wiese Jr. reports that the C-64 mode ran all his C-64 software, although it cannot access the improved features available in the C-128 mode. The system appears to be a good value and an interesting path of expansion for C-64 owners.

John D. Unger was impressed with the ITT XTRA XP. It is an IBM PC AT clone, but it is more compatible with the IBM PC and PC XT than the AT is. The benchmarks prove that the system is fast, especially when you use the disk-caching software provided with the unit. John believes that the combination of zero-wait-state RAM and disk caching put the XP ahead of the AT in most categories.

John also examines the Conquest Turbo PC, an IBM PC XT compatible with an 8088-2 central processor that you can switch between 4.77 and 8 MHz. He concludes that the machine, despite some small difficulties, is an excellent value that deserves consideration from experienced users.

William Wong examines two LISP implementations for MS-DOS. His comparative perspective explains the trade-offs you will face in deciding between a \$70 package and a \$169 package. BYSO LISP support of LISP 1.5 is relatively complete, but the author concludes that it may be inappropriate for very sophisticated work. Waltz LISP, based on Franz LISP, lacks floating-point numbers but is fast and very functional.

William Jacobs looks at ExperOPS5, a Macintosh implementation of OPS5. ExperOPS5 is an expert-system shell on which you can write microcomputer expert systems, but the author reports that using the production rule language for serious application development would be difficult.

Patricia Wirth and Lincoln E. Ford compare five laboratory interfacing packages. They conclude that the software packages differ in their emphasis, idiosyncrasies, quality of documentation, and ease of use. Those involved in the analysis of laboratory data will find the authors' views indispensable.

Finally, Robert D. Swearingin found that the IBM Wheelprinter E is a sturdy, no-nonsense daisy-wheel printer with slow speed but high quality. The documentation is good and the operation is flexible.

SCSI

MOVE INTO THE FAST LANE

Increase PC Performance and Expandability with SCSI Peripherals

Adding the improved system performance and expandability of SCSI peripherals is as easy as removing the PC cover and plugging in a half-size expansion board.

The economical CMS SCSI Host Adapter for the IBM PC family connects the system bus to the industry standard Small Computer Systems Interface (SCSI), harnessing the capabilities of this new generation peripheral interface.

Performance — Increases data transfer rate up to 140%.

Multiple Peripherals — A single host adapter can support as many as seven intelligent peripherals, reducing hardware costs and card-cage space.

Easy Upgrade Path — Future expansion with virtually any SCSI disk or tape drive, printer or other peripheral is easy with the device-independent SCSI peripheral bus.

Complete SCSI hard disk storage and tape backup combinations are available in internal or external configurations for the IBM PC, PC/XT and PC/AT.

Internal Mass Storage — Get compact performance from the 20 Mbyte Drive Plus expansion card drive with built-in SCSI host adapter. For a complete disk/tape storage capability, add the 20 Mbyte, half-height internal tape drive, with embedded VLSI controller. The combo connects to the PC bus through the Drive Plus. No other controller card slots are required.

The external SCSI Power Twin 20:20 includes half-height 20 Mbyte disk and tape drives in a slim cabinet with built-in power supply, surge protection and external power sockets. The disk and tape drives include embedded controllers, so the complete unit requires only one half-size host adapter card.

Call today to find out more more about moving your PCs into the fast lane with the high performance SCSI Portfolio from CMS.



401 West Dyer Road
Santa Ana, CA 92707
(714) 549-9111

Enhanced products for personal computers



IBM is a registered trademark; IBM PC, IBM PC XT and IBM PC AT are trademarks of International Business Machines, Corp.

Inquiry 68 for End-Users. Inquiry 69 for DEALERS ONLY.

There are always impressive new developments at COMDEX. Spring COMDEX in Atlanta is smaller than Fall COMDEX in Las Vegas, but it still took technical editor Stan Wszola and me three and a half days to visit all of the exhibits.

Laser printers and desktop publishing were conspicuous; the *Show Daily* counted 15 different laser printers on the floor. There were the well-known units, including those from Hewlett-Packard, Ricoh, Kyocera, and Canon, but perhaps the most unusual was the LaserPro from Oasys. Though only \$1895, the printer has some interesting features. It can accept envelopes and allow output to emerge print down to sequence documents in proper page order.

The Atari and Amiga booths were the center of most of the excitement. The Amiga Sidecar was particularly interesting. Scheduled for release this fall, this IBM PC hardware emulator allows you to run MS-DOS as an intuition task. The prototype, which contains an 8088 running at 4.77 MHz and 256K bytes of RAM (expandable to 512K bytes), includes three IBM PC-compatible expansion slots and ran a variety of applications without crashing and with impressive speed.

We also saw a number of new peripherals, including Digi-View from NewTek, a video digitizer that produces high-quality views of stationary objects. Digi-View connects to the printer port and takes a signal from a black-and-white video camera. By photographing an object three times, each with a different primary color filter, you can obtain and then manipulate color images.

One change merits mention: Atari has decided not to include an RF modulator with its 1040ST. Some folks at Atari have intimated that third par-

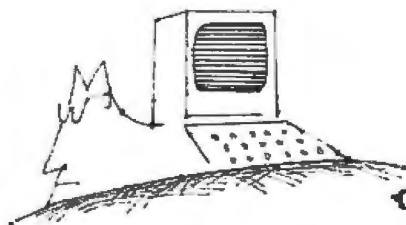

ties might market an RF modulator for the 1040ST; however, you should not expect, as Phillip Robinson and I suggested in our March preview, to be able to hook up the unit to your color TV in the near future.

Atari showed its own IBM PC-compatible box, a modest unit that will retail for under \$300. For the moment, the prototype provides limited compatibility and possibly only one expansion slot.

Perhaps the most impressive ST development (scheduled for the third quarter) is Batteries Included's Thunder, a writer's assistant that, for only \$39.95, will provide a 50,000-word spelling checker, a PRD+-like abbreviation facility, and a Borland Lightning-like thesaurus.

Pixelmaster, a color ink-jet printer from Howtek, caught our fancy. The printer uses hard, crayon-shaped plastic rods to produce near-offset-quality raised color text. A rotating print head has 32 separately aimed ink jets, 20 for black ink and 4 each for yellow, cyan, and magenta.

Another interesting new product is Toshiba's T3100, a PC AT portable that weighs only 15 pounds. The unit has an 80286 running at 8 MHz, a standard 640K bytes of RAM expandable to 1.6 megabytes, one 720K-byte 3½-inch disk drive, a 10-megabyte hard disk, and an 80-character by 25-line gas-plasma display.

IBM again showed off its Convertible. The major impact of IBM's announcement may well be to legitimate laptops and the 3½-inch drive in the MS-DOS world. A number of other new computers will also demand consideration, including the Bondwell 8

and the Toshiba T1100.

Torrington's Manager Mouse caught our eye. The mouse, which retails for \$198, plugs directly into the serial port of an IBM PC or compatible. The durable dual-wheel design of the mouse gives it a smoother feel and should eliminate most maintenance problems. The unique design allows you to use it on any horizontal or vertical surface. You can use the mouse with Lotus 1-2-3, dBASE II, Symphony, Framework, and WordStar 2000.

There are also two interesting developments in mass storage. Iomega's Bernoulli Box Plus combines two removable cartridge 20-megabyte disk drives with an 80-megabyte hard disk drive. Archival backup software can back up the fixed disk to multiple cartridges at the rate of 4 megabytes per minute. An alternative for fast and virtually unlimited on-line storage and backup is IDEAssociate's Diskit 2, a compact external disk drive with twin 10-megabyte Winchester removable cartridges.

There were also small items that are often easy to miss. The Missing Link (\$29.95) from Active Components (for a Commodore 128 or IBM PC, XT, or AT with a color graphics adapter) provides 16 shades of green or amber on a composite monitor. The Missing Link has a 9-pin connector on one end to attach to your system and an RCA connector on the other. The small device, which digitally combines an RGB signal into a standard composite black-and-white signal, requires no external power supply.

Comparative reviews will be appearing in coming issues. Please stay tuned for reviews of 24-pin printers, IBM PC AT multifunction boards, tape backup units, telecommunication software, laser printers, and more.

—Jon Edwards
Technical Editor, Reviews

Explore AI on your PC

Smalltalk/V transforms your PC into a versatile AI workstation

Only Smalltalk/V lets you experience the thrill of a responsive AI workstation while learning artificial intelligence techniques and using them to create practical applications.

"Smalltalk/V gives me the feel of an AI workstation on my PC."

—Darryl Rubin,
Technical Editor,
AI Expert
Magazine

Watching someone use an AI workstation is a vision of what the computer was meant to be. Fingers dance across the keys as windows dilate, shift, overlap, and disappear on the bit-mapped display. Ideas spring to life as program fragments execute, are modified, expanded, combined and tried again in a creative arabesque of text and graphics. The interface vanishes, man and machine are one. Smalltalk/V brings that experience to your IBM-PC.

"We use Smalltalk as our primary language for teaching artificial intelligence."

—Dr. John Pugh
Director, School of Computer Science
Carleton University

Of the three main AI languages, Smalltalk, LISP, and Prolog, only Smalltalk was intended for individual use on a personal computer. Only Smalltalk was designed to provide a match between human and computer models of reality. Only Smalltalk is easy to learn, easy to read, and easy to use.



"Smalltalk/V is the highest performance object-oriented programming system available for PCs."

—Dr. Piero Scaruffi
Chief Scientist
Olivetti Artificial Intelligence Center

\$99.00

Smalltalk/V Features

- High-performance object-oriented programming
- Integrates object-based and rule-based programming with object-oriented Prolog
- A user-extensible, open-ended environment
- A responsive graphical user interface
- Supports exploratory programming and prototyping
- Class hierarchy with inheritance creates highly re-useable code
- Smalltalk source code included, with browser windows for easy access and modification
- A huge toolkit of classes and objects for building a variety of applications
- Object-swapping creates virtual memory on hard or RAM disk
- Bit-mapped graphics with bit and form editors
- A sophisticated source-level debugger
- Automatic change log for easy recovery from errors
- Powerful directory/file browser system for organizing DOS files
- Optional communications interface to Unix™ and other systems
- Access to other languages and DOS functions
- DOS command shell
- Detailed owner's manual designed for both beginners and advanced programmers

"We found Smalltalk/V excellent for developing advanced decision-support tools based on decision analysis and AI techniques."

—Dr. Samuel Holtzman,
Professor, Stanford University

Smalltalk/V is pure object-oriented programming — a powerful tool for designing frame/script-based knowledge representations, inference engines, expert systems, simulation environments, intelligent interfaces, network control software, communications interfaces, and much more.

Methods, our character-based Smalltalk, is now available for \$79. It has all of the features of Smalltalk/V except graphics, rules, source-level debugger, and object-swapping. However, it supports color, includes the communication package, and does not require a mouse.

BYTE and BIX are trademarks of McGraw-Hill, Inc. IBM, IBM-PC, and IBM PC-AT are trademarks of International Business Machines Corporation. Unix is a trademark of Bell Laboratories.

Inquiry 114

YES! I want to turn my PC into an AI workstation. Send me...

Smalltalk/V\$99
 Communications for Smalltalk/V\$49
 Methods (Including Communications)\$79
 Shipping and Handling\$.....
 CA residents add applicable sales tax\$.....
TOTAL\$.....

Shipping and Handling
 U.S., Canada, and Mexico\$ 5.00
 Elsewhere\$15.00

I enclose Check Money Order

Credit card information MC VISA

Number: _____ Expiration: _____

Signature: _____

Name: _____

Street Address: _____

City/State/Zip: _____

Phone: _____

NOT COPY PROTECTED, 60-DAY MONEY-BACK GUARANTEE
 ON-LINE USER-SUPPORT CONFERENCE ON BYTE'S BIX™

Smalltalk/V requires DOS and 512K RAM on IBM PCs (including AT) or "compatibles," a Microsoft or compatible mouse, and a OGA, EGA, Hercules, or AT&T Hi-Res graphic controller.



5200 West Century Boulevard
 Los Angeles, CA 90045 (213) 645-1082



THE COMMODORE 128 PERSONAL COMPUTER SYSTEM

BY WILLIAM WIESE JR.

The Commodore 128 personal computer includes 128K bytes of RAM and uses two microprocessors, a Z80 and a 6502-compatible chip, the 8502, which supports bank-switched memory. The C-128 includes dual video outputs, a four-voice sound synthesizer, 80-column RGB text output with its own independent 16K of video RAM (supporting 640- by 200-pixel resolution), and the 40-column VIC-II chip, which supports 320- by 200-pixel high-resolution sprite graphics.

On power-up, the C-128 enters the "native," or C-128, mode, which uses the 8502 processor, switchable between a 1- and 2-megahertz clock speed. The mode accesses the 128K of RAM using bank-switching techniques and allows you to use BASIC 7.0, an advanced BASIC. In C-64 mode, you obtain full compatibility with the Commodore 64 but without access to any of the C-128's advanced features. Alternatively, you have a 2-MHz Z80-based CP/M machine that supports bank-switched CP/M version 3.0 (CP/M Plus).

C-64 MODE

In C-64 mode, I had no trouble loading and running all my C-64 programs, including heavily copy-protected ones. There are three ways to switch to C-64 mode: In C-128 mode, you can type GO 64; you can hold down the Commodore logo key while powering up; or you can put a C-64 ROM cartridge in the expansion port. Note

Compatibility with the Commodore 64, a Z80 for CP/M, a new BASIC, and more



that you cannot leave the C-64 mode—the slight changes in the operating system necessary to implement the exit would reduce compatibility with the C-64. Note also that in C-64 mode, you will not normally be able to access any of the C-128's improved features, such as 80-column video output or high-speed disk drive usage with the 1571 drive.

There are only three slight differences between the C-64 mode and an actual C-64. The VIC-II video graphics chip has two extra registers, #47 and #48 (at locations 53295 and 53296). Register 47, a keyboard control register, uses 3 bits (the 5 highest bits are unused) to scan the extended

key matrix. C-128 mode uses the register to read the numeric keypad, outboard cursor keys, Help, Tab, and other special function keys. To maintain full compatibility, the C-64 mode does not read the registers, but you could write code to read these keys even in C-64 mode.

Register 48 simply contains one bit that selects 1- or 2-MHz clock speeds. You can run many programs in C-64 mode at a 2-MHz clock rate, but you will not be able to access the VIC-II video chip; therefore, the screen will be blank. Additionally, the C-128 cannot communicate with its companion disk drive at this higher clock speed. The modem port and the sound chip do function properly when the system is running at 2 MHz.

The third difference results from having two 64K-byte RAM banks. If you power up in C-128 mode and select bank 0 or 1, that will be the bank of RAM that the C-64 uses. Of course, this "difference" has no effect on compatibility with a stock C-64.

I have experienced no incompatibilities, and I am completely satisfied with the C-64 mode, but I have heard that one program, Commodore's International Soccer, does not function properly because of incorrectly read

(continued)

William Wiese Jr. (118 West 36th Ave., Apt. D, San Mateo, CA 94403) is currently a college student in San Mateo. His interests include amateur radio and classical piano.

sprite definition data. Only programs that use locations 53295 and 53296 (D02F and D030 hexadecimal) will ever cause any small differences. Also, there may be minor incompatibilities due to the use of the new 1571 fast drive, which I discuss below.

C-128 MODE

The C-128 mode supports 80-column text output via an RGB output port, and 40-column text or high-resolution graphics output through a composite video port. The 80-column mode supports escape sequences that toggle true underlining and flashing characters. The 80-column video generator is an 8563, a proprietary chip that is a descendant of the 6845 CRT controller used in the IBM PC.

The 8563 has its own 16K of video RAM that is not part of the C-128's memory map. To access a memory location in this "detached" RAM, you must write the low and high bytes of the desired address to special registers in the 8563 and then read from or write to another special 8563 I/O register.

In the 2-MHz mode, you can only enable the 80-column screen; the VIC-II chip cannot generate video at 2 MHz. In 1-MHz mode, both the 8563 and the VIC-II are operational; you can have two displays running at once. There is an undocumented 640- by 200-pixel graphics mode on the 8563. This graphics mode doesn't support sprites and fancy multicolor graphics, and you cannot access the mode

from BASIC 7.0; you will need a machine code routine or use cumbersome PEEKs and POKEs. A simple graph-plotting program, in listing 1, demonstrates this mode.

In contrast to the slow serial link between the C-64 and the 1541 disk drive, there is a very fast serial link between the C-128 and the new 1571 disk drive. The serial port is fully compatible with the older, slow devices; you can put both slow devices (like printers) and fast devices on the serial bus at the same time. I have not encountered any problems with serial bus lockup.

The C-128 mode uses all the keys on the keyboard. The function keys are predefined with commonly used commands. You can list definitions of all the function keys with the KEY command and redefine them with the KEY# statement.

Listing 1: A demonstration of 640- by 200-pixel graphics.

```

100 DEF FNA(X)=SIN(X)
110 TRAP310:FAST:BANK15
112 WR=526B4:RE=5269B:REM EDITOR ROUTINE ADDRESSES FOR
    8563 REGISTER READ/WRITE
114 FORI=0TO7:MA(I)=2^(7-I):NEXT
120 INPUT "..... MAXIMUM (X)= ";MX
130 INPUT "..... MINIMUM (X)= ";MN
140 INPUT "EXPECTED MAXIMUM (Y)= ";Y2
150 INPUT "EXPECTED MINIMUM (Y) ";Y1
160 IF MN>MX THEN T=MN:MN=MX:MX=T
170 IF Y1>Y2 THEN T=Y1:Y1=Y2:Y2=T
180 VS=200/ABS(Y2-Y1)
190 VO=100-Y2-Y1
200 HS=ABS(MX-MN)/640
210 GOTO 260
215 REM PLOT X AND Y ON 640 X 200 BITMAP
216 REM LINE#220 CALCULATES ADDRESS HIGH & LOW BYTES
217 REM LINE#230 READS BYTE FROM BITMAP
218 REM LINE#240- SETS APPROPRIATE BIT IN BYTE,
    WRITES TO BITMAP
219 REM
220 AD=INT(X)/8+INT(Y)=80:H=AD/256:L=ADAND255
230 SYS WR,H,18:SYS WR,L,19:SYS RE,0,31:RREG BY
240 SYS WR,H,18:SYS WR,L,19:SYS WR,BY OR MA(XAND7),31
250 RETURN
255 REM
260 SYS WR,128,25:SYS WR,113,26:REM HOUSEKEEPING,
    TURN ON GRAPHICS
270 SYS WR,0,18:SYS WR,0,19
280 FORI=0TO 64:SYS WR,0,31:SYS WR,0,30:NEXT:REM
    CLEAR SCREEN
290 FOR X=0TO639:Y=VO-VS+FNA(X+HS+MN):GOSUB220:NEXT
300 GETKEY AS$
310 SYS WR,64,25:SYS WR,240,26:REM RETURN TO TEXT
    MODE
320 BANK15:FORI=0TO64:SYSWR,96,31:SYSWR,0,30:
    NEXT:SYS49191
325 REM SCREEN GARBAGE CLEARED,AND CHARACTER SET HAS
    NOW BEEN RESTORED
330 PRINT ERR$(ER); " ERROR IN ";EL
340 END

```

BASIC 7.0

The C-128 includes BASIC 7.0 in 32K of ROM. It is one of the most comprehensive BASICs I have seen and is upwardly compatible with the C-64's BASIC 2.0. BASIC 7.0 supports constructs such as IF...THEN...ELSE, and DO-LOOP, and you can modify the loop construct with UNTIL, WHILE, or EXIT. In addition to the standard implementation of PRINT USING, BASIC 7.0 also provides PUDEF, which replaces the standard space, dollar sign, decimal point, and comma characters used by PRINT USING with your own set of four special characters.

BASIC 7.0 includes a complete set of graphic commands, including BOX, CIRCLE, and PAINT. One of the graphic modes allows a split graphics/text screen with 5 text lines at the bottom of the screen; you can reset the number from 0 to 25. The screen coordinates can range from 0 to 65535, either in a monochrome or multicolor bit map. A sprite editor lets you create and save images of sprites. The BASIC command MOVSPR controls sprite movement. The WINDOW command takes parameters indicating the window's upper left row and column and lower right row and column. All output then appears there without overwriting text outside that window. Un-

Commodore 128

Company

Commodore Business Machines Inc.
1200 Wilson Dr.
West Chester, PA 19380
(215) 436-4200

Size

C-128: 12½ by 17 by 2 inches
1571 disk drive: 13½ by 8¼ by 3 inches

Components

Processors: 8502 (6502-compatible),
switchable 1 or 2 MHz
Z80A, 2 MHz

Memory: 128K RAM; 16K RAM, video
RAM for 8563 video chip, independent of
main memory; 48K ROM, containing
BASIC 7.0, editor, monitor, and operating
system; 16K ROM, containing BASIC 2.0
and operating system for Commodore 64
mode

Mass storage: 1571 intelligent disk drive;
5¼-inch double-sided double-density
(340K)

Display: 40-column/graphics; 80-column
text only

Keyboard: Commodore 64 layout; 14-key
numeric keypad; 4 auxiliary cursor keys;
8 special function keys

I/O interfaces: One RS-232C 3-line
interface, logical voltage levels; one serial
bus for disk drives and printers; two
joystick/paddle ports; one 8-bit I/O port

Software

BASIC, operating system, monitor in ROM,
C-128 tutorial/demo disk; CP/M version 3.0
operating system and associated utilities

Optional hardware

256K/512K RAM expansion cartridge

Price

C-128 computer: \$299
1571 disk drive: \$279

BASIC PERFORMANCE (IN SECONDS)

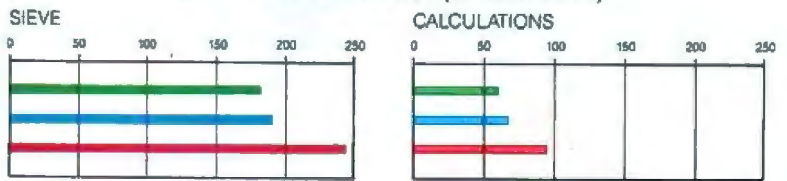

DISK ACCESS IN BASIC (IN SECONDS)

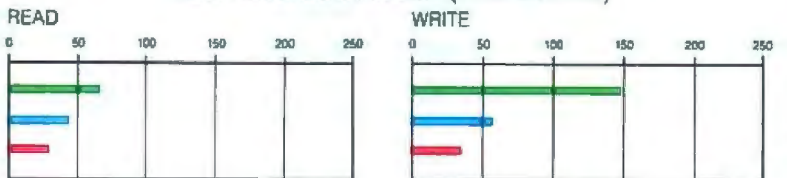

SYSTEM UTILITIES (IN SECONDS)

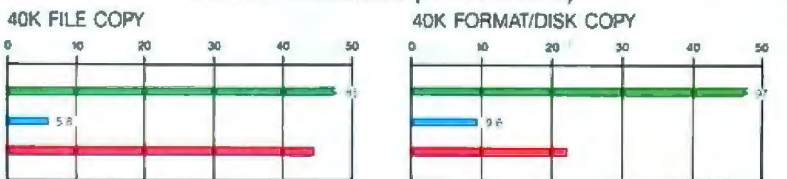

SPREADSHEET (IN SECONDS)

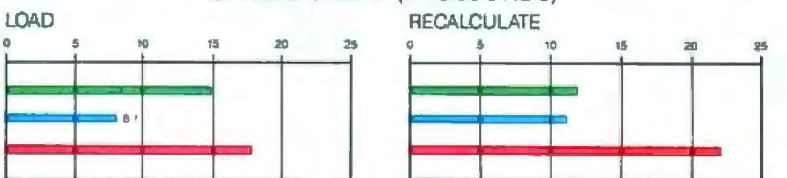

SYSTEM FEATURES

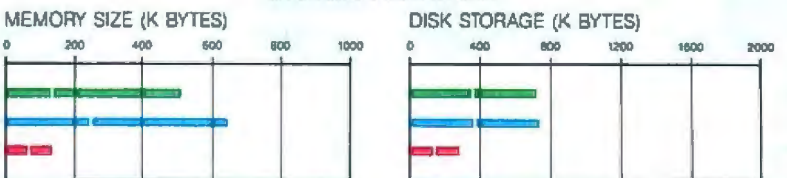

■ COMMODORE 128 ■ IBM PC ■ APPLE IIe

The Sieve graph shows how long it takes to run one iteration of the Sieve of Eratosthenes prime-number benchmark. The Calculations graph shows how long it takes to do 10,000 multiplication and 10,000 division operations using single-precision numbers. (For the program listings, see BYTE's *Inside the IBM PCs*, Fall 1985, page 195.) The graphs for Disk Access in BASIC show how long it takes to write and then read a 64K-byte sequential text file to a blank floppy disk. The System Utilities graphs show how long it takes to format and copy a 40K-byte file using the system utilities. The Spreadsheet graphs show how long it takes to load and recalculate a 25- by 25-cell spreadsheet in which each cell equals 1.001 times the cell to its left. The spreadsheet used was Microsoft's Multiplan. The Memory Size

graph shows the standard and optional memory available for the computers under comparison. The Disk Storage graph shows the highest capacity for a single floppy disk drive and the maximum standard capacity for each system. Tests on the Commodore 128 used BASIC 7.0 and Epyx's release of Multiplan version 1.07. For the Commodore 128, the Disk Write and Disk Read tests were modified to overcome the limitations of BASIC 7.0's 80-character (maximum) input buffer. For the Disk Copy test, we used the DOS Shell program that comes with the 1571 drive. This has a sector-by-sector disk copy program, which includes disk format time. There are many public domain programs that will copy an unprotected disk in 3 to 6 minutes.

fortunately, BASIC 7.0 does not include text and graphic screen dump commands as in Simon's BASIC.

To program music in BASIC on the C-64 you must use the 6581 Sound Interface Device (SID) chip, which requires using a series of obscure POKE commands. By contrast, BASIC 7.0 includes fairly self-explanatory sound statements like VOL, FREQ, DURation, and VC (voice number). Other statements set parameters such as sweep, frequency, waveform, and pulse width. PLAY, TEMPO, and ENVELOPE commands support music programming. Ten "Instruments" are predefined.

The disk-access commands in BASIC 7.0 are excellent improvements. DIRECTORY and CATALOG display the disk's directory without first loading it into memory. Moreover, you will not need to use the OPEN command to send most DOS commands. For example, to erase a disk file on the C-64 you must enter

```
OPEN 15, 8, 15, "S0:filename" :
CLOSE 15
```

To accomplish this same operation in C-128 mode, you simply type SCRATCH "filename". The CONCAT command links two disk files. DCLOSE is an especially important new command. When a BASIC program that accesses the disk drive encounters an error and stops, it often leaves all disk files open. DCLOSE sends an UNTALK command directly to the disk drive, closing all files properly. Remember, if a disk-accessing BASIC 7.0 program crashes, the first thing you should do is type DCLOSE.

There are several other helpful features. When a program stops due to an error, you can press the Help key and a program line. The line, with the offending statement underlined, will be listed. The Pointer function (Y = POINTER (X)) returns the address of the variable used as the argument. DEC and HEX\$ provide conversions between hexadecimal and decimal. You can obtain error trapping via TRAP and the reserved variables ER (error number) and EL (the line number where the error occurred). BANK *n* sets the memory configuration to any of 16 combinations of

RAM, ROM, and I/O.

The SYS command now accepts parameters to be loaded into the 8502 accumulator (.A), .X, and .Y registers before the machine language routine is executed. The companion of the new SYS instruction is the RREG instruction. RREG (read registers) is not mentioned anywhere in Commodore's documentation, but it returns the contents of the 8502's accumulator, *x*, *y*, and status registers to a sequence of BASIC variables. Its format is RREG A, B, C, D. Finally, MID\$ (A\$,5,3) = "WOW" is perfectly acceptable.

The C-128 provides a built-in machine language monitor that supports disassembly, memory dumps, and memory editing and has a one-line assembler. I was unhappy with disassembly because I was used to the Hesmon-64 monitor, which scrolls more easily both backward and forward through a disassembly or memory dump. The C-128 monitor includes a comprehensive base-conversion facility that accepts hexadecimal, octal, binary, or decimal numbers. In addition, the monitor's one-line assembler can accept operands in any of these bases. The monitor supports access to the disk command channel and can display the disk directory without first being loaded into memory. The L (load a program) command allows you to force-load a program into any area of memory by accepting an alternate load address as an optional parameter. Bank selection is easy. Instead of selecting a given bank and then doing all assembly, disassembly, and memory editing there, addresses can be five hexadecimal digits long, with the most significant digit indicating the bank to be used.

One feature that is missing is output diversion to the printer or a disk file. The only way to divert a disassembly, memory dump, or the like to an output device is to exit to BASIC with the X command and use the OPEN command to open a channel to device #4 (the printer) or #8 (the disk), use CMD to cause output diversion, then reenter the monitor and type in your desired commands. On completion of your task, you'll have

to exit to BASIC again, type PRINT# *n* to cause any untransmitted data to be sent to channel #*n*, and then type CLOSE *n*. The C-128 monitor does not support relocation of machine code containing absolute address references.

CP/M VERSION 3.0

The CP/M mode is a competent implementation of the operating system. It provides full CP/M compatibility at about the lowest price I've seen for a complete CP/M system, although I experienced some major problems.

The Commodore 128's third mode supports Digital Research's CP/M version 3.0 operating system, or CP/M Plus. The C-64 cartridge version of CP/M, which did not function with many C-64s, used the 40-column screen and was seriously inhibited by the slow speed of the 1541 disk drive. Furthermore, Borland International's Turbo Pascal is the only commercial software package available to C-64 CP/M users.

The C-128 has a standard CP/M system. It closely emulates a Lear Siegler ADM 31 terminal, whose commands are a superset of the famous ADM 3A terminal. The C-128's implementation of CP/M Plus supports all ADM 3A commands. It can use the slow 1541 drive, but CP/M Plus is designed to use the faster 1571 drive. In addition to the speed increase, the new drive can read many different disk formats, including MFM (modulated frequency modulation) disks that are used in standard 5¼-inch CP/M systems. The operating system can read four different, predefined floppy disk formats: the Osborne 1 single-sided double-density, the Kaypro 2 single-sided (or the Kaypro IV double-sided), the Epson QX-10, and the IBM PC CP/M-86 format. Note, however, that CP/M-86 programs will not run on the C-128: the operating system can merely read and write text or data files to or from the CP/M-86 disk.

The C-128 comes with the CP/M version 3.0 (banked-memory version) operating system on a 1541/1571 formatted disk. The operating system includes several standard utility programs—ED, PIP, REN, DIR, GET, PUT,

(continued)

SOLID CITIZENS.



Presenting four upstanding Citizens who give faithful service above and beyond the call of duty. Citizen™ dot matrix printers, precision-engineered by the people who've become a wristhold word in fine, precision-engineered watches.

The Citizens are sleek, quiet, and reliable. They're extremely easy to use. And feature a unique push-feed paper system that makes paper loading a breeze. What's more, the Citizens are IBM® and Epson®-compatible. Can print graphics.

Can dash out output at 160 cps (40 cps correspondence-quality) or a blazing 200 cps (50 cps correspondence quality). And offer a comprehensive 18-month warranty on *all* parts and labor, including the print head.

The Citizen MSP-10/15 and MSP-20/25. Four solid reasons to stop by your dealer.

And watch what the Citizens can do for you.

For more information, call 1-800-556-1234, Ext. 34.

In California, 1-800-441-2345, Ext. 34.

Or write Citizen America Corporation,

2425 Colorado Avenue, Santa Monica, CA 90404.



© 1986 Citizen America Corporation. Citizen and the Citizen logo are trademarks of Citizen Watch Co., Ltd. IBM is a registered trademark of International Business Machines Corporation. Epson is a registered trademark of Epson Corporation.

Inquiry 65

The C-128 uses the extra clock line on the serial bus to help make data transfer much faster.

SUBMIT, etc., as well as a comprehensive HELP program and file. For \$19.95, you can obtain additional CP/M version 3.0 documentation and programs from a joint Commodore/Digital Research offer. After a two-and-a-half-month wait, I received a complete user's and programmer's manual relevant to generic CP/M version 3.0, not the C-128 implementation specifically.

I also received two disks with, among other things, the SID debugger and its associated utilities (histogram generator and the like), and both the MAC macro assembler and the RMAC (the R is for relocatable) macro assembler. I especially like SID, which seems more powerful than the debugger/monitor packages for the C-64 and C-128 modes. These disks also contain several .LIB and .ASM files used to produce a customized operating system. One contained terminal emulation routines for a variety of standard terminals.

The banked-memory version of CP/M version 3.0 allows 59K bytes of transient program area to reside in RAM Bank 1, while much of the operating system resides in RAM Bank 0. Bank 0 also stores the console command processor, which interprets command-line entries. Storing the CCP in RAM makes it available without time-consuming disk access each time the system is "warm-booted." Extra RAM banks in the 256K/512K RAM expansion cartridge can function as a RAM disk. The version of CP/M Plus currently being shipped does not support RAM disk usage, although future versions probably will.

C-128 CP/M uses both the Z80 and 8502 processors. The Z80 executes

most of the CP/M BIOS functions. The 6502-compatible 8502 handles I/O to and from the serial modem port, the serial port connecting the disk drive(s) and printer, and the keyboard. As a result, the BIOS is split into chunks: BIOS80 contains Z80 code, and BIOS85 contains 8502 code.

The C-128 CP/M mode does not support a standard UART chip for RS-232C serial I/O. Instead, the 8502 is switched in to assemble serially received bits into a data byte, or to break down a data byte into a bit stream. 8502 software handles parity and stop bits. Commodore emulates the 6551 UART chip in software, but the emulation can only support 1200 bits per second, while the real 6551 can support communication rates up to 19,200 bps. I consider this one of the more serious limitations of the C-128—what if a user wants to communicate with a mainframe or quickly dump data to a printer buffer?

There seems to be no compatibility problem with Commodore's implementation of CP/M Plus. Most any program that functions under CP/M Plus on another machine should function properly on the C-128, although some programs that run under the older CP/M version 2.2 may not run under CP/M Plus. The WordStar program bundled with the Kaypro left a set of "01" characters on the screen. An Osborne-bundled WordStar functioned perfectly.

Note that the August 1985 version of CP/M Plus cannot use the modem port. I was unable to use a simple terminal program that ran properly on Osbornes and Kaypros. Other C-128 users have reported occasional lock-ups during attempts at RS-232C communications; I experienced no such problems myself. Commodore says it is now shipping a bug-free CPM.SYS program that not only supports the modem port but also is able to use the 256K/512K RAM expansion cartridges as speedy RAM disks. They have promised to send the disk to all registered C-128 owners, but as yet I have received nothing from them.

THE 1571 DISK DRIVE

Commodore uses an intelligent (microprocessor-controlled) disk drive

connected via a serial version of the IEEE-488 bus. The 1571 drive has a built-in power supply; the unit measures 13½ by 8¼ by 3 inches. It is enclosed in a sturdy plastic enclosure that is the same off-white color as the C-128. The drive mechanism is fairly quiet, and I've had no alignment problems with it after several months of intensive use. There are two small switches on the rear panel of the 1571 that allow you to change the drive's device number from 8 to 9, 10, or 11.

The 1541 drive, the companion of the C-64, is slow and frequently falls out of alignment. The 1571 drive is almost 100 percent compatible with the old 1541. Used with a C-64 (or C-128 in C-64 mode), the drive operates at the same slow speed as the 1541. However, the C-128 uses the extra clock line on the serial bus to help make data transfer much faster, and faster DOS routines are used as well. For example, formatting an ordinary single-sided (683 sectors) disk takes 79 seconds under the old DOS. Under the new DOS (brought up when the 1571 senses the computer has a fast serial bus), formatting a double-sided (1366 sectors total) disk takes only about 40 seconds. Loading a 158-block program using a 1541 (or a 1571 in 1541 mode) takes 105 seconds. With the 1571 in its fast mode, the same program loads in only 10 seconds. There are public domain programs that convert an ordinary Commodore sequential file to a 1571 CP/M file. Unfortunately, they are quite slow. A 40K file might take over half an hour to convert.

A DOS command selects 1541 mode or 1571 mode. In the slow 1541 mode, you can select either head in order to read data from either side of a double-sided disk. (Note that you cannot read the data by flipping the disk because of the reversed direction of rotation.)

Besides reading GCR (group code recording) format disks—that is, ordinary Commodore disks—the 1571 can also read MFM format disks. Although Commodore CP/M Plus only supports Osborne, Kaypro, Epson, and IBM CP/M-86 formats, there is no reason why the 1571 could not read

(continued)

With all these SoftLogic Solutions, you could run out of problems.

Now there's a whole family of low-cost, easy to use Softlogic software for the IBM PC, XT, AT, and compatibles. They'll save you time, aggravation, and lots of money. Got a problem? Check out these Softlogic Solutions.



Software Carousel™—The easy way to move from one program to another.

What a hassle. Saving, exiting, loading, retrieving—just to move from one application to another. With Software Carousel, you can keep up to ten programs loaded and ready to run. Best of all, you can use all your memory in each and every one. Supports AboveBoard™ and RAMpage™, too.

Disk Optimizer™—Speeds up your disk by cleaning up your files.

You may not notice, but your hard drive is getting slower. Because your files keep getting fragmented and scattered on your disk. Reading, writing, everything takes longer, because your disk is working harder. Disk Optimizer puts back the speed by putting your files back in one piece—where they belong.



Cubit™—Packs more of your data onto less disk space.

Filling up your hard disk again? Don't run out and get a bigger drive. Get Cubit, and get up to twice the storage capacity from the drive you already have. Cubit compresses and decompresses word processor, spreadsheet, database, all kinds of files—quickly, safely, invisibly.

DoubleDOS™—The multitasking software that takes less of everything.

You can spend more money, load more memory, and read more manuals with systems like Top-View™ or Windows™. Or you can get DoubleDOS, the amazingly simple concurrent software environment that lets you and your computer each work on different tasks at once. Nothing could be easier. And nothing costs you less.



Put your problems behind you. Order these SoftLogic Solutions today.

\$49⁹⁵*
Each

*Plus \$5.00 shipping & handling.

So why put up with problems? Especially when you can get dependable SoftLogic Solutions for just \$49.95* each. Ask for SoftLogic products at your computer dealer. Or order directly from SoftLogic Solutions by calling 800-272-9900 (603-627-9900 in New Hampshire).

Order today:
800-272-9900

SoftLogic Solutions, Inc.
530 Chestnut Street
Manchester, NH 03101
800-272-9900 (603-627-9900 in NH)

SOFTLOGIC
SOLUTIONS

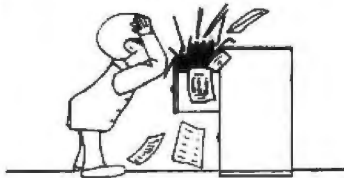
Does **YOUR** disk Look Like**THIS?**

Let

H.D. Tuneup cleanup your act!

H.D. Tuneup tunes your disk file system, making it better than new. File loads speed along like new. Directory searches are faster than new.

H.D. Tuneup reallocates all of your files to be contiguous. Each file is placed in its proper location, adjacent to its neighbors in the directory.

Disk operations run faster when your files have been Tuned.

H.D. Tuneup relocates your sub-directories into one area of your disk, as close to the root as possible. All deleted entries are actually removed.

Your drive head moves less from directory to directory than when your disk was new. TREE/F will fly when listing all of your files.

H.D. Tuneup requires IBM PC/XT/AT compatibility, 196k, and DOS 2.x/3.x. Fixed disks up to 32mb may be tuned, along with any 5.25" diskette.

NOT COPY PROTECTED!

ONLY \$39.95 plus \$3.00 S/H

SofCap Inc.
P.O. Box 131
Cedar Knolls, N.J. 07927

Visa (201) 386-5876 M/C

N.J. residents add 6% sales tax.

**For the best performance
from your disk
TUNE IT UP!!**

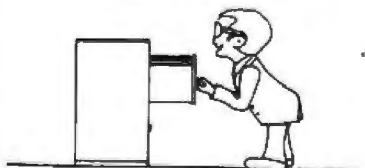

Visa, Master Card, Checks, Money Orders, or
COD only.

REVIEW: THE COMMODORE 128

any MFM double-sided double-density disk.

Machine language programmers will like the 1571 because of the extra, unused 2K bytes of RAM. Because the 1571 reads GCR format disks, it seems possible that routines could be stored in this auxiliary RAM to read Apple DOS 3.3 and ProDOS disks.

When a C-64 (or a C-128 in C-64 mode) runs programs that have drive-controller-resident subroutines, there may be some slight incompatibilities between the 1541 and the 1571. I have not had any trouble with heavily copy-protected programs whatsoever. However, a popular utility for C-64 users, Datamost's Kwik-Load, sometimes seems to lock up the computer until the drive is turned off and then on again. I have found that, upon entering C-64 mode, typing OPEN 15,8,15, "U0>M0": CLOSE 15 will eliminate most compatibility problems.

The 1571 drive's instruction manual is an excellent one for the new and intermediate-level user, but not for experienced programmers. There are no memory maps, and the description of the U0 commands that invoke special DOS functions merely tabulate the commands and their error returns. No instruction in using these commands is offered at all, leaving the user to attempt trial-and-error programming or to disassemble Commodore's CP/M Plus and struggle to find out more about the multi-format capabilities and burst-mode (5K bytes per second) data transfer.

THE OVERALL SYSTEM

The off-white Commodore C-128 measures only 12½ by 17 by 2 inches because it does not contain its own power supply. The external supply, which measures 6 by 4 by 3¼ inches, supplies much more power than a C-64; it's rated at 5 VDC, 4.3 amps and 9 VAC, 1 amp. The C-128 power supply is not sealed and potted; you can consider it user-serviceable. There is external access to the fuse, too—a real plus.

Along the side of the C-128 are two joystick ports, a reset switch, a rocker-style power switch, and the power connector. The reset switch works in all three modes. The standard 9-pin

"D" game ports also accept paddle and trackball inputs; one also allows a light pen hookup.

The user port, expansion port, serial port, and composite video port are all the same as on the C-64. However, the RF modulator seems significantly more stable on the C-128 than on the C-64; I have experienced no rippling or sparkle when using a television. A 9-pin "D" connector supplies 80-column RGB video output. In addition to a Commodore monitor, you can drive any good-quality NTSC composite monochrome monitor simply by connecting it to the "monochrome" pin (7) and the ground pin (1 or 2) on the RGB output connector. I use a Taxan KG-12 amber composite monitor for both 40-column/graphics and 80-column text work. The text display is extremely sharp and easy to read.

The alphanumeric portion of the keyboard resembles the C-64 layout. The four function keys above the numeric keypad are in a horizontal row. The top row also contains Escape, Tab, Alternate, Caps Lock, Help, Line Feed, 40/80 Display, No Scroll, and four cursor keys. The keys have a rather soft touch, but I could tolerate the general keyboard arrangement and "feel." Some may find that the three keys separating the Return key from the L key make typing awkward. The numeric keypad, though, is arranged perfectly.

DOCUMENTATION AND SUPPORT

There is good documentation provided with the system. A large system guide and a demonstration/tutorial disk explain BASIC 7.0 well and supply many example programs.

The C-64 mode is covered properly, but the CP/M coverage is skimpy; it is enough to get a CP/M program up and running and to do some primitive disk operations, but it is far from being complete. The Commodore 128 programmer's reference guide is as yet unavailable. For the moment, there is a summary of monitor commands and a few very primitive memory maps that serve only to describe the general layout of the system.

Unfortunately, Commodore has replaced its toll-free help line with a toll

(continued)

PERFORMANCE

THAT IS OUT OF THIS WORLD...



\$389⁰⁰

**MODEL 2000 20MHz
DUAL TRACE**

\$549⁰⁰

**MODEL 3500 35MHz
DUAL TRACE DELAYED SWEEP**

...AT A DOWN TO EARTH PRICE

At last! Truly affordable test equipment with no compromise in design, and features you would expect to find only on oscilloscopes costing hundreds of dollars more! JDR Instruments presents two, new, high-performance models backed by a two year warranty and technical support which is only a phone call away. Perfect for the technician or advanced hobbyist, both models feature Dual Trace capability and a variety of operating and triggering modes, including CH-B Subtract and X-Y operation.

MODEL 2000 has a 20 MHz bandwidth and 20 calibrated sweeps ranging from .2s to .2 μ s. A convenient built-in component tester provides additional diagnostic power.



INCLUDES TWO HIGH QUALITY
1x, 10x TEST PROBES

MODEL 3500 features a 35 MHz bandwidth and exceptional 1mV/DIV sensitivity. Delayed sweep and variable holdoff allow stable viewing of complex waveforms.

ORDER TOLL FREE
800-538-5000
800-662-6279 (CA)



JDR INSTRUMENTS

1224 South Bascom Avenue
San Jose, California 95128 (408) 995-5430

number that seems to be perpetually busy. Commodore's software division does publish the *C-128 Personal Computer Technical Notes*, which costs \$20, but the manual only seems to be available to writers and established software developers. It gives comprehensive RAM memory maps, advanced memory management information, more CP/M information, and a discussion of external RAM car-

tridge usage. It doesn't include much on programming the 8563 video chip or even a memory map of useful sub-routines in the BASIC 7.0 interpreter, monitor, or kernel. No 1571 disk drive programming information is included whatsoever.

SOFTWARE

There is already a good amount of software for the C-128. Timeworks has

Word Writer 128, Data Manager 128, and Swiftcalc 128, programs that take advantage of the extra RAM and the 80-column display. Batteries Included has a C-128 version of its Paper Clip word processor, and Epyx has a C-128 port of Microsoft's Multiplan.

Skyles Electric Works has released Blitz!-128, a full BASIC 7.0 compiler, but it only compiles to an intermediate p-code. Abacus Software has released a BASIC 7.0 compiler that generates not only p-code but true 8502 native code. This BASIC 7.0 compiler also features an optimizer and has a special high-speed floating-point library module. In addition, Abacus has released a full Jensen and Wirth Pascal compiler and a full Kernighan and Ritchie C compiler that both have extensions to support graphics and sound and generate native 8502 code.

BENCHMARKS

The benchmark results are shown on page 271. The Commodore 128 performed respectably. Figures given are for fast mode operation. The disk operations test used the 1571 disk drive; use of the 1541 will substantially decrease performance. Disk read/write performance can be substantially increased by appropriate record deblocking.

In 1-MHz mode, some C-128 BASIC programs will actually run slower than their C-64 counterparts because BASIC 7.0 uses 2-byte tokens for some statements, requiring an extra "fetch" by the interpreter. Overall performance is generally higher than with BASIC 2.0, due to much-improved string-handling routines and the virtual elimination of "garbage collection" time delays.

CONCLUSION

I am favorably impressed by the Commodore 128 system; I enjoy using my C-128, and I'm sure I'll use it for a long time. However, it does have some flaws that need correction. With good documentation for both the C-128 and the 1571 drive, a real UART (at least under CP/M), and software drivers to allow IBM PC-DOS disk compatibility, it would be a really superb system. ■

ALL OF OUR PRODUCTS ARE OF THE FAMILY PART OF THE SAME TREE



COMPATIBLE, DEPENDABLE & AFFORDABLE

"...masterpiece of IBM imitation ...minor masterpiece of the circuit designer's art."



MEGA-BOARD-XT™

Lee Konowe, American Software Club, Ridgefield, Ct.

"The most compatible IBM clone I've ever worked with."



SWITCHING BUFFER

Winn L. Rosch, Cloning Your Own PC, PC Magazine, July 10, 1984.



MEGA-KIT

■ **MULTIPLE INPUT/ DUAL OUTPUT SWITCHING BUFFER**
4 computers in—2 printers out
• Automatically routes computer to printer • Internal buffering 64K or 256K

■ **MEGA-BOARD-AT™**
80286 CPU • Our own DTC-AT-BIOS

■ **MEGA-BOARD-XT™**
The industry standard with our DTC-XT-BIOS

■ **MEGA-NET™**
Token-passing ring LAN • IBM NETBIOS Compatible

OEM QUANTITY PRICING AVAILABLE ON REQUEST

XT Bare Board	59.95
XT Assembled 256K	299.95
Mega-Case	69.95
Mega-Kit	750.00
DTC-XT-BIOS	29.95
Power Supply	89.95
Switching Buffer	399.00

AT-BIOS and XT-BIOS licensing.
IBM is a registered trademark of International Business Machines Corporation.

Display Telecommunications Corporation

8445 Freepoint Parkway • Suite 445 • Irving, TX 75063
1-800-227-8383 • For Technical Calls Only: 1-214-929-1382
TELEX 5106000176 DTC UD

Thanks for making us 1986 Small Business Exporter of the Year for the state of Texas.

Aztec C ... The Best C

Frees the genius in you

You've got a great idea . . .

. . . you're ready to write your programs.

You don't want to be sidetracked by all the paperwork. With Manx Aztec C and the ingenious **make** function, your creative processes won't get bogged down in program administration and housekeeping. Manx Aztec C has the most sophisticated, hardworking program administrator available to you. Once you've described your project, adding new features or enhancements is simple. You never have to concern yourself with the repetitive, tedious task of rebuilding your systems.

The development process moves quickly. Compiles, assemblies, link edits . . . all finish in record time.

Manx Aztec C is the fastest, most efficient C development system in the industry. Benchmarks show it . . . reviews commend it . . . users praise it.

You're ready to test the program. You're ahead of schedule. The Manx Aztec C Source Level Debugger shows you the exact C language statement giving you a problem. You fix the problem quickly . . . you're still ahead of schedule.

You've got some time for fine tuning. The Manx Aztec C Profiler examines your program, tells you where the slow spots are and validates your test procedure. A few changes and it's exactly what you wanted.

You've made it!

Aztec C is available for MS-DOS/PC DOS. Call for details on Macintosh, Amiga, Apple II, CP/M-80, CP/M-86, TRS-80, ROM and others.

To order, or, for information

Call Today

1-800-221-0440

In NJ or outside the USA call

(201) 542-2121

30-day satisfaction guarantee. Special Discounts are available to professors, students, independent developers, and on a "trade-in" basis. Site licenses.

MANX

Manx Software Systems
One Industrial Way
Eatontown, NJ 07724

" . . . a superb linker, a profiler, an assembler, and a set of development utilities are only the beginning of this package . . . performed admirably on the benchmarks, with short compile times and the best link times in this review . . . includes the most professional make utility . . . documentation is clear and complete. There is no doubt that this is a valuable and powerful programming environment." **Computer Languages Feb. '86**

" . . . execution times are very good, close to the best on most tests . . ." **PC Tech Journal Jan. '86**

" Easily one of the fastest compilers overall . . . library provides a lot of flexibility . . . generates small .EXE files." **Dr. Dobbs Journal Aug. '85**

C'Prime (Compiler, Assembler, Linker)	\$ 99.
Aztec C 86-d Developer's System	\$299.
Aztec C 86-c Commercial System	\$499.
PC ROM (8086, 68000, 8080, or 6502)	\$750.

Third Party Software for Aztec C: HALO, PHACT, C-tree, PRE-C, Windows for C, PC-lint, PANEL, Greenleaf, db Vista, C-terp, Plink-86, FirstTime, C Util Lib, and others.

NOTES

Aztec C Evaluation

FEATURES

- C Compiler
- Overlay Linker
- Librarian
- 8086 Macro Assembler
- Source for Library Routines
- Make, grep, diff, utilities
- Source level debugger and profiler.
- vi editor
- Pos functions, UNIX, and screen libraries
- Math, 8087/80287, and sensing libraries
- Intel hex utility
- Mixed memory models
- Intel object utility
- detailed documentation
- year of free updates

OPTIONS

ROM Support for 68009/6502, 8080/280 Series
Cross development to Mac, Amiga, Apple
CP/M-80 and others

*Call
MANX
800-221-0440*

MS is a registered TM of Microsoft, Inc. CP/M TM DRI, HALO TM Media Cybernetics, PANEL TM Roundhill Computer Systems, Ltd., PHACT TM PHACT Assoc., PRE-C, Plink-86 TM Phoenix, db Vista TM Raina Corp., C-terp, PC-lint, TM Gimpel Software, C-tree TM Faircom, Inc., Windows for C TM Creative Solutions, Apple II, Macintosh TM Apple, Inc., TRS-80 TM Radio Shack, Amiga TM Commodore Int'l

WHEN YOU NEED ACCESS TO FULL MEMORY, STRUCTURE, COMPATIBILITY WITH GW- & PC-BASICA, OR WHEN YOU NEED THE POWER AND FLEXIBILITY OF C OR PASCAL...



You need BetterBASIC.

The BetterBASIC compiler has become the standard by which other BASICs are evaluated. BetterBASIC is completely compatible with GW-BASIC and PC-BASICA when running on IBM PC's and true clones. You can load and run your existing BASIC programs in BetterBASIC. It uses standard MicroSoft syntax and gives you more than 150 additional statements such as XREF, DEFINE WINDOW, MAKE MODULE, and PROCEDURE. In benchmark comparisons, BetterBASIC is five times faster than interpreted BASIC. There is optional 8087/80287 math chip support, and an optional Runtime System to create stand-alone

EXE. files. BetterBASIC is not copy protected. Technical support is provided for all registered users.

See for yourself why Dick Aarons of *PC Magazine* said "BetterBASIC may be the best of all BASIC programming worlds" and selected BetterBASIC as "Editor's Choice" (Oct. 29, 1985).

BetterBASIC	\$199
8087/80287 Math Chip Support	\$99
Runtime System	\$250
Sample Disk with Tutorial	\$10

Ask your dealer or call to order:

1-800-225-5800

In Canada, call 416-469-5244

Summit Software Technology, Inc.™

106 Access Rd. Norwood, MA 02062

BetterBASIC is a registered trademark of Summit Software Technology, Inc. IBM PC, XT, AT are registered trademarks of International Business Machines Corp. Microsoft is a registered trademark of Microsoft Corp. Tandy is a registered trademark of Tandy Corp.

Better BASIC™

Inquiry 341

**FREE
BetterBASIC Demo Disk**
Take this coupon to your nearest
Radio Shack Computer Center or
Radio Shack Computer Center Plus.
Offer expires September 1, 1986



THE ITT XTRA XP

BY JOHN D. UNGER

The ITT XTRA XP is not simply another IBM PC AT clone; it is much more compatible with the IBM PC and PC XT, and it has hardware and software enhancements that make it capable of operating, in some cases, even faster than the AT. Although the XP will not accept cards made with a 16-bit data bus (such as those used in the AT), and while the unit does not have a 1.2-megabyte drive, the microprocessor is the 16-bit Intel 80286 running at 6 megahertz, the same clock speed as the PC AT. With a few keystrokes, you can also switch it to work at 4.77 MHz, which makes the XP compatible with those software applications sensitive to timing loops designed around that clock rate.

The central processor operates with zero wait states, thanks to fast dynamic memory chips used in RAM. Moreover, a disk-caching scheme, included in the operating system, markedly speeds up file transfers and other disk I/O tasks. Like an enhanced IBM PC AT, the XTRA XP comes standard with a 20-megabyte hard disk and 512K bytes of RAM. Its suggested list price is \$4595.

HARDWARE

Apart from insignificant cosmetic differences, the keyboard, monitor, and the external appearance of the XTRA XP are identical to the ITT XTRA that I reviewed in the April 1985 BYTE. The footprint is small, and you can place the 14- by 15.5- by 5.5-inch system unit on its side.

There are two versions of the XP. Each has a 360K-byte floppy disk

A fast IBM PC AT clone with hardware and software enhancements



drive and 512K bytes of RAM. The Model III has a 10-megabyte drive. I reviewed the Model V, which features a 20-megabyte hard disk. The unit had the maximum of 640K bytes of RAM.

The keyboard is similar to the IBM PC XT's but has LEDs for both the Caps Lock and Num Lock keys, and the left-hand Shift key is located just to the left of the Z key. I found the keyboard a bit stiff but comfortable to use. The keys have no audible feedback, but there is a definite "break" when they are pushed.

INTERNALS

The XP's motherboard can hold 640K of RAM. This RAM connects to the microprocessor via a 16-bit data path, which speeds up I/O operations.

Eighteen 256K by 1-bit DRAM chips provide the standard 512K bytes of memory. You can add eighteen 64K by 1-bit chips to empty sockets on the motherboard to bring the total system memory to 640K. The DRAM chips have to be the faster 150-nanosecond ICs because the CPU on the XP operates with zero wait states.

Inside the XP are five full-length slots. In the review unit, a disk controller and ITT's color graphics display board occupied two of the five slots. The 360K-byte floppy disk drive on my XP had a cable running from the motherboard to its controller bus, but the hard disk was connected to the board installed in slot 1 of my XP.

The expansion slots will accept only 8-bit expansion boards made for the PC or XT; the XP has no slots that are configured with the 16-bit data paths used for the AT expansion bus. The XP has an RS-232C serial port and a Centronics-compatible parallel port on the motherboard, so you will probably not find the limit of three empty slots a serious shortcoming. The ITT XTRA XP does not include an internal clock with a battery backup, but you can get one on ITT's optional integrated graphics controller card.

ITT offers an optional memory-expansion board that will add up to 2 megabytes of memory to the computer. However, the extended mem-

(continued)

John D. Unger (P.O. Box 95, Hamilton, VA 22068) is a geophysicist for the U.S. government who uses computers to study the structure of the earth's crust in earthquake-prone regions.

The benchmarks showed that the disk-caching program more than made up for the slower disk-access time.

ory is available only to the disk-caching, print-spooling, or RAM disk programs that ITT supplies with the operating system software, because the address area of the add-on RAM is above the 640K bytes of RAM used by MS-DOS.

The power supply is rated at 155 watts, which should be adequate for running all add-on cards that you need. Unfortunately, the cooling fan mounted in the power supply is rather loud and tends to be annoying.

ROM parity checking takes about 10 seconds with 640K of memory installed. A DIP switch on the motherboard allows you to disable the test. Another DIP switch enables a screen-blanking routine that will function automatically after 15 minutes of inactivity. In addition, ROM contains a menu-driven set of diagnostic tests similar to those that IBM supplies in its software. You can access the tests at any time by pressing Alt-Ctrl-Esc. The same keystrokes also activate a powerful utility monitor program. You can examine and modify memory and

floppy disk parameters (such as head settle time and motor startup time).

MONITOR AND DISPLAY

The review unit contained a color graphics display card and an optional RGB color monitor rather than the standard monochrome monitor. The display appeared to duplicate the IBM color graphics display exactly, although I find text displayed with this combination, especially the coarse 8-by-8-pixel characters, difficult to use for long periods of time, even with contrasting color combinations. On the other hand, the color graphics are impressive and clear and appear to be fully compatible with the IBM PC. If your main application for the XP uses text or numerical data, I would suggest installing ITT's integrated graphics board, which offers higher-resolution characters. The board supports IBM-type monochrome and color display modes, Lotus-compatible monochrome graphics, and extended color graphics modes. It also adds serial and parallel ports and a real-time clock.

STORAGE

ITT offers only a 360K double-sided double-density floppy disk drive and completely ignores the 1.2-megabyte high-density AT-type drive. You may particularly miss using a 1.2-megabyte drive to back up the hard disk.

The 20-megabyte hard disk was initially disappointing. The drive itself operates fairly quietly, but early

benchmarks indicated that the average access speed of the drive was in the same range as the XT's 10-megabyte drive (80 to 90 milliseconds). This is significantly slower than the 20-megabyte drive in the IBM PC AT, which has a 40-millisecond access time. However, the apparent access time of the hard disk decreased tremendously when I began using ITT's disk-caching program, FXPCOM.

SOFTWARE

The benchmark tests showed that the disk-caching program more than made up for the slower disk-access time. Disk caching is a technique that allocates RAM as a buffer for all disk I/O requests from the system. FXPCOM monitors the most accessed files and keeps them in RAM along with other information, such as the directories of the hard and floppy disks on the system. Once invoked, the cache program operates completely in the background, although with a big time savings (see table 1), particularly if you are using a floppy disk drive. FXPCOM also provides a print buffer.

You can vary the amount of RAM available for the disk cache, although the caching program will automatically use extended RAM (more than 640K bytes) if you install it on your XP. Unfortunately, you will have to reboot if you want to change the amount of RAM used by the program, a consideration if you need to reclaim that area of RAM. You can easily disable FXPCOM, but doing so will not reclaim the RAM that was assigned to disk caching and print buffering.

Like many RAM disks, you can install ITT's as a device driver with CONFIG.SYS. However, ITT's RAM disk has two interesting options. You can set up multiple RAM disks and you can use the memory area above 640K bytes as a RAM disk. ITT's optional memory-expansion board makes it possible to have up to 2 megabytes of above-board memory to use for the RAM disk.

The XP also comes with ITT's version of MS-DOS 2.11 and ITT Advanced BASIC 2.0, which is essentially GW-BASIC. In addition to the nor-

(continued)

Table 1: The size of the memory allocated to disk caching affects the speed of copying files from one area of the hard disk to another. I made successive copies of an 80K-byte ASCII source file after deleting the target file created during the previous iteration. The time for making the first copy is fairly constant, but subsequent copies become progressively faster as the amount of allocated RAM increases. Some of the trends are easy to decipher, but others are less easily explained. The apparent slowdown around 128K bytes may be due to some interaction with print buffering. All tests were run with the microprocessor in its 6-MHz mode.

0	16K	32K	64K	128K	256K	384K	512K
7.4	7.4	4.7	5.4	5.6	5.2	5.3	5.3
7.6	7.6	4.6	4.7	5.8	2.7	1.2	0.9
7.7	7.6	4.7	4.6	6.0	2.5	1.0	0.9
7.6	7.3	4.7	4.4	5.8	2.0	1.0	0.9

ITT XTRA XP

Company

ITT Information Systems
2350 Qume Dr.
San Jose, CA 95131
(800) 321-7661

Size

14 by 15.5 by 5.5 inches

Components

Processor: 80286 at 4.77 and 6 MHz (switchable under software control or from keyboard); CPU operates with no wait states in 6-MHz mode; socket for 80287 coprocessor

Memory: 512K of zero-wait-state dynamic RAM (standard) expandable to 640K on motherboard; 64K ROM (BIOS, bootstrap, and self-test); 4K text video RAM on monochrome board; 16K graphics video RAM on color graphics board

Mass storage: One 360K-byte DS/DD 5¼-inch drive; 10-megabyte hard disk (Model III); 20-megabyte hard disk (Model V)

Display: 80 columns by 25 lines (monochrome); graphics: text—80 by 25 by 2 colors; text—40 by 25 by 16 colors; 640 by 200 by 2 colors; 320 by 200 by 4 colors

Keyboard: Detached 84-key QWERTY

Expansion capability: Five card slots (IBM PC bus); hard disk controller and color graphics card each use a slot

I/O interfaces: One DB-25P Centronics-compatible parallel printer port; one RS-232C serial communications/printer port; speaker (accessed from BASIC or assembly language)

Documentation

User Guide, ITT Advanced BASIC manual, ITT DOS 2.11

Price

Model III: 512K, single floppy disk drive, 10-megabyte hard disk: \$3995
Model V: 512K, single floppy disk drive, 20-megabyte hard disk: \$4595

(Note: Monochrome units include monochrome monitor and monochrome expansion board)

BASIC PERFORMANCE (IN SECONDS)

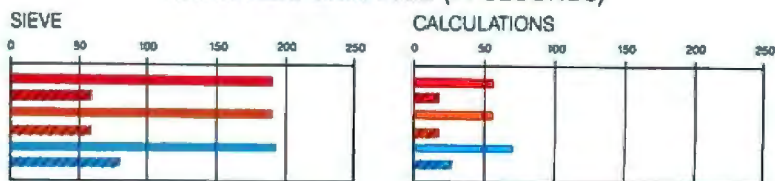

DISK ACCESS IN BASIC (IN SECONDS)

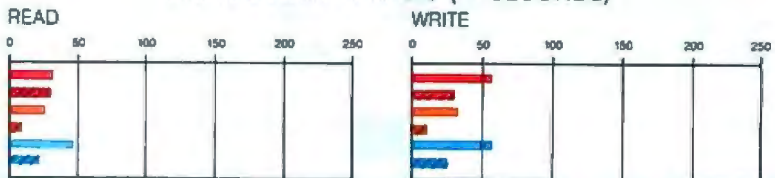

SYSTEM UTILITIES (IN SECONDS)

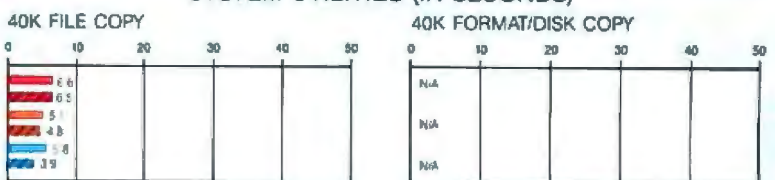

SPREADSHEET (IN SECONDS)



SYSTEM FEATURES

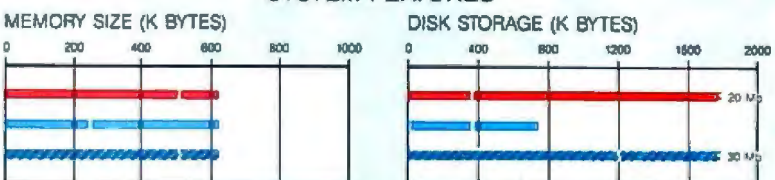

- ITT EXTRA XP 4.77 MHz
- ITT EXTRA XP 4.77 MHz WITH FXP
- ITT EXTRA XP 6.0 MHz
- ITT EXTRA XP 6.0 MHz WITH FXP
- IBM PC
- IBM PC AT

The Sieve graph shows how long it takes to run one iteration of the Sieve of Eratosthenes prime-number benchmark. The Calculations graph shows how long it takes to do 10,000 multiplication and 10,000 division operations using single-precision numbers. (For the program listings, see BYTE's *Inside the IBM PCs*, Fall 1985, page 195.) The graphs for Disk Access in BASIC show how long it takes to write and then read a 64K-byte sequential text file to a blank floppy disk. The System Utilities graphs show how long it takes to copy a 40K-byte file from the hard disk to the floppy disk. The Spreadsheet graphs show how long it takes to load and recalculate a 25- by 25-cell

spreadsheet in which each cell equals 1.001 times the cell to its left. The spreadsheet used was Microsoft's Multiplan. The Memory Size graph shows the standard and optional memory available for the computers under comparison. The Disk Storage graph shows the highest capacity for a single floppy disk drive and the maximum standard capacity for each system. Tests on the ITT XTRA XP used ITT DOS 2.11, ITT Advanced BASIC 2.0 (GW-BASIC), Multiplan 1.10, and ITT's FXPCOM disk-caching program, which was set up with 128K bytes of RAM. The XP had one 360K-byte floppy disk drive, a 20-megabyte hard disk drive, and 640K bytes of memory.

mal utility programs. ITT DOS 2.11 includes an adequate but simple asynchronous communications program.

BENCHMARKS

The XP is fast! Given the disk-caching software and the switch between 6 and 4.77 MHz. I used the benchmarks to test many system permutations (see page 283). When it operates at the "slow" clock rate, the computer's

performance is slightly better than that of the IBM PC XT. Performance is dramatically improved when the processor is running at 6 MHz. Pure calculation benchmarks like the single-precision calculations or the Sieve of Eratosthenes ran in two-thirds to three-fourths of the time that they take on the IBM PC AT. With the FXPCOM disk-caching program running, writing to and reading from the

floppy disk with BASIC takes only half the time of the AT.

DOCUMENTATION AND SUPPORT

You get three manuals with the XP—a user guide, a description of ITT DOS 2.11, and an ITT Advanced BASIC manual. The user guide contains complete and clear descriptions on how to set up and get the XP running. It is geared toward novices, but it also contains sections for advanced users on organizing the hard disk, using a RAM disk program, and using the disk-caching software. The DOS manual is thorough and well detailed. ITT's BASIC manual is also excellent.

The XP comes with a 90-day warranty; the dealer from whom you purchase the machine will be able to handle problems. The built-in ROM diagnostics should help both the owner and the service personnel to pinpoint difficulties.

CONCLUSION

The ITT XTRA XP is essentially a hardware upgrade of the IBM PC XT. The combination of zero-wait-state RAM and disk caching put the XP ahead of the IBM PC AT in virtually all the benchmarks while maintaining high compatibility with the PC and XT. It is a true high-performance microcomputer with more speed and power than the PC, and with its disk-caching software installed, the XP can easily outperform the AT at 6 MHz.

There are drawbacks, however. It is uncertain, for example, if the 80286 in the XP can be operated in its so-called "protected" mode, which would allow it to support a 16-mega-byte real address space and a virtual storage area up to one gigabyte (1 billion bytes). This limitation would prohibit you from using the multiuser XENIX operating system or future AT operating systems that take advantage of this feature of the 80286.

ITT claims 100 percent IBM PC compatibility in 4.77-MHz mode, and I had no difficulty running any software, even in the 6-MHz mode. Naturally, you should try software critical to you on the computer before you buy it. Finally, the XP represents a good value for its price, especially when compared to the AT. ■

ATRON BUGBUSTERS GREASE BORLAND LIGHTNING

"If I were starting a software company again, from scratch, Atron's AT PROBE™ would be among my very first investments. Without Atron's hardware-assisted, software debugging technology, the flash of Turbo Lightning™ would be a light-year away!"

Philippe Kahn, President, Borland

HOW BORLAND DOES SO MUCH, SO WELL, SO FAST

We asked Borland International president Philippe Kahn to share his secrets for rapidly taking a good idea and turning it into rock-solid reality. How does the Borland team do so much, so well, so fast?

He begins, "I remember when Atron used the June 24, 1985 *Wall Street Journal* chart of top-selling software in an ad." [Note: At that time, seven of the top ten software packages were created by Atron customers; it's now now nine out of ten.] "SideKick was number four, and I let Atron quote me in saying that there wouldn't have been a SideKick without Atron's hardware-assisted debuggers.

"You might say lightning has literally struck again. Turbo Lightning made number four on *SoftSel's Hotlist* within weeks of its introduction! And again, I say we couldn't have done it without Atron debugging technology.

"Cleverly written code is, by definition tight, recursive, and terribly complex," he continues. "Without the ability to externally track the execution of this code, competent debugging becomes very nearly impossible."

Concludes Philippe, "And after Turbo Lightning was solid and reliable, Atron tuning software turned our Probes into performance analyzers. How do you think we greased our lightning?"

Philippe, along with a couple million or so of your satisfied customers, we say congratulations on yet another best-selling product. We can't wait to see what awesomely useful technology will come shooting out of Borland International next.

HOW BUGBUSTERS KEEP YOU FROM GETTING SLIMED

The AT PROBE is a circuit board that plugs into your PC/AT. It has an umbilical which plugs into the 80287 socket and monitors all 80286 activity.

Since AT PROBE can trace program execution in real time, and display the last 2048 memory cycles in symbolic or source-code form, you can easily answer the questions: "How did I get here?" and "What are those silly interrupts doing?"

It can solve *spooky* debugging problems. Like finding where your program overwrites memory or I/O - impossible with software debuggers.

You can even do source-level debugging in your favorite language, like C, Pascal or assembler. And after your application is debugged, the AT PROBE's performance measurement software can isolate performance bottlenecks.

Finally, the AT PROBE has its own 1-MByte of memory. Hidden and write-protected. How else could you develop that really large program, where the symbol table would otherwise take up most of memory.

LOOK AT IT THIS WAY.

History shows that non-Atron customers don't stand a very good chance of making the Top Ten list. Lightning *really does* have a way of striking twice!

The PC PROBE™ is \$1595 and the AT PROBE is \$2495. So call Atron today. You can be busting some really scary bugs tomorrow. And maybe, just like Borland, you can also bust some records.



20665 Fourth Street • Saratoga, CA 95070 • 408/741-5900
Copyright © 1985 by Atron Corp. PC PROBE™ and AT PROBE™ Atron, SideKick™ and Turbo Lightning™ Borland International, Inc. • Atron by TRISA, 408/250-3708

GET SERIOUS



...ABOUT ANALYZING YOUR DATA. You might be spreadsheeting your spreadsheet a little too thin. Or maybe you're starting from scratch. But if you're serious about data analysis, you're ready for SPSS/PC+™ — a full software family that brings you five high-powered ways to complete any data analysis task.

Enter it. SPSS/PC+ Data Entry™ — our latest option — takes the effort out of entering and correcting data.

Analyze it. The SPSS/PC+ Base Package provides a powerful array of statistical and reporting procedures.

Examine it. SPSS/PC+ Advanced Statistics™ lets you get more serious with your data.

Table it. SPSS/PC+ Tables™ produces presentation-ready tables instantly.

Chart it. SPSS/PC+ Graphics™ featuring Microsoft® Chart creates show-stopping graphs and charts.

SPSS/PC+ products are being put to productive use by serious fact finders in business, government and education. For countless purposes such as market research. Wage and salary studies. Survey analysis. And quality control. Plus each product is superbly documented and supported by SPSS Inc., a leader in statistical software for nearly 20 years.

So if you're serious about data analysis, step up to SPSS/PC+. For details, contact our Marketing Department.

CALL 1/312/329-3630

SPSS inc.

SPSS Inc. • 444 North Michigan Avenue, Suite 3000 • Chicago, Illinois 60611

In Europe: SPSS Europe BV. • P.O. Box 115 • 4200 AC Gonnchem, The Netherlands • Telephone: +31183036711 • TWX: 21019

SPSS/PC+ runs on IBM PC/XT/AT's with hard disk. Contact SPSS Inc. for compatible microcomputers. SPSS/PC+, SPSS/PC- Data Entry, SPSS/PC- Advanced Statistics, SPSS/PC+ Tables and SPSS/PC+ Graphics are trademarks of SPSS Inc. for its proprietary computer software. Chart and Microsoft are trademarks of Microsoft Corporation. © 1986, SPSS Inc.

The WYSEpc. It but expensive.



runs everything

\$1499.

For this incredibly low price, you get everything but bulk. The WYSEpc runs virtually every popular IBM-compatible software package.

And \$1499 includes dual floppy drives, 14" tilt/swivel monitor, height-adjustable keyboard, 256K RAM, two serial ports, one parallel port, MS-DOS with GW-BASIC, manuals, the works.

How can we do it for \$1499? We leave out the ugly and don't charge you for it. That's how we got to be the world's leading independent manufacturer of terminals, shipping more than anybody but IBM.*

The WYSEpc is also available in an IBM PC/XT compatible model with a 10-Megabyte or 20-Megabyte Winchester disk, and a color graphics option.

For more information about the WYSEpc or our full line of computer display products, write or call toll-free, today.

© 1986 Wyse Technology. IBM and IBM PC/XT are trademarks of International Business Machines Corporation. The "V" shaped design is a trademark of Wyse Technology. MS-DOS and GW-BASIC are trademarks of Microsoft Corporation.
*Discontinued 1985 mid-year terminal update.

Inquiry 387

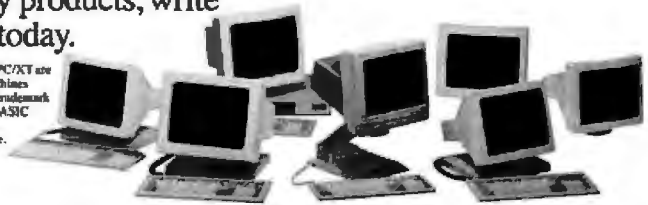

WYSE

Call 1-800-GET-WYSE

B-7/86

- Yes, please send me detailed information on the WYSEpc.
 Please send information about the entire Wyse product line.

Name

Title

Company

Phone

Address

City

State

Zip

Mail to: Wyse Technology, Attention: Marcom Department
3571 North First Street, San Jose, CA 95134.



NUMBER SMASHER™

Triple your PC speed for only \$599!

8087 Upgrades™

MicroWay is the world leader in 8087 support. Our 8087 development software has been in use since 1982. By 1984 we had become Intel's 97th largest OEM account. When you buy from us, you can be confident that you will receive the 8087 chip designed for your PC and that our unique diagnostics will instantly verify that your processor works correctly as installed. Call for current prices.

287Turbo™

This card plugs into the 80287 socket on your AT or COMPAQ, doubling the 80287 clock from 4 to 8 Mhz. It does not change the 80286 clock speed or affect your warranty. The card comes with an 8 Mhz 80287 and has provisions for faster crystals as better 80287s become available. It also has a reset button and circuit that provide a hardware alternative to CNTRL-ALT-DEL. 287Turbo with Diagnostics and Reset \$395

Number Smasher™

Number Smasher gives you AT speed and 100% compatibility with all PC software and hardware. It comes with a 10 Mhz 8086 and 512K of no wait state RAM. Most are shipped with an optional matched 10 Mhz 8087 and 128K daughterboard. The card runs programs a factor of 2.5 to 4.0 faster than the PC, XT or compatibles it runs in. Other features include FASTROM, a Ram Disk, Print Spooler and Disk Cache. Revision 2 of the Smasher is designed and manufactured by MicroWay in the U.S.A. and has the best service and support of any accelerator card.

MegaPage™

MicroWay's "Lotus/Intel" extended memory card has all the features of the others plus one: it uses low power, cool running CMOS DRAM. Ask for our pamphlet "Extended vs Expanded Memory" and learn why MegaPage is the right card for you. MegaPage with 2 Megabyte CMOS \$549



Inquiry 246

The World Leader in 8087 Support

P.O. Box 79, Kingston, Mass. 02364 USA (617) 746-7341
Tempo House, London, U.K. call 01-223-7662

Number Smasher, MegaPage and 287Turbo are trademarks of MicroWay, Inc. MicroWay is a registered trademark of MicroWay, Inc.

SAVE 50% *



- United States One Year \$21 2 Years \$38 3 Years \$55
Canada/Mexico One Year U.S. \$23 2 Years U.S. \$42 3 Years U.S. \$61
Europe \$69 (air delivery), U.S. Funds enclosed
Worldwide \$37 (surface mail), U.S. Funds enclosed

BILL ME. If I'm not completely satisfied with my first copy, I'll simply write "cancel" across your invoice, mail it back, and my subscription will be cancelled.

- Check Enclosed Bill VISA Bill Mastercard
Please allow 6-8 weeks for processing your subscription.

Name _____ 4276

Address _____

City/State/Zip _____

Card # _____ Expires _____

Signature _____

**off newsstand price of \$42.00*



SAVE 50% *



- United States One Year \$21 2 Years \$38 3 Years \$55
Canada/Mexico One Year U.S. \$23 2 Years U.S. \$42 3 Years U.S. \$61
Europe \$69 (air delivery), U.S. Funds enclosed
Worldwide \$37 (surface mail), U.S. Funds enclosed

BILL ME. If I'm not completely satisfied with my first copy, I'll simply write "cancel" across your invoice, mail it back, and my subscription will be cancelled.

- Check Enclosed Bill VISA Bill Mastercard
Please allow 6-8 weeks for processing your subscription.

Name _____ 4276

Address _____

City/State/Zip _____

Card # _____ Expires _____

Signature _____

**off newsstand price of \$42.00*





NO POSTAGE
NECESSARY
IF MAILED
IN THE
UNITED STATES

BUSINESS REPLY MAIL

FIRST CLASS PERMIT NO. 39 MARTINSVILLE, NJ

POSTAGE WILL BE PAID BY ADDRESSEE

BYTE

Subscription Dept.
P.O. Box 597
Martinsville, NJ 08836-9956



NO POSTAGE
NECESSARY
IF MAILED
IN THE
UNITED STATES

BUSINESS REPLY MAIL

FIRST CLASS PERMIT NO. 39 MARTINSVILLE, NJ

POSTAGE WILL BE PAID BY ADDRESSEE

BYTE

Subscription Dept.
P.O. Box 597
Martinsville, NJ 08836-9956

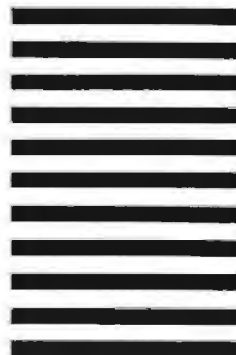



THE CONQUEST TURBO PC

BY JOHN D. UNGER

The Conquest Turbo PC by Microshop Computer Products, an IBM PC XT-compatible machine with an 8088-2 central processor, is hardware-switchable between 4.77 MHz and 8 MHz. You can speed up the running of many standard software programs, although I was disappointed that the benchmark tests did not show the consistent increase in computational speed that I expected from a clock-rate increase of 65 percent. In addition, you may not be able to use programs that rely on the internal clock for timing (especially games, music, and communications software) in the 8-MHz mode.

The Conquest has ample internal capacity for a hard disk and IBM-compatible expansion cards. The power supply is rated at 150 watts, obviously enough power to support an internal hard disk and any expansion cards you may want to add. The computer I reviewed had two double-sided double-density floppy disk drives and 256K bytes of RAM.

The Conquest also comes with an RS-232C serial port and an IBM-style 25-pin Centronics-compatible parallel port installed on the motherboard. Therefore, unlike the IBM PCs, it is not necessary to add an expansion card to provide I/O for the computer.

The Persyst color board in the Conquest has connectors for either a monochrome or an RGB monitor. I used my USI pi3 high-resolution amber monitor with the machine because I did not receive a monitor with the review unit. At \$1239, it is one of the least expensive of the IBM PC XT clones. However, don't expect

*This IBM PC XT
compatible can be switched
between 4.77 and 8 megahertz*



frills with the machine. The review unit came with no software, no operating system, and little documentation.

HARDWARE

The footprint of the Conquest is just slightly smaller than the IBM PC AT. The system unit holds two half-height floppy disk drives and one full-height floppy or hard disk drive. The two standard Toshiba FDD 5451E half-height double-sided double-density disk drives operated without any problem during the review, although drive A seemed to become progressively noisier, perhaps because I used it more. The optional full-height hard disk drive goes on the right-hand side of the front of the main unit. The cooling fan is quite loud and bothersome in my quiet environment, but in a busy

office situation, the fan noise would be less noticeable.

Qubie Distributing supplies the Conquest's full-size, complete, and well-laid-out keyboard. In addition to the QWERTY layout with 10 function keys, the keyboard has two keypads. I configured one for the cursor keys and the other as a numeric keypad. This made for a particularly nice spreadsheet environment, since I could move between cells and insert numbers without toggling the Num Lock key. The keyboard also makes warm starts easier by using the Ctrl key in combination with a special Reset key. Across the top of the keyboard are the 10 function keys, a Pause key to start and stop scrolling, and a key to enable the second cursor pad setup. The Caps Lock and Num Lock keys have LEDs.

I found the feel of the keyboard a bit awkward. The keys have virtually no audible feedback unless you hit them harder than it takes to produce a character. The initial feel of the keys is rather light, but a higher spring tension seems to take over after a short travel until the key hits bottom. Therefore, I began pounding away rather vigorously to ensure that I was really getting the job done.

INTERNALS

It is easy to remove the case of the computer. Internally, the Conquest ap-

(continued)

John D. Unger (P.O. Box 95, Hamilton, VA 22068) is a geophysicist for the U.S. government who uses computers to study the structure of the earth's crust in earthquake-prone regions. \

Conquest Turbo PC

Company

Microshop Computer Products
2640 Walnut Ave., Unit K
Tustin, CA 92680
(714) 838-7530

Size

System unit: 19.5 by 16 by 5.75 inches;
30 pounds
Keyboard: 20.25 by 8.5 by 2.25 inches;
5.75 pounds

Components

Processor: 8088-2 switchable between 4.77 and 8 MHz; socket for optional 8087 coprocessor

Memory: 640K bytes of dynamic RAM (standard); up to 1 megabyte of RAM on motherboard (optional)

Mass storage: Two 360K DS/DD 5¼-inch half-height floppy disk drives (standard)

Keyboard: Detached QWERTY with 99 keys including 10 function keys and separate keypads for cursor keys and numeric keypad; Caps Lock and Num Lock keys have indicator lights

Expansion capability: Five full-length slots (IBM PC bus)

I/O interfaces: One RS-232C serial port; one DB-25P Centronics-compatible parallel port; one coaxial connector for monochrome monitor (Persyst board); one 9-pin D connector for color monitor (Persyst board)

Options

Color monitor	\$125
Internal hard disk drives	
10 megabytes	\$499
20 megabytes	\$525

Documentation

25-page *Guide to Operations and Technical References*

Price

Includes two DS/DD floppy disk drives, 640K bytes of RAM, monochrome card, and green or amber monochrome monitor \$1239

BASIC PERFORMANCE (IN SECONDS)

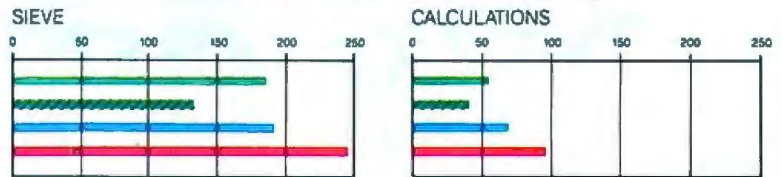

DISK ACCESS IN BASIC (IN SECONDS)



SYSTEM UTILITIES (IN SECONDS)

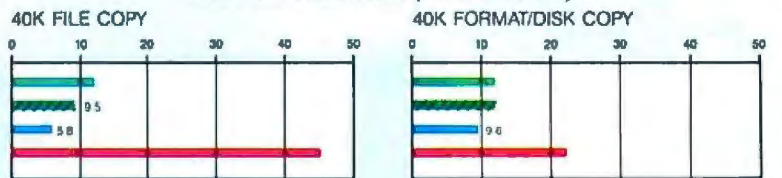

SPREADSHEET (IN SECONDS)

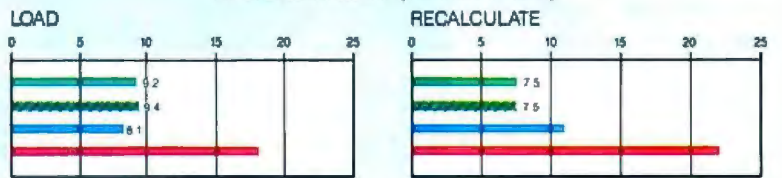

SYSTEM FEATURES

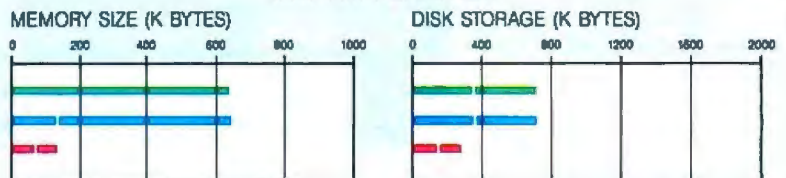

■ CONQUEST 4.77 MHz ■ CONQUEST 8.0 MHz ■ IBM PC ■ APPLE IIe

The Sieve graph shows how long it takes to run one iteration of the Sieve of Eratosthenes prime-number benchmark. The Calculations graph shows how long it takes to do 10,000 multiplication and 10,000 division operations using single-precision numbers. (For the program listings, see *BYTE's Inside the IBM PCs*, Fall 1985, page 195.) The graphs for Disk Access in BASIC show how long it takes to write and then read a 64K-byte sequential text file to a blank floppy disk. The System Utilities graphs show how long it takes to format and copy a 40K-byte file using the system utilities. The Spreadsheet

graphs show how long it takes to load and recalculate a 25- by 25-cell spreadsheet in which each cell equals 1.001 times the cell to its left. The spreadsheet used was Microsoft's Multiplan. The Memory Size graph shows the standard and optional memory available for the computers under comparison. The Disk Storage graph shows the highest capacity for a single floppy disk drive and the maximum standard capacity for each system. Tests on the Conquest were done using MS-DOS 2.11, GW-BASIC 2.02, and Multiplan 1.10. The Conquest had two 360K-byte drives and 256K bytes of memory.

appears to be well made and has a substantial steel chassis. A disk controller made by Progressive Computer Products and a Persyst color graphics display adapter take up two of the seven slots for expansion cards. The disk controller board accommodates up to four floppy disk drives, giving you another hardware option for the space behind the removable front panel. To gain access to the 8087 coprocessor's socket, you have to remove the floppy disk drives.

Advanced Logic Research makes the motherboard. The one on the review unit came fully populated with 64K-bit RAM chips in four banks of nine chips for a total memory of 256K bytes. Like the IBM PC, the Conquest performs a memory parity check when you turn it on; the test takes about 15 seconds with 512K bytes of RAM installed. You can replace each of the four banks of 64K-bit chips with nine 256K-bit RAM chips to obtain a maximum of 1 megabyte of memory on the motherboard.

You can change the clock speed from 4.77 MHz to 8 MHz by simply flipping a small rocker switch on the rear of the computer. When you turn on the computer with the switch in its 8-MHz, or "turbo," mode, a message at the top of the screen confirms that you are in the high-speed mode while the machine performs its memory check. I had mixed success switching modes without rebooting the computer. I had no success trying to change modes while in the middle of using GW-BASIC or WordStar. Usually, the computer locked up, and I was unable to reboot without first powering down. I had somewhat better, but still unpredictable, results trying to switch clock speeds at the MS-DOS prompt. The machine still locked up occasionally. I found that the safest and surest way to change clock rates was to turn the computer off, flip the clock-rate switch, and power back up. A simpler and more consistent method for switching speeds would be a large improvement.

BENCHMARKS

The results of running the standard BYTE benchmark programs are shown in the graphs at left. In the

standard 4.77-MHz mode, the Conquest's results are comparable to the IBM PC's. The benchmark results in the 8-MHz turbo mode, although generally faster, are neither consistent nor easy to understand. For processor-intensive tasks, the turbo mode should show an increase in processing speed roughly proportional to the 65 percent difference in the two clock rates. However, as you can see from the benchmarks, the differences average somewhat less than I expected. The effects of the increased clock speed were particularly small for WordStar (version 3.30), Multiplan (version 1.10), and the MS-DOS utilities.

The Norton Utilities' (version 3.0) System Information program showed a performance index on the Conquest of 1.0 relative to the IBM PC in the 4.77-MHz mode and 1.5 in the 8-MHz mode. It seems clear, therefore, that you will increase performance by using the Conquest in the 8-MHz mode, but the machine does not appear to run programs as quickly as other MS-DOS computers with 8-MHz 8088 processors.

SOFTWARE AND COMPATIBILITY

Although the computer comes with no software or operating system, I have encountered no compatibility problems. I had no trouble booting the machine with either MS-DOS 2.11 or PC-DOS 3.0. In addition to using WordStar 3.30, Multiplan 1.10, GW-BASIC, and a number of other commercial and public domain software programs, I used the Conquest to test a variety of C-language interpreters. However, you should contact the manufacturer if you need to run specific applications, especially if they are copy-protected.

The Conquest comes with a Persyst color display adapter designed for use in the IBM PC. I installed a Seattle Computer RAM+6 card on the Conquest to increase its memory to 512K bytes. The card is sold for the IBM PC XT, but I had no problems mounting the card or configuring it with the system RAM using the card's documentation. I recommend that you try products before you buy them

Flipping a rocker switch changes the clock speed from 4.77 MHz to 8 MHz.

or first find out about your dealer's refund or exchange policy.

DOCUMENTATION

I received only a terse 25-page document that is entitled *Guide to Operations and Technical References*. The only useful information is a description of the keyboard and information on a series of DIP switches that tell the computer how much memory is installed and that set other system-related options.

SUPPORT

Unless you live in southern California, you'll have a long way to go for service. However, the Conquest is assembled from a group of generic, easily obtained components; you should be able to obtain service from any experienced microcomputer technician. There is a 180-day warranty on the entire system and a 1-year warranty on the motherboard. The warranty requires, however, that you bring or ship your computer to Microshop.

CONCLUSION

The Conquest has an appealing price, given the overall quality of the hardware, the optional 8-MHz processor speed, and the fact that the motherboard can accommodate up to 1 megabyte of RAM and has built-in parallel and serial ports, leaving the expansion slots free for other options. However, I would not recommend this machine to a first-time user. Documentation is scanty, there is no bundled software, and it is not clear how much long-term support you can expect from the manufacturer. On the other hand, an experienced microcomputer user could assemble a custom machine by taking advantage of the ample internal space and power-supply capacity to add desired expansion cards. ■

MORE PERFORMANCE

In a multi-user system, performance is the most important ingredient.

Introducing the top-of-the-line in our 286 series, the CompuPro 286/80™ with more performance built in than ever.

For starters, our new 8 MHz 80286 processor gets data from memory in only two clock cycles, compared with the three or four required by other systems. In addition to the 768K of high speed memory, the system's high performance 80 Megabyte hard disk has a dedicated 512K byte cache buffer that boosts its performance even more.

Tape back-up and floppy drives are included along with nine serial ports, Concurrent DOS 816™ multi-user multi-tasking operating system and NewWord™ word processing software. The system includes a 16 slot

S-100R motherboard, which means there's plenty of room for adding options such as memory expansion to a megabyte, more cache memory, additional I/O ports, slave processors, graphics, networking and more.

All this tech-talk translates simply to this: The CompuPro 286/80 has the power to solve your business computing needs today and tomorrow as your business grows.

The price? A lot lower than you'd expect to pay for all this performance. Just \$12,500 suggested list. To find out how the CompuPro 286/80 (or any of our other multi-user systems) can give your business more performance, call today for the name of your nearest CompuPro dealer.



10 MHz available with AMD 80286! Dealers have details.

MORE NET PERFORMANCE

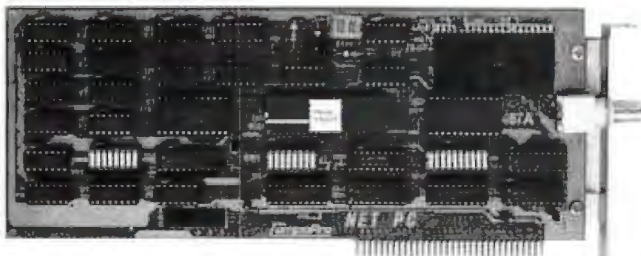

multi-user computers. Your problem of how to move up

TECH-TALK: All our network products use the high software protocols (except a PC with CPLINK, which emulates DOS 3.1 conventions). The NET PC is a fully compatible super-set of the SMC ARCNET card and therefore may be used with other network software systems.

NET PC with CPLINK: \$550. NET 100 (for S-100 systems and the 286 series): \$495. NET 10 (for the CompuPro 10 Plus™): \$495. All prices are suggested list.

CompuPro has been providing networking solutions for years with our NET 100™ and NET 10™ products, and we're proud to introduce the latest member of our network family—The NET PC™. Simply plug the NET PC into your IBM® PC, XT, AT or 100% compatible and your personal computer now becomes an integrated part of a high performance multi-user network. The NET PC includes the CPLINK™ requestor program that lets your PC become a part of the network while still running DOS.

CompuPro multi-user systems (like the 286/80) make ideal file-servers for networked PCs, and they're still fully functional as to a true multi-user system and keep your existing PCs is now solved. speed (2.5 MBPS) ARCNET® token passing hardware protocol and DR NET™

AT COMPUPRO, PERFORMANCE IS NOT JUST ANOTHER BUZZWORD.

SUMMER HOT FLASH! Get a super summer deal on a CompuPro 10 Plus four user system with a 40 megabyte hard disk. For a limited time we're slashing the price to just \$5995! See your nearest dealer for more details.

CompuPro™

Viasyn Corporation, 26538 Danti Court
Hayward, CA 94545-3999 (415) 786-0909

CompuPro, 286/80, 10 Plus, NET 100, NET 10 and NET PC are trademarks of Viasyn Corporation. Concurrent DOS 816 is compound trademark of Digital Research, Inc. and Viasyn Corporation. DR NET is a trademark of Digital Research, Inc. NewWord is trademark of NewStar Software, Inc. CPLINK is a trademark of ComputerNet A/S. IBM is registered trademark of International Business Machines Corporation. ARCNET is a registered trademark of Datapoint Corporation. Prices and specifications subject to change without notice.



BYSO LISP AND WALTZ LISP

BY WILLIAM WONG

MS-DOS-based languages have matured over the years, and the LISP implementations are no exception. This article examines two implementations with different levels of functionality and support. BYSO LISP version 1.17 costs \$69.95, and Waltz LISP version 5.01 is \$169.

DOCUMENTATION

BYSO LISP comes with a single user's manual, which is complete but laid out very poorly. The print quality is poor, too—BYSO LISP's documentation is its major fault. Read a good book on LISP before delving too deeply into this manual.

The Waltz LISP manual is very good. Layout, examples, and highlighting add to the product's worth. The table of contents provides a quick description of each function and its arguments along with the page number. There's a separate manual for Clog, a Prolog interpreter written in LISP.

COMPATIBILITY

BYSO LISP supports the popular LISP 1.5 and MacLISP via a compatibility "switch." This switch affects the mode and parameter order of a number of functions. For example, the parameters to PUTPROP are atom, property, and value in 1.5 mode, and atom, value, and property in MacLISP mode. The LISP 1.5 mode is relatively complete, since this specification was basic to begin with. The MacLISP mode lacks quite a number of functions, partly due to a limited number of data types. The mode switch is useful when learning LISP, depending upon the book you are using. Extensions for PC-DOS support are available but often difficult to use.

Waltz LISP is based on Franz LISP. It mirrors it relatively well and comes

Two implementations of LISP for the IBM Personal Computer and compatibles

surprisingly close to the UNIX-based versions of LISP. Waltz LISP's lack of floating-point numbers is its major deficiency. Extensions to support the operating system are consistent and well defined.

DATA TYPES

Both implementations support lists and symbols (or atoms), which are the basis for LISP. BYSO LISP limits are fixed at 10,800 list cells and 768 atoms, while Waltz LISP is limited by the amount of memory—it uses 4-byte list cells (16K cells maximum).

In addition, both LISPs support various types of numbers. BYSO LISP supports 16-bit signed integers, while Waltz LISP supports "big integers." These are essentially binary strings of variable length, the same as those found in muLISP. The integers are limited to 2048 bits. Neither version supports floating-point numbers.

String and array support levels vary significantly between implementations. BYSO LISP supports multidimensional arrays, where elements can be Boolean values, characters (strings), integers, and symbolic expressions. Array space is limited to 10,240 bytes, and string manipulation functions are minimal. Waltz LISP only supports character strings and these are limited to 256 characters, but its support functions are more sophisticated and include pattern-matching string search.

BYSO LISP also supports user-defined data structures; Waltz LISP does not. These types of data struc-

tures tend to be more efficient in terms of storage space and access time. They also make programs easier to understand, since you can create access names such as SHIP-SPEED instead of CADDR to access the third

element of a list.

Both versions support other data types, such as files.

FUNCTIONS AND CONTROL METHODS

BYSO LISP supports MacLISP-style function definitions with &OPTIONAL and &REST specifiers for functions with a variable number of parameters. MACRO (including Common LISP-format macros), and the standard control structures, including PROG, PROGN, and DO. CATCH and THROW functions are part of the system, but there is no UNWIND-PROTECT.

Waltz LISP uses the Franz LISP-style function definition and supports LAMBDA (which evaluates parameters), NLAMBDA (which does not evaluate parameters), LEXPR (with a variable number of parameters), and MACRO. Waltz LISP supports local variables, but the parameter-binding methods it uses are not as clean as BYSO LISP's.

Like BYSO LISP, Waltz LISP supports CATCH and THROW, but not UNWIND-PROTECT.

FILES

Both LISP implementations support sequential text files. BYSO LISP does not support random access files. Its support of directory functions is in-

(continued)

William G. Wong (Logic Fusion Inc., 1333 Moon Dr., Yardley, PA 19067) is president of Logic Fusion and a developer of systems and applications software.

	BYSO LISP version 1.17	Waltz LISP version 5.01
Company	Levien Instrument Co. Sittington Hill P.O. Box 31M McDowell, VA 24458 (703) 396-3345	Pro Code International Inc. 15930 Southwest Colony Place Portland, OR 97224 (800) 547-4000
Requirements	IBM PC or compatible One floppy disk 256K bytes of RAM	IBM PC or compatible (PC-/MS-DOS or CP/M-86) Z80 CP/M system for 8-bit version One floppy disk 128K bytes of RAM
Copy-Protected	No	No
Price	\$69.95	\$169

complete and involves writing interrupt calls.

Waltz LISP supports random access files and all PC-DOS directory functions. These are well documented and easy to use. It also supports a strange entity called a QUARK, which allows reading of non-LISP-format text. Support for binary data is not very good; it can only read one character at a time, as there are no record, string, or line input functions.

LOADING, SAVING, AND PACKAGES (NAME SPACES)

BYSO LISP supports a single name space (no packages). It lets you save the entire workspace and then restore it later, which is very handy. In addition, it lets you load and save function definitions and variable data incrementally in text form.

Waltz LISP also supports a name space. It does not let you save or restore the workspace, and functions and data may only be loaded. You can develop functions that will save the textual versions of functions and variables. Even so, the primary mode of operation is to edit a text file using the built-in screen editor and then read in the changed file, thereby keeping the most up-to-date function definitions on disk.

USER ENVIRONMENT (EDITORS AND DEBUGGERS)

BYSO LISP has a built-in screen editor that you can use on single functions or variables. The editor is both char-

acter- and structure-oriented, and it works well if the text only fills one screen; the editor is not designed to work with text files. Source code is provided, so enhancements are possible. BYSO LISP traps errors but does not provide any debugging tools except TRACE.

Waltz LISP comes with a built-in WordStar-like screen editor that works on text files, and a structure editor, similar to line-oriented text editors, that can manipulate structures in memory. The latter takes a bit of getting used to, but it is the only type of editor that allows modification of circular list structures and graph structures created using destructive list functions like RPLACA and RPLACD. Waltz LISP includes source code for the structure editor but not the screen editor.

Waltz LISP also includes a built-in debugger with trace and error-trapping support. From the debugger, you can continue execution, and examine and modify function parameters.

SYSTEM ACCESS AND ASSEMBLER INTERFACE

BYSO LISP provides limited access to the operating system and to functions written in other languages, such as assembler. BYSO LISP assumes that the support module is loaded as a memory-resident program prior to running BYSO LISP. The functions within the module are called through the interrupt table, which is modified by the resident program. A number

of example programs are provided. However, this mode of operation tends to be quite cumbersome.

Waltz LISP provides an assembler interface identical to BYSO LISP. However, Waltz LISP provides more built-in functions to access system resources, such as directory functions. Even so, functions such as the current time are not provided and you must write them yourself. Direct access to hardware I/O ports must also be added externally.

EXTENSIONS

I have already covered most of the extensions for BYSO LISP. Waltz LISP comes with a program called Clog, a Prolog interpreter, with source code and basic debugging tools provided. Clog provides a learning tool for Prolog and Prolog construction but it is too slow for any major Prolog program development.

COPY PROTECTION, LICENSE AGREEMENT, AND SUPPORT

BYSO and Waltz LISP do not have copy protection on the disk. The license agreement for BYSO LISP provides low-cost replacement if the original disk is defective. Telephone support seems good, and updates are free if you are the first to report a problem. The Waltz LISP license agreement is not overly restrictive, and updates are provided for one year. Phone support for registered users is good when you can get through.

PERFORMANCE

I timed the performance of simple operations repeated 5000 times to get reasonable test durations. Identical tests (although in slightly different syntax) were used on all three products. [Editor's note: Benchmark programs for BYSO LISP and Waltz LISP are available under the filename LISPTTEST.DOC from BYTEnet Listings at (617) 861-9764.]

I did not perform a Read File test due to the lack of a "read fixed-size buffer" function required for such a test. Using the normal LISP READ function would cause the program to "intern" a symbol, which takes some time and is not comparable to the Write String function used for the

(continued)

If Resolution Is A Numbers Game... So Be It.

From 480 dots x 200 lines up to 720 dots x 480 lines
fH scanning from 15.75 to over 25.00 KHz.

For over a decade, NANA O has been producing the finest monochrome and color monitors for OEM's worldwide. Now our high resolution monitors are available right from the source—factory direct. The quality, selection, and prices are beyond compare. But please do.



- 30 different models
- Broad range of features
- Monitors to fit almost every computer and configuration (including the IBM PC/AT and AT&T 6300)
- Designed, built, sold and serviced by NANA O

NANA O

NANA O USA Corporation
373 G. Vintage Park Drive Foster City, CA 94404 (415) 341-7055
Dealers and VAD/VAR Inquiries Welcome

Write File test. For comparison, I also tested Golden Common LISP.

BYSO LISP did well on every test except the Write File test (see table 1).

Evidently, BYSO LISP performs some buffering that is not as efficient as the other implementations, or it performs additional checks.

Waltz LISP also performed admirably and was the fastest when writing to disk. The indexing operations were slightly slower than BYSO or Golden Common LISP, but not excessively so. The times are still faster than many of the other LISPs on the market.

Table 1: A comparison of benchmarks performed on BYSO LISP, Waltz LISP, and Golden Common LISP. The tests, performed on an IBM PC XT with 640K bytes of memory, used a DO loop 5000 times. The Write File test created a 64K file on an empty floppy disk. Times are rounded to the nearest second.

LISP Benchmark Results			
	BYSO LISP	Waltz LISP	Golden Common LISP
Empty loop	13	16	16
CONS	18	18	18
Integer add	18	19	18
Integer multiply	21	20	19
Floating-point add	—	—	19
Floating-point multiply	—	—	22
Assignment	16	19	17
List index	26	36	26
Vector index	16	—	18
String index	17	23	18
Write file	210	31	81

SUMMARY

BYSO LISP is complete and runs well but lacks many of the features found in more expensive products. The documentation is complete but very poor. Even so, the implementation seems solid. As a low-cost learning tool, BYSO LISP is adequate, but it would be inappropriate for more sophisticated work.

At \$169, Waltz LISP is a relatively good buy. Its compatibility with Franz LISP will be a plus to some. The implementation is fast and very functional. The major missing component is a compiler. The Clog Prolog interpreter is slow but can be an aid to learning Prolog. ■

TWICE THE PROGRAMMER..A FRACTION OF THE COST!

TWO-IN-ONE (E)EPROM MULTIPROGRAMMER
 MINI GANG AND SET PROGRAMMING FOR LAB & LIGHT PRODUCTION

Model S125-EL



\$795 COMPLETE

ORDER TODAY:
 800-523-1565

In Florida — 1-305-994-3520
 MASTERCARD OR VISA WELCOME

- Supports virtually all MOS/CMOS EPROM/EEPROM Technologies to 512K
- 3-Way Device type selection: manually, auto ID or from menu
- 128K bytes download for set programming of two 512K devices simultaneously
- Algorithm updates easily installed by user

25 Key 32 Character LCD Display - Memory Expandable to 1 Megabyte
 Compatible with BYTEK IBM-PC Software Utilities
 Options: RS232 Interface for PC Operation - Parallel Printer Port
 21 Day No Obligation Trial Period

Made in the U.S.A.

BYTEK Instrument Systems Division • 1021 South Rogers Circle • Boca Raton, Florida 33431



EXPEROPS5

BY WILLIAM JACOBS

ExperOPS5 is a version of the relatively simple but very powerful OPS5 (Official Production System, Version 5) programming language.

ExperOPS5 was created by the Scientific Applications International Corp. and is marketed by ExperTelligence Inc. ExperOPS5 is implemented on top of ExperTelligence's version of LISP, ExperLISP, and requires a Macintosh with 512K bytes of RAM and two disk drives. ExperOPS5 currently sells for \$325; ExperLISP costs an additional \$495.

A BRIEF OVERVIEW OF OPS5

OPS5 is one of a series of production rule languages created by Charles Forgy and his colleagues at Carnegie-Mellon University over the past decade (see reference 1). All production rule systems contain three basic parts: a set of production rules, a set of facts against which the rules operate, and an inference engine that governs the execution of the rules. From an initial state reflecting a specific problem, execution of the rules modifies the set of facts.

The rules themselves are simply conditional statements indicating that when certain conditions hold, certain actions, such as the assertion and retraction of facts, are to be performed. No rule ever directly calls any other rule; instead, all interaction between rules is by means of the database of facts. As the set of accepted facts is altered, the rules that are satisfied (and hence made ready for execution) changes. The inference engine controls the cycle of matching rules to facts, deciding which rules to fire, and causing their consequents to be performed.

In OPS5, the current set of accepted facts is called the working memory.

An implementation of the OPS5 programming language for the Macintosh

Facts are represented as objects with up to 126 pairs of attributes and values. A typical OPS5 assertion might be

```
(mouse ^name Mickey
      ^disposition friendly
      ^favorite-foods cheese
      bread-crumbs table-scrap)
```

signifying that there is a mouse object whose name attribute has the value "Mickey," whose disposition attribute has the value "friendly," and whose favorite foods are cheese, bread crumbs, and table scraps. Associated with each element of the working memory is a time tag indicating the order of its creation or last modification.

The collection of OPS5 rules is known as production memory. Since this is treated as an unordered set, rule position does not affect firing precedence. The conditions of a rule are collectively referred to as its left-hand side, and the actions as its right-hand side. Each condition is a pattern that is satisfied by being matched against the facts in working memory. Thus, the single condition in the following rule

```
(p is-there-a-friendly-mouse
  (mouse ^disposition friendly)
  -->
  (write there is a friendly mouse)
)
```

will match against the Mickey Mouse fact and print out the appropriate message. Since a rule will fire for each fact against which the left-hand side

patterns match, if the working memory had contained the two facts

```
(mouse ^name Mickey
      ^sex male
      ^disposition friendly)
(mouse ^name Minnie
      ^sex female
      ^disposition friendly)
```

the previous rule would have been executed twice.

In OPS5, patterns can be matched against a single value, a complex set of values, or, by the use of variables, against any value whatsoever. Restrictive patterns can compare values in various ways. For example, the following condition will match any mouse object of either friendly or shy disposition weighing more than 10 grams and set the value of the variable *x* to the mouse's name for the duration of this rule:

```
(mouse ^name <x>
      ^weight { > 10}
      ^disposition << friendly shy >>)
```

With some restrictions, it is even possible to use negative patterns as conditions, that is, no working memory element has a given value.

On the right-hand sides of rules, working memory can be altered, files can be manipulated, information can be output, computations on variables can be performed, values can be assigned to variables, external user-defined functions can be called, additional rules can be added to production memory, and execution can be halted via 12 action types. For exam-

(continued)

William Jacobs (LinCom Corporation, 3200 Wilshire Boulevard, Suite 300, Los Angeles, CA 90010) is a knowledge engineer currently involved in the design and implementation of a microcomputer-based expert system to configure a satellite communications network.

ExperOPS5 (July 1985 version)

Type
Expert-system programming language

Company
Expertelligence Inc.
559 San Ysidro Rd.
Santa Barbara, CA 93108
(805) 969-7871

Format
One 3½-inch disk

Requirements
Apple Macintosh with at least 512K of RAM and two disk drives; Expertelligence's ExperLISP

Features
An implementation of the OPS5 production rule language for the Macintosh

Price
\$325 for ExperOPS5 and documentation;
\$495 for ExperLISP and documentation

Audience
Those wishing to develop expert systems on the Macintosh

ple, via make, modify, and remove commands, new working memory elements can be created, the values of the attributes of a current working memory element can be changed, and a working memory element can be completely deleted. To illustrate, the following rule fires when working memory contains elements representing less than 10 grams of unguarded cheese and a hungry mouse:

```
(p hungry-mouse
  (cheese ^weight {< 10}
    ^security unguarded)
  (mouse ^disposition hungry)
->
  (remove 1)
  (modify 2 ^disposition satisfied)
  (make cat ^job catch-mice)
```

This alters working memory according to certain obvious, predictable consequences.

The inference engine in OPS5 proceeds by means of a recognize-act cycle:

1. [Match] Determine the set of production rules whose conditions are satisfied and hence await execution. Should this set, known as the conflict set, be empty, then the program exits.
2. [Conflict resolution] On the basis of the current conflict-resolution strategy, select one of the members of the conflict set for firing.
3. [Act] Sequentially execute each of the actions of the rule selected in step 2.
4. If either a halt action was performed or the maximum cycle count has been reached, then exit. Otherwise, return to step 1.

OPS5 programs are developed and executed under a top-level interpreter that permits user control of the system. Interpreter commands concern such program features as compilation and execution, important debugging options, the inspection and modification of working memory, the examination of the conflict set, and the control of the inference engine.

THE EXPEROPS5 IMPLEMENTATION OF OPS5

Given that a relatively inexpensive software package running on a Macintosh cannot be expected to perform

up to the same standards as a \$100,000 dedicated LISP machine and similarly priced software, how well does ExperOPS5 perform, and what can you use it for?

Although ExperOPS5 claims to be a complete implementation of OPS5, this simply is not true. It does contain most of the basic OPS5 knowledge representation and inferencing features, and it claims to implement the Rete algorithm (which accelerates the matching of objects to patterns) and the two standard conflict-resolution strategies. Unfortunately, ExperOPS5 lacks OPS5's build action, which permits run-time creation of new production rules; the default action, which formats I/O; the literal statement, a way of specifying the order of an object's attributes; and various output formatting functions.

Unlike standard OPS5, ExperOPS5 objects are limited to at most 20 attributes, although you can increase this number by modifying an initialization file. In addition, because ExperOPS5 differs from standard OPS5 by having a space following each attribute caret (^) and by prohibiting working memory elements from having the value "nil," porting source files in either direction will require at least minor reediting.

Nor are the standard OPS5 and ExperOPS5 top-level interpreters identical. Certain important debugging commands are not implemented at all, such as ppwm, which prints only those working memory elements matching a certain pattern, and matches, which displays the partial matches for productions.

Other statements are not fully implemented. For example, in ExperOPS5 the working memory elements displayed by wm lack time tags, thereby complicating the debugging process. And the ExperOPS5 strategy command lets you change the current conflict-resolution strategy but doesn't let you determine what that strategy is; OPS5 does.

DEVELOPING SOFTWARE IN EXPEROPS5

During software development, ExperOPS5 relies upon Macintosh features

(continued)

You can't judge a scope by its cover.

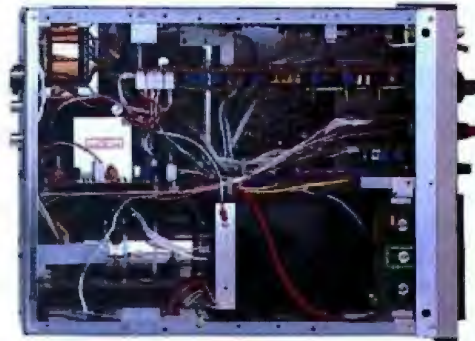
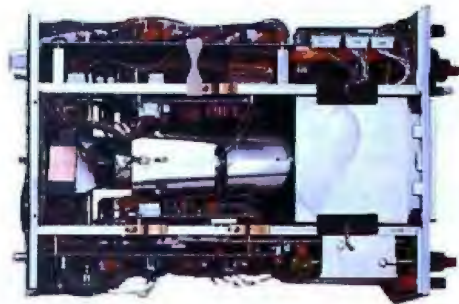
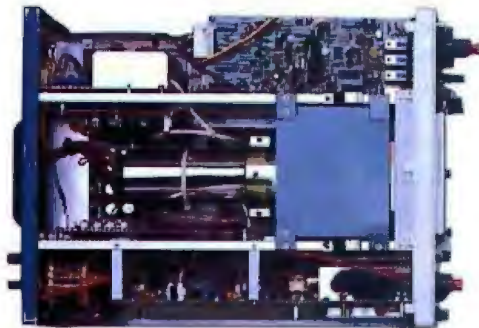

When you look at our simplified, practical internal design, you see why the Tek 2200 Series delivers unparalleled high performance and reliability in the field. You get quality that's unmistakably Tektronix in scopes so advanced, they cost you less to buy and own.

Through an innovative new concept in scope design we reduced the number of mechanical parts by 65%. Reduced cabling by 90%. Virtually eliminated board electrical connectors. And eliminated the need for a cooling fan.

The result: a scope with designed-in simplicity that increases reliability as it cuts downtime and repair costs. All of which means outstanding value in

a compact, lightweight package that your service technicians will appreciate.

Plus, you get a selection of performance to precisely match your needs. There are the 60 MHz single time base delay 2213A at \$1275* and the 60 MHz dual time base 2215A at \$1525*. And at 100 MHz, the dual time base 2235 at \$1750* and the 2236 with an integrated counter/timer/multimeter at \$2650*.

The industry's first three-year warranty† is testimony to 2200 Series dependability. Adding value to value are a variety of optional service plans that can economically extend this coverage to five years.

Consider what you're paying

now in downtime, in service, in back-up scopes. On the bottom line, a Tek 2200 Series scope will save you money, time and trouble now and in the years to come.

Contact your Tek Sales Engineer for a demo today. Or call 1-800-426-2200, Ext. 201. In Oregon, call collect: (503) 627-9000, Ext. 201.



*Prices F.O.B. Beaverton, Oregon
†3-year warranty includes CRT and applies to 2200 family oscilloscopes purchased after 1/1/83. Scopes are UL listed, CSA and VDE approved.

Copyright © 1985, Tektronix, Inc. All rights reserved. TTA-517-1
Prices subject to change.

Tektronix
COMMITTED TO EXCELLENCE

Inquiry 355

While it might provide a limited introduction to production rule systems, using ExperOPS5 for serious application development would be difficult.

such as pull-down menus and multiple windows. You can create files using standard Macintosh text editors, from which the files subsequently can be compiled and run. Various common OPS5 debugging commands are available, such as break points, stepped rule firing, and the inspection of the contents of working memory or the conflict set. Except for various graphics functions that are already available in ExperLISP, ExperOPS5 provides no tools for customizing a user interface.

I found the ExperOPS5 interface to be quite a disappointment, especially when compared to the very attractive, highly interactive interfaces of many other Macintosh programs. Much more could have been done to produce a more user-friendly run-time ExperOPS5 environment. For example, the ability to create predefined windows that continuously display the contents of working memory and the members of the conflict set would make debugging much easier. With ExperOPS5, you can only obtain such vital information during program breaks.

In the July 1985 version of the software that I reviewed, the function that was designed to reset the environment did not work properly. Thus, I had no easy way of fully reinitializing ExperOPS5, and when I wanted to begin a run in a totally clean workspace, I first had to reload ExperOPS5 and then the specific application program. Needless to say, this slowed my software testing considerably.

Two other problems that complicate

developing ExperOPS5 programs are inadequate error messages and limited access to source code. When the ExperOPS5 compiler encounters errors, it generates virtually useless, almost unintelligible comments. Unlike most LISP machine environments where you can inspect the actual system software, almost all of ExperOPS5 is concealed as object code. As a result, if a program should contain an obscure syntax error, you will be hard pressed to find the cause of the difficulty.

EXPEROPS5'S DOCUMENTATION

Regrettably, ExperOPS5 lacks good documentation. True, the package does contain an attractively printed, well-written pamphlet that briefly describes the software. Unfortunately, this booklet lacks sufficient material to enable a novice to understand OPS5, and it does not answer the questions that an advanced user would ask. For example, nowhere does it provide a complete BNF (Backus Naur Form) grammar for ExperOPS5, an especially annoying point given that ExperOPS5 is not a complete implementation of OPS5. As a result, programmers are left to discover on their own which OPS5 features have been implemented and which have not.

The ExperOPS5 disk does come with several short, commented files that explain how to utilize certain OPS5 features, such as how to employ vector attributes or to accept keyboard input into a program. This use of examples is worthy of emulation but is not a substitute for a complete language description and more thorough documentation.

SPEED AND SPACE

As part of a series of timing tests run by my associate, Gary Riley, using a 30-rule version of the well-known monkey-and-bananas problem (see reference 2), ExperOPS5 was found to fire rules at a rate of only 1.5 per second, considerably slower than the 4.3 firings per second obtained by running Artelligence's OPS5+ on an IBM PC or the 86 rules per second obtained on the Inference Corp.'s OPS5-based expert-system shell ART using

a Symbolics LISP machine. Such results will not encourage the use of ExperOPS5 in the development of any computationally intensive programs.

After ExperOPS5 is loaded on top of ExperLISP in a 512K Macintosh, at most only about 45K bytes of RAM remain free; on a HyperDrive-equipped machine, the available RAM can be even less. Given the trade-offs between working memory elements, production rules, and run-time memory requirements, this space is, at best, only sufficient for small to moderate programs.

Can other developers learn from ExperOPS5's relatively slow speed and large memory requirements? One thing they may learn is that unless you implement OPS5 in a language such as C, it will be impossible to produce an adequate implementation of OPS5 for the 512K Macintosh.

CONCLUSION

ExperOPS5 implements most of the significant aspects of the OPS5 programming language. It utilizes several Macintosh features, and, in contrast to certain other products that are currently being marketed as artificial intelligence tools, ExperOPS5 is a real expert-system shell on which you can write real microcomputer expert systems.

Still, ExperOPS5 is disappointing. While it might provide a limited introduction to production rule systems, using ExperOPS5 for serious application development would be difficult. ■

REFERENCES

1. Forgy, Charles L. "Technical Report CMU-CS-81-135." *OPS5 User's Manual*. Department of Computer Science, Carnegie-Mellon University, July 1981.
2. Brownston, Lee, with Robert Farrel, Elaine Kant, and Nancy Martin. *Programming Expert Systems in OPS5*. Reading, MA: Addison-Wesley, 1985.

ACKNOWLEDGMENTS

I would like to acknowledge the assistance of Gary Riley and Chris Culbert of the Mission Planning and Development Directorate, NASA Johnson Space Center, and Dr. Robert Allen and Dr. Joseph Giarratano of the University of Houston, Clear Lake, for their advice and comments on an earlier draft of this review.

Gold-Card™ Buy The Numbers!



21Mb PC □ 31Mb XT □ 15.5w □ 65ms □ 2K sb

\$695 2 year warranty

\$695* for 21Mb!

Now That's Price Performance

Silicon Valley Computer brings you the Gold-Card: the fastest, lowest powered, longest warrantied, most durable, highest capacity, most reliable, lowest priced Hard-Disk-On-A-Card available in the world today.

Silicon Valley Computer

Silicon Valley Computer has been a leading supplier of IBM PC/XT/AT quality disk drive, tape and memory expansion devices to the OEM/VAR/Dealer market since 1982.

Expand Your Memory

Maximize your capacity and performance by adding 21 Mb of hard disk storage (with a 2K bonus buffer) to your IBM PC/XT or compatible computer with Gold-Card.

Give Your XT 31MB!

Add our optional *Big File*™ enhancement program to your Gold-Card and instead of a 10Mb and a 21Mb, your XT will operate as if it has one large 31Mb disk (XT Adapter Kit required for 31Mb operation)

High Power, Low Power Consumption

The Gold-Card accomplishes all this speed and performance using a low 15.5 Watts during operation. This means you won't risk voiding your factory warranty by having to add an extra power supply to your standard PC.

Compare These Features

- Automatic Head Unloading—Protects Heads and Media
- 65ms Access Time—Fastest Available
- 15.5 Watt Power Consumption—Lowest Available
- 2K Sector Buffer—Increases System Throughput
- 2 Year Warranty—Longest Available
- High Reliability: 28,000 hr. MTBF—No One Else Comes Close
- Highest Shock Rating: 80Gs—Perfect For Portables
- 3.5" Plated Disk Mechanism—Planned Non-Obsolescence



Super Tough — The Gold-Card's automatic head unloading mechanism is key to its high reliability and makes it perfect for portables.

Price/Power/Performance Leadership

Silicon Valley Computer can provide you with everything from a half height floppy to our massive **150Mb MegaDrive**™. No one else comes close to our performance or pricing! All SVC kits come complete with pre-tested and formatted drive, controller, necessary software, cables and installation manuals.

Look and compare these outstanding values:

- 60Mb Tape Archive Kit \$795***
- 32Mb AT Hard Drive 38ms \$695***
- 40Mb AT Hard Drive Kit 21ms \$1295***
- 2MB AT RAM Board, Complete \$595***

Available NOW at your local Dealer!

Call today for the dealer nearest you!

(408) 288-8837

Silicon Valley Computer □ 140 Archer Street □ San Jose, California 95112

*Manufacturer's suggested retail price. Prices are subject to change without notice.
IBM PC, XT and AT are registered trademarks of International Business Machines, Inc.
Gold Cards are formatted to run PCDOOS 3.X when shipped from SVC.

At last, the world's
best-selling portable computer
has a little competition.



It's 30% smaller



17% lighter



400% faster

Now there's a portable personal computer so small, so light, and so fast it defines a new industry standard. From the same company that set the standard—COMPAQ® The new COMPAQ PORTABLE II™ has all the advantages of the world's best-selling full-function portable—the original COMPAQ Portable—plus it's even more portable. And it's far more powerful than most desktop computers. Never before has a computer this small been capable of so much.

With its 80286 processor, the COMPAQ PORTABLE II can run all of the popular business software written for IBM® personal computers. At speeds *three to five times faster* than the COMPAQ Portable, IBM PC/XT™, and other compatibles.

And because of its standard 360-Kbyte diskette drive format, your data diskettes will be fully interchangeable with other COMPAQ, IBM, and compatible personal computers.



Introducing the remarkable new COMPAQ PORTABLE II

Expansion potential? The COMPAQ PORTABLE II can handle an optional 10- or 20-Megabyte fixed disk drive and up to 4.1 Megabytes of RAM. And you can add a modem, a networking board, or a board for communicating with your mainframe.

The new COMPAQ PORTABLE II puts tremendous computing potential within the grasp of every computer user. It's backed by the service and support of over 2900 Authorized COMPAQ Computer Dealers worldwide. Plus, it's made by the undisputed

world leader in portable personal computers.

For the name of the dealer nearest you, call toll-free 1-800-231-0900 and ask for Operator 16. In Canada, call (416) 449-8741. In Europe, telex 84117898630AB; 898630 COMPAQ TTX D.

IBM® is a registered trademark and IBM PC/XT™ is a trademark of International Business Machines Corporation. ©1986 COMPAQ Computer Corporation. All rights reserved.

It simply works better.

COMPAQ
PORTABLE II™



FIVE LABORATORY INTERFACING PACKAGES

BY PATRICIA WIRTH AND LINCOLN E. FORD

EDITOR'S NOTE: This article is not a review in our usual sense. To understand the intent of the review, you must understand how it came to be written. Dr. Ford is a medical researcher at the University of Chicago. He wrote an extensive driver for the Tecmar Lab Master data-acquisition board and wanted to publish a description of it. The program is a threaded interpretive language interfaced to BASIC and embodies an essentially complete set of commands for controlling the Lab Master board. As a condition to publishing his description of the language ("SALT," June 1985 BYTE, with Samuel D. Fenster, who wrote most of the code), we prevailed upon Dr. Ford to make the program and its documentation available to our readers at the nuisance-value cost of filling orders (\$50).

There are advantages and disadvantages to using programs written by researchers instead of commercial products. The primary disadvantage is that the program is written to do what the researcher needs to do, not to support the requirements of a large group of customers. In the case of Dr. Ford's program, his requirements are far-reaching, so SALT ends up supporting most Lab Master functions. For example, while he had originally used only the 100-kHz option of the board, he later acquired a 30-kHz board and extended the program to include that configuration. However, he does not use other boards, so he does not support them. Similarly, Dr. Ford does little on-line analysis with his data, so the routines for such functions are limited.

The primary advantage of using a program developed by a researcher instead of by a programmer is that a programmer debugs programs, while a researcher debugs experiments. For example, Dr. Ford points out that all the commercial packages that he examined are unable to synchronize exactly the A/D board timers with external-event triggers. This kind of problem can be critical in an experiment but will not show up as a program bug.

With all this in mind, we asked Dr. Ford to take a look at some of the commercially available software packages for running A/D boards. The question we posed to Dr. Ford was, Given that SALT is available for \$50, why would anyone buy the commercial packages? Or, less sanguinely, what are the special strengths of these packages that make each of them uniquely attractive? What follows is the assessment by Dr. Ford and his research associate Patricia Wirth of what each package is best suited to do.

In the past two years, several general laboratory interface devices for microcomputers have appeared on the market, as well as a selection of software packages for running them. This review is aimed at the software packages, specifically at those products designed for use with two separate interface boards for the IBM Personal Computer.

Our perspective is that of physiologists. We acquire large blocks of digi-

tized data, often controlling various aspects of the experiments at the same time that the data is being collected. In general, we have given a lower priority to on-line data analysis and to graphics, since we do most of our analysis after the experiments. At the other extreme, one of the products reviewed here, ILS from Signal Technology Inc., was developed primarily as a data-analysis package, with relatively little emphasis on

laboratory control. Thus, the diversity in the software packages to be reviewed will accommodate many laboratory requirements, although not all specialized needs will be fulfilled by the same package. In this review, we have emphasized the data-acquisition and laboratory-control aspects of the packages.

INTERFACE BOARDS

All the software packages will control one or both of two interface boards, the Tecmar Lab Master and the Data Translation DT2801. See table 1 for the characteristics of the two boards. The major differences are that the DT2801 has a provision for direct memory access that the Lab Master does not, while the Lab Master has programmable counters not available with the DT2801. The direct memory access allows faster data transfers. The programmable counters on the Lab Master operate independently of the central processor, so accurate timing and control of experiments can be carried out much more rapidly than with the DT2801.

Both boards have a series of options. In addition to the standard characteristics listed in table 1, we have a DT2801 with a 16-bit A/D converter. This provides much higher resolution at the cost of a decrease in the maximum rate per conversion from 13.7 to

(continued)

Patricia Wirth is a Ph.D. student at Northwestern University who is collaborating in biomedical research at the University of Chicago. Lincoln E. Ford, M.D., is associate professor of medicine and cardiology at the University of Chicago. Address all correspondence in care of Dr. Ford at Hospital Box 249, University of Chicago Hospitals, 950 East 59th St., Chicago, IL 60637.

2.5 kHz. We have also obtained a Lab Master board with a 100-kHz option. Some other options that we have not tried are listed in table 1.

SOFTWARE

A list of the packages reviewed and the major characteristics of each package appears in table 2. LABPAC and PCLAB are sold by the manufacturer of the Lab Master and DT2801, respectively, and so are intended for use with those boards only. In addition, ILS will operate only the DT2801. We wrote our own language, SALT, for only the Lab Master. The two remaining packages, ASYST (Macmillan Software Co.) and Labtech Notebook (Laboratory Technologies), have provisions for running both boards, as well as A/D boards from IBM, Cyborg, Keithley DAC, and MetraByte. In addition, Labtech Notebook will support

Acrosystems, Burr-Brown, Datal, Action Instruments, Coulbourn Instruments, Interactive Microware, Advanced Peripheral, and Dataitek Microsystems boards.

The commercial packages cost between \$249 and \$1490 for the laboratory-application portion of the program. Two of them have separate, additional modules for graphics and data analysis, each module costing about \$500 to \$1500, so it is possible to spend up to \$2500 for a total package.

One major difference among the packages reviewed is the language they use. The two provided by the manufacturers of the boards simply use calls to assembly language routines from higher-level languages. Instructions for experimental functions are thus written as part of a larger program in the higher-level language.

This can be a great benefit when you require on-line computation during the experiments, since you can program these computations in a highly structured, well-documented, and well-known language. Another advantage of this approach is that the data is stored in files that the higher-level language can read later, when future analysis is required. The disadvantage with BASIC as the higher-level language is that the calls to assembly language routines are slow, requiring about 2 milliseconds, so substantial delays can occur when several functions are to be run in sequence. This disadvantage is not as great when you use a compiled language, such as FORTRAN or Pascal, but these languages have the disadvantage inherent in any compiled language, namely, that they are not interactive, and you lose control of the program once you start it. You can stop an interpretive language such as BASIC anywhere in its operation without losing control. Once you stop the program, you can determine or change the value of a variable and change the direction of program flow. This provision is a major advantage in the laboratory, where you cannot always anticipate events external to the computer in advance of the experiments.

Two packages, Labtech Notebook and ILS, operate on single commands at a time. Labtech Notebook is entirely menu-driven, while ILS simply accepts single commands. These packages are easy to get started. ILS creates files that FORTRAN can read, while Labtech Notebook creates files that Lotus 1-2-3 can read.

A third approach is the use of a separate, specialized language for operating the laboratory functions. A form of languages especially suited to this type of operation is the threaded interpretive languages (TILs). These languages consist of a dictionary of routines, "words," for carrying out specific tasks. Primary words, called primitives, consist of machine language subroutines. More complex words, secondaries, consist of a sequence of calls to the primitives. Higher-level words may call primitives or previously defined secondaries in

Table 1: Comparison of Data Translation DT2801 and Tecmar Lab Master A/D interface board functions.

	DT2801	Lab Master
Number of A/D channels	16 standard	16 standard—expandable to 256 optional
Resolution	12-bit standard 14- and 16-bit optional	12-bit standard 14- and 16-bit optional
Speed	13.7 kHz standard 27.5 kHz optional 2.5 kHz with 16-bit resolution	30 kHz standard 40 and 100 kHz optional 10 kHz with 14-bit resolution
Gain	Software-selectable up to 8 times on standard board Up to 500 times optional with substantial slowing of A/D rates	Software-selectable up to 500 times optional Resistor-selectable Gains up to 2000 times are available
Number of D/A channels	2	2
Digital I/O	16 channels configured as input or output in two 8-channel ports	24 channels configured as input or output in three 8-channel ports or two 8-channel ports and two 4-channel ports
Clock	400-kHz clock divisible by powers of 2 up to 2 ¹⁶ (163.8 seconds)	1-MHz clock divisible by powers of 10 up to 10 ⁴ (10 milliseconds) or by powers of 2 up to 2 ¹⁶ (65.536 seconds)
Programmable timer/counters	None	5 separate counters with outputs that can be made to change without intervention of the central processor
Direct memory access	Yes	No

(continued)

Multiuser & LAN Solutions

For IBM PC/XT/AT



MULTIUSER

KT-7/PC² PC Work-a-like Terminal
 Compatibility: Multilink Advanced³,
 PC-Slave/16⁴
 Display: 80 x 25, IBM PC character
 set, PC look-a-like attributes, 14"
 green or amber
 Keyboard: AT style std. IBM
 scan/ASCII codes. 5161/AT and
 RT style opt.
 Pages of memory: 1 std. 2 or 4 opt.
 Communications: 2 bi-directional
 RS-232C serial (data & printer)
 ports
 Operating systems: works with
 PC-DOS¹, MS-DOS⁵, QNX⁶,
 UNIX⁷, XENIX⁸, THEOS⁹, PICK⁹,
 and Concurrent DOS¹⁰.
 Retail price: \$695.00
 QUARTET² 4-port I/O card,
 RS-232C
 Retail price: \$299.00

LAN

K-Net² Local Area Network
 Compatibility: **NETBIOS**, Token-
 Ring¹ software, (Advanced
 Netware¹¹ 8/86)
 Data Rate: 1 million bps
 Cable: Twisted-pair/phone wire
 Distance: Up to 4000 ft.
 Addressable users: Up to 255
 Physical: Half-sized card
 Operating systems:
 PC-DOS¹/MS-DOS⁵ 2.0 or later
 Dedicated file server: Not needed
 Message communication:
 Interactive
 Multiuser solutions supported:
 Multilink Advanced³
 PC-Slave/16⁴
 Other features: electronic mail, net-
 work data management, and
 print spooling
 Retail price: \$395.00

WORKSTATIONS

KW-1 8088, 4.77 MHz, 512 Kbytes
 Retail price: \$995.00
 KW-2 8088-2, 8 MHz, 512 Kbytes
 Retail price \$1,195.00
 KW-3 80286, 6 or 8 MHz,
 640 Kbytes
 Retail price \$1,995.00
 All the above include: monochrome
 monitor with video board, AT style
 keyboard, 8 slots, built-in K-Net²
 with remote boot, upgradeable to
 "complete" PC.
 (800) 828-8899
 (408) 436-6550 (In CA)
 1705 Junction Ct., Bldg. #160
 San Jose, California 95112

Kimtron

Trademarks: ¹IBM ²Kimtron ³Software Link ⁴Alloy ⁵Microsoft ⁶Quantum ⁷Bell Labs ⁸THEOS Software ⁹PICK Technologies ¹⁰Digital Research ¹¹Novell © Copyright 1986
 by Kimtron Corp. See us at PC EXPO Booth # 1529 and NCC Booth # A-1750

Inquiry 199 for End-Users. Inquiry 200 for DEALERS ONLY.

REVIEW: A/D SOFTWARE

Table 2: Overview of reviewed A/D software capabilities. Where optional packages are available, capabilities are for the most extensive set of compatible functions.

	SALT	LABPAC	PCLAB	Labtech Notebook	ASYST	ILS
Company	Sam Fenster 4949 South Woodlawn Ave. Chicago, IL 60615	Scientific Solutions Inc. (Tecmar) 6225 Cochran Rd. Cleveland, OH 44139 (216) 349-4030	Data Translation Inc. 100 Locke Dr. Marlboro, MA 01752 (617) 481-3700	Laboratory Technologies 255 Ballarvale St. Wilmington, MA 01887 (617) 657-5400	Macmillan Software Co. 866 Third Ave. New York, NY 10022 (212) 702-3241 (800) 348-0033	Signal Technology Inc. 5951 Encina Rd. Goleta, CA 93117 (800) 235-5787
Price	\$50	\$495	\$249	\$895	\$550 (one module) to \$2195 ¹	\$995 to \$2490 ¹
Supports DT2801	No	No	Yes	Yes	Yes	Yes
Supports Lab Master	Yes	Yes	No	Yes	Yes	No
Language	TIL interfaced to BASIC	BASIC, Pascal, FORTRAN	BASIC, Pascal, FORTRAN	Menu-driven	Independent, FORTH-like TIL	Single instruc- tions at a time
Memory size	64K BASIC plus two 64K integer data buffers and one 64K floating- point data buffer	128K	64K in BASIC, more in newer version using FORTRAN and Pascal	Up to 400K for data	320K for pro- grams and data, 64K data buffers up to total memory in machine	Buffers up to total memory in machine
Digital I/O	Yes	Yes	Yes	Yes	Yes	No
File structure	BASIC or arrays transferred be- tween disk and high memory	Same as higher- level language	Same as higher- level language	ASCII or DIF, compatible with Lotus 1-2-3 and Symphony	IBM BASIC- compatible ASCII or own binary files	FORTRAN- compatible
Documentation	Terse, not example-based	Obscure, not example-based	Satisfactory, example-based	Satisfactory	Extensive, example-based	Satisfactory, example-based
Lab Master maximum A/D rate (100- kHz board)	48 kHz	1 kHz	—	20 kHz ² (300 Hz)	21.9 kHz ² (1 kHz)	—
DT2801 maximum A/D rate	—	—	13.7 kHz (2801) 27.5 kHz (2801-A)	13.7 kHz (2801) 27.5 kHz (2801-A) (300 Hz) ²	13.7 kHz (2801) 27.5 kHz (2801-A) (1 kHz) ²	13.7 kHz (2801) 27.5 kHz (2801-A)
Lab Master maximum D/A rate (100- kHz board)	26 kHz (two channels) 33 kHz (one channel) ³	1 kHz	—	300 Hz	14.4 kHz	—
DT2801 maximum D/A rate	—	—	14.8 kHz (2801) 29.5 kHz (2801-A)	300 Hz	10.8 kHz	16 kHz (2801) 33 kHz (2801-A)
Supports Lab Master timer/counters	Yes	No	—	No	Yes	—
Lab Master clock functions	1 MHz divisible by power of 10 to 10 ⁴	5 kHz to 30.2 Hz	—	No	No	—
Background data acquisition	No	No	Yes	Yes	Yes	No

REVIEW: A/D SOFTWARE

	SALT	LABPAC	PCLAB	Labtech Notebook	ASYST	ILS
GRAPHICS	No	Yes ⁴	No	Yes ^{4,5}	Yes	Yes
Number of channels displayed	—	One in high resolution, three in low resolution	—	Four for each of five windows	Unlimited	One
x,y display	—	Yes	—	No	Yes	No
x,y,z display	—	No	—	No	Yes	No
Cursor positioning and reading	—	No	—	No	Yes	Yes
Graphing maxima and minima	—	No	—	No	No	Yes
Histograms	—	No	—	No	Yes	No
DATA MANIPULATION	Yes	No	No	No	Yes	Yes
Scale and offset	Yes	—	—	—	Yes	Yes
Differentiate and integrate	Yes	—	—	—	Yes	No
Moving averages	No	—	—	—	No	Yes
Maxima and minima	No	—	—	—	Yes	Yes
Filter	No	—	—	—	Yes	Yes
FFT	No	—	—	—	Yes	Yes
STATISTICS	No	No	No	No	Yes	Yes
Mean and variance	—	—	—	—	Yes	Yes
Mode	—	—	—	—	Yes	No
Standard deviation	—	—	—	—	No	Yes
Probability distribution	—	—	—	—	Yes	No
Linear and polynomial fit	—	—	—	—	Yes	Yes

¹ Prices increase with additional modules for graphics, statistics, and data analysis. Base price shown includes A/D module.

² The highest A/D rate applies only when data is being acquired in the foreground mode and the computer is not performing other tasks. The lower rate applies when data is being acquired in the background, so that the computer can perform other routines simultaneously.

³ The D/A output for two channels is substantially faster than half the maximum conversion rate for one channel because both channels are converted following a single clock pulse.

⁴ These packages make displays in real time as data is being collected. Labtech Notebook makes only this type of display. LABPAC will display previously stored data as well.

⁵ Other graphics and analyses are intended for use with Lotus 1-2-3.

Several types of data manipulations can be performed while data is being collected.

any order. They consist of a list of calls to previously defined words. Program execution is rapid because all the primitives are run in machine language, and the only extra time is that required to pass parameters to each subroutine and to proceed from one routine to the next. A well-known example of a threaded interpretive language is FORTH, and one of the software packages, ASYST, is written in a FORTH-like language that provides a great deal of speed and flexibility. It also provides a disk-file structure that can be read later by other ASYST programs for subsequent data analysis. However, there are three major disadvantages in using a TIL for the entire programming. As with compiled languages, you lose control of the program once you start it. Also, many complex commands, such as print-formatting procedures, must be custom-built as secondary words that are listed in an individual user's "dictionary," the size of which usually increases with time. This type of language has a great deal of flexibility, but it fails to include a lot of procedures that exist in more complete languages. Finally, complex conditional branching routines are difficult to follow in threaded interpretive languages.

The approach we took with SALT was to interface a TIL to BASIC. The TIL is used just for the laboratory applications, such as data acquisition and experiment control, and for data storage. BASIC is used for program control and most analyses. This approach provides the speed of the TIL for real-time applications and the interactive characteristic of BASIC for all other applications.

MEMORY LIMITS

Many forms of experiments are associated with the initial collection of

a large amount of data. In some cases, the data is collected in much the same way that an oscilloscope trace is photographed. That is, one or more electronic signals are recorded in digital form for a specific period of time. To provide adequate resolution, the signals are digitized at fairly frequent intervals, so that in typical applications, a few kilobytes of data is collected for each signal. This much data would not tax the memory of computers that accommodate 512K bytes of memory, except when the entire program is run in BASIC.

The IBM PC BASIC is limited to 64K bytes of memory for program and data. Either a lengthy program or a large amount of data can easily outgrow this space. Thus, PCLAB or LABPAC run exclusively in BASIC can be inadequate in applications that require more than 64K bytes of memory, but when you encounter such limitations, you can use a compiled language such as FORTRAN or Pascal. The other programs provide considerably more space for data, as indicated in table 2.

PERFORMING MULTIPLE FUNCTIONS

As described below, the A/D routines in some of the packages will perform single functions nearly as fast as the hardware on the boards will allow. However, program execution can be greatly slowed when more than one function is to be performed at once.

For example, it is often desirable to output a control voltage, either through a D/A channel or through an I/O port, at the same time that data is being collected in the A/D channels. ILS cannot do this, because it accepts only one command at a time. It is possible to perform multiple tasks in sequence using batch files in PC-DOS, but since the routines for each command are read from disk each time they are called, time between commands is extremely long and variable. At the other extreme, routines that are called from compiled languages can pass from one routine to the next within a few tens of microseconds. The exact interval required varies according to the numbers of parameters that must be passed to the new rou-

tine, and thus we cannot give a single interval here.

When commands are called individually from BASIC, the time required to pass from one command to the next is about 2 milliseconds, so the time required to stop sampling data, output a control voltage, and resume data collection would be about 4 milliseconds. The same sequence would take about 150 microseconds in SALT and about 600 microseconds in ASYST. We have examined only the BASIC versions of LABPAC and PCLAB, which each take about 4 milliseconds for this sequence. The FORTRAN and Pascal versions should run substantially faster.

Another example of desirable simultaneous functions is dealing with recently acquired data while more data is being collected. The packages that have provisions for background data collection (see table 2) have considerably slower A/D conversion rates, but these are still sufficiently fast for many purposes.

Several types of data manipulations can be performed while data is being collected. For example, some analysis might be carried out to reduce the amount of data to be stored. Alternatively, some display of the data and/or the analysis might be made. Those packages that provide for the sequential operation of multiple commands (all but ILS and PCLAB) will allow for some form of data manipulation during data collection, although the collection rates must be relatively slow for those programs that are run entirely in BASIC. A type of manipulation that is not possible with most of the packages is the simultaneous storage of data on disk as it is being collected, termed "streaming to disk." Only one of the packages, Labtech Notebook, provides for this streaming. This can be an extremely valuable feature when large amounts of data are to be collected continuously, as with an analog strip-chart recorder. The data-collection rates are necessarily slow when streaming is being performed, but it does allow an enormous amount of data to be collected. With a standard 10-megabyte

(continued)

Some irresistible reasons to buy Revelation[®] before any other network database:

	Network Revelation	dBASE III PLUS [*]	R:base 5000 Multi-User [™]
Product Features:			
Maximum Characters per Record	65,000	4,000	1,530
Maximum Fields per Record	65,000	128	400
Maximum Files per Database	Unlimited	Unlimited	40
Variable-Length Fields	•		
Multi-Value Fields	•		
Programmable Data Dictionary	•		
Network Operating Systems Supported:			
IBM [*] PC Network	•	•	•
3COM EtherSeries [™] (2.4/3+)	•	•	•
Nestar Plan 3000/4000	•		
All Versions of Novell NetWare [™]	•		
Tapestry	•		
Alloy NTNX	•		
Networking Features:			
Full Record Locking During Relational Operations	•		•
Application Generator Automatically Creates Locking Statements	•		
Network DBMS Can Span Multiple Volumes or File Servers	•		
Network Run-Time Module	•		
Minicomputer Communications ¹	•		

¹ From original manufacturer.

These are just a few reasons why Network Revelation is the leading database applications environment for local area networks.

That's because only Network Revelation has the tools to create applications worth sharing.

Like a program generator that builds locking statements, automatically, so you don't have to; a fourth-generation query language and report writer; plus a robust version of BASIC with a high-speed compiler.

And unlike single-user databases pretending to run on networks, Network Revelation doesn't lock everyone out during routine sorts, joins, and math operations.

Sample the power of Revelation. \$24.95 gets you a comprehensive Demo/Tutorial. A phone call gets you complete information.

COSMOS[™]

Cosmos, Inc., 19530 Pacific Highway S.,
Seattle, WA 98188 (206) 824-9942,
Telex 9103808627

IBM is a registered trademark of International Business Machines Corporation. NetWare is a trademark of Novell, Inc. EtherSeries is a trademark of 3COM Corporation. dBase III PLUS is a registered trademark of Ashton-Tate. R:base 5000 is a trademark of Microsim, Inc.

Inquiry 399

THE VERY THOUGHT OF NETWORKING WITH A WIMPY DATABASE TERRIFIES ME, EDNA.



ACCOUNT-EZE

"We mean Business"

by DOBERMAN SOFTWARE

\$89.50

A completely integrated accounting package for MS-DOS computers.

EASY TO USE!

This is the accounting system for people who are not accountants! No debits, credits, accounting lingo, difficult reports to wade through and become confused and frustrated.

Free VCR training tape.

GENERAL INFORMATION

- Menu driven • Single or Multi-user (DOS 3.1) • Complete Manual • Phone support available • Not copy protected • Password protection

GENERAL LEDGER

- Complete chart of accounts • Out of Balance entries not permitted • Income Statement, Balance Sheet, Activity Reports • Entries can be corrected after posting • Cash or Accrual basis • Any fiscal period

ACCOUNTS RECEIVABLE

- Aging Schedule • Single & multiple invoice statements • Monthly Billing • Partial Payments • Customer List

ACCOUNTS PAYABLE

- Check printing • Vendor List • Multiple or single invoices

PAYROLL

- All federal and state deductions • Customized deductions • Quarterly reports • W-2, Payroll Liability Report

INVENTORY

- Point of Sale • Invoicing • Purchase orders • Activity reports • Number of inventory items limited only by disk space

SYSTEM REQUIREMENTS

IBM or compatible with 256K RAM, DOS 2.1 or higher.

ACCOUNT-EZE

To Order Call Toll Free 24 hrs.

1-800-824-7888

Ask For Operator 137

M/C, Visa, Am. Exp., C.O.D. or send check or money order to:

Doberman Software

3025 Alhambra Dr.,
Cameron Park, CA 95682

Add \$7.50 for shipping and handling.
CA residents add 6% sales tax.

Satisfaction Guaranteed!

If for ANY reason you are unhappy with ACCOUNT-EZE, we will gladly refund the purchase price within 30 days.

IBM and MS-DOS are registered trademarks of IBM and Microsoft respectively.

hard disk drive, 5 million integer samples can be collected at a rate of 300 Hz and stored for later analysis using Labtech Notebook.

A/D CONVERSION

Perhaps the most time-critical function of an interface board is the rate at which it can digitize analog data and put it into memory. Except for the high-resolution converters that have slow conversion speeds, the converters supplied by the manufacturers can operate at least as fast as the software packages allow.

All the packages have provisions for A/D conversion, and most will run at speeds close to the maximum speed of the standard A/D converters on the boards. A disappointing exception to this is LABPAC, which Scientific Solutions provides for its Lab Master board. The maximum timing interval that this package provides for is 1 kHz, even though the clock on the board itself runs 1000 times faster. LABPAC has a provision for making faster conversions using a separate, external clock, but the manual does not specify a maximum rate and we have not used an external clock to test the routine.

D/A CONVERSION

When you use the D/A converters to output voltages to control experiments, the speed of the output depends upon the required waveforms. If you require single voltage steps, great speed is not essential, and any of the packages that can operate the D/A converter will generally be sufficient for this purpose. However, when you require continuously changing waveforms, the smoothness of the waveform will depend greatly on the speed of the routines that run the converters; faster conversions let you use smaller voltage increments in providing a given total amplitude of waveform. In these applications, the faster routine will generally be more satisfactory.

Speed in D/A conversion is even more critical when the converters are used for oscilloscope displays. In general, displays must be made at rates of at least 15 Hz to avoid serious flicker. Since you will typically display

as many as 1000 samples per sweep, you want a D/A converter capable of at least 15 kHz for this kind of application. Speed is not nearly so essential when you display hard copy using analog recorders, and since the computer also has the ability to display waveforms on its monitor, the use of D/A conversion for oscilloscope displays is not as essential as it might otherwise be. However, it can be useful in many laboratory applications.

DIGITAL I/O PORTS

These ports, originally designed for transferring parallel digital data, are extremely useful for transmitting individual control signals between the computer and the experimental apparatus. All experiments have some need to synchronize the A/D recording of the computer with the experiments. Since each of the 8 channels in an I/O port can transmit a separate voltage signal, 24 separate channels are available on the Lab Master and 16 come with the DT2801.

The packages that provide the ability to use these I/O channels (table 2) allow a great deal of interaction between computer and experiment. Without the ability to use these ports, you must find some other method of synchronizing the computer with the experiment. For example, it is possible to use a D/A channel to output a control voltage and to accept digital signals through the A/D channels. However, there are fewer of these channels, and to the extent that they are used for digital communication, they cannot be used for other functions.

CLOCK FUNCTIONS

Each board has a clock, and the frequency of these clocks is divided down by powers of 2 on both boards, and by powers of 10 as well on the Lab Master (table 1). Division by powers of 2 can produce some awkward clock frequencies, so in developing SALT we have used only the powers-of-10 dividers. You can obtain frequencies other than those provided by the clock dividers by using the timer/counters on the Lab Master board, but they are not available on

REVIEW: A/D SOFTWARE

the DT2801. Thus, you can obtain much finer gradations in the clock frequencies with the Lab Master.

With most of the software packages reviewed, the actual operation of the clock and timer/counters is invisible. You select a trigger frequency, and the software establishes the correct timer output. In some cases, this reduces the number of timer/counters available to you when a timer/counter is not necessary for the desired frequency.

TIMER/COUNTERS

We have found these timer/counters extremely useful in high-speed operations. For example, it is possible to put out a control voltage to the experimental apparatus at precise times during data collection at the maximum rates. This is done by initializing the timer/counters to count the same pulses that are being used to trigger the A/D converters but inhibiting their operation until the series of A/D conversions is initiated. When each of the counters reaches its terminal count, the voltage output changes without any intervention from the central processor, so the operation of the timer/counters does not take up program-execution time during the critical period of data acquisition. It is also possible to generate different frequencies of trigger signals for different purposes. For example, one frequency might trigger A/D conversions, while the other triggers external events in the experiment.

Of the commercial packages that run Lab Master, only ASYST provides control of the timer/counter (table 2). However, ASYST reserves four of the timer/counters for its own operation so that only one is available to you. Our own SALT usually uses one of the counters for clocking the A/D conversions, so that when you use it in that mode, four of the five timer/counters are available to you. It is possible, however, to use the output of the clock dividers directly in SALT, so that all five timer/counters can be available.

SYNCHRONIZATION

When you program the computer to send or receive digital signals, you can

synchronize its data collection with external events. The accuracy of this synchronization depends upon whether the timing clocks can be synchronized and whether the interrupts within the computer can be disabled. The time-of-day clock within the computer generates a 250-microsecond interrupt every 55 milliseconds. If this interrupt is not disabled, an uncertainty of 250 microseconds occurs in every synchronization. As nearly as we could determine, most of the packages disabled this interrupt during data collection, but PCLAB requires that you write a routine specifically for this purpose when the interrupt is to be disabled.

A less serious problem occurs when the clock is made to run continuously and an external event initiates A/D conversion. In that state, synchronization uncertainties equivalent to one clock interval occur with each conversion. The commercial packages do not provide for synchronizing the timers exactly with external events.

GRAPHICS

Like SALT, PCLAB makes no provision for graphics. Two other packages, Labtech Notebook and LABPAC, let you display the channels of digitized data as they are collected. LABPAC also allows display of previously stored data and x,y plots of two separate channels. Neither of these two packages offers any more extensive graphics.

Most of the graphics routines come as part of the basic ILS package, although some additional graphics are part of an extra-cost data-analysis module. The graphics in ASYST come as part of an extra-cost module. Data obtained with Labtech Notebook can be graphed using Lotus 1-2-3.

DATA ANALYSIS

As with the graphics, ASYST and ILS offer extensive data-analysis routines at an increased price. These two products also offer substantial statistical packages. ASYST's statistics are included in the graphics option, while in ILS the statistics are included in the data-analysis option. As with the graphics, you can perform analysis of

(continued)

America's CENTECH Premium Quality Diskettes

- ✓ TIMELESS WARRANTY
- ✓ Performance exceeds A.N.S.I. specification by 88%
- ✓ Each disk 100% tested and certified
- ✓ 14 COLORS for data organization
- ✓ Pkgs. of 10, tyvek sleeves, w/p tabs, and ID labels

SS-DD	QTY. 10 BOXES 5.25"	DS-DD
.78	EA. Color, 48 TPI	1.03
.99	EA. Color, 96 TPI	1.19
	High Density, Color, 1.5mb, IBM AT Compatible	2.10

CentTech Bulk

SS-DD	QTY. 100 5.25"	DS-DD
.71	Color, 48 TPI	.91
.88	Color, 96 TPI	1.08

Subtract .05 per disk
for black disks



America's No. 1
Name-Brand Diskettes
Free! Headcleaning Disk
\$2.00 box rebate on H/C

- ✓ LIFETIME WARRANTY
- ✓ High quality and consistently reliable
- ✓ More rigid jackets than ever before

SS-DD	QTY. 5 BOXES	DS-DD
.78	5.25, 48 TPI	1.08
.78	5.25, 48 TPI with H/C Kit	1.08
1.49	5.25, 96 TPI	1.89
1.49	3.5", 135 TPI	2.14
1.85	3.5", 135 TPI w/Flip'n'File	2.39
	DS-HD 96 TPI, IBM AT Compatible	2.20
	3M Headcleaning Kit Plus \$2.00 Rebate	6.99
	3M Data Cartridges	QTY. 5 QTY. 10
	DC-100A	12.10 11.99
	DC-1000	12.40 12.29
	DC-300XLP	19.00 18.80
	DC-600A	20.25 19.99

Nashua™ Affordable Quality Incredible Value Best Prices Ever!

- ✓ LIFETIME WARRANTY
- ✓ Factory Fresh in BOXES of 10 with sleeves, w/p tab, ID labels

SS-DD	QTY. 10 BOXES	DS-DD
.63	5.25, 48 TPI, box of 10	.69 EA.
1.59	3.5", 135 TPI	2.19
	High Density, IBM PC-AT Compatible	2.09

BULK Made in U.S.A. Namebrand Quality at Affordable Prices

- ✓ LIFETIME WARRANTY
- ✓ Every diskette 100% tested and certified
- ✓ Performance exceeds A.N.S.I. specifications by 82.5%
- ✓ Packaged in boxes of 100 diskettes with tyvek sleeves, w/p tabs, ID labels

SS-DD	QTY. 100	DS-DD
.55	EA. 5.25, 48 TPI	.65 EA.
.69	EA. 5.25, 96 TPI	.89 EA.
	High Density, IBM PC-AT Compatible	1.85

Call for our low priced ribbon and disk storage boxes

ORDERING INFORMATION

TERMS: Free use of VISA, Mastercard, and American Express. P. O. orders accepted from recognized corporations rated SA2 or better, government and schools on 2%—net 30. PAYMENT: Add \$3.00 per 100 diskettes or fraction thereof, add \$3.00 for headcleaning kit or dozen ribbons, add \$3.00 for COD orders. PRICE PROMISE: We will better any lower delivered price on the same products and quantities advertised nationally.

Toll Free Order Line: 1-800-233-2477 Information Line: 1-801-561-0092

Computer
Affairs, Inc.

199 Cottage Avenue
Salt Lake City, Utah 84070
Hours: 8am to 5pm
(Mtn. Time)

*Labtech Notebook
was easy to learn
but was either too
simple or too slow.*

data obtained with Labtech Notebook in Lotus 1-2-3.

DOCUMENTATION

Most of the manuals were easy to understand and gave satisfactory explanations of each of the commands in the package. The documentation with ASYST was voluminous, mainly because it had to describe a whole new language. We found that it would take longer than we were willing to spend to fully appreciate the richness of this system. One of our colleagues and his technician spent several weeks studying the manual and at the end of that time still did not feel that they had mastered the language.

At the other extreme, we quickly learned the single-command package, ILS, and the menu-driven package, Labtech Notebook. We have worked with only the BASIC version of PCLAB. We found the manual for PCLAB very helpful in its explanations of the routines and the board. It gives numerous useful examples. We had some difficulty in obtaining specific information from the LABPAC manual, which gives very few examples.

IDIOSYNCRASIES

As with all new software, some relatively minor aspects of these packages did not operate exactly as we would have expected after reading the manuals or the advertising. In many instances, the manuals were inaccurate or misleading. For example, the documentation for the early version of Labtech Notebook stated that data could be acquired in the background mode at rates of up to 600 Hz when in fact the highest possible rate was only 300 Hz. Later versions of the manual have been changed to reflect the more limited rate. This type of disparity between manual and program differs from an actual bug, in

which the program does not operate correctly. An example of a relatively harmless bug in ASYST was that voltage values obtained through the A/D converters were half those expected from the input voltages and the amplifier settings. We never did know the reasons for this discrepancy.

We have refrained from cataloging these small deficiencies for two reasons. First, we did not test every aspect of every package, so such a catalog would be incomplete at best. The unwary reader might thus be given the false impression that some aspect of a particular package worked perfectly because we failed to state that it didn't. Second, for most users, the major difficulty will not be an actual bug in the program but some subtle characteristics of the routines that prevent them from carrying out a required task.

A good example is the problem described above of exactly synchronizing the initiation of A/D conversion to an external event. We once had such a problem with synchronization in the laboratory and have written the SALT A/D routines so that they can start the A/D clock after the external trigger is received. We could not find a process for such synchronization in any of the other packages, and it is not possible with the DT2801 board, which has only a free-running clock. This problem of synchronization is just one of many that you might encounter in a specialized application, and it is not possible to give a comprehensive list of the pitfalls that you might encounter in the diversity of laboratory applications. We can only caution prospective buyers of any of the packages to examine its characteristics carefully in light of individual protocols before purchasing the package.

Consequently, we have chosen to describe only a few of the major problems we found with the different packages.

We had the greatest difficulty with ASYST because it was so complex. It is undoubtedly a powerful system, but we estimate that it would take an experienced programmer at least a few months of full-time work to be able to use the routines effectively. However, the company has a user-support

program that we found to be very helpful when we telephoned.

Labtech Notebook was easy to learn but suffered from the drawback that it was either too simple or too slow. When run in its fast foreground mode, it could not do anything but the laboratory interfacing tasks assigned to it. It cannot, for example, collect data for brief periods at a rapid rate and then spend some time analyzing or displaying the data before beginning another period of rapid data collection. This deficiency occurs because Labtech Notebook does not provide data-analysis and display routines of its own but relies on Lotus 1-2-3 for these functions. Lotus 1-2-3 and Labtech Notebook cannot operate in the foreground mode simultaneously. When collecting data in the slower background mode, Labtech Notebook can analyze data using any other language, but the highest conversion rate is 300 Hz.

We found LABPAC to be very limited in its functions, and we found the manual to be somewhat misleading. Scientific Solutions has a user-support system, but it took us six telephone calls to the company before we could speak to someone willing to answer our questions. Even then, the individual with whom we spoke was not able to give specific answers to some questions about the capability of the routines.

CONCLUSION

The software packages reviewed here differ in their emphasis on hardware control, data manipulation, and data analysis. At one extreme, ILS provides few experimental control functions but extensive data analysis. Other packages (PCLAB, Labtech Notebook, and ASYST) provide background data acquisition while other programs operate in the foreground. The two most general packages, ASYST and Labtech Notebook, operate both boards. Labtech Notebook is menu-driven and therefore very easy to operate. ASYST, perhaps the most extensive package, offers separate modules for analysis, acquisition, and graphics/statistics but requires a great deal of time to learn its independent language. ■

15,000 SAVED FROM CRASH.

No hysteria. No panic. No reports of data loss. No wonder more than 15,000 Alpha Micro users have chosen our Videotrax™ backup technology over streamer tape or floppies.

The best news is it's now available for the IBM® PC-AT, XT and true compatibles.

BETTER TO BE FAIL-SAFE THAN SORRY.

Exhaustive testing and long term use of Videotrax technology prove it more reliable than any other backup



High-tech. Open your PC and slide the controller board into any expansion slot. Low-tech. Hook up VCR to computer with standard connector cables.

option available. Even more reliable than the hard disk you're backing up.

At the heart of the system is a patented video tape controller board that employs a standard video cassette recorder for copying data. Which means Videotrax offers the sophisticated technology of today's VCRs. And the depend-

ability of a durable consumer good.

EASY DOES IT.

If you own a VCR, you already own half the system. And you already know how to use it. Or you might opt for the complete subsystem (controller board plus enhanced VCR) and experience the

Your basic video cassettes. Reliable, cheap, easy to find.



joy of its automatic, unattended backup capabilities.

Either way, our menu driven software, clear documentation and wide range of backup modes keep it simple: Insert a blank video cassette tape and follow the directions that appear on your screen.

You can copy or restore your entire hard disk, specific files, or only files modified since the last backup, while the system busily self-monitors for proper functioning.

And for the price of taping your favorite TV shows, you can record your most valued computer data. Up to 80MB can be stored on a single cas-

sette at less than a third of the cost of streamer tape.

Of course, if you ever require service, your authorized Alpha Micro dealer and our world-wide network of factory service centers will provide all the support you need.

For more information on how Videotrax can keep you off the crash course, call your local dealer or Alpha Micro at 1-800-992-9779 (in California call 1-800-821-0612).

VIDEOTRAX™
DATA BACKUP FROM
ALPHA MICRO.

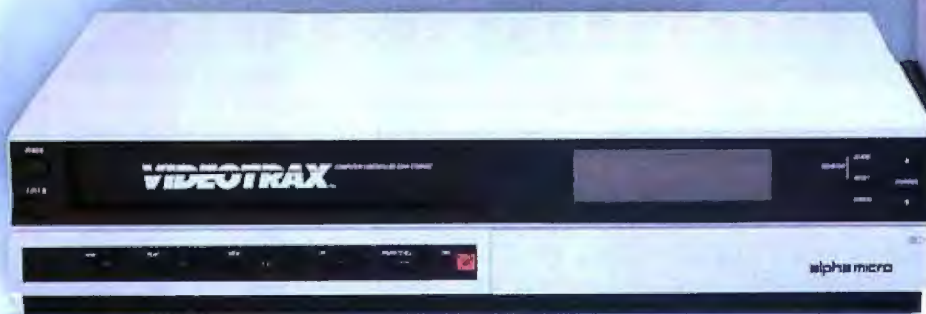

Corporate Headquarters: 3501 Sunflower, P.O. Box 25059, Santa Ana, CA 92799 ©1986, Alpha Microsystems. All rights reserved. IBM is a registered trademark of International Business Machines. U.K. Headquarters: Berkshire House, 56 Hershel St, Slough, Berkshire, Great Britain. European Headquarters: 130 Chaussee de la Hulpe, Box 14 1050 Brussels, Belgium.



FILE RECOVERY SYSTEM™

FOR THE IBM-PC

*"Brown Bag Software's™ File Recovery System™...
more powerful than the Norton Utility Version 3.1."
—PC Magazine*

We May Be Able To Save Your Job Or Your Life

\$69.95

Recover Erased Files
Edit Any Spot On A Disk
Change File Attributes

Fix A Damaged File
Menu-Driven and "Goof-Proof"
Context Sensitive Help

Recover Data From Physically Damaged Disks
Works On Hard And Floppy Disks

YES YOU CAN RECOVER ERASED FILES. Even*.* With Brown Bag Software's™ File Recovery System™ for the IBM-PC and compatibles, no programming experience required. If you can erase a file, you can restore it.

MENU-DRIVEN and "FOOL-PROOF." Do you have "one-of-those" in your office...we do too! That's precisely why we developed Brown Bag Software's™ File Recovery System™ for the IBM-PC and compatibles! Our menu-driven system is a snap.

FIX A DAMAGED FILE TOO! Sometimes files can get "glitched," by a power spike, bumping into the hard disk, dropping the computer on the floor, etc. We understand. That's why we've included a full screen editor to repair any spot in any file, hidden or otherwise.

IS IT HARD OR FLOPPY? We don't care. We work with floppy disk, most hard disks, and most IBM-PC compatible computers.

HELP IS ONLINE TOO! We know that most people don't read manuals. (But we include a comprehensive one anyway.) And when you erase a file and need it recovered NOW, you're not in any frame of mind to pour through any manual. We understand. That's why we've put hand-holding online. Just hit the ? key and the help appropriate to where you are and what you want to do is immediately available. The only thing better would be two aspirins!

OTHER HANDY TOOLS... HELP: WHERE'D THE FILE GO? We provide menu-driven tools to change a file's attributes, change disk labels, modify screen color, locate a lost file that you know is somewhere on the disk, but it's lost in a maze of sub-directories (you forgot which).

WITH YOUR CREDIT CARD, CALL NOW
24 HOURS A DAY, 7 DAYS A WEEK

800-523-0764

IF LINE IS BUSY OR YOU LIVE IN CALIFORNIA

CALL: 408-559-4545



THE IBM WHEELPRINTER E

BY ROBERT D. SWEARENGIN

The Wheelprinter E from IBM is a sturdy, no-nonsense daisy-wheel printer that delivers high-quality output. It is easy to install and operates with a minimum of tinkering. The Wheelprinter E's most serious limitation is its speed, which is just under 16 characters per second. A full page of text, 54 single-spaced lines, takes about 3½ minutes, an unsuitable time for jobs that require the quick printing of long documents. Still, the printer operates reliably when unattended. I ignored the printer while it ran for more than an hour on a large test file. It remained cool, retaining excellent character alignment and print quality throughout the document.

CONTROLS

I connected the printer and reached for the platen knob to roll in some paper, but there was no knob. I found this disconcerting at first; however, it really isn't needed. You simply align the paper against the backstop and pull the paper bail lever all the way forward. The paper feeds properly to the top of the form and the bail returns automatically to the platen after 6 to 10 carriage returns. That's all there is to it.

You can manipulate the paper directly with three of the five dual-function control panel buttons: Stop, Start, Paper Up, Paper Down, and Form Feed. The Stop and Start buttons switch the printer off- and on-line. The Paper Up and Paper Down buttons move the platen one line per touch, or continuously if held. Form Feed moves to the top line of the next form. The paper buttons work only

*A slow but sure
daisy-wheel printer that delivers
high-quality output*



when the printer is off-line.

To activate secondary functions, you simply hold down Stop/Code while pressing the desired button. Reset restores all printer defaults and is equivalent to turning the power off and on. Incr Up and Incr Down move the platen 1/96 inch for fine adjustments. Set establishes the current line as the first line of the next form.

Five indicator lights supplement the switches. These include power on, on-line, end of paper, end of ribbon, and daisy wheel not installed.

The printer's ten DIP switches are easily accessible under a flip-up door on the top of the printer. Three of them set the printer for foreign-language daisy wheels. The others are for hexadecimal dump, skip perforation, automatic linefeed with carriage

return, audible alarm for end of paper and ribbon, form length (11 or 12 inches), line spacing (6 or 8 lines per inch), and line length (8 or 13.2 inches). Maximum line length on the 15¼-inch platen is pitch-dependent, ranging from 132 columns in 10 pitch to 198 columns in 15. And with the 15-pitch daisy wheels, you can condense to 17 pitch.

FLEXIBLE OPERATION

The Wheelprinter E accepts both sheet and fanfold paper. The basic unit is friction feed and comes only with what IBM calls a "paper table"—a 2¼-inch-high backstop with a scale for aligning the paper. It does include auto-stop for single sheets. The printer goes off-line at the end of each page and beeps three times. You insert the next sheet, punch the

reset button, and it begins again without losing any copy.

For long documents you may find that it is too much trouble to insert the sheets by hand; you would then want the optional cut-sheet feeder (\$350) or the pinwheel feeder (\$75). The friction feed handles fanfold paper, but I found that the margin began to shift after three or four pages of text.

The IBM Cartridge Printwheel II, the fancy name for the daisy wheel, is easy to change. My printer came with 10-pitch Courier, which is a clean and readable face. Others, available for

(continued)

Robert D. Swearengin (127 Hunter Farm Rd., Peterborough, NH 03458) teaches English and journalism at North Adams State College in Massachusetts.

IBM Wheelprinter E

Type

Daisy-wheel printer

Company

IBM Corporation
1 Culver Rd.
Dayton, NJ 08810
(800) 426-2468

Size

21½ by 14½ by 6½ inches; 29 pounds

Features

2K-byte buffer

Options

Cut-sheet feeder: \$350
Pinwheel feeder: \$75
Daisy wheels for 10, 12, and 15 pitch
and proportional spacing: \$25 each
Technical reference manual: \$16

Documentation

User's manual, spiral-bound
147 pages

Price

\$699

PRINT SPEED (CHARACTERS/SECOND)



LIST PRICE (\$1000)



— IBM WHEELPRINTER E — JUKI 6300 — DIABLO 630

The IBM Wheelprinter E (using the 10-pitch Courier daisy wheel) is compared with the Juki 6100 (using a Courier 10-pitch daisy wheel) and the Diablo 630 (using a Courier Legal 10-pitch daisy wheel). Print speeds were

determined by timing how long it took the printers to print the Shannon test (573 characters). For more information on benchmarks, see "The Art of Benchmarking Printers" by Sergio Mello-Grand, February 1984 BYTE.

This is the IBM Wheelprinter E.
This is underlined printing.
This is emphasized printing.
~~This is double-strike printing.~~
^{This is superscript}
_{This is subscript}

This is the Juki 6100

This is the Diablo 630 printer.

525 each, include Artisan in 10 pitch; Courier, Letter Gothic and Prestige Elite in 12; Courier and Gothic in 15; and Boldface and Essay in proportional spacing. The printer uses IBM Easystrike ribbon cassettes (\$13.25). You can choose the fabric ribbon for general-purpose drafts or the multi-purpose cassette for high-quality images on a range of paper types.

The printer supports underline, double strike, superscript, subscript, and emphasized—an effective boldface produced with a 1/120-inch offset. Instead of making a second pass for these features, the print head pauses along the way. It's about half as fast as normal printing, but it probably reduces wear and tear. The platen moves up and down 5/96 inch for superscript and subscript.

SPEED TESTS

The Wheelprinter E plods along steadily. Using the BYTE printer

benchmark tests with 10-pitch Courier font, the bidirectional printer typed close to IBM's claimed 16 cps. Surprisingly, the printer was slightly slower on the 80-column Shannon test (15.1 cps), which has fewer linefeeds, than on the 60-column benchmarks (15.6 cps). On 60-column American English first-order random approximations it typed a full single-spaced page at 15.9 cps. (For more information on the benchmarks, see "The Art of Benchmarking Printers" by Sergio Mello-Grand, February 1984 BYTE.)

DOCUMENTATION

The manual covers the operation of the printer well. The chapters on set-up, operation, and options are clear, well written, and profusely illustrated. In just a few minutes, the manual takes you step by step through unpacking, plugging in a standard parallel cable, loading paper, and working the five buttons on the front control panel.

An excellent printer control code chart provides explanations and examples for manipulating the printer manually. You will have little trouble accessing features such as the bell, backspace, tabulation, linefeed, page length, skip perforation, print direction, and line length, or using the control codes to change the print mode, pitch, or character set.

Unfortunately, there is insufficient technical information. For example, the manual says the buffer holds "about one page" of text but doesn't give its size (2K bytes). For detailed information, you must order the technical reference manual (\$16), which contains sections on the parallel interface, hardware design, and the data-transfer sequence.

Overall, I was pleased with the Wheelprinter E. It will undoubtedly satisfy those who require the output of a daisy wheel but not the speed of a more expensive printer. ■

HELLO, **HARRY**? TED FROM TEXAS HERE.
 WE'RE BEING **KILLED** DOWN HERE!!!
 NO, IT'S NOT A HURRICANE - IT'S **AT&T**. YOU'D BETTER
 BELIEVE IT! YEAH... THEY'RE MOVING THEIR BUSINESS PHONES
 WITH THEIR **NEW AT&T PUSH-BUTTON**
SAVINGS PLAN - RIGHT - UP TO **20% OFF** ON A
 MULTI-YEAR LEASE, PLUS FINANCING IF YOU WANT TO BUY....
ALL SORTS OF WAYS TO SAVE MONEY....
 ...WHADAYA MEAN I SHOULD START PUSHING OUR TOASTERS.....

HARRY *the* **DISCOUNT KING!**



Introducing AT&T's **PUSH-BUTTON SAVINGS PLAN**.
 Now, you can save on AT&T telephones—plus other quality business equipment.



■ It's no wonder Harry's guys are harried. They simply can't compete with AT&T's remarkable new Push-Button Savings Plan. Because it offers a much greater number of financial options on business equipment. And greater savings—up to 20% off—on things like leasing. Plus, all of AT&T's equipment is built to last, unlike the stuff that Harry sells. It's clearly time you called AT&T's Small Business Connection. They can help you design a quality system that would be the envy of any Discount Tom, Dick or what's-his-name. ■



AT&T
 The right choice.

1 800 247-7000 / AT&T's Small Business Connection
 This toll-free number connects you to the office in your area.

You've chosen Reflex.TM Now choose the fast way to learn it:

FastStart REFLEX: the only way to produce as you learn. Only McGraw-Hill's FastStart has the advanced technology that lets you really use your software from the moment you open the package. As soon as you start learning, you start producing databases, reports, graphs, and charts—anything you've bought REFLEX to do! And only McGraw-Hill puts a training window right on REFLEX—actual on-screen instructions that guide you through the program.

FastStart REFLEX: the fun and fast way to learn. Only FastStart leads you gently through three levels of training: beginning, advanced, or expert. Each lesson builds on the last, painlessly reinforcing what you've



learned as you go. And all along, you're actually using REFLEX. With the help of FastStart, even the most inexperienced user can start producing with REFLEX, fast.

FastStart is also available for Lotus 1-2-3,TM dBase II,[®] and DOS.[®] In fact, FastStart tutorials are being created for all the most popular software programs. Look for FastStart dBase III,TM MultiMate,TM SuperCalc[®] 3, and SymphonyTM soon. No matter how complex the program, FastStart makes learning simple.



To order, call toll-free (800) 421-0833, Ext. 288 (in California, (800) 662-6222) or send in the coupon to:

McGraw-Hill
Training Systems

P.O. Box 641, Del Mar, CA 92014

The fastest way to save up to \$30:

Yes! I want to start producing! Send me:

FastStart REFLEX, regularly \$69.95 Now \$39.95

FastStart Lotus 1-2-3, regularly \$79.95 Now \$59.95
(Compatible with Release 1A)

FastStart dBase II, regularly \$64.95 Now \$49.95

FastStart dBase III, regularly \$69.95 Now \$59.95

FastStart DOS 2.0/2.1, regularly \$59.95 Now \$49.95

Name _____

Street Address _____

City _____ State _____ Zip Code _____ Phone _____

My check is enclosed Please bill me or Charge my _____

Card # _____ Exp. Date _____

Signature _____

Please send me more information on your FastStart tutorials.

Offer expires July 31, 1986

Offer good in USA only. Outside USA, contact your local McGraw-Hill representative.

8786

FastStart:
the fast way
to learn
your software.

REFLEX is a trademark of BORLAND/Analytica Inc. MS-DOS is a registered trademark of Microsoft Corporation. dBase II, dBase III, and MultiMate are trademarks of Ashton-Tate. Lotus 1-2-3 and Symphony are trademarks of Lotus Development Corporation. SuperCalc 3 is a registered trademark of Computer Associates International, Inc.

ZBASIC

I was pleased to see TI Byers's review of ZBasic (May) because the product deserves attention. But I don't think a user needs to relearn BASIC to the extent that you suggest. I've been using ZBasic for a few months, and it is not hard to convert MBASIC or BASICA to ZBasic with a text editor using search and replace commands.

A nice feature not mentioned in your review is the CALL statement and command in MS-DOS. From the editor you can make changes to one module of a chained program, compile, and then CALL the starting module without exiting ZBasic. You can also CALL batch files, full-screen editors, and most other applications.

One problem not mentioned in your review is that ZBasic variables default to integers. Complicating this are the parentheses, which are interpreted as variables. Thus, in the following computation, X# (a double-precision variable) is calculated as 1; $X\# = (1.3 * (1.2) ^ 2)$. To correct this, the manual suggests multiplying by 1, I found this was necessary at each embedded pair of parentheses as well.

On the whole, I would have given ZBasic more than just a "good" rating. This is a real breakthrough for less sophisticated programmers like me.

GLEN JANSMA
Austin, TX

NON-KEYBOARD INPUT DEVICES

There were a couple of factual errors in "Non-Keyboard Input Devices" by Chris H. Pappas (May).

First, he says that Ctrl-G acts as a destructive backspace in WordStar. This is not true: Ctrl-G deletes the character above the cursor, not the one immediately before. The destructive backspace does exist, though; it can be accessed by the Delete key or by Ctrl-hyphen.

Second, he says that you have to toggle the Num Lock key to use the cursor numeric keypad for numeric input. This is not true: You can also use the Shift key.

The intention behind the much-maligned IBM keypad seems to be to allow the user to type numbers with the right hand and then to press the Shift key with the left while moving the cursor with the right to the next cell or field. Ergonomically, this

keypad makes sense, since it does minimize hand movement. Unfortunately, IBM chose to hide the instructions on how to use it in a little-read section of the manual.

TIMOTHY HARRIGAN
Durham, NH

LETTRIX

I was very interested in Alan R. Miller's review of Lettrix (May), which I now use. Although the program's print quality is very good, I have some complaints to add.

I have gotten no support whatsoever from the vendor, Hammerlab Corporation. I have written to them about the problems and called them long distance, but I have not received a reply.

One of my problems is that I cannot get the program to run with Lotus 1-2-3. Since Hammerlab says the program is Lotus 1-2-3-compatible, this is disturbing; being ignored is even more disturbing. I also cannot get it to run with Turbo Lightning.

Another problem is the manual. It states that Lettrix is not compatible with spoolers, but this is only partly true. The DOS spooler works fine, but the foreground task runs very slowly. The operation on a print buffer might work similarly, although I haven't tried it. Those that have buffers should certainly give it a try rather than taking the manual's word for it.

My copy of Lettrix is not copy-protected, but if it had been I would have asked for my money back and not used it. Since the company only takes orders and will not talk to customers, such a demand would probably have been useless. Vendors that ignore customers usually go out of business sooner or later.

ROBERT A. DAY
Livermore, CA

AT&T PC 6300

I would like to support Al Sargeant's sentiments about the AT&T PC 6300 in his letter in the March Review Feedback.

I, too, have a PC 6300. It is less than one year old and has been laid up in the shop twice. So far it has gone through two power packs and three motherboards, and the problem remains unsolved. Sometimes only the fan comes on with no power-up. This is an expensive mystery.

I wonder how many people have had

similar major overhauls of their 6300s?

I think BYTE could provide an excellent reader service by issuing a "frequency of repair" rating of computers and printers, similar to *Consumer Report's* automobile evaluations based upon surveys.

RICHARD KELLY
Knoxville, TN

I am amazed that the question of DIP switch settings and memory chips on the AT&T PC 6300 motherboard was ever an issue with your readers. When I read Bob Troiano's review (December 1985), I thought that his criticisms of a lack of documentation for the settings required for adding RAM and the compatibility with 256K-byte RAM chip sets were due to the preliminary documentation that he had.

I bought my AT&T PC 6300 in September. The user's guide had clear documentation of settings and confirmation that 256K-byte RAM chip sets are welcome on the motherboard. Michael J. Sobota's letter (March Review Feedback) might give the impression that AT&T documentation is flawed, but I have had no cause to complain, despite having to refer to other optional AT&T manuals from time to time for other questions.

I can, however, complain about AT&T's quality control, as did Al Sargeant (March Review Feedback). My personal computer initially had a faulty floppy disk controller and was "dead on arrival"—it couldn't boot the system disk, even after the drives were changed. After I changed the motherboard, it blew its parallel port two weeks later and repeated this feat a month after that. Each time I had to replace the motherboard. Now, with the fourth motherboard in place, everything has been fine for four months.

I agree with Mr. Sargeant that the PC 6300's performance is amazing. Add an 8087 with the right software, and it flies.

KENNETH ALAN CROSSNER
Somerset, NJ ■

REVIEW FEEDBACK is a column of readers' letters. We welcome responses that support or challenge BYTE reviews. Send letters to Review Feedback, BYTE, One Phoenix Mill Lane, Peterborough, NH 03458. Name and address must be on all letters.

As your introduction to
The Library of Computer and Information Sciences
Take any 3 books

(Publishers' prices shown.)

OPERATING SYSTEMS:

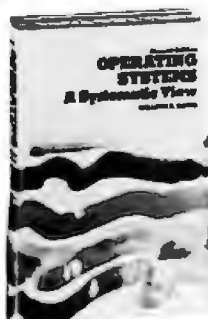

66008 \$28.95



74781 \$21.95
(Softbound)

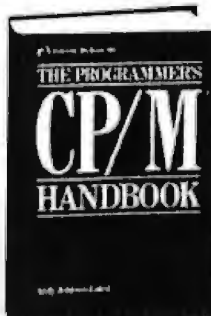

70723 \$27.95

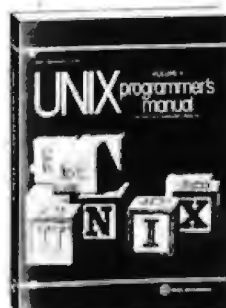

85372-3 \$77.90
(2 volumes count as 3 choices—Softbound)

COMPUTER SCIENCE:

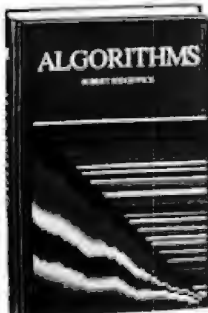

32486 \$28.95

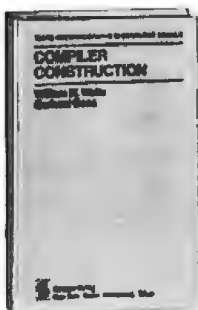

39763 \$26.95

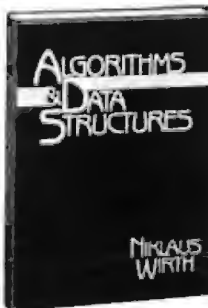

32490-2 \$32.95
(Counts as 2 choices)



49353 \$26.95



56277-2 \$37.95
(Counts as 2 choices)

ARTIFICIAL INTELLIGENCE:



56285 \$27.95



47100 \$24.95

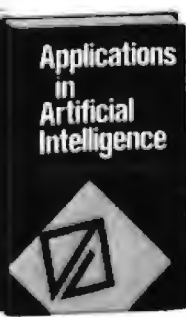

34137-2 \$49.95
(Counts as 2 choices)

SYSTEM DESIGN:



65400 \$26.95

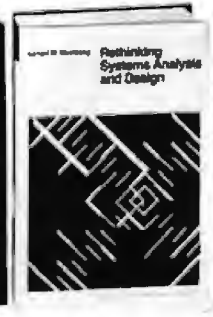

74030 \$22.95



42036 \$29.95

DATA COMMUNICATIONS:



39880-2 \$38.95
(Counts as 2 choices)

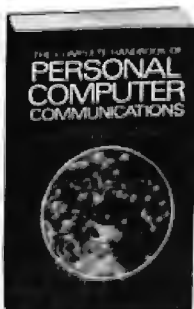

39796 \$14.95
(Softbound)

REFERENCE:



73341-2 \$37.50
(Counts as 2 choices)



44904-3 \$87.50
(Counts as 3 choices)



40862 \$21.95
(compound)



61613-3 \$63.50
(Counts as 3 choices)

for only \$100 each

values
to
\$89.85

You simply agree to buy 3 more books —at handsome discounts—within the next 12 months.

PROGRAMMING:

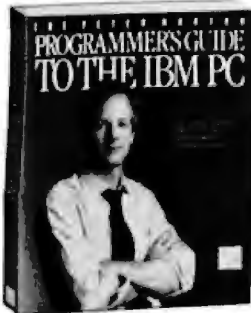

68430 \$1995
(Softbound)

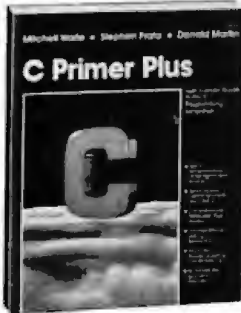

40925 \$2195
(Softbound)

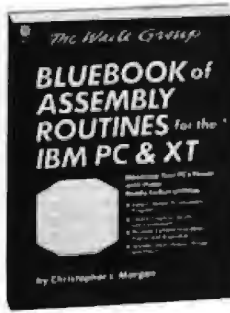

36455 \$1995
(Softbound)



52695 \$10.50
(Softbound)

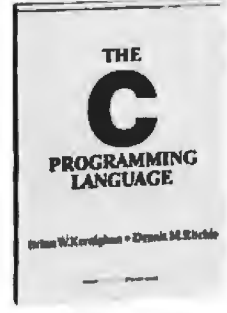

37206 \$2495
(Softbound)

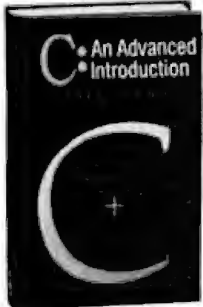

37194 \$2995



70749 \$995

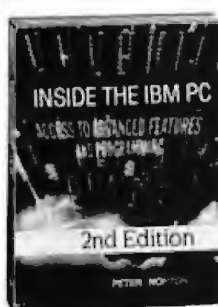

55520 \$1995
(Softbound)



55995 \$2995



38220 \$2495

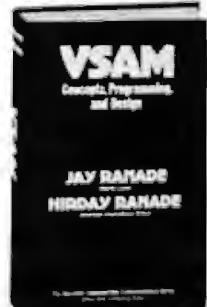

85950-2 \$3495
(Counts as 2 choices)

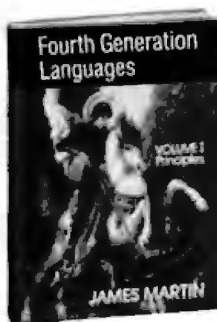

48822-3 \$82.50
(2 volumes count as 3 choices)

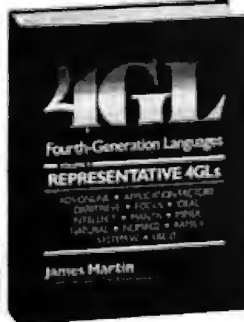

DATABASE:



32272 \$28.95
(Softbound)



70206-2 \$3395
(Counts as 2 choices)



41620 \$2950



41618-2 \$3695
(Counts as 2 choices)

4 Good Reasons to Join

1. The Finest Books. Of the hundreds of books submitted to us each year, only the very finest are selected and offered. Moreover, our books are always of equal quality to publishers' editions, never economy editions.

2. Big Savings. In addition to getting 3 books for only \$100 each when you join, you keep saving substantially, up to 30% and occasionally even more. (For example, your total savings as a trial member—including this introductory offer—can easily be over 50%. That's like getting every other book free!)

3. Bonus Books. Also, you will immediately become eligible to participate in our Bonus Book Plan, with savings of up to 70% off the publishers' prices.

4. Convenient Service. At 3-4 week intervals (16 times per year), you will receive the Library of Computer and Information Sciences News, describing the Main Selection and Alternate Selections, together with a dated reply card. If you want the Main Selection, do nothing, and it will be sent to you automatically. If you prefer another selection, or no book at all, simply indicate your choice on the card and return it by the date specified. You will have at least 10 days to decide. If, because of late mail delivery of the News, you should receive a book you do not want, we guarantee return postage.

If the reply card has been removed, please write to **The Library of Computer and Information Sciences, Dept. 7-DG6, Riverside, N.J. 08075** to obtain membership information and an application.
Byte 7/86



Kernel

COMPUTING AT CHAOS MANOR: TRAVELING COMPUTERS <i>by Jerry Pournelle</i>	325
ACCORDING TO WEBSTER: PROGRAMMING TOOLS <i>by Bruce Webster</i>	347
BYTE U.K.:	
PERSONAL SUPERCOMPUTERS <i>by Dick Pountain</i>	363
BYTE JAPAN:	
A JAPANESE COMDEX AND MORE <i>by William M. Raibe</i>	371
APPLICATIONS ONLY: CHEAP STUFF <i>by Ezra Shapiro</i>	381

CHAOS MANOR REACHED what may be a new high in disorganization this month. Jerry was putting the finishing touches on *two* books, so things got very hectic indeed. However, he was still able to do his column. It begins with Jerry using a program called Fastback to back up the files on Big Kat. The major theme he touches on is how to compute while traveling. New products help make this an easier task.

In According to Webster this month, Bruce looks at some programming tools, products that help you develop programs. Bruce finds himself impressed with the quality of some recently released products. What was once an insignificant segment of the software industry has mushroomed into a significant market, with rising quality and decreasing prices. Bruce's product of the month, Personal Pascal, is one of these tools.

In the U.K., Dick revisits the subject of the Inmos Transputer, which he introduced in his first BYTE U.K. column two years ago. He also discusses Meiko's Transputer-based Computing Surface.

And in Japan, Bill talks about this year's not-so-exciting COMDEX in Japan show and about Oki's laptop portable and some new NEC machines.

Ezra talks about several products that fit into a category he calls "disposable software." That is, each of these programs—It Figures, Dac-Easy Word, AI:Typist, and Datatext—costs less than \$100.

We have 1000's of Software and hardware items in stock. Shipments on almost all items within 24 hours!



Call for programs not listed

Technical & Other Info. (602) 246-2222

TOLL-FREE ORDER LINE 1-800-421-3135

FREE! UP TO \$100 SOFTWARE FREE!
With every purchase over \$100.00 you can select one of the following MS/DOS diskettes at no charge.

1. Blueberry I - 54 basic utility programs includes printer select, graphic generation, etc. **Retail value \$10.**
2. Blueberry II - includes a banner generator, a label maker and a checker game (requires graphics card). **Retail value \$10.**
3. Print Select program - Assembly language program to select different type fonts, etc., or make your printer function as a correctable typewriter - perfect for envelopes, notes, etc. Adaptation modules for popular printers included and capability to adapt any printer. **Retail value \$40.**
4. Deposit Program Compiled DBase to list and total cash, check, bank card for bank deposit and keeps history - Developed for our corporate use - Super Program! (source code available). **Retail value \$40.**

Select an additional diskette for every additional purchase of \$150 or purchase over \$500 and receive all four at no charge.

DATA BASE MANAGERS

Clipper	\$334
Clout 2	119
Condor III	310
Fox and Geller Quickcode	138
Fox and Geller Quickreport	138
Knowledgeman II	299
K Paint	60
K Graph	135
K Text	105
K Report	135
Nutshell	Call
PFS: File	78
RBase 5000	319
Think Tank	92
Tim IV	139

WORD-PROCESSING

Easy (Micro Pro)	88
Leading Edge w/Merge/Spell	75
Microsoft Word 3.0	Call
Multimate 3.31	Call
Multimate Advantage	Call
Oasis Word Plus	85
Peachtext 5000	145
PFS: Write	78
Random House Spell Checker	36
Samna III 3.0	265
Volkswriter 3	Call
Word Perfect 4.1	199
Wordstar	162
Wordstar Propac	233
Wordstar 2000	233
Wordstar 2000+	278

SPREADSHEETS

Microsoft Multiplan	109
PFS: Plan	78
Supercalc III 2.1	Call
VP Planner	49

ACCOUNTING

BPI Accounts Payable	299
BPI Account Receivable	299
BPI General Accounting	299
BPI Payroll	299
Cyma	Call
Dollars and Sense	95
Tobias Managing Your Money	94

TCS. Big Four equivalent of Peachtree Series 4 - Specially augmented and customized for your IBM PC Terminal and Printer - GL, AR, PA, AP, CP/M-80, CP/M-86 for PC XT, DOS 1.1, 2.0.
Each Module \$65 For All Four \$249

INTEGRATED

Enable	Call
Smart Software	Call

TRANSFER PROGRAMS

Crosstalk XVI	\$89
Hayes Smartcom II	88
Microsoft Access	149
Move-It	79
Remote	89

GRAPHICS

Chartmaster	205
Dr. Halo II	99
Energraphics w/o Plotter	160
Energraphics w/Plotter	205
Fancy Font	129
Fontrix	99
Freelance	197
Graphwriter/Combo	294
Microsoft Flight Simulator	30
Printshop	33
PFS Graph	78
Signmaster	134

INCREDIBLE VALUE!

Nationally advertised boards for IBM PC and most compatibles at giveaway prices.

1 year warranty

Keyboards (similar to 5151)	\$89
Monochrome Board w/Printer Port.	\$79
Graphic Board with parallel port (similar to Hercules Graphics)	\$95
Expansion Board 0 to 576K	\$42
Multifunction Board w/game port (similar to AST Six Pack)	\$99
Four Drive Floppy Controller	\$45
Color Card without printer port	\$79
Color Card with printer port	\$89
MULTITECH Turbo IBM Compatible Computer 256K, dual drives, 8MHZ. Ports-parallel, -serial-clock, 5151 type keyboard, graphics board (similar to Hercules), mono monitor, DOS 6 month national (TRW) warranty . \$995	

LANGUAGES

Lattice C Compiler 3.0	Call
Run C Professional	169
Microsoft C Compiler	222
Microsoft Fortran	196
Microsoft Macro Assembler	84
Microsoft Pascal Compiler	169
Microsoft Quick Basic	55
Multi Halo	140

UTILITIES

Copy II PC	19
Copy II PC Board	79
Copyright	45
Desqview	59
Fastback	69
Microsoft Windows	56
Norton Utilities 3.1	49
PC Tools	19
Prokey 4.0	72
Superkey	39

PROJECT MANAGEMENT

Microsoft Project	222
Super Project Plus	Call

HARDWARE

HARD DRIVES

Bernoulli 20 MB 1/2 ht.	2269
Lead Edge hi speed 30 MB AT	465
Seagate 20 MB Internal w/Controller	439

MODEMS

Hayes 1200	Call
Hayes 1200B w/Software	Call
Hayes 2400	599

HARDWARE

U.S. Robotics Courier 2400	Call
U.S. Robotics Password 1200	Call

RAM

64K 150NS Chips (Japan-Set of 8)	\$11.50
256K Ram Chips (Set of 8)	32

BOARDS

AST Advantage	359
AST Sixpack (384K)	Call
Hercules Color Card	145
Hercules Graphics Card	299
J RAM III (Tall Tree)	Call
J RAM III AT (Tall Tree)	Call
J Lazer (Tall Tree)	Call
Paradise Five Pak	99
Paradise Modular Graphics Card	249
Quadram Board with Par/Ser and Game Port	199
Quadcolor I	185
Sigma Maximizer Multifunction	149
STB Chauffeur Board	249
STB EGA Plus	320
STB Mono Board	155
AB Parallel Print Switch w/cables	75
Mini Micro Parallel Print Buffer	69
IBM 120 Watt Power Supply	83

COMPUTERS

Corona PC	Call
Sperry PC Mono 256K Dual Drive Serial Port, Clock, MS/DOS 2.11	Call

ITT Computers PC Compatible 256K Dual Drive, Mono, MS/DOS	Call
---	------

ITT XP 80286 IBM/PC Compatible, 512K, 10 MB Winchester, 3 times faster than an XT. 30% faster than an AT	Call
--	------

Sharp Portable	Call
----------------	------

PRINTERS

CITIZEN	
MSP-10	255
MSP-15	355
MSP-20	329
Citizen 120D	169
Premiere 35 Daisywheel	415
EPSON - Call on all models	

JUKI	
Juki 8100	349
Juki 6300	685
NEC	
8850	1098
P5 Parallel	995
P5 XL	1149
Elf 360	398

OKIDATA - Call on all models	
PANASONIC	
1091	235
1092	299
1592	435
KXP3151	410
STAR MICRONICS - Call for prices	
TOSHIBA	
P351	975
P341	799

MONITORS

AMDEK	Call for price
NEC Multi Sync	544
Taxan 121 Green	Call
Taxan 122 Amber	Call
Princeton Max 12	159

TERMS: Add 3% for C.O.D. orders. Shipping on most software is \$5.00. AZ orders +6% sales tax. Personal check - allow fourteen (14) days to clear. Prices are subject to change. We accept purchase orders from authorized companies. All returns are subject to a restock fee. We do not guarantee compatibility.

No Charge for MasterCard or Visa



TOLL-FREE ORDER LINE 1-800-421-3135

WAREHOUSE DATA PRODUCTS

2701 West Glendale Ave. • Phoenix, AZ 85051

Hours 7 A.M. to 5:30 P.M. M.S.T. - Mon. thru Fri.
Saturday 10:00 A.M. to 3:00 P.M.



TRAVELING COMPUTERS

BY JERRY POURNELLE

This place is a mess. I suppose that's no surprise in a place called Chaos Manor, but in fact it's worse than usual. A couple of days ago, Larry Niven, Steve Barnes, and I finished our new novel (*The Legacy of Heorot*) and got that off to our agent; and last night I completed a new anthology, *Imperial Stars*. As is usual when I'm in the final throes of creating a book, everything else gets neglected; and this time there were two books. The result is stacks of mail, unsorted piles of software, journals, partial drafts, books open to passages we copied out, notes, clippings, unread newspapers and magazines, and heaven alone knows what else, all draped artistically across every conceivable flat surface. The only things missing are empty bottles and dirty glassware: the housekeeper can't be sure about scraps of paper, but she *knows* dirty dishes don't belong here.

All this is by way of indicating that this month's column will be a bit disorganized; but since *every* column lately has been a bit disorganized, I don't suppose I've told you anything unexpected. Sigh.

FASTBACK

Fastback is a program that backs up your PC clone's hard disk onto floppies; it really works. The good news is that Fastback can be installed on your hard disk. The bad news is that you can no longer get an unprotected copy of it.

I have mixed emotions on that. The copy protection that Fifth Generation Systems has employed isn't onerous: it's one of the "key disk" things. Moreover, the Restore program is *not* copy-protected. You can make several backup copies of that and run them, even if your main program disk is

Jerry backs up Big Kat and talks about his lapboard computers

dead or lost. Finally, in their favor, you don't use Fastback very often, and when you do use it you aren't going to be using anything else, so it's only a minor inconvenience that you have to put the master disk into drive A before you get started. It's hard to make a valid case against copy protection that causes no real hardship to legitimate users.

I used Fastback to back up the files on Big Kat, my Kaypro 286i IBM PC AT work-alike. When I'd tried once before, I discovered that if Fastback detects that your disk drives are the modern ultrahigh-density megabyte-plus floppies, it automatically uses that format: or so it seemed to me. I didn't have any of the special disks needed to make use of that ultrahigh-density format. For that matter, I didn't really trust it. That's an awful lot of data packed onto such a small area.

Then Priority One had a big sale, and right there on the back cover of the flyer was ultrahigh-density disks. I figured I might as well bite the bullet, so I bought a couple of boxes; and one Saturday morning I sat down to back up all the stuff on Big Kat's hard disk.

A DIVERSION

My first attempt at backing up the hard disk was utterly unsuccessful. In fact, it was worse than that. You install and customize Fastback and save it off on your hard disk. The installation process is tedious enough that I didn't want to go through it again. I already had an installed Fastback somewhere

on the hard disk, but on a subsidiary directory, and I didn't remember which, so I did DIR/W and got the message "Invalid Parameter."

This didn't seem reasonable, but I'm *not* a DOS wizard, so off I go to look it up. First place is Alan Boyd's *PC-DOS/MS-DOS*: I look in the table of contents. There it is, "The DIR command;" so I turn to page 25—and there's nothing about parameters. Shriek. Look in the index. There are dozens of references under the entry "DIR" but nothing to indicate which, if any, tells about parameters. Look up several. Nothing. Shriek and throw the book across the room. Go find Van Wolverton's *Running MS-DOS*. That has no index entry to "DIR" but does have a pointer to "Directory Command," which, although it says nothing about parameters, has only three index references; and the second one shows the /w and /p parameters. Lo! I had it right all the time. . . except that DIR/W and dir/w and dir /W and all other permutations and combinations inevitably produced the same result, namely, "Invalid Parameter."

This was getting pretty irritating. Eventually I did Ctrl-Alt-Del: of course. I had the Fastback disk in drive A, and it has no operating system on it, so that was another delay. But, eventually, I got the machine reset and booted up; and DIR/W worked fine.

There's a moral to that story. I generally leave Big Kat running at all times; I'm told it's less strain on the hard disk, and anyway the machine with SideKick and Ready! has become my Rolodex, tickler file, calendar, tele-

(continued)

Jerry Pournelle holds a doctorate in psychology and is a science fiction writer who also earns a comfortable living writing about computers present and future.

phone dialer, logbook, memo pad, and just about everything else; I don't want Big Kat turned off.

But every now and then some feature of one of my memory-resident programs won't work. Once, when I was doing some work on-line, Side-Kick wouldn't upload stuff I'd written in the notepad. It would save it all right; but it just wouldn't squirt it uphill. Another time, another minor

glitch. Each time the problem was cured by resetting the machine, just as the "Invalid Parameter" glitch was.

CP/M used to reload itself and rewrite the bit maps every time you did a warm boot, which was generally each time you exited a program. MS-DOS does *not* do that. The result, apparently, is that once in a while something can drift. It isn't just Big Kat the Kaypro, either; I've asked others

with PC and PC AT machines, both genuine IBM and clones, and they report having had mysterious glitches that went away after resetting.

Anyway, I now reset Big Kat at least once a day; and since I took up doing that, I haven't had any more drift problems.

BACK TO FASTBACK

So. Once I got all that straightened out, I was ready to back up my hard disk; and off I went again. This time I found the proper directory, invoked Fastback, and—

I watched things blow up again. Fastback would get started, but it clearly wasn't working right.

There is a telephone number in the Fastback document. Two, actually: an 800 number and one for a normal exchange in Baton Rouge, Louisiana. The 800 number didn't answer—this was a Saturday morning—so I called the other, and Lo! I got one of Fastback's designers. We set to work on the phone.

The first problem was the number of buffers. The "buffer" command in your AUTOEXEC.BAT file is vital. Some numbers for "buffers" won't work. It's safest (but slower) to have no buffer command at all. It's not that much slower. This is not properly documented in the Fastback documents.

Once that was settled we started again. Fastback tells you what to do: put a blank disk in drive A, drive A done, put a blank disk in drive B, and so forth, and it trundles along *very* fast. You do have to pay attention to those prompts, but there's no disaster other than wasted time if you're a bit slow in responding. Fastback formats the disks for you if they aren't already formatted, so you needn't be bothered about that, either.

About halfway through the job, Fastback died. It didn't say it had died; but nothing happened for quite a long time. Since I was on the phone with one of the program's authors, I could ask what to do next.

"Are the disk lights on?"

"No."

"Hmm. It's dead, all right. We never worked with a Kaypro AT before. I

(continued)



USRobotics' COURIER 2400™
...The most dependable
at 2400- or 1200-bps

You get 2400/1200/300-bps data communications and every first-class feature you'd expect in an auto-dial, auto-answer modem...at a surprisingly affordable price.

But a modem at any price is only as good as its performance...And that's where Courier 2400 really shines. Don't take our word for it. Ask any of the nearly 2,000 electronic bulletin board system operators who have chosen the Courier 2400 for one of the most demanding modem applications imaginable.

Listen to the unanimous chorus of praise for the Courier 2400 from tough reviewers at more than a dozen highly respected computer magazines.

Consider Courier 2400's performance record—less than one percent of all Courier 2400s sold have been returned for service, a record we challenge the industry to match. And we back up our confidence in Courier 2400

with a full two-year parts and service warranty.

Quality, performance, value—your modem should be this good. It is, if it's the Courier 2400 from USRobotics.



The Intelligent Choice in Data Communications

8100 McCormick Blvd., Skokie, Illinois 60076
Phone toll free 1 (800) DIAL USA
In Illinois (312) 982-5001

To learn more, send for our
FREE booklet: "24 Questions
and Answers on 2400-BPS
Modems!"
NAME _____
ADDRESS _____
CITY _____
STATE _____ ZIP _____
COMPANY _____
TITLE _____
PHONE (_____) _____
PERSONAL USE BUSINESS USE

THE PROGRAMMER'S SHOP

helps save time, money and cut frustrations. Compare, evaluate, and find products.

RECENT DISCOVERY

Artck ADA Compiler - DoD standard minus multitasking. Includes trace, breakpoints, code disassembly, more. Produces virtual stack file or native code PC \$895

AI-Expert System Dev't

Arity System - incorporate w/C. PC \$295
Experteach - Improved, samples PC \$399
EXSYS - Improved. Debug, file & external program access. PC \$339
Insight 1 - Probabilities, fast MS \$ 79
Insight 2 - dB2, language MS \$399
Others: APES (\$359), Advisor (\$949), ES Construction (\$100), ESP (\$845), Expert Choice (\$449)

AI-Lisp

BYSO - Common, MacLISP compatible 250+ functions, fast. PC \$150
List Our
GCLISP Interpreter - "Common", rich. Interactive tutorial \$495 Call
Microsoft MuLisp 85 \$199
PC Scheme LISP - by TI. SCHEME has simple, "orthogonal" syntax. PC \$ 95
TLC LISP - "LISP-Machine" - like, all RAM, classes, compiler. MS \$225
TransLISP - Good for learning MS \$ 75
WALTZ LISP - "FRANZ LISP" - like, big nums, debug, CPM-80 MS \$149
Others: IQ LISP (\$155), UNX LISP (\$59), IQC LISP (\$269)

AI-Prolog

ARITY Standard - full, 4 Meg Interpreter - debug, C, ASM PC \$ 350
COMPILER/Interpreter-EXE PC \$ 795
With Exp Sys, Screen - KIT PC \$1250
MicroProlog - enhanced MS \$ 229
Professional MicroProlog MS \$ 359
Prolog-86 - Learn Fast MS \$ 95
Prolog-86 Plus - Develop MS \$ 250
TURBO PROLOG by Borland PC \$ 85
Others: Prolog-1 (\$365), Prolog-2 (\$1795)

Editors for Programming

BRIEF Programmer's Editor - undo, windows, reconfigure PC Call
C Screen with source 80/86 \$ 75
EMACS by UniPress - powerful, multifile, MLISP. Source: \$949 \$299
Epsilon - like EMACS PC \$169
Kedit - like XEDIT PC \$109
Lattice Screen Editor-multiwindow multi-tasking Amiga \$100 MS \$109
PMATE - power, multitask 80/86 \$159
VEDIT - well liked, macros, buffers. CPM-80-86 MS \$119
XTC - multitasking PC \$ 85

FEATURE

dBrief, the dBASE Assistant - optional syntax directed editing, screen gen, graphics, speed coding, dBASE II, III, Clipper. PC \$ 95

Inquiry 286

Compare Products Use Product Specialists

The Programmer's Shop is much more than the supplier of the largest selection of programmers' software. Trained programming consultants will answer your questions. Ask "product specialists" about Cross Assemblers, Translators, Debuggers, or C compilers.

Our Services:

- Programmer's Referral List
- Compare Products
- Help find a Publisher
- Evaluation Literature FREE
- BBS - 7 PM to 7 AM 617-826-0886
- Dealers Inquire
- Newsletter
- Rush Order
- Over 700 products
- National Accounts Center

C Support-Systems

Basic-C Library by C Source MS \$139
CSharp - well supported, Source, realtime, tasks PC \$600
C ToolSet - DIFF, xref, source MS \$ 95
Lattice Text Utilities PC \$ 99
The HAMMER by OES Systems PC \$179
PC LINT - checker. Amiga \$89, MS \$119
SECURITY LIB - add encrypt to MSC. C86 programs. Source \$250 PC \$125

Fortran & Supporting

Forlib+ by Alpha - graph, comm. \$ 59
MACFortran by Microsoft - full '77 \$229
MS Fortran \$219
No Limit - Fortran Scientific \$129
PolyFortran - xref, pp, screen \$149
Prospero - '66, recntrant \$349
RM Fortran - enhanced "IBM Ftn" \$395
Scientific Subroutines - Matrix \$149
Strings and Things - registers, shell \$ 59

MultiLanguage Support

BTRIEVE ISAM MS \$199
BTRIEVE/N - multiuser MS \$469
CODESIFTER - Execution PRO-FILER. Spot bottlenecks. MS \$109
Dan Bricklin's Demo Program PC \$ 75
HALO Graphics - 115+ device interfaces, rich, printer. Specify language interface PC \$249
PANEL - data validation, no royalties Xenix \$539, MS \$239
Pfinish Performance Analyzer MS \$279
PLINK-86 - a program-independent overlay linker to 32 levels. MS \$279
PLINK-86 PLUS - incremental MS \$369
PolyLibrarian MS \$ 85
PVCs Version Control MS \$359
Screen Sculptor - slick, thorough PC \$ 99
ZAP Communications - VT 100, TEK 4010 emulation, file xref. PC \$ 85

Atari ST & Amiga

We carry full lines of Manx, Lattice, Metacomco and Prospero.

Call for a catalog, literature and solid value

800-421-8006

THE PROGRAMMER'S SHOP™

128-B Rockland Street, Hanover, MA 02339
Mass: 800-442-8070 or 617-826-7531 \$/86

RECENT DISCOVERY

Microsoft Windows Software Development Kit - Run graphics. Eliminates need for hardware-specific support. Includes MS Windows user version PC \$399

C Language-Compilers

AZTEC C86 - Commercial PC \$399
AZTEC C65 - Personal Apple II \$199
C86 by CI - 8087, reliable MS \$299
Lattice C - from Lifeboat MS \$289
Lattice C - from Lattice MS \$339
Mark Williams - w/debugger MS \$399
Megamax - tight full ATARI/ST \$179
Microsoft C 3.0 MS \$259
Q/C 88 by Code Works - Compiler source, decent code, native MS \$125
Wizard C - Lattice C compatible, full sys. III, lint, fast. MS \$389

C Language-Interpreters

C-terp by Gimpel - full K & R, .OBJ and ASM, large progs. MS \$249
INSTANT C - Source debug, Edit to Run-3 seconds MS \$389
Interactive C by IMPACC Associates. Interpreter, editor, source, debug. PC \$225
Introducing C - learn C fast, self paced tutorial PC \$109
Run/C Professional - Run/C plus create add-in libraries, load/unload them. MS \$189
Run/C Lite - improved MS \$109

C Libraries-General

Blaise C Tools 1 (\$109), C Tools 2 \$ 89
C Essentials by Essential PC \$ 85
C Food by Lattice-ask for source MS \$109
C Utilities by Essential - Comprehensive screen graphics, strings. Source. PC \$139
Entelekon C Function Library PC \$119
Entelekon Superfonts for C PC \$ 45
Greenleaf Functions - portable, ASM \$139
PforCe by Phoenix - objects PC \$299

C Libraries-Communications

Asynch by Blaise \$149
Greenleaf - full, fast \$139
Software Horizons - pack 3 \$119

C Libraries-Files

dBASE Tools for C PC \$ 79
dbc Isam by Lattice MS \$199
FILES: C Index by Trio - full B + Tree, vary length field, multi compiler /File is object only MS \$ 89
/Plus is full source MS \$349
CBTREE - multiuser record locking, sequential, source, no royalties MS \$ 99
CTree by Faircom - no royalties MS \$339
dbVISTA - full indexing, plus optional record types, pointers, Network. Object only - MS C, LAT. C86 \$179
Source - Single user MS \$429
Source - Multiuser MS \$829

Note: All prices subject to change without notice. Mention this ad. Some prices are specials. Ask about COD and POs. All formats available. UPS surface shipping add \$3/ftm.

Turbo Extender

Barriers Were Made To Be Broken

If you're using Turbo Pascal, Turbo Extender is the software you need to break the 64K barrier. Now write programs as long as you need, limited only by available RAM.

LARGE CODE MODEL

Write programs using all 640K without overlays or chaining. Convert existing programs with minimal effort. Offers advanced dynamic binding or standard EXE files.

MAKE FACILITY

Offers separate compilation. No starting from scratch for source code changes.

LARGE DATA ARRAYS

Automatically manages data arrays up to 30 megabytes, as well as arrays stored in expanded memory.

ADDITIONAL TOOLS

Overlay Analyst, Disk Cache, Pascal Encryptor, Shell File Generator, and File Browser.

TURBO EXTENDER

Includes 2 DSDD disks, complete source code, 150 page printed manual. Requires Turbo Pascal 3.0 and PCDDOS 2.x or 3.x. Runs on IBM PC/XT/AT and compatibles. Call for MSDOS support. \$85 COMPLETE.

ALSO AVAILABLE TURBOPOWER UTILITIES

Bruce Webster, in BYTE Magazine, February 1988, named it Product of the Month, saying "If you own Turbo Pascal, you should own TurboPower Programmer's Utilities; that's all there is to it."

It offers 9 programs in all, including the Program Structure Analyzer which locates subtle coding problems the compiler fails to catch. It also produces reports that describe your code, providing cross reference and hierarchy diagrams. Also includes Execution Timer, Execution Profiler, Pretty Printer, Command Repeater, Pattern Replacer, Difference Finder, File Finder and Super Directory.

TURBOPOWER UTILITIES

Come compiled, ready to use. Includes manual, reference card, three DSDD disks, complete source code. Requires Turbo Pascal 2.0 or 3.0. \$95 with source code; \$55 executable only.

GET BOTH TURBO EXTENDER AND TURBOPOWER UTILITIES (Source) \$149

MC/VISA CALL TOLL-FREE 7 days a week 800-538-8157 x830 (CA) 800-672-3470 x830 For PO, COD, Dealers, Info, Brochures - call or write:



478 W. Hamilton # 196
Campbell, CA 95008
(408) 378-3672 M-F
9AM-5PM PST

INTERNATIONAL REPRESENTATIVES

Switzerland: Software Haus 064-572651
Japan: Southern Pacific Ltd 045-314-9514
Holland: Polysoft 03-425275
England: Grey Matter Ltd 0364-53499
Australia: Videogram Communications 02-627-1261

With Fastback, I backed up 20 megabytes in less than 15 minutes.

think it got retry errors and timed out."

Fortunately there's a solution. You can invoke Fastback with options. Some, like /360 and /720, will cause the disk drives to format disks to 360K or 720K bytes per floppy: I didn't have to buy the special ultrahigh-density disks and let the machine do the 1.2-megabyte format. This isn't well documented, but it does work. ("Isn't well documented" means "I didn't find it when I needed to." The information is in the book, but it has neither index nor analytical table of contents; you have to read all of it to find out things like that.) Anyway, if you have 1.2-megabyte drives, you can still use normal floppies by doing Fastback /720, or /360 if you're feeling conservative and have lots of floppies lying about. Of course, that wasn't the option I needed.

The option needed for Big Kat is Fastback /slow. You wouldn't deduce that, because when you install Fastback there's a "test" routine that runs and tells you whether or not you ought to invoke it with the /slow option, and Big Kat passed that test; but that's what I had to do. Incidentally, the /slow option doesn't really slow the program, or at least not by much: what it does do is make the program believe that you have a somewhat erratic disk controller and thus do more retry attempts if things get out of sync.

So. Next step: Fastback /slow.

That worked. It worked wonderfully well. Faster than you'd believe. In less than 15 minutes, I'd backed up 20 megabytes of stuff.

Now for the acid test: will it restore? Fastback's Restore program has a test mode: you can invoke the program in a way that won't write anything but verifies that what has been backed up is what's on the hard disk. I tried that. Worked fine.

There's more. Fastback has an error-correction feature. You can take your backup disk and put a staple through it. I don't recommend that you do that, at least not to your only backup copy, but you can do it, and chances are very good that the program will be able to restore your data anyway. (You do have to remove the staple. . .)

So, I love Fastback. I use it. It works with Big Kat (as it does with both the IBM PC and the Zenith Z-150 with the Hardcard). The documents are awful, but they're good about support if you call on the telephone; and I guess I can live with their form of copy protection for this kind of program. (Sigh. Every time I think I have rules established. . .)

TRAVELING

Last summer I went through The Great Portable Quest looking for a computer to carry with me to Europe. This year I won't have the problem. I know what I'll take.

My requirements are pretty simple. I want something light, battery-powered, with a reasonable text editor. I want plenty of storage space. I'm a fanatic about not losing text: I really want redundant storage if I can get it.

I don't need big number-crunching power, or Lotus 1-2-3, and I'm not likely to do any programming while on the road. I would like to have ways to update my calendar and address book and make notes for future reference.

I've left out the most important requirements of all: it has to be truly portable. I need a lapboard because I work in airplanes; I have to be able to see the screen in the not-always-good light that airplane cabins provide; and the thing has to be light enough to carry around airports.

For a while I solved the problem by carrying Adeline the Otrona, for use in hotels and for disk storage, and Percy the NEC PC-8201 lapboard, to use on the airplane and in lounges. This works reasonably well. Spin and Pop Enterprises (P.O. Box 6458, Denver, CO 80206) provides better service and support (including memory expansion and general updating) for the Otrona than the Otrona Com-

CHAOS MANOR

pany did before that outfit went south; and the Otrona, with hard disk and large monitor, is just one delightful machine to use. More, the NEC can be stuffed in alongside the Otrona in the Otrona's carrying case, and it's a very simple matter to squirt text from Percy to Adeline.

Alas, this combination is heavy. It's bad enough on short domestic trips; on long trips, or when I have to change planes, it's sheer murder. I already have plenty to carry, since I generally have a briefcase and shoulder bag, often a garment bag, and, if returning from a computer show, a couple of plastic bags of software and books. Adding 25 pounds of computer to that load is just a bit much.

One possibility is Purple Computing's Sidecar for the NEC. This is a removable bank of 98K bytes of memory with its own battery. It works wonderfully well, and last year when I decided not to take the Otrona to Europe, Sidecar was a real lifesaver. (On reflection, it should have been mentioned as one of my Products of the Year in the April issue. My apologies.) A NEC with Sidecar certainly works.

There are problems. Clearly you have no redundancy, unless you buy two Sidecars, and they're not cheap. Second, transferring text files between the NEC and the main computer—PC-DOS or CP/M—isn't too difficult, but it is a bit tedious, since you have to connect the machines with a cable and use serial-transfer methods. Finally, there are severe limits to the programs and electronic files you can carry. Still, for all the problems, the NEC PC-8201 with Sidecar worked and was the best thing around for me.

TS-DOS AND LAPDOS

Now enter Mark Eppley, whose Traveling Software company specializes in lapboard computer products. Eppley got hold of the Brother FB-100 battery-powered 3½-inch disk drive and put together a package to mate it with either the TRS-80 Model 100 or the NEC PC-8201. The result is called TS-DOS. TS-DOS works with the Ultimate ROM II, a ROM chip with application

(continued)

“BRIEF has improved my productivity tenfold. It paid for itself in 2 weeks!”
David Norwood, Microsystems Manager

Tailor Editing to Your Style

- A high-level, readable *Macro Programming Language* - allows customization for programming languages . . . Complete, unlimited variables, etc.
- Edit *multiple files of unlimited size* (2 Meg is OK)
- Multiple *Windows* on screen with different or same file, fragments, etc.
- A bona-fide *UNDO* stack (up to 300) of all operations: deletions, reading files, search, translate, more.
- Full “*regular expression search*” - wild cards, complex patterns
- Reconfigurable keyboard
- Adjustable line length - up to 512.
- *Keystroke macros* - for common typing sequences
- Suspend BRIEF to execute, exit to DOS - run another program (like a compiler, dir, XREF, DIFF, or DEBUG) then resume BRIEF session
- *Compiler-specific* support like auto indent, syntax check, compile within BRIEF

For PC, AT, compatibles and Tandy 2000.

Only \$195

Full Refund if not satisfied in 30 days.

Solution Systems

335-B Washington St., Norwell, MA 02061
 817-859-1571

CALL 800-821-2492.

LEARN LISP

Interactively and Write Real Programs with TransLISP for Only \$75

A “COMMON LISP” compatible Tutorial, Interpreter, Debugging, and Pretty Printer plus a Fast, Full Screen Editor, Samples and Help

Start Easily and Quickly:

A complete, modular tutorial helps you learn LISP at your own pace. An integrated, interactive environment provides all of the elements needed to enter, modify, analyze and debug programs.

Natural Language, Expert Systems and Symbolic Manipulation:

Natural Language concepts are illustrated by a phone number retrieval program. Choose the best word processing program for you with the Expert System. Arithmetic expressions are translated to Assembler using a code generation program.

Write Realistic Programs:

Short examples and substantial programs of about 10 pages in length help you learn by modifying, studying and using the key concepts needed to write programs of 1000 lines or more.

The “COMMON LISP” Standard:

TransLISP includes a 300+ function subset of the “COMMON LISP” Standard. Use extras like the MSDOS interface and graphics. Or use “strict compatibility” to make programs written in TransLISP, upwardly compatible with other COMMON LISP systems like VAX LISP, GC/LISP or LISP Machine LISP.

Recent Improvements: 640K Memory use supports 12000 line programs. Full 8087 and 8086 floating point included.

Runs on any MS/PCDOS System with 256K. It is not copy protected.

“The best LISP I’ve ever used. Three times before, I tried to learn LISP, but until now I could never break through the surface.” *W.L. Whipple, User*

ONLY \$75

Full refund if not satisfied during first 30 days.

Solution Systems™

335-B Washington St.
 Norwell, Mass. 02061
 617-659-1571
 800-821-2492

software, to be installed in the NEC or TRS-80 lapboard machine. You can also buy TS-DOS separately and load it from a 3½-inch disk. A 5¼-inch disk called LAPDOS enables your PC to access the disk drive through a serial port. Although I've used only the Brother FB-100, everything works with the Tandy portable disk drive you can get at your neighborhood Radio Shack.

The result is little short of wonderful. I can write a ton of text and save it onto a disk. If I'm feeling paranoid—I often do—I can then put in a fresh 3½-inch disk and save it all again. When I get home, I plug the disk drive into Big Kat's serial port and transfer the files.

There's more. I can also transfer files from the PC to the portable disk: calendar, telephone book, notes; any-

thing I like. All this works simply and easily. It sure makes traveling easier. The Brother FB-100 is quite small and can be carried in a case with either the TRS-80 Model 100 or NEC PC-8201. It's also rugged. You probably want to take the batteries out, since it would be pretty easy to accidentally turn on the switch, but otherwise there's absolutely no reason why you shouldn't roll the FB-100 up in your pajamas and send it along in checked luggage.

Traveling Software also sells a small TTXpress thermal printer. This little jewel is 12 inches wide by 5 inches deep by 2 inches thick and prints normal 8½ by 11 pages. It's larger than the little NEC roll printer I used last summer, but unless you're really fanatic on traveling light it's worth it. I can already hear the cheers from the BYTE staff who last summer had to type in my column from the "adding machine tape" output of the NEC printer.

One tricky point about the TTXpress printer: the NEC and Radio Shack computers have their printer ports reversed! A cable that works to connect the TTXpress to the NEC has to be twisted 180 degrees to make it work with the TRS-80 Model 100. I don't have the foggiest notion why.

Traveling Software has a deal on either TRS-80 Model 100 or NEC PC-8201 systems complete with the Brother FB-100 disk drive, the Ultimate ROM II, TS-DOS, LAPDOS, and carrying case. They'll also sell you the TTXpress printer; the Ultimate ROM II has a formatting program that works fine with the TTXpress.

Ultimate ROM II does a few other things, too, like adding a global replacement command to the text editor (the Radio Shack and NEC editors have good search commands, but not replace) and remedying a few other omissions.

Thus, for less than a thousand bucks you can get a complete portable word-processing system about as good as my first computer ever was. The text editor built into the NEC and Radio Shack machines isn't as fancy as I like, but it's surprisingly good and very easy to learn. Add an Epson printer—the Ultimate ROM II's format-

NEW!

For Your IBM PC or Compatible

RightWriter® Version 2.0

THE Intelligent Grammar and Style Checker

RightWriter is a new tool to help you produce lean, powerful BUSINESS WRITING. RightWriter uses advanced artificial intelligence technology to flag errors in GRAMMAR, STYLE, USAGE, and PUNCTUATION. RightWriter is the first office automation package aimed at producing better writing, not more writing.

- **Messages are Inserted** directly into text to point out possible errors and problem areas.
- **Easy to Use** — only one command to learn, your word processor does the rest.
- **Works with Leading Word Processors** — including WordStar®, Volkswriter®, PFS:write®, MultiMate®, and others.
- **Readability Index** — measures the reading grade level of the document using the D.O.D. standard Flesch-Kincaid formula.
- **Uncommon Word List** — lists misspelled, slang, and uncommon words.
- **Recommends** — never decides. RightWriter is a writing aid. The final decision is always left to you.

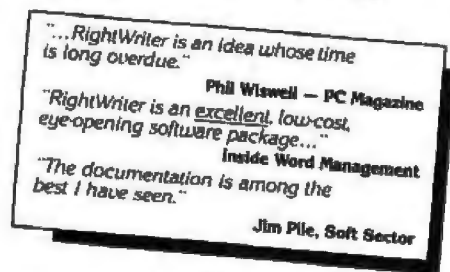

Price \$95.00

Available from your local dealer or:
 DECISIONWARE, INC./RightSoft Division
 2033 Wood St. • Suite 218
 Sarasota, FL 33577
 Phone Orders Call: (813) 952-9211
 Add \$4 for shipping and handling.
 VISA & MASTERCARD accepted
30 Day Money Back Guarantee

RightWriter is a trademark of DecisionWare, Inc., WordStar is a trademark of MicroPro International Corporation. MultiMate is a trademark of MultiMate International. PFS:write is a trademark of Software Publishing Corporation. Volkswriter is a trademark of Lifetree Software, Inc.

For about \$1000 you
can get a portable
word-processing
system about as good
as my first computer.

ter knows how to work with those—and you'd have a system good enough to be your *only* computer, at least to get started with. Eight lines of 40 characters isn't really optimum for writing, but that's all right; the Ultimate ROM II can set the system to display 60 characters, and that's quite enough.

Roberta and I have "his and her" NEC PC-8201s that we take with us everywhere; we share the printer and disk drive. We like these machines a lot. If you're at all interested in lap-board machinery, I strongly recommend you look into either the NEC PC-8201 or the TRS-80 Model 100. Probably the simplest way is to talk to Traveling Software and ask about their latest deal.

I especially recommend that you talk with Traveling Software or some other expert if you want to use the small disk drives on both the lap-board and a PC. Cables and stuff like that can be tricky.

NEC OR RADIO SHACK?

I now have both NEC PC-8201 and TRS-80 Model 100 machines. Both are equipped with Traveling Software's Ultimate ROM II, meaning that both work with the FB-100 battery-powered 3½-inch disk drive, TTXpress printer, etc.

On my most recent trips I carried both computers. It makes me look a bit odd as I board the airplane festooned with shoulder bag, briefcase, a sack full of software and books, and two computers. Oh, well. The purpose was to get a good comparison of the two machines.

I'm glad I did. I can honestly recommend either machine. Each has ad-

(continued)

Free Famous hi-tech catalog

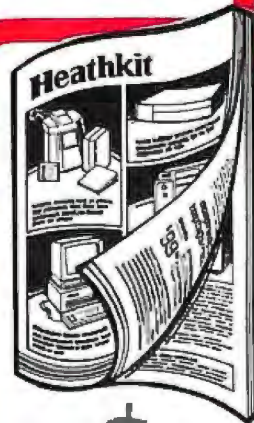

A very special computer & electronics guide that shows you what the exciting world of kitbuilding can do for you.

Challenge. Knowledge. Achievement. Enjoyment. All of these things are yours when you build a Heathkit high-quality product. Our colorful, informative catalog reflects the years of experience and technological expertise that make these things happen for you.



HERO® 2000 Educational Robot and Courseware
IBM-PC Compatible Expandable Computers

Amateur Radio Terminal Node Controller

Precision Test Instruments

Electronic Keyless Doorlock

In our catalog you'll find over 450 interesting and useful items — from computer hardware and software to robots and test instruments, and from home security systems to color tv's and amateur radio equipment.

But what makes Heath Company unique is that we offer you the confi-

dence and pride that you can only get by building a state-of-the-art product yourself. And you're backed by our promise, "We won't let you fail."

The Heathkit Catalog is a simple — and FREE — first step toward this excellent opportunity.

Send **NOW** for your **FREE** Heathkit Catalog



Yes! I want to see what kitbuilding can do for me. Please send me the latest Heathkit Catalog Free.

Send to: Heath Company, Dept. 334-432
Benton Harbor, Michigan 49022

Name _____

Address _____

City _____ State _____

Zip _____

Heathkit
Heath
Company

A subsidiary of Zenith Electronics Corporation

CL-787R1

Run Protected Software from a Hard Disk.

ZeroDisk
ZeroDisk
ZeroDisk
ZeroDisk

ZeroDisk lets you run dozens of popular business software packages without floppies. Call us for the latest list of software it handles. ZeroDisk needs an IBM PC or XT or AT or compatible, running under DOS version 2.0 or higher. It occupies 15k bytes of memory. ZeroDisk is not copy-protected.

ZeroDisk is revised monthly. You may get revisions for an \$18 US trade-in fee.

To order ZeroDisk, send a check for \$75 US, or call us with your credit card. We will ship the software within a day.



Quaid Software Limited

45 Charles Street East
Third Floor
Toronto, Ontario M4Y 1S2
(416) 961-8243

vantages and disadvantages.

Both machines are made by the same Japanese company and thus have a great deal in common. The major advantages of the NEC PC-8201 are that it has more memory, external (removable) memory cartridges are available, and the arrow keys are *much* better arranged than on the TRS-80 Model 100. The main advantages of the TRS-80 Model 100 are a built-in 300-baud modem, Selectric keyboard layout, and a resident address program that can function as a traveler's Rolodex.

The Radio Shack's built-in modem is tempting, but it's not all that inconvenient to carry a little external modem for the NEC; the modem is quite small and doesn't cost much. I originally got the NEC rather than the Radio Shack because of the external memory cartridges. The advent of the FB-100 disk drive makes that largely—though not totally—irrelevant. Although I like the NEC's large, easy-to-use arrow keys, I do *not* like the keyboard layout, which is the old "TTY" arrangement with quote marks as a capital Q and the semicolon where the quotes ought to be. I very much prefer the Radio Shack's straightforward Selectric keyboard. Yet, having said that, I'm strangely reluctant to convert to the Radio Shack. I'm used to the NEC, and of course that's what Mrs. Pournelle has. It's all purely subjective.

If you want to compare machines without buying either, you could do a lot worse than to get Marvin C. Mellon's twin books, *Exploring the NEC PC 8201* and *Exploring the Radio Shack Model 100* (CBS Computer Books, Holt, Rinehart & Winston). Between them they'll tell you just about everything you can learn intellectually; after that you'll want to get your hands on a machine. Incidentally, you're better off ordering the books directly from the author at 6914 Berquist Ave., Canoga Park, CA 91307.

Mellon's books are also good introductions to using the machines; they're more clearly written than the manuals you get with the computers. The manuals are more complete, and once you learn to use them you can find everything you need, but they'll

take getting used to; Mellon's books make it easier to get started.

TRAVELING SIDEKICK

Generally, when Borland has new products, I find out before they're released; but I discovered *Traveling SideKick* through an ad. It seemed like an excellent idea. After all, I use *SideKick* to keep my phone book and calendar. It would make sense to have a program that would print those out properly formatted, and even more to have a notebook the printouts would fit into.

Then too, every est graduate seems to be equipped with an enormous notebook that contains calendar, scheduler, phone book, expense record, and a whole raft of stuff; I don't know if they come with est training or the graduates are persuaded to buy them; I do know the books look like a pretty good idea.

Later I ran into Philippe Kahn, and he was carrying a *Traveling SideKick*, complete with shoulder strap. He said he'd developed the notion for his own use, and certainly he was using it. I mentioned that I didn't have one.

A couple of days later mine arrived. I think I've been bribed. What I got was an extremely handsome ostrich-skin notebook with my name tooled in it. Otherwise, I guess it's the same as the ones they sell. Certainly the software is.

The *Traveling SideKick* software formats calendars and address files. Another program included is *Convert*, which will take stuff from just about any database and format it so that *Traveling SideKick* can print it. The *Convert* program is infuriatingly good: it really works, but I had a heck of a time figuring out how it worked and finally had to get someone at Borland to explain. The young woman who walked me through on the telephone hadn't the foggiest notion who I was, so I presume they'll do that for any customer. Of course, they'd do better to improve the documents and help files.

Convert does the job, though. What you do is teach it what your data format is: what separates fields, and what is in the various fields, and which

(continued)

PC 3780 FILE TRANSFERS STAY ON THE TRACK



- Download Into Filing Assistant (Option)
- Easy to Use
Fast and 100%
Error Free

- Emulation 2780/3780/3740
All Features
- File Transfer, RJE
- PC to PC
- PC to Any Mainframe
(Using above Protocols)
- Unattended or Attended
Auto Pilot, Remote Startup
- Call Using Interface with User
Application Program, Basic, Cobol,
Pascal, C, Etc.
- Uses Standard IBM Hardware
(BSC Board)
- Changeable Translate
Tables

TO ORDER TOLL FREE
1-800-826-7839

Inquiry 350

\$149

305/372-9332

Telex 4947306

TDT GROUP
INC.

444 BRICKELL AVE., #902,
MIAMI, FLORIDA 33131

of those fields you'll want printed in your portable address book. Convert does the rest. It converts one record at a time, as you watch, meaning that you can intervene and change things or update data if you like; or it will do them automatically. "Automatic" still displays each one on the screen, and if you have a couple of hundred records to convert, it will take five minutes or so; there's nothing speedy about it. Fortunately, you don't have to do it often.

Once the files are formatted properly, Traveling SideKick prints them quite nicely in a format that makes it easy to use a three-hole punch and bind them in the notebook. Each page has the date it was printed, too, so you know just how current you are.

Traveling SideKick also prints calendars: by the month, the week, and the day. For my upcoming trip, for example, I'll have each: the current month, the two weeks I'll be gone, and a separate one for each day. New ap-

pointments can be put into the daily calendar by hand. Nifty.

I did have one problem printing. My HP LaserJet insisted on cutting the pages short. I should have known, of course, because the LaserJet thinks paper is only 63 lines long; every other printer believes it's 66. Once again I called Borland; this time after hours, so I had to tell them who I was. I pleaded a deadline, and a very nice young man did some experimenting with their LaserJet. Eventually he found the magic escape sequence—it's a dozen characters long!—that you can set up in the SideKick notepad and send out to be "printed," after which the LaserJet will believe paper is 66 lines long after all. This information was also given to all the people in customer support, so anyone calling in will get it; and they're going to put the HP LaserJet in as an installable printer option for Traveling SideKick.

I've had it only a few days, but already it's beginning to organize my

life. I wish I'd had it for years.

There are a couple of drawbacks. For one thing, you have to use that Convert program, which is slow and a bit tedious. I kept wishing there were some way to tell Traveling SideKick what my phone book format was and have it print the phone file without conversions.

The main problem, though, is that it's big; some people may find it too big. Philippe carries his everywhere. Me, I wonder; I can just see me getting on the airplane, with garment bag, briefcase, shoulder bag, computer, and on a shoulder strap a book every whit as large as the famous book of conquests Leporello carries for Don Juan. It may have to go in the briefcase.

I'm sure I'll carry it, though.

TRAVELING WARS

I don't insist that my friends like each other, but it helps.

(continued)



HEWLETT-PACKARD USERS

North American Conference • September 29–October 3, 1986

Five days of technical tutorials

Over 150 presentations aimed at HP 3000, HP 4000, HP 9000, and PC users

Hear what industry leaders have to say about:

- HP's new RISC-Architecture Computer
- 4th Generation Languages
- Local Area Networks
- Artificial Intelligence
- HP's AT-Compatible PC
- LaserJets in Electronic Publishing

Featured Speakers:

John Garman —
Deputy Director of NASA in charge of computer hardware and software

Joel Birnbaum —
Vice-President and Director of Hewlett-Packard Laboratories

For registration and detailed program information contact:

INTEREX, Conference Department
680 Almanor Avenue
Sunnyvale, California 94086-3513
(408) 738-4848 Telex: 4971527

Sponsored by: INTEREX, the International Association of Hewlett-Packard Computer Users and The Southeastern Michigan Users Group.

INTEREX 1 9 8 6 DETROIT

It seats 9 comfortably.

This is the new Sperry PC/IT™

A Personal Computer system with such speed and power, you can easily share it with a colleague.

Or with most everybody in your department.

Or even with the entire company.

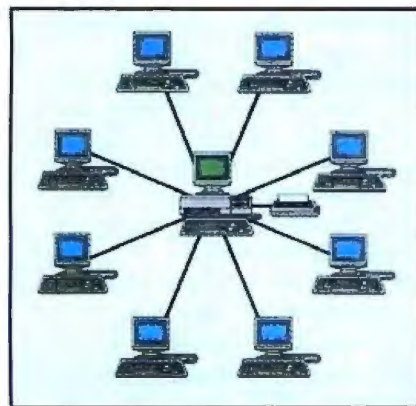

The miniature mainframe

The trend in PC applications today is toward allowing several people to use them concurrently.

Unlike most PCs.

The Sperry PC/IT, however, has the power to support up to nine users under Xenix.™ It's

like having a mainframe, where users can share the most expensive resources — memory, disk and printers.

Not a bad arrangement for a department in which people are working side by side. Using the same kind of applications and the same kind of data.

What if you need a network?

If nine connections aren't enough, the Sperry PC/IT will gladly host its own local area network.

Up to 56 people, using any IBM-compatible PC and any MS™-DOS program concurrently, can be connected. And share an array of printers and disks, on as many as eight additional data/print server PCs.

Want to talk speed?

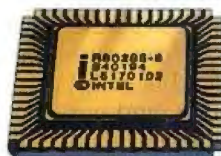

We asked Intel to provide us with the fastest version of the 80286 microchip available. The result is what our engineers call a "screamer": a machine as much as 15% faster

than the IBM PC/AT™ Enhanced. But there's more.

Up to 5MB of memory. 8 usable option card slots. An optional 60MB tape cartridge unit. Up to 80MB of hard-disk storage available today — expanding this summer to a maximum of 138MB.

A word about software

The Sperry PC/IT is fully industry compatible. In fact, both MS-DOS and Xenix are available.

So you can choose from the thousands of MS-DOS programs already in circulation, while still being prepared for the emerging Xenix boom.

The new Sperry PC/IT It takes a back seat to no one.

For further information, call toll-free 1-800-547-8362, and ask for Information Kit #94.

Or write Sperry Corporation, Dept. 100, Box 500, Blue Bell, PA 19424-0024.

The power to get things done.



Prolok doesn't work on an AT with ultrahigh-density floppy disk drives.

For the last couple of years, Mark Eppley has been trying to build a company identity under the name Traveling Software. Enter Philippe Kahn and Borland, who decided to market their new product under the name Traveling SideKick. This got Eppley worried that his identity would be submerged, given the size of Borland and the amount of advertising they would do.

Eppley tried to negotiate, but Philippe Kahn is a hard man to get hold of. Eventually lawyers got in the act, which in my judgment will aid no one but lawyers. Eppley's point is that he has a trademarked name and it has been usurped. Philippe's is that "traveling" is a generic name that can't be appropriated by some private company. "Where will they stop?" he asks rhetorically.

Me, I don't really care. Traveling Software already helps me interface my NEC with Traveling SideKick. I wish Kahn and Eppley would work together to simplify their customers' lives rather than hire lawyers to complicate things.

A NEAT HACK

It's from Klynas Engineering and calls itself "Los Angeles on a Disk—A game with a touch of reality." It's like nothing I've ever seen. It's a game, in that there's a score, and opponents, and even a touch of arcade action—although fortunately not much. On the other hand, it's an exploration: the game contains a map of most of Los Angeles and Orange counties. Naturally, all the LA streets aren't in there—how could they be?—but all the freeways are, and more than enough surface streets to make it interesting. In addition, there are some 300 "points of interest," ranging from the LA County Art Museum to Troubadour to Disneyland.

You play the game by moving about LA in search of a treasure. There are clues to the treasure's location in various points of interest; your job is to go to those places until you figure out where the treasure is. Meanwhile, four "trackers" are on your trail, and if one catches you the game is over. To make matters more complicated, you have to earn money to keep your car gassed and in repair and keep yourself fed and in good health. You have to sleep, meaning you have to find hotels and pay for rooms.

All the points of interest are real. Some of the descriptions are great. There were places left out that I thought should have been there. This turns out to be no problem: the game comes with a bunch of databases and instructions on how to alter them. I found it no trick at all to add streets and places. One place I added was the Los Angeles Science Fantasy Society. Another is Andre Lion's Mon Grenier, a restaurant Niven and I have written into many of our works. I'm sending those back to Scott Klynas, who says he'll incorporate them into the copies he ships.

He's also fixed a few minor bugs I found. For example, the game lets you control your walking and driving speed; but when I put it up on Big Kat, even the slowest speed was almost too fast. The new version takes care of that by asking if you have an AT.

The game visuals aren't spectacular. They're just lines, a two-dimensional map: actually a section of the map, since you'd never find anything if you put the entire LA map on a PC screen. The action isn't much; you just use the arrow keys to steer your car around LA until you find someplace you want to go into. The fun of the game is in the exploration.

More than that, though, it's a neat hack. If you don't like LA, you can use the system to create your own city. This can be a little tedious, but it's all explained in the rule book, and not difficult. You could put in Cincinnati or Chicago, or Dubuque for that matter, adding in your own points of interest. The game recognizes water boundaries, freeways, and surface streets. All these are line segments, so the resulting map is a bit crude and

stylized, but even so it's surprisingly well done. I found myself fooling about with the game for at least as long as it would have taken to read a couple of books, and every now and then I bring it up to add a few more places, like Dangerous Visions Bookstore. . .

PROLOK PROBLEMS

I've said this before: I find copy protection annoying, but I can certainly tolerate it for games. I wouldn't trust my business to a program I couldn't back up, but games aren't that critical.

However, Los Angeles on a Disk taught me something new about copy protection: the Prolok "key disk" scheme doesn't work on an AT with ultrahigh-density floppy disk drives. That is: I could copy the program to my hard disk all right. However, when the program asked me to put my master disk in drive A, I got horrible grinding sounds and eventually a disk error. It just wouldn't run. When I telephoned Klynas about that—I confess that I was interested in seeing Los Angeles on a Disk—he sent two more copies of the game. He *knew* they worked; and so they did, in my PC and the Zenith Z-150; but when I tried running them on Big Kat, the same result happened each time. Lots of grinding noises.

When I reported that, Klynas said to hell with it: the company has dropped copy protection entirely. Klynas hopes to get his money back—about five dollars a disk—for the Prolok disks he won't be using. I wish him the best of British luck. . .

Another game company wasn't so lucky. Last summer I got a copy of Quest for the Ring from Icon. This is a game built around Wagner's *Der Ring des Nibelungen*, and from the instruction book it might be interesting. I wouldn't know: again, the game will copy to my hard disk, and I can even play the first-level game; but as soon as I try to go to the next level of play, the program demands the master disk in drive A. Complying with that instruction results in endless grinding as if the floppy drive is shaking itself apart. Consequently, I've no report on Quest for the Ring.

(continued)

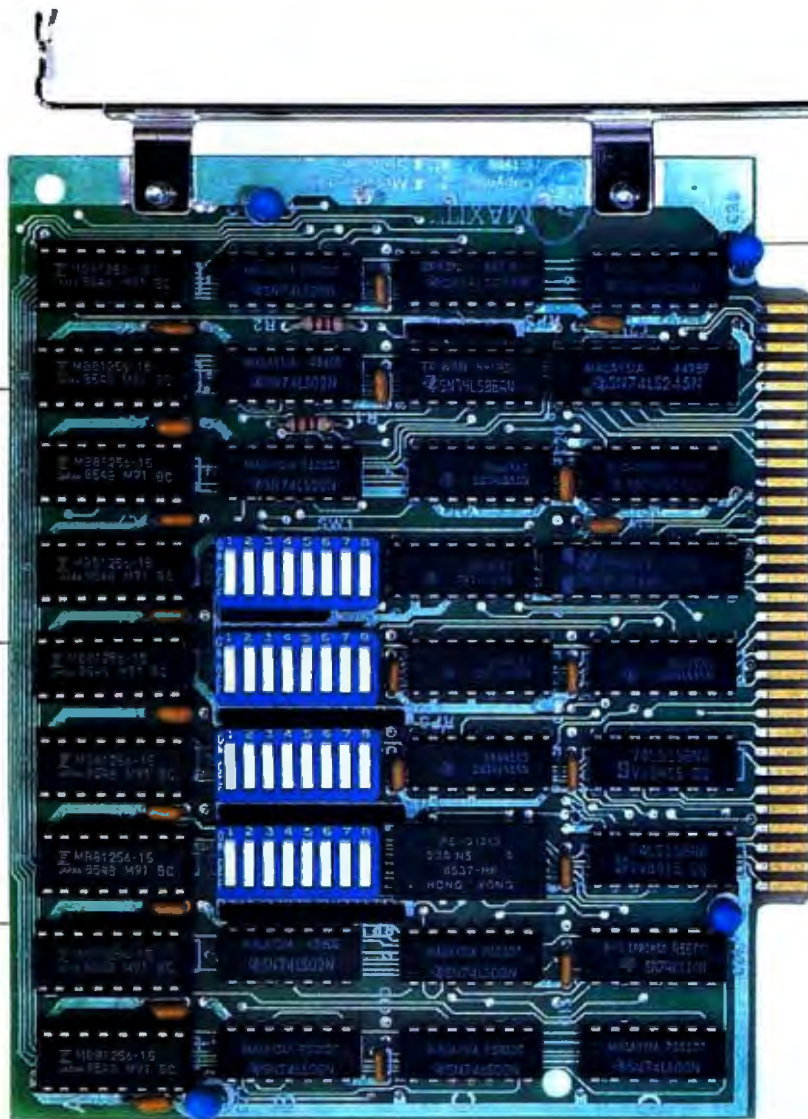

Add up to 96K above 640K to all programs including PARADOX and 1-2-3.

Parity-checked 256K with a one-year warranty.

Run custom software or the 3270 PC Control Program above 640K.

Run resident programs like Sidekick above 640K.

Top off a 512K IBM AT's memory to 640K and add another 128K beyond that.

Short card works in the IBM PC, XT, AT, and compatibles.

Add expanded memory to programs supporting the Lotus/Intel/Microsoft specification 32.

MAXIT™ memory works above 640K for only \$195.

Break through the 640K barrier. MAXIT increases your PC's available memory beyond 640K. And it does it for only \$195.

MAXIT includes a 256K half-size memory card that works above 640K. MAXIT will

- Add up to 96K above 640K to all programs.
- Run memory resident programs above 640K.
- Top off an IBM AT's memory from 512K to 640K.
- Expand 1-2-3 Release 1A or 2.0 worksheet memory by up to 256K.
- Add expanded memory above 640K to programs like Symphony 1.1.

Big gain — no pain.

Extend the productive life of your IBM PC, XT, AT or compatible. Build more complex spreadsheets and databases without upgrading your present software.

Installation is a snap.

MAXIT works automatically. You don't have to learn a single new command.

If you have questions, our customer support people will answer them fast. MAXIT is backed by a one-year warranty and a 30-day money-back guarantee.

Order toll free 1-800-221-8439.

MAXIT is just \$195 plus \$4 shipping and applicable state sales tax. Buy MAXIT today and solve your PC's memory crisis. Call toll free 1-800-221-8439 (In Texas 1-214-437-7411). We accept VISA, MC, AE, and DC.

McGraw-Hill CCIG Software

8111 LBJ Freeway, Dallas, Texas 75251

Dealer/corporate inquiries welcome.

MAXIT is a trademark of McGraw-Hill CCIG Software. IBM is a registered trademark of International Business Machines Corporation. 1-2-3 and Symphony are registered trademarks of Lotus Development Corporation. Sidekick is a registered trademark of Borland International, Inc. PARADOX is trademark of ANSA Software.



\$445.

A small price to pay for a full-duplex 2400 bps dial modem that lets you operate synchronously, or asynchronously with a unique auto dial feature, on virtually any computer.

Plus it's Hayes compatible. And available as a standalone unit or dual modem card, which lets you pack 32 modems into a single Codex nest.

The Codex 2233 dial modem. Find out about it. Call 1-800-426-1212. Ext. 230.

codex
MOTOROLA

Motorola and @ are trademarks of Motorola, Inc. Codex is a registered trademark of Codex Corporation.
© 1986 Codex Corporation.

I could, I suppose, make use of FUProlok, a public domain program available from bulletin boards or Workman and Associates. It's a program that can defeat the Prolok "key disk" system. There's also Copy II PC. I could use one of those, but I haven't got around to it, and I probably won't. Why should I fight Icon's copy protection? It isn't as if I don't have plenty to write about.

Meanwhile, I had those two spare copies of Los Angeles on a Disk, meaning that I had Prolok to play with. It turns out that if you erase all the files on a Prolok disk, a hidden file remains. I used the Norton Utilities. (Note: If you have a PC and don't have the Norton Utilities, run, do not walk, to your nearest dealer and get them. Nearly vital: They make DOS tolerable.) Anyway, the Norton Utilities found a hidden PROLOK.EXE file. That, when run, generates the copy-protection scheme. It's quite a small file, but running it generates about 10K bytes of code. I've been tempted to play around with a good debugger and see just what's going on in there, but I guess I'm not that interested.

ELECTRONIC MAILBOXES

A couple of months ago someone signed me up for MCI Mail.

I put it that way because I don't recall doing it, and I was signed up under a form of my name that I never use. The address was right, though. It's possible someone asked if I wanted to be signed up, and I said something that sounded affirmative, and I've since forgotten.

It hardly matters, except that once you're signed up with MCI Mail, other subscribers can find your name and send you messages. By the time I realized that the big packet of stuff MCI sent me wasn't just information but actually contained a log-in name and password, a couple of months had gone by; so when I logged on to the system out of curiosity, I found about 30 messages. Of course I answered each one of them, generally with much the same apology. That I found out later when I read the MCI explanation of charges, was fairly expensive (about 50 cents per reply).

(continued)

KEYS CAN TALK TOO!

Function-Kease™ make your keyboard talk at a glance.



Function-Kease™ for:	
1-2-3	Wordstar
MS-DOS	Symphony
Framework	dBase III
Crosstalk	Pfs: Write
Microsoft Word	
IBM Filing/Reporting Asst.	

IBM-PC, XT, AT
Compaq
Epson
Apple IIe
Sharp PC-7000

Function-Kease™ are solid plastic keycovers molded to fit your computer.

\$19.95

When Ordering specify software and computer model. Check, Visa, Mastercard and approved POs are accepted. Custom and dealer inquiries welcome.

Pictured is example of Function-Kease™ for 1-2-3.

SynTronics
4901 Morana Boulevard, Suite 302
San Diego, California 92117
619 692-0695

The price of power just went down.



Before you buy DBase III, QuickCode and Clipper, look at TAS-Plus

TAS-Plus just made it faster, easier and cheaper to build database applications. TAS-Plus combines the power of a Relational Database with the ease of a Program Generator. Then TAS-Plus adds a Runtime Compiler to produce lightning-fast finished code. Look at what TAS-Plus gives you:

- Relational Database**
- 4th Generation Language**
- Screen Painter**
- Program Generator**
- Report Writer**
- Source Code Editor**
- Runtime Compiler**

TAS-Plus gives you power where it counts. You can store up to 65,000 records, open up to 16 files at a time and enter up to 10,000 characters per record. TAS-Plus even reads your old DBase files.



The following are registered trademarks of these companies: TAS-Plus, The Accounting Solution, Business Tools, Inc.; DBase III, Ashton-Tate; CP/M, Digital Research; IBM PC/XT/AT, International Business Machines Corp.; QuickCode, Fox & Gillet; Clipper, Nantucket Inc.

© Copyright 1986 Business Tools, Inc.

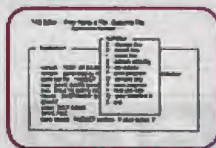

TAS-Plus writes the program for you

With TAS-Plus, you can start building professional database applications on day one. Just "paint" the screen the way you want and TAS-Plus writes the program for you. You can even paint using different colors or graphic characters. And custom reports are just as easy.

TAS-Plus has over 86 commands and 200 options available in its Source Code Editor, so you won't run out of room to grow.

Easy to use features

Add new databases quickly and easily. Add, change or delete records without any programming at all. Browse through your database and see multiple records on the screen at the same time. Restructure capability allows you to change existing databases without loss of any data.

All this for just \$69

TAS-Plus would be respectable at any price, at \$69 it's awesome.

30 day Money Back Deal

TAS-Plus comes with a 30 day money back guarantee (less \$15 handling fee). TAS-Plus is available for the IBM PC/XT/AT and fully compatible computers. Limited versions available for CP/M and non-IBM machines.

Order Today 1-800-648-6258

Call our Toll-Free Hotline. Use your VISA, MasterCard or American Express to order today. For information or Washington residents call 1-206-644-2015.

TAS+™

NOT COPY-PROTECTED

YES! Rush me the following items.

Qty.	Item	Price	Subtotal
1	TAS+	\$69	
	Shipping add \$8 USA, \$25 outside USA	Shipping	
	WA res add \$5.59 Tax	Tax	
		Amount Enclosed (US funds only)	

Name: _____

Shipping Address: _____

City: _____

State: _____ Zip: _____

Telephone: _____

Payment: VISA MC AMX Check

Credit Card Expiration Date: _____

Card Number: _____

Name on Card: _____

BUSINESS TOOLS INC.
4038-B 128th Ave. S.E., Suite 266
Bellevue, Washington 98006
(206) 644-2015



codex 2233

\$445.

A small price to pay for a full-duplex 2400 bps dial modem from the company preferred by more communications managers than any other.

The Codex 2233 dial modem. Find out about it. Call 1-800-426-1212. Ext. 230.

codex
MOTOROLA

Motorola and M are trademarks of Motorola, Inc. Codex is a registered trademark of Codex Corporation.
© 1986 Codex Corporation.

NEED SPACE?

\$645 Let Your PC Grow



HYMCO EXPANSION BOX (PEX-100) FEATURES:

- Interface to IBM PC, PC/XT and compatibles
- Complete I/O BUS extension
- Support DMA and all levels of INTERRUPT
- Transparent to operating system and all the application software
- Users gain 6 full-sized I/O slots overall
- Space for 4 half-height or 2 full-height drives (drives are not included)
- Flip-top case: easy installation of add-on cards and peripheral devices

ONE YEAR WARRANTY Dealer & Distributor Inquires Welcomed

IBM PC and IBM PC/XT are registered trademarks of International Business Machines Corp.

HYMCO

TECHNOLOGIES, INC.

5320-D Monterey Rd.
San Jose, CA 95111

Call Today: (408) 225-1511

MCI Mail is certainly easy enough to learn. There are menus, and while they're not as self-evident as they might be, they're good enough. I found I was able to use the system quite easily. There was one moment of panic: I'd begun replying to a letter. Once in the text-creation mode, you can't ask for help. When I finished the answer, I couldn't figure what told the program I was done editing and wanted to get back to command level.

BIX uses the UNIX convention of a line containing a dot and nothing else. MCI doesn't. I had to experiment; eventually, I found that a line containing nothing but typing "/" and hitting Return sends you to command level.

But, while MCI Mail is easy to learn, using it's a bit different. After 10 minutes I was familiar enough with the MCI menus that I could dispense with them—only you *can't* dispense with them. You have to grind through menu after menu.

I'd have known all this and a lot more if I'd looked at my incoming books shelf before I logged on to MCI Mail. *The Electronic Mailbox* by Ira Mayer (Hayden Books, 1985) does a good job of summarizing not just MCI Mail, but Delphi, The Source, CompuServe, and a bunch of others. It's really quite a good book, and if you're contemplating signing up for electronic mail, it would be worth reading this first. I hadn't read it because in the first chapter there's a "case history" that contains the flat statement that in 1980 no small computer measured up to dedicated word processors as a tool for writers. That's so patently false it made me put the book down in anger. Fortunately, Mayer has done more research on electronic mail systems than he did on small computers.

Mayer's book does not mention BIX because it was published in early 1985. I find the BIX system preferable: while MCI has no connect-time charges, it does charge a flat minimum for each "letter" you send. I find I can answer 15 BIX mail communications in 10 minutes. I don't pay for either BIX or MCI, but if I did, BIX would be cheaper. Of course, nothing says you *have* to answer all your mail, although I try to.

(continued)

The SourceSM Is Friendly.



Many online information services claim to be "user friendly." But only one really lives up to that promise.

The Source.

You see, The Source is specifically designed to save you time online. With new, shorter menus. Simpler commands. And a user's manual so well-written and easy to understand, it's setting an industry standard.

The Source is also the only service that gives you introductory lessons and assistance, free of on-line charges. So you get up-to-speed on our dime, not yours.

You get to the information you need in record

The Source is a service mark of Source Telecomputing Corp., a subsidiary of The Reader's Digest Assn., Inc. © 1985 Source Telecomputing Corp.



time, without frustration. Everything from the hour's headlines to travel reservations. From special interest groups to online stock trading. So you don't waste your valuable time. Or money.

Call 1-800-336-3366, send the coupon, or visit your nearest computer dealer.

And make friends with America's friendliest online information network.

INFORMATION NETWORK
The SourceSM

The most powerful resource any personal computer can have.

I'd like to make friends with The Source.
Please send more information to:

Name _____ 7526325

Address _____

City, State _____ Zip _____

Mail to: Source Telecomputing Corporation,
1616 Anderson Road, McLean, VA 22102

codex 2233

\$445.

A small price to pay for a full-duplex 2400 bps dial modem that gives you better performance, better features, and better support than anything else available.

The Codex 2233 dial modem. Find out about it. Call 1-800-426-1212. Ext. 230.

codex
 MOTOROLA

Motorola and @ are trademarks of Motorola, Inc. Codex is a registered trademark of Codex Corporation.
 © 1986 Codex Corporation.

Get up to speed in finite element analysis.

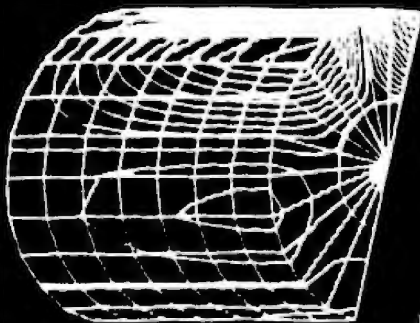

Stress plots on pressure vessel.

MSC/pal 2 gives you everything you need to perform 2-D and 3-D structural or mechanical analysis on your IBM PC/AT, PC/XT or compatible system. It's the ideal tool for preliminary design and design studies.

MSC/pal 2 has analysis capability for static, normal modes, transient and frequency response. A highly flexible, easy to use program, it features interactive menu-driven graphics that include contour plots, animated deformed shapes, and X-Y plots.

There's a modern element library and a wide choice of applied loading types. Plus interlaces are available for most popular CAD packages.

The price for all this power? Just \$1995* complete. Which makes it that much easier for you to get up to speed fast in finite element analysis.

For more information, call or write us today.

*Suggested retail.



The MacNeal-Schwendler Corporation

815 Colorado Blvd., Los Angeles, CA 90041
 (800) 336-4858, in California (213) 258-9111.

MSC/pal 2 is a registered trademark of The MacNeal-Schwendler Corporation. IBM is a registered trademark of International Business Machines Corporation.

MCI has one other problem: some of the "mail" I received was self-promotion stuff from MCI. In one case, I had to wait almost a full minute from asking for my "next letter" to receiving a message telling me about additional services MCI could provide. As a test, I asked for it again. Same result. A long wait. Maybe there's only the one copy, so if a bunch of people ask for it at once you have to wait your turn?

Problems and all, MCI is a pretty useful service, and a number of people I respect swear by it. I still think BIX is better, but you can certainly reach more people through MCI. Not only are more people signed up (as of now, anyway), but MCI has a "paper mail" option: they'll send your letter electronically to a place near the final destination, print it, and send it on first class by the U.S. Snail.

I expect I'll hang on to my MCI account; but I will have to get out of the habit of routinely replying to all messages. I even replied to MCI's house ad...

SHAREWARE

I recently saw Bob Wallace, president of Quicksort, and he tells me that PC-Write, the original "shareware," continues to sell. He also continues to improve the program. An awful lot of people swear by PC-Write as not only the most bang for the buck in a PC clone text editor but about as good as an editor gets.

Then there's Proindex, also shareware. This isn't an automatic indexing program. Automatic indexing programs aren't much use; indexing is a black art requiring human judgment. Proindex searches out words from your file of keywords, shows you the word in context, and asks if you want to reference this instance in the index. The instruction book that comes with Proindex is complete enough and has some useful hints on constructing indexes.

PC-Write and Proindex make a good pair of programs for a writer who uses PC clones.

DOCUMENTERS

I don't normally review capabilities, but I recently got something worth

mentioning. Computer Possibilities (320 South Pacific Ave., Pittsburgh, PA 15224, (412) 441-8949) is a start-up company that prepares documentation. One of the partners, Jeffrey Bonar, recently sent me a letter expressing their "philosophy," which I agree with. Sample: "Bringing a 'beginner's mind' to the primer. The designers of a sophisticated system are often the least appropriate people to be designing the documentation. They have no idea what makes their system hard to use."

They also enclosed a sample of their work, a primer for the Xerox Lisp Machine.

Clearly, any company in need of documentary services ought to look at a range of possibilities, from hiring an established firm like Stephanie Rosenbaum's Tec-Ed to doing it in house; and clearly which is best depends on a lot of factors. I can only say I was impressed with the sample Computer Possibilities sent.

WINDING DOWN

We had another Great Software Purge at Chaos Manor; anything sent before January 1986 was tossed in the garbage with military honors. As usual I had mixed emotions: joy at seeing some free space on the shelves and considerable sadness that I couldn't get to everything. I know just how much work that stuff represents.

For those who sent stuff I didn't get to, I can only suggest that you try again. There's a considerable element of luck, not to say whim, involved in selecting what I review. Given the volume that comes in here, how could it be otherwise?

The game of the month is Core Wars. This insidious shareware game (I got mine from Terry Ward of Uni-Academic Computing in Cedar Falls, Iowa) simulates a battle between computer programs for domination of the MARS computer. The version I have runs on the Macintosh; I gather there may be versions for other machines, but I haven't seen any.

Tactics in Core Wars include worm programs that crawl into the other guy's code; imps and dwarves that do terrible things to the computer memory; and other stuff. You can

ITEMS DISCUSSED

FASTBACK\$179
Fifth Generation Systems
7942 Picardy Ave., Suite B-350
Baton Rouge, LA 70809
(504) 767-0075

LOS ANGELES ON A DISK\$39.95
Klynas Engineering
P.O. Box 1666
Simi Valley, CA 93062
(805) 583-1029

MCI MAILContact company
MCI International
International Drive
Rye Brook, NY 10573
(800) 221-7902
(914) 937-3444

NEC PC-8201starts at \$499
NEC Home Electronics (U.S.A.) Inc.
Personal Computer Division
1401 Estes Ave.
Elk Grove Village, IL 60007
(800) 323-1728
(312) 228-5900

TRAVELING SIDEKICK
till 9/1/86\$69.95
after 9/1/86\$99.95
Borland International
4585 Scotts Valley Dr.
Scotts Valley, CA 95066
(408) 438-8400

TRS-80 MODEL 100 ..starts at \$599
Tandy Corporation
1800 One Tandy Center
Fort Worth, TX 76102
(817) 390-3011

ULTIMATE ROM II\$229.85
TS-DOS\$69.95
with Ultimate ROM II\$49.95
LAPDOS\$89.95
with Ultimate ROM II\$69.95
TTXPRESS PRINTER\$129
BROTHER FB-100 DISK DRIVE
WITH TS-DOS\$249.95
Traveling Software Inc.
11050 Fifth Ave. NE
Seattle, WA 98125
(800) 343-8080
(206) 367-8090

have one player or two. Core Wars is fascinating to watch and will teach you more about assembly language programming of an imaginary computer than you ever wanted to know.

The book of the month is by Eliot A. Cohen, *Citizens and Soldiers: The Dilemmas of Military Service* (Cornell University Press, 1985). This is the best summary and discussion of military policy and conscription that I've ever seen. Cohen may not settle the questions he raises, but he has assembled all the facts and arguments.

The computer book of the month is by Edward Joyce, *Modula-2: A Seafarer's Guide and Shipyard Manual* (Addison-Wesley, 1986). Like most Addison-Wesley books, this one is extremely well done. It's easy to read, written in a lighthearted style that tells you what you need to know without being pedantic. It's well edited, and there are plenty of examples. The best introduction to Modula-2 that I know of.

In addition to everything else I'm

doing, I've continued to run a BIX conference on space policy; about the time you read this, we'll fill Larry Niven's house with another big face-to-face meeting of experts, astronauts, science fiction writers, hackers, engineers, lawyers, and financial wizards; and with any luck we'll have some recommendations for the U.S. space program. BIX has been very helpful in doing the preliminary spadework for the conference. As one participant observed, an electronic conference's strengths are mirror images of its weaknesses, and we've yet to develop optimum ways to use it; but we're sure glad we have it. ■

Jerry Pournelle welcomes readers' comments and opinions. Send a self-addressed, stamped envelope to Jerry Pournelle, c/o BYTE, One Phoenix Mill Lane, Peterborough, NH 03458. Please put your address on the letter as well as on the envelope. Due to the high volume of letters, Jerry cannot guarantee a personal reply.

A COMPUTER PROGRAM THAT SPEAKS YOUR LANGUAGE



The Computer Chronicles, a half-hour weekly television series brings you news and information from Silicon Valley and around the world. Correspondent Stewart Cheifet and Gary Kildall, creator of CP/M cover today's headlines and the stories behind them. Find out what is, what was and what will be, with the only computer program you're ever going to need. **The Computer Chronicles**, every week on a public television station near you. (Check local listings for time and channel.)



Produced by KCSM, San Mateo, CA and WITF, Harrisburg, PA with funding from AFIPS and McGraw-Hill's **BYTE** magazine.

CLASSIC BYTE T-SHIRTS!

#T1 -
COMPUTER
ENGINEERING



#T3 -
INSIDE IBM



#T2 - SOFTWARE PIRACY



Software Piracy

#T4 -
FUTURE PAST



#T5 -
BREAKTHROUGH



Five classic Byte covers – and boy, do they look great on this ¾ sleeve “baseball shirt”! The vivid royal blue sleeves and neckline really complement the full-color design. And don’t mistake this for a rubbery patch that cracks and peels off after a few washings. This is true four-color process: the permanent inks are silk-screened into the fabric, resulting in a beautiful, full-color image that lasts!

You’ll also appreciate the shirt itself: a real

heavyweight made of 50% cotton, 50% polyester. You’ll enjoy cotton comfort in a tough, sporty shirt that keeps its crisp, fresh look through many washings – with almost no shrinking! The price for each Classic Byte T-Shirt is only \$12.50 (\$11.50 each for 3 or more). Be sure to include shirt size: **C**-(child 10-12), **S**-(34-36), **M**-(38-40), **L**(42-44), **XL**-(46-48). Most orders shipped within a week.

Please send me the following shirt(s) at \$12.50 each, or \$11.50 each for 3 or more. I have included \$2 for shipping and handling (\$5 overseas).

QTY.	#	TITLE	SIZE	AMOUNT
				\$
				\$
				\$
				\$
				\$
				\$
Shipping & Handling (see above)				\$
TOTAL				\$

Send free brochure.

I have enclosed check or money order.

VISA MasterCard Am. Express

Card #: _____

Exp. Date: _____

Ship my shirt(s) to:

Name: _____

(Business): _____

Address: _____

City: _____

State: _____ Zip: _____

Mail this coupon to:

Robert Tinney Graphics
1864 North Pamela Dr.
Baton Rouge, Louisiana
70815

For VISA, MasterCard or
American Express orders,
or for more information
Call 1-504-272-7266

CONNECT



IBM DISPLAYWRITER to IBM 5520 to IBM OS/6 to IBM S/36 to IBM 8100 to IBM PROFS to WANG OIS to WANG VS to CPT to LANIER to NBI to MICOM to DEC WPS to XEROX to LINOLEX to COMPUGRAPHIC to QUADEX to NCR to DEC VAX to CP/M to DATA GENERAL to UNIVAC to BURROUGHS to HONEYWELL to IBM PC/36

FLAGSTAFF ENGINEERING can connect your incompatible computer systems using diskette, tape, communications, or printed media. We have developed many low cost systems to help you transfer files and documents between different computer systems. Our "FILE", "WORD", and "TYPESETTING CONNECTION" products can read and write most of your 8", 5¼", and 3½" diskette formats. The "PROTOCOL CONNECTION" can provide RS232 communications between your different computers. The "TAPE CONNECTION" system is a 9-track tape drive that can read and write your files on 800, 1600, or 6250 BPI magnetic tape. Since 1982, we have installed thousands of conversion systems at customer locations around the world. Call us today for help in connecting your systems.



**Flagstaff
Engineering**

1120 W. Kaibab
Flagstaff, AZ 86001
Telephone 602-779-3341
Telex 705609 FLAGEN



PROGRAMMING TOOLS

BY BRUCE WEBSTER

It's now late March as I write this, and there isn't a whole lot new and exciting going on in the industry. Atari has finally started shipping the 1040ST, much to the relief of Atari dealers, who spent a long, dry month with nothing

to sell. Prices on the Macintosh Plus have plummeted from an official list price of \$2600 to a street price of \$1900. Commodore is reputedly about to cut the list price of the Amiga to \$995 (from \$1295) and to offer another \$200 off if you buy the 512K-byte upgrade and the monitor at the same time. Summer is typically a slow time for computer sales, so by the time you read this, additional price cuts may be in effect.

Around here, things have been anything but slow. A rising tide of software—mostly unsolicited—has been flooding the door. Much of it appears to be worthwhile and well done, and it's a bit frustrating to have to pick and choose which ones to look at and which ones to set aside for now. This month, I'm going to look at some programming tools, products to help you develop programs.

A few comments before I get started. I'm impressed with the quality of the programming tools—compilers, editors, utilities, libraries, and so on—that have been released in the last year or so. The common wisdom a few years ago was that the majority of computer owners were not—and never would be—interested in programming, that just a few hackers and computer nerds actually wanted to write their own code. The phenomenal success of Borland's Turbo Pascal—selling half a million copies in a market previously estimated at 30,000 units—has spurred a renaissance of sorts, turning a small, sluggish, uncompetitive segment of the software industry into a significant market, with prices going down and quality going up. Most welcome has been the disappearance of licensing fees, so that you no longer have to pay companies an annual or per-copy amount for programs developed using their products. The winners have been both the consumers as well as the companies willing to adjust to the new market conditions. The losers, of course, are those firms unwilling or unable to change their approach or to deliver a useful product at an acceptable price.

PRODUCT OF THE MONTH: PERSONAL PASCAL

I have groused much—probably too much—about how long it took for a native code Pascal compiler to appear for the Macintosh. Imagine, then, my pleasant surprise

*Products with a
high degree of quality are
being released*

when Optimized Systems Software released Personal Pascal for the Atari ST machines early this year, only about six months after the ST hit dealers' shelves. Even more pleasant is that it looks to be a well-done, complete,

and reasonably priced package. Personal Pascal costs \$69.95 and comes with a 200-page manual and a single 3½-inch disk (not copy-protected).

Personal Pascal meets the ISO standard and—like all good Pascals—significantly extends it. Strings are implemented as in UCSD Pascal and Turbo Pascal, with most of the "standard" procedures and functions (except for Str and Val). Many other common procedures and functions are also present, like SizeOf, IO_Result, Seek, and MemAvail. Language extensions include long (4-byte) integers, hexadecimal constants, an OTHERWISE clause in CASE statements, and a LOOP statement, with an EXIT IF clause allowed anywhere in the loop. The last two are particularly useful in keeping a program's flow of control straightforward.

The developer(s) of Personal Pascal (the manual just credits one "J. Lohse") obviously gave much thought to modular programming. The directive EXTERNAL lets you reference and call separately compiled Pascal and assembly language routines, while the directive C lets you call routines compiled using Digital Research's (Alcyon) C compiler. Systems procedures and functions can be referenced using the GEMDOS, BIOS, and XBIOS (extended BIOS) directives. The manual doesn't make it clear how to use those directives, but it's easy once you understand it. You declare the procedure or function with its parameter list, just as you would an EXTERNAL procedure. Instead of using the directive EXTERNAL, however, you would use GEMDOS(X), where X is the corresponding GEMDOS function number. For example, to be able to call the GEMDOS routine GetDate, you might declare the following:

```
function GetDate : Long_Integer;  
GEMDOS($2A);
```

The BIOS and XBIOS directives work in an identical manner.

To use Personal Pascal, you run a program that provides a GEM user interface with three menus: desk accessories,

(continued)

Bruce Webster, a consulting editor for BYTE, is reached clo BYTE, P.O. Box 1910, Orem, UT 84057, or on BIX as bwebster.

TOTAL CONTROL with LMI FORTH™



For Programming Professionals: an expanding family of compatible, high-performance, Forth-83 Standard compilers for microcomputers

For Development: Interactive Forth-83 Interpreter/Compilers

- 16-bit and 32-bit implementations
- Full screen editor and assembler
- Uses standard operating system files
- 400 page manual written in plain English
- Options include software floating point, arithmetic coprocessor support, symbolic debugger, native code compilers, and graphics support

For Applications: Forth-83 Metacomplier

- Unique table-driven multi-pass Forth compiler
- Compiles compact ROMable or disk-based applications
- Excellent error handling
- Produces headerless code, compiles from intermediate states, and performs conditional compilation
- Cross-compiles to 8080, Z-80, 8086, 68000, 6502, 8051, 8096, 1802, and 6303
- No license fee or royalty for compiled applications

For Speed: CForth Application Compiler

- Translates "high-level" Forth into in-line, optimized machine code
- Can generate ROMable code

Support Services for registered users:

- Technical Assistance Hotline
- Periodic newsletters and low-cost updates
- Bulletin Board System

**Call or write for detailed product information
and prices. Consulting and Educational Services
available by special arrangement.**

LMI Laboratory Microsystems Incorporated
Post Office Box 10430, Marina del Rey, CA 90295
Phone credit card orders to: (213) 308-7412

Overseas Distributors.

Germany: Forth-Systeme Angalika Fleisch, Titisee-Neustadt, 7651-1665
UK: System Science Ltd., London, 01-248 0962
France: Micro-Sigma S.A.R.L., Paris, (1) 42.65.95.16
Japan: Southern Pacific Ltd., Yokohama, 045-314-9514
Australia: Wave-onic Associates, Wilson, W.A., (08) 451-2946

ACCORDING TO WEBSTER

file (edit, compile, link, run program, quit), and options (for compiling and linking). The options items let you pre-define libraries to be linked in and set certain compiler options (range checking, stack checking, etc.) without having to use compiler directives (like `{$R -}`) within your program.

The editor is a basic screen-oriented editor, using a WordStar-like command interface (as does Turbo Pascal) and ignoring the mouse and menus. The editor works well but has one major lack: no block marking for moving and copying text or writing text to a file. Instead, you must delete text to get it into a copy buffer, which you can then write to disk or write back into your text at some other point. The danger with this approach (as users of the old UCSD p-System editor can tell you) is that a wrong move—like a deletion when you get to where you want to insert the text—will clear your copy buffer, losing forever the text you were holding there. The block-marking approach of WordStar works a lot better: I hope OSS will consider improving the editor in future releases.

After editing your text, you can hit the F9 function key to save your file to disk and automatically start the compiler. The compiler itself is not blindingly fast, though that may be due more to the ST disk drives than the compiler itself. (A quick aside: The ST disk drives are depressingly slow. In just about every test I've run—format, file copy, disk copy, program load, and file reads and writes from within a program—the ST has been slower than the Mac or the Amiga. A good hard disk should improve things greatly.) If an error is encountered, you have the option to abort, to continue compilation, or to return to the editor. If you choose the last option, your file is loaded in, the cursor is placed where the error occurred, and an error message is printed at the top of the screen. If the compilation succeeds, the linker is run to build an executable program file. You can then run the program using the run program item in the file menu.

The biggest problem that ST programmers have had is the lack of adequate GEM documentation. About the only way to get it has been to pay \$300 for the developer's package, which includes Digital Research's C and the GEM documents (written for the IBM PC). Having done that, the programmers then have to figure out how to use the GEM routines, something said documents don't always do a great job of explaining. To remove these problems for their customers, the folks at OSS have performed a wonderful service: They have written their own GEM/Pascal library to (in their words) "make working with GEM as painless as possible." Instead of just giving access to all the GEM routines (which you can have anyway, using the C directive), they have provided a selection of regular GEM routines along with "higher-level" routines that take some of the tedium and confusion out of using GEM. Then they do a good job of documenting every routine in the library, with examples and an explanation of how each is used. Frankly, I find their explanation of how the GEM routines are used easier to understand than the GEM manuals themselves.

(continued)

AMERICA'S NEXT FAVORITE MOUSE.

The best price: \$99



THE BEST HARDWARE:

LOGITECH has been the leading OEM mouse company for years, quietly providing mice to companies like AT&T, DEC, and H-P. We've designed LOGIMOUSE C7 just for the retail marketplace. And poured all our years of hardware engineering into it. You simply can't find a better mouse.

- IBM PC/XT/AT compatible through any serial port
- NO pad, NO external power supply
- HIGH (200 dpi) resolution
- Tactile feedback switches

THE BEST SOFTWARE:

LOGIMOUSE is now available with all new software that sets new performance standards for the mouse:

LOGIMOUSE Base Package \$99

- LOGIMOUSE Driver Version 3.0: Faster and smaller. Makes LOGIMOUSE compatible with all Microsoft applications.

LOGIMOUSE Plus Package \$119

- LOGIMENU — Programmable Pop-Up Menu System: Customizable for all your favorite keyboard-based applications. Fully compatible with Microsoft Menu, only better.
- CLICK: A new concept in mouse software! It resides in memory, detects which application you are running and sets the mouse to your predefined setting. You define macros for the mouse buttons, set the mouse baud rate and protocol, define the pop-up menus to be used by LOGIMENU. Just add CLICK to your autoexec file and LOGIMOUSE will be ready to go with each of your favorite applications. So you can get down to work.
- POINT-AND-CLICK SHELL for Lotus 1-2-3: No more jerky cursor movement, no more delays, no more beeping. To select a cell, execute a command, scroll your spreadsheet, or call up context sensitive pop-up menus, just point with the mouse and click!
- POINT EDITOR — Mouse Based Program Editor: If you think a mouse was not meant for editing, POINT will change your mind.

LOGIPAINT SET

With Base Package \$149
With Plus Package \$169

LOGIMOUSE C7 plus PC Paintbrush 3.0 is the most advanced paint set available for the PC. Use LOGIPAINT to design a logo, paint, or draw

a picture of a product you're developing. You won't believe its power with either free hand drawing or graphics.

LOGIMOUSE® C7

To place a credit card order call our special toll-free number:

800-231-7717

Call toll-free in California:

800-552-8885

YES! I want America's next favorite mouse!

Please send me:

- | | | |
|---|-------------------------------------|--|
| <input type="checkbox"/> LOGIMOUSE Base Package | \$ 99 | Add \$6.50 for shipping & handling. Calif. residents add applicable sales tax. |
| <input type="checkbox"/> LOGIMOUSE Plus Package | \$119 | |
| <input type="checkbox"/> Plus Package Software | \$ 29 | |
| <input type="checkbox"/> Base LOGIPAINT SET | \$149 | |
| <input type="checkbox"/> Plus LOGIPAINT SET | \$169 | MONEY BACK GUARANTEE |
| <input type="checkbox"/> VISA | <input type="checkbox"/> MASTERCARD | <input type="checkbox"/> CHECK ENCLOSED |

Card Number _____ Expiration Date _____

SIGNATURE _____

NAME _____

ADDRESS _____

CITY, STATE _____

ZIP _____ PHONE _____

DEALER INQUIRIES WELCOME



LOGITECH

LOGITECH, Inc.

805 Veterans Blvd., Redwood City, CA 94063, USA

Telephone: (415) 365-9852

LOGIMOUSE is a registered trademark of LOGITECH, Inc. Lotus and 1-2-3 are trademarks of Lotus Development Corp. Microsoft is a trademark of Microsoft Corp. PC Paintbrush is a registered trademark of ZSoft Corp.

STATISTICAL PACKAGES

Complete, high-performance data-analysis software from:



StatSoft™

Unbeatable power and flexibility for unbeatable prices!

1. **STATS-2™** (release 2.1): A complete, superfast statistical package. Can also be used as a statistical supplement for Lotus 1-2-3™ and other spreadsheet programs. Runs on IBM™ and compatibles, 256k, 2dd, 8087 support **\$149**

2. **STATFAST-2™** (release 2.1): The most powerful statistical package developed for the Macintosh™ 128k/512k/Plus, 1dd..... **\$119**

3. **APP-STAT™**: A complete statistical package for the Apple II™ family of computers, 1dd **\$99**

4. **PSYCHOSTAT-3™**: A complete statistical package, available for Kaypro™ and all CP/M™ computers, 1dd **\$99**

All of these statistical packages are user friendly and super-easy to use. They include the full range of basic statistical analyses (descriptive statistics, t-tests, correlations, cross-tabulations, nonparametric statistics, and much more) and advanced multivariate statistics (comprehensive multiple regression with forecasting, general multifactor ANOVA/ANCOVA up to 5 factors including a covariate, repeated measures, contrasts, unbalanced designs, and more). All packages can handle data files of unlimited size, include flexible Data Editors with complex transformations and complete data-base management functions, and can access data files from spreadsheets, data-bases, and mainframes.

Ask for our statistical packages for other computers.

TO ORDER: Send check, credit card number, or money order (plus \$5 shipping and handling) to:



StatSoft™

2832 EAST 10TH STREET, SUITE 4, TULSA, OK 74104
(918) 583-4149



To order by phone (Visa, MasterCard, C.O.D. orders accepted) or talk to our technical staff for more information, call (918) 583-4149.

STATSOFT STATSOFT logo STATS-2 STATFAST APP-STAT PSYCHOSTAT-3 LOTUS 1-2-3 IBM Macintosh Apple II Kaypro and CP/M are trademarks of respective companies

Technical support is provided in two ways. First, each copy of Personal Pascal has a unique ID number printed on both your registration card (which you should send in) and on a label that you can stick inside your manual. When you call with questions, you'll be asked for that number. It's an understandable approach to limiting technical support to legal owners of Personal Pascal. The second source of help is via OSS's bulletin board (available to registered users), which has sample programs, technical notes, and discussions about various problems and issues.

What complaints do I have about the product? Well, the manual is sparse in places, is not always well written, and needs an index. The editor could use some improvement, especially in cut-and-paste techniques. However, I prefer it over any language I've used on the ST to date, and I recommend it for anyone interested in programming on the ST, since it provides what is probably the most painless introduction to GEM I've run across.

PASCAL EXTENDER

I praised Personal Pascal for its efforts to make GEM manageable. Pascal Extender, from Invention Software Corporation, makes writing applications for the Macintosh easier. The Macintosh Toolbox routines, though more complete and better implemented than GEM, can still be overwhelming for someone programming the Mac for the first time. Or the second. Or the third. Or... well, you get the idea. One version supports MacPascal; another is for use with TML Pascal. It costs \$69.95 (seems to be a popular price) and comes with a 180-page manual and a single 3½-inch disk (not copy-protected). There are no licensing fees—though the agreement requires any software created using Pascal Extender for resale have a "Created Using Pascal Extender" statement in the manual.

The goal of Pascal Extender is to provide you with pre-declared routines and data types that make the Toolbox routines easier to use. This is done with a unit (for MacPascal) or an include file (for TML Pascal). Pascal Extender helps you in seven areas: event handling, menus, windows, controls, scroll bars, text editing, and dialog and alert boxes. For each area, you have a set of routines to help you create, use, and dispose of the appropriate items. For example, the following two routines for handling menus are among those provided in both MacPascal and TML Pascal:

- **BuildMenu(Num, Title, Items):** This function lets you add a menu to the menu bar, specifying the menu number, the title (for the bar), and the items in the menu itself (separated by semicolons).
- **StdMenus(aMenu, fMenu, eMenu):** This procedure creates and adds to the menu bar three "standard" menus: the Apple menu, with desk accessories and an "About xxx" item; the file menu, with items like "New," "Open," "Save," "Save as," and "Quit"; and the edit menu, with "Undo," "Cut," "Copy," "Paste," and so on.

A number of other routines—SetMenuItem, GetMenuItem, MarkMenuItem, DisableItem, EnableItem, Hilite-

(continued)

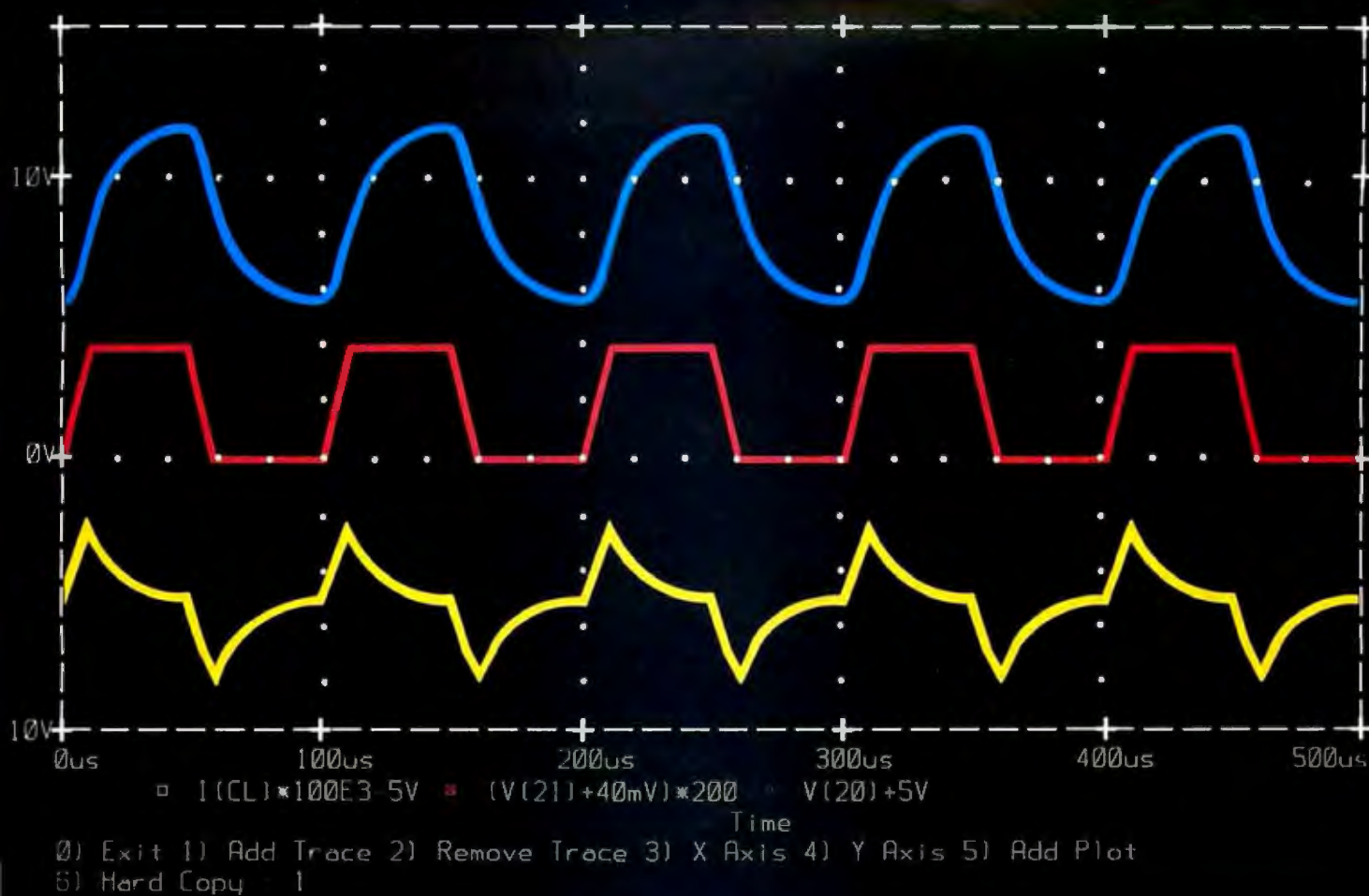

Accuracy. Speed. Reliability. Support. PSpice.

Since its introduction just over two years ago, MicroSim's PSpice has become the most popular commercial SPICE program in the world.

With over 20 years of combined real world experience in CAD, MicroSim offers an analog circuit simulator based on Berkeley version 2G.6 that has set the standard for IBM PC based machines.

PSpice allows you to simulate up to 140 transistor circuits (and up to 10,000 nodes). With PSpice you will be able to design in minutes complicated circuits that used to take hours, without doing costly breadboarding, all with the convenience of using your own PC.

Special features of PSpice include improved convergence properties;



MicroSim Corporation

a GaAs MESFET model; a device library which includes bipolar transistors, power MOSFETs, opamps, diodes and comparators. Complete telephone and mail-in support is included.

We also offer an innovative graphics post processor called Probe that transforms your CRT into a "software oscilloscope". (The graph above was generated using Probe.)

The most recent enhancement to PSpice is our Parts Option. It calculates a device's model parameters starting with data sheet specs. Interactive graphical feedback insures that the device has been correctly characterized.

If you are interested in doing your circuit simulations in a more timely manner and at a fraction of the cost, please give us a call today!

23175 La Cadena Drive • Laguna Hills, CA 92653
(714) 770-3022 • (800) 826-8603 • Telex: 265154 SPICE UR

Inquiry 242 for End-Users.
Inquiry 243 for DEALERS ONLY.

HOW TO BUILD AN XT compatible for under \$1000!

\$26⁰⁰

THIS IS THE CONFIDENTIAL, INSIDER INFORMATION THAT MAJOR COMPUTER MANUFACTURERS DON'T WANT YOU TO HAVE!

- All contained in a low-priced, fully illustrated 120 page manual.
- That's right. With nothing more than a screwdriver and two hours of your time—and this book—you can assemble your own PC-XT compatible for under \$1000.00!
- Where to find components and how to order them for the best price.
- Complete, step-by-step FULLY ILLUSTRATED assembly instructions requiring no technical knowledge whatsoever.
- This book provides absolutely everything you need to know to order components for and build your own XT containing: 640K, 2 floppy drives, keyboard, case & power, monochrome monitor & board.

ACT NOW WHILE THE SUPPLY LASTS. DON'T PAY THREE TIMES WHAT YOU HAVE TO FOR AN XT. BUY THIS BOOK AND BUILD YOUR OWN FOR UNDER \$1000.

THIS BOOK IS PRIVATELY PUBLISHED IN A LIMITED EDITION AND IS AVAILABLE ONLY THROUGH THIS ADVERTISEMENT!

Your fully-illustrated book, "How To Build an XT for under \$1000" will be rushed to you within three weeks.

Send your check or money order for \$26.00 plus \$3.99 for postage and handling (total \$29.99) to:

ADCOM, INC., 32 East 31 Street New York, NY 10016

MONEY BACK GUARANTEE: If not fully satisfied, return your book within two weeks for a full refund.

*New York state residents add 8% sales tax.

ACCORDING TO WEBSTER

Menu, GetMenu, GetMenuBar, and DisposeMenu—allow MacPascal to have direct access to these Toolbox routines (or equivalents); for TML Pascal, all are supported either by the Extender or by the TML libraries themselves.

Listing 1 shows a short demo program written using TML Pascal and Pascal Extender. This program brings up three "standard" menus—Apple, file, and edit—as well as a custom menu. It also brings up a window with scroll bars, a "go away" box, and a grow box. I've written a few dummy menu-handling procedures as well to show you how you might expand the program to actually do something. Figure 1 shows this program in action, with a few desk accessories up and running and one of the menus pulled down.

Pascal Extender is most useful for MacPascal, since it provides many standard Toolbox calls that aren't available in MacPascal (but are in TML Pascal). If you're already comfortable programming in TML Pascal, you might not want or need Pascal Extender—but I still find it useful. You will have to decide whether it's worth \$70 or not. And if you're using both MacPascal (for writing and debugging small routines) and TML Pascal (for producing final code), it's worth having for both compilers to help make your code as identical as possible. And for those of you who prefer C, Invention Software advertises two "C Extender" packages, one for Megamax C and one for Aztec C.

LATTICE SCREEN EDITOR

The Lattice Screen Editor for the Amiga has made my work on that machine easier. LSE, while not the best program editor I've used, beats the ED and EDIT programs that come with the Amiga. LSE is a straightforward, relatively complete, screen-oriented editor. It does not use menus or the mouse but is strictly keyboard-driven. It sets aside a few lines at the bottom for command options and menus. There are two layers of commands: those that execute directly, like Control-Q to abandon the file, and those that bring up a second, single-letter, menu, like Control-C for the Close File menu. This interface is easy to use and easy to learn.

LSE also has two types of help. First, a number of the function keys bring up quick summaries of your basic commands. These do help but are sometimes hard to decipher due to their terse nature. The Help key on the Amiga will summon a text file with more detailed instructions on how to use LSE. Unfortunately, the Help key is right below the Backspace key and next to the Return key, so I usually hit it accidentally a few times per editing session, causing a delay while LSE brings up the help window and another delay while I close it to go back to editing. Poor keyboard layout on Commodore's part.

One nice feature is the ability to have two files open and being edited at the same time. When you do this, LSE sets up two windows, one above the other, each taking up about half the screen. You can switch back and forth between the two with a single command (Control-X) and make either one take up the full screen (Control-D). This feature is great for referencing a definition file while editing

(continued)

CUSTOMIZE YOUR KEYBOARD



TOUCHDOWN™ EXPANDERS TOUCHDOWN™ KEYTOPS



P. O. Box 201, Dept. BY, Cornville, AZ 86325

- Eliminate Confusion
- Reduce Training Time
- Increase Productivity

Need Custom Keytops?
Call us today! 602-634-7515

KEY EXPANDERS

___ FULL KIT \$21.95

___ MINI KIT \$10.95

Black Gray

Touchdown™ key expanders enlarge small, critical keys (Return, Shift, Backspace, etc.) on the IBM PC and look-alikes to full-size, AT-style keys. Full kit has 12 separate expanders. Mini-Kit: Enter/Rel, both shifts, backspace. All kits support LED where needed. Must specify keyboard.

KEYTOPS—Kits to support most software, including:

___ PC to 5251 \$21.95

___ PC to 5520 \$29.95

___ DisplayWrite 3 \$21.95

___ WordPerfect 4.1 \$29.95

Language conversions available!

Send me FREE INFORMATION

Specify Keyboard Make/Model:

Name _____

Address _____

City, St., Zip _____

VISA MC # _____ Exp. _____

Visa or MC orders: 602-634-7515 Same Day Shipment • U.S. Postage Paid





DR. JACK PURDUM

Get the proven product from the man who wrote the books on "C".

C Programming Guide

After reading the 1st edition, Jerry Pournelle (BYTE Magazine) said: "I recommend this book... Read it before trying to tackle Kernighan and Ritchie." The second edition expands this best seller and walks you through the C language in an easy-to-understand manner. Many of the error messages include references to this book making it a perfect companion to Eco-C88 for those just starting out with C.

\$20

C Self-Study Guide

(Purdum, Que Corp.) Designed for those learning C on their own. The book is filled with questions-answers designed to illustrate many of the tips, traps, and techniques of the C language. Although written to complement the Guide, it may be used with any introductory text on C.

\$17

C Programmer's Library

(Purdum, Leslie, Stegemoller, Que Corp.) This best seller is an intermediate text designed to teach you how to write library functions in a generalized fashion. The book covers many advanced C topics and contains many useful additions to your library including a complete ISAM file handler.

\$22

CED Program Editor

CED now supports on-line function help. If you've forgotten how to use a standard library function, just type in the name of the function and CED gives you a brief summary, including function arguments. CED is a full screen editor with auto-flagging of source code errors, multiple windows, macros, and is fully configurable to suit your needs. You can edit, compile, link, and execute DOS commands from within the editor. Perfect for use with Eco-C88. For IBM PC, AT and look-alikes.

\$29.95

C Source for Standard Library

Contains all of the source code for the library functions that are distributed with Eco-C88, excluding the transcendentals and functions written in assembler.

\$10 (\$20 if not with order)

Developer's Library

Contains all the source code for the standard library, including transcendental and assembler functions. Available with compiler purchase only.

\$25 (\$50 if not with order)

Ecosoft Inc.
6413 N. College Ave.
Indianapolis, IN 46220

Inquiry 128

THE FIRST PROFESSIONAL 'C' COMPILER FOR UNDER \$60.00

Limited Time Offer
FREE
CED TEXT EDITOR WITH
"BUILT-IN" FUNCTION HELP.

NOTHING IN THIS PRICE RANGE EVEN COMES CLOSE.

"Ecosoft's Eco-C is going to turn some major heads."

"Eco-C is the first compiler reviewed that has clearly begun implementing the coming ANSI standard. Eco-C supports prototyping."

"Eco-C performed well on all the benchmarks, generating code that was quite comparable to that of compilers 10 times as costly."

from:
Christopher Skelly
Computer Language,
Feb., 1986

"The driver program is another strength: it compiles and links a list of files and provides a simple MAKE capability."

"This compiler does handle syntax errors much better than average—no avalanche of spurious messages here."

from:
William Hunt
PC Tech Journal,
Jan., 1986

"Eco-C88 is a high-quality package... comparable to systems costing much more."

"Eco-C88 is one of the fastest..."

"It is convenient to use, works well, and produces acceptably compact and fast programs."

from:
Dr. David Clark
Byte, Jan., 1986

Minimum System Requirements:

To use Eco-C88 Release 3.0, you must have:

1. An IBM PC, XT, or AT-compatible computer with monitor.
2. 256K or more memory.
3. Two 360K disk drives, or a hard disk.
4. PC or MSDOS 2.1 or later to include the MSDOS linker.

Eco-C88, mini-make, memfiles and CED are trademarks of Ecosoft Inc. IBM is a trademark of International Business Machines. UNIX is a trademark of Bell Labs. MSDOS and MASM are trademarks of Microsoft.

Full-featured C compiler. Supports all C features, data types (except bit fields), and operators.

New Language Enhancements. You also get prototyping, enum and void data types, plus structure passing and assignment.

Tiered Error Checking. All syntax errors are automatically flagged, but you can select the level of "link-like" semantic error checking you want.

Complete Standard Library. Over 200 functions, many of which are System V compatible for greater source code portability.

Screen and Memory Functions. Now you can write programs that use color, cursor addressing, even ones that let you design your own graphics functions. You also get memfiles™ that allow you to access memory outside the normal data segment as a file.

8087 and 80287 Support. If you have one of these math chips, your programs will take immediate advantage of it. If you don't have one, the code automatically switches to software floating point.

Full Screen Editor. The CED editor is a full screen editor with multiple windows, macro commands, on-line function help, plus a full set of editing commands. (Requires a true IBM PC compatible.) You can edit, compile, link, and execute programs from the editor which greatly reduces development time.

Includes a cc and mini-make™. The UNIX-like cc makes compiling programs a snap. You can run cc from within the CED editor.

ASM or OBJ Output. You can select assembler or relocatable output from the compiler. Both are MASM compatible and ready for use with the MSDOS linker to produce EXE files.

	Eco-C88	Lattice	Computer Inn. C86	Microsoft	Mark Williams
sieve	12	11	13	11	12
fib	43	58	46	109	—
deref	14	13	—	10	11
matrix	22	29	27	28	29

Computer Language, Feb., 1986, p. 18. Reprinted with permission.

Orders only: **1-800-952-0472**

ORDER FORM CLIP & MAIL TO: Ecosoft Inc., 6413 N. College Ave., Indianapolis, IN 46220

- C Compiler \$59.95 _____
- C Programming Guide \$20.00 _____
- C Self-Study Guide \$17.00 _____
- C Programmer's Library \$22.00 _____
- CED Program Editor \$29.95 _____
- C Source for Standard Library \$10.00 (\$20.00 if not with order) _____
- Developer's Library \$25.00 (\$50.00 if not with order) _____

SHIPPING \$4.00

TOTAL (IND. RES. ADD 5% TAX) _____

PAYMENT: VISA MC AE CHECK

CARD # _____ EXPIR. DATE _____

NAME _____

ADDRESS _____

CITY _____ STATE _____

ZIP _____ PHONE _____

ECOSOFT

COMPETITIVE EDGE

631 S. MAIN ST. • PLYMOUTH, MI 48170 • (313) 451-0685

FEATURING S-100 COMPONENTS FROM:

COMPUPRO®	RAM 22 ² \$446	CPU 286 ² \$671
	DISK 1A ² \$446	MDRIVE-H ² \$371
EARTH	TURBOMASTER 256K W/HDC	\$895
	TURBOSLAVE-1 8MHZ 128K	\$395
LOMAS	THUNDER 186 \$895	256K STATIC \$412
	COLOR MAGIC \$476	NVDISK 512K \$371
TELETEK	SYSTEMASTER ² 11 8MHZ 128K	\$795
	SBC-1 6MHZ 128K \$350	HDC \$375

ALSO FEATURING OUR AT COMPATIBLE:

VELOCITY 286



10 MHZ OPERATION
1024 K ON
MOTHERBOARD • 20MB
FAST HARD DISK HI RES.
MONOCARD STANDARD •
1.2MB FLOPPY DRIVE
WITH DOS 3.1 **\$3095**

MONITOR EXTRA OPTIONS:
UP TO 16 MEGABYTES OF MEMORY •
ENHANCED GRAPHIC ADAPTERS •
HARD DISK SUPPORT TO 240MB SCSI
XENIX® SYSTEM FIVE • AUTOCAD
READY SYSTEMS • 3278-79
TERMINAL EMULATION

ALSO
CE 20MB XT W/512K
\$1095

Includes floppy, hard disk, 512K
memory, monocard w/parallel
monitor.

CompuPro, Ram 22, Mdrive-H and other trademarks or registered trademarks of Vision Corporation. Systemaster is a registered trademark of Telebit Enterprises. PC AT is a trademark of International Business Machines Corp. Lotus is a registered trademark of Microsoft. WinPATH is a trademark of Pathway Design, Inc. SCC is a trademark of THE SANTA CRUZ OPERATION. Apollo is a trademark of Autodesk, Inc.

New Quark®/PC Single Board Computer



Base model 5.75" x 8"
Only **\$495.**

Quantity discounts available

- IBM PC® compatible single board computer mounts to 5 1/4" drive
- Includes Floppy Disk & Color Graphics CRT Controllers plus more

Also includes: Legal BIOS • Boots PC DOS® 2.1 • Printer Port • 2 Serial Ports • 256K RAM • Clock Speed at 4.77 MHz • Alphanumeric and Graphics Modes for Color Video Controller • Standard IBM® Keyboard Port.

Options include: 512K RAM • Piggyback I/O channel OEM Expansion Board • XT - Compatible Hard Disk SCSI Interface • Real Time Clock with battery-back-up • Clock speed of 9.5 MHz (twice as fast as a PC)

The Megatec Quark/PC is for OEM and end user applications that require PC compatibility in a compact single board computer. The Quark/PC BIOS will run most IBM PC® software including Flight Simulator and Lotus®. To meet your specifications a set of options let you add memory, speed and an XT-compatible hard disk interface. Not only does it quickly mount to a 5 1/4" drive, it also comes with floppy disk and CRT color graphics controllers — all for just \$495.

To order or enquire call us today. Dealer enquiries welcome. Megatec Computer Technologies (416) 745-7214 150 Turbine Drive Weston, Ontario M9L 2S2
Telex: 065-27453 U.S. Address: 1051 Clinton St., Buffalo, N.Y. 14206 Distributors: NCS Electronics Varese, Italy • SES Electronics Nordlingen, Germany • Perdux Microtronics Biggin Hill, U.K. • Microcomputing Ghent, Belgium • Asp Microcomputers Melbourne, Australia.

Quark is a registered trademark of Megatec. MFG CO LTD IBM IBM PC and PC DOS are registered trademarks of International Business Machines Corp. Lotus is a registered trademark of Lotus Development Corp. MS-DOS is a registered trademark of Microsoft Corp.

megatec

Listing 1: A short demo program written using TML Pascal and Pascal Extender.

```

program ExtTest;

{$I MemTypee.lpas }
{$I QuickDraw.lpas }
{$I OSIntf.lpas }
{$I ToolIntf.lpas }
{$I MacPrint.lpas }
{$I PackIntf.lpas }
{$I Extender.lpas }

const
  AM          = 1;
  FM          = 2;
  EM          = 3;
  NM          = 4;
  T           = True;
  F           = False;

  AppMenu    = 11;
  FileMenu   = 12;
  EditMenu   = 13;
  MyMenu     = 14;

var
  Done       : Boolean;
  theEvent   : EventRecord;
  WH         : EventStuff;
  IBeam,Cross,
  Plus,Watch : Cursor;
  MenuList   : array[AM..NM] of MenuHandle;
  MainRec    : WindowRecord;
  MainPtr    : WindowPtr;

procedure Initialize;
{ purpose: set program up }
var
  theRect    : Rect;
begin
  XTandIntf;
  Done := False;
  FetchCursors(IBeam,Cross,Plus,Watch);
  StdMenus(MenuList[AM],MenuList[FM],MenuList[EM]);
  MenuList[NM] :=
  BuildMenu(MyMenu,'Options','Do This;Do That;Do Nothing');
  SetMenuItem(MenuList[AM],1,'About This Program');
  SetRect(theRect,5,40,588,330);
  MainPtr :=
  CreateWindow(MainRec,theRect,'This Program',0,T,T,T,T);
end; { of proc Initialize }

procedure CleanUp;
{ purpose: clean program up }
begin
  KillWindow(MainPtr)
end; { of proc CleanUp }

procedure ShowInfo;
begin
  { here's where you'd put a box with
  info about your program }
end; { of proc ShowInfo }

procedure DoFileMenu(Item : Integer);
begin
  { here's where you'd handle all the file options }
  if Item = 12
  then Done := True
end; { of proc DoFileMenu }

procedure DoEditMenu(Item : Integer);
begin
  { here's where you'd handle the edit options }
end; { of proc DoEditMenu }

procedure DoMyMenu(Item : Integer);
begin
  case Item of
    1 : do this ;
    2 : do that ;
    3 : do nothing ;
  end
end; { of proc HandleMyMenu }

procedure HandleMenu(WH : EventStuff);
var
  MVal,Indx,Item : Integer;
begin
  MVal := -1; Indx := AM;
  Item := WH.ItemNum;
  while (Indx <= NM) and (MVal = -1) do
    if WH.MenuH = MenuList[Indx]

```

(continued)

KEY TRONIC...THE INDUSTRY STANDARD

ASK ANY OF OUR 200,000 CUSTOMERS WHY.

key tronic KB5151
Professional Series



A model is available for AT&T* 6300 and 6300 PLUS systems.

Key Tronic developed the Professional Series KB 5151 Keyboard so that IBM* PC/XT* or AT* users can increase word processing speed and spreadsheet accuracy. Today, it's the Industry Standard!

The KB 5151 is designed to work with both the old and new models of the IBM* PC/XT* and AT*.

There are a lot of reasons why the Key Tronic KB 5151 is so popular. For productivity, the keyboard features separate numeric pad and cursor keys, as well as the top row function keys and familiar typewriter layout.

"We input a lot of numbers and the Key Tronic KB 5151 keyboard saves keystrokes and time. I keep the Num/Lock down all the time . . . the numeric pad is like a calculator — it's that much faster."

—Lael Summer

Sr. Exp. Analyst, Guardian Life Insurance Co.
New York, NY

See us at PC Expo
July 9-11, 1986
New York City
Booth #2718

"The KB 5151 saves a ton of time. I wouldn't have a PC without one. We have two and expect to get others."

—John Shurtleff

Controller, Reinders Brothers Inc.
Elm Grove, WI

For service, worldwide Key Tronic customer support is available when you need it.

"I received very prompt response from the Key Tronic service department. My problem with the 5151 keyboard was taken care of very quickly with a seven day turnaround, and I couldn't be happier."

—Diane Ward, Secretary

M-A-Com
Burlington, MA

"Feel the Key Tronic Touch"™

key tronic.

The Responsive Input Company™

P.O. Box 14687 • Spokane, WA 99214 • USA
(509) 927-5515 TWX 510 773-1885

And for quality, you can depend on Key Tronic. The KB 5151 is designed to last up to five times longer than most other keyboards.

"I haven't had any problems with it, certainly. This is a good, solid keyboard. I plan to convert my clients to use this keyboard."

—E. F. Hafemeister, Owner

MTS Consulting
Park Ridge, NJ

Buying a KB 5151 is the best way to upgrade your system to the "Industry Standard." See your local dealer today, or call 1-800-262-6006 for more information. (7 a.m.-3 p.m. Pacific Time). In Washington State call (509) 927-5515.

\$25 Rebate Offer!

You can receive a \$25 rebate on the purchase of any Key Tronic keyboard. To receive this rebate, you must purchase a Key Tronic keyboard from a participating dealer. The rebate will be issued to you by mail. For more information, call 1-800-262-6006.

*IBM, XT, and AT are registered trademarks of IBM Corporation.
*AT&T is a registered trademark of AT&T Corporation.

```

    then MVal := Indx
  else Indx := Indx + 1;
case MVal of
AM      : if Item = 1
        then ShowInfo;
FM      : DoFileMenu(Item);
EM      : DoEditMenu(Item);
MM      : DoMyMenu(Item)
end
end; } of proc HandleMenu }

begin | main body of program ExtTest |
  Initialize;
  repeat
  repeat
    SystemTask;
    MaintainCursor(Arrow,iBeam,Cross)
  until GetNextEvent(Event, theEvent);
  HandleEvent(theEvent,WM);
  HandleMenu(WM)
  until Done;
  Cleanup
end. } of program ExtTest }

```

the source file or copying text from one file to another.

If you're using the Lattice C compiler on the Amiga, and you save the error messages out to a file (using the -e option), you can then invoke a special error mode with LSE. In that case, it goes to the line where each error occurred, shows you the corresponding error message, and gives you a chance to correct it. It works nicely, if not always perfectly, and it does make program correction a lot easier.

LSE also has a macro facility, allowing you to load in up to 10 keyboard macros, which can then be summoned by typing the function key F10. It works by saving your keystrokes into a file, then playing them back upon request.

I do have some complaints with LSE, though they tend to be minor. The manual is a bit sparse in some places, and it's not always easy to find what you want. As for the editor itself, an auto-indent mode would be nice for writing in Pascal or C. You can go to the Set Mode command (Control-M) and adjust the tabs, but having to hit multiple tabs for each new line can get tedious (though not as tedious as having to move over space by space). Also, I disagree with their implementation of the Quit (abandon changes) command. If you have two files open and hit the direct Quit command (Control-Q), LSE will close and abandon both files, not just the one you're working in at the moment. True, it does ask "ABANDON ALL CHANGES?" but it asks only once and then abandons both. Given the potentially catastrophic effects of abandoning all your changes to a file, it should either abandon just the active window or should ask for verification twice, once for each window.

LSE is a good, if not outstanding, program editor. You might want to test it out to see if you consider it enough

(continued)

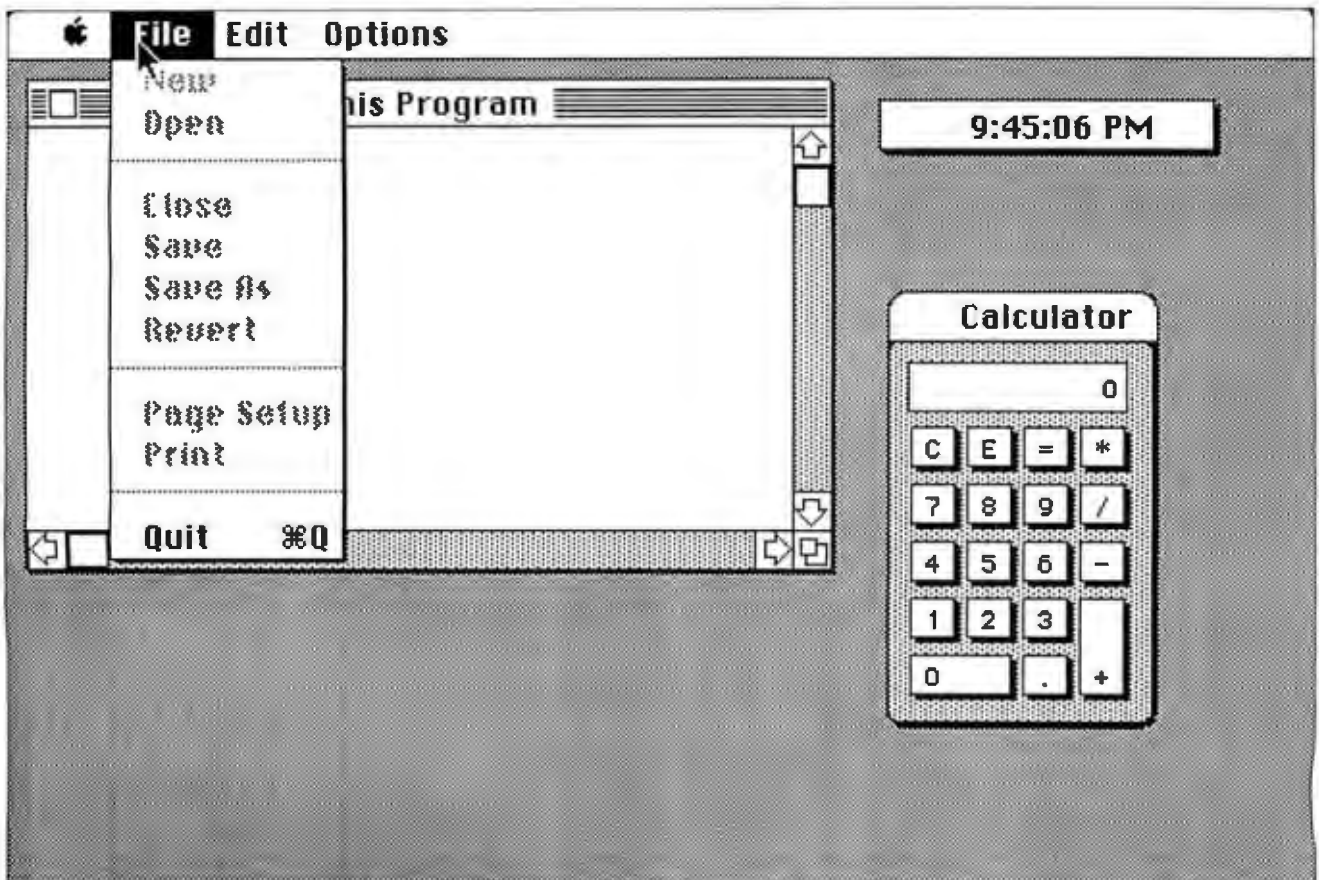

Figure 1: The program in listing 1 up and running, with a few desk accessories running and one of the menus pulled down.

Stunning Microsoft Word Processing *Fancy*WORD™

If you are a Microsoft Word user, using a dot matrix or laser printer, you now can print your letters, reports and presentation materials in **near typeset quality** with FancyWord.

You simply use Microsoft Word like you always have, including the paragraph and character format commands. The difference is **superior quality and font variety!** In fact, the copy and sample page in this ad were printed on an Epson FX80 printer using FancyWord.

Standard FancyWord font styles include Roman, Sans Serif, **Bold**, *Italic*, *Script*, *Old English* and many more in 10 to 24 point sizes. SoftCraft offers hundreds of optional fonts in sizes from 6 to 72 points. There is also an option that enables you to create your own **special characters and logos**.

Impact Your Laser

Combine the high quality of the HP LaserJet printer with the font styles and sizes of FancyWord for the ultimate in visual impact.

Cost Effective

FancyWord is available from your local dealer or direct from SoftCraft for only \$340.

You get near typeset quality at a small fraction of the time and cost of using art or typesetting services.

FancyWord runs on PC DOS and MSDOS systems with Epson, Toshiba, LaserJet and compatible printers.

Call **TOLL FREE** today to order FancyWord. We'll also be happy to answer any questions or send you additional information including actual samples and independent reviews.

CALL TODAY 1-800-351-0500

MasterCharge and Visa accepted

SoftCraft, Inc. Inquiry 314

222 State Street, Madison, WI 53703 (608) 257-3300

For Fancy letters, take our "WORD" for it.

SoftCraft, Inc.  8

Fancy WORD, from the developers of the highly-acclaimed *Fancy Font* personal typesetting system, brings Microsoft Word users the amazing print quality and variety of *Fancy Font* and the ease-of-use of Word. Use the Word "Format Character" command to select **bold** or *italic* for emphasis, *Old English* for formality, a clean Sans Serif font or *script* for a *handwritten look*. Print with ^{superscript}, _{subscript} or fine print or use a large, bold font to produce headlines with impact, such as:

Printed on an Epson Printer

All of Word's powerful formatting and on-screen editing features can be used with *Fancy* WORD, including justification, multiple columns and footnotes. This entire page was prepared with Word and printed with *Fancy* WORD.

In addition to the fonts that come with *Fancy* WORD hundreds of fonts in sizes from 6 points to 72 points are available, at a nominal charge, from SoftCraft's font library. You can also purchase the *Fancy Font* font editing utilities to create your own characters or logos, up to 1 inch by 1 inch in size.

The special math and symbol fonts available from the font library can be used in many special applications, such as printing equations:

$$\pi(n) = \sum_{k=2}^n \left[\frac{\phi(k)}{k-1} \right]$$

Now compatible with
Microsoft Word
Versions 2 and 3.

Expansion Chassis / Sub-System



Specification

Model No.	No. of Slot	Space for 1/2 Height Drive	Power Supply (Watts)	Dimension D x W x H (cm)	Price
M-1*	0	1	50	30 x 15 x 6.5	\$149
M-2	3	3	100	42 x 25 x 16	\$299
M-3	5	3	100	39 x 30 x 15	\$239
M-4	12	2	100	40 x 39 x 14	\$299
M-5	0	2	45	39 x 18 x 15	\$149
M-6	0	1	50	26.5 x 18 x 13.5	\$169
M-7	5	2	100	38.5 x 30 x 13.5	\$299
M-8	0	2	45	39.5 x 18 x 13.5	\$149
M-9	0	2	60	38.5 x 49 x 9	\$249
M-10	8	4	135	43 x 49 x 14	\$259

*Extra space for a stand alone controller

EXT and RCV Adapters (Interface Computers & Chassis) ... \$159

ORDER TOLL FREE: (800) 826-0267
In California Call (415) 651-3355
DEALER INQUIRIES INVITED

SOURCE ELECTRONICS CORP.
45277 Fremont Blvd., Unit 6
Fremont, CA 94538

Telex: 279366

Fax: (415) 791-0935

ACCORDING TO WEBSTER

ITEMS DISCUSSED

LATTICE SCREEN EDITOR \$100

Lattice Inc.
P.O. Box 3072
Glen Ellyn, IL 60138
(312) 858-7950

PASCAL EXTENDER \$69.95

Invention Software Corporation
P.O. Box 3168
Ann Arbor, MI 48106
(313) 996-8108

PERSONAL PASCAL \$69.95

Optimized Systems Software Inc.
1221 B Kentwood Ave.
San Jose, CA 95129
(408) 446-3099

of an improvement over ED and EDIT to plunk down \$100 for it.

BOOKS AS TOOLS

My favorite programming text is *Algorithms* by Robert Sedgewick (Addison-Wesley, 1983). I fell in love with the book the first time I saw it, and I strongly recommend it to anyone who wants to program. *Algorithms* has 40 chapters of, well, algorithms, that is, solved problems. The actual routines, written in Pascal, are short, easy to read, and readily translated into other languages. The book itself is divided into seven major sections: mathematical algorithms, sorting, searching, string processing, geometric algorithms, graph algorithms, and advanced topics. The book is easier to use, more relevant, and less intimidating than Donald Knuth's *The Art of Computer Programming* series ... and costs a lot less, as well. Not that it's cheap—I believe the current list price is around \$35—but it's worth it.

In my efforts to come up to speed in C, I have turned into a collector of C books. I have been somewhat frustrated, as each book seems to have glaring omissions, and I end up keeping a stack of three or four books handy for each time I need to research a particular topic (like string handling). I have, though, found three books from Que that form an ideal set for someone wanting to learn C: *C Programming Guide* (2nd ed., 1985), *C Self-Study Guide* (1985), and *C Programmer's Library* (1984). Jack Purdum wrote the first two by himself, and they're great for sitting down, learning the language by keying in programs, then testing your understanding by trying to answer questions given in the *C Self-Study Guide*. The third book, which Purdum coauthored with Timothy Leslie and Alan Stegmoller,

(continued)



Gil Roeder and his team can train you to program in C for less than one seminar fee

The Best C Video Ever

Now your entire staff can learn C language *faster, better, and at lower cost* than ever before. See why IBM, AT&T, Tandem, CitiCorp, Ernst&Whinney, Duke University, ITT, Teledyne, TWA, Teradyne, Compaq, Texas Instruments, Raytheon, Motorola and many other companies and universities are training thousands of programmers with this product. Our product itself is our best advertisement. The All-Hands-On C Video Workshop offers many benefits:

- Innovative Workshop skits help students remember content.
- Retention improved by 300 per cent.
- Ideal for self-paced study by individuals or instructor led groups
- Full features of C language explained—basics thru structures & pointers.
- The only video production about C Language which is not a "Talking Head" presentation.
- Dealer inquiries invited.

For more information, or to order call:
Retrieval Technology Corp.
3 Courthouse Lane
Chelmsford, MA 01824
(617)458-1130 ext. 105

All-Hands-On C Video Workshop

includes:
6 video modules
1 video workdisk
1 set student materials

\$995.00

serves much the same purpose as *Algorithms*: to give working solutions to problems like sorting, searching, and linked lists. It is nowhere as complete as *Algorithms*, but it is in C, and the code does work. All three books cost less than \$20 each; the first two are especially valuable for a C neophyte, while the third is not quite as crucial.

As far as a C reference text goes, the one I like the most is a thin tome jointly published by AT&T/Bell Labs and Prentice-Hall, entitled *The C Programmer's Handbook*. Written by M. I. Bolsky, it's a small spiral-bound book, about 90 pages long, that reads like an extended reference card. I keep it handy while programming in C.

I also have been collecting books on the 68000, for similar reasons. Again, each has its strengths and weaknesses, but the best overall introduction I've found so far is the *68000/68010/68020 Primer*. It's written by Stan Kelly-Bootle and Bob Fowler and published by Howard W. Sams as one of the Waite Group books. Note that this is a primer on the chip itself, not a guide to 68000 programming. It covers some of the design philosophy behind the 68000 family, the instruction set, and the differences between the different chips. I have yet to find a good general text on 68000 programming—I have two and am not fond of either one—but there are a couple of books dealing with 68000 programming on the Mac that look pretty good. I may talk more about them next month.

A WISH LIST

While we're on the subject of programming tools, I'd like to see a set of standard libraries (in C or Pascal) to aid parallel development on the Mac, the Amiga, and the ST. I've been tempted to work up something like this myself, and the MacLibrary from Lattice (C library for the Amiga that gives you some equivalent Mac Toolbox calls) is a start, but there's still a lot that could be done. The best solution might be to take a product like Pascal Extender or Simple Tools, both of which attempt to make use of the Mac routines easier, and redesign it to a more generic version that can then be used on all three systems.

Incidentally, I understand that Creative Solutions—the folks who developed MacFORTH—are coming out with a new FORTH that will run on the Amiga, the ST, and the

Macintosh. Apparently, they're attempting to make it "source-compatible" across all three machines, so that you could write an application on one and port it, unmodified, to the other two. Don Colburn, chief wizard at Creative Solutions, said that this effort forced them toward a "lowest common denominator" approach on menus, windows, and so on, but they do have extension files for each version to take advantage of each machine's specific features. I should have the Amiga version in a week or so; look for a report on it (at least a preliminary one) next month.

I would also like to see a Pascal-to-C translation program. I had someone call me looking for one of these; the only one he could find cost \$2500 (yes, that's "two thousand five hundred dollars"). He and I both ran across a small ad for another one, but the company no longer appears to exist. Because of Pascal's strict type checking and simple syntax, such a translator shouldn't be too hard to write, especially with user interaction to help resolve problems.

Finally, I'd like to see some good single-sheet reference cards on C and the 68000. When I was developing programs for the Apple II, I had a nifty 8½- by 11-inch plastic-coated, three-hole-punched reference card that told me all I wanted to know about the 6502: instruction set, op codes, register usage, condition flags, how to do unsigned tests, and so on. I don't know who made it—I don't have mine anymore—but I think one on the 68000 (and, for that matter, the 8086) would be very popular. A single-sheet card on C would also probably do well, though it might be harder to organize the information into a usable form.

IN THE QUEUE

It's always dangerous for me to predict what I'll cover next month, because I'm never sure what might show up between now and then. I hope to take a look at MultiFORTH for the Amiga. The SupraDrive 20-megabyte hard disk for the Atari ST has shown up and deserves some careful inspection. In addition, I've been making a collection of software packages for the Mac—MacSpin, StatView, PowerMath, PSI—that turn it into a kind of specialized supercalculator or data processor. Until then, see you on the bit stream. ■

mainframe powered CROSS ASSEMBLERS now under MS-DOS

The **UniWare™** family of cross assemblers. Fully relocatable, of course, but absolute listings are no problem, even in loads with many source files. With a linker so capable that even multiple overlays are a breeze. Lots of macro power. And all tools have unlimited symbol capacity.

\$295 COMPLETE
Includes One Assembler

Intel	8086, 80186, 80286, 8051, 8048, 8080/5, 8041
Motorola	68000, 68010, 68020, 68HC11, 6809, 6805, 6801, 6800
Hitech	HD64180, 6305, 6301
Zilog	Z80, Z8
Others	6502, 1802, TMS7000, 3870/F8

Software Development Systems, Inc.
(312) 971-8170

Visa & Master Charge Accepted (U.S.A.)
England: Unit-C, Ltd., (0903) 205233

Minimum 320K memory recommended; discounts available on purchases of multiple assemblers; prices subject to change without notice. MS-DOS is a trademark of Microsoft.

QNX vs UNIX

A QUESTION OF ARCHITECTURE



What do QNX and UNIX have to do with architectural design?

The design determines the environment in which you and your applications must survive. If the sheer weight of the UNIX operating system brings the PC to its knees, all applications running under it will suffer. Unix was conceived more than a decade and a half ago and the product today is the result of modifications, additions and patches by hundreds of programmers. The result is a large and convoluted piece of software which needs the resources of an AT or more.

QNX's superb performance and compact size is the result of one dedicated design team with a common purpose, and complete understanding of both the software and the environment in which it must run. It runs quickly and efficiently on PC's and soars on an AT. Unlike Unix, QNX is capable of real time performance and is the undisputed choice for real time process control, and office systems. You can buy an OS that offers you a 1 to 3 user dead end on an AT, OR, you can consider QNX which allows you anywhere from 1 to 10 users on both PC's and AT's. And we don't stop there. Unlike other Unix-type systems for PC's, QNX is also a networked operating system. Not a patch-on network, but a fully integrated networking system for up to 255 micros. QNX allows you to start with a single machine and grow if and as required. There are no dedicated file servers and you can attach terminals (users) to any machine. To choose a solution which ignores networking, is closing the door on your future.

Everyone is talking about Unix like systems, but no one wants to abandon the tremendous amount of DOS software available. QNX does not force you to make that decision. You can run either PC DOS 2.1 or 3.1™ as one of QNX's many tasks. (DOS File compatibility and DOS development tools are also available). Don't misunderstand us. We at Quantum have a great deal of respect for Unix. It was a major force in moving operating systems out of the 1960's and into the 70's. QNX however, was designed in

the 80's and will be a driving force of the 1990's. Over 20,000 systems have been sold since 1982.

Quantum strongly believes that there are good reasons for buying QNX, DOS and Unix. If you want more than DOS and a working alternative to PC Unix, give us a call and we will discuss your needs.

End-Users, VAR's, OEM's and software developers are invited to take the QNX challenge.

- **MULTI-USER:** -10 serial terminals per PC, AT.
- **MULTI-TASKING:** -40 tasks per PC, AT.
- **NETWORKING:**
 - 255 machines.
 - up to 10,000 tasks and 2000 users/network.
 - 2.5 Megabit token ring.
- **REAL TIME:** -2800 task switches/sec (AT).
- **MESSAGE PASSING:** -Intertask communication between any of 1000's of tasks on any machine.
- **MEMORY:** -88K to 110K for QNX.
- **PC DOS:** -Executes as a task under QNX.
- **C Compiler:** -Standard Kernighan and Ritchie.
- **Flexibility:**
 - Single machine or networked.
 - One to thousands of users. Full resource sharing of disks and devices on all machines.
- **Support:**
 - Online update system allows downloading of new releases over the phone.
 - Technical support hot line.
- **COST:**
 - From US \$450
 - Call for runtime prices.
- **HARDWARE SUPPORT:** -IBM PC, XT, AT™ (both real & protected) and compatibles.



Moodie Drive HiTech Park 215 Stafford Rd. Ottawa, Ontario, Canada. K2H 9C1 Phone (613) 726-1893

IBM PC, AT, XT AND PC-DOS ARE REG. TM OF INTERNATIONAL BUSINESS MACHINES CORP. UNIX IS A REG. TM OF AT&T BELL LABS

AVOCET INTRODUCES MACRO ASSEMBLERS.



Put your design ideas into more chips.

New AVMAC™ Macro cross-assemblers, combined with our simulators, emulators and EPROM programmers, turn your PC or VAX into a complete development system.

AVMAC is fast. Its transparent buffering scheme provides the speed of memory-based assembly without restricting file size. And, AVMAC has one of the most comprehensive macro facilities available.

AVMAC is loaded with features that make your development job easier. You get source code flexibility; AVMAC supports over 1000 relocatable segments. AVLINK™ linker and AVLIB™ librarian support modular programming with full control over segment combination and placement. AVREF™ generates cross-references by line and procedure. And, AVMAC gives you informative, plain English error messages.

AVMAC offers superior compatibility with manufacturers' assembly languages. And it's designed to work hand-in-hand with AVSIM™, Avocet's software simulator/debugger.

Every company talks about service. But at Avocet we're committed to satisfying customer requests for in-stock items in 2-3 working days. And that's a fact!

For easy access, call our 800 number for ordering, product information and technical assistance. We're also interested in your ideas on how we can better serve your needs.

AVMAC Macro Cross-assemblers

MSDOS™, PCDOS™	\$349
VAX™/UNIX™	\$995

Target Microprocessor Families Supported:

6804	6502/65C02	Z8
6805	6800/01, 6301	Z80
6809	NEC 7500	68H11
1802/1805	8085	HD64180
8048/8041	COP400	68020
8051	F8/3870	68000/68010
NEW!	TMS32010	TMS32020

In addition to AVMAC, Avocet provides everything you need to develop microprocessor software.

AVSIM full-screen Simulator/Debuggers make software simulation practical. Test your code in a crashproof, interactive environment, without additional hardware. Price \$299. **TRICE™ self-powered In-circuit Emulators** recognize 34 different commands;

set break points, single-step, trace and more. Priced from \$498.

AVPROM™ Programmers work with any PC. Program over 37 different devices, including EPROMs through 27512, CMOS and E²PROMS, and MPU/EPROM combos, using fast, "adaptive" algorithms. From \$429. Gang programmers from \$979.

To find out more about Avocet software development tools, call us toll-free:

1-800-448-8500

(In the U.S. except Alaska.)

VISA and Mastercard accepted. Most popular disk formats now available—please specify. Software shipment by second-day air within the continental U.S. included. Special handling and other shipping additional; call for exact quotes. OEM INQUIRIES INVITED. Avocet Systems Inc., P.O. Box 490-B16, Rockport, Maine 04856, (207) 236-9055. Telex: 467210 AVOCET CI.

AVOCET 
SYSTEMS INC.®

™ signifies manufacturer's trademark



PERSONAL SUPERCOMPUTERS

BY DICK POUNTAIN

Two years ago I wrote my first BYTE U.K. column, introducing the Inmos Transputer (August 1984, page 361). Since then I've received a lot of mail asking for more information on this chip, and so I decided to revisit the subject in this month's column.

The Transputer is now on sale, although it differs slightly from the design I described in 1984. A variety of evaluation boards, including one that plugs into the IBM PC, are also available from Inmos. But before I get down to details, some history first.

Samples of the Transputer were delayed well beyond the late-1984 date that the company was aiming for originally. The delay was not due to technical problems, as some reports suggested, but was a consequence of the 1984-1985 semiconductor industry slump. Inmos got hit where it hurt, in its valuable RAM business, and some company retrenchment and reorganization ensued. To cut the story very short, Inmos transferred fabrication of the Transputer from the U.S. to its U.K. plant in Newport, Wales, and modified the design so the chip could be made in Newport's existing process technology. With this change, Inmos gained more time to bring up the new and untried tungsten-silicide process it had planned originally. In the meantime, the firm settled for a chip design with a larger RAM cell and hence a lower density.

The resulting chip, called the IMS T414 Transputer, was formally launched on October 1, 1985. It combines a 32-bit RISC (reduced instruction set computer) processor, four 10-megabit-per-second full-duplex serial channels (called "links"), and 2K bytes of 50-nanosecond static RAM on a single chip. The links can all run concurrently with the processor, giv-

Dick looks at Inmos's Transputer and Meiko's Transputer- based Computing Surface

ing the chip a potential I/O bandwidth of 80 megabits per second. The amount of RAM is only half the 4K bytes originally planned, due to the simpler process technology used. The other major change from the original design is that the links are capable of concurrent block transfers as well as word-wide communication. This enhancement is supported by Occam, the language in which the Transputer is programmed.

The T414s being shipped as I write this column (March) run at 75 percent of their design speed of 10 MIPS (million instructions per second), and that figure should be up to 100 percent (50-nanosecond cycle time) by the time this article is published. A 16-bit version of the Transputer called the T212 is already running at 50 nanoseconds, with 45-nanosecond parts being sampled.

The most exciting news, however, is that the full 4K-byte Transputer, using the now-perfected tungsten process, will have an on-chip hardware floating-point processor. When the decision to go for the 2K-byte T414 was made, the chip layout had to be extensively redesigned (achieved in an heroic three months, thanks to Inmos's sophisticated CAD system). As a result, several improvements to an already remarkably clean layout were made, reducing the die size and making room for the floating-point circuitry. The resulting 32-bit chip, dubbed the IMS F424, should be without rival as the world's fastest microprocessor, capable of around 1

megaflop (million floating-point operations per second). It's fully pin-compatible with the T414, and samples are due late this year.

Inmos has also announced that by late 1987 the large-volume price for Transputers

will be reduced to \$50 apiece, which will make using them by the thousand a practical proposition for fifth-generation applications. (Currently, single-piece prices are \$500 for the T414 and \$350 for the T212.)

A lot of work is going on in the U.K. and elsewhere to gain experience in Transputer-based architectures, and it is becoming clear that the chip delivers everything that it promised—supercomputer performance from a desktop-size box of parallel-computing Transputers. Much of the research is in signal processing, some of it in areas from which the Official Secrets Act excludes this columnist. The British Home Office has commissioned a pilot study of a fingerprint identification system that uses arrays of Transputers to perform hugely computation-intensive pattern-recognition tasks and I/O-intensive database searches. Results from the prototype system suggest it will work ten times faster than, and for a tenth of the cost of, present systems built around superminicomputers with dedicated array processors. Another hot area of interest is graphics, and the film industry is beginning to appreciate the possibilities that a box of Transputers can offer for real-time, broadcast-quality animation.

The Occam language that I described briefly two years ago has

(continued)

Dick Pountain is a technical author and software consultant living in London, England. He can be contacted c/o BYTE, One Phoenix Mill Lane, Peterborough, NH 03458.

*The Computing Surface
is a modular machine,
built from combinations
of four different
kinds of boards.*

mutated into Occam 2, with some significant changes. (At this point I ought to mention that I wrote the tutorial manual for Occam 2, acting as a freelance author.) Occam is the first programming language to fully incorporate I/O, concurrency, and interrupts into the structure of the language itself, rather than as afterthoughts. The language is based on a model of independent processes that communicate over self-synchronizing channels and can run sequentially, concurrently, or alternatively (i.e., by interrupting each other). Occam programs can be developed on a single processor and then distributed over an arbitrary number of Transputers to achieve the desired performance level.

Occam 2 has become a typed language, supporting INT, BOOL, and a variety of lengths of REAL types. Since the hardware now supports block transfers, channels in Occam 2 have protocols describing the structure of the objects that can be communicated (Occam 1 channels are untyped and communicate only single words). Whole arrays can now be input and output in a single process, rather than element by element. Protocols allow message passing within programs to be type-checked at compile time and improve both security and readability. Occam 2 retains its interactive folding editor (developed several years before ThinkTank) but now supports separate compilation, using the fold as the unit of compilation.

The Occam 2 compiler will be ready for full release in the summer of this year, with its alternative C, Pascal, and FORTRAN front ends following in the last quarter. Transputer systems at the

moment are supplied with a Development System based on Occam 1.

MEIKO'S COMPUTING SURFACE

The U.K. launch of the Transputer took place in London's hypertrendy Institute of Contemporary Arts last fall. Inmos showed some classy graphics demonstrations, including multi-colored ray-tracing programs that speeded up as more Transputers got switched in and a neat animated butterfly that flies off one monitor screen onto another. The finale was a demonstration that was breathtaking for those in the know, but whose significance may have escaped the less technically knowledgeable people in the audience. In the demo, four layers of the actual CAD database files containing the layouts for the T414 were animated in three dimensions and real time so that we "flew" through the chip layout itself, like a flight simulator or one of those sci-fi landscapes so popular in TV advertisements. The significance of the demo is that it takes Inmos's VAX-11/780 eight hours to convert four layers of this database.

The box of tricks that performed this feat was the first prototype of the Meiko Computing Surface, a Transputer-based "personal supercomputer" and it contained 128 early 16-bit Transputers of a now-discarded design.

Meiko is an 18-month-old start-up company formed by several former employees of Inmos, all of whom were intimately involved in the development of the Transputer. The Computing Surface is, without exaggeration, a personal supercomputer—not a supermini, but a supercomputer. In its largest current configuration, with 150 32-bit Transputers in the box, it provides 1 GIP (1000 million instructions per second) of computing power for a single user. Meiko designed the computer for that group of people who so far have been left out of the personal computer revolution—the scientists, engineers, animators, and others whose computational needs are so large that they must still wait to share time on a Cray.

Choosing a parallel processor architecture to satisfy the needs of these

different classes of user is not easy, and so Meiko decided to give the machine a highly flexible and variable topology; hence the name Computing Surface, which suggests cubes, spheres, donuts, and other exotic possibilities. The user can configure the processors in a vast number of different ways. Someone who's accustomed to using an array processor, for example, could just string all the Transputers together into a pipeline, or perhaps a simple two-dimensional array. Others may want to partition the Transputers into several different functional groupings; in graphics one might devote a processor to each object on the screen, or to each bit plane, or whatever.

The Computing Surface is a modular machine, built from combinations of four different kinds of boards. Two models are being offered, with 10 or 40 slots. The 40-slot model is the size of a water cooler, while the 10-slot box can fit on a desktop or into a 19-inch rack mount. Both models are air-cooled by a fan. The backplane is Meiko's own design, since none of the standard buses can handle the communications requirements of such a system. Because of the "constructor set" design, users can specify special backplanes for special I/O demands.

Configuring the topology of the processors is currently performed manually using jumper leads on the reverse side of the backplane board, like a telephone switchboard. However, Meiko has designed a custom VLSI switching chip, due for delivery later this year, that will allow the topology to be set up electronically; sockets for this chip are included on the processor boards.

The four kinds of processor board are the Local Host, Compute Element, Display Element, and Storage Element. Of these, only the Local Host is compulsory; every system must have at least one.

The Local Host board is a powerful computer in its own right. It contains one 32-bit T414 Transputer, 3 megabytes of dynamic RAM, 128K bytes of EPROM, two RS-232C interfaces, and an IEEE-488 parallel interface that can be used to attach hard disks to the

(continued)

**NETWORK
VERSION
AVAILABLE**

INTRODUCING OPEN ACCESS II

**THE FULLY INTEGRATED BUSINESS SYSTEM
WITH THE WORLD AT YOUR FINGERTIPS**

Open Access II is a new, super-program which can perform virtually every managerial and business task you'll ever need with performance and ease-of-use unheard of in the industry.

Open Access II combines an extremely powerful relational database and superior spreadsheet with data communications, word processing, 3-dimensional graphics, and time management. Information is conveniently changed from module to module.

Open Access II's Database features an effective and flexible report generator and user definable screens. "Programmer," our new Database language, features simple interacting English-like commands to produce your customized applications.

Open Access II's Spreadsheet offers a unique combination of business problem solving capabilities; including goal-seeking, and an advanced table look-up command. Professional business presentations are easily produced by the enhanced graphic capabilities.

Open Access II's improved Word Processor can merge data from Spreadsheet or Database easily to produce reports, mail merge and graphic presentations.

Open Access II's data communications provides you with the capabilities to handle any of your micro computer communications needs. All of Open Access II's modules work together and data is easily communicated to the rest of the world.

**BEST OF ALL,
THE PRICE**

\$595.

Open Access II's super program is also available in the network version. Ask for details. Call (619) 450-1526 in California, or (800) 521-3511 if outside California for your nearest authorized dealer or distributor and expand your business base with Open Access II, the fully integrated business system.

SPI

SOFTWARE PRODUCTS INTERNATIONAL

10240 Sorrento Valley Road
San Diego, California 92121

(619) 450-1526

For Your Authorized Dealer
or Distributor Outside California

(800) 521-3511

**Open Access II
Comparison Chart**

	Database	Form Query	Report Generator	Query Processor	Relational Database	Graphics	3-D Graphics	Spreadsheet	Goal Seeking	Word Processor	Communications	Time Management	Price
Open Access II	✓	✓	✓	✓	✓	✓	✓	✓	✓	✓	✓	✓	595⁰⁰*
Lotus 1-2-3	✓					✓		✓					495 ⁰⁰
Symphony	✓	✓	✓			✓		✓		✓	✓		695 ⁰⁰
Framework	✓		✓	✓		✓		✓		✓	✓		695 ⁰⁰
Enable	✓		✓			✓	✓	✓		✓	✓		695 ⁰⁰
Smart	✓		✓			✓	✓	✓		✓	✓	✓	895 ⁰⁰



**Inquiry 321 for End-Users.
Inquiry 322 for DEALERS ONLY.**

Open Access II is a registered trademark of Software Products International, Inc.
Lotus, 1-2-3 and Symphony are registered trademarks of Lotus Development Corp.
Framework is a trademark of Ashton-Tate.
Enable is a trademark of The Software Group.
Smart is a registered trademark of Innovative Software, Inc.

system. Meiko can also provide a SASI interface or an attachment for using a MicroVAX II as a front-end processor.

The Local Host is responsible for booting the system and performing all housekeeping operations, including running the Occam Development System, source-level software debugging, and hardware monitoring (all the memory is parity-checked). In the event of hardware failures, the Local Host can pinpoint and report the site of the error, since all the other boards contain a channel leading straight back to the host that relays their "dying words." When the switching chip is ready, the Local Host will also control configuration of the network.

The workhorse component of the Computing Surface is the Compute Element, a board containing four 32-bit T414s, each with its own 256K bytes of dynamic RAM. The off-chip RAM on these boards is faster, at 16 megabytes per second, than the

COMPANIES MENTIONED

Inmos Corporation
P.O. Box 16000
Colorado Springs, CO 80935
(303) 630-4000
or
Inmos Ltd.
Whitefriars, Lewins Mead
Bristol BS1 2NP, England
(2072) 290861

Meiko Inc.
6201 Ascot Dr.
Oakland, CA 94611
(415) 530-3055

12.5-megabyte-per-second RAM used on the Local Host.

The processes of a typical number-crunching Occam program get distributed and executed on one or more Compute Elements. Meiko's FORTRAN compiler allows existing FORTRAN programs to be distributed

over these processors, using Occam as the "glue" to keep the individual processes communicating and co-operating.

The Storage Element board contains one T414 processor and 8 megabytes of dynamic RAM. These boards are used for applications that need to keep large data structures in memory for maximum speed. An example is graphics applications, in which complex pictures might be constructed in memory and then scrolled and panned through by a display processor (see figure 1).

The Display Element board contains one T414 processor, 1.5 megabytes of dual-ported video RAM, and three of Inmos's G170 8-bit Color Lookup Table chips. These chips contain a writable 256-entry color palette that governs the translation of colors on a graphics monitor. Each chip also has a D/A converter on board so that it can directly drive the gun of an RGB monitor.

As with the rest of the machine, Meiko has kept the options wide open with the Display Element board. One board could be used as a single 1.5-megabyte video buffer, with 8 bits per pixel (for 256 colors). It could also be used as a 0.5-megabyte buffer with 24 bits per pixel or as two 0.75-megabyte buffers for double-buffered animated graphics in 256 colors. Of course, it is possible to add as many Display Element boards as you need, to give more pixels per screen, or more bits per pixel, or more drawing speed. You could, for example, gang up these boards as separate bit planes for complex animation effects. For ultimate drawing power, the solution is to divide the screen into tiles or strips and devote one Transputer to updating each area.

Meiko's customers can mix and match a system by buying these boards in any numbers and combinations. More power can be added so long as there are slots, and whole boxes can be ganged together if you need more slots.

F424 Transputers, when they are available, can be retrofitted to the Computing Surface to give capability of over 100 megaflops—number-

(continued)

Forecasting and Statistical Analysis

StatPac™

the proven statistical analysis package

The standard for business and industry for over six years. Comprehensive and easy to use. StatPac is a full-featured statistical package for professional researchers.

StatPac Gold™

our top-of-the-line statistics package

An enhanced version of StatPac featuring windows, graphics, and command programming language. StatPac Gold is the most advanced statistical package available.

Forecast Plus™

a time-series analysis forecasting tool

A combination of data management, exploratory graphics, and over a dozen forecasting techniques, make Forecast Plus the most powerful time-series package available. It works fast, accurately and automatically.

Goodness-of-Fit™

a regression package for model building

A full-featured regression package for professional researchers. Command driven with versatile programming language.

Call for complete information: 1-800-328-4907

WALONICK ASSOCIATES

6500 Nicollet Ave. S., Minneapolis, MN 55423
(612) 866-9022



Osborne/McGraw-Hill Computer Books Your Link to Future Technology

The Practical Guide to Local Area Networks

by Rowland Archer
Learn how to evaluate and select a LAN so you can avoid unexpected surprises after you make a purchase. Archer discusses five of the most popular LANs available for the IBM® PC and compatible computers: 3Com Ethernet; Corvus Omninet; Orchid PCnet; Novell Netware; IBM® PC Network and IBM® Token Ring.

\$21.95, Order #0-07-881190-2, 283 pp.
6 1/4 x 9 1/4

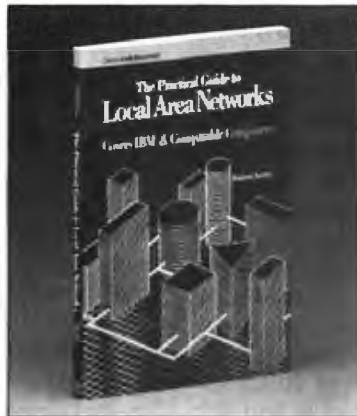

Desktop Publishing From A to Z

by Bill Groul, Irene Athanasopoulos, and Rebecca Kutlin
Create newsletters, catalogs, conference brochures, news releases, and more! This book helps you choose the software, equipment, and procedures you need to achieve professional-looking results.

\$17.95, Order #0-07-881212-7, 225 pp.
7 1/4 x 9 1/4



Micro-to-Mainframe Links

by Ronald F. Kopeck
Sort out all the complex issues involved in linking microcomputers to mainframes for sophisticated, high-powered applications. Thoroughly explains the planning and evaluation process, the real and hidden costs of linking, maintenance, service, and monitoring.

\$18.95, Order #0-07-881228-3, 300 pp.
7 1/4 x 9 1/4

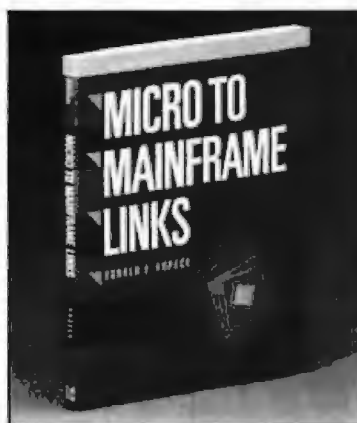

Project Management Using Microcomputers

by Harvey A. Levine
Describes state-of-the-art project management techniques that can be applied to every business and to almost every computer system. Includes many application examples.

\$18.95, Order #0-07-881221-6, 350 pp.
7 1/4 x 9 1/4

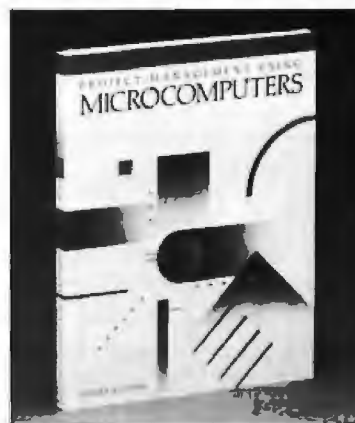

◆ Osborne/McGraw-Hill books are available at bookstores and computer stores everywhere.

◆ To order by mail, complete the coupon and send it to: Osborne/McGraw-Hill
P. O. Box 400
Hightstown, NJ 08520

◆ All orders must be prepaid and should include local tax.

◆ Checks, money orders, VISA and MasterCard are acceptable for payment. No postage or handling charges are required.

◆ Books will be shipped via UPS. Allow 4-6 weeks for delivery. Books will not be delivered to post office boxes.

This order is subject to acceptance by McGraw-Hill. Offer is good only in the U.S.A.

Osborne McGraw-Hill

NAME _____	
ADDRESS (No PO Box) _____	
CITY _____	
STATE _____	ZIP _____
INDICATE METHOD OF PAYMENT <input type="checkbox"/> CHECK/MONEY ORDER	
<input type="checkbox"/> VISA/EXP. DATE _____	<input type="checkbox"/> MASTERCARD/EXP. DATE _____
CARD # _____	
SIGNATURE _____	
QTY _____	ORDER # _____ PRICE _____
Osborne/McGraw-Hill	
PO Box 400, Hightstown, NJ 08520	SUBTOTAL _____
Clip and send.	TAX _____
42-Q-005-7000-1	TOTAL _____

crunching power that begins to enter Cray territory.

USING THE COMPUTING SURFACE
 Programmers who have not yet used Occam will have to take my word for it that the language makes writing massively concurrent programs a pleasure rather than an ordeal. Occam frees the programmer from concern with the details of synchronizing processes in a way that Ada and Modula-2 cannot begin to approach.

Nevertheless, when programmers deal with massively concurrent systems, issues arise that not even Occam can hide; they are only now being understood as such systems become more readily available. One such problem is achieving a correct balance between communication time and computation time. When you break down a problem into small pieces to be computed in parallel, it is possible to go too far, so that the time to communicate the partial results exceeds the computation time and the individual processors don't

have enough work to keep them busy. The program then runs more slowly than a more sequential equivalent would. The ideal is to keep each processor working flat out all the time.

Programmers like Meiko's Eric Barton (who wrote the fly-through-the-chip demo) and Immos's Phil Atkin are now tackling this tricky area, drawing on detailed analyses of the execution of concurrent test programs. They are exploring the technique of "dynamic load balancing" in Occam programs, whereby the program can redirect the flow of data at run time to keep the processors as busy as possible. Dynamic load balancing becomes possible only if there is spare communications bandwidth, permitting freedom of choice for routing results. Also, communication needs to be concurrent with processing. Transputer-based systems meet both these requirements; concurrent communication comes with the chip, and you can always get spare bandwidth by adding more processors.

The fly-through-the-chip demo pro-

vides a good example of the communication versus computation issue. This program involved taking the CAD database, which contains thousands of polygons that represent transistors and interconnections on various layers, transforming the polygons into three-dimensional perspective, and shading them in different colors. Barton and his colleagues first tried using a pipeline of Transputers for each layer, each chip performing only a part of the three-dimensional transformation, in textbook fashion.

The performance of this program was disappointing, and a close look showed that the Transputers were so fast that they were being underused. The final version of the program makes each Transputer perform the whole transformation, then uses the spare communications capacity to throughput the results to the display Transputers. The hardware configuration for this demo is shown in figure 1.

TWO YEARS LATER

At heart, I'm fond of fast motorbikes and fast computers. There is, however, a rational component to this addiction because in computers, at least, speed buys increased utility.

Meiko and other firms that will shortly be announcing Transputer-based products are pioneering a new generation of computing where seemingly impossible amounts of computing power can be made accessible to individuals. This power could be used to provide new programming tools and user interfaces that will make HAL seem old-fashioned. What is it that excites people about the Commodore Amiga, if not the fact that it's a little bit closer to the real world than its competitors? Transputer-based computers can be even closer. In time, Transputer-like processors will be integrated at wafer scale, and Alan Kay's Dynabook will cease to be a dream.

Two years later, I still find the Transputer the most exciting thing that's happening in silicon, and I make no apologies for preaching about it to U.S. readers who are understandably more aware of their own domestic chip manufacturers. Check it out. After all, you grew to like Porsches. ■

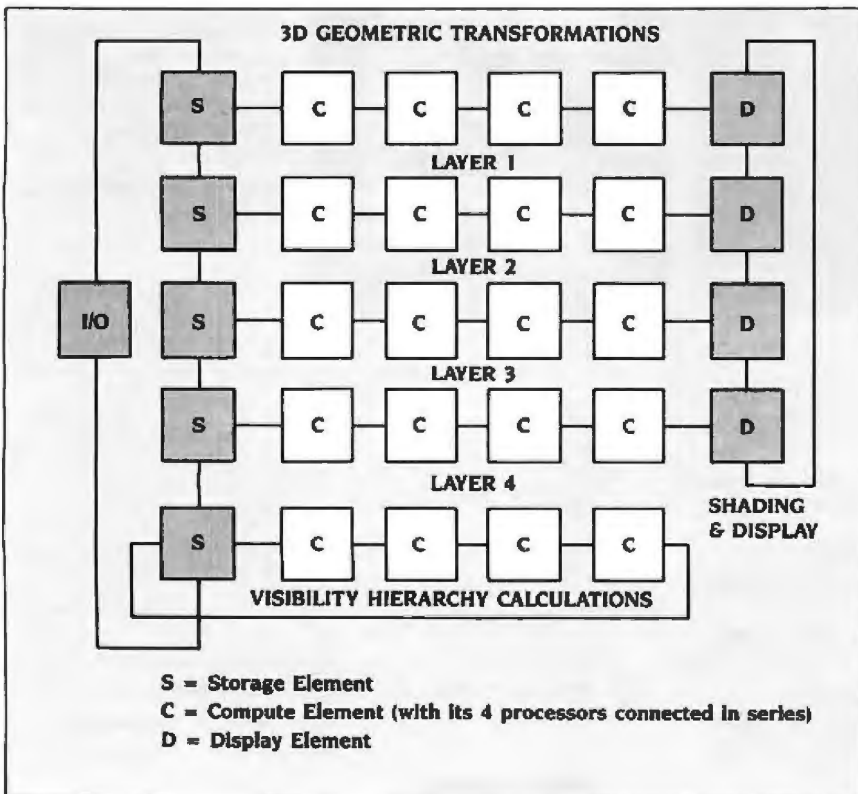

Figure 1: Meiko's prototype Computing Surface used this configuration for processing the three-dimensional views of the T414 chip layout.

Read what the experts say about the PC's Limited AT.

"I have no qualms recommending this system to experienced users who need the added speed."

—Sol Libes,
Micro/Systems Journal,
January/February 1986

30 DAY
Money-Back
Guarantee



"The PC's Limited AT™ proved to be the functional equivalent to the IBM® product, only faster. Priced at roughly one-third less, it rates as one of the best bargains available."

—Winn L. Rosch,
PC Magazine,
February 25, 1986

"If price is your primary consideration, skip both AT&T® and TI® and choose this issue's best buy, the PC's Limited AT™. Check its benchmark results—you won't be sacrificing performance to save money."

—*PC Magazine*,
Editor's Choice,
February 25, 1986

And if that's not enough to convince you, now we've got a 30-day money-back guarantee.



- One Year Limited Warranty
- 80286-based System Unit (Runs at 6MHZ. 8MHZ option included at no extra charge.)
- 1024K on Mother Board
- 1.2 Meg Floppy Drive
 - Combined Floppy/Hard Drive Controller Card
 - AT Keyboard
 - 192W Power Supply
 - 2 Serials and 1 Parallel Port
 - Clock/Calendar with Battery Backup
 - Operations Manual

\$1495

I'm Michael Dell, President of PC's Limited. And I want you to know about your latest industry-leading step. We're so sure that you'll like everything about our PC's Limited AT that we're willing to offer you a 30-day money back guarantee on it. This machine, with 1024K on the Mother Board and an 8MHZ option included at no extra cost, has been a standout since we introduced it. So give us a chance to show you what it can do for your operation. With a deal like this, there's no way you can lose. (And see the opposite side of this page for information about our Turbo PC™, plus details on our guarantee.)

Michael Dell

When a PC's Limited Turbo PC is on your desk, you'll think it's a headliner too.

"... a good machine. And a heck of a buy... a fine box. One I'd happily choose over Big Blue's original... no status... beyond the status that attaches to getting twice as much for your money."

—Jim Seymour,
PC Week,
August 13, 1985

"It almost sounds unbelievable."

—*MIS Week,*
August 21, 1985

TOTAL SATISFACTION GUARANTEE WARRANTY

For Warranty Services: One year Limited Warranty on PC's Limited products. Contact Technical Support for a Return Authorization Number (RMA). Returns must be accompanied by your RMA, the invoice, and a label explanation. During the Warranty Period, PC's Limited will repair or replace items at our option.

30-DAY TOTAL SATISFACTION GUARANTEE

Items first bought from PC's Limited may be returned within 30 days from the date it was shipped for a full refund of your purchase price. Returned items must be in new, unmodified or damaged, with all accessories, cards, manuals, and packaging intact. Returned items must be shipped prepaid and insured, and must bear a PC's Limited Credit Return Authorization (CRA) on the shipping label. Call PC's Limited's Customer Support Department for CRA. No credits issued after 30 days from date of shipment.

CONSUMER TIP

When shopping for PC products, ask our competitors about their refund policies.

"We tested a wide variety of software on the machine and everything ran well... The bottom line for anyone considering buying one of these computers would seem to be this: PC's Limited sells quality systems for extraordinarily low prices."

—*PC Week,*
October 29, 1985

- 16-bit 8088-2 System Unit (runs at 4.77 or 6.66MHZ)
- 640K on Mother Board
- 360K Floppy Drive
- AT Keyboard
- 130W Power Supply
- Operations Manual
- One Year Limited Warranty

\$795

Microsoft GW Basic™ \$95 • IBM DOS 3.1 \$85 • 8087-2 \$149



Our Turbo PC™ has sold in large quantities since the first week we introduced it. Of course, that's not surprising, since we were the first company to break the \$800 barrier with a machine that outruns the "Big" name by a 40% speed factor. Now, we're going to extend the margin even further by offering a 30-day money back guarantee. If that sounds good, it'll look even better when one of our Turbo PC's is on your desk. So call us today. We're guaranteeing you'll like what you get.

Some quantities may be limited. PC's Limited sells equipment certified to be compliant with FCC Class B standards. When equipment manufactured by PC's Limited has any required certification, PC's Limited will substitute equivalent certified equipment. All prices are subject to change without notice. We are an independent sales organization.



PC'S LIMITED™

SALES CALLS OUTSIDE TEXAS, 1-800-426-5150

SALES CALLS INSIDE TEXAS, 1-800-252-8336

1611 Headway Circle, Building 3, Austin, Texas 78754

Sales Calls from anywhere in the country, (512) 339-6962

Technical Support Calls, (512) 339-6963 Customer Service Calls, (512) 339-6964

*Limited Warranty

Telex No 9103808386 PC LTD FAX (512) 339-6721



Call for latest prices.

FREE SHIPPING

in the Continental United States via UPS Ground.

NO SURCHARGE FOR

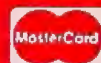

OR



Floppy Disk Drive



Also available for AT*
in Gray Color.

\$109

MITSUBISHI ELECTRONICS

Half-Height, DS/DD

PANASONIC

Half-Height, DS/DD

TEAC

5.5-B, Half-Height, DS/DD

PC's Limited AT Multifunction Card

- Expandable To 3 Meg (1.5 on Board/1.5 on Piggy Back Board)
- Supports 64 or 256K Rams
- Parallel Port
- Serial Port (2nd Serial Optional)



\$199

Piggy Back w/OK Board \$59 w/OK

PC's Limited Mini I/O

- Serial Port
- Parallel Port
- Clock
- Software
- Fits In Short Slot

\$99

300/1200 Baud Hayes Compatible Modem Fits in Short Slot



\$159

64K RAM

Set of 9 chips, 200 or 150 Nanoseconds

\$10

per set

256K RAM \$29

Set of 9 chips 150 Nanoseconds

PC's Limited Monochrome Graphics Fully Hercules Compatible

\$159



- Text Mode 80 x 25
- Graphics Mode 720 x 348 Pixels
- One Parallel Printer Port

Seagate 20, 30 and 40 MEG High Speed 40 MS Access Time Hard Drives for AT**

Uses Linear Voice Coil Activator.



Heads park automatically at power down.

20 MEG \$579
30 MEG \$699
40 MEG \$819

Includes Seagate Full Height Hard Disk Cable, and Mounting Rails. Boots from Hard Disk. One Year Warranty.

PC's Limited PC-576 RAM Board

- Expandable to 576K
- Supports 64K or 256K RAMS
- Fits in Short Slot



\$69 w/OK

PC'S LIMITED Six Function Card

- Upgradable to 384K
- Clock/Calendar
- Includes Software
- Parallel Port
- Serial Port
- Game Port



Two Year Warranty*

w/OK \$99 w/384K \$149

SOLVE YOUR POWER PROBLEM.

XT™ POWER 130W \$99



Directly replaces power supply in PC.™ Fully XT™ compatible. One Year Warranty*

PC'S LIMITED MONO-1 MONITOR \$169



- 11 inch screen
- Amber
- Compatible with monochrome or color graphics cards

PC'S LIMITED RGB-1 MONITOR \$459

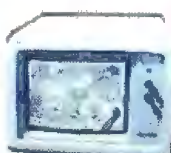

- JDM 4mm pitch
- RGB input
- 11-inch screen
- 600K/240 resolution
- 16 colors

TOTAL SATISFACTION GUARANTEE WARRANTY

For Warranty Service: One year Limited Warranty on PC's Limited products. Contact Technical Support for a Return Authorization Number (RMA). Returns must be accompanied by your RMA, the invoice, and a brief explanation. During the Warranty Period, PC's Limited will repair or replace items at our option.

10-DAY TOTAL SATISFACTION GUARANTEE
Any item bought from PC's Limited may be returned within 10 days from the date it was shipped for a full refund of your purchase price. Returned items must be as-new, not modified or damaged, with all warranty cards, manuals, and packaging intact. Returned items must be shipped prepaid and insured, and must bear a PC's Limited Credit Return Authorization (CRA) on the shipping label. Call PC's Limited's Customer Support Department for CRA. No credits issued after 10 days from date of shipment.

CONSUMER TIP

When shopping for PC products, ask our competitors about their refund policies.

Seagate HD - Western Digital Controller 20 MEG Hard Disk System for PC™



Internal \$449

For Xebec 1220 Combined Floppy/Hard Disk Controller add \$75.

Includes Seagate Hard Disk, Western Digital Controller, Cables, Manual, Software, and Mounting Hardware.

Boots from Hard Disk 65 MS Access Time One Year Warranty

This Hard Disk System are compatible with the latest versions of the following Computers: IBM PC, IBM XT, AT, ATX, Compaq Deskpro, Tandy 1000, PC's Limited Turbo PC, Zenith 150, Zenith 151, Leading Edge PC (Book Models), Sperry PC, Wyse PC, Compaq Deskpro, Zenith 150, Zenith 151, Televideo PC, Corona PC, Eagle PC, ATX 6300, Tandy 1000 and Tandy 1200 are trademarks of their respective companies.

PLEASE SPECIFY YOUR COMPUTER TYPE WHEN ORDERING.



PC'S LIMITED™

SALES CALLS OUTSIDE TEXAS, 1-800-426-5150

SALES CALLS INSIDE TEXAS, 1-800-252-8336

1611 Headway Circle, Building 3, Austin, Texas 78754

Sales Calls from anywhere in the country, (512) 339-6962

Technical Support Calls, (512) 339-6963 Customer Service Calls, (512) 339-6964

Telex No 9103808386 PC LTD FAX (512) 339-6721

Panasonic, TEAC, Mitsubishi, Intel, IBM, Hercules, Plantronics, Xebec, Seagate, Western Digital, AT&T, Compaq, Tandy, Leading Edge, Sperry, Wyse, Televideo, Freedom, Corona, Eagle, ITT, and Zenith are registered trademarks of their respective companies. IBM PC, IBM XT, IBM AT, are trademarks of IBM Corporation. Leading Edge PC, Sperry PC, Wyse PC, Compaq Deskpro, Zenith 150, Zenith 151, Televideo PC, Corona PC, Eagle PC, ATX 6300, Tandy 1000 and Tandy 1200 are trademarks of their respective companies.

*Not applicable to IBM PC's. Limited warranty equipment is restricted to be compatible with PC's Ultra II expansion cards. Where equipment manuals issued by PC's Limited have not yet received a certification, PC's Limited will substitute equivalent certified equipment. All prices are subject to change without notice. We are an independent sales organization.



*Limited Warranty

Ad Number 407/86

HI, HONEY!



Honeywell synchronous
VIP emulation and file
transfer (FTF an option).
Compatible with Topview.
Honeywell VIP
asynchronous emulation
and file transfer.
Compatible with Topview.

ASYNCHRONOUS \$399
SYNCHRONOUS \$499

TO ORDER PHONE TOLL FREE
1-800-826-7839

TDT

GROUP INC.

Rivergate Plaza, 444 Brickell Ave
Suite 902, Miami Florida 33131
Telephone 305/372-9332, Telex 4947306

Connections IBM PC—Honeywell mainframe.

DPS 4, 6, 7, 8, LEVEL 6, 66, ETC.

A JAPANESE COMDEX AND MORE

BY WILLIAM M. RAIKE

Not many dramatic developments, but some interesting possible future trends—that's my summary of the recent COMDEX show in Japan. Elsewhere, Oki Electric Company showed off its new MS-DOS laptop computer with an unexpected "feature." And NEC has introduced the latest model in its PC-9801 series of personal computers and new versions of its PC-8801 8-bit machines.

COMDEX IN JAPAN

Yawn. The best thing that can be said about this year's COMDEX in Japan is that there were only about 20,000 attendees, or about half of last year's meager crowd. That meant that the noise stayed down to a dull roar. Few new products were introduced at the show; most manufacturers wait until the annual Microcomputer Show, held two months later, to introduce interesting new computer products.

TEC was showing its LB-1301 desktop laser printer—again. Each time I see this printer at a show, I want to buy one, and each time the date it's supposed to be available ends up being pushed back a few months. This time TEC promises that you'll be able to buy one by autumn of this year. The printer is compact, its print quality appears to be every bit as good as the Canon laser printer, and the price is estimated to be in the \$2000 to \$2500 range. Don't hold your breath, though. [Editor's note: All prices mentioned in this column refer to the exchange rate of 179 yen to the dollar that was in effect when this was written.]

It was interesting, however, to see a handful of IBM PC AT clones offered by Japanese manufacturers who say

Bill attends COMDEX in Japan and looks at new NECs and Oki's laptop

that they are interested in selling these machines in the domestic Japanese market. So far, major vendors have shown only lackluster interest in supporting AT-compatible machines for the domestic market, which is understandable in view of the difficulty of selling computers in Japan that don't speak Japanese. Among the companies coming out with AT-compatible computers are Ricoh and Micro Research. The Ricoh machine will probably be priced out of the market, but the Micro Research PC-ATLAS, running its 80286 processor at 8 MHz, should be priced somewhere close to \$3000. Micro Research was also showing a prototype of a small portable AT-compatible machine.

Another small company, Tomcat Computers, says it has developed a PC AT clone, but I wasn't able to see it at the show. However, in view of the inexpensive IBM PC, PC XT, and PC AT compatibles starting to come from Taiwan, I'm skeptical of the Japanese manufacturers' prospects for successful competition in an arena full of IBM compatibles. Nevertheless, it's possible that this could be the beginning of a move to push these machines for the first time within Japan.

A LAPTOP PORTABLE FROM OKI

Oki has never had much success with its personal computers, and I'm not sure why, except that its prices are a

bit high. The Oki if800/60 desktop computer, in particular, is an interesting machine; it uses an 8086-2 microprocessor running at 8 MHz, comes with 512K bytes of RAM (expandable to 1 megabyte), and is available in

both dual floppy disk and hard disk versions. And it has the highest-resolution graphics, as standard equipment, of any personal computer available here—720 by 512 dots.

But Oki is hoping to broaden its market with its new ifCOM7 laptop computer. I saw the ifCOM7 last month at the OA Fair, and it indicates to me, among other things, that Japanese personal computer manufacturers are finally taking telecommunications seriously.

The ifCOM7 is the first laptop portable made in Japan (not counting the Tandy laptops) that features a built-in modem. The initial models will be equipped with only a 300-bps modem (but will be able to communicate at 1200 bits per second in half-duplex mode), but a full-duplex 1200-bps modem is promised. All of this is a sign of the late-to-arrive, but fast-growing, popularity of bulletin boards and computer communication services in Japan. In addition to numerous privately operated bulletin boards, services like The Source, CompuServe, and MCI Mail have been available in Japan for some time,

(continued)

William M. Raika, who has a Ph.D. in applied mathematics from Northwestern University, went to Japan in 1980 looking for 64K-bit RAMs. He has been there ever since as a technical translator and a software developer. He can be contacted c/o BYTE, One Phoenix Mill Lane, Peterborough, NH 03458.

Subscription Problems?



We want to help!

If you have a problem with your BYTE subscription, write us with the details. We'll do our best to set it right. But we must have the name, address, and zip of the subscription (new and old address, if it's a change of address). If the problem involves a payment, be sure to include copies of the credit card statement, or front and back of cancelled checks. Include a "business hours" phone number if possible. We'll respond A.S.A.P.

BYTE

**Subscriber Service
P.O. Box 328
Hancock, NH 03449**



and the market is now getting set for an explosion of Japanese-language information services. In fact, there are more than 1000 subscribers to The Source in Japan—giving it the largest single number of subscribers outside North America.

The ifCOM7 uses an MSM80C86 (a CMOS version of the 8086) as its microprocessor; it runs at 5 MHz. Standard RAM is 256K bytes, but you can expand the memory up to 512K bytes. The ifCOM7 has an additional 32K bytes of RAM backed up by a special nickel-cadmium battery and a kanji ROM containing the 2965 characters in the JIS No. 1 character set. An expanded kanji ROM with the extra 3000-plus characters in the JIS No. 2 standard character set is optional. Built-in interfaces include one RS-232C interface and two parallel printer ports.

The 80-character by 25-line (640-by-200-dot) liquid crystal display isn't hinged but instead is installed in a fixed position above the keyboard, inclined slightly toward you. I thought the display was quite legible, despite its slightly greenish cast. I keep hearing rumors about backlit LCDs, but until I see one I'll rank the Oki's LCD, along with the one on my own laptop (a Fujitsu FM-16 π), as among the best. The keyboard, unfortunately, has a slightly nonstandard layout; the Control key is located at the top left of the keyboard along with other function keys. That "feature" could be a major nuisance.

Unlike most other laptop machines available in Japan until now (with the exception of the expensive Data General/One and the SOTEC portable made by Kohjinsha and sold in the U.S. as the Datavue 25), the new Oki computer has a built-in 3½-inch floppy disk drive, formatted to hold 720K bytes, and it runs under Japanese-language MS-DOS 2.11.

I tried out the ifCOM7 running a simple editor and a primitive terminal-emulation program. Disappointingly, although Oki promises that all kinds of word-processing, spreadsheet, electronic desktop, and other applications software will be available, I didn't see any of them working. Limited software availability has been one of Oki's

vulnerabilities in the past; the future of this portable will depend on the availability of enough software to make it useful. The price is certainly right; it lists for only about \$1425, and you get a wide choice of options at reasonable costs. In addition to additional memory and add-on disk drives, Oki plans to offer peripherals like bar code readers, magnetic-stripe card readers, hand-held optical character readers, and a touch panel.

NEC's PC-9801VM4

The upper end of the NEC personal computer line gained a new member recently—the PC-9801VM4. The V designation refers to NEC's V-series microprocessors, which are fully code-compatible with the Intel 8088 and 8086 processors but run considerably faster. The PC-9801VM4 uses a V-30 microprocessor that NEC refers to as the μ PD70116; you can switch-select either an 8-MHz or a 10-MHz clock rate. The only drawback of the 10-MHz rate is that memory boards for previous PC-9801 models won't run that fast, and the newer and faster boards are somewhat more expensive.

Another feature of this microprocessor is that it provides on-chip emulation of the 8-bit 8080 microprocessor, which opens up the possibility of retaining access to older CP/M-80 software. The EM/3+ operating system extension I wrote about in the May column provides the necessary software support to accomplish this; the 8-bit emulation is done in software on my Fujitsu computer, but the new NEC machines do it in hardware about six times as fast.

The letter M in the model name refers to its 1-megabyte floppy disk drives (actually 1.2-megabyte drives). The PC-9801VM4 has two built-in floppy disk drives (the same as the VM2 model) and can also read and write disks recorded in the 640K-byte format used by the earlier PC-9801 models bearing an F letter designation.

But the major feature of the VM4 is its built-in 3½-inch 20-megabyte hard disk drive. Although hard disk units in Japan are still much more ex-

(continued)

Too much technical reading can affect your vision.



Nothing gives you a more focused view of your industry than the magazine you're holding right now.

But if you really intend to get ahead, you need a broader perspective as well. The kind provided by The Wall Street Journal.

In addition to thousands of technically oriented articles each

year, The Journal offers you a daily briefing of news, information and ideas that can help you make sounder, better-informed decisions.

To try The Journal for a week at no charge, mail the coupon or call the number at right. Of course, you're also welcome to start a subscription.

If you can see your way clear.

Get one week free.

To receive a full business week of The Wall Street Journal free and at no obligation, call 800-551-5700, ext. 71E. Or mail coupon to: The Wall Street Journal, Attn: Mr. Robert Merkel, 200 Burnett Road, Chicopee, MA 01021.

Name _____

Address _____

City _____ State _____ Zip _____

Offer limited to one free week per new customer; expires 9/31/86.

03AX

The Wall Street Journal.

The daily diary of the American dream.

DO YOU KNOW WHERE YOUR PROGRAM HAS BEEN?

If you know where your program is spending its time, you can improve its performance.

The Watcher makes it easy.

The Watcher collects data from one or more runs of your program. You can then instruct it to display as a histogram the percentage of time spent in different parts of your program and in DOS functions.

The Watcher uses symbolic information from the link map, including line numbers, or information you provide to relate the data to your source program.

THE WATCHER KNOWS!



\$39⁹⁵

Stony Brook
INC.
SOFTWARE

Forest Road, P.O. Box 107
Wilton, New Hampshire 03086
MC or Visa orders: (603) 654-2525

For any COM or EXE on PC, XT, AT or compatibles DOS 2.X or 3.X. Not for use with Basic or other interpreters.



Best Western has a FREE \$50 Bond for you!

All you have to do is go to any Best Western and ask for a Star Night Bond Kit. Then, whenever you travel, make your reservations at Best Westerns, using their Star system. When you have proof of these twelve Star Night stays, send in the kit and Best Western will have a \$50 bond issued to you or someone you love.



Look for the display at any Best Western. Pick up your Star Night Bond Kit and get started now on your \$50 U.S. Savings Bond.

*You and Best Western...
a very special Bond!*

Each Best Western is independently Owned & Operated.

pensive than in the U.S., prices are starting to come down. More and more high-end personal computers are being sold with built-in hard disks, especially for business applications, in conjunction with database management software. Japanese-language database programs are proliferating rapidly, and sales of personal computers that can take advantage of them are certain to climb.

The PC-9801VM4 comes with 384K bytes of main memory in addition to 192K bytes of graphics video RAM; 640- by 400-dot color graphics is standard. NEC puts its version of BASIC into an additional 96K bytes of ROM. You can expand the main RAM only up to 640K bytes (unlike the Fujitsu computers that can hold up to a megabyte of RAM), but third-party vendors offer expansion boards that provide still more memory for RAM disk applications. A mouse interface is standard along with an RS-232C serial interface.

You get extensive Japanese-language support with the PC-9801VM4. It's supplied with both the JIS No. 1 and No. 2 standard kanji character sets, for a total of over 6000 characters, in addition to the ASCII character set and the Japanese katakana phonetic alphabet. The Japanese-language capability gets software support at the operating system level, too; Japanese-language MS-DOS (versions 2.11 and 3.1) is available, as is Japanese-language CP/M-86, which enjoys a wide, if slowly diminishing, popularity in Japan. You can also buy a (very expensive) version of UNIX, called PC-UX. And NEC makes a big point of offering Concurrent CP/M-86, although in my opinion that operating system doesn't have much more of a future here in Japan than it did in the U.S.

The PC-9801VM4 offers absolutely nothing in the way of compatibility with U.S. computers like the IBM PC family, but its power is certainly in the same league as the PC AT, despite the fact that its microprocessor is less complex than the 80286 that's used in the PC AT and clones. Much more important, as far as the Japanese market is concerned, is the fact that

(continued)

Put **RUN/CPM™** in your PC today and run 50,000 programs that you couldn't run yesterday!

Here is what the reviewers are saying about "RUN/CPM."

RUN/CPM V-20/30 CP/M Emulator

RUN/CPM is a revolutionary new product which combines software and hardware to allow your PC to run 1,000's of programs written for the CP/M80 operating system. For years, popular 8 bit computers such as "Kaypro", "Osborne", and "Morrow" have relied on this vast library of high quality, inexpensive software, which can now be accessed by your PC. A simple replacement of your PC's 8088 or 8086 microprocessor with a dual 8/16 bit M.E.C. V-20 or V-30 microprocessor creates a system capable of running both CP/M80, and MS-DOS/PC-DOS software. In addition to adding 8 bit CP/M compatibility, your PC's overall performance will improve by up to 30% as a result of the speedup characteristics of the V-20 and V-30 microprocessors. Running CP/M software directly from CP/M disks is easy thanks to RUN/CPM's disk emulation feature, which will allow your PC's floppy drives to directly READ, WRITE, and FORMAT the most popular CP/M disks. You will also be able to run CP/M programs 2 to 3 times faster, in full color, from a hard disk or RAM disk, and actually run MS-DOS background programs such as Borland's "Sidekick" on top of CP/M programs! Add pop-up windows, terminal emulation, and help screens and it is easy to see why RUN/CPM is fast becoming the de facto standard in CP/M emulation software.

READ/CPM CP/M Disk Emulation

READ/CPM adds CP/M disk compatibility to your PC, XT, or AT. Now your PC's floppy drives can directly access data disks from approx. 100 of the most popular CP/M formats using DOS commands "COPY", "TYPE", "DIR" etc. This product does not require any additional hardware.

RUN/CPM™
ONLY \$99.95*

READ/CPM™
ONLY \$49.95

OSBORNE, TR...
MORROW, CRO...
OSBORNE, TR...
HEATH, CRO...
OSBORNE, TR...
HEATH, CRO...
OSBORNE, TR...
HEATH, CRO...
OSBORNE, TR...
HEATH, CRO...
OSBORNE, TR...
HEATH, CRO...

"It's an excellent program backed by a knowledgeable company."

ROBERT ATHEY
Micro Times

"... the most powerful of all the emulators reviewed."

TED DRUDE
Computer Shopper

Run CP/M Z80 for the incredible price of \$199.95

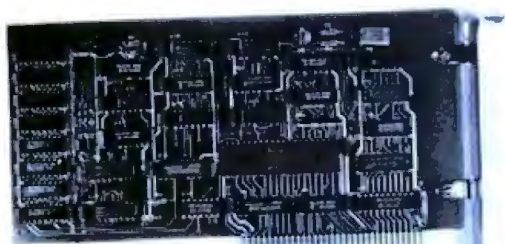

The RUN/CPM Z-80 co-processor gives you all of the incredible features of RUN/CPM, plus the advantage of the full Z-80 instruction set at a price you can afford. Never before has it been easier to add Z-80 compatibility to your PC, XT, or AT. The RUN/CPM Z80 co-processor board comes complete with 64K of memory, a 5Mhz clock, and of course the incredible RUN/CPM emulation software. Plug this half size card into one of your PC's slots and within minutes you will be running the most powerful CP/M software available, including the most popular assemblers, compilers, debuggers, and wide variety of application programs such as word processors and spreadsheets. Our ISIS-II emulation option will even allow you to run "Intel" development languages on your PC, or AT. If you want to step up to the ultimate in high speed Z80 processing, then check out our RUN/CPM Z80-H full size co-processor available for only \$499.95. Running in excess of 9mhz with 128 K memory on board, this co-processor virtually blows away the competition! Both the RUN/CPM Z80 & Z80-H co-processors come with the RUN/CPM emulator software and are backed by our 30 day money back guarantee.

Micro Interfaces Corporation
6824 N.W. 169th Street, Miami, Florida 33015
(305) 823-8088
Telex 5106004680 MICRO INTER CO
Ask About Our Intel Operating System Interfaces
OEM, VAR, Dealers, Inquiries Invited

I WANT TO ORDER!

To order by phone, or for a dealer nearest you, CALL (800) 637-7226
Technical Info call (305) 823-8088

Copies	Product	Price	Total
—	RUN/CPM requires V-20/30	\$ 99.95	—
—	RUN/CPM Z80 (Board 5mhz)	\$199.95	—
—	RUN/CPM Z80H (Board 9mhz)	\$499.95	—
—	READ/CPM	\$ 49.95	—
—	V-20 8mhz - Replaces 8088 up to 8 Mhz	\$ 24.95	—
—	V-20 5mhz - Replaces 8088 up to 5 Mhz	\$ 14.95	—
—	V-30 8mhz - Replaces 8088 up to 8 Mhz	\$ 29.95	—
—	V-30 10mhz - Replaces 8088 up to 10 Mhz (NEW)	\$ 49.95	—
—	MICRUN80 5 MHz Z80 Board	\$595.00	—
—	MICRUN80 9 MHz Z80 Board	\$995.00	—
—	MICRUN86 (UDI)	\$450.00	—

Add \$5.00 shipping charge per order except for V-20/30 chips which include shipping International orders add \$19.00

Payment - VISA MC AMEX ORDER C D D Add \$3.00
Credit Card Expiration / /
Card # [] [] [] [] [] [] [] [] [] [] [] [] [] [] [] []
Name _____
Address _____
City _____ State _____
Zip _____ Tel _____

30 DAY MONEY BACK GUARANTEE ON ALL PRODUCTS. SOFTWARE IS NOT COPY PROTECTED.

RUN INTEL SOFTWARE ON IBM PC'S

Transform an IBM PC, XT, AT, or compatible into a totally integrated Intel Micro Development System, capable of running all 8 bit ISIS-II, and 16 bit ISIS-III (UDI) software while remaining 100% MS-DOS compatible. MICRUN 80 and MICRUN 86 are Universal Development Interfaces which will allow you to increase your development capabilities with faster, more reliable and affordable PC based work stations. The MICRUN80 (UDI) utilizes the N.E.C. V-20/30 8/16 bit microprocessor to execute 8 bit Intel software on a PC, or XT, 2 to 3 times faster than an Intel MDS! For ultra fast execution speed, our Z80 co-processor version of MICRUN 80 runs in excess of 9 Mhz and is PC "AT" compatible. The MICRUN86 (UDI) is the perfect solution for running 16 bit ISIS-III software on PC's or XT's, and AT's and does not require any additional hardware. Both MICRUN80, and MICRUN86 come complete with a full featured communication program for transferring Intel software to your PC. Micro Interfaces Corporation has brought the power of Intel development to the PC, and in doing so provided you with an affordable alternative to the high cost of Intel development. To order, or obtain more information call the toll free number listed above or refer to the order coupon.

* Requires V-20 or V-30 microprocessor

RUN/CPM is a registered trademark of Micro Interfaces Corporation; Sidekick is a registered trademark of Borland International; Kaypro is a registered trademark of the Kaypro Corporation; Intel is a registered trademark of the Intel Corporation; CP/M is a registered trademark of Digital Research.

I wish NEC would simply use a new number for its next model instead of adding suffixes.

it's fully compatible with earlier models in the PC-9801 series. This philosophy has put NEC in the driver's seat as far as personal computers in Japan are concerned, and it is likely to stay there.

The list price for the PC-9801VM4 is 830,000 yen, or about \$4635 at current exchange rates.

8-BIT NECS

For the past few years, NEC has managed to maintain its position as a leader in personal computers for the Japanese market. In the U.S., manufacturers of personal computers introduce new models relatively infrequently, but here in Japan new models appear every few months. NEC continues to offer upgraded models of its 8-bit personal computer, the PC-8801, while the American 8-bit computer market is essentially moribund.

NEC's latest computers in its 8-bit PC-8801 family are 1-megabyte floppy disk versions of the PC-8801 MkII MR and FR series. These aren't new computers in any sense, but they represent further refinement of the original machine, which traces its ancestry all the way back to NEC's PC-8001 machine that appeared over five years ago. Based on NEC's μ PD780C-1 microprocessor, which is software-compatible with the Z80, and running at the usual 4 MHz, you can now buy one with up to 192K bytes of main memory. Their graphics performance is more than respectable—640- by 400-dot resolution for color graphics, using a palette of 8 out of a possible 512 colors. Most owners run only NEC's N88-BASIC, but the machines can run the CP/M 2.2 operating system, too.

The half-height, 1-megabyte floppy disk drives in the latest models are considerably faster than the sluggish 320K-byte drives NEC had used for so long in earlier models. Combine that speed with an additional μ PD780C-1 subprocessor and 8K bytes of dedicated RAM for handling disk I/O tasks, and these computers should be able to overcome one of the major drawbacks of this otherwise very useful computer. BYTE Japan readers may recall that, before buying my first in a series of Fujitsu 16-bit computers,

I owned an original model of the PC-8801 (see BYTE Japan, November 1984). Apart from the slow disk access, my only other complaint about that computer was the slow speed for updating the screen, which I suspect was partly due to the demands imposed by the PC-8801's powerful Japanese-language display capabilities. My Fujitsu, even though it's a 16-bit computer, uses a separate microprocessor as a coprocessor to relieve the main processor of the burden of handling the keyboard and the display.

It's hard to imagine a comparable market niche for an 8-bit computer in the U.S. these days, but these computers continue to sell well here in Japan, one step above the much cheaper MSX machines that most buyers still use as no more than video-game devices. And they're not cheap; there are various configurations available, but the list price of the PC-8801 MkII MR, without a display, is about \$1325.

I wish NEC would simply use a new number for its next model, though, instead of adding suffixes. At this rate, I nearly run out of breath before I can say the name of the computer.

NEXT MONTH

I'll look at Fujitsu's new 80286-based computers. And a different compatibility problem keeps coming up. ■

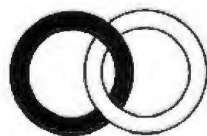

**FULL LINE
ADD ON CARD
FOR IBM**

We are the reliable manufacturer of ADD-ON card and peripheral:

All our products are superior than our competitors in multi-wise and function-wise.



Good quality, Reasonable price.

* WHOLESALE, DEALER, RETAIL, STORE AND OEM ENQUIRES WELCOME *

NIC TECHNOLOGY INC.

ADDRESS: 3020, SCOTT BLVD, SANTA CLARA, CA 95054, U.S.A.

TELEX: 1561096 PECO UT TEL: (408) 980-9511 (2 LINES) AITN STANLEY FAX: (408) 980-1530

The products:

1. ADD-ON card
 - a. Video card
 - b. I/O card
 - c. Memroy expansion card
 - d. Hard disk controller card
2. Peripheral:
 - Monitor, Keyboard, Driver, Modem, Cable, Power supply, P/C case.

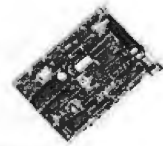

■ "STOCKS AVAILABLE"

• IBM is a registered trade mark of International business machines corp.

PC TECHNICIAN

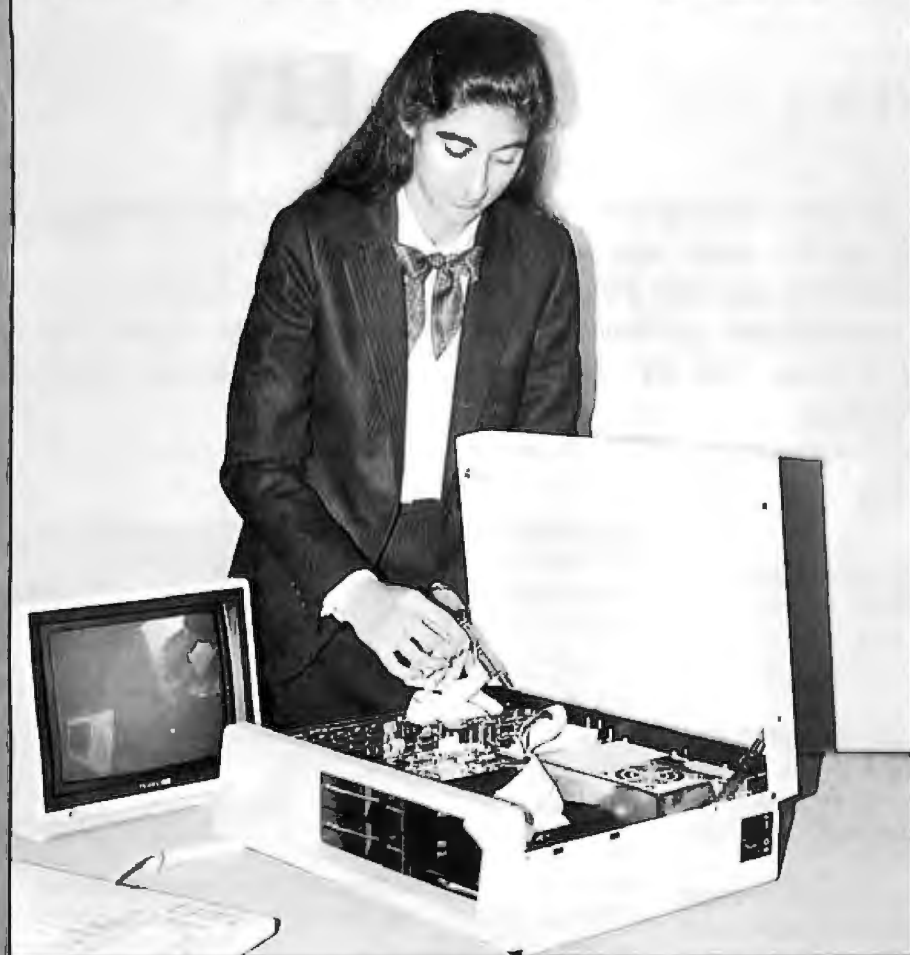

A NEW DIMENSION IN COMPUTER EDUCATION

'PC Technician provides an in-depth overview of the installation of computer components. We use it to train all our technicians and assemblers.'

John Atma, Chief Technician
for Tech Personal Computers

'After viewing PC Technician, I now understand the basics of how my computer works and was even able to replace the 1.2M drive on my AT at work. PC Technician was definitely worth the money.'

Brenda Hudson, Data entry and processor
for Sark Enterprises

'PC Technician is great. With the help of PC Technician, I was able to install a 10MB hard disk on my XT without taking it to an expensive service center.'

Gita Beant, Economics major
at UC Irvine

PC Technician is an innovative set of two 2-hour instructional video tapes which form a complete guide to the IBM® and compatible personal computer systems. Designed for everyone, from the complete novice to the software expert. PC Technician provides the viewer invaluable first hand instruction in the installation and maintenance for IBM® and compatible systems.

Part I of PC Technician is a complete and comprehensive presentation of prominent features of the PC family including:

- Motherboard architecture
- Memory Configuration and Addressing
- Monitor Technology
- Floppy and Fixed Disk Technology
- Bus Architecture
- Serial and Parallel Ports
- Local Area Networking

Part II of PC Technician shows the details involved in actually installing, configuring, troubleshooting and replacing:

- Motherboards
- Power Supplies
- Floppy and Fixed Disks
- Drive Controllers
- Popular Expansion Boards

PC Technician provides instruction not found in books or magazines. It is an essential tool for anyone interested in understanding their PC. You can't afford not to have PC Technician.

Other products available from PC Star Productions:

- PC Consultant Series
- Lotus 1-2-3
- Symphony
- Microsoft Word
- Word Perfect

PC Programers Series:

- Assembly
- Basic
- Pascal
- 'C'
- Prolog



SPECIAL INTRODUCTORY OFFER
\$89.95



ORDER NOW

NAME _____

ADDRESS _____

CITY _____ STATE _____ ZIP _____

PLEASE RUSH _____ COPIES OF
PC TECHNICIAN IN

VHS BETA FORMAT

VISA MASTERCARD

CHECK/MONEY ORDER ENCLOSED

C.O.D.

**OUTSIDE CALIFORNIA IN
CONTINENTAL U.S. - PUERTO RICO,
HAWAII EXCLUDING ALASKA:**

1-800-438-8877

CALIFORNIA RESIDENTS CALL:

(714) 771-3560

**PC STAR PRODUCTIONS
1040 EAST CHAPMAN AVE.
ORANGE, CA 92666**

BYTE Invites You to Join **BIX**

BYTE is the world's leading high-tech microcomputer magazine. Its readers collectively possess more information about personal computers and related topics than any other group in the world. BIX is BYTE's brand-new electronic information exchange, a computer conferencing system that puts you in touch with BYTE readers and other computer enthusiasts on a daily basis.

YOU AND BIX

BIX goes far beyond electronic bulletin boards to give you all the advanced features of true computer conferencing. It's the first major system dedicated to microcomputer information. Check these features:

- You can join ongoing discussions about your favorite computers, programming languages, operating systems, and applications programs, exchange information, ask questions, and offer opinions.
- You can read what others have already entered, add your own thoughts, and download information.
- You can participate when it's convenient for you, from home or office or while you're traveling.
- You also get electronic mail with BIX, putting you in direct, private contact with BYTE editors and BIX users everywhere.

CUSTOMIZE BIX TO MEET YOUR NEEDS

As a BIX user, you select only the conferences and topics that are of real interest to you. You may join a new conference or leave an old one anytime you want. Each time you log on to BIX, you're immediately notified of any electronic mail messages waiting for you, and you see which of the conferences you've joined have had new activity since the last time you logged on. BIX keeps track of your interests.

With BIX, you're an active participant in a giant microcomputer information exchange.

WHAT BIX COSTS...HOW YOU PAY

ONE-TIME REGISTRATION FEE:	
BYTE Subscriber	\$25
Nonsubscriber	\$39

BIX HOURLY USAGE FEES (All times are local):
Off Peak (6 p.m.-7 a.m. plus weekends and holidays)\$9
Peak (7 a.m.-6 p.m. weekdays).....\$12

TELECOMMUNICATIONS CHARGES:

BIX is available via Tymnet from anywhere in the United States.

TYMNET (Continental U.S.):

Off Peak\$2/hr. Peak\$6/hr.

PAYMENT:

BIX and Tymnet charges are billed through either VISA or MasterCard. No cash, checks, or money orders.

START USING BIX NOW!

With our easy on-line registration, you can start using BIX in the next few minutes. No lengthy waiting for your registration to be processed by mail. (Step-by-step instructions on how to log on to BIX follow. Reading this material before you log on will speed you through the registration process.)

LOG-ON INSTRUCTIONS AND REGISTRATION INFORMATION

BEFORE YOU CALL BIX:

Having your credit card handy (VISA/MasterCard) before you log on will speed you through BIX registration. *You will not be billed for the time you spend on line registering for BIX. If at any time during the on-line process you decide not to register for BIX, just hang up.*

HOW TO LOG ON TO BIX:

Step 1: Set your computer's telecommunications program for full duplex using 8-bit words, no parity.

and 1 stop bit, or 7-bit words, even parity, and 1 stop bit. You may call at either 300 or 1200 baud.

Step 2: To reach BIX via Tymnet.*

- * BIX is accessible from anywhere in the country through local Tymnet numbers. If you don't know the Tymnet numbers for your area, contact the BIX Customer Service Line (see below). At other times, numbers can be obtained by calling Tymnet at 800-336-0149.
- Call your local Tymnet number and log on.
- Depending on your baud rate, Tymnet will respond with "garble" or request a terminal identifier. Enter the letter "a". (Ignore quotation marks in this and succeeding entries.)
- Tymnet will ask you to log on. Enter "bytenet" and a carriage return (CR).
- Tymnet will ask you for a password. Enter "mgh" and (CR). You will then be at the door to the BIX computer.

Step 3: (If there is no prompt requesting a login at this point, hit a (CR) which should produce it.) When you see a phrase ending in "login:;", enter "bix". (Echoing of this response is normal.)

You should now see the BIX logo scroll onto the screen and a prompt asking you to enter your name. Since this will be your first time on the system, enter "new" and a carriage return. This will

take you to a special section where you enter the information we need to register you as a BIX user. Follow the on-line prompts and supply the information requested. BIX lets you re-enter data if you make a mistake.

When you've completed your registration, BIX will automatically take you to a special "Learn" conference where you'll get a quick tutorial on how to use the system. (Typing "help" or "?" at any prompt while you are on BIX will give you an immediate review of available commands.)

ACCESSING BIX FROM FOREIGN COUNTRIES

To reach BIX from other countries, you need an account with your local Postal Telephone & Telegraph (PTT) company. From your PTT, enter 310600157878. Then follow instructions starting at Step 3. A list of PTT addresses and contacts for most foreign countries is available by calling or writing BIX.

CUSTOMER SERVICE

If you follow these instructions but still are unable to log on to BIX, call the BIX Customer Service Line for assistance at 800-227-2983, 8:30 a.m.-11 p.m. eastern time weekdays. In New Hampshire and outside the U.S., call (603) 924-7681.



We'll Send You a BIX User's Manual and Subscriber Agreement As Soon As We've Processed Your Registration

**BYTE INFORMATION EXCHANGE
ONE PHOENIX MILL LANE
PETERBOROUGH, NH 03458
(603) 924-9281**

OUR PLUG-IN CARD GIVES YOU PLUG-IN CONTROL.

PC \leftrightarrow 488 allows your IBM PC/XT/AT or compatible to control IEEE-488 instruments.

WHAT ADDITIONAL SOFTWARE DO I HAVE TO BUY?

None. **PC \leftrightarrow 488** supports all popular programming languages including interpreted and compiled BASIC, TBASIC™, Microsoft® Pascal, Turbo™ Pascal, C, and FORTRAN. You can use Tektronix® Standard Codes and Formats and emulate HP controller statements. **PC \leftrightarrow 488** also runs IBM® IEEE-488 software as well as application programs.

IS IT DIFFICULT TO USE?

You just plug it in. **PC \leftrightarrow 488** is totally self-contained with all software packaged in read only memory. Documentation includes a complete tutorial and programming reference, plus more than thirty application programs.

WILL IT WORK WITH ALL MY INSTRUMENTS?

You bet! More than 500 companies, including every major instrument manufacturer in the U.S. and Europe, are currently using **PC \leftrightarrow 488**.

WHAT'S THE BOTTOM LINE?

That's the best part. **PC \leftrightarrow 488** costs just \$395 including software support for all popular programming languages, extensive applications library, and the programming and reference manual. Order today by calling (617) 273-1818 or Telex 247316.



cec

Capital Equipment Corporation
10 Evergreen Ave., Burlington, MA 01803.
(617) 273-1818, Telex 247316.

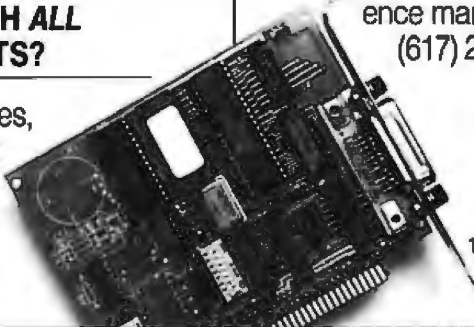



CHEAP STUFF

BY EZRA SHAPIRO

None of the products in this month's selection costs over \$100, so every one of them fits into a category I'm beginning to call "disposable software." That is, you can buy any of these programs on a whim, without having to swear to your spouse that it's your last computer purchase, ever.

I used to have real problems with inexpensive software; I never felt very good about applying a double standard, but I'd overlook a program's flaws if it did interesting things for cheap. These days, I'm quite a bit harsher. The producers of low-cost items have learned to tout their products with just as much hype as the large companies who hire advertising agencies. Once upon a time, I felt that by buying this stuff I was helping poor starving programmers with good ideas and no money. Today, as I pick my way through the outrageous claims and overblown adjectives, I have no such delusions—everyone wants to be a millionaire, and quickly, too. Every so often, I'll stumble across a nifty product from an honest shop, and I'll bend over backward to be nice—but that's not happening frequently.

TOP HONORS

This month's column would have been a sorry list of losers were it not for *It Figures* (SimplSoft, \$39.95), a program that makes such perfect, logical sense that I'm surprised no one thought of it before. It's nothing fancy, and that's why it's so good.

The idea is blindingly simple. *It Figures* is a three-column, 20-row mini-spreadsheet. Period. The first column holds formulas, the second shows the results of calculations, and the third is for comments. You enter your data on a command line at the

Low-cost software:

It Figures, Dac-Easy Word, AI:Typist, and Datatext

bottom of the screen, the program puts them up on the worksheet and computes your results, and you get your answer. Bingo.

It's designed for people who don't need all the complexity of a big spreadsheet, but that doesn't mean the program isn't powerful. You've got the full range of numerical, statistical, and trigonometric functions; named variables and line referencing; global variables loaded from a standing file; and worksheet chaining if you need more than 20 lines for your computation. You can't do any "either...or" branching, but that's not what this program is for.

Anyone who has ever sweated over trying to set up a template for a trivial problem on a big spreadsheet will appreciate the convenience of *It Figures*. To make life even easier, the program comes with 45 templates, including linear regression, Ohm's law, ACRS depreciation, return on investment, Rule of 78, auto MPG and cost, IRS 1040, the Pythagorean theorem, and 37 others.

It Figures is rock solid, clearly documented, and a snap to use. Rush out and buy this one.

LOSS LEADER

What to say about *Dac-Easy Word* (Dac Software, \$49.95)? It's inexpensive, that's for sure, and it has a lot of features that make it sound like the greatest thing since...whatever. Reeling off the list, I'll give you the good things: automatic hyphenation, four editing windows, database-like mail

merge, saving of special layouts as format files, a thorough list of supported printers, and all the usual word-processing operations.

I suppose if it were the only word processor available, or if I were incredibly stingy, I could learn to live with it. However, I find myself loathe to give it a recommendation; there are a number of *little* things that irk me.

First, the documentation is poorly organized and poorly written, and it is typeset in boldface, which is amazingly difficult to read.

Second, although the program accepts MS-DOS directory paths, it's obviously designed for a floppy-based system. It defaults to the root directory, not the current directory, every time it's loaded, which means that if you want to use it in a subdirectory on a hard disk, you have to reset the path every time you bring it up. You also can't avoid the default format; you have to enter the changes manually or load a format file.

Third, every file operation (directory, load from disk, save, rename, etc.) starts with a read of the current directory, which can take some time, particularly on a hard disk. This gets to be a real pain when you're dealing with windows. As multiple windows into the same file are not updated automatically, changes made in one window are not reflected in the second unless you save and reload the file. If you're viewing different files, you've got the same problem—you're going to be looking at those directory screens more than you'd like.

Fourth, many of the program's basic operations are controlled by second-

(continued)

Ezra Shapiro is BYTE's West Coast Bureau Chief. Contact him at BYTE/McGraw-Hill, 425 Battery St., San Francisco, CA 94111.

PORTABLE DISK DRIVE



Your Tandy 100 or NEC 8201 becomes a complete computer with our battery powered disk drive. Comes with POWR-DISK software from Acroatix. Holds 100k per 3.5" disk. Allows saving and loading directly from TEXT to disk-load and save with BASIC commands, and more.

TANDY 100, - \$179
NEC 8201, - \$199

PORTABLE PRINTER



\$149

The On-The-Go printer is less than 3 pounds (with batteries), yet its quiet thermal mechanism can run at 40 cps for two hours on battery power! Get shadow printing, underlining and four character types including condensed (160 characters per line—perfect for spreadsheets). Parallel interface lets it plug into everything from Apples to Zeniths.

LAPTOP MEMORY

24K for Tandy 200 \$75
8k Tandy 100, NEC 8201 \$29/3, \$75
96K for Tandy 600 \$249/2, \$449

30-Day Money Back Guarantee

Visa & Mastercard Accepted
include 4% for UPS shipping and insurance.
California residents add 6% sales tax.
...DEALER & OEM INQUIRIES INVITED...

California (805) 482-9699
Toll Free (800) LAP-TOPP



Laptop Systems - 515 Calle San Pablo
Dept. 4, Camarillo, CA 93010

dary menus generated from the function keys. Every time you complete a task, you remain stuck in the secondary menu; you have to press F10 to exit back to editing.

Fifth, there's this delete/insert business—the only way to delete single characters is with the Backspace key; the Del key triggers a delete mode in which you can erase longer chunks (words, sentences, paragraphs). It's three keystrokes to delete from the cursor to the end of a word—Del, F4, Del. Likewise, the Ins key toggles an

insert mode. If you move the cursor into a block of text and begin typing, you overwrite what's there. To insert, you have to press the Ins key, which breaks the line at the cursor. Enter your text, tap Ins again, and your paragraph is closed up and reformatted.

Finally, my copy of Dac-Easy Word didn't seem to like large files. I tried to load a 32K-byte pure ASCII file and then save it without changing anything. After countless carriage returns to get past "memory filled" error messages, I got the thing saved—with 2K missing. Not at the end, mind you—the program had eaten lines out of the text, every 10 to 12 lines or so, in no discernible pattern. "Okay," I muttered. "This program doesn't like alien files. Let's try to create a long file within the program itself and see what happens." I built a 640-byte block of text and began duplicating it with cut-and-paste. Well, the program began swapping to disk after about 5K. After zillions of error messages, I finally tried to save what should have been, by my calculation, a 32K file. Only got 14K of it.

Confused, I called Dac's customer-support department. For pure ASCII files, Dac plans to ship a conversion utility shortly, which should (the company claims) solve *that* problem. As for the Dac-generated big file, well, the woman to whom I spoke was as baffled as I was. With 640K bytes of RAM, she told me, I should be able to handle documents as large as 500 pages. Since there had been some revisions since my copy had been shipped, she suggested I send in my disk for a free upgrade. That's nice; Dac earns a bunch of points from me for friendly phone help.

Okay. Assuming the conversion utility is shipped and the big-file problem is fixed, what have you got? An adequate word processor with some annoying quirks that costs 50 bucks. I don't much care for it, but for 50 bucks the product is probably fine for an occasional memo or letter or short report. The menus make Dac-Easy Word moderately simple to learn, and if you're not going to use a word processor regularly, they'll protect you from silly mistakes.

ITEMS DISCUSSED

IT FIGURES \$39.95
(MS-DOS)
SimplSoft Products Inc.
5330 Sterling Dr., Suite C
Boulder, CO 80301
(303) 444-8772

DAC-EASY WORD \$49.95
(MS-DOS)
Dac Software Inc.
4801 Spring Valley Rd.
Building 110-B
Dallas, TX 75244
(214) 458-0038

PC-WRITE \$75
(MS-DOS)
Quicksoft
219 First North #224
Seattle, WA 98109
(206) 282-0452

AI:TYPIST \$99.95
(MS-DOS)
Airus
11830 Southwest Kerr Parkway
Lake Oswego, OR 97034
(503) 246-1782

DATATEXT \$95
(MS-DOS, CP/M-86, CP/M-80)
Datatek Inc.
909 State Road 584 West
PO. Box 850
Oldsmar, FL 33557
(813) 855-4408

On the other hand, if you're a heavy user, the little irritations will drive you crazy and cost time and frustration. If you're going to need a word processor for more than a couple of hours a week, check out PC-Write (Quicksoft, \$75), which only costs \$25 more and has *lots* more power (although it's tough to learn, and the documentation is so chunky you could eat it with a fork). It's not perfect either, but at least it's nicely configurable. I promise a thorough look at version 2.6 of PC-Write next month.

GIMME A BREAK

AI:Typist (Airus, \$99.95) is a simple word processor designed for first-time users, and boy, is it simple. Do first-time users really need all those complicated features other software firms throw into their products just to make their customers feel inferior? After all, first-time users might burst into tears when confronted with such technically complex concepts as mail merge, multiple windows, headers, footers, and page numbers, so AI:Typist just leaves them out. Therefore, the program is a stunted skeleton of a word processor, suitable for one-page memos and shopping lists, but not much else.

The product's only innovation is an as-you-type real-time spelling checker that operates character by character, supposedly designed using advanced artificial intelligence programming techniques. When you've typed far enough into a word for AI:Typist to figure out that it's not in the dictionary, the program beeps at you

and highlights the rest of the word. Unlike older, less-sophisticated spelling checkers, this one is incapable of suggesting other spellings. It just sits there and beeps as you go rummaging around for your Funk & Wagnalls.

The press handouts for the product state that it was developed as a demonstration of a brilliant new AI technology (which Airus is trying to license to other companies). There probably is a pretty impressive engine under there somewhere; if I were an AI expert, I might even be drooling. However, my job here is to evaluate applications software. As a word processor, not an AI demo disk, AI:Typist is inoffensive, but so limited as to be nearly worthless.

CURIOUSER AND CURIOUSER

For me, the beauty of modern micro-computing is that I *don't* have to develop arcane skills with cryptic commands in order to achieve mastery over the machine. Face it, does anyone really *like* using UNIX editors and formatters to manipulate text on a serial terminal? Come on now, wouldn't you rather slide over here to this nice copy of WordPerfect or XyWrite and just type away contentedly? Sure you would.

But, to prove that every rule has its exception, Datatext (Datatek, \$95) takes you back, back, back in time to the days when men were men, computers were computers, dinosaurs roamed the earth, and text had to be beaten over the head with a sledgehammer to make it come out right.

What we have here is a two-part

word processor (editor and text formatter) written mostly in 1981. The editor itself is horribly archaic; every time you want to do something, you have to change into the appropriate mode. The formatter makes the dot commands of WordStar, Peachtext, and ROFF look positively wimpy. What's more, you get a manual that rivals a metropolitan phone book in size, shape, weight, and readability, and complete source code in Pascal/M.

Before you programmers out there leap at the opportunity to get your hands on the source, let me point out that the program was written for CP/M-86 (yeah, right); in order to run it on an MS-DOS machine you need a CP/M-86 emulator. Datatext throws one in, and gives you the assembly language code for one, but do you really want to spend your time figuring out your way around this labyrinth?

This is an outdated product written in a dying language for a nearly dead operating system. It didn't make it the first time around as a commercial product; now it's gussied up and re-marketed as a programmer's toolbox. More like a programmer's nightmare, when you consider the editing needed to turn the code into anything useful.

I can't deal with this. I don't dislike Datatext; I just break into a cold sweat every time I think about it.

If this sort of masochism appeals to you, go for it, but please don't call me to tell me about it. I don't want to know. ■



PC/AT/XT, TURBO, ADD ON CARDS.

....IS YOUR RIGHT CHOICE

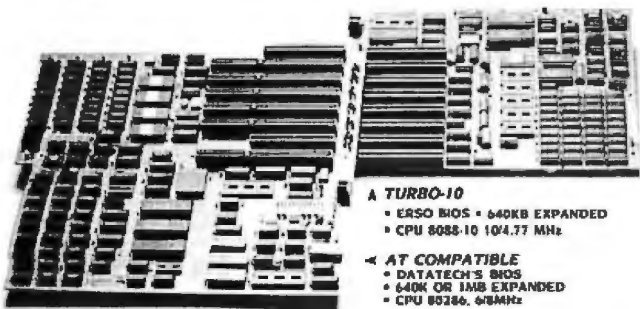

- A TURBO-10**
 - ERSO BIOS • 640KB EXPANDED
 - CPU 8088-10 10/4.77 MHz
- AT COMPATIBLE**
 - DATATECH'S BIOS
 - 640K OR 1MB EXPANDED
 - CPU 80286, 6/8MHz

TURBO-640

- ERSO BIOS • 640KB EXPANDED • CPU 8088-2, 8/4.77 MHz
- OPTIONAL 70108-8 CPU, 3 TIMES FASTER

PC/XT COMPATIBLE

- EROS BIOS • CPU 8088 • OPTIONAL CPU 70108-5, 1.7 TIMES FASTER

ADD-ON CARD

FOR AT:

- DISK DRIVE CONTROLLER, SUPPORTS 2x1.2 MEGA FLOPPY DISK DRIVE.
- I/O CARD • 2 MEGA MIF CARD, • 3 MEGA RAM CARD.
- SERIAL + PARALLEL PRINTER CARD AND MORE....

FOR PC/XT AND COMPATIBLE:

- ENHANCE COLOR CARD • MULTI I/O CARD.
- MONOCHROME GRAPHICS PRINTER CARD.
- COLOR GRAPHICS PRINTER CARD AND MORE...

****ALL PRODUCTS HAVE FCC APPROVAL****



DATATECH ENTERPRISES CO., LTD.
3RD FL. NO. 68 PA TE RD., SEC. 4, TAIPEI, TAIWAN, R.O.C.

TELEX: 12088 DATATECH
TEL: (02)7672553 (4 LINES)

P.O. BOX: 95-361 TAIPEI, TAIWAN
FAX: (02)7610681 DATATECH TPE

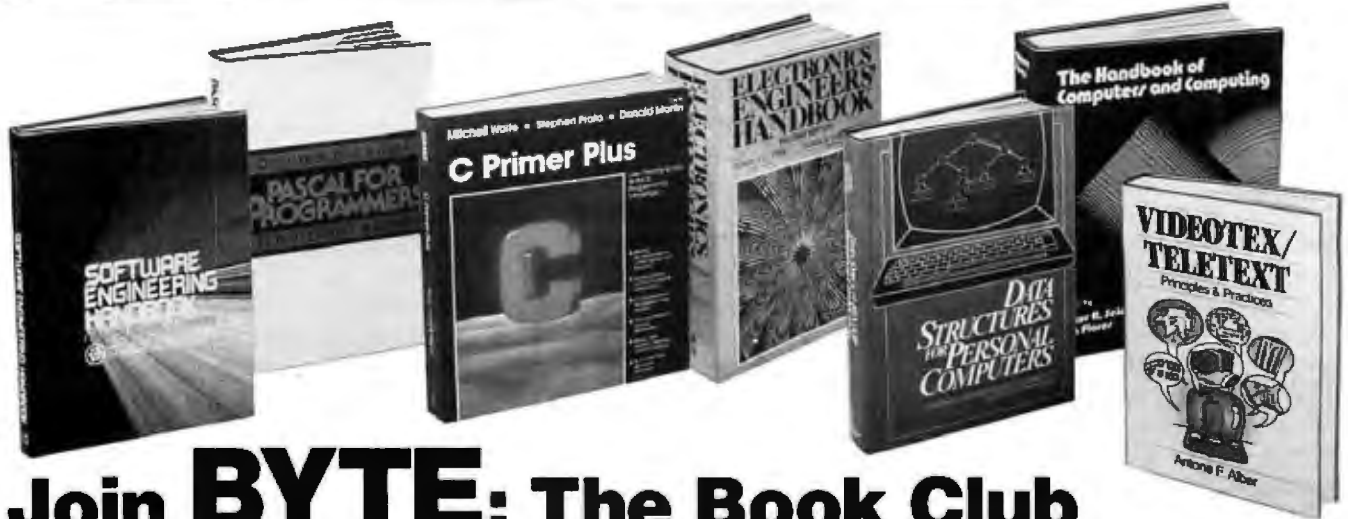

Join **BYTE**: The Book Club for the Computer Professional

Get the competitive edge with the newest and the best information in your field . . . with books from all the leading publishers.

ADVANCED PROGRAMMER'S GUIDE Featuring **dBase II and dBase III**. By L. Castro, J. Hanson and T. Rettig. 450 pp., illus. softbound. Most complete guide now available on advanced dBase. Covers the latest debugging techniques, subroutines, structured programming and system design and documentation. Thorough coverage included on the implementation process. 583149-XB \$28.95 (Counts as 2 of your 3 books)

SOFTWARE ENGINEERING HANDBOOK. By the Staff of General Electric Company. 224 pp., 114 illus., outsized 8 1/2 x 11 format. Proven-in-practice methods for tracking, controlling, and reporting each item produced as a part of the software development process are described and demonstrated. Review procedures are covered in detail. A recommended format for the system specification document is also included. 231/656A \$59.50 (Counts as 3 of your 3 books)

HANDBOOK OF SOFTWARE ENGINEERING. Edited by C. Vick and C. Ramamoorthy. 683 pp., 332 illus. and tables. Emphasizing quality assurance, this first-ever guide shows you how to design, implement, test and maintain virtually any type of software. Ranging from graphic theoretic modeling to software development you see how to apply the latest software engineering techniques in each stage of development. 583204-6A \$62.50 (Counts as 3 of your 3 books)

SINGLE-CHIP MICROCOMPUTERS. Edited by P. Lister. 231 pp., 102 illus., 25 tables. Comprehensive coverage of the single-chip micros now available, their characteristics and application range. Separate chapters cover Motorola's M6801 & M6805 families, TI's TMS 1000 & TMS 7000 devices, Zilog's Z80, National Semiconductors COP5 400 and Mostek's 16-bit MK 682000. 380/309B \$39.50 (Counts as 2 of your 3 books)

SYSTEM DESIGN FROM PROVABLY CORRECT CONSTRUCTS. By J. Martin. 392 pp., 155 two-color illus. Covers "Higher Order Software," the breakthrough in system development that translates & refines human thinking until program codes generate automatically. 583259-3B \$37.50 (Counts as 2 of your 3 books)

ENCYCLOPEDIA OF ELECTRONICS. Edited by S. Gibilisco. 983 pp., more than 1,300 illus., outsized 8 1/2 x 11 format. From basic electronics terms, amateur radio and microcomputer technology to state-of-the-art digital electronic applications, this massive reference provides practical information on each topic. Contains more than 3,000 alphabetically arranged articles. 583348-4A \$60.00 (Counts as 3 of your 3 books)

DATA STRUCTURES FOR PERSONAL COMPUTERS. By Y. Langsam, M. Augenstein and A. Tenenbaum. 560 pp., 116 illus. Gives you a solid grounding in high-level programming techniques by combining the elementary concepts of data structures with guidance on structured programming in BASIC. 583186-4B \$29.95 (Counts as 2 of your 3 books)

COMPARING AND ASSESSING PROGRAMMING LANGUAGES: ADA • C • Pascal. Edited by A. Feuer and N. Behani. 271 pp., softbound. Enhances your understanding of these languages by comparing their strengths and weaknesses. Contrasts and assesses each so you can choose the best for your application. 583262-3 \$16.95

PROGRAMMING ASSEMBLER LANGUAGE. By P. Abel. 2nd Ed., 581 pp., 154 illus. and listings. Updated and expanded this carefully detailed study of the 370 mainframe and Assembler covers the essentials of Assembler coding, binary operations, and external storage. Also discusses debugging, floating point operations, macro writing and operating systems. 583088-4B \$26.95 (Counts as 2 of your 3 books)

MULTIPLE PROCESSOR SYSTEMS FOR REAL-TIME APPLICATIONS. By B. Liebowitz and J. Carson. 383 pp., 150 illus. This definitive guide for the practicing professional covers each of the MPS's major building components, design tools and techniques and implementation methodology. Case histories from both government and industry are included. 583237-2B \$39.95 (Counts as 2 of your 3 books)

ART AND THE COMPUTER. By M. Prueitt; intro. by CARL SAGAN. 256 pp., 277 full-color illus. First comprehensive survey of today's extraordinary computer graphics. Describes and illustrates, in full color, the principles and techniques behind this revolutionary new art form. 508/941B \$44.95 (Counts as 2 of your 3 books)

STANDARD HANDBOOK OF ENGINEERING CALCULATIONS, 2/e. Edited by T. G. Hicks. 1,468 pp., 1,292 illus., tables. Now revised, updated, and considerably expanded, this huge handbook provides more than 5,100 step-by-step procedures to solve the kinds of engineering problems you encounter most frequently in your work. USCS and SI are used throughout. 287/35XA \$59.50 (Counts as 3 of your 3 books)

SUCCESSFUL DATA PROCESSING SYSTEM ANALYSIS, 2/e. By T. Gildersleeve. 369 pp., 117 illus. This completely revised, updated and expanded guide covers the whole process of system analysis. In clear, professional language it covers identifying the problem and developing a cost-benefit analysis to testing the system for acceptability. 583311-5B \$30.95 (Counts as 2 of your 3 books)

PROGRAMMABLE CONTROLLER HANDBOOK. By R. Wilhelm, Jr. 718 pp., 341 illus. First comprehensive reference on these special-purpose computers that are now the standard solution to most industrial control applications. Special attention is given to the many functions and operations not possible to perform with industrial control relays. 583244-5B \$49.95 (Counts as 2 of your 3 books)

DATA COMMUNICATIONS, NETWORKS AND SYSTEMS. T. Barteo, Editor-in-Chief. 359 pp., 196 illus. Brings you up-to-date pm digital system design. Shows how they operate and the trade-offs they entail. Covers basic system approaches, network security, error control techniques and common carrier regulations. 583276-3B \$39.95 (Counts as 2 of your 3 books)

New Members
TAKE ANY 3 BOOKS
FOR ONLY \$100 EACH*
Values up to \$89.00

BYTE BOOK CLUB™

Membership Order Card

Please enroll me as a member and send me the three choices I have listed below. Bill me only \$3.00, plus local tax, postage and handling. I agree to purchase a minimum of three additional books during my first year as outlined under the Club plan described in this ad. Membership in the club is cancellable by me any time after the three book purchase requirement has been fulfilled. A shipping and handling charge is added to all shipments.

Indicate below by number the books you want. A few expensive books (noted in the descriptions) count as more than one choice.

<input type="text"/>	<input type="text"/>	<input type="text"/>
----------------------	----------------------	----------------------

Signature _____

Name _____

Address/Apt. # _____

City, State, Zip _____

Corporate Affiliation _____

This order subject to acceptance by McGraw-Hill. All prices subject to change without notice. Offer good only to new members. Foreign member acceptance subject to special conditions.

BYTE BOOK CLUB™

Membership Order Card

Please enroll me as a member and send me the three choices I have listed below. Bill me only \$3.00, plus local tax, postage and handling. I agree to purchase a minimum of three additional books during my first year as outlined under the Club plan described in this ad. Membership in the club is cancellable by me any time after the three book purchase requirement has been fulfilled. A shipping and handling charge is added to all shipments.

Indicate below by number the books you want. A few expensive books (noted in the descriptions) count as more than one choice.

<input type="text"/>	<input type="text"/>	<input type="text"/>
----------------------	----------------------	----------------------

Signature _____

Name _____

Address/Apt. # _____

City, State, Zip _____

Corporate Affiliation _____

This order subject to acceptance by McGraw-Hill. All prices subject to change without notice. Offer good only to new members. Foreign member acceptance subject to special conditions.



NO POSTAGE
NECESSARY
IF MAILED
IN THE
UNITED STATES

BUSINESS REPLY MAIL

FIRST CLASS MAIL PERMIT NO. 42 HIGHTSTOWN, NJ

POSTAGE WILL BE PAID BY ADDRESSEE

McGraw-Hill Book Clubs
P.O. Box 582
Hightstown, NJ 08520-9959

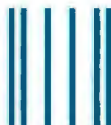

NO POSTAGE
NECESSARY
IF MAILED
IN THE
UNITED STATES

BUSINESS REPLY MAIL

FIRST CLASS MAIL PERMIT NO. 42 HIGHTSTOWN, NJ

POSTAGE WILL BE PAID BY ADDRESSEE

McGraw-Hill Book Clubs
P.O. Box 582
Hightstown, NJ 08520-9959

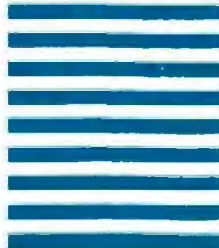



FROM FLOWCHART TO PROGRAM. By R. G. Todd
583600-9 \$19.95

HOW TO BE A SUCCESSFUL COMPUTER CONSULTANT.
By A. Simon
572/968 \$16.95

THE THEORY & PRACTICE OF COMPILER WRITING. By J. Tremblay & P. Sorenson
651/612B \$39.95
(Counts as 2 of your 3 books)

INTRODUCING PC-DOS & MS-DOS. By T. Sheldon
565/597 \$18.95

68,000 MICROPROCESSOR. By W. Triebel & A. Singh
583613-0B \$34.95
(Counts as 2 of your 3 books)

PROGRAMMING WITH TURBO PASCAL. By D. Carroll
852908-5B \$34.95
(Counts as 2 of your 3 books)

COMPUTER ARCHITECTURE, 3/e. By C. Foster & T. Iberall
583278-XB \$38.95
(Counts as 2 of your 3 books)

MICROPROCESSOR SYSTEM DESIGN CONCEPTS. By N. Alexandridis
583313-1B \$32.95
(Counts as 2 of your 3 books)

THE ENCYCLOPEDIA OF ELECTRONIC CIRCUITS. By R. F. Graf
583265-8A \$50.00
(Counts as 3 of your 3 books)

DESIGN AND ANALYSIS OF DISTRIBUTED REAL-TIME SYSTEMS By P. J. Fortier
216/193B \$39.95
(Counts as 2 of your 3 books)

THE ADA PRIMER By P. I. Johnson
326/266 \$16.95

MICROCOMPUTER ASSEMBLY LANGUAGE PROGRAMMING. By G. Elfiring
583190-2B \$29.95
(Counts as 2 of your 3 books)

FUNDAMENTALS OF PROGRAMMING LANGUAGES, 2/e. By E. Horowitz
583303-4B \$29.95
(Counts as 2 of your 3 books)

STEVE CIARCIA'S ASK BYTE. By S. Garcia
881200-3 \$14.95

THE MASTER HANDBOOK OF HIGH-LEVEL MICROCOMPUTER LANGUAGES. By C. Taylor
583096-5 \$21.95



* 3 books for only \$1.00 each . . . if you join now for a trial period and agree to purchase three more books—at handsome discounts—during your first year of membership. (Publishers' prices shown)

VIDEOTEX/TELETEXT. By A. Alber
009/570B \$39.50
(Counts as 2 of your 3 books)

CICS Made Easy. By J. J. LeBert
369/720B \$29.95
(Counts as 2 of your 3 books)

COMPUTER PERIPHERALS FOR MINICOMPUTERS, MICROPROCESSORS, AND PERSONAL COMPUTERS. By C. L. Hohenstein
294/518B \$39.50
(Counts as 2 of your 3 books)

THE HANDBOOK OF COMPUTERS AND COMPUTING. By A. Seidman and I. Flores
583138-4A \$77.50
(Counts as 3 of your 3 books)

REAL-TIME COMPUTING: With Applications to Data Acquisition and Control. Edited by D. A. Mellichamp
582844-8B \$44.50
(Counts as 2 of your 3 books)

ASSEMBLERS, COMPILERS, AND PROGRAM TRANSLATION. By P. Calingaert
582110-9B \$27.95
(Counts as 2 of your 3 books)

PASCAL FOR PROGRAMMERS. By O. LeCarme & J. Nebut
369/585B \$25.00
(Counts as 2 of your 3 books)

ADVANCED C. PROGRAMMING. By The Waite Group
583618-1 \$21.95

DATABASE DESIGN, 2/e. By G. Weiderhold
701/326B \$38.95
(Counts as 2 of your 3 books)

INTERACTIVE MESSAGE SERVICES. By D. Chorafas
108/501B \$32.95
(Counts as 2 of your 3 books)

STRUCTURE & INTERPRETATION OF COMPUTER PROGRAMS. By H. Abelson & G. Sussman
583258-5B \$34.95
(Counts as 2 of your 3 books)

C PRIMER PLUS. By M. Waite, S. Prata & D. Martin
583111-2B \$29.95
(Counts as 2 of your 3 books)

THE UNIX PROGRAMMING ENVIRONMENT. By B. Kernighan & R. Pike
583007-8B \$26.95
(Counts as 2 of your 3 books)

THE THEORY OF RELATIONAL DATABASES. By D. Maier
582986-XB \$35.95
(Counts as 2 of your 3 books)

More Books to Choose from

LEARNING WITH LOGO. By D. H. Watt
685/703 \$22.95

MICROCOMPUTER AND MICROPROCESSOR INTERFACING. By J. C. Cluley
582585-6B \$27.50
(Counts as 2 of your 3 books)

MICROPROCESSOR AND MICROCOMPUTER DATA DIGEST. By W. H. Buchsbaum & G. Weissenberg
582835-9B \$29.95
(Counts as 2 of your 3 books)

MICROPROCESSOR DATA BOOK. By S. A. Money
427/062B \$35.00
(Counts as 2 of your 3 books)

BUILD YOUR OWN Z-80 COMPUTER. By S. Ciarcia
109/621 \$22.85

MICROCOMPUTER INTERFACING. By B. Artwick
789/436B \$28.00
(Counts as 2 of your 3 books)

PRINCIPLES OF INTERACTIVE COMPUTER GRAPHICS, 2/e. By W. M. Newman & R. Sproull
463/387B \$41.95
(Counts as 2 of your 3 books)

MICROCOMPUTER OPERATING SYSTEMS. By M. Dahmke
150/710 \$18.95

ELECTRONIC ENGINEERS' HANDBOOK, 2/e. By D. G. Fink & D. Christiansen
209/812A \$89.00
(Counts as 3 of your 3 books)

Z80 USERS MANUAL. By J. Carr
582336-5 \$16.95

INTRODUCING THE UNIX SYSTEM. By H. McGilton & R. Morgan
450/013 \$24.95

HANDS-ON BASIC For the IBM Personal Computer. By H. Peckham
491/78X \$23.95

Why YOU should join the Byte Book Club™ now!

- **Best and newest books from ALL publishers!** Books are selected from a wide range of publishers by expert editors and consultants to give you continuing access to the best and latest books in your field.
- **Big Savings!** Build your library and save money too! Savings range up to 40% or more off publishers' list prices—usually 20% to 30%.
- **Bonus books!** You will immediately begin to participate in our Bonus Book Plan that allows you savings up to 70% off the publishers' prices of many professional and general interest books!
- **Convenience!** 14-16 times a year (about once every 3-4 weeks) you receive the Club Bulletin FREE. It fully describes the Main Selection

and alternate selections. A dated Reply Card is included. If you want the Main Selection, you simply do nothing—it will be shipped automatically. If you want an alternate selection—or no book at all—you simply indicate it on the Reply Card and return it by the date specified. You will have at least 10 days to decide. If, because of late delivery of the Bulletin you receive a Main Selection you do not want, you may return it for credit at the Club's expense.

As a Club member you agree only to the purchase of three additional books during your first year of membership. Membership may be discontinued by either you or the Club at any time after you have purchased the three additional books.

Fill out the card and mail today! If the card is missing, write to:
BYTE BOOK CLUB™, P.O. Box 582, Hightstown, New Jersey 08520-9959



**THE
MOST
AFFORDABLE.
IBM AT®
COMPATIBILITY
50% FASTER
QUANTUM™
286 TURBO**

with

**20MB
HARD DISK**

and

**FULL ONE
YEAR
WARRANTY**

\$1995⁰⁰

call

(714) 863-6951

for

**QUANTITY
DISCOUNTS**

**QUANTUM
XT TURBO
\$799⁰⁰**

- 8088-2 Processor (CPU BOARD, MADE IN USA)
- 4.77-8 MHz speed switch selectable
- 256K expandable up to 1MB on board
- Two-360K Floppy Drives
- Mono or Color Graphics Card
- Hi-Res Mono Monitor
- Parallel Printer Port
- AT style keyboard
- Full (1) One Year Warranty
- 80286-10 Processor (CPU BOARD MADE IN USA)
- 8-10 MHz speed switch selectable
- 512K RAM expandable up to 1MB on board
- 1.2 MB Floppy
- 20 MB Hard Disk
- Parallel Printer Port on board
- 200 W. Power Supply
- AT style keyboard
- Fully assembled, tested and 48 hour burn-in.



**QUANTUM XT
\$699⁰⁰**

- 8088 Processor
- 256K expandable up to 640K on board
- Two 360K Floppy Drives
- Mono or Color Graphics Card
- Hi-Res Mono monitor
- Parallel Printer Port
- AT style keyboard
- Full (1) One Year Warranty

- 20 MB Hard Disk Sub System (Controller & Cable) . . . \$ 465.00
- 20 MB Hard Disk (40MS) For AT \$ 650.00
- 33 MB Hard Disk Sub System (Controller & Cable) . . . \$ 695.00
- 33 MB Hard Disk (40MS) For AT \$ 750.00
- 68 MB Hard Disk (25MB Voice Coll) \$1499.00
- 60 MB Tape Streamer Back Up \$ 899.00
- Mono or Color Graphics Card \$ 110.00
- 14" TTL Mono Monitor \$ 149.00
- 12" TTL Mono Monitor \$ 99.00

AFTON COMPUTER INC.

24825 CALLE EL TORO GRANDE • EL TORO, CALIFORNIA 92630 • TELEPHONE (714) 863-6951
FAX (714) 553-1701 • TELEX 756731

LETTERS

(continued from page 24)

and object code of programs includes a protection of the screen displays and user dialog. I wish to caution you that this is not as simple as he would have you believe. Things that are purely functional, or that can only be expressed in a limited number of ways, are not eligible for copyright protection. I would say that one could not copyright the use of a picture of a floppy disk as an icon and have it be upheld. I can only think of two methods for pictorially conveying the idea of a disk—a picture of a floppy disk or a picture of a disk drive. Anything that's that limited can't be copyrighted. There is, therefore, argument that a trash can icon could also only be expressed in a limited number of ways (a trash can, a bit bucket, a spittoon, or a garbage truck). On the other hand, a slavish copying of the entire setup of icons and menus would be less supported by this argument.

In addition, it is not at all clear that the greeting card and TV show cases are dispositive of the issue. In such products the look and feel is everything. In computer software the look and feel is only one component of the total package. Programs have more than user interfaces; they have data manipulation functions, operating system interfaces, and numerous control structures and data structures that are connected to, but not dictated by, the user interface. To point to the way the program's screen looks and say that if it looks like some other program it is an infringement, in the way that the copying of the look and feel of greeting cards, cartoons, and television characters is an infringement, is a rather large jump in both legal and practical logic.

It is important to keep in mind that there are no court decisions that directly address these issues.

Mr. Bransfield failed to properly characterize the nature of both *SAS Institute, Inc. v. S&H Computer Systems, Inc.* and *Whelan Associates, Inc. v. Jaslow Dental Laboratory, Inc.* Neither of those is a "look and feel" case. In both cases the issue was whether or not the defendants violated the copyright holders' rights by translating the source code of a program to another machine/operating system environment. It is important that the defendants had access to the source codes of the programs and were copying not only the user interface but also the program structure and logic. This is clearly distinguishable from a "look-alike" or "work-alike" program that was written without access to either the source code or the disassembled object code of the original program.

(continued)

NO MANUFACTURE LABEL OR PRETTY BOX

DISKETTES

"Quality Bulk"

LIFETIME WARRANTY
Factory sealed in packs of TEN with white Tyvek Sleeves, Write Protect Tabs and ID Labels.

Single Side Double Density	.54 ea. (MIN. 50)	Double Side Double Density	.63 ea.
-------------------------------	--------------------------	-------------------------------	----------------

Manufactured 100% by one of the BIG BOYS

Old Reliable • Delaware 1-800-451-1849
• Oklahoma 1-800-654-4058
• Nevada 1-800-621-6221

TERMS: (Order Total, 30% Min.) VISA or MasterCard accepted. COD orders add 2% for local handling. SHIPPING 1% a \$1. Dealers Add 3% for every 100 Diskettes or any fraction thereof. Diskettes Add 4% for every 100 Diskettes or any fraction thereof. We ship UPS orders requiring other delivery methods add shipping plus 2% of total order.

AMERICAN MADE

LIFETIME WARRANTY

3M

Call For Quantity Discounts

<p>5 1/4" Disks</p> <p>S-Side 7⁹⁵ D-Den</p> <p>D-Side 11²⁵ D-Den</p> <p>S-Side 15⁷⁵ 96tpi</p> <p>D-Side 19⁷⁵ 96tpi</p> <p>HIGH DEN. 22⁹⁰</p>	<p>Data Cartridges</p> <p>DC 100A 12.95 DC 1000 12.95 DC 300A 16.60 DC 300XL 19.55 DC300KLP 19.85 DC 800A 22.00</p> <p style="text-align: center;">HEAD CLEANERS</p> <p style="text-align: center;">12⁷⁵ EA. 30 Cleanings</p>	<p>3 1/2" Disks</p> <p>S-Side 15⁷⁵ D-Den</p> <p>D-Side 22¹⁰ D-Den</p> <p>8" Disks</p> <p>S-Side 15⁴⁰ S-Den.</p> <p>S-Side 18⁹⁵ D-Den.</p> <p>D-Side 20⁹⁵ D-Den.</p>
--	---	--

Old Reliable • Delaware 1-800-451-1849
• Oklahoma 1-800-654-4058
• Nevada 1-800-621-6221

3M Authorized Distributor
Information Processing Products

LIFETIME WARRANTY

Verbatim

5 & 10 Box Quantity Discounts

<p>5 1/4" Disks</p> <p>S-Side 7⁹⁵ D-Den.</p> <p>D-Side 10⁹⁵ D-Den.</p> <p>S-Side 15⁷⁵ 96tpi</p> <p>D-Side 19⁷⁵ 96tpi</p> <p>HIGH DEN. 22⁸⁰</p>	<p>Digital Cassettes</p> <p>T300..... 4.05 R300..... 3.85 T450..... 5.55 DC30..... 6.60 MI 50..... 4.90 HD 10..... 7.95</p> <p style="text-align: center;">HEAD CLEANERS</p> <p>5 1/4" Kits... 4.75 5 1/4" Refills 7.00 8" Kits... 5.05 8" Refills 8.00</p>	<p>3 1/2" Disks</p> <p>S-Side 15⁶⁵ D-Side 21⁹⁵</p> <p>8" Disks</p> <p>S-Side 15⁴⁰ S-Den.</p> <p>S-Side 17⁹⁵ D-Den.</p> <p>D-Side 20⁹⁵ D-Den.</p>
--	--	---

Old Reliable • Delaware 1-800-451-1849
• Oklahoma 1-800-654-4058
• Nevada 1-800-621-6221

LIFETIME WARRANTY

Dysan

CORPORATION

QUANTITY DISCOUNTS

<p>5 1/4"</p> <p>D-Side 17⁹⁵ D-Den.</p> <p>S-Side 20⁹⁵ 96tpi</p> <p>RX 50 Format 21⁹⁵</p> <p>D-Side 25⁹⁵ 96tpi</p> <p>HIGH DEN. 29⁹⁵</p>	<p>8"</p> <p>S-Side 17⁹⁵ S-Den.</p> <p>S-Side 19⁹⁵ D-Den.</p> <p>D-Side 22⁹⁵ D-Den.</p>	<p>Dysan Interrogator 97⁹⁵ ea. PC DRIVE ANALYZER</p> <p>Anti-Glare Monitor Screen</p> <p>IBM PC 14⁹⁵ IBM PC (Color Mon.) 17⁵⁰</p>
--	---	---

Old Reliable • Delaware 1-800-451-1849
• Oklahoma 1-800-654-4058
• Nevada 1-800-621-6221

maxell
FLOPPY DISKS

5 & 10 box Quantity Discounts

<p>5 1/4" DISKS</p> <p>S-Side 7⁹⁵ D-Den.</p> <p>D-Side 11²⁵ D-Den.</p> <p>S-Side 16⁹⁵ 96tpi</p> <p>D-Side 19⁷⁵ 96tpi</p> <p>HIGH DEN. 22⁹⁰</p>	<p>3 1/2" DISKS</p> <p>S-Side 14⁷⁵ D-Side 21⁹⁵</p> <p>8" DISKS</p> <p>S-Side 19⁹⁵ D-Den.</p> <p>D-Side 21⁹⁵ D-Den.</p>
--	--

LIFETIME WARRANTY

Old Reliable • Delaware 1-800-451-1849
• Oklahoma 1-800-654-4058
• Nevada 1-800-621-6221

SONY

Quantity Discounts Available

VIDEO CASSETTES

STANDARD GRADE ULTRA-HIGH GRADE

T 120 L 750 **4⁶⁹** T120-UHG L750-UHG **6⁴⁹**

<p>3 1/2" SINGLE</p> <p>14⁷⁵</p>	<p>3 1/2" DOUBLE</p> <p>21⁹⁵</p>	<p>5 1/2" High Density</p> <p>22⁹⁵</p>
--	--	--

LIFETIME WARRANTY

Old Reliable • Delaware 1-800-451-1849
• Oklahoma 1-800-654-4058
• Nevada 1-800-621-6221

In SAS, there was far more copying of the code than Mr. Bransfield indicates. The number of lines he mentions were the number of lines that the court and the experts identified as being *directly* copied. Throughout the defendant's code were obvious examples of thinly disguised copying of the original statistical analysis program. There were also examples of dead-end bits of code that had no function in the SAS program. Equivalents of those dead ends were also found in the defendant's code. It was clear that the SAS case involved much more than a similarity between the two programs with respect to screen displays and user interaction.

Whelan is an even worse example for Mr. Bransfield to use. In *Whelan*, the defendant, Jaslow, attempted to write a program to computerize his dental lab. Upon realizing that the project was beyond his abilities, he hired a consulting firm. The consulting firm's agreement made the firm sole owner of any software that resulted from the work they did for the defendant. Jaslow assisted the consulting firm in designing the screens and user interaction dialog. If Mr. Bransfield's analysis of computer programming as merely "grunt work" is correct, then Whelan Associates rooked Mr. Jaslow. To anyone who has done any programming or read large amounts of other people's code, Mr. Bransfield's assertion that there is no artistry in writing code is absurd. Writing good code is a lot like writing good formal poetry. There are a lot of restrictions on how one may express an idea, and the object is to convey exactly what one wants to convey in the most concise and power-

ful fashion within the rules of the genre.

When the original code was written for Jaslow's lab it was in EDL on an IBM series I system. Later it was converted to BASIC on a DataMaster 26. Sometime after that, Whelan and Jaslow had a falling out. Later, Jaslow decided to convert the program for the IBM PC. With the help of another consultant, he did so and began marketing the product in competition with Whelan's version, also converted for the PC. Whelan sued; Jaslow lost. The case is now being appealed. It is clear that this is not just a "look and feel" case. Ethically, the rights to the screens and user dialog should belong to Jaslow. Legally, he gave up those rights in the original contract he and his company signed with Whelan. While Mr. Bransfield is correct in saying that the defendants in SAS stole the user interface from SAS's copyrighted program, it is not fair to all to characterize Jaslow's actions in the same breath. Given Apple's usurpation of Xerox PARC's interface, the characterization of DRI is a little like a defense of the pot calling the kettle black.

As for Mr. Bransfield's analysis of what drives software producers to make improvements to the user interface, he has made an error in interpreting history. Those user-vicious programs on mainframes were more a product of the environment and type of users such machines had, and not of the level of competition. The point he misses is that all of those developers are busy reinventing the wheel each time they come out with a more "user-friendly" interface. If one could use a common set of standards and improve on them within a particular program,

both the developer and the user would be that many steps ahead of the game.

These user-friendly interfaces are important mostly for people who want an automatic entry into new programs. If each user interface is different from every other, not much is accomplished. If, on the other hand, there are similarities where they would be helpful and innovations when they are needed, users would be much better off. This even applies to people who prefer the "stick-shift method" of controlling a computer. I am glad that Borland put the WordStar command set in the Turbo Pascal editor rather than something I had never seen before when I started using it in 1983. I am also glad that there are substantial similarities between MS-DOS and CP/M-80 and -86—it makes jumping back and forth between machines much easier and much less frustrating.

Conversely, I agree with most of Mr. Williams's reply. It is clear that Apple bullied DRI. Apple knew well that DRI did not have the resources for a prolonged legal battle and Apple probably saw it as a quick way to limit the impact of newer 68000 machines on the Mac's share of the market. As for the legality of visual copyrights in the context in which they are presently being discussed, I submit that things are not as cut and dried as Mr. Bransfield implies. I also second Mr. Williams's notion that the use of this concept should be curtailed in the area of computer software by either the courts or Congress.

In closing, I would like to make the suggestion that you do an article examining the ADAPSO plan for a hardware "key"

STAND-ALONE EPROM PROGRAMMER: \$395.00

14 DAY FREE
TRIAL
OFFER



SHOOTER — Aim low in cost and high in quality with this stand-alone EPROM programmer containing 128 k-bits of internal RAM. Program all popular single voltage EPROMs 2716-27256 including CMOS and "A" versions.

- Ideal for light use and personal projects; field service too!
- Stand-alone copy and verify
- Fast intelligent algorithm
- Built in debug firmware for RAM editing via terminal/PC
- RS232 port: to 2400 baud

- Communication software available directly from Logical Devices
 - Up/download INTEL/ Motorola type file formats and ASCII/Hex/ Binary type file formats
- Compare features, compare price; then make the Logical choice.

IT'S LOGICAL

For details, write or call:
1321 NW 65th Place,
Fort Lauderdale, FL 33309;
(305) 974-0967; toll free
800-331-PROM TELEX 383142

LOGICAL DEVICES INC.

system of copy protection. Now that the Justice Department has decided that it will not prosecute such a system under the antitrust laws, the system's legal viability has been increased. If anything will kill the plan, a good article on the costs and headaches this system is likely to cause for users should do the trick.

HENRY C. DAVIS
Carlisle, PA

Mr. Bransfield's letter never broached the crucial issue: Why is it Apple, not Xerox, that is entitled to believe it has proprietary rights over the Xerox Star/Macintosh-type interface? If Apple has paid royalties to Xerox for the interface pioneered at Palo Alto Research Center, then Apple's stance is justified. But I recall that present Apple Fellow Alan Kay originally dismissed the Macintosh as a cheap knock-off of the work done at PARC. In any case, as owner of an Atari 520ST, I was confident that Apple would run into a buzz saw had it tried to strongarm Jack Tramiel.

Mr. Bransfield has apparently done little or no programming, even on a hobbyist level. Even given the idea to be computerized and a general outline of how to accomplish it, writing sufficient code is creative and nontrivial: It is not grunt work.

DANIEL M. HOWARD
Oakland, CA

THE PERSONAL COMPUTER OF THE NINETIES

I have had the opportunity to work and play with microcomputers since I first

owned a TRS-80 Model I in 1978. I sold it long ago to pay the rent and feed three kids as I worked toward a computer science degree. As I starved my way through school I often thought about just what personal computer I would like to have when, and if, I graduated.

I have watched with interest as both my expectations and the technical abilities of personal computers grew over the years. I clearly remember when few people could figure out how anyone would be able to use the 48K you could get on a Model I. Now there are Ada compilers for the PC AT that require a minimum of 3 megabytes of RAM.

With this evolutionary process in mind, I have been thinking about what the personal computer of the nineties ought to be like. The perspectives I bring to this question are somewhat diverse. I am in my mid-thirties and have earned my keep as a programmer, microwave systems engineer, data communications technician, and small business systems consultant. Thus, I have dealt with everyone from the "power user" to the poor slob trying to balance his books. Given that, here is my "infinite wisdom," directed at the systems designers of the world, on what this next decade needs in a personal computer:

CPU: 80386. Compatibility with the massive base of 8086 software is absolutely critical. This 32-bit CPU offers it at a mind-blowing 3 to 4 MIPS! Make sure that there are provisions for a multiprocessing environment in the design.

Display: Minimum 1024 by 1024 by 16 colors. That may seem like a tall order, but chips capable of supporting this are

already in development at Intel and other companies. Users will demand it from an ergonomic viewpoint as more time is spent in front of CRTs. EGA may be nice, but is it really good enough for CAD, desktop publishing, or even Volkswriter?

Memory: 4 megabytes, no wait state, in the system as a minimum, with the capability to go much higher. The 80386 supports 4 gigabytes of RAM. Multitasking, multiuser, and multiprocessor environments will demand this much RAM.

I/O: The mouse, or its equivalent, will have to be supported directly from the system and not use up a serial port. Microsoft needs to put a standard interface in DOS. The growing use of environments such as Windows makes this necessary.

I challenge not only the American manufacturers but also those in Taiwan, Korea, and the rest of the Far East to look ahead. This system closely parallels the 3M university proposal while maintaining the path to the present software world. The use of the graphics device interface would remove any portability problems.

I estimate that a machine with these capabilities could be prototyped before the end of 1986, with the possible exception of the graphic capabilities. It could be on the market by the end of 1987.

The power it would provide to the user would be tremendous. It would take years for our software designers to come close to using the capabilities that a system like this would provide, but after they did, the benefits to the user and to society would be more than we can now imagine.

JIM TRUDEAU
Chico, CA ■

DEVICE PROGRAMMING WORKSTATION: \$2900.



14 DAY FREE TRIAL OFFER

ALLPRO—a total PROM/PLD/PAL* software driven device programming workstation when integrated with an IBM PC.

*Each socket pin is individually programmable for voltage, current, and slew rate to eliminate the need for active modules/adaptors

*New devices require only software updates via floppy disc and/or modem

Compare features, compare price; then make the Logical choice

IT'S LOGICAL

For details, write or call:
1321 NW 65th Place,
Fort Lauderdale, FL 33309;
(305) 974-0975;
toll free 800-EE1-PROM
TELEX 383142

*PAL is a registered trademark of Monolithic Memories, Inc.

LOGICAL DEVICES, INC.

Lycoc Computer Marketing & Consultants



SAVE ON THESE PRINTERS



COLOR RIBBONS NOW AVAILABLE!!

1091 \$228

SG-10 \$205

PANASONIC

1091	228
3131 (NEW)	254
1092	325
3151	409
1080 (NEW)	209
1592 (NEW)	439

OKIDATA

Okimate 10...	179
182	214
192	348
193	563

EPSON

LX80	209
FX85	333
JX80	Call
Homewriter 10	193
DX10	207
DX20	297
DX35	597
AP-80	244
HI-80	355
HS-80	298
FX-286 (NEW)	489
LO-800 (NEW)	529
LO-1000 (NEW)	659

LEGEND

1080	Call
1380	258
1385	289
808	148

CORONA

LP300	2495
200361 Toner Cartridge	89

STAR MICRONICS

SG-10	205
SG-10c	219
SG-15	367
SD-10	319
SD-15	438
SR-10	469
SR-15	578
SB-10	589
PowerType	297
NX-10 (NEW)	CALL
NB-15 (NEW)	CALL

JUKI

Juki 6100	344
FS232 Serial Board	55
6100 Tractor	119
6100 Sheet Feeder	209
Juki 6300	757

SILVER REED

EXP400	249
EXP500	295
EXP550	399
EXP770	749

BROTHER

HR-15XL-P	359
HR-15XL-S	359

SEIKOSHA

SP-1000 VC (C-64)	185
SP-1000 A Centronics	199
SP-1000 I IBM	199
SP-1000 AS RS-232	199
SP-1000 AP Apple IIc	199
BP-5200 I	649
BP sheet feeder	199
SP-1000 ribbon	8.50
BP-5200 ribbon	12.50

CITIZEN

MSP-10	255
MSP-15	355
MSP-20	337
MSP-25	485
120D	188
Premier 35	429

DIABLO

D25	549
630 API	1599
630 ECS	1758
D 80 1F	2395
P 32 CO1	699
P 3B	1748
C 150	999

TOSHIBA

P1340	469
P351+	1149
P341P	869
P341S	999
351 Sheet Feeder	529

C. ITOH

Prowriter 8510 sp+	Call
15505 sp+	Call
Printmaster	Call

MONITORS

PANASONIC

DTH103 10" RGB Hi-Res	395
TX12H3P 12" Color	419
TR120MBPA 12" Amber	109
TR122MSP 12" Green IBM	148
TR122MYP 12" Amber IBM	148

SAKATA

SG 1090 12" Green	99
SA 1000 12" Amber	109
SG 1500 12" Green TTL	119
SA 1500 12" Amber TTL	129
SC 100 13" Color Comp	209
SC 200 13" RGB	389
STS1 Tilt Stand	29

PRINCETON GRAPHICS

MAX 12 Amber	18*
HX 12 RGB	46*
SR 12 RGB	59*

COMMODORE

1902 Color	CALL
1802 Color	CALL

TEKNIKA

MJ-10 Composite	179
MJ-22	255

THOMSON

CM36512V1	269
CM36632	159

AMDEK

300 Green	118
300 Amber	128
310 Amber IBM	155
Color 300 Audio	234
Color 500 Composite	389
Color 600	397
Color 700	495
Color 710	589

ZENITH

ZVM 122A Amber	75
ZVM 1230 Green	75
ZVM 124 Amber IBM	129
ZVM 131 Color	275
ZVM 133 RGB	389
ZVM 135 Composite	448
ZVM 136 Hi-Res Color	589
ZVM 1220	95
ZVM 1230	95
ZVM 1240	149

DRIVES

INDUS

GT Atari	195
GT Commodore	195

TANDON

320K 5 1/4" Drive	115
-------------------	-----

TYMAC

MDD-640 3 1/2"	
Apple Drive 640K	289

DISKETTES

DENNISON

ELEPHANT 5 1/4" SSDD	11.99
ELEPHANT 5 1/4" SSSD	12.99
ELEPHANT 5 1/4" DSDD	14.99

VERBATIM

5 1/4" SSDD	13.99
5 1/4" DSDD	19.99

BONUS

5 1/4" SSDD	6.89
5 1/4" DSDD	12.99

MODEMS

HAYES

Smartmodem 300	133
Smartmodem 1200	377
Smartmodem 1200B	347
Smartmodem 2400	598

RACAL-VADIC

2400FC	549
2400PA	799
2400V	559
1200FC	329

KYOCERA

1200S	309
-------	-----

US ROBOTICS

Password 1200	229
Password 300	139
Courier 2400	469

DIGITAL DEVICES

Pocket Modem AT	Call
CompuServe	18.95

IBM-PC COMPATIBLE

BRODERBUND (IBM)

Bank St. Writer	48.95
The Print Shop	34.95
Graphics Library 1	22.95
Ancient Art of War	27.95
Champ Lode Runner	22.95
Karateka	22.95

LEADING EDGE

Nutshell	69.95
Nutshell Filer	149.00

SYNAPSE (IBM)

Synstock	64.95
Essex	28.95
Wizard of Wall St	28.95
Brimstone	28.95

SUBLOGIC (IBM)

Jel Simulator	34.95
Scenery Disks EA.	14.95
Set 1-6	69.95

SSI (IBM)

Battle for Normandy	24.95
Knights of Desert	24.95
Tigers in Snow	24.95
Computer Baseball	24.95
Cartels & Cutthroats	24.95
OP Market Garden	29.95
50 Mission Crush	24.95

TOLL FREE 1-800-233-8760



TO ORDER



CALL TOLL FREE 1-800-233-8760
In PA 717-494-1030
Customer Service 717-494-1870

or send order to
Lycoc Computer
P.O. Box 5088
Jersey Shore, PA
17740

RISK FREE POLICY

In-stock items shipped within 24 hours of order. No deposit on C.O.D. orders. Free shipping on prepaid cash orders within the continental U.S. Volume discounts available. PA residents add sales tax. APO FPO and international orders add \$5.00 plus 3% for priority mail service. Advertised prices show 4% discount for cash, add 4% for MasterCard or Visa. Personal checks require 4 weeks' clearance before shipping. Ask about UPS Blue and Red label shipping. All merchandise earned under manufacturer's warranty. Free catalog with order. All items subject to change without notice.

Conducted by Jerry Pournelle

ALIEN NAMES

Bob Albrecht tells me that the Allen Names program mentioned in a previous column is freeware and is available with source code from

*Dragon Quest
P.O. Box 7627
Menlo Park, CA 94026*

Those who need to generate names and/or insults for aliens are advised to write.

AN URGENT REQUEST

A group of prisoners at San Quentin are trying to learn a vocation. They are in dire need of donated PCompatible software in quantities of five copies or so. This includes the latest revisions of DOS, spreadsheets, and nearly anything else that might be useful in vocational classes. Those interested should write to Correctional Education Institute, Attn: Mr. Allan Jensen, Barclay's Bank, 3400 Central Expressway, Santa Clara, CA 95050.

The Institute is a 501(c)-3 organization and donations are deductible.

All the machines at San Quentin are PCompatibles except for one Apple IIe and one HP 150. I'm sure they could use hardware as well as software; none of their machines have clock boards, graphics cards, or memory extensions.

LANGUAGE SELECTION

Dear Jerry,

The letter in the March Chaos Manor Mail ("Language," page 293) was excellent and thought-provoking. I'm writing to encourage you to give your readers input from your experiences and perspective on considerations to keep in mind when choosing a programming language.

For some time I have been thinking about learning another programming language, but I'm not a professional programmer and don't have contacts with people to ask for guidance. I learned and used FORTRAN on a mainframe many years ago, and I quickly picked up BASIC after buying an Apple II+ four years ago. A year or so ago I began to wonder if I should learn a structured language, but which? Pascal turns me off (maybe for the reason David Suits cited), C is so "symbolic" It is

harder to read than Pascal, etc. Recently, several BASICs have been introduced that enable structured programming, and they would still be easy to read as well as more easily learned. But which one should I choose? (And many others must be in similar dilemmas.)

Your remarks on True BASIC in the same column were stimulating, but there are quite a few other BASICs now—Better-BASIC, Professional BASIC, QuickBASIC, and ZBasic among others. What considerations should a nonprofessional programmer, with needs somewhat like your own, keep in mind when deciding between the BASICs available now?

WAYNE L. ST. JOHN
Carbondale, IL

There's an excellent BASIC conference on BIX: It's conducted by Bruce Tonkin, who consistently proves that you can write good, practical programs in BASIC. He's quite fond of Microsoft's new QuickBASIC, which is fully compiled and very fast.

I also recommend Baen Software's QuickScreen (distributed by Simon and Schuster).

I still don't recommend True BASIC: It's not so much the language itself as that it's neither interpreted nor compiled and in my judgment incorporates many disadvantages of both. It does have features not found in other BASICs.

And, of course, those who want to learn new languages would do well to check out Modula-2 and Ada.

Best.—Jerry

LISA

Dear Jerry,

David Brandt's comments in the January bag of Chaos Manor Mail ("Sour Apples," page 366) caught my attention. He objected to the Macintosh because he felt it lacked the fundamental requirements of a "business computer": an ergonomic keyboard with separate numeric and cursor keypads; a large, clear display, with an option for color; two disk drives; and expansion slots.

Mr. Brandt failed to note that Apple once produced a product with most of the very features he desires, plus more that

were highly advanced. But despite all that, it still failed. And it was this irony that caught my attention.

The Apple product in question? Why the Lisa, of course.

It's true. The Lisa (later the Macintosh XL) had numeric and cursor keypads; a large, high-resolution display, with an option to correlate shades and patterns to different hues in order to produce printed output in color; two disk drives, or a disk drive and a hard disk; and expansion slots for memory up to 4 megabytes.

So, if it was so good, why did it fail? (And, for that matter, why bring up a defunct product?) The reason is that the Lisa had shortcomings that every microcomputer manufacturer must resolve: price and marketing, and performance and enhancements.

The Lisa was introduced with what was at the time a huge price tag—\$10,000. Whether Apple (or any other vendor) is justified in charging such fees is debatable. But if you charge such a high price, your customers are going to demand (and should get!) a lot of machine for their money.

Apple took an interesting approach to the Lisa software. They provided a package of closely related applications they felt met most of the needs of the typical business user: spreadsheet, word processor, graphics, etc. These applications were provided by various software houses. And while all were adequate, and some remain to this day among the best of their kind, the user was dependent upon Apple to provide timely enhancements with the abilities of equivalent stand-alone products. Though this was the need, enhancements were slow in coming, often buggy, and not always easy to use.

If performance of the software was questionable, that of the hardware was less equivocal. Microcomputer users have come to expect fast response time, especially if their machine has a hard disk. The Lisa was distressingly slow. One can find many reasons for this (the demands on the CPU to do graphics and multitasking; Lisa Pascal instead of assembly language; the slow ProFile disk, a carryover from the Apple III, that seemed hard-pressed to

(continued)

serve applications that went to the disk often; etc.). But the fact remains—performance was slow; the users expected more.

No matter how good your gear is, you've got to convince someone to buy it. Let's face facts: IBM is one of the best marketers in the world.

I have no ties to Apple, professionally or otherwise. But I like the Macintosh. A lot. I like it for reasons that are both technical and aesthetic and that go be-

yond the scope of this discussion. (Though you might ponder this: Because of the ability to *draw* information and controls as needed for an application, software can be liberated from many of the limits of interface hardware. This may be as significant as superseding teletypes with CRTs.)

I do not say that it is an ideal machine (some of the design decisions revealed in *Inside Macintosh* make me cringe). Nor that the IBM PC is a bad machine (though the history of IBM shows that they have always

pursued goals that might make Mr. Brandt pause in his enthusiasm). I do hope that Apple has learned from its mistakes and that the potential of the Macintosh evolves and flourishes. And that it does not meet the same fate as the Lisa.

TIM ALLEN
Seattle, WA

Gee, I'd have thought that Apple's "interesting approach" to software had more to do with Lisa's death than anything else.

Apple was built around open systems that generated not only user loyalty but third-party support. No company, no matter how large, can afford to have on staff as many skilled programmers and hardware designers as are out there in the user community; thus, other things being equal, the open system will always slaughter the closed one. Of course, other things aren't always equal.

There's a lot of evidence that Apple is no longer the same company. There are even rumors that Woz will be back. There are said to be frantic efforts to "open up" the Mac. I wish Apple well.—Jerry

Does your interface give you **A LONG FACE?**



It's sad! The hours that people spend trying to get two pieces of hardware interfaced through the serial ports. They buy "standard" cables that don't work! They call the "Tech Assistance" line and that's busy. They fiddle for hours with a breakout box and still don't get the correct pin configuration.

Well, now they can smile and use those hours for something productive! The SMART CABLEMAKER SC821 has arrived.

Unlike other cable devices claiming to resolve RS232 connections, SC821PLUS's LED display gives a complete graphic display of the interface. And you know the interface is correct because your system is already up and running.

Total time to interface 2 pieces of equipment and figure the correct interface? About 30 seconds! Try that with a breakout box.

Features:

- Instantly interfaces all RS232 serial asynchronous equipment.
- Displays the correct cable configuration of the equipment being interfaced.
- Reconfigures for each RS232 application needed.
- Comes with 2 cables with male and female DB25 connectors on each end.
- Does not require batteries or power supply, derives power from attached devices.
- Tri-state LED's. Smart Cable logic.

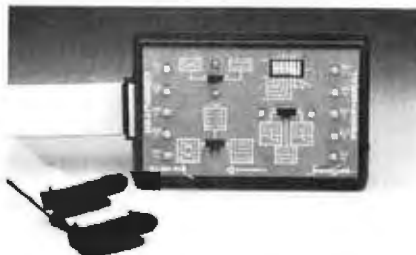

SmartCable

Just ***149.95**
plus shipping

Call **1-800-227-2817**

Dealer inquiries invited

MASTERCARD/VISA ACCEPTED

IQ TECHNOLOGIES, INC. BELLEVUE, WA

OTHER SMART PRODUCTS: SC 807 (IBM PCjr), SC 809 (Apple IIe), SC 817 (Universal RS-232 Interface), SC 880 (IBM PC-AT), SMART SWITCH BOX 1000, SMART SWITCH BOX 1300, SMART DATA METER 931.

MODULA-2

Dear Jerry,

In your February and March columns, you mentioned a CP/M Z80 Modula-2 compiler from Workman and Associates, but you gave no address for Workman or for any source that supplies it. How cruel of you!

Please send me the address ASAP so that I can order my copy. Professionally, I do Ada programming, and from what I hear about Modula-2, it sounds like it offers most of what Ada offers but is designed with smaller hardware systems in mind. Thanks.

DAN SANDERSON
Austin, TX

The addresses usually appear in the "Items Discussed" box; apparently not in this case:

Workman and Associates
112 Marlon Ave.
Pasadena, CA 91106

They've improved FTL Modula-2 since it came out. Workman also handles a CP/M version of RR Software's Janus/Ada, which is one of the best tools for teaching the essentials of Ada; but for practical Z80 programs, FTL Modula is better. Ada and Modula-2 have more in common than most suppose.—Jerry ■

THE BEST OF BIX is a selection of the most interesting messages from BIX, the BYTE Information Exchange conferencing system. The conferences covered for this month include those for the Commodore Amiga, Atari 520ST and 1040ST, the IBM PC family and compatibles, and the Macintosh computers. These pages represent only a small fraction of the material discussed in these conferences.

For information on joining BIX, see the instructions on page 378.

AMIGA

This month's Amiga highlights include a short tutorial on Amiga's joystick ports, a report on Transformer and 5¼-inch floppies, and discussion of hard disks and memory expansion options. The Bugs and Fixes section outlines problems and solutions involving Pascal, screen editors, and some mysterious vanishing icons. The Amiga highlights conclude with helpful hints for photographing Amiga display screens.

JOYSTICK PORTS

amiga/main #2447, from cmcmanis [Chuck McManis]

Amiga A/D Converters?

On the pin descriptions of the mouse port are two pins labeled "POT X" and "POT Y." Does this imply that the Amiga will also accept "analog-type" joysticks such as those available for the IBM PC? Further, are these pins looking for a resistance (change in current) or a change in voltage? If I knew, I would like to try a homemade A/D input circuit. The next thing would be how fast I can read the joystick port.

amiga/main #2448, from w.votkaegis [William Volk, Aegis Development]
a comment to 2447

The POT X and POT Y will measure resistance only, sort of like the old APPLE II pots; you can hook up analog joysticks or paddles or a photoresistor (hint, hint, ThunderScan).

amiga/main #2449, from jsan [Jez San, Argonaut Software]
a comment to 2447

Chuck, the Amiga A/D converters (labeled POT X and POT Y on the joystick port) are indeed for use with analog joysticks. They look for a resistance by discharging a capacitor at the vertical sync pulse (start of TV frame), and they time how long it takes for the capacitor to get charged up, which naturally depends on the resistance of the POT at the time.

I believe you must read a latch to determine which particular TV scan line was active at the time the capacitor was charged up. Since each scan line takes n microseconds, you can multiply through to find the exact resistance of the POT.

I'm not definite about this. Can someone from Commodore-Amiga confirm the actual method of reading the POT? Or have I gone and been "naughty" and described the "dirty" method of accessing it. Perhaps there is a "clean" OS call for reading the POT!

amiga/main #2454, from cheath [Charlie Heath, MicroSmiths]
a comment to 2447

There are device driver functions for the game port for several different types of controllers, including proportional joysticks. Incidentally, one of the mouse buttons actually is read via a resistive input, I believe the right (menu) button.

However, I tried to implement the digital joystick on the rear input port; I got it working so long as I didn't close and reopen the device. It

required about 100 lines of C code and crashed when I closed and reopened it. Then I switched to just reading the PIA and custom chip registers; it requires about five lines of C and doesn't crash.

amiga/main #2471, from pselverstone [Pater Selverstone]
a comment to 2447

I have gotten two 8-bit proportional pots (at 60 samples per second) and five buttons out of the right port by going directly to the chips. The A/D conversion seems reasonably linear with respect to resistance. No noise or crosstalk problems.

TRANSFORMER CAVEAT

amiga/main #2615, from rayzim [Ray Zimmerman]

Need Help with 5¼-inch Floppy and Transformer

I just got my Commodore-Amiga 5¼-inch floppy with Transformer and was amazed to find that it is not an "Amiga disk"—i.e., it is not recognized by AmigaDOS or Workbench. Furthermore, there is no known method to move files from PC-DOS/MS-DOS to the 3½-inch floppies, according to Commodore Tech Support.

Furthermore, Commodore Tech Support said there are no plans to integrate the 5¼-inch floppy with the rest of the Amiga. Is this true? I guess I was light-headed in assuming that I could do these things.

Do you, gentle reader, know of any software that will (a) make my 5¼-inch a "df2:" for AmigaDOS and/or wb, or (b) allow transfer from MS-DOS disks to Amiga disks?

I suspect that the public will be looking for such software also, or else they'll shun the drive.

amiga/main #2616, from pariseau [Bob Pariseau, Commodore-Amiga]
a comment to 2615

V1.2 will treat an external 5¼-inch floppy as an AmigaDOS disk with the exception of automatic recognition of disk change. You are correct in noting that no data transfer software comes with the v1.0 Transformer product. I do not expect a Transformer-based solution from Commodore very soon. This would be an ideal area for someone to make a quick buck (or perhaps some public domain software?).

HARD DISKS AND MEMORY OPTIONS

amiga/main #2510, from cmcmanis

SCSI for Amiga

By the by, at the West Coast Computer Faire the guys from MicroForge were showing their hard drives and expansion stuff. But what I found most intriguing was that their hard disk interface had only one 50-pin cable running from it.

After some marketing chit-chat it boiled down to the fact that they were indeed running an SCSI bus to the hard disk. Seems that one of these and an Ampro SCSI/IOP would provide nearly unlimited I/O capabilities. (The Ampro IOP is a board that has a programmable Z80 on it, an SCSI bus with built-in target firmware, and an STD bus edge connector.)

amiga/product.dcsn #717, from sparta [Tracy Icard, Sparta Inc.]
a comment to 2510

MicroForge Drive

A few weeks back I received my 40-megabyte MicroForge hard disk and put it on my machine. There were some problems with spurious read errors from files installed on the drive. The suspected problem hinged around the fact that my Amiga has a CSA piggyback board with 68020/68881 and 512K bytes of static RAM. This suspicion was

(continued)

substantiated by the fact that the drive appeared to work fine with a standard Amiga.

The other day I received my 7-slot expansion box and, I'm happy to report, this solved the problem. Once the drive was installed in the expansion box I had no more problems. The drive works magnificently so far. The problem is probably related to one (or both) of two things:

1. Using the single-slot adapter supplied with the disk. The controller board is powered from the Amiga rather than from the 130-W supply that powers the drive. The expansion box powers the entire expansion bus from the 130-W supply.
2. The design of the 7-slot adapter may act differently with respect to my machine, causing the error to no longer appear.

Whatever the cause, the unit now works fine. One new item that MicroForge passed on to me is regarding its 2-megabyte RAM board. They have shelved this board, as another company (RS Data Systems) is producing a better board that MicroForge is going to sell instead. This board will be available very soon and has a capacity of 2 to 8 megabytes. The basic board has sockets for 4 megabytes and comes either with 2MB (\$995 list) or 4MB (\$1395 list).

There will also be a piggyback board with capacity for another 4MB. The main board, with piggyback, loaded with 6MB will list for \$1675 and fully loaded with 8MB will list for \$1995.

Those who already ordered the 2MB MicroForge board will be shipped the basic board with 2MB on it. Just for the cost of 2MB of RAM, it can be upgraded by the purchaser to 4MB!

amiga/product.dcsn #718, from mposehn [Mike Posehn]
a comment to 717

How much memory is lost when the hard disk is attached? Is it 17K, like when a second floppy is installed?

amiga/product.dcsn #721, from cheath
a comment to 718

I would guess none, depending on the device driver. So far all of the hard disks I have heard about read via CPU rather than DMA; I would guess that the drivers are doing sector I/O rather than DMA track I/O. But the driver itself would also have to be in RAM, so it might use up a fair amount of RAM even doing sector I/O.

amiga/product.dcsn #723, from althoff [Tom Althoff, Indian Park Electronics]
a comment to 717

I just hooked up my 20MB MicroForge hard disk and 7-slot box. Yes, it works well, but I have two minor complaints. The top lid sags under a few pounds of weight (mine was bent during handling at MicroForge). I can set the Amiga RGB monitor on the case carefully, though, without causing a permanent bend.

The other concern is RF sensitivity. In a strong RF field, the Amiga itself is surprisingly resistant to any erratic behavior or even blooming of the monitor. However, with the expansion box on-line, the sensitivity to RF increases by a factor of 10. At some point, I will take the time to scrape the paint off the junctions of all the panels that make up the assembly and perhaps improve the shielding a bit. RF leaving the Amiga and MicroForge did not, however, seem to increase when monitored in a nearby HF receiver.

Just curious what your impression of the mechanical strength of the MicroForge unit itself is? Good luck with it!

amiga/product.dcsn #745, from mikeduffy [Mike Duffy]

I picked up a Comspec 2-megabyte memory expansion at the San Jose Amiga Faire on Saturday and brought it home to L.A.. Works like a charm (so far), and everything is much faster—I really don't need the

disk drives except to load and unload the RAM disk. It really speeds up development, and they have an attractive price for developers. The box lists for \$1079 U.S. (Comspec is Canadian), and I got a 30 percent discount. The only drawback is that it is only a 2-megabyte box (not like the ones that expand to 4 to 8 megabytes). On the other hand, it plugs into the side of my Amiga and doesn't require its own power supply.

Best of all, it's available *now* (unlike some other products). Comspec can be reached at (416) 787-0617. As far as price/performance, I would say that RAM is more useful than a hard disk for most developers. In addition, it helps to catch all those "it should be in CHIP memory to work" bugs that are lurking about.

amiga/product.dcsn #748, from langeveld [Willem Langeveld]
a comment to 745

Notice that one can chain those modules. So four of them give you the full 8 megabytes, but by then you've spent \$4000, still not bad compared to the price of 1 megabyte for a VAX.

BUGS AND FIXES

VANISHING ICONS

amiga/main #2411, from apl [Andy Levy]

Is anyone here interested in the following phenomenon?

1. Boot Workbench with active CLI.
2. Open main disk window.
3. Select an icon and move it out of disk window and onto main Workbench screen (in my case I moved "AmigaBasic").
4. Close the window.
5. Click in CLI, and on the same disk make a copy of the associated icon.info file but *without* the .icon extension (example: copy AmigaBasic.info to "dummy").
6. Reopen the window, move the icon back into it, and close the window.
7. Reopen the window and the icon will now be *gone*. However, the icon.info file is still on the disk (viewable via a "dir" or "type" command)—it just won't display its icon.

The icon can be made to reappear in at least three ways:

1. Delete the duplicate copy of the icon.info file (example: delete dummy). Or
2. Add the .info extension to the copy of the icon.info file (example: rename dummy to dummy.info), which will make two icons appear, the original and a duplicate named dummy. Or
3. Rename the original icon.info file (example: rename icon.info to newname.info), which will make the icon reappear as "newname".

You can now name it back to its original name, and it will remain. The changes appear to be due to alterations in the disk's main .info file. Using "lst" you can see it lose/gain bytes as the icons disappear/reappear.

Also, the disappearance will *not* occur if the original copy of the icon.info file is given the .info extension (example: copy icon.info to dummy.info); it will just create a duplicate icon with the name "dummy".

Anybody know what's happening? Looks like there may be a time bomb lurking in the operating system.

amiga/main #2412, from jdow [Joanne Dow]
a comment to 2411

Out of idle curiosity, where did the files go when you moved them off onto the main Workbench screen? If they stayed in the usual directories, when CLI looked at them, it seems to me that you confused Workbench. I would hope that moving things that way would create a copy in RAM.

Along these lines, I have noticed that AmigaDOS can become very confused if there are two disks, produced by a prior "diskcopy", followed by a reboot. I have learned to relabel immediately to avoid the problem (if there is ever a chance I will attempt to load both disks).

I thought AmigaDOS had a special tag field that guaranteed that the uniqueness of disks would be noted. I suppose two disks by the same name as system disks seems to confuse the SYS: and C: search paths.

amiga/main #2422, from apl
a comment to 2412

The files stayed where they were (in the root directory). The only thing that changed was the main .info file and of course the lack of the icon on the window. Funny thing, now I'm having trouble duplicating this. I can get icons to disappear, but the change is not permanent; rebooting clears it. This is *not* what happened before, but I'm using different disks, so maybe it's related to some problems on the specific disks I was using. Oh well, mark it down to a haunted Amiga.

amiga/main #2426, from cheath
a comment to 2412

I haven't run across the relabel problem. If you use a program like Marauder, which makes an "exact" duplicate of a disk, you will definitely have problems such as you mentioned; but I have never seen any problems using disks together that were created with "diskcopy". Maybe I've been lucky?

amiga/main #2428, from jdow
a comment to 2426

These are indeed Marauder disks, so I suppose that explains things more than a bit. No wait—one was a Marauder disk and the other was a "diskcopy" disk without the DPaint stuff on it. Strange effects here. It definitely goes fufu with two Marauder duplicates. It gets most confused, poor thing.

I wish there was a way to log in to or assign to a generic dff: disk rather than a specific disk. That'd make searching for a file on one of several disks much easier. Log to generic dff: and dir successive disks to my heart's content. Sigh—CP/M ain't all bad.

amiga/main #2431, from duck [Dale Luck, Commodore-Amiga]
a comment to 2428

Multiple Marauder disks are a good way to confuse the poor DOS. The secret ID numbers are duplicates, so its last-resort measure of telling the difference is broken.

PASCAL PROBLEMS

amiga/main #2452, from jveg [John Verøgge]

Lattice and Amiga Pascal Questions

I have kludged a Pascal environment using Lattice Screen Editor and Amiga Pascal. I use the following execute file for debugging my source files:

```
.key FWS/k
.def WS "25"
pascal > ram:<F>.err ram:<F>.pas cem ws <WS>
lse: ram:<F>.pas ram:<F>.err
```

This compiles and puts the error messages into a file and loads LSE, source file, and error file. The problem occurs when a true boo-boo creates many spurious error messages. LSE cannot load a 250K error file. A solution would be to echo the error file to the screen while it is being written, put in a break flag, so I can manually stop the compile, and have the execute file continue and put me back in the LSE to fix the real bug.

Is it possible in AmigaDOS to direct output to two different locations (screen and error file)? Suggestions? Aside from "switch to C"; I am teaching myself programming and have enough problems. Also, the manual for Amiga Pascal is !@#%±&*? and I am anxiously awaiting (but not with bated breath) the next release. In the meantime, what is the "double" option in Pascal 1.09? I can see it changes the size of the object file slightly, but I am too new at this to tell what it really is doing.

Compliment: I as an amateur like the compiler for learning purposes. An environment is easier, but sticking to the standard makes it complementary to a great many textbooks, and the error messages are easy to understand. I don't think this is possible (I am also asking in the Lattice C conference), but can anyone think of a way to use the LSE error-checking mode with other compilers? This would be extremely useful for many and widen the consumer base for Lattice.

(continued)

Dysan		30 disks 100
5%	SS DD 104/1D	01y 01y
	DS DD 104/2D	1.82 1.63
	DS DD 204/2D	2.37 2.11
		3.85 3.44
maxell		*Fast Delivery
5%	SS DD MD1	1.19 1.06
	DS DD MD2	1.71 1.53
	DS HD MD2-HD	3.49 3.11
Verbatim		*All Items In Stock
5%	SS DD 18158	1.39 1.24
	DS DD 18188	1.95 1.74
	DS DD 18239	3.26 2.91
Things		5% 8
Tyvek Envelopes (white)		08 18
Flip N File 50		14.94 19.50
EPSON FX/IX/RX-100-185		6.56 72.45
EPSON FX/IX/RX-80-85		4.08 44.85
Other Brands & Things Available Dealers Inquiries Welcome • Free Price List Available 818/706-8602 Phone Credit Available with \$25 Purchase Southern California 800 447-7425		
Disks 'n Things		
555 S Palm Cyn. Dr. #317 Palm Springs, CA 92264-7420		

DYNAMIC-CAD
The most powerful CAD system for the Amiga

Emerging from years of successful problem solving applications in piping, and electronics for the aerospace industry, DYNAMIC CAD has brought a highly advanced and powerful CAD system together with today's most dynamic and versatile micro-computer, the Amiga. DYNAMIC CAD takes full advantage of Amiga's enormous capabilities with its multiple modes of resolution, mouse functions, and ready accessible pull-down menus.

This is not some promoted vaporware. DYNAMIC CAD exists now and delivers to the Amiga with a proven track record. The time and money-saving applications of DYNAMIC CAD for engineers and architects are truly astounding. There is an advanced 2D drafting system with numeric capabilities that can be combined with many models of printers, plotters, and digitizers to generate standard you'll have the support of an extensive network of writers in understandable English along with working examples at several locations.

INTEGRAL SYSTEMS

Inquiries invited. (818) 360-3715
P.O. BOX 3475, GRANADA HILLS, CA 91344

Sure it's insured?

SAFEWARE® Insurance provides full replacement of hardware, media and purchased software. As little as \$39/yr. covers:

- Fire • Theft • Power Surges
- Earthquake • Water Damage • Auto Accident

For information or immediate coverage call:
1-800-848-3469
In Ohio call 1-614-262-0559

SAFEWARE
SAFEWARE, The Insurance Agency, Inc.

amiga/main #2453, from jim_kent [Jim Kent]
a comment to 2452

What's the Lattice Screen Editor error-checking mode?

amiga/main #2456, from cheath
a comment to 2453

They have a mode in their editor that reads in an error file from their compiler and allows you to jump to the error lines in the editor. I personally prefer to have the errors in the console window, and just click the editing window behind the console when I need to find the next error line.

amiga/main #2462, from jdow
a comment to 2452

Um, perhaps you have two paths to happiness. Trim your source to smaller modules, or first edit the error file and cut the last half or whatever, and then edit in the error-flagging mode.

I don't think a forked path is possible for redirection. Oh! Write a filter to trim the error file to perhaps 100 lines and run it before entering the LSE editor. That ought to nicely mechanize the process for you.

amiga/main #2463, from jdow
a comment to 2456

Actually, the error locator is a nice development feature. The LSE reads the error file along with the source file. It will do a Turbo Pascal and position the cursor on the line with the error in it. It will do TP one better by then positioning to the next error. The only gripe I have with it is the cluttered screen LSE gives me. When you have more than a screen full of errors this is a handy way to find the errors without bothering to create a listing of the error file in hard copy.

On the other tentacle, you might worry about your techniques if you get much more than a screen full of errors. Breaking up a huge file into smaller pieces is generally a good thing, has fewer error messages, and better data hiding.

PHOTOGRAPHING AMIGA'S DISPLAY

amiga/main #2443, from rgoldberg [Robert Goldberg]

Monitors

There has not been much discussion recently about monitors. I suppose everyone has bought one by now. I am doing a lot of photography directly off the screen, and the resolution of the Amiga monitor leaves me cold, especially for text in 400-line mode. Are there any monitors around that do a better job of resolution, especially for 400-line text? I have heard about the Sony, as well as the Atari (but does Atari's advertised 200-line resolution support Amiga hi-res?).

And what about the rumored "new" Amiga monitor? Will this be higher resolution or just a cosmetic redo with two tiny speakers?

If anyone has good thoughts about this problem, I would appreciate the advice.

amiga/main #2444, from cheath
a comment to 2443

What would be needed to display the Amiga's NTSC color without flicker in 400-line resolution is a higher-persistence monitor. Such monitors exist, and I have heard they aren't too much more expensive than standard analog RGB monitors; but I have no idea who makes one. I am baffled as to why Commodore has not pursued this at least to the point of finding out what sources are available for these monitors.

amiga/main #2446, from cmcmanis
a comment to 2444

Heath/Zenith is now selling a "high-persistence" color monitor specifically for interlaced color displays; the only drawback is that it is RGBI rather than analog RGB. (Seems some other manufacturer has made digital RGB quite popular.) Possibly a call into them might get a lead on one that accepts analog.

I remember looking in one of those RGBI monitors and seeing four op-amps as hysteresis input buffers. If they really are there just to convert the signal from the cable into full on or full off for the RGB amp stages, then it might be possible to add a feedback resistor/cap to make them analog once again.

amiga/main #2470, from bgill [Bill Gill]
a comment to 2443

I was at a NASACOM64 banquet here in Houston last night, and the guests from Commodore had nothing much to say about a new Commodore monitor, but they discussed briefly what can be done about the high-res flicker. Just about the only thing you can do is to get a monitor with a slow phosphor, and then you may get some smearing if you try to do animation.

They said there are several monitors with the long-persistence phosphor, but the only one they could remember right off the top of their heads was the Electrohome. I have heard the name in other contexts, so I guess you might want to investigate that. They also said that they had heard of a new Sony monitor that took the interlaced feed from the Amiga and converted it to a noninterlaced signal for the display. That sounds a bit tricky to me, but I suppose it is technically possible. It would take care of the high-res flicker.

amiga/main #2472, from pselverstone
a comment to 2470

I saw a reference to an RCA patent (4,573,068) that might relate to interlace-to-noninterlace conversion. It provides "twice the usual number of scan lines per picture frame." Next-generation TV sets will have digital field storage and therefore should be able to generate noninterlaced displays from interlaced signals. Does anyone know anything about this?

amiga/main #2473, from jdow
a comment to 2472

I don't know about the patent you mention, but the technology exists. In Europe the current method of scan conversion involves such tricks. All that such a scan converter would have to do to convert the signal to true RGB analog would be to sample at perhaps 10 MHz with a 6-to-8-bit flash converter.

The images are stored in a RAM large enough to store one full frame. The RAM would have to be fast enough to allow all the needed accesses for both scan rates. The output rate would be twice the input rate in order to complete the pictures fast enough.

No, I take that back. The conversion could also go to completing a picture perhaps 50 times per second for average viewers. (I do, however, remember French high-res TV mode, which wiped the picture to the screen 25 times per second.) I was younger at the time and could plainly see the sweep effect and found it unwatchable.

Anyway, the technology exists. It is rather expensive these days as perhaps (oops—Amiga pix would require sampling nearer 30 MHz to make Mr. Nyquist happy—equivalent to 960 dots per line, counting visible 640 and retrace period). The horizontal frequency is about 15,750 Hz, giving a dot rate of about 15 MHz.

The actual number would be twice our processor clock to be exact. A 640 by 400 picture fills the screen, giving 256K per color or $\frac{3}{4}$ megabyte of very, very fast RAM. If the RAM is organized perhaps 64

bits wide, then the access rates can bring it down to reasonable speeds for merely expensive RAM, perhaps 200 ns.

ATARI ST

Several applications developers and other conference members have recently been debating the pros and cons of a unified user interface for the Atari ST. While GEM's mouse-and-menu user interface established a precedent for ST applications, not all developers agree it should be used exclusively—it's a discussion that any ST owner should find interesting. Other topics covered this month are how to change the physical display base, information on a broad-band video bug, and discussions of the new OS-9 C compiler and Aicyn C.

UNIFIED USER INTERFACE

atari.st/clubhouse #141, from mmanlove [Mike Manlove]

I have a serious problem with the unified-user-interface approach: Much as we like our menus and so on, they are not always the best way to solve a given problem. I'm currently working on a sizable project that uses a fixed, always-present command list on the side of the screen. I won't go into my reasoning at the moment, but I think it's the right way to go. Now, the big question: What is the trade-off between a consistent but clunky interface and one that's different but better suited to the task at hand?

atari.st/clubhouse #142, from jruley [John Ruley, University of Dayton] a comment to 141

OK—there are *some* applications that are *not* suitable for menu/mouse operation. As a regular user of MacTerminal, I am pleased to be the first to agree on that! However, if you're going to have a GEM application that uses the menu, then you ought to stick with standard conventions.

One other convention—whether or not you are using the GEM menu bar, the Help key should give you a command list. If we can all agree on this much, then I think the rest of the problem will largely take care of itself.

atari.st/clubhouse #143, from mmanlove a comment to 142

I couldn't agree more about the Help key. One of the first things I did with my ST was to hack a little terminal emulator, and it used the Help key because I forgot what's going on in my own programs. Then I found out that most commercial software doesn't use it.

atari.st/clubhouse #145, from cheath [Charlie Heath, MicroSmiths] a comment to 143

I prefer to assume the user can get to the menu, which should be self-documenting as to functionality. Is that a bad assumption?

atari.st/clubhouse #147, from jruley a comment to 145

Yep. The menu bar ought to be self-documenting, but what's wrong with a little redundancy here? If I'm typing away on my word processor, it is very irritating to lift my hands from the keyboard to the mouse.

atari.st/clubhouse #148, from cheath a comment to 147

I guess we have a difference of opinion re Help key versus menu. My
(continued)

Little Board™/186... \$495

High Performance, Low Cost PC-DOS Engine

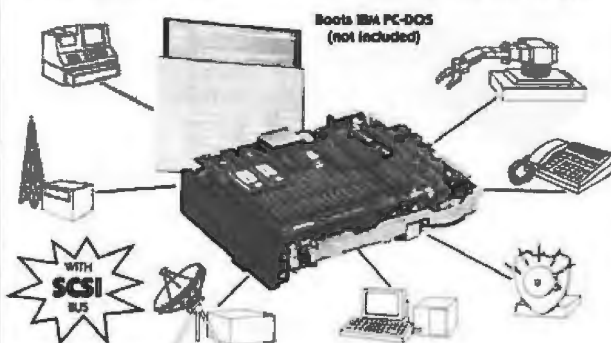

- Three times the COMPUTING POWER of a PC
- Data and File Compatible with IBM PC, runs "MS-DOS generic" programs
- 8 MHz 80186 CPU, DMA, Counter/Timers, 128/512K RAM, zero wait states, 16-128K EPROM
- Mini/Micro Floppy Controller (1-4 Drives, Single/Double Density, 1-8 sided, 40/80 track)
- 2 RS232C Serial Ports (50-38, 400 baud), 1 Centronics Printer Port
- Only 5.75 x 7.75 inches, mounts directly to a 5-1/4" disk drive
- Power Requirement: +5VDC at 1.25A; +15VDC at .05A; On board -12V converter
- SCSI/PLUS™ multi-master I/O expansion bus
- Software Included:
 - PC-DOS compatible ROM-BIOS boots DOS 2.x and 3.x
 - Hard Disk support
- OPTIONS:
 - Expansion board with:
 - 128 or 512K additional RAM
 - 2 Sync/Async RS232C/422 serial ports
 - Battery backed Real Time Clock
 - 8087 Math Co-Processor
 - Buffered I/O bus
 - STD Bus Adaptor
 - Utilities source code
 - TurboDOS / Networking

MPRO
COMPUTERS INCORPORATED

8801, Bix Corp., 80180*, Intel Corp., Turbo DOS*, Software 8008, Inc.

57 East Evelyn Ave. • Mountain View, CA 94041 • (415) 962-0230 • TELEX 4940302

It's Time To

NEW SLIM DESIGN and a LIFETIME WARRANTY...

Two great reasons to make the switch. Only 1 1/2" high, but still with the same high quality features you have come to expect from DATA SPEC Switch Boxes.

- Reinforced printed circuit boards
- Full shielding



Switch Boxes

- Durable metal construction
 - Gold-plated contacts
 - All pins switched
- And now, backed by a lifetime warranty. Visit your local DATA SPEC dealer and see our full line of slim style data switch boxes and other computer accessories.

DATA SPEC
A DIVISION OF ALLIANCE RESEARCH CORPORATION

THE ULTIMATE IN COMPUTER ACCESSORIES

20120 Plummer Street • P.O. Box 4029 • Chatsworth, CA 91313 • (818) 993-1202

In Japan: Call Data Spec Japan LTD., Tokyo, Japan, Tel. (03) 774-7741

IBM PC AT performance! PCjr price!

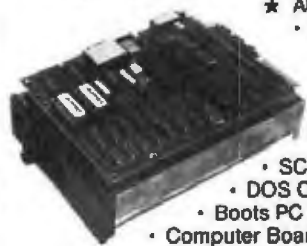

- ★ AMPRO Little Board/186
 - 8Mhz 16 Bit 80186 CPU
 - 512K RAM—No Wait—States
 - 2 Serial Ports 50-38.4K Baud
 - Parallel Printer Port
 - 4 Drive Mini/Micro-Floppy Controller
 - SCSI Bus Hard Disk Interface
 - DOS Compatible ROM-BIOS
 - Boots PC DOS 2.x, 3.x
- Computer Board Assembled and Tested with Tech Manual and DOS utilities...\$499

- ★ DRI Concurrent DOS 4.1 Multi-User O/S...\$395
- ★ Expansion Board for 512K (1Mb total) 8087-2 Socket, Real-Time Clock, 8530 SCC 2 Channel RS232/422, Buffered Expansion Bus and more... from \$295
- ★ AMPRO Little Board (Z80) Same as 80186 board but Z80A CPU, 64K RAM, 16K EPROM, CP/M 2.2 & ZCPR3 and manuals... \$239 (\$279 w/SCSI)
- Enclosures w/Power Supply... from \$99
- Floppy Drives... call for current price
- Xebec Owl SCSI Drive—Low power 1/2 Ht Drive w/built-in Controller 10/20Mb... \$499/\$649
- Terminals: WYSE, QUME, KIMTRON... from \$395
- Power supplies, cables, connectors in stock

Complete technical support. Assembled systems available. Write or call for free catalog. Most orders shipped same day.
 VISA, MasterCard, Money Order, C.O.D. Checks allow two weeks. Purchase orders and bids welcome. Prices F.O.B. Prairie View, IL.
IBM PC AT PCjr PC DOS are trademarks of International Business Machines Corporation. Concurrent DOS is a trademark of Digital Research Inc. Xebec Owl is a trademark of Xebec, Inc.

DISKS PLUS INC 15945 West Pope Blvd. Prairie View, IL 60069 (312) 537-7888

• BEST OF BIX • **BIX** • BEST OF BIX • BEST OF BIX

feeling is that it is easier to wander through various menus with the mouse and just release the menu button to have the help/menu retracted. I'm not sure how easy that is to do with GEM; I know the default is to leave the menu up, but I think a clever program can get the menu to disappear when the button is released. When you use the Help key, if there are multiple pages, you need some other keystrokes to get between pages, and you need a final keystroke to get rid of the "help" and get back to work.

atari.st/clubhouse #157, from dmenconi [Dave Menconi, co-moderator of the atari.st conference]

How about this: I think most programs should have a Help menu that gives information about all the other menus and about the program in general. If the Help key were a synonym for a help item that told all about functions of the program, then different types of users would be satisfied.

atari.st/clubhouse #177, from jruley

Hmm... on the Mac I've seen a lot of applications that use the "About..." item under the "Apple" menu bar for a form of on-line help. What I suggest is that we use the Help key the same way—it ought to (at least) list the major command headings, what their general function is, and (briefly) how to use them.

For a non-GEM application (no menu bar) this is more important, but in the interest of consistency, why not do it on GEM applications as well? I mean, since we have a Help key, why not use it?

atari.st/clubhouse #144, from cheath
a comment to 141

Interfaces depend a lot on the application, but I'll assume you are writing a "mass-market" application in which there are two priorities: (1) the interface has to be simple to learn, and (2) the interface should allow "power users" to quickly access the functions they need.

I don't think a standard is necessary or good. It is nice if there are conventions; that is, if you have a choice of two equally good alternatives, you should probably pick the most likely to be used in similar applications. But to assume that all programs should use a particular interface is to limit the definition of a program.

atari.st/clubhouse #189, from mmanlove

I am on record as being a bug about the Help key. Use it, implementers!

atari.st/clubhouse #154, from dmenconi
a comment to 141

Right now the proposed interface guidelines are not at all consistent—no one uses them—so your method would not have to be much better.

I would caution, however, that, in my experience on the Macintosh, a developer ignores the user interface guidelines at his peril. In fact, it seems to me that there are few really good reasons not to use menus other than a simple dislike of pull-down menus.

atari.st/clubhouse #156, from dmenconi
a comment to 144

On the Mac the interface may or may not be simple to learn (I think it is, but everyone is allowed an opinion), but it's the *only* interface you will ever have to learn. All decent products on the Mac use the interface (this is a slight exaggeration, but if a product doesn't use the guidelines, many users won't use it because it is too hard to use).

NOVAS BEYOND IBM COMPATIBILITY MORE POWER PLUS RELIABILITY

NOVAS TURBO 286 MOTHERBOARD

- Fewer ICs For Greater Reliability—Only 36 Compared to IBM's 131
- Dual Speeds—6 & 8 MHz—Keyboard Selectable
- 4 Serial and 1 Parallel Ports On Board Option
- Expandable to 1 Megabyte RAM
- Socket for 80287
- Fully Compatible BIOS
- Complete with Installation Program



\$595 OEM Quantities

All AT Accessories Available—Call!

NOVAS 1000 EGA BOARD

- Supports EGA, RGB, & Monochrome Monitors
- 640 x 350 Pixels EGA
- 640 x 200 Pixels Color
- 320 x 200 Pixels Color
- 720 x 350 Pixels Monochrome
- Parallel Port on Board
- 256K RAM on Board



\$250 OEM Quantities

NOVAS MF 3000 MULTIFUNCTION BOARD 286 & AT

- To 3M Memory
- 2 Serial & 1 Parallel Ports on Board

\$165 OEM Quantities

COMPLETE NOVAS PC TURBO SYSTEMS AND COMPONENTS IN ANY CONFIGURATION—CALL FOR CURRENT PRICES

OUR QUALITY AND PRICES CANNOT BE BEAT!
CALL US FOR COMPLETE SATISFACTION

COMPUTRADE COMPANY

780 Trimble Road, Suite 605
San Jose, CA 95131 Tel: (408) 435-2662
Fax: (408) 435-5458

NOVAS

Since 1983

* IBM & AT are trademarks of International Business Machines Corp.

Besides, if there are guidelines, we can use them where appropriate and ignore them where not.

CHANGING THE PHYSICAL DISPLAY BASE
 atari.st/questions #68, from cheath

Glitch Changing Physical Base

We're having a problem doing a double-buffered display. Occasionally, the display will glitch for what seems to be a single display frame. This happens about once every 10 minutes. We are updating the physical display base about eight times/second, and it seems that the problem must be related to this. Anybody know about a problem like this?

atari.st/questions #102, from cheath
 a comment to 68

My partner figured out the problem here; it's a glitch in *The Hitchhiker's Guide to the BIOS*. To switch physical screen base, use the Setscreen call. *The Hitchhiker's Guide* states incorrectly that the actual physical base is updated during the next vertical sync; taint so. Instead, the physical base is changed immediately. That can cause an intermittent screen flash if the Setscreen call is made at any time other than during vertical sync. Therefore, just prior to the Setscreen call, you should call `xbios(37)`, which will wait for vertical sync.

Also note that the `Physbase()` call does not wait until vertical sync, as implied in the *Guide*.

atari.st/questions #103, from jim_kent [Jim Kent]
 a comment to 102

Amazing. I was just down at Atari today and found this out myself. Actually, there is a system counter tied to the horizontal sync you can use too if you don't feel like waiting too much. I haven't gotten this to work yet. Interrupt vectors are scary!

BROAD-BAND BUG

atari.st/questions #79, from sprung [Ron Sprunger, R & D Tech]

On occasion, as when loading DEGAS, or a DEGAS picture, I get a half-dozen widely spaced broad black bands on the monochrome. I also have gotten them when returning from the control panel. Is this a system bug, or have I got a hardware problem?

atari.st/questions #80, from jim_kent
 a comment to 79

I think I know the source of the broad-band bug. It is what you get—more or less—in the color system when you load a low-resolution picture when you are actually in medium-resolution mode. You may have the bigger, broader version of this for monochrome. It's the way the "interleaved" part of the bit map goes.

atari.st/questions #86, from jruley
 a comment to 79

The vertical bars are a system problem—I also get them in DEGAS, and in Megaroids. A funny thing, though, they seem to go away after you've had the system on for a while.

Maybe it is a hardware problem, after all—does anyone know?

atari.st/questions #89, from dmenconi
 a comment to 86

I have the same problem except that it seems to happen after the machine has been on for a few hours while running the monochrome (I also have color). I suspected a heat problem, so I got a can of freon, took apart my ST, and waited until it did it again. The problem goes

(continued)

Computers For The Blind

Talking computers give blind and visually impaired people access to electronic information. The question is how and how much?

The answers can be found in "The Second Beginner's Guide to Personal Computers for the Blind and Visually Impaired" published by the National Braille Press. This comprehensive book contains a Buyer's Guide to talking microcomputers and large print display processors. More importantly it includes reviews, written by blind users, of software that works with speech.

Send orders to:

National Braille Press Inc.,
 88 St. Stephen Street, Boston, MA 02115
 (617) 266-6160

NBP is a nonprofit braille printing and publishing house.

BYTE back issues for sale

	1985	1986
Jan.	\$4.25	\$4.25
Feb.	\$4.25	\$4.25
March	\$4.25	\$4.25
April	\$4.25	\$4.25
May	\$4.25	\$4.25
June	\$4.25	\$4.25
July		
Aug.	\$4.25	
Sept.	\$4.25	
Oct.	\$4.25	
Nov.	\$4.25	
Dec.	\$4.25	

SPECIAL ISSUES and INDEX

BYTE '83-'84 INDEX	\$1.75
1984 Special Guide to IBM PCs (Vol. 9, No. 9)	\$4.75
1985 INSIDE THE IBM PCs (Vol. 10, No. 11)	\$4.75

Circle and send requests with payments to:

BYTE Back Issues
P.O. Box 328
Hancock, NH 03449

Check enclosed
 Payments from foreign countries must be made in US funds payable at a US bank.

VISA MasterCard

Card # _____

Exp. _____

Signature _____

The above prices include postage in the US. Please add \$.50 per copy for Canada and Mexico; and \$2.00 per copy to foreign countries (surface delivery). Please allow 4 weeks for domestic delivery and 12 weeks for foreign delivery.

Name _____

Address _____

City _____ State _____ Zip _____



So you can't get Toshiba Printer Accessories, Bunkie?

Any time (24 hours) grab your VISA or MasterCard
JUST CALL 800/854-0561 EXT 837
 IN CALIFORNIA CALL 800/432-7257 EXT 837

Type Font Cartridges for

Toshiba P351, P341 and P321 Printers

T/FC 011 \$69	T/FC 015 \$69
Bold Letter	ORATOR1
T/FC 012 \$69	T/FC 016 \$69
Elite Gothic	Outline Script
T/FC 013 \$69	T/FC 017 \$69
Greek/Math/Apl	Theme Litale

Type Font Disks (Downloadable)

G/FD 051 \$30:	Designed especially for scientific applications; 4 fonts.
G/FD 053 \$30:	Musset (oversized characters for headlines); 1 font.
T/FD 016 \$69:	Extended word processing package. Ideal for desktop publishing; 5 fonts.
T/FD 011 \$49:	Standard word processing packaging; 3 fonts.
T/FD 014 \$49:	Presentation size type fonts; 2 Orators & 1 Outline.
T/FD 015 \$49:	Correspondence quality type fonts; 1 Roman, 1 Script & 1 Italic.
T/FD 013 \$69:	Math and Scientific fonts, 2 Math; 1 Application & 1 Scientific.
T/FD 021 \$49:	Duality Pack, 1 Regular and 1 Bold Italic & 1 Gothic.
F/FD 001 \$95:	2 Micro (10 & 20 cpi), Copper, Reg Italic, Bold Italic, Zip & Science.
F/FD 002 \$95:	Demi Gothic, Gothic (15 cpi), Boss, Semi Italic, Gothic Italic, Fairhead, Greek.
F/FD 004 \$95:	Roman, Elite Italic, OCR A & B, Pres. Pica, Greek, Micro (15 cpi).

Ribbon for 3-in-One Printers

T/R 001 \$12: Ribbon fits Toshiba dot matrix printers.

Start-Up Kit

T/SK \$39: Accessory sample kit contains Type Font Cartridge (Bold Face, Letter Gothic), Type Font Disk (Extended Word Processing), Printer Ribbon, Data Disk, Enhancement Catalog, Type Font Catalog and much, much more.

P351 Dual Emulation Kit

T/DE 351 \$99: Upgrade your early model P351 to add IBM Graphics Printer emulation. Complete instructions included.

User's & Technical Reference Manuals

Complete line of manuals to support Toshiba Printers: P1340, P351, P341, P321. Write for complete catalog.

A minimum shipping and handling charge of \$4.75 will be added to each order. 6% sales tax will be added to California orders.

PRINTER ACCESSORIES

WRITE FOR A COMPLETE CATALOG

DIRECT INC. / P.O. BOX 19608-347, IRVINE, CA 92713

away when I hit the video chip with a blast of cold freon, so my problem is almost certainly a bad video chip. I also have a concurrent problem that the screen is shifted over about a half-inch to the right with the right edge showing up on the left. This is *not* fixed by freon, but I still suspect the video chip.

atari.st/questions #111, from alexl. [Alex Leavens, Dynamic Software Design]
 a comment to 86

Do you have a homebrew 1-megabyte system (with RAM chips piggy-backed)? If not, then my fix is worthless. It only applies to those of us crazy or power-hungry enough to piggyback. I had the same problem (you should've seen my original boot screen 'til the machine warmed up!) but had it fixed by Atari engineers. Seems you need to add a couple of resistors to the extra bank of RAM. If anybody needs the info, I'll see if I can dig up the exact documentation on the resistance, and where you put 'em, and all that good stuff.

atari.st/questions #116, from sprung
 a comment to 111

Yes, I'm piggy. Got the machine from MicroTyme with their upgrade. I looked inside and found the chips neatly stacked and tied down the line. The locations that were mentioned elsewhere show the values they should, and Michtron's RAM disk allows a 709K disk, so memory seems to be working, but the screen is really quirky.

atari.st/questions #118, from alexl.
 a comment to 116

OK, I'll see if I can dig up the info on the resistors.

atari.st/questions #129, from dsmall [David Small]
 a comment to 118

Use 47-ohm resistors in series with the RAS and CAS leads coming from the MMU. They help damp the ringing and undershoot from the DRAMs. Also, be sure you use nice thick stranded wire for the top buses (like 18-gauge) and connect the wires from the MMU to the center of each bus.

OS-9 C COMPILER

atari.st/main #101, from jim_kent

Have you had experience with the OS-9 68K C compiler? Could you relate raves and/or flames if you have? I'm not all that wild about the 6809 version, though it is a gem compared to Alcyon.

atari.st/main #102, from jimomura [Jim Omura, moderator of os.9 conference]
 a comment to 101

I haven't tried the 68K version myself yet, although I have the manual. My own 68K system is halted in mid-construction in part because the 68K port for it isn't done yet and in part because I'm short of cash. The current C compiler seems to have some bugs in it but not so many as to make it unusable. The OS-9 version of microEMACS, which is posted in the os.9 conference, has been compiled with it.

The latest version I know of doesn't handle bit fields within structs and unions, preprocessor #if <constant expression> (this is according to the manual—#if is partly working at least since the microEMACS has #ifdef, #ifndef, and #endif), structure assignments and functions returning type struct, and the enum and void data types.

On the other hand, it seems to support the whole OS-9 68K system itself and long relative addressing via the "remote" data type.

OEM DESIGN/DEALERS WELCOME!! 99% Hayes compatible 300/1200 MODEM

BEST ON THE MARKET ONLY \$139

- Auto dial, auto answer (tone or pulse)
- 8 status indicators & switch selectable
- Auto speed selection 10-300, 1200 bps
- Speaker with volume control
- Aluminum case, with adaptor

SEMI-ASSEMBLED 103/212A \$129
 Modem board completely assembled & guaranteed, 5 minutes assembly



NEW !! 2400 MODEM \$299
 Add 5% Shipping Charge
SEMI-ASSEMBLED 300/1200 2400 MODEM \$299

BUILD YOUR PORTABLE XT/AT XT PORTABLE \$199

(Price includes only case, full size keyboard)
 (9" monitor, 130 watt power supply extra)
 (Full mega XT/AT m-board & standard cards)



Size, weight & looks like Compaq

Replacement & 99% Compatible AT COMPATIBLE MOTHERBOARD

\$550
 For XT or IIe MOTHERBOARD
\$150

AT/XT KIT

AT \$279
XT \$169
 (Price includes only case, power supply, & keyboard)

CONCORD Technology Ltd.
 47 W. Broadway, Van., B.C. Canada V5Y 1P1
 Ph. (604) 879-3555 or 879-7419

FACTORY PRICES ON AT/XT or IIe cases, cards, keyboards (minimum 25) \$Call

atari.st/main #104, from ktracton [Ken Tracton, Prima]
a comment to 101

The OS-9 68K C compiler is *great*, though it's missing some things such as nonunique struct member names. Otherwise I find it to be excellent, free from bugs, and relatively fast—remember, OS-9 uses position-independent reentrant coding. Highly recommended.

atari.st/main #105, from jim_kent
a comment to 104

Did you say nonunique struct member names? Does this mean if I have

```
struct block
{
    short xoff, yoff, width, height;
};
and
struct block_list
{
    struct block_list *next;
    short xoff, yoff, width, height;
};
```

that I get to do lots and lots of hairy editing? I hope not. Woe to me for not choosing the lowest-common-denominator compiler to develop on.

atari.st/main #111, from ktracton
a comment to 105

Normally, elements/members in a structure can be differentiated by context. Of course, as a matter of style one would use only similar names for very closely related entities. I think that this will be cleared up shortly along with the other missing bits by Microware Systems.

atari.st/main #106, from jimomura
a comment to 104

You know, both ktracton and I have noted the deficiencies of the compiler. But it's extremely powerful as it is. There is a substantial set of libraries included: ctype, dir, direct, errno, events, math, modes, module, procid, setjmp, setsys, sgstat, signal, stdio, strings, time (all of which I'm hoping to give brief descriptions of in the os.9 conference someday). The compiler options are complete *and* outside the actual compiler. We have "make" and a shell supporting wildcards, and the overall structure of OS-9 itself is, of course, like UNIX.

Many UNIX system calls are translated by the C compiler. It works for OS-9 because there are similar calls in OS-9 to substitute.

atari.st/main #107, from jimomura
a comment to 104

Ken, which version are you using? Do you have Revision D (February 1986)? It might be that nonunique struct member names are supported now.

atari.st/main #113, from ktracton
a comment to 107

I'm on Revision E version 1.3—haven't tried nonunique yet. You caught me quoting from the book—I'll try and report back Real Soon Now.

atari.st/main #116, from timoren [Tim Oren, KnowledgeSet]
a comment to 104

We have found a couple of gotchas in constant initialization: "xxxxx" initializer is not supported. All number constants evaluated are as 32-bit

(continued)

SMD FOR PC-AT/RT APPLICATIONS

The industry standard NMS 8000A *Multifunction SMD/SCSI single board controller* . . . designed with the OEM in mind.

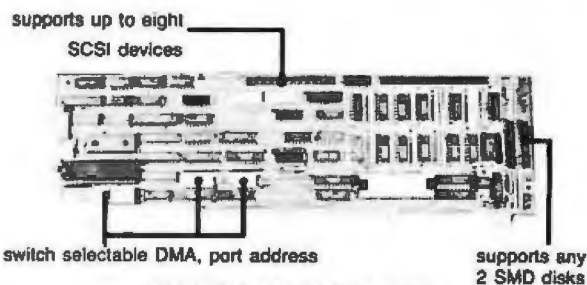

**—MONEY BACK POLICY—
(ASK FOR IT!)**

When you need performance and/or large storage on your PC, XT, AT, or RT, you need the industry standard NMS 8000A Multifunction Controller.

AVAILABLE NOW

- **CPU compatibility:** PC-XT/AT/RT and all compatibles
- **Operating system support:** DOS, Xenix, Unix
- **Major Drive manufacturers supported**
- **Special features:** simultaneous support of disk/tape/laser optical devices and:
 - **Switch selectable DMA** port address, and interrupts
 - **User selectable DOS volume size**
 - **User selectable interleave factor** of 1:1 to 20:1
 - **Data rate to 2.4mb/sec**
 - **24 month RTV warranty**

The SMD-SCSI Single Board Controller You've Been Waiting For Is Available Now . . . The NMS 8000A®

- Also ask about our complete disk and tape memory systems. Available with 5¼ inch and 8 inch technologies.

No one is developing technology like NMS

**CALL US TODAY
415-443-1669**

TWX 9103866006
TELEX 821892 NMS UD

8000A is a trademark of
National Memory Systems

The finest controllers and
memory systems for:
Microvax
Multibus
Texas Instruments
IBM PC-AT/RT



NEW

640K ON IBM/XT MOTHERBOARD

for \$ 39.95 *

Now you can have 640K Ram memory on your IBM XT motherboard without using any slots or taking any power. Easy to install two prom chip set lets you replace two banks of 64 chips with two banks of 256k chips, right on your motherboard!

- NO software or changes needed. NO soldering.
 - Works like a memory card but costs much less!
 - Requires two banks of 256K Ram memory.
 - Memory is checked and counted by IBM's built in P.O.S.T.
 - Satisfaction Guaranteed or your money back.
- MOTHER-MEM/XT Prom set with
 Instructions \$49.95
 * \$10.00 rebate when you send in your old 64K chips
 — Set of two banks (18 chips) 256K Ram memory tested and burned-in \$64.95.
 — Add \$2.00 shipping. Check, COD, MASTERCARD, VISA
 — TOLL FREE ORDERS: (800) 541-2255 wait for tone, then dial 4314311 (touch tone only)

DEALERS INQUIRIES WELCOME.



12062 S.W. 117 Court
 Suite 121
 Miami, Florida 33186



Dept. B-01

a message to our subscribers

From time to time we make the BYTE subscriber list available to other companies who wish to send our subscribers material about their products. We take great care to screen these companies, choosing only those who are reputable, and whose products, services, or information we feel would be of interest to you. Direct mail is an efficient medium for presenting the latest personal computer goods and services to our subscribers.

Many BYTE subscribers appreciate this controlled use of our mailing list, and look forward to finding information of interest to them in the mail. Used are our subscribers' names and addresses only (no other information we may have is ever given).

While we believe the distribution of this information is of benefit to our subscribers, we firmly respect the wishes of any subscriber who does not want to receive such promotional literature. Should you wish to restrict the use of your name, simply send your request to the following address.

BYTE Magazine
 Attn: Circulation Department
 One Phoenix Mill Lane
 Peterborough NH 03458



• BEST OF BIX • **BIX** • BEST OF BIX • BEST OF

quantities (can cause embarrassment in switch() statements).

atari.st/main #117, from jimomura
 a comment to 116

As for the 32-bit initial constants, that's what I'd have expected. The compiler is based on a VAX model, and I expect type int is probably 32-bit also (I don't have my manual handy).

ALCYON C

atari.st/c.language #20, from timpanton [Timothy Panton]

Registers in Alcyon C
 Has anyone out there had any problems with registers in the Developer's C compiler? I have a function that goes

```

bug(lpt)
BYTE *lpt;
{
WORD val;
register struct g_box *gb;
    gb = g_boxes;
    while ( /* some condition that's true for about 8 iterations */)
        {
            /* do some stuff with this g_box */
            gb++;
        }
}
    
```

It seems to hang the machine when lots of stuff is coming in the RS-232. The RS-232 is read by a function that is called every 20 ms by a multi-event call. All is well when the "register" is removed. Has someone been lazy with an interrupt routine, or have I goofed?

atari.st/c.language #21, from cheath
 a comment to 20

We had problems using structures, period. The structure offsets are sometimes random (or at least I could see no correlation between the output assembly code and the C source). You might do best to have a look at the assembly output.

atari.st/c.language #24, from sak [Sal Magnone, CIA Software]
 a comment to 21

I agree, if the register wasn't pushed, the routine would probably blow from the first trap you got. From what I hear, Developer's C likes to be creative with struct and union offsets.

atari.st/c.language #26, from swestrup [Stirling Westrup, Xuclid Research Inc.]
 a comment to 20

The bug is in Alcyon C. It doesn't properly support the register option. If you look at the machine code generated when you have the register versus the code when you don't have it, you will see that everything is done correctly except that there is either one too many pushes or pops in the register version. I forget the exact case. There is also a bug concerning arrays of structs.

atari.st/c.language #28, from cheath
 a comment to 26

Does anybody know if these Alcyon problems are in all of their compilers or just in the Atari version? Has there been any attempt to get this compiler updated?

```
\ object \ %1. \ execute \ %1. \ maps \ %1 > r1.lnk
echo (stuff from original r2 file) >> r1.lnk
link @r1.lnk
erase r1.lnk
```

I use a file of this nature for linking and find it works well.

ms.dos/commands #212, from rlang [Robert Lang]

On page 9-21 of the DOS 3.x manual the example used is

```
Link @RESP+mymod,@RESP2
```

Note the comma after the first entry. I didn't see a comma after @r1 in your example. Perhaps that's what's wrong.

ms.dos/commands #213, from geosch

Linking Resolved (I hope)

I just want you all to know I think this BIX idea is just great! I joined expressly for the purpose of resolving my linker problems. Even if I'm jumping the gun a little, you can't beat the attention of so many caring souls. I think I'll hang around.

Believe it or not, I hit on what is essentially rlang's solution just after I logged off last night. Rob, the key is not the comma but the plus sign after the first ARF. The comma won't work because that would exclude the main object file from the list (it isn't and can't, for sake of generality, be a part of r1) of object modules. Thank you very much, all of you, for responding.

If I have any more problems, first I'll try the "echo" solution. It sounds great to me. Then I'll let everyone know.

LET MY MEMORY GO

ms.dos/other #338, from hans [Henry Botjter]

I just read about a program called Ready! (see Jerry Pournelle's Chaos Manor column in the February BYTE). It loads into high memory and stays resident. Any idea how it does this? Also, how does SideKick free up memory if you "de-res" it (by pressing Ctrl-Home Ctrl-End)? Sounds interesting.

ms.dos/other #340, from denis.gilbert [Denis Gilbert]

I wrote a little resident program that displays the time of day in the upper right-hand side of the screen. Unfortunately, it seems to lock everything up very quickly. I think it's because I'm using INT 21 to get the time of day and that more clock interrupts come in while I'm processing the current one. Does anyone know how to turn the results of INT 1A into hours, minutes, seconds, and milliseconds? Thank you.

ms.dos/other #341, from barryn
a comment to 338

Programs that want to attach themselves to DOS ("terminate but stay resident") usually do it by issuing INT 27H instead of INT 20H. Freeing up the memory later is similar; there's a DOS function (49H, as I recall) for it.

ms.dos/other #342, from barryn
a comment to 340

It's easier to issue the DOS function call to get the time of day; why not try that instead? The result will come back nicely separated in the CX and DX registers and will even tell you the day of the week.

ms.dos/other #343, from rschnapp [Russell Schnapp]
a comment to 340

No! Don't try calling INT 21 from an interrupt routine! You shouldn't even call INT 1A, though you have a better chance of getting away

with it. The problem is that neither DOS nor the BIOS are reentrant. That is, if the currently executing program happens to be requesting service from DOS or the BIOS when a timer interrupt comes in and invokes your clock program, you will attempt to call the DOS or BIOS yet again. This messes up the system something awful.

Your better bet is to locate the BIOS memory location that contains the value returned by INT 1A. It is discernible from the Tech Reference Manual's BIOS listing. If you can't get it from there, let me know. I can dig it out from somewhere.

ms.dos/other #344, from jimkeo [Jim Keohane]
a comment to 343

If Denis Gilbert's resident program is invoked only by a calling program (via interrupts or long calls), then he should be OK.

I think, though, his resident routine attaches itself to the timer interrupts and gets invoked 18.2 times a second. If so, he's probably better off issuing a DOS time-of-day call before tying in his ISR and then bumping a counter whenever he's invoked. He can keep adding 10 to a counter. When the counter exceeds or equals 182, he redisplay the time and subtracts 182 from his counter. I assume, also, he's passing control (via user INT) to whatever ISR initially had the timer interrupt. By redisplaying the time I mean previous time + 1 second.

ms.dos/other #345, from dthielen
a comment to 340

There are two possible major causes of your resident program locking up your computer: (1) Does your program have its own stack that is constant? If so, and your program is called when you are in your program, you will cream your stack. If you use the DOS stack, you can fill it up fast. You need to have a stack that will allow your program to be called inside itself. (2) If your program is called while you are in DOS (like the prompt), you will cream DOS and it's all over. Only if you do not use DOS can your program run while in DOS.

ms.dos/other #346, from rduncan [Ray Duncan]
a comment to 341

In DOS version 2 and later, the "preferred" method of terminating and staying resident is with INT 21H function 31H, rather than INT 27H. INT 27H had a particularly bad bug in it for one thing. And INT 21H function 31H allows you to reserve more memory.

ms.dos/other #347, from denis.gilbert
a comment to 344

Thanks for all the suggestions. The idea of using a CS:relative counter and incrementing it is good, but I wonder how accurate it would be. If interrupts are turned off, which happens quite a few times, then wouldn't my "clock" slowly lose time? Perhaps another way would be to continue using the INT 1AH call but set a flag on entry to my ISR such that any interrupts received while "not yet done" would simply be ignored. Sort of like setting a variable to prevent reentrance.

ms.dos/other #348, from jimkeo
a comment to 347

The timer interrupt should be delayed only, not lost, unless INTs are off for more than 1/18 of a second. Even then I'd issue an INT 1AH once every couple of minutes just to stay in sync.

If your timer routine is in control for more than 1/18 of a second (highly unlikely), there probably still wouldn't be a problem, since it just goes back to sleep 17 of 18 times.

I'm just making suggestions to preclude issuing any INTs 18 times a second. You can poke the updated time direct to screen memory every second or every 5 seconds or whatever.

Dave's suggestion about setting up your own stack makes sense if you're gonna be issuing INTs or doing any stack pushing/popping. I don't think you have to, though.

ms.dos/other #349, from dthielen
a comment to 347

A flag would stop your program from clobbering its own stack. However, it doesn't answer the problem of calling INT 1A while in DOS and clobbering DOS. Also, if you use over about 16 bytes of stack, make sure you have your own stack. When resetting the SS:SP for the stack, you must change SP as the NEXT instruction after SS.

ms.dos/other #350, from rschnapp
a comment to 347

Denis, the problem is not with reentrance to your code, it's with reentrance to the DOS or BIOS code. You cannot protect against that without some severe measures. Really, there is a good counter, fixed at 40:xxx in the BIOS data segment. I forgot to dig it out of my manual at work today. If you've got one handy, just trace it down from the INT 1A ISR. You could even disassemble the code with Debug. Check the vector at 0:68; it points to the INT 1A ISR. Then disassemble from there.

I'll try to remember to get the BIOS address for you.

ms.dos/other #351, from rschnapp
a comment to 347

Here is the IBM (and compatible) solution: The location of the 32-bit clock counter is 40:6C through 6F. The low word is at 6C, the high word at 6E. I believe that the value there is the number of ticks since midnight.

For details on how to build this into a clock, see the July 1984 *Softalk/PC*, page 82, if you can get it. I have a copy of just such a program, but I don't have permission from the copyright holder to republish it. Sorry. The program is from that issue.

ms.dos/other #356, from denis.gilbert
a comment to 350

I did some digging around. The two locations used for the timer are

0040:006C (the low word) and 0040:006E (the high word). The high word is the number of hours, the low the number of seconds. This way, I don't clobber DOS's stack by issuing any INT 21s or INT 1As.

ms.dos/other #367, from dmick [Dan Mick]
a comment to 338

Regarding "de-resing," or freeing up memory that has been used to save a resident program, here is what I think, and someone please correct me if I'm wrong, 'cause I'm still kinda confused.

If a program such as SideKick or Quadram's print buffer relocates itself to hi-mem, then resets top-of-mem by fooling DOS, releasing the memory is no problem. Just re-reset top-of-mem to the original value saved somewhere in resident program's reserved area, and disable INT calls, etc. Then just let whoever wants at hi-mem next have it (COMMAND.COM, probably).

If, however, a program stays in lo-mem (above DOS) and terminates with either an INT 27H (and I hope no more systems programmers are still using this INT—read your DOS 2.xx manual(s)) or INT 21H function 31H—you can't let go of the memory you reserve via either of these calls, because it "doesn't belong" to whatever process is trying to free it up. The best you can do is disable the resident program and, perish the thought, do an INT 19H to reboot (on IBMs, anyway) or live with the used memory. Granted, this is *usually* not much memory, but does this strike everyone else as just reprehensibly inelegant and nonrobust? What about the multiuser system where 20 users may want to install/deinstall the same moderately large resident program?

Any comments here will be appreciated, any solutions profusely welcomed.

ms.dos/other #368, from jimkeo
a comment to 367

De-resing

Dan, Mark Welch has uploaded MARK-REL.ARC to the IBM area of Listings. Basically, the program takes a "snapshot" of critical portions of RAM before a "resident" program is brought in. You can then run the REL side of the package and it releases the memory by restoring those critical pieces of info. See pascal/turbo #922 for more info. Also, as to "de-resing" do's and don'ts, see pascal/source #25 and 26 for a

(continued)

Maxell Floppy Disks

The Mini-Disks with maximum quality.



Dealer inquiries invited. C.O.D.'s accepted. Call FREE (800) 235-4137.



PACIFIC EXCHANGES
100 Foothill Blvd., San Luis
San Luis Obispo, CA 93401
In Cal. call (800) 592-5935 or
(805)543-1037.

NEC PRINTERS

(1 Year Factory Warranty)

- Pinwriter P5\$ 925
- Pinwriter P5XL\$1100
- Pinwriter P6\$ 445
- Pinwriter P7\$ 575
- Elf 350/360\$ 380
- 3510/15/30/50\$ 715
- 8810/15/30/50\$1040

Optional Forms Handling DevicesCALL

QUALITY PRINTERS
8415 Cement City Road
Brooklyn, Michigan 49230
Phone: 517-592-3749

\$91.00
Single Board Computer

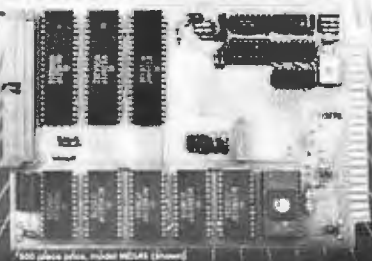

6800 MPU, serial I/O, parallel I/O, RAM, EPROM, 44-pin 4.5" x 6.5" PCB
EXPANSION MODULES: RAM, EPROM, CMOS RAM/battery, analog I/O, serial I/O, parallel I/O, counter/timer, IEEE-488, EPROM programmer, floppy disks, cassette, breadboard, keyboard/display.

WINTEK
Wintek Corp.
1801 South Street
Lafayette, IN 47904
317-742-8428

posting by Dave Winer of Living Videotext (Ready!, ThinkTank).

John Fistere, moderator of the ibm.pc conference, has also made Dave Winer's posting available to members of that conference in ibm.pc/long.messages #2 and 3.

Purportedly, MARK-REL.ARC handles the lo-mem and hi-mem resident programs, and there will be a version that even handles those resident programs that can reside in extended memory (Ready!).

ms.dos/other #370, from dmick
a comment to 368

It really doesn't seem as though that's what I want. A snapshot of the low 512 bytes will restore the INT calls, but the problem is the memory that DOS allocates (see INT 21H functions 4B, 49, 4A). My documentation says or, rather, implies that a program that deallocates memory not belonging to it can destroy DOS's memory management blocks, resulting in an "area trashed" error return.

Any other comments?

ms.dos/other #371, from jimkao
a comment to 370

MARK-REL.ARC

Dan, I haven't looked at MARK-REL yet, but I'm sure that it does more than just take a snapshot of the lower 512 bytes! I believe it takes snapshots of interrupt vectors, DOS memory control blocks, and all pertinent info required to later restore DOS to the exact state (including memory allocation) as before. I recall a comment somewhere on BIX from some authors of resident software stating that MARK-REL didn't free up extended memory but that it would handle extended memory in a future release. Ready! loads itself into extended memory (on the AT) if possible.

I'm guessing, but it may even restore previous directory, previous environment(s), previous DOS prompts, previous paths, etc., to as they were at MARK time. Obviously, it could dump/restore the entire contents of RAM, jump to its original return point, and have you back where you were (with the exception of a few bytes of RAM for its own termination).

ms.dos/other #374, from rschnapp
a comment to 371

I downloaded MARK-REL and examined it. It sure looks like it is only "snapshotting" 1K bytes of low memory.

ms.dos/other #375, from jimkao
a comment to 374

Thanks for the correction, Russ. Sorry if I misled anyone. I certainly had the impression from a comment elsewhere on BIX that MARK-REL addressed the freeing up of resident memory, too!

ms.dos/other #377, from rschnapp
a comment to 375

You're quite right, Jim. I'm sorry. In addition to snapshotting the lowest 1K of RAM, MARK-REL lets you peel off memory-resident code. Nevertheless, the only memory it is saving/restoring is the lowest 1K.

By the way, this is just from examination of the source code. I haven't tried running it yet.

ms.dos/other #380, from dmick
a comment to 375

Yet Another Message About MARK-RELEASE

Sorry, Jim, I looked only at MARK.ASM, partially out of laziness, partially because RELEASE is written in Turbo Pascal, and I'm not much of a Turbo'ar yet. In particular, the variables and functions and nested procedures used will keep me busy for a while. It sure seems as though

the author has access to some information about DOS's memory management that I've never seen anywhere, though, and since really what I'm looking to be able to do is to release memory through assembly language, the listing, once I understand it (substitute "if" for "once"), should lead me down the right path. It looks as though the RELEASE section hunts through memory for DOS memory control blocks (described but not documented in my DOS 3.0 Reference Manual) and then determines which were allocated after the MARK procedure saved a few bytes of text. From this, and I don't know how he knew to do it, it looks as though the DOS deallocate block is called for the remaining ones in the list.

Any thoughts on just where in the *-&*&-* one finds info on memory management? Or, alternatively, is Kim Kokkonen (the listing gives him as author) on BIX? If you are, Kim, I'd like to keep this discussion here—if not, all you other interested parties, I'll phone and ask him. Also listed is a company called TurboPower Software. How do I find out if he's on BIX, anyway? Is there a way?

For that matter, I don't know if the party in question is male, sorry about that! (Replace "he" with "he/she", or perhaps "she/he"? It really was an innocent mistake...) Anyway, Jim, thanks for the info, and everyone else interested in memory allocation, stay tuned.

ms.dos/other #381, from jimkao
a comment to 380

Dan, Kim Kokkonen's not currently on BIX—shame. I've done a little playing with DOS allocation blocks to see that it's not a linked list. When you do a DOS ALLOCATE, you get back the SEG value for that block. The paragraph (16 bytes) at SEG-1:0 contains some info. A word at offset 3 (yup, odd address) contains the number of paragraphs. Another byte (forget which one) indicates whether this block is free or allocated. I don't know where the first DOS mem block is, but knowing any DOS block, I can determine free and allocated blocks at higher mem locations. I also don't know of any such docs on DOS mem allocation nor whether it can be counted on with future releases of DOS.

ms.dos/other #382, from dmick
a comment to 381

I recently took apart the DOS loader (for the EXEC call in particular), which, of course, must allocate memory. I wondered what all that stuff at pspseg-1 was! Man, the carbon-arc light may have just clicked.

I think I'll phone Kim anyway, and I'll post the results here tomorrow. I'd like a good discussion of this if one is available, as well as the knowledge of whether or not this is one of those SWITCHAR deals that is undocumented only because it's not going to continue.

ms.dos/other #383, from billn (Bill Nichols)
a comment to 382

The initial DOS allocation scheme is not robust enough for multitask support, so I expect it will change in 4.0 and possibly again in 5.0. But it may be supported by calls at some point, so the internal details won't be so critical. Suggest you isolate any allocation stuff.

ms.dos/other #386, from dmick
a comment to 383

Sorry it's taken me so long, but I called Kim K., and he says "there's no good reference." He got info from snooping, did refer me to the August 1984 *PC Tech Journal*, which I have not yet had the opportunity to search for. I think I'll look for a back issue at a library, then report here; meanwhile I'll still be snooping!

ms.dos/long.messages #3, from dmick
a comment to 386

De-resing, Releasing Resident Program's Memory, MARK-REL, et al., More on the TSR Question, and DOS Memory Allocation

If you are good at Turbo Pascal, reading RELEASE.PAS (available on Listings as part of MARK-REL.ARC) is a good way to get an idea of what DOS does for memory allocation, but if you're not, perhaps you'll benefit from my experience.

When a program is executed by DOS, either in response to a program's EXEC function call or to a user's request as processed by COM-MAND.COM, DOS builds a 5-byte memory control block as follows (note that this works the same on PC-DOS 2.10 and MS-DOS 2.11 on the Zenith IBM clones):

First byte: either 4D or 5A depending on whether this is the last block allocated (5A) or middle block (4D)

Next 2 (word): segment address of segment this MCB references

Next 2 (word): length, in paragraphs, of the referenced segment

Example: 09CB:0000 4D CC 09 68 00 is an MCB that says:

1. this is *not* the last MCB that exists (4D)
2. it exists to control the block of memory beginning at segment 09CC
3. that block of memory is 68 paragraphs long (i.e., 680H bytes)

Note that the next MCB should appear at segment address 09CC + 68.

The MCB appears one paragraph before the PSP segment; thus, if 09C5 is the PSP segment address, 09C4:0 will contain the MCB for the PSP and its process (immediately following the PSP). PSPs may be identified by the first 2 bytes containing the process termination call, CD 20 (INT 20H).

The MCB for the environment of a process (environment segment address may be found at PSP:2C) has, as its "segment address of segment this MCB references" address, the PROCESS'S PSP SEGMENT ADDRESS, which seems rather confusing. The MCB for the environment also directly precedes the environment, which (near as I can tell) always directly precedes the process and its PSP. The environment MCB's length field is correct.

Sometimes, and it may depend on things about the way DOS manages memory that I don't understand, there exists an MCB as follows:

XXXX:0000 5A 00 00 YY YY

where YYYY represents the currently available RAM. This seems to me to say, "There is a segment starting directly after this MCB (i.e., at segment XXXX + 1) that consists of YYYY paragraphs." This MCB is the last in the list, since its ID byte is 5A. I've never been able to find any other kind of "last MCB," so maybe if a process loads and takes all of available memory, it has a "5A" ID byte but a real segment address and length, distinguishing its RAM from available RAM (as in the example above) by the fact that it has a real segment address in the MCB's second and third bytes. I'm not sure.

The whole reason I got into this mess is that I was trying to solve the following problem: I'd write a resident routine, say an A/D interrupt setter-upper/interrupt service routine. It installs itself and some buffer area, reserves memory, and terminates with "Terminate and keep process" function (31H). Fine; now later I want to deinstall, which at the very least involves undoing the ISR (which is no problem, just get its address from the vector and, knowing where in the ISR the old vector address is stored, restore the vector). Problem: How do I dump the memory it used (no longer needed and not necessarily wastable... small systems and/or a large buffer in the ISR) with a process that is executed later on? Granted, I knew I had to be reasonably sure that nothing had installed itself above me, but I thought I could say that OK. The problem was, the deallocate function (49H) has this error that's described:

9: Arena trashed—DOS's memory management arena has been corrupted.

This is probably due to a process reallocating memory that does not belong to it.

Well, that scared me off from even trying. As it turns out, though, if you can figure the address of the PSP of the process that reserved memory last, you can also get the address of its environment, and you can pop them both from the process that has (necessarily) loaded higher in memory and then terminate the deallocating process (of course, terminate and deallocate via function 4CH or equivalent) and get all your memory back leaving DOS unscathed.

Whew! That was an awfully long discussion, but the information would have been invaluable to me two or three months ago. For related information, look at MARK-REL.ARC in the IBM listings. Also, the author of that package has written several others that are now public domain, to use up memory (to test programs that may run on smaller systems) and a program that prints out all the MCBs that now exist on the system and what interrupts they may be controlling. The author also told me via phone that the August 1984 *PC Tech Journal* (which I have *still* not found) has an article referencing memory allocation.

Good luck all. I'll elaborate further or, if no one cares, I'll at least *feel* as though I've done a great public service.

ms.dos/other #389, from pittore [William Pittore]

The word that comes after the 4D or 5A is the segment address of the "owner" of the block of memory. For instance, if a program does several 48H (allocate) calls, it will have created several blocks of memory and each memory block descriptor will have that program's PSP as its owner. The last block of memory that has a 5A 00 00 means that no program owns this block of memory.

MACINTOSH

This month in the Macintosh conference we have a fix to the power supply dilemma posed by the pin-out change on the Mac Plus. We have programming questions about windows and resources. There is also a question on whether to upgrade from a Lisa to a Mac Plus.

THUNDERSCANNER POWER SUPPLY FIX FOR MAC PLUS macintosh/tech.talk #171, from rkaapke [Richard Kaapke]

I have got my ThunderScanner working with my Macintosh Plus. I wired a "toy" transformer to two pins on the DB-9 connector that the ThunderScanner adapter box connects to. First, let me give you the correct pin-outs for making an adapter from the peripheral-8 (aka mini DIN-8) to DB-9 connector:

Pin	Peripheral-8	DB-9 Female
1	+12	6
2	Handshake	7
3	TxD-	5
4	GND	3
5	RxD-	9
6	TxD+	4
7	N/C	
8	RxD+	8

Important: Jumper pins 1 and 3 together on the DB-9 side (this brings GND to both places it's expected). Next, to make this a port that can run peripherals requiring +5-V supplies, connect the ground lead of the power supply to pins 1 and 3 on the DB-9 and connect the +5-V lead of the external power supply to pin 2. If you don't want to use an exter-

(continued)

nal +5-V supply, find a way of jumpering the +5-V line from the mouse port (DB-9 pin 2 of the mouse port) to pin 2 of the adapter cable. This makes a bit of a tangle on the back of the Mac, and the +5 V cannot survive more than a 200-milliamp drain, mouse included. Therefore, it's not useful for many peripherals (although I know someone whose ThunderScanner is running off the +5 V from the mouse port).

I feel safer with an external +5-V supply myself; it's up to you to decide which way to do it. If you have no idea how many milliamps the peripherals requiring +5 V draw, it's better to be safe than sorry, as messing around with the voltages coming from your Macintosh Plus may possibly void your warranty.

MAC C UPGRADES, WINDOWING, AND RESOURCES

macintosh/softw.devlpmt #195, from rball [Richard Ball]

Help Needed with Window Definitions

I have a question for the experienced Mac programmers out there. I am writing a program to display and rotate molecules taken from a variety of databases (as an X-ray crystallographer in a university chemistry department I do this professionally and I figure the Mac should be a good tool to use). The program runs fine using an on-screen window for display, an off-screen bit map into which each new view is written, and COPYBITS to get the picture from one to the other. My question is this: Since rotations are simplest when they are centered at 0,0, the best window to have would be one in which 0,0 was at the center rather than the top left corner; however, all my attempts to get the two bit maps to behave in this way have failed. Presently I get around the problem by shifting each point by half the window dimension, but I would think that the proper set of definitions would make this kludge unnecessary. What is the best sequence of Toolbox calls and window definitions that will accomplish this task? Has anyone actually done this? It seems like it should be very simple, and any concrete help would be appreciated.

macintosh/softw.devlpmt #196, from rschnapp [Russell Schnapp]
a comment to 195

I know there is a Toolbox call to relocate the local coordinate system. Yeah, there it is, on page I-154 in the Addison-Wesley edition of *Inside Macintosh*. SetOrigin(x, y: integer) should do the trick. It should be in the QuickDraw chapter of whatever documentation you've got.

macintosh/softw.devlpmt #206, from dwaikert [Daniel Weikert]

Mac C and HFS

Can anyone tell me if Mac C is HFS-compatible?

macintosh/softw.devlpmt #207, from lloeb [Larry Loeb]
a comment to 206

Mac C should be shipping an HFS-updated product. Some of the equates were in the January *MacTutor*. Note that the HFS equates for MDS are sitting in the "mac.supplmt" area of the Listings conference as a .pit file.

macintosh/softw.devlpmt #208, from rkaapke
a comment to 206

There's a version 4.5 that is totally compatible with HFS and the Mac Plus. I have it on order, but it hasn't arrived yet. I also understand that it has support for the 68881 math coprocessor and the 68020. Of course, it has an intelligent linker that includes *only* those library routines your code requires, *not* the entire module the routine lives in.

This is a great boon for Mac 128K compatibility, at least as far as the code space requirement is concerned. The 68020 support team is real keen for producing custom software for those folks with the Levco or GCC Macintosh add-ons that include this and the 68881.

macintosh/softw.devlpmt #209, from msackett [Michael Sackett]
a comment to 208

I just received version 4.5. It supports HFS and I've seen additions to the COMMONLIB.ASM file with comments like "clear out 68020 cache" followed by a series of NOOPs. However, support for the 68881 boards that are out there is supposedly being provided by the "Direct Access" versions (extra cost) of the compiler.

macintosh/softw.devlpmt #210, from tom_thompson [Tom Thompson,
Technical Editor, BYTE]
a comment to 209

Did you have an earlier version of Mac C and get an upgrade, or what? What do owners of version 2.0 or 4.0 have to do to upgrade?

macintosh/softw.devlpmt #212, from rball
a comment to 196

Yes, I thought that would do the trick also. However, when I actually tried it, I had no luck. You do change the origin of the off-screen bit map, but it doesn't stamp on in the proper place. I'm still doing (or not doing) something wrong. I'll play some more. . . .

macintosh/softw.devlpmt #213, from msackett
a comment to 210

Yes, I had 4.0, and I sent in my registration card. About three weeks ago Consulair sent me a letter describing the upgrade and the "Direct Access" versions of the compiler. I suppose that anyone who sent in a registration card got the letter. The upgrade cost was \$20 if you sent back your old disks and \$35 if you didn't. It arrived in about a week.

macintosh/softw.devlpmt #214, from cecpate [Charles Pate]

Help on Understanding Resources

I need help on understanding resources. *Inside Macintosh* has information, but it just hasn't made my light bulb go on. I have checked out all books on the Mac and found they all have even less on resources and how to utilize them. It's so bad that I haven't been able to get my own icon for applications to appear on the desktop.

macintosh/softw.devlpmt #218, from rball
a comment to 212

OK, I got it figured out. It's critical where the SetOrigin call is placed in the flow of the code. The "bounds.rect" of the off-screen bit map must also be defined properly (i.e., ignore the SetOrigin). One call to SetOrigin to set it to negative values must be balanced by another to 0,0 for the routine to be reentrant.

macintosh/softw.devlpmt #219, from chrismason [Christopher Mason]
a comment to 214

What are you using to create the resources? If it's RMaker, give up. I never could get the thing to work right. I use Mac C also, but I create all my resources in assembler. A great reference that I still use is vol. 1 no. 7 of *MacTutor* magazine, where most of the common resource formats are described. Here's how to create a program icon:

1. You have to have the bundle bit on in your application. Use the bundle option on the MDS or Consulair linker.
2. You need several resources in your program. (Make sure the resource REL files are located in the resource section of the link file.)
3. Here's a sample:

```
.align 2
resource 'ICON' 128
<<dc.l, 128 bytes for icon, 128 bytes for mask >>
```

```
.align 2
resource 'BNDL' 128
dc.l 'xxxx' ;signature
dc.w 0,1 ;unknown data
dc.l 'ICN#'
dc.w 0 ;# of mappings—1
dc.w 0,128 ;map local 0 to icon 128
dc.l 'FREF'
dc.w 0 ;#
dc.w 0,128
.align 2
resource 'xxxx' 0 ;same signature as above—use also as type in linker
dc.b len,'version/name'
.align 2
resource 'FREF' 128
dc.b 'APPL0,0,0'
```

Then just follow the instructions for the linker; be sure you have bundle and type.

macintosh/softw.devlpmt #221, from paul.hoffman [Paul Hoffman] a comment to 219

I have no problems using RMaker, except that the Mac RMaker uses a different format (slightly) than the Lisa RMaker. Still, I've never had any problems with the Mac RMaker when I followed the examples that came with my compilers.

A PROBLEM WITH CHARACTERS IN PASCAL
macintosh/softw.devlpmt #223, from paul.hoffman

I am trying to count the number of CR characters in a file as part of a larger program. I have read the file into a buffer pointed to by IPtr. I tried the following procedure:

```
PROCEDURE CountCR(IPtr: Ptr; Size: longint; var Ct: longint);
Var
  nCRs, i: longint;
  testbyte: byte;
  testptr: ^byte;
Begin
  nCRs := 0;
  for i := 0 to Size-1 do
    begin
      testptr := POINTER(i+ORD(IPtr));
      testbyte := testptr^; {crash-o-rama}
      if testbyte = 13 then nCRs := nCRs + 1;
    end;
  Ct := nCRs;
End;
```

The line with the comment causes a system crash (ID=02). If I take out the commented line and the one following it, it runs just fine. If I take out the commented line and substitute "testptr" for "testbyte" on the following line, it crashes again. My guess is that something is wrong with using testptr.

I'm compiling with TML Pascal. Can anyone hazard a guess what I am doing wrong? Is it a compiler problem? Is there another graceful way to step through a buffer without knowing the size ahead of time?

macintosh/softw.devlpmt #224, from ccawfor [Chris Crawford] a comment to 223

At last I get to help somebody else for a change! Your problem lies in the fact that you have a pointer with an odd value. That is, when your loop index "i" has an odd value, the value of "testptr" will be odd. This is a severe no-no with the 68000, which is why you got an ID=02 error.

How, then, does one access individual bytes in a long sequence?

Well, you could make a hbyte and lbyte function in assembly language that takes a 16-bit word and returns the two constituent bytes of that word. That's the "trust nobody, do it yourself" solution. It is also possible to do the same thing in Pascal with modulo-256 computations. Alternatively, you might bring the file into a string 256 bytes at a time and then use string manipulation functions directly.

macintosh/softw.devlpmt #226, from paul.hoffman a comment to 224

Thank you, thank you, thank you. I know virtually nothing about the 68000, but I understand your explanation about the pointer being odd. I will simply try bringing two bytes in at a time and working from there.

ANOTHER MACPLOT QUESTION

macintosh/prod.discussn #375, from rweaver [Robert Weaver]

I have some questions about MacPlot:

1. Does it use the maximum resolution of the plotter?
2. Are all objects clipped properly with respect to other objects? (E.g., if I draw a white filled box over a black filled box, will the plot look the same as the screen?)
3. Is MacPlot a driver or an application?
4. Does it work with Houston Instrument plotters?

macintosh/prod.discussn #376, from bvanantwerp [Bill Vanantwerp] a comment to 375

Using the HP 7475 plotter, the resolution of the plotting is about the maximum of the plotter. The plots are scaled very closely to the screen if the drawing was done in MacDraft or MacDraw. MacPaint I cannot comment on. MacPlot is definitely an application and cannot be built into the normal applications except through Switcher. Several Houston Instrument plotters are supported. Caveat: The outputs are still not as good as from several of the IBM programs available.

LISA OR MAC PLUS?

macintosh/lisa #18, from johnbell [John Bell]

Apple has made the offer to accept our Lisas and \$1500 of our cash for a new Mac Plus with an HD20. Is this a good deal? How many of us are willing to switch? What are the benefits/faulds of this idea?

I desire to switch, but it is extremely unlikely that I can raise a spare \$1500 by the deadline (mid-August, right?). Also, I'm a little leery of getting an HD20 with it, as I understand that it is slow, because it connects to the external drive port. There are rumors that Apple is coming out with a faster HD for the Mac Plus, and I'd rather get that (or a HyperDrive) for my system. I've heard that there are some incompatibility problems between software written for the Mac and the Mac Plus—are these vendors going to rewrite their software? Are these the same incompatibility problems that I'm having with my Lisa in Mac Environment? I'm really not sure that trading to a Mac Plus will get me anything but sound if all of the incompatibility problems are addressed with a new version of MacWorks XL and by having vendors change their software to become more generic. Any ideas?

macintosh/lisa #19, from lloeb a comment to 18

The incompatibility problems are HFS-related, mostly. The future incompatibility problems will arise when software tries to use calls in the 128K ROM that are not in 64K ROMs, but those are not showing up yet. Depends on what you want to do. I don't want a machine I can't carry around with me, so I'm committed to the original case Mac. That doesn't mean there won't be alternative solutions for people who want different things from their machines. The HD20 will have an SCSI port soon, so that may speed it up. ■

THE BUYER'S MART

A Directory of Products and Services

THE BUYER'S MART is a monthly advertising section which enables readers to easily locate suppliers by product category. As a unique feature, each BUYER'S MART ad includes a Reader Service number to assist interested readers in requesting information from participating advertisers.

RATES: 1x—\$475 3x—\$450 6x—\$425 12x—\$375
Prepayment must accompany each insertion.

AD FORMAT: Each ad will be designed and typeset by BYTE. Advertisers must

furnish typewritten copy. Ads can include headline (23 characters maximum), descriptive text (250 characters maximum), plus company name, address and telephone number. Do not send logos or camera-ready artwork.

DEADLINE: Ad copy is due 2 months prior to issue date. For example: June issue closes on April 1. Send your copy and payment to THE BUYER'S MART, BYTE magazine, 70 Main Street, Peterborough, NH 03458. For more information call Karen Burgess at BYTE 603-924-3754.

ACCESSORIES

FREE CATALOG

Outstanding prices on computer accessories for your computer and workstation. Our catalog features a wide selection of quality products to meet all your accessory needs. Call or write today to receive your free catalog.

LINTEK COMPUTER ACCESSORIES
POB 8056, Grand Rapids, MI 49508
(616) 241-4040

Inquiry 710

ACCESSORIES

DATA CABLES & PARTS

EIA RS232-C Data Cables - standard, extended distance, Teflon Assemblies. Also Centronics (parallel), Coaxial (RG59U, RG62A/U, Dual Wang, Twin-axial), Ethernet, Ribbon, IBM, DEC Compatible cables, AB switches, connector parts, bulk cable, tools & hardware (wall plates) Send for Catalog.

Communication Cable Co.
POB 600-B, Wayne, PA 19087
215-644-1900

Inquiry 675

ACCESSORIES

SOFTWARE PACKAGING, DISKS

Cloth binders & slips like IBM's. Vinyl binders, boxes, and folders—many sizes. Disk pages, envelopes, & labels. Low qty. imprinting. Bulk & branded disks. Much More! Low prices. Fast service. Call or write for FREE CATALOG.

Anthropomorphic Systems Limited
378-B East St. Charles Road
Lombard, IL 60148
1-800-DEAL-NOW (312) 629-5160

Inquiry 657

FREE CATALOG

Thousands of parts and new surplus electronic parts at super low prices. FAST ORDER PROCESSING AND SHIPPING (95% of all orders shipped within 48 hours)

CALL OR WRITE FOR A FREE CATALOG

ALL ELECTRONICS CORPORATION
POB 20406, Los Angeles, CA 90006-0406
1-800-826-5432

Inquiry 654

LASER PRINTERS

I will pay you cash for your used toner cartridges!! (HP, Apple, Canon, etc.)

Recharging Service \$40

Call or write for free instant pickup service:

PC Corporation, Laser Printer Products
11 Freeman Street, Stoughton, MA 02072
(617) 893-9000 (24 hours)
(617) 341-3005 (9-5 pm Eastern)
Dealer inquiries welcome

Inquiry 742

BAR CODE

PRINT BAR CODES ON PC

Print Bar Codes and Large Text Labels on PC with Epson/Olivetti/IBM Printers - Code 39, 12of6, UPC, MSI, DOD-LOGMARS, AIAG. Text up to 1" tall. Labels and Catalogs from files. Assembly subrtns for BASIC, Turbo Pascal, Pascal, MS-C, Lattice C, dBASE III+.

Worthington Data Solutions
130 Crespi Court, Santa Cruz, CA 95060
(408) 458-9936

Inquiry 781

... SOFTWARE PUBLISHING. . .

GDS offers a wide variety of services that will help get your software to the market. Address your needs with GDS.

- IBM style cloth/vinyl 3-ring binder/slips
- Labels, sleeves, disk pages, bulk diskettes
- Disk duplication with 100% verification
- Shrink wrapping and product assembly
- Quick turn-around.

A well packaged product can make the difference in making a sale. Call us now! VISARMC.

GLENCO DEVELOPMENT SYSTEMS(312) 392-2492
3920 Ridge Ave., Arlington Hts., IL 60004

Inquiry 702

COMPUTER PROTECTION

- UPS • LINE CONDITIONERS • ISOLATORS
- MODEM PROTECTORS
- AC POWER INTERRUPTERS

— HUNDREDS OF HINTS & PRODUCTS —

FREE CATALOG 1-800-225-4876

ELECTRONIC SPECIALISTS, INC.
171 So. Main St., POB 389, Natick, Mass 01760
(617) 655-1532

Inquiry 686

BAR CODE READERS

Program-transparent, Keyboard-wedge Bar Code Readers for IBM PC, AT and compatibles—\$598. Other wedge readers for IBM 3180, 3178, 3278, 5251, 5291, and RS-232 terminals. Portable Bar Code Readers from \$325. Programmable Hand-Held Portables—\$1200.

Worthington Data Solutions
130 Crespi Court, Santa Cruz, CA 95060
(408) 458-9936

Inquiry 781

Save on TRIPP-LITE Model SK6-0, 6-Outlet Surge Suppressor

Immediate delivery Only \$25
Call INDUS-TOOL toll free

1-800-662-5021

Inquiry 710

Self-Inking Printer Ribbon

For users of Olivetti and other open spool ribbon printers. Controlled Printout Devices are a new kind of printing ribbon that re-ink themselves, and will last 15 times longer than the ribbon you are now using. For further information please call or write.

CONTROLLED PRINTOUT DEVICES, INC.
POB 869, Baldwin Rd., Arden, NC 28704
(704) 684-9044

Inquiry 682

BUSINESS OPPORTUNITIES

VIDEO STORES

We need ambitious dealers in all U.S. states and Canada to market a powerful system to computerize video tape rental stores.

WINCHESTER DATA PRODUCTS INC.

3301-Executive Drive., #204, Raleigh, N.C. 27609
(919) 872-0995

Inquiry 780

Lifetime Warranty

1-99 @ \$85 100-249 @ \$55 250+ @ \$52
Diskette from Software Mfg., old version hard-disk program (bulk erased). While supply lasts.

SS/DD 100-249 @ \$34 250+ @ \$28

DS/DD 100-249 @ \$40 250+ @ \$33

Shipping (UPS) \$2.50, C.O.D.'s \$2.00

H & O Enterprises

1250 North Broadway, Fargo, ND 58102
(701) 232-2780

Inquiry 706

LOWEST PRICES ON DISKETTES

- 6 1/4" SSDD 45, DSDD 55, High Density 1.65.
- 3 1/4" SSDD 1.45, DSDD 1.85.
- Lifetime warranty
- 100% error free
- Finest quality
- Includes tyvek sleeves
- Reinforced hub ring
- Labels & write protect tabs

Free UPS shipping. Minimum 100 diskettes.

Send check or call. CA residents add 8 1/4% sales tax.

Data Bureau Inc.

1633 Westwood Blvd., Ste 120
Los Angeles, CA 90024
213-479-0345

Inquiry 683

COMMUNICATIONS

TELETERM

Sophisticated Terminal Emulator of most popular terminals including DEC VT100, plus build your own upload/download direct to disk/printer, error free file transfer protocols, full screen ASCII text editor, remote print, unattended file transfer mode.

Telexpress, Inc.

P.O. Box 217, Willingboro, NJ 08046
(608) 877-4900

Inquiry 772

THE BUYER'S MART

DATA/DISK CONVERSION

CONVERSION SERVICES

Convert any 9 track magnetic tape to or from over 500 formats including 3 1/2", 5 1/4", 8" disk formats & word processors. Disk to disk conversions also available. Call for more info (312) 459-6010

Pivar Computing Services, Inc.

165 Arlington Hgts. Rd., Dept. #B
★ ★ Buffalo Grove, IL 60089 ★ ★

Inquiry 744

DATA/DISK CONVERSION

INCOMPATIBLE WORD PROCESSORS?

We convert to and from: XEROX, DEC, IBM, LANIER, WANG, PC-DOS, CONVERGENT TECHNOLOGY, WORDSTAR, MULTIMATE, SAMNA ASCII, MICOM, TAPE TO DISK. Also most CP/M systems. **LOWEST PRICES**

DATA CONVERSION INC.

6310 Caballero Blvd. • Buena Park, CA 90620
(714) 522-7762 (800) 824-4831 In CA.

Inquiry 684

GRAPHICS HARDWARE

HOUSTON INSTRUMENTS PLOTTERS

PC595/665 (4-Pen, A/B-size)	\$545/623
DMP-6142 (1-Pen, C/D-size)	\$2870
DMP-5152/3AP (C, D-size 1/4-Pen)	\$3895/5066

EMBITTERS

Summagraphics MM1201 complete	\$438
GTEC MD71212 complete	\$561
Hitech HDG 11118 Tiger II w/plot	\$747
Houston TG 1011 w/power & stylus	\$644
Sigma 400 board & TTX 14" monitor	\$799

Large corp. & institutional PO's accepted OAC

ARDEN SYSTEMS, INC. (213) 478-6707
12335 Santa Monica Bl. #260 Los Angeles, CA 90025

DOCUMENTATION

COMPUTER ASSEMBLY MANUALS

BIG BLUE SEED for IBM® BUILDERS: parts list, placement diagrams, instructions for assembling over 65 IBM compatible bare cards - \$14.95.

APPLE SEED II for APPLE™ BUILDERS: instructions for assembling 77 Apple compatible bare cards including the II+ and its motherboards - \$12.95.

OVER 40 DIFFERENT BARE CARDS IN STOCK FOR THE HOBBYIST

NuScope Associates

P.O. Box 790 • Lewiston NY • 14092

Inquiry 737

DISK AND TAPE CONVERSIONS

High quality conversion services for Dedicated Word Processors, Mini and Microcomputers. Over 600 3 1/2", 5 1/4", and 8" formats. Also 600-1600BPI tape. Included: Wang, NBI, CPT, DEC, Vydec, Lanier, OS/8, Xerox, IBM Sys/34/36/38/5520, Mac, Victor, TRS, Apple, NSTAR, IBM PC/XT, HP, and most of the other microcomputers. We can convert directly into word processing software such as: DWS, WP, MS/WORD, WS, Samna, MM, PFS, and many others.

DATA FORMATS, INC. (408) 972-1830

Inquiry 686

NEC APC H03

Color Graphics

Many extras.

Perfect home computer!

Call Elizabeth at:

617-267-2900

Boston Financial & Equity Corp.

P.O. Box 71, Kenmore Sta.

Boston, MA 02215

Inquiry 663

DUPLICATING SERVICES

BLANKET SERVICES

Diskette duplication • Packaging • Stocking/Drop shipping • 48 hour delivery • SUPERLOK copy protection • No mastering fee • No charge for standard labels • Place a blanket order with releases as you need them for any quantity at a fixed price.

Star-Byte, Inc.

2564 Industry Lane, Norristown, PA 19403
215-539-4300 800-243-1515

Inquiry 764

HARDWARE

\$79 MONO/GRAPHIC/PRINTER BOARD

- * Hercules compatible * 720 x 348 pixel
- * Lotus 1-2-3 compatible * 80 x 25 text
- * Printer, Monitor port * 1 year warranty
- * Light pen port * In stock delivery

1 - \$99 2-9 \$89 10 - \$79

SUGAR INTERNATIONAL

12015 NE 8th St. 3, Bellevue, WA 98005

(206) 462-9283, Mo-Sa, 9-6

Inquiry 765

Disk/Disk • Tape/Disk

Over 600 formats! 3 1/2", 5 1/4", or 8 inch disks; 9 track mag tape; 10 MB Bernoulli cartridge. Data base and word processor translation specialists.

Computer Conversions, Inc.

9580 Black Mountain Rd., Ste J
San Diego, CA 92126

(619) 693-1697

Inquiry 677

DUPLICATION SOLUTIONS

We have the answer to your duplication needs, no matter what the volume. We supply auto-loaders, disks, and technical support. We provide copy protection, serialization, package assembly, and distributive shipping.

MegaSoft

P.O. Box 710, Freehold, NJ 07728

1-800-222-0490 201-462-7626 (In NJ)

Inquiry 764

DISKETTE COPYING:

3 day turn around, security, quality, most popular formats.

MAG RABBIT

616-685-6186

Inquiry 720

IBM - TOSHIBA PRINTER INTERFACE

- all extended capabilities of the TOSHIBA available
- bit mapped graphics supported
- Prints all IBM extended ASCII characters
- screen dumps in text and graphics
- escape sequences supported
- popular software supported directly
- "Sideways" and "Pixel Visuals" support
- dealers welcome \$79.95 (\$2.50 S&H)

Integrated Data Technologies, Inc.

4775 Bunchberry Lane, Colorado Springs, CO 80917
303-488-2583 MC/VISA

Inquiry 711

99.8% vs 98% ACCURACY

100% TEXT ACCURACY plus unbelievable 99.8% FORMAT TRANSFER ACCURACY for most formats, compared to 98% with most other services. The difference between 1 to 2 format errors per line, and less than 1 to 2 per page. We support 1000 formats for disk, tape, wp & optical scanning. Guaranteed results.

DATA CONVERSION LABORATORY

718-939-4921

Inquiry 605

WESTERN TRANSDATA, INC.

Why risk duplicating your important programs on your computer, when our equipment is designed solely to duplicate disks & verify their perfection 100%? Over 600 formats, 3 1/2", 5 1/4" & 8" Plus serialization, copy protection, labeling, packaging, shrink-wrapping and fast, personalized service.

WESTERN TRANSDATA, INC.

1701 E. Edinger Ave. A-4
Santa Ana, CA 92705

714/547-3383 (collect)

Inquiry 779

Motorola 6805 Single Chip

Microcomputer Development System

Use the IBM PC or compat. to develop products based on Mot 68705P/3R/3U3 single chip micros. Complete sys includes an assembler, a debugger and a programming board with driver s/w for Intel or Mot files. 1 serial port required. Complete system \$495, Prog Bd \$349

TEC

P.O. Box 53, West Glover, VT 05875

(802) 525-3458 VISA/MC/MO/CK

Inquiry 769

ENTERTAINMENT

★ BORED WITH YOUR IBM PC? ★

Try our ABS (Anti-Boredom Software): TOMMY'S SEAWOLF Realistic submarine simulation for harassing enemy shipping lanes. Good enough to make you seasick. Requires 128K mem, 25 x 80 ASCII monitor. Source code included \$19.95 (check, MO) p/p FREE CATALOG

TOMMY'S TOYS

Box 11261, Denver, CO 80211

Inquiry 774

CONVERT TAPE TO DISK

We will transfer data from any 1/2" 9-track magnetic tape recorded at 1800 or 3200 bpi to 5 1/4" IBM PC floppies. Diskettes included. Quantity and repeat customer discounts. Fast turnaround. Disk to tape transfers also available.

Competitive Rates!

Micro Data Services

5 Town and Country Village, Suite 774 • San Jose, CA 95128

(408) 980-7203

Inquiry 729

MEGABYTES OF MEMORY

Lowest Prices Guaranteed in US. Dealer Inq Invited

Fully Populated 2MB Memory Boards

TALLTREE SYSTEMS — JRAM BOARDS

JRAM 2	\$339	OPEN 7
JRAM 3 Aboveboard	409	DAYS A WEEK
JRAM AT	389	M-F 9-8
JRAM AT Aboveboard	439	S-S 9-6
JDISKETTE	135	VISA, MC, AM, CHOICE
JLASER I	275	
JMODULES	CALL	703-370-7173

Information and Technology Services, Inc.

Inquiry 787

THE BUYER'S MART

HARDWARE

Tandy 1000 Hardware

TanPak Multifunction Cards \$329
Memory to 512K, RS232, Clock, DMA
TanPak Secondary \$249
Memory to 256K, RS232, Clock
10 Meg Hard Drive with Controller \$549
20 Meg Hard Drive with Controller \$749

Hard Drive Specialist
1-800-231-6671 or 1-713-460-6000
16206 Hickory Knoll, Houston, Texas 77059

Inquiry 707

HARDWARE

EPROM/EEPROM PROG. \$250

Programs 2716-27512, 25xx and 68764/66 eproms via RS-232. Also 874x micros and 28xxxA & 528xx EEPROMs. Automatic baud rate select, built in help menus, no personality modules!

16 BIT I/O MODULE \$75
Low cost control via RS-232. Expands to 512!

INTELLITRONICS
P.O. Box 3263, Tustin, CA 92680
(714) 869-0614

Inquiry 703

HARDWARE

SINGLE BOARD COMPUTER INDUSTRIAL STRENGTH

8085 CPU • RS232/RS422 • 16 A/D CHANNELS • BUFFERED DIGITAL I/O • WATCHDOG TIMER • COUNTER TIMER •

OPTIONAL FORTH Q.S. EDITOR, ASSEMBLER TARGET COMPILER • RAMDISK • REAL TIME CLOCK • NETWORKING UP TO 32 • FULL LINE OF SUPPORT HARDWARE/SOFTWARE • IBM/CPM SUPPORT • FROM \$295

EMAC, INC.
1400 West Main, Carbondale, Illinois, 62901
(618) 529-4525

Inquiry 698

USED APPLES & IBM'S

APPLE II+ as low as \$275.00
APPLE IIe — call
Motherboards & accessories — call
We buy, sell, & horsetrade — Apple, IBM, & CBM.

SHREVE SYSTEMS
845 Lark Ave., Shreveport, LA 71105
318-865-6743 4-9 p.m. C.S.T. VISA/MC

Inquiry 757

TANDY-EPSON

Our 10th year of DISCOUNTS
COMPUTERS & CELLULAR PHONES
Fgt. Prepaid. Save Tax
Toll Free 800-231-3680

MARYMAC INDUSTRIES, INC.
22511 Katy Fwy., Katy (Houston), TX 77450
1-713-392-0747 Telex: 774132

Inquiry 721

LOAD CELL INTERFACE

Connects weigh scales to any computer via serial RS232, 423 or 422, several units individually addressable from single computer port. Directly programmable in Basic - Demo program included. High accuracy 40,000 count. Options include NEMA-4, shunt cal, 4 load cell summing. Price \$599.

SCALE-TRON INC.

P.O. Box 424, Lachine, Quebec, H8S 4C2
(514) 634-7032

Inquiry 754

POWERLINE GREMLINS?? POWER FAILURES??

The MEIRICK STANDBY POWER SYSTEM is the TOTAL SOLUTION to your powerline problems

240 watt system - \$365; 400 watt system - \$495.
800 watt system - \$795

MEIRICK Inc., POWER SYSTEMS DIV.
Box 298, Frisco, CO 80443 303-688-3251

Inquiry 725

The BG-Boards

and well-crafted books teach you how to construct circuits for interfacing external devices to IBM, Apple, TRS-80, Tandy, Commodore, Timex-Sinclair micros for monitoring and control. \$35 to \$350. Free catalog.

Group Technology, Ltd.

Route 1 Box 83, Check, VA 24072
703-851-3153

Inquiry 702

LOW COST EPROM BURNER

Read, burn, and verify popular 28-pin EPROMs and EEPROMs, including 2704, 27128, 27256, 27512, 2817 and 2864. No personality modules. Uses intelligent programming algorithm for high speed burning. Operates through parallel port. Intel and Motorola hex formats supported. Complete hardware/software package.

Atari 520ST EPROM Burner \$139.95
IBM PC/PC compatible EPROM Burner \$189.95

Hippopotamus Software, Inc.
985 University, Suite #12, Los Gatos, CA 95030
(408) 395-3190
Price availability and specifications subject to change without notice

Inquiry 708

KING OF MICROCONTROLLERS

* 4000 Microcontroller Boards & Kits for
8035/8039/8040/8048/8049/8050/8031/8032/
8051/8052/8751/6511/7001/7809 from \$19.95

* 4008 Mini RS232 Terminal Kit. Full Keyboard,
LCD Display \$199.95

* 4015 8052 Basic System, EPROM Programming,
RAMs & I/O \$299.95

TECH STAR LABORATORY

Suite 709 R&B Corp. Park, 1701 N. Greenville Ave.
Richardson, Texas 75081

Inquiry 771

GBA

Full function IEEE-488 bus analyzer with 12,287 byte memory. Controlled from any RS-232 computer or terminal. Also provides full bus control and message sending capability. \$995.00

Connecticut microComputer, Inc.

568 Danbury Rd., New Milford, CT 06776
Phone: 203-354-9395 Telex: 710-456-0052

Inquiry 658

HARDWARE ADD-ONS

RS-232 RS-422

• Four Port RS-232 \$349.99
• RS-422/485 Serial \$149.99
• RS-232/422 with 24 Parallel I/O \$199.99
• RS-422 Synchronous \$299.99

Call About Custom Designed Boards

ADAMS

P.O. Box 17525
Greenville, South Carolina 29606
(803) 297-9630

Inquiry 652

ATTENTION 8-100 USERS

Upgrade your 256K Solid State Disk Simulator (sold by DRC of Texas) to over a MEGABYTE for \$279. Runs as if you plugged 3 more boards in your system. Up to 8 meg, warm boot with CPM 2.2, North Star DOS patches for either board. Also, new fully assembled 1 MB boards. We repair and stock most boards for Dynabyte, North Star, and Itasca systems.

SYNC studios

42 Pondview Drive, Southington, CT 06489
(203) 621-6839

Inquiry 767

CHIP CHECKER

• 54/74 TTL 14-24 Pin Chips
• 14/4000 CMOS Two 24 Pin ZIF sockets
• 54/74 CMOS3" and .6" IC widths

Tests/identifies chips with ANY type of output in seconds. Inexpensive software updates will be offered as new chips become available. For C128 and C64. \$129 plus \$3.50 s+h.

DUNE SYSTEMS

2603 Willis Dr., St. Joseph, MI 49085
(818) 983-2352

Inquiry 692

INFORMATION SERVICES

TURBO S.I.X.

The Turbo Pascal Software Information eXchange offers its members megabytes of Turbo Pascal code for only \$6 per diskette. Also a monthly newsletter. Send \$1.95 for the TURBO S.I.X. catalog. Deductible from the \$19.95 membership fee when you join. MC/Visa.

TURBO S.I.X.

P.O. Box 8373, Dept B2, Waco, Texas 76710
3101 Mitchell, Waco, TX (817) 753-2182

Inquiry 775

LANGUAGE TRANSLATOR

MICROSOFT TRANSLATOR

Translate MICROSOFT or GW BASIC programs to high powered Hewlett-Packard Series 200/300 BASIC. Translator converts more than 90 percent of code and moves source code to HP computer. Call for sample translated program, data sheets, demo. Oswego Software specializes in HP disk file copying, program translators.

Oswego Software Inc.

507 North Adams Street, Oswego, Illinois 80543 USA
(312) 554-3567 TELEX 858757

Inquiry 739

Z80™ / CP/M™ CO-PROCESSORS

Plug-in co-processors for PC, PC/AT.
Blue Thunder (5 mhz) \$199.50
Blue Lightnin' (9 mhz) \$595.00

Run CP/M software on PC as if MS-DOS software. Diskette conversion included. Can run Intel iSBIS software. We have cards for PDP-11 and VAX too.

DECIMATION

2085 Martin Ave. #110, Santa Clara, CA 95050
(408) 980-1678

Inquiry 688

CLOSE-OUT VIDEO FILM PRINTERS/ATD VFP-711

The Video Film Printer is designed for use with medium to high resolution computer graphics systems and NTSC composite video sources. The 711 will produce hard copy documentation in your choice of Polaroid Instant 4X5 black and white or color film, Polaroid professional SX-70 (Self Developing) film, or 35mm slides. CALL 213-879-6710.

ADVANCED TECHNOLOGY

1150 Brooklawn Drive, Los Angeles, CA 90077

Inquiry 717

THE BUYER'S MART

MULTIUSERS

LOCK UP CLIPPER!

Write Multiuser programs for clipper on Novell or IBM PC network.

* record & file locks * print spooling * and more!
Includes object code, examples and sample programs. Novell or PC network version only \$99 & s/h. (Now also for Multitlink).

Communication Horizons

701 7th Ave. #900, New York, NY 10036

Tel: (212) 724-0150

Inquiry 676

PRINTING

DO YOU NEED QUALITY COMMERCIAL PRINTING?

Call Eli's. Helping people since 1948.

Ask for Rick or Chuck

1-800-228-2007

1-402-342-7006

1231 South 14th Street
Omaha, Nebraska 68108

Inquiry 687

PROGRAM GENERATORS

WINDOW.LIB \$99.

An easy to use complete windowing system for programmers and writing in

* BASIC IBM, M-S, C86 * C LATTICE, M-S
* COBOL M-S, RMF * PASCAL M-S, TURBO
* FORTRAN M-S, RMF

Window editor included. Create callable pop-up menus, help screens. The line selector features auto reverse highlighting and cursor control. No royalties. Ask about our BIOS/DOCS LIB VISA/MC

GLENCO ENGINEERING (312) 392-2492
3920 Ridge Ave., Arlington Hts., IL 60004

Inquiry 703

PUBLIC DOMAIN

THE BEST OF THE BEST!

Public Domain & User Supported Software for IBM PC or compatible. Word Processing, Database, Spreadsheets, Utilities, Games, Accounting, etc! 50 disk package \$205.00, or rent 2 wks. \$75.00, info & Super Sampler Disk \$8.50, Deluxe Word Processor \$8.50, both \$12.00. MC/VISA

BLUE CIRCLE GROUP, INC.

Box 23502, Minneapolis, MN 55423

(612) 823-4111

Inquiry 681

Apple II Family + Mac Software

Software for Apple II family—280 disks—many categories—book describing programs \$6.95 + \$1.50 postage. Introductory set of 6 disks + book is \$37.95. Software for the Macintosh—75 disks—NEW book describing over 1000 programs \$7.95 + \$2. postage. Set of 3 introductory disks + book is \$34.95.

The Public Domain Exchange

2076C Walsh Ave., Suite 3, Santa Clara, CA 95050

(408) 496-0624

Inquiry 747

\$4.50 IBM PC Software

400 disks: \$4.50 ea. 1-2-3 WKS, 8 disks \$36.
Arcade games, 4 disks \$18. Directory, 2 disks \$9.
Utilities, 4 disks \$18. "c" routines, 6 disks \$27.
Turbo pascal routines, 3 disks \$36.
Unprotect software, 4 disks \$18.
Calling \$1.00. Add \$4 S&H. MC/VISA accepted.

The Computer Room

P.O. Box 1596, Dept. 102, Gordonsville, VA 22942

703/832-3341 (M-F 10-5)

Inquiry 681

PUBLIC DOMAIN

► SOFTWARE FOR PENNIES ◀

GET BEST AND LATEST PC-DOS, CPM-80 AND CPM-86 PUBLIC DOMAIN PROGRAMS FOR BUSINESS, PERSONAL, EDUCATION, SOFTWARE DEVELOPMENT, MODELING, SCIENCE, AND MORE AT LOW COST OF COPYING. 3 1/2, 5 1/4 AND 8" DISK FORMATS ARE SUPPORTED. SEND \$5.00 FOR CATALOG.

MULTIPATH, INC.

Box 395, Montville, NJ 07045

(201) 575-5880

Inquiry 732

SOFTWARE/ACCOUNTING

CALL 1-(800)-824-7888 op. 138

TIME & BILLING \$99 JOB COST OPTION \$30
Try It, You'll Like It With Our 30 Day Money-Back Trial. Great for contractors, accountants, architects, engineers, attorneys—anyone who needs to bill for service work and expenses. Very flexible and very easy to learn to use. Prints your statements, many reports. Job cost option includes job estimating, job summary, job detail, and more! For IBM PC and compatibles. Order with VISA, MC, COD or send for free comprehensive brochure.

Accounting Systems (919) 467-3428
1148-5 Executive Circle, Cary, NC 27511

Inquiry 650

CUSTOM PAYROLL

All systems have multiple pay categories, calculation of all taxes, user defined deductions, 401(k) handling, many reports, paychecks, W-2 forms, and much more. Custom features are available. Prices start at \$695 for system, manual, and PC Basic source code.

Datasmith, Inc.

Box 8036, Shawnee Mission, KS 66208

(913) 381-9118

Inquiry 687

► FINANCIAL CALCULATOR ◀

Memory resident calculator performs compound interest, NPV, IRR, bonds, depreciation, prints financial schedules. Allows importing/exporting of data. Includes all HP-12C functions plus more. Introductory price \$49.95 plus \$3 s/h; after 9/1/86, \$89.95.

K SOFTWARE HOUSE, INC.

Rt. 2, Box 83B1, Unionville, TN 37180

(615) 294-5090

Inquiry 718

MoneyCounts™ Version 3.1

Everything you need to take charge of your finances. Checking/Credit Card Mgr., Budgeting, Exp. Analysis, Financial Rpts., Graphics, Tutorial, much more. Great for home/business.

CPA designed IBM PC/XT & Compatibles with DOS 2.0 or later and 192K \$69.95

PARSONS TECHNOLOGY

5925 Surrey Dr. NE, Cedar Rapids, IA 52402

(319) 373-0197 CHECK/VISA/MC

Inquiry 741

SOFTWARE/BUSINESS

DATA ENTRY SYSTEM

Heads-down data entry with two-pass verification for the PC/XT/AT & compatibles. Loaded with features like: Auto dup & skip, verify bypass, range checks & table lookups. Fully menu driven only \$395. Call for free 30 day trial period.

COMPUTER KEYES

21929 Makah Rd., Woodway, WA 98020

(206) 776-6443

Inquiry 678

SOFTWARE/BUSINESS

PC-File III™ Version 4

Search, sort, browse, global changes, macros, making labels, format reports with selection & calculations, sub-totals, totals, averages, encryption. Exchange data with 1-2-3, WORD, WordStar. Over 190,000 users. \$99.95 + \$5 s/h. For IBM PC.

ButtonWare, Inc.

P.O. Box 5786, Bellevue, WA 98006

1-800-J-BUTTON

Inquiry 666

PC-File/R™

All the power of PC-File III plus: Relational link to other databases, integrated letter writing & mail-merge, context sensitive pop-up help windows. New binary search retrieves data hundreds of times faster. \$149.95 + \$5 s/h.

ButtonWare, Inc.

P.O. Box 5786, Bellevue, WA 98006

1-800-J-BUTTON

Inquiry 667

The Andsor Collection™

Unique concept. creates complete, self-contained, window-based data management environment, in one DOS file. Simplifies everything. Combine functions to create your own solutions in any application: calculations, database management, modeling, text processing, charts, data analysis, statistics, reports, labels, forms, presentations, mail-merge, etc. Simple enough for a PCjr, sophisticated enough for a PC AT.

SEE ALSO THE AD BELOW

Inquiry 667

The Andsor Collection™

From simple calculations, Mes, inquiries, to complex models, data structures, reports. Superb 400 page hard-cover manual, with many examples. US \$95 + \$5 s/h. 60-day money-back guarantee. Yes/MC/AmEx/Chq/MO/OD. Call or write now to order. IBM PC/XT/AT/PCjr, 128K +, one drive or hard disk, monochrome and/or color, DOS 2.0+. Not copy-protected.

ANDSOR RESEARCH INC.

181 University Avenue., Suite 1202,

Toronto, Ontario, Canada M5H 3M7

(416) 364-8423

Inquiry 656

EZ RUN

Run all your programs from one simple menu. 1-20 users/PC with app data dirs. Can log user time per program. Runs COM, EXE, BAT, or BAS programs. Data backups from menu. 15 day money back guarantee. IBM MS-DOS 2.0X up. Not copy prot. \$19.95 or \$1 sample disk.

NEWMAN COMPUTER

2 Briar Mills Drive, Bricktown, NJ 08724

(201) 458-5189 BIX EDNEWMAN

Inquiry 735

Info-Lion™ Relational DBMS

Outstanding data entry & validation. Powerful query. Password security. Easy to use, on-line help. Much more! For MS/PC-DOS systems. Only \$159.95 VISA/MC

Remember, go with the Lion... because it's a jungle out there!

Morgan Software Inc.

414 Valley Ave., Wilmerding, PA 15148

(412) 624-0468

Inquiry 731

THE BUYER'S MART

SOFTWARE/BUSINESS

TSAB8-TRANSPORTATION

A general-purpose system for solving transportation, assignment and transshipment problems. Solves transportation problems with up to 510 origins and/or destinations by applying the Transportation Simplex Algorithm. Menu-driven with features similar to LP88. Requires 192K, \$99 with 8087 support user's guide. VISA/MC

EASTERN SOFTWARE PRODUCTS, INC.
P.O. Box 15328, Alexandria, VA 22309
(703) 549-5469

Inquiry 694

SOFTWARE/BUSINESS

dFELLER Inventory

A business inventory program written in modifiable dBASE source code. The menu-driven program lets you locate items by inventory name or number. It keeps track of reorder points, vendors, average cost, and other info. Requires dBASE II or III, PC-DOS/CPM \$150.

Feller Associates
550 CR PPA, Route 3, Ishpeming, MI 49849
(906) 486-6024

Inquiry 701

SOFTWARE/GRAPHICS

FORTRAN PROGRAMMER?

Now you can call 2-D and 3-D graphics routines within your FORTRAN program.

GRAF-MATIC: 75 callable routines for screen output. \$135.

PLOT-MATIC: Pen plotter driver. \$135.
For the IBM PC, XT, AT and compatibles. We support a variety of compilers, graphics boards and plotters.

MICROCOMPATIBLES

301 Prelude Drive, Dept. B
Silver Spring, MD 20901
(301) 593-0683

Inquiry 726

PC-Write™ Shareware

Fast, powerful word processor/text editor for IBM PC. New Version 2.6 with auto reformat, optional menus, on-screen help, laser printer support, new expanded manual. Mailmerge, split screen, ASCII files, macros. All software, tutorial/guide on diskette, \$10. OK to copy. Register for full manual, support \$75. 90-day money-back guarantee.

Quicksoft (206) 262-0452 Visa/MC
219 First N. #224J, Seattle, WA 98109

Inquiry 751

BILINGUAL WORD PROCESSOR

DuangJan, a special word processor for English and: European, Greek, Lao, Portuguese, Russian, Spanish, Thai, Vietnamese, your own language, or more. For IBM PC/XT/AT/Clones with graphics & IBM/Epson/Clitch printer. \$59 + \$4 S&H in USA/Can (+10 others).

MEGACHOMP COMPANY

3524 Cottman Ave., Philadelphia, PA 19149. USA
(215) 331-2748/6138

Inquiry 723

GRAPHICS PRINTER SUPPORT

AT LAST! Use the PrtSc key to make quality scaled B&W or color reproductions of your display on any dot matrix, inkjet, or laser printer. GRAFFPLUS supports all versions of PC or MS-DOS with IBM, Techar, and Hercules graphics boards. \$59.95.

Jewell Technologies, Inc.

4302 SW Alaska St., Suite 207, Seattle, WA 98115
(206) 937-1081

Inquiry 716

C PROGRAMMERS

CCmem and CCfile are tools that can be used as front-ends to the standard memory and file primitives to perform usage and profiling statistics. Add your own features in one hour. Easily turned on and off. Super for debugging! Source is \$50 each.

COMEAU COMPUTING

91-34 120th Street, Richmond Hill, NY 11418
(718) 849-2355 — 24 hr. HOTLINE

Inquiry 674

"THE CLERK" RETAIL POINT OF SALE

New software gives your small-medium business the same advantages the "Big Guys" have. Automatic sales slip, invoices inventory control, discounts, taxes, reports, and much more! Indispensable management tool! Demo disk \$4.95 (refundable). Regular \$349.95 — Just \$179.95!

1-800-340-3026 ext.955

WDR SALES CO.

8604 BELMONT, KANSAS CITY, MO. 64134
Dealer Inquiries welcome

Inquiry 718

Z-100 TURBO SOFTWARE

-ZGL- Color graphics library with windows.
-ZPORTS- Directly control your I/O ports.
Full source code! Risk-free 15 day trial.
-ZGL- \$39.95, -ZPORTS- \$24.95
+ 2 S+H TX Res. add 8.125%

Zimbazi Products

7405 BERKMAN DRIVE, AUSTIN, TEXAS 78752

Inquiry 784

SMITH'S INVOICE

Invoices, shipping labels, customer database. Customer & product mailing lists and labels. Menu driven—easy to use. For IBM PC with 128K and 2 DS/DD drives or hard disk. All software, manual on disk \$15. Same-day shipment on personal checks.

Smith Consulting

Route 1, Box 213, Greensburg, IN 47240

Inquiry 758

SOFTWARE/CHURCH

Church Package

Panshioner Time, Talent and Treasure System program is written in modifiable dBASE source code.

- Contributions • Disbursements • Ledger
- Names with mailing labels
- Personal information database

Requires dBASE II or III PC-DOS/CPM-80 \$200.

Feller Associates

550 CR PPA, Route 3, Ishpeming, MI 49849
(906) 486-6024

Inquiry 700

GRAPHICS ART COLLECTION

Over 500 pieces of art to be used with PC Paint, PC Paintbrush and other popular graphics packages. \$34.95
Touch Typing Tutor \$24.95
8-tree Mailing List

(Simple checks for duplicates, 17M) \$72.00
All on disk. Shipped prepaid only. Please add \$4 P&H per order. For PC, AT and compatibles

Commercial Applications

R#1 Box #15, New Castle, IN 47362
(317) 522-0056

Inquiry 660

POWERFUL CUSTOM MAILBASE

Eliminate tedious typing of labels, rolo-dex cards, envelopes and even personnel directories. Instantaneous storage and retrieval of more than 32,000 addresses. Easy to use 20+ page manual with full examples. (Tech: file format given & Mail-Merge files built) IBM w/128K - Unprotected.

\$37 (CA 6%) S&H Incl. CK/MC/VISA

ACME SOFTWARE

Box 1446, Aptos, CA 95001 (408) 475-9188

Inquiry 651

SOFTWARE/GENERAL

AI for the IBM PC

TQPSI is a full version of QP86 which runs under MS-DOS, Unix or CPM. A fast, efficient expert system development tool.

Prototyping \$125
Production \$250
Professional \$375

C version, add \$20 Shipping, add \$5

DYNAMIC MASTER SYSTEMS

POB 566456, Atlanta, GA 30356
(404) 565-0771

Inquiry 693

GRA-FIT PLOTTING SYSTEM

Publication-quality scientific plots for IBM PC, HP plotters & Epson printer. Scatter plots, splines, polynomials, smoothing, linear, semi-log-log, probability scales—may be reversed. Also does text and flow charts. Only \$90 + \$5 s&h.

JAYAR Systems

P.O. Box 2885, Station "A"
Sudbury, Ontario, Canada P3A 5J3
(705) 522-2230

Inquiry 715

NEW LOGO FOR PC'S

- ZLOGO features advanced turtle graphics
- LISP-like equivalence of data and code
- Numeric, string, and list objects
- The command sequences of the built-in editor are user-definable
- There are over 130 commands
- ZLOGO can be easily converted to other languages such as French

192K \$65 S&H \$3 (602) 323-9874

COLORWORKS™

Dept BE 867 5337 E Bellevue, Tucson, AZ 85712

Inquiry 673

SOFTWARE/GRAPHICS

PLOTTER SOFTWARE

Save time and money by creating your own presentation quality text slides. THE DGI SIGNMAKER is an easy to use menu driven program for your IBM or APPLE computer and most plotters (Epson, HP, HP, HP-GL, IBM and others) for only \$75.

DECISION GRAPHICS, INC.

P.O. Box 2776-B, Littleton Colorado 80161

Phone (303) 795-0341

Inquiry 689

TI PRO + TURBO + GRAPHICS

UNLEASH YOUR TI PRO WITH: TURBO 2.0 or 3.0 + TIGrafx. GRAPHICS, TURBLEGRAPHICS, MUSIC, SCREEN & CURSOR CONTROLS & more routines than IBM TURBO. Use BASIC PICS w/o reprog. Convert IBM code to TI PRO. Source & doc included. TIGrafx \$69.95, + TURBO \$149.95, + TURBO 8087 \$179.95. SWITCH TO TURBO NOW!!!

ProWare, Inc. (503) 233-4465

1023 SE 36th Ave., Portland, OR 97214
VISA/MC/CHECK 7AM-7PM MON-FRI

Inquiry 745

THE BUYER'S MART

SOFTWARE/LANGUAGES

Minnesota SNOBOL4 Language
 Powerful string & data handling facilities. Interpreter compatible with mainframe SNOBOL4. 32K strings, 32 bit integers, 6087 for float & large memory model. Sample pgms include ELIZA. For >128K IBM PC & DOS or equivalent. Definitive "green" book by Gnsword et al available.
 Guide + 5 1/4" 5SD diskette \$44.95
 Guide + diskette + "green" book \$59.95
 "Green" book only \$26.95
 Postpaid in USA. In NY add tax. VISA/MC (814) 271-5855
BERSTIS INTERNATIONAL
 POB 441, Millwood, NY 10546

Inquiry 659

SOFTWARE/LANGUAGES

LISP for the MACINTOSH™
 MacScheme™ implements the Scheme dialect of LISP. It features a fast byte code interpreter, debugger, editor that understands LISP syntax, multiple windows, and Quickdraw graphics. University site licenses available \$125. (+\$10 overseas) MC/VISA. To order, call or write:
Semantic Microsystems
 4470 S.W. Hall St., Ste. 340, Beaverton, OR 97005 USA
 (503) 643-4539

Inquiry 755

SOFTWARE/SCIENTIFIC

HP-PC HYPER-CALCULATOR
 MS-DOS emulation of HP-11C programmable scientific calculator available inside any program, permits data return Program & data disk storage, indirect addressing, alpha prompts, printing, HELP, 100 registers, 1000 program steps FREE 8087 version & utility programs \$39.95 + \$1 s/h
SUNDERLAND SOFTWARE ASSOCIATES
 P O BOX 7000-64
 REDONDO BEACH, CA 90277
 CALL TOLL FREE 800-628-2828 ext. 502

Inquiry 786

CROSS ASSEMBLERS for VAX VMS and PC/MS DOS

New Low Prices
 Relocatable Macro Cross Assemblers, Linkers, Librarians
 Targeted to almost all Microprocessors
ENERTEC, INC.
 BOX 1312, Lansdale, PA 18446
 215-382-0966 MC/VISA

Inquiry 689

SOFTWARE/SCIENTIFIC

ORDINARY/PARTIAL DIFFERENTIAL EQN SOLVER

MICROCOMPATIBLES
 301 Prelude Dr., Silver Spring, MD 20901
 (301) 593-0683

Inquiry 727

FORTRAN SOURCE CODE PROFESSIONAL SIGNAL PROCESSING & MATRIX ANALYSIS UTILITIES

35 PROGRAMS W/TUTORIAL & EXAMPLES
 FFT, AR Modeling, Digital Filters, Matrix, SVD, Conjugate Gradient, Pseudo-Inverse Root Finder, Cubic Spline Interp. Graphics, Random Numbers. More. Disk/Hard-copy. Documented, 130 pages Bibliography. Send for Info Pkg \$99.
CLAREN SOFTWARE
 P.O. Box 5333 • MESA, AZ 85201
 (602) 820-3877

Inquiry 671

RUN FAST, LOOK BEAUTIFUL

If this is what people expect from your BASIC programs, then you need YES MASTER™: a DOS-resident development aid that includes a screen painter, an ISAM file manager, a window manager, a printer generator and more. All in one package. \$245. No royalty.

SOFTWAY, INC.
 500 Sutter St., Suite 222 BC
 San Francisco, CA 94102
 (415) 387-4666

Inquiry 761

Affordable Engineering Software

CALL OR WRITE FOR FREE CATALOG
 Circuit Analysis • Root Locus • Thermal Analysis • Plotter Drivers • Graphics • Signal Processing • Filter Design • Report Proliferator • Transfer Function Analysis.

BV Engineering
 2200 Business Way Suite 207, Riverside, CA 92501
 (714) 781-0252 VISA/MC

Inquiry 696

forMath® text-formatter

- Equations, matrices, ratios, integrals, diagrams
- Macros, fonts, Greek/math symbols
- Hyphenation, secn/eqn/ref numbering
- Indexes, table of contents, footnotes
- Dot-matrix, daisywheel, laser printers, all monitors \$400. \$50 for demo

SHANTHA SOFTWARE INC.
 50 West 97th St Room 11N, New York City 10025
 (212) 222-SNIP
 Touchtone toll free: 850-1088-wait-FORMATH

Inquiry 756

BE A SCREEN STARI!

In BASIC, PASCAL, DBASE, C, COBOL, FORTRAN, ASSEMBLER, design data entry screens in minutes! All popular features + 99 windows, save, restore, merge, redefine keys, pull down menus, ASCII table. No royalty. HIGH SCREEN is \$129. DEMO \$15. S&H \$5. CA add 6.5%.

SOFTWAY, Inc., PC/SOFT Product Line
 500 Sutter St., Suite 222, San Francisco, CA 94102
 (415) 387-4666

Inquiry 785

TURBO PASCAL TOOLS

Quinn-Curtis offers a family of Science, Engineering, Data Acquisition, and DOS/BIOS Tools for use with Turbo Pascal. All source code provided.

IPC-TP-006 Science and Engineering Tools \$69.95
 IPC-TP-008 Metabyte Data Acquisition Tools \$94.95
 IPC-TP-017 DOS/BIOS Tools \$69.95

Quinn-Curtis

49 Highland Ave., Needham, MA 02184
 (617) 444-7721

Inquiry 752

CHARACTER CUSTOMIZATION

CHARGEN! 2.1 lets you modify the character set on the EGA. Useful for scientific/engineering symbols on your word processor, special symbols in your programs, and more. Requires DOS 2.x or 3.x, Enhanced Graphics Adapter. \$35 + \$2 s/h (MN add 6%).

DK Micro Consultants

P.O. Box 8714, Minneapolis, MN 55406
 (612) 722-0931

Inquiry 691

68020

Motorola compatible macro Assembler Package features linker, object librarian, symbol report generator with cross reference. Produces S-records and ROMable code. For CP/M-88K, MS-DOS \$750. Portable Source in C \$3500. AVAILABLE NOW.

Quelo, Inc.

2464 33rd Ave. W. Suite 173, Seattle, WA 98199
 206/285-2528 telex 910-333-8171

Inquiry 748

System Simulations

Micro-CSMP simulates Control & Servo Systems of Robotics of High Order Filters of Chemical Processes of Stress & Strain. Graphical results in minutes typically requiring 10-20 lines of input. Full IBM S/360 CSMP compatibility. LSP analyzes linear systems producing Bode Nyquist, and Transient Response plots, and Root Locus diagrams. Micro-CSMP is \$300, LSP is \$450 for PC-DOS or MS-DOS systems.

Call (714) 561-7654

California Scientific Software
 25642 Hazelnut, El Toro, CA 92630

Inquiry 670

mCAP™ CIRCUIT ANALYSIS PROGRAM

For ac & dc electric, electronic, & polyphase power networks with up to 25 meshes or nodes having R, L, C, op-amps, transistors, transformers, dependent & independent V & I sources. Simple, fully documented for IBM PC/XT/AT/comp. \$69.95 + \$2 s/h. Request brochure.

TechniSoft, Inc.

P.O. Box 98017, Dept. 112, Baton Rouge, LA 70898
 (504) 767-4798

Inquiry 770

EXPERT SYSTEMS!

You can develop expert systems with KNOWOL, the Knowledge Oriented Language from IMCO. Includes a tutorial, unlimited development capability, and a smart rules editor. Not copy protected. An incredible introductory offer at \$39.95 plus \$2 s/h (\$4/COD).

Intelligent Machine Company

3813 N. 14th St., Arlington, VA 22201
 (703) 528-9136

Inquiry 712

LARGE SPARSE SYSTEMS

of simultaneous nonlinear equations in science and engineering can be solved by PC with PMSolver, the Pascal-based Modular Solver. Structured approach allows up to 640 variable problems, compact input code. Requires TurboPascal-87, 384K RAM, \$449.

DIGITAL ANALYTICS

P.O. Box 31430, Houston, TX 77231-1430
 (713) 721-2069

Inquiry 690

POP-UP HP-41 EMULATOR

Graphically presents HP-41 keypad and unique view of stack and registers. Binary, Octal, Decimal, Hexadecimal display and input 12 digit precision, 500 accessible registers. For IBM PC/XT/AT and close compatibles. Standard version \$69.95; 8087 version \$79.95 (\$4 shipping and handling, plus sales tax in Calif.)

ECLIPSE LOGIC INC.

P.O. Box 2003, Huntington Park, CA 90255-1303
 (213) 669-6020

Inquiry 685

THE BUYER'S MART

SOFTWARE/SCIENTIFIC

► MATRIX 100 ◀

Powerful Matrix operations with single statements in IBM PC BASIC. Perform multiple regression, solve simultaneous equations, invert matrices, etc. MATRIX 100 commands are fast, reliable and easy to use. Price \$80. 6087 support \$125; compiler support \$250. (\$4 a/h CA res. add sales tax).

STANFORD BUSINESS SOFTWARE, INC.
4151 Middlefield Rd., Suite 215, Palo Alto, CA 94303
To Order Call (415) 424-9499

Inquiry 763

SOFTWARE/TOOLS

CROSS ASSEMBLERS

Develop microprocessor programs on your IBM PC or MS-DOS computer.

• Macros • Conditional Assembly • Editor •

Complete support for most 8 bit microprocessors
Linker and EPROM Programmer Driver

MicroComputer Tools Co.
1255C Kenwal Rd., Concord, CA 94521
(415) 825-4200

Inquiry 728

STATISTICS

RATS!

RATS is a fast, accurate & complete regression package with unsurpassed POWER. Has both time-series & cross section analysis. Includes Box-Jenkins, logit & probit. Spectral analysis & graphics also available. Requires 256K RAM, IBM PC or compatible. \$200/MC/Year

VAR Econometrics

P.O. Box 19334, Minneapolis, MN 55419
(612) 822-9690

Inquiry 776

PC TECHNICAL GRAPHICS

TEKMAR is a graphics library for the Tecmar Graphics Master. Similar to PLOT-10, includes WINDOW, VIEWPORT, AXIS. Support for HP, HI plotters. Curve fitting, complete plotting program. Log, semi-log, multi-axis, 3-D, contours. Demo disk, literature available.

Advanced Systems Consultants
21115 Devonshire St., Suite 329, Chatsworth, CA 91311
(818) 407-1059

Inquiry 633

PC-Type™

Fast, compact, capable & easy! Help panels, hands-on tutorials, macros, multiple-line headings & footings, DOS path support, print spooling, block operations, etc. ASCII files. Install program allows customization \$59.95 + \$5 a/h For 128K IBM PC

ButtonWare, Inc.
P.O. Box 5788, Bellevue, WA 98006
1-800-J-BUTTON

Inquiry 668

STATISTICS CATALOG!

If you need statistics for IBM PC or Apple II, call us and let our technical advisors help you find the statistics programs you need. Write or call now to get a FREE catalog of statistics and quality control software.

HUMAN SYSTEMS DYNAMICS

9010 Reseda Blvd., Ste. 222
Northridge, CA 91324

(800) 451-3030 (818) 993-8536 (CA)

Inquiry 709

SOFTWARE/SORT

OPT-TECH SORT/MERGE

Extremely fast Sort/Merge/Select utility. Run as an MS-DOS command or CALL as a subroutine. Supports most languages and filetypes including Btrieve and dBASE. Unlimited filesizes, multiple keys and much more! \$149.

(702) 588-3737

Opt-Tech Data Processing
P.O. Box 678 - Zephyr Cove, NV 89448

Inquiry 738

BASIC PROGRAMMERS

Add SALT & PEPPER to your existing/new programs. Create dazzling Menus, intelligent Input Screens, Walking Strips, ASC/Desc Sort, PRT SCR, Date processing & more. SALT & PEPPER has 28 modules (in MS-DOS compatible interpretive BASIC). They merge with your program in minutes. S & P performs all the tricks. YOU get the applause. \$59.95. Demo disk, \$2.50. (\$2.50 a/h). MC/VISA

COMPUTER GURU

40 Wagner Ave., Piscataway, NJ 08854
201-356-6477

Inquiry 678

STATISTIX™

\$75 - Satisfaction guaranteed

A comprehensive, powerful, yet easy-to-use statistical analysis system for IBM PC/XT/AT's, Apple II's, and MS-DOS machines. Clear 200p manual. Write for information.

NH ANALYTICAL SOFTWARE

801 West Iowa Ave., St. Paul, MN 55117

(612) 488-4436

Inquiry 736

SOFTWARE/SYSTEMS

CPM-80 LIVES on your PC

CP/Mulator puts a 4MHz 8 bit CPM emulator in your IBM PC for \$99. (\$3 s+h).

- A great 8 bit development system
- Saves expensive CPM-80 applications
- Increases PC speed 10% for 8088 programs
- Priced less than most software only products
- Uses no valuable board slots

Source Information

P.O. Box 2974, Warminster, PA 18974

VISA Phone (215) 441-8178 MC

Inquiry 782

Does your hard disk seem like a vast and uncharted land?

JOBS

Job \ Organization \ Backup \ System
Clearly superior! Now with MACRO capability and user defined pop-up windows. \$49.95 & VISA Welcome

RCT Design

P.O. Box 178, Nipomo, CA 93444
(805) 934-2905

Advanced disk management for
IBM PC/XT/AT & compatibles.

Inquiry 753

SL-MICRO

Tabulate survey results or analyze experimental data using SL-MICRO. It has Frequencies with statistics, Crosstabs, Anova, Multiple Regression & Correlation Data Editor & Data Transformations.

Only \$250 for PC-DOS, MS-DOS or CP/M

QSC

Box 778, East Lansing, MI 48823

(517) 641-4428

Inquiry 750

SOFTWARE/TOOLS

Programmers:

We guarantee our products to be solid, bugfree
• CorrectForth - Very professional. 83 standard
• Correct_Datamizer - 50:1 data compression guaranteed.

\$90.75 per program MC/VISA/AMEX/MO/Check.
(SD sales tax 4%) Specify computer

Correct Software, Inc.
RR1 Box 140, Black Hawk, SD 57718
(605) 787-5904

Inquiry 766

STATISTICS

NUMBER CRUNCHER STAT SYS

Menu-driven Multiple & stepwise regression, ANOVA, time series, Discriminant, cluster, and factor analysis, principal components, scatter plots, histograms, t-tests, contingency tables, non-parametrics. Import export data. Spreadsheet, sort, join, merge. \$79. IBM PC/Macintosh. Quantity discount

NCSS-B

865 East 400 North, Kaysville, UT 84037
801-548-0445

Inquiry 733

TEXT SCANNING

ELIMINATE KEYBOARDING
CONVERT TYPESET AND
TYPEWRITTEN COPY
TO DISK OR TAPE
CALL

**MEDIA CONVERSION
CORPORATION**
312-346-0102

Inquiry 722

The Visible Analyst Workbench for \$1785.00
A powerful systems design and analysis tool for either structured or unstructured environments. Increase productivity in Design, Documentation and obtain control over the systems Development process. Do multiple projects on an IBM PC, 3270 PC, XT, AT and compatibles. Quantity discounts are available

VISIBLE SYSTEMS CORPORATION
336 Baker Avenue, Concord, MA 01742
(617) 369-1800

Inquiry 777

The Statistician

Includes: Multiple Regression (Stepwise ridge, all subsets, backward elimination)
• Time series analysis • descriptive statistics
• transformations • survey research • nonparametrics
• X-Y plots • ANOVA • random samples • data base
• data editor • search & sort • hypothesis tests
For IBM, MS-DOS, XENIX, CPM, TRS-DOS.

QUALITY SYSTEMS

Box 628, Charleston, SC 29402 1-800-334-0854
803-571-2825 (Ext. 814)

Inquiry 748

TYPESETTING

DESKTOP PUBLISHING

Laser Printer comp software to drive Cordata L300 with 78 PS lris \$495. With add 14 PS Lndscp lris \$895. For Canon LRP-8 A2 with 41 PS P1 or Lndscp lris \$895. H&J. 200 stored formats. Mix face & pt size anywhere on any line, multi tab & col justification. Boxes & Rules.

Micro Print-X, Inc.
P.O. Box 581, Ballinger, TX 76822
(915) 365-2343

Inquiry 730

THE BUYER'S MART

UTILITIES

COPYWRITE

CopyWrite backs up hundreds of the most popular programs for the IBM PC. CopyWrite is revised monthly to keep up with the latest in copy protection, and comes with a trade-in offer. It needs an IBM AT, XT, or PC, 128K and one disk drive, but can use more memory or another drive. \$50 US. Check/Credit Cards.

QUAD SOFTWARE LIMITED
45 Charles St. E. 3rd Fl.
Toronto, Ontario, Canada M4Y 1S2
(416) 961-8243

UTILITIES

BTrees with C Source

These are powerful, portable, dependable file utility libraries. Thousands of programmers worldwide rely on our quality code. All source code included, no royalty fees, works with any K&R compatible C compiler.

• Btree only \$78.00 • ISAM only \$40.00 additional.

SOFTFOCUS

1343 Stanbury Dr., Oakville, Ontario, Canada L6L 2J5
(416) 825-0903

UTILITIES

The EMCEE DOS IT ALL—EVEN WINDOWS

Now your PC's can be powerful, efficient & friendly. With TheEMCEE, your application manager, create unlimited custom menus for single keystroke access. Protect your data from being viewed, changed or deleted. Monitor & report system usage with SYSTEM LOG. Now with DOS WINDOWS. Virtually non-resident. Powerful control & protection for managers, friendly interface for users. \$49.95. VISA/MC

COMMAND SOFTWARE SYSTEMS, INC.
1-800-423-9147 or 213-457-1789

SOURCE CODE LIBRARIAN & REVISION CONTROL SYSTEM

TUB™ keeps ALL versions of your program in ONE compact library file, even with hundreds of revisions.

• 5 times faster than SCCS • LAN compatible
• Free public domain MAKE (with source) by L. Dyer
MS/PC-DOS 2.x & 3.x. \$99.95 + \$3 S&H VISA/MC

BURTON SYSTEMS SOFTWARE

POB 4158, Cary, NC 27511
(919) 469-3068

SUPERCOPY

The most EFFICIENT-INTELLIGENT-USER-FRIENDLY POWERFUL, AUTOMATIC BACKUP UTILITY of protected devices, for IBM PC/XT/AT EXCLUSIVE DISKETTE ANALYZER/DIAGNOSER FULL AUTOMATIC LOCKING CAPABILITY! Built-in HELP with L&R instructions in a disk file. \$50 VISA/MC/CHK

YETIWARE CORP.

P.O. Box 21152, Mid Town Station
New York, NY 10129
DEALERS, CONTACT US

RAMbak or WARP-TEN - 9.95

RAMbak automates the saving of new or changed RAM disk files to floppy disks and/or hard disk subdirectories. WARP-TEN is a programable disk cache. PC, XT, AT, compatibles with 256K DOS 2.0+. Introductory price is only 9.95 each. (MN Res. + 6%).

Software Brewing Company

P.O. Box 12094, St. Paul, MN 55112
612-636-2727

MEDIA MASTER PLUS

READ, WRITE, and FORMAT over 80 CP/M disks and run most CP/M-80 programs on your IBM PC! Two program package includes ZPEM, a CP/M-80 emulator program that transforms your IBM PC into a 1-2 MHz CP/M 2.2 computer. \$59.95 + \$3.00 S/H (CA 8%)

INTERSECTING CONCEPTS, INC.

4573 Heatherglen Ct., Ste 10
Moorpark, CA 93021
(805) 529-5073

STILL RIVER SHELL

Visual shell for PC/MS-DOS. Makes all your DOS dreams come true. V 1.33. Only \$9 for shareware diskette. \$29 manual & diskette.

Bob Howard

PO Box 57, Still River, MA 01487
617-456-3699

PADLOCK/PADLOCK II DISKS

PADLOCK furnishes the user with a method for providing protection against unauthorized duplication from DOS commands \$99. PADLOCK II disks come preformatted with linger-print and serialization. PADLOCK II disks offer superior protection. Ask about our HARD DISK protection with uninstall capability MC/VISA

GLENCO ENGINEERING

3920 Ridge Ave., Arlington Hts., IL 60004
(312) 392-2492

GENSCREEN

For Microsoft Cobol/IBM Cobol

Generates Cobol Source Code For Your Screen Section and Data Divisions Fast!!!

GenScreen is a powerful new programmers productivity tool which utilizes a screen image text file produced from your own editor. This in turn is run through our interactive utility to produce 100% syntax free Cobol source code. GenScreen will produce "generic" or custom data names for your code automatically. GenScreen is available for only \$99.99 from

Personal Computer Development Corp.

POB 8556 Warwick, RI 02886 8556
(401) 333-8704

THE NEWMAN UTILITIES

What the Norton Utilities is and should have been. 2 disks packed full of the most needed utilities with full printed manual 15 day money back guarantee. IBM and compatibles with MSDOS 2.XX up. Not copy protected. \$19.95 or \$1 sample disk.

NEWMAN COMPUTER

2 Bnar Mills Drive, Bricktown, NJ 08724
(201) 458-5169 BIX EDNEWMAN

PAL FOR SIDEKICK!

Personal Appointment Locator automatically shows coming appointments, searches your file, maintains to-do list, examines multiple files. Resident alarm tool. Only \$46. Cheap at twice the price!

PAL SOFTWARE

Ste. 12B 110 Green St., New York, NY 10012
212-925-1843

★ DEC RAINBOW USERS !! ★

B.E.V. SOFTWARE ANNOUNCES DR. DISK - The latest in DEC RAINBOW utilities!

View or modify any sector on the diskette
Restore deleted files
• Alter file attributes (HIDDEN, SYSTEM, etc.)
Learn RAINBOW MS-DOS disk organization
Determining the extent of crashed disks

This tool has long been used by software developers in the field and is finally being offered to the public at a fraction of its commercial cost. Send \$29.95 to:

Bill Norton - B.E.V. SOFTWARE
P.O. Box 139, Schenectady, NY 12301

UNLOCK PRINTING POWER

THE PRESIDENT™

UNIVERSAL PRINTER INTERFACE

Let us use ALL the features built into ANY PRINTER through ANY PROGRAM on IBM PC's or compat. Resident program uses only 3k of memory. Pop-up Help Recommended by Epson, Okidata, MicroPro, etc.

CMB3 Technologies \$99.00
P.O. Box 3061, Walnut Creek, CA 94598
(415) 930-0470

XENIX/UNIX

XENIX/UNIX SOFTWARE

TELETERM-X	Multi-User Telecommunications
XPD	Print Manager/Spooler
XTX	File Transfer Utility
X-MENU	System Administration Utility and Menu Package
TELETERM-EM	Terminal Emulator to turn your micro into a workstation
MSDOS/TRSDOS	

Telexpress, Inc.

P.O. Box 217, Willingboro, NJ 08048
(609) 877-4900

CONCURRENT DOS BACKUP

BackPack™ runs like BACKUP/RESTORE and supports DOS and CP/M media as well as users. Backs up and restores up to 1000K/min on an AT and 360K/min on an XT. Supports release 4.1. Also available on CP/M-80 and CP/M plus. \$150.

Bright Light, Inc.

520 Fellowship Rd. #C301, Mt. Laurel, NJ 08054
(609) 778-0772

Advertise your computer products for as little as \$375 in THE BUYER'S MART. For more information call Karen Burgess at **BYTE 603-924-3754.**

QUALITY • SERVICE • PRICE!

SUN-ST/TURBO 8 MHZ

\$530

(ASSEMBLED & TESTED)

Dealer & Computer Group
CALL FOR SPECIAL PRICE



- One 360 KB 1/2 Height Disk Drive
- 256K RAM (Expandable to 640K)
- Enhanced Keyboard (AT Style)
- 8 MHz Turbo CPU
- Keyboard Switchable to 4.77 MHz
- 8 Expansion Slots
- Uses MS & PC DOS Operating System
- Meets FCC Class A Regulations for Industry & Business Use

SUN-XT Mono System

\$825

- 2 Disk Drives • 640K RAM
- Mono G Card • 12" TTL Monitor
- Enhanced Keyboard • 135W P S
- Parallel Port

SUN-XT Color System

\$1095

- 2 Disk Drives • 640K RAM
- Color G Card
- 13" RGB Color Monitor (640x240)
- Enhanced Keyboard • 135W P S

SUN-ST Mono System (8MHz Turbo)

\$895

- 2 Disk Drives • 640K RAM
- Mono G Card • 12" TTL Monitor
- Enhanced Keyboard • 135W P S
- Parallel Port (Switchable to 4.77 MHz)

SUN-ST Color System (8MHz Turbo)

\$1145

- 2 Disk Drives • 640K RAM
- Color G Card
- 13" RGB Color Monitor (640x240)
- Enhanced Keyboard
- 135W P S (Switchable to 4.77MHz)

AT COMPATIBLE SYSTEM (8MHz)

\$1595

- One 1.2MB FDD • 640K RAM
- Keyboard • HDD FDD Controller
- 200W P S Case A&T
- (Call for other Configuration)

SPECIAL SALE ITEMS

SUN XT CPU (4.77MHz)	\$145
SUN ST CPU (8MHz Turbo)	\$195
FDC w/Cable	\$49
CABINET	\$49
MULTI I/O PLUS (Serial, Par, Clock, Game)	\$95
POWER SUPPLY 135W	\$75
AT STYLE KEYBOARD	\$65
OTHER PARTS AVAILABLE	



SUNTRONICS CO., INC.
12603 Crenshaw Blvd., Hawthorne, CA 90250

(Orders Only)
1-800-421-5775
(CA Orders & Tech Info.)
213-644-1140

STORE HOURS
MON - FRI 9:00am - 6:00pm
SATURDAY 10:00am - 5:00pm
Dealer & OEM Inquiries Invited

IBM® VISA, MasterCard (No Surcharges) CDD, Cash or Certified Check (VISA or MC Ref. Required). School & Gov. Contractor F.O. accepted. Shipping & HC \$4.00 for 1 lbs. plus \$4.00 for each additional lb. CA residents add CA Sales Tax. \$10.00 Min. Order. WARRANTY: 90 Day Warranty Labor, Parts Replacement Only.

PCAmericanMarketingInc.

IBM • COMPATIBLES • NETWORKING

We provide service, support and warranty to make you more successful

IBM

PC 256K, 2 Dr.	\$1395
PC 256K, 1 Dr., 20MB	\$1656
(NEW) XT 640K, 1 Dr.	\$1895
XT 256K, 1 Dr., 20MB	\$2195
AT 512K, 1.2 Dr., 20MB	\$3739
AT 256K, 1.2 Dr.	\$3164

COMPAQ

Portable 256K, 1 Dr.	\$1695
DeskPro 256K, 1 Dr.	\$1695
286 Port 2, 256K, 1.2 Dr., 20MB	\$3170
286 DeskPro 1, 256K, 1.2 Dr.	\$3164
286 DeskPro, 2, 640K, 1.2, 30MB	\$4140

PHOENIX TURBO (Best Buy Among IBM Compatibles!)

640K Expandable to 1024K on Main Board
8MHz Switchable from 4.77 MHz — 380K Floppy
20MB Disk Drive and Controller/Keyboard

	\$999
Monochrome Graphic Card and Monitor	\$209
Color Graphic Card and Monitor	\$399

PERIPHERALS

Amdisk 310A Color 600 RGB Color 722 EGA	169.95 399.95 529.95	D.C. Hayes Smartmodem 1200 Smartmodem 1200B	374.95 349.95	Master Piece Memory/Chips/Power Supplies 64/128/256K 8087-38087-Z/ 80287-3 135/150W pwr. supply	99.95 1040/33 135/150/100 99/99	Color w/384k PS/CC Mono w/304k PS/CC Short MEM P Short MEM w/384k	389.95 389.95 159.95 189.95	Jram III w/ok Jram III w/2mb	199.95 479.95	NEC 3860 NEC 8850 NEC EP 300 NEC 580 XL Color	759.95 1079.95 399.95 1099.95
AST Advantage AT w/128k AST 525/11 A Dimm AST 525/112 Ramove Prawse w/Flight Sim. Rampage AT w/512k Rampage PC w/2mb Rampage PC w/256k Rampage PC w/2mb Advantage AT w/128k Advantage AT w/2mb 8 Pac + w/384k	374.95 439.95 509.95 239.95 449.95 999.95 299.95 539.95 299.95 649.95 179.00 229.00	Hercules Color Graphics Mono Graphics	159.95 294.95	Microsoft Mouse Bus. w/PC Paint Mouse 232 w/PC Paint Mountain Drive Card 20mb Race Card-286	134.95 134.95 849.95 549.95	Plus Development Hard Card 10mb	689.95	Tecan 122 Amber 630 RGB (Req. BOB) 842 RGB (Req. BOB)	169.95 459.95 619.95	Tecan AT Maestro w/2.5mb Captiva w/384k Graphics Master Magnification w/384k 840+ w/2mb	839.95 244.95 449.95 399.95 559.95
Drives Tasc 360K/1.2 Seagate 20MB ST225 Seagate 30MB w/card Seagate 20MB ST4026 Seagate 30MB ST4038 Seagate 40MB ST451	709/775 369 449 590 590 790	Intell Above Bnd w/128k Above Bnd. w/2mb Above Bnd. w/4mb Above Bnd. PC w/64k Above Bnd. PS w/64k Above Bnd. PC w/2mb Above Bnd. PS w/1.5mb	389.95 669.95 1079.95 289.95 299.95 539.95 619.95	Mouse Systems PC Mouse w/DR Halo II	129.95	Princeton Max 12 E HX 12 HX 12 E SR 12	189.00 439.95 949.00 579.00	PRINTERS CIE 350 cps 350 Citizen MSP 10 180 Citizen MSP 20 200 Citizen MSP 25 200 Citizen 1200 Citizen Premier 35 Epson LO 800 Epson LX 1000 Epson LX 80 FT Epson FX 65 Epson FX 288 NEC P560 NEC P660 NEC P760	1499.95 379.95 349.95 519.95 169.95 419.95 569.95 699.95 279.95 409.95 389.95 339.95 434.95 579.95	CLONES (AST like) Multifunction OK (Hercules like) Col. Gr./Par (Hercules like) Mono Gr./P Parallel or Serial Cards (Hayes like) Modem 1200 Samsung Monitor TTL Disk Drive Cont. Card Keyboard 5150 IO Card 5/PP/CC 512K Ram Card OK	99 99 115 49 189 125 70 80 99 99

VISA, MasterCard, AMEX

17151 Newhope, Suite 104, Fountain Valley, California 92708

1-800-654-5365 • (714) 557-3903

IBM is a Registered Trademark of International Business Machines
Compaq is a Registered Trademark of Compaq Computer Corporation.

CHANGING SYSTEMS? What Happens to Your Data? Does JUST Media Conversion Solve Incompatibilities?

WHAT IF . . .

everything is changing, including your software, hardware, operating systems and media? What happens to your spreadsheet data and formulas, database structures and/or word processing documents and codes?

What do you do, and what is the cost?

We Make Incompatible Data Compatible!

The source can be mainframes, minis, micros, dedicated word processors or typesetters. ADAPSO member.

CompuData Translators, Inc. 213-462-6222
6565 Sunset BL, #301 Hollywood, CA 90028

Inquiry 77

8086
8088

AMX

Now
68000

8080
280
6809

Real-Time Multitasking Executive

- No royalties
- Source code included
- Fault free operation
- Ideal for process control
- Timing control provided
- Low interrupt overhead
- Inter-task messages

Options:

- Resource Manager
- Buffer Manager
- Integer Math Library

Language Interfaces:
C Pascal
PL/M Fortran

DOS File Access:
CP/M-80
IBM PC DOS

IBM & Intel are registered trademarks of International Business Machines Corporation. CP/M-80 is a registered trademark of Digital Research Corporation.

AMX for 8080	\$ 800 US
8080	950
8808	950
68000	1800

Minimal assembly processor 75

KADAK Products Ltd. (604) 734-2796
208-1847 W Broadway, Vancouver, B.C., Canada V6J 1Y5
Telex: 04-55570

Inquiry 196

Computer Parts Mart

San Jose, CA 95112
(408) 993-9011

634 North 8th St.

STEPPER ENSEMBLE

100 Step High Precision Motor
by Applied Motion. Stepper driver with bipolar windings, 26 ohms/15mm. 1/4" x 2.1" ground shaft with helical follower groove @ 0.182" pitch. This is an extremely high accuracy assembly good to better than 50 microns absolute. Ball bearings, 5.5gm/cm inertia, 10 oz in holding torque @ 400 ma. New, never used Driver I.C.s: 3717 for P.W.M. Micro-stepping allow efficient use of any supply voltage up to 40v D.C. Motor and Two I.C.s including data sheets

\$14.95

STD-BUS

64K RAM Card expandable to 256K	\$ 99
256K Card	\$249
Vortex Card	\$149
32AS Interface Card	\$199
4-SIO Card	\$195
4-PIO Card	\$129
2-SIO & 2-PIO Card	\$125
280 CPU Card	\$ 79
6800 Proc. Card	\$300

Complete STD Systems available—Up to 10 slots, 10 MB Disk, etc.

Inquiry 87

DATAFLEX™

- Multi-user Database
- Powerfull
- Multiple Operating System Compatibility!
- Attractive Dealer Pricing!
- Full Dealer Support!

Dataflex is a trademark of Data Access

COGITATE

24000 Telegraph Road
Southfield, Michigan 48034 USA
(313) 352-2345

Inquiry 74

DOUBLE LETTER COLOR-PRINTER LETTER
THE OPTION CAPACITY
OF YOUR IBM PERSONAL COMPUTER

PC-XTRA

- DIRECT EXTENSION OF IBM PC BUS
- NO SOFTWARE CHANGES
- NO HARDWARE MODIFICATION
- STYLING CONSISTENT WITH IBM

Add all these special options that you've been wanting without worrying about fitting your plug-in and back panel space

DEALER INQUIRIES INVITED.

\$549.00* F.O.B. SANTA ANA
SANTA ANA RESIDENTS ADD 6% SALES TAX

P C HORIZONS, INC.
1701 E. Edinger, Ste. A6, Santa Ana, CA 92705
(714) 953-5396

Inquiry 270

PC/XT USERS!

- COGTREE Utilities by Cogitate \$129.95
- LYNC by Norton-Lamber . . . \$199.95
- DATAFLEX by Data Access . . .Varies
- RMICOBOL by Ryan! McFarlandVaries
- Universe by Omnitrend . . . \$ 98.50
- Blue MacI by Cogitate . . . \$599.00
- CadPower+ by Triflex . . . \$995.00
- Softest Teaching Aids \$ 95.00
- PrintSet by Cogitate \$ 79.95
- CogITAPE by Cogitate CALL!!
- Anti-Static ProductsVaries
- Uninterruptable Power BackupsVaries
- TeleVideo SoftwareCALL!!

COGITATE

"A Higher Form of Software"
24000 Telegraph Road
Southfield, MI 48034
(313) 352-2345/Telex 386581

VISA/MASTERCARD ACCEPTED
Dealer Inquiries Welcomed

Inquiry 75

GREAT SOFTWARE AT MODEST PRICES

Some samples from our library of over 480 disks for the IBM PC:

- **Desk Organizer**—A great pop-up helper, phone dialer, note pad, calendar, and calculator
 - 405 Deskmate—More than a sidekick \$6
- **Communications**
 - 310 Qmodem—last with windows \$6
 - 212, 334 Set up a BBS system \$12
- **Assembler with tutorial**
 - 10 Chasm, the Cheap ASseMbler \$6
- **Draw on your computer screen**
 - 344, 345 PC Key Draw (graphics req.) \$12
- **Spreadsheet**
 - 199 PC-Calc—simpler than Lotus & effective \$6
 - 214, 215, 267, 268 Spreadsheet, database \$24
- **Powerful database management programs**
 - 5 PC-File III—Labels, forms, letters, more \$6
 - 287, 288 File Express—reports generator \$12
- **BASIC tutorial**—A nice way to learn BASIC
 - 105 PC Professor \$6
- **Word processing**
 - 294 Edit, small, full-featured \$6
 - 78 PC-Write, popular and powerful \$6
 - 388 100 form letters on disk \$6
 - 194 PC-Read, computes grade level of text \$6
 - 379 Wordstar utilities, color, ASCII converter \$6
 - 480 PC-Outline, create an outline \$6
- **Artificial intelligence languages**
 - 417 Prolog \$6
 - 148 XLISP—experimental version of Lisp \$6
 - 398 ESIE, expert system generator \$6
- **Japanese Art of Paperfolding**
 - 408 Ongami—graphics required \$6
- **Games**—The most interesting games on, or off, Earth.
 - 293 Arcade Games (color graphics req.) \$6
 - 390 Flight and others (graphics req.) \$6
 - 354 PC Jr games \$6
 - 292 Spacewars, great on Hercules card \$6
 - 476 Patrick's Best games (mostly mono) \$6
- **Recover lost files**—File examine/repair utility (floppies only)
 - 133 Ultra Utilities, similar to Norton's \$6
- **DOS Help and explanations for the new user**
 - 254 PC DOS Help \$6
 - 403 Computer Tutor, learn PC-DOS \$6
- **Housekeeping**—Our favorite utilities
 - 273 Best Utilities \$6
 - 478 Hard disk utilities, WHEREIS and more \$6
- **Unprotect popular software**
 - 414 Routines to disable copy protection \$6
- **Financial**
 - 164 Cashtrac, checkbook, personal finances \$6
- **Typing tutor** to train those digits to dance.
 - 320 Touch Type \$6
- **Something for programmers:**
 - 424 Pascal compiler written in Turbo Pascal \$6
 - 263, 264 Laxon & Perry FORTH \$12
- **Genealogy**—several to choose from:
 - 90 Genealogy, keep track of family tree \$6
 - 240 FT-etc., family tree organizer \$6
- **For more software than you ever thought possible.**
 - 350-page directory (disks 1-300) \$8.95
 - Supplement (disks 301-454) \$3.95
 - 400 Listing of latest disks—401-480+ \$6
- **PC-SIG Membership**—includes directory, supplement, newsletters, and more
 - PC-SIG 1 yr. Membership (\$35 fore gn) \$20
 - Choose one: Printed On disk directory

SPECIAL

Any 5 Disks plus Directory, Supplement and 1-Year Membership Only \$39 (Reg \$50)

Most programs have documentation on disk and request a donation from satisfied users. Please add \$4 postage and handling per order (\$10 foreign)—California residents add state sales tax.

Total Enclosed \$_____ by Check VISA MC

Card No. _____

Exp. date _____ Signature _____

Name _____

Address _____

City _____ State _____ Zip _____

PC-SIG

To order, call: 800-245-6717
In CA: 800-222-2966
For technical questions or local orders: (408) 730-9291

1030-D East Duane Avenue Sunnyvale, CA 94086

Dealer Inquiries Invited #156

JULY 1986 • BYTE 419

Compu\$ave

Call Toll Free: 1-800-624-8949

A DIVISION OF ADLANKO CORPORATION

MONITORS

Amdek 310A	143	Amdek 722	499
NEC Multisynch	542	NEC/TTL	119
PGS HX12E	499	Teclar LP	539
Samsung 1251	75	PGS MAX12	158
Tatung 1370	449	Taxan 630	429
Tatung 1380	519	Taxan 640	495
Mitsuba/TTL	539	Wyse 620	399
Thom 36382S1	375	Zenith 1230	92
Roland/12"/RGB/640x240/.37	299		
Sakatz/13"/Comp & RGB 640x200	359		
Thomson/14"/Color Comp/Apple	139		
Hitachi/Mitsubishi/Quadram	CALL		

MODEMS

Anchor Volksmodem	49
Anchor Lightning 2400/Software	308
Incomm 2400 (Upgradable 4800+)	385
Novation 212 Apple Cal II	375
Novation 2400 Professional	509
PracticalP 1200 Half-Card/Software	145
Prometheus Promodem 1200G	195
Prometheus 300/Apple II/Software	79
Racal-Vadic 1200V	209
Racal-Vadic 2400PC/Software	389
Zoom IIE Internal/Software/Apple	92
Zoom PC 1200ST/Software	189
AST/Hayes/Rixxon/AUDS/Ven-Tel	CALL

COMPUTERS

Lazer 3000/1 Drive/Apple Compal	395
Olivetti M24/640K/8 MHz/Monitor	1645
Panasonic Sr. Partner/2 Drives	1395
Panasonic Exec. Partner/2 Drives	1995
Sharp PC7000 Portable/2 Drives	1295
Sperry IT/1M/40M Hard Drive	2975
Televideo AT/1.2M/20M/Monitor	2349
Wyse PC1100/256K/1 Drive	965
Zenith ZF138 Portable/1 Drive	1195
Zenith ZF158/256K/1 Drive	1399
Altos/Corona/ITT/Molecular	CALL

PC-XT CLONE \$558

640K/4.77 MHz/1 Floppy Drive/135 W Power Supply/XT-Style Keyboard/ User Documentation/6 Months Warranty

PC/AT CLONE \$1783

1M/8 MHz/1.2M Floppy Drive/200 Watt Power Supply/Keyboard/Clock/Calendar 1 Parallel & 2 Serial Ports/Documentation/FCC Approved/6 Months Warranty

TERMINALS

IBM 3163-11	629	Altas IV	359
Televideo 905	299	Dume 202G	459
Televideo 955	445	Dume 101B	293
Wyse 30	289	Visual 85	425
Wyse 85	438	Wyse 50	418
Ampex/CIE/Kimtron/Liberty/Link	CALL		

PRINTERS/PLOTTERS

Citizen 1200	169	Canon A40	235
Citizen MSP10	248	Canon Lazer	1875
C Itch 8510SP	365	Diablo D25	515
Corona Lazer	2265	Juki 6300	659
Epson FX286	539	Nec P5	965
Epson LX90	239	NEC P5XL	1079
Panasonic 1585	599	NEC P7	569
Panasonic 1091	234	Ricoh 52LQ	795
Toshiba 321 Ctr	1199	Star NX10	249
Toshiba 341	765	Tally MT86	425
Fujitsu Color/220CPS/Amiga	485		
Anadex/Brother/Data Prod/Dume	CALL		
Genicom/Okidata/Televideo/TI	CALL		
Buffers/Cables/Sheet Feeders	CALL		
Stands/Switch Boxes/Tractors	CALL		
Houston/Inline/Roland Plotters	SAVE		
Houston/Kurta/Summa Digitizers	SAVE		

DISK DRIVES

Apple Compatible Floppy Drives	121
Archive 60M Internal Tape Backup	799
IDOMEGA Dual 20M Bernoulli Box	2695
Seagate 20M Hard Drive Kit	419
Tallgrass 25M Drive/60M Backup	2199
Tandon 20M Hard Card	659

OTHER FLOPPY AND HARD DRIVES

Archive • CDC • Corvus • Gamma • Irwin Maxtor • Maynard • Mitsubishi • Priam Panasonic • Sanyo • Shugart • Toshiba Teac • Tecmar • Tulin • Western Digital

BOARDS

AST Rampage/PC-XT	279
AST Advantage/128K	299
Six Pack Clone/Game Port/OK	99
ATI Graphics Solution	199
Hercules Color Card	143
Color Card Clone	85
Orange Grappler + (Apple)	69
Orchid Tiny Turbo 286	465
Paradise Hi Res Graphics Card	189
PC Monochrome Graphics Card	89
PC 576K RAM Board (OK)	59
Sigma 400 High Res Card	445
STB Super Res 400 Card	285
STB EGA+ Card	279
Tecmar Graphics Master	279
Intel/Microtek/Persyst/Quadram	CALL
Prac Peripherals/Thasys/Vutek	CALL

ALL TYPES OF BUSINESS, CAD AND RECREATIONAL SOFTWARE VERY LOW PRICES. CALL

WE ALSO CARRY

PTI 300W Backup Power Supply	349
Intel 8087-2 Coprocessor Chip	152
Keytronics 5151 Keyboard	155
Cables/Disk Controllers/Joysticks	
Graphics Tablets/Keyboards/Labels	
Light Pens/Mice/Power Protectors	
LOW PRICES	CALL

HOURS: MON - FRI 8AM - 6PM/SAT 9AM - 2PM IN ARIZONA CALL (602) 437-8855

CompuSave: 4207 S. 37th St., Phoenix, AZ 85040/For Customer Service Call (602) 437-8850/Prices Reflect Cash Discounts And Are Subject To Change Without Notice/Minimum Shipping Charge \$4 Purchase Orders & Major Credit Cards Welcome

BYTE CONNECTION INC. (714) 778-6496

BOTTOM LINE PRICE BUSTERS! - "Who you gonna call?"

PRINTERS

BROTHER M-1509	\$ 350	CITIZEN C10H LQ24	\$ 895	D10-40	\$ 750
C-10	\$ 475	CITIZEN MSP 15	\$ 365	MSP 25	\$ 525
PREMIER 35	\$ 450	CORONA LASER	\$ 2350		
DIABLO 835	\$1250	INKJET	\$ 895	34LQ	\$1095
LAZER/COPIER 4045	\$4259	EPSON	CALL		
DATA PRODUCTS	CALL	FUJITSU MAX24	\$1175		
2400 PLUS	\$ 919	DL 2400	\$ 895	2100	\$495
HEWLETT-PACKARD LASER JET	\$2295	HP Plus	\$3250		
HP LASER 500 Plus	\$4145	NEC P580	\$ 895	P780	\$ 595
OKIDATA 192	\$ 369	193	\$ 479	PANASONIC P1592	\$1149
P1592	\$ 625	TOSHIBA P351	\$1095	P341	\$ 750

PLOTTERS & DIGITIZERS

CALCOMP 1042 - While Supplies Last	\$8395	1043	\$7359
1044	\$11,195	GOULD 6320 11 x 17	\$1550
ID LINE 3700	\$3895		
HI DMP 56	\$4596	DMP 40	\$ 775
DMP 51/52	\$4145		
HP 7475	\$1659	HP 7580	\$8415
NICOLET ZETA 824	\$8995	ZETA 836CS	\$13,295
GTCC 3648L	\$3085	1117A	\$1195
2436TL	\$5995		
KURTA 12 x 12	\$ 595	12 x 17	\$ 695
SUMMAGRAPHICS 11 x 11	\$ 495	18 x 12	\$ 750
HITACHI 36 x 48	\$4195	TIGER 11 x 11	\$ 675
10 x 15	\$1295		

GRAPHIC CONTROLLERS & MONITORS

HITACHI HM 3719 & BNW 15	\$3290
MICROVITEC 905CNO GRAPHPORT D	\$2795
TAXAN 640 & COLOR 400L	\$1199
PERSYST BOB 16 & NEC 1401	\$1295
GALAXY 800 & MITSUBISHI 6489	\$2895
VERTICOM CD-1 & VERTICOM M-18	\$2395
BNW ADAPTER	\$1950
ARTIST-IT	\$2295
CONOGRAPHICS 400 & MITSUBISHI 3479 LP	\$2295
MITSUBISHI 1341 & SIGMA 400	\$1195

HARD DRIVES & BACK UP SYSTEMS

UBM 10 MB HD, 10 MB Tape B/U & Cont	\$ 889
UBM 20 MB HD, Controller	\$ 479
UBM 30 MB HD & Controller	\$ 695
UBM 70 MB HD, 26 MB for AT	\$1550
UBM(Archive) 60 MB Tape B/U	\$ 750
RHODINE 40 MB HD	\$ 875
PRIAM 60 MB HD	\$1595
FUJITSU 55 MB HD	\$2095
MOUNTAIN 80 MB	\$2250
MOUNTAIN 30 MB HD	\$1295

PERSONAL COMPUTERS

UBM * I (IBM Compatible), 640K, AT or 5151 Look Alike Keyboard, Two 360 Floppies, PP, Graphics Board & Monitor	\$ 879
UBM * II Turbo, all the above with 360 Floppy, 20 MB HD	\$1359
UBM * IV, (IBM AT Compatible), with 8 MHz, 640 K, 1.2 MB Floppy, 20 MB HD, Graphics Card, Monitor & Keyboard	\$2405
UBM Monographics	\$ 120
UBM AT Serial, Parallel	\$ 95
UBM Multi Function, S, P, C/C, Zero-384K	\$ 125
UBM 20 MB Subsystem	\$ 479
UBM Color Graphics	\$ 120
UBM EGA Compatible	\$ 350

DEALER'S INQUIRIES INVITED	
IBM PC, with 256K, K.B., Two 360 Floppies	\$1295
IBM PC XT, with 256K, 360 Floppy, 20 MB HD, K.B., Graphics Card, Monitor	\$2350
IBM PC AT, with 512K, K.B., 20 MB HD	\$3795
IBM PC Convertible 80 C 88 Processor, with 512K, Two 720KB Floppies	CALL
IBM Printer	\$ 475
IBM Quietwriter	CALL
IBM EGA, with 256K Memory	\$ 775
IBM EG Monitor	\$ 695

COMPAQ PORTABLE II with 512K, 80286 Processor, Two 360 Floppies	\$2875
COMPAQ DESK PRO, with 640K, Two 360 Floppies, Graphics Card & Monitor	\$1895
COMPAQ DESK PRO & PORTABLE 286, with 640K, 1.2 Floppy, 20 MB HD, Monitor	\$3895
For 85 MB, instead of 20 MB, add	\$ 995

AT & T 8300 PC, with 256K, K.B., Two 360 Floppies, AT & T Graphics Card & Monitor	\$1795
AT & T 8300 Plus, with 512 K, 1.2 Floppy, K.B., Graphics Card & Monitor	\$3495

SPERRY PC-IT, with 640K, 1.2 MB Floppy, 40 MB HD, K.B.	\$3095
--	--------

SOFTWARE

Accounting Package	\$ 495
AUTOCAD	\$1950
CALVANCE, VERSACAD, HITACHI & ANVIL	CALL
ARMOR SYSTEM'S Escalibur & Plus Series	CALL
COMPUTER ASSOCIATE (IUS) A/R, A/P, G/L	EACH \$ 350
UNIVAIR'S Dental Management & Medical Management-9000	CALL
CYMA Medical, Chiropractic, Orthodontic, Dental Package	\$1625
Physici: n Micro Systems Package	\$1850
Hotel Information Systems Package	\$2450
MICROCRAFT, BALCONE, UNIVAIR	CALL
IBM Doctor Officer Manager	\$2195

CALL FOR WHAT IS NOT LISTED, WE GUARANTEE THAT YOUR CALL WILL NOT BE A WASTE.

No charges for testing and configuring equipment. Prices and availability subject to change without notice.

(714) 778-6496

163 West Cerritos Ave., Anaheim, CA 92805

TIMELINE INC.

CALL US FOR ALL YOUR NEEDS! We have 10 Million I.C.'s in stock! OEM INQUIRIES WELCOME Minimum I.C. Order: \$200.00

THE CLASSIC SOLUTION!

CLASSIC TECHNOLOGY CORPORATION

286 SPEED PAK FOR IBM PC & XT

UP TO 7 TIMES PC SPEED

\$770.00



- Increases speed of PC/XT to make it 33% faster than an AT -20-30% faster than boards that use cache
- Compatible with IBM Enhanced Graphics Adapter and the Lotus/Intel above board
- Can run programs designed for the AT's and also PC/XT's
- No software patches needed
- Includes native mode
- Made in U.S.A.

BOARD COMPATIBILITY	80387	80387	80387	80387	80387
SPEED	Yes	Yes	Yes	Yes	Yes
COMPATIBILITY	Yes	No	No	No	No
UPGRADEABILITY	Yes	No	No	No	No
PERFORMANCE	Yes	No	No	No	No
3-YR WARRANTY	Yes	No	No	No	No

MOTOROLA 7" DIAGONAL SCREEN HIGH RESOLUTION GREEN SCREEN MONITOR

22 MHZ TYPICAL BANDWIDTH **\$29.95** MODEL MD1700

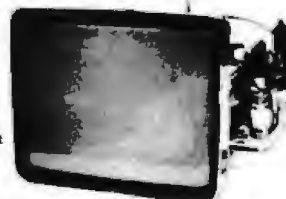

- Flat Facelplate
- 900 lines at Center 650 lines at corners
- Operates from 12VDC at 1 Amp.
- Vertical input is 47 to 63 Hz.
- Horizontal input: 15.7 KHz (18.7 KHz optional)
- Video input signal: Positive white, input termination 470 ohms ±
- 5%, 2.5V to 5.0V P-P Weight: 6lbs.

For split video (TTL Input) operation. Not composite video.

HIGH SPEED MONOCHROME GRAPHICS & MEMORY EXPANSION ADAPTER FOR IBM AT

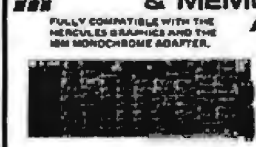

Lotus Compatible -Graphics mode: 720x348 -Parallel Printer Interface -Comes with 128 or 384K -3 YEAR WARRANTY

\$279.00

PLUS-- 3 TIMES FASTER SCREEN UPDATING -16 BIT OPERATION -UP TO 384K MEMORY EXPANSION TO BRING AN AT UP TO 640K MEMORY (NO EXTRA SLOT NEEDED)

MULTIFUNCTION ADAPTER

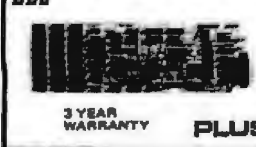

-Clock Calendar - 384K RAM Included - Serial Port - Parallel Port - Game Port - High Speed Electronic Disk - Software Included - Printer Cable Included - Made in the U.S.A.

\$179.00

PLUS-- FASTER PRINTER SPOOLER WITH MORE OPTIONS -ALARM CLOCK & OTHER CLOCK FEATURES!

MONOCHROME GRAPHICS ADAPTER

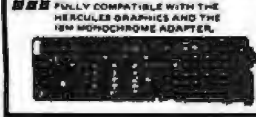

Lotus Compatible -Graphics Mode: 720x348 -Parallel Printer Interface -Made in the U.S.A.

\$139.00

PLUS-- TURN ON/OFF OF PARALLEL PORT -IDEAL FOR USE IN PC/XT!

NASHUA DISKETTES 9K" SOFT SECTOR

Nashua Diskettes were judged to have the highest polish & recorded amplitude of any diskettes tested, according to "Comparing Floppy Disk" Bytes 9/84.

\$8.00 BOX OF 10

.70c 5 BOXES OF 10

.82c 10 BOXES OF 10

IBM KEYBOARD CABLE (DIN connector on one end) **4.95**

115V FANS

Recon/2400 1/2" 1.5A 1.50
Gen 1/2" 1.5A 1.50
Recon/2400 1/2" 1.5A 1.50

\$7.00 year choice!

EPSON QX-10 MOTHERBOARD WITH VIDEO CARD & YOUR CHOICE OF ASCII KEYBOARD (ENCLOSED) OR HASCII (BARE)



\$169.95

ONLY 250 SYSTEMS AVAILABLE!
Will work with any IBM compatible disk drive + CPU +PD780AC-1 (286A compatible, 8 MHz) + Memory-RAM 256K on board. Video RAM 128K on CRT board. C-MOS RAM 2K. EPROM-24/16K (for IPL) C-MOS. C-MOS real-time clock. Interface Serial and Parallel DMA 7 channels. Interrupt levels 15. Counter/timer: 8 channels. Card slots. 5. Compatible with any TTL monitor. Weight: 10 lbs. with enclosed keyboard, 8 lbs. with bare keyboard.

KEPCO/TDK SWITCHING POWER SUPPLY

\$39.95

ONLY 250 AVAILABLE!
Model EPX 100T-3 100W +5V @ 2A + -5V @ 1.5A + -12V @ 2.0A + -12V @ 2.0A + Input Voltage: 100 to 130VAC or 200 to 260VAC 47-440 HZ Single phase + Brownout Voltage 90VAC-180VAC + Fused Input/Output protection against short circuit. Dim 9 1/2" x 4 1/2" x 7 1/2" Weight: 3 lbs. Spool included.

QUME Sprint 9/35 KSR

TERMINAL/PRINTER -35 CPS -Serial Interface 51lbs.

\$299.00

"Spy in the Sky" Fairchild CCD122 1,728 ELEMENT Linear Image Sensor \$29.95

"The Twilight Zone" Designed for page scanning applications including facsimile, Optical Character recognition and other imaging applications which require high resolution and high sensitivity.

RICOH PRINTER RP 1200N - 25 CPS

Centronics Interface -Daisy Wheel **\$400.00**

SIEMENS 8" DISK DRIVE \$44.95

OR FOR **\$69.95**

FD0100-8 Shugart 8011 equivalent Single Sided, Single/Douze Density. Full Height Drive. 48 lbs. Documentation included. Specify 110 or 220 Volt Mopex + These drives are new and sold AS IS Weight: 14 lbs.

Switchable Power Supply

110/220V 141 Watt +5V @ 2.0A
Dim: 10x3x3/8 +5V @ 3.5A
+12V @ 0.1A
+12V @ 0.2A
+12V @ 2.0A

\$49.95

Weight: 7lbs.

HIGH CAPACITY AMLYN 1860A DRIVE

5 1/4" DS/High Density 3.2 mByte Unformatted 1.2 Formatted Takes 8" controller to operate

\$139.00

Wt: 4lbs.

Standard Date - Local Area NETWORK BOARD

With Software **\$150.00**

4164-15 .89c EACH

MINIMUM 50 PCBs. Call for quantity discount.

Tandon 848-2 IBM COMPATIBLE DOUBLE SIDED/DOUBLE DENSITY 1/2 HEIGHT - 1" DRIVE 1.8 mByte Unformatted 1.2 Formatted Wt: 7lbs.

\$199.95

SERIAL PRINTER /MODEM CABLE (Male to Female) \$7.95 OFF!

FOR USE IN SERIAL APPLICATIONS Both in Serial Printer and Modems.

18" length Full outside plating of 18/19 50P Turned copper leads 24 x 180 wires -Insulated 0.05 pin strips & female connectors -All exterior mount pins are plated -Plus 1 x 9 x 30 wires -Color: Blue

DISK DRIVE CABINET \$12.95

Full Height Disk Drive case for Apple + Fits 2 half height drives. Can be modified for other uses. Dim: 9 1/2" x 5 1/2" x 3 1/4" Weight: 3 lbs.

1490 W. ARTESIA BLVD., GARDENA, CA. 90247

Continental U.S.A. (800) 872-8878 Inside California (800) 223-9977 L.A. Area & Technical Info (213) 217-8912 (800) 428-1616

VISA MasterCard

Minimum Order: \$25.00. Shipping & handling charges via UPS Ground: \$.50c/lb. UPS Air: \$1.00/lb. Minimum Charge: \$4.00. We accept cashiers checks, MC or VISA. No personal check COD's. Items reflect 5% cash or check discount. California residents add 6 1/2% sales tax. We are not responsible for typographical errors. All merchandise subject to prior sale. Phone orders welcome. Foreign Orders require special handling



Inquiry 361

Your System/Controller should fit you like a good suit.



LET MICROMINT CUSTOM FIT YOU

Whether it's suits or system controllers, you can't buy off the rack when you need a custom fit.

That's why Micromint individualizes its system controllers to meet your particular needs and budget. What's most important to you? Software compatibility? Speed? Everything on one board? Economical computing power?

#1: "I want software compatibility."

Solution:

THE SB180 COMPUTER/CONTROLLER

The SB180, only 4" by 7½", offers a Z80 compatible CPU running at 6MHz, 256K bytes of RAM, up to 32K bytes of ROM, two serial ports, a parallel port, Z80/6800 I/O expansion bus, and an industry standard 765A-compatible disk controller for up to four disk drives — any combinations of 3½", 5¼" or 8" drives. The SB180 is based on the Hitachi HD64180 CPU, a microcoded CMOS chip which provides high performance, reduced system cost, and low power operation while maintaining complete compatibility with the large base of standard CP/M software.

SB180-1 w/8K ROM monitor... \$369.00

SB180-1-10 w/8K ROM monitor,
BIOS source and
Z-system... \$418.00

#2: "I need speed."

Solution:

THE Z8 FORTH SYSTEM/CONTROLLER

The Z8 FORTH System/Controller is only 4" by 4½" and includes a custom masked Z8 version of the FORTH

language with a full screen editor, cassette I/O driver primitives, EPROM programmer primitives, and other utility words. It also contains up to 4K bytes of RAM or EPROM, an RS-232 serial port with selectable baud rates, and two parallel ports. Additional Z8 peripheral boards include memory expansion, a smart terminal board, serial and parallel I/O, real time clock an A/D converter, and an EPROM programmer. It's perfect for data reduction and high speed control applications.

BCC21 w/utilities... \$225.00

#3: "Let me have an entire development system on one board."

Solution:

THE BCC52 SYSTEM/CONTROLLER

The BCC52 is a new stand alone single board microcomputer which is bus compatible with the Micromint BCC11/BCC21 Z8 System/Controllers and expansion boards. The BCC52 features the Intel 8052AH-BASIC microprocessor which includes a ROM resident 8K byte floating point BASIC inter-



For a System Controller suited to your needs, give us a call.

preter with extensions for process control work. It contains sockets for up to 48K bytes of RAM/EPROM, an "intelligent" 2764/128 EPROM programmer, 3 parallel ports, a serial terminal port, and a serial printer port.

BCC52... \$239.00

#4: "Give me lots of economical computing power."

Solution:

THE BCC11 BASIC SYSTEM/CONTROLLER

The Z8 BASIC System/Controller is nearly identical to the FORTH System/Controller but contains a tiny BASIC interpreter, up to 6K bytes of RAM and EPROM, an RS-232 serial port with switch selectable baud rates, and two parallel ports. Add a power supply and terminal to start programming in BASIC or machine language. Programs can be transferred to 2732 EPROMS with the optional EPROM programmer for auto-start applications. It can also use any of the expansion boards mentioned under the Z8 FORTH System/Controller.

BCC11... \$149.00

Additional information on peripheral boards and OEM pricing is available.

Order Toll Free

1-800-635-3355

In Connecticut call: 1-871-6170



MICROMINT, INC.
25 Terrace Drive
Vernon, CT 06066

ATTAK-286™

HIGH SPEED 12 MHZ OPERATION Software Selectable for **6,8,10, and 12 MHZ!**

- FULL IBM PC-AT* COMPATIBILITY!
- FOUR MEGA-BYTE RAM CAPACITY ON MOTHERBOARD! USING 1 MEGA-BIT DRAMS.

QUANTITY DISCOUNTS AVAILABLE FOR QUALIFIED DEALER, OEM, UNIVERSITY AND CORPORATE ACCOUNTS.

NEW!

HIGH SPEED INDUSTRIAL GRADE COMPUTER FOR:

- Scientific
- Engineering
- Industrial
- Medical
- University/Education
- Artificial Intelligence
- Etc., Etc., Etc.

Eight Compatible I/O Interface Connectors (Same as PC-AT)

Keyboard Interface (Same as PC-AT)

On Board Battery

CMOS Clock Calendar

Standard Power Connector (Same as PC-AT)

80287 Math Processor (Same as PC-AT)

Runs Intel 80286 at 6,8,10&12 MHZ! (Software selectable)

Extended ROM Capability (Operates on all compatible BIOS ROMS)

Extended Memory Capacity! Full Four Mega-Byte Capacity on Motherboard! (Uses 256k or NEW 1 Mega-Bit Drams)

Peripheral Support Circuits (Same as PC-AT)

ORDER NOW!!

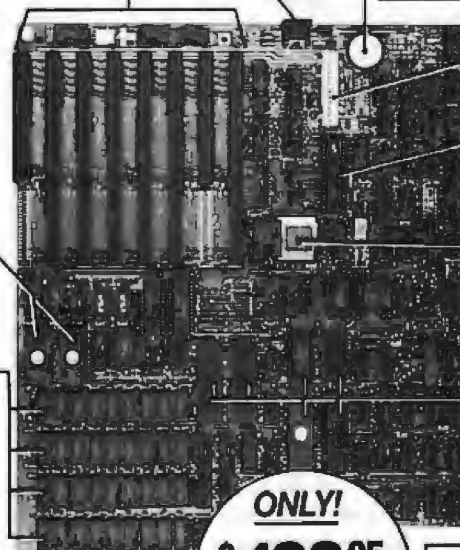

ONLY!

\$199⁹⁵

EVALUATION BOARD KIT

- ATTAK-286™ FULLY ASSEMBLED (LESS ICS)\$499.95
- AT CASE 100% COMPATIBLE.....\$129.95
- AT POWER SUPPLY 182W.....\$129.95
- ATTAK-286™ TECHNICAL REFERENCE MANUAL\$ 29.95
- TURBO-SCOPE™ A/D BOARD.....\$ 99.95

Board Size: Standard IBM-AT* Dimensions: 12 inch x 13.8 inch with 6 mounting holes to fit all AT compatible cases.

100% SATISFACTION GUARANTEED.
10 DAY MONEY BACK GUARANTEE IF NOT COMPLETELY SATISFIED!



ATTAK-286™ evaluation board kit highest quality multi-layer PC board with full assembly instructions and parts lists!

AiT CORPORATION ADVANCED INTELLIGENCE TECHNOLOGY

4100 Spring Valley Road
Suite 400
Dallas, Texas 75244
(214) 490-0344

TERMS: We accept cash, checks, money orders and credit cards. Prices and availability subject to change without notice. Shipping and handling charges via UPS ground 50¢/lb UPS air \$1.00/lb. Minimum charge \$3.00.

*IBM and IBM PC-AT are trademarks of International Business Machines

© 1986 AIT CORP.

ROBOTICS — SCIENTIFIC BUS

For IBM PC/XT/AT/compatibles, Apple II...



The Local Applications Bus

- Host Adapter: Modular approach to data acquisition and control. A 40 conductor ribbon cable bus is generated by a host adapter card. Up to 8 low cost Modules can be located anywhere on a cable up to 100 ft long. Bus features: DMA, interrupts, 16 data bits. Copy & non-proprietary. Host adapter card, utility software & manual \$180.
- Fast A/D Module: 650K resolution, 8 bit, four differential channels programmable gain & offset, 650K. Complete package with Scope program, host adapter, Fast A/D Module & cable \$699.75T available.
- 12 Bit A/D Module: four channels, 10K samples/sec, Inst. amp \$230
- Parity/Relay Module: 8 standard relay cards, 54 bits 602 interrupts.
- Clock Module: Real time & periods, battery, interrupts, software.
- Four Axis Stepper Motor Driver Module: 11V @ 1.5A/phase/motor. Full map, full map, brake, free wheel. Software & motor included \$92
- Smart Dual Axis Motor Control Module: For DC, brushless or stepper motor drivers & encoders. Processors (from HP) allow changes & monitoring on the fly. Completely featured. Call for low cost.
- Unique to LAW 40 is its ability to efficiently interface directly to chips, such as co-processors & converters, with the lowest hardware & software overhead. Call for more info or order our Proposition.

• LAW 40 Propositions: 10 hardware and software projects with IBM PC \$25

Computer Continuum
75 Southgate Ave., Suite 5 • Daly City, CA 94016
(415) 755-1070

MODULAR DATA ACQUISITION



- For IBM & Compatibles
- Flexible and Inexpensive
- Money Back Guarantee
- Free Technical Support

Fast Delivery
QUA TECH, INC.
478 E. Exchange St. Akron OH 44304
(216) 434-3154 TLX: 5101012726

Inquiry 289

8051 8048

SIMULATORS - CROSS ASSEMBLERS - PROGRAMMERS - SIM51 and SIM48 Software Simulators run on IBM-PC, CP/M-80, MS-DOS. Designed for validation & debugging application software. Simulation includes all on chip functions plus expansion chips. \$250, one year FREE updates. Formats: PC-DOS 2.x DSDD, CP/M-80 8" SSSD, many 5 1/4" formats. Cross Assemblers and EPROM pgmrs also available. Logical Systems Corp. 6184 Teal Station, Syr., NY 13217. (315) 478-0722

Local Systems

Inquiry 210

PC-WRITER™



IBM PC GRAPHICS & LETTER QUALITY
Enhancement for Okidata ML82A/83A Dot Matrix Printers

- Plug-in module easily installs in printer.
 - Draft (120 cps) & Letter Quality (6 cps)
 - Elite character pitch
 - Front panel access to all features
 - Emulation of IBM PC Graphics printer
 - Superscripts / subscripts
 - Foreign / scientific characters
 - Works with print screen key in graphics mode
 - Prints and displays screen characters and background symbols exactly as they appear on display (double line as well as single line box symbols)
- About **OK-WRITER** Okidata graphics for \$99 with many of above features

RAINBOW TECHNOLOGIES INC.
17971-E Skypark Circle, Irvine, CA 92714
(714) 261-0228 Telex 386078
UK Distributor: X-DATA (0753) 72331

Inquiry 297

WAVEFORM SYNTHESIZER

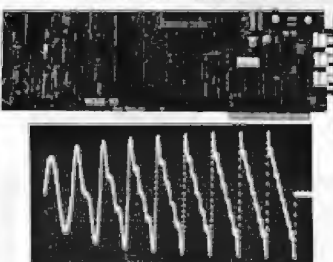

- For IBM-PC/XT/AT and compatibles
- Generates user-definable signal
- Up to 2000 points per envelope

\$795.00
QUA TECH, INC.
478 E. Exchange St. Akron OH 44304
(216) 434-3154 TLX: 5101012726

Inquiry 290

The greatest value ever Special Offer on BASF Qualimetric diskettes!

Buy 10, get 12
and a

FREE storage case!

This is an exclusive offer from DISK WORLD!...your chance to buy 5.25" BASF Qualimetric diskettes at our low prices and ...get 12 instead of 10 and ...get a **FREE** plastic storage case (a good one, not a cheapie)!

.79 ea. < SSDD DSDD > **.90 ea**
Qty. 50 Qty. 50

Quantities are limited, so act now! BASF special promotion diskettes are in plastic boxes of 12 with Tyvec sleeves.

LIFETIME WARRANTY!

Regular BASF Price List:

	Qty. 20-40	Qty. 50+	Qty. (BULK) 150+
5.25 Diskettes			
SSDD (P N3406)	81	79	72*
DSDD (P N3407)	92	90	83**
SSDD96 (P N3404)	92	90	N/A
DSDD96 (P N3405)	1.03	1.01	N/A
DSDDHD (P N3403)	2.07	2.04	N/A

* Bulk is (P N3408) ** Bulk is (P N3409)
Regular (non-bulk) product is packed 10 to a box with Tyvec sleeves, user-ID labels and write-protect tabs. BULK product is in cartons of 150 diskettes with Tyvec sleeves.

	Qty. 20-40	Qty. 50+	Qty. (BULK) 200+
3.50 Diskettes:			
SSDD (P N3402)	1.53	1.48	1.52
DSDD (P-N3412)	2.06	2.01	2.05

BASF 3.5" diskettes, except for bulk, are packed in boxes of 10 and include user-ID labels. BASF bulk product is in boxes of 100 and includes user-ID labels.

PRINTER RIBBONS!

Brand new ribbons to factory specs!	
EPSON MX-70/80(P N2500)	\$2.70ea
EPSON MX-100(P N2501)	\$4.08ea
Okidata Micro83(P N2505)	\$1.37ea
Okidata Micro84(P N2502)	\$2.98ea

Add 25c per ribbon for shipping!

STORAGE CASES!

DISKMINDER II(P N2850) Holds 75 5.25" diskettes with dividers \$9.69ea + \$2.00 Shpg
DISK MINDER 36(P N2950) Holds 36 3.50" diskettes with dividers \$6.49ea + \$2.00 Shpg
DISK CADDIES(P N2200) Beige Holds 10 diskettes \$1.65 ea + 20 Shpg

HOW TO ORDER:

ORDERS ONLY:

1-800-621-6827

(In Illinois: 1-312-256-7140)

INQUIRIES:

1-312-256-7140

FOR FASTEST SERVICE, USE NO-COST MCI MAIL. Our address is DISKORDE. It's a FREE MCI MAIL letter. No charge to you. (Situation permitting, we'll ship these orders in 24 hours or less.)

SHIPPING: 5.25" & 3.50" DISKETTES-Add \$3.00 per each 100 or fewer diskettes. OTHER ITEMS: Add shipping charges as shown in addition to other shipping charges. **PAYMENT:** VISA, MASTERCARD and Prepaid orders accepted. **COD ORDERS:** Add \$5.00 special handling charge. **APO, FPO, AK, HI & PR ORDERS:** include shipping charges as shown and additional 5% of total order amount to cover PAL and insurance. We ship only to United States addresses, except as shown above. **TAXES:** Illinois residents add 7% sales tax.

MINIMUM ORDER: \$35.00

DISK WORLD!, Inc.

629 Green Bay Rd • Wilmette IL 60091

DISK WORLD!, Inc.

An end to diskette lies!

Super Star™ Diskettes are of equal or higher quality than 3M, Maxell, TDK and many other "famous" brand names. They simply cost about half as much!

Super Star™ diskettes are manufactured to equal or exceed the same specifications as 3M, Maxell, TDK and many other "famous" brand name products.

They are designed for 60% or higher clipping levels, not the 40% used in IBM and ANSI standards. Each is guaranteed for ten million read/write passes. Every Super Star™ diskette is 100% verified and carries a LIFETIME WARRANTY!

Yet Super Star™ diskettes cost only about half as much...

How can we deliver Super Star™ diskettes of such high quality at such a low price?

Simple...we don't make fools out of our customers.

We bargain hard with the same people who turn out many of the "famous name" brands. Their manufacturing capacity far exceeds their capability to sell everything they make. So, as large scale purchasers, we are able to obtain significantly lower prices than others for high-quality diskettes.

For example, we pay one of the big name manufacturers 98¢ for their "famous name" diskette in a pretty box. In an unequalled display of favoritism, that same manufacturer sells the same diskette in the same fancy box to a major corporation for 42¢ each. Finally, a software duplicator can buy the same diskette without the box for 37¢!

A 265% price difference: for what?

In the example above, that's a difference of 265% in price for the very same diskette!

So you see, paying for a "famous name" on a diskette doesn't guaranty you that you're getting any more for the money.

You may be paying for some big corporation's fleet of aircraft and their executive retreats in Minnesota and Canada, but you are not paying for any more quality.

You're simply getting rooked out of money you could have in your own pocket.

There are four kinds of diskettes:

And Super Star™ is right up there with the best.

As you leaf through the pages of this magazine, you will see diskettes advertised at prices as low as 33¢. Every one, of course, claims to be the "best".

It's simply not true.

Here are the only kinds of diskettes you can buy:

High-Clip Product: this is what you get when you buy Super Star™, 3M™, Maxell™, TDK™ or any number of other famous and not so famous name diskettes. They have clipping rates of 60% or more, are certified for ten million read/write passes or more and are simply the best diskettes available. You can expect perhaps 1 out of 100,000 to fail...and that will usually be the result of dirty or misaligned drives.

ANSI Spec Product: These are "okay" diskettes. They have a clipping level of 40%. Usually they are the fall-out from a manufacturer's "high-clip" product line. You can expect about 1 out of 20 to fail in normal

(But that failure rate has more to do with the disk drive rather than the diskette.) The price difference between an ANSI-spec disk and a High-Clip product is only a few cents. But the failure rate of ANSI product is 50,000 times higher!

Duplicator Product: This is a catch-all category. Some of it may be High-Clip Product, some ANSI spec, some cosmetically blemished, some garbage. Usually anyone who buys product in this class justifiably anticipates that 20 out of every 100 diskettes will not format properly.

Floor Sweepings: This is just plain "garbage". For example, the 5.25" SSSD diskettes that you see advertised for 39¢ are exactly that: garbage. No decent manufacturer has sold any 5.25" SSSD diskettes in several years. SSSD is the absolute bottom of the line in terms of quality. Most of the discount diskettes you see advertised are "floor sweepings"...bought up by brokers and passed on to the unsuspecting public by unscrupulous merchants who are simply out to make a fast buck.

When every bit counts, you can count on Super Star™!

Well, I wish we had more space, but we don't.

So, here's the message in a nutshell:

1. Super Star™ diskettes are high-clip product, 100% certified, tested to 60% or higher clip levels and not less than ten million read/write passes.

2. Super Star™ diskettes carry a LIFETIME WARRANTY.

3. Super Star™ diskettes equal or exceed the published specifications of such "famous" brand names as 3M, Maxell, TDK, etc.

4. Super Star™ diskettes give you this quality at about half the price of the big names!

Save your money: buy Super Star™ diskettes!

That's the message:

Super Star™ diskettes mean the highest quality at about half the price!

SUPER STAR SPECIAL!

Your choice of storage for \$ 4.95!

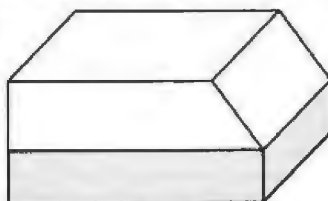

Buy 50 Super Star™ diskettes of either size and you can get a nice plastic storage case for only \$ 4.95 (shipping included!).

These are durable plastic cases with dividers.

The 5.25" unit holds 50 diskettes and the 3.50" unit holds 40 diskettes.

5.25" Storage Unit (P/N3100) \$ 4.95ea.

3.50" Storage Unit (P/N3102) \$ 4.95ea.

Super Star™ 5.25"

SSDD (P/N3800) .55ea.

DSDD (P/N3801) .62ea.

SSDD96 (P/N3802) .78ea.

DSDD96 (P/N3803) .82ea.

DSDDHD (P/N3804) \$ 1.61ea.

ORDER IN MULTIPLES OF 50 ONLY!

All Super Star 5.25" Diskettes are poly-bagged in lots of 25 with Tyvec sleeves, write-protect tabs and user ID labels.

QUANTITY DISCOUNTS: 350-500 diskettes, deduct 3%. 550-700 diskettes, deduct 6%. 750-1,000 diskettes, deduct 9%. 1,050+ diskettes, deduct 12%.

Super Star™ 3.50"

SSDD (P/N3805) \$ 1.52ea.

DSDD (P/N3806) \$ 1.67ea.

ORDER IN MULTIPLES OF 50 ONLY!

Super Star 3.50" diskettes are packaged in boxes of 50 with user ID labels.

QUANTITY DISCOUNTS: 350-500 diskettes, deduct 1.5%. 550-700 diskettes, deduct 3%. 750-1,000 diskettes, deduct 4.5%. 1,050+ diskettes, deduct 6%.

TAKE A CLOSE LOOK AT OUR DISCOUNTS!

Take a real close look at our discounts. They're some of the best around.

HOURS:

8AM-6PM Central Time

Monday - Friday

HOW TO ORDER:

ORDERS ONLY:

1-800-621-6827

(In Illinois: 1-312-256-7140)

INQUIRIES:

1-312-256-7140

FOR FASTEST SERVICE, USE NO-COST MCI MAIL. Our address is DISKORDER. It's a FREE MCI MAIL letter. No charge to you (Situation permitting, we'll ship these orders in 24 hours or less.)

SHIPPING: 5.25" & 3.50" DISKETTES-Add \$ 3.00 per each 100 or fewer diskettes. OTHER

ITEMS: Add shipping charges as shown in addition to other shipping charges. **PAYMENT:**

VISA, MASTERCARD and Prepaid orders accepted. **COD ORDERS:** Add \$ 5.00 special

handling charge. APO, FPO, AK, HI & PR **ORDERS:** Include shipping charges as shown

and additional 5% of total order amount to cover PAL and insurance. We ship only to United States

addresses, except as shown above. **TAXES:**

Illinois residents add 7% sales tax.

MINIMUM ORDER: \$ 35.00

DISK WORLD!, Inc.

629 Green Bay Road
Wilmette, Illinois 60091

WHY PAY MORE?

IBM Compatible Software only \$6 per disk

OVER 500 DISKS FULL OF PUBLIC DOMAIN AND USER SUPPORTED PROGRAMS



Summary of Disks

People often ask "... how can you sell any really good programs for \$6? After all, everyone knows you have to spend \$300 on a good word processor, database manager, or spreadsheet program... don't you?"

The truth is many of our satisfied customers have discovered that our public domain and user supported programs are actually some of the best and most sophisticated software you can buy, at any price! The commercial retailers don't want you to know about us or our programs, but why pay hundreds of dollars more for software that won't do anymore than our \$6.00 package. Here is a sample of our library by category.

WORD PROCESSORS

PC-Write 2.5 (#78) A full featured word processor that is faster than Wordstar.
TSCRIPT (#422) word processor for PC-JR only. Pascal source code included.
DICTIONARY (#378) Dictionary type spelling checker.
IV-ED (#415) Word processor - editor.
LETTERWRITER (#415) controls letter processing.

SCREEN EDITORS

FRED (#83) Screen editor similar to IBM's Personal Editor.
RV-EDIT (#190) Full screen editor from Bob Volmer.
FOIL EDIT (#347) Full screen editor. Top to bottom and left to right.

TEXT PROCESSING TOOLS

PC-READ (#194) Program to determine clarity of text.
FOGFIND (#378) reverses writing complexity using the "Fog Index".
ROFFA 1.61 (#416) make beautiful text formats with this processing tool.
QPARSER (#418) Public Domain version of this famous system.
WORDSTAR AIDS (#379) collection of the most useful utilities for the Wordstar user.

DATABASE PROGRAMS

PC FILE III (#5) most popular database program from Jim Butson.
U-MIND (#133) Fast hashing makes this a dandy database. (Intelligent database)
DATABASE OF STEEL 3.1 (#214, 215, 267, 268) Database spreadsheet and expert system from Potomac Engineering.
NEWBASE (#233) Menu driven database for the beginner.

PC-DBMS (#383) A relational database management system that provides on-line help and screen editing functions.
ELSIE EXPERT SYSTEM (#398) Artificial intelligence shell to build a custom knowledge-base.
PDB*BASE (#396) Complete hierarchical data base system master/detail or mother/daughter type.
CREATOR (#339) creates, report, and sort makes this a super database management system.
INFOBASE (#340) Forms driven database management system similar to INFOSTAR.

DATABASES

BOBCAT (#247) Small business database. Excellent!
MPIND (#311) Database of over 2000 movies that can be searched in any category, or you can add your own.

SPREADSHEETS

PC-CALC (#199) Fabulous 123 work-a-like from the author of PC-File.
PC-PAD (#406) Spreadsheet and address book program written in basic.

SPREADSHEET TEMPLATES

LOTUS 1-2-3 TEMPLATES AND MACROS (#140, 141, 165, 257, 289, 301-304, 406, 414) Why spend hours of writing your macros when these are ready made? Modify them yourself!
SYMPHONY WORKSHEETS (#305, 306)

FINANCIAL PROGRAMS

PC-CHECK MANAGER (#275) Keeps multiple checkbooks in balance.
TAX FILE DBS (#295) Tax record keeping system that saves you money on April 15.
SAGE TRADER (#242) Analyzes commodity trades. Don't "short" this one!
PORTSWORTH PACKAGE (#101) Evaluates your ever changing stock portfolios.
FINANCE (#164, 227) Determine present and compound values, interest rates, etc.
HOME FINANCE (#406) Lotus 1-2-3 Macros for real life applications.
PC-GENERAL LEDGER 1.2 (#237) An exceptional accounting system Used by some CPA's.
TIME AND MONEY (#251) Financial record keeping and analyst system.
LOAN AMORTIZATION (#399) For output to screen or printer. Lots of on-line help.

COMMUNICATIONS

OMODEM (#310) The best and fastest com-

munications programs you can buy at any price, bar none!
PC-TALK (#391) The classic "Freeware" communication program.
PC-VT (#286) VT-100 Emulation.
SYSCOMM (#338) Menu driven system allowing unattended file transfer.
RBS 12.2 (#212) Become a SYSOP and start a bulletin board.
FIDO NET (#333) Bulletin Board System. Perhaps the easiest to run.

MATH AND STATISTICS

EPISTAT 3.1 (#88) Statistical analysis of small to medium-sized data samples.
KLP 1.9 (#332) Kinetics linear programming system.
MATH PAK (#394) Programs to teach and accelerate some math functions. BASICA

LANGUAGES

CHASM 2.13 (#10) Cheap assembler with tutorial.
LADYBUG 1.0 (#94) Logo like program.
XLISP 1.4 (#148) Lisp language interpreter.
LAXON & PERRY FORTH (#263, 264)
MVP-FORTH (#31, 32) Two disk set of Mountain Valley Press Forth
3 FORTHS (#352) To modify or expand your own forth language. MVPFORTH, FORTH-H and SEATTLE Computer's Forth.
PROLOG & UNIFORTH (#417) Complete with editor and documentation.
SNOCREST BASIC (#409, 410) two disk set. Real basic interpreter with manual. Can be used with a multi-user system.
TBASIC (#381) Tiny basic. A limited subset of BASIC. Could be placed on a chip.

PASCAL SETS

PASCAL TOOLS (#130, 133) Volume 1, 2 and 3 with source code from the famous book.
TURBO PASCAL-TOOLS (#248, 279, 292, 298, 324, 351, 353, 364, 365, 368, 375, 392) 12 volumes of tools and utilities written especially for turbo Pascal. The most extensive collection around!

UTILITIES

DISKCAT 4.0 (#108) Catalog all your disk files in a hurry.
GINACO (#86) 54 polished routines written in basic for any beginner or experts. We love it!
ULTRA-UTILITIES 4.0 (#133, 245) Recover lost files, modify sectors, etc. Like Norton's.
SYSTEMU (#250) Build a menu driven menu system. Excellent for hard disks.
LOAD-UB (#284) Allows Lotus and Symphony to be used on a hard disk.

ALIGN 1.6 (#217) Disk alignment tool
TOP UTILITIES (#273) All of the most requested utilities on one disk.
NUMZAP (#284) Removes line numbers from BASIC programs.
BASIC XREF (#359) Chase bugs with this BASIC cross-22 reference utility.
PC-INPUT (#363) Program for BASIC screen generation.
PATCHES (#376) make back up copies of some of the most popular commercial programs with this collection.

PRINTER UTILITIES

SP 3.4 (#186, 275) Printer buffer that partitions your data so you can use your computer and print at the same time.
SIDEWAYS (#265, 411) Prints text sideways on an Epson printer.
SETPRTR (#79) Sets up Epson printer from a menu.
SLIDE (#244) produce medium resolution slides and overhead transparencies.
PRINTER UTILITIES (#411) Sorgesboard of utilities and tools.
EPSON PRINTER UTILITIES (#326) Spool, set up routines all designed for Epson codes
BANNER (#386) make long banners with large letters. Includes MS-FORTRAN source codes.

EDUCATION

PC-TOUCH (#249) A typing tool.
EQUATOR (#249) A teaching tool for math, science and finance.
PC-TUTORIAL (#403) A first course in computer usage covering various aspects of MS-DOS. Good!
PC-PROFESSOR (#105) Learn Basic the easy way. One of the best tutorials on BASIC.
PC-DOS HELP (#254) type "help" for the DOS command you forgot.
FLASH CARDS (#367-370) 4-disk set. Vocabulary builder, spelling teacher.

GAMES

TOP GAMES (#274) The most requested arcade type games.
ARCADE GAMES (#293) Another goodie bag of top Arcade games.
EMON (#296, 297) Adventure game compiler.
TRIVIA GAMES (#327-329) Lots of files and documentation for hours of fun. Will not work on PC JR.
PC JR GAMES (#354) Games that will work only on PC JR. Combat, dungeons and dragons, Global Thermonuclear War.
MISC. GAMES (#390) Good selection of educational, adventure, and arcade games

MUSIC

PC-MUSICIAN (#127) Compose music on your PC, save and play again.
PIANO MAN (#279) Play your PC keyboard like a piano.

APPLICATIONS

GENEALOGY ON DISPLAY 3.0 (#90)
GENEALOGY - FT 1.25 (#240) from Pine Cone software
LABELMAKER (#148) Our favorite label file and maker Menu driven.
PC-FLY "Fliteplan" 2.1 (#261) Pilots prepare and file your flight plans.
RECIPE 83 (#251) Recipe index for use with PC File II (#5)
FAMILY HISTORY (#361) Family history, ancestor and descendant charts. Sample programs.
FORM LETTERS (#388) LOTS of samples of the most commonly used business letters. Modify!

GRAPHICS

PC-KEY DRAW (#344-345) A small CAD system. Lots of demonstration files.
PC-PICTURE GRAPHICS (#136) Drawing package allows you to zoom, color, and store pictures.
PC-GRAPH (#418) Allows user to create graphics from PC-File report files.

ORDER FORM

LONE STAR SOFTWARE, INC.
 2100 Hwy. 360, Suite 1204
 Grand Prairie, Texas 75050
 214/647-1010

SHIP TO: _____

TOTAL \$ _____ x \$6 = _____

DISK DIRECTORY (Explanation of all files & programs) x \$6 = _____

OTHER _____

SUBTOTAL _____

TEXAS RESIDENTS ADD 8 1/4% TAX _____

SHIPPING & HANDLING _____

(1 at \$1.00 and \$0 for each additional disk.)

TOTAL _____

MASTERCARD VISA

CARD NO _____

EXPIRATION DATE _____

SIGNATURE _____

PLEASE ENCLOSE CHECK WITH ORDER

CIRCLE DISK NUMBER DESIRED:

1	2	3	4	5	6	7	8	9	10	11	12	13	14	15	16	17	18	19	20
21	22	23	24	25	26	27	28	29	30	31	32	33	34	35	36	37	38	39	40
41	42	43	44	45	46	47	48	49	50	51	52	53	54	55	56	57	58	59	60
61	62	63	64	65	66	67	68	69	70	71	72	73	74	75	76	77	78	79	80
81	82	83	84	85	86	87	88	89	90	91	92	93	94	95	96	97	98	99	100
101	102	103	104	105	106	107	108	109	110	111	112	113	114	115	116	117	118	119	120
121	122	123	124	125	126	127	128	129	130	131	132	133	134	135	136	137	138	139	140
141	142	143	144	145	146	147	148	149	150	151	152	153	154	155	156	157	158	159	160
161	162	163	164	165	166	167	168	169	170	171	172	173	174	175	176	177	178	179	180
181	182	183	184	185	186	187	188	189	190	191	192	193	194	195	196	197	198	199	200
201	202	203	204	205	206	207	208	209	210	211	212	213	214	215	216	217	218	219	220
221	222	223	224	225	226	227	228	229	230	231	232	233	234	235	236	237	238	239	240
241	242	243	244	245	246	247	248	249	250	251	252	253	254	255	256	257	258	259	260
261	262	263	264	265	266	267	268	269	270	271	272	273	274	275	276	277	278	279	280
281	282	283	284	285	286	287	288	289	290	291	292	293	294	295	296	297	298	299	300
301	302	303	304	305	306	307	308	309	310	311	312	313	314	315	316	317	318	319	320
321	322	323	324	325	326	327	328	329	330	331	332	333	334	335	336	337	338	339	340
341	342	343	344	345	346	347	348	349	350	351	352	353	354	355	356	357	358	359	360
361	362	363	364	365	366	367	368	369	370	371	372	373	374	375	376	377	378	379	380
381	382	383	384	385	386	387	388	389	390	391	392	393	394	395	396	397	398	399	400
401	402	403	404	405	406	407	408	409	410	411	412	413	414	415	416	417	418	419	420
421	422	423	424	425	426	427	428	429	430	431	432	433	434	435	436	437	438	439	440
441	442	443	444	445	446	447	448	449	450	451	452	453	454	455	456	457	458	459	460
461	462	463	464	465	466	467	468	469	470	471	472	473	474	475	476	477	478	479	480
481	482	483	484	485	486	487	488	489	490	491	492	493	494	495	496	497	498	499	500

© 1986 Lone Star Software Inc



COMPUTERBANC

IBM COMPATIBLE HARDWARE

DRIVES

20 MB Seagate drive\$439
 30 MB drive for AT\$649
 360 K Floppy for AT.....\$110
 Teac 55B\$109

Multifunction card 384K, S, P, CLK\$139
 AT Multifunction card OK-3MB\$169
 MONOCROME graphics card\$99
 Color Graphics card\$89
 ComBo CARD ser. par. clock\$69
 EXPANSION CHASIS 7 slots\$569

TAPE DRIVES

10 MB Irwin\$379
 20 MB Irwin\$429
 Everex Stream 20\$599
 Everex Stream 60\$899

SYSTEMS

COMPAQ 286, 20MB
 Portable, 512K, DOS
\$3999

COMPAQ Deskpro 20MB
 640K, Monitor, DDS
\$2399

SPERRY 11 44MB
LEADING EDGE

**CALL
CALL**

IBM AT COMPATIBLE
 8MHZ, 512K, 20meg
 Monitor, graphics, ser, par
\$2399

IBM XT COMPATIBLE
 256K, 20 meg, Monitor
 graphics, ser, par
\$1195

IBM AT 30MB\$3900
 512K, DOS, Monitor

IBM XT 20MB\$2495
 256K, DOS, Monitor

EQUITYCALL
ITT XTRACALL

IBM SOFTWARE

LOTUS 123 CALL
 Symphony CALL
 ENABLE 399.00
 V P Planner 59.00
 ASHTON TATE Framework 369.00
 dBASE II 279.00
 dBASE III Plus 369.00
 POWERBASE CALL
 CLIPPER dBASE III Compiler 355.00
 LATTICE C COMPILER 249.00
 MULTIMATE 225.00
 MULTIMATE ADVANTAGE 269.00
 SORCIM SUPERCALC III 199.00
 MICROSOFT Multigen Word 225.00
 Windows 65.00
 Project 239.00
 FOX & GELLER Quickcode 149.00
 BORELAND TURBO PASCAL 39.00
 REFLEX 55.00
 LIGHTENING 59.00
 SUPERKEY 39.00
 SIDEKICK (unprotected) 49.00
 ASCII PRO Comm Software 69.00
 CROSSTALK XVI 99.00
 MIRROR Comm Software 49.00
 PEACHTREE Back to Basics 199.00
 BPI GENERAL ACCOUNTING 299.00
 OPEN SYSTEMS CALL
 REALWORLD CALL
 ONE-WRITE PLUS 149.00
 IN-HOUSE ACCOUNTANT 89.00
 ACCOUNTING PARTNER 199.00
 MONOGRAM DOLLARS & SENSE 99.00
 TOBIAS MANAGING YOUR MONEY 99.00
 SATELLITE WORD PERFECT 225.00
 MICROPRO WordStar PRO 249.00

WordStar 2000 PLUS 285.00
 SAMNA WORD III 279.00
 RBASE 5000 359.00
 PRINTMASTER 35.00
 BREAKTHROUGH TIMELINE 255.00
 DECISION RESOURCES CHRTMSTR 219.00
 ENERGRAPHICS w/plotter opt 207.00
 FUNK SIDEWAYS 36.00
 LIFETREE VOLKSWRITER DELUXE 149.00
 HARVARD TTL PROJECT MNGR 285.00
 THINKTANK 110.00

IBM HARDWARE

AST 6 Pack Plus w/ 384k 229.00
 Advantage W/ 128k 399.00
 STB Rio Plus 384K 5 function 215.00
 Rio Grande 3 function for AT 289.00
 Companion PC 2 MB LIMS 199.00
 Chateaur monographics 229.00
 EGA Plus Color Board 329.00
 JRAM 3 175.00
 JRAM AT3 225.00
 HERCULES Mono Graphics CALL
 Color Card CALL
 ORCHID Tiny Turbo CALL
 QUADRAM Quadboard O-K 199.00
 EGA + 379.00
 QuadPort for AT ser & par 125.00
 PARADISE Modular Graphics Card CALL
 130 WAT Power Supply 79.00
 TALLGRASS W/ Tape CALL
 Graphics Edge Card 239.00
 1.2MB FLOPPY for AT 149.00
 MOUSE SYSTEMS Mouse 119.00
 MICROSOFT Mouse w/stlwr 117.00
 KOALA KAT 137.00

MODEMS

ANCHOR Express 300/1200 220.00
 Volksmodem 1200 (5 yr wrnty) 169.95
 EXPRESS I 300/1200 169.00
 Lightning 2400 Baud CALL
 HAYES 1200 369.00
 1200B 349.00
 2400 CALL
 PROMETHEUS 1200 259.00
 Promodem 1200B 219.00
 Promodem 1200A 249.00
 Promodem 300 IIC 115.00
 Promodem 2400 CALL

SUMMER SPECIALS

MONITORS

AMDEK 300A 139.00
 310A Hi-Res Amber 149.00
 Color 722 RGB 720 X 350 CALL
 PRINCETON GRAPHICS MX-12 399.00
 MX 12E RGB 720X350 CALL
 SR-12 CALL
 MAX-12 149.00
 TAXAN: ALL MODELS CALL
 PANASONIC DT H103 10" High Res RGB 369.00
 IBM COMPATIBLE Monochrome 99.00
 Color RGB Monitor (640X200) 349.00

PRINTERS

PANASONIC (2 yr warranty) 199.00
 KK-P1080 229.99
 KK-P1091 315.00
 KK-P1092 419.00
 KK-P1592 CALL
 KK P1595 240 CPS 249.00
 KK-P3131 17cps Daisy 249.00
 KK-P3151 22 cps Daisy 385.00

Glitzan MSP-10 266.00
 MSP-15 355.00
 MSP-25 489.00
 STAN MICRONICS CALL
 EPSON LX-80 CALL
 Fx 28C for Best Prices
 LO 1000
 LO 1000
 BROTHER - All Models We Will Beat
 Twinwriter 5 Any Advertised Price
 OKIDATA - All Models CALL
 TOSHIBA All Models CALL
 CANNON Laser Printer CALL
 NEWLETT PACKARD PRINTERS CALL
 HOUSTON INSTRUMENTS Plotters CALL
 Digitizers CALL

APPLE PRODUCTS

APPLE Compatible Drive Re 99.00
 IIC compatible drive 99.00
 MAC Compatible 3 1/2 drive 229.00
 MICROSOFT Softcard II 259.00
 ASCII XPRESS (Communications) 69.00
 APPLWORKS 215.00
 SPELLWORKS 49.00
 PRINT SHOP 35.00
 Mach III Joystick 39.00
 SYSTEM SAVER Fan 69.00
 VIDEO 7 IIC Enhancer CALL
 VIDEX Ultraterm 165.00
 APRICORN (Lifetime Warranty)
 Super Serial Imager 75.00
 Graphics Interface 65.00
 80 Column/64X 75.00
 EXTEND IT BAK 55.00
 KOALA SpeedKey 99.00

Call for catalog. Thousands of products available. Volume discounts.



COMPUTERBANC

16783 Beach Blvd., Huntington Beach, CA 92647
 TELEX #550757 ANSWER BACK—COMPUTER UD

Orders Only

800/332-BANC

OUTSIDE CALIFORNIA

714/841-6160

For Customer Service Call 714-847-BANC

Cash prices indicated. All products are in factory sealed packages. We guarantee all items for 30 days. Within this period, defective merchandise returns must be accompanied by RMA number. All other returns will be subject to a 10% restocking fee. For prepaid orders, there will be a 3% shipping charge; 5% for UPS. Blue Label: \$5.00 minimum; all orders outside U.S.A. or 15% shipping. California residents add 6% sales tax. Prices subject to change without notice.

©Copyright 1985 COMPUTERBANC. All Rights Reserved.

NEW DEALER SPECIAL

XT-COMPUTER	QTY	2
640K MOTHER BOARD W/OK	89	
256K RAM	27	
135 WATT POWER SUPPLY	53	
FLOPPY DISK CONTROLLER	27	
FLIP TOP BOX	38	
XT/AT KEYBOARD	59	
MONO/GRAPHICS/PRN (HERC)	54	
TTL MONITOR W/SWIVEL	96	
(1) 360K FLOPPY	92	
PARTS	\$535	
ASSEMBLY & TEST	64	
	\$599	

20 MEG HARD DISK W/CONTROLLER	425
--------------------------------------	------------

AT COMPUTER	QTY	2
80286 MOTHER BOARD	595	
W 512K RAM		
200 W POWER SUPPLY	98	
AT BOX W/KEY LOCK	79	
SERIAL & PARALLEL CARD	85	
AD KEYBOARD	59	
1.2 M FLOPPY	129	
FDD & HDD CONTROLLER CARD	226	
PARTS	\$1,250	
ASSEMBLY & TEST	150	
	\$1,400	
30 MEG 40 MSEC HARD DRIVE	615	
EGA CARD	295	
EGA MONITOR	449	

XT PORTABLE \$895

- 640K MOTHER BOARD
- 640K RAM
- MULTI I/O CARD
- CLOCK, CALENDAR, SERIAL, PARALLEL
- TWO 360K FLOPPY DRIVES
- MONO/GRAPHICS/PRN (HERC)
- DETACHED KEYBOARD
- 135 W POWER SUPPLY
- PORTABLE CASE
- 9" MONITOR, GREEN or AMBER

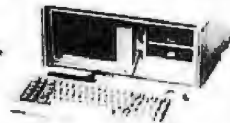

ADD ON BOARDS - PARTIAL LIST

XT-640K TURBO 4.77/8 MHZ W/OK	99
LOCAL AREA NET CARD W/SOFTWARE	249
384K MULTI-FUNCTION (AST & COMP) OK	69
MODEM CARD 300/1200 (HAYES COMP)	149
DISK I/O 2FD CTRL, PRN, SER, CLOCK, CAL, GAME	70
AB SWITCH BOX W/64K BUFFER (1:2 or 2:1)	94
AB SWITCH BOX (1:2 or 2:1)	29
COLOR/GRAPHICS/PRINTER CARD RGB	58

ACS IMPORTERS

5311 DERRY AVE, UNIT A
 AGOURA HILLS, CA 91301
 HOURS 9 AM - 6 PM PST
 (818) 889-1092
 TELEX 299353 POST UR

ROSE DATA SWITCHES

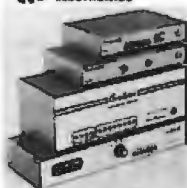

SHARE computers, printers, any parallel or serial device
 ELIMINATE cable swapping
 INEXPENSIVE way to network
 COMPATIBLE with all computers
 Businesses, Schools, Homes
 WE ALSO OFFER:
 Data Buffers, Line Drivers,
 Modems, Protocol Converters,
 Parallel - Serial Converters,
 Cables, Computers, Printers,
 Disk Drives, and more

AUTOMATIC - CARETAKER is ideal for a business or school to share a printer or modem among many computers. Operation is fully automatic with no software required.
 Parallel or Serial 4 channels - \$295 8 channels - \$395

MANUAL - HARD SWITCH is operated with the flip of a switch. 2:2 and 2:4 models allow simultaneous communication.
 Serial 1:2 - \$50 1:4 - \$ 60 2:2 - \$100 2:4 - \$160
 Parallel 1:2 - \$70 1:4 - \$130 2:2 - \$110 2:4 - \$190
 LED and spike protection on serial models add \$20.

CODE ACTIVATED - PORTER connects one computer to multiple peripherals. A software code selects the peripheral.
 Parallel or Serial 4 channels - \$280 8 channels - \$395
 Buffer option 84K - \$100 256K - \$250

REMOTE - TELEPATH connects multiple computers to multiple peripherals. A selector at each computer or terminal chooses up to 4 peripherals and displays busy status.
 4:4 - \$495 4:8 - \$795 selector - \$39

Give a Rose to your computer.
ROSE ELECTRONICS (713) 933-7673
 P.O. BOX 742671 MC & VISA Accepted
 HOUSTON, TX 77274 Dealer inquiries invited
CALL US FOR ALL YOUR INTERFACE NEEDS

Inquiry 300

American Semiconductor

TOLL FREE

10 mb	IBM Compatible Winchexor HARD DRIVE	245.
20 mb	For AT, XT, Compaq, Tandy, Corona	345.
TURBO XT		495

2087	116
2087	174
80X	69
288K	8.70
V-20	18
FLOPPY	70
XT ADD ON CARDS	

Call us for your other needs.

1-800-237-5758

SALES EXT. 505

Vendor Line 833-903-8444 Tech. Line 813-741-3594
 All prices plus post. All mon-ham for guaranteed.

Inquiry 23

LOW COST UNIVERSAL PROGRAMMER KITS

- * NO PERSONALITY MODULES REQUIRED
- * ON LINE HELP AND MENU SELECTION
- * ON BOARD 110/220V POWER SUPPLY
- * FAST PROGRAMMING MODE AT 6V VCC
- * BUILT IN MONITOR FOR I/O DEBUG
- * CAD PCB, SILKSCREEN & SCHEMATIC
- * SOFTWARE DRIVERS FOR MOST PCs
- * SUPPORTS ALL 5V EPROMS, EEPROMS AND INTEL MICROCOMPUTERS

KITS FROM \$125 ASSEMBLED \$295
 DRIVERS \$35 SHIPPING \$4
 VISA & MASTER CARD ACCEPTED

B&C MICROSYSTEMS

6322 MOJAVE DR. SAN JOSE CA 95120
 PHONE (408) 937-7685 TELEX 4895363

PC Compatible CASH DRAWERS



M-S CASH DRAWER
 10711 Flower St., Stanton, CA 90680
(800) 544-1749
 In California call:
(714) 821-1133

Inquiry 248

maxell.

5 1/4" \$S/DD \$.64

OTHER BRANDS AS LOW AS \$.54
 BULK DISKETTES- QUANTITIES OF 500 with TYVEK SLEEVES

RIBBONS (All Brands)
EPSON MX 70/80 \$4.20
 Prices based on quantities of 48

C.O.D. **800-222-0490** C.O.D.
 201-462-7628 In N. J.

MEGRSoft P.O. Box 710, Freshhold, NJ 07728

UNIVERSAL EPROM PROGRAMMER

- * NO PERSONALITY MODULES REQUIRED
- * ON LINE HELP AND MENU SELECTION
- * ON BOARD 110/220V POWER SUPPLY
- * FAST PROGRAMMING MODE AT 6V VCC
- * BUILT IN EPROM ERASER W/TIMER
- * GANG PORT FOR FUTURE EXPANSION
- * SOFTWARE DRIVERS FOR MOST PCs
- * SUPPORTS ALL 5V EPROMS, EEPROMS AND INTEL MICROCOMPUTERS

1409C-33 \$545 1409C-34 \$695
 DRIVERS \$35 SHIPPING \$6
 VISA & MASTER CARD ACCEPTED

B&C MICROSYSTEMS

6322 MOJAVE DR. SAN JOSE CA 95120
 PHONE (408) 937-7685 TELEX 4895363

S-100 Boards & Accessories

If you bought before calling S-100 you paid too much! We stock COMPUPRO, DUAL, ICM, KONAN, MULLEN, PICKLES & TROUT, INDUSTRIAL COMPUTER DESIGNS, TARBEEL, VECTOR...

Just a few of THIS MONTH'S SPECIALS!

RAM 16 84K Static.....	\$85	
COMPUPRO RAM 22 256K Static.....	446	
COMPUPRO CPU 286.....\$429	SPUZ 256	\$249
COMPUPRO Disk-1A.....	\$372	
Disk-3	\$447	
DUAL AIM-12 A/D Input 12 Bit/32 Channel	\$29	
INTERCONTINENTAL MICROSYSTEMS Master 8 Slave Boards 8 & 16 bit. IN STOCK	CALL NOW	
MACROTECH MI-286 80286/280 Dual Proc.....	675	
MACROTECH MSR-II 1MB DRAM / 2Mb.....	\$25/1059	

PC Scientific and Industrial Cards

INDUSTRIAL COMPUTER DESIGNS

1018-PC 86TTL I/O Lines	\$448	
A/D 84-PC 84 Input...\$448	D/A 84-PC 84 Output ..	\$527

SCIENTIFIC SOLUTIONS/ BASEBOARD (86 I/O Lines); DADIO (D to A Conv.) Call Now for Lowest Price!

TECMAR IEEE 488	\$235
-----------------------	-------

Software

We sell all well known brands. ORDER CORRECTLY! SOFTWARE IS NOT RETURNABLE!

NEW STAR NEWWORD 2 w/ MergePrint, WordPlus spell check, WordStar Compatible 8 bit...\$99 16 bit 129
NEW STAR NEWWORD 3 for PC's. Spell checker, Indexing, Content Tables, Macro's, Shorthand keyboard, Run other programs while in NewWord 209
8D SOFTWARE C Compiler 8" SSSD 8 bit..... 95
pfs-FILE, REPORT, PLAN, etc. 43% OFF LIST!

PC & AT Multi-user Cards

ALLOY PC-SLAVE/16 1Mb 8MHz	\$395
ALLOY PC-PLUS Package/ PC-SLAVE/16, 1Mb, 8MHz, Link PC-Term Terminal, 20' Cable	1160
RTNX MSDOS 2.1 / ATNX MSDOS 3.1	109/189

PC and AT Extended Memory, etc.

We carry the best selection of Multifunction & Memory Cards for IBM-PC, XT, AT, portables and compatibles!
INTEL Above Board PCMB 1010 - 64K to 512K - Allows Lotus, Symphony, others to run above 640K..... \$195
INTEL Above Board-AT 128K to 4MB 399

Video / Graphics / CAD

TATUNG SUPER RES PACKAGE

EGA (EGA) Monitor (640x260) w/ Dual Scan
EGA/Hercules compat. card w/ 256Kl., \$795

8TB EGA Plus - TTL mono & HiRes RGB	\$371
HOUSTON INSTRUMENT PLOTTERS	
Call Now - We Will Not Be Underbid!	

Hobby Corner

ADAPTEC 2002A ST-508 PC Hard Disk Ctrl.....	195
ATARI 520ST Color System with Dual Flips	849
FUJITSU 2302B 8" 23.4Mb H.D. (SA 4000)	789
INTEGRAND 2210F 4 Slots Dual 5 1/4" Drives	189
MICROPOLIS 1303 43Mb 30mSec. Avg.....	1,095
OKIDATA 5K" 1/3 - 1/2 HL. Bazel.....	75
PARA DYNAMICS 2300-G3 8" & 5K Flipy & H.D. ..	189
PC-CLONE with Mono and Color, Flip-Top, Multi-Function, Etc., Etc.	395
STANDARD DATA NETWORK 3 PC's	595
8TB SUPER RIO 258k, S.P.G. Clk	199
TATUNG 12" GRN/AMB. Swivel Base, RCA	69
TECMAR 40410 Expan. w/33 & 5Mb Remov.	2,995
TECMAR WAVE 84K-256K 1/2 Card	189
U.S.R. AUTO DIAL 212A Hayes Compat	229
U.S.R. PC MODEM 256K, Paral., Clk, Teल्प	189
U.S.R. PC % CARD MODEM W/ Teल्प	149
IBM SUPER BD 0-384K, S.P. CLK, & G Ports ..	125
XEBEC XE1210A ST-508 PC Hard Disc Ctrl	195

Floppy Disk Drives

MITSUBISHI 2894 8".....\$475	2896 1/2 ht 8"	\$435
MITSUBISHI MF501 48TPI, 1/4 HT 5 1/4" Flipy		95
TEAC FD55GFV / IBM-AT 96TPI		125
TEAC FD55FV 86TPI...\$115	FD55BV 48 TPI	95

Printers and Buffers

BROTHER M-1509 180/45cps, Parallel & Serial Ports, 13" w/ Tractor, EPSON FX286 Compatible CALL
BROTHER HR-35 36cps Daisy, Wide Carriage.... \$729
BROTHER HR-15XL 17cps Daisy, S or P..... 359
CALL 1-800-528-3138 Today for the BEST PRICE on EPSON - OKIDATA - CITIZEN
HANZON Buffer 64K-256K S-S,S-P,P-S,P-P Ports .. 265

BUCK\$ BACK from XEROXI!

Its Rebate time and XEROX is peeing out the cash. Buy one of these printers and get up to \$300.00 back! Also the first month of your 1 Year Warranty includes On Site Service! You have to love adversity to ignore this deal.

\$100 Break!



Xerox 635

BIG REBATES ON ALL XEROX PRINTERS!
Xerox D25 Diablo.....\$497 less \$50 Rebate = \$447
Diablo 635
 1049 less \$100 Rebate = 949 || Diablo D80-IF | 2159 less \$500 Rebate = 1659 |
Diablo 34LQ	899 less \$100 Rebate = 799
4045 Laser w/Copier.4995 less \$400 Rebate = 4595	
Call 1-800-528-3138 Now and Put Your Money Back to Work for You. REBATES END JULY 31st	

Modems

PROMETHEUS PROMODEM 1200/2400-Hayes Compatible with Power Supply and Software. \$275/\$385
PROMODEM OPTIONS:
Communications Buffer, 2K.....\$99
512K..... \$158
Alpha Numeric Display Buffer Messages
 75 || PROMETHEUS 1200G without Options | 169 |
PROMETHEUS 300C - Apple IIc Piggy Back	129
MULTITECH MT224EH MNP Error Correction.....	529
MULTITECH MT224AR Rack Mount Card Modem ..	459
MULTITECH MT224ER Rack Mount with E.D.C.	495

CTS 224ADH Hayes 2400 Compatible with pfs: Access \$395

Monitors and Terminals

TATUNG CM-1360 640x200 RGB, 13", G/A switch, \$395	
TATUNG MM-1222 HiRes 12" TTL (IBM).....	109
TATUNG CM-1390 EGA 640x350 RES.....	499
ZENITH ZVM-1240 Amber (IBM)	155
LIBERTY Freedom Terminals	CALL
LINK 125 Emulates WY-50 and others, HiRes 14" Grn/Amb 6 Scroll Rates, IBM Selectic K.B. 1 YR Warrt.....	399
LINK PC-TERM Emulates WY-50, TVI925 & More, 132 Col, IBM-AT KB, Ideal for Multi-user PC-Slave BDS.	449
LINK 220 DEC Compat., 26 Lines, Amb., 8 pgs Memory, RS-423, To 38.4K Baud, 38 Funct. Keys, More.....	459

Hard Disk and Tape Subsystems

PC-INSIDER/OUTSIDER, AT-INSIDER, Hard Disk Series for IBM. Boots from Hard Disk, Formatted w/ Ctrl. & Cble., Hardware & P/S or PC Style Cabinet CALL NOW!

THIS MONTH'S SPECIAL

140MB Hard Disk w/20ms access 85MB Tape \$/UP4595	
TECMAR OIC-80 External Tape	1905
TECMAR 40410 - II Slot 35 + 5Mb Remov.	2995
SMS OMTI 5510 - 7 Controller	135
WANGTEK PC-38 60Mb Int. Tape w/ Ctrl., Cable, S/W 918	
MICROPOLIS 1325 85Mb Drive / 25ms Access	1490
QUANTUM Q-540 40Mb Drive, 1 Year Warranty	1095
DRIVE SUBSYSTEMS for COMPUPRO with Disk 3, CABINET, FAN, P/S, CABLES, etc.	
-20Mb Seagate / Tec.....	1115
-40Mb Quantum Q-540.....	1715
-72Mb MC1325. \$2159	MM6085. \$2459
2XT-1085 \$2369	
10MB TAPE Int. (Requires COOS 4.1)	439
10MB TAPE Ext. (Requires Concurrent DOS)	549
ALLOY IDXCS-100T 17.7Mb Ext. Taps (CPM-80/86)1588	

ATTENTION! 280 CPM OWNERS:

HARD DISK SUBSYSTEMS STARTING AT \$785

Computer Systems

MULTIUSER / NETWORK SYSTEMS I

INTEGRATED & SUPPORTED BY S100
SCO-XENIX - AT'S, ALTOS
68000 UNIX - S100 & VME
NOVELL - Complete HW & SW Line
ALLOY PC-SLAVE Networks
TurboDOS - PC/DOS Networks
MS-DOS on S-100
Concurrent DOS on S-100, PC's

CompuPro™

816/C2 w/80286, 512K RAM, SPUZ-258, 40MB HD, 10MB Tape, 5" 96TPI flpy, COOS 616/286, NewWord & SuperCalc2.....
CALL SYSTEM 10 4 User, 8/16 bit, 40MB HD, 10MB Tape, CCP/M 816, 1MB M-Drive/H, NewWord, SuperCalc2, HyperTyper, Field Companion, Write, Friday!, etc. \$5095

IBM-PC COMPATIBLES

We carry a wide range of Desktop, Laptop & Portables designed to run the software that fuels today's business.
ZENITH 148, 158, 171, 200AT CALL
SPERRY IT, HT, USER NET..... CALL
XEROX 6084 AT&T 6300 Compatible From \$1888

EPSON EQUITY II

IBM-PC compatibility mated to the new NEC V30 microprocessor gives you 8086 CPU power at speeds of 4.77 and 7.16 MHz. On board you'll find 640K RAM, Hercules compatible mono graphics, clock/calendar and 6 full size option slots - all standard equipment! Add to this two 380K drives, an AT-type keyboard, TTL monitor and a one year warranty - well, you can see it makes sense to start building some EQUITY into your business.

The Epson EQUITY II... CALL



ATD/ATP

- 80286 CPU @ 8MHz
- 1.2 MB Floppy Drive
- HiRes Graphics (640x400)
- Serial/Parallel Ports
- 130 Watt P/S & 640K RAM

ROM BIOS Compatible to the IBM-AT. The CORDATA ATD/ATP runs virtually all software designed for today's business environment.

Desktop Publishing



LP-300 DESKTOP PRINTSHOP

Create professional looking newsletters, ad copy, documents, etc. with LASER accuracy.

- 8 pages/min
- Autofeed
- Cable & Toner included
- 300x300 dots
- 38 fonts

Top your CORDATA systems off with the fastest CAD package on the market.

FASTDRAFT 480

- 640x480 Color Card & 80287-3 Co-Processor
- NEC Multisync RGB Monitor

BULLETTINI Cordata Announces HUGE PRICE DROP

Call 1-800-528-3138 for HOT DEALS!

Power Solution

TRIMPLITE BC-425-PC 425 Watts, 15-20 Minutes ... 389
COMPUTER ACCESSORIES U-600 Watt, 12-35 Min. 699
8AFT SPS 1000VA 1000 Watt & Line Wave 999

All merchandise new. Advertised prices are cash prepaid only. PO's from qualified firms & AM. Express - add 5%. MC & Visa - add 3%. Wires, COD's (\$5 min. fee) with Cashiers Check, MO & APO's accepted. Shipping minimum \$4 first 5 lbs. Tax: AZ RES ONLY add 6% sales tax. All returns subject to 20% restocking fee or credit towards future purchases. All prices & availability subject to change without notice.

**ORDER TOLL FREE
24 HOURS EVERY DAY
800-662-2686**

HARDWARE

COMPUTERS
IBM Compatible

256K Ram (Expands to 540K) 1 year warranty 649
DUAL FLOPPY SYSTEM 1048
20MB HARD DISK SYSTEM

ATARI, PANASONIC, IIT COMPUTERS CALL

MODEMS, BOARDS, DRIVES

Evercom 1200 Internal 175	SinPakPlus 384K 219
Hayes-All Models CALL	Intel Above Board 269
Race! Vadic 1200 239	Above Board PS 299
Practical Modem 1200 135	Above Board AT 419
Genoa Spectrum 279	J-Ram 2/3 135/179
QuadEGA+ 399	J-Ram 3AT 235
Taxan 555 199	J-Laser I 199
Sigma Color 350 389	Tecmar Captain 384K 199
Sigma Color 400 489	6 Function Card 384K 159
Mono Graphics Card 99	384K Ram Card 99
Video 7 Vega 399	20MB Hard Disk Kit 429
AST Rampage 239	File Card 20MB 639
Rampage AT 439	Sigma One Real Tape 659
AST Advantage 359	Imega 210H 1995

PRINTERS, PLOTTERS & MONITORS

EPSON-All Models, DOT MATRIX & DAISYWHEEL CALL	Roland DXY101 Plotter 509
Canon Laser Beam 2099	Houston Inst DMP-29 1850
Citizen 1200 175	Amdak 310A 149
Citizen Premiere 35 425	Amdak 600/722 419/519
Panasonic 1080 199	NEC 1280 TTL Mono 119
Panasonic 1091 249	NEC 1401 Multi-Sync 559
Panasonic 1092 319	Taxan 620 399
Panasonic 1592 449	Taxan 630/640 455/519
Sweet P 600 739	

SOFTWARE

ACCOUNTING & DATABASE

BPI Accting/Mod from 319	dBase III Plus 389
BPI Enterprise/Mod 439	Nutshell 79
Peachtree/Module 289	Paradox CALL
Back To Basics Accting 209	Reflex 89
Open Systems/Module 389	Revelation 549
Paragon 675	PFS File & Report 149
SBT-All Modules CALL	Q & A/256K 206/239

SPREADSHEETS & INTEGRATED SOFTWARE

Lotus/Symphony CALL	Ability 83
Framework II 409	Multipan 2.0 119
Supercalc 3 209	Mosaic Twin 89

WORD PROCESSING

Walkwriter 3 155	PFS Write & Proof 82
Microsoft Word 3 259	Multimate 219
Word Perfect 4.1 215	Multimate Advantage 309

GRAPHICS

Chartmaster 219	InA'Vision 289
Energraphics w/Plot 829	Microsoft Chart 2 179
FreeLance 289	Dr. Halo II w/Mouse 119

UTILITIES & LANGUAGES

Turbo Lightning 57	Fontrix 82
Microsoft Project 2 239	Fastback 89
Superproject+ 259	Sideways 37
Timeline 2 259	Traveling Sideluck 39
True Basic 95	Windows 89
Microsoft C Compiler 239	Pop-Up Desktop 55
Microsoft Fortran 205	Desqview 89
Macro Assembler 90	Prokey 77
Quick Basic 63	Xtree 31

Call Toll Free 24 hrs Every Day
800-662-2686 orders only
for Ca. Orders, Tech Support, Price Quotes, Info
415-668-9350 9-5 pacific time, m-f
Call or Write for Free Catalog

PAYMENT: (No Fee For Credit Cards) Visa, MasterCard, Cashier's Checks, Personal Checks with 2 wk. hold. Qualified P.O.'s. Ca. residents add sales tax. SHIPPING: UPS ground-2% per order, \$4 min. FREE for SW orders over \$1000, UPS blue-3% per order, \$6 min. FREE for SW orders over \$1500. Printers, Monitors, Disk Drives, computers - Call for charges.

All Products New with full warranties.
Price & availability subject to change without notice.



564 CASTRO ST., SUITE 487 SAN FRANCISCO, CA 94114
a division of MCS, Inc. Computer & Software specialists since 1981
430 BYTE • JULY 1986



! not only a printer buffer !

THIS IS THE MOST SOPHISTICATED
PRINTER BUFFER - MULTIPLEXOR - SWITCH

WITH TWO SEPARATE INPUTS (SERIAL AND PARALLEL) AND TWO SEPARATE OUTPUTS (SERIAL AND PARALLEL) CAN BE USED LIKE STANDARD BUFFER - WITH ANY INPUT TO ANY OUTPUT. BUT ALSO YOU CAN CONNECT 3 COMPUTERS TO 1 PRINTER, OR 1 COMPUTER TO 2 PRINTERS OR 2 COMPUTERS AND 3 PRINTERS AND MORE - 1 COMPUTER TO 2 PRINTERS OR 3 COMPUTERS TO 1 PRINTER.
HIGH CAPACITY - 64 KB TO 384 KB AND - 384 KB TO 1 MB (MODELS A AND B) PAUSE, COPY AND RESET FUNCTIONS SERIAL PORTS WITH 7 OR 8 BITS WORD LENGTH, 1 OR 2 STOP BIT, PARITY, XON/XOFF, DTR, RTS

DCB-A-64K \$ 289 (*) DCB-B-384K \$ 289 (*)

(*) Power supply and parallel cables are included

ALSO WE HAVE THE MOST COMPLETE DATA CONVERTER UNIT CONVERTS RS232 SERIAL TO CENTRONICS PARALLEL OR VICE VERSA, JUST BY MOVING JUMPERS. BAUD RATE AND PROTOCOL FULLY PROGRAMMABLE FROM 50 TO 19200 BAUDS INCLUDES DTR, RTS, XON/XOFF, PARITY, etc.

DCU \$ 89 (*)

(*) Power supply and cables NOT included



serial to parallel
bi-directional converter



INECTRA INC. Dept. 222
1057 HINDSLEY BLVD
MOUNTAIN VIEW, CA 94040
(415) 967-8818 TLX 348545

RS-422
Communications Board

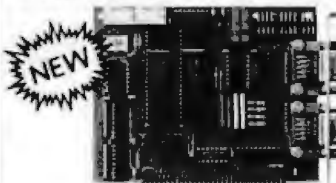

- For IBM-PC/AT/XT and compatibles
- Dual RS-422 serial interface
- Programmable to 56k baud
- Differential drivers to 4000 ft.

\$345.00
QUA TECH, INC.

478 E. Exchange St. Akron OH 44304
(216) 434-3154 TLX: 5101012726

Inquiry 291



5 1/4" DS/DD with hub ring and sleeve.
factory warranted, packaged in 50's.
Shipping Extra. Quantity 50, 85¢ each

The same low price our volume copying customers pay!
75¢ each
Qty 100

We sell 3 1/2" & 5 1/4" disks—all types, major brands. Call toll free:

1-800-321-4668
in Colorado, 303-234-0871

VISA, MASTERCARD, OR COD ACCEPTED

ALF 1315-F Nelson St.
Denver, CO 80215

Inquiry 11

72 Digital I/O



PXB-721
Parallel Expansion Board

- For IBM-PC & Compatibles
- 72 Digital I/O Lines
- Simple Programming
- Uses One Expansion Slot
- Fast Delivery

\$195

QUA TECH, INC.

478 E. Exchange St. Akron OH 44304
(216) 434-3154 TLX: 5101012726

Inquiry 292

MYSTIC PASCAL
Fastest Compiler on Earth
NOW ONLY \$16!!!

- 640K code, data and stack
- incremental compiler runs in background while you are editing
- effective compiler speed greater than 100,000 lines/min
- immediate execution of Pascal statements
- true multi-tasking for up to 100 Pascal procedures
- full screen editor
- complete Help windows

disk with condensed manual to print out \$16—
printed manual \$16—both \$32—for IBM PC 256K
Visa/MC/COD—add \$2 shipping, COD \$5,
overseas \$10

Mystic Canyon Software
P.O.B. 1010
Pecos, NM 87552 505/757-6344

Inquiry 250

"CPYAT2PC"
IS LIKE HAVING A
FREE
360K FLOPPY DRIVE

Allows copying of IBM AT file for use on IBM PC's & compatibles with no modification of existing hardware or software. A 360K floppy drive is not required. CPYAT2PC may reside on your IBM PC/AT hard disk and copies 1 file or entire subdirectories in 1 step. Also runs on other AT compatibles such as COMPAQ 286, ZENITH Z-200, and KAYPRO 2861. Dealer inquiries welcome. ONLY \$79 + shipping.

MICROBRIDGE COMPUTERS
Sky Way Building, Suite 125
655 Sky Way, San Carlos, CA 94070
(415) 593-8777 • (415) 595-2150

CHECK, COD WELCOME
(Prepayment Required)



Inquiry 297

DO YOU LIKE TO SAVE MONEY?

NO CREDIT CARD SURCHARGE . . . NO FINE PRINT!!

2% DISCOUNT ON ALL ADVERTISED PRICES WITH PREPAYMENT (800) 662-7253

SPECIAL #1

PC XT Compatible Turbo

- 640K • 8 MHz • Keyboard
- Flip Top Case • Two 360K Drives
- 135 Watt • 8 Slots • DOS 2.1

\$659

SPECIAL #2

IBM PC 256K

- Two 360K Drive

\$1449

SPECIAL #3

10 MEG

HARD DISK

- For IBM or Compatible
- Controller and Cables

Complete **\$359**

SPECIAL #4

NEW SPERRY IT

IBM AT compatibility for an affordable price!

- 1 Meg Ram included
- 1.2 MG floppy • 44 MG Hard Disk
- 8 MHz Operations • Monitor
- DOS 3.1 • Printer Port
- Two Serial Ports
- 100% AT Compatibility

ONLY \$3799

SPECIAL #5

XT COMPATIBLE

- 8 Slots • Two 360K Drives
- Keyboard • 135 Watts

640K 256K

\$569 \$489

SPECIAL #6

IBM AT COMPUTER SYSTEM

- 20 Meg hard Disk
- 1.2 Meg Floppy • DOS 3.1
- 512K Ram

D & D IBM

\$3699 \$4299

SPECIAL #7

CORONA PORTABLE

- IBM Compatible
- 256K • 2 Drives
- Monitor • Keyboard • DOS

\$1179

All Sales Are Warranted for 90 Days, Parts & Labor

WE SERVICE WHAT WE SELL!

ALL SYSTEMS INCLUDE ASSEMBLY AND TESTING

VISIT OUR NEW RETAIL LOCATION:

12824 INGLEWOOD AVE., HAWTHORNE, CA 90250

PLEASE CALL: (213) 676-0815

IBM COMPATIBLE EQUIPMENT

IBM

PC 256K, 2 Drives **\$1395**
 XT 256K, 1 Drive 1699
 XT 256K, 1 Drive 1-10 MG 2099

COMPAQ

Portable, 2 Drives, 640K . **\$1875**
 Call on Desk Pro's & 286 Systems

CORONA

Portable **\$1195**
 Desk Top, 2 Drives, 256K
 w/monitor 1395

AST RESEARCH

SixPak+, 64K w/Side Kick \$209
 Reach w/Crosstalk 369

HERCULES

Color Card w/Printer Port.. \$149
 Mono Graphics Card 299

HAYES

Micromodem IIE Apple \$149
 300 External..... 129
 1200 External..... 369
 1200B IBM Internal 339
 2400 External 639

DISK DRIVES

Teac 55B \$109
 Mitsubishi 4851 99
 Tandon TM 100-2 99
 Qume DT142..... 89
 Okidata 1/2 HT 84
 10 MG Hard Card New
 20 MG Hard Card Call

EPSON

Call For Best Pricing
 We Are An Authorized Dealer

OKIDATA

182, 120 cps \$218
 192, 160 cps, w/Roms 349
 193, 160 cps, IBM..... 499
 84, 200 cps, IBM 658
 OKI-MATE 20, Color, IBM .
 Apple & Amiga **199**

TOSHIBA

P321 New
 P341 Call
 P351 \$1059
 P351 Tractor 159

STARMICRONICS

SG10/15 \$219/389
 SD10/15 355/469
 SR10/15 489/589
 Reach w/Crosstalk 369

PRINCETON GRAPHICS

Max 12E \$159
 HX-9 Call
 HX-12 425
 SR-12 749

TAXAN

Call for Best Price

AMDEK

310A \$139
 600 Color..... 389
 722 Color..... 519

SPECIAL #8

APPLE DISK DRIVE

100% APPLE

COMPATIBLE 5 1/4"

525A for IIE and II+ \$99
 525C for IIE 109
 350M for Mac Special

SPECIAL #9

NEW COMPAQ PORTABLE II

	LIST	D & D
MODEL 1	\$3599	\$2749
MODEL 2	\$4699	\$3649
MODEL 3		Call

IN STOCK

SPECIAL #10

MULTIFUNCTION CARD

- Serial and Parallel Ports
- Clock/Gameport
- Ram disk/Printer spool Software
- 1 Year Warranty

w/384K only **\$154**

SPECIAL #11

PC XT COMPATIBLE

- 640K • 360K Drive • Keyboard
- 20 MG Hard Drive
- Monochrome • 8 Slots
- Card w/printer port
- 135 Watt Power Supply
- Green Monochrome • Monitor
- DOS 2.1 • 120 Day Warranty

ONLY \$1249

SPECIAL #12

20 MEG HARD DISK

FOR IBM

- Seagate Drive
- Western Digital Controller

TESTED **\$455**

SPECIAL #13

COMPAQ 286 PORTABLE

- IBM AT Compatible • DOS
- 1.2 Meg Floppy • 640K
- 20 Meg Hard Disk • Monitor

\$3989

MAKE THAT CALL!

Order Desk (800) 662-7253
 In California (213) 970-0206
 Customer Service (213) 970-9215
 Technical Support (213) 970-0215
 Retail Store (213) 676-0815

BUILD A PC & WE A&T IT FREE!

640K Mother Board
 w/8 Slots \$179
 IBM Printer Cable 15
 64K Ram Set of Nine Chips 15
 256K Ram Set of Nine Chips 39
 Power Supply 135 Watts ... 75
 8087 CoProcessor 129
 DOS 2.1 65
 DOS 3.1 69 DOS 3.2 79

640K Mother Board
 w/8 Slots Turbo \$199
 Flip Top Case w/speaker ... 49
 Disk Controller w/cable ... 39
 Color Card w/printer 89
 Monochrome Card w/printer 100
 Keyboard 0151 89
 100 DS/DD 5 1/4 69
 10 1.2MG for AT 5 1/4 259

WE CARRY TOO MANY ITEMS TO LIST

CITIZEN MITSUBISHI THOMPSON SAMSUNG
 EVEREX MANNESMANTALLY DIABLO MICROSOFT

ALTOS PROMETHEUS IBM
PLEASE CALL FOR A QUOTE ON ANY ITEM.

MAIL ORDER:

13324 HAWTHORNE BLVD., SUITE 201
 HAWTHORNE, CA 90250

ORDER DESK:

Inside California (213) 970-0206

Outside California (800) 662-7253

Hours: Monday—Friday 7 am to 6 pm

Open Saturdays

d&d Discount Computers

A CALIFORNIA CORPORATION



Terms: Prices reflect a cash prepaid discount. All merchandise new. We accept MC, Visa, Wire Transfer, Certified Check, P.O.'s from qualified firms. P.O. subject to approval & 3% surcharge. Terms: 2% 10 net 20. UPS Shipping: minimum \$4.00 first 5 pounds. We also ship U.S. Mail and Federal Express. Call for exact shipping cost. Tax: California residents only add 6 1/2% sales tax. All returns subject to 15% restock fee. Prices Subject to Change.

DoKay

COMPUTER
PRODUCTS,
Inc.

ORDER TOLL FREE

(800)
538-8800

(CALIFORNIA RESIDENTS)

(800)
848-8008



RAMS

STATIC		DYNAMIC	
2114L	200ns .99	4116	200ns .35
2016	200ns .99	4116	150ns .45
2018	150ns 1.35	4104	200ns 1.05
HM6116 P	150ns 1.35	4104	150ns 1.20
HM6116LP	150ns 1.45	4112B	150ns 4.95
Z-6132	300ns 19.89	41256	150ns 2.89
HM6184 P	150ns 3.35	41256	120ns 3.89
HM6184LP	150ns 3.45	4418	150ns 3.95
HM6184LP	100ns 12.45	4464	150ns 6.95

EPROMS

2516	450ns 2.95	2732 A	250ns 2.95
2532	350ns 3.75	2784	450ns 2.95
2708	450ns 2.95	2784	250ns 3.45
2718-5	490ns 1.95	2712B	250ns 3.95
2718	450ns 2.45	27256	250ns 6.99
2718-1	390ns 2.95	27512	250ns 29.99
2732	450ns 2.95	MC88784	450ns 15.99
2732 A-2	250ns 3.85	MC88786	350ns 16.99

8088 / 8086 UPGRADE

V-20... 5 MHz... 13.95

V-20... 8 MHz... 19.95

— High Speed —

DP-25 Solder Cup



Male, Female, Hoods... 99¢ ea.

UV ERASERS

QUV-T8/1... \$49.95
ECONOMY Model

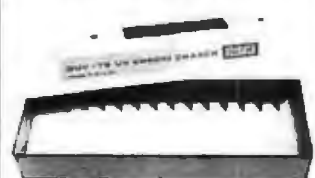

- Erases 15 EPROMS in 20 minutes
- Plastic Enclosure

74LS00

74LS100	.14	74LS125	.46	74LS260	.46
74LS101	.14	74LS126	.36	74LS265	.36
74LS102	.14	74LS132	.36	74LS273	.78
74LS103	.14	74LS133	.40	74LS275	1.90
74LS104	.14	74LS136	.36	74LS279	.39
74LS105	.16	74LS137	.36	74LS280	1.18
74LS106	.16	74LS138	.36	74LS283	.56
74LS109	.16	74LS139	.36	74LS290	.80
74LS110	.14	74LS145	.86	74LS293	.78
74LS111	.18	74LS147	.86	74LS295	.66
74LS112	.18	74LS148	.86	74LS298	.68
74LS113	.36	74LS151	.36	74LS299	1.48
74LS114	.24	74LS153	.36	74LS323	2.48
74LS115	.24	74LS154	1.46	74LS324	1.68
74LS120	.16	74LS155	.40	74LS352	1.24
74LS121	.20	74LS156	.46	74LS353	1.18
74LS122	.16	74LS157	.34	74LS363	1.20
74LS126	.20	74LS158	.28	74LS364	1.88
74LS127	.20	74LS160	.28	74LS385	.36
74LS128	.24	74LS161	.30	74LS386	.36
74LS130	.16	74LS162	.48	74LS387	.36
74LS132	.16	74LS163	.36	74LS388	.36
74LS133	.26	74LS164	.48	74LS373	.75
74LS137	.24	74LS165	.64	74LS374	.75
74LS138	.24	74LS166	.86	74LS377	.76
74LS140	.16	74LS168	.94	74LS378	1.12
74LS142	.36	74LS169	.94	74LS385	1.84
74LS147	.36	74LS170	.84	74LS386	1.42
74LS148	.66	74LS173	.46	74LS390	1.06
74LS149	.66	74LS174	.36	74LS393	.78
74LS151	.16	74LS175	.36	74LS395	1.05
74LS154	.18	74LS181	1.48	74LS399	1.98
74LS155	.20	74LS189	3.89	74LS424	2.86
74LS163	.96	74LS181	.46	74LS447	.62
74LS173	.28	74LS181	.46	74LS490	1.40
74LS174	.22	74LS192	.68	74LS824	1.82
74LS175	.28	74LS193	.66	74LS840	.96
74LS176	.28	74LS194	.56	74LS845	.96
74LS178	.36	74LS195	.56	74LS868	1.48
74LS183	.46	74LS196	.56	74LS869	1.26
74LS185	.46	74LS197	.56	74LS870	.86
74LS186	.20	74LS221	.56	74LS874	9.58
74LS189	.36	74LS240	.66	74LS882	3.14
74LS191	.86	74LS241	.66	74LS883	2.86
74LS192	.46	74LS242	.66	74LS884	2.86
74LS193	.36	74LS243	.66	74LS885	2.86
74LS195	.46	74LS244	.50	74LS888	1.86
74LS196	.46	74LS245	.66	74LS889	2.86
74LS107	.32	74LS247	.68	74LS783	21.96
74LS109	.34	74LS248	.68	81LS95	1.36
74LS112	.26	74LS249	.96	81LS96	1.36
74LS113	.32	74LS251	.46	81LS97	1.36
74LS114	.32	74LS253	.46	81LS98	1.36
74LS122	.44	74LS257	.36		
74LS123	.46	74LS258	.46	25LS252	2.48
74LS124	2.60	74LS259	1.18	25LS259	2.48

MEMORY EXPANSION KIT



41256 150ns
\$2.89 each!

8000		8200 (continued)	
8031	4.95	8253-6	1.79
8035	1.45	8256	1.59
8039	1.89	8255-5	1.79
8080A	2.89	8257	1.99
8085	2.35	8257-5	2.29
8085A-2	4.89	8259	1.89
8086	7.89	8259-5	1.89
8087-3	124.95	8271	48.95
8087-2	139.95	8272	4.79
8088	5.95	8274	4.79
8089	39.95	8275	24.99
		8279	2.29
		8279-5	2.79
		8282	3.79
		8283	3.79
		8284	2.79
		8286	3.79
		8287	3.79
		8288	4.79
		8289	19.89
		8292	12.99
8100		8300	
8131	2.90	8303	1.79
8155	2.35	8304	1.79
8155-2	3.89	8307	1.79
8156	2.89	8308	1.79
8185	26.89	8310	2.29
8185-2	26.89	8311	2.29
8200		8700	
8202	6.96	8741	8.89
8203	29.89	8748	6.89
8205	2.99	8749	9.89
8212	1.35	8755	18.89
8214	3.59		
8216	1.35		
8224	2.09		
8226	1.59		
8228	3.29		
8227	4.79		
8237-5	5.29		
8238	3.99		
8243	2.39		
8250	9.95		
8251	1.49		
8251A	1.89	80186-8	48.89
8253	1.89	80188	48.89

CRYSTALS

ALL STANDARD VALUES 1.00



CRYSTAL CLOCK OSC.
ALL STANDARD VALUES 4.89

DIP Switches 79¢

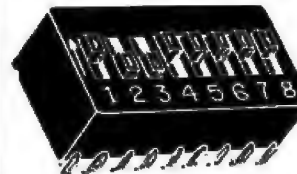

ORBITAL SYSTEMS:

EXTENDED 80-Col. Card for Apple IIe

64K to 128K Upgrade; 2-Yr. Warranty \$89.95

Z-80 (CP/M) CARD, for Apple II+, IIe
Compatible with all Apple CP/M

Lifetime Warranty 69.95

IBM ACCESSORIES

8087-3 5 MHz..... 124.95

8087-2 8 MHz..... 139.95

80287 1 MHz..... 179.00

80286..... 99.00

Power Supply, 135W..... 89.00

Monochrome Graphic Card... 119.00

Memory Card..... 139.00

Multifunction Card..... 129.00

AT Crystal: 16, 18, 20 MHz.... 4.95

MACINTOSH UPGRADE

(PARTS ONLY) 50.00

128K to 512K..... 50.00

Consists of: (1) 41256, 150ns;

(1) 74F253;

(17) 16-Pin Sockets

Resistors and Capacitors ALSO INCLUDED

APPLE ACCESSORIES

Parallel Printer Card..... 49.95

80-Col. card for Apple II+... 149.95

80-Col. card for Apple IIe... 69.95

Cooling Fan..... 38.95

Power Supply..... 69.95

Joystick..... 29.95

RF Modulator..... 13.95

Disk Drive Full Height.... 159.95

Disk Drive 1/2 Height.... 129.95

Controller Card..... 49.95

16K Card..... 39.95

Z-80 Card..... 69.95

★ DISKETTES BULK ★

SS/DD..... 25/\$17.25

DS/DD..... 25/\$19.75

AT disks..... 25/\$50.00

3 1/2" disks... 25/\$50.00

ALL DISKETTES HAVE A FULL 1-YEAR WARRANTY

6500 6500 A

6502	1.99	6502A	2.49
6504	6.79	6520A	2.49
6505	8.79	6522A	4.99
6507	9.79	6532A	9.89
6520	1.59	6545A	6.89
6522	3.99	6551A	6.89
6532	5.99		
6545	4.69		
6551	5.89		

6800

1 MHz	68B00
6800	1.89
6802	4.89
6803	9.89
6804	4.89
6804E	5.89
6806	5.89
6810	1.89
6820	2.89
6821	1.89
6828	13.89
6840	5.99
6843	16.89
6844	10.89
6845	4.89
6847	10.89
6850	1.89
6852	4.59
6860	7.59
6862	10.89
6875	6.89
6880	1.49
6883	21.89

68000

68000-8	9.89
68047	12.89
68488	14.89
68652	14.89
68661	8.89
68784	15.89
68786	18.89

Z-80 Z-80A

Z-80	Z-80A (continued)
Z80-CPU	.99
Z80-CTC	1.49
Z80-DART	3.89
Z80-DMA	3.89
Z80-PIO	1.59
Z80-SIO/0	3.89
Z80-SIO/1	3.89

WORLDWIDE'S PC HEADQUARTERS

TURBO

Including DOS 3.1!

FCC Class B Approved

640k installed on motherboard
1.360k floppy. 5150 keyboard.
8088-2 microprocessor (4.77MHz and 8MHz)

657

SUPER VALUE!

30MB SYSTEM
Featuring Adaptec's 2070 with Seagate's new ST238

\$479 ea.
Quantity 10 \$499 ea qty 1-9 includes cables & inst proc

TAPE BACK-UPS

40MB INTERNAL \$399 <small>With data card and software</small>	60MB INTERNAL \$665 <small>With data card, software and controller</small>	60MB EXTERNAL \$499 <small>With data card, software and controller</small>
--	--	--

AT DRIVES
Prices include cables, rails and inst. proc.

20MB SEAGATE 4026 40 ms access \$479	40MB SEAGATE 4051 40 ms access \$669	44MB MINISCRIBE 6053 28 ms access \$898
--	--	---

LAZER PRINTERS
Name brand fully IBM and EPSON graphics compatible 8ppm 16 type variations and serial/parallel interface built in

\$1788

YOU LIKE IT, OR WE TAKE IT BACK!
If for any reason, you are not satisfied with any product you purchase, you may return it within 10 days of receipt for replacement, credit or refund.

WE'LL PAY YOU IF YOU FIND A LOWER PRICE!
If you buy any item from us at pricing in this ad and find a lower price from any source in this issue, that has the identical product in stock, we'll not only refund the difference you paid, but also pay you 20% of the difference for your trouble! If you find a lower price in this issue before you buy, from any source that has the identical product in stock, we'll beat it!

GUARANTEED AVAILABILITY!
Any item you order will be shipped within two working days or you will be given a firm ship date when you order! If for any reason we cannot ship by the date you are given, we will issue you a credit equal to 5% of the price of the products shipped late.

XT DRIVES

10MB DRIVE ONLY Microscience \$198	10MB SYSTEM With West Dig controller, drive, cables & inst proc \$294
20MB SYSTEM With West Dig controller, drive cables & inst proc \$379	20MB DRIVE ONLY Seagate \$289

MODEMS

NAME BRAND 1200
1200/300 baud auto answer/auto dial Hayes (AT) compatible external modem. Monitor speaker tone/pulse indicator lights.
\$155

ZOOM 1200
1200/300 baud auto answer/auto dial Hayes (AT) compatible sharing dual phone jacks, call progress tone detection 2 Year warranty. Made in USA.
\$194

FLOPPY DRIVES

- PANASONIC 1/2 Ht. PC compatible \$99
- SANYO 1/2 Ht. PC compatible \$94
- APPLE II compatible, including cable \$98

2 MEGABYTE EXPANSION BOARD
Bank switched memory board supporting the LOTUS[®] expanded memory spec. With Print Spool and RAM Disk software.

O-K	1-Mb	2-Mb
\$184	\$292	\$388

COMPONENTS

- 256K DRAMS 9-150ns . . . \$27
- 64K DRAMS 9-150ns . . . \$9
- 8087 \$108
- 8087-2 \$145
- 80287-3 \$168
- V20 5MHz \$ 9
- V20 8MHz \$10
- V30 8MHz \$10

PC POWER SUPPLIES
*150 Watt, Digital Switching \$88

KEYBOARDS (IBM XT Compatible)
*S150 style \$69
*S151 style \$88

BOARD PRODUCTS
*AST Snpak - compat multi board (see per game manual exp to 384k RAMDISK & PSPool) by MULTITECH (10k ms) \$96
*MULTITECH 576k short card (10k ms) \$56

ACCESSORIES
WEST DIG. 10025WX2 XT hard disk cont. \$128
3 DRIVE floppy controller \$40
Mercedes compatible monochrome graphics card 720x348 w par port & light pen interface by MULTITECH \$112
MULTITECH color graphics card 1 2 3 IBM mono and CGA compatible \$98
TAXAN SS3 Ultra Hi Res color card \$244
MULTITECH E.G.A. card IBM mono CGA and EGA compatible \$288
SIGMA E.G.A. \$369

MODEMS
ZOOM 1200 baud Apple internal \$93
Smart TEAM 103-2124 1200-300 baud external Hayes (AT) compatible \$168
ANCHOR EXPRESS 1200 baud w/ short \$188
ANCHOR LIGHTNING 2400 baud external Hayes compatible \$348

MONITORS
TATUNG MM1222A amber TTL \$126
TATUNG CM1360 Hi Res RGB (640 x 200) \$367
PRINCETON MX-12E E.G.A. RGB (640 x 350) \$518

ORDER LINES OPEN 7 AM to 6 PM P.S.T. MON-FRI

Dealers: Call for quantity prices!

Outside California

Inside California

1-800-826-3736

1-800-358-8881

THE FINE PRINT
No returns on software. Prior return authorization required. All items returned must be in original condition with carton packing and all manuals. Some returns may involve a restocking charge. We accept Cashier and Certified checks, Money Orders, personal and company checks (product shipped when check clears). VISA and Mastercard with no surcharge. All products shipped UPS ground unless specified otherwise (minimum shipping charge \$5.00 exact charges specified at time of order). All normal manufacturer's warranties apply. Membership clubs excluded. All items priced and in stock at time of ad placement and subject to vendor changes and prior sale at time of ad publication.



WORLDWIDE ACCESS INC.

EVERYBODY HATES US, BUT OUR CUSTOMERS!

MON-FRI

6311-L DeSoto Avenue • Woodland Hills, California • 91367 • Phone (818) 703-7996

OFFICE HOURS: 9AM to 5PM PST

P.C. Computer Brokers Inc.

The Place To Buy Your Epson Printers

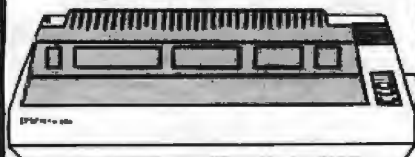

EPSON **EPSON FX-286**
 List \$799⁰⁰ **\$529⁰⁰**

Epson Printers	List	SALE
Homewriter Printer	\$249 ⁰⁰	\$ 199 ⁰⁰
AP-80 Printer	\$379 ⁰⁰	CALL
LX-80 Printer	\$329 ⁰⁰	\$ 229 ⁰⁰
SQ-2000 Ink Jet Printer	\$2295 ⁰⁰	\$1579 ⁰⁰



FX-85
 list \$499⁰⁰ **\$349⁰⁰**

Call Toll FREE **1-800-245-4122**
 Colo. WATS—Outside Metro Denver
1-800-826-9333. After Tone 9111510.

Epson Printers	List	SALE
Spectrum LX-80	\$ 299 ⁰⁰	\$ 219 ⁰⁰
HS-80 Ink Jet Printer	\$ 449 ⁰⁰	\$ 339 ⁰⁰
Comrex High Speed		
CR-420 Printer	\$2195 ⁰⁰	\$1449 ⁰⁰
HI-80 Four Pen Plotter	\$ 599 ⁰⁰	CALL

Call P.C. Computer Today For
 Low Prices on Many Other
 Computer Products—Call
1-800-245-4122

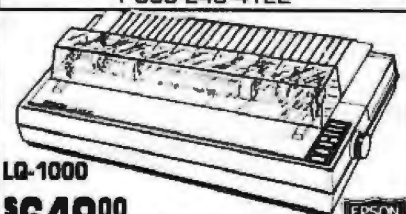

LQ-1000
 list \$995⁰⁰ **\$649⁰⁰**

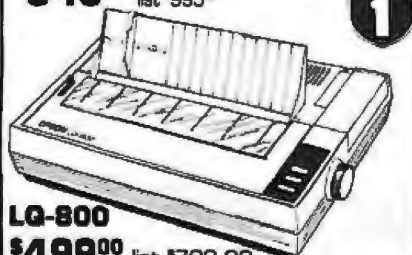

LQ-800
 list \$700.00 **\$499⁰⁰**

Prices Subject to Change Without Notice



Add 2.9%
 For Use of
 Visa, M/C
 & Choice.

These Prices Are Good For Mail Order Dept. Only

P.C. Computer Brokers Inc.
3879 East 120th Ave.
Thornton, CO 80233
(303)450-6727

Call Toll FREE **1-800-245-4122**

Get the whole
 story on graphics
 terminal emulation.



To find out more about software
 that lets your PC emulate
 TEKTRONIX™ 4105/6/7/9 and
 DEC VT100™ terminals,
 call or write:

GRAFFPOINT

4340 Stevens Creeks Blvd., Suite 280,
 San Jose, CA 95129 (408) 249-7951

Inquiry 155

OC8000



**EXPANDS PC
 PERFORMANCE AT A FRACTION
 OF NETWORKING COST**

- Adds four to eight serial communication ports to IBM PC, XT, AT or compatibles.
- Standard RS-232 or optional RS-422 ports for increased transmission speed and distance.
- Supported by Xenix, Multi-Link, BTCS, QNX, and other multi-user, multi-tasking operating systems.

STAR GATE TECHNOLOGIES, INC.

Suite 109

33800 Curtis Blvd. • Eastlake, OH 44094

Call: (216) 951-5922

Inquiry 333

Still Waiting?

**ATTENTION
 BERNOULLI BOOSTERS**
 Go Either Way!

BOOT
 from the Bernoulli Box!
 from the AT Hard Disk!

FORMAT WITH DOS
 PARTITION WITH FDISK
 NO SLOWING

We've been shipping Bernoulli Boosters
 that work for over a year —
 (all) waiting?

Golden Bow Systems

\$95-\$110

Add \$5 for shipping!
 handling
 California residents add
 6% sales tax



P.O. Box 2000
 San Diego, CA 92102
 (619) 298-9349

Inquiry 154

**16-BIT RESOLUTION
 ANALOG-TO-DIGITAL
 CONVERTER**
12,000 SAMPLES/SEC
 for IBM PC, XT & AT
SINGLE PIECE PRICE
\$475

We manufacture a broad line
 of data acquisition and control
 hardware and software for Apple
 and IBM computers.

Call for quotes on custom
 hardware or complete systems.

LAWSON LABS, INC.

5700 RAIBE ROAD
 COLUMBIA FALLS, MT 59912
 406-387-5355

Inquiry 204

**Ramjet 256K
 Print Buffer**



- FREES YOUR COMPUTER UP FAST
- FULL 256K BYTES OF BUFFER SPACE
- FAST DATA RATE - UP TO 7000 CPS
- WILL PAUSE FOR INDIVIDUAL PAGES
- MUCH LESS EXPENSIVE THAN OTHERS
- ALL FOR ONLY \$269.00

The RAMJET 256K Print Buffer is available in either
 parallel or serial versions. Dealer inquiries are very
 welcome. Custom programming for special applica-
 tions is available. For more information or to order
 the RAMJET 256K Print Buffer:

CALL (206) 236-2983
Omnitronix, Inc.
 P.O. Box 43 - Mercer Island WA 98040

Inquiry 264

DATA ACQUISITION TO GO
INTERFACE FOR ANY COMPUTER
FREE IBM SOFTWARE



Connects via RS-232. Fully IBM com-
 patible. Built-in BASIC. Stand alone
 capability. Expandable. Battery
 Option. Basic system: 16 ch. 12 bit
 A/D, 2 ch. D/A, 32 bit Digital I/O.
 Expansion boards available. Direct
 Bus units for many computers.

(201) 299-1615

P.O. Box 246, Morris Plains, NJ 07950

ELEXOR

Inquiry 129

MSO
MICRO
SUPPLY
 ORGANIZATION INC.

the giveaway.

MSO, the leader in cost effective computer systems, is offering the Sanyo MBC 1200 at a giveaway price!

The MBC 1200 Accounting Software -G/L, A/R, A/P, Inventory and Payroll modules retail for \$398 per module. Now from MSO you pay only \$99 per module or all five for \$299! Second disk drive with fan-option available. COMPAT disk utility available.

SPECIFICATIONS:

- Two Z-80A (main and subsidiary) CPUs with no-wait mode for fast execution, substantial memory capacity (RAM 64KB, ROM 4KB).
- High-resolution full graphic function with 640 x 400 dot matrix display.
- Choice of 33 or 40 line text mode.
- CP/M operating system complete with interpreter, editor and all utilities.
- Easy-to-use Sanyo graphic BASIC.
- One (MBC 1200) or two (MBC 1250) internal double-sided, double-density, double-track, 5¼" slim-type 640KB formatted mini floppy disk drives.
- Special design featuring detachable ergonomic keyboard with coiled cable.
- Interfaces for Centronics printer and one RS-232C port provided.

SANYO
MBC 1200

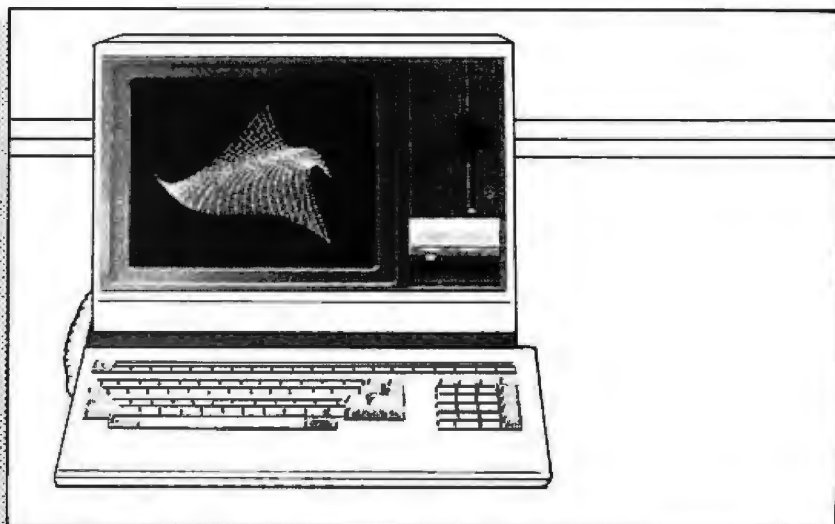

20 meg internal hard drive sub-system for Sanyo MBC 1100, 1160 & 1200
\$599 (with purchase)

Printer specials with purchase

805/393-2247

All systems carry full 90 day warranty.

CASH PRICE ONLY

Check in advance. Add 3% for VISA/MC Shipping & handling charges will be added to each order

For our catalog with complete details and prices, send \$2 to:

Micro Supply Organization, Inc.
 4509 Stockdale Hwy. #180
 Bakersfield, CA 93308



15% Restocking on Returned Orders

FREE SOFTWARE

- Wordstar • Spellstar
- Calcstar • Mailmerge
- Infostar • Basic

\$399

TIME SAVING — MONEY SAVING PRINTER BUFFER

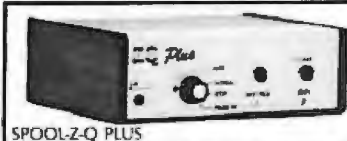

SPOOL-Z-Q PLUS

SPOOL-Z-Q PLUS — a parallel printer buffer which works with any parallel printer and frees up your computer for other use while printing. Very high capacity (128K x 512K) and full time space and null character compression means that SPOOL-Z-Q PLUS is ready to take on the real life jobs. A special Password Protected feature allows printing single sheets from the buffer. SPOOL-Z-Q PLUS also has Copy, Clear, and Refresh functions built in. Supplied complete with a 1.5A (and power supply, the SPOOL-Z-Q Plus buffer is easy to install and use. All models are set expensable to 32K at any time by just plugging in standard 256K RAM. SPOOL-Z-Q Plus is the professional's choice for size, features, and price.

(Without Cable) 128K-5279 256K-5309 512K-5369
(Including Cable) 128K-5309 256K-5339 512K-5399

SPOOL-Z-Q BLUE PLUG IN PRINTER BUFFER FOR THE IBM PC and compatible computers is a **CABLE** HARDWARE PRINTER BUFFER, NOT A SPOOLER. Parallel only and format/parallel models available. Works with any software and does not use any of the computer's memory. Sizes from 256K to 1024K are available. SPOOL-Z-Q Blue replaces the parallel printer card in the PC. (May be IFTL 2 or 3. Many many advanced features. Call or write for full details. Prices start at \$179 (Parallel only) and \$199 Serial capable.

As little from dealers or direct from us. We accept MC, VISA, AMEX or ECHO cards. No charge for shipping to CND. 15 day total price (includes return policy) on all products. CA residents — 6% tax.

DEALER INQUIRIES INVITED.

OEMAs — We can modify our buffers to meet your special requirements.

1603 Fulton Ave., Suite 10A
Sacramento, CA 95825
(916) 483-0709

DISKETTES

Why PAY more??

5 1/4 DS/DD
Soft Sector
Bulk Quantity 100
39¢ ea

Each Diskette 100% certified at Manufacturer

LifeTime Warranty

**ACT NOW! These are not seconds.
MONEY BACK GUARANTEE!
No questions asked.**

MEI ORDER LINES
USA ORDER LINE 800-634-3478
OHIO ORDER LINE 614-481-4417

MEI™
1555 West Lane Ave.
Columbus, Ohio, 43221

9-TRACK MAG. TAPE SUBSYSTEM FOR THE IBM PC/XT/AT



For information interchange, backup and archival storage, IDEX offers a 9-track, IBM format-compatible 1" magnetic tape subsystem for the IBM PC, featuring:

- 42 M-Bytes on a single reel.
- IBM format 1600 cpl.
- Software for PC-DOS, MS-DOS.

Write, phone or FAX for information

IDEX

IBEX COMPUTER CORP.
20741 Marlin St.
Chesapeake, CA 91311
(818) 738-1920
TWX: 910-80-0071

Inquiry 195

Inquiry 172

COLOR VT220 \$150*

*plus your
PC, jr, XT, AT or compatible

ZSTEMpc-VT220 Smart Terminal Emulator
132-col. by windowing - no addit hardware
Double High Double Wide Characters
Full VT100 line graphics. Smooth scrolling
2-way file transfers incl. XMODEM and KERMIT

Full keyboard software/MACROS
Data rates to 38.4KB. High Throughput
Color/graphics, monochrome & EGA support
International Font Support • DOS Access
ISO and attribute mapped color

ZSTEMpc-VT220 \$150. 4010/4014 Option \$89
ZSTEMpc-VT100 — Choice of the U.S. Airforce
30 day money back guarantee. MC/VISA

KEA SYSTEMS LTD.

#412 - 2150 W. Broadway
Vancouver, B.C. CANADA V6K 4L9
Support (604) 732-7411
TELEX 04-352848 VCR

Order Toll Free (800) 663-8702

Zstem by **KEA**
SYSTEMS

Inquiry 390

NEW

SIBEC II

- 8052AH BASIC V1.1 CPU
- ISBX* expansion connectors
- Prototyping area
- Five 8 bit input/output ports
- PROM programmer
- Expansion connectors

CALL TODAY 603/469-3232
\$295

Binary Technology, Inc.
MAIN ST., P.O. BOX 67 • MERRIDEN, NH 03776
603/469-3232
*ISBX is a trademark of the Intel Corporation

Inquiry 38

ICs PROMPT DELIVERY!!!

SAME DAY SHIPPING (USUALLY)
QUANTITY ONE PRICES SHOWN

OUTSIDE OKLAHOMA NO SALES TAX

DYNAMIC RAM		
256K 64Kx4	150 ns	\$4.37
256K 256Kx1	100 ns	4.87
256K 256Kx1	120 ns	3.35
256K 256Kx1	150 ns	2.95
128K 128Kx1	150 ns	4.55
64K 64Kx1	150 ns	1.40
EPROM		
27512 64Kx8	250 ns	\$28.00
27C256 32Kx8	250 ns	7.85
27256 32Kx8	250 ns	5.45
27128 16Kx8	250 ns	3.90
27C64 8Kx8	200 ns	5.10
2764 8Kx8	250 ns	3.55
STATIC RAM		
43256L-12 32Kx8	120 ns	\$50.00
6264LP-15 8Kx8	150 ns	3.10
6116LP-3 2Kx8	150 ns	2.10

640 Kbytes MOTHERBOARD KITS: Zenith 150: \$78.10
IBM PC/XT/AT Compat. Portable & Plus: \$109.95

OPEN 6 1/2 DAYS WE CAN SHIP VIA FED-EX ON SAT

NO EXTRA COST FOR FED-EX SAT DELIVERY ON ORDERS RECEIVED BY 11:59 AM EST MON-FRI. (918) 267-4961

Prices shown above are for May 25, 1986

Please call for current prices. Prices subject to change. Please proceed higher on some prices on your order due to market & demand and not changing rates. Shipping & handling extra. Sales discount program. Orders received by 4 PM CST can usually be delivered to you by the next morning, via Federal Express Standard Air — \$6.00, or Priority One — \$13.00!

Inquiry 241

ATTENTION MEGABYTES

Beat The 33 Mbyte Limit!

Veature for **BIG** disks for files User-Transparent Security Features Included.

Golden Bow Systems

\$80 — \$120
Add \$3 for shipping/handling
California residents add 9% sales tax

619/298-8348
P.O. Box 2626
San Diego, CA 92101

Inquiry 153

NEW!

SafeSkin™

KEYBOARD PROTECTOR

Remains in place during keyboard use. Prevents damage from liquid spills, dust, ashes, etc. Fits like a second skin, excellent feel. Available for: IBM-PC, AT, Apple (all), Compaq, Model 100, NEC 8201, C64, Zenith 150, DEC, Kaypro, KB5151, AT&T 6300, WYSE 50 and many others. Send \$29.95, check, M.O., Visa & MC include exp. date. Specify computer type. Dealer inquiries invited. Free brochure avail.

Merritt Computer Products, Inc.
2925 LBJ Fwy. #180 / Dallas, Texas 75234
(214) 339-0753

Inquiry 229

Serial ← → Parallel

NEW!

Convert What You Have To What You Want!

- RS232 Serial
- 8 Baud Rates
- Latched Outputs
- Centronics Parallel
- Handshake Signals
- Compact 31, x 45, x 112

No longer will your peripheral choices be limited by the type of port you have available! Our new High Performance 700 Series Converters provide the missing link. Based on the latest in CMOS technology, these units feature full baud rate selection to 19.2K, with handshake signals to maximize transfer efficiency. Detailed documentation allows simplified installation. Order the Model 770 (SerPar) or Model 775 (ParSer) Today!

Buffer Products Coming Soon!

Aigeronics
2734-C Johnson Dr.
P.O. Box 377
Van Nuys, California 91408

only \$89.95
Consultor Option \$10.00
CA Residents 8% Use
LPH Shipping \$5.00

CALL (805) 658-7466 or 658-7467
For FAST Delivery

Inquiry 360

U.L. Rated • High Reliability • Full Technical Support



140W (Typ.) 150W(Max.)
 PC/XT \$129.00

- U.L. recognized, yellow card available File # E-101115(S)
- Meet FCC class B, European safety spec.
- 115/230V AC convertible
- Low noise DC fan
- OVP, OCP, short circuit protection
- IBM® standard pin out or Faraday type pin out selectable
- 100% 24 hrs. burn-in 100% pre-shipment test.
- One full year warranty

Your PC represents a substantial investment. It does not make sense to risk costly down time due to budget power supply, when for a few dollars more you can have the confidence of FORTRON QUALITY.

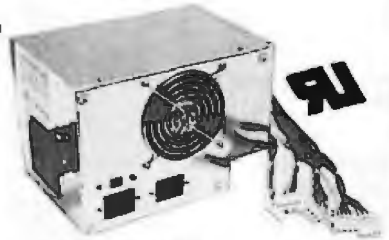

IBM is a registered trademark of International Business Machines.







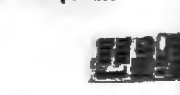

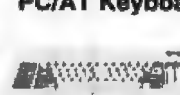
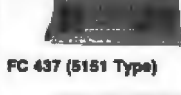
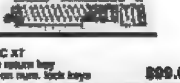
FC 5192 200W (max)
 PC/AT \$189.00

PROFITABLE DISCOUNT PRICES FOR SYSTEM INTEGRATORS & DEALERS - PLEASE CALL

FC 520 Color Graphic/ Mono/Printer  <ul style="list-style-type: none"> • TTL/composite level outputs • 384x 200 (color) 640 x 200 (BW) • Cartridge Printer Port \$99.00	FC 550 (CT-6040) Monochrome / Graphic / Printer  <ul style="list-style-type: none"> • 80 w/ 25 text mode • 720 x 348 graphic mode • True Lotus VGA-2 suite dist. etc. • IBM® compatible \$109.00	FC 730 (CT-6050C) 384K Multifunctions  <ul style="list-style-type: none"> • Memory expansion to 384K • Clock / calendar • Switch, parallel ports • Game port (pin) \$119.00	FC 740 Multi-I/O w/Floppy Controller  <ul style="list-style-type: none"> • 1 EM-RS232C port (2nd optional) • 1 Centronics port, game port • Clock / calendar • Control 2 floppy drives • FC 770 w/4 Floppy Controller \$99.00	FC 1730 Multifunction Card for PC AT  <ul style="list-style-type: none"> • 1 EIA-RS232 port (2nd optional) • 128K to 1.5 MB memory • Expandable to 1 MB (optional) by piggy back board • Game port \$189.00	FC 1830 RS232/Printer Port for PC AT  <ul style="list-style-type: none"> • 1 EIA-RS232 port (2nd optional) • Cartridge parallel port \$99.00
FC 940 RS232/Real Time Clock  <ul style="list-style-type: none"> • RS232C port • To 9800 baud • Battery back-up \$59.00 (clock only) \$49.00	Hard Disk Controller  Hard Disk Controller for XT <ul style="list-style-type: none"> • DTC 5160 BX \$149.00 • WD WVD (Western Digital) \$148.00 • Cable \$ 8.50 F.D. & H.D. Controller for AT <ul style="list-style-type: none"> • DTC 5280 \$258.00 • Western Digital WA-2 \$ 18.00 	FC 230 Floppy Disk Controller  <ul style="list-style-type: none"> • Drives up to four 5 1/4" floppy drives • IBM compatible • With cables \$59.00	XT CPU Board  <ul style="list-style-type: none"> • FC 150 (4.77 MHz) \$149.00 • FC 180 (6.00 MHz) \$189.00 • Expandable to 640K on board memory • Optional 8087 co-processor • Optional IBM® comp. BIOS 	Modems \$149.00  INTERNAL Hayes 1200 RS232C...\$389.95 Everex 1200 bps...\$148.00 Practical Peripheral...\$199.00	SPECIAL <ul style="list-style-type: none"> • FC 830 512K memory exp. card...\$69.00 • FC 830S 576K memory exp. card...\$69.00 • FC 930 parallel adaptor for XT...\$49.00 • FC 530 monochrome controller w/printer port...\$79.00

Enhanced Graphic Adaptor IBM® Compatible \$289.00  w/o printer port  w/printer port EGA Monitor \$499.00 <ul style="list-style-type: none"> • For PC/XT/AT and compatibles • 256K on board memory • Full 16 colors in 640x350 on IBM® enhanced color display • Support 640x350 IBM® compatible enhance color and monochrome monitors • Parallel port • Light pen interface 	FORTRON 200 U.P.S. for PC  <ul style="list-style-type: none"> • 115V / 230V AC input convertible • Fixed current 2.5 amp • 250W continuous • 1/2 cycle typical transfer time • Hold-up time from 20 minutes (200W) up to 60 minutes (500W) • 5.12" x 7.7" x 13.48" \$259.00	FC 447 PC/AT Keyboard  <ul style="list-style-type: none"> • IBM AT compatible keyboard • Elegant return key • Light on num. lock key \$109.00	FC 427 (5150 Type) \$79.00  FC 437 (5151 Type)  <ul style="list-style-type: none"> • For PC XT • Large return key • Light on num. lock key \$99.00
---	---	---	--

CABINETS & EXPANSION CHASSIS

FC 630 A-2 XT CHASSIS  <ul style="list-style-type: none"> • For PC XT compatible side switch • To use FC 135-40 power supply • Complete mounting hardware \$79.00	FC 620 AT CHASSIS  <ul style="list-style-type: none"> • For PC AT compatible • LED timer, try, test, speaker and mounting hardware included \$139.00	FC 510 Drives Chassis  <ul style="list-style-type: none"> • 18" x 8" x 8 1/2" • Capable of holding 2 half-height drives • Cable w/ power supply, fan • LED power indicator \$149.00	FC 640/5 Slots PC Expansion Chassis \$239.00  <ul style="list-style-type: none"> • W/5 slot mother board • 100W power supply, fan • Capable of holding 3 half-height drives • Dia 15 1/4" x 12" x 6 1/4" • Options of system interface adaptor \$149.00	FC 650/8 Slots PC Expansion Chassis \$249.00  <ul style="list-style-type: none"> • PC XT identical size • W/8 slot mother board • 140W power supply • 4 half-height drives • System interface adaptor \$149.00	FCC 660/12 Slots PC Expansion Chassis \$269.00  <ul style="list-style-type: none"> • Dia. 18 1/4" x 12 1/4" x 6 1/4" • W/12 slot mother board power supply, fan • Capable of holding 3 half-height drives • System interface adaptor \$159.00
--	--	---	---	---	--

MONITORS \$99.00 <ul style="list-style-type: none"> • Monochrome Teklog MM 1332 A/O \$129.00 Samsung \$99.00 • Color Hi-Res (840 x 200) Teklog CM-1080 \$309.00 • Enhanced Graphic (840 x 350) Teklog CM-1280 \$499.00 Princeton HV-12E \$699.00 Mitsubishi SGA \$699.00 Odetics PW-22 \$499.00 	DISK DRIVES <ul style="list-style-type: none"> • Floppy Tasc 588V 1.2 MB 500PV \$119.00 Hard for (controller & cable) \$149.00 • Hard 10 MB \$419.00 20 MB ST-026 \$449.00 20 MB ST-026 (40 MB) drive only \$279.00 30 MB ST-026 (40 MB) drive only \$289.00 31 MB CM-6646 (40 MB) drive only \$499.00 	Tape Back-Up (w / controller, cable & tape)  <ul style="list-style-type: none"> INTERNAL Sygen 20 MB \$649.00 Sygen 30 MB \$699.00 Sygen 40 MB \$749.00 Sygen 60 MB \$799.00 EXTERNAL Sygen 20 MB \$799.00 Sygen 30 MB \$849.00 Sygen 40 MB \$899.00 	Printers \$89.00  Admits DP-120 \$199.00 <ul style="list-style-type: none"> • 130 C.P.S. • 80 columns • 6 x 9 dot matrix field • Parallel standard interface • TT-60 • 50 C.P.S. • 80 columns • Parallel standard interface • Thermal printer 	RAM CHIPS <ul style="list-style-type: none"> • 64K RAM \$11.00 / B pm. • 256K \$23.00 / B pm. • 128K \$44.00 / B pm. (for PC AT)
---	---	---	---	---

Terms:

- Min shipping & handling \$6.00
- CA res. add 6.5% tax
- Restocking charge 15%
- No rtn goods w/o a RMA no
- Prices subject to change w/o notice

Lowest Price Ever!
on 3M Data Products
LIFETIME WARRANTY

SS-DD Qty - 5 Bx (lesser qty add 3%) 75¢ \$1.48 \$1.50	DS-DD "FREE H/C KIT" While supplies last 5.25" 5.25 96 TPI 3.50"/1357PI" OS-HD 96 TPI (For the "AT") "Pre-packaged in 3M's Flip'n'File for \$4./box 8.00" SS-SD W/Wp 8.00" W/WP 3M Head Cleaning Kit 3M Data Cartridges - Qty 10-case (lesser qty add 5%) DC-100A DC-1000 DC-300XLP DC-600A	\$1.07 \$1.58 \$2.15 \$2.19 \$2.05 \$6.99 \$12.30 \$12.35 \$19.00 \$20.80
--	--	--

BASF **An Apple A Day**
Win FREE Apple IIc Computer and CASH!
LIFETIME WARRANTY

SS-DD Qty 5 Bx (lesser qty add 3%) 75¢ \$1.50	DS-DD 5.25" Qty 50 (10/Bx) 3.50" Qty 50 (5 plastic case) OS-HD for "AT" Qty 50 (10/Bx)	85¢ \$2.15 \$1.99
--	---	--

BASF diskettes are factory packed in boxes of 10 with Tyvek sleeves, user ID labels and write-protect tabs.

Best Deal Ever Lifetime Warranty
Nashua Boxed

SS-DD (lesser Qty add 10%) 65¢ \$1.55	DS-DD 5.25" Qty 10 BX 3.50" 135 TPI	69¢ \$2.15 \$1.99
--	---	--

DS-HD for the "AT"

BULK Diskettes
No Logo Made by the leading USA magnetic media manufacturer
Same name brand quality w/o box
PACK DISKETTES LIFETIME WARRANTY

SS-DD	DS-DD
100 500 1000	100 500 1000
.53 50 .47 5.25"	.62 58 .55
1.50 1.45 1.40 3.50"/135 TPI	1.75 1.70 1.65
5.25" DS-HD for the "AT"	1.72 1.65 1.55

COLOR DISKETTES
Rainbow Pack Business Pack

- With Hub Rings
- Tyvek Envelopes
- Write-Protect Tabs
- User Labels
- Warranted Forever
- 100% Tested & Certified
- Thicker 10 mil jacket
- Exceed ANSI specs

SS-DD	DS-DD
65¢	79¢
85¢	99¢

Pre-packed in plastic library case
Private labelling available call for more info

RIBBONS
Epson MX 70/80
Epson MX 100
Okidata 80/82/83-92/93-128
Apple Image Writer

STORAGE
2" Amray Media Mate
3" Disk Minder II-75
Micro Disk Minders-36
3" Plastic Library Case

TERMS: VISA MasterCard American Express C.O.D. orders add \$4.00 Pre-
paid orders deduct 2% discount. P.O.s accepted from corporations rated 3A2
or better government and schools on Net 30 basis FPO, APO, AK, HI and
PR orders add 5%. No sales tax outside Utah! Minimum order \$30.00
SHIPPING: Minimum \$3.00 for 100 or fewer diskettes or less 5 pounds
WE MEET OR BEAT ANY PRICE ON THE SAME PRODUCTS IN THIS ISSUE!

TOLL FREE
ORDER LINE **1-800-523-9681**
INFORMATION AND INQUIRIES
1-801-942-2273

DISKOTECH
DISKOO TECHNOLOGIES, INC.
2034 East 7900 South Salt Lake City, Utah 84121
Hours: 7 AM - 6 PM (Mtn. Time)

I.C.s and Peripherals

- * 64K / 128K / 256K D-RAMs at the LOW PRICES
- H-P Vectra 128K Upgrade \$39.95
- * V20-S \$14.00 / V20-S \$16.00
- V30-S \$18.00 / 8087 \$118.00
- 8087-2 \$195.00 / 80287-3 \$180.00
- * TEAC FOSS-BV DS/DD Disk Drives w/1 year factory warranty \$95.00
- * MultiTech External Modem MultiModem (100% Hayes compatible) 1200/300 bps \$249.00 2400/1200/300 bps \$449.00
- * Memory Boards JRAM3-P / 3-S w/2MB \$388.00 JRAM AT-3 w/2MB \$448.00 JLASER-1 w/cable \$255.00 Par/Ber/Clock Module \$140.00
- * 155W Power Supply for IBM/PC & XT/125.00
- * 2732, 2784, 27128, 27258, 4484, 8118, 8284, etc are available!

WARRANTY: All I.C.s are guaranteed for 180 days from the invoice date on defective items. We will replace them free of charge.

Advanced Technology Products, Corp.
P.O. Box 2205 / 11141 Georgia Ave., Silver Spring, MD 20902
301-933-3523
Prices are subject to change without notice
Call us for the latest prices.
*** OEMS AND DEALERS ARE INVITED ***

Inquiry 7

NO SHIPPING CHARGES
ORDER TOLL-FREE 800-824-3432
In California Call 916-341-8833

DRIVES

1/2 Hr. IBM™ Compatible	89.99
Tandon 100-2	99.99
Tandon 100-4 (85 tpi)	129.99
Tandon 248-2	299.99

ADD ONS

Multi-Function w/DK	119.99
Monochrome Graphics	99.99
Color Graphics	109.99
64K D-Rams	9/10.99
640K Motherboard w/bios	189.99
Printer Card by IBM	49.99

MONITORS

Princeton Graphics MAX 12E	159.99
Princeton Graphics HX 12	439.99

SYSTEMS
PC/XT Compatible 499.99

HARD DRIVE SUB-SYSTEMS

10 Meg	399.99
20 Meg	499.99

We carry a complete line of electronic components
Call or write for our free catalog!

NICORN ELECTRONICS
10210 Carnegie Ave. Unit B-9 Chesham, CA 91311

Minimum order \$10.00 - No shipping charges on prepaid orders - C.O.D. add \$3.00 - UPS Blue box \$18.00 - Call approvals add \$1.00 sales for Personal Checks need for clearance "VISA" fee

Inquiry 371

Heritage Systems Corp.

HSC-9128 Video Terminal Card
80 by 24 Alpha-numeric video display
ANSI X3.64 command set
TTL/CMOS serial port (50 to 38.4K baud)
Off card line drivers (RS-232, Fiber optic)
IBM PC compatible keyboard input
On Screen configuration utility
100 by 10mm, 5V only, 200mA

HSC-9128 video terminal card	\$129
HSC-9128 with RS-232, cables	\$159
HSC-9129 keyboard	\$119
Amdtek 300G Video monitor (Green)	\$139
Amdtek 300A Video monitor (Amber)	\$148

PO Box 10588, Greensboro, NC 27404-0588
(919) 274-4818

Inquiry 164

\$1295
NEW System 570
PC Data Acquisition Workstation

- 7 I/O FUNCTIONS
- EXPANSION SLOT
- SOFTWARE INCLUDED

CALL FOR FREE BROCHURE
KEITHLEY
1-800-552-1115

Inquiry 197

TERMINAL EMULATION

Softerm PC emulates over 30 popular terminals including the:

- DEC VT102, VT220
- Data General D200, D410
- IBM 3101-20 (block mode)
- Hewlett-Packard 2622A
- Honeywell VIP7801, VIP7803

Guaranteed Compatibility
Call for free product brief
\$195 MC-VISA-COD
For the IBM PC/XT/AT, DG1, NEC, Wang PC, TI Pro, Gridcase, Tandy

SOFTRONICS
7899 Lexington Dr., Ste 210
Colorado Springs, CO 80918
(303) 593-9540

Inquiry 318

DYNAMIC RAMS

41256	100ns	\$5.85
41256	120ns	\$3.35
✓41256	150ns	\$2.75
4164	120ns	\$1.40
✓4164	150ns	\$1.30
4464	150ns	\$5.50

PROCESSORS

8087-2	\$160.00
8087-3	\$118.00
80287-3	\$178.00
80287-8	\$187.00
V-20	\$180.00
V-30	\$180.00
STATIC RAMS	
6264L-15 150ns	\$2.95

E. PROMS

27C256	250ns	\$9.99
27C56	250ns	\$7.99
27C128	250ns	\$3.99
27C64	300ns	\$5.28
2784	250ns	\$3.58
2702A	250ns	\$4.28
8000's		

(Parts in stock)

I.C. EXPRESS
15358 Valley Blvd., City of Industry, CA 91746
Phone 818-269-2688 (In CA Fri + Sat)
ORDER TOLL FREE
(800) 892-8889 • (800) 882-8181
Outside California
CALL FOR CURRENT PRICES & VOLUME DISCOUNTS
Price Shown for Cash + MasterCard VISA add 3% more
Prices are subject to change. Minimum order \$10.00
California residents must add 6.25% sales tax
Shipping & Handling: UPS Ground \$3.00 UPS Air \$7.00 (under 1 lb.)
ALL MERCHANDISE IS 100% GUARANTEED

Inquiry 176



pinecom™

AREA CODE (818)

575-1882

Dealer Inquiries Invited

EXPENSIVE COMPUTER Without THE EXPENSIVE PRICE!



\$1495⁰⁰



IBM PC/AT COMPATIBLE

- * Complete System With:
- * INTEL 80286 Processor
- * 6 Mhz/8Mhz Switchable
- * 1 MGB Loaded With 512K On Motherboard
- * Dual Floppy and Hard Disk Controller
- * 1.2 MGB High Density Floppy Disk Driver
- * Clock/Calendar With Battery Back-Up
- * 80287 Co-Processor Socket Ready
- * 200 Watt Power Supply
- * Real AT Style Keyboard

OPTIONAL ADD ONS:

- A. 20 MGB (40 MS) Internal Hard Disk Add \$530⁰⁰
- B. 30 MGB (40 MS) Internal Hard Disk Add \$620⁰⁰
- C. 360K Floppy Disk Drive Add \$98⁰⁰
- D. Monochrome Graphic Card With Printer Port Add \$99⁰⁰
- E. HI-RES TTL Mono Chrome 12" Monitor Add \$130⁰⁰

TURBO SPEED XT

FULLY COMPATIBLE AND 40% FASTER THAN IBM PC/XT

By Using State Of The Art *NEC V-20 Processor



\$595⁰⁰



- * Fully IBM PC/XT Compatible
- * 640k On Board Memories
- * 8 IBM PC/XT I/O Slots
- * Standard 4.77 Mhz Clock Speed
- * Slide in FCC Type Case
- * 150 Watt Power Supply
- * AT Style Full Function Keyboard
- * 2 Half Height Disk Drives
- * Floppy Disk Controller

OPTIONAL ADD ONS:

- A. For 5151 Keyboard Add \$40⁰⁰
- B. RGB Color Monitor + Color Graphic Card Add \$410⁰⁰
- C. 22 MGB Internal Hard Disk With Controller Add \$460⁰⁰
- D. TTL Monochrome Monitor + Monochrome Graphic Card With Parallel Printer Port Add \$229⁰⁰
- E. 300 1200 Baud Auto Dial Auto Answer Modem Card Add \$145⁰⁰

*V20 by NEC is the superset of 8088 and pin to pin compatible with 8088, increases speed of PC from 40% to 80% (rated 1.8 according to Norton Utility 3.0's system information while IBM PC and PC/XT are rated 1.0 as standard) without changing the clock speed of the system, run all IBM PC compatible software with no problem.

SHIPPING CHARGES: 5% for C.O.D., 2% for prepaid orders inside Continental U.S. No Personal Checks Accepted.

All computers are fully assembled and tested in the U.S.A. - 6 months parts & labor warranty.

* IBM is registered trade mark of IBM Corp.

OTHER SYSTEM CONFIGURATIONS AVAILABLE: PLEASE CALL FOR DETAILS

PINE COMPUTER INC. • (818) 575-1882

9690 TELSTAR AVENUE • SUITE 204 • EL MONTE, CA 91731 • STORE HOURS: Mon. - Sat. 9 AM - 6 PM

GMX[®] Micro-20 68020

Single-Board Computer
Mainframe CPU Performance
on a 5.75" x 8.8" Board
(benchmark results available on request)

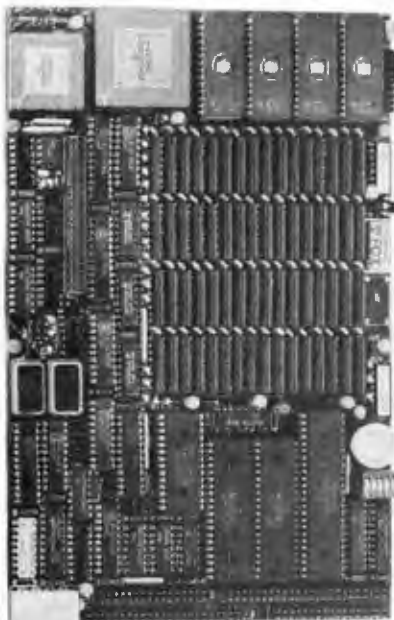

\$2750⁰⁰ 12.5 MHz Version
Quantity Discounts Available

Features

- 32-Bit MC68020 Processor (12.5 or 16.67 Mhz)
- MC68881 Floating-point coprocessor (optional)
- 2 Megabytes of 32-bit wide, high-speed RAM
- 4 RS-232 Serial I/O Ports (expandable to 20)
- 8-bit Parallel I/O Port ('Centronics' compatible)
- Time-of-Day Clock w/battery backup
- 16-bit I/O Expansion Bus
- Up to 256 Kbytes of 32-bit wide EPROM
- Floppy Disk Controller for two 5 1/4" drives
- SASI Intelligent Peripheral Interface (SCSI subset)
- Mounts directly on a 5 1/4" Disk Drive

Software

Included:

- GMX Version of Motorola's 0208ug Debugger with up/download, breakpoint, trace, single-step, and assembler/disassembler capabilities
- Comprehensive Hardware Diagnostics

Optional:

*UNIX[™]-like Multi-user/Multi-tasking
Disk Operating Systems*

- OS-9/68000[™] (Real-time and PROMable)
- UniFLEX[™]

*Programming Languages and Application
Software*

- BASIC, C, PASCAL, FORTRAN, COBOL, and ASSEMBLER
- Spreadsheet, Data Base Management, and Word Processing

GMX^{inc.}

1337 West 37th Place
Chicago, IL 60609

(312) 927-5510 • TWX 910-221-4055

State-of-the-Art Computers
Since 1975

Incredible SwyftWare!™

It is not possible in an ad to really explain this Apple II (e or c) product which outperforms all other software in speed and simplicity. It does no-frills word processing, information retrieval, telecommunications and many other tasks. Reviewers call it "foolproof and frustration free" and "blindingly fast."

It appeals to beginners and experts. *Jef Raskin*, who invented the Macintosh and who later created SwyftWare, has written up the hows and whys of this product. Please write for a copy. No charge. Or order SwyftWare and see for yourself. At \$49.95 and with a 30-day refund policy, there's no risk.

US 800/982-5600 CA 800/562-7400

Information Appliance

1014 Hamilton Ct., Menlo Park, CA 94025

NEW EPROM PROGRAMMER

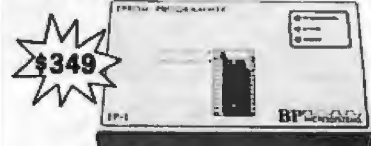

The EP-1 is a great value, here's why:

- IBM PC Compatible, Communication Disk included.
- Also works with CP/M and Development Systems.
- Supports over 100 types including 2716 through 27512, CMOS, and A-Suffix Parts.
- Menu Driven Chip Selection by Manufacturer and Part Number.
- No Personality Modules.
- Fast Programming Algorithm.
- Gold Tantalum ZIF IC Socket.
- RS-232, 9 baud rates to 38,400.
- Full One Year Warranty.
- UV Erasers from \$34.95.

BP Microsystems

5325 Glenmont, Suite E, Houston, TX 77081
(713) 887-1636

Inquiry 53

SOLAR POWER YOUR PC'S REAL TIME CLOCK NO MORE BATTERIES

★ REPLACES THE EXPENSIVE, HARD TO FIND, 3 V LITHIUM BATTERY IN YOUR PC'S REAL TIME CLOCK.

★ STATE OF THE ART AMORPHOUS SILICON SOLAR CELL AND NICAD COMBO.

★ CHARGES EVEN IN ROOMLIGHT OR INDIRECT SUNLIGHT.

★ NEVER OPEN YOUR PC UP AGAIN.

SEND \$19.95 PLUS \$2.25 SHIPPING TO:

STAR TECHNOLOGY
P.O. BOX 606
RUSHLAND, PA 18956

Inquiry 335

DATA SWITCH \$39

Parallel 2 pos(A-B)	\$39
Serial 2 pos(A-B)	\$35
Parallel 4 pos(A-D)	\$52

XT, AT POWER SUPPLY

\$65 XT-135 Watt **\$109** AT-200 Watt

ADD-ON & ACCESSORY

5151 Style Keyboard	\$75
AT Style Keyboard	\$77
Multi-I/O Card	\$90
Color/Graphic/Printer	\$83
1.2 MB Floppy Adapter	\$95
Floppy Drive Controller	\$39
Parallel Printer Cable	\$10
Turbo XT System	\$7.19
XT Type Case	\$39
AT Type Case	\$75

More Items Available

BUDGET COMPUTERS

2620 Concord Ave., Suite 108
Alhambra, CA 91803
(818) 281-2833 Telex 5106006329

Inquiry 55

SPEED IBM-PC/XT TO 700%

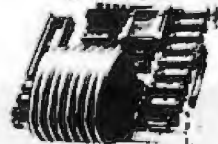

- Uses 80286 Processor
- Installs in Minutes
- Fits Short Slot
- Optional 80287 Processor

\$399

Computer-Age, Inc.
55 Fishry Street
Hartford, CT 06120
203-724-5100

VISA/MC/AE

Inquiry 81

30 Meg Hard Disk Kit—\$535⁰⁰

Includes Half Height 30MB Hard Disk with controller and cables, 1 year warranty.

Turbo Plus Motherboard

w/0K—\$195⁰⁰

5 or 8 MHz switchable without powerdown, runs 3 times faster than PC/XT in 8 Mhz

PC/XT COMPATIBLE PARTS

JUMBO-840 (4.77 MHz)	
Motherboard w/0K	\$125.00
AT-1 Meg Motherboard w/0K	\$695.00
Mono/Graphic Card w/ Printer Port	\$ 85.00
Color Card with Printer Port	\$ 85.00
EGA Color Card	\$275.00
RAMBANK Memory Expansion	
Card w/0K	\$215.00
Internal Modem (1200 baud)	\$165.00
Mitsubishi 360K Floppy Disk Drive	\$115.00
Irwin Tape Drive (10 Meg)	\$395.00

LUCKY COMPUTERS

(214) 690-8110

1701 Greenville Ave. #602, Richardson, TX 75081

Inquiry 215

THE DIVERSIFIED GROUP

4732 Rosecrans, Hawthorne, California 90250

FREE SYSTEM PACKAGE WITH ALL DG-PC'S

FREE	DG-PC'S	IBM
<p>RETAIL VALUE \$186</p> <p>FREE</p> <p>System Package Includes:</p> <ul style="list-style-type: none"> ★ 6 Ft Parallel Shielded Cable ★ Tilt and Swivel Monitor Stand ★ Twenty 5 1/4" Diskettes w/Lifetime Guarantee ★ Flip File Stores Seventy Diskettes ★ Parallel Port ★ Surge Protector Six Receptacles <p>★ FREE FREE FREE FREE ★</p> <p>Offer Expires May 15, 1986</p>	<p>BASE UNIT</p> <p>System Unit 640K on Board One 360K Drive w/Controller 150 Watt Power Supply</p> <p>\$69995</p> <p>SYSTEM</p> <p>System Unit 640K on Board Two 360K Drives 150 watt pwr sply Hi-Res Monitor w/Interface Card</p> <p>\$84795</p> <p>The DG PC</p> <p>Our computers offer the maximum alternatives in the PC XT compatible market. Alternatives which exceed current PC XT configurations. Standard features on all DG PC Series computers include:</p> <ul style="list-style-type: none"> • Full compatibility with IBM PC XT^m machines • 640K bytes of parity checked memory, 8 slots • 150 watt power supply + keyboard • 1 Full Year Warranty on Parts and Labor. • 4 Layer Motherboard 	<p>AT</p> <p>System Unit 80286 Microprocessor 512K Memory 1.2 Meg Floppy AT Type Kybd, Runs PC, XT & AT Sthw, Par & Ser Ports</p> <p>\$163895</p> <p>XT</p> <p>System Unit 640K on Board One 360K Drive 10Meg Hard Disk Monochrome Mon Mouse card</p> <p>\$119595</p>
	<p>IBM PC</p> <p>Base 256K \$1099</p> <p>One 360K Dr. 256K \$1199</p> <p>IBM XT</p> <p>One 360K Drive & 20 Meg Drive \$223795</p> <p>IBM AT</p> <p>Unenhanced \$339150</p> <p>Enhanced \$399595</p>	<p>IBM SYSTEM</p> <p>PC-XT with 10 Meg One 360K Drive, Monochrome Monitor Monochrome Card</p> <p>\$242195</p>
	<p>Service Contract Available on All Products</p>	

DISK DRIVES

MPI B-52
• Tandem Compatible • 360K
Double Side/Double Density • Full Height
2 for \$137.98

5 1/4" DISK DRIVES

	QTY. 1	QTY. 5
Tandem 1/2 Height	\$ 99.95	\$ 99.95
IBM "Logo" Drives	119.95	109.95
Tandem TM100-2	99.95	99.95
MPI (Tandem Compatible)	79.95	79.95
AT 360K w/Interface	119.95	—

DISK DRIVE CONTROLLERS

IBM (Original) Controller \$ 99.95 —
IBM Compatible Controller 99.95 —

PRINTERS

LETTER QUALITY — DOT MATRIX

OKIDATA

ML182P, 120 cps, Parallel Call
ML192P, 180 cps, w/NO Call
ML193P, 18" Carriage, 180 cps, w/NO Call

PANASONIC

KX 1091 \$269.95
KX 1092 349.95

TOSHIBA

P341 24 pin 136 col. \$399.00
P351 24 pin Par. & Ser. 1099.00
P1348 34 pin 48 col. 399.00

EPSON — Call for Availability

We also carry Jobi, Dymac, Toshiba, Star, Panasonic, NEC, Brother

MONITORS

AMDEK

300G Composite Green \$124.95
300A Composite Amber 134.95
310A Monochrome Amber 159.95

TAXAN

620 (640 x 200) \$399.95
630 (640 x 400) 446.00
640 (720 x 400) 549.95

PRINCETON GRAPHICS

HX12, 640x200 Dot Pitch .31 \$421.95
HX12E, 640x350 Dot Pitch .28 617.95
SR12, 640x480 Dot Pitch .31 573.95
SR12P, 640x480 Dot Pitch .26 787.95
HX-9, 640x350 Dot Pitch .28 432.95
MAX12E, 728x250 169.95

MEMORY

64K SETS
All Upgrades Carry a 2 Year Warranty
Wine 416A, 1500s \$10.95

128K SETS **256K SETS**

Miles, 4128 \$39.95 9, 41256, 2000s \$34.95
25 Sets \$32.85 ea. 25 Sets \$32.95 ea.

80287
8MHz for AT & Desktop \$189.95

8087-3 **8087-2**

8MHz Math Co-Processor for IBMPC \$142.95
8MHz Math Co-Processor for XT&T, Compat, Desktop \$164.95

HARD DISK DRIVES

All Hard Disks Come With: 90 Day Warranty, Cables, and Controller

	QTY. 1	QTY. 5
10 Megabyte w/Controller	\$349.95	\$349.95
20 Megabyte w/Controller	489.95	469.95
30 Megabyte w/Controller	729.00	714.00

Most Hard Disks are Shugart, Microsci, CMI, Rodime, Seagate
Call for Others

BERNOULLI BOX

10 Meg \$1779.95 —
20 Meg 2399.95 —

TAPE BACK-UP BY IRWIN

10 Meg Internal 1/2 Height, Low Power \$445.00 \$430.00
10 Meg External Back-up \$69.00 \$79.00

DISK DRIVE CONTROLLERS

Western Digital Hard Disk Cont. \$179.95 —
Adaptec Hard Disk Cont. 199.95 —

VIDEO CARDS

DG GRAPHICS

Color Graphics w/Parallel Port 2 Yr. War. \$194.95
Monochrome Graphics w/Par Port 119.95

EVEREX

The Edge Color/Mono \$269.95
The Graphics Edge 269.95

IBM

IBM Monochrome w/Parallel Port \$226.95
IBM Color Card w/Parallel Port 214.95

PARADISE

Monitor Graphics Card \$259.95
Multi Display 159.95

EGA

DG EGA \$292.95
STB EGA + 349.95
QUADRAM + 399.95
IBM EGA 499.95

SIGMA

Color 400 Board \$459.95

HERCULES

Color Graphics \$169.95
Monochrome Graphics 319.95

IBM ACCESSORIES

A-B SWITCH BOXES

Parallel 2 pos. \$49.95 Serial 2 pos. \$54.95

DISKETTES

3 1/2" Disk/Unit 5 Year Warranty
1 box of 10 \$9.95

KEYTRONICS KEYBOARDS

8153 Touch Pad \$289.95
5150 Standard \$169.95 5151 Deluxe \$179.95

BELKIN CABLES

6 foot Shielded IBMPC to Par. \$14.95 IBMPC to Modem \$16.95

EXPANSION CARDS

AST SixPac + w/384K 2 Yr War \$261.95
MF-180 SixPac Compatible plus Gameport \$89.95

AST Advantage w/1.5 Megabyte of Memory Parallel & Serial Ports \$497.95
AST Rampage \$362.95

MODEMS

Hayes

1200B w/Smartcom II \$382.95
1200 External \$392.95 2400 External \$595.95

DG

300/1200 Internal Hayes compatible, \$156.95

VISA MasterCard
No Surcharge on Credit Cards

TERMS:
P.O.'s from Government Institutes, Universities, Fortune 1000
C.O.D.'s w/Guarantee.
Visa, MC, MO, Cashier's Check, Cash.
Please Call for Shipping: Min. \$4.50
We ship Fed. Express, USP, U.S. Mail

THE DIVERSIFIED GROUP

MAIL ORDERS: 8726 S. Sepulveda, Suite A132, Los Angeles, CA 90045
WAREHOUSE: 4732 Rosecrans, Hawthorne, CA 90250

TOLL FREE ORDER LINE
(800) 523-1041
INSIDE CALIFORNIA
(213) 675-0717

CORPORATE BUYERS CALL
GILLES, LOUANE, MANDI, MIKE or DAVE

TOLL FREE
800-854-8230
CA Residents 714-558-8813

OUR POLICY
•Surcharge for VISA or Mastercard. Inquiry 6
•Volume purchasing agreements available.
•Orders subject to availability. •Supply limited on certain items.
•Pricing subject to change without notice.
•ACP Retail Store pricing may vary. Not responsible for typos.

IBM Compatible ADVANCED PC/XT

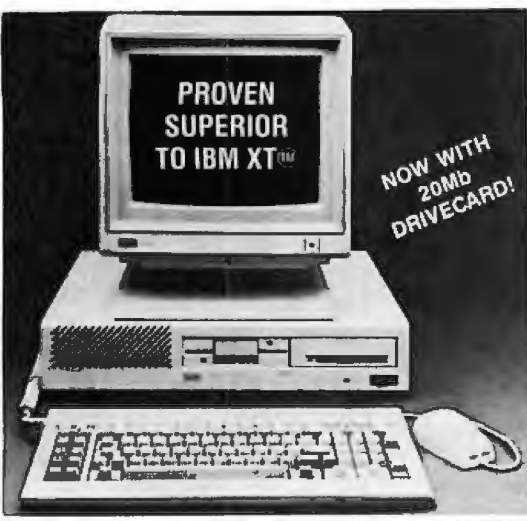

Don't miss out on this unbeatable system manufactured by Toshiba for ACP. ACP has sold over 3,000 ADVANCED XT's to satisfied customers including "true blue" users like Rockwell, Hughes, and Kodak. Not only is the price affordable but the features and compatibility are unbeatable. For more details call one of our expert consultants. Don't hesitate this will be a sellout!

COMPLETE SYSTEMS FROM \$895.00

Call for complete Monochrome or Color RGB system prices with 10 or 20 Mb hard disk drives or the NEW 20Mb Drivcard.

20 Mb Upgrade **\$449** 20 Mb Drivcard **\$699**
Package (1 Yr War) Plug-in 1 Yr War)

SEAGATE FOR AT
(Linear Voice Coil Activator)
20 Mb for AT.....\$575.00
30Mb for AT.....\$695.00
40Mb for AT.....\$815.00
(Inc. Cable & Mounting Rails)

PC UPGRADE SPECIAL

\$14.95 SET OF (9) 64K RAMS
\$36.95 SET OF (9) 256K RAMS
\$7.95 4128 PIGGYBACK RAM
\$139.00 8087 Coprocessor
\$169.00 8087-2 Coprocessor

1200 Baud Hayes™ Comp. Modem Short Card by U.S. Robotics with Teipac I Software.
List \$499 ACP. **\$149.95**
Buy (6).....**\$139.95**

- AST**
Sixpak Plus w/0.....\$175.00
Advantage 128K, AT.....\$99.00
ALPS.....\$95.00
AST 5251-11.....\$75.00
AST 3780.....\$75.00
RAMpage up to 2 Mb.....Call
DCA
Irma.....\$785.00
Irmaline.....\$95.00
- DIABLO/XEROX**
620 Serial LOP.....was 1495 now \$349.00
620 API LOP.....\$99.00
620 D36 (36cps).....\$49.00
Tractor.....was 395 now \$99.00
F-21 Sheet Feeder.....was 896 now \$49.00
Cable for 620 (to IBM).....\$29.00
Diablo P-11 100cps.....\$129.95
Diablo S-11 100cps Serial.....\$139.95
Diablo P-31 Wide.....\$249.95
Diablo S-31 Wide.....\$289.95
Other Diablo Dot Matrix's available.....Call

★ NEW ★ Advanced AT!
INTRODUCTORY PRICE

- 80286 CPU-8MHz
- 1.2 Mb Floppy Disk Drive
- Hard Disk Controller w/Floppy
- AT Style Keyboard
- 192W Pwr Sup. • 8 Expan. Slots
- MS-DOS 3.1, BIOS

\$1495.00

- ORCHID**
PC Turbo 186 w/256K.....\$583.00
- PARADISE**
Color/Monocard.....\$185.00
Modular Graphics Card.....\$274.00
- PERSYST**
Mono Board w/Parallel.....\$159.00
Color Board.....\$139.00
Time Spectrum.....Sale Call
- PRINCETON GRAPHICS**
HX-12 RGB (640x240).....\$445.00
MAX-12E Amber TTL.....\$175.00
SR-12.....\$575.00
HX-12E (690x350).....\$465.00
- PROMETHEUS**
ProModem 1200 w/Mile (Int).....\$339.00
ProModem 1200B (Hayes Comp.).....\$289.00
Alpha/Num or Options Proc.....\$79.95

- EPSON**
FX85 160cps NLO.....\$375.00
FX286.....\$99.00
- EVEREX**
Graphics Edge or Edge.....\$259.00
- HAYES**
Smartmodem 1200.....\$385.00
Smartmodem 1200B.....\$48.00
Smartmodem 2400 (Int).....\$73.00
Smartcom II 2.1 Software.....\$8.00
Hayes Comp. 1200 (Int) w/SW.....\$159.95
Hayes Comp. 1200 (Ext).....\$199.95
- HERCULES**
Color Card.....\$166.00
Graphics Card w/Software.....\$265.00
- INTEL**
Above Board PC or AT.....Lowest Price
- IRWIN**
310A 10 Mb Tape (Ext).....\$849.00
110D 10 Mb (Int).....\$495.00
- KEYTRONICS**
5151 Deluxe Keyboard.....\$169.95
5153 w/Touchpad.....\$285.00
PC Jr. Numeric Keypad.....\$39.95
- MICROSOFT**
Mouse.....\$139.99
Mouse (Serial).....\$155.00
- MOUNTAIN COMPUTER**
20Mb Drivcard.....\$699.95
- MOUSE SYSTEMS**
PC Mouse w/Palmbrush.....\$138.00
ACP Mouse w/Keyboard.....\$48.00

- ADVANCED AT CARDS**
- ADV-320 Hard Disk Controller with Floppy for AT.....\$229.00
ADV-6020AH Color/Graphics/Printer.....\$9.95
ADV-6050 2Mb Multifunction with RS-232, Game & Cable 169.95
ADV-6080 3Mb Memory Expansion 129.95
ADV-6120 Printer/RS-232 and RS-232 (Opt.).....\$9.95

- ADVANCED PC/XT CARDS**
- ADV-6040 Monochrome/Graphics/Printer.....\$99.95
ADV-6040-3 As Above for 132 Col. 139.95
ADV-6050A Monochrome/Printer Adapter.....\$5.95
ADV-6050C 384K Multifunction Card RS-232, Printer, Game, Clock 1/2 Card.....\$119.95
ADV-7060 Floppy Controller, 2 Floppies.....\$39.95
ADV-EGA EGA Short Card.....\$29.95
ADV-6120E Printer, RS-232 x 2.....\$79.95
ADV-6250A Multifunction, RS-232, Printer, Game, 1/2 Card.....\$95.95
6260A Multifunction, Floppy Cont., RS-232, Printer, Game, 1/2 Card.....\$149.95
ADV-6280 640K Memory Card, OK.....\$5.95
ADV-6090 Mono/Color/Graphics, Printer 80/132 Columns 179.95

- QUADRAM**
Expanded Quadboard (OK).....\$185.00
Gold Quadboard (OK).....\$385.00
Silver Quadboard (OK).....\$215.00
Quadlink.....\$99.00
- SIGMA**
Color 400 Card.....\$485.00
- SHARP**
12" Med-res RGB Monitor.....\$269.95
Color Plotter w/Software.....\$199.00
- STAR MICRONICS**
Gemini 10X.....reduced \$179.00
Gemini 15X.....sale 299.00
HX-10.....MEW! 335.99
- TAXAN**
415 (640x260) RGB.....was 899 now \$279.95
Mod. 640 (Ultra Hi-res).....\$95.00
- TEMPLATES**
Lotus, dBase III, etc.....Lowest Price
- TITAN**
Accelerator PC w/256K.....sale Call
- TOSHIBA**
P321 "3 in 1" LQ Printer.....sale \$599.00
P341 24 Pin 136 Col.....\$669.00
P351 24 Pin w/Serial & Parallel.....\$1099.00
T-1100 MS-DOS Lap Top.....Call
- WESTERN DIGITAL**
Cobra Hard Disk Controller.....\$179.95
- ZENITH**
ZVM-1220/30 12" Grm/Amb TTL.....\$169.00
ZVM-1240 & ZVM-135 RGB.....Call

SYSGEN 20/20

- 20Mb Hard Disk
- 20Mb Tape Back-up
- New/Factory Box
- PC/XT/AT Comp.
- External Complete
- Reg. Retail \$3300

ACP Only **\$999**

Grid Compass MS-DOS Lap
Computer Demo Sale Call for Details. 100's in Stock as Low as **\$849.00**

EGA SPECIAL

New Advanced EGA Card for High-res IBM Graphics.

SPECIAL PRICE! Only \$288.88

UNBELIEVABLE!

Micropro INFOSTAR SYSTEMI includes

- Datastar, Reportstar (PC DOS).....\$99.95
- IBM brand Pascal Compiler.....\$99.95
- IBM Pascal Reference.....\$49.95
- IBM DOS 2.0.....\$24.95
- Visicalc IV IBM.....\$39.95
- Compaq MS DOS/BASIC ver.2.....\$49.95

Advanced Computer

WE WILL MEET ANY PRICE FOR CURRENT PRODUCT ADVERTISED IN POPULAR MAGAZINES. POLICY APPLIES FOR BOTH SOFTWARE AND HARDWARE!

GET OUR FLYER? IF NOT - CALL & GET ON OUR MAIL LIST.

JULY SPECIALS (SUPPLY LIMITED)

SYS GEN 20 Mb w/20Mb Backup \$999.00

For PC Jr. SUPER NUMERIC KEYPAD

Manufactured by Keytronics. We have sold 1000's of these. **ACP \$29.95**
Reg Retail \$99 or 6 for 29.95 ea

PC Jr. Color Adapter **\$19.00**
PC Jr. TV Adapter **29.95**
PC Jr. Operation Manual **19.95**
PC Jr. Compact Printer **69.95**
PC Jr. 64K Adapter **39.95**
Lotus 1-2-3 PC Jr. **179.95**

*** MONITOR SPECIALS ***

SAMSUNG TTL Green **\$89.88**
TTL Amber... **98.88**
LUXOR RGB 720 x 800 **298.88**
NEC Multi-synch... **598.88**
MITSUBISHI RGB Color **298.88**
MAGNAVOX RGB w/Gm Switch **328.88**

UPS POWER SUPPLY
Sheds 150 Power for your IBM, Apple or Compatible

UPPC 300 Watt **\$277.00**
UPPC 350 Watt **419.00**
UPPC 400 Watt **730.00**

A-B PRINTER SWITCH
An A-B Switch allows you to free printers with your computer system. We stock over 150 brand combinations.

AS Switch (Compatible) **\$69.00**
AB Switch (IBM) **\$9.00**

DRIVE CABINETS

IBM Style Hard Disk with power supply and fan **\$179.00**
Dual Head Disk w/cover sup & fan **289.00**
Dual 5 1/4" Full Height vertical mount **68.00**
Dual 5 1/4" Thin Height vertical mount **99.00**
Single 5 1/4" Full Height w/cover sup & fan **99.00**
Single 5 1/4" Thin Height w/cover sup & fan **99.00**

5800

80002	810.00	80000	1 2.90	80009	5 5.25
80020A 10	80000	80000	3.75	80007	8.00
80009	2.90	80021	2.90	80009	7.00
80000	2.75	80020	14.90	80075	3.00
80003	30.00	80000	12.75	80007	25.00
80001	3.00	80045	11.00		

CMOS

4000 2	26	4000 5	88	4000 57	80	4000 6	1.00
4000 2	4000 75	4000 8	4000 8	4000 8	4000 8	4000 8	4000 8
4000 2	4000 2	4000 2	4000 2	4000 2	4000 2	4000 2	4000 2

NEW NEC V20 P/N up'd 70108
Replaces your 8008 to increase speed up to 40% **\$18.95**

TANDON FLOPPYS PULL OUTS

TANDON TM100-2 **69.95**
TM100-1 **39.95**
TM48-1 **69.95**
TM48-2 **189.95**

8000

80000	3 2.25	80114	3 3.75	80000	9 0.70
80000	3 3.75	80000	1 1.25	80000	1 1.25
80000	2 9.00	80000	2 9.00	80000	2 9.00

74000

74000 2	74000 2	74000 2	74000 2	74000 2	74000 2
74000 2	74000 2	74000 2	74000 2	74000 2	74000 2

DEC RAINBOW UPGRADE
16K UPGRADE CARD **\$49.95** Best Plus Many DEC Software/Hardware Items!

INTERNAL STD BUS BOARDS
ALMOST SOLD OUT
Send or Call for List

Z-80

2800-CPU	2.90	2.75	2.50
2800-DMT	7.50	8.50	17.50
2800-DMT	8.00	8.50	17.50

74000

74000 2	74000 2	74000 2	74000 2	74000 2	74000 2
74000 2	74000 2	74000 2	74000 2	74000 2	74000 2

Build Your Own XT Compatible

- 8 Slot XT MB **\$158.00**
- XT-8IOS **27.95**
- 130 Watt Power Supply **65.00**
- TTL Jump Cables **49.90**
- XT Keyboard **75.00**
- 1/2 Hi 360K Floppy **99.00**
- Floppy Controller **49.95**
- Monochrome Adapter **49.95**
- TTL Mono Monitor **97.77**
- 256K RAM **36.95**

TRANSISTORS/DIODES

PN2222A	1051.00	1N4001	1145.00
PN2222A	501.00	1N4001	1145.00
PN2222A	31.50	1N4001	31.50

DISK CONTROLLERS

4800 68	1.97	821 95	66.2	821 95	66.2
4800 68	1.97	821 95	66.2	821 95	66.2
4800 68	1.97	821 95	66.2	821 95	66.2

LINEAR

LM1084M	53.00	LM2000	92.46	LM2000	92.46
LM1084M	53.00	LM2000	92.46	LM2000	92.46
LM1084M	53.00	LM2000	92.46	LM2000	92.46

CAPACITORS

01uf 50V BYPASS CAPACITOR **10058.00**
1 uf 50V BYPASS CAPACITOR **10060.00**
01uf MONOLITHIC CAPACITOR **10071.25**
1 uf MONOLITHIC CAPACITOR **10074.25**

LED LAMPS

4800 68	1.97	821 95	66.2	821 95	66.2
4800 68	1.97	821 95	66.2	821 95	66.2

IC SOCKETS

16 Pin STAP	12	11
16 Pin STAP	17	12
16 Pin STAP	17	12

STATIC RAMS

2701 (4096b)	82.29	2701 (4096b)	82.29
2701 (4096b)	82.29	2701 (4096b)	82.29

CONCORD ICM FILTER

STD CONCORD 3 Conductor Filter **\$4.00**
Line Cord for above - 3 feet **25**
Line Cord 2 Conductor - 6 feet **25**
Line Cord 3 Conductor - 6 feet **25**

AC/DC 24V POWER SUPPLY SPECIAL
24V @ 1A Open Frame OEM Model **Reg 34.95 ACP ONLY \$11.95**

EPROMS

1702 (16Kb)	2 3.50	2704 (32Kb)	5 4.50
1702 (16Kb)	2 3.50	2704 (32Kb)	5 4.50

VOLTAGE REGULATORS

7805 5V	1.80	7805 5V	1.80
7805 5V	1.80	7805 5V	1.80

MUFFIN FANS
Over 1000 in Stock

12VDC Fan **NEW! 35.95**
12VDC Fan **NEW! 12.95**
12VDC Fan **NEW! 14.95**
Finger Guards set **1.49**
Power Cord set **1.49**

CALL ACP FOR ALL YOUR VOLUME IC REQUIREMENTS

UARTS/USARTS

16C45	33.00	16C45	33.00
16C45	33.00	16C45	33.00

SPECIAL POWER CHIPS

MC14681	511.20	MC14681	511.20
MC14681	511.20	MC14681	511.20

IC SOCKETS

16 Pin STAP	12	11
16 Pin STAP	17	12
16 Pin STAP	17	12

EDGE CONNECTORS

5-100 ST	1.49	908
5-100 WW	4.75	4.00
64 Pin ST	2.75	2.00

DYNAMIC RAMS

7401 (4096b)	82.29	7401 (4096b)	82.29
7401 (4096b)	82.29	7401 (4096b)	82.29

DISK SPECIAL (IBM PC DOSDD)

59¢ IBM PC DOSDD
PACKAGE OFF 100

WREWRAP (ROLLS)

8 Pin WWRAP	3.49	9.40
14 Pin WWRAP	69	49
18 Pin WWRAP	85	66

D-SUBMINUTURE

DB25 (Female)	63.10	82.90
DB25 (Male)	7.40	2.30

APPLE FLIPPY DISKETTE

IBM PC DOSDD
Hub Rings
Type C
Major Set

DISK ACQUISITION

AD0000	\$14.80	AD0000	\$14.80
AD0000	\$14.80	AD0000	\$14.80

TELETYPE/VIDEO INSERTION

16 Pin STAP **\$4.75** 64 Pin STAP **\$9.00**
16 Pin STAP **\$4.75** 64 Pin STAP **\$9.00**

CENTRALS

80C 30 Pin Male	16.95	16.95
80C 30 Pin Female	16.95	16.95

APPLE FLIPPY DISKETTE

IBM PC DOSDD
Hub Rings
Type C
Major Set

DISK ACQUISITION

AD0000	\$14.80	AD0000	\$14.80
AD0000	\$14.80	AD0000	\$14.80

ICD CONNECTORS

10	20	26	34	40	60
1.00	1.20	1.80	2.10	2.40	3.00

APPLE FLIPPY DISKETTE

IBM PC DOSDD
Hub Rings
Type C
Major Set

DISK ACQUISITION

AD0000	\$14.80	AD0000	\$14.80
AD0000	\$14.80	AD0000	\$14.80

DISK ACQUISITION

AD0000	\$14.80	AD0000	\$14.80
AD0000	\$14.80	AD0000	\$14.80

ICD CONNECTORS

10	20	26	34	40	60
1.00	1.20	1.80	2.10	2.40	3.00

APPLE FLIPPY DISKETTE

IBM PC DOSDD
Hub Rings
Type C
Major Set

DISK ACQUISITION

AD0000	\$14.80	AD0000	\$14.80
AD0000	\$14.80	AD0000	\$14.80

DISK ACQUISITION

AD0000	\$14.80	AD0000	\$14.80
AD0000	\$14.80	AD0000	\$14.80

ICD CONNECTORS

10	20	26	34	40	60
1.00	1.20	1.80	2.10	2.40	3.00

APPLE FLIPPY DISKETTE

IBM PC DOSDD
Hub Rings
Type C
Major Set

DISK ACQUISITION

AD0000	\$14.80	AD0000	\$14.80
AD0000	\$14.80	AD0000	\$14.80

DISK ACQUISITION

AD0000	\$14.80	AD0000	\$14.80
AD0000	\$14.80	AD0000	\$14.80

ICD CONNECTORS

10	20	26	34	40	60
1.00	1.20	1.80	2.10	2.40	3.00

APPLE FLIPPY DISKETTE

IBM PC DOSDD
Hub Rings
Type C
Major Set

DISK ACQUISITION

AD0000	\$14.80	AD0000	\$14.80
AD0000	\$14.80	AD0000	\$14.80

DISK ACQUISITION

AD0000	\$14.80	AD0000	\$14.80
AD0000	\$14.80	AD0000	\$14.80

ICD CONNECTORS

10	20	26	34	40	60
1.00	1.20	1.80	2.10	2.40	3.00

APPLE FLIPPY DISKETTE

IBM PC DOSDD
Hub Rings
Type C
Major Set

DISK ACQUISITION

AD0000	\$14.80	AD0000	\$14.80
AD0000	\$14.80	AD0000	\$14.80

DISK ACQUISITION

AD0000	\$14.80	AD0000	\$14.80
AD0000	\$14.80	AD0000	\$14.80

ICD CONNECTORS

10	20	26	34	40	60
1.00	1.20	1.80	2.10	2.40	3.00

APPLE FLIPPY DISKETTE

IBM PC DOSDD
Hub Rings
Type C
Major Set

DISK ACQUISITION

AD0000	\$14.80	AD0000	\$14.80
AD0000	\$14.80	AD0000	\$14.80

DISK ACQUISITION

AD0000	\$14.80	AD0000	\$14.80
AD0000	\$14.80	AD0000	\$14.80

ICD CONNECTORS

10	20	26	34	40	60
1.00	1.20	1.80	2.10	2.40	3.00

APPLE FLIPPY DISKETTE

IBM PC DOSDD
Hub Rings
Type C
Major Set

DISK ACQUISITION

AD0000	\$14.80	AD0000	\$14.80
AD0000	\$14.80	AD0000	\$14.80

DISK ACQUISITION

AD0000	\$14.80	AD0000	\$14.80
AD0000	\$14.80	AD0000	\$14.80

ICD CONNECTORS

10	20	26	34	40	60
1.00	1.20	1.80	2.10	2.40	3.00

APPLE FLIPPY DISKETTE

IBM PC DOSDD
Hub Rings
Type C
Major Set

DISK ACQUISITION

AD0000	\$14.80	AD0000	\$14.80
AD0000	\$14.80	AD0000	\$14.80

DISK ACQUISITION

AD0000	\$14.80	AD0000	\$14.80
AD0000	\$14.80	AD0000	\$14.80

Product Inc

Mail Order: P.O. Box 17329 Irvine, CA 92713
Retail: 1310 B.E. Edinger, Santa Ana, CA 92705

7400

Part No.	Price	Part No.	Price
SN7400N	19	SN7485N	55
SN7402N	19	SN7486N	35
SN7404N	25	SN7489N	1.95
SN7405N	29	SN7490N	39
SN7406N	29	SN7493N	35
SN7407N	29	SN74121N	29
SN7408N	25	SN74123N	49
SN7410N	19	SN74125N	45
SN7414N	45	SN74126N	49
SN7418N	35	SN74143N	3.95
SN7417N	35	SN74150N	1.29
SN7420N	19	SN74154N	1.25
SN7430N	19	SN74156N	1.39
SN7432N	29	SN74173N	75
SN7439N	29	SN74174N	59
SN7442N	45	SN74175N	59
SN7445N	69	SN74176N	69
SN7448N	79	SN74181N	1.25
SN7447N	79	SN74185N	1.95
SN7448N	79	SN74193N	69
SN7472N	39	SN74196N	1.35
SN7473N	35	SN74221N	69
SN7474N	35	SN74273N	1.95
SN7475N	39	SN74365N	59
SN7476N	35	SN74367N	59

74LS

74LS00	19	74LS165	79
74LS02	19	74LS166	89
74LS04	25	74LS173	49
74LS05	25	74LS174	39
74LS06	29	74LS175	39
74LS07	19	74LS189	3.95
74LS08	19	74LS191	49
74LS10	29	74LS193	69
74LS14	39	74LS221	69
74LS27	25	74LS240	69
74LS30	19	74LS243	69
74LS32	25	74LS244	69
74LS42	39	74LS245	69
74LS47	39	74LS246	1.19
74LS73	35	74LS273	79
74LS74	25	74LS279	39
74LS75	29	74LS322	2.95
74LS76	29	74LS365	39
74LS85	49	74LS366	39
74LS86	25	74LS367	39
74LS90	39	74LS368	39
74LS93	39	74LS373	79
74LS123	49	74LS374	79
74LS125	39	74LS393	79
74LS138	39	74LS590	5.95
74LS139	39	74LS624	1.95
74LS154	1.49	74LS629	2.49
74LS157	35	74LS640	99
74LS158	35	74LS645	99
74LS163	49	74LS670	99
74LS164	49	74LS688	1.95

74S/PROMS*

74S00	29	74S188*	1.75
74S04	35	74S189	1.95
74S06	35	74S198	1.95
74S10	29	74S240	1.49
74S32	35	74S244	1.49
74S74	49	74S253	79
74S85	1.49	74S287*	1.69
74S86	39	74S298*	1.69
74S124	2.75	74S373	1.69
74S174	79	74S472*	1.69
74S175	79	74S472*	3.49

74ALS

74ALS00	35	74ALS138	89
74ALS02	35	74ALS174	89
74ALS04	39	74ALS175	89
74ALS06	35	74ALS240	1.79
74ALS10	35	74ALS244	1.79
74ALS27	25	74ALS365	2.49
74ALS32	35	74ALS373	1.95
74ALS39	39	74ALS374	1.95
74ALS74	55	74ALS573	1.95

74F

74F00	59	74F139	1.29
74F04	65	74F157	1.29
74F08	59	74F193	4.95
74F10	69	74F240	2.49
74F32	65	74F244	2.49
74F74	69	74F253	1.79
74F86	69	74F373	2.95
74F138	1.19	74F374	2.95

CD-CMOS

CD4001	19	CD4081	25
CD4011	19	CD4082	25
CD4013	35	CD4083	39
CD4015	39	CD4084	29
CD4017	49	CD40103	2.95
CD4018	69	CD4503	49
CD4020	59	CD4510	69
CD4024	49	CD4511	69
CD4027	69	CD4512	1.39
CD4033	39	CD4518	79
CD4040	65	CD4520	79
CD4049	29	CD4522	79
CD4050	29	CD4538	89
CD4051	85	CD4541	89
CD4052	69	CD4543	99
CD4053	65	CD4553	4.95
CD4059	3.49	CD4555	89
CD4060	89	CD4566	1.95
CD4066	29	CD4583	1.95
CD4069	25	CD4584	59
CD4070	25	CD4585	75
CD4071	25	MC14441	9.95
CD4072	25	MC14490P	4.49
CD4076	89	MC14572	89

CUSTOM COMMODORE CHIPS

For VIC-20, C-64 and C-128 Personal Computers

Part No.	Price	Part No.	Price	Part No.	Price
*6510CPU	9.95	*6560VIC-I	14.95	82S100PLA	19.95
*6525TPI	9.95	*6567VIC-II	19.95	*8701 Clock Chip	9.95
*6526CIA	14.95	*6581SD	19.95	*8721	9.95

*Specs. Available @ \$1.50 ea.
 NOTE: 82S100 = U17 (C-64)



MC68701 - Microcomputer with EPROM

The MC68701 is an 8-bit single chip microcomputer unit (MPCU) which significantly enhances the capabilities of the MC6800 family of parts. On-chip resources include 2048 bytes of EPROM, 128 bytes of RAM, Serial Communications Interface (SCI), parallel I/O, and a three function Programmable Timer.



MC68701.....\$19.95

MICROPROCESSOR COMPONENTS

MICROPROCESSOR CHIPS		6500/6800/68000 Cont.		8000 SERIES Cont.	
Part No.	Price	Part No.	Price	Part No.	Price
0785AC	4.95	6843	9.95	8237-S	6.95
CDP1802CE	6.95	6845	4.95	8243	2.49
2661-J	6.95	6850	1.85	8250A	6.95
		6852	4.75	8250B (For IBM)	7.25
		68000L8	8.95	8251A	2.25
		68661	9.95	8253-S	2.25
				8254	9.95
				8254-2	11.95
				8255A-S	2.25
				8257-S	2.49
				8259-S	2.49
				8272	4.95
				8275-S	2.25
				8741	6.95
				8748	7.95
				8749	9.95
				8751	29.95
				8755	14.95

Part No.	Function	DYNAMIC RAMS	Price
4118N-15	16,384 x 1	(150ns)	.89
4128 (Peggyback)	131,072 x 1	(200ns)	5.95
4164N-150	65,536 x 1	(150ns)	1.25
4164N-200	65,536 x 1	(200ns)	1.15
TMS4416-12	16,384 x 4	(120ns)	4.95
MM5260	40,960 x 1	(200ns) 2107	1.95
8118	16,384 x 1	(150ns) (+5V Only Required)	.95
41295-150	252,144 x 1	(120ns)	2.95
50464-15	65,536 x 4	(150ns) (4464) (41464)	6.49

Part No.	Function	STATIC RAMS	Price
TM2016-12	2048 x 8	(120ns)	1.89
2102	1024 x 1	(350ns)	.89
2102-2L	1024 x 1	(250ns) LP (91102)	1.49
2114N	1024 x 4	(450ns)	1.99
2114N-L	1024 x 4	(450ns) LP	1.09
2114N-2	1024 x 4	(200ns) LP	1.49
2114N-2L	1024 x 4	(200ns) LP (CMOS)	.49
21C14	1024 x 4	(45ns)	4.95
2149	1024 x 4	(45ns)	4.95
8101	256 x 4	(45ns) CMOS	3.95
HMS116P-3	2048 x 8	(150ns) CMOS	1.45
HMS116LP-3	2048 x 8	(150ns) LP CMOS	1.49
HMS264P-12	8192 x 8	(120ns) CMOS	4.00
HMS264LP-12	8192 x 8	(120ns) LP CMOS	4.29
HMS264P-15	8192 x 8	(150ns) CMOS	3.75
HMS264LP-15	8192 x 8	(150ns) LP CMOS	3.89
8514	1024 x 4	(350ns) CMOS (UPD4444C)	4.49

Part No.	Function	PROMS/EPROMS	Price
1702A	256 x 8	(1µs)	5.95
TMS2518	2048 x 8	(450ns) 25V	4.95
TMS2532	4096 x 8	(450ns) 25V	5.95
TMS2564	8192 x 8	(450ns) 25V	9.95
2708	1024 x 8	(450ns)	3.95
TMS2716	2048 x 8	(450ns) 3 voltage	9.95
2716	2048 x 8	(450ns)	3.49
2716-1	2048 x 8	(450ns) 25V	4.95
27C16	2048 x 8	CMOS	7.95
2732	4096 x 8	(450ns)	4.75
2732A-20	4096 x 8	(200ns) 21V	4.95
2732A-25	4096 x 8	(250ns) 21V	4.49
2732A-45	4096 x 8	(450ns) 21V	4.25
27C32	4096 x 8	CMOS	7.95
2764-20	8192 x 8	(200ns) 21V	4.95
2764-25	8192 x 8	(250ns) 21V	4.25
2764A-25	8192 x 8	(250ns) 12.5V	4.49
2764-45	8192 x 8	(450ns) 21V	3.95
27F04	8192 x 8	CMOS 21V	5.95
2712B-25	16,384 x 8	(250ns) 128V 21V	3.95
2712BA-25	16,384 x 8	(250ns) 12.5V	5.95
27256-25	32,768 x 8	(250ns) 256K (CMOS) (12.5V)	6.95
27256-25	32,768 x 8	(250ns) 256K (CMOS) (12.5V)	10.95
6876A	8192 x 8	(450ns) 25V	15.95
6876B	8192 x 8	(450ns) 25V	16.95
74S387	256 x 4	PROM O.C.	1.69
74S471	256 x 8	PROM TS	4.95
82S123	32 x 8	PROM TS	2.95
82S129	256 x 4	PROM TS	2.95

LOW PROFILE (TIN) SOCKETS 1-9 10-99 100-up
 8 pin LP 13 12 11
 14 pin LP 15 13 11
 16 pin LP 17 15 13
 24 pin LP 31 30 29
 28 pin LP 39 37 35
 40 pin LP 45 43 43

Part No.	Function	WIRE WRAP SOCKETS (GOLD) LEVEL #3	Price
8 pin WW	55	49 45
14 pin WW	69	65 59
16 pin WW	75	69 65
24 pin WW	1.19	1.09 99
28 pin WW	1.39	1.29 1.19
40 pin WW	1.79	1.69 1.59

SOLDER TAIL STANDARD (GOLD & TIN) AND HEADER PLUG SOCKETS ALSO AVAILABLE

SATELLITE TV DESCRAMBLER

The MM5321 is a TV camera sync generator designed to supply the basic sync functions for either color or monochrome S25 line/60Hz interlaced and camera video recorder applications. COLOR BURST GATE & SYNC
 ALLOW STABLE COLOR OPERATION

MM5321.....\$9.95

DIGITAL TALKER™

DT1050 - Applications: Teaching aids, appliances, clocks, automotive, telecommunications, language translators, etc. The DT1050 is a standard DIGITAL TALKER kit encoded with 137 separate and useful words, 2 tones, and 5 different sentence durations. The words and tones have been assigned discrete addresses, making it possible to output single words or words concatenated into phrases or even sentences. The "voice" output of the DT1050 is a highly intelligible male voice. The DT1050 consists of a Speech Processor Chip, MM54104 (40-pin) and two (2) Speech ROMs MM52164SSR1 and MM52164SSR2 (24-pin) along with a Master Word list and a recommended schematic diagram on the application sheet.

Part No.	Description	Price
DT1050	DigitalTalker™	\$24.95
MM54104	Processor Chip	\$12.95

DT1057 - Expands the DT1050 vocabulary from 137 words to over 250 words. Includes two (2) ROMs and specs.
 DT1057.....\$11.95

INTERSIL

Part No.	Price	Part No.	Price
FE0202D	12.95	7207AEV/KGL	8.49
FE0203D	12.95	7211FL (FTL)	7.95
7106CP	8.95	7211MPL (Micro)	8.49
7106EV/KGL	46.95	7217LUL	10.95
7107LUL	8.95	7217APR	8.95
717EVR/KGL	46.95	7224PL	10.95
7207AIPD	5.95	7226AEV/KGL	99.95

74HC-HI-SPEED CMOS

74HC00	35	74HC175	.89
74HC02	39	74HC221	1.95
74HC04	39	74HC240	1.39
74HC08	39	74HC244	1.49
74HC10	39	74HC245	1.59
74HC15	39	74HC253	79
74HC30	39	74HC259	1.19
74HC32	45	74HC273	1.79
74HC74	45	74HC373	1.49
74HC75	69	74HC374	1.49
74HC76	69	74HC393	1.19
74HC85	1.19	74HC395	1.95
74HC154	1.95	74HC401	1.95

Worldwide • Since 1974

• QUALITY COMPONENTS • COMPETITIVE PRICING
• PROMPT DELIVERY

Mail Order Electronics • Worldwide
Jameco
ELECTRONICS

COMMODORE® COMPATIBLE ACCESSORIES



Now Compatible With C-128!
RS232 Adapter for VIC-20, C-64 and C-128

The JE232CM allows connection of standard serial RS232 printers, modems, etc. to your VIC-20, C-64 (including the SX-64 Portable), and C-128. A 4-pole switch allows the inversion of the 4 control lines. Complete installation and operation instructions included.

Plugs into User Port - Provides Standard RS232 signal levels
Uses 6 signals (Transmit, Receive, Clear to Send, Request to Send, Data Terminal Ready, Data Set Ready)

JE232CM \$39.95

Voice Synthesizer VIC-20 & C-64
Plug-In - Talking in Minutes!

JE520CM \$99.95

300 Baud Auto Modem

Mitey-Mo (For C-64) \$69.95

Parallel Printer Interface

FREE 10K Buffer Included!

MW350 (For VIC-20, C-64 & C-128) \$69.95

TRS-80® COMPATIBLE ACCESSORIES

E-X-P-A-N-D TRS-80 MEMORY

All kits come complete with documentation

TRS-80 MODEL I, II

TRS-16K3 200ns (Model III) \$5.95

TRS-16K4 250ns (Model I) \$5.48

TRS-80 COLOR AND COLOR II

TRS-64K-2 \$11.95

New models only -

TRS-CoCo-Incl. 2-50484's (41464's) . . . \$15.95

TRS-80 MODEL 4, 4P

TRS-64K-2 \$11.95

Expands Model 4 from 16K-64K or Model 4P from 64K-128K

TRS-64K-2PAL \$29.95

Expands Model 4 from 64K to 128K

TRS-80 Model 100 • NEC • Olivetti

M100BK \$29.95 ea. or 3 for \$79.95

TRS-80 Model 100 Expansion

NEC3KR \$29.95 ea. or 3 for \$79.95

NEC Model PC-8201A Expansion

OM100K \$29.95 ea. or 3 for \$79.95

Olivetti Model M10 Expansion

TANDY 200

M200R \$74.95 ea. or 2 for \$129.95

Tandy Model 200 Expansion

UV-EPROM ERASER

Erases all EPROMs. Erases up to 8 chips within 21 minutes (1 chip in 15 minutes). Maintains constant exposure distance of 1". Special conductive foam liner eliminates static build-up. Built-in safety lock to prevent UV exposure. Compact - 9.00" L x 3.70" W x 2.60" H. Complete with holding tray for 8 chips.

DE-4 UV-EPROM Eraser \$74.95

UVS-11EL Replacement Bulb \$17.95

DATA BOOKS

30003 National Linear Data Book (82) \$14.95

30009 Internal Data Book (85) \$ 9.95

30013 Zilog Data Book (85) \$14.95

30022 Nat'l. Logic Data Book Set (84) \$24.95

210830 Intel Memory Handbook (86) \$17.95

230843 Intel Microsystem Hndbk. Set (86) \$24.95

MUFFIN/SPRITE-STYLE FANS

MUF80 (2PAC-15-2462) \$9.95

Howard Industries (4.63" sq., 80 cfm)

SUZC7 \$9.95

ES&G Roton (3.125" square, 20 cfm)

NEW PRODUCTS!

ZUCKERBOARD Expansion Memory Half Card and Clock/Calendar for the Tandy 1000

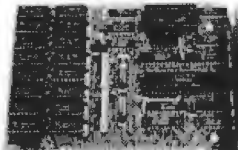

The Zuckerboard Expansion Memory Board allows you to expand the memory of your Tandy 1000 (128K Model) as much as 640K! 256K DRAM chips increase your computer's memory by either 256K or 512K, bringing your total system memory up to either 384K or 640K. The memory board also includes a DMA controller chip. Optional clock/calendar plugs directly onto the memory board. Manual included.

TAN-Clock Clock/Calendar Option (only) \$ 39.95
TAN-EM256K Includes 256K RAM \$ 99.95
TAN-EM512K Includes 512K RAM \$139.95



1MBYTE RAM CARD for Apple II, II+ and IIe*

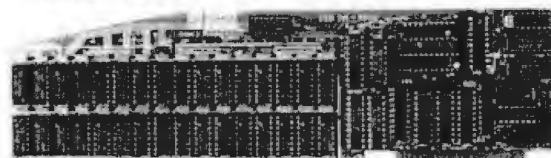

Introducing a third generation memory card that gives you both great expandability and great versatility at an extraordinary price. Versatility to users means that BIG BOARD is compatible with software written for the Synetix SSD (Flashcard) as well as for Jameco's JE868 128K RAM Card. Big Board makes available 426K of worksheet space, using the program THE Spreadsheet Version 2.0. It is compatible with PLUSWORKS XM for running Appleworks on the Apple II. Versatility also means that BIG BOARD comes complete with RAMDISK software for DOS 3.3, ProDOS, Pascal 1.2, and CP/M for Microsoft's Softcard. A separate driver is available for the AppliCard (StarCard).

BIG BOARD-256K 256K RAM \$224.95
BIG BOARD-512K 512K RAM \$269.95
BIG BOARD-1M 1Meg RAM \$299.95

1 Yr. Warranty! External Power Supply for the Commodore 64



• Input 117VAC @ 50Hz • Output 5VDC @ 3 Amps, 10VAC @ 250mA • Short circuit protected and current limited • Transient spike suppression on two auxiliary 110VAC sockets • Switch on front serves as power switch for the computer and other peripherals • RFI/EMI filtered • Adjustable linear regulator • Has less than 50mV ripple rms at full load • 5 Amp primary fuse • Two conductor with ground line • Color: brown • Size: 7 1/2" D x 5 1/2" W x 2 1/2" H • Weight: 5 lbs.

CPS-10 \$49.95

Serial to Parallel/Parallel to Serial Interface Converter

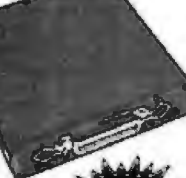

The ADAPTA™ Interface Converter performs either RS-232 serial to Centronics parallel port conversion or the reverse. An internal switch selects whether the device operates as a serial to parallel or parallel to serial converter. The basic module provides 2048 bytes of buffering. The buffer may be switched out if unbuffered operation is desired.

• Uses DTR and CTS to control the serial port data stream • Uses ACK and BUSY to control the parallel port data stream • 8 switch selectable baud rates: 110, 300, 600, 1200, 2400, 4800, 9600, 19200 • Switch selection allows 7 or 8 data bits, parity or non-parity and 1 or 2 stop bits • PVAC adapter incl. • DB-25S serial and Centronics parallel connectors • Selectable control signal polarity • Size: 5 1/2" L x 5 1/2" W x 1 1/4" H • Wt: 2 lbs • Manual incl.

ADAPTA \$74.95

IBM® COMPATIBLE ACCESSORIES

83-KEY KEYBOARD



• Identical layout as original IBM PC Keyboard • Highly desirable case with paint rest • Complete with cable and data • JUST PLUG IN!

KB83 \$49.95

Build an IBM PC/XT™ Compatible!

IBM-64K 64K RAM Chips (18) \$ 24.98
IBM-83 83-Key Keyboard \$ 49.95
IBM-FCC Floppy Controller Card \$ 54.95
IBM-Case Case \$ 49.95
IBM-MCC Monochrome Card \$ 89.95
IBM-PS Power Supply \$ 89.95
FD55B Disk Drive \$119.95
IBM-MON Monochrome Monitor \$109.95
IBM-MB Motherboard \$199.95

Regular List \$789.58

IBM™-Special (Incl. 9 Items Above) . . \$699.95

Additional Add-Ons Available!

IBM-KB 83-Key Keyboard \$ 79.95
IBM-ENH Enhanced Keyboard \$ 99.95
IBM-ICB Integrated Color Board \$109.95
IBM-E384K Multimonitor Card \$169.95
IBM-20MBK 20MB Hard Disk Drive \$499.95

IBM is a registered trademark of IBM Computers

NEW! Universal NEW! 64K/256K Printer Buffer

JOHNATHON FREEMAN DESIGNS



The UBUFFER Universal Printer Buffer is a hi-speed data buffer that accepts data at a high rate, and then outputs this data to your printer. You save valuable computer time. The UBUFFER can be connected to practically any computer or printer. There are four possible combinations: 1) Serial to Serial, 2) Serial to Parallel, 3) Parallel to Parallel, 4) Parallel to Serial. Manual included. Size: 9-1/2" L x 4 1/4" W x 1 1/4" H.

UBUFFER-64K . . . \$199.95

UBUFFER-256K . . \$229.95

IBM Compatible DISK DRIVES

Documentation Included

FD55B 5 1/4" DS 1/2-High \$119.95

SA455 Shugart 5 1/4" DS 1/2-High \$139.95

TM100-2 Tandon 5 1/4" DS Full-High \$139.95

JMR 5 1/4" DISK DRIVE ENCLOSURES

Complete with power supply, switch, power cord, fuseholder and connectors.

DDE-1FH \$69.95

Houses 1 Full-Height 5 1/4" Floppy Drive

DDE-2HH \$79.95

Houses 2 Half-Height 5 1/4" Floppy Drives - Vertical

HDDE-1FH \$199.95

Houses 1 Hard Disk Drive

\$20 Minimum Order - U.S. Funds Only
Shipping: Add 5% plus \$1.50 Insurance

California Residents: Add 6% or 6 1/2% Sales Tax

Spec. Sheets - 30¢ each
Prices Subject to Change

Send stamped, self-addressed envelope to receive a Quarterly Sales Flyer - FREE!

7/86



Send \$1.00 Postage for a FREE 1986 JAMECO CATALOG

© 1986 Jameco Electronics

1355 SHOREWAY ROAD, BELMONT, CA 94002 • PHONE ORDERS WELCOME 415-592-8097 Telex: 176043

California Digital

17700 Figueroa Street • Carson, California 90248

Letter Quality Printer F-10 DAISY WHEEL



\$429

Quantity
Two

Single unit price is \$499. But if you have already purchased an F-10 printer from California Digital, we will honor the \$429 price on the second printer.

The F-10 Daisy Wheel printer is the perfect reasonably priced 40 character per second word processing printer. This printer is "extremely" similar to C. Itoh's F-10-40 Starwriter printer, however we have been advised by legal counsel for the C. Itoh Company that we should refrain from referring to the F-10 printer as a Starwriter.

This printer auto installs with Wordstar and Perfect Writer, features extensive built-in word processing functions that allow easy adaptability and reduced software complexity. Industry standard Centronics interface provides instant compatibility with all computers equipped with a parallel printer port. The F-10 accepts paper up to 15 inches in width.

These printers were originally priced to sell at over \$1400. Through a special arrangement California Digital has purchased these units from a major computer manufacturer. We have a limited number of these popular printers left... while they last we're offering a special Accessory Pak, including six Diablo daisy wheels and two ribbon cartridges, with every F-10 printer already priced at a fraction of their original cost.

Options available: sheetfeeder, tractor feed, buffered memory and an assortment of printer cables for a variety of computers.

FREE

Accessory Pak
Includes 6 Daisy Wheels
& 2 ribbon cartridges
With F-10 Purchase



SONY 53W Floppy Disk Drive 3 1/2" New IBM portable compatible

\$139



5 1/4" DISK DRIVE SALE \$89

Quantity Two

Your Choice 48 or 96 TPI drive.
QUME MODEL 142 • 48 TPI
MITSUBISHI 4853 • 96 TPI



XEROX SUNRISE \$299 COMPUTER



The Sunrise was originally priced at \$2995, but as Xerox has since dropped the computer from their product list, California Digital has purchased all remaining inventory and is making these units available at a fraction of their original cost.

This self contained battery and AC operated portable features a built-in 80 column liquid crystal display, along with both RF monitor and television outputs. The internal 300/1200 baud modem includes an auto dial telephone assembly and the unit has both Centronics parallel and a serial port programmable to 19,200 baud. The self contained micro cassette is capable of capturing data from the keyboard as well as doubling as a recorder for dictating messages.

An optional dual floppy disk drive module is available for only \$219. (When purchased with the Sunrise 1810) Also available, for \$59 is an 80 column printer that mounts in the drive module. The Sunrise features a CPM operating program in Xerox 5 1/4" disk format and over 5000 CPM programs are available in Public Domain.

TEKTRONIX MOUSE



\$79

- 200 dots-per-inch resolution
- Programmable baud rate
- Multiple protocols
- Programmable buttons
- Serial interfaces
- Runs on any surface
- Free of pads or grids
- Microsoft TM compatible driver

Moving your cursor has never been so easy! This mouse combines the best features of optical and mechanical technology into one high performance mouse. The Tektronix mouse was privately labeled by LogiTech for Tektronix. The 200 dots-per-inch resolution requires less desk space and gives you precision control. This mouse is fast and precise in the most demanding environments. And it has a programmable baud rate so you can use it with almost any of your favorite software.

PLOTTER



\$179

The Centronics Controller for the plotter is available with all of our existing hardware and software. This is a graphic presentation menu facility for programs such as Lotus 1-2-3, VisiCalc and Apple II software. It is available for only \$199.

The Centronics Controller is available for purchase with the plotter for only \$199. The plotter is available for purchase with the plotter for only \$199. The plotter is available for purchase with the plotter for only \$199.

The Centronics Controller is available for purchase with the plotter for only \$199. The plotter is available for purchase with the plotter for only \$199. The plotter is available for purchase with the plotter for only \$199.

IRWIN Streamer Tape Back Up

\$489



The Irwin Streamer Tape Drive is a low cost answer to backing up your hard disk drive. One removable cartridge can backup 10 megabytes of data in less than eight minutes.

The Irwin drive includes software for file by file or total disk backup. All programs are menu driven for easy use.

Quick-Link 300



\$59

The Quick-Link 300 gives you an instant link to any dial up data base. Such as Dow Jones, Western Union or the Source. The Quick-Link has four user programmable log-on keys, allowing the operator, with only one key stroke, to dial the data base, log-in and give the password. All this information is permanently stored in non-volatile RAM.

Features include video output to television or monitor, auto dial, auto log, full sized keyboard, 300 baud modem and 1200 baud auxiliary printer port. All this is available for only \$59.

	One	Two	Ten
TEAC FD55BV half height	119	109	99
TEAC FD55GF 96 TPI, half ht.	119	109	105
TEAC FD55GF for IBM AT	189	179	175
SHUGART SA455 Half Height	119	109	105
SHUGART SA465 1/2 Ht. 96TPI	125	119	109
TANDON 100-2 full height	129	125	119
MITSUBISHI 4851 half height	119	109	105
MITSUBISHI 4853 96/TPI 1/2 Ht.	99	89	89
MITSUBISHI 4854 8" elec.	295	285	275
QUME 142 half height	99	89	89
Switching power supply			49
Installation Kit with manual			10
Dual enclosure for 5 1/4" drives			59
34 pin edge connectors			5
Scotch head cleaning kit			19
Flip & File Storage tubs			15



**QUME
\$149**

Eight Inch Single Sided Drives

QUME 841 single side	159	149	call
SHUGART 801R	359	359	354
SIEMENS FDD 100-8	119	115	109

Eight Inch Double Sided Drives

QUME 842 "QUME TRACK 8"	189	179	call
SHUGART SA851R	495	485	475
OLIVETTI double sided	189	179	159
REMEX RFD-4000	179	169	159
MITSUBISHI M2896-63 1/2 Ht.	459	449	409
Dual 8" enclosure with power and fan			259
Switching power supply			89
Installation kit with manual			10

MEMORY

4164 DYNAMIC MEMORY 150ns
Quantity 100
\$99

DYNAMIC MEMORY

	1-100	100+	1000+
4164 150ns, 128 refresh	1.30	1.19	.99
41256 150ns, 256K	4.59	3.95	3.29

VISA

Shipping: First five pounds \$3.00, each additional pound \$.50.
Foreign orders: 10% shipping, excess will be refunded.
California residents add 6 1/2% sales tax. • COD's discouraged.
Open accounts extended to state supported educational institutions and companies with a strong "Dun & Bradstreet" rating.



California Digital

17700 Figueroa Street • Carson, California 90248

IBM Compatible Computer



\$495

Eclipse
DATA PRODUCTS

- 256K Expandable to 640K on Motherboard
- Double Sided Double Density Disk Drive
- IBM Type Keyboard (with LED indicators)
- Floppy Controller Card
- Eight Expansion Slots
- 135 Watt Power Supply

The Eclipse 16 is an outstanding value in IBM Compatible Computers. After careful research and evaluation we found it to be the most reliable unit.

Our computer includes some of the newest features available, such as the 4.7MHz, multi-layer motherboard with 256K of RAM upgradable on board to 640K. A generous eight expansion slots and 135 Watt power supply give you ample room and power for add-on boards. The enclosure has an easy-access flip top lid making upgrades a breeze. And our floppy controller supports up to four drives, so as many as three additional drives can be used. Finally, each computer is configured and fully tested before sending it to you.

Satisfaction Guaranteed! We're really excited about this new unit, and so sure you will be too... that you may return the Eclipse 16 for a full credit towards an IBM PC if you are not completely satisfied.

OPTIONS

20MB Hard Drive w/Controller.....\$495	RGB Color Monitor.....199
Additional Drive-Installed.....89	TTL Monochrome Monitor.....139
Irwin 10 Meg. Tape Back up.....489	Microsoft Mouse.....139
Upgrade from 256K to 640K RAM.....79	Upgrade from Floppy Controller to Disk I/O
8087 Math Co Processor.....119	2 drive controller, clock/cal., software
Color Graphics Card.....79	parallel, serial, and game ports.....79
Monochrome Graphics Card.....99	1200 Baud Internal Modem w/Software 179

Don't Get Caught with your Zipper down!



\$359

Buy The ECLIPSE 2400 Modem

- Hayes & Bell 212A/103 Compatible
- CCITT V.22, V.22 bis (European standard compatible)
- Industry Standard AT Command Set
- Voice Data Switching
- RS 232C Interface
- Auto Baud Rate Selection (0-300,600,1200,2400)
- Full/Half Duplex
- Auto Answer/Auto Dial
- Speaker Volume Control
- External Status Indicators

The ECLIPSE 2400 modem is a microprocessor-based full or half-duplex modem incorporating the latest in high speed data communications capabilities. It also accommodates computers and terminals equipped with an RS-232 port allowing communication with other computers or timesharing systems either locally or remotely. Compatibility, Versatility and Performance are yours in a configuration designed to provide years of reliable operation.

NOW YOUR COMPUTER CAN READ!!

Omni-Reader... the first optical character reader designed and priced for the small computer

\$179

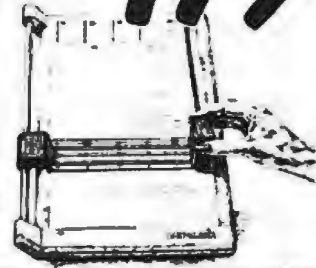

- COPY:**
- Manuscripts
 - Contracts
 - Articles
 - Forms
 - Invoices
- APPLICATIONS:**
- Mailing Lists
 - Editing
 - Data Base Management
 - Transferring Information between incompatible systems

Uses a standard RS-232 serial port hookup to interface easily with your computer.

1200 BAUD MODEMS

AVATEX 1200

\$99



This 300/1200 baud modem matches the design specs of the Bell 212A feature by feature, bringing you reliability, impeccable transmission and easy operation. Hayes Compatible except for S register Communication software included. The AVATEX 1200, at \$99, is a steal!

SMARTTEAM 1200

\$189



The Team 212A offers all the features of the Hayes Smart Modem 1200 for a fraction of the price. Now is your opportunity to purchase a 1200 baud modem at the price of a 300 baud modem.

SIGNALMAN MARK VI 300 BAUD

\$49



The Anchor Automation Mark VI is a 300 baud direct connect modem that plugs into any slot of your IBM PC. This modem supports auto answer and auto dial capabilities. Other features include telephone number storage, send / receive text files, single key-stroke dialing along with many other functions provided on disk. The Mark VI was originally priced at over \$300.

UltraLink 1200

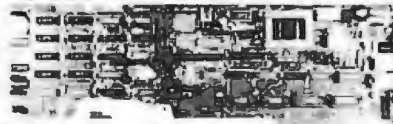

The UltraLink is a 1200 baud HALF DUPLEX bell 202 compatible internal modem card for the IBM/PC. This unit operates full duplex at 300 baud.

The UltraLink adds a voice/data demodulation to your PC. Manufacturers original suggested price on this modem is \$795. California Digital's price is only \$99.

\$99

MODEMS

Eclipse 1200 100% Hayes, with status lamp	ECP-1200	179 00
Eclipse 1200B internal with software	ECP-1200B	179 00
Hayes Smartmodem 2400 baud modem	HYB-2400	599 00
Fujitsu 2400/1200 baud auto everything	FUJ-1035D	499 00
Team 1200 Hayes Compatible, 300/1200 baud	TEAM-SM1200	189 00
UltraLink 1200 data and voice on same line	UTL-1200A	99 00
CTS 212AH 1200 baud, auto dial	CTS-212AH	219 00
Terminal software for CTS 212AH	CTS-212SFT	35 00
Prometheus 1200 super features	PRM-P1200	299 00
Prometheus 1200B internal PC	PRM-P1200B	279 00
Signalman Mark VI, 300 baud internal PC	SGL-MK6	49 00
Hayes Smart Modem 1200 baud, auto dial	HYS-212AD	369 00
Hayes 1200B for use with the IBM/PC, 1200 baud	HYS-1200B	299 00
Hayes Smartmodem, 300 baud only, auto dial	HYS-103AD	199 00
Hayes Chronograph, time & date	HYS-CHR232	199 00

Seagate \$359

20 MEGABYTE WINCHESTER HARD DISK DRIVE

Quantity Two

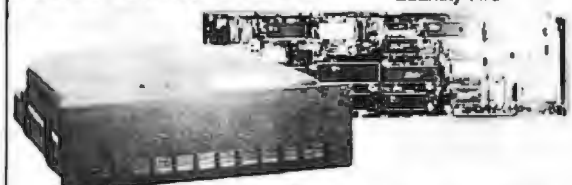

Five Inch Winchester Disk Drives

SEAGATE 225 20 Meg. 1/2 Ht.	389	359
SEAGATE 4026 26 M. 35ms.	859	829
SEAGATE 4051 51 M. 35ms.	1095	1058
FUJITSU 2242 55 M. 35ms.	1799	1720
FUJITSU 2243 86 M. 35ms.	2295	2219
RODIME RO-202E 27 Meg.	759	720
RODIME RO-203E 40 Meg.	995	950
RODIME RO-204E 53 Meg.	1259	1195
CONTROL DATA 94155-86 M.	1829	1779
MAXTOR XT1140 140 Meg.	3379	3295
HONEYWELL 85M. 27 ms.	1795	1695
TOSHIBA MK56 70 M. 30ms.	1789	1720
TANDON 502 10 Meg.	419	379

- Winchester Controllers for IBM/PC
- FALCON FT-HDC half card 189
- XEBEC 1220 with floppy controller 289
- NATIONAL COMPUTER 5004 159
- OMT 5150BX 159
- DTC 5510 half card 189
- ADAPTEC 2010A software install 189
- WESTERN DIGITAL WD/1002 189
- SCSI/SASI Winchester Controllers
- XEBEC 1410A 5 1/4" foot print 236
- OMT 20L 119
- Winchester Accessories
- Installation Kit with manual 10
- Winchester enclosure and supply 139
- Dual 20/34 cable set 25
- Switching power supply 49

TOLL FREE ORDER LINE
(800) 421-5041

TECHNICAL & CALIFORNIA
(213) 217-0500

1200 BAUD MODEM

Fully Hayes compatible, intelligent 1200 baud modems with features found on the expensive name brand modems. Also, a one year factory warranty from a reliable U.S. manufacturer. Choose either the internal Jade

1200 baud Smart-Card, including software for your IBM PC compatible; or our best selling Jade 1200 baud external modem for any computer with a serial RS-232C port. We guarantee your satisfaction.

INTERNAL
OR
EXTERNAL

\$149

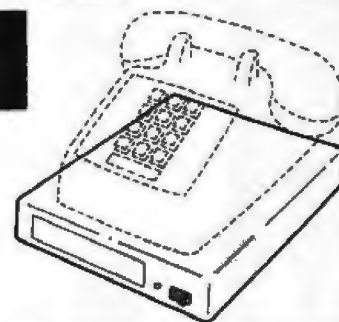

JADE XPC or XPC-AT

- 640K of RAM
- 4.77 MHz 8088
- 7 MHz turbo mode
- 135 watt power supply
- 360K disk drive
- Floppy disk controller
- 5151-style keyboard
- 8 expansion slots
- PC-style case
- 90 day warranty



\$788

- 1 MB of RAM
- 6 MHz 80286
- 8 MHz turbo mode
- 200 watt power supply
- 1.2 MB disk drive
- Floppy/hard disk controller
- AT-style keyboard
- 8 expansion slots
- AT-style case
- 90 day warranty

\$1988

OPTION #1
Two disk drives
Mono graphics card
Parallel printer port
Amdk 310A monitor

XPC XPC-AT
\$1188 \$2488

OPTION #2
20 MB hard disk
Mono graphics card
Parallel printer port
PGS MAX-12E monitor

XPC XPC-AT
\$1588 \$2888

OPTION #3
20 MB hard disk
Color graphics card
Parallel printer port
Magnavox hi-res color monitor

XPC XPC-AT
\$1788 \$3088

STAR GEMINI 10-X

\$179⁹⁵

GEMINI 15X
15" wide carriage

\$289⁹⁵

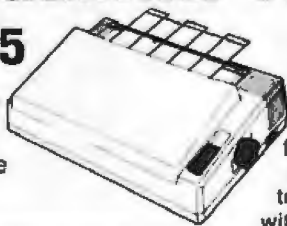

Limited quantity

120 cps,
friction and
adjustable
tractor feed
with graphics



MANNESMANN TALLY PIXY 3 3-PEN PLOTTER

\$198

LIST PRICE \$799
YOU SAVE OVER \$600!

Limited Quantity

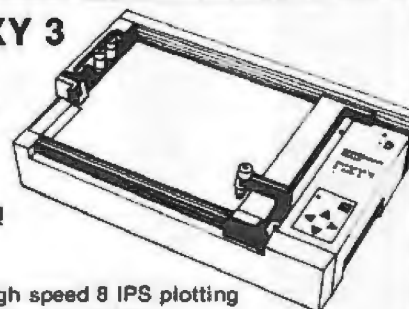

We're probably making a mistake selling this high speed plotter for only \$198. They are easily worth at least \$500 more. Compare the features to plotters costing \$2000 or more.

- High speed 8 IPS plotting
- 3-pen auto select
- 8 colors available
- Serial interface
- Full graphics + built-in fonts
- 8½ x 11 paper or transparencies

	LIST	SALE
8 extra water base pens	\$30	\$16 ⁹⁵
4 extra oil base pens	\$30	\$16 ⁹⁵
100 sheets 8½ x 11 paper	\$9	\$4 ⁹⁵
50 sheets 8½ x 11 transparencies	\$9	\$4 ⁹⁵
Plotter software for IBM PC	\$195	\$59 ⁹⁵

Why pay \$1149 for a C. Itoh STARWRITER F-10

when our 40 cps letter quality daisywheel from the same manufacturer is only as low as

\$399⁹⁵

Each for
5 or more

Each—\$499 | 2 to 5—\$429

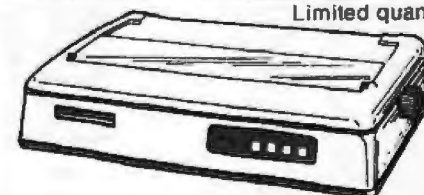

Limited quantity

Bi-directional deluxe tractor —\$249 \$149⁹⁵
Automatic cut sheet feeder —\$449 \$199⁹⁵

**StarWriter is a Trademark of C. Itoh Digital Products, Inc.

HARD DISK SYSTEM

FOR YOUR
IBM PC

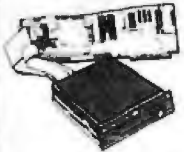

\$399⁹⁵

Complete with controller card, data cable, and mounting hardware, totally PC/XT compatible.

	LIST	JADE
10 MB Internal KII _____	\$890	\$399. ⁹⁵
20 MB Internal 1/2 High _____	\$1550	\$445. ⁹⁵

POWER/SURGE PROTECTION

6 Button, Under-Monitor, Swivel
Power/Surge Control Center

\$79⁹⁵

List Price \$129



6 Socket, UL Listed, U.S. Made
Power/Surge Strip

\$18⁹⁵

List Price \$49

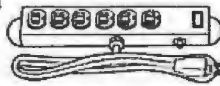

360K DISK DRIVE

\$69⁹⁵

IBM PC, XT
or
Compatible

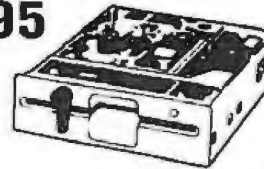

	LIST	JADE
TANDON 100-2, DS, DD _____	\$299	\$119. ⁹⁵
TEAC 55B, DS, DD _____	\$249	\$119. ⁹⁵

20 MEGABYTE HARD- CARD **\$599**

- Uses only one slot
- 21.3 MB formatted capacity
- Low power - only 11 watts
- Installs in just minutes
- Works w/standard power supply

80 COLUMN PC PRINTER **\$98**

CALL FOR DETAILS!

FREE Software W/ MOUSE

	LIST	JADE
Microsoft Mouse w/Paintbrush _____	\$199	\$139. ⁹⁵
PC Mouse w/PC Paint Plus _____	\$195	\$139. ⁹⁵

High Speed APU Chips

8087-3 _____	\$149. ⁹⁵	80287 _____	\$249. ⁹⁵
8087-2 _____	\$199. ⁹⁵	NEC V-20 _____	\$24. ⁹⁵

AST Boards On Sale!

	LIST	JADE
AST Six Pak Plus 64K _____	\$395	\$229. ⁹⁵
AST Six Pak Plus 384K _____	\$945	\$279. ⁹⁵
AST Rampage 256K _____	\$485	\$379. ⁹⁵
AST Rampage 2 MB _____	\$1995	\$679. ⁹⁵
AST Advantage-AT 128K _____	\$595	\$399. ⁹⁵
AST Advantage-AT 3 MB _____	\$4145	\$999. ⁹⁵

ISO-BAR

These industrial quality ISO-BAR's contain surge suppression circuitry and built-in noise filters plus a 15 amp circuit breaker.

6 Socket, 1 Filter ISO-BAR _____	\$69	\$44. ⁹⁵
4 Socket, 2 Filter ISO-BAR _____	\$69	\$59. ⁹⁵
8 Socket, 4 Filter ISO-BAR _____	\$99	\$69. ⁹⁵
200 Watt Standby Power Supply _____	\$359	\$269. ⁹⁵
425 Watt Standby Power Supply _____	\$539	\$449. ⁹⁵

MICROFAZER Buffers

Expandable to 64K (Parallel model to 512K)

8K Parallel in/Parallel out _____	\$169	\$139. ⁹⁵
64K Parallel in/Parallel out _____	\$225	\$184. ⁹⁵
128K Parallel in/Parallel out _____	\$445	\$269. ⁹⁵
512K Parallel in/Parallel out _____	\$879	\$499. ⁹⁵

Your choice: serial in/serial out; parallel in/serial out; serial in/parallel out.

8K _____	\$199	\$169. ⁹⁵	64K _____	\$260	\$199. ⁹⁵
----------	-------	----------------------	-----------	-------	----------------------

TALLTREE

JRAM-2 OK _____	\$169. ⁹⁵	JRAM 3-AT OK _____	\$259. ⁹⁵
2 MB _____	\$599. ⁹⁵	2 MB _____	\$699. ⁹⁵
JRAM-3 OK _____	\$199. ⁹⁵	Add-on Modules S/P/C _____	\$159. ⁹⁵
2 MB _____	\$629. ⁹⁵	S/S/C _____	\$159. ⁹⁵

Printers

EPSON FX-85	OKIDATA
EPSON FX-286	TOSHIBA
EPSON LQ-800	CITIZEN
EPSON LQ-1000	C. ITOH
EPSON LX-80	DIABLO

PRICED TOO LOW TO PUBLISH!
Call us for our best price.

New HAYES 2400B Internal

	LIST	JADE
New 2400B Card w/Smartcom _____	\$799	\$579. ⁹⁵
HAYES Smartmodem 2400 _____	\$899	\$629. ⁹⁵
HAYES Smartmodem 1200 _____	\$699	\$389. ⁹⁵
HAYES 1200B w/o Smartcom II _____	\$539	\$339. ⁹⁵
HAYES 1200B for IBM PC _____	\$599	\$359. ⁹⁵

Multifunction Card

Up to 384K, parallel printer port, RS-232 serial port, game port, clock/calendar, RAM disk/printer buffer software package.

	LIST	JADE
OK JADE 7 Pak Plus _____	\$299	\$119. ⁹⁵
384K JADE 7 Pak Plus _____	\$649	\$199. ⁹⁵

135/150 Watt Power Supply

135 Watt Power Supply _____	\$199	\$89. ⁹⁵
150 Watt Power Supply _____	\$249	\$99. ⁹⁵

Apple Accessories

	LIST	JADE
IIc 1/2 High Disk Drive _____	\$279	\$119. ⁹⁵
IIe 1/2 High Disk Drive _____	\$239	\$119. ⁹⁵
IIe, II+ Disk Drive Full Ht. _____	\$249	\$139. ⁹⁵
IIe 64K, 80 Column Card _____	\$159	\$79. ⁹⁵
Grappler Printer Card _____	\$175	\$89. ⁹⁵
II+ 16K RAM Card _____	\$99	\$39. ⁹⁵
II+, IIe Printer Card & Cable _____	\$109	\$49. ⁹⁵
II+, IIe Cooling Fan _____	\$89	\$59. ⁹⁵

INTEL Above Board

64K PC expands to 2MB _____	\$299. ⁹⁵
2MB PC Above Board _____	\$599. ⁹⁵
128K AT expands to 4MB _____	\$449. ⁹⁵
4 MB AT Above Board _____	\$1299. ⁹⁵

IBM Video Boards

	LIST	JADE
Hercules Color Graphics _____	\$245	\$189. ⁹⁵
JADE Color Graphics _____	\$199	\$99. ⁹⁵
Hercules Monochrome Graphics _____	\$499	\$339. ⁹⁵
JADE Monochrome Graphics _____	\$299	\$119. ⁹⁵
JADE EGA+ Card _____	\$495	\$389. ⁹⁵

JADE COMPUTER

4901 W. Rosecrans Ave. Box 5046
Hawthorne, CA 90251-5046

We accept cash, checks, credit cards or purchase orders from qualified firms and institutions. Minimum prepaid order \$15.00. California residents add 6 1/2% tax. Prices & availability subject to change without notice. Shipping & handling charges via UPS Ground 50¢/lb. UPS Air \$1.00/lb. Minimum charge \$3.00.



PLACE
ORDERS
TOLL
FREE!

Continental U.S.A.
(800)421-5500
Inside California
(800)262-1710
Los Angeles Area
(213)973-7707

FREE CATALOG



Outstanding prices on computer accessories for your computer and workstation. Our catalog features a wide selection of quality products to meet all your accessory needs. Call or write today to receive your free catalog.

LINTEK COMPUTER ACCESSORIES
POB 8056, Grand Rapids, MI 49518
(616) 241-4040

Inquiry 207

Share A Serial Printer or Modem without Switching

\$44.95
Each

Model
232PDS
(Printer)

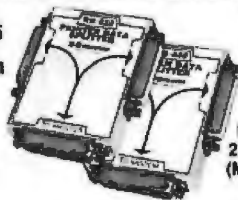

Model
232MDS
(Modem)

Both computers or terminals remain connected at same time. Both view same data. No power required. Data lines isolated by passive OR gates. Order Now! \$44.95 each. Specify unit desired. All cash orders ppd. (IL Res. add 6% sales tax), MC, VISA accepted. FREE: new illustrated catalog of RS-232 interface & testing equipment. Phone: 815-434-0846. Make checks payable to:

B&B electronics
MANUFACTURING COMPANY
1500B BOYCE, OTTAWA, IL 61350

Inquiry 33

The Bullet-286 XT



Better than the AT

FASTER—8 MHz, 80286 processor (10 MHz optional), no wait states, scores a 9.2 in Norton's Sys Info 3.0 (10 MHz scores an 11.4)
MORE COMPATIBLE—100% BIOS and bus compatible with the IBM PC XT, completely network and multiuser compatible including Xenix, Thoroughbred, concurrent DOS and more
HIGHER CAPACITY—20 to 70 MB hard disk drives, including new RPL format drives
LESS MONEY—System prices start at under \$1700 without monitor

Marchand International
1240 N. Van Buren, Unit 100, Anaheim CA 92807
(714) 630-3382
PC approved

Inquiry 219

Displayphone

\$295

(85% off original list price)



THE
#1 SELLING
TELEPHONE/TERMINAL!

These lease returns are all in 1st class condition
It's a 2-line phone.
It's a Speakerphone.
It's an 81# Auto-dialer.
It's an ASCII Video Terminal
It has a 300 BPS Modem
It shows date & time.
It times your call.
It has reminder service
Send your check for \$295 plus \$15 for shipping and we will ship within 2 days!
We have been in business 18 years.

COMPUTER WAREHOUSE STORE
P.O. 68 - Kenmore Station
Boston, MA 02215
617/437-1100

Inquiry 22

Protect Your Private Parts.

Whether you're a software developer or an end user, whether you work alone on a PC or you're part of a 24-person project team, keeping new software or sensitive data from prying eyes is serious business.

Short of complicated, wizard-like protection schemes, or James Bond, you haven't had too many realistic alternatives. Until now. Because Rainbow Technologies has developed simple, easy-to-use systems called Sentinels that say no to prying eyes. No matter how hard they look.

The key to Sentinel is just

that—a smart piece of plastic smaller than a best-selling cassette that plugs into the parallel port of your IBM PC/XT/AT or compatible.

There are two ways to go. The Software Sentinel™ that prevents anyone from using your licensed software program unless you give them a key. And the Data Sentinel™, Rainbow Technologies' newest prying eye-stopper, that automatically protects sensitive personal or project data as you enter it. The Sentinel Security Systems from Rainbow Technologies. The only hard part is the key.



RAINBOW TECHNOLOGIES
1771 SkyPark Circle, Suite B, Irvine, CA 92714
Phone (714) 264-0228 Telex: 386008

Inquiry 298

FREE SOFTWARE FROM THE PUBLIC DOMAIN

User Group Software isn't copyrighted, so no fees to pay! 1000's of CP/M and IBM software programs in .COM and source code to copy yourself! Games, business, utilities! All FREE!

	Rent	Buy
IBMPC-SIG 1-458 Diskettes	460.	845.
IBMPC-BLUE 1-187 Diskettes	190.	345.
SIG/M UG 1-246 Diskettes	160.	550.
CP/M UG 1-92 Diskettes	45.	250.
PICO NET 1-34 Diskettes	25.	100.
KAYPRO UG 1-80 Diskettes	70.	210.
EPSON UG 1-58 Diskettes	70.	230.
Commodore CBM 1-102 Diskettes ..	100.	200.

Public Domain User Group Catalog Disk \$5 pp. (payment in advance, please, and specify format!) Rental is for 7 days after receipt, 3 days grace to return. Use a credit card, no disk deposit.

Shipping, handling & insurance \$9.50 per library.
(619) 749-7534 Orders & Technical (9 to 5)
(619) 727-1015 24 Hr. 3 Min. Info Recording
Have your credit card ready!

National Public Domain Software

1533 Avohill Dr.
Vista, CA 92083

1-800-521-5640
then dial
782-642

BBB



Inquiry 255

ROMDISK

EPROM AND RAM DISK AND DRIVE EMULATORS

For the IBM PC* and Compatibles

APPLICATIONS

- Deskless control and communications systems
- Dedicated workstations - customized smart terminals
- Industrial control and manufacturing test systems

FEATURES

- Solid state speed, reliability and performance
- Self contained EPROM programming circuitry (simply copy a Master Disk to ROMDISK)
- Emulates a 9 sector, 40 track 5.25 or 8.00 diskette
- Compatible EPROM, Dynamic RAM and Static RAM versions
- Two autoboot modes and a file mode
- RAMdisk versions are battery backed up
- I/O mapped - does not occupy system RAM space

EPROM version PCA-1 (180K)	\$495
EPROM version PCA-2 (360K)	\$595
Dynamic RAM version PC DRAM-1 (180K)	\$495
Dynamic RAM version PC DRAM-2 (360K)	\$595
Static RAM version PC SRAM-1 (180K)	\$695
Static RAM version PC SRAM-2 (360K)	\$995



CURTIS, INC. 22 Red Fox Road
St. Paul, MN 55110 612/484-5064

*IBM PC is a registered trademark of IBM Corporation

Inquiry 103

GFK MEMORIES

ADD-IN BOARDS PIN-FOR-PIN COMPATIBLE EASY INSTALLATION

HP 150
HP 1000
HP 3000
WANG PC

GFK

Amendastr. 60, 2000 Hamburg 6
West Germany

Phone (40) 4301051 Telex 2162272

Dealers are invited

US Distributor:
HyPoint Technology [216] 526-0323

Inquiry 410

PROF JONES
1840 W. STATE ST.
BOISE, IDAHO 83732
ORDER LINE
(208) 342-6939

PROFESSIONAL HANDICAPPING SYSTEMS

PROFESSIONAL SERIES™ (Throughbred/Grayhound/Pointer) — The all new Professional Series™ represents the most advanced handicapping software available

Analyze Module™ — Complete bet analysis highlights the basic Professional Series™ module. For 10 Macintoshes \$249.95

Factor Value/Multiple Regression Module™ — Factor Value Weighting highlights the advanced module™ \$199.95

Data Base Manager Module™ — Automatic storage of up to 11 years highlights the module (288KB) over Factor Value Module \$149.95

GOLD EDITION™ (Throughbred/Grayhound/Pointer) — The classic Gold Edition™ from Prof Jones offers weekly results and odds of odds

Gold Edition™ \$149.95

Enhanced Gold Edition™ \$199.95

Limited Gold Edition™ \$149.95

Ultim Edition™ \$299.95

Professional Pickle Packer™ — 30000 with automatic power (except \$149.95 Professional Series™ \$199.95)

Expanded Lottery/Lotto Analysis™ — Lottery 3-4 digit \$79.95. Lotto max of 99 digits \$99.95. Enhanced Lottery/Lotto \$129.95

Handicapper's Bulletin Board and VHS Training Tapes now available

Special: Free shipping on software. Add \$6.00 COD. \$6.00 UPS (Sun - Sat. Out of country / ID residents add 5% / 3 states personal clients / cash price only add 2% / Post. INC. 64952. Prices subject to change

FREE CATALOG

Inquiry 285

PORTABLE ADDITIONS

PORTABLE DISK DRIVE \$229
3 1/2", batt. oper., TS-DOS, 100K storage

24K RAM CHIP for Tandy 200 \$89

8K RAM CHIP for Model-100 \$29
and NEC 8201. . . 3 for \$72, 6 for \$149

SIDESTAR for NEC Starlet \$399
128K Ram Disk Cartridge

SIDECAR for NEC PC-8201A \$259
4 banks of 32K in one cartridge

CALL TOLL FREE 1-800-732-5012

Call: 805-987-4788
Canada: 604-856-8858, Australia: 02-419-8899

PURPLE COMPUTING VISA/MC & AMER. EXP.
420 Constitution Ave., Camarillo, CA 93010

Inquiry 288

64K ■ 128K ■ 256K DRAMS

80287-8 ■ 80287-3
8087-3 ■ 8087-2
8087-1

BITTNER
3E
ELECTRONICS

899 SOUTH COAST HIGHWAY
LAGUNA BEACH, CA 92651
(714) 497-6200
CALL NOW FOR **FREE CATALOG**

Inquiry 39

IBM PC/VT220

EM220 \$149

- VT220, VT102 emulation
- File Transfer
- 132 Column modes
- Color Support
- Hot Key

TEK 4010/4014

EM4010 \$249

- Tektronix 4010 emulation
- VT220, VT102 emulation
- Picture files
- High resolution hardcopy
- Supports IBM, IBM Enhanced, Hercules, Teemar and AT&T.

Diversified Computer Systems, Inc.

7775 Iris Ave., Suite 1B
Boulder, CO 80301
(303) 447-9251
Telex 9103800693 DCSINC

Trademark: VTR8 — Digital Equipment; IBM PC, XT — IBM Corp.

Inquiry 122

IF YOU USE A COMPUTER YOU CAN USE

UNIT CONVERSIONS™

NOW ONLY **\$49.95**

IBM PC/XT/AT and Apple IIe/IIc/IIx — Compatible
Virtually ALL the conversions you will ever need!

UNIVERSAL UNCHANGING PRECISE

Feet to metres, kilowatts to horsepower,
light years to angstroms and 3,561 MORE!

TO ORDER: see your local software dealer or
call toll free 24 hours a day
1-800-356-5324 (ext 1328)
WI or outside USA: 608-257-6618
VISA, MasterCard, or C.O.D. Welcome

ALL ORDERS SHIPPED WITHIN 48 HRS. OF RECEIPT
SHIPPING PAID BY ICI FOR USA ORDERS

Outside USA: add \$10.00 shipping and handling,
pay in U.S. dollars (No C.O.D.)

ICI INTERNATIONAL COMPUTING, INC.
1501 Monroe, Madison, WI 53711 USA
The Quiet Star in Software

Inquiry 182

1-800-826-0843

THE COMPUTER BARN

Super Low Prices on Micro Computers and Accessories...

WYSE 30 \$ 330	TeleVideo 905 \$ 285
WYSE 50 408	TeleVideo 9220 465
WYSE 75 539	Canon Laser 8A1 2195
WYSE PC 1158	Canon A40 245
WYSE 85 439	Diablo 635 1095
Compaq Port 2100	Compaq DeskPro2
IBM PC 1660	

WY-500 (Green Mono) \$ 160
IBM XT w/10MB 3295
IBM AT w/20MB 5095

CASE/RIXON, ARK PARADYNE, PRENTICE, Modems. Complete line of Canon, Diablo, Datasouth Printers. Many other Products.

CALL FOR FREE BROCHURE

Inquiry 409

If you paid more for Chips,
you didn't buy them at:

MicroTech

(206) 384-2209, 8 - 6 Mon.-Sat.
P.O. Box 27083, Seattle, WA 98125

RAMS

256K	150 ns	2.75
256K	120 ns	3.25
64K	150 ns	1.20
64K	120 ns	1.35
6264LP-15	150 ns	3.15

EPROMS

2764	250 ns	3.35
2764	200 ns	3.75
27128	250 ns	3.65
27256	250 ns	5.25

PROCESSORS

C8087-2	8MHz	150.00
C8087	5MHz	125.00
V-20	8MHz	14.00

Prices shown for cash. Master Card/VISA add 3%. Prices subject to change. Call for current prices & volume discounts. Shipping & handling UPS ground \$2.00. Wash residents add 2% sales tax. Satisfaction guaranteed.

Inquiry 244

5 1/4" 3M FLEXYDISKS

Free headcleaner in each box. 5 1/4" only.

	10-90	100+
SS/DD Soft	\$.86 ea	\$.84 ea
DS/DD Soft	\$1.21 ea	\$1.18 ea
High Density (IBM-AT)	\$2.49 ea	\$2.47 ea
3.5/SS Micro	\$1.85 ea	\$1.80 ea

In Stock — Immediate Shipment.
Mastercard, VISA, Check or Money Order.
Add \$3.00 shipping charges per each 100 or part.
Add \$2.50 additional for C.O.D. shipments.
N.J. residents add 6% sales tax.

Data Exchange
Dept. B, PO Box 993
178 Route 206 South
Somerville, N.J. 08876
(201) 874-5050

Inquiry 107

Printer (Data) switch \$45.00
Distributors, Dealers welcome



- Metal case, fully shielded
- Push button switch
- 2 layer PC board
- 1 year warranty
- Dimension 1" x 4 1/2" x 8 1/2"
- All pin switched
- Color badge

Switch box DS 25Castronic	PS-232 Miniature	\$7
2-way switch (both battery)	Dynamic Changer Mini. P/P	\$10
2-way cross (battery)	Roll Mamm	\$10
4-way switch (battery)	Jumper box Surge-protector	\$10
	Mini-adapter Mini-switch box	\$15

Cable
Model: Standard UL cable 512 and up

30 Day Money Back Guarantee
Returns Shipping & handling \$3.00. C.O.D. add \$1.00.
California residents add sales tax.

JACO ENTERPRISES
1478 POPPY WAY, CUPERTINO, CA 95014
(408) 896-0675

Inquiry 185

THE LATEST IN PC ENHANCEMENT PRODUCTS

ENHANCED GRAPHICS ADAPTOR \$295.00

100% IBM COMPATIBLE—PASSES IBM EGA DIAGNOSTICS

- COMPATIBLE WITH IBM EGA, COLOR GRAPHICS ADAPTOR AND MONOCHROME ADAPTOR
- DISPLAYS 16 COLORS OUT OF 64 COLORS
- COMES WITH 256K OF VIDEO RAM
- DUAL SCANNING FREQUENCIES—WORKS WITH STANDARD OR EGA TYPE RGB MONITORS
- LIGHT PEN INTERFACE



EXPANDED MEMORY CARD \$199.95

UP TO 2 MEGABYTES OF LOTUS/INTEL COMPATIBLE MEMORY

- CONFORMS TO LOTUS/INTEL EXPANDED MEMORY SPECIFICATIONS (EMS)
- SHIPPED WITH ZERO K RAM, USER EXPANDABLE TO 2 MEGABYTES
- USES 64K OR 256K DYNAMIC RAMS
- USE AS EXTENDED (EMS) OR CONVENTIONAL MEMORY, RAMDISK OR SPOOLER
- SOFTWARE INCLUDES EMS DEVICE DRIVERS, PRINT SPOOLER AND RAMDISK

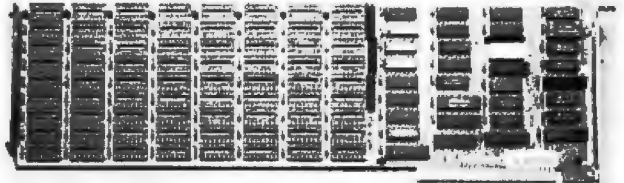

AT MULTIFUNCTION CARD \$199.95

ADDS UP TO 3 MEGABYTES OF USER EXPANDABLE MEMORY

- SHIPPED WITH ZERO K RAM, USER EXPANDABLE TO 1.5 MEGABYTES RAM ON BOARD, UP TO 3 MEGABYTES WITH OPTIONAL PIGGYBACK CARD
- USES 64K OR 256K DYNAMIC RAMS
- PARALLEL PORT & GAME PORT
- SERIAL PORT
- OPTIONAL SECOND SERIAL PORT

PIGGYBACK MEMORY CARD (NO MEMORY INSTALLED) \$49.95

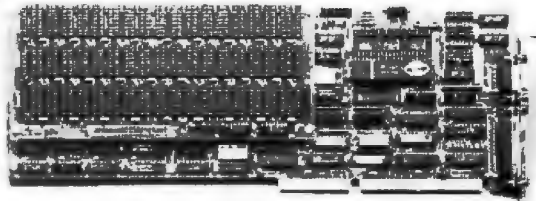

CLASSIC 286 SPEED PAK \$795.00

8 MHz 80286 ACCELERATOR BOARD FOR IBM PC/XT

- 8MHz 80286 RUNS 33% FASTER THAN A STANDARD AT
- RUNS AT PROGRAMS—COMPATIBLE WITH DOS 2.1, 3.0 & 3.1
- COMPATIBLE WITH ALL PC/XT HARDWARE & SOFTWARE WITH NO PATCHES OR MODIFICATIONS NEEDED
- 1 MEGABYTE MEMORY ON BOARD, EXPANDABLE TO 16MB
- HIGH SPEED 16-BIT BIOS AND RAM
- OPTIONS INCLUDE 80287 MATH CO-PROCESSOR, MULTITASKING SUPPORT AND MULTIUSER SUPPORT

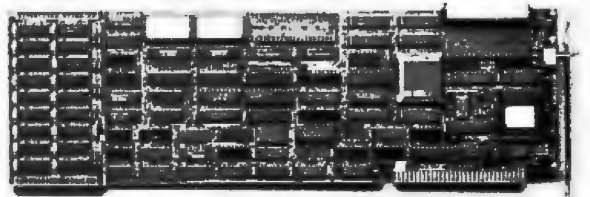

EPROM PROGRAMMER \$129.95

FOR IBM PC/XT/AT AND COMPATIBLES

- PROGRAMS 27xxx SERIES EPROMS UP TO 27512
- MENU DRIVEN SOFTWARE PROVIDED ON DISKETTE
- AUTOMATICALLY SETS PROGRAMMING VOLTAGE
- LOADS AND SAVES EPROM BUFFER TO DISK
- READ, WRITE, COPY, VERIFY OR CHECK BLANK
- DEBUG STYLE EDITOR FOR EASY MODIFICATION OF PROGRAM
- SPLITS OR COMBINES EPROMS OF DIFFERING SIZES
- INTERNAL CARD WITH EXTERNAL ZIF SOCKET MODULE

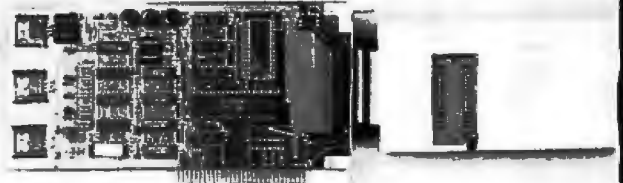

VISIT OUR RETAIL STORE LOCATED AT 1256 SOUTH BASCOM AVENUE IN SAN JOSE



JDR Microdevices

1224 S. Bascom Avenue, San Jose, CA 95128

Toll Free 800-538-5000 • (408) 995-5430

FAX (408) 275-8415 • Telex 171-110

© COPYRIGHT 1986 JDR MICRODEVICES

THE JDR MICRODEVICES LOGO IS A REGISTERED TRADEMARK OF JDR MICRODEVICES. JDR INSTRUMENTS AND JDR MICRODEVICES ARE TRADEMARKS OF JDR MICRODEVICES. IBM IS A TRADEMARK OF INTERNATIONAL BUSINESS MACHINES.

HOURS: M-W-F, 9-6

TU-TH, 9-9

SAT, 9-5

PLEASE USE YOUR CUSTOMER NUMBER WHEN ORDERING

TERMS: Minimum order \$10.00. For shipping and handling include \$2.50 for UPS Ground and \$3.50 for UPS Air. Orders over 1 lb. and foreign orders may require additional shipping charges - please contact our sales department for the amount. CA residents must include applicable sales tax. All merchandise is warranted for 90 days unless otherwise stated. Prices are subject to change without notice. We are not responsible for typographical errors. We reserve the right to limit quantities and to substitute manufacturer. All merchandise subject to prior sale.

BUILD A COMPLETE 256K XT SYSTEM—\$717

STATIC RAMS

2101	256x4	(450ns)	1.95
5101	256x4	(450ns)(CMOS)	3.95
2102L-4	1024x1	(450ns)(LP)	1.95
2112	256x4	(450ns)	2.99
2114	1024x4	(450ns)	.99
2114L-4	1024x4	(450ns)(LP)	1.09
2114L-2	1024x4	(200ns)(LP)	1.49
2114L-15	1024x4	(150ns)(LP)	1.95
TMS4044-4	4096x1	(450ns)	1.95
TMM2015-150	2048x8	(150ns)	1.49
TMM2015-100	2048x8	(100ns)	1.95
HME116-4	2048x8	(200ns)(CMOS)	1.39
HME116-3	2048x8	(150ns)(CMOS)	1.49
HME116LP-4	2048x8	(200ns)(CMOS)(LP)	1.49
HME116LP-3	2048x8	(150ns)(CMOS)(LP)	1.59
HME116LP-2	2048x8	(120ns)(CMOS)(LP)	2.95
HME284P-15	8192x8	(150ns)(CMOS)	3.83
HME284LP-15	8192x8	(150ns)(CMOS)(LP)	3.95
HME284LP-12	8192x8	(120ns)(CMOS)(LP)	4.49

LP—Low power

DYNAMIC RAMS

4116-250	16384x1	(250ns)	.49
4116-200	16384x1	(200ns)	.49
4116-150	16384x1	(150ns)	.49
4116-100	16384x1	(100ns)	1.49
MK4332	32768x1	(200ns)	6.95
4164-200	65536x1	(200ns)(5v)	1.19
4164-150	65536x1	(150ns)(5v)	1.29
4164-120	65536x1	(120ns)(5v)	1.99
MCM6665	65536x1	(200ns)(5v)	1.95
TMS4164	65536x1	(150ns)(5v)	1.95
4164-REFRESH	65536x1	(150ns)(5v)(REFRESH)	2.99
TMS416	16384x4	(150ns)(5v)	4.85
41126-150	131072x1	(150ns)(5v)	6.95
TMS4464-15	65536x4	(150ns)(5v)	6.95
41256-200	262144x1	(200ns)(5v)	2.99
41256-150	262144x1	(150ns)(5v)	2.95

5v—Single 5 Volt Supply

REFRESH—Pin 1 Refresh

★★★★HIGH-TECH★★★★

NEC V20 UPD70108 \$1495

REPLACES 8088 TO SPEED UP IBM PC 16-40%

- HIGH-SPEED ADDRESS CALCULATION IN HARDWARE
- PIN COMPATIBLE WITH 8088
- SUPERSET OF 8088 INSTRUCTION SET
- LOW POWER CMOS

8MHz V20 UPD70108-8 \$24.95

8MHz V30 UPD70118-8 \$26.95

★★★★SPOTLIGHT★★★★

EPROMS

2708	1024x8	(450ns)	3.95
2716	2048x8	(450ns)(5V)	3.49
2716-1	2048x8	(350ns)(5V)	3.95
TMS2532	4096x8	(450ns)(5V)	3.95
2732	4096x8	(450ns)(5V)	3.89
2732A	4096x8	(250ns)(5V)(21V PGM)	3.99
2732A-2	4096x8	(200ns)(5V)(21V PGM)	4.25
27C64	8192x8	(250ns)(5V)(CMOS)	6.95
2764	8192x8	(450ns)(5V)	3.49
2764-250	8192x8	(250ns)(5V)	3.95
2764-200	8192x8	(200ns)(5V)	4.25
MCM68766	8192x8	(350ns)(5V)(24 PIN)	17.95
27128	16384x8	(250ns)(5V)	4.25
27C256	32768x8	(250ns)(5V)(CMOS)	12.95
27256	32768x8	(250ns)(5V)	7.49

5V—Single 5 Volt Supply

21V PGM—Program at 21 Volts

ORDER TOLL FREE 800-538-5000



SPECTRONICS CORPORATION EPROM ERASERS



Model	Timer	Capacity Chp	Intensity (uW/cm ²)	Unit Price
PE 14	NO	9	8,000	\$83.00
PE-14T	YES	9	8,000	\$119.00
PE-24T	YES	12	9,600	\$175.00

8000

8035	1.49
8039	1.95
8080	2.95
8085	2.49
8087-2	169.95
8087	129.00
8088	6.95
8088-2	9.95
8155	2.49
8155-2	3.95
8748	7.95
8755	19.95
80286	129.95
80287	199.95

6500

6502	2.79
65C02 (CMOS)	12.95
6507	9.95
6520	1.95
6522	4.95
6526	26.95
6532	6.95
6545	6.95
6551	5.95
6561	19.95
6561	34.95

CRT CONTROLLERS

6845	4.95
6846	8.95
6847	11.95
HD485065P	6.95
MC1372	2.95
8275	26.95
7220	4.95
CRT5027	12.95
CRT5037	3.95
TMS9918A	19.95

CRYSTALS

32.768 KHz	95
1.0 MHz	2.95
1.8432	2.95
2.0	1.95
2.097152	1.95
2.4576	1.95
3.2768	1.95
3.579545	1.95
4.0	1.95
4.032	1.95
5.0	1.95
6.0688	1.95
6.5	1.95
6.144	1.95
6.5536	1.95
8.0	1.95
10.0	1.95
10.738635	1.95
12.0	1.95
14.31818	1.95
16.0	1.95
16.0	1.95
17.430	1.95
18.0	1.95
2793	19.95
2797	29.95
6843	19.95
8272	4.95
UPD765	4.95
MB8876	12.95
MB8877	12.95
1691	6.95
2143	6.95

CRYSTAL OSCILLATORS

1.0MHz	5.95
1.8432	5.95
2.0	5.95
2.4576	5.95
4.0	4.95
5.0688	4.95
6.0	4.95
6.144	4.95
4702	4.95
COM8116	8.95
NM5307	4.95

8200

8203	29.95
8205	3.29
8212	1.49
8216	1.49
8224	2.25
8237	4.95
8237-5	5.49
8250	6.95
8251	1.89
8251A	1.89
8253	1.89
8253-5	1.95
8255	1.89
8255-5	1.89
8259	1.95
8259-5	2.29
8272	4.95
8279	2.49
8279-5	2.95
8282	3.89
8284	2.95
8286	3.95
8288	4.95

2.0 MHz

6502A	2.95
6520A	2.95
6522A	5.95
6532A	11.95
6545A	7.95
6561A	6.95

3.0 MHz

6502B	6.95
-------	------

DISK CONTROLLERS

1771	4.95
1791	9.95
1793	9.95
1795	12.95
1797	12.95
2791	19.95
2793	19.95
2797	29.95
6843	19.95
8272	4.95
UPD765	4.95
MB8876	12.95
MB8877	12.95
1691	6.95
2143	6.95

BIT RATE GENERATORS

MC14411	9.95
BR1941	4.95
4702	9.95
COM8116	8.95
NM5307	4.95

UARTS

AVS-1013	3.95
AV3-1015	4.95
TR1602	3.95
2651	4.95
IM6402	6.95
IM6403	9.95
INS8250	6.95

MISC.

TMS99531	9.95
TMS99532	19.95
ULM2003	.79
3242	7.95
3341	4.95
MC2470	1.95
MC3480	8.95
MC3487	2.95
11C90	13.95
2513-001 UP	6.95
AVS-2376	11.95
AVS-3600 PRO	11.95

Z-80

Z80-CPU 2.5 MHz	1.69
Z80A-CPU	1.79
Z80A-CTC	1.89
Z80A-DART	5.95
Z80A-DMA	5.95
Z80A-PIO	1.89
Z80A-EIO-0	5.95
Z80A-EIO-1	5.95
Z80A-EIO-2	5.95

2.0 MHz

68800	4.95
68802	6.95
68809E	6.95
68809	6.45
68821	3.90
68845	6.75
68850	3.95
68854	7.95

SOUND CHIPS

76477	3.95
76489	8.95
SSI-263	39.95
AY3-8910	12.95
AY3-8912	12.95
SP1000	39.00

4.0 MHz

Z80B-CPU	3.75
Z80B-CTC	4.25
Z80B-PIO	4.25
Z80B-DART	14.95
Z80B-SIO-0	12.95
Z80B-SIO-2	12.95
Z8671 ZLOG	19.95

CLOCK CIRCUITS

NM5369	1.95
NM5369-EST	1.95
NM58167	12.95
NM58174	11.95
MSM5832	2.95

VISIT OUR RETAIL STORE LOCATED AT 1256 SOUTH BASCOM AVENUE IN SAN JOSE

JDR Microdevices

1224 S. Bascom Avenue, San Jose, CA 95128

Toll Free 800-538-5000 • (408) 995-5430

FAX (408) 275-8415 • Telex 171-110

© COPYRIGHT 1986 JDR MICRODEVICES

THE JDR MICRODEVICES LOGO IS A REGISTERED TRADEMARK OF JDR MICRODEVICES. JDR INSTRUMENTS AND JDR MICRODEVICES ARE TRADEMARKS OF JDR MICRODEVICES. IBM IS A TRADEMARK OF INTERNATIONAL BUSINESS MACHINES. APPLE IS A TRADEMARK OF APPLE COMPUTER.

HOURS: M-W-F, 9-6 TU-TH, 9-9 SAT, 9-5

PLEASE USE YOUR CUSTOMER NUMBER WHEN ORDERING

TERMS: Minimum order \$10.00. For shipping and handling include \$2.50 for UPS Ground and \$3.50 for UPS Air. Orders over 1 lb. and foreign orders may require additional shipping charges - please contact our sales department for the amount. CA residents must include applicable sales tax. All merchandise is warranted for 90 days unless otherwise stated. Prices are subject to change without notice. We are not responsible for typographical errors. We reserve the right to limit quantities and to substitute manufacturer. All merchandise subject to prior sale.

PARTIAL LISTING ONLY — CALL FOR A FREE CATALOG

CMOS

4001	.19	14419	4.95
4011	.19	14433	14.95
4012	.26	4503	.49
4013	.35	4511	.69
4015	.29	4516	.79
4016	.29	4516	.89
4017	.48	4522	.79
4018	.89	4527	1.95
4020	.89	4528	.79
4021	.89	4528	.79
4024	.49	4529	2.95
4025	.25	4532	1.95
4027	.39	4536	.95
4028	.65	4541	1.25
4035	.89	4553	5.79
4040	.89	4555	.75
4041	.75	4702	12.95
4042	.89	74C00	.59
4043	.85	74C14	.59
4044	.89	74C14	.59
4046	1.95	74C83	1.95
4046	.69	74C85	1.49
4047	.89	74C95	.99
4049	.29	74C150	5.75
4080	.29	74C161	2.25
4081	.89	74C161	.99
4082	.89	74C163	.99
4083	.69	74C164	1.39
4086	2.19	74C192	1.49
4086	.69	74C193	1.49
4086	.29	74C221	1.75
4086	.19	74C240	1.89
4078	.59	74C244	1.89
4077	.29	74C374	1.99
4081	.22	74C905	10.95
4085	.79	74C911	8.95
4086	.89	74C917	8.95
4093	.49	74C922	4.49
4094	2.49	74C923	4.95
14411	9.95	74C926	7.95
14412	6.95	80C97	.95

7400/8000

7400	.19	74147	2.49
7402	.19	74148	1.29
7404	.19	74150	1.35
7406	.29	74151	.55
7407	.29	74153	.55
7408	.24	74154	1.49
7410	.19	74155	.75
7411	.25	74157	.55
7414	.49	74159	1.65
7416	.25	74161	.69
7417	.25	74163	.69
7420	.19	74164	.85
7423	.29	74165	.85
7430	.19	74166	1.00
7432	.29	74175	.89
7438	.29	74177	.79
7442	.49	74178	1.15
7445	.69	74181	2.25
7447	.89	74182	.79
7476	.35	74184	2.00
7476	.34	74181	1.15
7474	.33	74192	.79
7476	.45	74194	.85
7478	.35	74196	.79
7483	.50	74197	.75
7485	.59	74199	1.35
7488	.35	74221	1.35
7489	2.15	74246	1.35
7489	.39	74247	1.25
7489	.50	74248	1.85
7493	.35	74249	1.95
7486	.55	74251	.75
7497	2.75	74265	1.35
74100	2.29	74273	1.95
74121	.29	74278	3.11
74123	.49	74367	.85
74125	.45	74348	.85
74141	.65	8368	3.95
74143	5.95	9602	1.50
74144	2.95	9837	2.95
74146	.80	98502	1.95

74S00

74500	.29	74S163	1.29
74502	.29	74S168	3.95
74503	.29	74S174	.79
74504	.29	74S175	.79
74505	.29	74S188	1.95
74508	.35	74S189	1.95
74510	.29	74S195	1.49
74515	.35	74S196	1.49
74530	.39	74S197	1.49
74532	.35	74S226	3.99
74537	.69	74S240	1.49
74538	.69	74S241	1.49
74574	.49	74S244	1.49
74585	.95	74S257	.79
74586	.65	74S253	.79
745112	.50	74S258	.95
745124	2.75	74S260	1.95
745138	.79	74S287	1.69
745140	.65	74S288	1.69
745151	.79	74S295	2.25
745163	.79	74S373	1.69
74S157	.95	74S374	1.69
74S158	.95	74S375	1.69
74S161	1.29	74S571	2.95

VOLTAGE REGULATORS

TO-220 CASE	
7806T	.49 7905T .59
7808T	.45 7908T .55
7812T	.49 7912T .59
7815T	.49 7915T .59
TO-3 CASE	
7805K	1.39 7905K 1.49
7812K	1.39 7912K 1.49
TO-93 CASE	
78L05	.45 79L05 .69
78L12	.49 79L12 1.49

OTHER VOLTAGE REGS

LM323K	6V 3A TO-3 4.79
LM328K	Adj. 5A TO-3 3.95
78M05K	5V 6A TO-3 7.95
78M12K	12V 6A TO-3 8.95
78P05K	5V 10A TO-3 14.95

LINEAR

TL066	.99	LM733	.98
TL071	.69	LM741	.29
TL072	1.09	LM747	.69
TL074	1.95	LM748	.59
TL081	.59	MC1390	1.69
TL082	.59	MC1390	1.19
TL083	1.95	MC1372	6.95
LM301	1.34	LM1414	1.89
LM309K	1.25	LM1458	.49
LM311	.59	LM1488	.49
LM311H	.89	LM1489	.49
LM317K	3.43	LM1496	.85
LM317T	.99	LM1812	6.25
LM318	1.49	LM1889	1.95
LM319	1.25	ULN2003	.79
LM320	9997900	KA2200	3.75
LM322	1.65	KR2211	2.95
LM323K	4.79	XR2240	1.95
LM324	.49	MPO2907	1.95
LM331	3.95	LM2817	1.95
LM334	1.15	CA3046	.89
LM335	1.40	CA3081	.99
LM336	1.75	CA3082	.99
LM337K	3.95	CA3086	.80
LM338K	3.95	CA3089	1.95
LM339	.59	CA3130E	.99
LM340	9997800	CA3146	1.25
LM350T	4.60	CA3160	1.19
LF263	.59	MC3470	1.85
LF356	.99	MC3480	2.95
LF357	.59	MC3487	2.95
LM358	.59	LM3900	.49
LM359	.89	LM3909	.98
LM383	1.95	LM3911	2.25
LM396	.85	LM3914	2.39
LM393	.45	MC4024	.49
LM394H	4.60	MC4044	3.59
TL494	4.20	RC4136	1.25
TL497	3.25	RC4958	.89
NE555	.29	LM13600	1.49
NE556	.45	75107	1.49
NE558	1.25	75110	1.49
NE564	1.39	75150	1.95
LM565	.95	75154	1.95
LM566	1.49	75188	1.25
LM567	.79	75189	1.25
NE570	2.95	78451	.39
NE590	2.50	78452	.39
NE592	.98	78453	.39
LM710	.76	78477	1.29
LM713	.49	78492	.79

DATA ACQ INTERFACE

ADC0800	15.55	8T28	1.29
ADC0804	3.49	8T28	1.29
ADC0809	4.49	8T35	.89
ADC0816	14.95	8T96	.89
ADC0817	9.95	8T97	.89
ADC0831	8.95	8T98	.89
DAC0800	4.49	DMB131	2.95
DAC0806	1.95	DP8304	2.29
DAC0808	2.95	DS8833	2.25
DAC1020	8.25	D88835	1.99
DAC1022	5.95	D88836	.99
NC1408L8	2.95	D88937	1.65

EDGARD CONNECTORS

100 PIN ST	5-100	125	3.95
100 PIN WW	5-100	125	4.95
62 PIN ST	IBM PC	100	1.95
50 PIN ST	APPLE	100	2.95
44 PIN ST	STD	156	1.95
44 PIN WW	STD	156	4.95

36 PIN CENTRONICS

MALE		
IDCEN36	RIBBON CABLE	6.95
CEN36	SOLDER CUP	4.95
FEMALE		
IDCEN36/F	RIBBON CABLE	7.95
CEN36/F	RT ANGLE PC MOUNT	4.95

INTERSIL

ICL7105	9.95
ICL7107	12.95
ICL7160	2.95
ICL8038	4.95
ICM7207A	5.95
ICM7208	15.95

DIP CONNECTORS

DESCRIPTION	ORDER BY	CONTACTS								
		8	14	16	18	20	22	24	28	40
HIGH RELIABILITY TOOLED ST IC SOCKETS	AUGATxxST	.62	.79	.89	1.09	1.29	1.39	1.49	1.69	2.49
HIGH RELIABILITY TOOLED WW IC SOCKETS	AUGATxxWW	1.30	1.80	2.10	2.40	2.90	2.90	3.15	3.70	5.40
COMPONENT CARRIES (DIP HEADERS)	ICCxx	.49	.59	.69	.99	.99	.99	.99	1.09	1.49
RIBBON CABLE DIP PLUGS (IDC)	IDPxx	—	.95	.95	—	—	—	1.75	—	2.85

FOR ORDERING INSTRUCTIONS SEE D-SUBMINIATURE BELOW

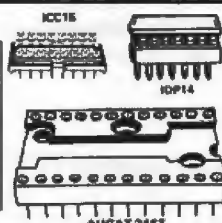

DIODES/OPTO/TRANSISTORS

1N751	.25	4N26	.69
1N759	.25	4N27	.69
1N4148	25/1.00	4N28	.69
1N4004	10/1.00	4N33	.89
1N5402	.25	4N37	1.19
KBP04	.55	MCT-2	.59
KBUBA	.98	MCT-5	1.29
MDS990-2	.35	TIL-111	.99
NZ222	.25	2N3906	.10
PN2222	.10	2N4401	.25
2N2905	.90	2N4402	.25
2N2907	.25	2N4403	.25
2N3998	.79	2N6045	1.75
2N3904	.10	TIP31	.49

D-SUBMINIATURE

DESCRIPTION	ORDER BY	CONTACTS						
		8	15	19	25	37	50	
SOLDER CUP	MALE	DBxxP	.82	.90	1.25	1.25	1.80	3.48
	FEMALE	DBxxS	.95	1.15	1.50	1.50	2.35	4.32
RIGHT ANGLE PC SOLDER	MALE	DBxxPR	1.20	1.49	—	1.95	2.65	—
	FEMALE	DBxxSR	1.29	1.55	—	2.00	2.79	—
WIRE WRAP	MALE	DBxxPWW	1.69	2.56	—	3.89	5.60	—
	FEMALE	DBxxSww	2.78	4.27	—	6.84	9.95	—
IDC RIBBON CABLE	MALE	IDBxxP	2.70	2.95	—	3.98	5.70	—
	FEMALE	IDBxxS	2.92	3.20	—	4.33	6.76	—
HOODS	METAL	MHOODxx	1.25	1.25	1.30	1.30	—	—
	GREY	MOODxx	.65	.65	—	.65	.76	.95

ORDERING INSTRUCTIONS: INSERT THE NUMBER OF CONTACTS IN THE POSITION MARKED "x" OF THE "ORDER BY" PART NUMBER LISTED

EXAMPLE: A 15 PIN RIGHT ANGLE MALE PC SOLDER WOULD BE DB15PR

MOUNTING HARDWARE \$1.00

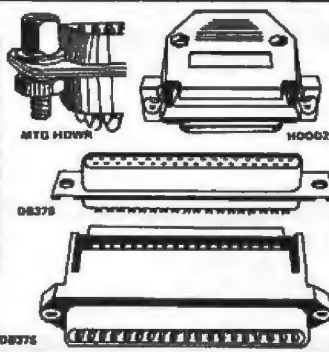

IDC CONNECTORS

DESCRIPTION	ORDER BY	CONTACTS					
		10	20	26	34	40	50
SOLDER HEADER	IDHxxS	.82	1.29	1.88	2.20	2.58	3.24
RIGHT ANGLE SOLDER HEADER	IDHxxSR	.85	1.35	1.78	2.31	2.72	3.39
WW HEADER	IDHxxW	1.86	2.98	3.84	4.50	5.28	6.63
RIGHT ANGLE WW HEADER	IDHxxWR	2.05	3.28	4.22	4.45	4.80	7.30
RIBBON HEADER SOCKET	IDBxx	.79	.99	1.39	1.59	1.99	2.25
RIBBON HEADER	IDNxx	—	5.50	6.25	7.00	7.50	8.50
RIBBON EDGE CARD	IDExx	1.76	2.25	2.65	2.75	3.80	3.95

FOR ORDERING INSTRUCTIONS SEE D-SUBMINIATURE ABOVE

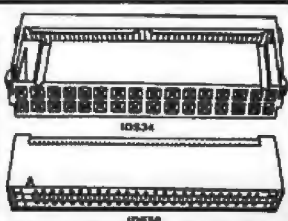

HARD TO FIND "SNAPABLE" HEADERS

CAN BE SNAPPED APART TO MAKE ANY SIZE HEADER, ALL WITH .1" CENTERS

1x40	STRAIGHT LEAD	.99
1x40	RIGHT ANGLE	1.49
2x40	STRAIGHT LEAD	2.49
2x40	RIGHT ANGLE	2.99

BARGAIN HUNTERS CORNER ATTENTION PC USERS!

10 MB HARD DISK SYSTEM \$349

- * SHOCK MOUNTED FOR 80 Gs—IDEAL FOR PORTABLES!
- * MMI MODEL MM212, 1/2" HEIGHT, 75ms ACCESS
- * INCLUDES CONTROLLER, CABLES & INSTRUCTIONS FOR IBM

WIRELESS KEYBOARD \$129

- * MADE BY CHERRY FOR IBM PC & PCjr
- * OPERATES UP TO 40 FEET FROM COMPUTER
- * INFRARED RECEIVER FOR PC/XT INCLUDED

HURRY—QUANTITIES ARE LIMITED!
SPECIALS END 8/31/86

PAGE WIRE WRAP WIRE PRECUT ASSORTMENT IN ASSORTED COLORS \$27.50

100mm: 1.5", 6.0", 6.5", 7.0"
250mm: 2.5", 4.5", 5.0"
500mm: 3.0", 3.5", 4.0"

SPOOLS

100 feet \$4.30 250 feet \$7.25
500 feet \$13.25 1000 feet \$21.95

Please specify color:
Blue, Black, Yellow or Red

EMI FILTER \$4.95

- * MANUFACTURED BY CORCOM
- * LOW COST
- * FITS LC-HP BELOW
- * 5 AMP 120/240 VOLT



8 FOOT LINE CORDS

LC-2 2 CONDUCTOR .39
LC-3 3 CONDUCTOR .89
LC-HP 3 CONDUCTOR W STD FEMALE SOCKET 1.49

MUFFIN FANS

3.15" SQ ROTRON 14.95
3.63" SQ ETRI 14.95
3.18" SQ MASUSHITA 16.95

WIRE WRAP PROTOTYPE CARDS FR-4 EPOXY GLASS LAMINATE WITH GOLD-PLATED EDGE-CARD FINGERS



IBM-PR2

IBM

BOTH CARDS HAVE SILK SCREENED LEGENDS AND INCLUDES MOUNTING BRACKET

IBM-PR1 WITH +6V AND GROUND PLANE . . . \$27.95
IBM-PR2 AS ABOVE WITH DECODING LAYOUT \$29.95

S-100

P100-1 BARE - NO FOIL PADS . . . \$15.15
P100-2 HORIZONTAL BUS . . . \$21.80
P100-3 VERTICAL BUS . . . \$21.80
P100-4 SINGLE FOIL PADS PER HOLE . . . \$22.75

APPLE

P500-1 BARE - NO FOIL PADS . . . \$15.15
P500-2 HORIZONTAL BUS . . . \$22.75
P500-3 SINGLE FOIL PADS PER HOLE . . . \$21.80
7060-45 FOR APPLE IIe AUX SLOT . . . \$30.00

SOCKET-WRAP I.D.™

- * SLIPS OVER WIRE WRAP PINS
- * IDENTIFIES PIN NUMBERS ON WRAP SIDE OF BOARD
- * CAN WRITE ON PLASTIC, SUCH AS IC #

PINS	PART#	PCK. OF	PRICE
8	IDWRAP 08	10	1.95
14	IDWRAP 14	10	1.95
16	IDWRAP 16	10	1.95
18	IDWRAP 18	5	1.95
20	IDWRAP 20	5	1.95
22	IDWRAP 22	5	1.95
24	IDWRAP 24	5	1.95
28	IDWRAP 28	5	1.95
40	IDWRAP 40	5	1.95

PLEASE ORDER BY NUMBER OF PACKAGES (PCK. OF)

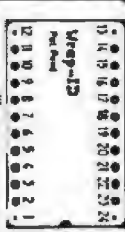

FRAME STYLE TRANSFORMERS

12.6V AC CT 2 AMP 5.95
12.6V AC CT 4 AMP 7.95
12.6V AC CT 8 AMP 10.95
25.2V AC CT 2 AMP 7.95

25 PIN D-SUB GENDER CHANGERS \$7.95



SWITCHING POWER SUPPLIES

PS-IBM \$89.95

- * FOR IBM PC/XT COMPATIBLE
- * 135 WATTS
- * +5V @ 1.5A, +12V @ 4.2A
- * -5V @ .5A, -12V @ .5A
- * ONE YEAR WARRANTY



PS-IBM-150 \$99.95

- * FOR IBM PC/XT COMPATIBLE
- * 160 WATTS
- * +12V @ 5.2A, +5V @ 1.6A
- * -12V @ .5A, -5V @ .5A
- * ONE YEAR WARRANTY



PS-130 \$98.95

- * 130 WATTS
- * SWITCH ON REAR
- * FOR USE IN OTHER IBM TYPE MACHINES
- * 90 DAY WARRANTY



PS-A \$49.95

- * USE TO POWER APPLE TYPE SYSTEMS
- * +5V @ 4A, +12V @ 2.5A
- * -5V @ .5A, -12V @ .5A
- * APPLE POWER CONNECTOR



PS-SPL200 \$49.95

- * +5V @ 2.5A, +12V @ 3.5A
- * -5V @ 1A, -12V @ 1A
- * UL APPROVED
- * ALUMINUM ENCLOSURE



CAPACITORS

TANTALUM

1.0µf	15V	.35	.47µf	35V	.45
6.8	15V	.70	1.0	35V	.45
10	15V	.80	2.2	35V	.65
22	15V	1.35	4.7	35V	.85
.22	35V	.40	10	35V	1.00

DISC

10µf	50V	.05	.880	50V	.05
22	50V	.05	.001µf	50V	.05
27	50V	.06	.0022	50V	.05
33	50V	.06	.005	50V	.05
47	50V	.05	.01	50V	.07
68	50V	.05	.02	50V	.07
100	50V	.05	.05	50V	.07
220	50V	.05	.1	12V	.10
560	50V	.05	.1	50V	.12

MONOLITHIC

.01µf	50V	.14	.1µf	50V	.18
.047µf	50V	.15	.47µf	50V	.25

ELECTROLYTIC

RADIAL		AXIAL			
1µf	25V	.14	1µf	50V	.14
2.2	35V	.15	10	50V	.16
4.7	50V	.15	22	16V	.14
10	50V	.15	47	50V	.20
47	35V	.18	100	35V	.25
100	16V	.18	220	25V	.20
220	35V	.20	470	50V	.30
470	25V	.30	1000	16V	.30
2200	16V	.70	2200	16V	.70
4700	25V	1.45	4700	16V	1.25

DATARASE EPROM ERASER \$34.95

- * ERASES 2 IN 10 MINUTES
- * COMPACT-NO DRAWER
- * THIN METAL SHUTTER PREVENTS UV LIGHT FROM ESCAPING



1/4 WATT RESISTORS

5% CARBON FILM ALL STANDARD VALUES FROM 1 OHM TO 10 MEG. OHM

10 PCS 5% value .05 100 PCS 5% value .02
50 PCS 5% value .025 1000 PCS 5% value .015

RESISTOR NETWORKS

SIP	10 PIN	9 RESISTOR	.69
SIP	8 PIN	7 RESISTOR	.59
DIP	16 PIN	8 RESISTOR	1.09
DIP	16 PIN	15 RESISTOR	1.09
DIP	14 PIN	7 RESISTOR	.99
DIP	14 PIN	13 RESISTOR	.99

SPECIALS ON BYPASS CAPACITORS

.01 µf CERAMIC DISC 100/\$5.00
.01 µf MONOLITHIC 100/\$10.00
.1 µf CERAMIC DISC 100/\$6.50
.1 µf MONOLITHIC 100/\$12.50

WISH SOLDERLESS BREADBOARDS

PART NUMBER	DIMENSIONS	DISTRIBUTION STRIPS	TIE POINTS	TERMINAL STRIPS	TIE POINTS	BINDING POSTS	PRICE
WBU-D	3.8 x 6.50"	1	100	---	---	---	2.95
WBU-T	1.38 x 6.50"	---	---	1	630	---	6.95
WBU-204-3	3.94 x 8.45"	1	100	2	1260	2	17.95
WBU-204	5.13 x 8.45"	4	400	2	1260	3	24.95
WBU-206	6.88 x 9.06"	5	500	3	1890	4	29.95
WBU-208	8.25 x 9.45"	7	700	4	2520	4	39.95



LITHIUM BATTERY AS USED IN CLOCK CIRCUITS



3 VOLT BATTERY \$3.95
BATTERY HOLDER \$1.45

NEW EDITION!

1986 IC MASTER
THE INDUSTRY STANDARD
\$129.95



VISIT OUR RETAIL STORE LOCATED AT 1256 SOUTH BASCOM AVENUE IN SAN JOSE

JDR Microdevices

1224 S. Bascom Avenue, San Jose, CA 95128

Toll Free 800-538-5000 • (408) 995-5430

FAX (408) 275-8415 • Telex 171-110

© COPYRIGHT 1986 JDR MICRODEVICES

THE JDR MICRODEVICES LOGO IS A REGISTERED TRADEMARK OF JDR MICRODEVICES. JDR INSTRUMENTS AND JDR MICRODEVICES ARE TRADEMARKS OF JDR MICRODEVICES. IBM IS A TRADEMARK OF INTERNATIONAL BUSINESS MACHINES. APPLE IS A TRADEMARK OF APPLE COMPUTER.

HOURS: M-W-F, 9-6

TU-TH, 9-9

SAT, 9-5

PLEASE USE YOUR CUSTOMER NUMBER WHEN ORDERING

TERMS: Minimum order \$10.00. For shipping and handling include \$2.50 for UPS Ground and \$2.50 for UPS Air. Orders over 1 lb. and foreign orders may require additional shipping charges - please contact our sales department for the amount. CA residents must include applicable sales tax. All merchandise is warranted for 90 days unless otherwise stated. Prices are subject to change without notice. We are not responsible for typographical errors. We reserve the right to limit quantities and to substitute manufacturer. All merchandise subject to prior sale.

PARTIAL LISTING ONLY — CALL FOR A FREE CATALOG

DISK DRIVES FOR APPLE COMPUTERS

AP-150
\$89.95

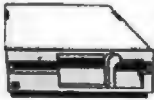

- 1/2 HT, DIRECT DRIVE
- 100% APPLE COMPATIBLE
- SIX MONTH WARRANTY

BAL-500
\$129.95



- TEAC MECHANISM-DIRECT DRIVE
- 100% APPLE COMPATIBLE
- FULL ONE YEAR WARRANTY

AP-135
\$129.95



- FULL HT SHUGART MECHANISM
- DIRECT REPLACEMENT FOR APPLE DISK II
- SIX MONTH WARRANTY

DOUBLE SIDED

MAC535
\$249.95



- 3.5" ADD-ON DISK DRIVE
- 100% MACINTOSH COMPATIBLE
- DOUBLE SIDED 800K BYTE STORAGE
- HIGH RELIABILITY DRIVE
- HAS AUTO-EJECT MECHANISM
- FULL ONE YEAR WARRANTY

AD-3C
\$139.95

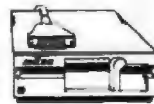

- 100% APPLE IIc COMPATIBLE. READY TO PLUG IN, W/ SHIELDED CABLE & MOLDED 19 PIN CONNECTOR
- FAST, RELIABLE SLMUNE DIRECT DRIVE
- SIX MONTH WARRANTY

DISK DRIVE ACCESSORIES

- FDD CONTROLLER CARD \$49.95
- IIc ADAPTOR CABLE \$19.95
- ADAPTS STANDARD APPLE DRIVES FOR USE WITH APPLE IIc

KB-1000

\$79.95

CASE WITH KEYBOARD FOR APPLE TYPE MOTHERBOARD

- USER DEFINED FUNCTION KEYS
- NUMERIC KEYPAD WITH CURSOR CONTROL
- CAPS LOCK • AUTO REPEAT

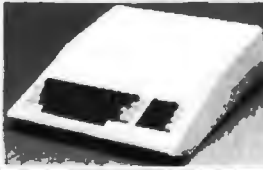

KEYBOARD-AP

\$49.95

- REPLACEMENT FOR APPLE II KEYBOARD
- CAPS LOCK KEY, AUTO-REPEAT
- ONE KEY ENTRY OF BASIC OR CP/M COMMANDS



EXTENDER CARDS

- IBM-PC \$45.00
- IBM-AT \$68.00
- APPLE II \$45.00
- APPLE IIc \$45.00
- MULTIBUS \$86.00

APPLE COMPATIBLE INTERFACE CARDS

EPROM PROGRAMMER \$59.95

MODEL RP525

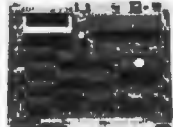

- DUPLICATE OR BURN ANY STANDARD 27_{xx} SERIES EPROM
- EASY TO USE MENU-DRIVEN SOFTWARE IS INCLUDED
- MENU SELECTION FOR 2716, 2732, 2732A, 2764 AND 27128
- HIGH SPEED WRITE ALGORITHM
- LED INDICATORS FOR ACTIVITY
- NO EXTERNAL POWER SUPPLY NEEDED
- ONE YEAR WARRANTY

18K RAMCARD \$39.95



- FULL TWO YEAR WARRANTY
- EXPAND YOUR 48K APPLE TO 64K
- USE IN PLACE OF APPLE LANGUAGE CARD

BARE PC CARD W/ INSTRUCTIONS \$9.95

IC TEST CARD \$99.95



- QUICKLY TESTS MANY COMMON ICs
- DISPLAYS PASS OR FAIL
- ONE YEAR WARRANTY
- TESTS: 4000 SERIES CMOS, 74HC SERIES CMOS, 7400, 74LS, 74L, 74H & 74S

300B MODEM \$49.95

FOR APPLE OR IBM
INCLUDES ASCH PRO-EZ SOFTWARE



- FCC APPROVED
- BELL SYSTEMS 103 COMPATIBLE
- INCLUDES AC ADAPTOR
- AUTO-DIAL
- DIRECT CONNECT
- CABLE FOR APPLE IIc \$14.95

JOYSTICK CN-401 \$7.95

FOR ATARI 400, 800, 2600,
VIC 20/64 AND APPLE IIc



DISKFILE
HOLDS 70 5 1/4" DISKETTES



\$895
3.5" DISKFILE HOLDS 40 \$895

POWER STRIP

- UL APPROVED
- 15A CIRCUIT BREAKER

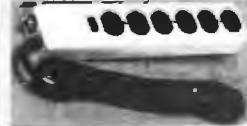

3-WAY SWITCH BOXES

- SERIAL OR PARALLEL
- CONNECTS 3 PRINTERS TO ONE COMPUTER OR VICE VERSA
- ALL LINES SWITCHES
- HIGH QUALITY ROTARY SWITCH MOUNTED ON PCB
- GOLD CONTACTS
- STURDY METAL ENCLOSURE



SWITCH-3P CENTRONICS PARALLEL \$99.95
SWITCH-3S RS232 SERIAL \$99.95

PRINTER BUFFERS

- FREES COMPUTER FOR OTHER TASKS WHILE PRINTING LOW DOCUMENTS
- STAND-ALONE DESIGN; WORKS WITH ANY COMPUTER OR PRINTER
- ALL MODELS FEATURE PRINT PAUSE MEMORY CHECK, GRAPHICS CAPABILITY

SP120P PARALLEL \$139.95

- 64K UPGRADABLE TO 256K
- LED INDICATOR SHOWS VOLUME OF DATA IN BUFFER

SP120S RS232 SERIAL \$159.95

- 64K UPGRADABLE TO 256K
- 6 SELECTABLE BAUD RATES, FROM 9600 - 19,200B

SP110P PARALLEL \$249.95

- 64K UPGRADABLE TO 512K
- SPOOLS OUTPUT OF UP TO 3 COMPUTERS
- LED BARGRAPH DISPLAYS AMOUNT OF DATA IN BUFFER
- REPEAT FUNCTION CLEARS DATA IN BUFFER
- REPEAT FUNCTION CAN PRODUCE MULTIPLE COPIES OF A DOCUMENT



SP120 SP110

NASHUA DISKETTES DEALS

5 1/4" SOFT SECTOR
DS/DD WITH HUB RINGS

\$9.90 **69¢ ea** **59¢ ea**
BOX OF 10 BULK QTY 50 BULK QTY 250

NASHUA DISKETTES WERE JUDGED TO HAVE THE HIGHEST POLISH AND RECORDED AMPLITUDE OF ANY DISKETTES TESTED ACCORDING TO "COMPARING FLOPPY DISKS", BYTE 9/84

DISKETTES

NASHUA 5 1/4"

N-MD2D DS DD SOFT \$9.90
N-MD2F DS QUAD SOFT \$34.95
N-MD2H DS HD FOR AT \$49.95

NASHUA 8"

N-FD1 SS DD SOFT \$27.95
N-FD2D DS/DD SOFT \$34.95

NASHUA 3.5"

N-3.555 3.5" SS/DD FOR MAC \$32.95

VERBATIM 5 1/4"

V-MD1D SS DD SOFT \$23.95
V-MD2D DS/DD SOFT \$29.95
V-MD110D SS/DD 10 SECTOR HARD \$23.95

TEST EQUIPMENT FROM JDR INSTRUMENTS

DIGITAL MULTIMETER PEN DPM-1000

AUTO RANGING, POLARITY AND DECIMAL!

\$54.95

- LARGE 3.5 DIGIT DISPLAY
- DATA HOLD SWITCH
- FREEZES READING
- FAST, AUDIBLE CONTINUITY TEST
- LOW BATTERY INDICATOR
- OVERLOAD PROTECTION



20MHZ DUAL TRACE OSCILLOSCOPE

MODEL 2000

\$389.00

35MHZ DUAL TRACE OSCILLOSCOPE

MODEL 3500

\$549.00

FOR MORE INFORMATION ON THE OSCILLOSCOPES, CALL US FOR FREE PRODUCT BRIEFS.

Sakata 120 CPS DOT MATRIX PRINTER

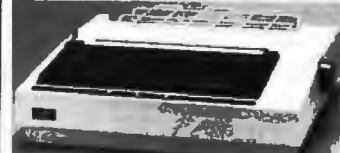

MODEL \$P-1200 \$169.95

- EPSON/IBM COMPATIBLE
- 9-WIRE PRINTHEAD
- 120 CPS-BIDIRECTIONAL, 80 COL
- FRICTION AND TRACTOR FEED
- PROPORTIONAL SPACING
- CENTRONICS PARALLEL INTERFACE
- 8 CHARACTER SETS AND GRAPHICS

6 FOOT IBM PRINTER CABLE \$9.95
REPLACEMENT RIBBON CARTRIDGE \$11.95

5 1/4" FLOPPY DISK DRIVES

- TEAC FD-55B 1/2 HT DS/DD (FOR IBM) \$109.95
- TEAC FD-55FV 1/2 HT DS/QUAD (FOR IBM) \$124.95
- TEAC FD-55GFV 1/2 HT DS/HD (FOR IBM AT) \$154.95
- TANDON TM100-2 DS/DD (FOR IBM) \$129.95
- TANDON TM50-2 1/2 HT DS/DD (FOR IBM) \$69.95
- NPI-852 DS/DD (FOR IBM) \$69.95
- QUME QT-142 1/2 HT DS DD (FOR IBM) \$79.95

8" FLOPPY DISK DRIVES

- FD 100-8 SS/DD (SA/801 EQUIV) \$119.00
- FD 200-8 DS/DD (SA/861R EQUIV) \$159.00

DISK DRIVE ACCESSORIES

- TEAC SPECIFICATION MANUAL \$5.00
- TEAC MAINTENANCE MANUAL \$25.00
- 1/2 HT MOUNTING HARDWARE \$2.95
- MOUNTING RAILS FOR IBM AT \$4.95
- "Y" POWER CABLE FOR 5 1/4" FDDs \$2.95
- 5 1/4" FDD POWER CONNECTORS \$1.19



TEAC FD-55 TANDON TM100-2

DISK DRIVE ENCLOSURES

- CAB-APPLE \$24.95**
APPLE TYPE CABINET W/ OUT POWER SUPPLY
- CAB-1FH5 \$69.95**
FULL HT 5 1/2" BEIGE CABINET W/ POWER SUPPLY
- CAB-28V5 \$49.95**
DUAL SLMUNE 5 1/2" CABINET W/ POWER SUPPLY
- CAB-28V5 \$209.95**
VERTICAL DUAL SLMUNE 8" CABINET W/ POWER SUPPLY
- CAB-2FH8 \$219.95**
HORIZONTAL DUAL FULL HT 8" CABINET W/ POWER SUPPLY

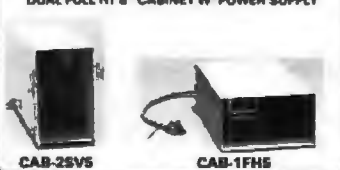

CAB-28V5 CAB-1FH5

CALL FOR VOLUME QUOTES © COPYRIGHT 1986 JDR MICRODEVICES

BUILD A COMPLETE 256K XT SYSTEM—\$717

SEAGATE ST-225 20MB HARD DISK SYSTEM

INCLUDES HALF LENGTH HD CONTROLLER, CABLES, MOUNTING HARDWARE AND INSTRUCTIONS. ALL DRIVES ARE PRE-TESTED AND COME WITH A ONE YEAR WARRANTY.

\$449.00

XT COMPATIBLE MOTHERBOARD

\$159.95

- 4.77 MHz 8088 CPU, OPTIONAL 8087 CO-PROCESSOR
- 8 EXPANSION SLOTS
- 6K RAM INSTALLED, EXPANDABLE TO 640K ON-BOARD MEMORY
- ALL ICs SOCKETED-HIGHEST QUALITY PC BOARD
- ACCEPTS 2764 OR 27128 ROMS

PRO-BIOS \$29.95



IBM COMPATIBLE INTERFACE CARDS

ALL WITH A ONE YEAR WARRANTY

MULTI I/O FLOPPY CARD \$129.95

PERFECT FOR THE 640K MOTHERBOARD



- 2 DRIVE FLOPPY DISK CONTROLLER
- 1 RS232 SERIAL PORT, OPTIONAL 2nd SERIAL PORT
- PARALLEL PRINTER PORT
- GAME PORT
- CLOCK CALENDAR
- SOFTWARE: CLOCK UTILITIES, RAMDISK, SPOOLER
- OPTIONAL SERIAL PORT \$15.95

MULTIFUNCTION CARD \$119.95

ALL THE FEATURES OF ASTS 6 PACK PLUS AT HALF THE PRICE

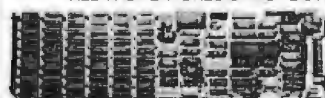

- CLOCK CALENDAR
- 0-364K RAM
- SERIAL PORT
- PARALLEL PORT
- GAME PORT
- SOFTWARE INCLUDED
- PRINTER CABLE \$29.95
- 64K RAM UPGRADE \$57.07

COLOR GRAPHICS ADAPTOR \$99.95

FULLY COMPATIBLE WITH IBM COLOR CARD



- 4 VIDEO INTERFACES: RGB, COMPOSITE COLOR, HI-RES COMPOSITE MONOCHROME, CONNECTOR FOR RF MODULATOR
- COLOR GRAPHICS MODE: 320 x 200
- MONO GRAPHICS MODE: 640 x 200
- LIGHT PEN INTERFACE

MONOCHROME GRAPHICS CARD \$119.95

FULLY COMPATIBLE WITH IBM MONOCHROME ADAPTOR & HERCULES GRAPHICS

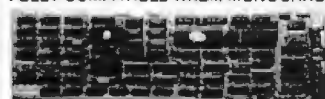

- LOTUS COMPATIBLE
- TEXT MODE: 80 x 25
- GRAPHICS MODE: 720 x 348
- PARALLEL PRINTER INTERFACE
- OPTIONAL SERIAL PORT \$19.95

MONOCHROME ADAPTOR \$49.95

ANOTHER FANTASTIC VALUE FROM JDR!

- IBM COMPATIBLE TTL OUTPUT
- 720 x 350 PIXEL DISPLAY
- PLEASE NOTE: THIS CARD WILL NOT RUN LOTUS GRAPHICS AND DOES NOT INCLUDE A PARALLEL PORT

FLOPPY DISK DRIVE ADAPTOR \$49.95



- INTERFACES UP TO 4 STANDARD FDDs TO IBM PC OR COMPATIBLES
- INCLUDES CABLE FOR TWO INTERNAL DRIVES
- STANDARD DB37 FOR EXTERNAL DRIVES
- RUNS QUAD DENSITY DRIVES WHEN USED WITH JFORMAT

EASYDATA 1200 BAUD MODEM FOR IBM

INCLUDES PC TALK III COMMUNICATIONS SOFTWARE



- NEW 10 INCH CARD
- HAYES COMPATIBLE
- AUTO DIAL / AUTO ANSWER
- AUTO RE-DIAL ON BUSY
- INCLUDES SERIAL PORT!
- ONE YEAR WARRANTY

\$169.95

CRT MONITORS FOR ALL APPLICATIONS



LUXOR HI-RES RGB MONITOR
MODEL 190-9528

- DIGITAL RGB IBM COMPATIBLE
- 14" SCREEN
- 16 TRUE COLORS
- 25 MHz BANDWIDTH
- RESOLUTION > 640 x 282
- 31mm DOT PITCH
- CABLE FOR IBM PC INCLUDED

\$299.95



SAKATA COMPOSITE COLOR
MODEL SC-100

- TOP RATED FOR APPLE
- 13" COMPOSITE VIDEO
- RESOLUTION 280H x 300V
- INTERNAL AUDIO AMP
- ONE YEAR WARRANTY

\$169.95



CENTER SYSTEMS MONOCHROME
MODEL XLM-1211

- IBM COMPATIBLE TTL INPUT
- 12" NON-GLARE SCREEN
- P39 GREEN PHOSPHORUS
- VERY HIGH RESOLUTION
- 25 MHz BANDWIDTH
- 1100 LINES (CENTER)

AMBER VERSION \$189.95
\$99.95

BUILD YOUR OWN 256K XT COMPATIBLE SYSTEM

XT MOTHERBOARD	\$159.95
PRO-BIOS	\$29.95
256K RAM	\$26.55
130 WATT POWER SUPPLY	\$89.95
FLIP-TOP CASE	\$49.95
DKM-2000 KEYBOARD	\$79.95
1/2 HEIGHT QUME DRIVE	\$78.95
FLOPPY DISK CONTROLLER	\$49.95
MONOCHROME ADAPTOR	\$49.95
MONOCHROME MONITOR	\$99.95
TOTAL:	\$716.10

MONITOR STAND



TILTS AND SWIVELS
ONLY \$12.95

IBM PRINTER CABLE



• DB25 TO CENTRONICS
• SHIELDED CABLE
\$9.95

IBM STYLE COMPUTER CASE

AN ATTRACTIVE STEEL CASE WITH A HINGED LID FITS THE POPULAR PC/XT COMPATIBLE MOTHERBOARDS

- SWITCH CUT-OUT ON SIDE FOR PC XT STYLE POWER SUPPLY
- CUT-OUT FOR 8 EXPANSION SLOTS
- ALL HARDWARE INCLUDED

\$49.95

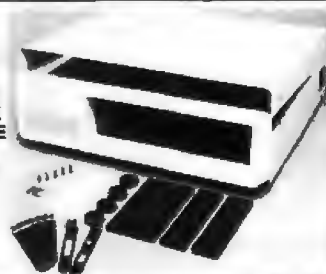

IBM COMPATIBLE KEYBOARDS

DKM-2000 \$79.95

IBM-5151 \$99.95



- "5150" STYLE KEYBOARD
- FULLY IBM COMPATIBLE
- LED STATUS INDICATORS FOR CAPS & NUMBER LOCK
- 83 KEY — SAME LAYOUT AS IBM PC/XT KEYBOARD

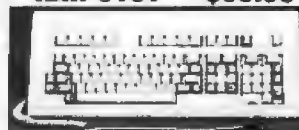

- REPLACEMENT FOR KEYTRONICS KB-5151™
- SEPARATE CURSOR & NUMERIC KEYPAD
- CAPS LOCK & NUMBER LOCK INDICATORS
- IMPROVED KEYBOARD LAYOUT

POWER SUPPLY



NOW ONLY \$89.95

- FOR IBM PC-XT COMPATIBLE
- 135 WATTS
- +5V @ 15A, +12V @ 4.2A
- -5V @ .5A, -12V @ .5A

150 WATT MODEL \$99.95

DISK DRIVES

TANDON TM50-2

\$89.95

- 1/2 HT DS/DD
- IBM COMPATIBLE
- EXTREMELY QUIET!

TEAC FD-55B	DS/DD	\$109.95
TEAC FD-55F	DS/QUAD	\$124.95
TEAC FD-55B	DS/HD	\$154.95
QUME QT-142	DS/DD	\$79.95
MOUNTING HARDWARE		\$2.95
AT/RAILS		\$4.85

JDR Microdevices

1224 S. Bascom Avenue, San Jose, CA 95128

Toll Free 800-538-5000 • (408) 995-5430 • FAX (408) 275-8415 • Telex 171-110

D·I·S·K·S A·N·D D·O·W·N·L·O·A·D·S

ORDERING DISKS OF BYTE LISTINGS

Listings that accompany BYTE articles are available on disk in a variety of formats and in Cauzin Softstrip format. (For details on the Softstrip format, see page 460.) For each BYTE issue, beginning with December 1985, all the listings mentioned in that issue are on that month's disk. There's no need to request individual listings or to send additional fees: the cost per disk covers an entire month's listings. To order a disk of these listings for non-commercial purposes, indicate the issue and the kind of disk on the form below. Enclose a check or money order in the correct amount made out to BYTE Listings. We cannot accept credit card orders at this time. All prices include postage. Send requests to BYTE Listings, One Phoenix Mill Lane, Peterborough, NH 03458. Program Listings may also be downloaded via BYTEnet Listings at (617) 861-9764.

BYTE issue: _____

COMMON 5¼-INCH FORMATS

(All cost \$5 per disk in North America, \$6 in Europe and South America, \$7 in Asia, Africa, and Australia.)

- Apple II 5¼-inch DOS 3.3 (5 disks)
- Apple II 5¼-inch ProDOS (5 disks)
- Hewlett-Packard 125 (2 disks)
- IBM PC (2 disks)
- Kaypro 2 CP/M (2 disks)
- Texas Instruments Professional (2 disks)
- TRS-80 Model III (4 disks)
- TRS-80 Model 4 (4 disks)
- Zenith Z-100 (2 disks)

COMMON 3½-INCH FORMATS

(All cost \$6 per disk in North America, \$7 in Europe and South America, \$8 in Asia, Africa, and Australia.)

- Apple Macintosh (2 disks)
- Atari 520ST (2 disks)
- Commodore Amiga (1 disk)
- Data General/One (1 disk)
- Hewlett-Packard 150 (1 disk)

CP/M STANDARD 8-INCH FORMAT

(\$6 per disk in North America, \$7 in Europe and South America, \$8 in Asia, Africa, and Australia.)

- Single-sided single-density (2 disks)
- Double-sided double-density (1 disk)

OTHER FORMATS

Due to the diversity of requests and the custom work involved, there will be some delay in fulfilling these requests. (All cost \$6 per disk in North America, \$7 in Europe and South America, \$8 in Asia, Africa, and Australia.)

Size 8-inch 5¼-inch 3½-inch
Machine _____

CAUZIN SOFTSTRIP

SEND TO:

Name _____

Street _____

City _____ State or Province _____

Postal Code _____ Country _____

Check or money order enclosed for \$ _____

BULLETIN BOARDS IN CANADA

Listed below are some computer bulletin boards that carry program listings from BYTE. Programs are for noncommercial use in connection with BYTE articles only. Some BBSs may charge an annual maintenance fee, and you must pay your own telephone charges.

Western Canadian Distribution Center (3420 48th St., Edmonton, Alberta T6L 3R5) will be supplying listings to its member bulletin-board systems.

Edmonton, Alberta, (403) 454-6093

Meadowlark, Alberta, (403) 435-6579

Montreal, Quebec, PComm Systems,
(514) 989-9450

Prince George, British Columbia, (604) 562-9519

Regina, Saskatchewan, (306) 586-5585

Toronto, Ontario, Epson Club of Toronto (EPCOT),
(416) 635-9600

Winnipeg, Manitoba, (204) 452-5529

In addition, arrangements for BYTEnet Listings have been made with one or more system operators in the following nations: Australia, Brazil, Denmark, France, Hong Kong, Indonesia, Italy, Japan, Malaysia, The Netherlands, Nigeria, Norway, Saudi Arabia, Singapore, Sweden, Switzerland, United Kingdom, and West Germany. Contact us at (603) 924-9281 for an up-to-date list. ■

Back, by popular demand.

Just a few years ago, illegal hunting and encroaching civilization had all but destroyed the alligator population in the south. They were added to the official list of endangered species in the United States.

Now alligators have made a comeback.



Conservationists intent on preserving this legendary reptile helped the alligator get back on its feet. Once again some southern swamps and marshes are teeming with alligators.

With wise conservation policies, other endangered species have also made comebacks... the cougar, gray whale, Pacific walrus, wood duck, to name a few.

If you want to help save our endangered species, join the National Wildlife Federation, Department 106, 1412 16th Street, NW, Washington, DC 20036.



THE CAUZIN SOFTSTRIP

Starting with this issue, BYTE will offer the text files of program listings from each issue in Cauzin Softstrip format. This new medium adds to the other ways you can get the full text of programs referred to in BYTE: the free BYTenet Listings bulletin board, BIX (BYTE Information Exchange), and the disks of listings available through BYTE.

The Cauzin Softstrip was conceived by Robert Brass and implemented at Cauzin Systems Inc. It is a machine-readable form of printed software (see figure 1) that can be created on laser and dot-matrix printers and reproduced in magazines, newspapers, and other printed forms (including photocopies). Files in Softstrip format are highly reliable and resistant to errors. Softstrips can be folded, crumpled, smudged, or written over with most inks and still read correctly. (For a technical description of Softstrips, see Letters, January BYTE, page 24.)

We will offer the text-file content of the BYTE disks in Softstrip format as an experiment for the next 18 months; the price will be \$2 per month for North America, \$3 for Europe and South America, and \$3.50 for Asia, Africa, and Australia. If the demand is sufficient at the end of this period, we will continue to offer software in Softstrip format. (We will supply only the text files associated with a given issue. Executable files are often too large to convert and are specific to one machine only; also, almost all the code associated with a given issue is source code.

The Cauzin Softstrip System Reader is a sound piece of technology that has the potential to be an economical way to distribute software, but it suffers from the chicken-and-egg problem that most new computers face: Users won't buy them until software exists, and software vendors won't support them until they have a large user base. Already several computer magazines are printing Softstrips. Although we currently do not have the space in BYTE to do this, we want to make them available at low cost to interested readers.

Currently, the Softstrip Reader works with the IBM PC, Apple II, and Macintosh families of computers (the Accessory Kit for each computer includes the appropriate computer-to-reader cable and the software for reading Softstrips). However, anyone with a computer capable of telecommunications and data capture at 4800 baud can read any text file in Softstrip format, including those supplied by BYTE (see "Reading Text Softstrips" at right for details). We feel that this capability makes Softstrip software available to a large segment of our audience, which contributed to our decision to offer this option.

This service is in no way an endorsement of Cauzin Systems or its product. We plan to publish a review of the Softstrip System Reader in an upcoming issue. For more information, contact Cauzin Systems, 835 South Main St., Waterbury, CT 06706, (203) 573-0150.

To order Softstrip versions of BYTE listings, see Disks and Downloads on page 459. ■

READING TEXT SOFTSTRIPS

To read text-file Softstrips on an unsupported computer, you need the following:

- a computer that can connect to a modem through a male DB-25 connector (on the computer's side)
- a terminal program that has a data-capture mode and the ability to send and receive data at 4800 baud
- a Cauzin Softstrip System Reader package with the IBM PC Accessory Kit (includes the necessary cable that ends in a female DB-25 connector)

To read a text-file Softstrip, connect the Softstrip Reader to your computer as if it were a modem, turn on the Reader, position a Softstrip for reading, set your terminal program to capture incoming text at 4800 baud, 8 data bits, 1 stop bit, no parity bit, and type the letter "T." The reader reads the Softstrip and sends the information to your computer. Repeat this process for any additional Softstrips. (Note that if a file is distributed on multiple Softstrips, you may have to manually edit text broken by Softstrip boundaries.) After you have closed and edited the resulting file, you will have a text file that can be manipulated normally by your system.

In many cases, BASIC text files can be loaded and executed with little or no modification on your computer. For example, at BYTE we tested the above setup with an Amiga running the MaxiComm terminal program. We read in the Softstrip version of a short BASIC program (LCD.BAS from page 400 of the January Mathematical Recreations), loaded it into AmigaBASIC, and found that it ran without modification.

Figure 1: A Softstrip containing two Turbo Pascal programs, ANAGRAM.PAS and SETPROB.PAS, from "Anagram Solving in Pascal" by Bob Keefer (page 113 of this issue).

SET PROB.PAS
ANAGRAM.PAS

1 |

2 |

3 |

4 |

5 |

Softstrip

B·O·M·B

BYTE'S ONGOING MONITOR BOX

ARTICLE#	PAGE	ARTICLE	AUTHOR(S)	ARTICLE#	PAGE	ARTICLE	AUTHOR(S)
1	9	Microbytes	staff	15	235	A Material Selection Program	Sawyer, Pecht
2	29	What's New	staff	16	253	Small-Scale Engineering Applications	Stone
3	50	Ask BYTE/Circuit Cellar Feedback	Ciarcia	17	269	The Commodore 128 Personal Computer System	Wiese
4	63	Book Reviews	Bridger, Unger, Clark	18	281	The ITT XTRA XP	Unger
5	85	Ciarcia's Circuit Cellar: Parallel Interfacing: A Tutorial Discussion, Part 1: Basics	Ciarcia	19	289	The Conquest Turbo PC	Unger
6	96	Programming Project: Build a Spreadsheet Program	Amsterdam	20	293	BYSO LISP and Waltz LISP	Wong
7	113	Programming Insight: Anagram Solving in Pascal	Keefe	21	297	ExperOPS5	Jacobs
8	120	The Defnicon 68020 Coprocessor, Part 1: The Hardware and Operating System	Marshall, Jones, Kluger	22	303	Five Laboratory Interfacing Packages	Wirth, Ford
9	145	Engineering on a Micro Computer Circuit Simulation	Pedcini	23	315	The IBM Wheelprinter E	Swearingin
10	165	Analog Circuit Analysis	Blume	24	325	Computing at Chaos Manor: Traveling Computers	Poumelle
11	170	An 8031 In-Circuit Emulator	McNeill	25	347	According to Webster: Programming Tools	Webster
12	181	Structural Analysis	Dinwiddie	26	363	BYTE U.K.: Personal Supercomputers	Pountain
13	199	Stress Analysis	Johnson, Loygorri, Petersen, Crouch	27	371	BYTE Japan: A Japanese COMDEX and More	Raike
14	219			28	381	Applications Only: Cheap Stuff	Shapiro
				29	393	Best of BIX	BIXen

BOMB Results

POWER AND SECURITY

Steve Ciarcia's Circuit Cellar adventure in April, "Computer On Guard!" wins first place. In second is "Jerry's Best of 1985 Awards" from Dr. Pournelle's enviable vantage point at Chaos Manor. "A Micro-based Supercomputer" placed third, awarding its authors, Norman H. Christ and Anthony E. Terrano, the \$100 bonus. Best of BIX wins fourth. And

in fifth place is "Making UNIX Secure." Coauthors Alan Filipiski and James Hanko will split the \$50 prize.

The new \$50 award for quality, which just began last month, goes to Norman H. Christ and Anthony E. Terrano for "A Micro-based Supercomputer." Congratulations one and all.

BYTE ADVERTISING SALES STAFF:

Dennis J. Riley, Advertising Sales Manager, One Phoenix Mill Lane, Peterborough, NH 03458, tel. (603) 924-9281

NEW ENGLAND
ME, NH, VT, MA, RI,
EASTERN CANADA
Paul McPherson Jr. (617) 262-1160
McGraw-Hill Publications
575 Boylston Street
Boston, MA 02116

ATLANTIC
NY, NJ, CT, NJ (NORTH)
Leah G. Rabinowitz (212) 512-2096
McGraw-Hill Publications
1221 Avenue of the Americas—
39th Floor
New York, NY 10020

Dick McCurk (203) 968-7111
McGraw-Hill Publications
Building A—3rd Floor
777 Long Ridge Road
Stamford, CT 06902

EAST
PA (EAST), NJ (SOUTH),
MD, VA, W.VA, DE, D.C.
Daniel Ferro (215) 496-3833
McGraw-Hill Publications
Three Parkway
Philadelphia, PA 19102

SOUTHEAST
NC, SC, GA, FL, AL, TN
Maggie M. Dorree (404) 252-0626
McGraw-Hill Publications
4170 Ashford-Dunwoody Road—
Suite 420
Atlanta, GA 30319

MIDWEST
IL, MO, KS, IA, ND, SD, MN, WI, NB, IN
Bob Denmead (312) 751-3740
McGraw-Hill Publications
Blair Building
645 North Michigan Ave.
Chicago, IL 60611

GREAT LAKES, OHIO REGION
MI, OH, PA (ALLEGHENY) KY,
ONTARIO, CANADA
Renee Navarro (313) 352-9760
McGraw-Hill Publications
4000 Town Center—Suite 770
Southfield, MI 48075

SOUTHWEST, ROCKY MOUNTAIN
UT, CO, WY, OK, TX, AR, MS, LA
Kevin Harold (214) 458-2400
McGraw-Hill Publications
Prestonwood Tower—Suite 907
5151 Bellline
Dallas, TX 75240

SOUTH PACIFIC
SOUTHERN CA, AZ, NM, LAS VEGAS
Jack Anderson (714) 557-6292
McGraw-Hill Publications
3001 Red Hill Ave
Building #1—Suite 222
Costa Mesa, CA 92626

Karen Niles (213) 480-5243, 487-1160
McGraw-Hill Publications
3333 Wilshire Boulevard #407
Los Angeles, CA 90010

NORTH PACIFIC
HI, WA, OR, ID, MT, NORTHERN CA,
NV (except LAS VEGAS), W CANADA
Mike Kisseberth (415) 362-4600
McGraw-Hill Publications
425 Battery Street
San Francisco, CA 94111

Bill McAfee (415) 349-4100
McGraw-Hill Publications
951 Mariner's Island Blvd—3rd Floor
San Mateo, CA 94404

**WEST COAST SURPLUS
AND RETAIL ACCOUNTS**
Tom Harvey (805) 964-8577
3463 State Street—Suite 256
Santa Barbara, CA 93105

The Buyer's Mart
Karen Burgess (603) 924-3754
BYTE Publications
70 Main Street
Peterborough, NH 03458

BYTE BITS (2x3)
Dan Harper (603) 924-6830
BYTE Publications
70 Main Street
Peterborough, NH 03458

**Post Card Mailings
National**
Brudley Browne (603) 924-6166
BYTE Publications
70 Main Street
Peterborough, NH 03458

International Advertising Sales Staff:

Mr. Hans Csokor
Publintermedia
Reismenstrasse 61
A-1037 Vienna Austria
227 75 76 84

Mrs. Gurik Gepner
McGraw-Hill Publishing Co.
PO Box 2156
Bat Yam, 59121 Israel
3 866 561 321 39

Mr. Fritz Krusebecker
McGraw-Hill Publishing Co.
Liebigstrasse 19
D-6000 Frankfurt/Main 1
West Germany
69 72 01 81

Mrs. Maria Sarmiento
Pedro Teixeira 8. Off. 320
Iberia Mart 1
Madrid 4, Spain
1 45 52 801

Mr. Andrew Karnig
Andrew Karnig & Associates
Finnbodavagen
S-131 31 Nacka Sweden
8-44 0005

Mr. Alain Faure
McGraw-Hill Publishing Co.
128 Faubourg Saint Honore
75008 Paris
France
(1) 47-20-33-42

Mr. Arthur Scheffer
McGraw-Hill Publishing Co.
34 Dover St.
London W1X 3RA
England 01 493 1451

Manuela Capuano
McGraw-Hill Publishing Co.
Via Flavio Baracchini 1
20123 Milan, Italy
02 86 90 617

Seavex Ltd
400 Orchard Road #10-01
Singapore 0923
Republic of Singapore
Tel. 734-9790
Telex: RS55339 SEAVEX

Seavex Ltd
503 Wilson House
19-27 Wyndham St.
Central, Hong Kong
Tel: 5-260149
Telex: 60904 SEVEX HX

Hiro Morita
McGraw-Hill Publishing Co.
Overseas Corp.
Room 1528
Kasumigaseki Bldg
3-2-5 Kasumigaseki
Chiyoda-Ku
Tokyo 100, Japan
3 581 9811

Mr. Ernest McCrary
Empresa Internacional de
Comunicacoes Ltda
Rua da Consolacao 222
Conjunto 103
01302 Sao Paulo, S.P., Brasil
Tel. (11) 259-3811
Telex: (100) 32122 EMBN

R·E·A·D·E·R S·E·R·V·I·C·E

Inquiry No.	Page No.	Inquiry No.	Page No.	Inquiry No.	Page No.	Inquiry No.	Page No.
391 A. W. ABLE	179	* CODEX CORPORATION	340	147 FOX SOFTWARE INC.	20	220 MARK WILLIAMS CO	51
* ACS IMPORTERS	428	* CODEX CORPORATION	342	148 FUJITSU AMERICA	193	221 MARK WILLIAMS CO	53
411 ACS INT'L	239	73 COEFFICIENT SYS. CORP.	54	150 GENOA SYSTEMS CORP.	225	* MAXELL DATA PRODUCTS	7
406 ADCOM INC.	352	74 COGITATE	419	151 GENOA SYSTEMS CORP.	225	223 MCGRAW-HILL SOFTWARE	337
2 ADV DIGITAL CORP.	28	75 COGITATE	419	410 GFK	450	224 MCGRAW-HILL SOFTWARE	52
3 ADV DIGITAL CORP.	28	* COMPAQ COMPUTER CORP.	302	152 GMX INC.	440	225 MCGRAW-HILL TRAINING SYS.	318
4 ADV INTELLIGENCE TECHN.	423	76 COMPETITIVE EDGE	354	153 GOLDEN BOW SYSTEMS	436	226 MCGRAW-HILL TRAINING SYS.	318
6 ADVANCED COMP. PROD.	442, 443	77 COMPUdata TRANSLATORS INC.	419	154 GOLDEN BOW SYSTEMS	434	* MEGASOFT	428
7 ADVANCED TECHNOLOGY PROD.	438	* COMPUPRO	292	155 GRAFFPOINT	434	228 MEGATEL COMPUTER TECH.	354
8 AFTON COMPUTER	386	78 COMPUSAVE	420	157 GTEC INC.	227	* MEJ	436
9 AFTON COMPUTER	386	79 COMPUSERVE	180	158 GTEC INC.	227	* MERCEDES-BENZ OF NA	22
11 ALF PRODUCTS, INC.	430	80 COMPUTER AFFAIRS INC.	311	159 GW INSTRUMENTS	147	229 MERRITT COMP PRODUCTS	436
404 ALPHA MICRO	313	* COMPUTER CONTINUUM	440	160 H & S ELECTRONICS	104	230 METACOMCO	138
13 ALPS AMERICA	60, 61	409 COMPUTER BARN	452	* HARMONY COMPUTERS	403	231 MICRO DATA BASE SYS.	19
14 ALPS AMERICA	60, 61	* COMPUTER CHRONICLES	344	392 HEATH COMPANY	331	232 MICRO INTERFACE CORP.	375
15 ALSYS LTD	216, 217	* COMPUTER CONTINUUM	424	162 HENHOUSE ELECTRONICS	402	234 MICRO MART, INC.	57
16 AMBER SYSTEMS	109	83 COMPUTER FRIENDS	107	163 HERCULES COMPUTER TECH.	252	235 MICRO PRODUCTS INT'L	451
17 AMBER SYSTEMS	109	86 COMPUTER MAIL ORDER	196, 197	164 HERITAGE SYSTEMS CORP.	438	236 MICRO SUPPLY	435
20 AMERICAN COMP & PERIPH.	173	87 COMPUTER PARTS MART	419	166 HOOLEON COMPANY	352	237 MICROBRIDGE COMP INT'L	430
21 AMERICAN COMP & PERIPH.	173	88 COMPUTER SURPLUS STORE	403	167 HOOLEON COMPANY	352	238 MICROGRAFX	17
23 AMERICAN SEMICONDUCTOR	428	89 COMPUTER WAREHOUSE	243	168 HOUSTON INSTR. BAUSCHELOMB	21	* MICROILLUSIONS	395
24 AMERICAN SMALL BUSN. COMP	141	90 COMPUTER WAREHOUSE	243	169 HOWARD W. SAMS CO	108	* MICROMINT INC.	422
25 AMPRO COMPUTERS INC.	397	22 COMP WAREHOUSE STORE	450	170 HYMCO TECHNOLOGIES INC.	340	240 MICROPRO INT'L	118, 119
* ANTHRO CORP.	16	91 COMPUTERBANC	427	172 IBEX COMP CORP.	436	241 MICROPROCESSORS UNLTD	436
* APROTEK	424	94 COMPUTRADE	398	173 IBM/SMALL SYSTEMS DIV.	213	242 MICROSIM CORP.	331
26 ARITY CORPORATION	158	95 CONCORD TECHNOLOGY CO	400	174 IBS CORP.	74	* MICROSIM CORP.	331
28 ASHTON-TATE	94, 95	96 CONROYLAPOINTE	160, 161	175 IBS CORP.	74	* MICROSOFT CORP.	59
29 AST RESEARCH INC.	12, 13	97 CONROYLAPOINTE	160, 161	176 I.C. EXPRESS	438	244 MICROTECH	452
30 AST RESEARCH INC.	12, 13	98 CONROYLAPOINTE	160, 161	179 INNOVATIVE SOFTWARE	250, 251	245 MICROWAY	67
* AT&T GENERAL	317	99 CORDATA	115	* INTECTRA INC.	430	246 MICROWAY	288
31 ATRON CORP.	284	399 COSMOS INC.	309	180 INTEGRAND RESEARCH CORP.	140	10 MIX SOFTWARE	241
32 ATRONICS INT'L INC.	93	102 CUESTA SYSTEMS	56	181 INTEREX	334	247 MOUNTAIN VIEW PRESS	154
* AVOCET	362	103 CURTIS, INC.	450	182 INTERNATIONAL COMPUTING	452	248 M-S CORPORATION	428
33 B&B ELECTRONICS	430	104 D AND D DISCOUNT	431	* IO TECHNOLOGIES	392	250 MYSTIC CANYON SOFTWARE	430
* B&C MICROSYSTEMS	428	105 DAC SOFTWARE INC.	47	185 JACO ENTERPRISES	452	251 NANAQ USA CORP.	295
* B&C MICROSYSTEMS	428	107 DATA EXCHANGE	452	186 JADE COMP PROD.	448, 449	252 NANAQ USA CORP.	295
34 BARRINGTON SYSTEMS	26, 27	108 DATA SPEC	397	187 IAMECO ELECTRONICS	444, 445	253 NANTUCKET	39
36 BAY EXPRESS	430	109 DATA SPEC	397	188 IC INFORMATION SYSTEMS	207	254 NANTUCKET	39
37 BAY TECHNICAL ASSOC.	117	110 DATATECH ENTERPRISE	383	189 IC INFORMATION SYSTEMS	207	255 NAT'L PUBLIC DOMAIN SFTW.	450
* BEST WESTERN INT'L	374	111 DECISIONWARE INC.	330	190 IDR INSTRUMENTS	277	256 NATIONAL INSTRUMENTS	213
38 BINARY TECHNOLOGY	436	112 DECISIONWARE INC.	330	191 IDR MICRODEVICES	453	257 NATIONAL MEMORY SYSTEMS	401
39 BITTNER ELECTRONICS	452	113 DICONIX	262, 263	192 IDR MICRODEVICES	454, 455	258 NEC HOME ELECTR/USA	189
40 BITWISE DESIGN COMPANY	206	114 DIGITALK INC.	268	193 IDR MICRODEVICES	456, 457	259 NEC INFORMATION SYS.	CHI
450 BIX	378, 379	115 DISKOTECH	438	194 IDR MICRODEVICES	458	260 NIC TECHNOLOGY INC.	376
41 BLAISE COMPUTING INC.	230	116 DISKETTE CONNECTION	387	195 IVB ELECTRONICS	436	261 NICOLET PARATRONICS	248
42 BLAISE COMPUTING INC.	230	117 DISKS 'N THINGS	395	196 KADAK PRODUCTS LTD	419	262 NORTHEASTERN SOFTWARE CO.	79
43 BLAISE COMPUTING INC.	231	118 DISKS PLUS	398	390 KEA SYSTEMS	436	263 OHIO CACHE SYS. CORP.	153
44 BLAISE COMPUTING INC.	231	120 DISKWORLD, INC.	424, 425	197 KEITHLEY DAC	438	264 OMNITRONIX, INC.	434
45 BORLAND INT'L	CHI, 1	121 DISPLAY TELECOMMUNCTS	278	198 KEY TRONIC CORP.	355	265 ORCHID TECHNOLOGY	155
46 BORLAND INT'L	CHI, 1	122 DIVERSIFIED COMPUTER SYS.	452	199 KIMTRON CORP.	305	266 ORCHID TECHNOLOGY	155
47 BORLAND INT'L	31	123 DIVERSIFIED GROUP THE.	441	200 KIMTRON CORP.	305	267 ORION INSTRUMENTS	164
48 BORLAND INT'L	31	124 DOBERMAN SOFTWARE	310	202 LABORATORY MICROSYS	348	* OSBORNE/MCGRAW-HILL	239
49 BORLAND INT'L	33	125 DOKAY COMP PROD INC.	432	211 LAPTOP SYSTEMS	382	268 OSBORNE/MCGRAW-HILL	367
50 BORLAND INT'L	33	* DRESSELHAUS COMP PROD	248	203 LATTICE, INC.	99	269 PC COMPUTER BROKERS INC.	434
51 BORLAND INT'L	35	126 EARTH COMPUTERS	58	204 LAWSON LABS, INC.	434	270 PC HORIZONS INC.	419
52 BORLAND INT'L	35	127 EARTH COMPUTERS	58	205 LEADING EDGE PROD.	55	272 PACIFIC EXCHANGES	405
53 BP MICROSYSTEMS	440	128 ECOSOFT	353	206 LIFEBOAT ASSOC.	203	275 PC AMERICAN	418
54 BROWN BAG SOFTWARE	314	129 ELEXOR INC.	434	207 LINTEK COMP. ACCESSORIES	490	276 PC MART	249
92 BTE COMPUTERS	68	130 ELLIS COMPUTING INC.	77	208 LOGICAL DEVICES	388	277 PC NETWORK	80, 80 A-B, 81
55 BUDGET COMPUTERS	440	131 ENERTRONICS RESEARCH	201	209 LOGICAL DEVICES	389	278 PC SIG	419
57 BUSINESS TOOLS INC.	339	133 EVEREX SYSTEMS	37	210 LOGICAL SYSTEMS CORP.	424	* PC'S LIMITED	368 A-B
* BUYER'S MART SECTION	410-417	134 EVEREX SYSTEMS	37	400 LOGICSOFT	48 A-F	279 PC'S LIMITED	369
* BYTE BACK ISSUES	399	137 FLAGSTAFF ENGINEERING	346	212 LOGITECH INC.	41	393 PC STAR PROD	377
* BYTE BOOK CLUB	384, 385	138 FLAGSTAFF ENGINEERING	346	213 LOGITECH INC.	349	394 PC STAR PROD	377
397 BYTE CONNECTION, THE	420	139 FORESIGHT RESOURCES CORP.	159	214 LONE STAR SOFTWARE	426	401 PERMA POWER ELECTRONICS	247
398 BYTE CONNECTION, THE	420	140 FORESIGHT RESOURCES CORP.	159	215 LUCKY COMPUTERS	440	402 PERMA POWER ELECTRONICS	247
* BYTE SUB MESSAGE	402	141 FORMAT SOFTWARE	48	216 LYCO COMPUTER	390	281 PERSOFT INC.	8
* BYTE SUB SERVICE	372	142 FORMAT SOFTWARE	48	* MACMILLAN BOOK CLUBS	320, 321	282 PERSONAL TEX, INC.	70
58 BYTEK COMP SYS. CORP.	296	143 FORTRON CORPORATION	76	396 MACNEAL SCHWENDLER CORP.	342	283 PINE COMPUTER INC.	439
* C WARE/DESMET C.	74	144 FORTRON CORPORATION	76	217 MANX SOFTWARE SYS.	139	284 PRINTER ACCESSORIES DIRECT	400
* CALIFORNIA DIGITAL	446, 447	145 FORTRON CORPORATION	437	218 MANX SOFTWARE SYS.	279	395 PRINTING & GRAPHIC ENHANCE	224
59 CAPITAL EQUIPMENT CORP.	380	146 FORTRON CORPORATION	437	219 MARCHAND INTERNATIONAL	450	285 PROFESSOR JONES, INC.	452
60 CAUZIN SYSTEMS	183					286 PROGRAMMER'S SHOP	327
101 CEC	144					287 PROSOFT	43
62 CHALCEDONY SOFTWARE	64					288 PURPLE COMPUTING	452
63 CHALCEDONY SOFTWARE	64					289 QUA TECH, INC.	424
64 CHORUS DATA SYSTEMS	112					290 QUA TECH, INC.	424
65 CITIZEN AMERICA	273					291 QUA TECH, INC.	430
68 CMS	266					292 QUA TECH, INC.	430
69 CMS	266					* QUAD SOFTWARE LTD	332
* CODEX CORPORATION	338					294 QUALITY PRINTERS	405

TO GET FURTHER information on the products advertised in BYTE, either pick up your touch-tone telephone and use TIPS (if you are a subscriber), or fill out the reader service card. Either way full instructions are provided following this reader service index which is provided as an additional service by the publisher, who assumes no liability for errors or omissions. *Correspond directly with company.

BYTE READER SERVICE



Fill out this coupon carefully. PLEASE PRINT. Requests cannot be honored unless the zip code is included. This card is valid for 6 months from cover date.

Name _____ JULY 1986
4176
(Title) _____ (Company) _____
Address _____ Telephone _____
City _____ State _____ Zip _____

I purchased this copy by Subscription Newsstand, computer store, or bookstore

1 23 45 67 89	111 133 155 177 199	221 243 265 287 309	331 353 375 397 419	441 463 485 507 529	551 573 595 617 639	661 683 705 727 749	771 793
2 24 46 68 90	112 134 156 178 200	222 244 266 288 310	332 354 376 398 420	442 464 486 508 530	552 574 596 618 640	662 684 706 728 750	772 794
3 25 47 69 91	113 135 157 179 201	223 245 267 289 311	333 355 377 399 421	443 465 487 509 531	553 575 597 619 641	663 685 707 729 751	773 795
4 26 48 70 92	114 136 158 180 202	224 246 268 290 312	334 356 378 400 422	444 466 488 510 532	554 576 598 620 642	664 686 708 730 752	774 796
5 27 49 71 93	115 137 159 181 203	225 247 269 291 313	335 357 379 401 423	445 467 489 511 533	555 577 599 621 643	665 687 709 731 753	775 797
6 28 50 72 94	116 138 160 182 204	226 248 270 292 314	336 358 380 402 424	446 468 490 512 534	556 578 600 622 644	666 688 710 732 754	776 798
7 29 51 73 95	117 139 161 183 205	227 249 271 293 315	337 359 381 403 425	447 469 491 513 535	557 579 601 623 645	667 689 711 733 755	777 799
8 30 52 74 96	118 140 162 184 206	228 250 272 294 316	338 360 382 404 426	448 470 492 514 536	558 580 602 624 646	668 690 712 734 756	778 800
9 31 53 75 97	119 141 163 185 207	229 251 273 295 317	339 361 383 405 427	449 471 493 515 537	559 581 603 625 647	669 691 713 735 757	779 801
10 32 54 76 98	120 142 164 186 208	230 252 274 296 318	340 362 384 406 428	450 472 494 516 538	560 582 604 626 648	670 692 714 736 758	780 802
11 33 55 77 99	121 143 165 187 209	231 253 275 297 319	341 363 385 407 429	451 473 495 517 539	561 583 605 627 649	671 693 715 737 759	781 803
12 34 56 78 100	122 144 166 188 210	232 254 276 298 320	342 364 386 408 430	452 474 496 518 540	562 584 606 628 650	672 694 716 738 760	782 804
13 35 57 79 101	123 145 167 189 211	233 255 277 299 321	343 365 387 409 431	453 475 497 519 541	563 585 607 629 651	673 695 717 739 761	783 805
14 36 58 80 102	124 146 168 190 212	234 256 278 300 322	344 366 388 410 432	454 476 498 520 542	564 586 608 630 652	674 696 718 740 762	784 806
15 37 59 81 103	125 147 169 191 213	235 257 279 301 323	345 367 389 411 433	455 477 499 521 543	565 587 609 631 653	675 697 719 741 763	785 807
16 38 60 82 104	126 148 170 192 214	236 258 280 302 324	346 368 390 412 434	456 478 500 522 544	566 588 610 632 654	676 698 720 742 764	786 808
17 39 61 83 105	127 149 171 193 215	237 259 281 303 325	347 369 391 413 435	457 479 501 523 545	567 589 611 633 655	677 699 721 743 765	787 809
18 40 62 84 106	128 150 172 194 216	238 260 282 304 326	348 370 392 414 436	458 480 502 524 546	568 590 612 634 656	678 700 722 744 766	788 810
19 41 63 85 107	129 151 173 195 217	239 261 283 305 327	349 371 393 415 437	459 481 503 525 547	569 591 613 635 657	679 701 723 745 767	789 811
20 42 64 86 108	130 152 174 196 218	240 262 284 306 328	350 372 394 416 438	460 482 504 526 548	570 592 614 636 658	680 702 724 746 768	790 812
21 43 65 87 109	131 153 175 197 219	241 263 285 307 329	351 373 395 417 439	461 483 505 527 549	571 593 615 637 659	681 703 725 747 769	791 813
22 44 66 88 110	132 154 176 198 220	242 264 286 308 330	352 374 396 418 440	462 484 506 528 550	572 594 616 638 660	682 704 726 748 770	792 814

BYTE's BOMB is your direct line to the editor's desk. Each month, the two top-rated authors receive bonuses based on your evaluation. First look at the list of this month's articles and corresponding article numbers (located on the page preceding the Reader Service list) then rate each article you've read as Excellent, Good, Fair, or Poor based on your overall impression of the article by circling the appropriate number in each column below. Your feedback helps us produce the best possible magazine each month.

Article No.	1	2	3	4	5	6	7	8	9	10	11	12	13	14	15	16	17	18	19	20	21	22	23	24	25
Excellent	1	5	9	13	17	21	25	29	33	37	41	45	49	53	57	61	65	69	73	77	81	85	89	93	97
Good	2	6	10	14	18	22	26	30	34	38	42	46	50	54	58	62	66	70	74	78	82	86	90	94	98
Fair	3	7	11	15	19	23	27	31	35	39	43	47	51	55	59	63	67	71	75	79	83	87	91	95	99
Poor	4	8	12	16	20	24	28	32	36	40	44	48	52	56	60	64	68	72	76	80	84	88	92	96	100

Article No.	26	27	28	29	30	31	32	33	34	35	36	37	38	39	40	41	42	43	44	45	46	47	48	49	50
Excellent	101	105	109	113	117	121	125	129	133	137	141	145	149	153	157	161	165	169	173	177	181	185	189	193	197
Good	102	106	110	114	118	122	126	130	134	138	142	146	150	154	158	162	166	170	174	178	182	186	190	194	198
Fair	103	107	111	115	119	123	127	131	135	139	143	147	151	155	159	163	167	171	175	179	183	187	191	195	199
Poor	104	108	112	116	120	124	128	132	136	140	144	148	152	156	160	164	168	172	176	180	184	188	192	196	200

BYTE READER SERVICE



Fill out this coupon carefully. PLEASE PRINT. Requests cannot be honored unless the zip code is included. This card is valid for 6 months from cover date.

Name _____ JULY 1988
4178
(Title) _____ (Company) _____
Address _____ Telephone _____
City _____ State _____ Zip _____

I purchased this copy by Subscription Newsstand, computer store, or bookstore

1 23 45 67 89	111 133 155 177 199	221 243 265 287 309	331 353 375 397 419	441 463 485 507 529	551 573 595 617 639	661 683 705 727 749	771 793
2 24 46 68 90	112 134 156 178 200	222 244 266 288 310	332 354 376 398 420	442 464 486 508 530	552 574 596 618 640	662 684 706 728 750	772 794
3 25 47 69 91	113 135 157 179 201	223 245 267 289 311	333 355 377 399 421	443 465 487 509 531	553 575 597 619 641	663 685 707 729 751	773 795
4 26 48 70 92	114 136 158 180 202	224 246 268 290 312	334 356 378 400 422	444 466 488 510 532	554 576 598 620 642	664 686 708 730 752	774 796
5 27 49 71 93	115 137 159 181 203	225 247 269 291 313	335 357 379 401 423	445 467 489 511 533	555 577 599 621 643	665 687 709 731 753	775 797
6 28 50 72 94	116 138 160 182 204	226 248 270 292 314	336 358 380 402 424	446 468 490 512 534	556 578 600 622 644	666 688 710 732 754	776 798
7 29 51 73 95	117 139 161 183 205	227 249 271 293 315	337 359 381 403 425	447 469 491 513 535	557 579 601 623 645	667 689 711 733 755	777 799
8 30 52 74 96	118 140 162 184 206	228 250 272 294 316	338 360 382 404 426	448 470 492 514 536	558 580 602 624 646	668 690 712 734 756	778 800
9 31 53 75 97	119 141 163 185 207	229 251 273 295 317	339 361 383 405 427	449 471 493 515 537	559 581 603 625 647	669 691 713 735 757	779 801
10 32 54 76 98	120 142 164 186 208	230 252 274 296 318	340 362 384 406 428	450 472 494 516 538	560 582 604 626 648	670 692 714 736 758	780 802
11 33 55 77 99	121 143 165 187 209	231 253 275 297 319	341 363 385 407 429	451 473 495 517 539	561 583 605 627 649	671 693 715 737 759	781 803
12 34 56 78 100	122 144 166 188 210	232 254 276 298 320	342 364 386 408 430	452 474 496 518 540	562 584 606 628 650	672 694 716 738 760	782 804
13 35 57 79 101	123 145 167 189 211	233 255 277 299 321	343 365 387 409 431	453 475 497 519 541	563 585 607 629 651	673 695 717 739 761	783 805
14 36 58 80 102	124 146 168 190 212	234 256 278 300 322	344 366 388 410 432	454 476 498 520 542	564 586 608 630 652	674 696 718 740 762	784 806
15 37 59 81 103	125 147 169 191 213	235 257 279 301 323	345 367 389 411 433	455 477 499 521 543	565 587 609 631 653	675 697 719 741 763	785 807
16 38 60 82 104	126 148 170 192 214	236 258 280 302 324	346 368 390 412 434	456 478 500 522 544	566 588 610 632 654	676 698 720 742 764	786 808
17 39 61 83 105	127 149 171 193 215	237 259 281 303 325	347 369 391 413 435	457 479 501 523 545	567 589 611 633 655	677 699 721 743 765	787 809
18 40 62 84 106	128 150 172 194 216	238 260 282 304 326	348 370 392 414 436	458 480 502 524 546	568 590 612 634 656	678 700 722 744 766	788 810
19 41 63 85 107	129 151 173 195 217	239 261 283 305 327	349 371 393 415 437	459 481 503 525 547	569 591 613 635 657	679 701 723 745 767	789 811
20 42 64 86 108	130 152 174 196 218	240 262 284 306 328	350 372 394 416 438	460 482 504 526 548	570 592 614 636 658	680 702 724 746 768	790 812
21 43 65 87 109	131 153 175 197 219	241 263 285 307 329	351 373 395 417 439	461 483 505 527 549	571 593 615 637 659	681 703 725 747 769	791 813
22 44 66 88 110	132 154 176 198 220	242 264 286 308 330	352 374 396 418 440	462 484 506 528 550	572 594 616 638 660	682 704 726 748 770	792 814

To get further information on the products advertised in BYTE, fill out the reader service card with your name and address. Then circle the appropriate numbers for the advertisers you select from the list. Add a first-class stamp to the card, then drop it in the mail. Not only do you gain information, but our advertisers are encouraged to use the marketplace provided by BYTE. This helps us bring you a bigger BYTE. The index is provided as an additional service at no charge. No liability for errors or omissions.

PLACE
POSTAGE
HERE

BYTE

READER SERVICE
PO BOX 298
DALTON, MA 01227-0298
USA

PLACE
POSTAGE
HERE

BYTE

READER SERVICE
PO BOX 298
DALTON, MA 01227-0298
USA

BYTE



SUBSCRIPTIONS

4178

For a subscription to BYTE, please complete this card.

Name _____

Address _____

City _____

State _____ Zip _____ Country _____

Card No. _____

Expiration date _____

Four digits above name—Master Charge only _____

Signature _____ Date _____

Please allow eight weeks for processing. Thank you

	USA	Canada Mexico
<input type="checkbox"/> 1 year	<input type="checkbox"/> \$21	<input type="checkbox"/> \$23
<input type="checkbox"/> 2 years	<input type="checkbox"/> \$38	<input type="checkbox"/> \$42
<input type="checkbox"/> 3 years	<input type="checkbox"/> \$55	<input type="checkbox"/> \$61

- \$69. Europe (air delivery) payment enclosed
 \$37 Worldwide (surface mail) payment enclosed

(Air mail rates available upon request)

Please remit in US funds drawn on a US bank. Thank you.

- Check enclosed (Bonus: [North American only] one EXTRA issue—receive 13 issues for the price of 12)



- Bill me (North America only)

BYTE



SUBSCRIPTIONS

4178

For a subscription to BYTE, please complete this card.

Name _____

Address _____

City _____

State _____ Zip _____ Country _____

Card No. _____

Expiration date _____

Four digits above name—Master Charge only _____

Signature _____ Date _____

Please allow eight weeks for processing. Thank you

	USA	Canada Mexico
<input type="checkbox"/> 1 year	<input type="checkbox"/> \$21	<input type="checkbox"/> \$23
<input type="checkbox"/> 2 years	<input type="checkbox"/> \$38	<input type="checkbox"/> \$42
<input type="checkbox"/> 3 years	<input type="checkbox"/> \$55	<input type="checkbox"/> \$61

- \$69. Europe (air delivery) payment enclosed
 \$37 Worldwide (surface mail) payment enclosed

(Air mail rates available upon request)

Please remit in US funds drawn on a US bank. Thank you.

- Check enclosed (Bonus: [North American only] one EXTRA issue—receive 13 issues for the price of 12)



- Bill me (North America only)

*Note our special offer!
Send cash with your order
and receive 13 issues
for the price of 12 for
each year you subscribe.
(North America only, please.)*

Don't Miss An Issue!

Have BYTE delivered to your door.

Each month BYTE will bring you the latest in microcomputer technology.

DISCOVER and IMPLEMENT new ideas. Don't miss the original information presented in the pages of BYTE.

With BYTE you'll always be among the first to know about the important breakthroughs, worthwhile new equipment, and innovative projects in the world of computing.

CHALLENGE US to deliver the very best idea in microcomputers and advanced technology to you. Return the attached card today!

Subscribe to BYTE—the world's leading computer magazine.



NO POSTAGE
NECESSARY
IF MAILED
IN THE
UNITED STATES

BUSINESS REPLY MAIL
FIRST CLASS PERMIT NO. 39 MARTINSVILLE, NJ

POSTAGE WILL BE PAID BY ADDRESSEE

BYTE SUBSCRIPTIONS
PO Box 597
Martinsville, NJ 08836-9956
USA



NO POSTAGE
NECESSARY
IF MAILED
IN THE
UNITED STATES

BUSINESS REPLY MAIL
FIRST CLASS PERMIT NO. 39 MARTINSVILLE, NJ

POSTAGE WILL BE PAID BY ADDRESSEE

BYTE SUBSCRIPTIONS
PO Box 597
Martinsville, NJ 08836-9956
USA



PRINTERS' PROGRESS.

For what you
used to pay for
a 9-pin printer

now, you can buy
our fully-featured
24-pin printer.

Our new Pinwriter™ P6, P7 series dot matrix printers are the first 24-pin printers that list for as little as \$699. Or about what you would have paid for an ordinary 9-pin printer a year ago.

Now, that's progress. Especially when you consider our new printers have an advanced 24-pin printhead. And print data at 216 characters per second and crisp, dense letter-quality at up to 65 cps.

Actually these new Pinwriter dot matrix printers surpass every other printer in their price range. In their combination of speed, graphics resolution, the number of built-in fonts and low noise level.

None of which will surprise you if you know NEC printers. Because nobody does more with 24-pin technology than NEC. In fact, we now have more 24-pin printer models than any other manufacturer.

So if you're looking for a printer that will do more and do it better, just progress to your NEC dealer and you'll get it for less than you imagined.

You can see the Pinwriter P6, P7 and our other 24-pin printers at your local dealer. For more information, call 1-800-343-4418 (in MA 617-264-8635). Or write: NEC Information Systems, Dept. 1610, 1414 Massachusetts Ave., Boxborough, MA 01719.



**NEC PRINTERS. THEY ONLY STOP
WHEN YOU WANT THEM TO.**

NEC

NEC Information Systems, Inc.

Today's Lowest-Priced PC/XT Compatible

Tandy® 1200

A mirror image of the
IBM® PC/XT computer.

2-Disk Tandy 1200*
Sale Priced at

\$999 Reg. 1499.00
Less Monitor
Save \$500

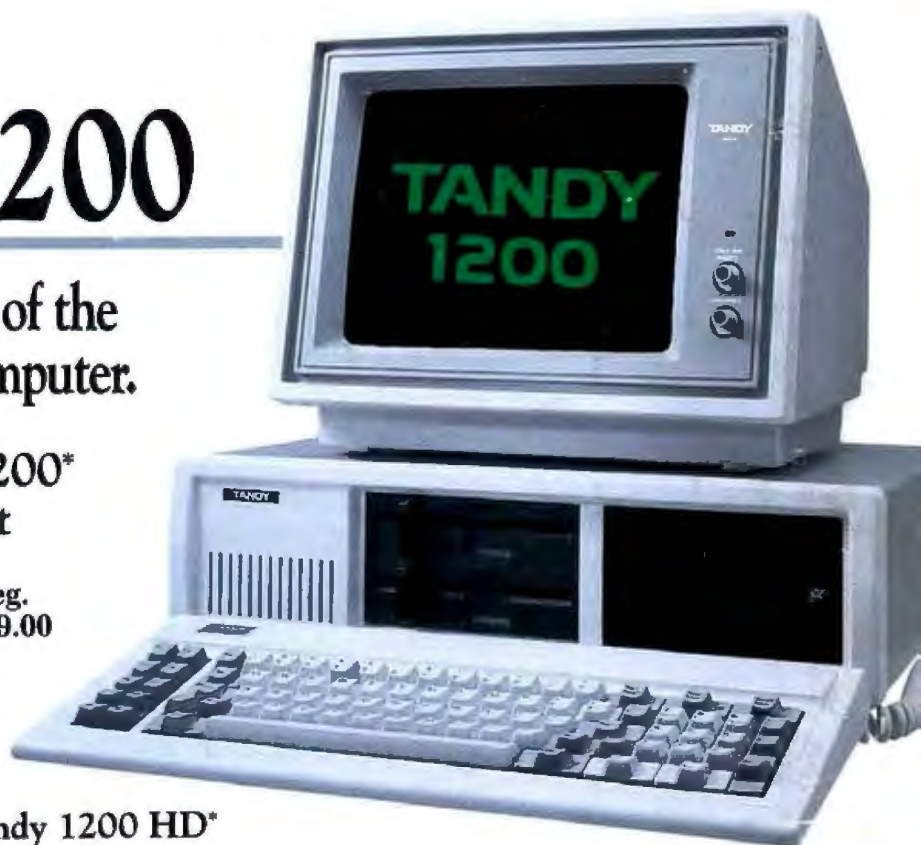

10-Megabyte Hard Disk Tandy 1200 HD*

Sale Priced at **\$1499** Reg. 1999.00 Save \$500

Get compatibility for less

How would you like a system that works like an IBM PC/XT, but costs much less? The Tandy 1200 is compatible with virtually all software and hardware designed for IBM's XT. And when you buy the Tandy 1200 at this special low price, you're getting the lowest-priced XT compatible—with the best in support available anywhere!

The best choice in software

The Tandy 1200 uses many popular MS-DOS® packages that are available off the shelf at Radio Shack Computer Centers, and through our exclusive Express Order Software service. Independent testing by Future Computing Inc. found the 1200 to be "operationally compatible with the IBM personal computer," which is their highest rating.

All the features you demand

The 2-disk Tandy 1200 (25-3001) comes with 256K RAM, expandable on board to 640K. A standard parallel

interface—an extra-cost option on the IBM—is included. Seven card slots are available for expansion.

Or for the ultimate in data-storage power, choose the Tandy 1200 HD (25-3000), with a 360K floppy drive, plus an internal 10-megabyte hard disk drive.

We back the Tandy 1200 with software, service agreements, credit and leasing terms, as well as professional instruction. Come in today—sale ends June 30, 1986.

System Overview

Microprocessor: Intel 8088, 4.77 MHz.

Memory: 256K RAM, expandable to 640K.

Storage: Tandy 1200—two 360K floppy drives.

Tandy 1200 HD—one 360K floppy and one 10-megabyte hard disk.

Internal Expansion: Seven card slots.

Available at over 1200
Radio Shack Computer Centers and at
participating Radio Shack stores and dealers.

Radio Shack®
COMPUTER CENTERS

A DIVISION OF TANDY CORPORATION

Prices apply at Radio Shack Computer Centers and participating stores and dealers. Monitor, adapter and MS-DOS sold separately. IBM/Registered TM International Business Machines Corp. MS-DOS/Registered TM Microsoft Corp. *Limited quantities available. Inquiry 296