

BYTE

THE SMALL SYSTEMS JOURNAL®

AUGUST 1986 VOL. 11, NO. 8

\$3.50 IN UNITED STATES
\$4.25 IN CANADA / £1.75 IN U.K.
A MCGRAW-HILL PUBLICATION
0360-5280

Object-Oriented Languages



ROBERT
BETTMAN

Turbo GameWorks™

Also recently released, Turbo GameWorks is what you think it is: "Games" and "Works." Games you can play right away (like Chess, Bridge and Go-Moku), plus the Works—which is how computer games work. All the secrets and

strategies of game theory are there for you to learn. You can play the games "as is" or modify them any which way you want. Source code is included to let you do that, and whether you want to write your own games or simply play the off-the-shelf games, Turbo GameWorks will give hours of diversion, education, and intrigue. George Koltanowski, Dean of American Chess, and former President, United States Chess Federation, reacted to Turbo GameWorks like this, "With Turbo GameWorks, you're on your way to becoming a master chess player," and Kit Woolsey, writer, author, and twice Champion of the Blue Ribbon Patra, wrote, "Now play the world's most popular card game—Bridge... even program your own bidding or scoring conventions." Suggested retail: \$69.95.



Turbo Graphix Toolbox™

It includes a library of graphics routines for Turbo Pascal programs. Lets even beginning programmers create high-resolution graphics with an IBM, Hercules,™ or compatible graphics adapter. Our Turbo Graphix Toolbox includes all the tools you'll ever need for complex business graphics, easy windowing, and storing screen images to memory. It comes complete with source code, ready to compile. Suggested retail: \$69.95.



Recognition for Borland International has come from business, trade, and media, and includes both product awards and awards for technical excellence and marketing. Borland was named "Company of the Year" by PC Magazine; SideKick, the #1 best seller for the IBM PC, was named "Product of the Year" by InfoWorld; Turbo Pascal was selected one of PC Week's Top 10 Products for 1984; SuperKey won one of PC Magazine's "Best of 1985" awards; Reflex, The Analyst was recognized in the "Software Products of the Year" awards by InfoWorld, and Reflex and SideKick were both nominated for British Micro Awards in 1986.



Turbo Database Toolbox™

A perfect complement to Turbo Pascal, because it contains a complete library of Pascal procedures that allows you to search and sort data and build powerful database applications. Having Turbo Database Toolbox means you don't have to reinvent the wheel each time you write a Turbo Pascal program. It comes with source code for a free sample database—right on disk. The database can be searched by keywords or numbers. Update, add, or delete records as needed. Just compile it and it's ready to go to work for you. Suggested retail: \$69.95.

Technical Specifications:

- TURBO PASCAL 3.0** Minimum memory: 128K. Includes 8087 and BCD features for 16-bit MS-DOS and CP/M-86 systems. CP/M-80 version minimum memory: 48K. 8087 and BCD features not available.
- TURBO DATABASE TOOLBOX** Minimum memory: 128K. CP/M-80 minimum memory: 48K. Requires Turbo Pascal 2.0 or later.
- TURBO GRAPHIX TOOLBOX™** Minimum memory: 192K. Requires PC/MS-DOS 2.0 or later, Turbo Pascal 3.0, and IBM CGA, Hercules Monochrome Card or equivalent.
- TURBO TUTOR 2.0** Minimum memory: 192K. CP/M-80 version minimum memory: 48K. Requires PC/MS-DOS 2.0 or later and Turbo Pascal 3.0.
- TURBO EDITOR TOOLBOX™** Minimum memory: 192K. Requires PC/MS-DOS 2.0 or later and Turbo Pascal 3.0.
- TURBO GAMEWORKS™** Minimum memory: 192K. Requires PC/MS-DOS 2.0 or later and Turbo Pascal 3.0.
- TURBO PROLOG™** Minimum memory: 384K.
- REFLEX: THE ANALYST™** Minimum memory: 384K. Requires IBM CGA, Hercules Monochrome Card or equivalent. Works with Intel's AboveBoard-PC and -AT, AST's RAMpage! and RAMpage! AT, Quadram's Liberty-PC and -AT, Tecmar's 640 Plus; IBM's EGA and 3270/PC; AT&T's 6300 and many others.
- REFLEX WORKSHOP™** Minimum memory: 384K. Requires Reflex: The Analyst. Two disk drives or hard disk recommended.
- TURBO LIGHTNING™** Minimum memory: 256K. Two disk drives required. Hard disk recommended.
- LIGHTNING WORD WIZARD™** Minimum memory: 256K. Requires Turbo Lightning. Turbo Pascal 3.0 required to edit source code.
- SIDEKICK™** Minimum memory: 128K.
- TRAVELING SIDEKICK™** Minimum memory: 256K.
- SUPERKEY™** Minimum memory: 128K.

*For IBM PC, AT, XT, PCjr and true compatibles only, running PC/MS-DOS 2.0 or later.





COMPLETELY
NEW VERSION!

Turbo Tutor® 2.0

Just released (July '86), the new Turbo Tutor can take you from "What's a computer?" on through to complex data structures, assembly languages, trees, tips on writing long programs in Turbo Pascal, and a



high level of expertise. Source code for everything is included. New split screens allow you to put source text in the bottom half of the screen and run the examples in the top half. There are quizzes that ask you, show you, tell you, teach you. You get a 450-page manual—which is not as daunting as it sounds, because unlike many software manuals, it was not written by orangutans. (With our all "almost-free" upgrade, you can upgrade to Turbo Tutor 2.0 by sending us your master diskettes, proof of purchase, and \$10.00, which covers shipping and handling.) Suggested retail: \$39.95.

NEW SPECIAL!

Turbo Pascal® 3.0

"For the IBM PC, the benchmark Pascal compiler is undoubtedly Borland International's Turbo Pascal," says Gary Ray of PC Week. We and more than 500,000 other people around the world think Mr. Ray got that right.



Since launch, Turbo Pascal has become the *de facto* worldwide standard in high-speed Pascal compilers. Described by Jeff Duntmann of PC Magazine as the "Language deal of the century," Turbo Pascal is now an even better deal than that—because we've included the most popular options (BCD reals and 8087 support). What used to cost \$124.95 is now only \$99.95! You now get a lot more for a lot less: the compiler, a completely integrated programming environment, and BCD reals and 8087 support—all for a suggested retail of only \$99.95.

Turbo Editor Toolbox™

Recently released, we called our new Turbo Editor Toolbox a "construction set to write your own word processor." Peter Feldmann of PC Magazine covered it pretty well with, "A 'write your own word processor'



program for intermediate level programmers, with lots of help in the form of prewritten procedures covering everything from word wrap to pull-down windows."

Source code is included, and we also include MicroStar, a full-blown text editor with pull-down menus and windowing. It interfaces directly with Turbo Lightning to let you spell-check your MicroStar files. Jerry Pournelle of BYTE magazine said, "The new Turbo Editor Toolbox is the Turbo Pascal source code to just about anything you ever wanted a PC-compatible text editor to do." Suggested retail: \$69.95.



Borland's Business Productivity Programs:

Reflex: The Analyst Analytical database manager. Provides complete new look at data normally hidden by programs like 1-2-3* and dBASE* Best report generator for 1-2-3.

NEW! Reflex Workshop Important new addition to Reflex: The Analyst. Gives you 22 different templates to run your business right.

SideKick Complete RAM-resident desktop management includes notepad, dialer, calculator and more

Traveling SideKick Electronic version of business/personal diaries, daytime organizers; works with your SideKick files; important professional tool.

SuperKey Keyboard enhancer. Simple macros turn 1000 keystrokes into 1. Also encrypts your files to keep confidential files confidential.

Borland's Electronic Reference Programs:

Turbo Lightning Works with all your programs and checks your spelling while you type! Includes 80,000-word Random House* Concise Dictionary and 50,000-word Random House Thesaurus. Forerunner of Turbo Lightning Library

Lightning Word Wizard Includes ingenious crossword solver and six other word challenges. If you're into programming, Lightning Word Wizard is also a development toolbox and the technical reference manual for Turbo Lightning

All Borland products are registered trademarks or trademarks of Borland International, Inc. or Borland/Analytica, Inc. 1-2-3 is a registered trademark of Lotus Development Corp. dBASE is a registered trademark of Ashton-Tate. Random House is a registered trademark of Random House, Inc. Hercules is a trademark of Hercules Computer Tech. IBM, AT, XT, and PCjr are registered trademarks of International Business Machines Corp. Copyright 1986 Borland International BI-1067

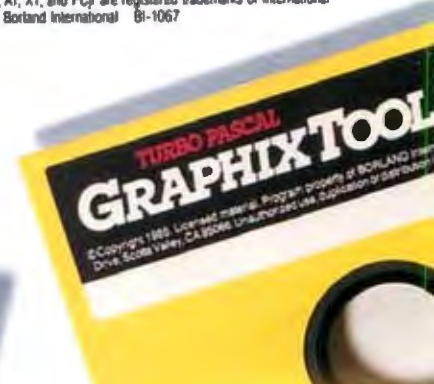



We frequently surprise people with inventive, imaginative software, and people frequently surprise us with the way they use it.

For example, you'll read on this page how Michael J. Watkins of the Petroleum Technology Center in Houston, Texas,

used Turbo Pascal® (and Turbo Graphix Toolbox™ and Turbo Tutor®) to cut down the tedium and time in creating Circular Performance Profile Charts (CPPCs).

We didn't know they existed, but you learn something new every day!

Applications like CPPCs might not fit your exact needs, but at the same time they might stimulate fresh ideas in your mind about how you can put Turbo Pascal and the Turbo Pascal family to work for you.

And thank you for your interest in and support for Borland International.

Philippe Kahn,
President, Borland International

INSIDE STORIES!

- Turbo Pascal 3.0, already described by *PC Magazine* as "Language deal of the century," is now an even better deal than that, because we've included the most popular options (BCD reals and 8087 support). What used to cost \$124.95 is now only \$99.95!
- Completely new Turbo Tutor 2.0 now available. New software. New manual. New split screens. New quizzes. Only \$39.95. Upgrades available under Borland's "Almost-Free" upgrade plan. Details inside.

LATE NEWS!

- June/July Special Artificial Intelligence Issue of *The Micro Technical Journal* says, "Turbo Prolog looks like it's going to be a winner, for both the beginner and professional programmer."

Turbo Pascal deliberately programmed to go around in circles

Circular charts (or CPPCs) are used by Michael J. Watkins of the Petroleum Technology Center in Houston, Texas, to plot a single performance property for a large number of elastomers, which have elastic, rubber-like properties.

Mr. Watkins wrote us saying, "Because CPPCs condense a lot of data in one graphic, they can be very tedious and time-consuming to draw."

What he did to solve these problems was to write a Turbo Pascal program for IBM® personal computers to "generate these charts quickly and easily."

He used Turbo Pascal "because it has a companion set of very powerful graphics programs (Turbo Graphix Toolbox) which greatly simplifies the required programming.

Turbo Pascal is not a difficult language to use and can be easily learned by persons who can program in FORTRAN or BASIC. An excellent tutorial (Turbo Tutor) is available for the novice or experienced programmer. The Turbo Pascal products are also very moderately priced."



*"The computer is no better than its program."
Elting Morison, author of "Men, Machines and Modern Times"*

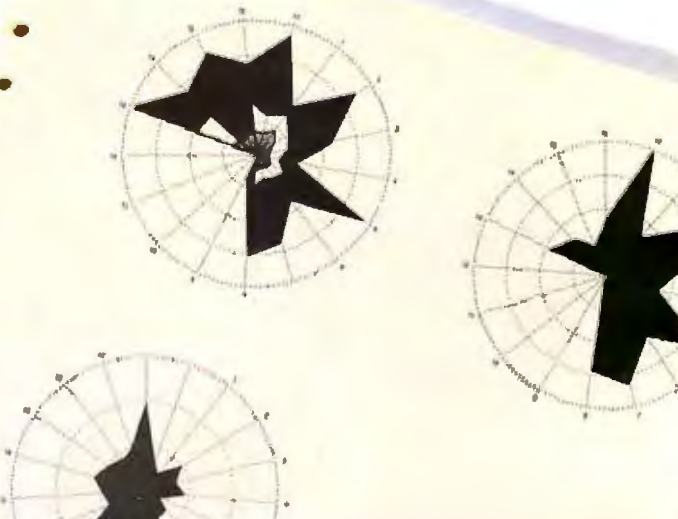

Step-by-step tutorial, demo programs with source code included!

Borland's new Turbo Prolog is the powerful, completely natural introduction to Artificial Intelligence

Prolog is probably one of the most powerful computer programming languages ever conceived, which is why we've made it our *second language*—and "turbo-charged" it to create Turbo Prolog.

Our new Turbo Prolog, the natural language of Artificial Intelligence, brings supercomputer power to your IBM® PC and introduces you step-by-step to the fascinating new world of Artificial Intelligence. And does all this for an astounding \$99.95.

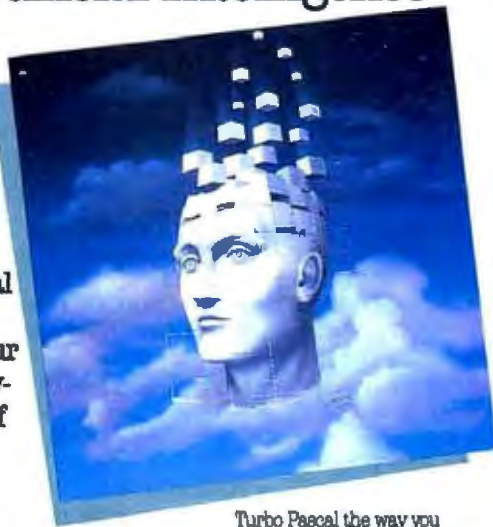

Turbo Prolog is to Prolog what Turbo Pascal® is to Pascal!

Our Turbo Pascal astonished everyone who thought of Pascal as "just another language." We changed all that—and now Turbo Pascal is the de facto worldwide standard, with hundreds of thousands of enthusiasts and users in universities, research centers, schools, and with professional programmers, students, and hobbyists.

You can expect at least the same impact from Turbo Prolog, because while Turbo Prolog is the most revolutionary and natural programming language, it is also a complete development environment—just like Turbo Pascal. Minimum memory: 384K

“ Turbo Prolog offers generally the fastest and most approachable implementation of Prolog.

Darryl Rubin, AI Expert **”**

Even if you've never programmed before, our free tutorial will get you started right away

You'll get started right away because we have included a complete step-by-step tutorial as part of the 200-page Turbo Prolog Reference Manual. Our tutorial will take you by the hand and teach you everything you're likely to need to know about Turbo Prolog and artificial intelligence.

For example: once you've completed the tutorial, you'll be able to design your own expert systems utilizing Turbo Prolog's powerful problem-solving capabilities.

Think of Turbo Prolog as a high-speed electronic detective. First you feed it information and teach it rules. Then Turbo Prolog "thinks" the problem through and comes up with all the reasonable answers—almost instantly.

If you think that this is amazing, you just need to remember that Turbo Prolog is a 5th-generation language—and the kind of language that 21st century computers will use routinely. In fact, you can compare Turbo Prolog to

Turbo Pascal the way you could compare Turbo Pascal to machine language.

You get the complete Turbo Prolog programming system for only \$99.95

You get a complete Turbo Prolog development system including:

- The lightning-fast Turbo Prolog incremental compiler and the interactive Turbo Prolog editor.
- The 200-page reference manual which includes the step-by-step Turbo Prolog tutorial.
- The free GeoBase™ natural query language database including commented source code on a disk—ready to compile. GeoBase is a complete database designed and developed around U.S. geography. It includes cities, mountains, rivers, and highways, and comes complete with natural query language. Use GeoBase immediately "as is," or modify it to fit your own interests.

So don't delay—don't waste a second—get Turbo Prolog now. \$99.95 is an amazingly small price to pay to become an immediate authority—an instant expert on artificial intelligence! The 21st century is only one phone call away.

YES! I want the best!
For credit card orders or the dealer nearest you
call (800) 255-8008
in CA call (800) 742-1133

Copies	Product	Price	Total
—	Turbo Prolog	\$99.95	\$
—	Reflex: The Analyst	149.95*	\$
—	Reflex Workshop	69.95*	\$
—	Reflex, Reflex Workshop	189.95*	\$
—	Turbo Pascal 3.0 w/8087 & i802	99.95	\$
—	Turbo Pascal for CP/M-80	69.95	\$
—	Turbo Database Toolbox	69.95	\$
—	Turbo Grapher Toolbox	69.95	\$
—	Turbo Tutor 2.0	39.95	\$
—	Turbo Editor Toolbox	69.95	\$
—	Turbo GameWorks	69.95	\$
—	Turbo Lightning	89.95	\$
—	Lightning Word Wizard	69.95	\$
—	Turbo Lightning, Lightning Word Wizard	149.95	\$
—	SideKick	64.95	\$
—	Travelling SideKick	69.95*	\$
—	SideKick, Travelling SideKick	129.00*	\$
—	SuperKey	69.95	\$
Outside USA add \$10 per copy CA and MA res. add sales tax			
Amount enclosed		\$	

Prices include shipping to all US cities.

Carefully describe your computer system:

Micro is: 8-bit 16-bit

I use: PC-DOS CP/M-80 MS-DOS CP/M-86

My computer's name and model is:

The disk size I use is: 3 1/2" 5 1/4" 8"

Payment: VISA MC Money order Check

Credit card expiration date: / /

Card #

NOT COPY PROTECTED GF15

**90-DAY MONEY-BACK GUARANTEE

Name:

Shipping Address:

City:

State:

Zip:

Telephone:

CODs and purchase orders WILL NOT be accepted by Borland. Outside USA make payment by bank draft, payable in US dollars drawn on a US bank.

*Limited Time Offer until September 1, 1986.

**YES, if within 90 days of purchase you find that this product does not perform in accordance with our claims, call our customer service department and we will gladly arrange a refund.

Prices subject to change without notice.

Turbo Prolog 1.0 Technical Specifications

Compiler: Incremental compiler generating native in-line code and linkable object modules. The linking format includes a linker and is compatible with the PC-DOS linker. Large memory model support. Compiles over 2500 lines per minute on a standard IBM PC.

Interactive Editor: The system includes a powerful interactive text editor. If the compiler detects an error, the editor automatically positions the cursor appropriately in the source code. At run-time, Turbo Prolog programs can call the editor, and view the running program's source code.

Type System: A flexible object-oriented type system is supported.

Windowing Support: The system supports both graphic and text windows.

Input/Output: Full I/O facilities, including formatted I/O, streams, and random access files.

Numeric Ranges: Integers—32767 to 32767, Reals 1E-307 to 1E+308

Debugging: Complete built-in trace debugging capabilities allowing single stepping of programs.



4585 SCOTT'S VALLEY DRIVE
SCOTT'S VALLEY, CA 95066
(408) 438-8400 TELEX 172373

Vive la différence

Inquiry 42 for End-Users. Inquiry 43 for DEALERS ONLY.



CONTENTS



82



136

FEATURES

- INTRODUCTION** 82
- SIMILARITY MAPPING** by Rob Spencer 85
This Microsoft BASIC program for the Macintosh can create "maps" from tables of distance data.
- CIARCIA'S CIRCUIT CELLAR: PARALLEL INTERFACING: A TUTORIAL DISCUSSION, PART 2: APPLICATIONS** by Steve Ciarcia 97
Steve briefly looks at some specific interface adapters.
- THE DEFINICON 68020 COPROCESSOR, PART 2: SOFTWARE SUPPORT** by Trevor Marshall, Christopher Jones, and Sigi Kluger 108
The conclusion of this article focuses on the software available for the DS1-020 coprocessor board for IBM PC XTs, ATs, and work-alikes.
- MATHEMATICS OF PROGRAMMING** by C.A.R. Hoare 115
Programs written using mathematical laws promise significant benefits.
- PROGRAMMING INSIGHT: POLAR NORMAL DISTRIBUTION** by Alain Latour 131
This complex method of generating normal deviates offers distinct advantages.

THEME: OBJECT-ORIENTED LANGUAGES

- INTRODUCTION** 136
- ELEMENTS OF OBJECT-ORIENTED PROGRAMMING** by Geoffrey A. Pascoe 139
An analysis of just what makes a language object-oriented.
- A SMALL TASTE OF SMALLTALK** by Ted Kaehler and Dave Patterson 145
An introduction to programming in the oldest of the object-oriented languages.
- OBJECTS, ICONS, AND SOFTWARE-ICS** by Brad Cox and Bill Hunt 161
Reusable software components help designers achieve pleasant user interfaces.
- OBJECT-ORIENTED LANGUAGES FOR THE MACINTOSH** by Kurt J. Schmucker 177
A look at seven languages and their features.
- MACAPP: AN APPLICATION FRAMEWORK** by Kurt J. Schmucker 189
A tool for Macintosh applications developers is soon to be released.
- PROGRAMMING EXPERIENCES** by Larry Tesler 195
Interviews with satisfied users of object-oriented languages.
- DESIGNING AN EFFICIENT LANGUAGE** by Charles B. Duff 211
The architect of Neon—and more recently, Actor—discusses his design philosophy.
- OBJECT-ORIENTED FORTH** by Dick Pountain 227
Incorporate a new object-oriented mechanism into FORTH programs.

REVIEWS

- INTRODUCTION** 236
- REVIEWER'S NOTEBOOK** by Jon Edwards 239
- THE NCR PC6** by Arthur Little 241
A robust IBM PC compatible with two clock rates.
- THE SPERRY PC/IT** by Frederick D. Davis 247
A fast IBM PC AT-compatible machine designed for multiuser applications.

BYTE (ISSN 0360-9280) is published monthly with one extra issue per year by McGraw-Hill Inc. Founder: James H. McGraw (1860-1948). Executive, editorial, circulation, and advertising offices: One Phoenix Mill Lane, Peterborough, NH 03458, phone (603) 924-9281. Office hours: Monday through Thursday 9:30 AM - 4:30 PM, Friday 9:30 AM - 1:00 PM, Eastern Time. Address subscriptions to BYTE Subscriptions, PO Box 590, Monticello, NJ 08836. Postmaster send address changes: USPS Form 1579, undeliverable copies, and fulfillment questions to BYTE Subscriptions, PO Box 596, Monticello, NJ 08836. Second-class postage paid at Peterborough, NH 03458 and additional mailing offices. Postage paid at Winnipeg, Manitoba. Registration number 9321. Subscriptions are \$21 for one year, \$38 for two years, and \$55 for three years in the U.S. and its possessions, in Canada and Mexico \$23 for one year, \$43 for two years, \$61 for three years; \$69 for one year air delivery to Europe, 11,000 yen for one year air delivery to Japan, 15,600 yen for one year surface delivery to Japan, \$37 surface delivery elsewhere. Air delivery to selected areas at additional rates upon request. Single copy price is \$7.50 in the U.S. and its possessions, \$4.25 in Canada and Mexico, \$4.90 in Europe, and \$5 elsewhere. Foreign subscriptions and sales should be remitted in U.S. funds drawn on a U.S. bank. Please allow six to eight weeks for delivery of first issue. Printed in the United States of America.

BYTE August

VOLUME 11, NUMBER 8, 1986

DESNET C DEVELOPMENT PACKAGE FOR THE MACINTOSH by Jonathan Robie	253
An inexpensive but fast C compiler.	
TOPSI 2.0 by Leonard Moskowitz	261
An MS-DOS version of the OPS5 production system language.	
LET'S C AND CSD by William G. Wong	267
A software package and a symbolic debugger for learning and developing programs in C.	
NEWWORD 3 by John Heilborn and Nanci Reel	273
This latest NewWord is faster than its previous versions.	
REFLEX by Rusef DeMaria	277
An analytical database loaded with unique features.	
GURU by Ernest R. Tello	281
Powerful, integrated software with an expert-system shell.	
THE DATRAN MODEM ACCELERATOR by Barry Nance	289
An add-on board and software combination that compresses text files.	
REVIEW FEEDBACK	295
Readers respond to previous reviews.	

KERNEL

INTRODUCTION	296
COMPUTING AT CHAOS MANOR: OFF WE GO by Jerry Pournelle	299
Jerry visits the Air Force Academy and the West Coast Computer Faire.	
APPLICATIONS ONLY: MORE WORDS by Ezra Shapiro	319
The flood of word processors for MS-DOS machines continues.	
ACCORDING TO WEBSTER: GOING TO THE FAIRE by Bruce Webster	323
Bruce also makes trips to Commodore and Atari.	
BYTE JAPAN: FUJITSU PROCESSOR UPGRADE by William M. Raikie	329
This upgrade could make UNIX-based systems more common in Japan.	
MATHEMATICAL RECREATIONS: NUMBER GAMES by Robert T. Kurosaka	333
Old tricks can be explored much easier with a computer.	

BEST OF BIX

AMIGA	344	MACINTOSH	354
ATARI ST	347	OBJECT-ORIENTED PROGRAMMING LANGUAGES	357
IBM PC AND COMPATIBLES	351	CIRCUIT CELLAR FEEDBACK	54
EDITORIAL:		BOOK REVIEWS	63
PROGRESS ON SOURCE CODE LISTINGS ..	6	EVENT QUEUE	78
MICROBYTES	9	CHAOS MANOR MAIL	341
LETTERS	14	DISKS AND DOWNLOADS	405
WHAT'S NEW	29	BYTE'S ONGOING MONITOR BOX:	
CLUBS AND NEWSLETTERS	48	BOMB RESULTS	406
FIXES AND UPDATES	49	READER SERVICE	407
ASK BYTE	50		



236



296

Address editorial correspondence to Editor, BYTE, One Phoenix Mill Lane, Peterborough, NH 03458. Unacceptable manuscripts will be returned if accompanied by sufficient postage. Not responsible for lost manuscripts or photos. Opinions expressed by the authors are not necessarily those of BYTE. Copyright © 1986 by McGraw-Hill Inc. All rights reserved. Trademark registered in the United States Patent and Trademark Office. Where necessary, permission is granted by the copyright owner for libraries and others registered with the Copyright Clearance Center (CCC) to photocopy any article herein for the flat fee of \$1.50 per copy of the article or any part thereof. Correspondence and payment should be sent directly to the CCC, 29 Congress St., Salem, MA 01970. Specify ISSN 0360-9280/83 \$1.50. Copying done for other than personal or internal reference use without the permission of McGraw-Hill Inc. is prohibited. Requests for special permission or bulk orders should be addressed to the publisher, BYTE is available in microform from University Microfilms International, 300 North Zeeb Rd., Dept. PR, Ann Arbor, MI 48106 or 18 Bedford Row, Dept. PR, London WC1R 4EJ, England. Subscription questions or problems should be addressed to: BYTE Subscriber Service, P.O. Box 328, Hancock, NH 03449.



MANAGING EDITOR, BYTE
FREDERIC S. LANGA

ASSISTANT MANAGING EDITOR

GLENN HARTWIG
CONSULTING EDITORS
STEVE CIARCIA
JERRY POURNELLE
EZRA SHAPIRO
BRUCE WEBSTER

SENIOR TECHNICAL EDITORS

ION R. EDWARDS, *Reviews*
G. MICHAEL VOSE, *Themes*
GREGG WILLIAMS, *Features*
TECHNICAL EDITORS
DENNIS ALLEN
RICHARD GREHAN
KEN SHELDON
GEORGE STEWART
JANE MORRILL TAZELAAR
TOM THOMPSON
CHARLES D. WESTON
EVA WHITE

STANLEY WszOLA

ASSOCIATE TECHNICAL EDITORS

CURTIS FRANKLIN, JR., *Best of BIX*
MARGARET COOK GURNEY, *Book Reviews*
BRENDA McLAUGHLIN, *Applications Software Reviews*,
San Francisco

COPY EDITORS

BUD SADLER, *Chief*
FAITH HANSON
NANCY HAYES
CATHY KINGERY
PAULA NOONAN
WARREN WILLIAMSON
JUDY WINKLER

ASSISTANTS

PEGGY DUNHAM, *Office Manager*
MARTHA HICKS
JUNE N. SHELDON

ADVERTISING SALES

DENNIS J. RILEY, *Director of Sales and Marketing*
SANDRA FOSTER, *Administrative Assistant*
ADVERTISING/PRODUCTION (603-924-6448)

LISA WOZMAK, *Supervisor*
ROBERT D. HANNINGS, *Senior Account Coordinator*
MARION CARLSON
KAREN CILLEY
LYDA CLARK
MICHELE JACKSON
WAI CHIU LI, *Quality Control Manager*

JULIE MURPHREE, *Advertising/Production Coordinator*

MARKETING COMMUNICATIONS

HORACE T. HOWLAND, *Director (603-924-3424)*
VICKI REYNOLDS, *Promotion Manager*
LISA JO STEINER, *Marketing Assistant*
STEPHANIE WARNESKY, *Marketing Art Director*
SHARON PRICE, *Associate Art Director*
WILBUR S. WATSON, *Operations Manager, Exhibits*

RESEARCH

PATRICIA AKERLEY, *Research Manager*
JULIE PERRON, *Market Research Analyst*
CYNTHIA DAMATO SANDS, *Reader Service Coordinator*

NEWS AND TECHNOLOGY

GENE SMARTE, *Bureau Chief, Costa Mesa*
RICH MALLORY, *Senior Technical Editor, New York*
PHILLIP ROBINSON, *Senior Technical Editor, San Mateo*
CINDY KIDDOD, *Editorial Assistant, San Francisco*
ASSOCIATE NEWS EDITORS
DENNIS BARKER, *Microbytes*
CATHRYN BASKIN, *What's New*
ANNE FISCHER LENT, *What's New*

CONTRIBUTING EDITORS

JONATHAN AMSTERDAM, *programming projects*
MARK DAHMKE, *video, operating systems*
MARK HAAS, *at large*
RIK JADRNICEK, *CAD, graphics, spreadsheets*
ROBERT T. KUROSAKA, *mathematical recreations*
PHIL LOPICCOLO, *computers in medicine*
ALASTAIR J. W. MAYER, *software*
ALAN R. MILLER, *languages and engineering*
DICK POUNTAIN, *U.K.*
ROGER POWELL, *computers and music*
WILLIAM M. RAIKE, *Japan*

ART

NANCY RICE, *Art Director*
IAN MULLER, *Art Assistant*
ALAN EASTON, *Drafting*

PRODUCTION

DAVID R. ANDERSON, *Production Director*
DENISE CHARTRAND
MICHAEL J. LONSKY
VIRGINIA REARDON

TYPOGRAPHY

SHERRY MCCARTHY, *Chief Typographer*
LEN LORETTE
DONNA SWEENEY

PLANNING AND DEVELOPMENT/PUBLIC RELATIONS
(603-924-7255)

MICHELE P. VERVILLE, *Manager*
FAITH KUWITZ, *Copyrights Coordinator*

FINANCIAL SERVICES

PHILIP L. PENNY, *Director of Finance and Services*
KENNETH A. KING, *Business Manager*
CHRISTINE LEE, *Assistant*
VICKI WESTON, *Accounting Manager*
LINDA SHORT, *D/P Manager*
EDSON WARE, *Credit*
MARILYN HAIGH
DIANE HENRY
VERN ROCKWELL
JOANN WALTER

PUBLISHER'S ASSISTANT

BEVERLY JACKSON

EXECUTIVE EDITOR, BIX
GEORGE BOND

SENIOR EDITOR

DAVID BETZ
ASSOCIATE EDITORS
TONY LOCKWOOD
DONNA OSGOOD, *San Francisco*

BUSINESS AND MARKETING

DOUG WEBSTER, *Director, (603) 924-9027*
PATRICIA BAUSUM, *Secretary*
BRIAN WARNOCK, *Customer Service*
DENISE A. GREENE, *Customer Service*
TAMMY BURGESS, *Customer Credit and Billing*

TECHNOLOGY

CLAYTON LISLE, *Director, Business Systems Technology, MHIS*
BILL GARRISON, *Business Systems Analyst*
JACK REILLY, *Business Systems Analyst*
LINDA WOLFF, *Senior Business Systems Analyst*

Officers of McGraw-Hill Information Systems Company: President, Richard B. Miller; Executive Vice Presidents, Frederick P. Jannott, Construction Information Group; Russell C. White, Computers and Communications Information Group; Thomas Ryan, Marketing and International; Senior Vice Presidents, Francis A. Shinal, Controller; Robert C. Violette, Manufacturing and Technology; Senior Vice Presidents and Publishers, Laurence Altman, Electronics Week; Harry L. Brown, BYTE; David J. McGrath, Construction Publications; Group Vice President, Peter B. McCuen, Communications Information; Vice President, Fred O. Jensen, Planning and Development.

Officers of McGraw-Hill, Inc.: Harold W. McGraw Jr., Chairman; Joseph L. Dionne, President and Chief Executive Officer; Robert N. Landes, Executive Vice President and Secretary; Walter D. Serwatka, Executive Vice President and Chief Financial Officer; Shel F. Asen, Senior Vice President, Manufacturing; Robert I. Bahash, Senior Vice President, Finance and Manufacturing; Ralph R. Schulz, Senior Vice President, Editorial; George R. Elstinger, Vice President, Circulation; Ralph J. Webb, Vice President and Treasurer.

BYTE, BIX, and The Small Systems Journal are registered trademarks of McGraw-Hill Inc.

CIRCULATION (800-258-5485)

ANDREW JACKSON, *Subscriptions Manager*
LAURIE SEAMANS, *Assistant Manager*
SUSAN BOYD
MARY EMERSON
LOUISE MENEGUS
AGNES E. PERRY
JENNIFER PRICE
JAMES BINGHAM, *Single-Copy Sales Manager*
CATHY A. RUTHERFORD, *Assistant Manager*
CLAUDETTE CARSWELL
KAREN DESROCHES

PERSONNEL

CHERYL HURD, *Office Manager*
PATRICIA BURKE, *Personnel Coordinator*

BUILDING SERVICES/TRAFFIC

ANTHONY BENNETT, *Building Services Manager*
BRIAN HIGGINS
MARK MONKTON

RECEPTIONIST

DONNA HEALY

EDITORIAL AND BUSINESS OFFICE: One Phoenix Mill Lane, Peterborough, New Hampshire 03458 (603) 924-9281.

West Coast Offices: 425 Battery St., San Francisco, CA 94111 (415) 954-9718; 951 Mariner's Island Blvd., San Mateo, CA 94404 (415) 954-9702; 3001 Red Hill Ave., Building #1, Suite 222, Costa Mesa, CA 92626 (714) 357-0292. New York Editorial Office: 1221 Avenue of the Americas, New York, NY 10020, (212) 512-2000.

Circuit-Board-Artwork Software for the Design Engineer in a Hurry

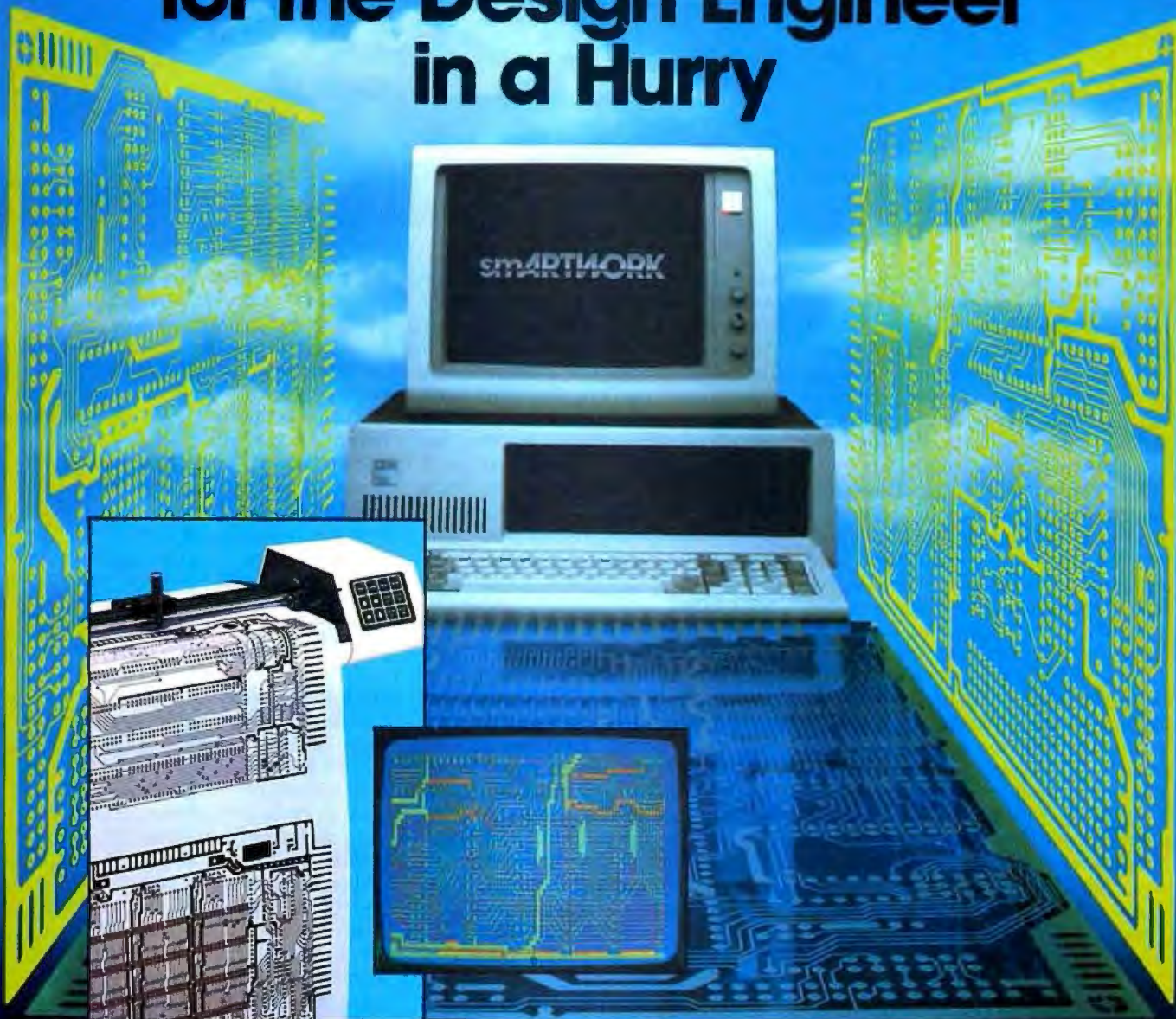

For only \$895, smARTWORK® lets the design engineer create and revise printed-circuit-board artwork on the IBM Personal Computer. You keep complete control over your circuit-board artwork — from start to finish.

Forget the tedium of taping it yourself or waiting for a technician, draftsman, or the CAD department to get to your project.

smARTWORK® is the only low-cost printed-circuit-board artwork editor with all these advantages:

- Complete interactive control over placement and routing
- Quick correction and revision
- Production-quality 2X artwork from a pen-and-ink plotter
- Prototype-quality 2X artwork from a dot-matrix printer

- Easy to learn and operate, yet capable of sophisticated layouts
- Single-sided and double-sided printed circuit boards up to 10 x 16 inches
- Multicolor or black-and-white display

System Requirements:

- IBM Personal Computer, XT, or AT with 256K RAM, 2 disk drives, and DOS Version 2.0 or later
- IBM Color/Graphics Adapter with RGB color or black-and-white monitor
- IBM Graphics Printer or Epson FX/MX/RX series dot-matrix printer
- Houston Instrument DMP-41 pen-and-ink plotter
- Optional Microsoft Mouse

The Smart Buy

At \$895, smARTWORK® is proven, convenient, fast, and a sound value. Call us today. And put it to work for yourself next week.



Wintek Corporation Inquiry 317
1801 South Street
Lafayette, IN 47904-2993
Telephone: (317) 742-8428
Telex: 70-9079 WINTEK CORP UD

In Europe contact: RIVA Terminals Limited,
Woking, Surrey GU21 5JY ENGLAND,
Telephone: 04862-71001, Telex: 859502

smARTWORK®, Wintek and the Wintek logo are registered trademarks of Wintek Corporation.

PROGRESS ON SOURCE CODE LISTINGS

We believe we are finally at the point of providing program listings for BYTE articles in ways that all BYTE readers will find satisfactory. You will have your choice of listings on disk, in print, by download from BYTEnet Listings, or by download from the BYTE Information Exchange (BIX).

Before explaining more about these four ways of receiving listings, let me explain what we have found out about your preferences. For years, some readers have complained that publishing complete listings in the magazine is silly. These readers generally want discussion of algorithms rather than complete programs, and they consider it out of the question to type in a program listing. These readers say nothing is duller than 10 consecutive pages of source code when the program doesn't interest you. If they want to run or study the program in detail, these readers say, they will download the listing.

Another set of readers has expressed the opposite preference: listings in print—and nothing less than listings in print. These readers say they seldom want to run programs; rather, they want to study source code alongside the article about the program. They want all articles laid out so that descriptive text is always beside the relevant passage of source code—something that is seldom possible under the best of circumstances. These readers' primary interest is to learn programming techniques and apply them in their own programs. Readers of this type have been understandably upset by our recent emphasis on the electronic publication of listings. Whenever these readers have written, we have sent them photocopies of specific listings on request. This has been a strain on our editorial assistants and has been inconvenient for the readers affected.

Our impression is that most readers want the program listings in machine-readable form. Readers who don't have modems want the source code listings on disk. In trying to satisfy this need, we have tied up several staff members in converting data from one disk format to another and in making copies in each format.

North American readers who do own

modems have expressed no dissatisfaction with the availability of listings, either through our three free bulletin boards or through our commercial service, BIX. Those who use the free bulletin boards must pay their own long-distance charges. Those who use BIX must pay a sign-up fee and connect-time charges, but they can call a local Tymnet node and avoid telephone tolls. Readers outside North America have faced high telephone tolls or data-communications charges in trying to get BYTE listings by modem.

SOLUTIONS

Starting in September, we will provide in BYTE postage-paid order cards for program listings in a choice of 12 disk formats. To make it possible to fulfill orders with acceptable efficiency, we had to limit the number of formats supported. But we have chosen the formats based on requests received over the past several months. We have also made an arrangement with a commercial disk-fulfillment service that will provide rapid turnaround on orders. The order card will permit you to subscribe to a year's listings on disk, if you wish. Readers will be able to subscribe to the listings on disk just as they subscribe to BYTE itself.

Also starting in September, we will offer quarterly printed volumes of source code to accompany BYTE articles. To help all readers catch up, we will first offer a single volume of printed listings to accompany the January-June 1986 issues. Thereafter, we will offer a volume of source code in the middle of the second month of each quarter. Readers will be able to subscribe to the listings in print if they prefer this medium to disk. The advantage of having the source code in volumes separate from the articles is that the reader will always be able to open both the listing and the article to the desired page. This solves the layout problem in the best possible way.

We are pricing the quarterly listings now. We want to hold the price as low as possible but must pay for paper, printing, shipping, postage, and handling. Our management thinks it unlikely that advertisers will want to buy space in a volume that consists entirely of program listings. Advertisements in BYTE's regular issues make

the magazine much less expensive to readers than it would otherwise be. The quarterly listings volume will probably have to derive all its support from the cover price. But the quarterly will contain many pages of source code in high-level languages—code for which there could never be room enough in BYTE itself.

For those who prefer to download listings, BYTEnet Listings will remain free (except for your own telephone tolls); BIX will continue to have a one-time \$25 sign-up fee and evening connect-time charges of \$9 per hour plus \$2 per hour Tymnet surcharge.

We hope every reader will find listings available in a satisfactory form.

PROGRESS ON BIX

BIX now (mid-June) has more than 6000 users and continues to grow rapidly. Growth was slowing system performance until we put four 68020s into the Arete 1200 in place of the three 68000s that were serving as processors. We also increased RAM from 4 megabytes to 8. Together with the twelve 68000s that handle I/O, the four 68020s have made the Arete run with blazing speed again. We are considering the use of multiplexers, to increase the capacity of each port, and Sun's Network File System, to go beyond the capacity of one Arete 1200.

David Betz, BIX senior editor and author of XLISP, has made a number of enhancements to the BIX code since joining us. His new cyclic redundancy check routines have made downloads through packet nets (Tymnet) quite reliable and accurate. Other enhancements will make BIX easier to use. Programmers in New York are at work on direct-debit billing and corporate billing options to make BIX accessible to those who prefer not to use MasterCard or Visa.

McGraw-Hill has decided to send out requests for quote to provide the hardware for the next generation of BIX. The Arete machines are very much in the running, as are a number of other supermicros and some superminis. One large timesharing service wants to host BIX on Cyber mainframes.

—Phil Lemmons
Editor in Chief

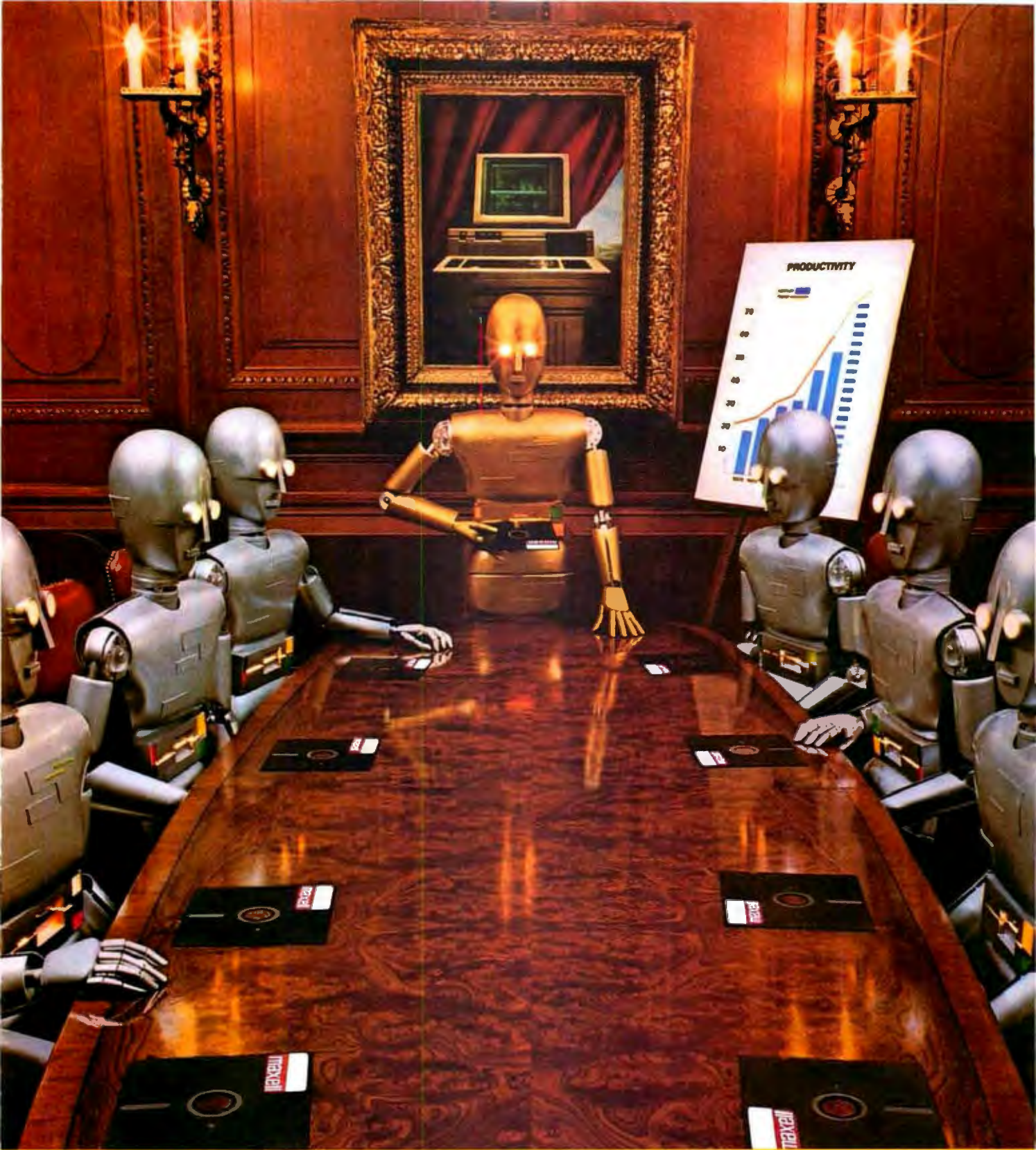

When computers get down to business, they move up to Maxell.

Maxell was first to provide you with a 5 1/4" high density floppy disk. Just another example of how we keep you a step ahead.



maxell.
THE GOLD STANDARD

Before you invest in a DEC®VT240 terminal, consider the software alternative.

Stop and think about what you really need: A text terminal. Tektronix® graphics. ReGIS® graphics. File transfer capabilities. Communications.

Purchasing a state-of-the-art terminal may be one option, but Persoft has a smarter solution—**SmarTerm® 240**, the ultimate in terminal emulation software.

SmarTerm can do everything the state-of-the-art terminal can do—and more. That's why we call it **state-of-the-smart**.

With SmarTerm 240, the emulation is so exact you'll forget you're using a PC. It features superior text emulation, ReGIS graphics, Tektronix graphics, outstanding communications and file transfer capabilities.

You also get on-line help screens, remappable keyboard layouts and programmable softkeys which can simplify your most frequently performed tasks. You can even customize your own menus!

And because SmarTerm runs on your PC, you've always got a wealth of computing power right at your fingertips.

All SmarTerm products are backed by Persoft's strong technical support network. It's a service you expect from the industry leader in terminal emulation software.

No matter which terminal you're currently using—Data General Dasher® D400, Tektronix 4010/4014, DEC VT100, VT125, VT220 or even the new VT240,



SmarTerm has a state-of-the-smart solution for you.

To find out more about the SmarTerm family of terminal emulation software, see your local dealer. Or contact: Persoft, Inc. 2740 Ski Lane Madison, WI 53713 (608) 273-6000 – Telex 759491

STATE OF THE ART

VS

STATE OF THE SMART

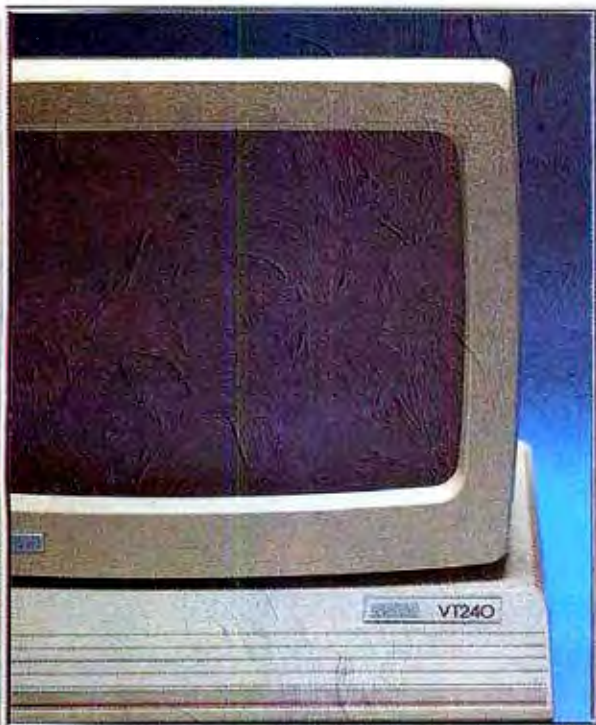

*SmarTerm is a registered trademark of Persoft, Inc. *DEC, VT and ReGIS, are trademarks of Digital Equipment Corp. *DASHER is a registered trademark of Data General Corp. *Tektronix is a registered trademark of Tektronix, Inc. © Persoft, Inc., 1988. All rights reserved.

persoft

Inquiry 228

CMU Researchers at Work on Storage Device, NAND Gate Based on Biological Materials

Researchers at Carnegie-Mellon University in Pittsburgh are at work on two digital electronics devices based on biological materials: a storage device that can pack data at a density of 1 gigabyte per square centimeter and a NAND gate that is 1000 times smaller than current NAND gate circuits.

According to Robert Birge, head of the chemistry department at CMU, the storage device is based on a protein called bacteriorhodopsin, which can exist in two states, each of which absorbs light at a different frequency. The state of each molecule can be read and flipped with a laser tuned to one of these frequencies.

In a prototype built by the CMU group, three molecules can hold 1 bit of data. This triad of molecules is relatively small, encompassing an area of approximately 100 square angstroms. Although the storage density in the prototype is 1 gigabyte per square centimeter, the small size of the triad implies that the theoretical molecular limit for data storage is 100,000 gigabytes per square centimeter.

The speed of these molecules is estimated at 10 picoseconds per transaction, much faster than the time required by any optical modulator to access the molecules with the laser light. The data-access rate for this device is thus a function of the speed of the optical modulator.

Bacteriorhodopsin, produced by a genetically modified strain of bacteria found originally in the salt marshes of San Francisco Bay, is said to be very stable and can stand up to high temperatures and high amounts of optical radiation. Birge and his colleagues are working on genetically modifying the bacterium to yield a protein that will perform satisfactorily at room temperatures.

The CMU group is talking with Seagate Technology regarding possible implementations of research results.

The NAND gate that's based on biological molecules will be composed of two cyanine/quinone complexes joined to a porphyrin molecule. If both cyanine groups are excited, for example, by two lasers, the porphyrin molecule will become excited. The excited porphyrin can in turn excite a chromophore molecule, which can be read by a third laser or can serve as input for another NAND gate.

Although an individual NAND gate has not yet been completed, Birge expects the gate to change states in a mere 3 picoseconds. As for size, at 10 nanometers per gate, the gates would be 100 times smaller than sizes predicted for future conventional NAND gates.

Funding for the NAND gate research is being supplied by IBM.

Cover Designed to Thwart Electronic Eavesdropping

In response to a report detailing the ease with which unauthorized persons can eavesdrop on computer terminals (see *Microbytes* in the March *BYTE*), a start-up company in Canada is planning to bring to market a flexible covering for terminals that will help eliminate this possibility. The new product, tentatively called the Erintec Security Canopy, is designed to absorb electromagnetic radiation emanating from a terminal's cathode-ray tube. Last year, a Dutch engineer named Wim van Eck demonstrated how easy it is to receive and decode that radiation. Using only an ordinary television, an antenna, and electronics parts worth about \$15, van Eck was able to eavesdrop on confidential information on a terminal screen located hundreds of yards away.

The canopy is made of metalized fabric and glass and completely encloses a terminal. The product was designed by an Irish research firm called Securi-Tek Ltd.; it will be marketed by the newly formed Erintec, of Toronto, in the fall. According to a company spokesperson, the price of the canopy has not been set, but it will probably be in the neighborhood of \$500.

(continued)

Ex-Apple Engineers Plan Card That Brings XT Compatibility to IIe

A start-up engineering firm headed by ex-employees of Apple Computer expects to give the venerable Apple II yet another life by adding IBM PC XT compatibility to the machine. The Engineering Department Inc. (Campbell, CA) hopes to have its Little Blue card for the Apple IIe in production and available by January 1987, according to marketing manager Dave Larson. The Engineering Department is headed by Wendell Sander, a former Apple engineer who designed the Apple III and the Integrated Woz Machine, a custom integrated disk controller used in the Apple IIc and Macintosh.

Based on a 7.2-MHz 8086 processor, the Little Blue design includes 640K bytes of user RAM, IBM CGA-compatible video, hard disk support (including the ability to store MS-DOS files on Apple hard disks such as the ProFile), and a socket for an 8087 math coprocessor.

Little Blue won't be the first attempt to bring IBM PC compatibility to the Apple II. One now-defunct product, the Rana Box, housed an 8088 in an external system with its own PC-style 5¼-inch disk drive. Little Blue is designed as an internal product that will be able to use newer Apple 3½-inch drives to read and write both Apple II and IBM PC XT software.

"Rana was external and it wasn't the right solution," Peter Quinn, executive vice-president of The Engineering Department, told BYTE/BIX. Quinn worked as hardware and product design manager of the Apple IIe and IIc and was an integrated circuit designer at Zilog. "The software alone will represent four man-years of development [when Little Blue is finished]," said Quinn. "There's a lot of skepticism [that it can be done], but we're not afraid."

Stanford Designs New RISC Chip

Engineers at Stanford University's Center for Integrated Systems have designed a microprocessor they say is capable of speeds of 20 million instructions per second and of running in parallel with others like it. The MIPS-X is a CMOS chip that uses the RISC (reduced instruction set computer) design. Although the actual chip has not been fabricated, one will be made this summer, according to Mark Horowitz, an assistant professor of electrical engineering and team leader of the project.

The 8- by 8.5-millimeter MIPS-X will contain 150,000 transistors. The MIPS-X project is the lineal descendant of one of the first RISC machines, the MIPS processor designed at Stanford by John Hennessey.

"In fairness, the 20 million instructions is really the peak, the best it could ever do," Horowitz said. "We hope to have an effective throughput of 10 million [to] 12 million instructions per second."

A computer built with 10 MIPS-X chips operating in parallel could perform as many as 100 million instructions per second, making it one of the fastest computers in the world. However, Horowitz said he has no intention of trying to build a computer system based on the MIPS-X chip. "If people who are doing work in operating systems and other kinds of software development are interested in using it, that's fine," he said.

NANOBYTES

VLSI Technology Inc. (Phoenix, AZ) and **Intel Corp.** (Santa Clara, CA) have teamed up to design and market the CMOS VL82C389 Message Passing Coprocessor (MPC) chip. According to the two companies, the MPC increases the reliability and decreases the power consumption of Multibus II boards by replacing as many as 50 chips. It handles interboard communications tasks and relieves the CPU of monitoring or directing those tasks. Use of the MPC could allow architects to fashion Multibus II systems with multiple 80386 boards, each dedicated to a particular part of a computing task. Intel used VLSI's software to design the 70,000-transistor chip, which is being manufactured by VLSI in CMOS technology. . . . **Corvus Systems Inc.** (San Jose, CA) says it is beta-testing a central processor for networks that is based on Intel's 32-bit 80386 microprocessor. Corvus calls the system a "departmental" processor and says that it would serve as the focal point of a LAN connecting several microcomputers. . . . **California State University, Northridge**, will host a three-hour presentation on the use of computers with learning-disabled students as part of the Computer Technology/Special Education/Rehabilitation conference, slated for October 16-18. For more information, contact Harry J. Murphy at CSU, Northridge, 18111 Nordhoff St., Northridge, CA 91330, (818) 885-2578. . . . Although the secrecy-shrouded **National Security Agency** will not comment on it directly, several sources in the security field say the NSA is withdrawing its support of the Data Encryption Standard (DES) and championing a new encryption scheme based on a classified algorithm that's being implemented only in hardware. The agency is apparently so adamant about keeping the algorithm secret that it is said to be investigating the use of special chips that will self-destruct if tampered with.

The last thing you want from your modem is excitement.

Ven-Tel modems let you use your phone to exchange information with PCs anywhere in the world. We think that's pretty exciting.

Getting line hits, dropped connections and incompleting calls from your modem can be thrilling in its own way, too. But that's not the kind of excitement you need in business. And we go to great lengths to make sure you don't get it.

At Ven-Tel we've been making more reliable modems since 1974.

Ven-Tel modems put less stress on your PC because they have fewer components—70 vs. the 300 or so in other modems. And while other manufacturers may settle for random testing, every Ven-Tel modem must pass a 72 hour "burn-in" period—plus extensive testing on real phone lines.

As good as Ven-Tel modems are, we still back every one with a free *five-year* warranty. No other major manufacturer even comes close.

So if you want a modem that won't add the wrong kind of excitement to your workday, you want Ven-Tel.

Ven-Tel
Modems

Our free 24-page booklet, "How To Select The Correct Modem," contains specific information about our full line of modems. To request your copy, call 800-538-5121. In California, call 408-727-5721.



SONY

TRUEVISION

PC CAROUSEL PRESENTATION VERSION 10



ATEC

TRUEVISION

IMAGE PROCESSING SOFTWARE VERSION 10



ATEC





See-worthy PC graphics from AT&T and Sony.

Computer graphics like you've never seen.

AT&T and Sony unlock the doors that have restrained creative use of the PC. With real-time frame capture and vivid color display that make PC graphics a breeze. AT&T Truevision™ hardware and software bring a new dimension to computer graphics—freedom. And that dimension is best displayed on Sony Trinitron™ computer monitors. Together, these products are changing the role of the PC forever.

Discover uncharted realism with Truevision.

The Truevision single-slot boards for AT&T- and IBM-compatible PCs let you capture TV-quality images from real life and display them in as many as 16.8 million colors. And with Truevision Image Processing Software you can manipulate those images or create your own from scratch, in ways and colors never before possible. Then arrange your images into an electronic slide show with PC Carousel Presentation Software. And send them to other locations over ordinary phone lines with Truevision Still-Frame Teleconferencing Software.

Sony sets you free.

See your images come to life on a Sony Trinitron computer monitor. Only Sony gives you the performance of Emmy award-winning Trinitron technology and the flexibility of both analog RGB and digital input. To produce the brightest colors, the sharpest text. In fact, Sony monitors have the finest dot pitch and the highest horizontal resolution of any monitors in their price class. And only Sony offers you such a wide selection, with screen sizes from 9 to 25 inches, and up to 200 inches in front projection.

Explore the depths of your imagination.

Set sail with AT&T and Sony. Truevision products are available to suit any application, from the Image Capture Board (32,768 colors) for only \$1,295 to the TARGA 24 (16.8 million colors) for \$3,995. Sony Trinitron computer monitors will display your images beautifully, starting at \$495.

AT&T and Sony have made PC graphics smooth sailing. For more information, or for the name of your nearest representative, call **1-800-858-TRUE.**



SONY

©1986 AT&T, Sony

Display shows unretouched TARGA 16 image on Sony CPD-1201 Monitor.

Truevision is a trademark of AT&T. Sony, Trinitron are registered trademarks of Sony Corporation. IBM is a registered trademark of International Business Machines Corp. Truevision design and development by: KLACAACCCJWHCBHRAKSGKBBRUSSJKSJAWANW

L·E·T·T·E·R·S

VOLLEYING ATARI AND AMIGA

Editor's note: The following two letters are representative of several we received on the subject, all of which were similar in opinion, if not in style.

In the May issue of *BYTE*, a letter appeared by Mike Farnsworth (page 16) giving a comparison of the Atari 520ST and the Amiga. Unfortunately, the letter contains some misinformation about the Amiga.

Concerning the Amiga, Mr. Farnsworth states, "In the low-resolution mode, those great graphics chips steal almost 75 percent... of the possible CPU time that could be used for other real-computer things." A more accurate description of the Amiga's bus timings can be found in the August 1985 *BYTE*. In brief, the Amiga's memory operates at exactly twice the speed of the CPU. Running at full speed, the CPU uses only half the memory cycle time available, leaving the other half to the custom chips. To fully utilize the 50 percent allotted to the custom chips, the Amiga could simultaneously read the disk, play four channels of audio, and show 16-color low-resolution bit-plane graphics and eight sprites with virtually no slowdown of the 68000. [Editor's note: See page 87 of the August 1985 issue for more details.] While higher screen resolution and high activity of the blitter (a custom graphics chip) will cause cycle stealing from the CPU, one must remember that these chips are doing work that would otherwise be done by the CPU, and they perform that work two to thirty times faster. As far as non-graphics timings, page 354 of the May *BYTE* contains a few benchmarks of the two machines. It should be noted that while the ST is somewhat faster in some benchmarks involving numeric computation, the expansion bus of the Amiga facilitates the addition of a math coprocessor (unlike the ST), which can speed calculations by an approximate factor of ten.

Looking at the same table on page 354, note that the difference in disk I/O ranges from a 315 percent advantage for the Amiga on disk writes, to a 25 percent advantage for the ST on random access. This brings up a point about the slowness of AmigaDOS in some activities. It is untrue, as stated, that the Amiga has anything in

common with the C-64 disk formats. Remember that the original operating system and hardware design was not done by Commodore but by Amiga. An excellent description of the AmigaDOS formats and operation can be found on page 321 of the February *BYTE*. In short, files and directory blocks are scattered on an Amiga disk. While this improves on error recovery compared to other disk formats, it is inherently slow in operations such as directory listings. Its slowness is in finding the file, but it's quick once the file is found.

Mr. Farnsworth also states that AmigaDOS is clumsy, though he gives no examples to substantiate this claim. Considering that one must reboot an ST to change from monochrome to color or from a windowing to a command-line interface, I can't see how AmigaDOS could be considered clumsy in comparison.

Finally, support for the ST has been praised. Note that about 300 to 500 pages of technical documentation on the ST can be obtained from Atari, while a full set of manuals for the Amiga contains slightly over 2000 pages. I personally doubt that Atari intends to support its customers via a support line. So from whom would you rather get support, an Amiga dealer or your local department store?

BERNIE J. LOFASO JR.
Austin, TX

The 68000 CPU used in the Amiga has about a 50 percent duty cycle. By that I mean it spends about half its time on the memory bus and the other half doing internal processing. The quoted clock figures for the Amiga are stated with respect to the CPU. In fact, the Amiga uses an internal clock with twice that speed (yielding about 14.4 MHz). The custom chips do 16-bit transfers in one of those cycles.

That means the custom chips can do one heck of a lot of transfers in the "off" cycles where the 68000 is twiddling its thumbs internally. The bus arbitration is handled, again, with the custom chips. Each of the 25 DMA channels has its own slots in the timing, which let it get its work done without interfering with the 68000.

What this means is that you can have a 320 by 400 by 4 display with four audio channels, the disk, the sprites, and the

68000 all going at the same time. The 68000 will see no contention! It doesn't even think those DMA channels are on the bus!

The blitter is a cycle-stealing device. It will use whatever cycles are not taken up by the other DMA channels and it will use the cycles normally reserved for the CPU. In normal blitter operation, it is set up to yield whenever the CPU tries to access memory on that bus. This means the CPU can get in to process interrupts, for instance, even if the blitter is in the midst of a large transfer.

The upshot is that blitter operations happen as fast as the memory can go, with 16-bit transfers continuously going at twice the memory bandwidth of the 68000, not even including any 68000 processing time that would be involved if you used it instead of the blitter. This is why the machine really screams for blitter-supported operations such as area move, area fill, and line draw.

The display coprocessor is also a cycle-stealing device. It allows raster-beam synchronized control of all the machine's custom chip functions without requiring the 68000 to take the time to perform an interrupt context switch. This is why we've got enough horsepower to slide screens around in real time while animation and graphics rendering is going on in the screens.

You can set up the display so the 68000 sees contention. The worst case is a four-plane high-res image, where the video bandwidth blocks the 68000 except during horizontal and vertical blanking intervals.

Note, however, that the 68000 can only
(continued)

LETTERS POLICY: To be considered for publication, a letter must be typed double-spaced on one side of the paper and must include your name and address. Comments and ideas should be expressed as clearly and concisely as possible. Listings and tables may be printed along with a letter if they are short and legible.

Because *BYTE* receives hundreds of letters each month, not all of them can be published. Letters will not be returned to authors. Generally, it takes four months from the time *BYTE* receives a letter until it is published.

LOOKING FOR THE BEST VALUE IN PC/AT COMPATIBLES?



INTRODUCING THE \$1495 A★STAR™

Looking for a lower priced, higher quality PC/AT compatible than our new A★Star™ is like looking for a needle in a haystack. You're more apt to come up with a case of hayfever.

A★Star gives you features you won't get from any other vendor. Not IBM. Not Compaq. Not even those foreign manufacturers. Features like a 220 watt power supply, eight available expansion slots and "network ready" multi-user operation. All for only \$1495. And that price includes a 1.2MB diskette drive, 512KB memory, a fixed disk/diskette drive controller, a tactile feedback keyboard (you'll love it!) and a 6/8MHz switch/software selectable 80286 CPU.

Best of all, A★Star is quality built right here in America by Wells American Corporation - an American Stock Exchange manufacturer. So now you

can buy with confidence from a vendor you can trust, just like you've trusted IBM. And you'll get a genuine, top quality product (not a cheap imitation) for a price even less than those "questionable" mail order clones. And if that's not enough, it's all money-back guaranteed!

The \$1495 Wells American A★Star.™



A PC/AT FOR ONLY \$1495? THAT'S NOTHING TO SNEEZE AT!

(Hurry! This offer is limited.)

- I'm tired of sneezing! Have someone else buy it for me immediately to take my order.
- A★Star sounds terrific. Tell me more.

Name: _____
 Company: _____
 Phone: _____
 Address: _____
 City: _____
 State: _____ Zip: _____

 **Wells Am**
 803/796-7800•TWX
 Sunset Boulevard • West Colu

ATTN: SCH...
 NOT CO...
 Mail You...
 Pecan St...
 1470 - 39...
 Brooklyn...
 (718) 851...
 ITT TELEX...
 COMPUSE!
 Please add \$2...
 payable in US \$...
 UCSO Pascal let...
 Inquiry 225



Super Power Compatibility

The POWER SYSTEM™ from PECAN has set a new standard for comprehensiveness in program development environments that you won't find anywhere else:

PORTABILITY: Whether you're an ardent beginner or a seasoned pro, THE POWER SYSTEM lets you design software that can run on virtually any mini or micro without having to rewrite the program. The program you write on one computer will operate on another— even if the two hardware systems are incompatible. Your software never becomes obsolete — even if your hardware does.

INTEGRABILITY: The versatility and flexibility of THE POWER SYSTEM enables different users to exchange program modules freely with one another, even though the modules may be written in different programming languages.

LANGUAGE INTERCHANGEABILITY: THE POWER SYSTEM lets you customize the modules of your application in the most appropriate of Pecan's powerful languages including UCSD PASCAL, BASIC, FORTRAN-77, ASSEMBLER, or MODULA-2. Once you've created your multi-language program, the modules are linked automatically. The application then runs as if you'd written it all in one language.

THE POWER SYSTEM FEATURES:

- NATIVE CODE • SEPARATE COMPILATION OF UNITS • EXTENDED PRECISION ARITHMETIC
- DYNAMIC MEMORY MANAGEMENT • EVENT-DRIVEN MULTI-TASKING • CONFORMANT ARRAYS
- PROCEDURAL PARAMETERS • 8087 AND BCD SUPPORT (PC'S AND COMPATIBLES) • LARGE FILE EDITOR
- LIBRARY UTILITY • ON-LINE HELP SYSTEM • FILE MANAGER

THE POWER SYSTEM Only \$99.95

PC-DOS, MS-DOS, AMIGA, ATARI ST, MACINTOSH, RAINBOW, TANDY, STRIDE, as well as most regular 8/16/32 bit systems. Also available in VAX, UNIX, PDP-11 OS's & others.

THE POWER SYSTEM includes the language of your choice: UCSD PASCAL, MODULA-2, BASIC, ASSEMBLER and FORTRAN-77. Choose an additional language for only \$79.95. Buy three and we will give you a fourth one **FREE!**

For custom-tailor software, PECAN offers such programming tools as:

ASSEMBLER/NOG PACKAGE.....	\$79.95	SOFTTEACH TUTORIAL.....	\$49.95
SEQUENTIAL ACCESS METHOD....	\$59.95	MENUMAKER.....	\$49.95
OPTIMIZER.....	\$59.95	PROGRAM ANALYSIS TOOLKIT.....	\$59.95
PUBLIC DEBUGGER.....	\$59.95	SORT UTILITY.....	\$59.95

Write for complete list of development aids.

ATTENTION CORPORATIONS: Call and ask about our training seminars.
STUDENTS: Special Educational Discounts

BY PROTECTED

Check Or Money Order To:
Software Systems, Inc.
100 Street
New York 11218
1100
NUMBER: 494 8910
TELEPHONE CODE: 76703,520

PECAN™
The UCSD Pascal Company

Credit Card Orders **1-800-63-PECAN**
Call Toll Free
(NYS) 1-800-45-PECAN

For shipping within the US. Foreign orders add \$10.00 and make payment by bank draft or check on US bank. New York State residents add appropriate sales tax.
PECAN is a trademark of The Regents of University of California.

see contention on the internal RAM, never on the Writable Control Store RAM or on an external RAM (this is why the external RAM is referred to as "fast" RAM).

You can avoid contention by going to fewer bit planes (for instance, Workbench and the CLI use two planes of high resolution, yielding no contention) or by reducing the vertical size of your image (such as by using the litigation screens to make most of your display be at some other resolution).

Note that interlace is not an issue here. Yes, there is twice as much data to display, but remember that the machine takes two frames to display it.

The next revision of the hardware manual will include detailed information on the DMA priority and the time-slot allocations, for all you guys who want to run right at the edge.

The only (charitable) explanation I can come up with for someone to say that the Amiga custom chips slow down the 68000 by 70 percent in normal operation is that someone misread the chart showing the allocation of DMA channels to the off cycles and assumed that the 68000 was in fact capable of using those cycles. An 8-MHz 68000 can't. Does anybody have a 16-MHz 68000 they'd like to loan me?

ROBERT S. PARISEAU
Santa Clara, CA

EUROPEANS LEFT OUT OF THE TELECOMMUNICATIONS REVOLUTION

Although I agree with the tenor of your May editorial ("Let Our Modems Go"), there are some misunderstandings:

First, you are mixing international telephone fees with Datex-P fees. Only one of those applies to a given connection.

Second, although modem leasing is expensive, a Datex-P20 (PAD connection via your own line) is not much more expensive than a modem alone. The U.S. Air Force in Geilenkirchen uses this. A Datex-P line costs 130 deutsche marks (about \$57) per month and DM 200 for first-time installation. This is cheaper than comparable U.S. prices.

By the way, modems are part of the monopoly situation of the Bundespost. This will probably change quickly because of a lawsuit against the government.

So modems of some kind will become available on the free market after being approved (and having received a license number) by the ZZF (part of the Bundespost).

Technical problems: When I say "modems" I do not mean those units available in the U.S. The modems to which I

(continued)

New! Windows-Compatible In-a-Vision 1.1

FREE Microsoft Windows!
Limited Offer

Complex Drawing Made Easy

We created In-a-Vision just for you. The engineer who needs more productive drafting support. The designer who needs versatility for alternate ideas or quick revisions. The architect who needs to manage a variety of working drawings. And the businessman who needs first-class presentation materials as well as detailed flow charts and organization charts.

Point. Click. Draw.

Now all you do to create complex technical drawings, systems designs, blueprints, diagrams, illustrations, and proposals is point, click and draw. With In-a-Vision's mouse support, windowing, icons,

and pull-down menus, you produce drawings more quickly, accurately and efficiently than ever before. In-a-Vision's advanced technology includes many features not found on comparable systems costing thousands more. For example, you can pan around in a user-definable drawing space up to 68" x 68" and zoom in on specific areas for



FREE Microsoft® Windows from MICROGRAFX!®

If you purchase In-a-Vision directly from MICROGRAFX, we'll give you a free retail copy of Microsoft Windows so you can use In-a-Vision as part of a fully integrated working environment. Move instantly from In-a-Vision to other applications and back ... cut and paste text and drawings

greater detail. Scale, rotate and dimension symbols, fill an area with your choices of pre-defined colors and patterns, as well as draw lines with multiple styles and widths. Other features include overlays, predefined and user-definable page sizes, rulers, grids, and templates to speed popular applications.

Multi-tasking in a PC-based CAD system.

In-a-Vision uses multi-tasking to enable you to continue drawing while printing hard copies or edit multiple drawings simultaneously.

between applications ... and more!

We're confident you'll agree — In-a-Vision will make your complex drawing tasks simple and make you more productive. Satisfaction guaranteed.

TO ORDER CALL:
800-272-3729

Demo disk* or brochure available to qualified customers. In Texas or for customer support, call (214) 234-1769.

MICROGRAFX, Inc., 1820 North Greenville Avenue, Richardson, Texas 75081.



MICROGRAFX®
The Picture of Success.

Inquiry 193

(Most popular graphics cards, plotters, and printers supported.)
Microsoft Windows-compatible. Call for specific operating environment requirements.

* Demo requires MS Windows. Full demonstration system for users without Windows available for \$49.00.

In-a-Vision and MICROGRAFX are trademarks of MICROGRAFX, Inc.
Microsoft is a trademark of Microsoft, Inc.



Let Lab Boss™ turn your IBM PC into a powerful instrument controller.

You can spend thousands of dollars for a dedicated instrument controller. Or a few hundred for a controller that's dedicated to you and your IBM PC.

Lab Boss™ from National Instruments puts you and your IBM PC (or compatible) firmly in charge of GPIB instruments. From sophisticated laboratory equipment, like digitizing oscilloscopes and spectrometers, to standard printers, plotters, tape drives and more. At data transfer speeds

that are the highest in the industry.

And Lab Boss products offer a direct data link from your measuring equipment to a full range of analysis software, including RS/1, Lotus 1-2-3, and Symphony. So you can easily report your findings on the same system you used for

instrument control, data acquisition and analysis. Try that on a dedicated controller! So — you want to be the boss? Call National Instruments. 800/531-4742.

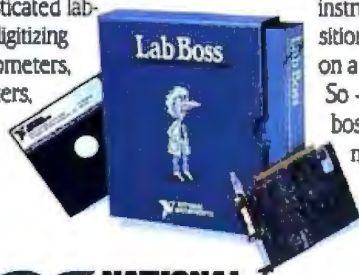

NATIONAL INSTRUMENTS
12109 Technology Blvd.
Austin, TX 78727 512/250-9119

refer use the CCITT conventions. So there will not be a direct market for Hayes-compatible modems here. I think.

A further complication is the different tone systems used in European nations.

Third, you can get into the network in several ways:

By telephone: A call to the PAD (one of 17 locations) is DM 0.23 for 0.5 to 12 minutes, depending on distance, plus DM 0.06 per minute telephone access costs.

By Datex-P line: If you own a Datex-P line, using the Post PAD facilities costs DM 0.05 per minute, plus:

By Datex-P10 line: If you have an X.25 equipment/line, it costs DM 0.20 per minute to the U.S. and DM 0.016 per segment, plus:

Any connection costs are DM 0.05 extra. Also, a segment is not a kilocharacter but 64 bytes or a packet, whichever comes first. This means an empty carriage return costs 1.6 pfennigs!

That last one is a difficulty Europeans (not just Germans) have with U.S. hosts, which sometimes echo single characters. This is extremely expensive for us. The next problem: Reversing charges does not work on international lines, but most of the U.S. hosts depend on this and charge users with connection fees, which they have already paid to their local authorities. So we have to pay twice for CIS, BIX, The Source, etc. And no one understands our problems, because all those companies think the whole world is just like the U.S. It is not!

If there is any way I can help you in learning the German (Austrian, Swiss) telecommunications networks, please don't hesitate to ask.

MATTHIAS R. MOHR
RMI Aachen
Aachen, West Germany

I thoroughly approve of, and appreciate, your editorial titled "Let Our Modems Go." I talked with some people in Belgium and France and quickly realized that the local PTT monopolies prevented them from joining the telecommunications revolution. Now I am moving from the University of Maryland into a permanent academic job in Geneva, Switzerland, and I am almost certain that I won't be able to connect from home to the mainframe any longer or pick up public domain software from a local bulletin board.

Furthermore, as teleconferences will surely become the new way of American academic communication in the near future (see the June 1984 BYTE), how long will I be left out of this development

(continued)

Introducing SixPakPremium.[™] Finally, Performance Exceeds Demand.

Also
Compatible with
Original IBM PC's & XT's

THE AST
PREMIUM
SERIES

WordStar.[®] Write a letter while running up to eight other applications.

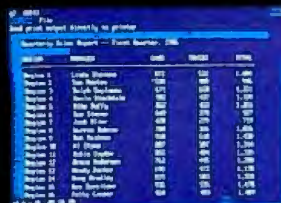

Lotus[®] 1-2-3.[®] All releases of 1-2-3 run in SixPakPremium's DESQview windows.

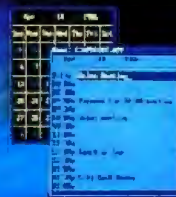
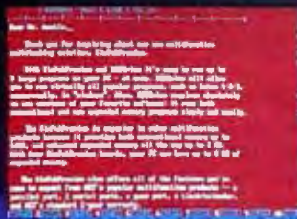

SideKick.[™] Keep track of schedules with popular desktop management programs.



Dow Jones.[®] Monitor on-line stock quotations while working on other projects.



dBASE II[®]/dBASE III.[®] Use any release of this popular data base to sort files while working on other applications.

AST Research announces a new generation in PC performance... SixPakPremium. Now one person and one PC have the power to meet the demands of business.

Designed for the new IBM[®] PC-XT, SixPakPremium is also fully compatible with original XT's and PC's. It offers popular multifunction features plus two full megabytes of expanded memory and the powerful software to use it.

Premium Performance. Run up to nine applications simultaneously. Sort a data base, write a letter, calculate a spreadsheet, monitor stock quotations, print labels... all at the same time... on the same PC! Windows let you view and access all nine applications instantly. You'll toggle between applications with no work flow interruption.

SixPakPremium is compatible with all

current applications for the PC, including new expanded memory applications like Lotus 1-2-3 Release 2.0. And over 200 of the most popular packages run in *our* windows.

Premium Features. SixPakPremium offers up to two megabytes of expanded memory, two serial ports, parallel port, game port, battery-backed clock/calendar, DESQview[™] software and SuperPak[™] utilities.

Premium Quality. As the world's leader in PC enhancement, with over a million products shipped, we're known for high-quality, reliable products.

Make The Premium Choice. For performance that exceeds demand, call our Customer Information Center

(714) 863-1480. Or send the coupon to AST Research, Inc., 2121 Alton Avenue, Irvine, California 92714.



Yes, I want to learn more about Premium Performance. Please send me your special SixPakPremium information package today!

Name _____

Title _____

Company _____

Address _____

City _____ State _____ Zip _____

Phone _____

SixPakPremium and SuperPak trademarks of AST Research, Inc. IBM registered trademarks of International Business Machines Corp. Lotus and 1-2-3 registered trademarks of Lotus Development Corp. DESQview trademark of Quarterdeck Office Systems. WordStar registered trademark of MicroPro International Corp. dBASE II and dBASE III registered trademarks and Framework trademark of Ashton-Tate. Dow Jones registered trademark of Dow Jones & Company Inc. SideKick trademark of Borland International. Copyright © AST Research, Inc., 1984. All rights reserved.

AST RESEARCH INC.

because of my move to Europe? If you know of any people or institutions in Geneva who are pushing to reform the system, please kindly send me their address so I can add my voice to theirs.

FRANKLIN MENDELS
Columbia, MD

I have been a longtime reader (and off-and-on subscriber) for many years now. Never has an issue arisen that has affected me to the point where I thought I had to

write. Until now, I've lived in France for two years and am scheduled to remain for another seven. I would like to share with you the horror story of access to BIX from France. This could explain why you might hear from me on BIX next summer, but not before.

You may use any 300- or 1200-baud modem that you can buy, as long as it has a French PTT agreement number.

You may use any telephone line as long as it corresponds to your name and ad-

dress on the application form (i.e., no using your friend's computer).

Now let's talk bucks:

- 70 francs (about \$10) one-time registration fee.
- 70 francs per month subscription.
- 0.77 franc per 20 minutes (local calls to server).
- 1.50 francs per minute (correct time to server), or about \$12.86 per hour.
- 43 francs (about \$6) per 64K bytes transmitted.

Help!

Anyhow, I took the liberty of sending photocopies of your editorial to the director of Network Services for the PTT, Jacques Chirac (new prime minister and minister of telecommunications). Not that any of this does any good. The only people who use large networks are rich companies. Right? Hah!

Keep up the good work at BYTE. (Some day I'll share with you the horror story of how long it takes the local bookstore to get BYTE, but as long as my subscription comes early...)

NAME WITHHELD
Paris, France

Why buy 3 packages to get a complete multi-user dBASE* System?



After all, FoxBASE is a compiler, an interpreter and a multi-user dBASE system all in one. That means single vendor support and no problems with product incompatibility.

Not only that, FoxBASE actually outperforms dBASE and other dBASE compiler products: its program execution speed is far superior to the competition and its compiler runs up to 60 times faster than other compilers. And FoxBASE is available

FoxBASE™
does it better.
For less.



for the widest variety of machines and operating systems.

In addition, FoxBASE is interactive and 100% dBASE compatible (including full macro usage). The only thing you won't get is all those annoying dBASE bugs!

Best of all, FoxBASE costs less than half the other packages.

So call (419) 874-0162 now, and ask for a copy of our comparative analysis (including benchmarks). After all...

Nothing Runs Like a Fox.

FoxBASE™ 

Fox Software, Inc.
27475 Holiday Lane, Perrysburg, OH 43551
(419) 874-0162

† Multi-User MOS - DOS version. Multi-User Xenix version also available for \$795

*dBase is a registered trademark of Ashton-Tate FoxBASE is a trademark of Fox Software, Inc. Clipper™ is a trademark of Hantucket

CRT RADIATION

In the May letters column ("CRTs Are Safe," page 24), William G. Nabor stated, "In my 12 years as a health physicist... I have yet to measure any ionizing radiation from any CRT, old or new, color or monochrome." Mr. Nabor further claimed that "... CRTs do not emit hazardous radiation. Period. Any claim to the contrary is misleading to the point of fraud." Perhaps Mr. Nabor should have stated that CRTs do not emit hazardous levels of radiation. He has not identified the radiation-monitoring instruments he has used to check CRTs. I have detected radiation from color CRTs by means of simple Geiger counters that I designed and built. I have also used a commercial Geiger counter for this purpose. Though the radiation level from CRTs is very low, it does exceed the background count. For example, the background count inside my office is typically 17 events per minute. The counts at the glass surfaces of two different color CRTs I checked are 28 and 35 events per minute. These counts are so very low that there is no cause for alarm. Indeed, a brick tile I checked generated 40 events per minute and a thorium mantle from a camping lantern registered a much more potent 0.3 milliroentgens per hour.

Incidentally, it is a simple matter to connect a Geiger counter to a computer to generate random numbers. One such pro-

(continued)

C FEVER *catch it!*

It's becoming an epidemic . . . everyone is switching to C! First there were a few hackers, then came the college students, next the major software houses, and now the rest of the programming world. Programmers everywhere are infected with the desire for SPEED, POWER, and PORTABILITY.

It's time to face the inevitable. You're going to catch the fever too! When you do, give us a call. We've got the best cure— an illustrated guide to the C language, plus a complete program development system. Everything you need to master the C programming language . . . all at a price that's less than the cost of a book!

But don't let this price fool you. Our system is powerful; it compiles twice as fast as the others, is completely standard, and it's very easy to use. Most C compilers are designed for wizards. We have designed ours for you!

What do you get for a mere \$39.95?

- A 150 Page book filled with sample programs, plus . . .
- A fast, standard, full featured C compiler that supports all data types and the latest features like bit fields, enumerations, structure assignment, and passing/returning structures.
- A *linker* that loads separately compiled files, searches libraries, and builds an executable program.
- An extensive library of more than 170 functions (including the standard C functions and the computer specific functions that provide direct access to the operating system and BIOS).
- *Tools* that allow you to optimize your programs for minimal space or maximum speed.



Works on all MSDOS/PCDOS and all CP/M Z80 COMPUTERS! (Not Copy Protected!)

The Powerful MIX
C COMPILER
Harness the Power of the C Language with this full featured Compiler

Incredible Value
\$39.95
AT ONLY **With 30 Day**
Money-Back Guarantee

Operators are standing by . . . Please use this Number for ORDERS ONLY!
CALL TOLL FREE FOR RUSH ORDER DELIVERY!

1-800-523-9520

IN TEXAS, PLEASE CALL TOLL FREE 1-800-622-4070

For Technical Support Please call 1-214-783-6001

MDX Software, Inc. / 2116 E. Arapaho / Suite 363 / Richardson, Texas 75081

Or contact our Worldwide Distributors direct in:

Canada: Saraguay Software 1-416-923-1500 Switzerland: DMB Communication CH 1-825-53-29
Australia: Techflow 047-586924 France: Info/Tech 1-43-44-06-48

Split Screen Text Editor

an Incredible Value **\$29.95** AT ONLY

(Not Copy Protected! Works on all MSDOS/PCDOS and CP/M Z80 Computers)

Our high powered editor is great for editing high level languages. It works just like Micropro's Wordstar[®] but macros allow you to create your own custom editor, and the split-screen feature lets you edit two files at the same time.



The MSDOS/PCDOS version is loaded with special features:

- Execute any DOS command or RUN other programs from the editor.
- Quickly edit files as large as 300,000 characters.
- Compile MIX C programs directly from memory. The editor automatically positions the cursor to the first error in your program

ASM UTILITY
an Incredible Value **\$10** AT ONLY



Call assembly language routines from your C programs. The ASM utility works with Microsoft's MASM or M80 assembler. Macros make it easy! Works just as if you were calling a C function, and you can even call C functions from assembly language. Lots of useful assembly language functions are included as examples.

RUSH REPLY ORDER FORM!

SPECIAL OFFER!

Buy both for an even greater value!

SAVE \$14.95 Off Our Regular List Price!

Limited Time Only **\$54.95**

C Compiler & Text Editor

Please check method of payment:

Check Money Order MasterCard/VISA

Your Card #: _____

Expires _____

Shipping Charges: (No charge for ASM Utility)

In the U.S.A.: Add \$5.00 per Order.

In CANADA: Add \$10.00 per Order.

OVERSEAS: Add \$10.00 per Text Editor.

Add \$20.00 per C Compiler. Add \$30.00 for combined C Compiler and Text Editor.

Operating System: (Check one)

CP/M Z80 MSDOS/PCDOS

Specify Your Computer Name _____

Specify Disk Format _____

NAME _____

Telephone A/C (_____) _____

Street _____

City _____

State _____

Country _____ ZIP _____

MDX software 2116 East Arapaho Suite 363 Richardson, Texas, 75081

Ask about our Volume Discounts!
Call 1-214-783-6001

Description	Quantity	PRICE	Total Order
Split-Screen Text Editor	_____	\$29.95	\$ _____
C Compiler	_____	\$39.95	\$ _____
C and Text Editor (Special)	_____	\$54.95	\$ _____
ASM Utility	_____	\$10.00	\$ _____
Texas Residents Add 6.125% Sales TAX			\$ _____
Shipping Charges (See at Right)			\$ _____
TOTAL OF YOUR ORDER:			\$ _____

cedure is described in detail in *Forrest Mims's Computer Projects* (Osborne/McGraw-Hill, 1985). I will explain at length how to use a computer-enhanced Geiger counter to make long-term measurements of very low-level radiation, including that emitted from CRTs, in a future installment of my column in *Modern Electronics*.

FORREST M. MIMS, III
Seguin, TX

SHORTCOMINGS OF MODULA-2

"Modula-2 As a Systems Programming Language" by Ryn C. Corbeil and Anne H. Anderson (May) is an interesting overview of some of the features of the language. Modula does indeed provide some features that are useful in a "bit-banging" environment and allows access to the bare iron when necessary. Whether or not it will displace Pascal is problematic, given that the better Pascal implementations provide many of the Modula mechanisms as extensions to elementary Pascal.

Corbeil and Anderson did not address the suitability of Modula for other than system programming, nor did they discuss Modula's shortcomings as a programming language, regardless of the application

area. Modula does have a fix for Pascal's conformant array problem, for instance. Unfortunately, the fix only extends to single-dimensional arrays. One is still hard pressed to produce general-purpose procedures that accept an array of strings as an argument, for example, unless one of the dimensions is passed as another argument, à la FORTRAN.

The lack of any intrinsic I/O capability may also be considered a Modula shortcoming. The weakness of Pascal's I/O has been roundly criticized, but at least a rudimentary mechanism exists that often suffices, and the mechanism can be (and regularly is) extended to something useful. Modula gives you nothing to criticize, nor does it give you anything with which to work. Library modules are supposed to provide the I/O interface, but again, what assurance is there of these being adequate, complete, and having any degree of commonality among implementations? If one must deal with the bare iron, then Modula isn't burdened with excess baggage, but you are at the mercy of the underlying operating system (if any) and you had better have a good set of reference materials for the hardware and

operating system. Modula is not for the faint of heart.

I found the letter of Chuck Musciano (May, page 14) to be ironically coincidental. There are some of us who become livid when faced with legislated morality, in this case the enforced case-sensitivity of identifiers and keywords. Modula's forcing the use of uppercase characters should please Mark Pickerill (February Letters, page 356), but some of us wouldn't care if we never saw another uppercase character in a source program. Having worked in the industry since the days of punched cards and uppercase-only printers, I've seen enough all-uppercase printouts to last the rest of my life. On the other hand, C's insistence on lowercase alphabetic characters is just as bad. The point is that computer programs shouldn't be establishing arbitrary requirements.

In addition to displeasing half or more of the users, case-sensitivity lends itself to the bad practice of using the same identifier capitalized differently to represent different variables. The user's manual for one implementor's Modula-2 contains several examples of this abuse in the ex-

(continued)

Program
with
PANACHE

MSDOS,
PCDOS IBM PC,
XT, AT compatibles.

Program generation with power,
sophistication, and especially

Style



Form Editor:

- AI Techniques minimize keystrokes.
- Automatic multi-dimensional array recognition.
- Automatic field naming.
- Wordstar™ compatible editor.
- Diagonal cursor movement.
- Pop-Up Windows/Menus.
- Multi-File Clipboard.
- Crash recovery.

Writes Programs in "C"

Order Toll Free
1-800-624-8711



In SC call
1-803-278-3811

\$99.95

UNIX is a trademark of AT&T Bell Laboratories.
Wordstar is a trademark of Micropro Int. Corp.

Program Generator:

- Writes "C" Code.
- Does not generate reams of case statements like other similar products.
- Generated code is ultra-efficient.
- Supports all standard data types and user-defined types.
- Custom code independence - Code that you add is isolated from other changes.
- Files feature B+ Tree index support.
- Partitioned screens support scrolling, flat, and cyclic forms, and Pop-Up menus.

Generated programs use supplied library routines and can use your favorite commercial libraries as well.
Fitting solutions to digital problems...

Library Packages:

- "C" source for all routines.
- B+ Tree Manager features:
 - Optimized fan-out for each key type.
 - Secondary key GETNEXT support.
 - User-defined ordering for keys.
- Open File Cache places no limit on the number of files open at a time.
- Disk-Based Garbage Collector handles variable length records and multiple indexes per file.
- Window/Menu manager is call-compatible with UNIX™ curses package.
- Generic list processor.

Digifit Inc.

105 Clearwater Rd.
Belvedere, SC 29841

Orchid's TurboEGA™

The world's fastest EGA



**FREE
MS WINDOWS™**



Introducing the only Enhanced Graphics Adapter with Pcturbo™ speed.

The experts agree: the EGA is the breathtaking new graphics standard, but the sophisticated software written for it places a big burden on the PC's processing speed. Beautiful graphics, crisp text, but too slow.

Everyone else rushed their EGAs to the market, but Orchid Technology took the time to do it right. Orchid's TurboEGA™, from the inventors of PC TurboProcessing, packs a high-speed Turbo and an EGA into one slot, for the world's fastest EGA.

Graphics with Speed

TurboEGA makes IBM PCs and XT's run faster than an AT. It brings dazzling speed to sluggish graphics programs. All types of software run faster, so you finish more quickly. Transparent to the user, you won't know it's there until you see its speed.

We are so confident that our TurboEGA is the ultimate graphics card that we decided to give away a free copy of Microsoft's Windows™ with each TurboEGA*. Even Microsoft recommends that you run Windows on an AT. Now Orchid's TurboEGA gives you AT speed so XT users can use this number one windowing software at the speed they demand.

The Complete Solution

Only Orchid puts this much performance into one slot and comes fully loaded with 256K of RAM, so there's no hidden cost. TurboEGA is the complete graphics solution.

Pick up the phone and find out how you can have the EGA the competition wishes they had: Orchid's TurboEGA, the world's fastest.

If you have an AT or a system with 80286 speed, ask about the Orchid EGA™—four graphic-card compatibility in one slot.

Features:

- Powered by 7.2MHz 80286
- Optional 5 or 8MHz 80287
- 256K of on-board RAM
- Four graphics modes: EGA, CGA, MDA, Hercules
- Supports the long list of EGA software:
 - Microsoft Windows & Word
 - Lotus 1-2-3 & Symphony
 - Topview
 - Framework
 - Chart-Master
 - AutoCAD
 - PC Paint Plus
 - and more...



TurboEGA, Orchid EGA, and Pcturbo and trademarks of Orchid Technology. Microsoft Windows is a trademark of the Microsoft Corporation. All other product names are trademarks of their manufacturers. CGA screen by PC Paint Plus.

*Offer good only on TurboEGA purchases until July 31, 1986. Please allow two weeks for delivery.

ample programs, including the use of an otherwise reserved word as a procedure name. To be "thrashed with a stack of listings," as suggested by Mr. Musciano, is too kind for the supposed professional who perpetrates such a crime.

E. M. GREENE
Ridgecrest, CA

ARGUMENTS IN C

I write to correct two inaccuracies in John D. Unger's book review of *Variations in C*

in the May issue. I will also present an argument against a third point of his.

In what is otherwise a favorable review of the book, Mr. Unger raises the criticism that examples follow the proposed ANSI C standard rather than the Kernighan and Ritchie standard. The evidence cited for this is the use of enumeration data types and the void type for functions that return nothing. The interesting fact is that there is a page of the UNIX reference manual dated November 15, 1978 (actually the

same year as that of K&R) defining two extensions to the C language, implemented by the portable C compiler, and therefore existing on all current UNIX systems. The first of these is the ability of a function to return a structure, and the second is enumeration types. The C compilers on UNIX also admit the void declarator, but I do not know what year this came out.

I would also like to take issue with Mr. Unger's complaints about the dependence on #define and typedef. He claimed that heavy use of these reduced readability. I am on shaky ground here, not having read the subject book, but I would like to make some comments on the use of these and on good C style for large programs.

Nobody can argue with the simple application of #define to replace integer values with meaningful symbolic equivalents, for example:

```
#define TRUE 1
#define FALSE 0
#define MAXINT 32767
```

It is when #define is used to define a parameterized macro, as in

```
#define putchar(x) puts(x, stdout)
```

that debate might arise. It is usually done as an efficiency measure to save the overhead of a function call. Although the example above, taken from the source of 4.2BSD UNIX, is pretty clear, such macros are often relatively unreadable, and the calls thereof are not traceable by symbolic debuggers. Consider the following horror, taken from the same source:

```
#define getc(p) (--(p) -> __crt) == 0?
*(p) -> __ptr ++ &&0377: __filbuf(p))
```

In the language C++, which is essentially C extended to have classes, a provision was made to specify that member functions of classes produce in-line code where desired, and it was pointed out that this provision should reduce the extent to which #define is used for the same purpose.

Now a word about typedef. The important, legitimate use of this construct is in conjunction with structure, or union, declarations. In the construction

```
struct silly {
    int a;
    char b[6];
    struct silly *next;
} s1, s2
```

I have declared a structure consisting of an integer, an array of six characters, and a pointer to an instance of the same structure, and declared s1 and s2 to be variables that are instances of the structure. The

(continued on page 339)

IMAGINE WHAT YOUR COMPUTER COULD SAY WITH PC DIAL/LOG™



PC DIAL/LOG™ consists of an expansion card, software and a cable that connects a Touch Tone® telephone directly to your computer. When installed the PC Dial/Log™ automatically dials and answers the phone, saves and sends telephone messages and stores and forwards telephone calls.

IT'S SIMPLE, with direct installation and a menu-driven program. These features make PC Dial/Log™ convenient and easy to use.

UNPARALLELED VOICE QUALITY made possible by the Votrax® voice digitization process enables PC Dial/Log™ to deliver the best low-cost voice reproduction.

VOTRAX®'S SOFTWARE INTERFACE PROGRAM, THE TOOL KIT, created especially for the developer whose application includes PC Dial/Log™, will help save valuable programming time.

Other Votrax® Products
—Personal Speech System™
—Type-N-Talk™ Stand-Alone Devices
—IBM, Apple II, Commodore 64
—Plug In Board Synthesizers
—Votrax® Speech Chips

APPLICATIONS including appointment scheduling, telemarketing, marketing surveys, financial updates, inventory status reports, dispatching and order entry are just some of the many ways that PC Dial/Log™ can be used.

WE WELCOME DEALERS AND DISTRIBUTORS to contact Votrax® regarding our complete line of products. Our reputation has been built on quality products and outstanding customer service that are sure to satisfy you.

AN UNBEATABLE PRICE at only \$495*, PC Dial/Log™ is the lowest priced digital board available today. Please contact Votrax® directly for additional information.

*Plus shipping and handling.

votrax

VOTRAX/CMC Int'l, Inc.
"Technology That Talks"
1394 Rankin, Troy, MI 48063
1-800-521-1350
In Michigan 313-588-0341
TWX-8102324140 Votrax-TRM1
For a voice demonstration call
313-588-2926

LANGUAGES THAT ARE CAUSING THE BIGGEST PROGRAMMING BACKLOG IN HISTORY ARE ALSO EATING NICE BIG HOLES IN OUR POCKETS.

Whether it's BASIC, COBOL, Pascal, "C", or a data base manager, you're being held back.

Held back because the language has frustrating limitations, and the programming environment isn't intuitive enough to keep track of what you're working on.

In the real world, there's pressure to do more impressive work, in less time, and for more clients.

We've been given some incredibly powerful hardware in recent times, but the languages aren't a whole lot better than they were 20 years ago.

So, whatever language you have chosen, by now you feel it's out to get you — because it is.

Sure, no language is perfect, but you have to wonder, "Am I getting all I deserve?"

And, like money, you'll never have enough.

Pretty dismal, huh?

We thought so, too.

So we did something about it.

We call it CLARION™.

You'll call it "incredible."

Distributed on 7 diskettes, CLARION consists of over 200,000 lines of code, taking 3+ years to hone to "world-class" performance.

With CLARION you can write, compile, run and debug complex applications in a New York afternoon.

Even if you're in Savannah.

It gives you the power and speed to create screens, windows and reports of such richness and clarity you would never attempt them with any other language.

Because *you* would have to write the code.

With CLARION you simply design the screens using our SCREENER utility and then CLARION writes the source code AND compiles it for you in seconds.

Likewise, you can use REPORTER to create reports.

Remember, only CLARION can recompile and display a screen or report layout for modification.

And with no time wasted.

All the power and facilities you need to write great programs, faster than you ever dreamed of.

Programs that are easy to use. Programs that are a pleasure to write.

And to you that means true satisfaction.

You've coveted those nifty pop-up help windows some major applications feature. But you can't afford the time and energy it takes to write them into your programs.

That's the way it used to be.

So we fixed that, too.

CLARION's HELPER is an interactive utility that lets you design the most effective pop-up help screens that you can imagine. And they're "context sensitive," meaning you can have help for every field in your application.

Unlike the other micro languages, CLARION provides declarations, procedures, and functions to process dates, strings,

screens, reports, indexed files, DOS files and memory tables.



SAY IT IN

CLARION™

DEPT. A2BY/3

1-800-354-5444



Imagine making source program changes with the CLARION EDITOR. A single keystroke terminates the EDITOR, loads the COMPILER, compiles the program, loads the PROCESSOR and executes the program. It's that easy!

Our data management capabilities are phenomenal. CLARION files permit any number of composite keys which are updated dynamically.

A file may have as many keys as it needs. Each key may be composed of any fields in any order. And key files are updated whenever the value of the key changes.

Like SCREENER and REPORTER, CLARION's FILER utility also has a piece of the CLARION COMPILER. To create a new file, you name the Source Module. Then you name the Statement Label of a file structure within it.

FILER will also automatically rebuild existing files to match a changed file structure. It creates a new record for every existing record, copying the existing fields and initializing new ones.

Sounds pretty complicated, huh?

Not with CLARION's documentation and on-line help screens. If you are currently competent in BASIC, Pascal or "C" you can be writing CLARION applications in a day. In two days you won't believe the eloquence of your CLARION programs.

Okay, now for the best part of all. You can say it in CLARION for \$295.00—plus shipping and handling. All you need is an IBM® PC, XT, AT or true compatible, with 320 KB of memory, a hard disk drive, and a parallel port. And we'll allow a full 30 day evaluation period. If you're not satisfied with

CLARION, simply return it in its original condition for a full refund.

If you're not quite ready to take advantage of this no-risk opportunity, ask for our detailed 16 page color brochure. It vividly illustrates the elegance of CLARION. Consider it a preview of programming in the fast lane.

Either way, the 800 call's a freebie.

BARRINGTON SYSTEMS, INC. 150 EAST SAMPLE ROAD POMPANO BEACH, FLORIDA 33064 305/785-4555

IBM is a registered trademark of International Business Machines Corporation. CLARION™ is a trademark of Barrington Systems, Inc. ©1986 Barrington Systems

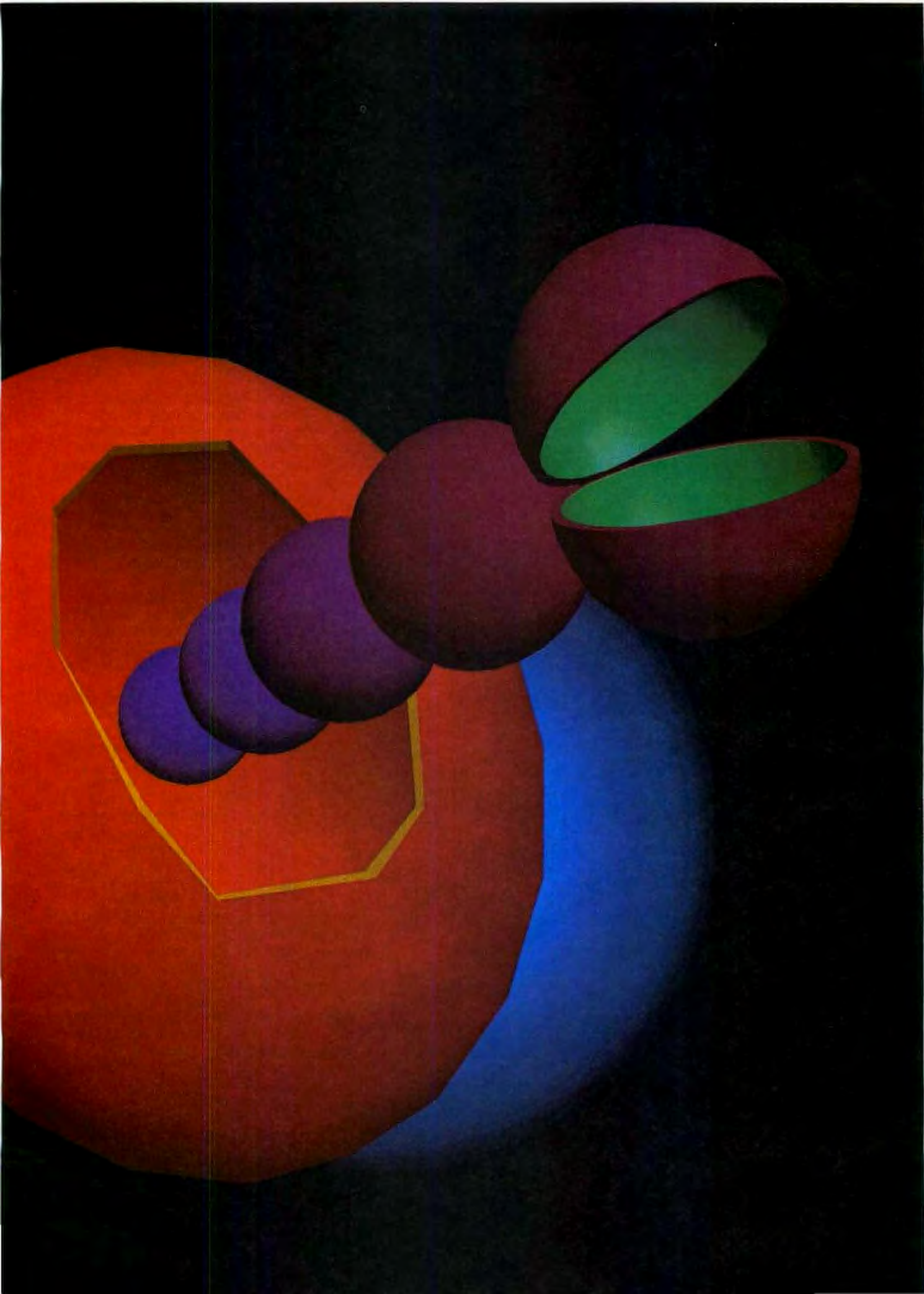

Object Lesson

It's clear that building all new software from scratch isn't a very productive way to work.

But that's been the only option open for developers.

Until now.

Software Evolution

PPI's object-oriented software engineering environment lets designers and programmers build their own reusable Software-ICs® and use Software-ICs built by others—giving them the same advantages integrated circuits give hardware designers.

No longer do systems have to be created from scratch.

Encapsulation, inheritance and runtime binding are all available to you without sacrificing the benefits of programming in C.

Seamless Integration

As you adopt object-oriented technology, PPI will support you with the expanding supply of tools and training necessary to achieve a fully integrated, seamless development environment.

Just as important, PPI's unique hybrid-language approach lets you continue to use your current software investment. Which means

you don't have to learn a new language to get the benefits of object-oriented technology.

Real Solutions

Right now, PPI products are in use by many Fortune 500 companies, U.S. Government agencies and major universities. Systems of up to 180,000 source lines of code have been completed ahead of schedule and are in commercial use.

In fact, many users report a better than five-fold increase in productivity on their first projects using PPI products.

To learn how PPI products, training and support can help you meet your development goals faster while maintaining high quality, call us at (203) 426-1875.

Or write PPI, 27 Glen Road, Sandy Hook, CT 06482.



The leader in
object-oriented software
engineering.

Inquiry 236

MORE USERS FOR YOUR PC

Advanced Digital's PC-Slave is the solution to your multi-user or local area network problems.



Just plug Advanced Digital's PC-Slave board into your PC expansion slot, a connecting cable, a low-cost dumb terminal or a PC look-alike terminal and you're in business. As many as 31 low-cost workstations may be added to your IBM-PC, AT, XT, and the compatibles. Share a common data base without loss of speed or efficiency since each PC-Slave has its own 8088 CPU, 256-768K RAM dedicated to each user. Advanced Digital provides additional software which supports File & Record locking and print spooling. Advanced Digital's slave concept provides the best multi-user PC system available today! For the location of the dealer nearest you contact:

Advanced Digital Corporation
5432 Production Drive
Huntington Beach, CA 92649
(714) 891-4004 (800) 251-1801
Telex 183210 ADVANCED HTBH

**ADVANCED
DIGITAL
CORPORATION**

Advanced Digital U.K. Ltd.
27 Princes Street, Hanover Square
London W1R8NQ-United Kingdom
(01) 409-0077 (01) 409-3351
TLX 265840 FINEST

Regional Distributors: In California, Thomas Data Systems, Inc. (213) 214-4661, MP Systems (714) 770-6411; In Texas, MP Systems (214) 385-8885 or (800) 854-8885; In Ontario, Canada, Computer Lab (416) 299-7660; In Australia, Archives Computers (03) 699-8377; In Florida, International Micro Systems (305) 665-1515

Inquiry 5 for End-Users. Inquiry 6 for DEALERS ONLY.

Graphics Package Works in Medium and High Resolution

VCN Concorde, an integrated graphics program, provides tools for freehand painting, animation, creating charts, and mixing text and images in medium or high resolution. It can plot graphs from Multiplan, Lotus 1-2-3, Symphony, and DIF spreadsheets. Painting capabilities include multilevel zoom, 64 colors, and scaling. A database comes with 2000 icons and symbols, but you can also draw your own.

You can send Concorde output to a printer (dot-matrix, ink-jet, or laser) or plotter, or use it in a 35mm slide program or self-running presentation (dissolve and fade options are included).

The package runs on the IBM PC series and work-alikes. It functions with machines using the Enhanced Graphics Adapter (and compatible cards) and with the AT&T 6300/Olivetti line using the Display Enhancement Board. Price is \$695. Contact Visual Communications Network Inc., 238 Main St., Cambridge, MA 02142, (617) 497-4000. Inquiry 550.

The Data General/One Model 2

Data General announced a second version of its Data General/One portable computer. The new model, which weighs less than 12



Images produced using VCN Concorde.

pounds, is equipped with an electroluminescent display or a liquid-crystal display that, the company claims, provides twice the contrast of the previous model's LCD.

Like the first version of the portable, the Data General/One Model 2 is compatible with the IBM PC. It runs on an 80C88 processor and comes with 256K bytes of NMOS RAM (expandable to 640K) and a 3½-inch floppy disk drive. Prices start at \$2795 for a base configuration with an electroluminescent display or \$1795 for the same configuration with an LCD screen.

The electroluminescent screen displays 80 columns by 25 lines and 640 by 200 pixels. The LCD screen also displays 80 columns by 25 lines and features a resolution of 640 by 256 pixels. According to the company, the LCD displays characters with a 2:1 height/width ratio, which enables it to display IBM PC-compatible graphics without distortion. The Model 2 EL has an optional external battery pack that reportedly will power the

system for up to 3 hours; with the LCD version, internal nickel-cadmium batteries provide up to 7 hours of power.

Other standard features of the Model 2 include a serial and a parallel interface, a 79-key keyboard, and two slots at the rear of the machine for expansion cards. Among the available options are a 10-megabyte internal hard disk drive, a second 3½-inch floppy drive, an 8087 math coprocessor, an internal 300/1200-bps modem, an interface card for an external monitor, an external 5¼-inch floppy disk drive, and an expansion chassis that will hold PC-compatible expansion cards.

An LCD unit with two floppy drives sells for \$1995; with one floppy drive and a 10-megabyte hard disk drive, it costs \$2995. An electroluminescent model with two floppy drives costs \$2995; with a floppy and a hard disk drive, it sells for \$3995. The company has also reduced the price of the Data General One/Model 1 from \$2195 to \$1495. Contact Data General Corp., 4400 Computer Dr., Westboro, MA 01580, (617) 366-8911. Inquiry 551.

Graphics Chips from Intel and TI

Intel has developed a graphics coprocessor chip, the 82786, that can manipulate windows and other graphics elements as much as 100 times faster, the company says, than is possible through software. Designed

(continued)

to work alongside an 8-, 16-, or 32-bit general-purpose processor such as the 8088, 80286, or 80386, the 16-bit 82786 is made by the same CMOS process as the 80386 processor. It handles up to 32 DRAMs in a dedicated graphics memory and has its own complete DRAM controller.

The chip includes two processors: a graphics processor (GP) and a display processor (DP). The system processor sends a command to the 82786's GP, which executes the command and updates graphics and text in graphics or system memory. This execution can run concurrently with further processing by the main processor. The DP operates independently from the GP: It collects bits from memory and sends them to display devices such as CRTs, LCDs, and laser printers.

The GP works with several bit maps to perform line drawing, color filling, or polygon creation. To change the size, shape, or information content of a window, the processor changes only the pointers to the proper bit maps. Bit maps in the chip's linear, 4-megabyte memory can be as much as 32,000 pixels on a side and 8 bits deep (for color or gray scale).

According to Intel, the 82786 working on a 6-MHz IBM PC AT with a 640 by 480 by 8 screen resolution shows a speed increase over software-driven graphics of 100 times in line drawing, 25 times in bit-blitting, and 15 times in displaying bit-map characters. Windowing, panning, and scrolling are virtually instantaneous. The technical specs are: 2.5 million pixels/second on lines and polygons, 2 million pixels/second on circles and arcs, 24 million bits/second for bit-plt, and 30 million bits/second for fills.

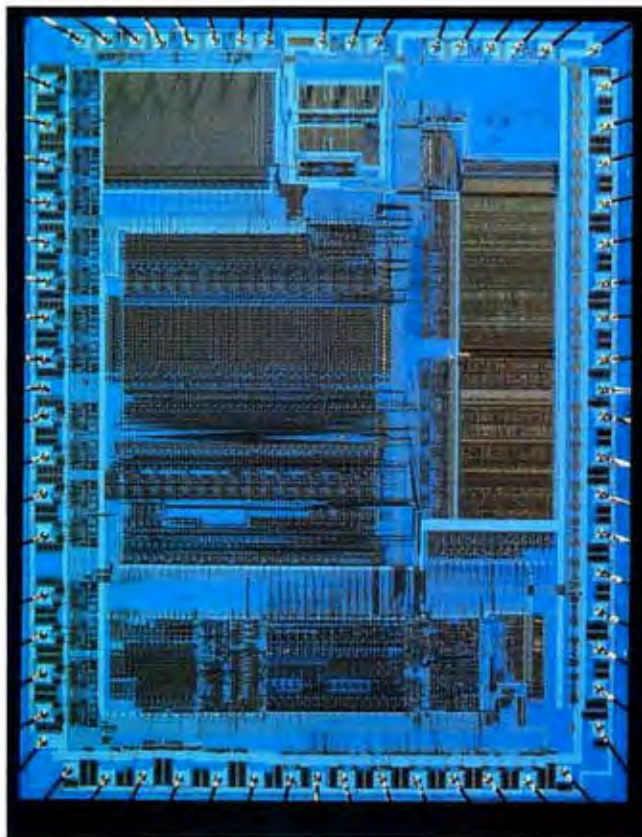

TI's TMS34010 is a 32-bit processor for graphics operations.

The 82786 supports the ANSI CGI (Computer Graphics Interface) standard and IBM's CGA (Color Graphics Adapter) standard. Ashton-Tate, Digital Research, Graphic Software Systems (GSS), Lotus Development, and Microsoft are supporting the chip.

82786 samples are in the hands of hardware designers, and Intel expects production runs in the fourth quarter of 1986. At that time, the chip should cost approximately \$100 in quantities of 1000 and \$80 in quantities of 10,000. The company foresees the large-quantity price eventually dropping to approximately \$50 per chip. Contact Intel Corp., 1900 Prairie City Rd., Folsom, CA 95630, (916) 351-5000.

Inquiry 552.

Texas Instruments has released the Software Development Board, which incorporates the company's recently developed TMS34010 Graphics System Processor (GSP). In addition to the GSP processor, the Software Development Board contains 256K bytes of multiport display memory, 512K bytes of program memory, and the TMS34070 Color Palette chip with three high-speed D/A converters for driving analog RGB outputs. The board is priced at \$3995.

TI describes the GSP as a high-performance (6 MIPS or a draw rate of 48 million pixels per second) CMOS 32-bit microprocessor optimized for graphics display systems.

The processor has a 1-gigabit address space, addressable on bit boundaries using variable-width data fields. The GSP also features 31 general-purpose 32-bit

registers, a 256-byte on-chip instruction cache, an instruction set containing 79 general-purpose instructions, 27 specialized variable field MOVE instructions, and 23 graphics instructions, including the specialized PIXBLT instructions.

The PIXBLT instructions manipulate pixel data, accessed via memory addresses or *x,y* coordinates. These instructions provide the capability for array and raster operations as well as individual pixel processing, windowing, plane masking, and transparency.

The company is sampling the GSP now and plans to have large-volume shipments of the final version early next year. In quantities of 50,000, the company anticipates a price of about \$40; in single-unit quantities, the chip will cost about \$155.

TI provides hardware and software support tools for GSP developers. The hardware consists of a Color Graphics Controller Board with Debugger interface software (an IBM PGA emulator) for the TI Professional Computer and IBM PC and compatibles, as well as the Software Development Board, which works with the same computers.

Software tools include a C compiler, an assembly support package, graphics function libraries, and a CGI standards package. The C compiler is a full-featured Kernighan and Ritchie C with in-line assembly extensions, 64-bit IEEE floating point, and memory-management run-time support. The assembly support package includes an assembler, linker, ROM utility, software simulator, and librarian/archiver.

Contact Texas Instruments Inc., P.O. Box 809066, Dallas, TX 75380-9990, (800) 232-3200.

Inquiry 553.

(continued)

If you can't put a Hayes modem on every PC in your IBM network, here's the next best thing.

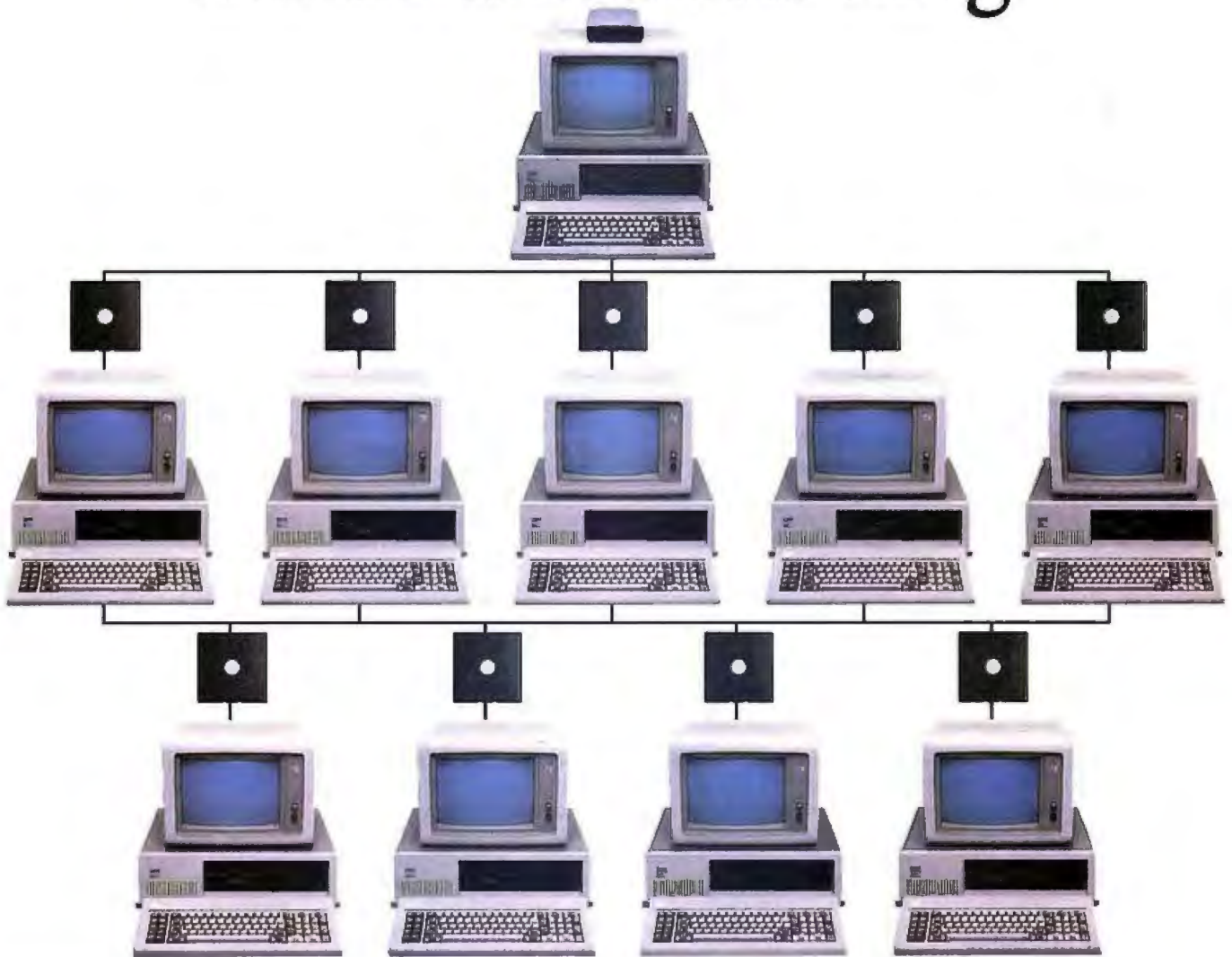

© 1986 Hayes Microcomputer Products, Inc.

*Manufacturer's estimated retail price.

It's new communications software from Hayes called Smartcom II® for the PC Network.

It lets you share modems. So even PC's without their own modems can communicate outside the network.

Before now, if you needed to communicate outside the network, you had to physically go to wherever the modem was. That, in turn, meant bumping the operator off his modem-equipped PC, so that you could handle your communications.

Hayes Smartcom II for the PC Network puts an end to all the delay and inconvenience. Now, when a PC needs the modem, the user is automatically connected from his own desk. So communications

capabilities are immediately available to everyone on your network, whether their PC has a modem or not.

You only buy one software package per modem. The workstation part of the software can then be duplicated for each PC on the network, at no extra cost. It's better than having a site license!

Each PC can have its own password, define its own log-on procedures, set its own macros, and use

all the other outstanding operating features of our standard Smartcom II while connecting with any of the shared modems on the network.

You get all this for only \$599*! And it's backed by Hayes, the PC communications leader.

So if you currently utilize, or are contemplating adding, IBM PC networks, you should also add Smartcom II for the PC Network. For efficient communications. Without delay.

See your authorized Hayes dealer for details. Or contact Hayes at 404/441-1617.

Hayes Microcomputer Products, Inc., P.O. Box 105203, Atlanta, Georgia 30348.

Hayes®

Say yes to the future

Smalltalk for \$99

Smalltalk/V, an implementation of the Smalltalk environment for IBM PCs and compatibles, comes with a Prolog compiler that allows integration of object-based and rule-based programming techniques. The package's graphics capabilities provide bit and form editors for making icons and fonts. Each graphical object has its own behavior and can be linked to other objects through the language's message-passing paradigm; as a result, you can build simulations using algorithms or rules.

This version of Smalltalk lets you object-swap to a hard or RAM disk, which means you can write large programs (up to 32,000 objects and 4 megabytes of memory). The package comes with a source-level debugger; you can check and change local variables and then resume the program or execution of a particular method.

Smalltalk/V costs \$99. Contact Digitalk Inc., 5200 West Century Blvd., Los Angeles, CA 90045. (213) 645-1082. Inquiry 554.

Object-oriented Graphical Modeling Program

Sherrill-Lubinski's Object-Oriented Graphical Modeling System consists of software for drawing, animating, coloring, or rotating pictures and objects. The company describes it as a tool for programmers who are modeling data or viewing it graphically. Typical applications include developing real-time process control displays, building workstations for graphics design, and creating graphically oriented interfaces.

OOGMS comes with a drawing/editing program called SL-Draw; a collection

of C function calls termed the Graphical Modeling Function Library; and a graphics interpreter, called the Graphical Modeling Language Interpreter, for handling and animating models.

SL-Draw is \$2400 in binary form, \$6000 in source; the function library and the interpreter are sold as a package for \$3500 in binary form, \$35,000 in source. Contact Sherrill-Lubinski, Suite 110 Hunt Plaza, 240 Tamal Vista Blvd., Corte Madera, CA 94925, (415) 927-1724. Inquiry 555.

Amiga Math Coprocessor

Designed for the Commodore Amiga and other 68000-based systems, the math coprocessor board from Netch Computer Products features a Motorola 68881 chip and 68010 microprocessor. The company says the board can boost the processing speed of math-intensive software by 300 to 500 percent.

The board is sold as an internal piggyback replacement for the Amiga's 68000. The 68010 runs on the 68000's system clock, while the 68881 operates asynchronously with a maximum clock rate currently at 16.5 MHz. Because the 68010 is not directly compatible with the 68881, the company provides a software emulation of the 68020's coprocessor interface, which is installed in AmigaDOS. Software libraries for Aztec C and Lattice C compilers and assembler tools are also included with the board.

A bare-board kit is priced at \$149. Assembled and tested without the 68881, the board costs \$269; assembled and with the

68881, the board costs \$529. The company says the board should work in any 68000-based system with adequate board clearance and software-accessible trap vectors. Contact Netch Computer Products, P.O. Box 645, Monrovia, CA 91016. (818) 334-1002. Inquiry 556.

DEC's Engineering Workstation

Digital Equipment Corp. introduced the VAXstation II/RC, an entry-level member of the firm's VAXstation series of computers. According to the company, the workstation is designed for applications in electronics, mechanical computer-aided design, software development, computer-aided software engineering, technical publishing, and others that require computation-intensive performance and networking.

The workstation is based on DEC's MicroVAX II 32-bit processor and is available in configurations with 3 megabytes and 5 megabytes of RAM, priced at \$14,995 and \$16,995, respectively. Both versions of the workstation are equipped with a 19-inch monochrome monitor with 1024 by 864 resolution, a 71-megabyte hard disk and disk controller, an Ethernet interface, a 95-megabyte streaming tape drive, a video controller, a keyboard, and a three-button mouse. The workstation supports the MicroVMS and ULTRIX-32m (DEC's implementation of UNIX) operating systems; a license for one of these operating systems is included in the system price.

Fully compatible with the company's line of VAX computers, the workstation can be linked with the systems via Digital's network. Contact Digital Equipment Corp., Maynard, MA 01754-2571. Inquiry 557.

Smalltalk-80 for IBM PC AT

Softsmarts has combined its ST80 "virtual machine" with Xerox's "virtual image" to put Smalltalk on the IBM PC AT. The combination converts the AT into a fully functional Smalltalk-80 version 2 workstation with as much as 2 megabytes of memory space and a 640 by 350 bit-mapped graphics interface.

The company says that because it designed the underlying virtual machine specifically for the AT, users get complete PC-DOS compatibility and the full power of the 80286.

Softsmarts ST80 runs on an AT with 640K bytes of base memory, at least 512K expansion memory (1 megabyte preferred), an IBM Enhanced Graphics Adapter, a Mouse Systems three-button mouse, and a monochrome or IBM enhanced color monitor. An 80287 math coprocessor enhances performance. The system can run on an AT with a single 1.2-megabyte floppy drive, but a hard disk is needed for full source browsing. ST80 for the AT costs \$995. Contact Softsmarts Inc., 4 Skyline Dr., Woodside, CA 94062. (415) 327-8100. Inquiry 558.

Drives Work with Apples and Macs

The ProAPP 10 and ProAPP 20, 10-megabyte and 20-megabyte hard disk drives, can be used with Apple II and Macintosh computers without the need for changing or adding disk controllers. Moving a drive from one Apple machine to another requires disconnecting the subsystem from the first, reconnecting it to the second with the appropriate

(continued)

Book your trip from start to finish.

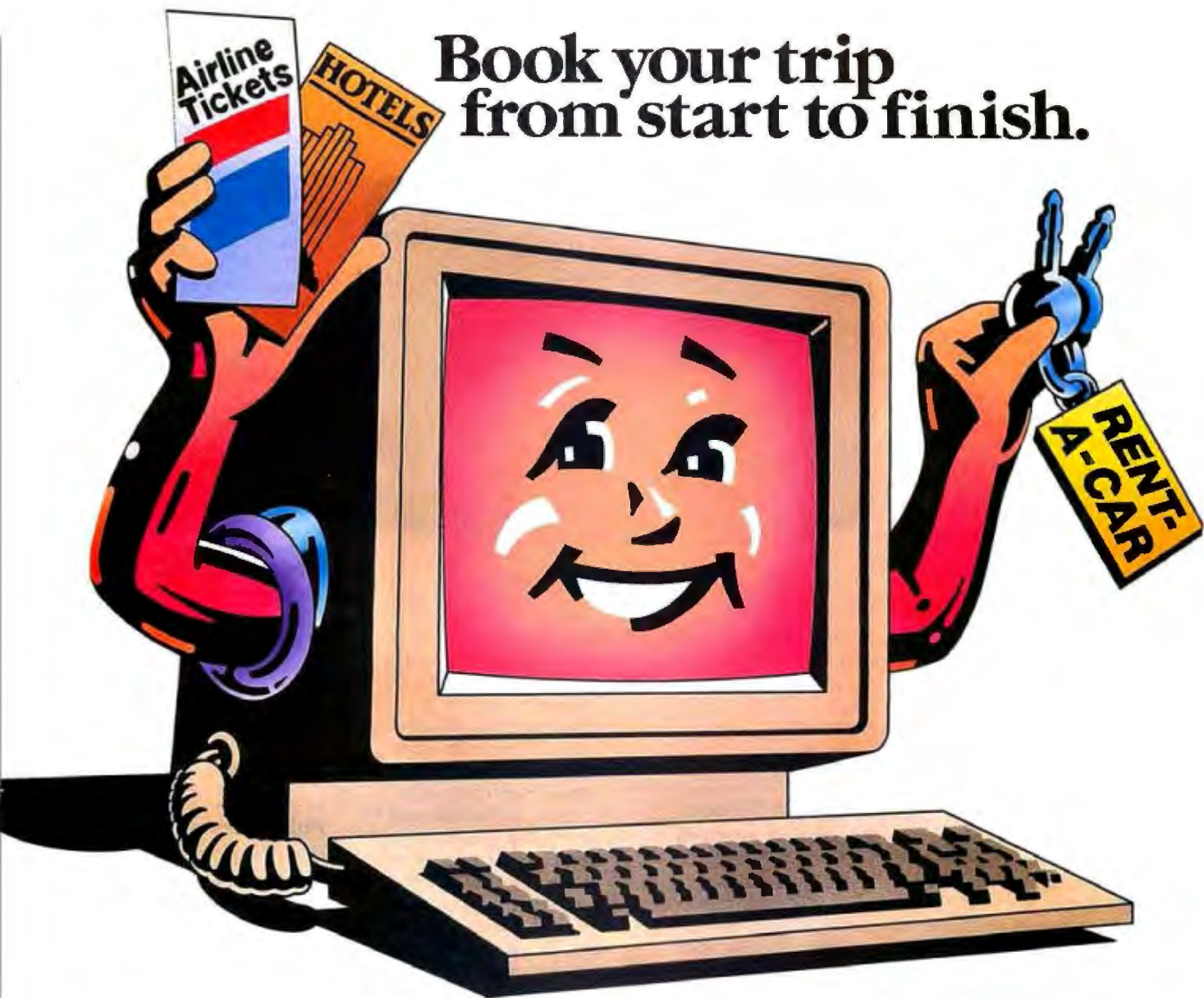

All on your own PC.

Now you can get quick information and *immediate reservations* for flights, hotels and rental cars with EAASY SABRE, the American Airlines personal reservations system.

EAASY SABRE lets you look directly at schedules and fares, 24 hours a day. On any type of PC that has a modem or on any kind of communicating terminal. And, all the help you need is available on line.

This special service will show you flights for over 650 airlines worldwide. And the quickest routes to almost any place you want to go.

It will also show you more than 13,000,000 fares. Our exclusive Bargain FinderSM feature assures that you'll get the lowest possible fares available for the seats you book.

In addition, you can reserve a room at more than 12,000 hotels — by name, by price or by location. You can also confirm a car from over 20 rental car companies. Look at your personal AAdvantage[®] account. And even check the weather in the city you'll be visiting.

Once your reservations are booked, EAASY SABRE lets you decide where to pick up the ticket — from your SABRE Automated Travel Agency or Corporate Travel

Office, at the airport, at an American Airlines City Ticket Office, by mail or from any other American Airlines authorized distribution channel.

Access the world's most sophisticated travel automation system. It's that simple. And economical. Because there's currently no surcharge for using EAASY SABRE. You just need to subscribe to one of the data networks listed.

For more information on subscribing to a network, call:

Dialcom, Inc.
1-800-258-3311

General Electric Information Services Company
1-800-433-3683

QuantumLink (for Commodore computers only)
1-800-392-8200

EAASY
SABRESM

AAdvantage[®] is a registered service mark of American Airlines, Inc.

cabling, and then reconfiguring an 8-pin DIP switch on the bottom of the drive.

The drives attach to the floppy disk ports on the Apple IIe/IIc and 128K and 512K Macintoshes or the SCSI port on the Macintosh Plus. You can use the drives to transfer text files between IIs and Macs, the company says. The drives also include a printer/spooler interface that's compatible with the Apple Imagewriter.

The ProAPP 1 sells for \$795; the ProAPP-20 costs \$995. For more information, contact ProAPP Inc., 1475 South Bascom Ave., Suite 101, Campbell, CA 95008, (408) 559-3552. Inquiry 559.

CAD in Three Dimensions

T&W Systems has developed a module that works with the company's VersaCAD Advanced for three-dimensional computer-aided design. VersaCAD 3D is a true three-dimensional surface modeling system that accomplishes geometric design in *x*, *y*, and *z* coordinate space, absolute or relative; isometric and perspective views include real 3D lengths rather than lengths created by 2D conversion, T&W says.

Cones, cylinders, spheres, and boxes are among the primitives in the package. They can be rotated about the *x*, *y*, and *z* axes, and most can be shown as partial objects. The program has four display modes: sketch, for a quick preview showing only front vectors; wireframe, which shows all vectors; hidden line removal, which cleans up the design; and hidden line conversion, which displays hidden lines as dotted ones.

VersaCAD 3D runs on IBM PCs and compatibles. It

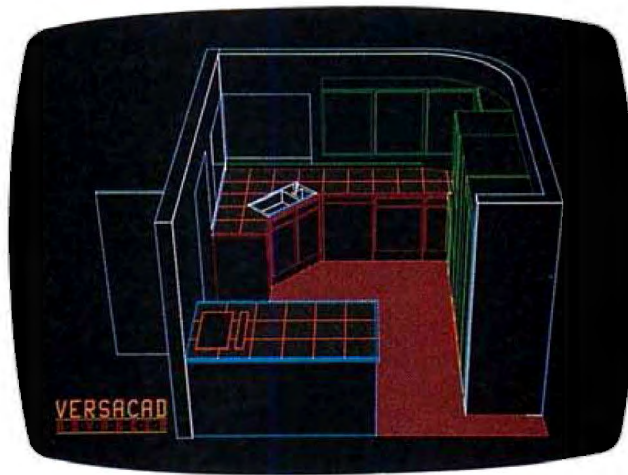

VersaCAD 3D adds 3D modeling to VersaCAD Advanced.

costs \$495. Contact T&W Systems Inc., 7372 Prince Dr., Suite 106, Huntington Beach, CA 92647, (714) 847-9960. Inquiry 560.

Sony's Still-Video Recording System

Sony's ProMavica system, a still-frame video recorder, is designed for recording, storing, and manipulating video images on 2-inch still-video floppy disks. According to the company, the system can connect with IBM PC-compatible computers, allowing you to store computer-generated text and color graphics and mix them with video images on the floppy disks. The system enables you to display the images on a monitor, project them on a wall, or transfer them to hard copy. The system also lets you generate computer-controlled video presentations that can be reordered, edited, duplicated, and combined with other audio/visual media.

On each video 2-inch disk, the ProMavica unit can record 50 frames of still-video pictures or 25 frames with double the vertical resolution and with up to 360 lines of horizontal resolu-

tion. The recorder can access images, which are keyed with a 6-digit code, in 2 seconds or less.

The system is compatible with all composite video and analog/digital RGB signals from computers, cameras, videodisks, and TV tuners. The RGB input connector on the back of the unit works with IBM PC-compatible computers. The recorder has an RS-232C port as well as two 6-pin remote control ports for the company's Program Editing Controller, which enables you to make dubs between two recorders.

The ProMavica Still Video Recorder is priced at \$3400; 10 video floppy disks sell for \$100. Contact Sony Corp. of America, 9 West 57th St., New York, NY 10019, (212) 418-9470 or (201) 930-6432. Inquiry 561.

Networking Atari STs and IBM PCs

BMB Compuscience Canada released a version of its Imagnet network that connects IBM PCs and Atari STs. The network runs at speeds of up to 2 megabits per second and can transmit data over distances of up to 1500 feet

on either side of the server. Longer distances can be achieved by adding repeaters to the cable.

Up to 63 workstations can be supported by a dedicated disk and print server, which must be a PC-compatible computer with a hard disk. The server itself can be a workstation on a higher-level Imagnet network. Workstations in the network have access to several simulated disk drives and a simulated printer, which are resident on the server.

The network costs \$900 for the first IBM PC, \$800 for each additional IBM PC, and \$500 for each Atari ST. Contact BMB Compuscience Canada Ltd., 500 Steeles Ave., Milton, Ontario, Canada L9T 3P7, (416) 876-4741. Inquiry 562.

Public Domain, User-Supported Programs on CD-ROM

PC-SIG, a clearinghouse for public domain and user-supported software, is selling a CD-ROM optical disk holding 490 "volumes" (equivalent to 490 floppy disks) of applications and utilities for PC- and MS-DOS machines. The collection covers word-processing, communications, accounting, and programming software. Educational programs, games, printer utilities, languages, and BASIC development tools round out the disk.

The CD-ROM collection costs \$195; you're asked to send a donation to authors of programs that perform "satisfactorily." PC-SIG also sells a Hitachi CD-ROM player, PC controller, cabling, and software drivers for \$995. Contact PC-SIG Inc., 1030D East Duane Ave., Sunnyvale, CA 94086, (408) 730-9291. Inquiry 563.

(continued)

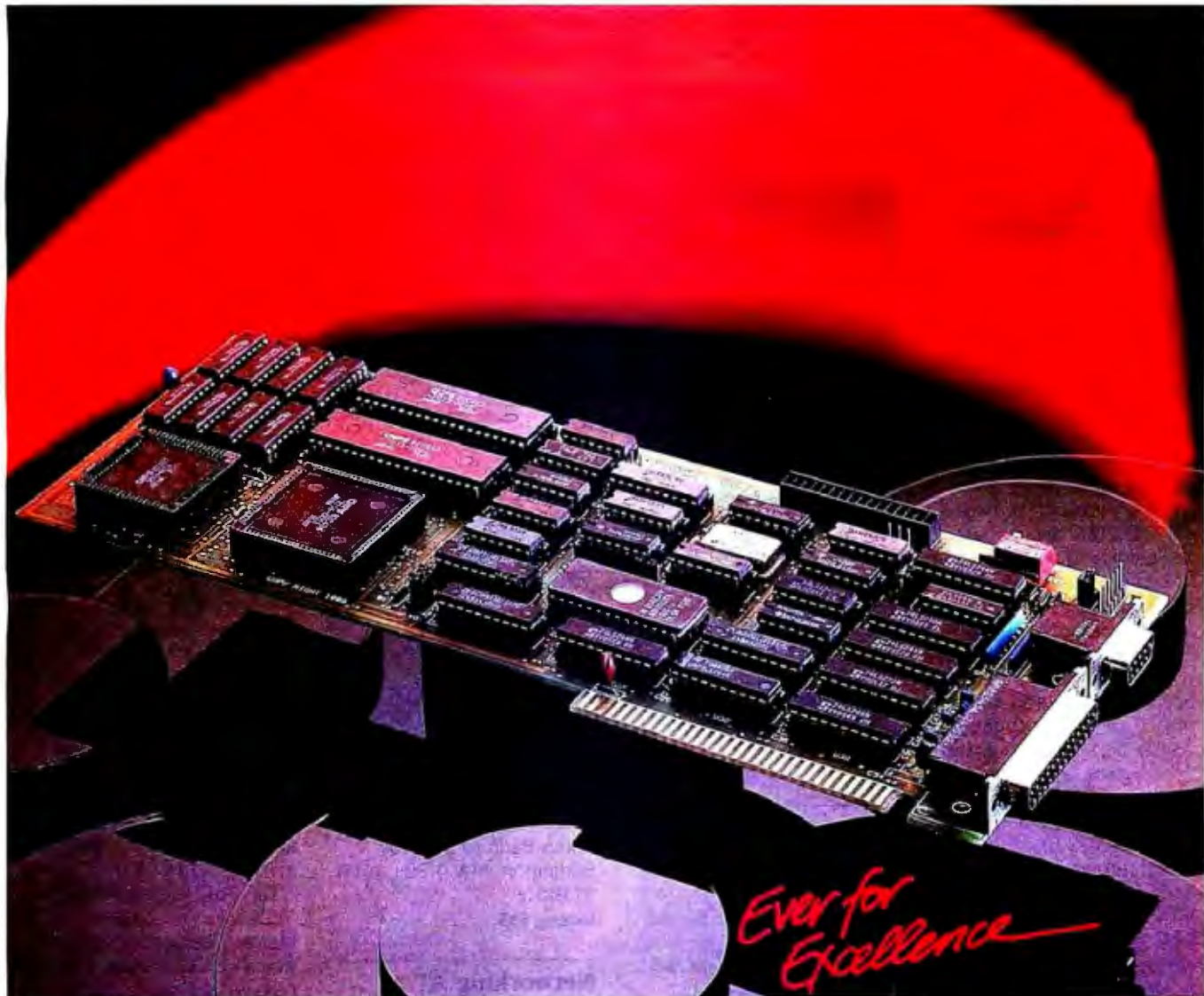

Enhancer™ ... EGA card, \$399

The EVEREX Enhancer is the IBM compatible EGA card that delivers value with price, performance, and features! **No Options Needed.**

With other EGA cards you have to pay extra for options like 256K screen memory and a parallel printer port. With the Enhancer these features are standard and there are no extras to buy.

11 Display Modes

There's 16 colors from a palette of 64 in 640x350 resolution. Text is displayed in readable 8x14 character format in text mode. And the Enhancer's monochrome mode can support monochrome graphics on a monochrome monitor. In addition to 6 EGA modes and a monochrome mode, there's 4 color modes.

Software Switched

The Enhancer comes with EGMODE menu-driven software that lets you change display modes, even monitors, without opening your chassis, with the push of a button. Useful help windows take all the mystery out of each possible display mode.

The Perfect Adapter

For enhanced color graphics, monochrome text, and standard color text and graphics, the EVEREX Enhancer is the perfect adapter to pair up with your software library. Call your local dealer for a demo, or call EVEREX to get all the facts on our new line of video adapters.

1-800-821-0806 **1-800-821-0807**

In California

48431 Milmont Dr.
Fremont, CA 94538
(415) 498-1111

EVEREX

EVER for Excellence

Enhancer is a trademark of EVEREX SYSTEMS, INC. IBM is a trademark of International Business Machines Corp.

SYSTEMS

Two-Board Multiuser System

Ampro has released a two-board computer that offers multitasking, multiuser capabilities. The two-board set occupies nearly the same space as a half-height 5¼-inch disk drive, according to the company.

The set consists of the Little Board/186 single-board computer and an Expansion/186 daughterboard. The boards include an 8-MHz 80186 microprocessor, 1 megabyte of RAM, 128K bytes of EPROM, four serial ports, a floppy disk controller, an SCSI port and a printer port, an 8087 math coprocessor, a battery-backed clock, and an I/O expansion bus. The boards support RS-232C or RS-422 asynchronous or synchronous serial protocols.

The two-board set sells for \$895 without a math coprocessor, which costs an additional \$119. A two-user (\$250) or four-user (\$300) version of Concurrent DOS 4.1 for the Ampro hardware is also available. For more information, contact Ampro Computers Inc., 67 East Evelyn Ave., Mountain View, CA 94041, (415) 962-0230. Inquiry 564.

System for Scientists and Engineers

Compatible with the IBM PC AT, the System 488 computer is designed specifically for use by scientists and engineers. The system runs on an 8-MHz 80286 microprocessor and comes with 512K bytes of RAM, a serial and a parallel port, an IEEE-488 interface card, a hard disk and floppy disk controller, and a 1.2-megabyte floppy disk drive. An enhanced graphics dis-

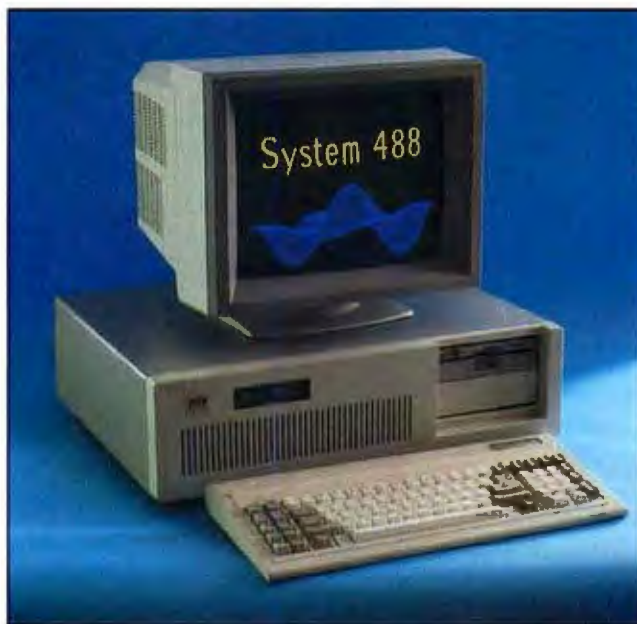

The System 488 comes with an IEEE-488 interface and specialized software.

play adapter for color or monochrome monitors and a monochrome monitor are also standard features with the base model.

In addition to MS-DOS 3.1 and BASIC, software bundled with the computer includes SuperKey, PC-Write, HP-85 graphics emulation, and application programs for use with digital oscilloscopes, IEEE-488 printers and plotters, and other common instruments such as digitizers and digital voltmeters. According to the company, about 90 files are provided on disk, including source code.

Expansion options include an additional 512K bytes of RAM, 128K bytes of ROM, a second floppy drive, an enhanced color monitor, and three serial ports. System configurations with 20-, 30-, or 40-megabyte hard disks and a professional color monitor are also available.

Priced at \$3980, the system runs IBM PC-compatible software and the UNIX operating system. Contact Capital Equipment Corp., 99

South Bedford St. #107, Burlington, MA 01803, (617) 273-1818. Inquiry 565.

Networking AT Compatible

The A-Star, an IBM PC AT-compatible computer from Wells American, is "network-ready," according to the company. The computer incorporates multiuser circuitry that enables it to connect to up to 255 units when used with the firm's Network Adapter card.

The A-Star is based on a 6- and 8-MHz 80286 microprocessor. The machine is equipped with 512K bytes of memory (expandable to 1 megabyte on the motherboard), a 1.2-megabyte floppy disk drive, and a hard and floppy disk controller. Other features include a keyboard, eight available expansion slots, and a 220-watt power supply. The computer has space for two

additional half-height drives.

The base unit sells for \$1495; additional configurations are available. A Network Adapter card costs \$295 for A-Star computers and \$495 for IBM PCs, XTs, ATs, and compatibles. Contact Wells American, 3243 Sunset Blvd., West Columbia, SC 29169, (803) 796-7800. Inquiry 566.

Datavue's Single-Board Computer

Datavue Technical Systems announced the Datavue 8612, a single-board computer that can be used to replace an existing IBM PC XT motherboard. The 8612 comes on a full-size expansion card and includes an NEC V30 or Intel 8086-1 microprocessor operating at 10 MHz, as well as a 16-bit data bus.

The 8612 is available with 512K bytes of RAM and a Master Interconnect Board, which can be installed in a passive backplane as the bus control device for IBM PC expansion cards. The computer's proprietary ROM BIOS, the company says, is fully compatible with IBM PC hardware and software. The 8612 sells for \$695.

The company also announced the Datavue Series 30 computer, which is powered by the 8612 single-board computer. The base model is equipped with an IBM PC AT-type keyboard, a 360K-byte floppy disk drive, a Master Interconnect Board, a monochrome video controller, and a power supply. Prices for a monochrome system start at \$1695; prices for a system with an RGB monitor start at \$1895. Contact Datavue Technical Systems, 4355 International Blvd., P.O. Box 2687, Norcross, GA 30093, (404) 564-5783. Inquiry 567.

(continued)



Clipper is the fastest dBase III and dBase III Plus™ compiler available. Nothing else comes close. When performance counts, experts rely on Clipper for more speed, more power, and more creative freedom. You can, too. Call for details.

- Clipper compiled programs run 2 to 20 times faster.
- No royalties...no runtime fees.
- Source code security.
- User defined functions.
- Arrays.
- Simple menu commands.
- Context sensitive help can be included with programs.
- More fields; more memory variables.
- Call C and Assembly programs.
- Complete debugging facilities.
- Multiple file relationships.
- IBM PC, XT, AT, 3270 compatible™
- Multi-user capability.

Clipper™

**CLIPPER. THE dBASE COMPILER.
A WINNING PERFORMANCE EVERY TIME.**



Nantucket™

Nantucket Corporation
5995 South Sepulveda Boulevard
Culver City, California 90230
(213) 390-7923
Outside California call toll-free:
1-800-251-8438

dBase, dBase III, and dBase III Plus are trademarks of Ashton-Tate, Inc.
IBM PC, XT, AT, and 3270 are trademarks of International Business Machines Corporation.
Clipper and Nantucket are trademarks of Nantucket Corporation.

PERIPHERALS

Removable Hard Disks

SyQuest announced the SQ1500, an external removable hard disk subsystem that provides up to 90 megabytes of fixed and removable storage for IBM PCs, XT's, AT's, and compatibles. The SQ1500 is available with single or dual 5¼-inch 15-megabyte removable drives; with a 45-megabyte fixed drive and a 15-megabyte removable drive; or with two 45-megabyte fixed drives.

The company reports that the subsystem transfers data at 7.5 megabits per second. A controller, utility software, two removable hard disks, cables, and mounting brackets come with the unit.

The company also sells the SQ319, an internal version of the SQ1500. It features a 5¼-inch 15-megabyte removable hard disk drive and includes a controller, utility software, and installation hardware.

Prices for the SQ1500 start at \$2499; the SQ319 kit is \$1395. Contact SyQuest, 47923 Warm Springs Blvd., Fremont, CA 94539, (415) 490-7511. Inquiry 568.

Universal Development Lab

O Orion Instruments' UniLab II, a development system for computer-aided engineering, connects to IBM PCs and compatibles and provides support for more than 120 microprocessor types. The system combines an advanced 48 channel bus-state analyzer, a real-time in-circuit emulator that uses a target microprocessor for code execution, a stimulus generator for special test cases, and a built-in EPROM programmer.



The UniLab II, a development system for CAE.

Like the firm's original Universal Development Laboratory, the UniLab II can be used for programming 2708 through 27256 EPROMs.

According to the company, the device can be used on virtually any 8- or 16-bit microprocessor. Personality Paks are also available for specific microprocessor types and include cables and software.

The standard UniLab II-32 with 32K bytes of emulation memory is priced at \$4980 and works with processors running at speeds of up to 10 MHz. A model with 128K of memory works with processors operating at up to 13 MHz and costs \$6080. A Personality Pak for an 8-bit processor typically costs \$575; for a 16-bit processor, \$675. The UniLab II runs under PC-DOS 3.1 or later on IBM PCs or compatibles with a minimum of 256K bytes of RAM and two floppy disk drives. Contact Orion Instruments Inc., 702 Marshall St., Redwood City, CA 94063, (800) 245-8500; in California, (415) 361-8883. Inquiry 569.

Professional Graphics Tablet

The Professional Series graphics tablet from Summagraphics works with the IBM PC and compatibles and the Macintosh. The 18-by 12-inch tablet has a resolution of 1000 lines per inch, and the tablet's active area can accommodate a B-size drawing or two A-size sheets of paper.

The Professional Series comes with an interface cable, stylus, four-button cursor, and power supply.

The tablet costs \$995. Contact Summagraphics Corp., 777 State St. Extension, Fairfield, CT 06430, (203) 384-1344. Inquiry 570.

Ink-jet Printer from H-P

Hewlett-Packard's QuietJet Plus ink-jet printer offers draft and near-letter-quality printing. It works with the IBM PC, XT, AT,

and compatibles, as well as the Apple II series and Macintosh computers.

According to the company, the wide-carriage printer operates at 40 characters per second for near letter quality, and 160 cps (10-pitch) and 192 cps (12-pitch) for draft quality. It offers three graphics resolutions: 96 by 96 dots per inch, 192 by 96 dpi, and 192 by 192 dpi.

The QuietJet handles tractor-feed and cut-sheet paper in widths from 5 to 15 inches. It features RS-232C and Centronics interfaces and comes with Hewlett-Packard's Printer Command Language.

The QuietJet costs \$799. For more information, contact Hewlett-Packard, 1820 Embarcadero Rd., Palo Alto, CA 94303, (800) 367-4772. Inquiry 571.

Low-Cost Network

Designed to work with IBM PCs and compatibles, Macintoshes, and other computers, the Micro-link network can connect up to 255 computers and peripherals capable of communicating asynchronously through a V.24/RS-232C or current loop interface. The network consists of twisted-pair cables and connector units, one of which is required for each peripheral or port. Each connector costs approximately \$520.

According to the manufacturer, the network can operate over distances up to 1200 meters. It uses a transmission rate of 125K bits per second, which permits more than 10 simultaneous connections at 9600K bits per second.

For more information, contact Tech Trade ab, Box 197, 191 23 Sollentuna, Sweden, 08-92 01 35. Inquiry 572.

(continued)

QNX vs UNIX

A QUESTION OF ARCHITECTURE



What do QNX and UNIX have to do with architectural design?

The design determines the environment in which you and your applications must survive. If the sheer weight of the UNIX operating system brings the PC to its knees, all applications running under it will suffer. Unix was conceived more than a decade and a half ago and the product today is the result of modifications, additions and patches by hundreds of programmers. The result is a large and convoluted piece of software which needs the resources of an AT or more.

QNX's superb performance and compact size is the result of one dedicated design team with a common purpose, and complete understanding of both the software and the environment in which it must run. It runs quickly and efficiently on PC's and soars on an AT. Unlike Unix, QNX is capable of real time performance and is the undisputed choice for real time process control, and office systems. You can buy an OS that offers you a 1 to 3 user dead end on an AT, OR, you can consider QNX which allows you anywhere from 1 to 10 users on both PC's and AT's. And we don't stop there. Unlike other Unix-type systems for PC's, QNX is also a networked operating system. Not a patch-on network, but a fully integrated networking system for up to 255 micros. QNX allows you to start with a single machine and grow if and as required. There are no dedicated file servers and you can attach terminals (users) to any machine. To choose a solution which ignores networking, is closing the door on your future.

Everyone is talking about Unix like systems, but no one wants to abandon the tremendous amount of DOS software available. QNX does not force you to make that decision. You can run either PC DOS 2.1 or 3.1™ as one of QNX's many tasks. (DOS File compatibility and DOS development tools are also available). Don't misunderstand us. We at Quantum have a great deal of respect for Unix. It was a major force in moving operating systems out of the 1960's and into the 70's. QNX however, was designed in

the 80's and will be a driving force of the 1990's. Over 20,000 systems have been sold since 1982.

Quantum strongly believes that there are good reasons for buying QNX, DOS and Unix. If you want more than DOS and a working alternative to PC Unix, give us a call and we will discuss your needs.

End-Users, VAR's, OEM's and software developers are invited to take the QNX challenge.

- **MULTI-USER:** -10 serial terminals per PC, AT.
- **MULTI-TASKING:** -40 tasks per PC, AT.
- **NETWORKING:**
 - 255 machines.
 - up to 10,000 tasks and 2000 users/network.
 - 2.5 Megabit token ring.
 - 2800 task switches/sec (AT).
- **REAL TIME:**
- **MESSAGE PASSING:** -Intertask communication between any of 1000's of tasks on any machine.
- **MEMORY:** -88K to 110K for QNX.
- **PC DOS:** -Executes as a task under QNX.
- **C Compiler:** -Standard Kernighan and Ritchie.
- **Flexibility:** -Single machine or networked. One to thousands of users. Full resource sharing of disks and devices on all machines.
- **Support:**
 - Online update system allows downloading of new releases over the phone.
 - Technical support hot line.
- **COST:**
 - From US \$450
 - Call for runtime prices.
- **HARDWARE SUPPORT:** -IBM PC, XT, AT™ (both real & protected) and compatibles.

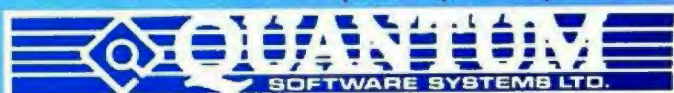

Moodie Drive HiTech Park 215 Stafford Rd. Ottawa, Ontario, Canada. K2H 9C1 Phone (613) 726-1893

IBM PC, AT, XT AND PC-DOS ARE REG. TM OF INTERNATIONAL BUSINESS MACHINES CORP. UNIX IS A REG. TM OF AT&T BELL LABS

PERIPHERALS

AST's Hard Disk with Tape Backup

AST Research announced an external 3½-inch hard disk and tape backup subsystem for the Macintosh Plus and Apple IIe. The AST-2000, which uses an

SCSI port, incorporates a 20-megabyte hard disk drive and a 20-megabyte cartridge tape drive. The Macintosh Plus version of the unit can be expanded to 60 megabytes.

The company reports that the disk's transfer rate is 5

megabytes per second; the tape's is 500K bytes, and it backs up 20 megabytes in 8 minutes. The tape drive allows file-by-file backup and restore operations.

The AST-2000 connects to the Mac Plus via cable and to the Apple IIe with a

cable and a controller card that plugs into an I/O slot. The system costs \$2795; if purchased separately, the tape drive is \$1695. Contact AST Research Inc., 2121 Alton Ave., Irvine, CA 92714, (714) 863-1333. **Inquiry 573.**

ADD-INS

AutoSwitch EGA

The Autoswitch EGA Card from Paradise Systems supports IBM's Enhanced Graphics Adapter and other display modes and automatically switches to the appropriate mode depending on the software being used. The half-slot card includes 256K bytes of memory and supports Color Graphics Adapter, Monochrome Display Adapter, Hercules graphics, and Plantronics ColorPlus display modes.

Suggested retail price is \$599. For more information, contact Paradise Systems Inc., 217 East Grand Ave., South San Francisco, CA 94080, (415) 588-6000. **Inquiry 574.**

Dual-Tasking Turbo Board

The Bi-Turbo board, an accelerator board from Alloy Computer Products, offers dual-tasking capabilities for IBM PCs, XT's, AT's, and compatibles. The board has an 8-MHz NEC V20 microprocessor, 640K bytes of RAM for applications programs, 256K bytes of RAM for disk caching, and a COM2 port for use by the second task. It comes with Alloy's proprietary BTNX software that can control two tasks from the computer's keyboard and monitor.

According to the company,

the board is based on the multiuser technology incorporated in the firm's Slave/16 boards. The Bi-Turbo sells for \$995. For more information, contact Alloy Computer Products Inc., 100 Pennsylvania Ave., Framingham, MA 01701, (617) 875-6100. **Inquiry 575.**

Data Acquisition Processor

The Data Acquisition Processor installs in a single slot in an IBM PC or compatible and offers real-time processing of analog data, according to Microstar Laboratories, the product's manufacturer.

The board has an 8-MHz 80186 microprocessor, 128K RAM, and one serial port. It features a 16-channel analog section with a programmable gain amplifier, dual sample and hold circuits, a 16-bit A/D converter, and an 8-bit analog output port. The board's 64- by 16-bit FIFO and direct memory access allow it to run real-time computations while the host computer operates other applications simultaneously. The board also has a multi-processing operating system that handles control and communication functions.

The Data Acquisition Processor sells for \$2500. Contact Microstar Laboratories Inc., 2863 152nd Ave. NE,

Redmond, WA 98052, (206) 881-4286. **Inquiry 576.**

Graphics Card for IBM RT PC

Microfield Graphics' T4 Color Graphics Controller card plugs into a single slot on the IBM RT PC's peripheral bus and provides high-speed 1024 by 800, 4-plane color graphics. The T4's proprietary architecture uses the 2901 bit-slice processor chip.

The board supports the ANSI CGI interface and works with applications on the RT's RISC processor or the optional DOS coprocessor. Applications can access the line drawing, polygon and text manipulation, bit-bit (bit block transfer), and window-management microcode of the T4 directly from subroutines written in C. Microfield's terminal emulator for the T4 lets the board act as a console device for the RT's AIX (Advanced Interactive Executive) operating system.

The T4 costs \$2850 and works with the IBM RT PC or the PC AT and compatibles. The price includes a first-level graphics package but not the CGI software (\$300/board). The RT support package costs \$150. Contact Microfield Graphics Inc., 8285 Southwest Nimbus Ave., Suite 161, Beaverton, OR 97005, (503) 626-9393. **Inquiry 577.**

PC Compatibility for Sun Workstations

The Sun Integrated Personal Computer (Sun-IPC) from Sun Microsystems is a 10-MHz 80286 coprocessor board with 1 megabyte of memory that provides Sun workstations with IBM PC AT compatibility and the ability to run MS-DOS applications in a window under UNIX.

The SunIPC, a VMEbus board, executes MS-DOS color or monochrome applications requiring the IBM PC AT color graphics adapter or the Hercules monochrome adapter. The board includes one parallel port, which allows the use of two workstation ports as standard serial ports. Options include an 8-MHz 80287 coprocessor and external 360K-byte and 1.2-megabyte floppy drives. The accompanying software includes MS-DOS 3.1, GW-BASIC, file-sharing software for the Sun Network File System, and utilities.

The SunIPC board costs \$1995 in single quantities plus \$395 for a single-user version of the software. A multiple-access version is available for \$995. Site licenses are also available. Contact Sun Microsystems Inc., 2550 Garcia Ave., Mountain View, CA 94043, (415) 960-1300. **Inquiry 578.**

(continued)

Multuser & LAN Solutions

For IBM PC/XT/AT

Now!



MULTIUSER

KT-7/PC² PC Work-a-like Terminal
 Compatibility: Multilink Advanced³,
 PC-Slave/16⁴
 Display: 80 x 25, IBM PC character
 set, PC look-a-like attributes, 14"
 green or amber
 Keyboard: AT style std. IBM
 scan/ASCII codes. 5161/AT and
 RT style opt.
 Pages of memory: 1 std. 2 or 4 opt.
 Communications: 2 bi-directional
 RS-232C serial (data & printer)
 ports
 Operating systems: works with
 PC-DOS¹, MS-DOS⁵, QNX⁶,
 UNIX⁷, XENIX⁸, THEOS⁹, PICK⁹,
 and Concurrent DOS¹⁰.
 Retail price: \$695.00
 QUARTET² 4-port I/O card,
 RS-232C
 Retail price: \$299.00

LAN

K-Net² Local Area Network
 Compatibility: **NETBIOS**, Token-
 Ring¹ software, (Advanced
 Netware¹¹ 8/86)
 Data Rate: 1 million bps
 Cable: Twisted-pair/phone wire
 Distance: Up to 4000 ft.
 Addressable users: Up to 255
 Physical: Half-sized card
 Operating systems:
 PC-DOS¹/MS-DOS⁵ 2.0 or later
 Dedicated file server: Not needed
 Message communication:
 Interactive
 Multiuser solutions supported:
 Multilink Advanced³
 PC-Slave/16⁴
 Other features: electronic mail, net-
 work data management, and
 print spooling
 Retail price: \$395.00

WORKSTATIONS

KW-1 8088, 4.77 MHz, 512 Kbytes
 Retail price: \$995.00
 KW-2 8088-2, 8 MHz, 512 Kbytes
 Retail price \$1,195.00
 KW-3 80286, 6 or 8 MHz,
 640 Kbytes
 Retail price \$1,995.00
 All the above include: monochrome
 monitor with video board, AT style
 keyboard, 8 slots, built-in K-Net²
 with remote boot, upgradeable to
 "complete" PC.
 (800) 828-8899
 (408) 436-6550 (In CA)
 1705 Junction Ct., Bldg. #160
 San Jose, California 95112

Kimtron

Trademarks: ¹IBM ²Kimtron ³Software Link ⁴Alloy ⁵Microsoft ⁶Quantum ⁷Bell Labs ⁸THEOS Software ⁹PICK Technologies ¹⁰Digital Research ¹¹Novell © Copyright 1986 by Kimtron Corp.

MS-DOS Version of C++

Oasys is selling a version of AT&T's programming language, C++, for MS-DOS computers. Called Designer C++, it works with the Lattice 3.0 or Microsoft 3.0 C compilers. It functions as a translator/preprocessor that generates compilable C source code from C++ source files. The generated C code adds no run-time overhead, Oasys says.

Developed by Glockenspiel Ltd. (Dublin, Ireland), Designer C++ features strong type checking, function and operator overloading, data abstraction and hiding using classes, virtual functions, stream-oriented I/O, and other facilities for object-oriented programming.

Priced at \$500, Designer C++ comes with a tutorial and release notes. It runs on a 512K-byte IBM PC or work-alike. Contact Oasys, 60 Aberdeen Ave., Cambridge, MA 02138, (617) 491-4180. Inquiry 579.

Two Prologs

Chalcedony Software announced two Prologs, one for the IBM PC and the other for the Macintosh.

Prolog/i, the IBM PC version, features floating-point arithmetic, transcendental and trigonometric math functions, a built-in integrated editor, and interactive debugging facilities. This version requires PC- or MS-DOS version 2.0 or later, true IBM compatibility, ANSI-standard support, one disk drive, and at least 256K RAM (320K is recommended).

Prolog/m, for the Macintosh, has the following features in addition to those of Prolog/i: 8087 support, calls to subroutine function library, calls to DOS, and screen and graphics man-

agement. System requirements are the same as those for the MS-DOS version except that 512K RAM is needed and an external disk drive is preferred.

Prolog/i costs \$69.95; Prolog/m, \$99.95. Contact Chalcedony Software Inc., 5580 La Jolla Blvd., Suite 126, La Jolla, CA 92037, (619) 483-8513. Inquiry 580.

A Toolkit for Framework's FRED

The FRED Development Toolkit is a collection of user-defined functions, utilities, abbreviations, macros, and templates for use with FRED, the object-oriented language built into Ashton-Tate's Framework II. FDT turns many of FRED's functions into tools for system development and macro programming.

According to vendor PCE Inc., all of Framework II's pull-down menu options and function and navigational keys are accessible through the FDT. A "toolkit compiler" converts FDT functions into FRED code.

The package includes source code and costs \$49.95. You also get a subscription to, and on-line support from, PCE's Expert WorkBench NETWORK, a private network on The Source. Contact PCE Inc., 6033 West Century Blvd., Los Angeles, CA 90045, (213) 757-7537. Inquiry 581.

OS for Software Development

PAX (Personal Applications Executive), an operating system for software development, runs with PC-DOS on IBM PCs or compatibles.

Included are high-speed device drivers and a demonstration system. The drivers include assembly language procedures for video display, interrupt-driven serial I/O over multiple channels, printer output, and interrupt management.

Baker & Rabinowitz reports that the PAX System 8632 can execute 32 tasks concurrently and that individual tasks can be written and debugged under DOS, then ported to PAX.

The system requires 128K RAM, DOS 2.x or 3.x, and a macro assembler.

PAX System 8632 sells for \$149.95. Contact Baker & Rabinowitz Inc., 3869 Kilbourne Ave., Cincinnati, OH 45209-1814, (513) 871-0886. Inquiry 582.

Three 68020 Operating Systems

Technical Systems Consultants announced the UniFLEX/DA, the UniFLEX/RT, and the UniFLEX/MX operating systems, all of which are written in assembly language.

UniFLEX/DA is a ROM-based operating system intended for process control and dedicated applications. You can configure it with or without a file system.

UniFLEX/RT is a real-time OS with communications facilities. Each real-time task has control of its own priority. RT also has a communications driver intended for transferring data, and a named enqueue/dequeue mechanism, which the company says allows you to run semaphore and resource-control operations.

UniFLEX/MX, an enhanced version of the original UniFLEX/VM, is a virtual-memory OS designed for use in a multiuser, multitasking environment. MX has all the features of DA and RT plus the ability for the user

to create and control multiple RAM disks.

These three systems can be configured for most hardware built around the 68010 or 68020 microprocessors, according to the company.

Prices range from \$400 to \$1000. Contact Technical Systems Consultants Inc., 111 Providence Rd., Chapel Hill, NC 27514, (919) 493-1451. Inquiry 583.

Display Management for IBM and TI Machines

Sydetech's C-Display Utilities include C-Display Compiler, a screen-management utility that has editing capabilities and supports color and character-generated graphics. Requirements include 128K RAM, one disk drive, a color monitor (with a CGA for the IBM PC model), MS-DOS 2.11 or higher, and a Microsoft C 3.0 or Lattice C 2.15/3.0 compiler.

C-Display Librarian is a collection of C functions that allow you to execute BIOS video services, perform virtual display management, create bit-mapped graphics, and conduct interactive screen I/O via high-level function calls. System requirements are the same as for the C-Display Compiler.

C-Display Utilities are available for the IBM PC, XT, AT, and PCjr and for the Texas Instruments Professional or Business Professional. C-Display Compiler sells for \$125. Librarian for \$145; the two combined in a package called the C-Display Manager costs \$245. Contact Sydetech System Development

(continued)

NEW RELEASE
EVEN MORE FEATURES

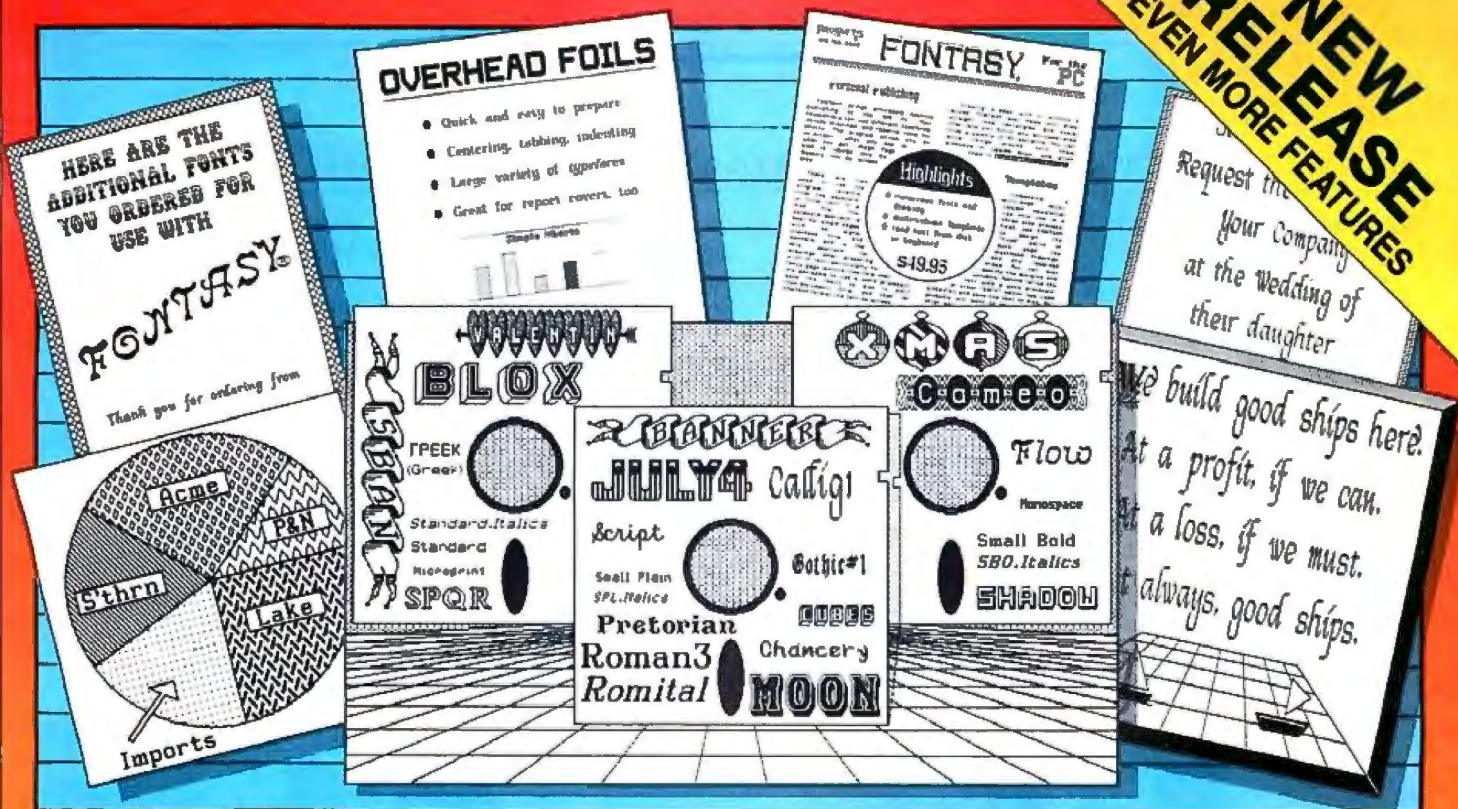

Fontasy printed all of these.

See What You Can Do With

Presentations! Newsletters! Flyers! Signs! Overhead Foils! Invitations! Menus! Logos! Announcements! Banners! Layouts! When you need a goodlooking visual quickly you need FONTASY — superb typefaces and simple drawing in one easy-to-use package.

FONTASY gives you a "what-you-see-is-what-you-get" picture, as you type and draw on the graphics screen of your IBM-PC. You can create a page at a time, see a mini-picture of that page, print it, and save it on disk. Page size is limited only by memory, not by screen size.

Features

Proportional space, justify, kern, bold-face, rearrange, magnify, black/white reversal, rotate, mirror image, lines, rectangles, ovals, draw, fill in, undo (and un-undo), on-line help, 200-page book, and easy control from keyboard or mouse. Corporate licenses available.

Fonts, fonts, and more fonts! We have over 275 typefaces in our growing library, and will be happy to send you free print samples on request.

When you deal directly with the manufacturer (that's us), you pay rock-bottom distributor prices. If you order FONTASY now, we will give you 28 fonts (a \$50 value) at no extra charge. With so many features at such a low price, FONTASY belongs in your software library even if you already have a "font" program.

Inquiry 239

FONTASY®

\$69⁹⁵

Includes 28 Fonts and free ClipArt.

Equipment Needed

IBM-PC, XT, AT, or true compatible (Compaq, etc.) with IBM or Hercules graphics adapter and graphics monitor. 256K memory needed for partial pages, 448-640K recommended for full pages. Dot-matrix printer. Mouse optional. MS-DOS 2.00 or above.

FONTASY supports: IBM graphics printer, Proprinter; Epson FX, JX, LX, MX, RX, and LQ-1500; C. Itoh 8510, 1550, 1570, Pro-writer-Jr, H-P Laserjet, Thinkjet, Microline 92, 93; Gemini 10X, 15X; Radio Shack DMP 105-430, 2100; Toshiba 351, 1340-1351; Star; and most Epson-compatibles.

Money-Back Guarantee

Fontasy is not copy-protected and has a 30 day money-back guarantee. So, take advantage of our breakthrough price and order now TOLL-FREE:

1-800-824-7888, operator 669 (ORDERS ONLY)

For further information and same day shipping, call: (818) 765-4444

PROSOFT®

7248 Bellaire Ave., Box 560
No. Hollywood, CA 91603-0560

Name _____ Company _____
Address _____ Telephone _____
City, State, ZIP _____
Visa/MC _____ Exp. Date _____
Computer _____ Memory _____ Printer _____

Terms: M/C, Visa, checks. Please add \$3.00 shipping and handling in U.S. or Canada, \$20.00 overseas, \$2.00 for C.O.D., and sales tax in Calif.

FONTASY \$69.95

Tax _____
Shipping _____
Total _____

SOFTWARE • PROGRAMMING LANGUAGES AND AIDS

opment Technologies, 43-23 Colden St., Suite 17C, Flushing, NY 11355, (718) 886-0221.

Inquiry 584.

Programming Tools for True BASIC

T rue BASIC Inc. has expanded its True BASIC Programming Libraries with tool and utility companion products: the Developer's Toolkit, Communications Support, Forms Management Library, Btrieve Interface, Sorting and Searching, and Advanced String Library. The company reports that

Communications Support allows simultaneous use of two COM ports at up to 19,200 bits per second. The Btrieve file management package is from SoftCraft Inc. and allows for database management of up to 4 million bytes per record and 24 key fields per file, according to True BASIC. Sorting and Searching provides 14 subroutines for string and numeric sorting. And a 38,000-word dictionary is included in the Advanced String Library, which also provides pattern matching, parsing, and text manipulation.

All libraries are available for the IBM PC or compat-

ibles running DOS 2.0 or higher. Communications Support and Sorting and Searching also run on the Macintosh and Amiga. Each package costs \$49.95. Contact True BASIC Inc., 39 South Main St., Hanover, NH 03755, (603) 643-3882. Inquiry 585.

C Cross Compiler for AT&T 6300 Plus

U niPress announced a Lattice C Cross Compiler for AT&T's 6300 Plus operating under UNIX. You can use UNIX software tools with the Lattice C Compiler

to develop MS-DOS code for 8086 and 80186 microprocessors. Relocatable machine code is produced by the compiler; then, using the linker, you can produce MS-DOS executable code.

The compiler supports the Kernighan and Ritchie C standard and library. It comes with a linker, librarian, disassembler, and floating-point support, and it requires a hard disk drive with 1 megabyte of RAM.

The cost of the compiler is \$795. Contact UniPress Software, 2025 Lincoln Highway, Edison, NJ 08817, (201) 985-8000. Inquiry 586.

SOFTWARE • SCIENTIFIC AND ENGINEERING

Mac Package for Structural Engineering

E rez Anzel's Frame-Mac helps in the analysis and design of any two-dimensional frame or truss, with any number of nodes, elements, and supports (limited by RAM only). The package utilizes scrollable windows, the mouse, and pull-down menus. You never need to type in commands. Any number and type of loads can be applied or changed at any time, as can the structure, units, and decimal formats. I/O is shown in numeric and graphic form.

Frame-Mac does linear analysis by using the modified Cholesky method to solve a structure's stiffness matrix; this matrix is made and calculated as a band matrix. At your request, the program provides values such as displacements, internal forces, and bending stresses.

The package runs on a 512K Mac with a 400K-byte internal drive (or bigger configuration). Price is \$495. Contact Erez Anzel, 5800

Arlington Ave. #5T, Riverdale, NY 10471, (212) 884-5798. Inquiry 587.

Statistical Analysis Package for Macintosh

C LR ANOVA, for the 512K Macintosh and Macintosh Plus, can compute up to a 10-factor analysis of variance with unequal sample sizes and repeated measures. It lets you plot interactions by clicking the mouse and making a menu selection. Marginal means, pairwise comparisons (Newman-Keuls, Duncan, Tukey hsd, and t-tests), simple effects, and specific contrasts (planned or unplanned) among means can also be computed. A desk-accessory editor lets you enter or change data even after an analysis has been started. Data from MacWrite, MS-File, MS-Word, Multiplan, Excel, and MacTerminal can also be analyzed.

The package sells for \$50

until September 1; thereafter, it's \$75. Add \$3 shipping. Contact Clear Lake Research, 5615 Morningside #127, Houston, TX 77005, (713) 523-7842. Inquiry 588.

Protein Programs

D NASTAR is selling two packages for researchers dealing with protein data. The first product, an analysis program, plots secondary structural predictions and hydrophilicity. It includes programs for determining optimal DNA probes for specific proteins or peptides, titration curves, isoelectric points, molecular weights, and other analytic functions.

The other package, Genman, helps search protein and genetic databases and retrieve information based on keywords, sequence matrices, and a combination of terms. It lets you create screen, printer, or subindex files from a search. GenBank and the Protein Identification Resource databases are supplied with the package.

Other databases, such as PGtrans and EMBL, can also be used.

Both programs run on IBM PCs and compatibles. Each is packaged with other programs and sold for \$3000. For more specific information, contact DNASTAR Inc., 1801 University Ave., Madison, WI 53705, (608) 233-5525. Inquiry 589.

Stat Package for Apple IIs

H istogram Plot, a statistics program for the Apple II, IIe, and compatibles, lets you input, edit, print, and save data. It can display and print raw and computed data and can compute means, medians, standard deviations, expected cell frequencies, and actual cell limits and frequencies. Graph sizes are variable. The price is \$29. Contact Andent Inc., 1000 North Ave., Waukegan, IL 60085, (312) 223-5077. Inquiry 590.

(continued)

Explore AI on your PC

Smalltalk/V transforms your PC into a versatile AI workstation

Only Smalltalk/V lets you experience the thrill of a responsive AI workstation while learning artificial intelligence techniques and using them to create practical applications.

"Smalltalk/V gives me the feel of an AI workstation on my PC."

—Darryl Rubin,
Technical Editor,
AI Expert
Magazine

Watching someone use an AI workstation is a vision of what the computer was meant to be. Fingers dance across the keys as windows dilate, shift, overlap, and disappear on the bit-mapped display. Ideas spring to life as program fragments execute, are modified, expanded, combined and tried again in a creative arabesque of text and graphics. The interface vanishes, man and machine are one. Smalltalk/V brings that experience to your IBM-PC.

"We use Smalltalk as our primary language for teaching artificial intelligence."

—Dr. John Pugh
Director, School of Computer Science
Carleton University

Of the three main AI languages, Smalltalk, LISP, and Prolog, only Smalltalk was intended for individual use on a personal computer. Only Smalltalk was designed to provide a match between human and computer models of reality. Only Smalltalk is easy to learn, easy to read, and easy to use.



"Smalltalk/V is the highest performance object-oriented programming system available for PCs."

—Dr. Piero Scaruffi
Chief Scientist
Olivetti Artificial Intelligence Center

\$99.00

Smalltalk/V Features

- High-performance object-oriented programming
- Integrates object-based and rule-based programming with object-oriented Prolog
- A user-extensible, open-ended environment
- A responsive graphical user interface
- Supports exploratory programming and prototyping
- Class hierarchy with inheritance creates highly re-useable code
- Smalltalk source code included, with browser windows for easy access and modification
- A huge toolkit of classes and objects for building a variety of applications
- Object-swapping creates virtual memory on hard or RAM disk
- Bit-mapped graphics with bit and form editors
- A sophisticated source-level debugger
- Automatic change log for easy recovery from errors
- Powerful directory/file browser system for organizing DOS files
- Optional communications interface to Unix™ and other systems
- Access to other languages and DOS functions
- DOS command shell
- Detailed owner's manual designed for both beginners and advanced programmers

"We found Smalltalk/V excellent for developing advanced decision-support tools based on decision analysis and AI techniques."

—Dr. Samuel Holtzman,
Professor, Stanford University

Smalltalk/V is pure object-oriented programming — a powerful tool for designing frame/script-based knowledge representations, inference engines, expert systems, simulation environments, intelligent interfaces, network control software, communications interfaces, and much more.

Methods, our character-based Smalltalk, is now available for \$79. It has all of the features of Smalltalk/V except graphics, rules, source-level debugger, and object-swapping. However, it supports color, includes the communication package, and does not require a mouse.

BYTE and BIX are trademarks of McGraw-Hill, Inc. IBM, IBM-PC, and IBM PC-AT are trademarks of International Business Machines Corporation. Unix is a trademark of Bell Laboratories.
Inquiry 91

YES! I want to turn my PC into an AI workstation. Send me . . .

<input type="checkbox"/>	Smalltalk/V	\$99
<input type="checkbox"/>	Communications for Smalltalk/V	\$49
<input type="checkbox"/>	Methods (including Communications)	\$79
	Shipping and Handling \$
	CA residents add applicable sales tax \$
	TOTAL \$

Shipping and Handling
U.S., Canada, and Mexico \$ 5.00
Elsewhere \$15.00

I enclose Check Money Order

Credit card information MC VISA

Number: _____ Expiration: _____

Signature: _____

Name: _____

Street Address: _____

City/State/Zip: _____

Phone: _____

NOT COPY PROTECTED, 60-DAY MONEY-BACK GUARANTEE
ON-LINE USER-SUPPORT CONFERENCE ON BYTE'S BIX™

Smalltalk/V requires DOS and 512K RAM on IBM PCs (including AT) or "compatibles," a Microsoft or compatible mouse, and a CGA, EGA, Hercules, or AT&T Hi-Res graphic controller.

digitalk inc.

5200 West Century Boulevard
Los Angeles, CA 90045 (213) 645-1082

Mac Comics

ComicWorks is a Macintosh program that lets you play Stan Lee and draw comic strips. The package incorporates drawing and painting tools, text editing, and the ability to mix text and graphics anywhere on a page. You can pull in images from other ComicWorks documents or from MacPaint (using Art Grabber). The program also includes graphics objects you can move independently, comic-book fonts, panels, and voice balloons.

ComicWorks, developed by MacroMind Inc. (Chicago), is being sold by Mindscape for \$79.95. It runs on the 512K Mac. Contact Mindscape Inc., 3444 Dundee Rd., Northbrook, IL 60062, (312) 480-7667. Inquiry 591.



Comic-book art created with ComicWorks and a Macintosh.



Random data arranged by Tornado Notes.

Access to Random Data

ARAM-resident program for IBM PC-type machines, Tornado Notes is designed to let you store and access random information. You enter text into logical modules. When you need to find a note, the program uses a search tool based on an "and-or-not" system. You can hunt for related notes based on any word, phrase, or combination.

The publisher says that, unlike spreadsheets and databases, which handle structured data, this package uses a form of parallel text processing that treats windows of data according to content. The software includes an editor with cut and paste, a "pile-of-paper simulator," and a note-joining function.

Tornado Notes runs under MS- or PC-DOS 2.0 or later, does not use bit graphics,

and supports most 80-character monochrome and color displays. The publisher says the program works with most software and uses 50K bytes of RAM, plus space for notes. It's not copy-

protected, and it costs \$49.95. Contact Micro Logic Corp., P.O. Box 174, 100 Second St., Hackensack, NJ 07602, (201) 342-6518; by modem, (201) 342-8101. Inquiry 592.

WHERE DO NEW PRODUCT ITEMS COME FROM?

The new products listed in this section of BYTE are chosen from the thousands of press releases, letters, and telephone calls we receive each month from manufacturers, distributors, designers, and readers. The basic criteria for selection for publication are: (a) does a product match our readers' interests? and (b) is it new or is it simply a reintroduction of an old item? Because of the volume of submissions we must sort through every month, the items we publish are based on vendors' statements and are not individually verified. If you want your product to be considered for publication (at no charge), send full information about it, including its price and an address and telephone number where a reader can get further information, to New Products Editor, BYTE, One Phoenix Mill Lane, Peterborough, NH 03458.

Personal What'sBest

General Optimization has released the Personal Version of its "spreadsheet optimization" package, What'sBest. This edition (not copy-protected) functions like the original but runs in 256K RAM and can optimize spreadsheets with as many as 800 numeric cells. Up to 250 of these can be variable (manipulated by the program during the optimization process).

What'sBest is designed to generate solutions to business problems modeled in Lotus 1-2-3 or Symphony. It uses a linear programming approach and a spreadsheet interface to answer "what if" questions.

It runs on IBM PC-type computers and costs \$149. Contact General Optimization Inc., 2251 North Geneva Terrace, Chicago, IL 60614, (312) 248-7300. Inquiry 593.

Idea Processing on the Amiga

New Horizons Software has developed a package for helping you process your ideas on an Amiga. The company says the program's primary use is in organizing and rearranging information in preparation for writing, or for planning and decision making. You enter your ideas in an outline fashion and use the mouse or keyboard to manipulate them. The program provides pull-down menus for command entry. Because Flow opens its own window on the Workbench, you can use the computer's multitasking capabilities. New Horizons says.

Suggested retail is \$99.95. Contact New Horizons Software, P.O. Box 43167, Austin, TX 78745, (512) 280-0319. Inquiry 594.

100 MHz scope, counter, timer, multimeter: All one integrated system.

100 MHz dual time base scope. 3.5 ns risetime; sweeps from 0.5 s to 5 ns/div; alternate sweep; $\pm 2\%$ vertical/horizontal accuracy; vertical sensitivity to 2 mV/div @ 90 MHz.

9-digit fluorescent display. Digitally accurate readouts accompany the CRT waveform. Error messages and prompts also appear on the display.

Dc volts and ac coupled true RMS volts. Measured through the Ch 1 scope input.

Gated measurements. Use the scope's intensified marker to measure frequency, period, width and to count events within specified portions of the signal.

Auto-ranged, auto-averaged counter/timer. Frequency, period, width, delay time, Δ -time, plus totalize to more than 8 million events—with 7 digits plus exponent displayed.

Auto-ranged DMM. Use floating DMM side inputs with up to 5000-count resolution. Get precise readouts of average dc and true RMS voltage. Measure resistance from milliohms to gigohms.

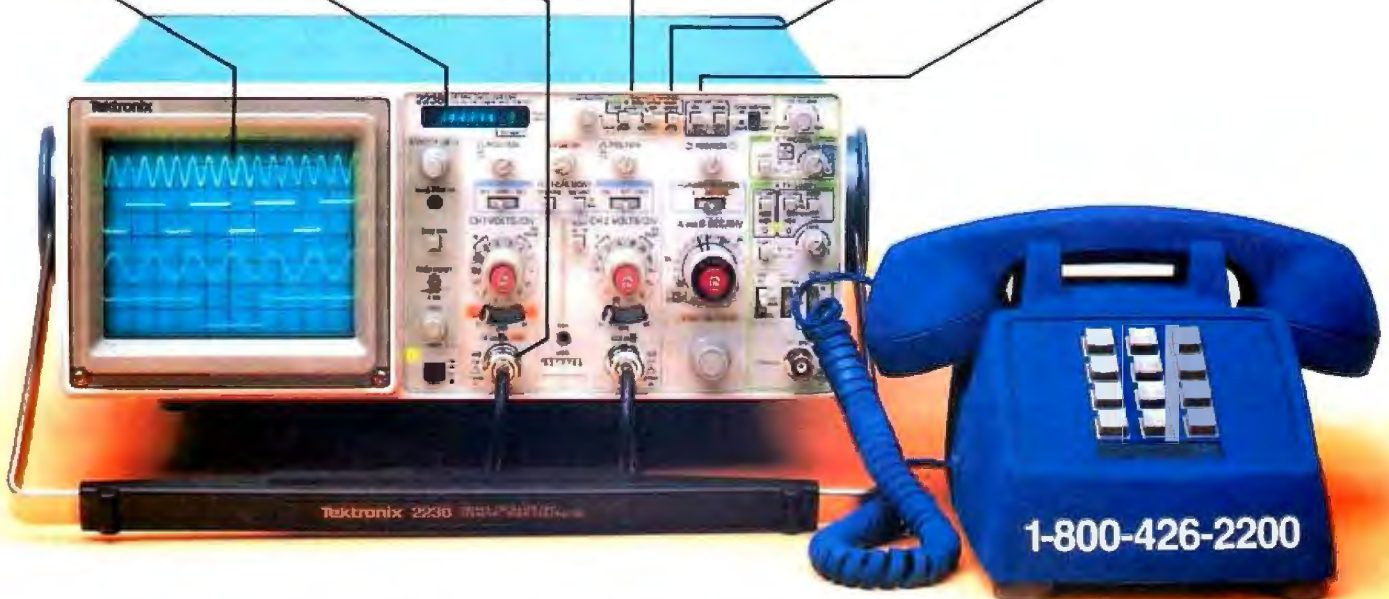

Now make measurements faster, easier, with greater accuracy and user confidence. The Tek 2236 makes gated counter measurements, temperature, time, frequency, resistance and voltage measurements push-button easy. You see results concurrently on the 9-digit numeric readout and CRT display.

Its complete trigger system includes pushbutton trigger view, plus peak-to-peak auto, TV line, TV field, single sweep and normal modes.

At just \$2650*, the 2236 includes the industry's first 3-year warranty on all parts and labor, including the CRT.

Integrated measurement system. 3-year warranty. 15-day return policy. And expert advice. One free call gets it all! You can order, or obtain literature, through the Tek National Marketing Center. Technical personnel, expert in scope applications, can answer your questions and expedite delivery. Direct orders include probes, operating

manual, 15-day return policy, full warranty and worldwide service back-up.

**Order toll-free:
1-800-426-2200
Extension 57**

In Oregon call collect:
(503) 627-9000 Ext. 57
Or write Tektronix, Inc.
P.O. Box 1700
Beaverton, OR 97075

Tektronix
COMMITTED TO EXCELLENCE

MetaComCo™ Languages

Atari ST™ • Amiga™ • QL™

LATTICE® C

The well known LATTICE® C compiler, full featured portable implementation.

MCC™ PASCAL

An ISO/ANSI standard Pascal. A fast single pass compiler, ideal for commercial, educational and personal use.

MCC™ ASSEMBLER

A professional standard macro assembler with many powerful features.

CAMBRIDGE LISP

LISP interpreter/compiler providing a complete LISP development environment.

BCPL

A powerful compiler offering the convenience of a high level language with the flexibility of an assembler.

APL

Keyword and symbolic versions of this important language from MicroAPL.

MCC™ BASIC

68000 BASIC interpreters and compilers from MetaComCo.

MENU+™

An easy to use program environment with pull-down menus. Menu+ comes free with Atari software. Upgrades ready for registered users.

TOOLKIT

Provides useful tools and utilities. From the people who wrote AmigaDOS.

Product	Atari™ ST	Commodore™ Amiga	Sinclair™ QL
Lattice C	\$149.95	\$149.95	\$129.95
Pascal	\$99.95	\$99.95	\$99.95
Assembler	\$79.95	*	\$49.95
Lisp	TBA	\$199.95	\$79.95
BCPL	TBA	TBA	\$79.95
APL	\$199.95	TBA	\$129.95
Basic	†	*	—
MENU+	\$29.95	TBA	—
TOOLKIT	TBA	\$49.95	—

* = available from Commodore

† = available from Atari

Cambridge LISP is available for CP/M-68K™

QL LISP includes interpreter only



The Quality Source for 68000 Software
5353 #E Scotts Valley Dr., Scotts Valley, CA 95066

Contact your local dealer or call:

Tel: US 800-AKA-META

Cal 800-GET-META, Eur (UK) 44-272-428781

Telex (UK) 444874 METACO G

Add 6.5% tax if CA resident.

Lattice is a registered trademark of Lattice Inc.

Amiga and AmigaDOS is a trademark of Commodore-Amiga Inc.

Atari ST is a registered trademark of Atari Inc.

CP/M-68K is a trademark of Digital Research Inc.

C·L·U·B·S A·N·D N·E·W·S·L·E·T·T·E·R·S

DISABILITY NEWS ONLINE, Robert Mauro, 257 Center Lane, Levittown, NY 11756. Electronic newsletter by and for the disabled.

PC TECH REPORT, William J. Claff, 7 Roberts Rd., Wellesley, MA 02181. (617) 235-9505. Technical code and techniques for professional software developers; \$18 subscription rate includes back issues.

MADISON MACINTOSH USERS GROUP, P.O. Box 1522, Madison, WI 53701. \$15 subscription to the *Mad Mac News*; frequent meetings.

FOREFRONT, C-128 NATIONAL USERS GROUP, P.O. Box 21836, St. Louis, MO 63109. Send SASE for information.

PC USERS GROUP OF NEW YORK, P.O. Box 560, Wall St., New York, NY 10005. Free publication with 98-cent-stamped, 8½-by-11-inch self-addressed envelope. \$25 membership includes newsletter and discounts; send SASE for details.

COMPAQ CORNER, 714 Ocean Ave., Sea Bright, NJ 07760. 300- or 1200-baud BBS, on-line 24 hours a day at (201) 530-5639.

SMALL COMPUTERS IN THE ARTS NEWS (SCAN), P.O. Box 1954, Philadelphia, PA 19105. Triannual newsletter, annual symposium; \$15 subscription.

PC-HUG (HUNTINGTON PC USERS GROUP), P.O. Box 1958, Huntington, WV 25720. (304) 526-5189. Monthly meetings, no admission fee; dues only for use of public domain library.

THE INSTITUTE OF INTELLIGENCE TECHNOLOGY, 571 Ontario St., Toronto, Ontario, Canada M4X 1M9. (416) 924-3819. Correspondence courses, bimonthly newsletter, IQ evaluator. One-time fee of \$25 U.S., \$35 Canadian.

MINDSET BBS—EAST COAST CHAPTER OF THE FIRST MINDSET USERS GROUP (FMUG), James Pallack, 23 Hayward St. #8, Burlington, VT 05401-4759. (802) 658-1255. Operating 7 days a week at 300 and 1200 baud at (802) 658-2494.

THE MCSPIRITT NEWSLETTER, 185A Smith Ave., Garden City, GA 31408. (912) 966-2323. ISPF techniques and programs. Subscription: \$51 annually.

PHILADELPHIA AREA COMPUTER SOCIETY'S MACINTOSH SPECIAL INTEREST GROUP (MAC SIG), Melanie Hoag and Simon Edkins, Drexel University, Biosciences and Biotechnology, Philadelphia, PA 19104. (215) 895-2628. Public domain library, regular meetings, monthly newsletter; \$10 annual subscription.

INTERNATIONAL COMPUTING ASSOCIATION (ICA), c/o Markus Mäge, Röbbek 6, 2000 Hamburg 52, West Germany. BBS, global BBS information, quarterly newsletter. \$20 annually.

CLACK! AMIGA USER GROUP, Stefan Ram, Claszeile 27, 1000 Berlin 37, West Germany. English and all European languages welcome for information exchange about the Commodore Amiga.

TELECOMMUNICATIONS USERS GROUP (TUG), P.O. Box 45254, Seattle, WA 98145-0254. Monthly journal, regular meetings. \$12 annual dues.

MICRO BULLETIN BOARD SYSTEMS, MBBS Headquarters PDSE, 8033 Sunset Blvd. #975, Los Angeles, CA 90046. (213) 653-6398. Clearinghouse for sysops and users. Membership: \$10 per year.

ANKARA APPLE USERS CLUB (AAUC), Çağlan M. Aras, 4. cadde 165/31, 06490 Bahçelievler, Ankara, Turkey. (90) 41 23 43 69. Regular meetings, monthly newsletter. Annual fee: 2000 Turkish liras, or about \$4.

SANTA BARBARA ATARI COMPUTER ENTHUSIASTS (SBACE), P.O. Box 3678, Santa Barbara, CA 93130. Regular meetings, newsletter, BBS at (805) 965-5709. ■

CLUBS AND NEWSLETTERS is an acknowledgment of new clubs and newsletters received at BYTE. Allow at least four months for your club's mention to appear. Send information to BYTE, Clubs and Newsletters, One Phoenix Mill Lane, Peterborough, NH 03458.

**IT'S TIME
YOU SAW
THE ALPS.**

SO HERE

Only \$995.

Fast. Top speed
250 cps in draft mode.

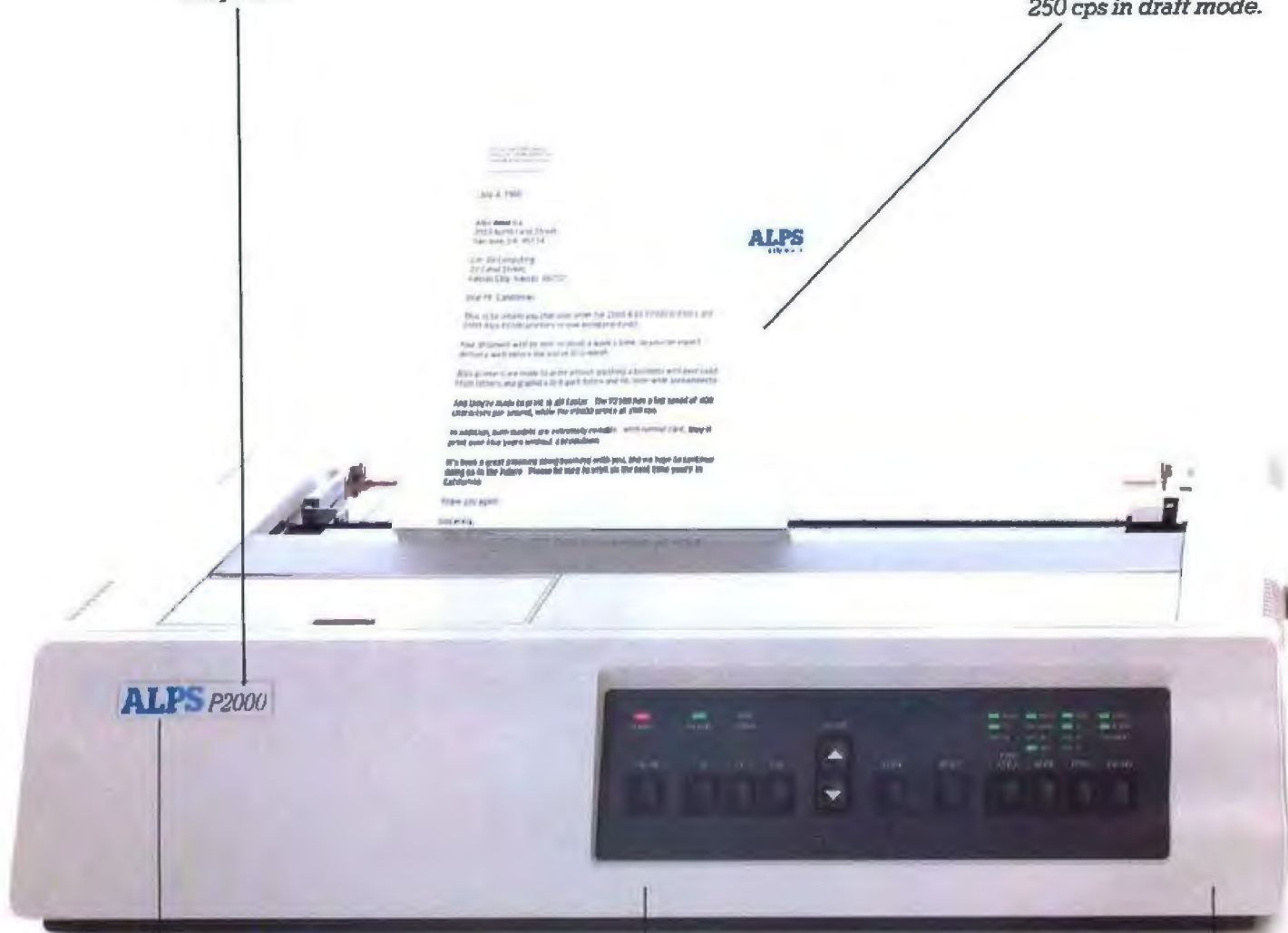

Manufactured by Alps Electric, a \$1.5 billion Japanese maker of computer and electronic products, and member of the International Fortune 500.

Fully compatible with all the most popular business PCs and software.

Built like a tank.

Welcome to the Alps.
The Alps P2000™ and new P2100™
Dot Matrix Printers. They just may
be the perfect printers for a department
full of PCs.

They're fast. The P2100 prints

drafts at an amazing 400 characters per
second (cps), the P2000 at an almost
amazing 250 cps.

They're reliable. With normal care,
they'll last for over five years without
a breakdown.

THEY ARE.

Sold, serviced and supported in the U.S.A. by Alps America.

Very fast. Top speed 400 cps in draft mode.

July 4, 1988

ALPS America
2051 North First Street
Los Altos, CA 94024

Car-In Computing
77 Lake Street
Mountain View, CA 94035

Dear Mr. Customer:

This is to inform you that your new ALPS P2100 printer or P2100 plus printer is now being processed.

Your shipment will be sent to about a week's time, or you will receive it directly from the end of stock month.

ALPS printers are made to be an almost anything you can do with them. From letters and reports to 4 part forms and 24-hour-a-day operations.

And they're made to print in all colors. The P2100 has a top speed of 400 characters per second, while the P2100 plus is 250 cps.

In addition, both models are extremely reliable. With normal care, they'll print over 100,000 characters without a breakdown.

It's hard to find a printer that works with you, and we hope for additional proof in the future. Please be sure to visit us, the next time you're in California.

Thank you again.

ALPS
1988

ALPS P2100

Likewise.

Only \$1,595.

And they're versatile. They'll print most anything, and run with all the most popular PCs and software.

Now, if you'd like to explore these Alps further, our free tour begins on the next page.

It's your chance to see something you probably don't see every day. Printers that work as hard as you do.

MEET DISTINGUIS

*Diagnostic self-test
signals errors with
flashes and beeps.*

*A choice of paper
feeding controls.*

*Go off-line to change
type styles and modes
without lengthy soft-
ware commands.*



*12 pushbuttons
control printing
functions.*

*Lets you feed paper
line-by-line, by
1/216-inch increments,
or continuously.*

The first thing that sets Alps printers apart from similarly-priced models is their sheer wealth of printing functions. And the ease with which you can perform them.

For example, you can change type styles or print modes without getting

involved in lengthy software commands. Just push a button on the front panel instead.

Which is about all you'll ever have to do to handle any Alps printing job. Whether you're feeding paper in 1/216-inch increments or reprinting

OUR HED PANEL.

*Clears print buffer
of data without
printing it.*

*17 LEDs indicate
functions in
operation.*



*Automatically reprints
data stored in print
buffer.*

*Select type styles,
printing modes, print
itches and spacing
quickly and easily.*

*Boy, is it fast. 400 cps
in draft mode.*

data stored in the print buffer.

The built-in print buffer (4K expandable to 256K) also frees up your PC for other jobs while the Alps is still printing.

And in the unlikely event of an operating error, our panel will imme-

diately diagnose the problem and inform you.

With distinguished beeps and flashes.

FEED IT A

Can print 6-part forms.

3 standard paper feeding methods, including top, bottom and rear feed.

ALPS P2100

Most business printers are very picky.

They simply refuse to deal with some of the jobs you have to deal with. Like printing on heavy stock. Or on oversized sheets.

But Alps printers are different. They're made to print almost anything your business will ever need. From letters and graphs to six-part forms and 16-inch-wide spreadsheets. And they not only handle most

ANYTHING.

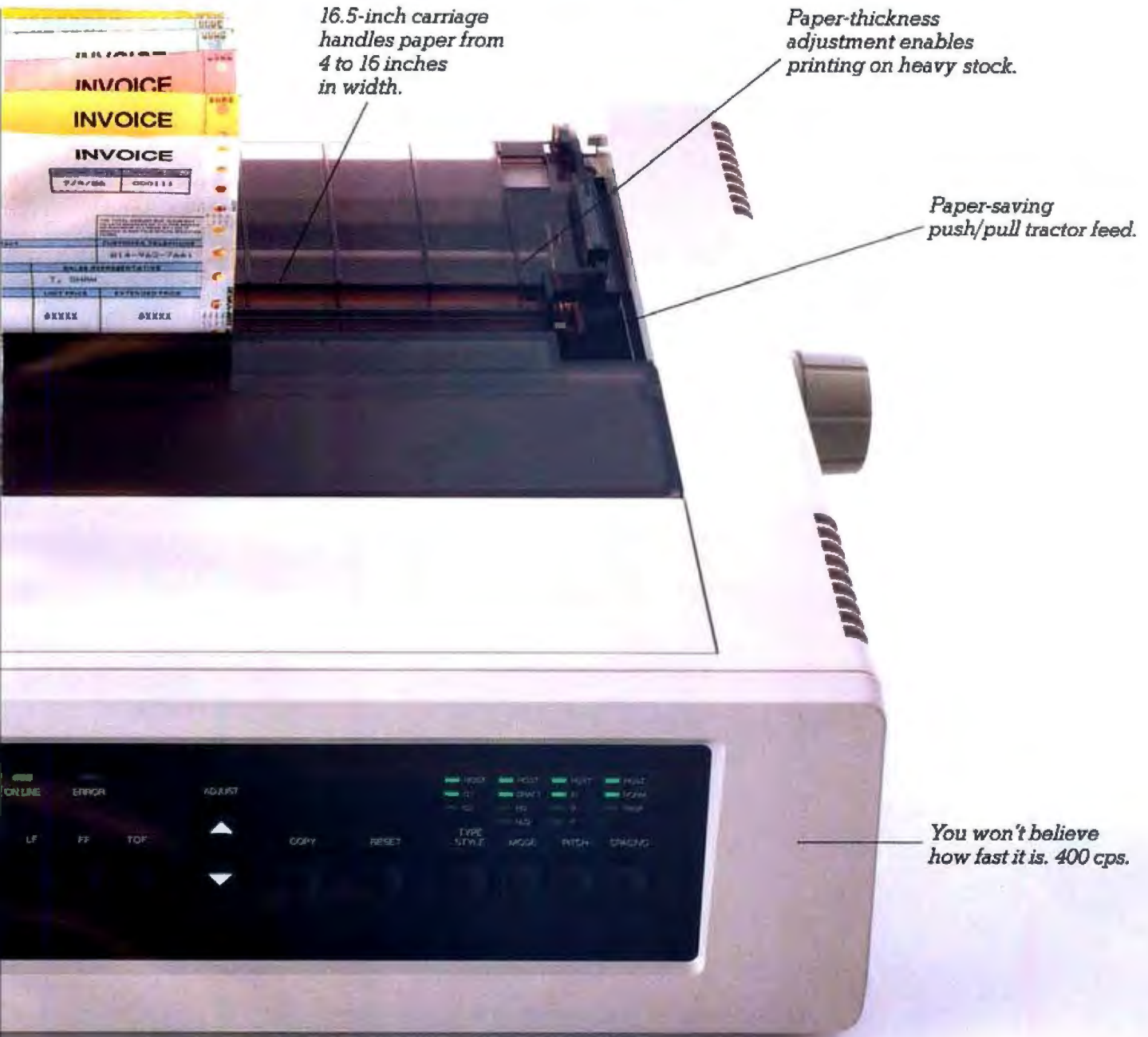

16.5-inch carriage handles paper from 4 to 16 inches in width.

Paper-thickness adjustment enables printing on heavy stock.

Paper-saving push/pull tractor feed.

You won't believe how fast it is. 400 cps.

everything, they handle it more efficiently.

Both come with a built-in two-way tractor feed (push and pull) that saves paper other printers would normally waste. Plus a choice of three different

paper feeding methods, all standard.

All in all, you'd be hard pressed to find printers with a greater appetite for work.

TURN UP T

P2000 prints at speeds of 250, 125 and 50 cps, fast enough for high-volume work.

Easily accommodates 16-column spreadsheets.

Multiple font cartridges let you change type styles quickly.

ALPS P2100

P2100 prints at speeds of 400, 200 and 80 cps, fastest in its price range. (We're not kidding, it's fast.)

Kept adequately fed, Alps printers will handle more work than any printers in their class.

Each offers a choice of three speeds. All fast.

The P2100 prints drafts at 400 cps, memos at 200 cps and letter-quality documents at 80 cps, while the P2000 prints at 250, 125 and 50 cps in its three modes.

THE VOLUME.

*3 print modes:
draft, memo and
letter quality.*

*Precision-engineered
print head is designed
for high-speed,
heavy-volume
printing.*

*4K print buffer
(expandable to 256K)
can store up to
128 pages.*

So either printer can easily take on all the work an office full of PCs can dish out.

And they'll take care of it faster, thanks to time-saving features like a

built-in tractor feed, expandable print buffer and multiple type font cartridges.

In fact, for heavy volume work, Alps printers stack up favorably against much more expensive machines.

LISTEN TO

July 4, 1986

*Superb print quality
in all three printing
modes.*

Alps America
3553 North First Street
San Jose, CA 95134

Can-Do Computing
22 Canal Street
Kansas City, Kansas 66222

Dear Mr. Candelman

This is to inform you that your order for 2000 Alps P2000 printers and 2100 Alps P2100 printers is now being processed.

Your shipment will be sent in about a week's time, so you can expect delivery well before the end of this month.

Alps printers are made to print almost anything a business will ever need from letters and graphics to 6-part forms and 16-inch-wide spreadsheets.

And they're made to print it all faster. The P2100 has a top speed of 400 characters per second, while the P2000 prints at 250 cps.

In addition, both models are extremely reliable. With normal care, they'll print over five years without a breakdown.

It's been a great pleasure doing business with you, and we hope to continue doing so in the future. Please be sure to visit us the next time you're in California.

Thank you again.

*Rugged print head
has life span of over
200,000,000
characters.*

*With normal care,
will last over five years
without a breakdown.*

One-year warranty.

ALPS

Even when the volume's up all the way, you won't hear much. Because Alps printers are built to print up a storm without sounding like one.

Every open space is covered with sound-absorbent layers, keeping noise in and dust out.

But Alps printers aren't just built to run quietly. They're built to run a long, long time.

Our precision-engineered print head will deliver over 200 million characters of superb output. No matter how hard you work it.

THIS PAGE.

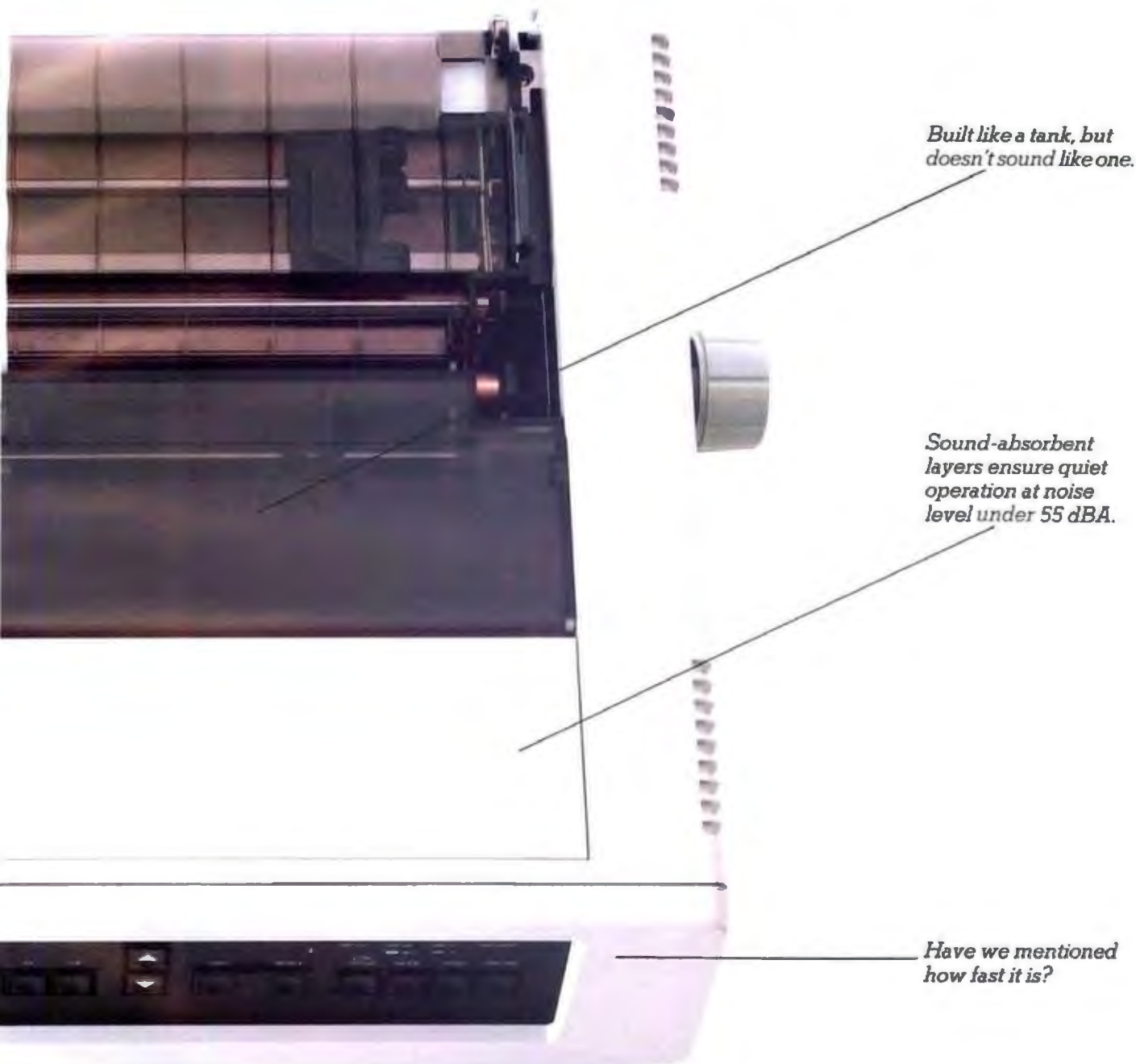

*Built like a tank, but
doesn't sound like one.*

*Sound-absorbent
layers ensure quiet
operation at noise
level under 55 dBA.*

*Have we mentioned
how fast it is?*

What's more, if you give our printers normal care, they'll give you over five years of trouble-free printing.

Which is not surprising when you consider that they're built by Alps Electric, a \$1.5 billion Japanese company that's been successfully

manufacturing computer printers for over a decade.

And though our printers are quiet, we're sure you'll be hearing a lot about them from now on.

SEE THE ALPS AND SEE THE ALPS. FREE.

The one thing better than an Alps demonstration on paper is an Alps demonstration in person.

Especially when it could get you a free trip for two to the Japanese or Swiss Alps. For 10 days. With all expenses paid, including airfare, hotel and meals.

Just fill out and send in the attached coupon. Or, if it's been removed,

you can call or write us at the address shown below.

We'll then contact you to arrange a free demonstration of the Alps P2000 or P2100 at your convenience. And we'll enter your name in our drawing for a free Alps vacation.

After all, anyone working without an Alps printer could certainly use a vacation.

ALPS
AMERICA

3553 North First Street
San Jose, CA 95134
(800) 828-ALPS
In California, (800) 257-7872

SEE THE ALPS FREE.

Yes, I'd like to see the Alps P2000 and P2100 Dot Matrix Printers in action. Please contact me to arrange a free demonstration. And enter my name in your drawing for a free 10-day vacation to the Japanese or Swiss Alps.

No, I'm not interested in a free demonstration right now. But please enter my name in your drawing anyway.

NAME: _____

COMPANY: _____ TITLE: _____

ADDRESS: _____

CITY: _____ STATE: _____ ZIP: _____ PHONE: _____

NO PURCHASE NECESSARY TO ENTER OR CLAIM A PRIZE.

1 To enter sweepstakes, fill out the information on this card and return it to Alps America, 3553 North First St., San Jose, CA 95134. Only one entry per person. Mechanically reproduced entries not eligible. All entries must be received no later than Sept. 30, 1986. Not responsible for late, lost, or misdirected mail.

2 Winner will be selected in a random drawing on or about October 15, 1986, from all entries received under the supervision of Marden-Kane, an independent judging organization. By participating in the sweepstakes, entrants agree to be bound by the rules and the decision of the judges, which shall be final. Winner will be notified by mail and must be required to sign an Affidavit of Eligibility and Release which must be returned within 14 days, or an alternative winner will be selected. The awarding of the prize to an individual shall be made at the discretion of your employer and/or in accordance with your employer's written policies governing promotion awards, where applicable. Winner grants permission to the use of their name, photograph/likeness for advertising and promotion for this and similar promotions without additional compensation. Odds of winning depend upon the number of entries received. All taxes are the responsibility of the winner.

3 Prize structure: (1) Grand Prize: a 10-day trip for two to the Japanese or Swiss Alps. Trip consists of round trip air transportation (coach) from a major airport nearest to the winner's residence, 9 nights and 10 days hotel accommodations, 2 meals daily and \$500 spending money. No prize substitution permitted, nor is prize transferable. Trip must be completed by June 30, 1987, and is subject to availability.

4 Sweepstakes open to individuals who purchase, specify, evaluate, recommend or use printers for personal computers, and are residents of the United States, except for employees and their immediate families of Alps Electric (USA), Inc., their subsidiaries, affiliates, advertising or public relations agencies, and Marden-Kane. Void where prohibited by law.

5 For the name of the winner, send a stamped, self-addressed envelope to "See the Alps" Winner, Alps America, 3553 North First St., San Jose, CA 95134.



NO POSTAGE
NECESSARY
IF MAILED
IN THE
UNITED STATES

BUSINESS REPLY MAIL

FIRST CLASS MAIL PERMIT NO. 7931 SAN JOSE, CA

POSTAGE WILL BE PAID BY ADDRESSEE

ALPS
AMERICA

3553 North First Street
San Jose, CA 95134



F·I·X·E·S A·N·D U·P·D·A·T·E·S

FIX

Man Baffled by Maryland Move

Boy, was Mike Barlow surprised when he found out he had moved from Pierrefonds, Quebec, to Wheaton, Maryland. We told him about his relocation in the Clubs and Newsletters section of our February issue. Mike edits the newsletter of the American

Cryptogram Association, and he still does that job at his place in the Great White North. It's the ACA's *treasurer* who lives in Maryland.

You can get information about the newsletter for cryptologists by writing to Mr.

Barlow at 5052 Chestnut Ave., Pierrefonds, Quebec, Canada H8Z 2A8.

If you want to join the association, write to the ACA treasurer, who is still staking out the 12317 Dalewood Dr., Wheaton, MD 20902 address.

BYTE'S BITS

Software Exchange for Turbo Pascal Users

Steve Wood, author of *Using Turbo Pascal* (Osborne/McGraw-Hill, 1986), tells us he's organized Turbo SIX, the Turbo Pascal Software Information Exchange. Mr. Wood

says the objective is "to collect, analyze, and disseminate information and software" to users of Borland International's Turbo Pascal. The software is from the

public domain and from members. For more information, contact Turbo SIX at 2012 Lake Air, Waco, TX 76710, (817) 753-2182.

Publications We'd Like to Tell You About and Can't Find an Appropriate Place for Anywhere Else

Ken Knecht is offering his booklet *Macintosh Hints and Kinks* on a shareware basis. It describes undocumented command- and option-key combinations, the MacPaint/Write/Draw trio, and other programs. "I will encourage the recipient to, in turn, send me \$3 or whatever seems fair," Mr. Knecht writes.

Send a 6-by 9-inch SASE (with 39 cents postage) to Ken Knecht, 1340 West 3rd St. #130, Yuma, AZ 85364, (602) 783-9259.

Howard Boyet writes to tell us about a book he cowrote with Ron Katz called *The 16-Bit 8096—Programming, Interfacing, Applications: 122 Hands-On Experiments with Intel's iSBE-96 Emulator*. Mr. Boyet says, "The aim

of this book is the complete understanding and mastery of this formidable chip and all its functionality."

With Intel's emulator, the programs for the 122 experiments can be entered in ASM-96 and downloaded with an IBM PC AT, PC XT, or compatible.

The book sells for \$39.95 (plus \$2 shipping). Contact MTI Publications, 14 East 8th St., New York, NY 10003, (212) 473-4947.

The Society of Manufacturing Engineers has bound 22 technical papers representing highlights of the CIMTECH Conference sponsored recently by SME and its Computer and Automated Systems Association. The papers present models for im-

plementing computer-integrated manufacturing theories and applications.

Contact SME, Publication Sales, One SME Dr., P.O. Box 930, Dearborn, MI 48121, (313) 271-1500, ext. 418.

John Wiley & Sons has begun publishing a new journal "devoted to the systematic development of the theory necessary for the construction of intelligent systems." Wiley says its *International Journal of Intelligent Systems* includes "scholarly, peer-reviewed" articles on expert systems, knowledge representation, interactions between man and computer, and machine learning.

Contact Wiley at 605 Third Ave., New York, NY 10158, (212) 850-6000.

UPDATE

New and Improved MicroTEX

Addison-Wesley has informed us of an update to its MicroTEX typesetting package, reviewed by Hal Varian in our April issue. A new version, 1.5A1, has since been published and features the following changes:

MicroTEX now has drivers for all PostScript printers and phototypesetters. Hewlett-Packard LaserJet Plus and compatible printers, Imagen Impress laser printers, QMS Quic laser printers, Epson FX, MX, and RX printers, and IBM's Graphics Printer and Proprinter.

The package now lets you create and read FMT files.

Preview software lets you check your output on the screen and see what you're going to get.

It's smaller. A fully loaded version of "Plain TEX" fits on one 360K floppy disk; A-W says you can run MicroTEX on a two-floppy system.

It can run BibTEX and other big macro packages.

Most recent versions of L^AT_EX and AMS

TEX are available to let users format work in predefined document styles.

MicroTEX with either a PostScript printer driver or a LaserJet Plus driver is \$495; with an Epson or IBM driver, \$369.95. Owners of older versions can upgrade to 1.5A1 for \$50; owners of Personal TEX Inc's PCTEX can upgrade to the new MicroTEX for \$100. For further information, contact Addison-Wesley Publishing Co., Reading, MA 01867, (617) 944-3700. ■

Conducted by Steve Ciarcia

APPLE IIe

Dear Steve,

I am an Apple IIe user looking for information in a few areas. First, I would like to find DOS 3.3 source listing and documentation.

I am interested in controlling a cutting tool from my computer. I am thinking of a machine with *x, y* coordinates and up-down control. This would be for light work, such as cutting thin cardboard.

I need information on an arithmetic processor for three-dimensional graphics operations. Where can I obtain information about the 9511 or 9512 APU?

Finally, I would like some information on three-dimensional digitizing equipment.

Thanks for your help.

JOSE LUIS DARIAS GARCIA
Caracas, Venezuela

DOS 3.3 source code can be obtained from these two sources:

Apple Assembly Line
P.O. Box 280300
Dallas, TX 75288
(214) 324-2050

Nibble
MicroSparc Inc.
42 Winthrop St.
Concord, MA 01742
(617) 371-1660

Nibble magazine published the source code as part of the "Disassembly Lines" column by Sandy Mossberg. Beneath Apple DOS from Quality Software (6660 Reseda Blvd., Suite 105, Reseda, CA 91335) also contains source code information.

I know of no products available that are the same as your cutting tool description. However, the mechanism you describe is functionally similar to some of the two-axis plotters available for the Apple from several manufacturers. If a knife with a freely swiveling blade were substituted for the felt-tip pen, you might have a workable system if cutting forces are extremely low. Suitable knives can be obtained from art and drafting supplies distributors. Some manufacturers of plotters are

Houston Instrument
8500 Cameron Rd.
Austin, TX 78753
(800) 531-5205

Mannesmann Tally
8301 South 180th St.
Kent, WA 98032
(206) 251-5524, ext. 5645

Roland DG
7200 Dominion Circle
Los Angeles, CA 90040
(213) 685-5141

Information on the 9511 and 9512 arithmetic processors can be obtained from

Advanced Micro Devices
P.O. Box 3453
Sunnyvale, CA 94088
(408) 732-2400

At least one company is manufacturing a high-speed plug-in arithmetic card for the Apple II-series computers. The MicroSPEED II uses an Intel 8231 math processor at 2 or 4 megahertz, depending upon the version (two are available). The manufacturer is

Applied Informatics Inc.
15104 St. Thomas Church Rd.
Upper Marlboro, MD 20772
(301) 627-6650

A source of image-digitization hardware and software for the Apple II series is

HAL
P.O. Box 293
Scotch Plains, NJ 07076

—Steve

FRANKLIN

Dear Steve,

I have a Franklin Ace 1200 with Franklin's version of VisiCalc known as AceCalc. While I was using AceCalc, I cleared the worksheet and saved a file instead of loading it. This literally wiped out the file. However, the catalog still shows the file as 28K bytes in size. Can I do anything to rescue or restore it?

ROBERT A. KELLY
Florham Park, NJ

If your copy of AceCalc uses the standard Apple DOS 3.3 file format and you did not use DIF as a data format, rescuing the file should be fairly easy (as long as you did not save additional data to that disk since your "accident"). If the DOS is radically different from DOS 3.3, you used DIF, or overwrote the original file with a subsequent file save, things will be much more difficult or impossible. The following suggestions assume a standard DOS and a non-DIF type of file format. The fact that the disk catalog still shows a 28K-byte file size (I assume it shows sectors and that you have translated to bytes) strongly suggests a fairly standard DOS 3.3. The erroneous file-size indication is the result of a bug in DOS 3.3 that results in an incorrect file-size indication if a file is shortened and then saved under the same name without first deleting it.

At least two versions of AceCalc were produced; most, apparently, had a customized version of Apple DOS 3.3. If you have one of the DOS 3.3 versions, the method below will rescue the file under the conditions stated.

Several utility programs are available that can be used to "undelete" files and otherwise manipulate the contents of disks. You will have to restore the catalog and the track-sector list for the file. I suggest that you obtain a book called Beneath Apple DOS (Quality Software, 6660 Reseda Blvd., Suite 105, Reseda, CA

(continued)

IN ASK BYTE, Steve Ciarcia answers questions on any area of microcomputing. The most representative questions received each month will be answered and published. Do you have a nagging problem? Send your inquiry to

Ask BYTE
c/o Steve Ciarcia
P.O. Box 582
Glastonbury, CT 06033

Due to the high volume of inquiries, personal replies cannot be given. All letters and photographs become the property of Steve Ciarcia and cannot be returned. Be sure to include "Ask BYTE" in the address.

The Ask BYTE staff includes manager Harvey Weiner and researchers Eric Albert, Bill Curlew, Ken Davidson, Jeannette Dojan, Jon Elson, Roger James, Frank Kuechmann, Dave Lundberg, Edward Nisley, Dick Sawyer, Andy Siska, and Robert Stef.

News about the Microsoft Language Family

Improved Microsoft® C Compiler Version 4.00 Is Now Available

ANSI compatibility: Microsoft C Compiler Version 4.0 provides increased support for the developing ANSI standard. **Library support:** Over 30 new library functions have been added, including UNIX™ System V functions `vprintf`, `vscanf`, and `setvbuf`. **More memory models:** Compact and huge memory models have been added for increased versatility, bringing the number of supported memory models to five. **Optimizations:** Elimination of common sub-expressions joins our list of optimizations to make your generated code tighter than ever before. **Source code:** Full start-up and exit source code is provided. In addition to these new features, Microsoft C Compiler Version 4.0 allows you to compile and optimize larger programs, get mixed source and disassembly listings, control floating-point math better, and use improved overlay capabilities. And MAKE, the program maintenance utility, helps ensure up-to-date program components by automatically recompiling and relinking to keep up with your source code changes.

The New CodeView™ Source Debug Utility Is Bundled with Microsoft C. All the power of SYMDEB plus full windowing orientation make CodeView the debugger you will want to grow into. See source code and disassembly interspersed. Use drop-down menus, multiple windows, independent graphics screen swapping, and a read-only source code editor to navigate through your code and locate logic errors more quickly than ever before. Exercise your code with the dynamic C expression evaluator instead of recompiling multiple test cases. Set conditional breakpoints. See registers and variables (even locals) change as you watch an animated trace program execution. Special offer for CodeView demo: Words can't say it all here, but our freely copyable demo disk is available for only \$5. Take a test drive!

New Microsoft QuickBASIC Version 2.00 Makes Programming in BASIC Easier and Faster

Microsoft QuickBASIC has undergone a major transformation in its new Version 2.0 release. We think that it will change the way you program in BASIC. The Microsoft QuickBASIC programming environment features an integrated editor, compiler, and runtime.

The editor uses a Microsoft Windows-like interface for full screen editing with pull-down menus. The editor supports the Microsoft Mouse and the IBM® 43-line Enhanced Graphics Adapter. The faster compiler can be invoked directly from the editor, compiling Microsoft QuickBASIC programs directly into memory and bypassing the link step. If no errors are detected the program can start executing immediately. Both compilation errors and runtime errors will restart the editor and place the cursor on the troublesome line.

Debugging compiled programs is easier with Microsoft QuickBASIC 2.0. The TRON statement enables the new source display animated trace and step modes. The tracing features can be toggled on and off using the function keys.

Large BASIC program development is supported by an additional new method of separate compilation. User libraries of BASIC and assembly language routines can be loaded into the in-memory compilation and execution environment. Microsoft QuickBASIC 2.0 also supports stand-alone application development.

New Microsoft QuickBASIC language features include block IF/THEN/ELSE, Enhanced Graphics Adapter support including the new 640 by 350 graphics modes, and dynamic arrays that can now use all of available user memory.

For more information on the products and features discussed in the newsletter,
write to: Microsoft Languages Newsletter
16011 NE 36th Way, Box 97017, Redmond, WA 98073-9717
Or phone:
(800) 426-9400. In Washington State and Alaska,
call (206) 882-8088. In Canada, call (416) 673-7638.

Latest DOS Versions:

Microsoft C Compiler	4.00
Microsoft COBOL	2.10
Microsoft FORTRAN	3.31
Microsoft Macro Assembler	4.00
Microsoft Pascal	3.31
Microsoft QuickBASIC	2.00

Microsoft is a registered trademark and CodeView is a trademark of Microsoft Corporation. UNIX is a trademark of AT&T Bell Laboratories. IBM is a registered trademark of International Business Machines Corporation.

Look for the Microsoft Languages Newsletter every month in this publication.

91335) and a suitable utility program like Bag of Tricks, Copy II Plus, or Locksmith. The book explains how the disks are formatted and how information is stored on them. The utility programs permit modification of individual data bytes on the disk. These items are available through local computer dealers and those that advertise in publications like BYTE and Computer Shopper. You should be able to fully recover your data as long as you have not saved any files to that disk since your inadvertent save of a blank file.

The first thing you should do is copy the disk using a copy program that copies tracks rather than files. COPYA on the DOS 3.3 system master is such a program; FID on the same disk is not. Then work only with the copy in attempting to recover your data. I suggest first trying the FIXCAT program on the Bag of Tricks disk, instructing it to scan the disk for lost files. It will locate all sectors on the disk that contain valid data but aren't listed in the catalog. Once they are located, these sectors can be marked as "used" in the VTOC. You may have to do a bit of looking and patching with a sector

editor to fully reassemble the missing file. If DIF was used, you may have to use a sector editor to change the file to a standard text file.—Steve

AT COMPATIBLES

Dear Steve,

I am currently using an IBM PC AT with 640K bytes of memory, a 1.2-megabyte floppy disk drive, a 20-megabyte hard disk, a Princeton HX-12 color monitor, and an Epson FX-185 printer/plotter. This machine is on loan to me, and I am using it for scientific computations.

In the near future, I would like to buy an AT-compatible machine. I was thinking of the Columbia microcomputer, but Columbia is out of business now. What machines do you recommend? Should I wait for the new 32-bit computers or the new reduced instruction set computers?

Also, would it be possible for me to attach an array processor to an AT (or AT compatible) without spending a large amount of money? If so, what programming languages should be used to get the most out of such a configuration?

GEZA SZONYI
Lexington, MA

If you haven't seen the November 12, 1985, and February 25, 1986, issues of PC Magazine, you should get copies. Between these two issues, more than a dozen alternatives to the AT are reviewed and compared. I haven't had the opportunity to try any of these machines, but one of them should come close to your criteria. If you are using the machine to do a lot of number crunching, you should probably invest in the 80287 coprocessor (assuming your software can make use of it). I have seen three-dimensional rotation of complex molecules run on such a machine, and it is quite impressive.

There will always be a trade-off between programming efficiency and runtime performance. Nothing beats good assembly language programming for speed, but it is intensely time-consuming. A good optimizing compiler is never as fast, but the time to develop applications is greatly reduced. FORTRAN is still used for many scientific applications; a good version for MS-DOS is available from

Lahey Computer Systems Inc.
31244 Palos Verdes Dr. W. #243

(continued)

Get with the program!

Object-oriented programming for better productivity



Object-Oriented Programming: An Evolutionary Approach, by Brad J. Cox. You won't find a better way to learn object-oriented programming (OOP) than from Brad Cox. His is the first book written on OOP, and he brings to it all the experience he's gained in devoting a great part of his career to making OOP a practical, everyday tool for production programming. Cox introduces "software ICs," which enable you to encapsulate tested code for use in future projects. This eliminates having to re-code each line from scratch and allows you to increase your software design productivity significantly. 0-201-10393-1/hardcover/274 pp./1986 \$24.95*

The C++ Programming Language, by Bjarne Stroustrup. The definitive reference to the C++ language that Stroustrup developed after years of on-the-job experimentation and research at AT&T Bell Laboratories. C++, an extension of C, can produce programs that are shorter, easier to understand, and easier to maintain than traditional C programs. Plus the book allows you to conduct actual programming projects while still learning the new capabilities of C++. 0-201-12078-X/softcover/328 pp./1986 \$22.95*

Also Available:

Smalltalk-80: The Language and Its Implementation, by Adele Goldberg and David Robson. 0-201-11371-6/hardcover/736 pp./1983 \$41.95*

Smalltalk-80: Bits of History, Words of Advice, Glenn Krasner, Editor. 0-201-11669-3/softcover/1984 \$25.95*

Smalltalk-80: The Interactive Programming Environment, by

*Prices good in U.S. only.

I've enclosed a check for \$ _____, the total of my order plus my local state sales tax (Addison-Wesley will pay postage and handling).

Please charge: VISA MasterCard (Interbank # _____)

Acct. # _____ Exp. date _____

Signature _____

Please ship UPS U.S. Mail

Name/Title _____

Address _____

City _____ State _____ Zip _____

Send order with payment to Addison-Wesley Publishing Company, Attn: Denise Descoteaux, Reading, MA 01867
 Addison-Wesley Publishing Company • Reading, MA 01867 • (617) 944-3700 • We publish the leaders.

A DECADE OF SERVICE

TURBO XT

Dual Spd CPU,
2-FD, 640K
Gm Monitor,
complete



\$895

AT&T*† 6300

2-FD, 256K,
Keyboard, AT&T
Hi-Res Mono
Monitor



\$1,795

IBM* PC

2-FD, Graphics
mono monitor,
256K, list 2810



\$1,579

Turbo* AT-Enhanced

20-Megabyte Hard
Disk, 1.2-MB FD,
512K, Keyboard,
Amber Monitor



\$2,495

**Complete systems
shipped overnight.**

SOFTWARE

ANDREW TOBIAS MANAGING
YOUR MONEY **\$129**
ASHTON TATE FRAMEWORK II **call**
ASHTON TATE dBASEIII plus **call**
BORLAND SIDEKICK **\$39**
BORLAND TURBO PASCAL **\$45**
BORLAND TURBO LIGHTNING **\$59**
BORLAND SUPERKEY **\$59**
BORLAND REFLEX **\$99**
CLIPPER dBASE COMPILER **call**
COMPUTER ASSOCIATES
IUS Acctg Series from **\$299**
DECISION RESOURCES
CHARTMASTER **\$239**
DECISION RESOURCES
SIGNMASTER **\$189**
DECISION RESOURCES
DIAGRAMMASTER **\$259**
DIGITAL RESEARCH GEM
DRAW/COLLECTION **call**
DIGITAL RESEARCH
GEM COLLECTION **call**
FUNK SOFTWARE SIDEWAYS **\$48**
HARVARD TOTAL PROJECT
MANAGER **call**
HAYES SMARTCOM II **\$89**
IBM DISPLAYWRITER III **\$369**
LATTICE C-COMPILER **\$298**
LIFETREE VOLKSWRITER
DELUXE **\$249**
MICROSOFT WINDOWS **\$79**
MICROSOFT WORD **\$319**
MICROSTUFF XTALK XVI **\$99**
MULTIMATE latest **call**
MULTIMATE ADVANTAGE **call**
NORTON UTILITIES **\$69**
OPEN SYSTEMS ACCOUNTING
SERIES **call**
ROSESOFT PROKEY **\$99**
SATELLITE SOFTWARE
WORDPERFECT 4.1 **call**
SOFTWARE PUBLISHING CO.
PFS SERIES from **\$79**
SORCIM SUPERCALC III **\$197**

MASS STORAGE

floppy drives
MITSUBISHI 1/2ht 360k **\$98**
(bl/gry)
MITSUBISHI 1/2ht
1.2 mb (gry) **\$147**
TANDON TM100-2 **\$125**
TOSHIBA 1/2 ht. **call**

internal hard drives
All hard drives complete with
controllers, mounting hardware &
instructions. All are formatted,
tested & have 1 year warranty.
SEAGATE 10MB **\$399**
SEAGATE 20 MB **\$475**
SEAGATE 30 MB **call**
SEAGATE 20 MB for AT **\$689**
SEAGATE 30 MB for AT **\$796**
PRIAM 40MB/60MB **\$1395/1595**
PRIAM 40MB/60MB
for AT **\$1425/1625**

disk cards
HARDCARD
10MB/20MB **\$695/895**
CMS 10MB/20MB **\$499/699**
MOUNTAIN 10MB/20MB **call**

disk subsystems
BERNOULLI BOX 20MB/40 MB
\$2095/2695
SYSGEN FLATPACK **call**
TALLGRASS all models **call**

tape drives
IRWIN 10MB/20MB inter. **call**
IRWIN 10MB/20MB exter. **call**
TALLGRASS 4060 **call**

BOARDS

multifunction
QUADRAM QUADPORT AT **\$119**
QUADRAM LIBERTY **call**
QUADRAM EMS + **call**
AST SIXPAK 384k **\$219**
AST RAMPAGE XT/AT **call**
QUADRAM QUADBOARD
384k **call; new low, low price**
THESYS FASTCARD V Ok **NEW!**
RAM BOARD 384k half card **\$169**

video/graphics
AST PREVIEW **\$289**
HERCULES COLOR **\$188**
HERCULES GRAPHICS **\$319**
IBM COLOR **\$198**
IBM MONOCHROME **\$198**
QUADRAM EGA + **\$399**
QUADRAM QUADCOLOR I
COLOR CARD w/par. **call**
MONOCHROME GRAPHICS
Herc comp. **\$198**

network
ORCHID PCNET **call**
QUADRAM QUADNET IX **call**

emulation
AST 5251 mod 11/12 **call**
DCA IRMA **call**

MONITORS

monochrome
AMDEK 310a **\$168**
IBM MONOCHROME **\$224**
PRINCETON MAX 12 **\$178**
QUADRAM AMBERCHROME **\$166**

color
AMDEK 600/772 **call/\$528**
IBM ENHANCED COLOR **\$594**
PRINCETON
HX12/H12E **\$436/\$526**
QUADRAM QUADCHROME II **call**
QUADRAM ENHANCED Color **NEW!**

MODEMS

HAYES 1200/1200B **\$398/329**
HAYES 2400/2400B **\$596/526**
US ROBOTICS PASSPORT
1200/2400 **call**
1200 BAUD EXTERNAL MODEM **\$196**
VENTEL 1200 w/XTALK **call**

SUPPLY HOUSE

PC MART DISKETTES box **\$18**
case **\$159**
VERBATIM DISKETTES box **\$28**
case **\$258**

Specialists in complete computer
systems for business applications.

PRINTERS

dot matrix
BROTHER HR1509 **\$398**
EPSON LX-80 **call**
EPSON FX-85/FX-286 **call**
EPSON LQ-800/LQ-1000 **call**
IBM PROPRINTER **\$425**
OKIDATA 182 **\$268**
OKIDATA 192/193 **\$399/545**
OKIDATA 2410 **call**
TOSHIBA 321 **call**
TOSHIBA 341/351 **\$859/1159**

laser/letter quality
BROTHER HR15 **\$249**
BROTHER HR25/HR35 **\$568/798**
CORONA LP300 **\$2395**
EPSON DX20/DX35 **call**
IBM QUIETWRITER II **\$1259**
QUADRAM QUADLASER **in stock!**

plotters
HOUSTON INSTRUMENTS **call**
all models available
for quick delivery

MISCELLANEOUS

MOUSESYSTEMS PC
MOUSE w/PAINTE **\$149**
MICROSOFT MOUSE
serial/bus **\$129**
KEYTRONICS
5151/5153 **call**
AT Keyboard **\$149**
QUADRAM MICROFAZER 8k **\$129**
QUADRAM MICROFAZER II **New!**
TRIPPLITE ISOBAR from **\$45**
TRIPPLITE UPS 400w/800w **call**
CURTIS PROTECTORS from **\$29**

CHIPS

64k/128k/256k **call for
market price**
8087/80287 **call for
market price**

*Registered Trademark

†Some systems available to qualified accounts only.

PC MART™

Personal Computer Centers

1485 Northeast Express NE • Atlanta, GA 30329

Visit our showrooms in Atlanta, Charlotte, Durham and Raleigh

SALES • SERVICE • FINANCING • DELIVERY • SUPPORT

1-800-241-0286

ORDERS

1-404-634-5995

INFORMATION



VISA®

Rancho Palos Verdes, CA 90274
(213) 541-1200

I don't know of an array processor for the AT right now, though someone is bound to come up with one sooner or later.

IBM's RISC machine is now available. But remember that it does not run MS-DOS, so any packages that you now use on the AT will not run on this new machine. I understand that IBM will offer an 80286 board for the RISC machine, but

this will not run any faster than a standard AT. The 32-bit machines are on the drawing board, but it is anyone's guess as to when they will appear in the marketplace. I understand that the 80386s will run three to five times faster than the 80286s. Since they will run the same MS-DOS software, this will provide an easier upgrade path than waiting for specific software for the RISC machine or developing your own.

I've always adopted the philosophy

that it is better to jump on the computer bandwagon now than it is to wait. If you wait until next year, yet another development will be just over the horizon, and another one beyond that. If you get your feet wet now, you will be that much more knowledgeable and further ahead when the next generation of machines comes out.—Steve

CIRCUIT CELLAR FEEDBACK

LIQUID-CRYSTAL DISPLAYS

Dear Steve,

In some of your articles, you have made reference to LCDs. I am having great difficulty finding them at any price. I'm looking for a multiline dot-matrix LCD. I would also like to find a small keyboard with a QWERTY configuration similar to those on HP 70 hand-held computers. If you could steer me to a source of these items, I would be most grateful.

RIC BRANDT
Hamilton, OH

LCDs with fixed alphanumeric characters can be found in the hobbyist market from a number of sources. You will have difficulty finding the multiline dot-matrix variety in this market due to their price—they are expensive items.

Keyboards similar to that found in the HP 70 series are custom items, usually consisting of solid key caps that push down onto a membrane switch panel. Since these items are custom, most companies keep a supply on hand for repair. I suggest contacting such a company to purchase a keyboard assembly. If you can't find a company willing to sell you one, you can always pick up a relatively inexpensive compact keyboard from many mail-order electronics parts companies.

Two mail-order electronics firms that carry alphanumeric LCDs and keyboards are the following:

Digi-Key Corporation
P.O. Box 677
Thief River Falls, MN 56701
(800) 344-4539

Jameco Electronics
1355 Shoreway Rd.
Belmont, CA 94002
(415) 592-8097

For information on dot-matrix LCDs, contact

(continued)

Your
modem
should
be this
good



USRobotics' COURIER 2400™
...The most dependable
at 2400- or 1200-bps

You get 2400/1200/300-bps data communications and every first-class feature you'd expect in an auto-dial, auto-answer modem...at a surprisingly affordable price.

But a modem at any price is only as good as its performance...And that's where Courier 2400 really shines. Don't take our word for it. Ask any of the nearly 2,000 electronic bulletin board system operators who have chosen the Courier 2400 for one of the most demanding modem applications imaginable.

Listen to the unanimous chorus of praise for the Courier 2400 from tough reviewers at more than a dozen highly respected computer magazines.

Consider Courier 2400's performance record—less than one percent of all Courier 2400s sold have been returned for service, a record we challenge the industry to match. And we back up our confidence in Courier 2400

with a full two-year parts and service warranty.

Quality, performance, value—you modem should be this good. It is, if it's the Courier 2400 from USRobotics.

USRobotics

The Intelligent Choice in Data Communications

6100 McCormick Blvd., Skokie, Illinois 60076
Phone toll free 1 (800) DIAL USR
In Illinois (312) 982-5001

To learn more, send for our
FREE booklet: "24 Questions
and Answers on 2400-BPS
Modems."

NAME _____
ADDRESS _____
CITY _____
STATE _____ ZIP _____
COMPANY _____
TITLE _____
PHONE (_____) _____
PERSONAL USE BUSINESS USE

"Information Is The Next Frontier"

Michael B. Shane
Chairman, Leading Edge World Trade, Inc.
and Leading Edge Products, Inc.

ACCESS INFORMATION*



The Leading Edge Model "D" comes complete with more standard features than most others list as options. It's IBM®-compatible, it comes with a 15-month warranty and when configured with a single drive is priced at \$1345.00. A dual disk-drive version and a 30MB Fixed-drive version of the Model "D" are also available.



The Leading Edge Model "L" Series 1200B Modem fits in full or half-size slots of the Leading Edge Model "D", "M", and "MH", the IBM PC, AT, and IBM compatibles. It's Hayes®-compatible, yet at \$149.95 is priced at about a third the price of Hayes' equivalent.



Electronic data bases like the SourceSM, CompuServeSM, and 2,500 others, give you instant access to information on just about every topic under the sun. (Access charges vary.)

If you were to buy a Leading Edge® Model "D"™ Personal Computer and plug into it a Leading Edge® Model "L" Series™ Modem, you'd have created one of the most powerful information gathering and processing tools ever to sit on a desktop — for \$1495.

How Powerful?

Think about instant access to current and historical financial quotes, up-to-the-minute news on all topics, detailed statistics on companies, industries, or even the entire economy.

Think about instant access to information on topics like medicine, law, finance, real estate, politics, farming, and automotive repair — to name only a few.

Think about having immediate access to documented information on every subject from astrology to zoology.

Just think about what you could do with all that information; think of how profoundly it could improve your life.

Now, stop thinking about it and call 1-800-USA-LEAD for more information and a Leading Edge Dealer near you. For our Fortune Fleet Division, call 1-800-457-7286.

*To obtain a copy of the Leading Edge Corporate Philosophy on Information, please write to this address.

Leading Edge Hardware Products, Inc.
225 Turnpike Street
Canton, MA 02021
In MA, (617) 828-8150. Fortune Fleet Division (617) 769-8050

Inquiry 160



Leading Edge and Logo are registered trademarks of Leading Edge Products, Inc. Model "D", "M", M-H, Model "L" Series, and Information System are trademarks of Leading Edge Products, Inc. IBM is a registered trademark of International Business Machines Corporation. Hayes is a registered trademark of Hayes Microcomputer Products, Inc. The Source is a service mark of Source Telemarketing Corporation, a subsidiary of the Readers Digest, Inc. CompuServe is a service mark of CompuServe Information Services, Inc.



Copying diskettes will never be easier than pushing one button.

While your computer is busy doing other things, your Victory Duplicator can be making as many as eight copies of a diskette at once — producing up to 400 copies in an hour. DualMaster™ models can even make multiple copies of two different diskettes simultaneously. Just insert the diskettes and press one button.

Copy different formats, flawlessly.

An automatic format analysis program makes it possible for the Victory Duplicator to

copy virtually any 5¼, 3½ or 8-inch diskette. The system tests for quality and accuracy at every stage of the process.

It practically services itself.

Each drive has a separate controller to maximize up-time. Simple diagnostics to verify drive alignment and industry standard drives allow you to maintain your system without waiting for outside service.

All at an attractive price.

Victory Duplicators offer fast copying, serialization,

copy protection, a communications port, a four-month warranty and much more — all for one low price.

Call 1-800-421-0103.

Call today for more information. (In Texas, call 512-450-0801.)



VICTORY ENTERPRISES

Technology, Inc.

8910 Research Blvd., Suite B2
Austin, Texas 78758

©1986 Victory Enterprises Technology, Inc.

CIARCIA FEEDBACK

Sanyo Semiconductor Corporation
7 Pearl Court
Allendale, NJ 07401
(201) 825-8080

Seiko Instruments U.S.A. Inc.
2990 West Lomita Blvd.
Torrance, CA 90505
(213) 530-8777

—Steve

ULTRASONIC RANGING

Dear Steve,

I recently became interested in building your ultrasonic ranging system described in the October 1984 BYTE, so I bought the kit from Micromint. I have scoured back issues of BYTE, Radio Shack stores, parts stores, the Canal Street area of New York City, and every other source that I can think of. But so far I have been unable to locate the UXD LCD that was described in figure 10 as being available from Liquid-Crystal Displays Inc. Would you please let me know this company's address?

I thought that I would try the LCD version of your project so that I could isolate mistakes that I may make in wiring from errors in communication between the sonar unit and my Osborne computer. I want to use the device to measure and price 1000 Christmas trees that we want to sell to raise money for my daughter's school.

JEFFREY T. ELLIOT
New York, NY

I don't have a current source for the LCD unit mentioned in the article, but you should be able to use the Amperex LC513040-301.15/1S sold by Digi-Key as part no. LCD003. The address is

Digi-Key Corporation
P.O. Box 677
Thief River Falls, MN 56701
(800) 344-4539

—Steve

SPEECH SYNTHESIS

Dear Steve,

I have been following your articles on speech synthesis and recognition in BYTE for several years, hoping to come across something practical that can help me in my job as a speech pathologist. I teach speech to deaf children.

Since I have an Apple IIe in my clinic room, I ordered your Lis'ner 1000 board (November 1984) and have had fun using it with my deaf kids. You wouldn't believe how they light up when they see the Lis'ner 1000 recognize their speech and the words flash on the screen! Although

(continued)

DataSaver⁴⁰⁰ Standby UPS

Power protection for the most powerful micro-computer systems with peripherals is here, now, with the 400 Watt DataSaver. Protect your investment in application software and hardware with reliable, continuous power. 90 and 200 Watt capacities and international models are also available.



Cuesta Systems Corporation

3440 Roberto Court
San Luis Obispo, CA 93401
TLX: 4949381 CUESTA

©1985. Made in U.S.A.

Write or call 805/541-4160
Dealer, O.E.M. inquiries invited

MARK WILLIAMS

Those who insist on C compiler performance
are very big on Mark Williams.

And the compiler is just part of our total C Programming System.

NEW 3.0 ENHANCEMENTS

These and other powerful utilities now *included* in the C Programming System:

- **make**: compiles only what's necessary from multiple modules, a powerful programming discipline
- **diff**: identifies differences between two files
- **m4**: macroprocessor expression editing and substitution
- **egrep**: extended pattern search
- **MicroEMACS**: full screen editor with source

COMPILER FEATURES

- Runs under MS-DOS
- Full Kernighan & Ritchie C with recent extensions including void and enum
- Register variables for fast, compact code
- Full UNIX™ compatibility and complete libraries
- Large and small memory models
- MS-DOS linker compatibility
- 8087 Support
- One-step compiling
- English error messages
- ROMable code
- Linker, assembler, archiver
- Extensive third party library support

csd C SOURCE DEBUGGER

- Debugs at C source level without assembly language
- Separate evaluation, source, program and history windows
- Can execute any C expression
- Capabilities of a C interpreter, but runs in real time
- Set trace points on any statement or variable

Mark Williams' C compiler has earned a place in some very big companies for some very good reasons: it proves the benchmarks right with the speed, code density, consistent performance and expert support required in professional development environments.

But a total development tool shouldn't stop with compiling. Or go on and on with extras that add up and up.

Only Mark Williams' C Programming Systems *includes* the csd C Source Debugger with true source level debugging to speed your programming job.

And only Mark Williams' new 3.0 version *includes* utilities like "make" to make quick work of even the largest projects.

From source code to final product, only one takes you all the way: Mark Williams' C Programming System.

All for only \$495. Ask about our 60-day money back guarantee when you call

1-800-692-1700 to order today.*

You'll be big on the total C Programming system from Mark Williams, too.



1430 West Wrightwood
Chicago, Illinois 60614

© 1985 Mark Williams Company
UNIX is a registered trademark of Bell Labs.

*In Illinois call 312-472-6659.

Try It. Then Buy It. PC-Write.

A fast, full-featured word processing package for the unbelievable price of \$10. Complete. You get a manual on disk, mail merge, split screen, keyboard macros, on-screen formatting, full printer support, and more.

Try *PC-Write* for \$10. Then register for \$75 to get:

- latest diskette
- printed manual
- two updates
- phone support
- newsletter

Registration supports our "shareware" concept that keeps our prices low, and allows our development of *PC-Write* enhancements.

Shareware means you can get *PC-Write* from a friend or user group to try, and give away copies yourself. Then register if you like it. No risk!

Byte
August 1986

Soon Version 2.7

has a built-in spelling checker plus new 2.6 features like our new manual, bracket matching, extended directory, and menus. New 2.7 registration price \$89.



Order *PC-Write* Today.
Satisfaction Guaranteed.

Quicksoft

(206) 282-0452

219 First N. #224y
Seattle, WA 98109



CIARCIA FEEDBACK

the Lis'ner doesn't really give them any articulatory feedback, except for right or wrong. I am using it to get them used to computers in speech therapy while I wait to find a visible speech display system that can give them useful feedback on their production of consonants and vowels. Of course, several systems are commercially available now, but I am not particularly impressed with their performance, and the price is prohibitive.

To date, I think the system you described in your March 1982 article ("Use Voiceprints to Analyze Speech") appears to do the best job of visually displaying critical consonant-vowel information that deaf children could use as articulation models. Could the system described in March 1982 be easily modified to display spectrograms on an Apple IIe monitor in place of an oscilloscope?

Would it be possible to use the Lis'ner 1000 to visually display speech waveforms?

CHARLES FRAME
Onelda, WI

The voice analysis system described in March 1982 was an experimental system designed solely to test and experiment. It was never intended to be, nor is it, a commercial product. The system described uses an oscilloscope, which is not suitable for display of the test data on an Apple system. The only information available is contained in the article.

It would be reasonable to use the data from the Lis'ner 1000 to display speech waveforms using the high-resolution-graphics capability of the computer, although not in real time. The chief requirements for using the system in this way would be a knowledge of 6502 assembly/machine language, microcomputer interfacing, and the Apple hardware. Given the extremely specialized nature of your application, doing it yourself may be the most practical approach.

If you are unable to handle the hardware/software required, I suggest contacting local users groups. These groups frequently contain highly skilled assembly language programmers and hardware interfacers who would be willing to assist you.

A system to display voice waveforms can be made from a microphone, a suitable adjustable preamplifier/amplifier, and an oscilloscope. A bit of research in a local library should provide specific circuits and methods.

Some additional sources of information and inspiration you might find useful:

An article in the April 1984 issue of BYTE

by Richard C. Hallgren ("Putting the Apple II Work, Part 1: The Hardware") describes a high-speed data acquisition and analysis system for the Apple. This is a more general form of what you are trying to do, minus the display. This issue has several articles on real-time data acquisition that contain valuable information.

De Jong, Marvin L. Apple II Assembly Language (Howard W. Sams, 1982)

Lancaster, Donald E. Don Lancaster's Micro Cookbook, Vol. 2 (Howard W. Sams, 1983)

Lancaster, Donald E. Assembly Cookbook for the Apple II/IIe (Howard W. Sams, 1984)

Sather, James. Understanding the Apple IIe (Quality Software, 1985)

Titus, Jonathan S., David Larsen, and Christopher A. Titus. Apple II Interfacing (Howard W. Sams, 1981)

Titus, Jonathan S., Christopher A. Titus, and David Larsen. Microcomputer-Analog Converter Software and Hardware Interfacing (Howard W. Sams, 1978)

Goldsbrough, Paul, et al. Analog Electronics for Microcomputer Systems (Howard W. Sams, 1983)

—Steve

Between Circuit Cellar Feedback, personal questions, and Ask BYTE, I receive hundreds of letters each month. As you might have noticed, in Ask BYTE I have listed my own paid staff. We answer many more letters than you see published, and it often takes a lot of research.

If you would like to share the knowledge you have on microcomputer hardware with other BYTE readers, joining the Circuit Cellar/Ask BYTE staff would give you the opportunity. We're looking for additional researchers to answer letters and gather Circuit Cellar project material.

If you're interested, let us hear from you. Send a short letter describing your areas of interest and qualifications to Steve Ciarcia, P.O. Box 582, Glastonbury, CT 06033. ■

Over the years I have presented many different projects in BYTE. I know many of you have built them and are making use of them in many ways.

I am interested in hearing from any of you telling me what you've done with these projects or how you may have been influenced by the basic ideas. Write me at Circuit Cellar Feedback, P.O. Box 582, Glastonbury, CT 06033, and fill me in on your applications. All letters and photographs become the property of Steve Ciarcia and cannot be returned.

Mark Williams

Now the biggest name
in C compilers comes in a size
everybody can afford.

Let's C.[™]
\$75

Introducing Mark Williams' \$75 C compiler. Want to explore C programming for the first time? Or just on your own time? Now you can do it in a big way without spending that way. With Let's C.

This is no little beginner's model. Let's C is a powerful programming tool, packed with all the essentials of the famous Mark Williams C Programming System. The one chosen by Intel, DEC, Wang and thousands of professional programmers. The one that wins the benchmarks and the reviewers' praise:

Mark Williams Let's C

- For the IBM-PC and MS-DOS
- Fast compact code plus register variables
- Full Kernighan & Ritchie C and extensions
- Full UNIX[™] compatibility and complete libraries
- Small memory model
- Many powerful utilities including linker, assembler, archiver, cc one-step compiling, egrep, pr, tail, wc
- MicroEMACS full screen editor with source
- Supported by dozens of third party libraries
- Upgradeable to C Programming System for large scale applications development

Let's C Benchmark Done on an IBM-PC/XT, no 8087.
Program: Floating Point
from BYTE, August, 1983.

Exec Time in Seconds

Let's C	134.20
MS 3.0	347.45

"Let's C is a thoroughly professional C environment loaded with tools and programming utilities. It is also another fine Mark Williams Co. product."
—Christopher Skelly, Computer Language Magazine, Feb. 1986

And now for more big news. Get our revolutionary csd C Source

Debugger for just \$75, too. You can breeze through debugging at the C source level ignoring clunky assembler code.

Affordable, powerful, debuggable. Mark Williams Let's C is the big name C compiler at a price you can handle. Get your hands on it now.

Affordable, powerful, debuggable. Mark Williams Let's C is the big name C compiler at a price you can handle. Get your hands on it now.

ORDER NOW! 60-DAY MONEY BACK GUARANTEE!

Mark Williams Let's C

Please send me:

_____ copies of Let's C and _____ copies of csd (C Source Debugger) at \$75 each. (Ill. residents add 7% sales tax.)

Check Money Order Visa, MasterCard or American Express

Name _____

Address _____

City _____ State _____ Zip _____

Card # _____ Exp. Date _____

Signature _____ BY086



Mark Williams Company

1430 West Wrightwood
Chicago, Illinois 60614 Inquiry 180

DATABASE SYSTEMS

- ASHTON-TATE
 6479. dBase III+
 BORLAND
 95. Reflex
 MICRORIM
 375. R-Base 5000
 NANTUCKET
 369. Clipper
 PAPERBACK
 65. VP Info

WORD PROCESSING

- DAC
 6 39. Easy Word
 LIVING VIDEOTEK
 59. Ready
 109. Think Tank
 MICROSOFT
 259. Word
 MICROPRO
 79. Easy
 179. WordStar 3.3
 249. WordStar Professional
 295. WordStar 2000+
 MULTIMATE
 69. Just Write
 229. Multimate
 245. Executive
 289. Advantage
 SSI (Satellite)
 69. The Library
 235. WordPerfect 4.1

SPREADSHEETS

- LOTUS
 6339. 1-2-3
 MICROSOFT
 124. Multiplan
 PAPERBACK
 65. VP Planner

INTEGRATED PACKAGES

- ASHTON-TATE
 6415. Framework II
 LOTUS
 459. Symphony
 MICROSOFT
 65. Windows
 SOFTWARE PUBLISHING
 75. Report
 84. File, Write, Graph, Access or Plan
 QUARTERDECK
 65. Desqview

ACCOUNTING

- BPI
 6325. GL, AR, AP or Payroll
 DAC
 39. Easy Payroll
 59. Easy Accounting
 EVERGREEN
 165. One-Write-Plus
 STATE OF THE ART
 379. GL, AR, AP, Inv or Payroll

PERSONAL FINANCE

- MECA
 6 85. Managing The Market
 109. Managing Your Money
 MONOGRAM
 109. Dollars & Sense
 SIMON & SCHUSTER
 55. J. K. Lasser Money Manager
 TIMEWORKS
 75. Personal Financial Planner

CAD SYSTEMS

- AMERICAN SMALL BUSINESS
 6185. Pro Design I
 FORESIGHT RESOURCES
 239. Drafix I
 GENERIC SOFTWARE
 119. Generic CAD With Dot Plot

COMMUNICATIONS

- HAYES
 6 99. Smartcom II
 MICROSOFT
 169. Access
 MICROSTUF
 105. Crosstalk
 165. Transporter
 VM
 95. Relay
 149. Relay Gold

Use Your Credit Card

We're your full line, full service

- Business Accounts Program
- Second Day Air Shipping
- Toll Free Technical Support

ORDERING INFORMATION

- Most orders shipped second day air.
- Shipping Charges:
 - US & Puerto Rico — 3% (\$6 minimum)
 - Canada — 12% (\$15 minimum)
 - Foreign — 18% (\$25 minimum)
 - APO, FPO — 6% (\$10 minimum)
- Large products may require additional shipping charges.
- No additional charges for Visa, MasterCard, American Express.
- Your credit card not charged until we ship.

PRICES AND AVAILABILITY SUBJECT TO CHANGE WITHOUT NOTICE

UTILITIES

- ALPHA SOFTWARE
 6 57. Keyworks
 AMBER
 40. Homebase
 BORLAND
 46. Superkeys
 55. Sidekick (copiable)
 CENTRAL POINT
 23. Copy II PC
 23. PC Tools
 81. PC Option Board
 FIFTH GENERATION
 105. Fastback
 FINOT GROUP
 64. Keep Track
 FUNK
 39. Sideways
 NORTON
 55. Utilities
 ROSESOFT
 83. Prokey

PROGRAMMING LANGUAGES

- BORLAND
 6 22. Turbo Tutor
 32. Turbo Toolbox
 35. Turbo Graphix Toolbox
 33. Editor Toolbox
 46. Word Wizard
 46. Turbo Pascal
 46. Traveling Sidekick
 49. Turbo New Pack
 65. Turbo Prolog
 65. Turbo Lightning
 79. Turbo Pascal w/8087 & BCD
 79. Traveling Sidekick Combo
 155. Jumbo Pack
 MICROSOFT
 99. Macro Assembler
 199. Pascal Compiler
 275. C Compiler
 229. Fortran Compiler

GRAPHICS

- DECISION RESOURCES
 6155. Sign Master
 209. Diagram Master
 235. Chartmaster
 245. Map Master
 GRAPHICS COMMUNICATION
 219. Freelance
 329. Graphwriter Combo
 MICROGRAFX
 115. Windows Draw (Req. Windows)
 229. PC Draw
 275. In-A-Vision
 MICROSOFT
 199. Chart

Conroy-LaPointe

The IBM® Compatible With

\$789

640K, Dual Floppy Drives



\$979

640K, Dual Floppy Drives, Graphics Card & Monitor

LASER 128:
Better than Apple
at half the price.

\$499

With Monitor & Cable

- 128K RAM, 32K ROM
- 65C02 CPU
- 5 1/4" Floppy Drive, Internal
- 1 Expansion Slot, I/O
- 1 Parallel & 2 Serial Ports
- External Drive Port
- Numeric Keypad
- 4 Cursor & 10 Function Keys
- Supports Double Hi Res
- Mouse/Joystick Port

\$949 With Monitor, Printer, 2nd Floppy Drive, Cables

MAGNUM™ MEMORY & MULTIFUNCTION BOARDS

PC MASTERCARD™

"0" KB \$129 • Expandable to 1.5 MB

384 KB \$185 • Serial Port

1.5 MB \$309 • Parallel Port

• Clock/Calendar

• Game Port

• Utility Software

• 1 Year Limited Warranty

ECONORAM™

384KB \$109 • Short Card

• 1 Year Limited Warranty

• Full 384K Installed

In Oregon 1-800-451-5151
 Hours 6-6 Pacific
 Mon-Fri, 8-4 Sat

B41

Mall To:
 12060 SW Garden Place
 Portland, OR 97223

1-800-547-1289

Business Accounts Call: 1-800-4-CONROY

... No Extra Charge!

discount computer source.

- No Credit Card Surcharge
- Conroy-LaPointe Credit Card
- No Sales Tax — Anywhere!

BUSINESS ACCOUNTS

Not just for business, but for schools, government agencies, and other institutions. In addition to our regular low prices, wide selection and professional service, we now accept purchase orders from organizations who qualify. To receive an application, just call 1-800-4-CONROY (or 503-684-7261 in Oregon). Orders shipped FOB shipping point. Call for full ordering information.

XT/Model 2™

More Standard Features

- 640K RAM On Motherboard
- Dual 360K Floppy Drives
- Dual Speed 4.77 & 8 MHz Processor
- 135 Watt Power Supply
- Selectric, PC/AT Style Keyboard
- Parallel Printer Port
- 2 Serial Ports
- 5 Slots & Clock/Calendar
- MS-DOS 2.11
- Limited Warranty: 1 Year Parts, 90 Days Labor
- FCC "B" Approval

FREE SHIPPING

on purchase of Conroy-LaPointe XT/Model 2 to U.S. and Canada

MEMORY CHIPS & COPROCESSORS

- RAM CHIPS**
- 8 13. 64K, 200 NS Kits
 - 14. 64K, 150 NS Kits
 - 36. 256K Kits
 - 49. 128K Kits for AT
- HAUPPAGE**
- 119. 8087 Chip
 - 175. 8087-2 Chip
 - 229. 80287 Fast 5 for AT
 - 349. 80287 Fast 8 for AT

EXPANSION BOARDS

- AST**
- 8225. SixPak Plus, 384K
 - 339. Rampage for PC
 - 399. SixPak Premium
 - 495. Rampage for AT
- INTEL**
- CALL Above Board 64K For PC
 - CALL Above Board 128K for AT
- MAGNUM**
- 109. EconoRAM 384K
 - 129. PC MasterCard No RAM
 - 185. PC MasterCard 384K
 - 329. PC MasterCard 1.5 MB
- ORCHID**
- 278. Conquest No RAM
- TALLTREE**
- 269. JRAM 3, 256K EMS Board, PC
 - 279. JRAM AT3, No RAM for AT

VIDEO BOARDS

- EVEREX**
- 8265. The Edge
- HERCULES**
- 159. Color Graphics
 - 319. Graphics Card
- ORCHID**
- 718. Turbo EGA
- QUADRAM**
- 419. Quad EGA+ Board
- STB**
- 349. EGA Plus
- VIDEO 7**
- 185. Mono Graphics Adapter
 - 398. VEGA Board

INPUT DEVICES & DIGITIZERS

- HITACHI**
- 8969. Tiger Tablet II (6 Buttons)
- KEYTRONICS**
- 185. KB 5151 Keyboard
 - 319. KB 5153 Keyboard
- MICROSOFT**
- 129. Mouse
 - 139. Serial Mouse
- MOUSE SYSTEMS**
- 129. Mouse With Software & PC Paint

DRIVES & TAPE BACKUPS

- CDC Floppy Drives**
- 8 98. Half Height 360K
 - 119. Full Height 360K
- IRWIN**
- 539. 10 MB Tape Backup Kit
- SILICON VALLEY COMPUTER**
- 599. Goldcard 21 MB Hard Disk Card
- SEAGATE Hard Drives**
- 479. 20 meg for PC, XT
 - 649. 20 meg for AT
 - 599. 30 meg Half Hgt For PC, XT
 - 789. 30 meg for AT
- SYSGEN**
- 1085. 60 MB Internal Tape Backup
 - 1159. 60 MB External Tape Backup
 - 1225. 20 MB Hard Disk, 20 MB Tape For PC
 - 1999. 30 MB Hard Disk, 60 MB Tape For AT
- TEAC Floppy Drives**
- 109. 55-BV Half Height 360K
- TOSHIBA**
- 113. 360K Floppy Drive For AT
 - 169. 1.2 MB Drive For AT

MODEMS

- HAYES**
- 419. 1200 External
 - 379. 1200B Internal
 - 629. 2400 External
 - 579. 2400B Internal
- CONROY-LAPOINTE**
- 185. 1200B Internal w/Software
 - 195. 1200 External w/Software
 - 389. 2400 External w/Software

PRINTERS & PLOTTERS

- CANON**
- 2199. Laser Printer A1-P
- EPSON**
- 388. FX 85 160 cps, 32 NLQ
 - 419. HI 80 Plotter
 - 499. FX 285 200 cps, 40 NLQ
 - 649. LQ 800 180 cps, 60 LQ
 - 795. LQ 1000 180 cps, 60 LQ, 15"
 - 995. LQ 1500 200 cps, 67 LQ, 15"
- OKIDATA**
- CALL 182 S or P, 192 S or P, 193, 292, 293
- PANASONIC**
- 275. P1091 120 cps
 - 439. P3151 Daisywheel
- TOSHIBA**
- 959. 341 Printer 216 cps
 - 1249. 351 Printer 288 cps

MONITORS

- AMDEK**
- 8125. 300G 12" Green Composite
 - 135. 300A 12" Amber Composite
 - 159. 310A 12" Amber TTL
 - 409. Color 600
 - 349. Color 722
 - 609. Color 725
 - 795. Color 730
- NEC**
- 599. JC 1401P3A Multisynch
- PRINCETON**
- 179. MAX 12 12" Amber TTL
 - 459. HX-12 12" Color RGB
 - 559. HX 12e RGB for IBM-EGA
 - 599. SR-12 Hi Res RGB

POWER & SURGE PROTECTION

- CONROY-LAPOINTE**
- 8 93. 130 Watt Power Supply
- CURTIS Surge Suppressors**
- 30. Diamond, 6 outlets
 - 35. Emerald, 6 outlets, 6' cord
 - 47. Sapphire, 3 outlets, RFI filter
 - 55. Ruby, 6 outlets, cord, RFI Filter
- KENSINGTON**
- 92. Masterpiece
 - 129. Masterpiece Plus

DISKETTES & ACCESSORIES

- CONROY-LAPOINTE DISKETTES**
- 8 16. DS/DD 10
 - 119. DS/DD 100
 - 29. DS/HD 10 for AT
 - 279. DS/HD 100 for AT
- FUJI**
- 19. DS/DD 10
 - 39. DS/HD 10 For AT
- GENERIK DISKETTES**
- 11. DS/DD 10
 - 89. DS/DD 100
 - 28. DS/HD 10 for AT
- DYSAN**
- 28. DS/DD 10
- MAXELL**
- 19. DS/DD 10
 - 34. DS/HD 10 for AT

MAGNUM

XT/MARK 2™

IBM PC/XT Compatible with Twice the Features, and Nearly Twice the Speed at Half the Price.

\$1249 With 640K, Dual Floppy Drives, Graphics Card & Monitor

SPERRY PC/IT

IBM® PC/AT Compatible

\$2599

- 512K RAM Expandable to 5 MB
- 6, 7.16, & 8 MHz Processor
- 1 Parallel & 2 Serial Ports
- 8 Expansion Slots
- Clock/Calendar
- Hard Disk Systems Available

\$2899 With Mono Card & Monitor

Conroy-LaPointe Inc.

\$2000? That's Too Darned High!

Why should a CAD package cost more than a Word Processor? It shouldn't! Lots of people ask how we can offer a CAD system as good as ProDesign II at a price as low as \$299. It's easy. A PC Software Package does not cost \$2000 to manufacture. It doesn't even cost \$200. It makes us ask the questions, "Why do comparable CAD packages cost \$2000 and more?" "What makes a CAD package cost more than a Word Processor?"

ProDesign II doesn't. ProDesign II is the complete CAD package you get for \$299. With ProDesign II, you get such advanced features as Auto Dimensioning, Area Fill, Fillets, Mirroring, Isometrics, Curve Fitting, Object Snap, Attributes, Drawing Merge, and many, many more. Features once available only for \$2000 or more. Features you get at no extra charge with ProDesign II.

But there is another, very important reason you should get ProDesign II. ProDesign II is very unique among CAD packages. It is easy to learn and use. When we call ProDesign II "The Easy To Use CAD System", we're not joking. You will be productive with ProDesign II in an hour or two instead of a week or two.

What else does ProDesign II offer? Compatibility. Compatibility with over 100 printers. Compatibility with

over 50 plotters. Compatibility with most graphics adapters, digitizing tablets, and mice. Compatibility with most display adapters. Compatibility with any software that can produce HP plotter commands. Compatibility with mainframe CAD systems (IGES). All at no extra charge! (You can also get an AutoCAD Interchange Utility for \$99 that converts drawings to or from the AutoCAD format.)

What additional hardware do you need? None! An IBM PC compatible and 512K RAM are all you need. ProDesign II produces high resolution drawings on your dot matrix printer - better than .005" resolution on an IBM/Epson compatible printer. And you don't have to get a mouse or digitizing tablet. ProDesign II is designed for easy and efficient keyboard use. You won't even need a math coprocessor, although it is supported. From a small drawing on a dot matrix printer to an E-Size drawing on a large plotter, ProDesign II is the one to use!

ProDesign II — Affordable, Compatible, and Usable!

Where do you get it? See your local dealer or contact:
American Small Business Computers, Inc.
 118 South Mill Street
 Pryor, OK 74361
 918/825-4844

PRODESIGN II — ONLY \$299!

F-18 HORNET DRAWN USING PRODESIGN II

1. ENGINE
2. MAIN ROTARY GROUP
3. ANIMATION MAGAZINE
4. WINDOW
5. INSTRUMENT PANEL
6. HEAD-UP DISPLAY
7. CHAIR
8. EJECTION SEAT
9. AIRCRAFT EQUIPMENT
10. SECOND SEAT SPACE
11. LEADING EDGE FOOT EXTENSION
12. FUELING TANKS
13. LEADING EDGE FLAP
14. WING TANK
15. SIDEWINDER AIR-AIR MISSILE
16. MISSILE LAUNCH RAIL
17. IDENTIFICATION LIGHT
18. WING FOLD HINGE JOINT
19. AIRLORD
20. FLAP WING
21. FLAP
22. HYDRAULIC RESERVOIR
23. STROBE LIGHT
24. HYDRAULIC ACTUATOR
25. NAVIGATION LIGHT
26. BRUSH BRUSHING ANTENNA
27. FUEL ATTACHMENT
28. MOVING TAILPLANE
29. ECH ANTENNA
30. RADAR WARNING ANTENNA
31. FORWARD LIGHTING STRIP
32. AFTERBURNER NOZZLE
33. MOVING TAILPLANE
34. TAILPLANE PIVOT HEATING
35. TAILPLANE HYDRAULIC ACTUATOR
36. FORWARD ENGINE
37. AILEADON HYDRAULIC ACTUATOR
38. WING FOLD ACTUATOR
39. SIDEWINDER AIR-AIR MISSILE
40. LEADING FLAP ACTUATOR
41. WING TANK
42. LEADING FLAP DRIVE SHAFT
43. EQUIPMENT CABINETS
44. AUXILIARY POWER TURBINE
45. FUEL LAUNCH CUP
46. SPARROW AIR-AIR MISSILE
47. LEADING FLAP DRIVE MOTOR
48. MAIN RETRACT ACTUATOR
49. FORWARD RETRACT ACTUATOR
50. LIQUID BYPASS CONVERTER
51. FORWARD LUGGER
52. FORWARD LAUNCH CUP
53. CONTROL COLUMN
54. HUDGER PANELS
55. AMMUNITION FEED CASE
56. HANDLE OF PITING SENSOR
57. PILOT SEAT
58. FORWARD LIGHTING STRIP
59. BRUSH EQUIPMENT MAT
60. FORWARD ECH ANTENNA
61. BRUSH PIVOT RESEARCH FROM SENSOR
62. 16
- 17
- 18
- 19
- 20
- 21
- 22
- 23
- 24
- 25
- 26
- 27
- 28
- 29
- 30
- 31
- 32
- 33
- 34
- 35
- 36
- 37
- 38
- 39
- 40
- 41
- 42
- 43
- 44
- 45
- 46
- 47
- 48
- 49
- 50
- 51
- 52
- 53
- 54
- 55
- 56
- 57
- 58
- 59
- 60
- 61
- 62

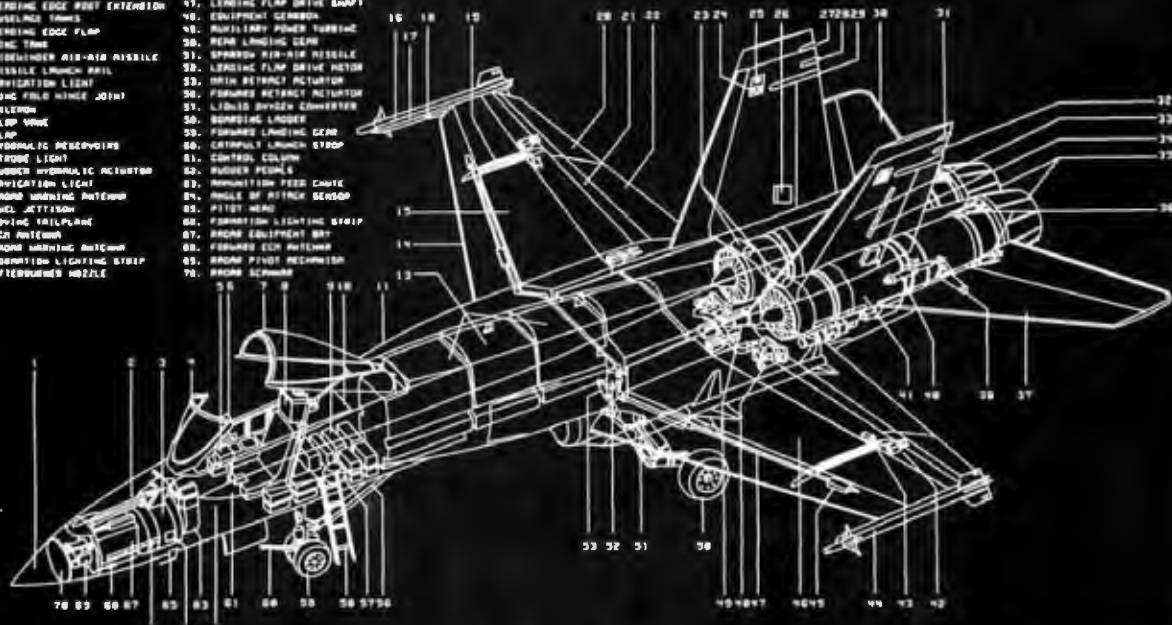

B·O·O·K R·E·V·I·E·W·S

THE C++
PROGRAMMING
LANGUAGE
Bjarne Stroustrup
Addison-Wesley
Reading, MA: 1986
327 pages, \$22.95

ADVANCED
PROGRAMMER'S GUIDE
TO UNIX SYSTEM V
Rebecca Thomas,
Lawrence R. Rogers,
and Jean L. Yates
Osborne/McGraw-Hill
Berkeley, CA: 1986
575 pages, \$21.95

MIND OVER MACHINE
Hubert L. Dreyfus
and Stuart E. Dreyfus
Free Press
New York: 1986
231 pages, \$16.95

THE C++ PROGRAMMING LANGUAGE

Reviewed by
G. Michael Vose

One of the tenets of evolutionary theory states that changes in the environment cause subtle mutations in an organism that transform it into a new organism. The changing nature of the hardware environment of computers causes an analogous evolution of programming languages. Bjarne Stroustrup's *The C++ Programming Language* describes one recent language mutation.

Following the example of its parent, Brian W. Kernighan and Dennis M. Ritchie's *The C Programming Language* (also known as K&R or the "white" book), this book defines the superset of C called C++. Both books provide multiple-chapter tutorials for their respective languages as well as the languages' official reference manuals. Both contain examples and exercises for readers to solve.

Stroustrup's book assumes a familiarity with C (referring the beginning reader to K&R) but is nearly 100 pages longer



than the white book. C++ adds considerably to the complexity of an already obtuse lexicon. Furthermore, C++ provides the tools to allow an object-oriented approach to programming in C.

Evaluating a book like Stroustrup's is difficult because microcomputer implementations of C++ are just becoming available (see the What's New section). I have no concrete experience with the language and no facility for using the tutorial sections of the book. Therefore, the judgments I can make are limited to two areas: Does the book adequately describe the concepts of C++, and do the C++ extensions seem useful? The historical significance of both the book and the language will have to wait for the judgment of some future reviewer.

People familiar with C instantly recognize the significance of the name

C++. C's increment operator is symbolized using two plus signs (++). The suggestion is that C++ increments the power of the language, and this is certainly true. But for many C programmers, adding new constructs takes a back seat to fixing some of the awkward aspects of the original language. The authors provide some of these fixes.

Programmers enjoy using C because of the freedom of expression it provides due to a rich set of operators and great flexibility in declaring and manipulating data types. C++ increases this freedom substantially by offering additional data types and constructs that permit programmers to more easily build complex data structures (a process known as data abstraction). The emphasis in C++ is on types and structure.

(continued)

MAKE YOUR PC CLONE A GOOD INVESTMENT!

Your PC represents a substantial investment, so it does not make sense to risk costly downtime or system failure due to the use of a so-called "BARGAIN" power supply.

At Fortron we insist on quality and reliability. That's what has earned us a UL rating. For your complete satisfaction we offer a one-year warranty and full technical support.

**200 WATTS
PC AT
\$189.00**



**MEETS
FCC CLASS B**

**150 WATTS
PC XT
\$129.00**



- U.L. Recognized
- Meets FCC Class B requirements
- 115/230 VAC, selectable
- OVP, OCP short circuit protection
- Power failure signal
- All U.S. made connectors provide better connection to drives and CPU board
- Meets European safety specs
- 100% burn-in & pre-shipping test, one full year warranty
- Direct replacement for original IBM® power supplies
- FARADAY® type pin-out available upon request

PC EXPANSION CHASSIS

Provides easy expansion to your PC, PC XT, Tandy 1000™, Compaq Portable™, Compaq Desk Pro™, and other PC clones by having extra expansion slots for video controllers, disk drives or I/O boards.

FC 640 ... \$388.00

- 5 slot mother board
- 100 w. power supply
- Capacity for 3 drives
- 15 1/4" x 12" x 6 1/4"



FC 650 ... \$398.00

- 8 slot mother board
- 150 w U.L. reg power supply
- Capacity for 4 drives
- 19 1/4" x 15" x 5"



FC 660 ... \$438.00

- 12 slot Mother board
- 100 w power supply
- Capacity for 2 drives
- 15 3/4" x 15 1/4" x 15 1/4"



*Prices above include system interface adaptors

SPECIAL OFFER

- 20 MB hard disk drive with controller and cables \$385.00
 - 20 MB internal tape back-up with controller, cable and software \$545.00
- (Special prices valid with expansion chassis purchase only)

FORTRON CORPORATION

3225 Seldon Court **Orders Only: (800) 821-9771**
 Fremont, CA 94538 In Calif: (415) 490-8171
 Telex: 559291 FORTRON Technical Service: (415) 490-8403

Compaq Portable, Desk Pro™/ Compaq Corp
 IBM™/I B.M., Tandy 1000™/Tandy Corp

For example, you create objects by using the class declaration. Objects have common characteristics, and the definition of objects in a class specifies how they behave, how they get created and destroyed, and how they can be used and manipulated. Therefore, a class is a type, but a type defined by the programmer. While an int or a char have definitions imposed by the compiler, a class and the objects that are instantiations of that class are under your control.

Classes have many unique characteristics; the internals of a class can be made invisible to the rest of the program or made public, known to the program (a public class is just a structure); class internals can be hidden from the rest of a program but still known to data types declared as friends; and derived classes permit adding to a class without revising the source code or recompiling.

The emphasis of the extensions of C++ is on the easy creation of new data types. Secondly, C++ classes provide a way to "hide" data to make it invisible, and therefore uncorruptible, by other parts of a program.

How might these powerful new types be used? Stroustrup provides examples of simple classes that manipulate sets, manage symbol tables, and manipulate a stack. You might well wonder if there is a price to pay for this ability to create new types and if it will lead to programs voluminous in source text. Apparently not, according to Stroustrup, who claims that more freedom of expression in creating types leads to economy of expression and slightly shorter programs.

The C++ compiler is actually a translator that uses a C++ source file to generate a C source file that can in turn be compiled into an executable file. The C++ translator features strict type checking at the translation stage, offering the kind of checks that previously required a separate utility like lint.

One of the principal advantages of C++'s data abstraction richness is modularity. Since you can build objects, software "black boxes" that take an easily defined input and generate a predictable output, teams of programmers can more easily generate large programs. AT&T's new Ada compiler was written by a team of programmers using C++.

C++ also provides operator and function overloading. Function overloading allows the multiple definition of a function. You can define the function foo() so that it acts differently when passed an integer argument than when passed a character argument. Overloaded operators permit the definition of how an operator affects a data stream. For example, addition of integer and real numbers is defined in C++, but addition of complex numbers is not. You can overload the addition operator by declaring its effect on the combining of a real number and a complex number with syntax similar to that of a data declaration.

FIXING C

For many programmers, the intrinsic object orientation of C++ is less important than its streamlining of C. As the theme articles of this issue relate, object-oriented programming as a paradigm for conceptualizing problems is still

(continued)

THE PROFESSIONAL'S CHOICE

Lotus 1-2-3 \$319	Lotus Symphony \$449	dBase III Plus \$369	FrameWork II \$369	MultiMate \$219	Word Perfect 4.1 \$209
-----------------------------	--------------------------------	--------------------------------	------------------------------	---------------------------	----------------------------------

Software

Word Processing Editors

FANCY FONT	\$119
FINAL WORD II	\$219
MICROSOFT WORD	\$239
MULTIMATE	\$219
MULTIMATE ADVANTAGE	\$289
OFFICE WRITER/ SPELLER	\$239
PFS: WRITE	\$ 89
SAMNA WORD III	\$259
THINK TANK	\$109
TURBO LIGHTNING	\$ 59
VOLKSWRITER 3	\$159
VOLKSWRITER SCIENTIFIC	\$259
WORD PERFECT 4.1	\$209
WORDSTAR 2000	\$249
WORDSTAR 2000+	\$289
WORDSTAR PRO	\$259
XYWRITE III	\$239

Database Systems

ALPHA DATA BASE MANAGER II	\$179
CLIPPER	\$359
CONDOR III	\$339
CORNERSTONE	\$259
DBASE III PLUS	\$369
KMAN 2	\$269
PARADOX	\$499
PFS: FILE/PFS: REPORT	\$169
POWERBASE	\$189
Q & A	\$199
QUICKCODE III	\$159
QUICKREPORT	\$159
R BASE 5000	\$359
REFLEX	\$59
REVELATION	\$499

Spreadsheets/Integrated Packages

ENABLE	\$349
FRAMEWORK II	\$369
JAVELIN	\$549
LOTUS 1-2-3	\$319
MULTIPLAN	\$135
OPEN ACCESS	\$259
SMART SYSTEM	\$489
SPREADSHEET	\$ 99
AUDITOR	\$ 99
SUPERCALC 3	\$209
SYMPHONY	\$449

Graphics

CHARTMASTER	\$219
DIAGRAM MASTER	\$199
EKECUVISION	\$249
ENERGRAPHICS	\$179
FREELANCE	\$209
GEM DRAW	\$149
GRAPHWRITER COMBO	\$299
IN-A-VISION	\$259
MS CHART NEW	\$189
OVERHEAD EXPRESS	\$139
PC DRAW	\$209
PC PAINTBRUSH	\$ 89
PFS: GRAPH	\$ 89
SIGNMASTER	\$149

Project Management

HARVARD TOTAL	\$279
PROJECT MANAGER	\$279
MICROSOFT PROJECT	\$249
PROJECT SCHEDULER NETWORK	\$339
SUPERPROJECT +	\$269
TIMELINE 2.0	\$259

Communications/Productivity Tools

CROSSTALK	\$ 99
PROKEY	\$ 85
KEYWORKS	\$ 59
RELAY GOLD	\$149
REMOTE	\$109
SMARTERM	\$Call
SMARTCOM II	\$ 99
SUPERKEY	\$ 49

Statistics

SPSS/PC	\$575
STATPAK-NWA	\$299
STATPAK GOLD-WALDNICK	\$399
SYSTAT	\$419

Desktop Environments

DESK ORGANIZER	\$ 89
GEM DESKTOP	\$ 39
SIDEKICK	\$ 39

Network Applications

DBASE III LAN PAK	\$599
KMAN 2	\$899
OPEN SYSTEMS	\$459
R BASE 5000	\$799
REVELATION	\$999
WORD PERFECT	\$450

Languages/Utilities

CONCURRENT DOS	\$179
C86 C COMPILER	\$299
FASTBACK	\$ 99
LATTICE C COMPILER	\$269
MARK WILLIAMS C	\$319
MICROSOFT C COMPILER	\$249
MS BASIC COMPILER	\$249
MS FORTRAN	\$229
NORTON UTILITIES	\$ 59
QUICK BASIC	\$ 49
TURBO PASCAL	\$ 49
XENIX	\$Call

Accounting

BPI	\$299
GREAT PLAINS	\$479
IUS EASYBUSINESS	\$309
ONE WRITE PLUS	\$159
OPEN SYSTEMS	\$409
PEACHTREE	\$259
REAL WORLD	\$399
STAR ACCOUNTING PARTNER II	\$529

Hardware *

Multifunction Boards

AST ADVANTAGE (128K)	\$359
AST 6 PAK PLUS (0K)	\$229
AST RAMPAGE PC	\$319
AST RAMPAGE AT	\$459
GOLD QUADBOARD (0K)	\$419
INTEL ABOVEBOARD PS (64K)	\$329
JRAM AT-3 (0K)	\$239
JRAM 3 (0K)	\$179
ORCHID CONQUEST (0K)	\$279
ORCHID ECCOL (0K)	\$459
PC TURBO 286 (0K)	\$899
PC TINY TURBO 286	\$549
PERYST TIME SPECTRUM (384K)	\$279
QUADBOARD (384K)	\$249
SILVER QUADBOARD (0K)	\$219
TECMAR CAPTAIN (384K)	\$289

Display Boards

HERCULES GRAPHICS CARD	\$299
HERCULES COLOR CARD	\$159
PARADISE COLOR/MONO	\$169
PARADISE MODULAR GRAPHICS	\$259
QUADRAM EGA+	\$379
SIGMA EGA 350	\$379
SIGMA COLOR 400	\$449
STB EGA PLUS	\$399
TECMAR GRAPHICS MASTER	\$469
TSENG ULTRA PAK	\$429
TSENG ULTRA PAK-S	\$389

Emulation Boards

AST 5251-11 +	\$649
AST 5251-12	\$499
AST BSC	\$499
AST SNA	\$599
CKI 3278/9 Plus	\$849
IRMA	\$799
IRMALINE	\$999

Modems

AST REACH 1200	\$359
HAYES 1200	\$389
HAYES 1200B	\$349
HAYES 2400	\$579
HAYES 2400B	\$549
TRANSET 1000	\$279
VENTEL 1200	\$369
HALF CARD	\$319
WATSON	\$319

Mass Storage/Backup

EXCEL STREAM 60 TAPE (INT)	\$899
IOMEGA BERNOULLI BOX-10-10	\$2399
IRWIN 310A 10MB TAPE (EXT)	\$850
IRWIN 110D 10MB TAPE (INT)	\$479
MAYNSTREAM 60MB TAPE (INT)	\$1199
MOUNTAIN DRIVECARD 20MB	\$899
PLUS HARDCARD 10MB	\$889
PRIAM 42MB AT	\$1295
SYSGEN SMART IMAGE 20 MB (INT)	\$625
TALLGRASS	\$Call
TECMAR QIC-60AT TAPE (INT)	\$1199

Monitors

AMDEK 600/722	\$429/\$539
NEC MULTISYNC	\$599
PRINCETON HX-12	\$448
PRINCETON MAX-12E	\$179
PRINCETON SR-12	\$579
PRINCETON HX-12E	\$539
PRINCETON HX-9	\$529
TAXAN 122 AMBER	\$159
TAXAN 630/640	\$469/\$539

Networks

AST PC NET	\$Call
ORCHID PC NET	\$Call
3 COM	\$Call

Printers/Plotters

BROTHER TWINWRITER	\$939
DIABLO	\$Call
EPSON FX-85	\$399
EPSON FX-286	\$589
EPSON LO-800	\$589
EPSON LO-1000	\$729
HP 7475A	\$Call
JUKI 6300	\$699
NEC 3550	\$869
OKIDATA 192	\$379
OKIDATA 193	\$519
TI 865	\$1025
TOSHIBA P321	\$565
TOSHIBA P341	\$629
TOSHIBA P351	\$1069

Input Devices

KEYTRONIC 5151	\$179
KOALA	\$109
MICROSOFT MOUSE	\$129
PC MOUSE W PAINTPLUS	\$139

Accessories

CURTIS SURGE PROTECTORS	\$Call
DASHBOARD BACKUP POWER	\$Call
GILTROMIX SWITCHES	\$Call
MASTERPIECE PLUS	\$135
MICROFAZER INLINE BUFFERS	\$Call
TRIPPLITE BACKUP POWER	\$Call
256K RAM SET	\$ 39
8087 MATH CHIP	\$135
80287 MATH CHIP	\$199

NEC Multisync NEW \$599	Mountain Drivecard 20 NEW \$899	Quadram NEW EGA \$379	Princeton HX-12E \$539	J RAM AT-3 \$239	IRMA Board \$799
-----------------------------------	---	---------------------------------	----------------------------------	----------------------------	----------------------------

*CALL FOR SHIPPING COSTS



LOWEST PRICE GUARANTEE!!

We will match current nationally advertised prices on most products. Call and compare.

free!

Diskette Library Case with your order



1-800-221-1260

In New York State call (718) 438-6057

TERMS
Checks—allow 14 days to clear. Credit processing—add 3%. COD orders—cash. M O or certified check—add \$5.00. Shipping and handling UPS surface—add \$3.00 per item (UPS Blue \$8.00 per item) NY State Residents—add applicable sales tax. All prices subject to change.



MON.-THURS. 9:00AM-8:00 PM
SUN. & FRI. 9:00AM-4:00 PM

Softline Corporation
P.O. Box 729, Brooklyn, N.Y. 11230
TELEX: 421047 ATLN UI
FAX: 718-972-8346

COMPUTER WAREHOUSE

CALL TOLL FREE **1-800-528-1054**

FREE *FEDERAL EXPRESS*

Air Express Shipping

See Details Below

HARDWARE

NOW

BEST PRICES

No Charge for Bank Cards

PRINTERS

Anadex All Models	Call
Brother All Models	Call
Cannon Laser Printer	\$1949
Citizen MSP-10	\$250
MSP-15	\$349
MSP-20	\$315
MSP-25	\$485
Premier 35	\$409
Datsouth All Printer Models	Call
Diablo D-25	\$489
835	\$1035
Other Printer Models	Call

EPSON

All Printer Models	Call
Fujitsu	Call
Fuji	Call
6100	\$349
6300	\$689
NEC	Call
3510, 3550, 3515, 3530	\$729
8810, 8830, 8850	\$1039
PS, P6, P7	Call
ET 360	\$379
ET 370	\$379

OKIDATA

All Printer Models	Call
Panasonic 1080	\$199
1091	\$239
1092	\$309
1592	\$425
KXP3151	\$399

STAR MICRONICS

All Printer Models	Call
Toshiba 321 Parallel & Serial	\$449
341	\$769
P251 Parallel & Serial	\$869

MONITORS

Amdex All Monitors	Call
NEC All Monitors	Call
Princeton Graphics	Call
Zenith All Models	Call

VIDEO TERMINAL

Qume QVT Green 101	\$299
QVT Amber 101	\$314
Wyse 30	\$299
50	\$419
75	\$559
Wyse 85	\$439
Wyse 350	\$859
Zenith Z-22	\$455
Z-29A	\$559
Z-49	Call

MODEMS

AT&T	Call
4000 External	\$309
Anchor Automation	Call
Anchor Express	\$235

HAYES

All Modems	Call
Prometheus All Models	Call
US Robotics Courier 2400	\$379
Password 1200	\$180
Microlink 2400	\$379

DISK DRIVES

Alpha Omega Turbo 10	\$379
Turbo 20	\$439
Turbo 30	\$669
Omega Bernoulli 10 meg	\$1275
Bernoulli 20 meg	\$1659
Bernoulli 40 meg	\$2549
Paradise Macintosh Hard Disk	\$609
Seagate 20 meg w/Western I/O	\$409

COMPUTERS

PANASONIC	
St. Partner Dual Drive	\$1309
Exec. Partner Dual Drive	\$1899
TOSHIBA	
T-1100	Call
SPERRY	
Sperry IT	\$1899
Other Models	Call
WYSE	
Wyse pc 1100-1	\$979
Wyse pc 1100-20	\$1539

Zenith Computer Products
SAVE Up to 50%
All Models Call

DISKETTES

Maxell MD-2 (Qty 100)	\$125
Sony MD/2 (Qty 100)	\$119

BOARDS

AST Advantage	\$329
Rampage PC	\$239
Six Pack Plus	\$159
Hercules Color Card	\$149
Graphic Card	\$305
Intel	Call
Above Boards	Call
Maynard Hardcard	\$549
Paradise Modular Graphic 06-1	\$239
Five Pak	\$115
Quadram	Call
Gold & Silver Boards	Call
Quadlink	\$329
Quad EGA+	\$365
Tec Mar Graphics Master	\$289
Captain No Memory	\$169

PLOTTERS

Epson Hi-80	Call
-------------	------

KEYBOARDS

Keytronics 5151	\$159
-----------------	-------

COPIERS

Canon «PC»

Canon PC-10	\$509
Canon PC-14	\$649
Canon PC-20	\$719
Canon PC-25	\$939

XEROX
1020 w/Toner \$1099

SANYO
SFT 800 Call



SOFTWARE

IBM PC and 100% Compatibles

TRAINING

Flight Simulator	\$28
PC Logo	\$76
Typing Instructor	\$28
Typing Tutor III	\$28

LANGUAGES

C Computer (Microsoft)	\$219
Fortran Compiler (Microsoft)	\$195
Lattice C Compiler	\$242
Macro Assembler (Microsoft)	\$84
Pascal Compiler (Microsoft)	\$166
Quick Basic 2	\$55
Run C Interpreter	\$82
Turbo Pascal 3.0	\$38
Turbo Database Tool Box	\$30

PROJECT MANAGEMENT

Harvard Total Project Manager	\$262
Microsoft Project	\$219
Super Project Plus	Call
Timeline 2.0	\$209

COMMUNICATIONS

CompuServe Starter Kit	Best Price
Crosstalk XVI	\$92
MS Access 1.01	Call
PFS Access	\$76
Remote	\$92
Smartcom II	\$83

INTEGRATIVE SOFTWARE

Enable 1.1	\$319
Framework II	Call
Smart Software System	\$379
Symphony	Call

GRAPHICS

Charmaster	\$205
Diagram Master	\$185
Energraphics 2.0	\$289
In-A-Vision	\$249
Microsoft Bus Mouse	\$106
w/PC Paintbrush 3.0	\$164
Microsoft Chart	\$119
Microsoft Serial Mouse	\$39
Newsroom	\$52
PC Draw	\$99
Click Art Personal Publisher	\$104
PC Mouse w/Dr. Halo II	\$119
PC Paint w/Mouse	\$76
PFS Graph	\$30
Printmaster	\$132
Signmaster	\$30
Turbo Graphix Tool Box	\$30

WORD PROCESSORS

Leading Edge Word Processor	\$48
Leading Edge W/P w/Spell & Mail	\$72
Lightning	\$55
Microsoft Word 2.01 Advantage	Call
Multimate Advantage	Call
PFS Write w/Spell Checker	\$76
Wordstar w/Tutor	\$162
Wordstar Pro Pack	\$233
Word Perfect Ver. 4.1	\$198
Wordstar 2000 - 2.0	\$378

UTILITIES

Copy II PC	\$19
1 DIR	\$47
Fastback	\$87
Norton Utilities 3.1	\$48
Printworks	\$36
Sidekick	\$30
Sidekick (Unprotected)	\$47
Sidekick - Superkey (Bundle)	\$85
Travelling Sidekick	\$39
Turbo Prolog	\$54
Sideways 3.1	\$34
Superkey	\$39

SPREADSHEETS

Lotus 1-2-3	Call
Multipan	\$108
Spreadsheet Auditor 2.0	\$82
VP Planner	\$49

Supercalc 4 Call

MONEY MANAGEMENT

Dollars & Sense w/Forecast	\$94
Tobias Managing Your Money	Call

DATA BASE MANAGEMENT

Clipboard	\$339
Cornerstone	\$67
dBase II	Call
dBase III Plus	Call
Extended Report Writer	\$74
KnowledgeMan II	\$279
KnowledgeMan Upgrade KA	\$145
Nutshell 2.0	\$59
PFS: File	\$76
PFS: Report	\$67
Quickcode	\$138
QuickReport	\$138
Reflex	Call
Think Tank	\$91

R:Base 5000 \$319

Many other titles available.

We do not guarantee computer compatibility.

Inquiry 71 for MS DOS Products. Inquiry 72 for all others.

COMPUTER WAREHOUSE

Order Line: 1-800-528-1054
Order Processing: 602-224-9345
2222 E. Indian School Rd.
Phoenix, Arizona 85016
602-954-6109

Store Hours: Mon-Fri 10-5:30
Saturday 9-1
Order Line Hours: Mon-Fri 7-5:30
Saturday 9-1
Order Processing Hours: Mon-Fri 10-3

Product shipped in factory cartons with manufacturer's warranty. Please add \$6.00 per order for UPS ground shipping on orders up to 10 lbs. Orders 10 lbs. and under you pay for ground service, receive air service at no extra charge. Available on orders 11-30 lbs. \$17 for air service. Prices & availability subject to change without notice. Send cashier's check or money order. All other checks will delay shipping two weeks.



CWF-588

in its infancy. Smalltalk showed the way for an object-oriented approach to programming, but implementations of it and other object-oriented languages have been too slow to be useful or are restricted in some other way.

Does C++ fix enough of C's problems to warrant its adoption independent of its object-oriented extensions? Probably not. C++ does provide for single-precision floats, adds enumerated and constant types, and comes with a stream-oriented I/O library that simplifies I/O for UNIX programmers (unfortunately, the stream.h library itself is written in C++ and cannot, at present, be used in regular C programs). But in order to be a superset of C, C++ had to retain the original syntax and organization of its predecessor; C++ could not differ markedly from C and still translate existing programs.

There are significant lexical improvements in C++. Unlike macros, the constant data type follows normal C scoping rules. Two new keywords, new and delete, eliminate the need to use malloc() and free(), simplifying the management of memory. Using classes eliminates the need for typedefs. C++ even lets you specify default values for arguments to a function so that the function can be called without argument values.

PURPOSE SERVED

As a study of sophisticated data structures, *The C++ Programming Language* makes interesting reading. For example, C++ permits the use of virtual functions, those that use the same name with the proper function chosen by the program according to an input parameter. A class Shape using a function Draw() might have virtual functions for the derived classes of Shape called Circle and Square. Each of these classes has its own function Draw(), and the program employs the one necessary to do Circle or Square, depending on which is called.

A couple of things confused me as I delved into this book. First, Stroustrup calls attention to a new stream I/O library that comes with C++ and uses its conventions in his example programs right from the beginning of the book. Without a more detailed explanation of the stream I/O functions (which doesn't occur until the final chapter), I had trouble following the examples. While the stream I/O syntax of C++ is much cleaner than that of C, I missed not seeing familiar functions like printf() in the early examples. Second, I found Stroustrup's use of the jargon of C++ (classes, friends, references, derived classes) distracting because he tends to use these terms before defining and explaining them.

Another legitimate question to ask about this book is, Will AT&T try to push C++ as the next incarnation of C? If so, will the rest of the world follow? It seems more likely that the world will follow the ANSI/ISO standard that is nearing completion and that may be in place by mid-1987. The standard does provide some of the extensions of C++, but it falls far short of implementing its major facilities, like classes and stream I/O. C++ may turn out to be only an interesting curiosity, not the next evolutionary stage of C.

However, C programmers embarked on an object-
(continued)

STATISTICAL PACKAGES

Complete, high-performance data-analysis software from:



StatSoft™

Unbeatable power and flexibility for unbeatable prices!

1. **STATS-2™** (release 2.1): A complete, superfast statistical package. Can also be used as a statistical supplement for Lotus 1-2-3™ and other spreadsheet programs. Runs on IBM™ and compatibles, 256k, 2dd, 8087 support **\$149**
2. **STATFAST-2™** (release 2.1): The most powerful statistical package developed for the Macintosh™ 128k/512k/Plus, 1dd..... **\$119**
3. **APP-STAT™**: A complete statistical package for the Apple II™ family of computers, 1dd **\$99**
4. **PSYCHOSTAT-3™**: A complete statistical package, available for Kaypro™ and all CP/M™ computers, 1dd **\$99**

All of these statistical packages are user friendly and super-easy to use. They include the full range of basic statistical analyses (descriptive statistics, t-tests, correlations, cross-tabulations, nonparametric statistics, and much more) and advanced multivariate statistics (comprehensive multiple regression with forecasting, general multifactor ANOVA/ANCOVA up to 5 factors including a covariate, repeated measures, contrasts, unbalanced designs, and more). All packages can handle **data files of unlimited size**, include flexible Data Editors with complex transformations and complete data-base management functions, and can access data files from spreadsheets, data-bases, and mainframes.

Ask for our statistical packages for other computers.

TO ORDER: Send check, credit card number, or money order (plus \$5 shipping and handling) to:



StatSoft™

2832 EAST 10TH STREET, SUITE 4, TULSA, OK 74104
(918) 583-4149



To order by phone (Visa, MasterCard, C.O.D. orders accepted) or talk to our technical staff for more information, call (918) 583-4149.

STATSOFT STATSOFT logo STATS-2 STATFAST APPSTAT PSYCHOSTAT LOTUS 1-2-3 IBM Macintosh Apple II Kaypro and CP/M are trademarks of respective companies

AT LAST: Professional Typesetting Capability For PC Users

With **PC \TeX** TM — the best-selling full implementation of Professor Don Knuth's revolutionary typesetting program **\TeX** .

FINEST Typeset Quality Printing From:
 dot matrix laser phototypesetter

$$\sum_{i=1}^{\infty} \frac{1}{i} \begin{pmatrix} a_{11} & \dots & a_{1n} \\ a_{21} & \dots & a_{2n} \\ \vdots & \ddots & \vdots \\ a_{m1} & \dots & a_{mn} \end{pmatrix} \int_{-\infty}^{\infty} e^{-x^2} dx$$

WIDEST Range Of Output Device Drivers:

- Epson FX, LQ
- HP LaserJet*
- Toshiba
- Apple LaserWriter
- Corona LP-300*
- APS-5 phototypesetter
- Screen preview, with EGA or Hercules card

MOST COMPLETE Product Offering:

PC \TeX (not copy protected) includes the following:

- Our specially written *PC \TeX Manual*, which enables you to start using \TeX right away.
- Custom "macro packages" that provide formats for letters, manuals, technical documents, etc.
- The \LaTeX document preparation system, a full-featured macro package for preparing articles, books, reports, etc., and *\LaTeX User's Manual*.
- $\AMS\text{-}\TeX$, developed by the *Amer. Math. Society* for professional mathematical typesetting.

Site licenses, volume discounts, and interfaces to PC Paintbrush, PC Palette, FancyFont and Fontrix are also available.

PRICED FROM ONLY \$249.00!

(Printer drivers and interfaces additional.)

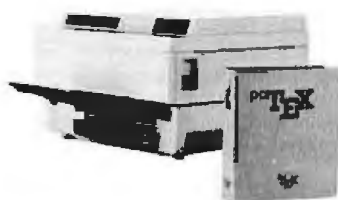

**Laser printer,
 fonts & software
 from \$2995.00**

For IBM PC/XT, AT or compatible, DOS 2.0 or higher, and 512K RAM. Hard disk required for printer drivers and fonts.

*HP LaserJet and Corona require additional interface boards.

For more information call or write:

Personal \TeX , Inc.

20 Sunnyside, Suite H, Mill Valley, CA 94941 (415) 388-8853

This ad, with space for the photograph, produced by PC \TeX . Typeset on the Epson FX80, the Corona LP-300 laser printer, and the Autologic APS-5 phototypesetter.

\TeX is a trademark of the American Mathematical Society. Manufacturers' product names are trademarks of individual manufacturers.

BOOK REVIEWS

oriented programming odyssey and others interested in object-oriented languages should investigate this book.

Because the style of Stroustrup's exposition approximates that of his colleagues Kernighan and Ritchie, I expect that there will be an outpouring of books on C++ if it catches on, just as there has been on C. A rich and complex language needs much explanation.

G. Michael Vose is a senior technical editor at BYTE (One Phoenix Mill Lane, Peterborough, NH 03458).

ADVANCED PROGRAMMER'S GUIDE TO UNIX SYSTEM V

Reviewed by Gary D. Kendall

Advanced Programmer's Guide to UNIX System V by Rebecca Thomas, Lawrence R. Rogers, and Jean L. Yates summarizes material also found in the *UNIX System Administrator's Manual*, *Text Processing Guide*, *Program Development Tools Manual*, and the *System Utilities Manual*. If you have access to these manuals, you may not be interested in this book, although the examples may prove helpful to you. But if you are in the unfortunate position of having to work on a UNIX system without benefit of the accompanying manuals, this book will give you the information you need to develop useful programs on a UNIX system. Although the authors deal with some aspects of UNIX that could be considered advanced, such as signals, named pipes, semaphores, and shared memory, the abundance of program examples makes the book a good tutorial introduction to programming on UNIX System V.

From reading the preface, I have the impression that most, if not all, of the book, including the sample code, was written by Lawrence Rogers with Jean Yates as technical consultant, and that Rogers is somewhat new to UNIX. I could find no mention of Rebecca Thomas anywhere (except on the cover). It also seems that Rogers's programming experience is based in FORTRAN. This is evidenced by his use of nested if...else statements instead of a switch, by his heavy use of subscripts as array indexes rather than pointers, and by his use of the word "subroutine" when making reference to a function. I found his style of coding very difficult to read at best.

TOPICS COVERED

The book explains the operation of the UNIX kernel and the structure of the file system. Yet the diagram on page 19 of the book, which illustrates the mounting of a file system on a directory, is in error. The mount directory (*/usr*) is shown to belong to the file system being mounted, when actually it is a part of the root file system. Later, in the section describing the sequence of events from boot to log-in, there is no mention of the execution of the */etc/rc*, */etc/profile*, and */etc/login* scripts. This is an unfortunate omission, since the user can modify these scripts to include such things as the mounting of file systems, the initialization of demons, and the maintenance of spooling

(continued)

Put RUN/CPM™ in your PC today and run 50,000 programs that you couldn't run yesterday!



RUN/CPM V-20/30 CP/M Emulator

RUN/CPM is a revolutionary new product which combines software and hardware to allow your PC to run 1,000's of programs written for the CP/M80 operating system. For years, popular 8 bit computers such as "Kaypro", "Osborne", and "Morrow" have relied on this vast library of high quality, inexpensive software, which can now be accessed by your PC. A simple replacement of your PC's 8088 or 8086 microprocessor with a dual 8/16 bit N.E.C. V-20 or V-30 microprocessor creates a system capable of running both CP/M80, and MS-DOS/PC-DOS software in addition to adding 8 bit CP/M compatibility, your PC's overall performance will improve by up to 30% as a result of the speedup characteristics of the V-20 and V-30 microprocessors. Running CP/M software directly from CP/M disks is easy thanks to RUN/CPM's disk emulation feature, which will allow your PC's floppy drives to directly READ, WRITE, and FORMAT over 175 different CP/M disk formats! You will also be able to run CP/M programs in full color, from a hard disk or RAM disk, and you can even run MS-DOS background programs such as Borland's "Sidekick" on top of CP/M programs! Add pop-up windows, terminal emulation, and help screens and it is easy to see why RUN/CPM is fast becoming the de-facto standard in CP/M emulation software.

READ/CPM CP/M Disk Emulation

READ/CPM adds CP/M disk compatibility to your PC, XT, or AT. Now your PC can directly READ, WRITE, and FORMAT over 175 different CP/M disks using DOS commands such as "COPY", "TYPE", "DIR" etc. READ/CPM supports a variety of disk drives including 5 1/4", 3 1/2", and with the proper disk controller even supports 8" disk drives. READ/CPM is the solution to your disk compatibility problems.

Run CP/M Z80 for the incredible price of \$199.95

The RUN/CPM Z-80 co-processor gives you all of the incredible features of RUN/CPM, plus the advantage of the full Z-80 instruction set at a price you can afford. Never before has it been easier to add Z-80 compatibility to your PC, XT, or AT. The RUN/CPM Z80 co-processor board comes complete with 64K of memory, a 5Mhz clock, and of course the incredible RUN/CPM emulation software. Plug this card into one of your PC's slots and within minutes you will be running the most powerful CP/M software available, including the most popular assemblers, compilers, debuggers, and wide variety of application programs such as word processors and spreadsheets. Our ISIS-II emulation option will even allow you to run "Intel" development languages on your PC, or AT. If you want to step up to the ultimate in high speed Z80 processing, then check out our RUN/CPM Z80-H full size co-processor available for only \$499.95. Running in excess of 9mhz with 128 K memory on board, this co-processor virtually blows away the competition! Both the RUN/CPM Z80 & Z80-H co-processors come with the RUN/CPM emulator software and are backed by our 30 day money back guarantee.

"It's an excellent program backed by a knowledgeable company."

ROBERT ATHEY
Micro Times

"... the most powerful of all the emulators reviewed."

TED DRUDE
Computer Shopper

I WANT TO ORDER!

To order by phone, or for a dealer nearest you, CALL (800) 637-7226
Technical info call (305) 823-8088

Codes	Product	Price	Total
—	RUN/CPM requires V-20/30	\$ 99.95	—
—	RUN/CPM Z80 (Board 5mhz)	\$199.95	—
—	RUN/CPM Z80H (Board 9mhz)	\$499.95	—
—	READ/CPM	\$ 49.95	—
—	V-20 8mhz - Replaces 8088 up to 8 MHz	\$ 24.95	—
—	V-20 5mhz - Replaces 8088 up to 5 MHz	\$ 14.95	—
—	V-30 9mhz - Replaces 8086 up to 9 MHz	\$ 29.95	—
—	V-30 10mhz - Replaces 8086 up to 10 MHz (NEW)	\$ 49.95	—
—	MICRUN80 (UD1) requires V-20/30	\$450.00	—
—	MICRUN80 5 MHz Z80 Board	\$395.00	—
—	MICRUN80 9 MHz Z80 Board	\$595.00	—
—	MICRUN80H (UD1)	\$450.00	—

BB \$69.95

Add \$5.00 shipping charge per order except for V-20/30 chips which include shipping. International orders add \$18.00

Payment VISA MC MONEY ORDER C.O.D. Add \$3.00 orders

Credit Card Expiration /

Card #

Name

Address

City State

Zip Tel

30 DAY MONEY BACK GUARANTEE ON ALL PRODUCTS. SOFTWARE IS NOT COPY PROTECTED.

Micro Interfaces Corporation
6824 N.W. 169th Street, Miami, Florida 33015
(305) 823-8088 — Telex 5106004680 MICRO INTER CO
DEM. VAR. Dealers. Inquiries Invited

* Requires V-20 or V-30 microprocessor

RUN/CPM is a registered trademark of Micro Interfaces Corporation. Sidekick is a registered trademark of Borland International. Kaypro is a registered trademark of the Kaypro Corporation. Intel is a registered trademark of the Intel Corporation. CP/M is a registered trademark of Digital Research. Z80 is a registered trademark of the Zilog Corporation. ISIS-II & ISIS-III are registered trademarks of the Intel Corporation.

RUN INTEL SOFTWARE ON IBM PC'S

Transform an IBM PC, XT, AT, or compatible into a totally integrated Intel Micro Development System, capable of running 8 bit ISIS-II, and 16 bit ISIS-III (UDI) software while remaining 100% MS-DOS compatible. MICRUN 80 and MICRUN 86 are Universal Development Interfaces which will allow you to increase your development capabilities with faster, more reliable and affordable PC based work stations. The MICRUN80 (UDI) utilizes the N.E.C. V-20/30 microprocessor to execute 8 bit Intel software on a PC, or XT, 2 to 3 times faster than an Intel MDS! For ultra fast execution speed, our Z80 co-processor version of MICRUN 80 runs in excess of 9 Mhz and is PC "AT" compatible. The MICRUN86 (UDI) is the perfect solution for running 16 bit ISIS-III software on PC's or XT's, and AT's and does not require any additional hardware. Both MICRUN80, and MICRUN86 come complete with a full featured communication program for transferring Intel software to your PC or choose our "8" compatibility option, which will allow you to connect an 8" disk drive to your PC and directly access single density 8" Intel format disks. Micro Interfaces Corporation has brought the power of Intel development to the PC, and in doing so provided you with an affordable alternative to the high cost of Intel development. To order, or obtain more information call the toll free number listed above or refer to the order coupon.

STOP SHOPPING!

BASIC TURBO SYSTEM

COMPARE OUR BASIC SYSTEM TO OTHERS & SAVE!



OURS

- 8mhz "super" Mother Board
- 256K of memory installed
- Mother Board expandable to 1024K
- 150-watt power supply
- Deluxe keyboard with large return key
- Full warranty on all products
- Built-in clock & game I/O port
- MS-DOS and GW-Basic, fully licensed

THEIRS

- Slower 4.77mhz Mother Board
- No memory included
- Only 256K capacity Mother Board
- Less powerful 135-watt power supply
- Standard keyboard with inconvenient small return key
- ? ? ? ?
- Not included
- Not included

INCLUDES:

- Super-fast 8mhz Mother Board, Expandable to 1024K with 256K Installed
- Built-in Clock and Game I/O Port
- 150-Watt Power Supply
- IBM® At-Lookalike Case with Key Lock
- MS-DOS and GW Basic
- IBM® -Style Keyboard with Large Return Key
- FCC Approval
- Manual and System Packing Box

\$438

SmarTeam Modem



103/212A—Operates at 300 Baud & 1200 Baud
•Hayes Compatible
•Auto Answer, Dial & Redial

Uses RS 232-C Connector
No. 91990

\$165.00

MAGNAVOX Color Monitor



•RGB High Resolution
•14" diagonal
•640 Dots/H-240 lines/ 80 column

No. 97890

\$298.00

Avatex 1200 Modem

•Auto Answer, Dial & Redial
•FCC Approved
•PC TALK III Software included
•Automatic Self Test on Power-Up
COMPARE AT \$199.00

No. 97070

\$87.00

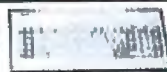

Keyboards

K-134 IBM Type Keyboard Caps and Num Lock FCC approved
No. 51515 **\$76.00**
K150M XT Keyboard—looks like AT, has big return key & LED indicators FCC approved
No. 99020 **\$59.00**

ADD-ON BOARDS FOR IBM® COMPATIBLE SYSTEMS

FCC approved

Monochrome Graphic Printer Board

•Built in Parallel Printer Port •Text: 25 line x 80 column •Graphics: 720x348 resolution •TTL High Resolution Output

No. 99010

\$77.00

Multi I/O Card

•Built-in Floppy Controller that can drive 2 floppy drives •Two RS 232 Serial Adapters •Timer Port •Parallel Printer Port •Joystick Adapter

No. 96770

\$88.00

Multifunction Board

•Expandable to 384K RAM •Serial Port, Game Port •Parallel Printer Port •Clock Calendar w/Battery Backup •Software, Manuals and Cables

No. 9229

\$78.00

RS 232 Serial Board

•1 Serial Port •2nd Port optional

No. 92310

\$27.00

Parallel Printer Card

•Also may be used as I/O Port

No. 92700

\$21.00

Color Graphics Board

•RGB and Composite Port •Light Pen Interface •Graphics: 320x200 (color): 640x200 (BW) •Text: 25x80

No. 92280

\$69.00

Floppy Disk Controller

•Drives 2 internal drives •Includes cable •IBM PC compatible

No. 92260

\$29.00

PLUS A HUGE SELECTION OF CABLES & ACCESSORIES!

IBM, PC, XT are registered trademarks of International Business Machines, Inc.

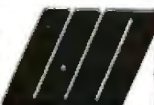

THE WHOLESALE OUTLET

DEPT. BV, 1 INTERSTATE AVENUE, ALBANY, NY 12205. To order call 1-800-344-4367 (Non-NYS Res.) or 518-459-7883 (NYS Res.) Customer pays freight & handling FOB Albany, NY. Non-credit card orders shipped UPS, C.O.D. Minimum order \$25. Dealer and large quantity orders call 518-459-7883. Ask for Computer Dept. Some items not as pictured. Prices subject to change.



directories and log files.

There are chapters on the interactive use and programming of the shells, /bin/sh and /bin/csh. The sample scripts should be read carefully where the command substitution operator ('') is involved. At first glance, these characters appear to be single quote marks ('), but a close examination shows the difference. A different choice of font for the sample code could have removed this ambiguity, because the font used in the text portions clearly shows the difference. Moreover, on page 527, figure 9.L.3 is purported to be a csh script but is actually written in the language of sh (the Bourne shell).

The rest of the book deals with the use of the vi and ex text editors, the C compiler, and the make and ar utilities for creating software tools. Thomas, Rogers, and Yates expound some design philosophies in UNIX programming, which should help you in the creation of error-free programs, but they do not always follow them. The authors, however, always follow the "one exit" philosophy (often associated with structured programming); unfortunately, it's at the expense of readability of the code. Moreover, the authors state that software tools should handle multiple file specifications to encourage the use of the shell's filename expansion metacharacters, but the program for line numbering accepts only one file argument and cannot be made to read the standard input, so it cannot be used as a "filter" in a pipeline. There are chapters covering the use of the standard library functions and system calls, with emphasis on the new System V inter-process communication features. The examples of how to use these will be a boon to System V neophytes and may prove helpful to experienced UNIX programmers also.

While this book contains some very worthwhile information, I don't recommend it as a substitute for the full set of System V documentation. In conjunction with the UNIX documentation, however, it would be very appropriate as a tutorial guide to UNIX programming.

Gary D. Kendall (Creative Computing, 96 Forest St., Danvers, MA 01923) is a consulting systems analyst/programmer who specializes in operating systems.

MIND OVER MACHINE

Reviewed by Stan Czarnik

In *Mind Over Machine*, Hubert and Stuart Dreyfus contend that traditional digital computers can never be programmed to produce genuine artificial intelligence because they cannot replicate intuition. Educators and business people who believe otherwise, they claim, are in for disappointment, if not catastrophe. The argument thus feeds on a mix of pessimistic prognosis and it-ain't-gonna-work-anyway philosophy.

COMMON SENSE AND EXPERTISE

Standard von Neumann computing systems process discrete, finite, isolated units of binary data in sequential

(continued)



The C for Microcomputers

PC-DOS, MS-DOS, CP/M-86, Macintosh, Amiga, Apple II, CP/M-80, Radio Shack, Commodore, XENIX, ROM, and Cross Development systems

MS-DOS, PC-DOS, CP/M-86, XENIX, 8086/80x86 ROM

Manx Aztec C86

"A compiler that has many strengths ... quite valuable for serious work"

Computer Language review, February 1985

Great Code: Manx Aztec C86 generates fast executing compact code. The benchmark results below are from a study conducted by Manx. The Dhrystone benchmark (CACM 10/84 27:10 p1018) measures performance for a systems software instruction mix. The results are without register variables. With register variables, Manx, Microsoft, and Mark Williams run proportionately faster, Lattice and Computer Innovations show no improvement.

	Execution Time	Code Size	Compile/Link Time
Dhrystone Benchmark			
Manx Aztec C86 3.3	34 secs	5,760	93 secs
Microsoft C 3.0	34 secs	7,146	119 secs
Optimized C86 2.20J	53 secs	11,009	172 secs
Mark Williams 2.0	56 secs	12,980	113 secs
Lattice 2.14	89 secs	20,404	117 secs

Great Features: Manx Aztec C86 is bundled with a powerful array of well documented productivity tools, library routines and features.

Optimized C compiler	Symbolic Debugger
AS86 Macro Assembler	LN86 Overlay Linker
80186/80286 Support	Librarian
8087/80287 Sensing Lib	Profiler
Extensive UNIX Library	DOS, Screen, & Graphics Lib
Large Memory Model	Intel Object Option
Z (vi) Source Editor <	CP/M-86 Library <
ROM Support Package <	INTEL HEX Utility <
Library Source Code <	Mixed memory models <
MAKE, DIFF, and GREP <	Source Debugger <
One year of updates <	CP/M-86 Library <

Manx offers two commercial development systems, Aztec C86-c and Aztec C86-d. Items marked < are special features of the Aztec C86-c system.

Aztec C86-c Commercial System	\$499
Aztec C86-d Developer's System	\$299
Aztec C86-p Personal System	\$199
Aztec C86-a Apprentice System	\$49

All systems are upgradable by paying the difference in price plus \$10.

Third Party Software: There are a number of high quality support packages for Manx Aztec C86 for screen management, graphics, database management, and software development.

C-tree \$395	Greenleaf \$185
PHACT \$250	PC-lint \$98
HALO \$250	Amber Windows \$59
PRE-C \$395	Windows for C \$195
WindScreen \$149	FirstTime \$295
SunScreen \$99	C Util Lib \$185
PANEL \$295	Plink-86 \$395

MACINTOSH, AMIGA, XENIX, CP/M-68K, 68k ROM

Manx Aztec C68k

"Library handling is very flexible ... documentation is excellent ... the shell a pleasure to work in ... blows away the competition for pure compile speed ... an excellent effort."

Computer Language review, April 1985

Aztec C68k is the most widely used commercial C compiler for the Macintosh. Its quality, performance, and completeness place Manx Aztec C68k in a position beyond comparison. It is available in several upgradable versions.

Optimized C Macro Assembler	Creates Clickable Applications
Overlay Linker	Mouse Enhanced SHELL
Resource Compiler	Easy Access to Mac Toolbox
Debuggers	UNIX Library Functions
Librarian	Terminal Emulator (Source)
Source Editor	Clear Detailed Documentation
MacRam Disk <	C-Stuff Library
Library Source <	UniTools (vi,make,diff,grep) <
	One Year of Updates <

Items marked < are available only in the Manx Aztec C86-c system. Other features are in both the Aztec C86-d and Aztec C86-c systems.

Aztec C68k-c Commercial System	\$499
Aztec C68k-d Developer's System	\$299
Aztec C68k-p Personal System	\$199
C-tree database (source)	\$399

AMIGA, CP/M-68k, 68k UNIX call

Apple II, Commodore, 65xx, 65C02 ROM

Manx Aztec C65

"The AZTEC C system is one of the finest software packages I have seen"

NIBBLE review, July 1984

A vast amount of business, consumer, and educational software is implemented in Manx Aztec C65. The quality and comprehensiveness of this system is competitive with 16 bit C systems. The system includes a full optimized C compiler, 6502 assembler, linkage editor, UNIX library, screen and graphics libraries, shell, and much more. The Apple II version runs under DOS 3.3, and ProDOS. Cross versions are available.

The Aztec C65-c/128 Commodore system runs under the C128 CP/M environment and generates programs for the C64, C128, and CP/M environments. Call for prices and availability of Apprentice, Personal and Developer versions for the Commodore 64 and 128 machines.

Aztec C65-c ProDOS & DOS 3.3	\$399
Aztec C65-d Apple DOS 3.3	\$199
Aztec C65-p Apple Personal system	\$99
Aztec C65-a for learning C	\$49
Aztec C65-c/128 C64, C128, CP/M	\$399

Distribution of Manx Aztec C

In the USA, Manx Software Systems is the sole and exclusive distributor of Aztec C. Any telephone or mail order sales other than through Manx are unauthorized.

Manx Cross Development Systems

Cross developed programs are edited, compiled, assembled, and linked on one machine (the HOST) and transferred to another machine (the TARGET) for execution. This method is useful where the target machine is slower or more limited than the HOST. Manx cross compilers are used heavily to develop software for business, consumer, scientific, industrial, research, and educational applications.

HOSTS: VAX UNIX (\$3000), PDP-11 UNIX (\$2000), MS-DOS (\$750), CP/M (\$750), MACINTOSH (\$750), CP/M-68k (\$750), XENIX (\$750).

TARGETS: MS-DOS, CP/M-86, Macintosh, CP/M-68k, CP/M-80, TRS-80 3 & 4, Apple II, Commodore C64, 8086/80x86 ROM, 68xxx ROM, 8080/8085/Z80 ROM, 65xx ROM.

The first TARGET is included in the price of the HOST system. Additional TARGETS are \$300 to \$500 (non VAX) or \$1000 (VAX).

Call Manx for information on cross development to the 68000, 65816, Amiga, C128, CP/M-68k, VRTX, and others.

CP/M, Radio Shack, 8080/8085/Z80 ROM

Manx Aztec CII

"I've had a lot of experience with different C compilers. But the Aztec C80 Compiler and Professional Development System is the best I've seen."

80-Micro, December, 1984, John B. Harrell III

Aztec C II-c (CP/M & ROM)	\$349
Aztec C II-d (CP/M)	\$199
C-tree database (source)	\$399
Aztec C80-c (TRS-80 3 & 4)	\$299
Aztec C80-d (TRS-80 3 & 4)	\$199

How To Become an Aztec C User

To become an Aztec C user call 1-800-221-0440 or call 1-800-832-9273 (800-TEC WARE). In NJ or outside the USA call 201-530-7997. Orders can also be telexed to 4995812.

Payment can be by check, COD, American Express, VISA, Master Card, or Net 30 to qualified customers.

Orders can also be mailed to Manx Software Systems, Box 55, Shrewsbury, NJ 07701.

How To Get More Information

To get more information on Manx Aztec C and related products, call 1-800-221-0440, or 201-530-7997, or write to Manx Software Systems.

30 Day Guarantee

Any Manx Aztec C development system can be returned within 30 days for a refund if it fails to meet your needs. The only restrictions are that the original purchase must be directly from Manx, shipped within the USA, and the package must be in resalable condition. Returned items must be received by Manx within 30 days. A small restocking fee may be required.

Discounts

There are special discounts available to professors, students, and consultants. A discount is also available on a "trade in" basis for users of competing systems. Call for information.

Inquiry 175

MANX

To order or for information call:

800-221-0440

HERE'S 118 REASONS AND IS AMERICA'S

1 LOW PRICES. Micro Mart specializes in giving you the best value on all your PC product needs.

2 QUALITY PRODUCTS. We've got a huge selection of national brand name products. Computer systems, printers, peripherals, and more!

3 FULL SERVICE SALES. Our friendly, knowledgeable sales staff will help you

choose the right product at the right price.

4 COMPLETE TECHNICAL SUPPORT. For pre-sale or post-sale advice, give us a call. We're here to help.

5 CUSTOMER SATISFACTION. It's made us famous. Drop in at one of our many store locations or give us a call today.

Shop us today and save on these specials...

6 ProLine XT—A complete system for only \$995!

Here's a system value that can't be beat. Features full PC compatibility. 640K RAM memory. One 360K half height floppy drive. Six expansion slots. Monochrome graphics card and monitor. Printer and communications ports. Clock/calendar. Game port. MS DOS with GW BASIC. Enhanced IBM-style keyboard. UL and FCC approved. Full 1 year parts exclusive warranty.



All systems built and tested! Call for custom configurations!

FREE!

With the purchase of our ProLine XT

This complete accessory pack: 10 pk. DS/DD Maxell Diskettes. SRW Media Storage Case. Six-outlet Curtis power strip with surge protection. Texwipe PC careware kit with anti-static solution and CRT cleaning fluid and wipes. Perfect Data 5¼" drive head cleaning kit. ProLine XT dust cover. Total Retail Value—\$89.95!

7 ProLine AT—Powerful AT performance for only \$2,289!

All the speed and power you need. Features full PC compatibility. 512K RAM memory. One 360K floppy drive. Eight expansion slots. Monochrome graphics card and monitor. Printer port. Clock/calendar. MS DOS.



UL and FCC approved. 90 day exclusive warranty.

All systems built and tested! Call for custom configurations!

FREE!

With the purchase of our American AT

This complete accessory pack: 10 pk. tpi quad density Maxell Diskettes. SRW Media Storage Case. Six-outlet Curtis power strip with surge protection. Texwipe PC careware kit with anti-static solution and CRT cleaning fluid and wipes. Perfect Data 5¼" drive head cleaning kit. American XT dust cover. Total Retail Value—\$99.95!

MORE WHY MICRO MART PC SPECIALIST!

MULTIFUNCTION BOARDS

We have a complete line of Multifunction Boards compatible with the PC, XT & AT and all compatibles.

- 8. SIX PAK 64-384K, multifunction, fully loaded w/384K \$239
- 9. AST I/O MINI I/O shortboard for Portable & AT **New Low Price!**
- 10. ADVANTAGE 128K-3Mb, expansion for AT
- 11. RAMPAGE 64K-2Mb with Deskview **NEW!**
- 12. QUADRAM QUADBOARD loaded, 384K **CALL!**
- 13. QUADRAM GOLDBOARD, 384K \$459
- 14. TECMAR MEGAFUNCTION, 1 Meg of nonvolatile memory \$369
- 15. TALLTREE J-RAM III **CALL!**
- 16. INTEL ABOVE BOARD, PC & AT **From \$280**
- 17. THESYS FASTCARD up to 1 MB **From \$235**

GRAPHICS CARDS

- 18. HERCULES Mono & Color Graphics cards **New Low Price!**
- 19. TECMAR Graphics Master, HiRes Color & Mono supports Lotus \$449
- 20. QUADRAM Quadcolor I & II color cards \$389
- 21. QUADRAM EGA, Includes 256K memory \$389
- 22. STB EGA + Mono & Graphics cards also available **CALL!**
- 23. Generic monographic cards **From \$99**
- 24. SIGMA Color 400 for PC5 SR-12 **New Low Price!**

FLOPPY DISK DRIVES

- 25. 1/2 HEIGHT Disk Drives from Panasonic, Mitsubishi, & Teac; 360K &
- 26. 1.2 MEG Floppy drives for the PC, XT, AT and Compatibles **From \$99**

HARD DISCS

- 27. IRWIN Tape Back-up systems **Call!**
- 28. SYSGEN Complete line **Call for our special Sysgen pricing!**
- 29. BERNOULLI TECHNOLOGY Hard disc Subsystems (20 & 40 MB) **From \$2875**
- 30. SEAGATE Fast 10, 20, 30 Meg. for PC & AT **Call!**
- 31. PRIMA Superfast 40 & 60 Meg. for AT **CALL!**
- 32. TALLGRASS 25, Through 80 Meg. Hard drive systems, including 60 Meg. tape back-up
- 33. WESTERN DIGITAL 10 & 20 MB File cards **CALL!**
- 34. Best availability of voice coil and stepper motor hard drives with highest quality controllers **From \$495**

SOFTWARE

ACCOUNTING

- 35. SORCIMI/US Complete line including windows **From \$295/each**

SPREADSHEETS & INTEGRATED PACKAGES

- 36. SORCIMI SuperCALC 3, Vers. 2.0 **New Low Price!**

ENHANCEMENTS & UTILITIES

- 37. NORTON Utilities 3.0 \$69
- 38. ROSESOF ProKey 3.0 \$89
- 39. CENTRAL POINT SOFTWARE Copy II PC \$35
- 40. SOFTSTYLE Set FX+ and Printworks, printer control \$51
- 41. SIDEWAYS Inverts printout \$51
- 42. BORLAND SideKick and SuperKey **From \$40**
- 43. BORLAND Lightning and Reflex **NEW! CALL!**

COMPILERS & LANGUAGE TOOLS

- 44. LATTICE C-Compilers \$279
- 45. MICROSOFT Complete line **New Low Price!**
- 46. MICROSOFT Quick-Basic
- 47. BORLAND Turbo Pascale, Turbo Toolbox, & more **From \$35/each**

GRAPHICS

- 48. Z-SOFT PC Paintbrush, mouse graphics \$95
- 49. DECISION RESOURCES Diagram Master **From \$199**
- 50. MICROSOFT Chart **CALL!**
- 51. MICROSOFT Windows **CALL!**

COMMUNICATIONS

- 52. MICROSTUF Crosstalk XVI, Latest version \$105
- 53. HAYES Smartcom II \$85
- 54. MICROSOFT Access **CALL!**

WORD PROCESSING

- 55. MULTIMATE Advantage \$294
- 56. MICROSOFT Word, new version **New Low Price!**
- 57. LIFETREE Volkswriter Deluxe, ver 3.0 \$169
- 58. SSI WordPerfect, version 4.1 **New Low Price, CALL!**
- 59. MICROPRO Wordstar Professional series **New Low Price!**
- 60. LEADING EDGE Nutshell \$59
- 61. LEADING EDGE Word Processor \$59

OFFICE & PLANNING

- 62. HARVARD Total Project Manager \$339
- 63. SORCIMI/US Super Project \$209
- 64. MICROSOFT Project, vers. 2.0 \$269

DATA BASE MANAGERS

- 65. Call For Unadvertised Data Base Managers
- 66. MICRORIM 5000, Report Writer & Clout **New Low Price!**
- 67. MICROSTUF Infoscope \$99
- 68. D BASE III plus **CALL!**

NETWORKING PROTOCOL CONVERSION

- 69. SNA & BISYNC 3780, 5251, Mod 11 & 12, 3274, 3278
- 70. PC TURBO 186/187 board, 128K, 8087 Serial Board attached \$875
- 71. IRMA Complete line **From \$849**

PRINTERS

DOT MATRIX

- 72. EPSON FX85/286 **NEW!**
- 73. EPSON LQ800/LQ1000 **NEW PRICES!**
- 74. OKIDATA 192, 193, 292, 293, Pacemark 2410
- 75. TOSHIBA P-341, P-351, & NEW 321 **New Low Price!**
- 76. NEC New P-5, P-6, & P-7 **Low Price!**

LETTER QUALITY

- 77. NEC Spinwriters 2050, 3550, 8850 **New Low Prices!**
- 78. EPSON DX20 & DX35 **NEW PRICE!**

QUALITY PRINTERS

We carry a full range of form handling options.

CHIPS

- All our chips are tested and priced for quick sale. Call us!
- 79. INTEL 8087, 80287, math coprocessors **Call for Market Price.**
- 80. 64K-256K RAMCHIPS **Call for Market Price.**
- 81. 128K Piggy-back chips for your AT **Call for Market Price.**

MODEMS

- 82. HAYES Smartmodem 300, 1200, 1200B & 2400. We have the best stock in the U.S.A. **CALL!**
- 83. VEN-TEL 1200 Baud Half Card w/Crosstalk \$399
- 84. PEACHTREE TECHNOLOGIES P-1200 (Hayes compatible external) \$249

MONITORS & CRTS

- 85. PG5 Max 12(E), HX12, HX12(E), & SR-12 **New Low Prices!**
- 86. AMDEK Color 600 **CALL!**
- 87. AMDEK 722, New alternative to IBM enhanced monitor \$569
- 88. AMDEK 310 A **CALL!**
- 89. MAGNAVOX Monochrome monitors \$129
- 90. SONY, monitors in stock **CALL!**

MISCELLANEOUS

- 91. MOUSE SYSTEMS PC Mouse, optical w/software \$139
- 92. MICROSOFT Mouse, bus or serial mechanical **New model in stock!**
- 93. KEYTRONICS 5151 Keyboards **CALL!**
- 94. KEYTRONICS 5153 Keyboard w/mouse **NEW!**
- 95. GRAYIS Joysticks \$45
- 96. QUADRAM Microfazer print buffer 8-128K **From \$129**

DISKETTES

Following items available only in sets of 100 each brand.

- 97. Precision Diskettes by Xidex, SS/DD \$.65/ea.
- 98. Precision Diskettes by Xidex, DS/DD \$.69/ea.
- 99. Maxell SS/DD MD1 \$.99/ea.
- 100. Maxell DS/DD MD2 \$1.25/ea.
- 101. Maxell High Density MD2 \$2.60/ea.
- 102. Maxell 3 1/2 inch SS/DD MF1 \$1.60/ea.
- 103. Maxell 3 1/2 inch DS/DD MF2 \$2.35/ea.
- 104. Fuji SS/DD MD1 \$.89/ea.
- 105. Fuji DS/DD MD2 \$1.15/ea.

MEDIA STORAGE

- 106. Flip N File Original, stores fifty 5 1/4" diskettes with free twin pack of Fuji diskettes (\$25 retail value) Now 1/2 price \$12.50
- 107. Flip N File, stores 25 5 1/4" diskettes with lock \$12.99
- 108. Flip N File, stores 50 5 1/4" diskettes with lock \$19.99
- 109. Innovative Concepts Data Case \$ 9.99
- 110. Microdex by S.R.W., stores 25 3 1/2" diskettes \$ 9.99
- 111. Microdex by S.R.W., stores 60 5 1/4" diskettes \$11.99

SURGE PROTECTORS

- 112. Curtis 6 outlet power strip with surge protection \$19.99
- 113. Curtis Diamond \$31.99
- 114. Curtis Emerald \$37.99
- 115. Curtis Sapphire \$49.99
- 116. Curtis Ruby \$56.99
- 117. Network Wire Tree, 4 outlet surge and spike protector \$44.99
- 118. Network Wire Tree Plus, 6 outlet surge, spike, and modem protector \$64.99

(404) 449-8089 *Orders Only* 1-800-241-8149



America's PC Specialist

© Copyright 1986, Micro Mart, Inc. Technology Corporate Campus 3159 Campus Drive, Norcross, GA 30071
Prices are subject to change without notice and are similar, but may vary at Micro Mart Retail Stores.

ACCESS TO FULL MEMORY, STRUCTURE, COMPATIBILITY WITH GW- & PC-BASICA, AND WITH THE POWER AND FLEXIBILITY OF C OR PASCAL

BetterBASIC runs existing GW-BASIC/PC-BASICA programs on IBM PCs and true clones yet gives you structure and access to full memory. BetterBASIC has more than 150 statements in addition to the standard Microsoft syntax. There is optional 8087/80287 math chip support. The Runtime System creates stand-alone EXE. files. Call us or ask your local dealer for...

Better
BASIC™

1-800-225-5800

In Canada, call 416-469-5244

Summit Software Technology, Inc.™
106 Access Rd. Norwood, MA 02062

BetterBASIC is a registered trademark of Summit Software Technology, Inc. IBM PC is a registered trademark of International Business Machines Corp. Microsoft is a registered trademark of Microsoft Corp.

fashion. On/off, yes/no, true/false—any kind of digital symbolic representation can be processed in a conventional computer with swift and sure logical precision. *Mind Over Machine* is an elaboration of the idea that while human understanding avails itself of the power of logical reasoning, logical reasoning fails to account completely and consistently for how people actually think.

For example, consider everyday visual identification. Recognizing the face of a friend in a crowd instantaneously seems to require no conscious analysis of the presence or absence of individual physical facts or traits. Spotting someone you know is, apparently, just that. Recognition does not follow neatly logical chains of reasoning, at least none that we know of. According to the authors, this involves no little packages of binary information, no computerlike processing at all. What occurs, in fact, is an intuitive leap from one holistic state of being out in the real world to an equally holistic counterpart stored as an image in the mind and formed from past experience. Traditional computational techniques cannot easily simulate this kind of mental picture matching. If the limits of logic are the limits of AI, then conventional AI is in for a long hard climb. The formal representation of knowledge that resists formalization is a complicated and difficult task.

Professional expertise is another example. The authors explain why the mechanization of human expertise with conventional AI technology is neither possible nor desirable. Imagine a seasoned driving instructor with a new student. The rules of the road are systematically described and explained: Don't speed, don't pass on the right, don't go through red lights, and so on. Now imagine the same instructor rushing an injured child to the hospital: He passes on the right, goes through all the red lights, speeds like crazy, and gets the car to the emergency room without a scratch.

So how does he do it? The Dreyfuses would say that our anxious expert driver who knows all the rules is not following any rules. He's just driving, with most of his behavior guided not by reference to a calculated collection of factual material on automobiles and traffic laws, but by intuition. And so it is with all human experts, from chess masters to virtuoso jazz pianists. There is, the authors claim, a qualitative difference between the rule-following behavior of any novice, like someone learning to use a typewriter, and how any true expert implements his or her expertise. Consider an experienced touch-typist zipping along at 60 words per minute while thinking about something entirely different.

MICROPROCESSING THE MIND

The final chapters of the book focus on the social and psychological ramifications of computerized expertise. The automation of education receives first priority: The authors sense a serious danger here. If this trend is permitted to continue in our schools, we can look forward to a twenty-first-century population of maladjusted logic choppers. To whatever extent digital computers are allowed to replace human teachers, the chances of students going beyond

(continued)

Programming Ease for Scientific & Engineering Applications

No matter what your programming language; FORTRAN, BASIC or C, Wiley Professional Software's technical programming tools enable you to save programming time and development costs. These tools allow you to generate dependable, accurate and error-free code, quickly and easily.

New! A Brand New Subroutine Library:

The 50 More: FORTRAN Library, developed by Peerless Engineering Service, offers you a collection of subroutines and utilities previously unavailable in our first FORTRAN Library; most are provided in single and double precision versions. This second

volume provides pre tested and precompiled subroutines covering such areas as: Matrices, Polynomials, Differential Equations, and Numerical Analysis (including FFT's) plus utilities for more effective screen handling. SOURCE CODE INCLUDED.

MICROSOFT FORTRAN or Professional FORTRAN version **\$125**

New! LabSoft,™ A Powerful Programming Tool For IBM Data Acquisition and Control Adapter Users.

LabSoft, developed by Cyborg® Corporation, provides over 40 programming tools for developing data acquisition and control programs on the IBM® PC. If you need to customize your data acquisition & control programs, then LabSoft can provide you with more power and flexibility than IBM Pro-

gramming Support software at a very affordable price. Choose from 3 versions: FORTRAN, BASIC or a C Language supplement.

MICROSOFT FORTRAN version **\$350**

BASIC version **\$350**

C Language supplement **\$75**

Subroutine Library For BASIC, FORTRAN, & C Programmers:

This Library, also developed by Peerless, provides 114 (C Library 112) pre-tested and pre-compiled mathematical and statistical subroutines covering such areas as: Analysis of Variance, Regressions, and Time Series Analysis. The Library is supplied

on disk as a linkable library and as source code. Extensive documentation and reference material make using these subroutines fast, dependable and error-free. SOURCE CODE INCLUDED.

MICROSOFT FORTRAN Library **\$175**

C Language Library **\$175**

BASICA Library **\$125**

IBM Professional FORTRAN Library **\$175**

To order any of Wiley's scientific and engineering programming tools, call: **212-850-6788**

Or write:



Wiley Professional Software
John Wiley & Sons, Inc.
Attn: Leslie Bixel
605 Third Avenue
New York, NY 10158
Dealer Inquiries Invited

wiley
PROFESSIONAL
SOFTWARE

THE TECHNICAL SOFTWARE SOURCE.

ACTOR debut in two months.

There's a better way to program coming in October.

It's like an advanced research system. Instead of data structures and procedures, it uses active objects. But it produces finished, useful programs. Not experiments.

It's easy to optimize, and it has a new way to reclaim unused memory. As a result, it runs so fast on microcomputers, it's good even for real-time control.

And it's built around Microsoft[®] Windows, which help when you write your programs. And when other people use them.

It's called ACTOR,[™] and it will perform like nothing you've ever seen. To find out more about it, just call.

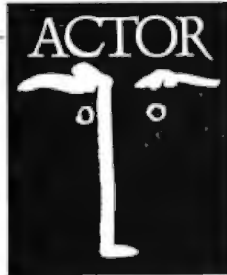

The Whitewater Group[®]

906 University Place, Evanston, IL 60201
(312) 491-2370

the mechanical rule-following phase of instruction and on to genuine mastery and expertise may deteriorate. Logic in, logic out, and nothing more: "Thinking like a computer will retard passage to the higher levels of proficiency and expertise." The problem of Why Johnny Can't Read may become Why Johnny Has No Expert Intuition. But how many concrete cases of computer retardation are the Dreyfuses able to cite? Not one.

They argue that veteran business professionals do not typically reason their way through predicaments in any purely detached, objective, structured manner. The decision-making process is driven not by logic but by a close "intuitive understanding" of the problem at hand. Since computerized expertise can be neither involved nor intuitive, it follows that automated decision support systems may not improve but may actually "degrade performance" and encourage "regressive thinking." Yet here again, how many real degraded performances and regressive meditations can the authors find? None.

INTO THE FUTURE

Intuitive forms of judgment and comprehension do exist. But the question remains, What is intuition and how does it work? With the exception of a few pages, the authors tend to avoid the issue. The closest they come amounts to saying that since human thinking seems often to involve holistic visual imagery, then perhaps the mind is like a holographic pattern recognizer. Without rules, features, or descriptions, we sense similarity by matching mental pictures. This accounts for the instantaneousness of so much intuitive thought. *Mind Over Machine* makes it plain that experimentation is only beginning to shed light on how a holographic mind might operate.

The Dreyfuses are careful to leave the back door open for massive parallel networks and the "connectionist" approach to computer architecture. The basic point: Computational models that permit many things to happen at once in a dynamic weblike configuration in which relations among elements are changing seem much closer to how the brain functions than traditional von Neumann designs.

It is of the utmost importance to note that *Mind Over Machine* is not about "what computers can't do." Not quite. It's mostly about what *conventional* computers can't do and a well-worded reflection on the problems AI researchers have been talking about for a long time. Hubert and Stuart Dreyfus successfully patch together a "sad history of artificial intelligence." However, the authors cannot extend their skepticism into the future. To articulate the limitations of traditional AI may serve to accelerate development in heretofore exotic technical areas.

The authors believe that current AI has been brought to a standstill, but their book itself contains evidence that the interlude may be coming to an end. *Mind Over Machine* is a crucially important book, and no one interested in the destiny of artificial intelligence, or our technological way of life in general, can afford to miss it.

Stan Czarnik is a teacher, musician, and technical writer. He can be reached at 2716 West Evergreen Ave., Chicago, IL 60622. ■

New Quark[®]/PC Single Board Computer



Base model 5.75" x 8"

Only \$495.

Quantity discounts available

- IBM PC[®] compatible single board computer mounts to 5 1/4" drive
- Includes Floppy Disk & Color Graphics CRT Controllers plus more

Also includes: Legal BIOS • Boots PC DOS[®] 2.1 • Printer Port • 2 Serial Ports • 256K RAM • Clock Speed at 4.77 MHz • Alphanumeric and Graphics Modes for Color Video Controller • Standard IBM[®] Keyboard Port.

Options include: 512K RAM • Piggyback I/O channel OEM Expansion Board • XT-Compatible Hard Disk SCSI Interface • Real Time Clock with battery-back-up • Clock speed of 9.5 MHz (twice as fast as a PC)

The Megatec Quark/PC is for OEM and end user applications that require PC compatibility in a compact single board computer. The Quark/PC BIOS will run most IBM PC[®] software including Flight Simulator and Lotus[®]. To meet your specifications a set of options let you add memory, speed and an XT-compatible hard disk interface. Not only does it quickly mount to a 5 1/4" drive, it also comes with floppy disk and CRT color graphics controllers — all for just \$495.

To order or enquire call us today. Dealer enquiries welcome. Megatec Computer Technologies (416) 745-7214 150 Turbine Drive Weston, Ontario M9L 2S2
Telex: 065-27453 U.S. Address: 1051 Clinton St. Buffalo, N.Y. 14206 Distributors: NCS Electronics Varese, Italy • SES Electronics Nordlingen, Germany • Perdux Microtronics Biggin Hill, U.K. • Microcomputing Ghent, Belgium • Asp Microcomputers Melbourne, Australia.

Quark is a registered trademark of F. and K. MFG. CO. LTD. IBM, IBM PC and PC DOS are registered trademarks of International Business Machines Corp. Lotus is a registered trademark of Lotus Development Corp. MS-DOS is a registered trademark of Microsoft Corp.

megatec



**GET THIS FOR
\$99.⁹⁵ . . .**

**. . . AND GET RID OF
THIS IN 3 MINUTES**

UNLIMITED MULTI-COMPANY ACCOUNTING PACKAGE

- Standard charts of accounts provided - easily modified.
- Help screens on line to assist you at all data entry levels.
- File capacities limited only by disk space - dynamic allocation of file sizes.
- Fully menu driven - totally integrated to General Ledger.
- No complicated Balance Sheet/Income Statement setup required. System operable after corporation details entered. (± 3 minutes)
- Incredibly easy to use - no expertise, either computing or accounting, required.
- All financial accounts prepared from source documents - no need to duplicate accounting work.

GENERAL LEDGER

Variable report format on all financial statements.

Department & sub-accounts unlimited (financial reports on a department or consolidated available on demand.)

All transactions have automatic audit trails.

Monthly budgeting/variances and 3 years history.

Cash book included.

ACCOUNTS RECEIVABLE

Open item or balance forward - automatic or manual cash payment aging.

Large variety of reports - all variable

as per your needs, on demand (Aging lists, etc.)

Automatic generation of arrear interest on overdue accounts.

ACCOUNTS PAYABLE

Cash requirements report on demand.

Unlimited General Ledger allocations per invoice.

Large variety of reports - all variable as per your needs - on demand.

INVENTORY CONTROL

2 years on line trend history - updated automatically by the system.

Detailed stock movement reporting by product.

Supports Standard & Average costing methods.

BILLING

Automatic updating of all files at time of invoice production.

Allows invoicing of inventory items not usually held (eg. - buyouts).

Supports 3 price breaks & 5 warehouses.

Please note that this is a very short summary of some of the features of the Foundation Series Accounting suite. Space prohibits us listing them all.

SEND THIS COUPON C.O.D. OR WITH YOUR CREDIT CARD INFORMATION. MONEY ORDER OR CHECK FOR \$99.95 PLUS \$5.00 POSTAGE AND HANDLING TO:

**the
FOUNDATION
SERIES**

KALGAN SOFTWARE INC.
17975 SKYPARK CIRCLE, SUITE D, IRVINE, CA 92714
TELE (714) 770-7660

PLEASE SEND ME _____ COPIES
OF THE FOUNDATION SERIES ACCOUNTING PACKAGE

..... COD MONEY ORDER

CHECK CREDIT CARD

(Type Expires Account No)

NAME

COMPANY NAME

ADDRESS

.....

CODE

PHONE

SIGNATURE

30 DAY MONEY BACK GUARANTEE

SYSTEM REQUIREMENTS: IBM (PC, JR., PC, XT, AT) OR COMPATIBLES

256K RAM 80 OR 32 COL. PRINTER

E·V·E·N·T Q·U·E·U·E

August 1986

BUYING AND SELLING RIGHTS TO HARDWARE, SOFTWARE, AND SERVICES, various sites throughout the U.S. Data-Tech Institute, Lakeview Plaza, P.O. Box 2429, Clifton, NJ 07015, (201) 478-5400. *August*

UNDERSTANDING DATA COMMUNICATIONS—A PRACTICAL GUIDE, various sites throughout the U.S. Data-Tech Institute, Lakeview Plaza, P.O. Box 2429, Clifton, NJ 07015, (201) 478-5400. *August*

APPLYING MACHINE VISION TO YOUR MANUFACTURING PROCESS: A HANDS-ON WORKSHOP, Cambridge, MA, and Minneapolis, MN. Joanne Rogers, Society of Manufacturing Engineers, One SME Dr., P.O. Box 930, Dearborn, MI 48121, (313) 271-0039. *August-September*

DATA COMMUNICATIONS: NETWORKING, PROTOCOLS, AND COMPATIBILITY; LOCAL NETWORKS; TELECOMMUNICATIONS; and related courses, various sites throughout the U.S. Datapro Research Corp., Educational Services, 1805 Underwood Blvd., Delran, NJ 08075, (800) 328-2776. *August-October*

WRITING PROCEDURES, POLICIES, AND DOCUMENTATION, Boston, MA. Mary Ann Cluggish, Information Mapping Inc., 275 Wyman St., Waltham, MA 02154, (617) 890-7003. *August 4-8*

1986 NATIONAL PROFESSIONAL ELECTRONICS CONVENTION, Tropicana Hotel, Las Vegas, NV. NPEC '86, 2708 West Berry St., Fort

Worth, TX 76109, (817) 921-9061. *August 4-9*

INTERNATIONAL CONFERENCE ON COURSEWARE DESIGN AND EVALUATION (ICCDE), Tel Aviv, Israel. Benjamin Feinstein, ICCDE Organizing Committee, Israel Association for Computers in Education, P.O. Box 13009, Hakiryia Romema, Jerusalem 91130, Israel, telephone: 521930; telex: 361931 HUAGR IL, ATTN FEINSTEIN. *August 8-13*

24TH ANNUAL CONFERENCE OF THE URBAN AND REGIONAL INFORMATION SYSTEMS ASSOCIATION: WHAT'S THE DIFFERENCE? Marriott Hotel, Denver, CO. URISA, 319 C St. SE, Washington, DC 20003, (202) 543-7141. *August 9-14*

ADVANCED RECORDS MANAGEMENT, Washington, DC. Darold Aldridge, Continuing Engineering Education, The George Washington University, Washington, DC 20052, (800) 424-9773; in DC, (202) 676-6106; in Canada, (800) 535-4567. *August 11-12*

DESIGN AND MANAGEMENT FOR EFFICIENT SOFTWARE DEVELOPMENT, Milwaukee, WI. John T. Snedeker, Center for Continuing Engineering Education, University of Wisconsin-Milwaukee, 929 North Sixth St., Milwaukee, WI 53203, (414) 224-4193. *August 11-15*

NATIONAL CONFERENCE OF THE AMERICAN ASSOCIATION

FOR ARTIFICIAL INTELLIGENCE, University of Pennsylvania, Philadelphia, PA. AAAI-86, AAAI, 445 Burgess Dr., Menlo Park, CA 94025-3496, (415) 321-1118 or 321-3123. *August 11-15*

THIRD INTERNATIONAL ROBOTIC SYSTEMS EDUCATION AND TRAINING CONFERENCE, and MACHINE VISION FOR EDUCATORS: A HANDS-ON CLINIC, Plymouth, MI. Mary Dombrowski, SME Special Programs Division, Society of Manufacturing Engineers, One SME Dr., P.O. Box 930, Dearborn, MI 48121, (313) 271-1500, ext. 392. *August 11-15*

MACWORLD EXPO, Bayside Exposition Center, Boston, MA. Mitch Hall Associates, P.O. Box 155, Westwood, MA 02090, (617) 329-7466. *August 14-16*

FOURTH ANNUAL HAM & CHIP FLEA MARKET, La Salle University parking lot, Philadelphia, PA. Philadelphia Area Computer Society, 20th and Olney Ave., Philadelphia, PA 19141, (215) 951-1225. *August 16*

SIXTH ANNUAL NOTRE DAME SHORT COURSE SERIES: COMPUTERS IN BIOLOGY, Notre Dame, IN. Ronald A. Hellenenthal, Biocomputing Short Courses Coordinator, Department of Biological Sciences, University of Notre Dame, Notre Dame, IN 46556, (219) 239-7255. *August 17-22*

EFFECTIVE ANALYSIS AND DESIGN OF INFORMATION SYSTEMS, Worcester, MA. Kathy Shaw, Office of Continuing Education, Worcester Polytechnic Institute, Higgins House, Worcester, MA 01609, (617) 793-5517. *August 18-20*

ACM SIGGRAPH 86: 13TH ANNUAL CONFERENCE ON COMPUTER GRAPHICS AND INTERACTIVE TECHNIQUES, Dallas Convention Center, Dallas, TX. Conference Management, Smith, Bucklin and Associates Inc., 111 East Wacker Dr., Chicago, IL 60601, (312) 644-6610. *August 18-22*

INTRODUCTION TO TELECOMMUNICATIONS, Cambridge, MA. Charlotte Scannell, Lesley College Graduate School, Division of Education and Special Education, 29 Everett St., Cambridge, MA 02238-9990, (617) 868-9600. *August 18-22*

COMPUTERFEST '86, Dayton, OH. Computerfest '86, Dayton Microcomputer Association, 143 Schloss Lane, Dayton, OH 45418-2931, (513) 268-7225. *August 23-24*

TIDEWATER VIRGINIA 11TH ANNUAL COMPUTER FAIR—RADIO AMATEUR HAMFEST, Pavilion, Virginia Beach, VA. Manny Steiner, 3512 Olympia Lane, Virginia Beach, VA 23452, (804) 340-6105. *August 23-24*

RED ROSE FOURTH ANNUAL COMPUTERFEST, Guernsey Sales Pavilion, Lancaster, PA. Computerfest Committee, P.O. Box 5029, Lancaster, PA 17601. *August 31* ■

IF YOU WANT your organization's public activities listed in BYTE's Event Queue, we need to know about them at least four months in advance. Send information about computer conferences, seminars, workshops, and courses to BYTE, Event Queue, One Phoenix Mill Lane, Peterborough, NH 03458.

Pick a card and get \$50.00

Putting your money on a Hercules™ Graphics Card or a Hercules Color Card has always been a safe bet.

After all, Hercules is the industry standard in high resolution graphics hardware. And we back each of our cards with a full two-year warranty.

Which explains why we've already sold more than 500,000 cards to owners of IBM® PCs, XTs, ATs and many compatibles.

But there are still some people out there who have yet to buy a Hercules card.

So we're sweetening the pot.

Between now and August 31, when you buy a Hercules Graphics Card or a Hercules Color Card,



we'll send you a check for \$50.00. See your local Hercules dealer. When you've made your best deal, ask him for one of our rebate applications and send it in with your Purchaser Registration Card and dated sales receipt.

We'll pay off in short order. Your Hercules card, on the other hand, will pay off for a lot longer than that.

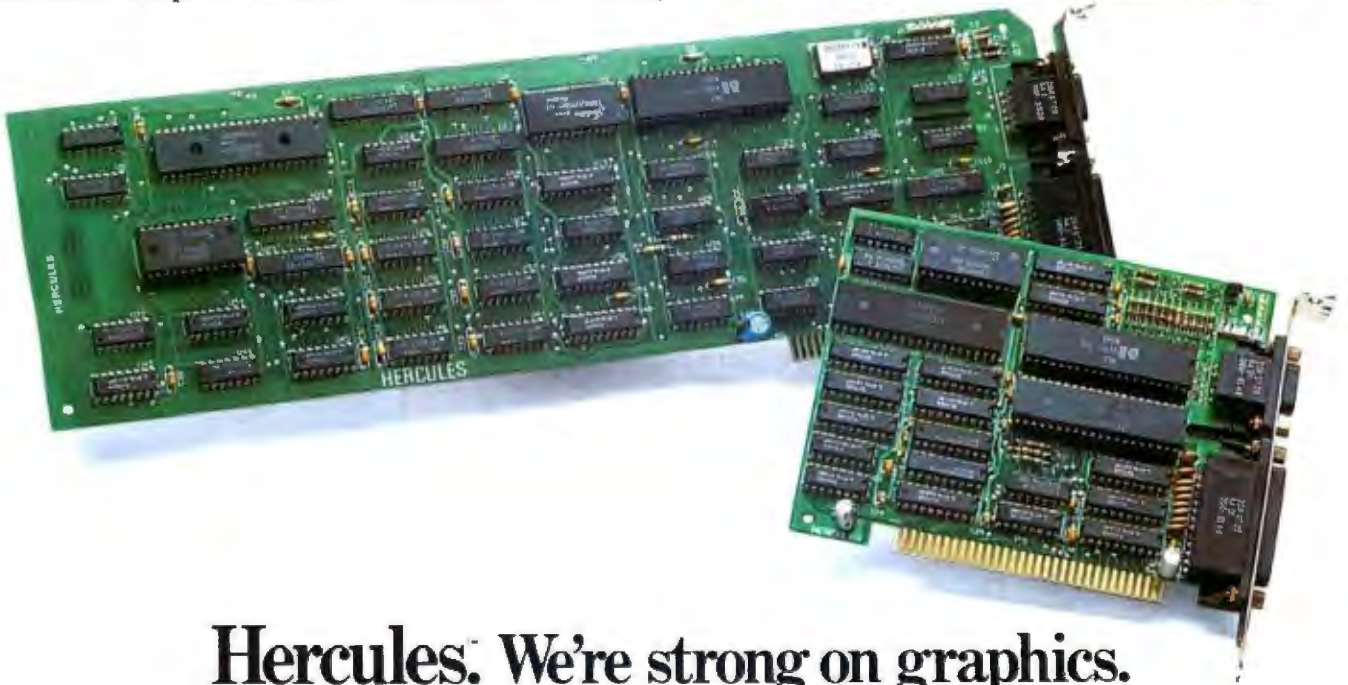

Hercules. We're strong on graphics.

Trademarks/Owners: Hercules/Hercules Computer Technology; IBM/IBM. Offer valid in the United States, U.S. Territories and Canada from May 1 through August 31, 1986. Rebate application, accompanied by Purchaser Registration Card and dated sales receipt must be sent to Hercules Rebate Offer, PROMARK Depot, P.O. Box 3947, Milford, CT 06461-0397 no later than September 15, 1986. Applications received after that date will not be honored. Rebate will be paid in the same currency in which the card was purchased. Offer void where prohibited, taxed or restricted. Dealers are not eligible to claim rebate. Offer limited to one rebate per product serial number and original Purchaser Registration Card. Each rebate must be applied for on an individual basis. Other application constitutes fraud. Rebate offer applies to Hercules Graphics Card (model GB102) and Hercules Color Card (model GB200). Other Hercules products are not eligible. Allow 6-8 weeks for redemption. For additional information in the United States call (800) 532-0600 ext. 708. In Canada call (800) 323-0601 ext. 708.

Simply put: THE™ highest quality and best value in computer products anywhere.

THE™ commitment to our customers is compatibility, quality, value, service and support

THE™ backs every product with a 45 DAY MONEY BACK GUARANTEE

and a FULL 1 YEAR PARTS AND LABOR WARRANTY

THE™ MULTI 384

This multi-function card features 0-384K memory, a parallel printer port, a serial port for communications, a clock/calendar with battery backup, and a software bonus that includes RAMdisk and other utilities. Retail Price \$90.00

\$72.00*
Special Wholesale Price



BEST BUY
Functional Clone of AST SixPackPlus

THE™ COLOR CARD

100% compatible with the IBM™ colorcard with display modes of 80x25 alphanumeric and 320x200 graphic. Retail Price \$75.00

\$60.00*
Special Wholesale Price

THE™ 576K MEMORY +

Supports 0-576K of available memory and is compatible with all IBM™ PC's. Retail \$46.25

\$37.00*
Special Wholesale Price

THE™ PRINTERFACE

Supports all text and graphics features and is fully compatible with third party software. Retail Price \$23.13

\$18.50*
Special Wholesale Price

THE™ MODEMS

100% Hayes compatible

THE™ 1200 COM EXTERNAL

This self-testing 1200 BPS modem comes with auto answer, auto dial, auto redial and a built-in speaker. Retail Price \$161.25*

\$129.00*
Special Wholesale Price



THE™ 1200 COM INTERNAL

Features auto answer, dial and redial, with a built-in speaker, RS 232-C serial port and PC Talk III. Retail Price \$148.75

\$119.00*
Special Wholesale Price

THE™ 2400 COM EXTERNAL

Eight times the speed of a 300 BPS unit makes this 2400 Baud modem truly affordable, and we've made it truly compatible. With auto answer, auto dial, auto redial, and a built-in speaker with volume control. Retail Price \$346.25

\$277.00*
Special Wholesale Price

THE™ H720 MONO

This monochrome graphics card with printer port features 100% IBM™ and Hercules™ compatibility, at a fraction of their prices. Retail Price \$91.25

\$73.00*
Special Wholesale Price



BEST BUY
Functional Clone of Hercules Graphics Card

A \$120.00 VALUE!

ADAM OSBORN'S PAPERBACK SOFTWARE

- Paperback Writer
- Paperback Speller
- Numberworks Spreadsheet

PC + STARTER KIT

\$32.00*

With the purchase of a PC +

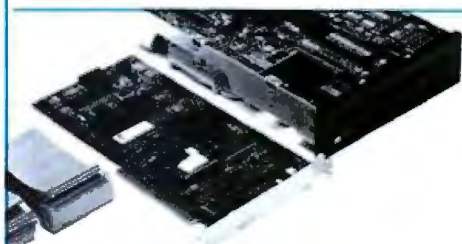

THE™ 20MB HARD DISK

Featuring a half-height IBM™ PC compatible internal 20MB disk drive, controller card, connecting cables and installation manual. Retail \$458.75

\$367.00*
Special Wholesale Price

THE™ MULTI I/O

Feature for feature, THE™ matches the AST™ I/O + and comes up a winner, with serial/parallel and game ports standard, (a second serial port optional), a clock/calendar, RAMdisk and print spooler. Retail Price \$75.00

\$60.00*
Special Wholesale Price



BEST BUY
Functional Clone of AST™ I/O +

THE™ EGA PLUS

With 256K standard this 100% IBM™ EGA and Hercules Graphics compatible card is ideal for high resolution graphics display of Microsoft™ Windows, Lotus™ and AutoCAD™. Retail Price \$283.75*

\$227.00*
Special Wholesale Price

*All Items Subject to Availability - Prices Subject to Change
TM - Registered Trademarks of IBM Ast Research
Microsoft Hercules Hayes

Thompson, Harriman and Edwards Computer

THE™

Thompson, Harriman and Edwards
Computer Products Company Ltd.

THE™ PC+ COMPUTER

THE™ PC+ is compatible with all business, professional and personal software written for the IBM™ PC. It will also enhance your productivity with its ability to switch to an 8 megahertz clock rate, enabling you to run your software twice as fast as the IBM™ PC. THE™ PC+ also comes standard with an "AT" style keyboard, correcting the inefficiencies found by IBM™ on their regular PC keyboard. 256K standard (640K optional) on the mother board will allow you to run memory intensive programs such as Lotus 1-2-3, DBase III and Framework without adding extra memory cards. Plenty of power, with a 135 Watt source and lots of room for expansion

with 8 card slots is also standard. Base unit includes: 256K RAM, Computer with One 360K 5¼" Floppy Drive, Dual Turbo Clock Speed, 8 Expansion Slots, 135 Watt Power Supply, "AT" Style Keyboard, Full Year Warranty and 45 Day Money Back Guarantee!

Retail Price \$586.25*

Special Wholesale Price

\$444.00*
(Monitor Not Included)

All THE products in this special sale are offered thru

PC Network

*All prices in this ad are wholesale - PC Network Members pay wholesale + 8% and shipping.

CALL TOLL FREE B3N8

(800) 621-SAVE

In Illinois (312) 280-0002

**THE MOST INCREDIBLE
LIMITED TIME OFFER IN
COMPUTER HISTORY, FROM
THE™ and PC NETWORK...**

THE™ PC+

**256K RAM,
IBM™ PC
compatible,
360K 5.25"
Disk Drive,
Turbo Speed,
"AT" Style
Keyboard**

Special Wholesale Price

\$444.00*

\$469.00 for 640K System*

Products Company Ltd.

Dealer Inquiries Call THE™ at (312) 642-9626
319 West Ontario Street, Chicago, Illinois 60610

PC NETWORK

BUY HARDWARE AND SOFTWARE AT WHOLESALE + 8%, AND GET 14-30 DAY SOFTWARE RENTALS†...

Listed below are just a few of the over 30,000 products available at our **EVERYDAY LOW PRICES!** The Network carries products for Apple, IBM, CP/M and most other popular computer families.

GAMES & EDUCATIONAL SOFTWARE FOR YOUR APPLE II & MACINTOSH

(Please add \$1 shipping and handling for each title ordered from below.)

Wholesale	Wholesale
Arrows Home Accountant-Mac Only \$65.00	Miles Computing Misc Attack-Mac Only \$22.00
Aztec Art Portfolio & Card Shoppe \$1.00	Palatit Mac Typo-Mac Only 23.50
Blackby Bayou-Macintosh Typoon 19.75	Panguin Graphics Magician 28.97
Broderbund Lode Runner 17.25	Panguin Pensate Xyplus/Transylvania-Mac Only 20.00
Broderbund Chopster 17.00	Professional Software Trase Fever 19.00
Broderbund Pure Show 24.75	Priority Software Forbidden Quest 21.00
Broderbund Dazzle Draw 31.97	Scarbrough Master Type 19.75
CBS Mastering the GRE 63.50	Scarbrough Run for the Money 26.00
CBS Murder by the Dozen 20.87	Simon & Schuster Typing Tutor III 28.25
CBS Gone Broke Made Easy 45.00	Sir-Tech Hwarady 17.25
Counterpoint The News Form 28.97	Sir-Tech Knight of Diamonds or Rescue Raiders 18.97
Davidson Speed Reader II 31.00	Sublogic Night Mission Pinball 19.25
Davidson Math Blaster or Word Attack 21.50	Sublogic Flight Simulator II 15.25
Tot Byte Smooth Talker-Mac Only 44.00	▶ Spinaker Alphabet Zoo Face Master 20.77
Hayden Detective House-Innors/Landscapes 23.00	▶ Spinaker King of the Hill Castle Doodle 20.75
Hayden Gordon III 24.75	▶ Spinaker Most Amazing Thing/Delta Drawing 25.00
Infocom Deadline or Suspended 24.00	▶ Spinaker Delta Drawing 25.00
Infocom Encounter Planetfall 19.75	T/Marker Check Art-Mac Only 65.00
Infocom Cutthroat Witness or Zork I 19.75	Warner Desk Organizer 25.00
Infocom Hecheker's Guide or Sneaker 17.75	Video Fun Pack-Mac Only 19.25
Infocom Suspact Sorcerer Intel Zork II or III 61.50	Video Mac Checkers & Reversi 25.17
Layered Fun Desk-Mac Only 21.00	Virtual Combinatorics Micro Cookbook 17.50
Mirage Concepts Time 21.00	

BUSINESS SOFTWARE FOR YOUR APPLE II & MACINTOSH

(Please add \$2.50 shipping and handling for each title ordered from below.)

▶ Apple Apple Works 1160.00	MECA Managing Your Money 887.50
Assimilation Process/Mac Memory Disk 17.75	Microsoft Word-Full/Multiplatform for Macintosh 97.80
Borland International Turbo Pascal or SideKick 37.50	Microsoft Excel for Macintosh 187.50
BPI GL AP AR PR or RV 190.00	Microsoft Basic for Macintosh 75.00
Broderbund Bank Street Writer 35.25	Microsoft Chart for Macintosh 82.50
Central Point Copy II Plus or Copy II Mac 18.25	Monogram Doctors & Sense for Apple II 55.00
Font Software Setways 26.50	Monogram Doctors & Sense for Macintosh 63.00
Futura Macrom 60.00	Odesta Hyla for Macintosh Rega 512K 200.00
Hobo Habades 40.00	Provue Overview-Mac Only 130.00
Harvard Mac Manager 29.95	Sensible Software Sensible Sporter IV 87.50
Human Edge Mind Procer 21.00	Softcraft Fancy Fonts 109.00
Human Edge Sales Edge 21.00	Softech Microsystems UCSD Pascal 37.00
Human Edge Communication Edge 98.00	Software Publishing PFS File Write or Graph 81.00
▶ Living Videotext Thru Talk-Mac Top! 85.00	Stonerware DB Master-Mac Top! 95.00
Main Street Fair-Mac Only 67.00	Talos Filopaper for Mac 90.00

HARDWARE FOR YOUR APPLE II & MACINTOSH

(Please add shipping and handling charges found in italics next to price.)

Wholesale	Wholesale
Apple MAC 800K Eastar Drive \$349.85 (7/50)	Hayes Macrodrive II w/Smartcom \$125.00 (2/50)
▶ Haba 800K Double Speed Mac Dvd 215.00 (1/64)	Novation Apple Cal II 174.45 (1/50)
▶ Omega 800K 5MB Removable Drive for Macintosh 999.00 (2/158)	Prometheus 1200 A 229.00 (6/00)
▶ Omega Dual 10MB Removable for Mac with SCSI Port 1,805.00 (38/99)	Low Cost 1200 Baud Internal Modem for Apple II
▶ Micro Srl A2 143KB Drive 150.00 (15/00)	Prometheus/Promodem 1200 Mac Pack 299.00 (8/00)
▶ Micro Srl Floppy Controller 85.00 (2/50)	Prenbex Popcorn MacPack 219.00 (12/50)
▶ Paradise Mac 10MB Hard Drive 525.00 (11/34)	1200 Baud External Cable Straighttalk
▶ Paradise Mac 20MB Hard Drive 749.00 (16/09)	
▶ PC Network 149K External Drive for Apple II 95.00 (12/50)	
▶ PC Network 140K Drive for Apple/II 95.00 (12/05)	
▶ Tecmar 5MB Removable Drive for MAC 990.00 (2/158)	
▶ Tecmar 10 MB MAC Drive 990.00 (2/158)	

BOARDS AND BUFFERS

AST Multi-G-2 Serial Clock 1155.00 (2/50)	Apple Macintosh Carrying Case 569.00 (1/49)
Microsoft Premium Software Tick 243.67 (2/50)	Apple Macintosh Security Kit 29.00 (1/50)
Microtek Duplicating GX 55.00 (2/50)	Curtis Ruby Surge Protector 39.00 (1/50)
Orange Micro Gopher 66.00 (2/50)	Hayes Attach II Joystick w/ Fire Button for IIe 28.50 (1/50)
Orange Micro Serial Grappler 85.00 (2/50)	Kensington Dual Cover for MAC or ImageWriter 7.50 (1/50)
PC Network 280 Card 35.00 (2/50)	Kensington Slant Page 49.00 (3/00)
Quadrant APIC G Graphics Interface 82.00 (2/50)	Kensington Surge Protector 29.50 (2/50)
Quadrant E-RAM-80 68.00 (2/50)	Kensington System Server Fan 56.97 (1/50)
Quadrant Multisync-1 Parallel 140.00 (2/50)	Koala MacVaron 150.00 (3/00)
Thunderware Thunderdisk 164.00 (2/50)	Koala Keyboard Touch Tablet 78.00 (1/50)
Titan Technologies Accelerator IIe 107.35 (1/48)	M&R Sup-R Mod RF Modulation 44.00 (1/50)
	PC Network Cooling Fan with Surgo Protector & Dual Outputs 25.00 (2/50)

MEMORY CHIPS

(All Memory Chips Guaranteed for Life!)

▶ 64K Memory Upgrade Kit (8 Chips) 99.00 (1/00)	Quantum 3550 Disks (Box of 10) 7.95 (1/00)
▶ 64K Dynamic Ram Chips (Each) 1.00 (1/00)	PC Network Macintosh Disks (includes Free File & File Case) 12.50 (1/50)
▶ 64K Dynamic Ram Chips (Each) 2.90 (1/00)	These Disks are Guaranteed for Life! No Generics!
▶ 128K IBM AT Mother Board Chips (Each) 3.50 (1/00)	Sony Mac Diskettes (Box of 10) 19.00 (1/50)
	Thunderware ThunderDisk 155.00 (3/35)

EXTERNAL MODEMS

Anchor Signatman Express \$205.00 (5/00)	Amdisk Video 300G Composite Green \$110.00 (3/00)
Anchor Lightning 2400 309.00 (2/50)	Amdisk Video 300A Composite Amber 120.00 (3/00)
Hayes Smartmodem 300 129.00 (1/00)	Amdisk Video 310A IBM Type Amber 130.00 (3/00)
Hayes Smartmodem 1200 340.00 (5/00)	Amdisk Color 600 NEW! High Res RGB 365.00 (7/88)
▶ Hayes Smartmodem 2400 525.00 (5/00)	Amdisk Color 712 Enhanced Graphics 424.00 (9/88)
Prometheus Promodem 1200 276.00 (1/00)	Magnavox 1277L IBM Type Amber 79.00 (5/00)
U.S. Robotics Courier-2420BPS Modem 345.00 (1/00)	A great looking performing monochrome
U.S. Robotics Passport 172.00 (1/00)	NEC SC-1401 Multi-Function RGB 480.00 (10/37)
ALL THE MODEMS ARE 100% HAYES COMPATIBLE	Princeton HX-12 RGB Monitor 399.00 (8/80)
THE 1200 Com External 129.00 (3/58)	Princeton HX 12E CGA/EGA Monitor 449.00 (9/87)
THE 2400 Com External 277.00 (5/54)	Princeton MAX-12e 132.00 (5/00)

TERMS & CONDITIONS

PC NETWORK - Members pay just 8% above the wholesale price, plus shipping. All prices reflect a 3% cash discount. Minimum shipping \$2.50 per order. International orders call for shipping & handling charges. Money orders, personal and company checks please allow 10 working days to clear. All prices subject to change without notice!

RENT BEFORE YOU BUY - Members are eligible to join the NETWORK's Business and Game software Rental Libraries and evaluate products for a full 14 (14 regular) or 30 (30 VIP) days to see if it meets your needs. And the NETWORK's rental charges are for less than other software rental services - just 20% OF THE MEMBER WHOLESALE PRICE. Rental titles available in IBM/Apple/MAC and CP/M Formats. Hardware prices highlighted by * reflect recent major price reductions.

GAMES & EDUCATIONAL SOFTWARE FOR YOUR IBM

(Please add \$1 shipping and handling for each title ordered from below.)

ATI Intro to PC DOS Vol. 1 & II or BASIC \$23.00	▶ Infocom Deadline or Suspended 624.00	Wholesale
Bluebus Chess (Your Toughest Opponent) 34.00	Microsoft Flight Simulator 27.00	24.75
Bluechip Milano/Clu Baron or Tycoon 18.75	Mouse Systems PC Paint - Turn your PC Into a Color Macintosh! 59.95	
Broderbund Lode Runner 17.25	Scarbrough Master Type 18.75	
CBS Gone Broke Made Easy 40.00	Sierra On-Line Crossing 18.00	
CBS Mastering the SAT 50.00	Sierra On-Line King's Quest II 24.75	
CBEA Training for Wordstar 37.25	Spectrum Holobyte GATO 18.00	
Comprehensive Intro to Personal Computing 26.50	▶ Spinaker Alphabet Zoo Kinder Com 15.25	
Davidson Math Blaster Word Attack 21.50	Stacy Machine Face Maker Hay Diddle Diddle Rhymes & Riddles 20.75	
Davidson Speed Reader II 31.00	▶ Spinaker Delta Drawing or Most Amazing Thing 20.75	
Hayden Gordon III 24.75	Sublogic Night Mission Pinball 19.25	
Individual Professor DOS 29.75	Virtual Combinatorics Micro Cookbook 17.50	21.00
Individual The Instructor 24.50		
▶ Infocom Zork I or Wastrels 19.75		

BUSINESS SOFTWARE FOR YOUR IBM

(Please add \$2.50 shipping and handling for each title ordered from below.)

▶ Ashlon-Tate DBase III or Framework II \$365.00	MicroPro Wordstar 2000+ \$262.50
Borland Turbo Pascal 35.00	MicroRim RBase 5000 288.00
Borland SideKick (Protected) 24.50	Microsoft C Compiler 205.00
Borland SuperKey 34.50	Microsoft Word - Latest Version 3.0 197.90
BPI GL AR or A P 99.00	Microsoft Multiplan 161.00
BPI Personal Accounting 43.75	Microsoft Mouse 107.00
Breakthrough Typewiz 203.00	Monogram Doctors & Sense 85.00
▶ Central Point Copy II PC 20.00	▶ Multimate Multimat (Latest Version) 160.00
Conceptual Instruments Desk Organizer 47.00	Norton Norton Utilities 3.1 43.00
Digital Research DR Logo 75.00	Open Eysiartem P.O. Sales wa.270.00
Digital Research Gem Desktop 25.00	A R INV G L A P Team Mgr 200.00
Digital Research Gem Draw 117.00	Power Base Power Base 200.00
Electronics Energraphics 143.00	Real World G L A P AR or CE/INV na.350.00
Font Software Setways 32.00	Rosesoft ProKey Version 3 65.00
▶ Harvard Harvard Project Manager 175.00	Ryan McParland RM COBOL (Dev. System) 520.00
▶ Harvard Total Project Manager 225.00	▶ Samna Samna II Word Processor 207.75
▶ Hayes Smartcom II - New VT100 Emulator 88.00	▶ Samna Word + 346.00
▶ Human Edge Management Edge or Mind Procer 24.00	▶ Satellite Software Word Perfect 139.00
Infocom Cornerstone 85.00	Softcraft Fancy Fonts 125.00
Infocom Volkswart III 126.50	Software Group Enable 283.00
Lotus Development Lotus 1-2-3 273.00	Software Publishing PFS File Write Graph 68.00
MDBS Knowledge2 229.00	Software Publishing PFS Report 59.50
MicroPro Wordstar2000 200.00	Softcom SuperCalc II 183.00
	Xenaro Ability 247.50

HARDWARE FOR YOUR IBM

(Please add shipping and handling charges found in italics next to price.)

▶ Omega Bernoulli Box \$1,849.00 (39/94)	Hayes Smartmodem 1200B \$305.00 (2/50)	Wholesale
Dual 10MB Drives	with New Smartmodem II VT100 Emulator	285.00 (2/50)
▶ PC Network 10MB INTERNAL 1/2 340.00 (7/34)	Hayes Smartmodem 1200B Alone 285.00 (2/50)	
Height Adjustable Drive. New lower price	Prometheus/Promodem 1200B Internal 225.00 (2/50)	
▶ PC Network 10MB Tape Backup 995.00 (8/94)	▶ THE "Internal 1200 1200BPS Model 119.00" (2/50)	
Same unit used in Company's DeskPro!	Lowest Cost Hayes Compatible w/FREE PC Ink II	
▶ PC Network AT 42MB Internal HD 1,050.00 (24/95)		
35MB Access Time - Comes Complete		
▶ PC Network 20MB Tape Backup 495.00 (10/88)		
High Height Internal w/ controller		
▶ PC Network Half Height DS-DD Drives 85.00 (11/77)		
▶ Tandon TM-100 120.00		
2 Full Height DS-DD Drives		
▶ THE "20MB Internal 1/2 Height Autoload Drive By Seagate or Microscan 367.50 (7/83)		

ACCESSORIES

▶ Apple Macintosh Carrying Case 569.00 (1/49)	
Apple Macintosh Security Kit 29.00 (1/50)	
Curtis Ruby Surge Protector 39.00 (1/50)	
Hayes Attach II Joystick w/ Fire Button for IIe 28.50 (1/50)	
Kensington Dual Cover for MAC or ImageWriter 7.50 (1/50)	
Kensington Slant Page 49.00 (3/00)	
Kensington Surge Protector 29.50 (2/50)	
Kensington System Server Fan 56.97 (1/50)	
Koala MacVaron 150.00 (3/00)	
Koala Keyboard Touch Tablet 78.00 (1/50)	
M&R Sup-R Mod RF Modulation 44.00 (1/50)	
PC Network Cooling Fan with Surgo Protector & Dual Outputs 25.00 (2/50)	
PC Network 550D Disks (Box of 10) 7.95 (1/00)	
PC Network Macintosh Disks (includes Free File & File Case) 12.50 (1/50)	

MULTIFUNCTION CARDS

▶ Appart AT Ram Expansion Card \$139.00 (2/50)	Hayes Smartmodem 1200B \$305.00 (2/50)	Wholesale
▶ AST SuperPremium "2MB Multi-OK 315.00 (2/50)	with New Smartmodem II VT100 Emulator	285.00 (2/50)
▶ AST SuperPlus (with 64K 139.80 (2/50)	Hayes Smartmodem 1200B Alone 285.00 (2/50)	
▶ AST "1.0 Plus II" 120.00 (2/50)	Prometheus/Promodem 1200B Internal 225.00 (2/50)	
▶ AST "Advantage for AT" 325.00 (2/50)	▶ THE "Internal 1200 1200BPS Model 119.00" (2/50)	
▶ Everest Magic Card 60.00 (2/50)	Lowest Cost Hayes Compatible w/FREE PC Ink II	
▶ Quadrant Gold Card 340.00 (2/50)		
▶ 384K Multifunction Color Card in OK Tecmar Captain Multi Card w/OK 148.00 (2/50)		
▶ THE "786K Plus Memory Board w/OK 37.00 (2/50)		
▶ THE "Multi 384 A functional clone 72.00 (2/50)		
▶ of AST's "SuperPlus" 168.00 (2/50)		
Includes up to 384K of expansion memory! 1 series 1 parallel 1 game port a clock divider and 3 software starters		
▶ THE "Multi MD Plus II Clone 60.00 (2/50)		

COMPLETE SYSTEMS

Apple Macintosh Base System CALL	▶ COMPAQ Hard Disk Portable \$1,835.00 (42/88)	Wholesale
▶ Central Point Laser 128 \$355.00 (1/67)	20MB Hard Disk 1 Floppy 256K	
Appy Up II or II Compatible	▶ IBM PC/AT Base System 2500 FDC 256K 1,150.00 (25/03)	
▶ AT&T 7300 Unix PC 3,899.00 (79/90)	▶ IBM PC Professional Hard Disk 1,499.00 (30/38)	
10MB Hard Disk 1 Floppy 512K	▶ IBM PC AT Base System - 1 2MB 2,875.00 (52/10)	
▶ COMPAQ DeskPro 1,805.00 (38/99)	Floppy 256K	
1 Floppy 104KB Hard Disk	▶ IBM AT Professional System CALL	
	1 2MB Floppy 20MB Hard Disk 1 Soft Tpr 512K	

PRINTERS

▶ Citizen MSP 10 NEW* \$229.00 (1/88)	▶ NEC 3530 300PS LQ Parallel 889.00 (19/88)
▶ 160CPS 80CPL Fric + Trac	▶ NEC 3550 300PS LQ 920.00 (17/87)
▶ Citizen AISP 15 NEW* 218.00 (6/80)	▶ NEC 8850 55CPS 1,336.00 (28/73)
▶ 160CPS 132CPL Fric + Trac	▶ Okidata ML 182 New 120CPS LQ 188.00 (4/88)
▶ Citizen MSP 20 NEW* 299.00 (6/88)	▶ Model Fric IBM Graphics & More
▶ 200CPS 80CPL Fric + Trac	▶ Okidata ML 182 New Stroke Design 299.00 (6/86)
▶ Citizen MSP 25 NEW* 435.00 (9/84)	▶ 60CPS LQ Fric IBM Graphics
▶ 200CPS 132CPL Fric + Trac	▶ Okidata Color 30 80CPS 1100 + 1,099.00 (7/88)
▶ Citizen Program 33 NEW* 390.00 (7/87)	▶ Colors LQ IBM Graphics & More (Requires Interface)
▶ 30CPS 80CPS 132CPL Fric + Trac	▶ Okidata ML 153P 60CPS 425.00 (9/88)
▶ Citizen 120-D 105CPS 10-Trac 159.00 (3/83)	▶ Okidata AB4100 56.00 (1/50)
▶ Epson LX 80 100CPS 80CPL LQ 199.00 (4/81)	▶ Okidata ML 2410 P Postscript 599.00 (12/94)
▶ Epson FX 85 333.00 (7/24)	▶ Okidata 2410 P Postscript 350CPS CALL
▶ Epson FX 286 NEW* 485.00 (10/48)	▶ Ome Sprint 11-40-80CPS LQ 1,165.00 (24/00)
▶ Epson LX 1000 NEW* CALL	▶ Star Microline Power Type 300.00 (6/48)
▶ 180CPS-80CPS NLO	▶ 18CPS Letter Quality 569.00 (1/87)
▶ Epson SO 3000 Impact Printer 1,359.00 (29/31)	▶ Toshiba P331 110CPS 132CPL 699.00 (15/90)
▶ Epson DX 35 35CPS LQ Impact 605.00 (12/29)	▶ Toshiba P351 286CPS 132CPL 426.00 (9/20)
▶ NEC 3030 300PS LQ Parallel 605.00 (1/80)	
▶ NEC 2050 30CPS Letter Quality 570.00 (1/80)	

COMPLETE SYSTEMS

(Optional local warranty service available in most major metro areas)

IBM PC BASE SYSTEM

IBM PC w/256K
Floppy Drive Controller
2 Double Sided Double
Density Disk Drives
Mix and Match with
your Favorite Monitor
and Printer!

\$1,159.00*

CUSTOM
CONFIGURATIONS
WELCOME



IBM PC HARD DISK SYSTEM

IBM PC w/256K
Floppy Drive Controller
1 Double Sided Double
Density Disk Drive
Half Height Hard Disk

w/20MB
\$1,499.00*

CALL FOR
LATEST IBM
ANNOUNCEMENTS

PORTABLE HARD DISK SYSTEM

256K/1 Floppy/Hard Disk



\$1,910.00* w/20MB
call for 10MB

DESKPRO SYSTEM

256K CPU/1 Floppy/Hard Disk



\$1,805.00* w/10MB
\$1,910.00* w/20MB

APPLE IIc



APPLE IIe



MACINTOSH SYSTEMS



64K IBM PC MEMORY EXPANSION KITS

Quantity Discounts Available.
Guaranteed for Life!

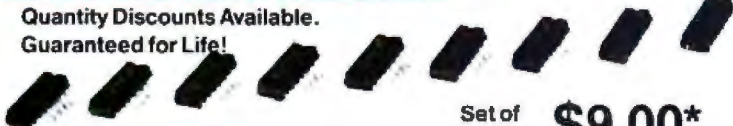

Set of
9 Chips **\$9.00***

DISKETTES

Guaranteed for Life!

Brand Name Diskettes available in prices of 10 or bulk packs of 50

5 1/4" DS/DD
\$7.95*
Bx 10 / Bx 50
ea. **.54***

5 1/4" SS/DD
\$6.95*
Bx 10 / Bx 50
ea. **.47***

3 1/2" SS/DD
Bx 10
\$12.95*
Free Flip & File Case

1/2 HEIGHT DS/DD DISK DRIVES



The Network buys direct and makes fantastic deals with manufacturers like MPI/Tandon/CDC/Shugart/Queme/TEAC and others to bring you fantastic prices on Name Brand drives for your PC/AT/XT/100 Compatible

\$85.00*
Quantity Discounts Available

INTERNAL PC HARD DISK

Low Power/Automatic Boot. Works on standard PC's and Compatibles. Includes drive/controller/cables/mounting hardware and instructions.



Full one year warranty!

10MB
\$367.00*

20MB
\$367.00*
Quantity Discount Available

Lotus
\$270.00*

WordPerfect
\$180.00* ea.
MultiMate

*Members pay 8% above this wholesale price plus shipping.

CALL TOLL FREE 1-800-621-S-A-V-E (orders and memberships)

In Illinois call (312) 280-0002 Validation code: B386

Customer Service and Order Status (312) 280-1567

TM & R - Registered trademarks of IBM/COMPAQ/APPLE/AST Research/LOTUS/MultiMate Int./JOMEGA.

Inquiry 220

PC NETWORK

SEE WHY OVER 150,000 HAVE JOINED
MAKING US THE NATION'S #1 SOURCE
FOR EVERYTHING IN COMPUTING

- **Our 600 Page Wholesale Catalog**
Over 30,000 products priced at Wholesale + 8%. Anything you will ever need at a Consistent low price...
- **Quarterly Catalog Updates**
Your Catalog is never obsolete! Keep on top of the newest products and latest price changes.
- **The Printout**
Our newsletter gives you fantastic specials along with unbiased analysis of new products and industry trends.
- **10 Day Returns on any Hardware!!**
If you don't like any hardware product—for any reason—return it for a refund.
- **1000 + Title Rental Library**
14 to 30 day rentals on over 1000 different titles. Try before you buy!!
- **Size, Strength and Stability**
The Network has over 150 employees, 45,000 square feet of office and warehouse space, inventory valued in excess of \$15,000,000 and is ranked the largest computer product supplier in the nation! Our commitment is to serve our customers and our 90% repeat business rate is proof!!
- **OnLine™ Bulletin Board**
Download "Freeware" from the nation's largest single concentration of Public Domain software available! Get tied into the nation's largest technical information network! Place orders, get tech support or contact customer service from the Network's OnLine, "not just a bulletin board but a complete customer information network."

CALL TOLL FREE
1-800-621-S-A-V-E

(Orders—Membership and Advice!)

In Illinois call (312) 280-0002

Your Membership Validation Number **B386**

You can validate your membership number and, if you wish, place your first money-saving order over the phone by using your VISA, MASTERCARD or AMERICAN EXPRESS. Our knowledgeable sales consultants are on duty Mon.-Fri. 8:00 AM to 7:00 PM, SAT. 9:00 AM to 5:00 PM CST.

PERSONAL COMPUTER NETWORK
320 West Ohio
Chicago, Illinois 60610

Call now...Join the PC NETWORK and start saving today!
Customer Service and Order Status (312) 280-1567
8:30 AM to 4:30 PM, Mon.-Fri. CST

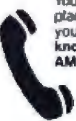

PC NETWORK • MEMBERSHIP APPLICATION

YES! Please enroll me as a member in the PC Network™ and send my catalog featuring thousands of computer products, all at just 8% above DEALER WHOLESALER PRICES. I will also periodically receive "THE PRINTOUT," a special up-date on merchandise at prices BELOW even those in my wholesale catalog, and all the other exclusive, money-saving services available to Members.

386

I am under no obligation to buy anything. My complete satisfaction is guaranteed. Please check (✓) all boxes that apply.

Basic Membership with optional 14 Day Evaluation.

- One-year membership for \$8
- Two-year membership for \$15 (Save \$1)
- Business Software Evaluation Library for \$25 add'l per year—with 14-day returns
- Games Software Evaluation Library for \$10 add'l per year

Special V.I.P. Membership with optional 30 Day Evaluation.

- One-year membership for \$15
 - Two-year membership for \$25 (Save \$5)
 - BOTH Business and Game Software Evaluation Libraries for \$30 add'l per year—with 30 day returns
- *V.I.P. members may receive advance notice on limited quantity merchandise specials

Bill my credit card. VISA MasterCard American Express

Account Number

Exp. Date

Check or money order enclosed for \$_____

Name

Address

City State Zip

Telephone ()

My computer(s) is IBM PC IBM-XT IBM-AT Apple II Macintosh Other

Signature (Signature required to validate membership)

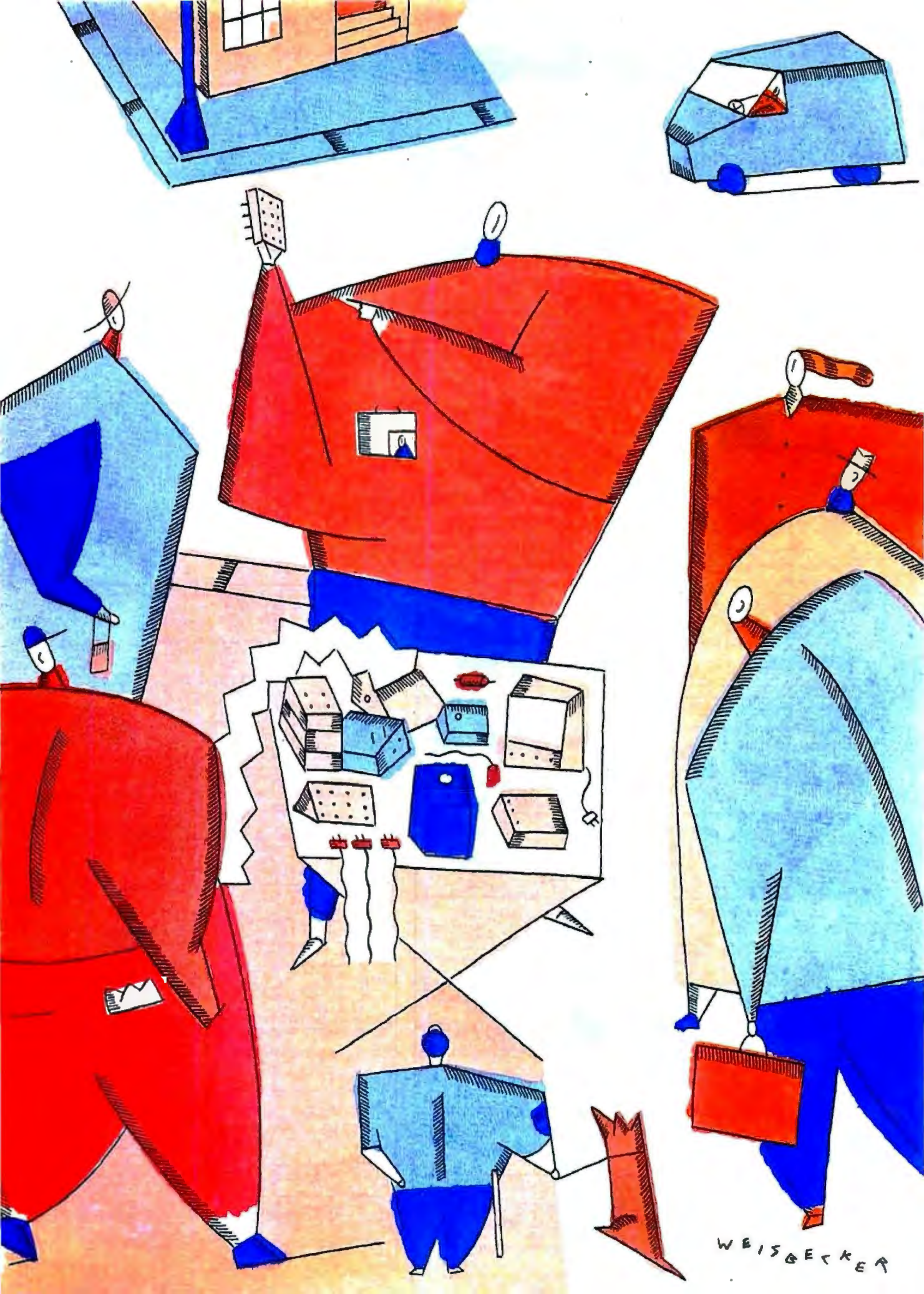

WEISBECKER

Features

SIMILARITY MAPPING <i>by Rob Spencer</i>	85
CIARCIA'S CIRCUIT CELLAR: PARALLEL INTERFACING: A TUTORIAL DISCUSSION, PART 2: APPLICATIONS <i>by Steve Ciarcia</i>	97
THE DEFINICON 68020 COPROCESSOR PART 2: SOFTWARE SUPPORT <i>by Trevor Marshall, Christopher Jones, and Sigi Kluger</i>	108
MATHEMATICS OF PROGRAMMING <i>by C. A. R. Hoare</i>	115
POLAR NORMAL DISTRIBUTION <i>by Alain Latour</i>	131

SUPPOSE YOU WERE ABOUT TO START on a long car trip, but the road atlas in the trunk was soggy and all you could salvage was a large table of distances between cities. Rob Spencer tackles this interesting problem in "Similarity Mapping" by using a Microsoft BASIC program for the Macintosh that creates "maps" from distance or difference data.

Two features this month are conclusions of two-part articles. Steve Ciarcia concludes his discussion of parallel interfacing in the Circuit Cellar by looking at a number of interface adapters and suggesting applications for them. Steve doesn't have the space to give a complete functional description of each adapter. Instead, he points out their significant differences. Steve hopes this two-part article will answer many of the interfacing questions he receives. In part 2 of "The Definicon 68020 Coprocessor," Trevor Marshall, Christopher Jones, and Sigi Kluger focus on the software available for the DSI-020 coprocessor board for IBM XT's, AT's, and work-alikes.

In honor of BYTE's 10th anniversary, a reception was held at the Boston Computer Museum. The guest speaker was Dr. C. A. R. Hoare, who chose the topic "Mathematics of Programming." It is Dr. Hoare's thesis that programmers should follow mathematical laws in the construction of programs. This type of construction would promise benefits in systems software, safety-critical programs, silicon design, and standards.

Finally, in this month's Programming Insight, "Polar Normal Distribution," Alain Latour explains the "polar method" of generating normal deviates and evaluating the cumulative probability of a normally distributed random variable.

At last, the world's best-selling portable computer has a little competition.



It's 30% smaller



17% lighter



400% faster

Now there's a portable personal computer so small, so light, and so fast it defines a new industry standard. From the same company that set the standard—COMPAQ® The new COMPAQ PORTABLE II™ has all the advantages of the world's best-selling full-function portable—the original COMPAQ Portable—plus it's even more portable. And it's far more powerful than most desktop computers. Never before has a computer this small been capable of so much.

With its 80286 processor, the COMPAQ PORTABLE II can run all of the popular business software written for IBM® personal computers. At speeds *three to five times faster* than the COMPAQ Portable, IBM PC/XT™, and other compatibles.

And because of its standard 360-Kbyte diskette drive format, your data diskettes will be fully interchangeable with other COMPAQ, IBM, and compatible personal computers.



Introducing the remarkable new COMPAQ PORTABLE II

Expansion potential? The COMPAQ PORTABLE II can handle an optional 10- or 20-Megabyte fixed disk drive and up to 4.1 Megabytes of RAM. And you can add a modem, a networking board, or a board for communicating with your mainframe.

The new COMPAQ PORTABLE II puts tremendous computing potential within the grasp of every computer user. It's backed by the service and support of over 2900 Authorized COMPAQ Computer Dealers worldwide. Plus, it's made by the undisputed

world leader in portable personal computers.

For the name of the dealer nearest you, call toll-free 1-800-231-0900 and ask for Operator 16. In Canada, call (416) 449-8741. In Europe, telex 84117898630AB; 898630 COMPAQ TTX D.

IBM® is a registered trademark and IBM PC/XT™ is a trademark of International Business Machines Corporation. ©1986 COMPAQ Computer Corporation. All rights reserved.

It simply works better.

COMPAQ
PORTABLE II™

SIMILARITY MAPPING

A Macintosh program that creates "maps" from tables of distance data

Imagine that you're about to start a long car trip, but you can't find the maps. After a frustrating search, you find a road atlas in the trunk of the car—but it's soggy and torn, and only the last page is legible. All you have on that

page is a big table of distances between cities. Can you recreate a good map from that distance table?

In another scenario, let's say you're a market researcher about to make a presentation. You have lots of data from supermarket taste tests in which people tried to tell the difference between your brand of soft drink and the other major brands. Is there a succinct and accurate way to present all these results without showing a huge table of numbers?

Finally, suppose you design printed circuit boards. You know what chips you need to do the job and how they're connected. Is there a method that will suggest the layout of the board so as to minimize signal path distances and the need for jumpers?

These problems have a common theme: They start with a large set of known *distances* (or, conversely, *similarities*), and they seek a graphic solution in the form of a *map*. In this article I'll present an algorithm and a program to solve such problems. The technique is called *multidimensional scaling*, but I prefer the term *similarity mapping*.

I wrote the program Mapper in Microsoft BASIC 2.0 (binary version) for the Macintosh, and it demonstrates the language's avoidance of line numbers, reference by name, potential for Pascal-like structure, and use of the Mac's mouse-driven menus, dialog boxes, and buttons.

OVERVIEW OF THE METHOD

Similarity mapping has four major parts: input of the data, generation of

(continued)

Rob Spencer (4230 Fieldgate Dr. #5, Mississauga, Ontario, Canada L4W 2M5) is a biochemist at Syntex Inc.

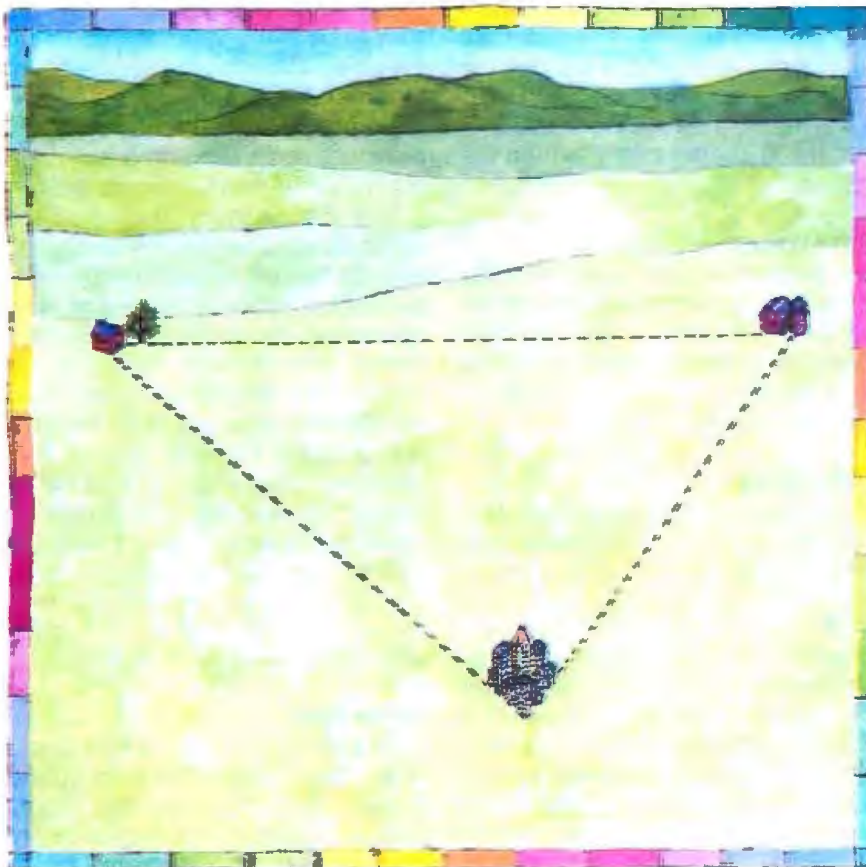

Table 1: The distances between nine major U.S. cities.

	Boston	N.Y.	D.C.	Miami	Chicago	Seattle	S.F.	L.A.	Denver
Boston									
New York	206								
Washington, D.C.	429	233							
Miami	1504	1308	1075						
Chicago	963	802	671	1329					
Seattle	2976	2815	2684	3273	2013				
San Francisco	3095	2934	2799	3053	2142	808			
Los Angeles	2979	2886	2631	2687	2054	1131	379		
Denver	1949	1771	1616	2037	996	1307	1235	1059	

"Intercity distances"

9

Boston, NY, DC, Miami, Chicago, Seattle, SF, LA, Denver

206

429,233

1504,1308,1075

963,802,671,1329

2976,2815,2684,3273,2013

3095,2934,2799,3053,2142,808

2979,2786,2631,2687,2054,1131,379

1949,1771,1616,2037,996,1307,1235,1059

Figure 1: The data file Cities, based on the information contained in table 1 and used by the program Mapper.

an initial map, iterative refinement of that map, and generation of the display. These can be seen directly in the first main section of the program, which consists of eight sequential subroutine calls followed by a WHILE . . . WEND loop. Some of these subroutines, like Initialize and InputData, are part of any program. Some deal with more Macintosh-specific things: SetMenus, WaitForMenu, and HandleMenus. Two are for screen display: ShowTable and ShowMap. The heart of the algorithm and all of the mathematics are in the remaining subroutines, InitializeMap and RefineMap.

I'll go through the program in order, using the soggy road atlas problem as an example. The input data (table 1) consists of the distances, in miles, between nine U.S. cities. Since you know what the final map should look like, it's easy to tell if the program is working.

INITIALIZE

The first subroutine in Mapper, Initialize, sets up the screen (WINDOW, CALL TEXTFONT, etc.), defines

several variables (R and Criterion are the most interesting; I will discuss them later), and defines the plotting functions (DEF FNPx, DEF FNPY) in a way that makes it easy to manipulate the map after it is drawn on the screen.

SETMENUS

The SetMenus subroutine creates a single pull-down menu titled Control. It has three options: Change Map, Show Table, and Quit. You control the program by selecting these options with the mouse.

INPUTDATA

Using the InputData subroutine, Mapper reads its data from simple text files. You can write such files with any word processor as long as you save them as "text only." The program begins by asking you to choose a data file from the "minifinder" box created by the FILES\$ function. Figure 1 is a data file called Cities, which is based on table 1. Note that between n cities there are $n \times (n-1)/2$ distinct distances, as assigned to the variable NumPairs. (Thus, the nine cities in

table 1 have 36 distances.) The names of the cities are assigned to Label\$(), and the distance between the i th and j th cities to both $d(i,j)$ and $d(j,i)$.

INITIALIZEMAP

As in many iterative techniques, the speed and stability of convergence to a final answer depend on having a good initial guess. The method I've used is an exercise in geometry as illustrated in figure 2. First, the program InitializeMap searches the distance table for the two most distant points; in the example these are Miami and Seattle, which are 3273 miles apart. These points now define the horizontal axis, and they're labeled j_1 and j_2 (figure 2a).

The program searches the distance table again for the next most distant point, in this case Boston, which is labeled j_3 . Boston is given the map coordinates $(x(j_3), y(j_3))$ such that the triangle formed by these three cities has sides of the correct lengths (figure 2b). Note that the program places Boston below the Miami-Seattle line; this is because the Macintosh, like most microcomputers, defines $(x,y) = (0,0)$ to be in the upper left corner of the screen. You can change the orientation and scaling of the map later; remember that the input data is just distances and there's no information about north, south, east, or west.

Now the program assigns all the other points. It assigns the i th city just as it did Boston, except that the city's placement above or below the Miami-Seattle line is no longer arbitrary. The decision is based on whether the distance between Boston and the point p is greater or less than the distance between Boston and (i) (below) (see figure 2c). In other words, the program uses Boston to break the symmetry of the map.

Finally, the program shifts the coordinates of all points so that $(0,0)$ is at the center of the screen. This helps with later scaling and rotation.

SHOWMAP

A frequently called subroutine, ShowMap, simply draws the map on the screen. Note that the map coordinates $x(i), y(i)$ of the points retain their units—in this case, miles. This is

so that calculated distances and errors will have familiar units. The program does the conversion to screen units (i.e., pixels) with the functions FNPx and FNPy. The initial map from our example is shown in figure 3.

REFINEMAP

The iterative refinement of the map is done by the subroutine RefineMap. RefineMap consists mostly of a WHILE...WEND loop that calls the subroutine IterateMap to do the math; checks to see if you have selected a menu item, and, if so, goes to deal with it; draws the new map; and checks for convergence and exits appropriately. The map has converged if two successive iterations produce average errors differing by less than the variable Criterion, which I set at 0.2 percent.

ITERATEMAP

In forming the initial map, I gave the three most mutually distant points (Miami, Seattle, and Boston) special status; they were fixed, and all the other points were assigned relative to them. Now, in iteration, all of the points are allowed to move to minimize the error between the input distances $d(i,j)$ and the calculated distances based on the current map coordinates. An analog computer equivalent of this would involve putting pegs in a pegboard at the initial guess coordinates, connecting each pair of pegs with a spring cut to the length $d(i,j)$, cutting the pegs free from the board, and letting go! When the oscillations died down, you'd have a minimum-error map.

In IterateMap, moving the points is done in two nested FOR...NEXT loops by using the variables Dx(i) and Dy(i) to add up, as vectors, all the errors between each pair of points. These resultant vectors are then multiplied by R and added to the coordinates. Figure 4 shows the changes this makes in the first iteration; the cities move in various directions for various distances, all movements serving to improve the map. The constant R is analogous to the "stiffness" of the springs in the analog model. If R is too big (in my experience, more than about 0.2), the springs are too stiff,

and the map will oscillate and may not converge. If R is too small, convergence will be very slow.

MANIPULATING THE MAP

Even though the map has converged, you may want to change it for presentation purposes or see the results in tabular rather than graphic form. The subroutines called in the final WHILE...WEND loop of the main program allow for this.

When you look at a road map, you usually put north at the top and west at the left—but, as mentioned above, there's nothing in the distance table data to suggest an absolute orientation. When you select Change Map from the menu, a panel appears (via subroutine ShowPanel) that allows you to reorient the map. Figure 5 shows this panel and the final map, after rotation (by 205 degrees) and ex-

(continued)

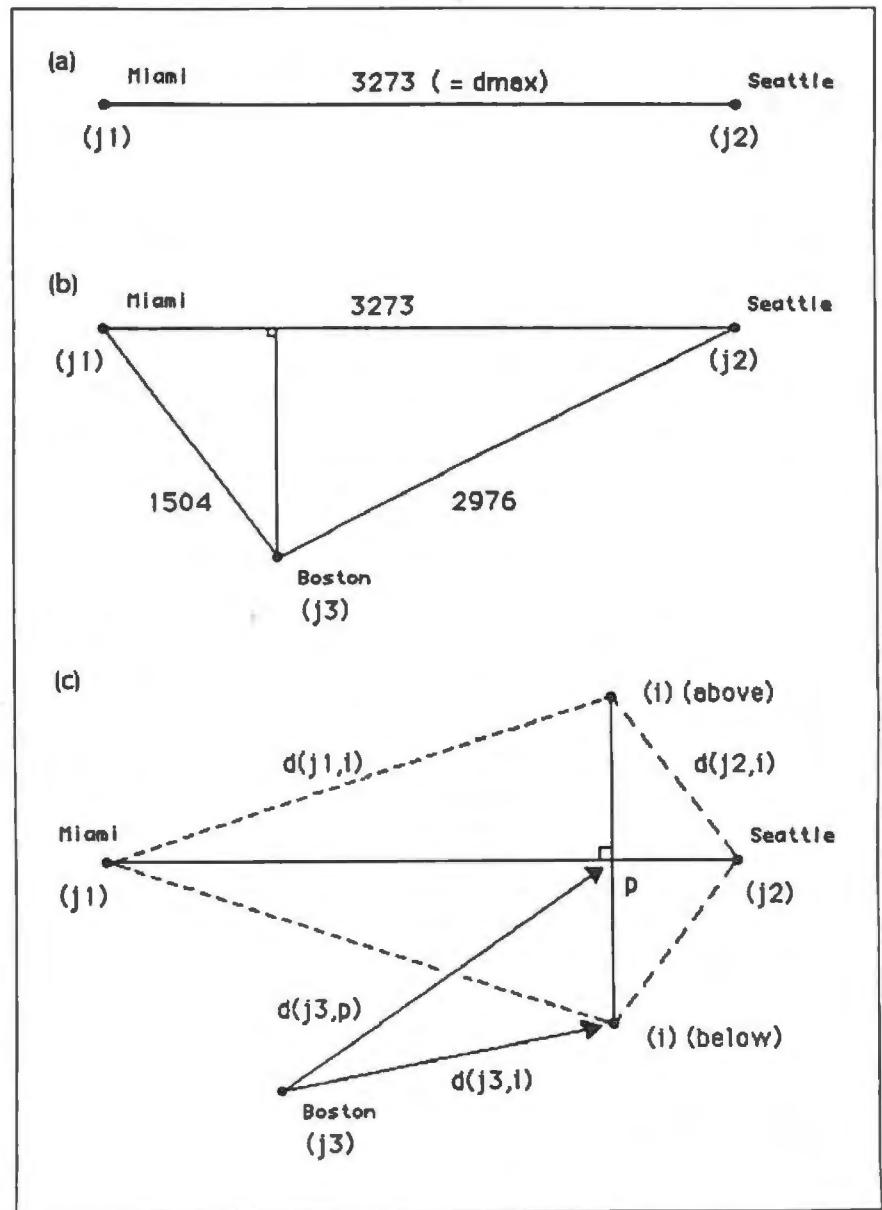

Figure 2: The geometry used to construct the initial Cities map. (a) Mapper uses the pair of points that are the farthest apart to define the x axis. (b) It then places the most distant point so that the triangle formed has sides corresponding to the first three. (c) Finally, the program places all other points relative to the first three.

pansion to fill the screen.

The menu option Show Table gives the original distance table as well as the distances calculated from the map coordinates; it also shows the root mean square error, which for the Cities example is 33 miles.

I have not put any printer output statements in the program, but Command-Shift-3 will send a screen snapshot to disk, Command-Shift-4 will send it to the printer, and you could easily make a printed table by changing the subroutine ShowTable to have

LPRINT instead of PRINT, or with PRINT#2 where file #2 is opened to the screen or the printer.

MISSING DATA AND ERROR LOCATION

Remember the soggy road atlas? Imagine further that even the distance table is torn up and that some of the distance values are missing. One bonus of similarity mapping is that it can give reasonable estimates *even for missing data*. Mapper makes provision for this: If any input distances are

negative, the program treats them as unknowns in the iteration process. For example, if the data file lists the Washington, D.C., to San Francisco and the Chicago to Los Angeles distances (2799 and 2054 miles, respectively) as -1, and you run the program, the map converges normally. The calculated distances are 2804 and 1974 miles, errors of +5 and -80 miles, or +0.2 and -3.9 percent. If too many values are missing or the map isn't as intrinsically flat as in the Cities example, the initial map determination or convergence may fail.

Another advantage of similarity mapping is that it can find the likely sources of error in appropriate data sets. What if one input distance is very wrong—how could you find out which one? The program can easily be changed to show all the differences between input and calculated distances. A single difference that is much larger than the average might be due to experimental error. This sort of error finding might be useful in surveying, where the expected errors are small.

OTHER EXAMPLES: DEFINING DISTANCE

At the beginning of this article, I suggested three applications. The Cities example is quite intuitive, since we expect that the distances in the table should produce a good, flat map, and we're comfortable with distances measured in miles. How about the other examples? How do you define "distance" in the soft-drink marketing case or the circuit board design problem? Why should either of these produce a flat map?

How you define distance depends on the type of data available. In the marketing case, suppose that you ask the customers, "Which soft drink is Brand A?" and let them taste two unlabeled cups of Brand A and Brand B. The "distance" between Brands A and B could be defined as $d(A,B) = 200 \times (n/N - 0.5)$, where n is the number of times that Brand A was correctly identified in N trials. If the two brands taste very different, n will approach N and $d(A,B)$ will approach 100. If the brands are indistinguish-

(continued)

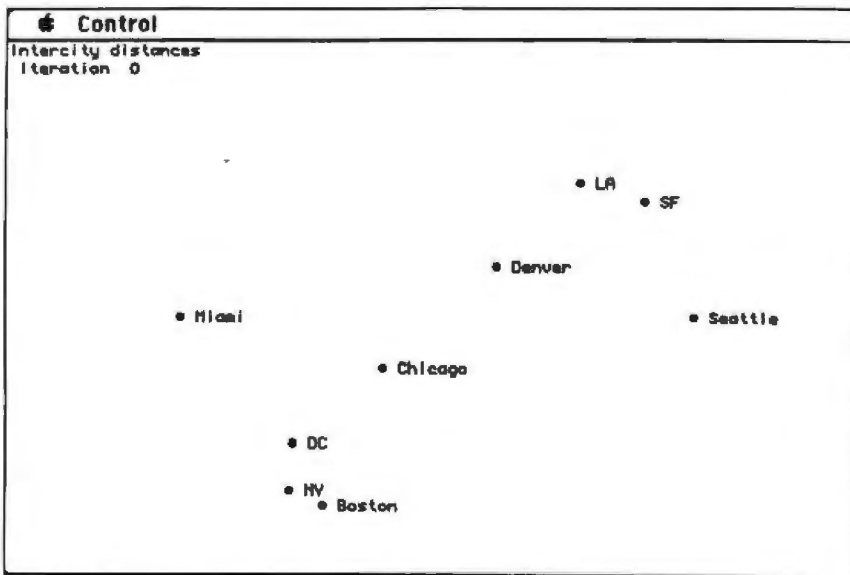

Figure 3: The initial map drawn by Mapper using the Cities data file.

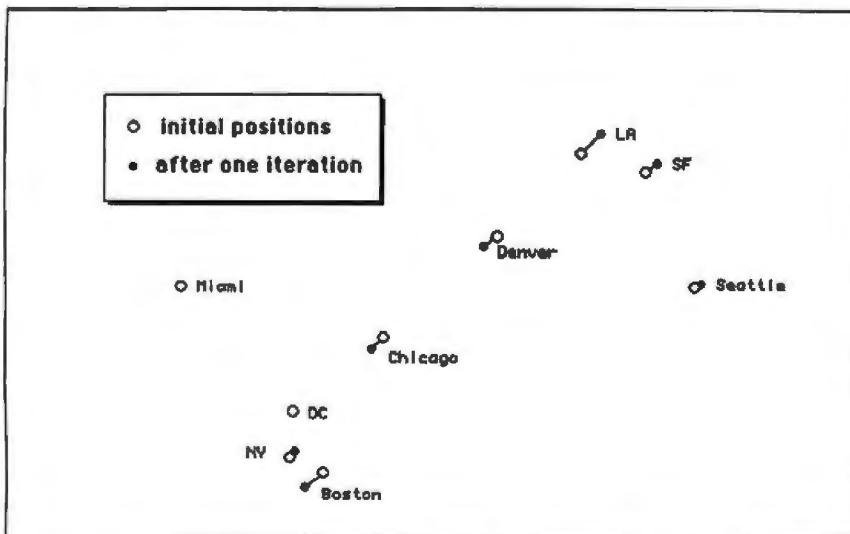

Figure 4: The Cities map during iteration, showing the movements of the cities between the initial map (open circles) and the first iteration (filled circles).

\$4 REBATE

Desk-Top Premium Trays



\$2 REBATE

Desk-Top Econo/Stor 50



\$2 REBATE

Portable Files



\$2 REBATE

Security Mailers



Finally—a rebate on something you really need!

Eichner—the recognized name for quality and dependability in diskette storage—is offering a special rebate on our most popular products. And if you're serious about computers, you *have* to be serious about organizing and protecting your diskettes. So choose the Eichner product that fits your special needs and save money! But you'd better hurry—this is a limited time offer. Available at participating computer and office supply stores nationwide.

FELLOWES
MANUFACTURING CO.

1789 Norwood Avenue, Itasca, Illinois 60143

Inquiry 110

Rebate offer good only from July 1 to September 30, 1986 on the model numbers displayed in this ad.

To receive your rebate:

1. Complete and return this form, including all requested information.
2. Include original dated sales receipt with store name clearly shown. Please circle the price.
3. Cut out and include the universal product code symbol.



Model Number	Product Description	Rebate Amount	Quantity Purchased	Total Rebate

Name _____

Address _____

City _____ State _____ Zip _____

Mail to: Eichner Rebate Offer
Fellowes Manufacturing Co.
P.O. Box 541, Prospect Heights, IL 60070

BY-8

MAXIMUM REBATE PER CUSTOMER—\$100. Please allow 6-8 weeks for processing. Resellers not eligible. Offer void where prohibited, taxed or restricted by law. All requests must be postmarked no later than September 30, 1986.

SHIPPING NOW !!!

SHIPPING NOW !!! SHIPPING NOW !!! SHIPPING NOW !!! SHIPPING NOW !!! SHIPPING NOW !!!

SHIPPING NOW !!! SHIPPING NOW !!! SHIPPING NOW !!! SHIPPING NOW !!! SHIPPING NOW !!!



The power of dBASE III for the Macintosh has arrived!!!

This new software product, named dMac III, is fully compatible with dBASE III and is three times faster.

dMac III features a powerful programming language that offers its owners the ability to develop professional business applications for the Macintosh.

In addition, you can transfer your dBASE III applications and databases to the Macintosh where dMac III will allow you to use them without modification.

Of course you can use dMac III along with the other popular Macintosh software products such as Microsoft WORD and Microsoft FILE.

As a dMac III owner you get the best of both worlds. All of the features of the most popular programmable database for the IBM PC plus the user friendliness of Apple's Macintosh.

To order dMac III contact:

FORMAT SOFTWARE
11770 BERNARDO PLAZA CT.
SAN DIEGO, CA 92128
(619) 487-6946

Macintosh is a trademark of Apple Computer
dBASE III is a trademark of Ashton-Tate
IBM PC is a trademark of IBM
Microsoft WORD and Microsoft FILE are trademarks of Microsoft
dMac III is a trademark of FORMAT Software

SIMILARITY MAPPING

Two-dimensional maps are the easiest to display and to reproduce.

able, n will be $N/2$ (i.e., random) and $d(A,B)$ will be zero. Such "distances" can be used directly in similarity mapping. The final map will not have any meaning in the north-south-east-west sense, but it will quickly and easily show which brands are closest to each other in taste.

In the circuit board design problem, you might define distance as follows: If two chips are directly connected, let their distance be $1/n$, where n is the number of connections between them. If they aren't directly connected, let their distance be the minimum sum "hopscotch" distance required to bridge them through other chips that are directly connected. On the final map, after appropriate scaling, you can interpret the distances as centimeters or inches of circuit board.

As for the question of map "flatness": There is no reason why either of these latter examples should result

in a low-error two-dimensional map; we are just forcing them to do so. Two-dimensional maps are simply the easiest to display and reproduce. In trying many examples with this program, I've found that final errors are often in the 15 to 20 percent range. If the final error were much larger, I'd be concerned that too much information was being lost by forcing the distances to lie in the plane.

OTHER APPLICATIONS AND REFERENCES

The book by Schiffman, Reynolds, and Young (reference 1) is an excellent general reference. It has many diverse examples and discussions of algorithms and error analysis. Tobler and Wineburg (reference 2) and Kendall (reference 3) present some fascinating applications in archaeology and sociology in which distances defined by historical records of marriage or trade are used to recreate maps of ancient Assyria and Oxfordshire. Fitch and Margoliash (reference 4) tabulate the "minimum mutation distances" between different species for the protein Cytochrome C. I've given the final map resulting from their data in figure 6. Distances on this map are a measure of similarity of DNA sequences, that is, genetic similarity.

(continued)

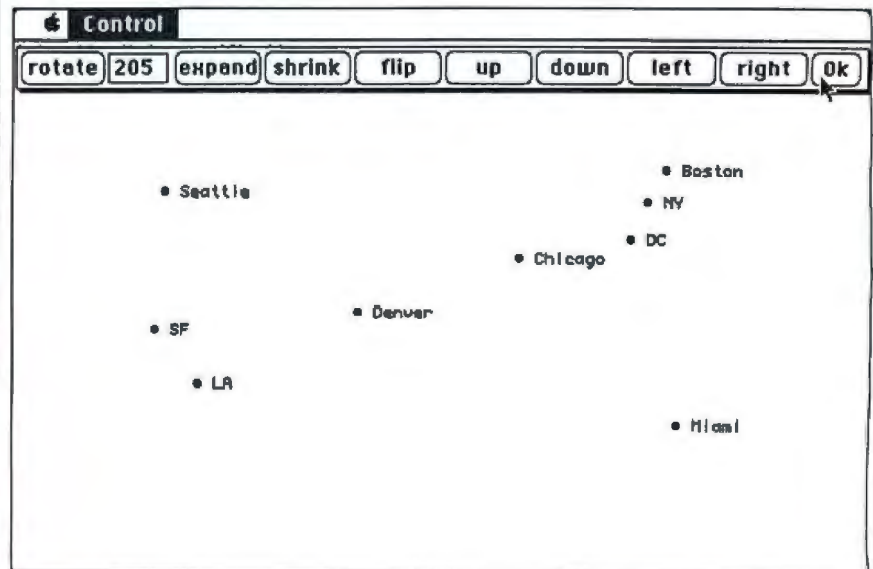

Figure 5: The final Cities map, after convergence, rotation, and expansion. Note the panel at the top of the screen, with buttons that let you adjust the map size and orientation.

Two great reasons to buy Turbo Pascal™

System Builder™ \$99⁹⁵ and Report Builder™ \$75⁰⁰

From the Designer Series™ by Royal American Technologies.

Now, experience the magic of 5th generation software.

It's a state-of-the-art program generator that automatically builds a relational database application for you in just seconds. You just paint your screen and datafile layouts.

SO EASY... Ideal for entry level "coders" to produce relational database systems without coding. (Entry level guide with sample On-disk systems is provided.) SO POWERFUL... it provides programming professionals with more flexibility and horsepower than any development tool on the market (guide is provided.)



REPORT BUILDER CYCLE:

- Key in the report parameters on screen
- Print your listings
 - New report format for reference
 - Report element layout
- Key in the report data elements on screen
 - Report Builder automatically writes the program code and links it to your datafile
- Print your listing
 - Report program source code listings
- Compile the report builder code using the Turbo Pascal™ compiler
- Attach the new report module to your system menu

SYSTEM BUILDER CYCLE:

- Paint the menu screens
- Paint the application screens
- Define the datafile(s) on the screen
 - System Builder automatically writes the program code and combines the datafiles into a relational database
- Print your listings
 - Program source code listing
 - Datafile layouts
 - Self-documenting program (includes screen schematics)
- Compile the System Builder code using Turbo Pascal™ compiler
- Start using the completed system

Press a key, wait 6 secs*

Press a key, wait 6 secs*

*System Builder will generate 2,000 lines of program code in approximately 6 seconds.

REPORT BUILDER FEATURES:

- Automatically generates Indented, Structured Source Code ready for compiling Turbo Pascal (no programming needed)
- Automatically interfaces to a maximum of 16 Datafiles created with System Builder
- Supports Global Parameters such as Headings, Footers, Lines Per Page, Print Size and Ad Hoc Sorting
- Produces reports containing an unlimited number of Sub-Headings, Sub-Totals and Totals
- Page breaks on Sub-Totals
- Report Builder will generate Report Programs which can contain Report Elements not just restricted to Data Elements. Reports can also include Text Strings, Variables or Computed expressions containing references from up to 16 Datafiles
- Use range input screens produced by System Builder to allow End Users to select portions of a report as needed (i.e. specific account ranges can be requested)
- Produces standalone Report Modules
- Easy-to-use Interface Program to access dBase Files

SYSTEM BUILDER PERFORMANCE (Typical 10 screen 8 file/index application)

TASK	SYSTEM BUILDER	DBASE III™
Planning and Design	60 minutes	60 minutes
Screen Painting	15 minutes	3 hours
Programming	2 minutes	10 hours
Elapsed time to completed system	1 hour and 17 minutes	14 hours

SYSTEM BUILDER FEATURES:

- Automatically generates Indented, Structured, Copy Book Source Code ready for compiling with Turbo Pascal (no programming needed)
- Paint Application and Menu screens using Keyboard or Microsoft Mouse™
- Finished Application screens all use System Builder's In-Line machine code for exceptional speed
- Use fully prompted Screen Guidance Templates™ to define up to 16 Datafiles per application, each record having an Unlimited Number of fields
- Define up to 16 Index Keys per application database
- Paint functions include:
 - Center, copy, move, delete, insert or restore a line.
 - Go straight from screen to screen with one keystroke
 - Cut and paste blocks of text screen to screen
 - Draw and erase boxes, Define colors and intensities
 - Access special graphic characters and character fill
- Supports an unlimited number of memory variables
- File Recovery Program Generator to make fixing of corrupted datafiles an automatic process
- Automatically modifies datafiles without loss of data when adding/deleting a field
- Menu Generator with unlimited Sub-Menu levels
- Experienced developers can modify the System Builder
- Develop systems for Floppy or Hard Disk
- Modify System Builder's output code to include External Procedures, Functions and Inline Code
- Easy-to-use Interface to access ASCII and dBase Files

VARS, System Integrators and Dealers, let's work together. Your inquiries are always welcome. (415) 397-7500.

"I think it's wonderful... prospective buyers should seriously consider DESIGNER even before dBASE III."

*Mr. Greg Weale
Corporate Accounts Manager,
Computerland*

"We used DESIGNER last year to program a major application. It saved our programmers so much time. We now use DESIGNER instead of dBASE III as our development standard!"

*Mr. Peter Barge, Director
Services Division, Horwath & Horwath*

"DESIGNER has resulted in significant time savings... We use it on classical database applications!"

*Mr. Andy Rudevics, Director
Andrasoft Corporation*

**Royal American Technologies
201 Sansome, Suite 500
San Francisco, CA 94104**

**(800)654-7766
California (800) 851-2555
Ask for Operator 105.**

Please rush me: ___ copies of SYSTEM BUILDER at \$99.95 per copy;
___ copies of REPORT BUILDER at \$75.00 per copy. I've enclosed \$5.00 for postage and handling. California residents add 6% sales tax.

Name _____

Address _____

City _____

State _____ Zip _____

Phone _____

Payment: Check Money Order

Cashiers Check AMEX

VISA MASTERCARD

Expiration date _____

Card Number _____

Signature _____

30-Day Money-Back Guarantee. Not copy protected. \$10 restocking fee if envelope is opened.

System Requirements—System Builder/Report Builder: IBM PC/XT/AT¹, or similar, with minimum 256K RAM, dual floppy drives, or hard disk, color or monochrome monitor, MS² or PC DOS³ version 2.0 or later, Turbo Pascal Version 2.0 or later (Normal, BCD or 8087 versions).

¹Trademarks of International Business Machines Corp.

²Trademark of Microsoft Corp.

³Turbo Pascal is a registered trademark of Borland International.

⁴dBASE is a registered trademark of Ashton-Tate.

ROYAL AMERICAN Technologies Corporation™

SIMILARITY MAPPING

It's easy to see at a glance how the birds are closely related to each other and distant from the others, how close the primates are, and how the mammals form a broad group from horses to humans. Streich, Dove, and Franke (reference 5) discuss the use of a similar mapping technique in medicinal chemistry.

Finally, similarity mapping can be compared to cluster analysis, a technique I discussed in an earlier BYTE article ("Cluster Analysis," September 1984, page 129). Both techniques have the same general goal: simple graphic presentation of large amounts of data. In cluster analysis the input data is often tabulated characteristics

and the output is a dendrogram (tree diagram). In similarity mapping the input data is distances and the output is a map.

The two techniques are not mutually exclusive, however, and either may be applied to a given set of data. For example, the data used to create the map in figure 6 was used by Fitch and Margoliash to build a dendrogram. Similarly, internode distances taken from my cluster analysis article produce the map of figure 7 when run through similarity mapping. In this figure, nearby points represent microcomputers that are similar to each other in features such as price and amount of memory.

The same conclusions that can be drawn from the "Cluster Analysis" dendrogram (figure 1 of that article) are apparent in this map. In addition, you might conclude from the map that the Apple IIe and the TRS-80 Model 4 are in the "middle" of the space defined by the other computers. On the other hand, cluster analysis does not "squeeze out" information by forcing points to lie on a map. Experiment with both techniques and choose the one that suits your data or the presentation that you prefer.

REFERENCES

1. Schiffman, S. S., M. L. Reynolds, and F. L. Young. *Introduction to Multidimensional Scaling*. New York: Academic Press, 1981.
2. Tobler, W., and S. Wineburg. "A Cappadocian Speculation." *Nature* 231, 1971, pages 39-41.
3. Kendall, D. G. "Construction of Maps from 'Odd Bits of Information.'" *Nature* 231, 1971, pages 158-159.
4. Fitch, W. M., and E. Margoliash. "Construction of Phylogenetic Trees." *Science* 155, 1967, pages 279-284.
5. Streich, W. J., S. Dove, and R. Franke. "On the Rational Selection of Test Series 1. Principal Component Method Combined with Multidimensional Mapping." *Journal of Medicinal Chemistry* 23, 1980, pages 1452-1456.

Editor's note: Mapper is written in Microsoft BASIC 2.0 (binary version) for the Macintosh. The source code, MAPPER.BAS, is available in a variety of formats; see page 405. Also available are CITIES.DAT, CYTOC.DAT, and MICROS.DAT; data files for the examples given in this article. ■

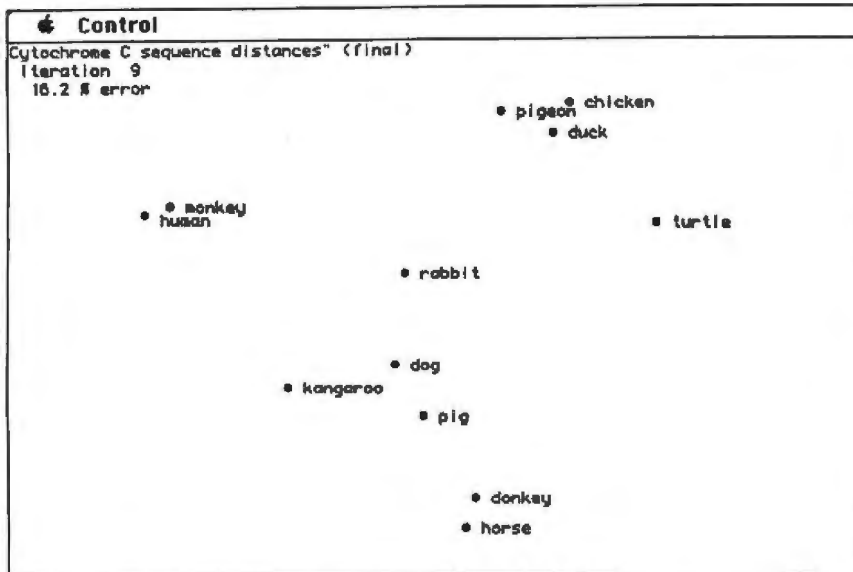

Figure 6: A Mapper application drawn from biology. The "distance" between any two species relates to the similarity between the genetic sequences of the protein Cytochrome C found in the species. Note how the birds and mammals are widely separated.

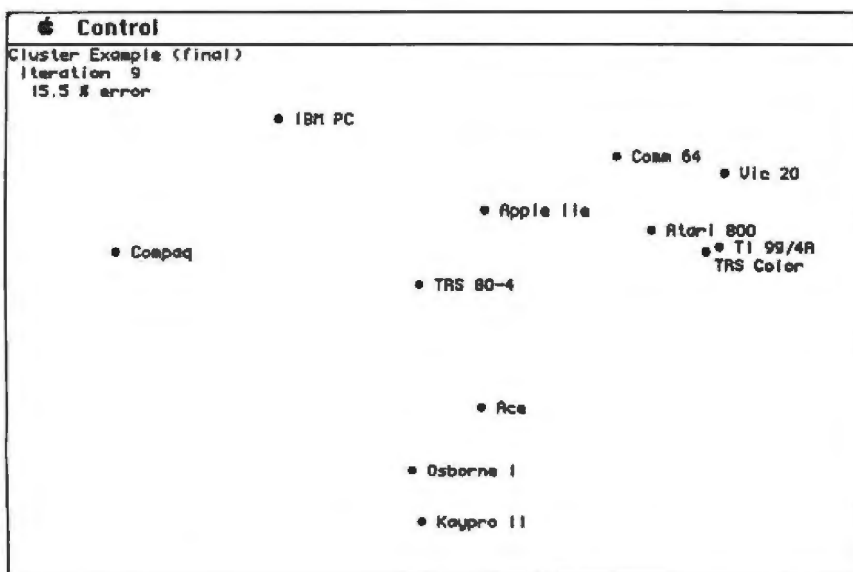

Figure 7: A similarity map of microcomputers in which the "distance" represents similarity in terms of price, amount of memory, and so on. In a previous BYTE article ("Cluster Analysis," September 1984), this data was expressed as a dendrogram (tree diagram) created by cluster analysis.

GET SERIOUS



...ABOUT ANALYZING YOUR DATA. You might be spreadsheeting your spreadsheet a little too thin. Or maybe you're starting from scratch. But if you're serious about data analysis, you're ready for SPSS/PC+™ — a full software family that brings you five high-powered ways to complete any data analysis task.

Enter it. SPSS/PC+ Data Entry™ — our latest option — takes the effort out of entering and correcting data.

Analyze it. The SPSS/PC+ Base Package provides a powerful array of statistical and reporting procedures.

Examine it. SPSS/PC+ Advanced Statistics™ lets you get more serious with your data.

Table it. SPSS/PC+ Tables™ produces presentation-ready tables instantly.

Chart it. SPSS/PC+ Graphics™ featuring Microsoft® Chart creates show-stopping graphs and charts.

SPSS/PC+ products are being put to productive use by serious fact finders in business, government and education. For countless purposes such as market research, Wage and salary studies, Survey analysis. And quality control. Plus each product is superbly documented and supported by SPSS Inc., a leader in statistical software for nearly 20 years.

So if you're serious about data analysis, step up to SPSS/PC+. For details, contact our Marketing Department.

CALL 1/312/329-3630

SPSS inc.

SPSS Inc. • 444 North Michigan Avenue, Suite 3000 • Chicago, Illinois 60611

In Europe: SPSS Europe B.V. • P.O. Box 115 • 4200 AC Gorinchem, The Netherlands • Telephone: +31183036711 • TWX: 21019

SPSS/PC+ runs on IBM PC/XT/AT's with hard disk. Contact SPSS Inc. for compatible microcomputers. SPSS/PC+, SPSS/PC+ Data Entry, SPSS/PC+ Advanced Statistics, SPSS/PC+ Tables and SPSS/PC+ Graphics are trademarks of SPSS Inc. for its proprietary computer software. Chart and Microsoft are trademarks of Microsoft Corporation. © 1988, SPSS Inc.

Power has never



looked this good.

Introducing the WYSEpc 286 and a brilliant new range of display options.

Now you can get higher speed and higher resolution, together, in extremely high style.

The WYSEpc 286 goes from "normal" speed to full 10 MHz throttle — *up to 25% faster than an IBM Personal Computer AT* — with the touch of a switch. A new lineup of graphics monitors lets you choose exactly the display capability you need.

Combine the WYSEpc 286 with the WY-530 monochrome or WY-630 color monitor and get outstanding performance. For enhanced color graphics, move up to the WY-640 EGA monitor. Or, bring CAD and desktop publishing applications into better focus, price-Wyse and pixel-Wyse, with the WY-700 high resolution graphics display (as shown with the WYSEpc 286 at left).

With the new WYSEpc 286, you can also choose the keyboard that's the best fit: either the standard AT-style, or the IBM Enhanced PC keyboard. And you get the complete compatibility you should expect in every other way, including more than 350 tested off-the-shelf software packages.

Up to 80 Mb of disk storage and 8 expansion slots give you

everything you need for the most demanding single-user applications, or to anchor the most effective, economical multi-user systems.



And behind this incredible display of power and versatility is a company that ships more terminals than anybody but IBM.*

Call toll-free or write, today, for more information.

WYSE

YOU NEVER REGRET A WYSE DECISION.



Please send me detailed information on the WYSEpc 286 and the entire Wyse product line.

Name _____ Title _____

Company _____ Phone _____

Address _____

City _____ State _____ Zip _____

Mail to: Wyse Technology, Attention: Marcom Dept. 286
3571 N. First Street, San Jose, CA 95134

Call 1-800-GET-WYSE B-8/86

Wyse is a registered trademark of Wyse Technology. WYSEpc 286, WY-640, WY-530, WY-630 and WY-700 are trademarks of Wyse Technology. IBM and Personal Computer AT are trademarks of International Business Machines Corporation. © 1986 Wyse Technology. *Dataquest 1985 terminal shipment update.

12MHz SPEED plus A MEGABYTE FOR DOS!



THEY ALL NEED NUMBER SMASHER/ECM™

Turn your PC or XT into the machine it should have been! The 12 MHz Number Smasher/ECM is the fastest accelerator on the market. It is also the most powerful, providing a **true megabyte** for DOS!

To break the 640K DOS barrier MicroWay designed a Memory Management Unit (MMU) that is tailored to DOS plus a 2000 byte resident driver—MegaDOS™. MicroWay calls this breakthrough Extended Conventional Memory. When you type CHKDSK with the board installed, your system will report 1,036,288 bytes total memory and 1,010,016 bytes free! Any conventional DOS program can utilize a full megabyte for data or code without changing a byte.

Downloading a mainframe application? ECM memory runs with any program that uses DOS for screen services including RM and MS FORTRAN and MS and LATTICE C! This means you have an additional 384K available for oversized applications. Programs which write directly to the screen require a simple patch to adhere to the new standard. MicroWay has already developed patches for the Lotus, WORDSTAR and AUTOCAD screen drivers. Release 1A of 1-2-3 jumps from 535,516 to 916,444 bytes available and runs faster than Release 2 for most worksheets.

Number Smasher/ECM is 100% compatible with all hardware and software including EMS and EGA boards. The compatibility is a result of control: its speed is switch, keyboard or software selectable from 4.77 MHz to 12.0 MHz. Applications which have not been upgraded to ECM can still be run by setting DOS to 640K or 704K and using the memory above DOS for I/O enhancers.

Number Smasher/ECM runs floating point bound programs faster than an AT or any other 80286 based machine. In fact, Number Smasher's 12 MHz 8087 runs a factor of three faster than the standard 80287 on the AT, delivering up to 125 kflops. Software is included for RAM Disk, print spooler, and disk caching, which speeds up floppy and hard disks by a factor of 2 to 10!

Number Smasher/ECM is the most cost effective productivity tool you can buy. The base board which runs at 9.54 MHz comes with 512K and costs only \$599! The complete system which includes a motherboard accelerator, one megabyte of memory and a 12 MHz 8087 is just \$1199. Call today to discuss your particular configuration. Remember: "The advantage of buying from MicroWay is outstanding personal service." (PC Magazine, 6/10/86 - p. 162)

Micro Way

The World Leader in 8087 Support

P.O. Box 79, Kingston, Mass. 02364 USA (617) 746-7341
Tempo House, London, U.K. call 01-223-7662

Number Smasher, ECM and MegaDOS are trademarks of MicroWay, Inc. MicroWay is a registered trademark of MicroWay, Inc.

PARALLEL INTERFACING: A TUTORIAL DISCUSSION PART 2: APPLICATIONS

BY STEVE CIARCIA

*Steve discusses various adapters
and possible uses for them*



Last month, I described circuits that use LSTTL (low-power Schottky transistor-transistor logic) and ALSTTL (advanced LSTTL). While these are workable, it is frequently easier and more advantageous to use a single LSI interface adapter instead of many smaller packages.

Interface adapters come in many forms: disk controllers, CRT controllers, ACIAs (asynchronous communications interface adapters) and USARTs, and various parallel I/O adapters. These devices are all programmable. You can alter their functions and the way they perform those functions, within reasonable limits, under software control.

As I indicated last month, this discussion is about parallel interfacing. I will thus confine myself to parallel I/O interface adapters. I will not, however, attempt a complete functional description of the parts that I mention. This would take up too much space. Instead, I'll point out some of the more significant differences between them. (The manufacturers' data sheets should be consulted if you need more detailed information.)

ALPHABET SOUP

When discussing parallel peripheral interface adapters, we encounter more alphabet

soup. The 6820, 6821, and 6520 are PIAs (peripheral interface adapters). The 6522 is a VIA (versatile interface adapter), the 6822 is an IIA (industrial interface adapter), the 8255 is a PPI (programmable peripheral interface), and the Z80 family's Z8420 is a PIO (parallel input/output controller). [Editor's note: Figures included in this article show pin-outs and functional block diagrams for five popular parallel interface LSI chips.]

While these various devices have many similarities, each has unique qualities and capabilities that suit it to certain situations better than the others. They could all be programmed for single-package solutions to the keyboard-input/printer-output functions described last month.

We use interface adapters for several good reasons. They act as buffers for the system bus during output. While drive capability may be somewhat enhanced, a more important function is protection: The adapter helps isolate the system from outside problems. Although the external problems, if serious enough, may permanently damage the adapter, the computer system

(continued)

Steve Ciarcia (pronounced "see-ARE-see-ah") is an electronics engineer and computer consultant with experience in process control, digital design, nuclear instrumentation, and product development. The author of several books on electronics, you can write to him at P.O. Box 582, Glastonbury, CT 06033.

would continue to function.

If outside devices were tied directly to the bus, this protection would be missing. If a peripheral device were tied directly to the microprocessor system bus, a failure in that device could seriously damage many of the components found in the microcomputer.

Interface adapters can also be used to compensate for timing differences between the computer system and slower peripheral devices, like printers, or relatively slow special-purpose integrated circuits. They are also versatile, and inputs and outputs can often be redefined at will without any hardware changes. Inputs can become outputs, and vice versa. The way the system functions can be altered readily to meet changing needs.

While most distinct functions of LSI programmable interface adapters can be implemented using LSTTL integrated circuits, the ability to accommodate changing circuit requirements without hardware modifications gives interface adapters an advantage in applications where such capability is either desirable or a requirement. Also, using a single package rather than many SSI and MSI chips can greatly simplify printed circuit layouts and shorten design time.

Z8420 PIO

A member of the Z80 family of microprocessors and support circuits, the Z8420 PIO differs from the rest of the parallel interface adapters discussed in this article in that its design dictates that all transfers of data through it are interrupt-driven. Its two I/O ports, which are designated A and B, each consist of eight data lines and two handshaking lines. Four distinct operating modes determine how the ports are configured.

In mode 0, all eight data pins of a port are configured as outputs; one handshaking pin is an output, and the other is an input.

In mode 1, all eight data pins of a port are inputs, and the handshaking lines are used as in mode 0.

Mode 2 employs the A port data lines, plus the handshaking pins for both ports, for bidirectional data transfers.

Pin-out and functional block diagram of the R6520 PIA.

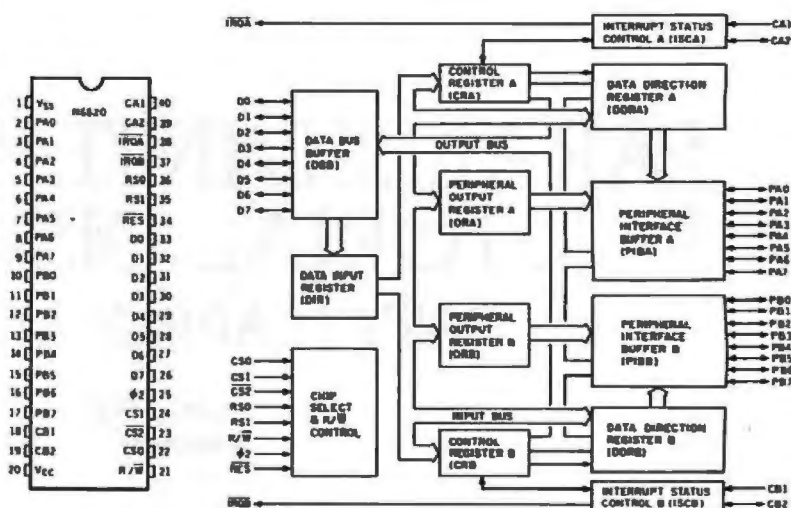

Pin-out and functional block diagram of the 6821 PIA.

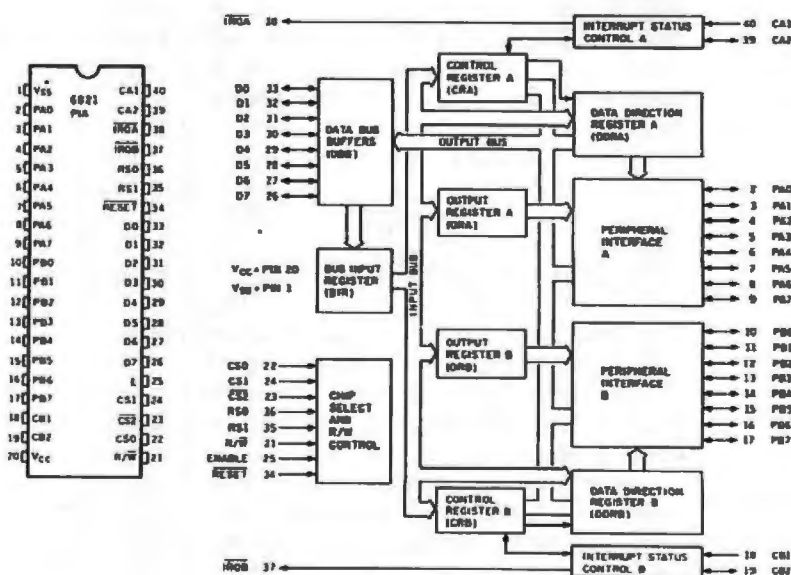

Pin-out and functional block diagram of the R6522 VIA.

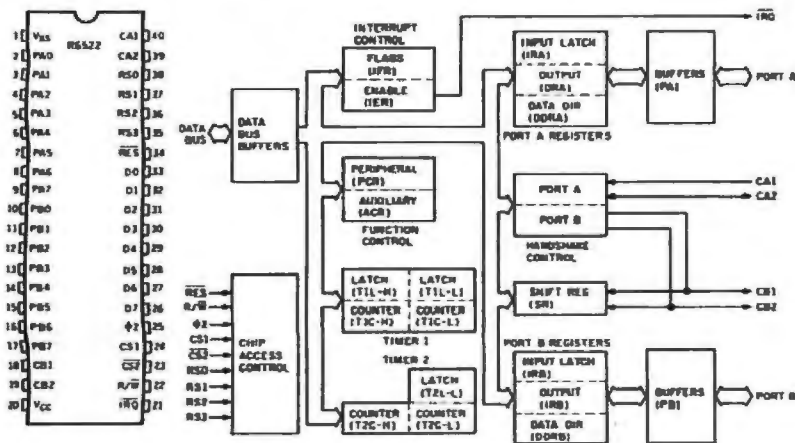

Pin-out and functional block diagram of the Z8420 PIO.

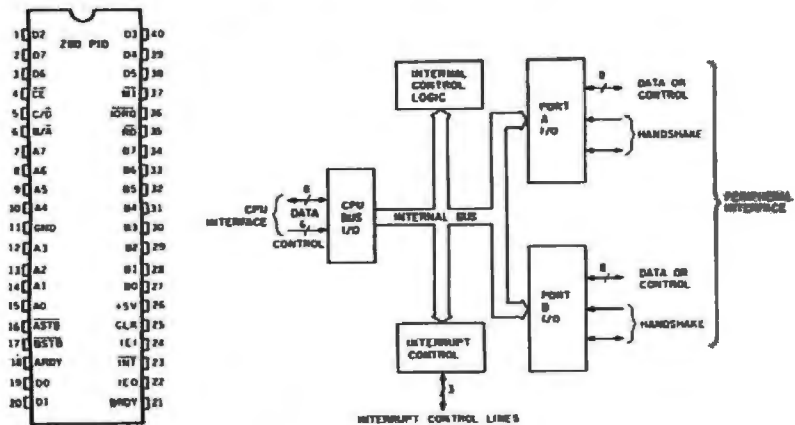

Pin-out and functional block diagram of the 8255A PPI.

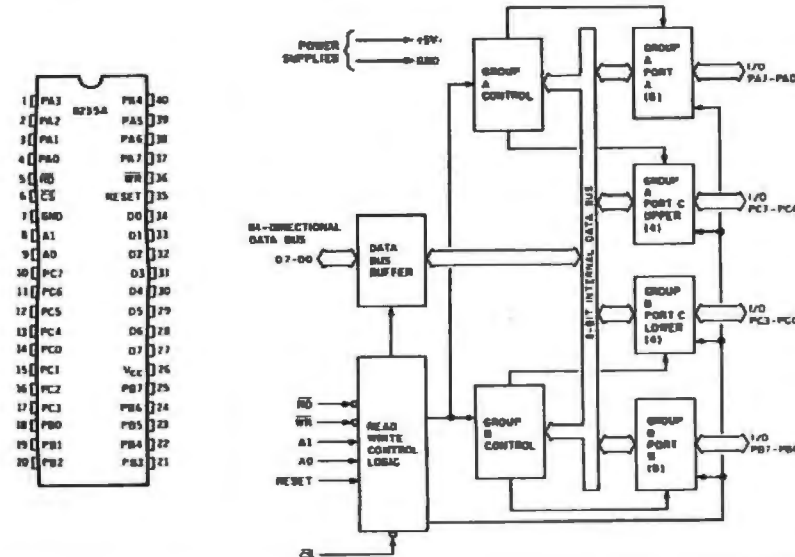

In mode 3, each individual data I/O pin is defined as either an input or an output. A mask register determines when input conditions generate an interrupt.

Because of the versatility of its interrupt capabilities, including extensive prioritizing, this integrated circuit is an excellent choice for a Z80 system when many sources of interrupts are incorporated and they must be carefully ordered and controlled.

8255 PPI

One of the earliest interface adapters on the market was Intel's 8255 PPI. This is also available from National Semiconductor and NEC. It was designed originally by Intel for use in 8008 and 8080A systems (which gives away its age).

The 24 I/O pins are grouped as three ports, designated A, B, and C. Three modes govern how these ports function. In general, the A and B ports are data ports, while the C port can be either a data port or a control port, depending upon the operating mode selected. The A and B ports can each be programmed as all inputs or all outputs (they are not programmable on a line-by-line basis, as are the ports of some other adapters).

In mode 0, each port is divided into two groups of four pins; each group of four pins is definable as all inputs or all outputs.

In mode 1, the A and B ports can be defined individually as an input port or an output port. In this mode, the upper half of port C handshakes for port A; the lower half handshakes for port B.

Mode 2 uses the eight port A lines as a bidirectional port, with five lines from port C used for handshaking and control.

The I/O pins of this IC are functionally similar to the B port of 6500- and 6800-series PIAs. N-channel transistors connect to both ground and the positive supply when a pin is configured as an output. Thus, when high, the outputs get to TTL levels (2.4 volts minimum) without pull-ups; to get to CMOS thresholds, the pull-ups (which are typically 10 kilohms) are then required.

(continued)

This IC can be especially useful where the largest possible number of I/O lines is required: It has 24 lines, whereas the other adapters discussed in this article have only 20.

6821 PIA AND FRIENDS

These interface adapters (6820, 6821, 6822, and 6520) differ primarily in the characteristics of their A and B ports. Except for the types of external devices that they are designed to interface to, these adapters are nearly identical.

They all contain six registers occupying four addresses: Each port has one control register, one data-direction register, and one data register. The data-direction register for each port shares an address with the port's data register. The active register is selected by the status of a bit in the port's control register.

If the bit is clear, the data-direction register is selected; if the bit is set, the data register is accessed. The data-

direction register for the A port is usually referred to as DDRA; the corresponding register for port B is called DDRB. The state (0 or 1) of each individual bit in the data-direction register determines whether the corresponding pin in the data register is an input or an output. If the bit in the data-direction register is a 0, the corresponding data-register pin is an input. If the bit in the data-direction register is set, the corresponding data-register pin is an output. This line-by-line programmability gives PIAs great versatility.

Each port has two handshaking pins. The pins for the A port are designated CA1 and CA2; for the B port, CB1 and CB2. CA1 and CB1 can be used only as inputs: An active transition on either pin sets a flag in the corresponding control register and will cause interrupt output IRQ-A or IRQ-B to go low if that interrupt is enabled. CA2 and CB2 can each be configured as either input or output, and both are

able to generate interrupts when used as inputs. The configuration of the control pins is determined by the settings of individual bits in the control registers.

The two ports of a PIA, while in many ways similar, differ significantly in the way they are implemented. Each line of the A port has an n-channel transistor between the pin and ground and a passive pull-up resistor between the pin and the positive supply. While this enables the port, when used as outputs, to drive CMOS without external pull-ups, it prevents the port, when in the output state, from sourcing more than a tiny trickle of current. The A port is thus not suited to driving NPN transistors or other components requiring source current.

The B port has an active transistor between the pin and ground and another between the pin and the positive supply. Thus, while the B port pins can source current to drive, for example, NPN transistors, they get only to TTL levels when used as outputs. If higher levels are required, such as when driving CMOS, external pull-ups must be used.

The 6820 and 6821 PIA designations are frequently used interchangeably, but significant differences are found, and the 6821 is the only one of the two in the current Motorola 6800-series microprocessor data catalog. Each pin of the A port of a 6821 is specified as capable of driving two TTL loads when used as an output and imposes a maximum of one and one-half TTL loads when driven as an input. The corresponding figures for the 6820 are much lower. Thus, the 6820 is preferred when a component with limited drive capability is driving the A port. When higher-output drive capability is required, the 6821 is the one that should be used.

The 6822 is similar to the 6821, except that all outputs are open-drain and capable of withstanding voltages as high as 18 V (although Motorola specifies a maximum normal working voltage of 15 V). The IIA can thus be used to interface with devices operating at levels substantially higher than standard 5-V logic.

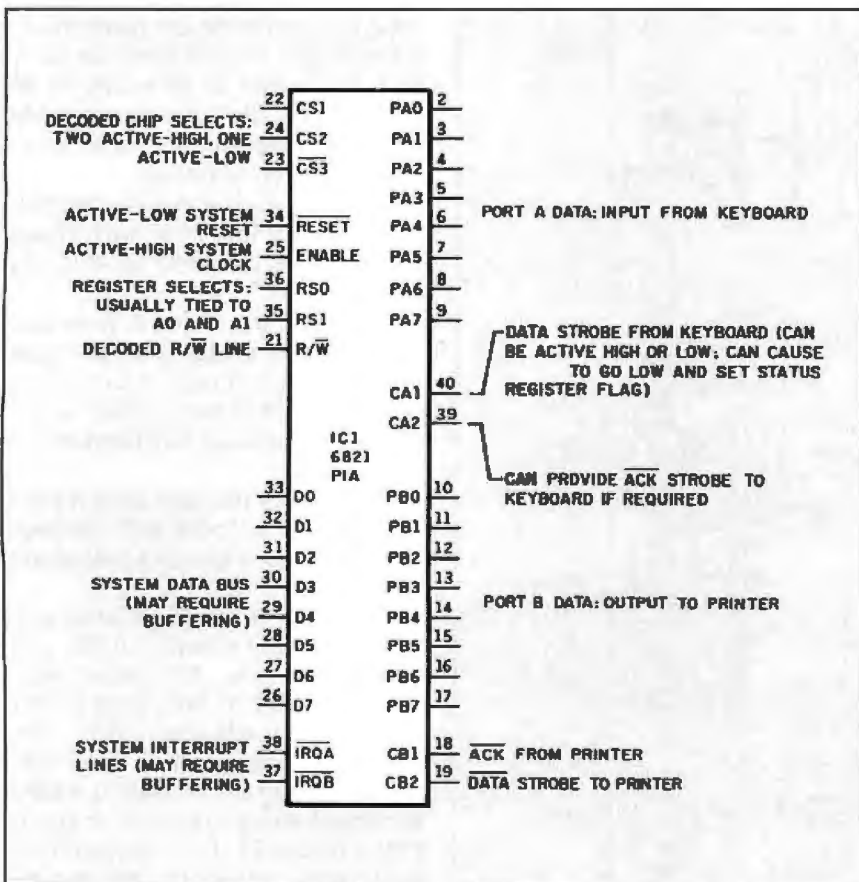

Figure 1: Using a PIA for keyboard-input and printer-output interfaces.

Many specialized laboratory instruments and industrial machine tools output BCD data with levels ranging from near ground to as high as 12 to 14 V. These devices are easy to interface using this part. As the designation "industrial interface adapter" implies, the high-voltage capability and large noise margins of this device can be quite useful dealing with the typically high noise and interference levels in an industrial setting.

The 6520 differs only slightly from the 6821. The 6520 outputs are specified to drive one TTL load, whereas the 6821 is specified at two TTL loads. The 6520's A port inputs impose one TTL load on a driving circuit rather than the one and one-half load maximum for the 6821's A port. Otherwise, the two parts are essentially identical.

6522 VIA

The 6522 is in many ways merely an enhanced 6520. The drive levels and loading of the A and B ports are essentially identical, as are the pin designations for the ports. The 6522 has 16 internal registers occupying 16 addresses and uses four register-select lines instead of two. Only one active-high chip select is provided, and there is only one interrupt output instead of two.

The additional registers control a number of other functions: the T-1 one-shot 16-bit timer/counter that decrements with the phase 2 system clock, plus a second counter, T-2, that can decrement with each time-out of the T-1 timer or with each negative transition on pin PB6.

The T-2 counter is capable of counting pulses from an external source. The chip can generate a square wave on pin PB7, whose frequency is determined by the T-1 counter. A bidirectional 8-bit shift register makes simple serial I/O possible. In addition, the programmed handshaking capabilities of the ports are enhanced, and the 6522 has the ability to latch input data under the control of an external device.

APPLICATIONS

In general, it is easiest to match the microprocessor to the interface

adapter by chip series. With a Z80, use a Z8420 PIO. With a 6809, use a 6821, and so on. The 6500- and 6800-series microprocessors and interface adapters can usually be freely mixed without timing or other problems. But you can use an 8255 adapter in a 6502-based system if you decode

separate active-low READ and WRITE strobes and provide an active-high RESET signal.

A 6522 VIA is found in the 8088-based Victor 9000 PC and in the 68000-based Macintosh, which also uses a Z80-series dual serial-interface

(continued)

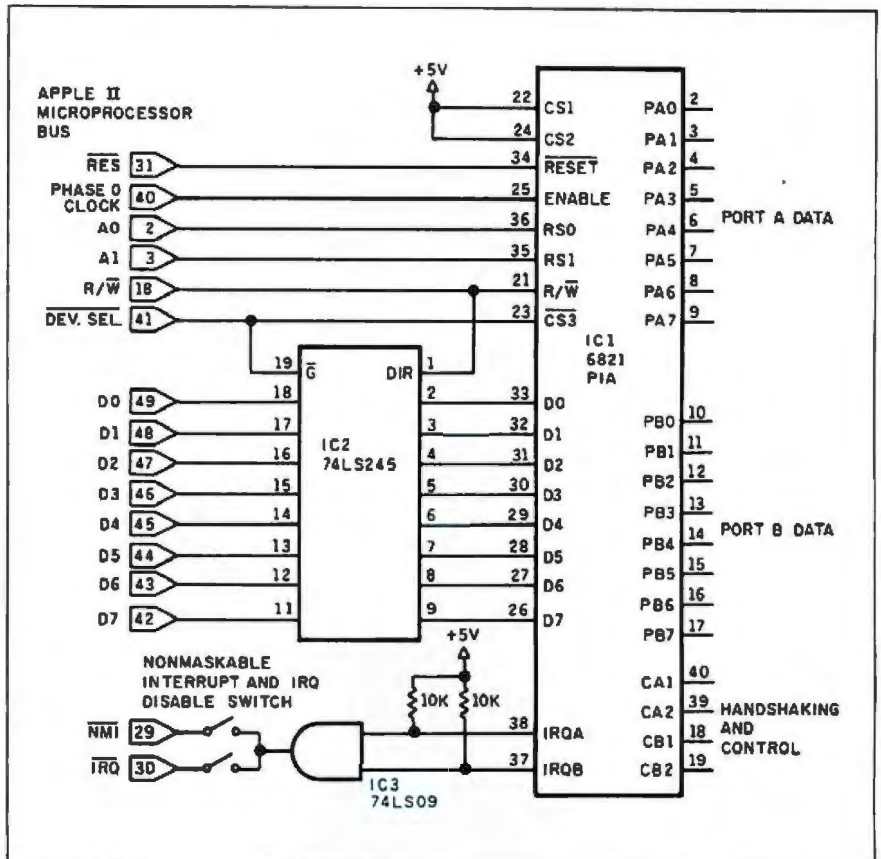

Figure 2: The essential PIA interface. (This example is from an Apple II computer.)

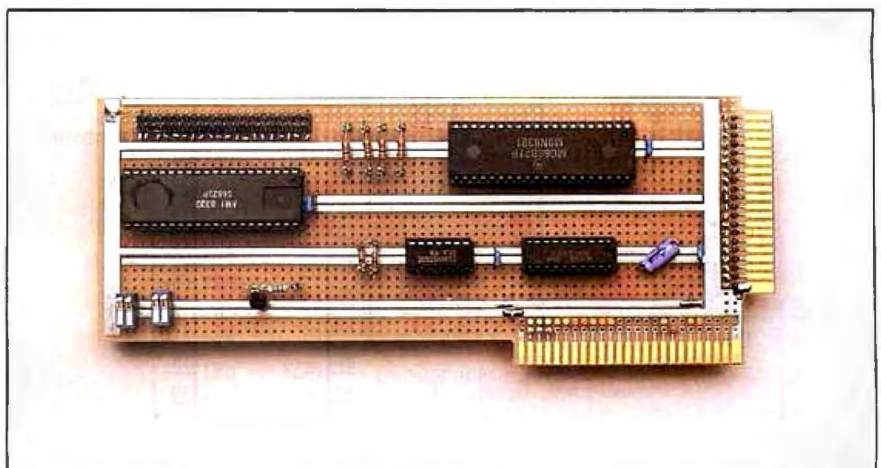

Photo 1: A dual PIA card for the Apple II computer.

chip. A great deal of intermixing can be done if circuit characteristics and component capabilities are compatible. It's often best to use a familiar part if it will do the job satisfactorily, rather than switching to an unfamiliar

component with an insignificant performance increase.

In the 6500/6800 family, the 6522 should be used only if its enhancements over the 6821/6520 are useful. The built-in timer/counters and ex-

tended handshaking abilities of the 6522 can be useful, but the part is more complex and expensive than the 6821, and its timing requirements are more critical.

INTERFACING WITH THE 6821

Any of these interface adapters can be used to replace the LSTTL circuits outlined last month in part 1 (figures 2-5), with functionally similar results. They can generate the handshaking signals necessary for printer interfacing automatically, in hardware. Any of them can be used for keyboard input and printer output by programming the appropriate handshaking.

The hardware example described this month uses the 6821 since its configuration for this purpose is relatively straightforward and easy to describe. The Z8420 and 8255 could also be used, of course, but the configuration procedure would be more complex.

Figure 1 shows the A port of a 6821 used to interface a keyboard. The keyboard's data outputs drive PA0-PA7 on the PIA, configured as inputs. The keyboard data strobe is connected to CA1, and CA2 can be connected with a keyboard input, if that is required. A transition on CA1 will set a control-register flag and can be used to cause a processor interrupt via output IRQ-A. If the interrupt output IRQ-A is left unconnected, keyboard I/O can be handled through polling. The details of the chip-select decoding were outlined last month in figure 2a on page 88.

Figure 1 also shows port B of a PIA being used to drive a parallel printer. PB0-PB7 drive the printer data lines. CB2 generates the DATA strobe (active-low) one clock cycle after the data is written to the B port. The ACKnowledge from the printer triggers CB1. This will set a flag in the B port control register, and, if IRQ-B is connected to the processor-interrupt line, the ACKnowledge from the printer will cause a processor interrupt. Output to the printer can be controlled either through an interrupt subroutine or by polling.

An 8255 could also have been used to perform these functions. With the 8255, the A port functions as the key-

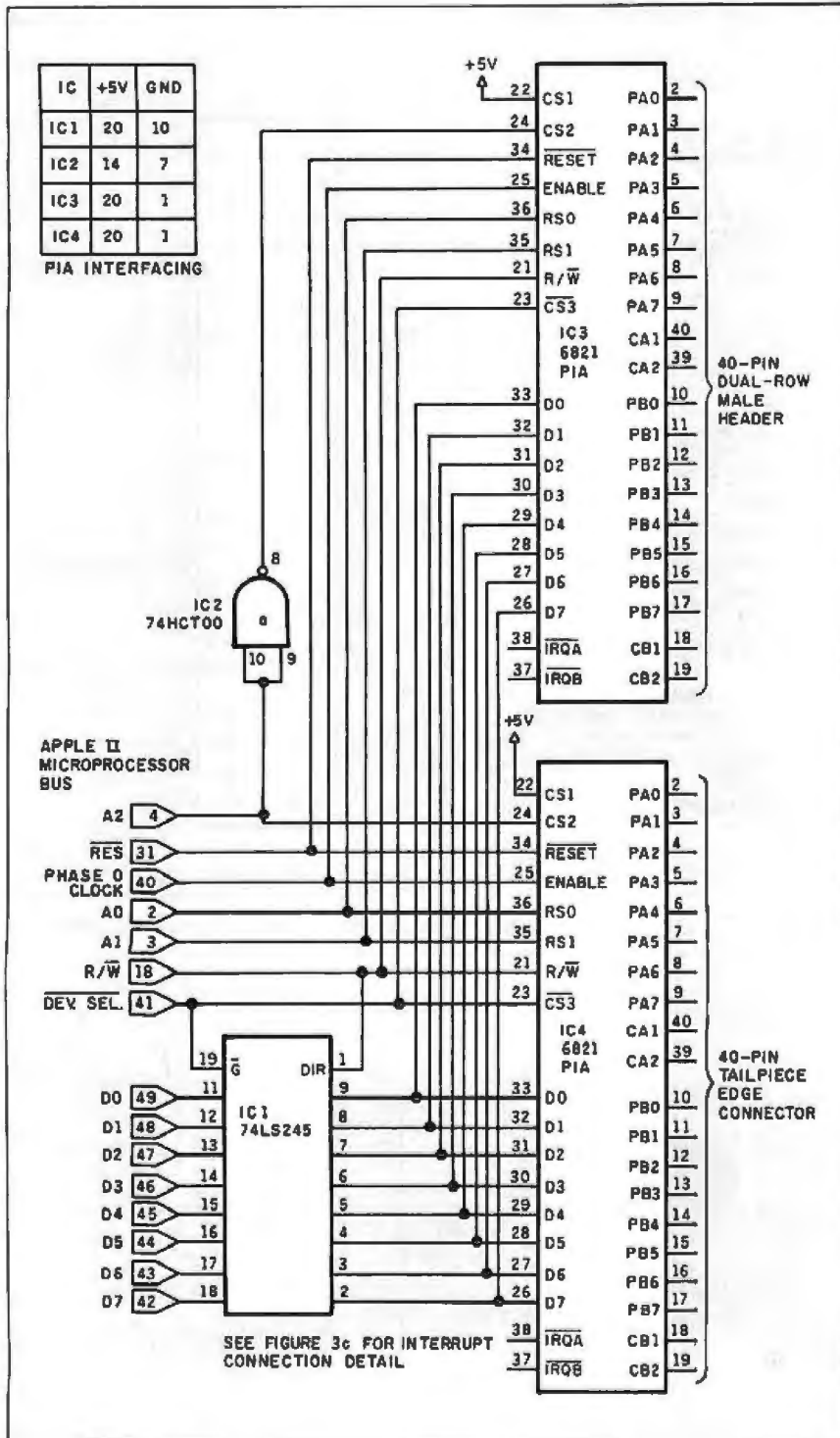

Figure 3a: A dual PIA interface for the Apple II computer.

board input, with the four high-order pins of the C port used for handshaking. The B port outputs data to the printer, with the four low-order pins of the C port for handshaking. The 8255 would be configured for mode 1 operation.

DUAL PIA INTERFACE FOR APPLE II

Figure 2 shows the essential elements of a PIA interface connected to the Apple II microcomputer bus. (See photo 1.) The chip-select decoding can be done various ways.

Each Apple II peripheral slot has 16 exclusive I/O addresses assigned to it. Pin 41 on any given slot is low when any of the slot's 16 addresses is referenced. In the interface depicted in figure 3a, one PIA occupies the lowest four addresses in the 16-byte range, and the other PIA is addressed at the next higher four addresses.

The pin 41 DEVICE SELECT microprocessor bus signal partially enables both PIAs when it goes low, driving the single active-low chip-select input on each PIA. Microprocessor bus address line A2 drives an active-high enable of IC3 through 74HCT00 NAND gate IC2a, wired as an inverter. A2 is tied directly to an active-high enable of the second PIA, IC4.

When pin 41 is low, the active interface adapter will be selected by A2. A2 will be low when the lowest four I/O addresses for the slot are referenced, high for the next four higher addresses, then low again for four, and finally high for the highest four. Each PIA occupies eight addresses out of the sixteen total. However, the chip still has only six internal registers accessed through four addresses.

The two PIAs occupy the eight lower of the slot's sixteen I/O addresses and, without further decoding, the upper eight addresses, also. If you had a large enough prototyping card, you could have four PIAs on a card, using half of a 74LS139 decoder to divide the 16-byte address range into four 4-byte ranges, with a PIA assigned to each block.

Figure 3b shows this approach. The 74LS245 transceiver (IC1 in figure 3a) that buffers the data lines is enabled directly by pin 41 on the micropro-

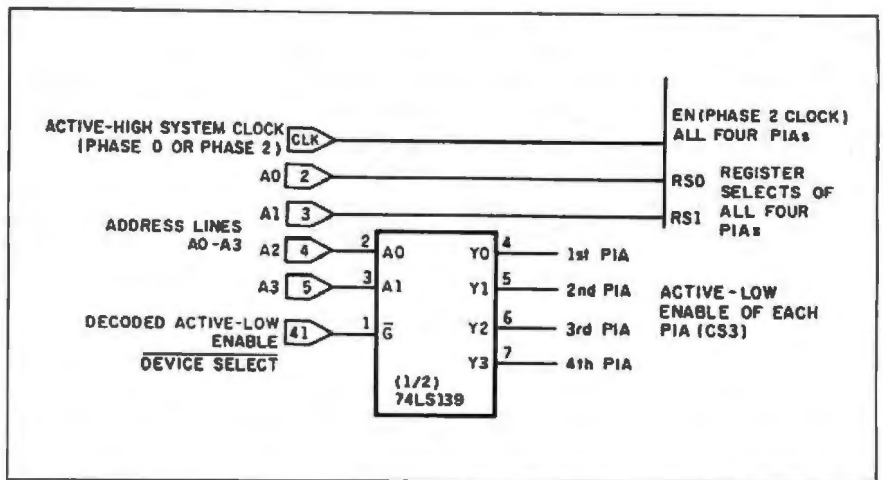

Figure 3b: Using a 74LS139 decoder to put four PIAs in a single Apple II slot.

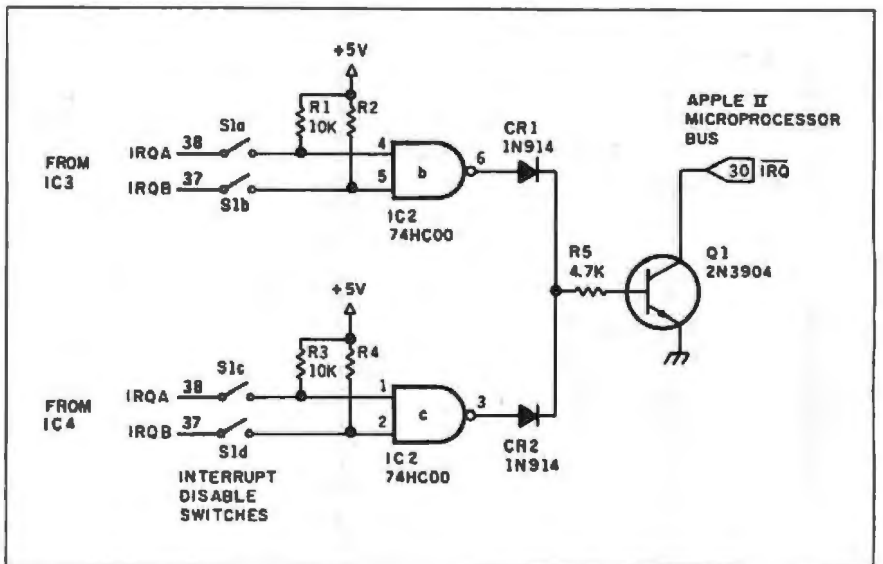

Figure 3c: An interrupt circuit for the Apple II. The DIP switches (S1a through S1d) allow any of the four PIA-generated interrupts (IRO-A and IRQ-B from IC3 and IC4) to be disabled.

cessor bus and is always active whenever any of the slot's addresses is referenced.

For interrupt generation, two of the gates in the 74HC00 NAND gate package (IC2b and IC2c in figure 3c) are used to source base current to a 2N3904 transistor through 1N914 or similar switching diodes (CR1 and CR2). The 2N3904 transistor, in turn, drives the IRQ pin on the bus, pulling it low when active. Each interface adapter has two interrupt outputs, IRQ-A and IRQ-B, both open-drain, active-low. Each is held high with a 10-kilohm pull-up resistor (R1 through

R4) and drives an input of a NAND gate (IC2b and IC2c).

DIP switches S1a through S1d enable the user to disconnect the interrupt outputs on the PIAs from the NAND gates. Any of the four interrupts can be enabled/disabled through these switches. The choice of the NPN transistor is not critical. Any general-purpose NPN transistor will do. The 2N3904 was selected because it is easy to find. The collector of the transistor is tied to the IRQ line on the microprocessor bus, and the emitter is connected to ground.

(continued)

Both interrupt outputs of a PIA are normally high. This causes the outputs of the NAND gates IC2b and IC2c to be low and keeps transistor Q1 turned off. If a PIA interrupt output goes low, the output of the NAND gate driven by it will go high, sourcing base current to transistor Q1,

which turns on, pulling the IRO line nearly to ground. This interrupts the 6502 microprocessor (assuming the interrupt has not been masked). DIP switches S1a through S1d are provided so that each interrupt output can be disconnected, allowing the corresponding port to be used for

polled I/O with a control-register bit for a flag.

INTERFACES FOR THE PIA CARD

Figure 4 shows an ADC0809 8-channel, 8-bit A/D converter (IC1) interfaced to the PIA card. Connection between the boards is through 40-conductor ribbon cable with an appropriate connector at each end. Typically, a 40-pin edge-card or header-socket connector would be used.

The PIA card and the external card are connected so that the control pins of the converter, ALE (address latch enable), START CONVERSION, and the address inputs (ADD A, ADD B, and ADD C) are driven by the A port of one of the PIAs. The guaranteed input threshold for a high for the ADC0809 is 1½ V below the positive supply. With the converter operating at 5 V or somewhat higher (e.g., 5.12 V, for ratiometric conversions), the B port pins aren't guaranteed to reach that minimum, 3.5–3.62 V, without pull-ups.

The eight data outputs of the converter are therefore connected with the 6821 port B. The PIA's A port, with its built-in pull-ups, easily meets the threshold minimums of the converter. Figure 5 shows how the A port of a PIA, with its built-in pull-ups (RA shown in figure), can be used with optical couplers as an isolated input port with up to ten I-bit inputs (PA0–PA7, CA1, and CA2).

The diagram shows an unbiased phototransistor (Q1) and an LED (CR1). They can be separate components, as pictured, or combined into one of the commercially available isolator packages like the 4N26 or 4N28. This arrangement can be used to sense switch openings or closings and to monitor low-speed events in circuits with incompatible voltage levels.

The "switch" could be window foil in a security system, or it could be another phototransistor, illuminated by its own LED, that is part of an intrusion alarm system.

You'll find a number of additional uses for this type of interface. The current-sourcing capability of the B port could be used to drive NPN transistors, which in turn could drive

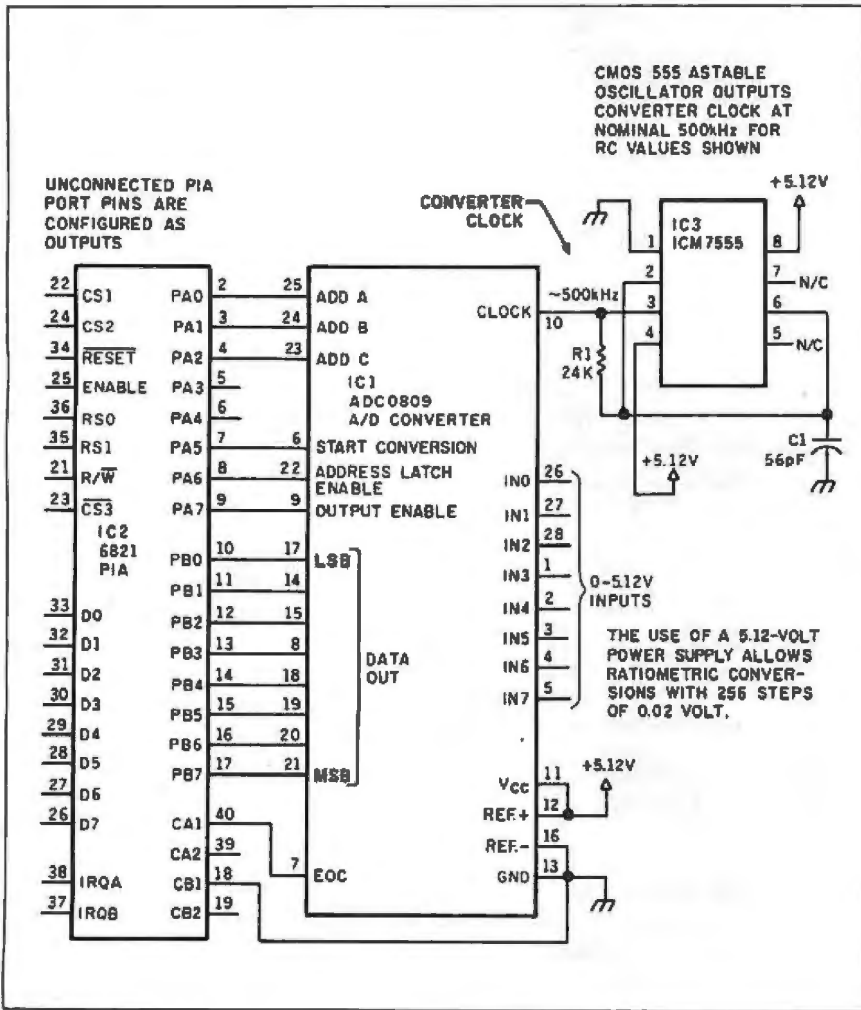

Figure 4: An ADC0809 A/D converter with dual PIA interface.

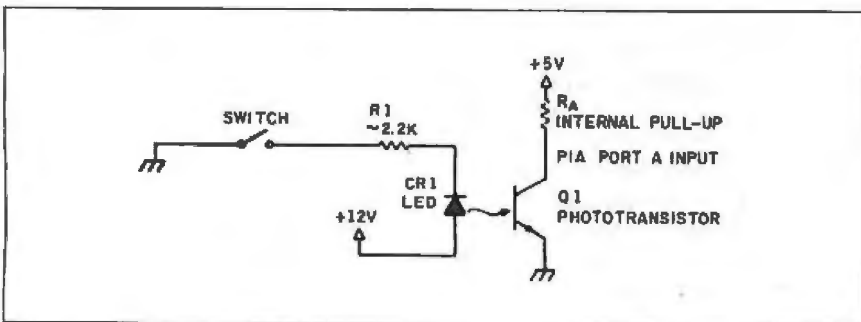

Figure 5: Using an optoisolator to interface to the A port of a PIA.

CIRCUIT CELLAR

relays or solenoids. Specialized relay drivers, like the NE5090, could be driven by either port, although the built-in pull-ups of the A port could guarantee that no relays would be active on start-up.

CONCLUSIONS

Knowing the difference between a PIA and an IIA might not be earthshaking news, but there will be that trivia question someday that only you can answer. Discussing basic electronics might seem redundant to many of you, considering the usual Circuit Cellar fare, but I do get a lot of interfacing questions. Perhaps this article will help answer some of them.

I haven't spent the summer needlessly proving E=IR, however, and it will be back to the snowy blizzards of the past this fall.

CIRCUIT CELLAR FEEDBACK

This month's feedback begins on page 54.

NEXT MONTH

Build the Circuit Cellar data encryptor. ■

Special thanks to Frank Kuechmann for his contributions to this article. JDR Microdevices provides the chips mentioned in this and many previous Circuit Cellar projects.

There is an on-line Circuit Cellar bulletin board system that supports past and present projects. You are invited to call and exchange ideas and comments with other Circuit Cellar supporters. The 300/1200/2400-bps BBS is on-line 24 hours a day at (203) 871-1988.

Editor's note: Steve often refers to previous Circuit Cellar articles. Most of these past articles are available in book form from BYTE Books. McGraw-Hill Book Co., P.O. Box 400, Hightstown, NJ 08250.

Ciarci's Circuit Cellar, Volume I, covers articles in BYTE from September 1977 through November 1978. Volume II covers December 1978 through June 1980. Volume III covers July 1980 through December 1981. Volume IV covers January 1982 through June 1983. Volume V covers July 1983 through December 1984.

To be included on the Circuit Cellar mailing list and receive periodic project updates and support materials, please circle 100 on the Reader Service inquiry card at the back of the magazine.

Attention all FX80, FX100, JX, & RX owners:
You already own half of a great printer

Now Only \$79.95



Now for \$79.95 you can own the rest. You see, today's new dot matrix printers offer a lot more.

Like an NLQ mode that makes their letters print almost as sharp as a daisy wheel. And font switching at the touch of a button—

in over 160 styles. But now, a Dots-Perfect upgrade kit can make your printer work like the new models in minutes. At a fraction of their cost.

Call now and use your Visa or Master Card. Don't replace your printer, upgrade it!

1-800-368-7737

In California: 1-800-831-9772



Dots-Perfect



*** Dresselhaus**

837 E. Alosta Ave., Glendora, CA 91740 Tel: (818) 914-5831

An upgrade kit for EPSON FX, JX and RX printers



EPSON is a trademark of EPSON America, Inc.

KEYS CAN TALK TOO!

Function-Kease™ make your keyboard talk at a glance.



Function-Kease™ for:
 1-2-3 Wordstar
 MS-DOS Symphony
 Framework dBase III
 Crosstalk Pfs: Write
 Microsoft Word
 IBM Filing/Reporting Asst.

**IBM-PC, XT, AT
 Compaq
 Epson
 Apple IIe
 Sharp PC-7000**

Function-Kease™ are solid plastic keycovers molded to fit your computer.

\$19.95

When Ordering specify software and computer model. Check, Visa, Mastercard and approved POs are accepted. Custom and dealer inquiries welcome.

Pictured is example of Function-Kease™ for 1-2-3.

Syntronics

4901 Morena Boulevard, Suite 302
 San Diego, California 92117
 619 692-0695

NOBODY ELSE HAS MADE THE CONNECTION.

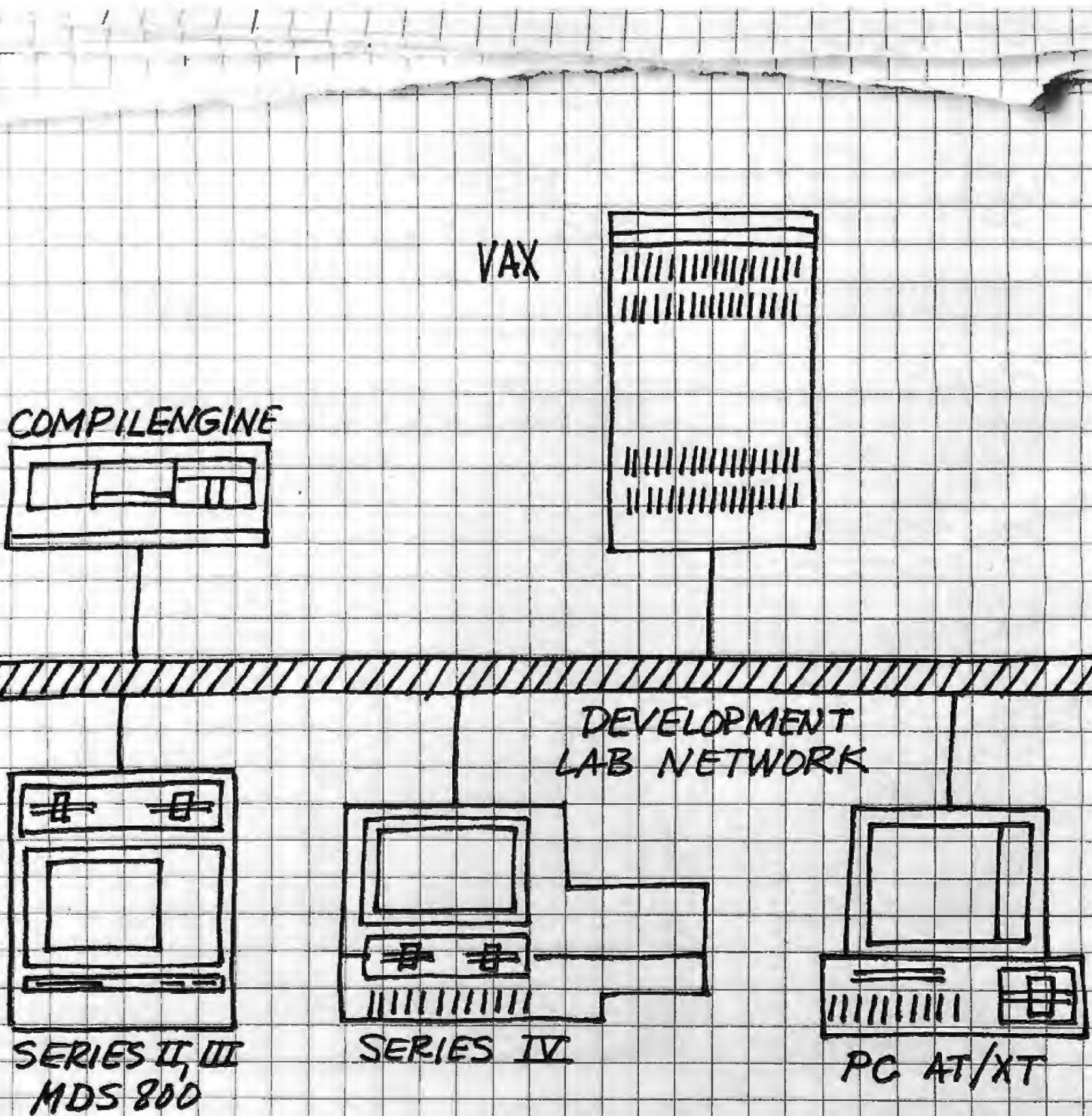

There's only one way to link the extensive resources of Intel's microprocessor development system with the power of a DEC VAX® and the affordability of the IBM® PC.

And that's via our enhanced version

NETWORK RESOURCE MANAGER

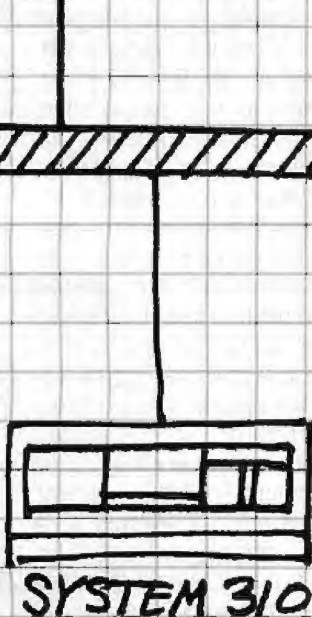
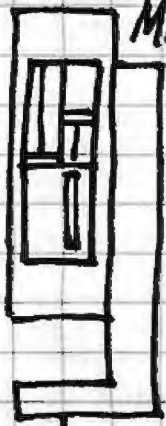

of OpenNET™ for the development lab.

Thanks to this open architecture network, engineers can have immediate, and transparent, access to other team members' work.

Plus you have the ability to add special-purpose hardware to make those teams more productive.

For example, by connecting our high-performance file server, the Network Resource Manager, you can off-load file management and job distribution from the shoulders of your design team. On the off chance nobody wants to spend his time chasing down floppy disks.

And then you can hook up an 80286-based Compilengine to off-load compute-bound compilations from VAXs and workstations. Leaving them, and their human partners, more time for interactive tasks.

Equally important, the network maximizes the value of your existing development

hardware while minimizing your outlay for new equipment.

That's because OpenNET adheres very rigidly to some very flexible standards. Standards like Ethernet/IEEE 802.3. And the ISO message delivery and Intel/IBM/Microsoft® Network File Access protocols.

All of which means existing development hosts, languages and tools, including ICE, are instantly compatible with the latest ones. So you can avoid obsoleting one set of tools just to use another.

We'll even take full responsibility for servicing and supporting your network. Anywhere in the world.

Sound like we've got things together? Then call us at (800) 548-4725.

Ask to meet with one of our experienced network engineers. We'll see you make all the right connections.

VAX is a registered trademark of Digital Equipment Corporation. IBM is a registered trademark of International Business Machines Corp. OpenNET is a trademark of Intel Corporation. Microsoft is a registered trademark of Microsoft Corporation. © 1986 Intel Corporation.

THE DEFINICON 68020 COPROCESSOR

Software to give you 32-bit capabilities in a 16-bit machine

Editor's note: This is part 2 of a two-part article describing Definicon Systems Inc.'s DSI-020 coprocessor board for IBM XT, AT, and work-alikes. Part 1 (July BYTE) described the hardware and operating system kernel. Part 2 will focus on the software available for the board. For full information on the Motorola 68020 CPU chip, see "The MC68020 32-bit Microprocessor" by Paul F. Groepler and James Kennedy (November 1984 BYTE).

Last month we presented the schematics and hardware theory of operation for the DSI-020 coprocessor. Hardware, however, doesn't function too well without software tools; so this month, after looking at the remaining hardware topics, we'll discuss the available software support.

EFFECTIVENESS OF THE 68020'S INSTRUCTION CACHE

A jumper has been provided so that the internal instruction cache memory of the 68020 can be manually disabled. Running a program with and without this jumper quickly demonstrates how effective an instruction cache can be.

On short programs, such as the memory test in listing 1, the speed advantage with the cache is about 40 percent. The reason for this enhancement becomes evident if the scope photograph of the bus activity with the cache on (photo 1) is compared to that with the cache off (photo 2). Both photos were taken of the 68020 \overline{AS} address strobe with a time base of 1 microsecond per centimeter. A high level on the \overline{AS} signal indicates no bus activity. If the \overline{AS} signal is low for 75 percent of the total time, the bus is fully utilized. Note that bus access occurs only during instructions that actually reference data memory when the cache is on, while the bus has to also supply all the program code fetches when the cache is off.

By comparison, on floating-point-intensive programs, such as the Whetstone benchmark, the difference is only a few percent. When the number of CPU wait states is increased (for slow memory) the speed enhancement due to the cache becomes even greater. If you wish to investigate this phenomenon further, pull the $\overline{2WATS}$ input of the DSACK20 PAL low to simulate the effect of having slower memory on the system. The program execution in photo 1 was optimized in that the data fetches are aligned on a long-word boundary, while in photo 3 data fetches are not aligned on a long-word boundary, and thus two 16-bit fetches are required for each 32-bit access. In photo 2 (cache off) you can clearly see the execution of each instruction. Note that the two

Listing 1: Memory test program.

```

                ORG      $00004000
;
; set to 4030 if test on longword boundary
;
TSTORG EQU      $00004032
;
START:  MOVE.L   #RWADDR,A0
        MOVE.L   #$$5555AAAA,D0
BEGIN:  CLR.L    D1
LOOP:   MOVE.L   D0,(A0) ;data memory access
        CMP.L    (A0),D0 ;data memory access
        BNE.L    ERROR
        SUBQ    #1,D1
        BNE.L    LOOP
        BRA.L    BEGIN
;
ERROR:  STOP    #0
;
                ORG      TSTORG
;
RWADDR: DC.L    0
        END

```

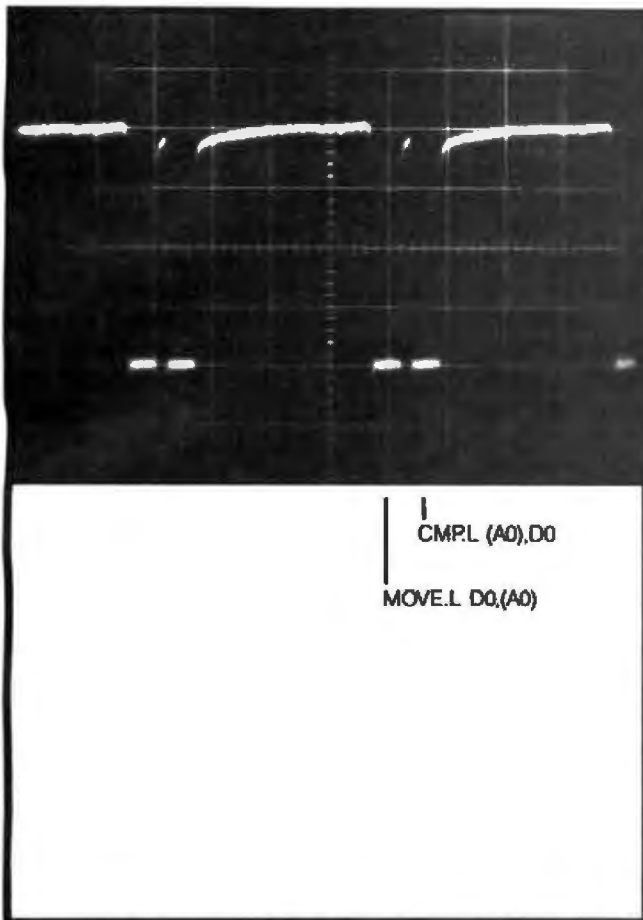



Photo 1: The two fetches referencing data locations are displayed. All op-code fetching is from the cache.

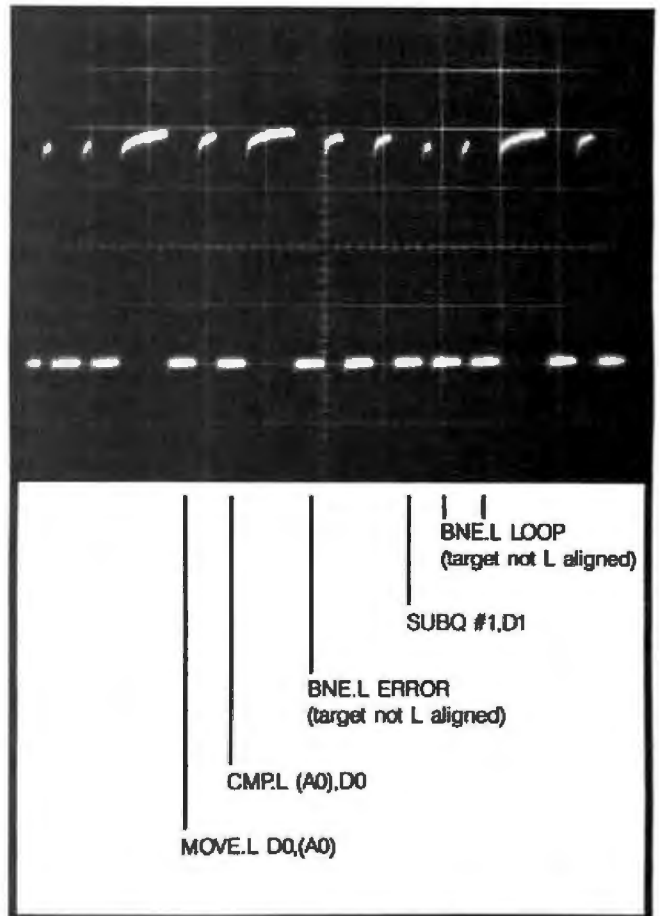

Photo 2: With the cache disabled, all data fetches are seen on the scope. Note that two fetches occur for each of the conditional branches to non-long-word-aligned addresses.

conditional branches reference non-long-word-aligned targets and require two cycles.

THE EEPROM CONTAINING THE DSI-020 SERIAL NUMBER

To get some of the larger software houses to port their products to the DSI-020, we had to provide a means to ensure that the software was indeed running on the board for which it was sold. The on-board 9306 COPS EEPROM can be interrogated by the kernel using function 33. It will return the serial number as a 32-bit integer. The most significant byte of the serial

(continued)

Trevor Marshall, Christopher Jones, and Sigi Kluger are engineers with Definicon Systems Inc. They can be contacted at 31324 Via Colinas #108/9, Westlake Village, CA 91362.

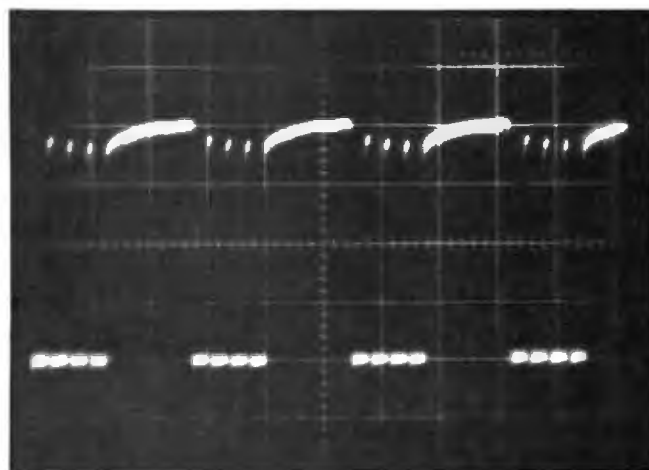

Photo 3: This photo shows two memory fetches for each of the data locations due to the data not being aligned on a long-word boundary. Instead of fetching 32 bits of data, two 16-bit transfers are executed.

*The kernel software,
a simple assembler, a
linker, and a debugger
are bundled with
the DSI-020 hardware.*

number carries information about the hardware revision level.

Some bytes of this EEPROM are available for storing software parameters (such as passwords).

OPERATING SYSTEM

The basic operating system for programming or operating the DSI-020 is MS-DOS, and all communication between the user program and the MS-DOS host occurs via the 68020 TRAP #14 instruction. Parameters are transferred in registers. Data registers are used for values, address registers for pointers. All functions save only the registers they use, but data registers used to pass values may return with their contents altered. Abnormal conditions, such as trying to execute an invalid instruction, division by zero, attempts to use privileged instructions, or undefined function calls, will cause an error message on the host's console and immediate termination to MS-DOS or the debugger.

On entry to a program the kernel sets up the stack at the top of RAM and preloads the following registers:

- A0.L program entry point (4000 hexadecimal)
- A1.L start of heap
- A2.L top of heap/bottom of stack

- 4(A7) ARGV pointer
- 8(A7) ARGC

ARGC is the count of command-line arguments that were used when the program was invoked. ARGV points to a list of ARGC pointers that address the command-line arguments, saved as ASCIIZ strings (zero-terminated ASCII strings).

For HEX or IMAGE programs the entry point must be 4000 (hexadecimal). The remainder of your program can be located anywhere in the user program space. Files in DSI-LINK format (.E20) may be located at any address above 3FFF.

You can stop the program either by executing a TERMINATE service request (function 15) or by returning to the kernel using the RTS instruction. The TERMINATE service request always returns 00, while RTS supplies a value in D0.B to MS-DOS as return code. Since the return code may be tested in a conditional MS-DOS batch stream, the RTS method is preferred, provided you can maintain the stack integrity.

Your program may set up its own stack pointer, which can be located anywhere within the user program space. Alternately, you can use the system-provided default stack space allocated to start at the end of RAM and grow downward.

The interface kernel uses only 16K bytes of the 68020's address space, allowing your application to use almost the full megabyte of available RAM. Table 1 shows the memory map utilization. Note that the 68020 uses the first 400 hexadecimal bytes for its trap vector locations, and the rest of the address space to 4000 hexadecimal is used for disk buffers and the kernel code itself. After a pro-

grammed or power-on reset, the 68020 picks up its initial stack pointer from address 0 and its initial program counter value from address 4. This value points to the 2010 kernel code, which loads your program from the disk, relocates it to 4000, places the stack at the top of RAM, points HEAPLOW at the top of the program code, and begins execution.

The kernel software, a simplified assembler, a linker, and an assembly-level debugger are bundled with the DSI-020 coprocessor hardware. The simple assembler supports all the 68000 op codes, plus the 68881 floating-point instructions. However, many of the newer 68020 addressing modes are not supported. In addition, the syntax of those newer addressing modes that are supported follow the 68000, rather than the 68020, conventions. The debugger provides facilities similar to those of DOS's Debug or CP/M's DDT within the 68020 environment.

The kernel can load and execute disk files that have been created using Motorola S record format, absolute image format, or the DSI-020 linker. Programs created in S record or image format must load and begin execution at 04000 hexadecimal.

PROGRAMMING THE 68020 KERNEL IN ASSEMBLY LANGUAGE

Listing 2 contains a short program (in simplified 68020 assembly language) that takes an MS-DOS ASCII file of any length and types it on the console. Note that the program uses the (preferred) UNIX-like I/O functions 5, 8, and 9 to access the DOS file system. On entry from the kernel the stack is already initialized and pointers to the command-line parameters have been placed on it. The filename you give is opened for reading using function 5. The kernel returns a "handle" used to identify this file on subsequent accesses. A multibyte read command (80000 hexadecimal bytes) is executed. The return code, which is zero (if nothing has been read) or the actual number of bytes read, is examined. If it is zero, the program terminates. Otherwise, the number of bytes actually read are written to the

(continued)

Table 1: Memory map of the DSI-020. The DSI-020 decodes 16 megabytes of 68020 address space.

00000000-000003FF	reserved for 68020 reset and trap vectors
00000400-00003FFF	used by the kernel
00004000-000FFFFF	user program RAM space
	user default stack grows down from top of RAM
00F7FE03	2681 DUART base address
00F00000	addresses the VEC20 PAL
	reads EEPROM and RS-232C channel B signals

DEFINICON SOFTWARE

Listing 2: Program to type an MS-DOS file on the console. Note the calls to the DSI-020 kernel for file I/O and the alternate console I/O method for the error message.

```

;THIS PROGRAM TYPES A FILE ON THE CONSOLE USING THE DSI-020 CARD
;USE: LOAD TYPE FILENAME
;
;          ORG      $00004000
;
ENTRY:  MOVE.L   8(A7),D0      ; GET ARGC PASSED BY KERNEL INIT
        MOVE.L   4(A7),A1      ; GET *ARGV
        MOVE.L   4(A1),A0      ; GET POINTER TO ARGV[1]
        CMPI.W   #2,D0         ; DO WE HAVE AN ARG?
        BEQ.B    OKAY         ; YES, GO ON
        MOVEQ    #1,D0         ; ELSE SET BOOS REQUEST
        MOVEQ    #9,D1         ; FUNCTION 9
        MOVE.L   #MESS1,A0     ; ERROR MESSAGE TO PRINT
        TRAP     #14           ; DO IT
        CLR.B    D0           ; CLEAR ERROR RETURN CODE
        RTS      ; RETURN TO MSDOS

;
;OKAY:   MOVEQ    #0,D1         ; 0 IN D1 MEANS OPEN FOR READ
        MOVEQ    #5,D0         ; FUNCTION 5 = OPEN FILE
        TRAP     #14           ; GET MSDOS TO DO IT
        CMPI.W   #$FFFF,D0    ; ERROR RETURN CODE?
        BEQ.W    NOTOPN       ; YES, GO FUSS ABOUT IT
        MOVE.W   D0,(HANDLE)   ; ELSE SAVE THE FILE'S HANDLE
LOOP:   MOVE.L   #BUFFER,A0    ; STORE BUFFER POINTER
        MOVE.W   (HANDLE),D1   ; GET FILE HANDLE AGAIN
        MOVEQ    #8,D0         ; READ FILE REQUEST
        MOVE.L   #$80000,D2    ; READ UP TO 524288 bytes
        TRAP     #14           ; DO IT
        CMPI.L   #0,D0         ; END OF FILE ENCOUNTERED?
        BNE.B    RDOK         ; IF NOT GO DISPLAY WHAT WE HAVE
        RTS      ; ELSE JUST RETURN TO MSDOS

;
;RDOK:   MOVE.L   D0,(BYTES)   ; STORE # OF BYTES READ
        MOVE.L   #BUFFER,A0    ; SET UP BUFFER PTR
        MOVEQ    #1,D1         ; WILL WRITE TO STDOUT
        MOVE.L   (BYTES),D2    ; # OF BYTES
        MOVEQ    #9,D0         ; WRITE FILE REQUEST
        TRAP     #14           ; SEND BYTES AND IGNORE RET CODE
        BRA.B   LOOP          ; SINCE STDOUT SHOULD EXIST

;
;NOTOPN: MOVEQ    #1,D0         ; TELL THE OPERATOR HE
        MOVEQ    #9,D1         ; BLEW IT
        MOVE.L   #MESS2,A0     ; AND HAD BETTER LEARN TO SPELL
        TRAP     #14           ;
        RTS      ; THEN LET DOS MAKE HIM TRY AGAIN

;
;MESS1:  DC.W     $0D0A        ; CARRIAGE RETURN AND LINE FEED
        DC.W     'USE: LOAD TYPE FILENAME'
        DC.W     $0D0A
        DC.W     '$'          ; TERMINATES THE DOS OUTPUT STRING

;
;MESS2:  DC.W     $0D0A
        DC.W     'CANNOT OPEN FILE',$0D0A,'$'

;
;HANDLE: DC.W     0            ; USED TO HOLD THE FILE HANDLE RETURNED BY DOS
;BYTES:  DC.L     0            ; THE NUMBER OF BYTES WE ACTUALLY READ
;
;BUFFER: DC.B     0            ; BUFFER START, ENDS AT THE TOP OF RAM
        END

```

*It is possible to
code specialized
multitasking software
using the 2681
DUART timer.*

console by addressing it as stdout, and the read operation is repeated. The second read attempt after reading the whole file will, of course, cause the program to terminate. Thus, you can display a file of any size up to the disk or operating system limits.

The error message handler, however, uses the alternate console I/O method. Function I (BDOS call) is used to send an MS-DOS interrupt 21H to the host with AH = 9. Reference to a DOS manual will show that this causes MS-DOS to output the indicated string until a \$ character is reached. Although this technique is often simpler for an experienced programmer, you should not attempt it if you are unfamiliar with MS-DOS assembly language programming. One of the pitfalls of this method is that some DOS functions require a buffer to be placed in 8086 memory

to receive the data (this is the function of system calls 23 and 24).

MULTITASKING

The structure of the DSI-020 kernel makes it possible, but difficult, to write specialized multitasking software using the interrupt-driven timer in the 2681 DUART. Most programming applications typically require tasks such as target program execution, editing, and printing to be concurrent. This allows you to set up an execution task, the source code, and a link map in windows on the display. Because the host MS-DOS kernel is not reentrant and the editor and typing functions are usually performed in the host environment, a multitasking host DOS will be necessary. We have found that Concurrent DOS (Digital Research, Pacific Grove, CA), which offers four concurrent tasks windowed onto the display, comes closest to the ideal environment. Unfortunately, it is not MS-DOS and so is not 100 percent compatible. It also requires significant user familiarization before all its features become usable.

Other multitasking systems that work fine with the DSI-020 include DoubleDOS (SoftLogic Solutions, Manchester, NH), Microsoft Windows, and TopView (IBM). Note that early versions of Windows did not allow a background task to remain active.

DoubleDOS is by far the least expensive solution, and although it offers only two tasks plus a print spooler, this is often as many activities as you can concentrate on anyway!

With such a multitasking environment you can operate the DSI-020 as an array processor. An application can be set up in the DSI-020 to, for example, invert some large matrices. You can switch the DSI-020 to a background task and pass parameters to it from a foreground program running on the host computer. It is our experience, however, that this approach is seldom worthwhile. This multiprocessor approach rarely gives equivalent performance to having the entire software package running on the 32-bit processor itself. If it is necessary for you to examine the results using a package such as dBASE, the results can be easily passed to the 8086 in a disk file.

SOFTWARE DEVELOPMENT TOOLS

Two sets of commercial compilers are available for the DSI-020. In addition, Definicon has ported Gordon Brandley's 68000 version of the public domain Palo Alto Tiny BASIC interpreter and a minimal 8080 emulator that can run CP/M-80 software. Tiny BASIC provides the minimal environment to experiment with the 68020.

NEW FROM LOGICAL DEVICES INC:

PROMPRO-8X™ Model II

A stand-alone programmer starting at \$895.00 can put you in business to program EE/EPROMs PAL/PLDs,* Single Chip micros,* and Bipolar PROMs,* + EPROM IN-CIRCUIT EMULATION* capability that can speed up your development time considerably and an RS-232 communications port that lets you integrate it with your IBM PC as a total firmware and Logic development station.

All from a company with an excellent reputation for quality and service.

A UNIVERSAL DEVICE PROGRAMMER

and its performance in no way compares with that of the other DSI-020 software.

All of the specialized compilers are fully optimizing compilers that produce compact and efficient code. Assembly language modules, written using the bundled simple assembler, can be interlinked with the code from any of these compilers.

It should be noted that all of these compilers produce object code directly. In order to see the efficiency of the code being generated you must use a disassembler or Definicon's assembly-level debugger.

Silicon Valley Software (Cupertino, CA) has ported its FORTRAN, Pascal, C, and BASIC to the DSI-020. SVS compilers are currently sold (at much higher prices) by most major workstation manufacturers. The linker and assembler were written by SVS. In addition, Lattice Logic Ltd. (Edinburgh, Scotland) has provided ports of its optimizing Pascal and C compilers for the DSI-020.

The SVS FORTRAN is a 68020 version of the company's fully validated ANSI-77 FORTRAN. It also includes a number of the more common extensions.

The SVS Pascal is an ANSI Level 0 Pascal enhanced with a number of extensions predominantly derived from the UCSD system, including string

Table 2: Comparison of the LINPAK results with two versions of the DSI-020, an IBM RT PC Model 20, and a VAX-11/780. All machines have floating-point hardware or math coprocessors. VAX-11/780 LINPAK values courtesy Argonne National Laboratories.

Double-Precision LINPAK

Performance is quoted in terms of total time taken, in seconds.

DSI-020 (12.0 MHz)	DSI-020 (16.7 MHz)	IBM RT PC	VAX-11/780
10.0	7.38	19.1	4.96

handling and the ability to compile code modules separately. Thirty-two-bit integers and both single- and double-precision floating-point data types are supported.

LLL Pascal is a 68020 version of Lattice's fully BSI (British Standards Institute) certified compilers, which comply with the standard for ANSI Level 1 Pascal with conformant arrays. The BSI uses the identical standards required by the FSTC (Federal Software Test Center). ANSI Pascal does not support the string data type directly. Strings may, however, be programmed using conformant arrays.

The SVS BASIC interpreter follows the DEC BASIC Plus language definition. SVS will support this interpreter only by paying prompt attention to any bugs that may be reported. It will not be enhanced from its current capabilities.

Both SVS C and LLL C are full Ker-

nighan and Ritchie definitions as extended by the UNIX environment. The compatibility of the SVS compiler is sufficient to allow the entire UNIX System V source kernel to be compiled without error.

Definicon has ported the BASIC-to-C converter from Living Software (Milton Keynes, Great Britain) to the DSI-020. This converter takes Microsoft (IBM) BASIC and converts it to a form that can be compiled using either C compiler. The BASIC run-time functions are implemented for the 68020. This converter provides programmers with the fastest possible environment to execute BASIC code. It is not, however, an interpreter. Microsoft BASIC (on the host PC) should be used to debug the program before attempting to convert and run it using the 68020.

Assembly language software development
(continued)

LEADER IN DEVICE PROGRAMMING

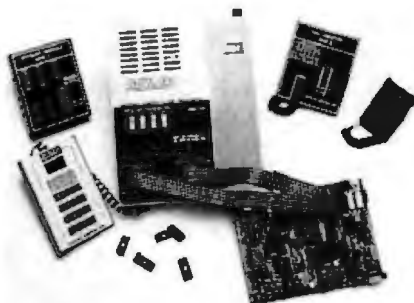

*some devices require optional adaptors.

FEATURES:

- Stand-Alone/RS-232
- 512K bits RAM buffer
- EPROMs 2716-27512
- Capacity: Two EPROMs (set programming)
- Accepts Intel, Mot. Hex files
- Accepts JEDEC files
- Optional Keypad/Alpha display
- Tilt stand and carrying handle
- Works with Exatron IC handler

also available: **UV ERASERS and GANG programmers.**

All products 100% made in U.S.A.

CALL 1-800-331-7766

Logical Devices Inc. 1321 NW 65th Place
Ft. Lauderdale, FL 33309

	TELEPHONE	TELEX
U.S.A.	(305) 974-0967	383142
Canada East	(514) 694-7710	05-823554
Canada West	(604) 291-8866	04-356533
England	0652-688626	527339
Italy, Ger., Swss	(02) 688-2141	845 79734
Australia	(03) 560-1011	790 35703
	(02) 736-1564	790 82635

WITH AN UNUSUAL PRICE TAG: \$895

opment has been supported by Quelo Inc. (Seattle, WA). Quelo has written a complete software development package that enables you to directly bootstrap a 68020 product. The DSI-020 itself is testimony to the effectiveness of Quelo software. Quelo is offering a specially priced subset of its complete package to BYTE readers, consisting of an assembler, macro preprocessor, and symbol

report generator. In addition it is providing LTXCON, a converter to allow modules compiled using Quelo tools to link and run on the DSI-020.

Quelo's assembler package is identical in capability to Motorola's Macro Assembler. It implements completely all the 68020 instructions and addressing modes. The assembler creates standard S record output files in addition to the relocatable output

format. This package allows programmers to develop and test other (dedicated) 68020 systems using the DSI-020. Although the program's starting point must be 4000 hexadecimal, all of the memory can be used by a stand-alone program. If the kernel is overwritten, however, no MS-DOS support functions will be available to the user's program.

Editor's note: For prices of the software mentioned in the section above, see part 1 of this article (July BYTE) or contact Definicon Systems.

CONCLUSION

Since the publication of the first part of this article, we have obtained the LINPAK benchmark results for the DSI-020 board. The LINPAK test suite, from the Argonne National Laboratories, tests the ability of a computer system to perform linear arithmetic, that is, matrix algebra, addition, subtraction, multiplication, and division. Specifically, it uses Gauss-Jordan elimination to solve a series of large matrices. It is written in FORTRAN. Table 2 gives the double-precision results obtained with the DSI-020 at 12.0 MHz, the DSI-020 at 16.7 MHz, the IBM RT PC, and a VAX-11/780. Note: the CPU frequency for the production model DSI-020 is 12.5 MHz, while the benchmark times are for a prototype board (12.0 MHz) and a peak performance version (16.7 MHz).

The DSI-020 is the second 32-bit coprocessor to come from a Definicon design team. As technology marches on, it is often hard to stop and look at where we are and where we are going. The DSI-020, we believe, represents the achievement of a goal we set two years ago: to put VAX-11/780 power on every scientist's desktop.

Reaching that goal, however, is like shooting at a moving target. Already Motorola is talking about 25-MHz 68020s, bringing further memory and peripheral interface problems. It often seems that engineers are good at creating more work for themselves. Let's hope that while we press on with faster and faster technologies, the tools we leave behind get into the hands of the applications programmers who can put them to good use. ■

SideTalk™

It minds the phone while you do your work

No more interruptions! Because now SideTalk can transfer your files or receive your mail while you're using your computer for other important matters. And SideTalk is programmable with its own BASIC-like language. What's more, you're never more than a keystroke away from all of the power of SideTalk.

When we say SideTalk is the best telecommunications program on the market, we're not just talking out of the side of our mouth.



To place your order:
Lattice, Incorporated
Post Office Box 3072
Glen Ellyn, Illinois 60138
312-858-7950
TWX 910-291-2190



Only \$119.95



MATHEMATICS OF PROGRAMMING

Mathematical laws help programmers control the complexity of tasks

Editor's note: This article contains the text of the speech given by Tony Hoare at the Boston Computer Museum on the occasion of BYTE's 10th Anniversary celebration. For practical reasons, some of the author's original notation has been modified slightly.

I hold the opinion that the construction of computer programs is a mathematical activity like the solution of differential equations, that programs can be derived from their specifications through mathematical insight, calculation, and proof, using algebraic laws as simple and elegant as those of elementary arithmetic. Such methods of program construction promise benefits in specifications, systems software, safety-critical programs, silicon design, and standards.

PRINCIPLES

To substantiate this opinion, I begin with four basic principles:

1. Computers are mathematical machines. Every aspect of their behavior can be defined with mathematical precision, and every detail can be deduced from this definition with mathematical certainty by the laws of pure logic.
2. Computer programs are mathematical expressions. They describe, with unprecedented precision and in the most minute detail, the behavior, intended or unintended, of the computer on which they are executed.
3. A programming language is a mathematical theory that includes concepts, notations, definitions, axioms, and theorems. These help a program-

(continued)

Professor C. A. R. Hoare (Oxford University Computing Laboratory, 8-11 Keble Rd., Oxford OX1 3QD, U.K.) has experience in software development in industry and in research and teaching in universities. He was educated at Oxford in the classics, philosophy, and statistics.



mer develop a program that meets its specification and prove that it does.

4. Programming is a mathematical activity. Like other branches of applied mathematics and engineering, its successful practice requires the determined and meticulous application of traditional methods of mathematical understanding, calculation, and proof.

HOWEVER . . .

These are general philosophical and moral principles, but all the actual evidence is against them. Nothing is as I have described it, neither computers nor programs nor programming languages nor even programmers.

I find digital computers of the present day to be very complicated and rather poorly defined. As a result, it is usually impractical to reason logically about their behavior. Sometimes, the only way of finding out what they will do is by experiment. Such experiments are certainly not mathematics. Unfortunately, they are not even science, because it is impossible to generalize from their results or to publish them for the benefit of other scientists.

Many computer programs of the present day are of inordinate size—many thousands of pages of closely printed text. Mathematics has no tradition of dealing with expressions on this scale. Normal methods of calculation and proof seem wholly impractical to conduct by hand, and 15 years of experience suggest that computer assistance can only make matters worse.

Programming languages of the present day are even more complicated than the programs you write with them and the computers on which they are intended to run. Valiant research has attempted to formulate

mathematical definitions of these standard languages. But the size and complexity of those definitions make them impractical in deriving useful theorems or proving relevant properties of programs.

Finally, many programmers of the present day have been educated in ignorance and fear of mathematics. Of course, many programmers are mathematical graduates who have acquired a good grasp of topology, calculus, and group theory. But it never seems to occur to them to take advantage of their mathematical skills to define a programming problem and search for its solution.

Our present failure to recognize and use mathematics as the basis for a programming discipline has a number of notorious consequences. They are the same as you would get from a similar neglect of mathematics in drawing maps, marine navigation, bridge building, air-traffic control, and exploring space. In the older branches of science and engineering, the relevant physical and mathematical knowledge is embodied in a number of equations, formulas, and laws, many of which are simple enough to be taught to schoolchildren. The practicing scientist or engineer will be intimately familiar with these laws and will use them explicitly, or even instinctively, to find solutions to otherwise intractable problems.

What then are the laws of programming that would help programmers control the complexity of their tasks? Many programmers would be hard-pressed to name a single one.

ARITHMETIC

But the laws of programming are as simple, as obvious, and as useful as the laws in any other branch of mathematics, for example, elementary

arithmetic. Consider the multiplication of numbers. Figure 1 shows some of the relevant algebraic laws: Multiplication is associative; its identity (or unit) is the number 1; it has the number 0 as its zero (or fixed point); and, finally, it distributes through addition. Figure 2 gives the defining properties of an ordering relation (\leq) like comparison of the magnitude of numbers. Such an order is reflexive, antisymmetric, and transitive. These laws hold also for a partial ordering like the inclusion relation between sets.

Figure 3 describes the properties of the least upper bound, or LUB, of an ordering, denoted by the cup notation (\cup). These laws are equally valid, whether the LUB is the union of two sets or the greater of two numbers. The first law states the fundamental property that the LUB is an upper bound on both its operands, and it is the least of all such bounds. The remaining laws are derived from the fundamental law by the properties of ordering. They state that the LUB operator is idempotent (i.e., $x \cup x = x$), symmetric, and associative. Finally, the partial ordering can itself be defined in terms of LUB.

Figure 4 shows some additional laws that hold for natural numbers or non-negative integers. Here, the LUB of two numbers is simply the greater of them. If you multiply the greater of x or y by z , you get the same result as multiplying both x and y by z and choosing the greater of the products. This fact is clearly and conveniently stated in the laws of distribution of multiplication through the LUB. An immediate consequence of these laws is that multiplication is a monotonic operator, in the sense that it preserves the ordering of its operands. If you decrease either factor, the product can only decrease, too, as stated in

$$\begin{aligned}
 x \times (y \times z) &= (x \times y) \times z \\
 x \times 1 &= 1 \times x = x \\
 x \times 0 &= 0 \times x = 0 \\
 (x + y) \times z &= (x \times z) + (y \times z)
 \end{aligned}$$

Figure 1: Some algebraic laws relevant to the multiplication of numbers.

$$\begin{aligned}
 x &\leq x \\
 x \leq y \ \& \ y \leq x &\rightarrow x = y \\
 x \leq y \ \& \ y \leq z &\rightarrow x \leq z
 \end{aligned}$$

Note: \leq can be interpreted as "is a subset of"; \rightarrow denotes "implies"; $\&$ denotes "and."

Figure 2: Defining properties of an ordering relation or a partial ordering.

$$\begin{aligned}
 (x \cup y) \leq z &\rightarrow x \leq z \ \& \ y \leq z \\
 x \cup x &= x \\
 x \cup y &= y \cup x \\
 x \cup (y \cup z) &= (x \cup y) \cup z \\
 x \leq y &\rightarrow x \cup y = y
 \end{aligned}$$

Note: \leftrightarrow denotes "is equivalent to."

Figure 3: Properties of the least upper bound of an ordering.

the last law of figure 4.

In the arithmetic of natural numbers, multiplication does not in general have an exact inverse. Instead, we commonly use a quotient operator—which approximates the true result from below. It is obtained from normal integer division by just ignoring the remainder. Thus, the result of dividing y by nonzero z is the largest number such that when you multiply it back by z , the result still does not exceed y . This fact is clearly stated in the first law of figure 5. The same fact is stated more simply in the second law, which I will call the fundamental law of division.

Other properties of division can be easily proved from the fundamental law. For example, the third law of figure 5 is proved by substituting y divided by z for x in the first law. The last law states that division by a product is the same as successive division by its two factors. A proof is given in figure 6. The proof shows that any w that is bounded by the left-hand side of the equation is bounded also by the right-hand side, and vice versa; it follows by the properties of partial ordering that the two sides are equal. The only laws used in the main part of the proof are the associativity of multiplication and the fundamental law of division, which is used three times to move a divisor from one side of the inequality to the other.

PROGRAMS

I have selected these laws to ensure that computer programs satisfy the same laws as elementary arithmetic. I will write programs in a mathematical notation first introduced by Edsger W. Dijkstra. Some of the commands are summarized as follows:

- The SKIP command terminates but

does nothing else. In particular, it leaves the values of all variables unchanged.

- The ABORT command is at the other extreme. It may do anything whatsoever, or it may fail to do anything whatsoever. In particular, it may fail to terminate. A computer that has "gone wrong" or a program that has run wild, perhaps by corrupting its own code, can behave this way. You would not want to write an ABORT command; in fact, you should take pains to prove that you have not created such a situation by accident. In such proofs, and in the general mathematics of programming, ABORT plays a valuable role. However much we dislike it, there is ample empirical evidence for its existence.

- The sequential composition of two commands x and y is written $(x \circ y)$. This starts behaving like x . If and when x terminates, y starts in an initial state equal to the final state left by x . The composition $(x \circ y)$ terminates when y terminates but fails to terminate if either x or y fails to do so.

The basic algebraic laws for sequential composition are given in figure 7. The first law of associativity states that if three commands are combined sequentially, it does not matter in which way they are bracketed. The second law gives SKIP as the unit of composition. It states that a command x remains unchanged when it is either followed or preceded by SKIP. The third law gives ABORT as a zero for composition. You cannot recover from abortion by preceding it or following it by any other command. These three algebraic laws for composition are the same as those for multiplication of numbers.

The next important feature of programming is the conditional. Let b be

a logical expression that in all circumstances evaluates to a logical value, true or false. If x and y are commands, the notation

$$x \ll b \gg y \quad (x \text{ if } b \text{ else } y)$$

denotes the conditional command. If the logical expression b is true, the command x is obeyed and y is omitted. If the result is false, y is obeyed and x is omitted. This informal description you will find summarized in the first law of figure 8.

Interpreting the if symbol \ll and the else symbol \gg to be brackets surrounding the logical expression b , the notation $\ll b \gg$ appears as an infix operator between two commands x and y . The reason for this novel notation is that it simplifies the expression and use of the relevant algebraic laws. For example, the conditional $\ll b \gg$ is idempotent (i.e., $x \ll b \gg x = x$) and associative, and it distributes through $\ll c \gg$ for any logical expression c . Finally, sequential composition distributes leftward (but not rightward) through a conditional.

Figure 9 shows a picture of the conditional as a structured flowchart. Such pictures are useful in first presenting a new idea and in committing it to memory. But pictures are quite unsuitable for expressing algebraic laws or for mathematical reasoning. Unfortunately, some problems are so widespread and so severe that flowcharts must be recommended and actually welcomed as their solutions.

Listing 1 shows the expression of the structure of a conditional in BASIC. Programming in BASIC is like doing arithmetic with roman numerals. For simple tasks like addition and subtraction, roman numerals are easier than arabic because you do not first have to learn 100 facts about the

(continued)

$$\begin{aligned} x \cup y &= \text{the greater of } x \text{ and } y \\ (x \cup y) \times z &= (x \times z) \cup (y \times z) \\ z \times (x \cup y) &= (z \times x) \cup (z \times y) \\ w \leq y \ \& \ x \leq z &\rightarrow w \times x \leq y \times z \end{aligned}$$

Figure 4: Some additional laws for natural numbers or nonnegative integers.

$$\begin{aligned} \text{if } z \neq 0 \\ y + z &= \max \{x \mid x \times z \leq y\} \\ x \leq (y+z) &\rightarrow (x \times z) \leq y \\ (y+z) \times z &\leq y \\ x + (y \times z) &= (x+z) + y \end{aligned}$$

Figure 5: Properties of division of natural numbers.

$$\begin{aligned} \text{Given } y \neq 0 \text{ and } z \neq 0 \\ w \leq x + (y \times z) \\ \rightarrow w \times (y \times z) &\leq x \\ \rightarrow (w \times y) \times z &\leq x \\ \rightarrow w \times y &\leq x + z \\ \rightarrow w \leq (x+z) + y \end{aligned}$$

Figure 6: A proof of the last law of division given in figure 5.

addition and subtraction of the 10 digits, and you avoid most of the complications of carry and borrow.

The disadvantages of roman numerals become apparent only in more complex tasks like multiplication, or worse, division for which the only known technique is trial and error. You have to guess the solution, test it by multiplying it by the divisor and comparing the dividend, and make a new guess if you are wrong. This is the way we teach beginners in BASIC, but division of roman numerals is much easier because the fundamental law of division tells you whether the new guess should be smaller or greater than the last.

Thankfully, arabic numerals have displaced roman ones in our schools, and the effective algorithm for long division has replaced the roman method of trial and error with an orderly process of calculation; when carefully executed, it leads invariably to the correct solution. In cases of doubt, the answer can still be checked by multiplication; but if this discovers an error, you do not try to debug the digits of your answer by trial and error. You go back over the steps of the calculation and correct them—or else you start again.

ABSTRACTION

An abstract command is one that specifies the general properties of a

computer's desired behavior without prescribing exactly how that behavior is to be achieved. A simple example of an abstract command is the union, or LUB ($x \cup y$), of two commands x and y , which may themselves be either abstract or concrete. The union command can be obeyed by obeying either of its operands. The choice between them is left open and can be made later by the programmer, the compiler, or even by some device in the computer during program execution. For this reason, abstract programs are sometimes called non-deterministic.

The properties of the union operator (figure 10) are exactly what you would expect. A command to do x or x leaves you no choice but to do x . To do x or y gives you the same choice as y or x . And in a choice between

three alternatives, it does not matter in what order you choose between them. Finally, ABORT (as defined above) is the abstract program that allows any behavior whatsoever.

Introducing abstraction permits you to define a useful ordering relation between concrete and abstract commands. If y is an abstract command specifying some desired effect, and x is a concrete command that achieves this effect, you can say that x satisfies y and use the notation used here for a partial order: $x \leq y$.

The command x can also be abstract. If it is, the ordering relation means that x is the same as y or that x is more specific, concrete, or deterministic than y . In either case, x meets the specification y because every possible execution of x is described and therefore allowed by y . As stated in figure 11, the satisfaction relation is a partial order, and the abstraction operator is its LUB.

Abstract commands can be combined by all the same operators as concrete commands. Figure 12 shows that sequential composition distributes through abstract choice in both directions. It follows that composition is monotonic in both its arguments. In fact, all the operators of a programming language are monotonic in this sense. There are good theoretical reasons for this, and there are also

(continued)

Listing 1: The expression of the structure of a conditional in BASIC.

```

410 IF b THEN GO TO 554
411
      .
      .
      .
550 GO TO 593
554
      .
      .
      .
593 REM
    
```

$x \circ (y, z) = (x \circ y) \circ z$
 SKIP $\circ x = x = x \circ$ SKIP
 ABORT $\circ x =$ ABORT $= x \circ$ ABORT
 Note: \circ denotes "composition."

Figure 7: The basic algebraic laws for sequential composition of commands.

$(x \leftarrow \text{true} \rightarrow y) = x - (y \leftarrow \text{false} \rightarrow x)$
 $(x \leftarrow b \rightarrow x) = x$
 $x \leftarrow b \rightarrow (y \leftarrow c \rightarrow z) = (x \leftarrow b \rightarrow y) \leftarrow c \rightarrow z$
 $= x \leftarrow b \rightarrow z$
 $x \leftarrow b \rightarrow (y \leftarrow c \rightarrow z) = (x \leftarrow b \rightarrow y) \leftarrow c \rightarrow (x \leftarrow b \rightarrow z)$
 $(x \leftarrow b \rightarrow y) \circ z = (x \circ z) \leftarrow b \rightarrow (y \circ z)$
 Note: \leftarrow denotes "if"; \rightarrow denotes "else."

Figure 8: The conditional operator.

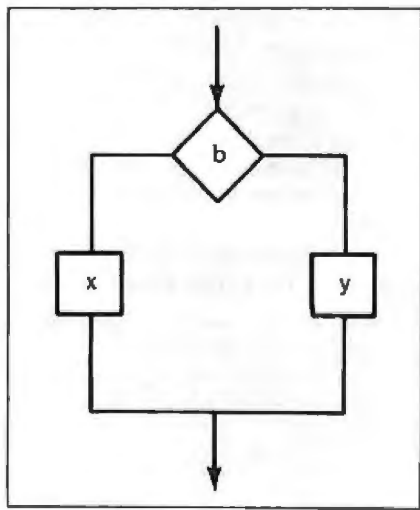

Figure 9: A picture of the conditional as a structured flowchart.

$x \cup y$ behaves like x or y
 $x \cup x = x$
 $x \cup y = y \cup x$
 $x \cup (y \cup z) = (x \cup y) \cup z$
 $x \cup$ ABORT $=$ ABORT

Figure 10: Properties of the union, or abstraction, operator.

$x \leq y = x \cup y = y$
 $\rightarrow x$ satisfies specification y
 $x \leq x$
 $x \leq y \ \& \ y \leq z \rightarrow x \leq z$
 $x \leq y \ \& \ y \leq z \rightarrow x \leq z$
 $(x \cup y) \leq z \rightarrow x \leq z \ \& \ y \leq z$

Figure 11: The satisfaction relation (\leq), a partial order, with the abstraction operator (\cup) as its LUB.

“Turbo Pascal...
is a very good system.
But don't make
the mistake of trying to
use it for large programs.”

*Niklaus Wirth
as reported in Micro Cornucopia
August-September 1985*



LOGITECH
MODULA-2/86

very beneficial consequences for the practical solution of programming problems.

REFINEMENT

The task of a programmer can be described as a problem in mathematics. You start with an abstract description of what you want the computer to do, carefully checking that it is an accurate description of the right problem. This is often the most difficult part of the task and requires the most powerful tools. So in the specification y , you should take advantage of the full range of concepts and notations of mathematics, including concepts that cannot be represented on a computer and operations that could not be implemented in a programming language.

You must then find some program x that solves the inequality $x \leq y$, where y is the specification of the program. Mathematics provides many formulas and methods for solving equations (and inequalities), from linear and quadratic to differential and integral. In all cases, the derivation of a solution can use the full power of mathematics, but the solution itself must be expressed as a formula in some more restricted notation. The same is true in programming, where the eventual solution must be expressed in the restricted notations of an implemented concrete programming language.

The most powerful general method of solving a complicated problem is to split it into simpler subproblems, which can then be solved independently. The same method can be applied again to the subproblems until

they are simple enough to solve directly by some other more direct method. In the case of computer programming, this is often called *top-down development* or *stepwise refinement* (see figure 13). You start with the problem of finding some command x (expressed in a concrete programming language) that meets the specification y (expressed in the abstract language of mathematics). The first step requires the insight to split this task into two subproblems and the skill to specify them as abstract programs v and w . Before proceeding further, you prove the correctness of your design so far by showing that the sequential composition of v and w meets the original specification y , or more formally, $v \circledast w \leq y$.

Now these two subproblems v and w can be solved sequentially or concurrently by a single programmer or by two teams of programmers, according to the size of the task. When both subproblems are solved, you will have two commands, t and u , expressed in the restricted notations of your chosen programming language, each meeting their respective specifications: $t \leq v$ and $u \leq w$. All that remains is to deliver their sequential composition ($t \circledast u$) as a solution to the original problem y . Correctness of the solution has been established not by the traditional laborious and ultimately unsound method of integration testing and debugging after the components have been constructed, but rather by a mathematical proof, which was completed on the very first step, even before the construction of components began.

The validity of the general method

of top-down development depends on monotonicity of the composition operator and transitivity of the abstraction ordering. The method can therefore be applied to any other operator of a concrete programming language. It has been treated at length in many learned articles and books. A characteristic of the simplifying power of mathematics is that the whole method can be described, together with a proof of its validity, within the seven lines of figure 13.

I have drawn an analogy between the multiplication of natural numbers and the sequential composition of commands in programming. This analogy extends even to division. As with division of natural numbers, the quotient of two commands is not an exact inverse. However, it is uniquely defined by the same fundamental law, as shown in figure 14. The quotient of y divided by z is the most abstract specification of a program x , which, when followed by z , is sure to meet the specification y . As a consequence, the quotient itself, when followed by z , meets the original specification. And, finally, when the divisor is the composition of two commands, you can calculate the quotient by successively dividing by these two commands in the reverse order. Since the composition of commands is not symmetric, the reversal of order is important here.

In factoring large numbers, division saves a lot of effort: You only have to guess one of the factors and obtain the other one by calculation. The division of commands offers the same advantages in the factorization of pro-

(continued)

$$\begin{aligned} (x \cup y) \circledast z &= (x \circledast z) \cup (y \circledast z) \\ z \circledast (x \cup y) &= (z \circledast x) \cup (z \circledast y) \\ w \leq y \ \& \ x \leq z &\Rightarrow w \circledast x \leq y \circledast z \end{aligned}$$

Figure 12: Sequential composition of commands distributes through abstract choice in both directions.

Problem: find x such that $x \leq y$
 Step 1: find v, w such that $v \circledast w \leq y$
 Step 2a: find t such that $t \leq v$
 Step 2b: find u such that $u \leq w$
 Step 3: deliver $t \circledast u$
 Proof: $t \circledast u \leq v \circledast w$ \circledast is monotonic
 $\therefore t \circledast u \leq y$ \leq is transitive

Figure 13: Top-down development or stepwise refinement.

$$\begin{aligned} (x \circledast z) \leq y &\Rightarrow x \leq (y \circledast z) \\ (y \circledast z) \circledast z &\leq y \\ x \circledast (y \circledast z) &= (x \circledast z) \circledast y \end{aligned}$$

Figure 14: The fundamental law of the quotient of commands. Like the division of natural numbers, the quotient of two commands is not an exact inverse of their multiplication.

TAKE THE NEXT LOGICAL STEP



\$89 Price

- Separate Compilation
- Native Code Generation
- Large Memory Model Support
- Multitasking
- Powerful Debugging Tools
- Comprehensive Module Library
- Available for the PC and the VAX

Move up to LOGITECH MODULA-2/86. Whether you're a single programmer or part of a team, with LOGITECH MODULA-2/86 you'll decrease your overall development cycle and produce more reliable, more maintainable code. Build your program using our extensive library modules, your own modules or those from a growing list of available third-party software vendors. If you're a Turbo Pascal user you can even take your existing code along with you with the help of our new Translator!

NEW & IMPROVED!

Turbo Pascal to Modula-2 Translator ^{\$49}

Now it's even easier for Turbo users to step up to Modula-2/86. Our improved Translator changes your Turbo source code into Modula-2/86 source, solving all the incompatibilities, and translating the function calls of Turbo into Modula-2/86 procedures. Implements the complete Turbo library!

LOGITECH MODULA-2/86 ^{\$89}

Complete with Editor, Run Time System, Linker, 8087 Software Emulation, Binary Coded Decimal (BCD) Module, Logitech's comprehensive library, Utility to generate standard .EXE files. AND more!

- LOGITECH MODULA-2/86 with 8087 Support ^{\$129}
 - LOGITECH MODULA 2/86 PLUS ^{\$189}
- For machines with 512K of RAM. Takes advantage of larger memory to increase compilation speed by 50%.

Turbo Pascal is a registered trademark of Borland International.

NEW, improved Turbo Pascal to Modula-2 Translator!

Call for information about our VAX/VMS version, Site License, University Discounts, Dealer & Distributor pricing.

To place an order call our special toll free number:

800-231-7717

In California:

800-552-8885

MODULA-2/86

RUN TIME DEBUGGER ^{\$69}

(Source level!)
The ultimate professional's tool! Display source code, data, procedure call chain and raw memory. Set break points, assign values to variables, pinpoint bugs in your source.

UTILITIES PACKAGE ^{\$49}

Features a post-mortem debugger (PMD). If your program crashes at run time the PMD freezes the situation so you can pinpoint, in the source, the cause of the error and the status of the data. Also includes a disassembler, cross reference utility and version that allows conditional compilation.

LIBRARY SOURCES ^{\$99}

Source code for our major library modules is now available for customization or exemplification.

WINDOW PACKAGE ^{\$49}

Now you can build true windowing into your Modula-2 code. Powerful, though only 15K in size. Features virtual screens, color support, overlapping windows and a variety of borders.

MAKE UTILITY ^{\$29}

Automatically selects modules affected by code changes to minimize recompilation and relinking. Even figures out dependencies for you!

CROSS RUN TIME DEBUGGER AND ROM PACKAGE ^{\$199}

Now available at an introductory price!

YES I want to move up to LOGITECH MODULA-2/86!

Here's the configuration I'd like:

- | | |
|---|-------|
| <input type="checkbox"/> Logitech Modula-2/86 | \$89 |
| <input type="checkbox"/> with 8087 support | \$129 |
| <input type="checkbox"/> Plus Package | \$189 |
| <input type="checkbox"/> Turbo to Modula Translator | \$49 |
| <input type="checkbox"/> Run Time Debugger | \$69 |
| <input type="checkbox"/> Utilities Package | \$49 |
| <input type="checkbox"/> Library Sources | \$99 |
| <input type="checkbox"/> Window Package | \$49 |
| <input type="checkbox"/> Make Utility | \$29 |
| <input type="checkbox"/> ROM Package | \$199 |

Total Enclosed \$ _____

Visa Mastercard Check Enclosed

Card Number _____ Expiration Date _____

Signature _____

Name _____

Address _____

City, State _____

Zip _____ Phone _____



LOGITECH

Logitech, Inc.
805 Veterans Blvd.
Redwood City, CA 94063
Telephone 415-365-9852

For European pricing please contact:

Logitech SA
Box 32, CH-1143
Apples, Switzerland
Telephone 41-21-774545

programming problems. In refinement, it replaces the guesswork required in discovering two simpler subtasks by the discovery of only the second of them, as shown in figure 15. Furthermore, the proof obligation in step 1 of figure 15 has been eliminated. It is replaced by a formal calculation of the weakest specification that must be met by the first operand of the composition. Reducing guesswork and proof to calculation is how mathematicians simplify their own tasks, as well as those of users of mathematics—the scientist, the engineer, and now the programmer.

The quotient operator for commands was discovered in a slightly restricted form by Dijkstra, who called it the weakest precondition (see reference 1). It is one of the most effective known methods for the design and development of correct algorithms, as shown in numerous examples by David Gries in reference 2.

PROGRAM MAINTENANCE

In my description of the task of a programmer, I have concentrated on the more glamorous part of that task: specifying, designing, and writing new programs. But a significant portion of a programmer's professional life is spent making changes to old programs. Some of these changes are necessitated by the discovery of errors, some by changes in the specification of the program's desired behavior. The program and the specification may be so large that it is not practical to write a new program from scratch; when only a small part of the specification is changed, you hope that only a small part of the program will need changing to meet it.

Of course, such a hope is not always

justified. Consider again the analogy of the division of numbers. A small change in the least significant digits of the dividend results in a small change in the least significant digits of the quotient and can be achieved by a small amount of recalculation. But a small change in the most significant digit of either operand requires that you start the calculation again, leading to a completely different result. In the case of programs, it is often difficult to know which small changes in a large specification will require major changes to the program.

It is, therefore, most important for the original programmer to decide which parts of a specification are most likely to be changed and to structure the program design so that a change to one part of the specification requires a change to only one part of the program. The programmer should then document the program with instructions on how to carry out the change. This too can be done in a rigorous mathematical fashion (see figure 16). Let y be that part of a complete specification $g(y)$ that is liable to change. Let x be that command in a big program $f(x)$ that is designed to change when y changes. The problem now is to change x to x' so that $f(x')$ meets the changed specification $g(y')$.

The problem of program maintenance is most easily solved when the structure of the program f is the same as the structure of the specification g ; in this case, it will be sufficient to ensure that the modified component meets the modified specification.

However, it is not always possible to preserve the structure of a specification in the design of a program. A specification is often most clearly structured with the aid of logical oper-

ators like negation and conjunction, which are not generally available in an implemented programming language. Nevertheless, mathematics can often help. Sometimes, the program f has an approximate inverse (f^{-1}), defined in the same way as for the quotient; it is then possible to calculate the proof obligation of the modified program as $x \leq f^{-1}(g(y'))$.

IN REALITY

I must inject a note of realism into my mathematical speculations. Many operators of a programming language do not have suitable approximate inverses, and even if they do, their calculation is impossibly cumbersome. Would you like to calculate the inverse of f , when f is a million lines of FORTRAN code? The problem of the size of mathematical formulas is exactly the same problem that limits the use of mathematics in other branches of science and engineering. Many scientists believe as fervently as I do in the principle that the whole of nature is governed by mathematical laws of great simplicity and elegance, and brilliant scientists have discovered many laws that accurately predict the results of experiments conducted in a rigorously controlled laboratory environment. But when the engineer tries to apply the same laws in practice, the number of uncontrollable variables is so much greater than in the laboratory that a full calculation of the consequences of each design decision is hopelessly impractical. As a result, the engineer uses experience and understanding to formulate and apply various rules of thumb, and uses flair and judgment to supplement (though never to replace) the relevant mathematical calculations.

Experienced programmers have developed a similar intuitive understanding of the behavior of computer programs, many of which are now remarkably sophisticated and reliable. Nevertheless, I would suggest that the skills of our best programmers will be even more productive and effective when exercised within the framework of understanding and applying the relevant mathematics. The mathematics has been demonstrated on

(continued)

Problem: find x such that $x \leq y$
 Step 1: choose suitable z
 Step 2a: find t such that $t \leq y + z$
 Step 2b: find u such that $u \leq z$
 Step 3: deliver $t \circ u$
 Proof: $t \circ u \leq (y + z) \circ z$ \circ is monotonic
 $(y + z) \circ z \leq y$ property of $+$
 $\therefore t \circ u \leq y$ \leq is transitive

Given: $f(x) \leq g(y)$
 Problem: find x' such that $f(x') \leq g(y')$
 Case 1: $f = g$
 solve $x' \leq y'$
 Case 2: f has approximate inverse f^{-1}
 solve $x' \leq f^{-1}(g(y'))$

Figure 15: A simplification of figure 13, using division of commands.

Figure 16: Mathematical treatment of program maintenance.

AMERICA'S NEXT FAVORITE MOUSE.

The best price: \$99

THE BEST HARDWARE:

- PC/XT/AT compatible through your serial port
- NO pad. NO power supply
- High (200 DPI) resolution
- Tactile feedback switches

THE BEST SOFTWARE:
LOGIMOUSE with Plus Package Software
\$119

- Driver 3.0: makes LOGIMOUSE run with all mouse based software, including Microsoft.
- LOGIMENU: a programmable Pop-Up Menu System that customizes LOGIMOUSE for each of your keyboard based applications.
- CLICK: a new concept in mouse software! It resides in memory, detects what application you're running and automatically sets the mouse to your predefined setting.
- POINT-AND-CLICK SHELL for Lotus 1-2-3: the only mouse interface for 1-2-3 that goes beyond keyboard emulation. With context sensitive pop-up menus and an independent mouse cursor that changes shape and meaning in different areas of the 1-2-3 screen. Makes it faster and easier to select a cell, invoke a command or scroll.
- POINT EDITOR: a mouse based program editor featuring pop-up menus and overlapping, color windows for faster, easier file editing. Use it instead of EDLIN or any other ASCII file editor.

THE BEST DEALS:

NEW! Introductory Price!
LOGIMOUSE with Plus Pkg. & Reflex ~~\$268~~ \$199
A winning combination! LOGIMOUSE enhances the power of Reflex, Borland's amazing database management system, to probe relationships in your data and display them in graphic form.

NEW! Introductory Price!
LOGICADD-LOGIMOUSE with Plus Pkg. & Generic CADD 2.0 with Dot Plot ~~\$244~~ \$189
Everything you need to turn your PC into a CAD workstation. Generic CADD has the features and performance of high-priced CAD. DotPlot turns your dot matrix printer into a plotter, and LOGIMOUSE is the ultimate input device.



NEW Reflex & LOGICADD Packages!

LOGIPAINT SET - LOGIMOUSE

with Plus Pkg. & PC Paintbrush 3.0 ~~\$258~~ \$169
LOGIMOUSE plus PC Paintbrush 3.0 is the most advanced paint set available for the PC. Use it for designing a logo or painting a picture. You won't believe its power with either freehand drawing or graphics!

LOGIMOUSE® C7

To place a credit card order call our special toll-free number:
800-231-7717

Call toll-free in California:
800-552-8885

YES! I want America's next favorite mouse!

- Please send me:
- | | | |
|---|-------|--|
| <input type="checkbox"/> LOGIMOUSE with Driver 3.0 | \$ 99 | 30-Day Money-Back Guarantee/
New 3-Year Warranty |
| <input type="checkbox"/> LOGIMOUSE with Plus Software | \$119 | |
| <input type="checkbox"/> Plus Package Software | \$ 29 | |
| <input type="checkbox"/> LOGIMOUSE with Reflex | \$199 | Add \$6.50 for shipping & handling. Calif. residents add applicable sales tax. |
| <input type="checkbox"/> LOGICADD | \$189 | |
| <input type="checkbox"/> LOGIPAINT | \$169 | |

For your computer model: _____

VISA MASTERCARD CHECK ENCLOSED

Card Number _____ Expiration Date _____

SIGNATURE _____

NAME _____

ADDRESS _____

CITY, STATE _____

ZIP _____ PHONE _____

DEALER INQUIRIES WELCOME

 **LOGITECH**

United States:
LOGITECH, Inc.
805 Veterans Blvd.
Redwood City, CA 94063
Tel: 415-365-9852

In Europe:
LOGITECH SA
CH-1143 Apples
Switzerland
Tel: 41-21-774545

LOGIMOUSE is a registered trademark of LOGITECH. Lotus and 1-2-3 are trademarks of Lotus Development Corp. Reflex is a trademark of Borland-Analytics. Generic CADD is a trademark of Generic Software, Inc.

Safeguard your computer system
with the essential peripheral...

Perma Power® Power Commander™ Computer Power Control Center

When valuable equipment and irreplaceable data are on the firing line, it makes sense to protect them from the dangers lurking in the power line. Trust the Power Commander™ Computer Power Control Center to guard your sensitive circuitry from voltage spikes and surges, while giving you fingertip control of your computer and four peripherals.

- Prevents data loss and physical damage from switching and lightning-induced transient voltage surges
- Provides both common-mode and normal-mode surge suppression
- Reduces line noise from RFI/EMI interference
- Positive Shutdown Mechanism* prevents operation of unprotected equipment
- Performance specified to IEEE Std. 587 (Category A)
- U.L. listed
- FULL FIVE-YEAR WARRANTY

See the new Power Commander™—along with the full line of Perma Power Surge Suppressors and Sockets Plus™ Multiple Outlet Strips—at computer stores and office supply dealers nationwide.

*patent pending



PERMA POWER. Electronics Inc.

5615 West Howard Avenue • Chicago, Illinois 60648
Telephone (312) 647-8414

MATHEMATICS

small examples, as it were, in the laboratory. The time has come to start the process of scaling up to an industrial environment. At Oxford University, we have a number of collaborative projects with industry to attempt this technology transfer. Preliminary indications are quite promising, both for advances in theory and for benefits in practice.

But it will be no easier to change the working habits of programmers than those of any other profession. I quote from Lord Hailsham, the British minister in charge of our judicial system (see reference 3). He is conducting a review on the improvement of judicial practices in the legal profession. He first lists the faults of our current system, including delay, complexity, and obscurity. He continues: "A change in working methods is of course immensely difficult. Habit, interest, training all militate in favour of the status quo. People must be persuaded, taught, if necessary possibly even leaned on—or at least assisted."

Pilot schemes may be necessary to test new methods. They may be unpopular, "but if the alternative is to let all cases to continue subject to the anomalies of a malfunctioning system, we may have to contemplate unprecedented arrangements to allow new methods to be tested."

Changes in professional practice will be just as difficult for programmers as they are for lawyers and judges. They will occur first in the areas of greatest necessity, where the lack of mathematical precision leads to the heaviest costs. In particular, I suggest five such areas: specifications, systems software, standards, silicon structures, and safety.

SPECIFICATIONS

In the initial specification and design of a large-scale software product, the use of mathematics has been found to clarify design concepts and enable you to explore a wide variety of options at a time when less successful alternatives can be cheaply discarded. As a result, the final agreed-upon specification may enjoy that simplicity and conceptual integrity that characterizes the highest quality in design.

(continued)

How to tackle a 300 page monster.

Turn your PC into a typesetter.

If you're writing a long, serious document on your IBM PC, you want it to look professional. You want MicroT_EX. Designed especially for desktop publishers who require heavy duty typesetting, MicroT_EX is based on the T_EX standard, with tens of thousands of users worldwide. It easily handles documents from smaller than 30 pages to 5000 pages or more. No other PC typesetting software gives you as many advanced capabilities as MicroT_EX.

So if you want typesetting software that's as serious as you are about your writing, get MicroT_EX. Call toll free 800-255-2550 to order or for more information.* Order with a 60-day money back guarantee.

MicroT_EX™
from Addison-Wesley

Serious typesetting for serious desktop publishers.

*Dealers, call our Dealer Hot Line: 800-447-2226
(In MA, 800-446-3399), ext. 2643.

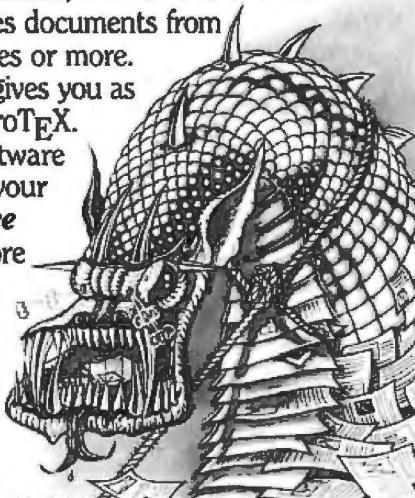

PERFORMANCE

THAT IS OUT OF THIS WORLD...



\$389⁰⁰

**MODEL 2000 20MHz
DUAL TRACE**

\$549⁰⁰

**MODEL 3500 35MHz
DUAL TRACE DELAYED SWEEP**

...AT A DOWN TO EARTH PRICE

At last! Truly affordable test equipment with no compromise in design, and features you would expect to find only on oscilloscopes costing hundreds of dollars more! JDR Instruments presents two, new, high-performance models backed by a two year warranty and technical support which is only a phone call away. Perfect for the technician or advanced hobbyist, both models feature Dual Trace capability and a variety of operating and triggering modes, including CH-B Subtract and X-Y operation.

MODEL 2000 has a 20 MHz bandwidth and 20 calibrated sweeps ranging from .2s to .2 μ s. A convenient built-in component tester provides additional diagnostic power.



INCLUDES TWO HIGH QUALITY
1x, 10x TEST PROBES

MODEL 3500 features a 35 MHz bandwidth and exceptional 1mV/DIV sensitivity. Delayed sweep and variable holdoff allow stable viewing of complex waveforms.

ORDER TOLL FREE
800-538-5000
800-662-6279 (CA)



JDR INSTRUMENTS

1224 South Bascom Avenue
San Jose, California 95128 (408) 995-5430

Furthermore, user's manuals, tutorials, and guides that are based on mathematical specifications can be better structured, more complete, and more comprehensible, even to users who have no knowledge of the underlying mathematics. This promises to mitigate the greatest single cause of error, inconvenience, and customer frustration in the use of sophisticated software products, that is, failure to read and understand the user's manual.

SYSTEMS SOFTWARE

A computer's basic systems software includes items like an operating system, language compilers, utilities, transaction-processing packages, and database management systems. These programs are written by large teams of programmers and are delivered to thousands or millions of customers, who use them daily, hourly, or even continuously. In the years after delivery of such software, many thou-

sands of errors are discovered by the customers themselves; each error must be laboriously analyzed, corrected, and retested; and the corrections must be delivered to and installed by the customer in the next release of the software. A reduction in the number of corrections needed would be cost-effective for the supplier and convenient for the customer. A reduction in the number of errors discovered before delivery of the software could also save a lot of money. No method by itself can guarantee absolute reliability. However, in combination with management control, a mathematical approach looks promising. Even when mistakes are made, they can be traced to their source, and steps can be taken to ensure they do not happen again.

STANDARDS

The standardization of languages and interfaces in hardware and software is a vital precondition for free competi-

tion and for the propagation of technical advances. The construction of a mathematical specification for these standards offers the same promise of improved quality in design that I have just described; it also offers a hope of reducing the ambiguities and misunderstandings which lead to errors and incompatibility in various implementations of the standard, and which have prevented us from obtaining full benefit from the existing standards.

SILICON STRUCTURES

The advance of technology in very-large-scale integration now makes it possible to build hardware as complex as software. As a result, we are beginning to detect as many design errors during the manufacture and testing of complex devices as we have been finding with software. But now each error costs many thousands of dollars to remove; what is worse, by delaying the introduction of a new

Why an Amdek monitor is a better investment than buying from Mr. Blue Chip.

Buying a monitor is an important decision. After all, it's a key component of your computer system that must have the capabilities of matching your application needs.

There's no question that ordering a "bundled system" is easier than selecting individual components. But the easy way isn't always the best way. And when it comes to monitors, there's none better than Amdek.



device onto the market, these errors can prevent an innovative company from assuming market leadership or even prejudice its survival. As a result, many products are delivered with known design errors, for which the customer will never obtain a correction or restitution. Fortunately, mathematical methods similar to those for sequential programs can be adapted to check logic designs. These methods are especially valuable when the design involves concurrency or parallelism.

SAFETY

Computer programs are increasingly used in systems that are critical to the safety of the general public—control of railway signaling, airplane engines, and chemical and nuclear processes. The engineering techniques used in these systems are subject to the most rigorous analysis and control, often enforced by law. Mathematical methods offer the best hope of extending

such control to computer software, and when this happens, a program could gain a reputation as the most reliable component of any system in which it resides.

CONCLUSION

These are the five areas in which I believe the introduction of mathematical methods gives the greatest promise of rapid economic return. But their implementation will require a significant change in working habits and working attitudes, not only of individual programmers but of whole teams and departments. It requires the enthusiastic participation of coders, systems analysts, project leaders, and managers at all levels. It involves reforming the curricula in training departments, colleges, and universities. It even requires educating the general public to demand and expect as much—or more—quality and design integrity from computer programs as they do from other products

critical to their economic and physical well-being.

That is why I am pleased and grateful for this opportunity to address you on the 10th anniversary of the foundation of BYTE magazine. This is a magazine that has a deservedly wide readership in our profession, ranging from theoretical computer scientists through lecturers, teachers, managers, engineers, and students to home computer enthusiasts. But it is also a magazine that takes seriously its responsibility to propagate improved methods and higher standards in the programming profession. I salute its ideals and achievement and wish it continued prosperity and progress. ■

REFERENCES

1. Dijkstra, Edsger W. *A Discipline of Programming*. Englewood Cliffs, NJ: Prentice-Hall, 1976.
2. Gries, David. *The Science of Programming*. New York: Springer, 1981.
3. *The Guardian*, July 10, 1985, London, England.

Once you compare the quality, features, options and price you'll see that ordering the first three letters that pop into your head doesn't necessarily give you the best return on your investment. Because soon after you compare, it'll become very clear that Amdek is clearly the finest in monitors.

Amdek features a complete line of monitors—from full color RGB's to single color monochromes. What's more, Amdek offers monitors that are capable of supporting a full range of graphic boards.

And every Amdek is backed by a 3-year warranty on the CRT, and two full years on all other parts and labor.

It's no wonder Amdek has sold over one million units to date. Now the only wonderment is why anyone would pay more for anything less than an Amdek.

AMDEK

Clearly the finest in monitors.

2201 Lively Boulevard, Elk Grove Village, IL 60007
 Phone: 312/364-1180, Tlx: 280-803
 Inquiry 15



Finally, a language worth

For years BASIC has been everyone's first language. And for almost as long, they've been tempted by other languages. Lured by promises of more speed, more power.

We have a solution. A new language that's a substantial improvement over BASICA. Faster. More structured. Finally, a compelling reason to leave BASIC.

Introducing Microsoft's QuickBASIC Compiler, Version 2.0.

At last, you can have the latest programming techniques, combined with the solid foundation of BASIC. Our new compiler is as compatible with BASICA as you can get. At the same time it offers the extra speed and power you've been looking for.

Run faster with compiled code.

If there's one thing you've asked for, it's speed. And Microsoft® QuickBASIC simply blazes. Old BASICA programs will run up to ten times quicker once they've been compiled. Sometimes even faster.

Everything you need. Built-in.

Making programs run faster is only part of the story, though. The new Microsoft QuickBASIC Compiler includes a full-screen editor, built-in. So now you can make the jump from writing to RUNning in no time flat. Edit your program, compile it, and run it. Faster than any other BASIC compiler around. All without leaving our on-line help and prompts.

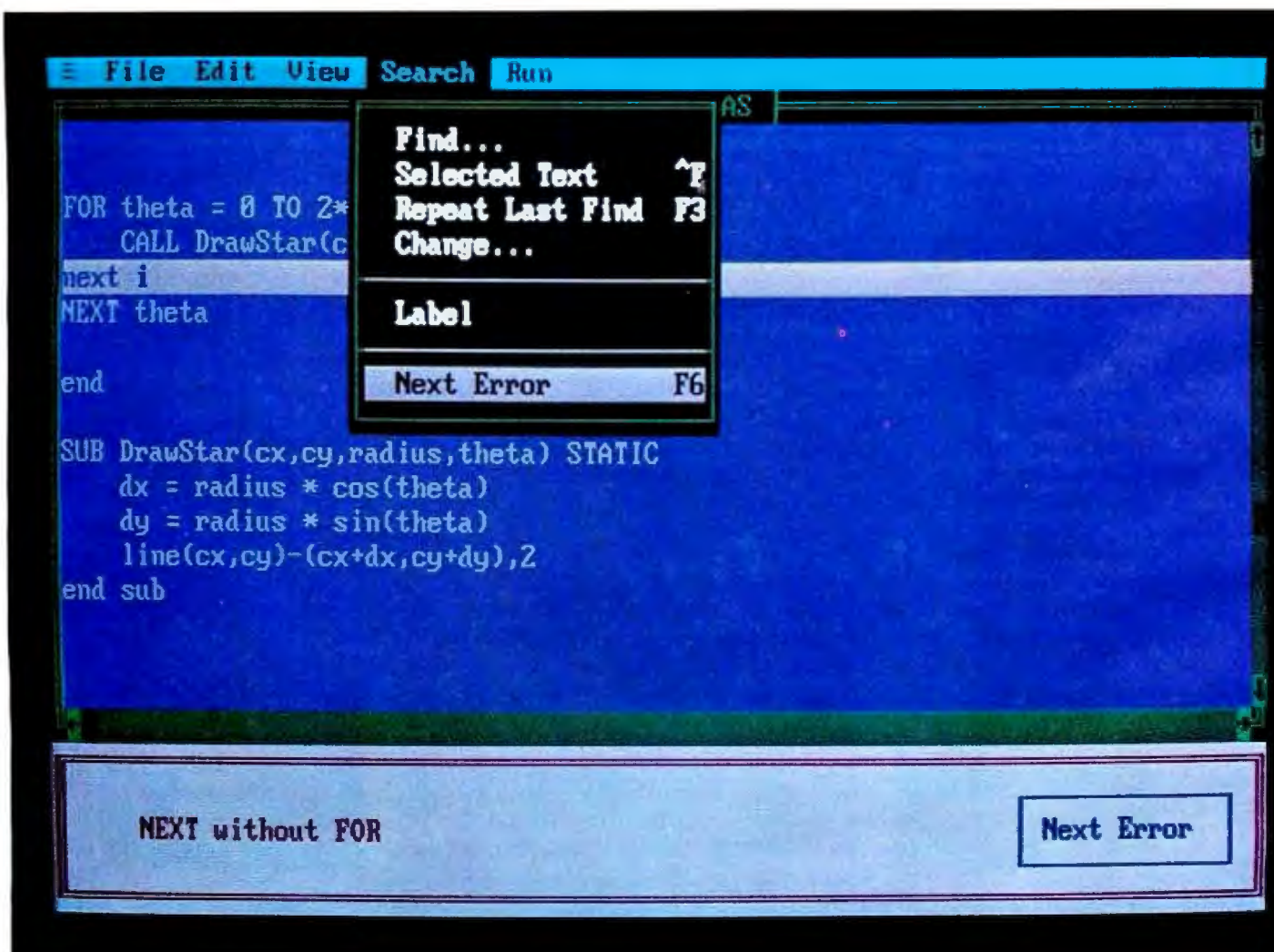

leaving BASIC for.

On the rare chance your program doesn't run 100% the first time out, we've got another surprise for you. The Microsoft QuickBASIC debugger. Our full-screen tracing lets you debug your programs while watching the source code execute. A line at a time, or with breakpoints. As easy as can be.

Our compiler is also smart enough to save you time. First, by finding any errors in one pass. Second, by putting your editor's cursor on the problem. Automatically. So you don't have to get lost in a maze of error codes and line-numbers.

The BASIC virtues. And more.

Speaking of line numbers, let's not. Because line numbers are strictly optional. And Microsoft QuickBASIC lets you use alphanumeric labels as well. Now you can GOTO *ErrorCheck* instead of line number 6815.

Or you could stop using GOTOs altogether. There are a variety of options that could make the GOTO an endangered species. Features like multi-line IF-THEN blocks. And named subprograms. Now your BASIC programs can be as structured and organized as you want.

We've only just begun to talk about the virtues of Microsoft QuickBASIC. There are dozens of enhancements to your favorite language. Things like larger arrays. Local and global variables. Reusable modules that let you create libraries of your most often-used routines. All explained in a revised manual that includes a complete language reference.

Making your quick escape.

If all these features follow your BASIC instincts, then zip on down to your nearest Microsoft dealer. That's where you'll discover the best surprise of all. The price. Only \$99 for the best reason to leave BASIC.

For the name of your nearest Microsoft dealer, call (800) 426-9400. In Washington State and Alaska, (206) 882-8088. In Canada, call (416) 673-7638.

Microsoft® QuickBASIC
The High Performance Software™

Microsoft QuickBASIC Compiler Version 2.0 for IBM® PC and Compatible Computers.

BASICA Compatibility

- Sound statements including SOUND and PLAY.
- Graphics statements including WINDOW, VIEW, DRAW, GET, PUT, LINE, CIRCLE, LOCATE and SCREEN.
- Support of EGA extended graphics modes. NEW!
- BASICA structures are supported including WHILE/WEND, IF/THEN/ELSE, FOR/NEXT, GOSUB/RETURN, and event handling.

Results of Sieve Benchmark	BASICA 3.1	Microsoft QuickBASIC 2.0
Seconds per iteration	78	0.52

Complete Programming Environment

- Built-in Editor that places the cursor on found errors automatically. NEW!
- Compile entirely in memory at speeds up to 6000 lines per minute. NEW!
- Link routines once when starting a programming session and no need to link again when changing programs. NEW!
- Built-in debugger with single-step, animate, and trace modes. NEW!

Create stand-alone programs.

Alphanumeric Labels

- Can be used to make your programs more readable. Line numbers are not required but are supported for BASICA compatibility.

Structured Programming Support

- Block IF/THEN/ELSE/END IF eliminates the need for GOTO statements. NEW!
- Subprograms can be called by name and passed parameters. Both local and global variables are supported.

Modular Programming Support

- Separate compilation allows you to create compiled BASIC libraries to use and re-use your programs.
- A library of routines to access DOS and BIOS interrupts is supplied. NEW!

Large Program Support

- Code can use up to available memory.
- Numeric arrays, each up to 64K bytes, can use up to available memory. NEW!

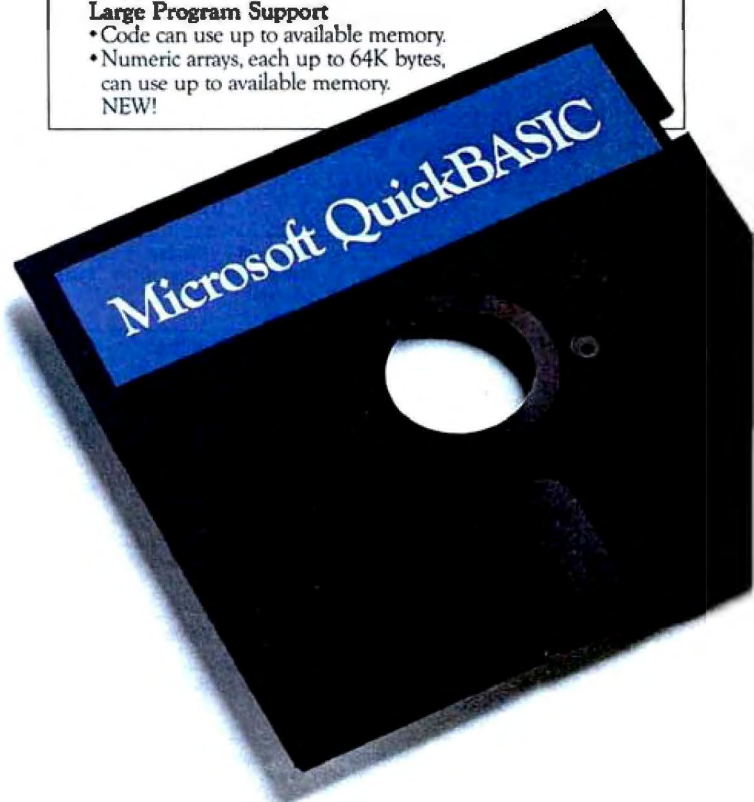

Introducing the 10/6 MHz Multitech 900 Innovation without compromise



The high-performance Multitech 900 is your innovative alternative in an AT system.

Poised to run faster.

The Multitech 900 operates at 6 or 10 megahertz. With this speed advantage switching from 6 to 10 megahertz cuts processing time almost in half — you spend less time waiting for the information you need to analyze.

Bundled Soft-white display.

A high-resolution, non-glare, soft-white display and monochrome-graphics adapter are included with your Multitech 900 — not priced separately.

Price/performance breakthrough.

At \$2,395 the Multitech 900 delivers the high-performance you demand in

an AT system but at an affordable price to fit within all budgets.

Uncompromising.

While the Multitech 900 introduces innovation it doesn't compromise any industry standards.

For example: *Software compatibility* with programs designed for the IBM PC/AT and PC/XT; *hardware compatibility* to tie into your networking options; full *one-year warranty* and guaranteed *support* from Multitech, a company with a proven track-record in quality microcomputer manufacture; and, *Nationwide service** that is convenient and dependable. Call us today for more information about the Multitech 900 or our full line of personal computer products.

	CPU Speed	Mother-board Memory	Max. # of Half-Height Internal Drives	Display	Operating System	Warranty Period	Suggested List Price
Multitech 900	10 or 6 MHz Keyboard, Software or Hardware Switchable	512K RAM Up to 1MB	5	Hi-Res., Soft-white	MS-DOS 3.1	12-Months	\$2395
IBM PC/AT	8 MHz Only	512K RAM Up to 640K	3	Option	Option	12-Months	\$5295*
Sperry PC/XT	6, 7, 16 or 8 MHz Hardware Switchable	512K RAM Up to 1 MB	4	Option	MS-DOS 3.1	12-Months	\$3395
Compaq Deskpro 286	6 or 8 MHz Keyboard & Software Switchable	256K RAM Up to 2.2MB	4	Option	Option	3-Months	\$3395
Tandy 3000	8 MHz Only	512K RAM Up to 640K	3	Option	Option	3-Months	\$2599
Televideo Telecat-286	6 or 8 MHz Keyboard & Software Switchable	512K RAM Up to 1MB	3	Hi-Res., Green	Option	3-Months	\$2995**

*Includes 30MB Hard Disk Drive All prices reflect manufacturers' suggested list for base models as of June 4, 1986

Multitech 900 is a trademark of Multitech Electronics Inc. All other product names are trademarks of their respective manufacturers.

Multitech
ELECTRONICS INC.

Committed to Excellence, Quality & Service

1012 Stewart Drive
Sunnyvale, CA 94086
Tel: (408) 773-8400
(800) 538-1542

A Division of MSC International
*Served Nationwide by TRW

POLAR NORMAL DISTRIBUTION

BY ALAIN LATOUR

Generate normal deviates and evaluate the cumulative probability of a normally distributed random variable

IN THE OCTOBER 1985 BYTE, Arthur G. Hansen suggested a way to generate normal deviates (Programming Insight: "Simulating the Normal Distribution"). Basically, a normal deviate is obtained by considering the value

$$X = (U_1 + U_2 + \dots + U_n - n/2) / \sqrt{(n/12)}$$

where U_1, U_2, \dots, U_n are independent uniform numbers between 0 and 1. The value of X can be considered as a normal deviate with mean $\mu=0$ and standard deviation $\sigma = 1$, if n is sufficiently large. As reported by Abramowitz and Stegun (reference 1), "When $n=12$, the maximum errors made in the normal deviate are 9×10^{-3} for $|X| < 2$, 9×10^{-4} for $2 < |X| < 3$." But if n is too small, we have only an "approximate normal distribution."

THE POLAR METHOD

I would like to suggest a relatively simple approach, known as the "polar method," proposed by G. E. P. Box, M. E. Muller, and G. Marsaglia, which is proven in reference 2. Here is the pseudocode of the algorithm:

Repeat

1) Get 2 independent random variables, V_1 and V_2 , uniformly distributed between -1 and 1 .

2) Evaluate $S := (V_1)^2 + (V_2)^2$ until $S < 1$.

Evaluate $S := \sqrt{-2 \ln(S)/S}$

Set $X_1 := V_1 S$ and $X_2 := V_2 S$.

The two random numbers X_1 and X_2 are independent normal variables. If the uniform generator used returns a number U between 0 and 1, you just have to set $V = 2U - 1$ to obtain a number between -1 and 1 . The square root and the logarithm functions must be evaluated for each pair of normal deviates.

Although the algorithm is complex, its advantage is that you obtain numbers really distributed as normal deviates, and fewer uniform deviates are needed. The last point may be an important one. For example, the random-number generators available on some personal computers cannot produce a sequence of numbers longer than 65,536 without cycling.

CLASSIFYING THE OBSERVATIONS

Suppose you know that almost all the observations will fall between the

limits Y_{Min} and Y_{Max} . That would mean that the data range is approximately $Y_{Range} = Y_{Max} - Y_{Min}$. To classify the values in Nb classes where Y is an observed value, you can use

$\text{Trunc}((Y - Y_{Min}) / Y_{Range} \times Nb)$

For example, if $Y = Y_{Min}$, the above statement will produce 0. And you could use the extreme classes to collect extreme values.

I have written a short Pascal program called NORMAL.PAS that generates 10,000 normal deviates and sorts them into 30 classes as they are generated. The results could be used to plot the observed distribution of the numbers generated. [Editor's note: NORMAL.PAS is available in a variety of formats; see page 405 for details.]

THE CUMULATIVE PROBABILITY FUNCTION

If you're interested in comparing the simulated distribution with the theoretical distribution, you must

(continued)

Alain Latour (Département de Mathématiques et d'Informatique, C. P. 8888, Succ. "A," Université du Québec à Montréal, Montréal, Quebec, Canada H3C 3P8) teaches statistics and computer science.

evaluate the probability of each class. One way to do it is by tedious calculations using a table of probability. Another, more interesting way is to write a function that, given a number x , will give you the probability that a normal deviate will be less than or equal to x . We will denote this probability by

$P\{z \leq x\}$. There is a polynomial approximation of degree 5 to this probability that is quite good (see reference 1). It requires the evaluation of the density function of a normal variable, that is:

$$f(x) = c e^{-x^2/2}$$

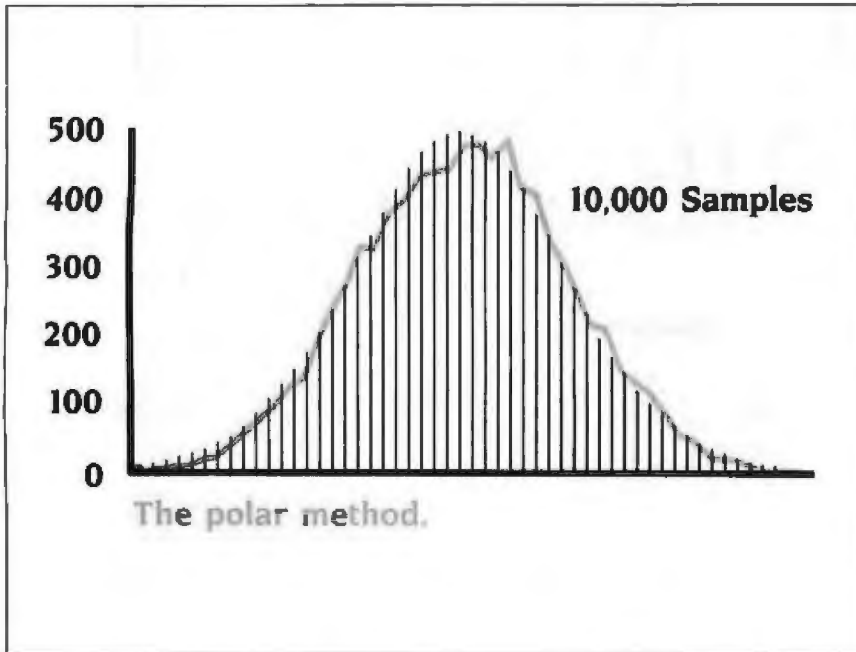

Figure 1: The empirical distribution obtained by simulating 10,000 deviates by the polar method. The adjustment seems to be quite good.

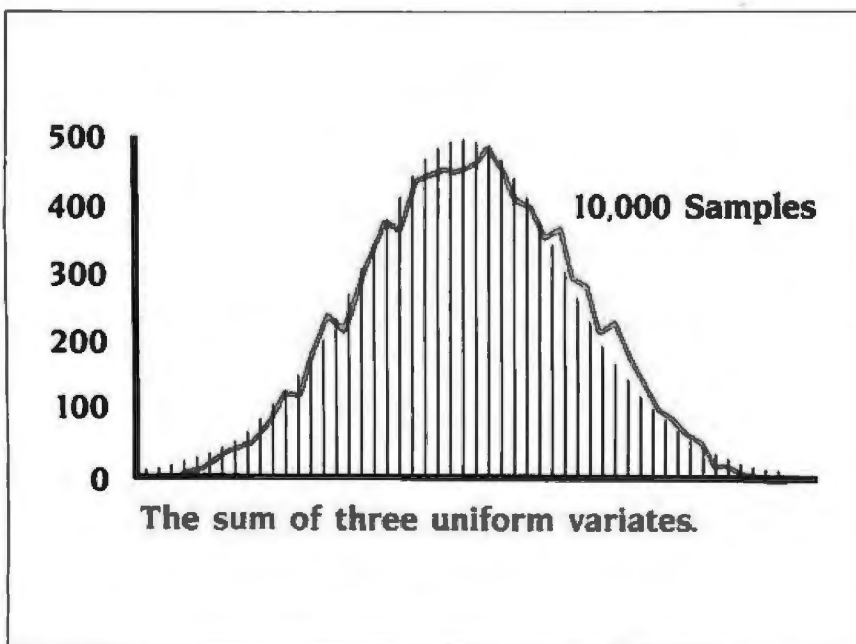

Figure 2: The empirical distribution obtained by using the sum of three uniforms.

To compare the simulated distribution with the theoretical distribution, you must evaluate the probability of each class.

where c is a constant equal to $1/\sqrt{2\pi} = 0.3989422804$. So, for $x \geq 0$, we have

$$P\{z \leq x\} = 1 - f(x) (b_0 + b_1 t + b_2 t^2 + b_3 t^3 + b_4 t^4) + \text{error}$$

where $t = 1/(1+px)$ with $p = 0.2316419$ and where $b_0 = +0.319381530$, $b_1 = -0.356563782$, $b_2 = +1.781477937$, $b_3 = -1.821255978$, and $b_4 = +1.330274429$. The error is less than 7.5×10^{-8} . If $x < 0$, you can use the well-known property of the normal curve, $P\{z \leq x\} = 1 - P\{z \leq -x\}$. [Editor's note: Both functions are contained in DENSITY.PAS, which is available in several formats; see page 405.]

Figure 1 shows the empirical distribution obtained by the polar method. As you can see, the adjustment seems to be quite good.

Figure 2 shows the empirical distribution obtained by using the sum of three uniforms. Both cases simulated 10,000 deviates. Obviously, the adjustment is not as good as that in figure 1. You can also compare the two methods by evaluating the chi-square measure of adjustment. With 47 degrees of freedom, in the first case we have a chi-square equal to 36; in the second case, the chi-square is equal to 147. In other words, the method using the sum of three uniforms doesn't pass the chi-square test. ■

REFERENCES

1. Abramowitz, M., and I. A. Stegun, eds. *Handbook of Mathematical Functions*. New York: Dover Books, 1964.
2. Knuth, D. *The Art of Computer Programming, Volume 2*. Reading, MA: Addison-Wesley, 1969.



New Version 4.0 FILE RECOVERY SYSTEM™

FOR THE IBM-PC

*"Brown Bag Software's™ File Recovery System™...
more powerful than the Norton Utility Version 3.1!"*
—PC Magazine

We May Be Able To Save Your Job Or Your Life

\$129⁹⁵

Recover Erased Files
Edit Any Spot On A Disk
Change File Attributes

Fix A Damaged File
Menu-Driven and "Goof-Proof"
Context Sensitive Help

Recover Data From Physically Damaged Disks
Works On Hard And Floppy Disks
Not Copy-Protected

• **YES YOU CAN RECOVER ERASED FILES.** Even *. With Brown Bag Software's™ File Recovery System™ for the IBM-PC and compatibles, no programming experience required. If you can erase a file, you can restore it.

• **MENU-DRIVEN and "FOOL-PROOF."** Do you have "one-of-those" in your office...we do too! That's precisely why we developed Brown Bag Software's™ File Recovery System™ for the IBM-PC and compatibles! Our menu-driven system is a snap.

• **FIX A DAMAGED FILE TOO!** Sometimes files can get "glitched" by a power spike, bumping into the hard disk, dropping the computer on the floor, etc. We understand. That's why we've included a full screen editor to repair any spot in any file, hidden or otherwise.

• **IS IT HARD OR FLOPPY?** We don't care. We work with floppy disk, most hard disks, and most IBM-PC compatible computers.

• **HELP IS ONLINE TOO!** We know that most people don't read manuals. (But we include a comprehensive one anyway.) And when you erase a file and need it recovered NOW, you're not in any frame of mind to pour through any manual. We understand. That's why we've put hand-holding online. Just hit the ? key and the help appropriate to where you are and what you want to do is immediately available. The only thing better would be two aspirins!

• **OTHER HANDY TOOLS.** **HELP: WHERE'D THE FILE GO?** We provide menu-driven tools to change a file's attributes, change disk labels, modify screen color, locate a lost file that you know is somewhere on the disk, but it's lost in a maze of sub-directories (you forgot which).

WITH YOUR CREDIT CARD, CALL NOW
24 HOURS A DAY, 7 DAYS A WEEK

800-523-0764

IN CALIFORNIA
800-323-5335

The new Diconix 150. The printer that
It's the one PC printer you



works hard, yet hardly makes a sound.
can take lightly. Anywhere.



DICONIX

A Kodak Company

3100 Research Boulevard

Dayton, Ohio 45420

1-800-DICONIX

Inquiry 90

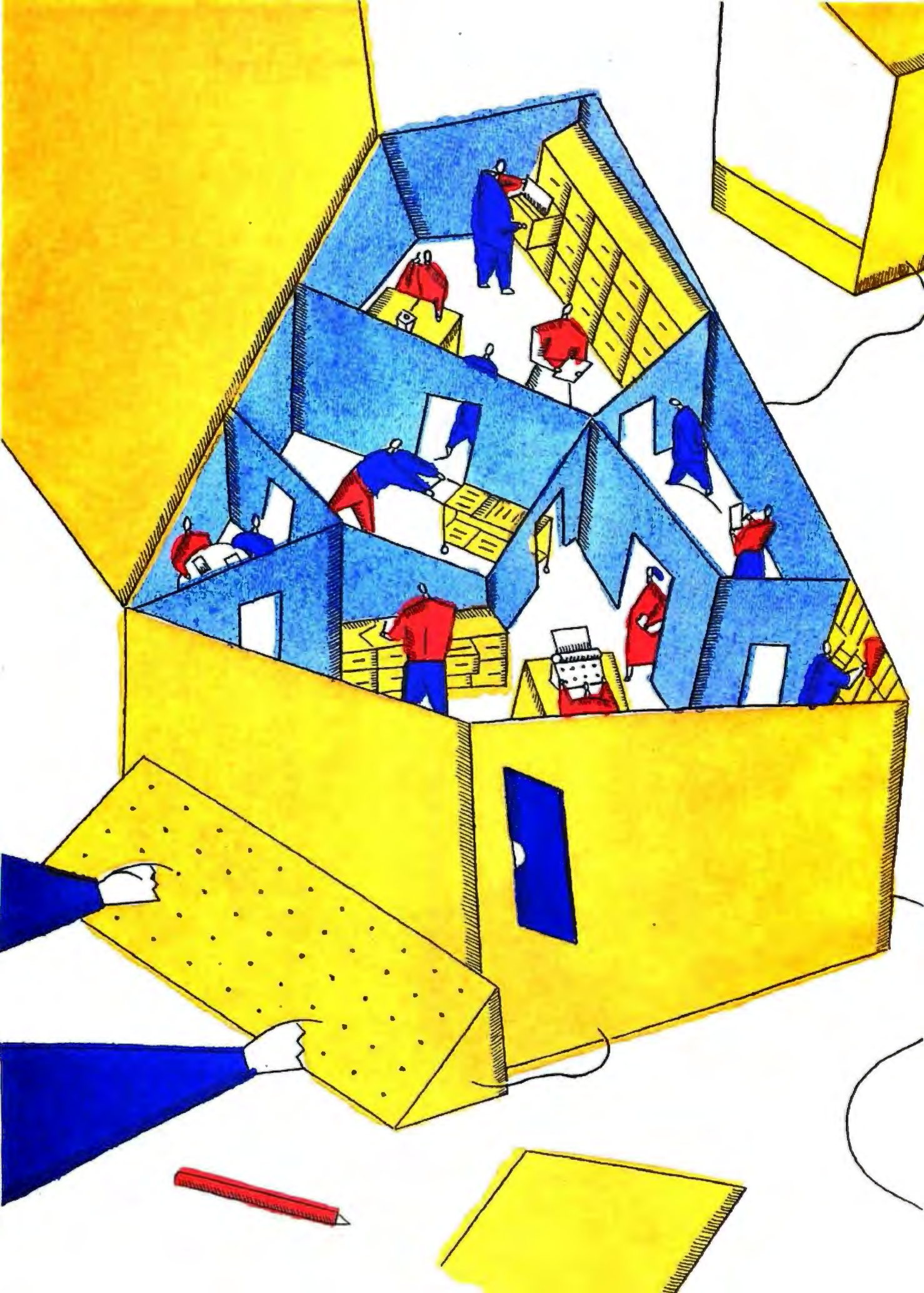

Object-oriented Programming

ELEMENTS OF OBJECT-ORIENTED PROGRAMMING <i>by Geoffrey A. Pascoe</i>	139
A SMALL TASTE OF SMALLTALK <i>by Ted Kaehler and Dave Patterson</i>	145
OBJECTS, ICONS, AND SOFTWARE-ICs <i>by Brad Cox and Bill Hunt</i>	161
OBJECT-ORIENTED LANGUAGES FOR THE MACINTOSH <i>by Kurt J. Schmucker</i>	177
MACAPP: AN APPLICATION FRAMEWORK <i>by Kurt J. Schmucker</i>	189
PROGRAMMING EXPERIENCES <i>by Larry Tesler</i>	195
DESIGNING AN EFFICIENT LANGUAGE <i>by Charles B. Duff</i>	211
OBJECT-ORIENTED FORTH <i>by Dick Pountain</i>	227

OBJECT-ORIENTED PROGRAMMING, with its claims of improved programmer productivity and easy program maintenance, is emerging as a vital force in the programming community. This is despite the fact that object-oriented languages were not generally available until fairly recently.

The prototypical object-oriented language is Smalltalk, and in August 1981, BYTE devoted an entire issue to it, even though at the time the language was not commercially available. Today, Smalltalk is available for microcomputers, and object-oriented concepts have been extended to many conventional languages.

In this issue, we present a group of articles examining the current state of object-oriented languages. To start things off, Geoffrey A. Pascoe outlines the basics of the subject in "Elements of Object-oriented Programming." Geoff does a good job of defining exactly what object-oriented programming is and, more important, what it is not.

For those who may have missed our Smalltalk issue, Ted Kaehler and Dave Patterson give the flavor of what it's really like to program in that language in "A Small Taste of Smalltalk," excerpted from their recent book, *A Taste of Smalltalk*.

The microcomputer that is most closely related to the original Smalltalk philosophy and object-oriented programming in general is the Apple Macintosh. And, not surprisingly, a number of object-oriented languages have evolved for that machine. Kurt J. Schmucker explores a number of them in his comprehensive article, "Object-oriented Languages for the Macintosh," comparing seven languages that are now or soon to be available for the Mac. We also convinced Kurt to write a few pages on MacApp, a powerful object-oriented application framework that Apple Computer will be releasing shortly.

Brad Cox, one of the developers of Objective-C, has helped promote the understanding of object-oriented programming by proposing the concept of the software-IC, a software module that can be easily added to a program. Brad, together with Bill Hunt, shows how object-oriented programming techniques make building iconic user interfaces easier in their article, "Objects, Icons, and Software-ICs."

Another early object-oriented language for micros is Neon for the Macintosh. The developer of that language, Charles B. Duff, discusses the inefficiencies of object-oriented languages and ways to improve them in "Designing an Efficient Language."

Finally, we bring back one of the authors from our 1981 Smalltalk issue. Larry Tesler, a former Xerox PARC researcher, presents interviews with people who are actually using object-oriented languages in their various fields of work in "Programming Experiences."

The article by our U.K. correspondent, Dick Pountain, is particularly fitting this month. Dick, a formidable FORTH programmer in his own right, has written his own object-oriented extension to FORTH. In "Object-oriented FORTH" he describes his program and how it works.

—Eva White and Rich Malloy, Technical Editors

Get started in AI with Gold Hill.

You know artificial intelligence is the wave of the future. Programs based on the ideas of artificial intelligence are being written today in COMMON LISP—the new LISP standard developed by researchers from universities and corporations such as Carnegie Mellon, DEC, MIT, Stanford, Symbolics and TI. LISP allows the development of programs that are intelligent, flexible, and even human-like. The problem has been that hardware needed to run LISP is expensive.

No longer. GOLDEN COMMON LISP (GC LISP) makes it possible for you to learn and use LISP on your *personal computer*. When you use GC LISP in combination with the AI examples provided, you will be able to develop such exciting applications as expert systems, natural language systems, and intelligent interfaces to complex software. The possibilities are endless. With GC LISP you can tackle problems that you could not solve before with ordinary number crunching programs. You will be able to write powerful programs that can accommodate casual computer users who want intelligible answers quickly.

Learn Quickly with GC LISP
GC LISP makes it easy for you to learn the technology of AI at your own pace. Each package includes the *San Marco LISP Explorer*—an interactive software tutorial developed by San Marco Associates with Patrick H. Winston. This 800-frame instructional system guides you through the

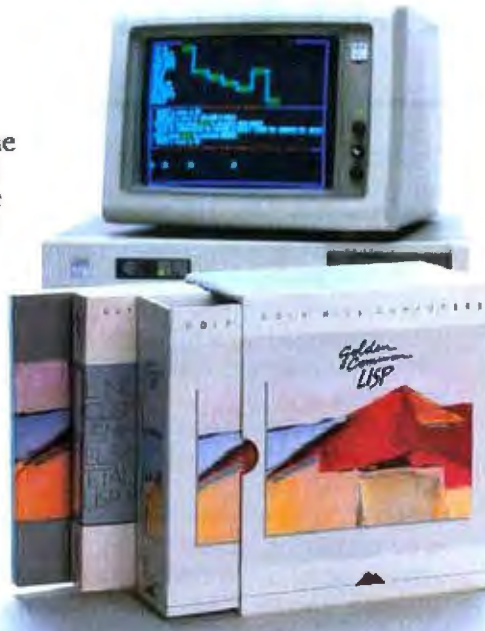

GOLDEN COMMON LISP is the best selling AI language.

steps of LISP programming and makes the full range of LISP's power accessible to both novice and experienced programmers. The second edition of the classic *LISP* textbook by Winston and Horn is also included.

GC LISP comes complete with the intelligent GMACS editor (based on EMACS), full on-line documentation of all GC LISP and GMACS functions, the *Common LISP Reference Manual* by Steele, and a comprehensive user manual. In short, GOLDEN COMMON LISP comes with everything you need to program in LISP.

NEW!

The GC LISP 286 DEVELOPER
Discover programming power you never thought possible on your PC AT! GC LISP 286 DEVELOPER is a complete programming environment designed for GC LISP-based applications requiring extended memory and faster execution. The 286 DEVELOPER includes a Large Memory Interpreter capable of addressing 15 megabytes of physical memory, a Large Memory Compiler that runs applications up to 15 times faster, and a complete set of program development features including lexical and dynamic scoping. The 286 DEVELOPER is the first PC-DOS programming environment that takes full advantage of the speed and memory capacity of the IBM PC AT and compatibles, and it's now available to help you develop powerful and productive AI applications.

Order Today

For more information on Gold Hill products, please call today:

1-800-242-LISP

In Massachusetts call collect
(617) 492-2071

GC LISP requires an IBM PC, PC XT, PC AT, or IBM-compatible with a minimum of 512K and PC-DOS 2.0 or higher. GC LISP 286 DEVELOPER is non-copy protected, and requires an IBM PC AT or compatible with a minimum of 512K of base memory, 2 megabytes of extended memory, and PC-DOS 3.0 or higher.

© 1986 Gold Hill Computers



G O L D H I L L C O M P U T E R S

163 Harvard Street, Cambridge, Massachusetts 02139

GOLDEN COMMON LISP, GC LISP and GC LISP 286 DEVELOPER are trademarks of Gold Hill Computers. The San Marco LISP Explorer is a registered trademark of San Marco Associates. LISP is copyrighted by Addison-Wesley Publishing Company, Inc. The COMMON LISP Reference Manual is copyrighted by Digital Equipment Corporation. IBM PC, PC XT, PC AT, and PC DOS are trademarks of International Business Machines.

ELEMENTS OF OBJECT-ORIENTED PROGRAMMING

BY GEOFFREY A. PASCOE

What features must a language have to be considered an object-oriented language?

THERE ARE AS many different views of what object-oriented programming is as there are computer scientists and programmers. Because the term was first used to describe the Smalltalk programming environment developed at Xerox PARC (see references 1-5), this article will present object-oriented programming concepts, terminology, and characteristics from that perspective. I will stress the differences between an object-oriented programming style and the more conventional procedure-oriented style. I hope to show that a language must have four elements to support object-oriented programming: information hiding, data abstraction, dynamic binding, and inheritance. (Some languages that have one or two of these elements have been improperly called object-oriented.) I will follow this with a discussion of the advantages and disadvantages of object-oriented programming languages.

DATA PROCEDURES VS. OBJECT MESSAGES

Most programming languages support the "data-procedure" paradigm.

Active procedures act on the passive data that is passed to them. A typical example might be a square root function, `sqrt(x)`, that takes a number and returns its square root.

In a strongly typed language such as Pascal, it would be typical to have a different version of `sqrt(x)` for each data type of `x`, usually returning a floating-point result. A late-binding language such as LISP detects `x`'s data type at run time and performs the appropriate operations for that data type. Such generic operations are generally primitives restricted to a small class of data types such as numbers, or they are functions defined in terms of such primitives.

Object-oriented languages employ a data or object-centered approach to programming. Instead of passing data to procedures, you ask objects (data) to perform operations on themselves. To emphasize this difference I will use an object-oriented expression syntax of my own invention. The object name is followed by `:`operation, followed by any further arguments, and terminated by a period (in some ways the syntax is similar to that of Small-

talk-80, though simpler). For example, an expression to take the square root of `x` will look like this:

```
x :sqrt.
```

The implication is that `x` is asked to perform the `:sqrt` operation on itself. You say that `x` is the *receiver* of the *message* `:sqrt`.

A more complicated example would be the dot-product operation. The dot-product of two one-dimensional vectors, `x` and `y`, is computed, producing a scalar result:

```
x :dot y.
```

Here, `x` is told to perform a dot-product operation with itself and the argument `y`. You could take the square root of the dot product of `x` and `y` and assign the result to the variable `z` in the following manner

```
z ← (x :dot y) :sqrt.
```

(continued)

Geoffrey A. Pascoe (1027 Scituate Harbor, Pasadena, MD 21122) is a researcher in the Department of Defense's Computing Systems Research Division and comoderator of the Smalltalk conference on BIX.

800-222-8324



10 Meg
\$369

20 Meg
\$395

30 Meg
\$595

Seagate

Hard Drive Blowout!

- All Drives Seagates w/ Controller
- 10 Meg Seagate \$369
- 20 Meg Seagate \$395
- 30 Meg For XT \$595

Other Specials

- 20 Meg Hardcard (uses 1 slot) \$599
- 20 Meg Seagate for "AT" \$549
- 30 Meg for "AT" \$549
- 20 Meg Tape (Teac) w/cont. & soft \$595
- 65 Meg Tape (3m) w/cont. & soft .. \$695

brother

- M1509 NEW
- M-1109 \$195
- HR-15XL \$360
- HR-25 \$499
- HR-35 \$880
- Twinriter-5 Dual Head \$ Call

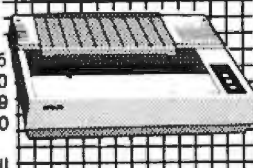

Epson Products

- LX-80 \$220
- FX-80* \$259
- FX-85 \$ Call
- JX-80 \$349
- FX-286 \$ Call

EPSON

- LQ-800 \$545
 - LQ-1000 \$765
 - LQ-1500 \$999
- Accessories Available

Okidata

- 182 \$299
- 192 \$399
- 193 \$599
- 84 \$699
- 2410 \$ Call

Panasonic

- KXP 1080 \$199
- KXP 1091 \$239

Blowout

Computers (IBM Compatibles)

- IDS PC-XT 8088 Base Mono Color \$595 795 895
- IDS Turbo 8 Mghz
- 2 Drives MS-Dos \$649 895 1095
- IDS AT
- 1 1.2 Meg Floppy/M.S. Dos & 1495 1695 1895
- Leading Edge Call for Lowest Price
- AT&T 6300 Call for Lowest Price
- Epson Equity I, II, III Call for Lowest Price

Everex Products

- Everex 1200 Modem \$149
- Everex Edge Card \$199
- (Mono-Graphics-Color)
- Everex Mini Magic Card \$129
- (W/384k 1/2 slot)
- Everex Magic Multi-function \$99
- (Six Pac Clone)

CARDS & ACCESSORIES for IBM

- Mono/Printer \$95.00
- Color/Printer \$99.00
- Mono/Graphics/Printer \$99.00
- RS-232 \$59.00
- RS-232/Clock \$69.00
- Parallel \$59.00

1-800-222-8324

CALL NOW!!!!

COMPUTERS INTERNATIONAL

6619 U.S. 1 Miami, FL 33143
IN FLORIDA CALL (305) 667-5936



PROGRAMMING ELEMENTS

using parentheses to indicate the order of evaluation, although the parentheses are really not needed here, assuming left-to-right evaluation.

SOME TERMINOLOGY

The basic terminology of object-oriented programming is illustrated in the text box "Data Structures" on page 142. The object that I have been referring to (i.e., x, in the sqrt example) is an *instance* of a *class*. The class provides all the information necessary to construct and use objects of a particular kind, its instances. (For this reason, a class is sometimes called a *factory*.) Each instance has one class; a class may have multiple instances.

The class also provides storage for *methods*. Methods are simply procedures that are invoked by sending *selectors* to a class's instances (also called sending messages). The methods reside in the class to save storage, since all instances of a class have an identical set of methods. Methods may allocate temporary variables for use during the execution of the method. These temporary variables are much like local variables in Pascal procedures in that their value is lost when you leave the method.

Each instance has storage allocated for maintaining its individual state. The state is referenced by *instance variables*. Instance variables may be primitive data types such as integers, other objects, or both, depending on the language. Each object has its own set of instance variables. Both temporary and instance variables may be freely referenced within the scope of an object's method, but unlike temporary variables the value of instance variables is not lost when you leave the object's method.

Computation is performed by sending messages to objects, which invokes a method in the object's class. Typically, a method sends messages to other objects, which invokes other methods, etc., until you reach the point where a *primitive method* is invoked. Here ends the chain of message-sends. Each message-send eventually returns a result to the sender (e.g., x:sqrt returning the square root of x). The end result of all these message-sends is usually the changing of

the state of one or more objects. Sometimes, however, a message is sent simply to invoke some primitive having a side effect external to the world of objects, for example, accessing an external file system or controlling hardware.

To fully support object-oriented programming a language must exhibit four characteristics: information hiding, data abstraction, dynamic binding, and inheritance. I will examine two languages, Ada and Modula-2, that have been mistakenly called object-oriented in order to illustrate why all four characteristics are necessary and why conventional procedure-oriented languages cannot adequately support object-oriented programming.

INFORMATION HIDING

Information hiding is important for ensuring reliability and modifiability of software systems by reducing interdependencies between software components. The state of a software module is contained in private variables, visible only from within the scope of the module. Only a localized set of procedures directly manipulates the data. In addition, since the internal state variables of a module are not directly accessed from without, a carefully designed module interface may permit the internal data structures and procedures to be changed without affecting the implementation of other software modules.

Most modern languages, even FORTRAN, to some degree, support information hiding. ISO (standard) Pascal is one notable exception, since it provides no way to declare static variables within the scope of a procedure.

DATA ABSTRACTION

Data abstraction could be considered a way of using information hiding. A programmer defines an abstract data type consisting of an internal representation plus a set of procedures used to access and manipulate the data. Modula-2 provides excellent data abstraction mechanisms. Listing 1 is a fragment of Modula-2 module that implements a stack as an abstract data type (called an *opaque type* in Modula-2 terminology. See reference 6). Variables of type Stack may be

declared and manipulated in other program units.

Modula-2's data abstraction mechanism provides a certain degree of protection since no direct access to the internal state of a stack is provided. The stack is manipulated through the module's processing and query procedures. But there are a couple of problems with the Modula-2 solution. One is that the procedures used by a module must have either unique or qualified names. For example, if a module uses (imports) two different abstract data types, Stack and Queue, and variables of these types must be initialized, then the initialization procedures defined for these types must have different names, such as InitializeStack and InitializeQueue, or their usage must be qualified, as in Stack.Initialize and Queue.Initialize. This makes the resulting program less versatile. But more important than the need for unique identifiers is the drawback that Modula-2 abstract data types can operate on only one type of data. Stack, therefore, can store only integers.

Ada partially solves both these problems through two language features: operator overloading and generic program units (see reference 7). Operator overloading permits a program to use multiple operators with the same name. The distinction between operators can be determined at compile time by examining the types and number of parameters, just as + can be used to add either integer or real numbers in most modern languages. Generic program units permit the definition of a module to be used with different data types. The generic program unit is a procedural template that can be parameterized with actual types during compilation of programs using its capabilities.

A problem still exists if you wish to use the stack to store heterogeneous elements. Neither compile-time solution, operator overloading or generic program units, is sufficient. The solution is dynamic binding.

DYNAMIC BINDING

Dynamic binding is needed to make full use of this code for stacking other

types of data. Consider the addition of a procedure, Print, to the StackHandler module that prints the contents of a stack. If you use the stack for storing integers, floating-point numbers, character strings, etc., a traditional procedure-oriented approach dictates that you include a

case statement to check at run time that the correct printing procedure for an element's type is used. Trying to print an integer with a procedure designed to print character strings is potentially disastrous. The resulting problem is that every time you add

(continued)

Listing 1: Definition and implementation modules for the abstract data type Stack.

```

DEFINITION MODULE StackHandler;

TYPE
  Stack; (* Opaque type *)

  StackType = INTEGER;

PROCEDURE Initialize(VAR s: Stack): BOOLEAN;

PROCEDURE Push(s: Stack;
               value: StackType): BOOLEAN;

PROCEDURE Pop(s: Stack;
              VAR value: StackType): BOOLEAN;

PROCEDURE IsEmpty(s: Stack): BOOLEAN;

PROCEDURE IsEmpty(s: Stack): BOOLEAN;

PROCEDURE IsFull(s: Stack):BOOLEAN;

END StackHandler.
-----
IMPLEMENTATION MODULE StackHandler;

FROM SYSTEM IMPORT TSIZE;

FROM storage IMPORT Allocate, Available;

CONST
  BufferSize = 1000;

TYPE
  IndexRange = [0..BufferSize];

  StackRecord =
    RECORD
      Index: IndexRange;
      buffer: ARRAY [1..BufferSize] of StackType
    END;

  Stack = POINTER TO StackRecord;

(* code for implementation part of Initialize,
Push, Pop, IsEmpty, and IsFull goes here *)
.
.
.

BEGIN (* StackHandler *)
  (* No Initialization Required *)
END StackHandler.
    
```

a new type of data to the software system, you must modify all such case statements and recompile—a time-consuming and error-prone procedure. Ideally, additions should require only additions, not modifications.

The object-oriented approach pushes the responsibility for printing elements onto the objects themselves. Each object is sent the exact same message selector, `Print`, so that it will print itself in the proper way. This is known as *polymorphism*, since the same message can elicit a different response depending on the receiver. Operator overloading in Ada does not exhibit this form of dynamic polymorphism since the address of the procedure invoked is fixed at compile time.

This model of object-oriented programming can be improved. As presented thus far, the addition of a new type of object requires writing entirely new procedures for common operations such as `Print`. What's worse is that there will be a great deal of similarity between different `Print` methods, requiring continual rewrites of methods that differ slightly or not at all. This burden is likely to be so great that programmers would avoid the creation of new object types, significantly reducing the practical usefulness of object-oriented programming systems. Inheritance is a mechanism that largely relieves programmers of this burden.

INHERITANCE

Inheritance enables programmers to create classes and, therefore, objects that are specializations of other objects. For example, you might create an object, `Trumpet`, that is a specialization of a `BrassInstrument`, which is a specialization of a `WindInstrument`, which is a specialization of `MusicalInstrument`, etc. A `Trumpet` inherits behavior that is appropriate for `BrassInstruments`, `WindInstruments`, and `MusicalInstruments`.

Creating a specialization of an existing class is called *subclassing*. The new class is a *subclass* of the existing class, and the existing class is the *superclass* of the new class. The subclass inherits instance variables, class variables, and

methods from its superclass. The subclass may add instance variables, class variables, and methods that are appropriate to more specialized objects. In addition, a subclass may override or provide additional behavior to methods of a superclass. Methods are overridden when you provide a new method for an old method's selector.

The mechanism to add new behavior to an existing method tends to be language-dependent. In those languages most closely modeled after Smalltalk, this is accomplished by embedding a message-send to the *pseudovariation* `super` in the new definition of a method (see the text box "Pseudovariations" on page 144). For example, suppose you have an initialization method, `initialize`, defined in a superclass. If a subclass adds some instance variables, `x` and `y`, that must also be initialized to zero, then both initialization behaviors will be exhibited by the following method:

```
initialize
  super initialize.
  x ← y ← 0.
```

The initialization in the superclass is performed, followed by the added initialization behavior. Depending on the placement of the message-send to `super`, the new behavior may precede, follow, or surround the existing behavior.

Inheritance enables programmers to create new classes of objects by specifying the differences between a new class and an existing class instead of starting from scratch each time. A large amount of code can be reused this way.

ADVANTAGES

Object-oriented languages have many advantages over more traditional procedure-oriented languages. Information hiding and data abstraction increase reliability and help decouple procedural and representational specification from implementation. Dynamic binding increases flexibility by permitting the addition of new classes of objects (data types) without having to modify existing code. Inheritance coupled with dynamic binding permits code to be reused. This

(continued)

DATA STRUCTURES

The class data structure in figure A contains information needed to construct and use object instances. The first and second fields indicate the number of instance variables and their names, respectively. The names are needed so that when methods are compiled, the instance variable names can be identified as referring to instance variables.

The third field of the class data structure is a flag that indicates whether an instance contains a variable number of indexable instance variables. Arrays are examples of objects that may have a variable number of instance variables. The instance variables of an array are accessed by indexing instead of by names. Since arrays of different sizes will respond to the same protocol (the set of messages to which an object responds), it does not make sense to have different classes for each array size.

The class variable field contains storage for variables shared by all instances. Class variable names are also stored here. Class variables can be convenient for storing information that should be common to all instances of the class. Not only does this save storage, but it greatly simplifies changing shared information. Otherwise, all instances of a class would have to be located to change an instance variable.

The method dictionary contains pairs of selectors and methods. When a message is sent to an object, the class's method dictionary is searched for a method to execute.

The superclass field points to the superclass of this class. The superclass is another class data structure that has all the same fields as this class. Other instance variables, class variables, and methods may be defined in the superclass.

If during a message-send a method is not found in the instance's immediate class, the superclass method dictionary is searched. If it is not found there, the superclass's superclass method dictionary is searched, and so on, until the class at the root of the hierarchy (most often called `Object`) is searched and found not to have a matching selector. In this case an error is returned.

Note that each instance contains a

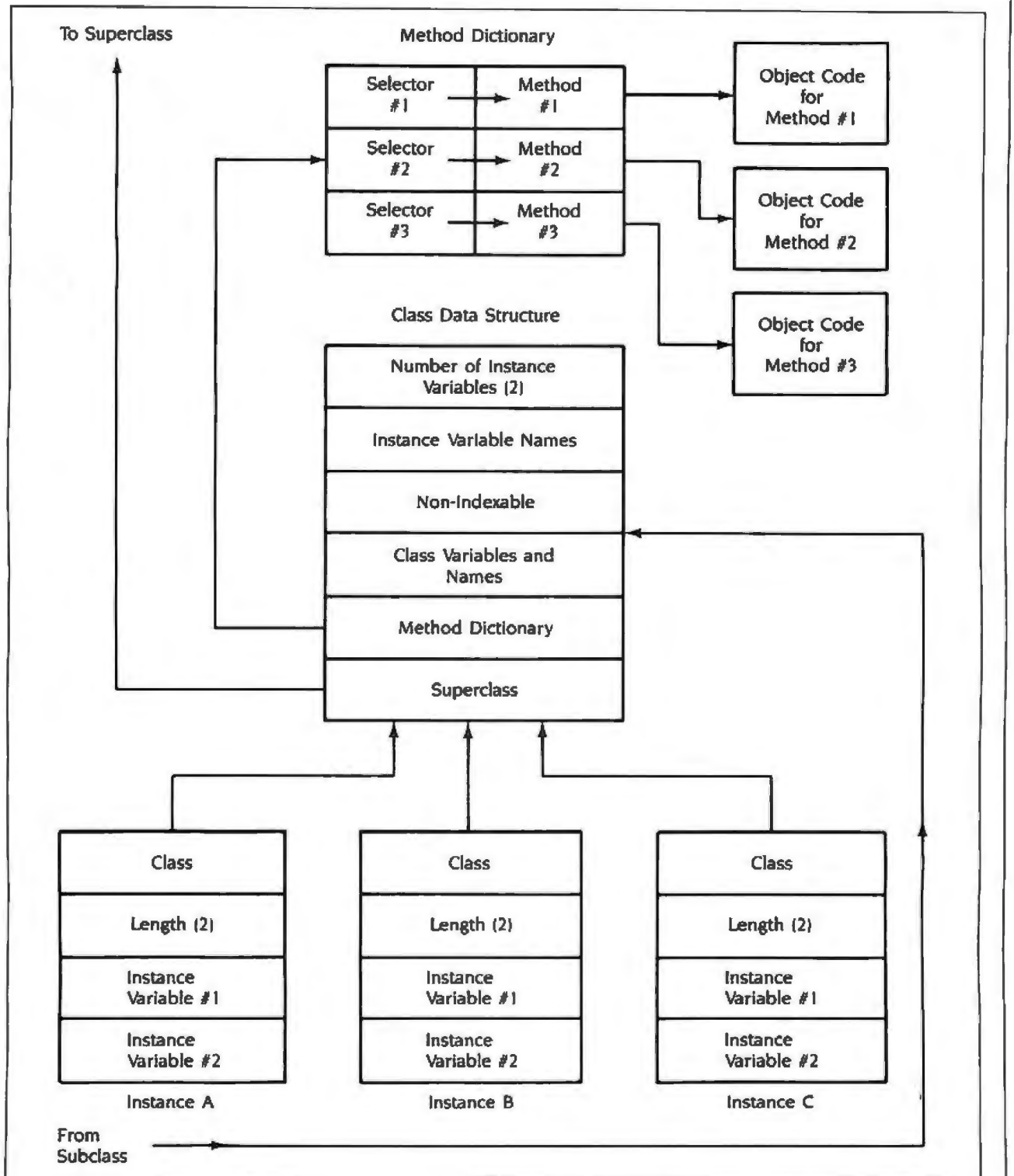

Figure A: Data structures illustrating concepts related to object-oriented programming. Arrows indicate pointers.

pointer to its class and a field indicating the length of the instance. The pointer to the class is needed so that

the class, and therefore an object's methods, may be easily located when the instance is sent a message. Storing

length information in the instance aids the storage manager and is useful when dealing with indexable instances.

has the attendant advantage of reducing overall code bulk and increasing programmer productivity, since you have to write less original code. Inheritance enhances code "factoring" (see references 1 and 2). Code factoring means that code to perform a particular task is found in only one place, and this eases the task of software maintenance.

DISADVANTAGES

Object-oriented languages have a few characteristics that are considered disadvantages by some. The one most often debated is the run-time cost of the dynamic binding mechanism. A message-send takes more time than a straight function call. Some studies have shown that with a well-implemented messenger this overhead is approximately 1.75 times a standard function call (see references 8 and 9). Actual differences in execution speed between traditional languages and their object-oriented counterparts, however, do not prove to be very significant. This is most likely due to the fact that the overhead applies only to message-sends and that message-sends accomplish more than a function call. Often, some of the work done automatically by a message-send must be done by the programmer anyway using code surrounding function calls or even multiple function calls. In fact, a case can be made that in large applications the ability to standardize and fine-tune

the functionality supplied with the message-sends can make the application run faster than a traditional counterpart. The primary reason is that messaging obviates much of the variability in function setup code that results from different programming styles and skill levels. Messaging also eliminates the complex code often needed when traditional programs have to simulate dynamic binding.

Another disadvantage often cited is that implementation of object-oriented languages is more complex than comparable procedure-oriented languages, since the semantic gap between these languages and typical hardware machines is greater. Therefore more software simulation is required. Fortunately, you pay the cost of implementation only once for a given machine.

Another potential problem is that a programmer must learn an often extensive class library before becoming proficient in an object-oriented language. As a result, object-oriented languages are more dependent on good documentation and development tools such as Smalltalk-80 browsers (see references 2 and 4).

CONCLUSION

There are other important concepts in object-oriented programming that I haven't covered because they either do not fit well into the Smalltalk model or are not central to object-oriented programming. Two that re-

quire at least abbreviated mention are multiple inheritance and automatic storage management.

Multiple inheritance allows a class to have more than one superclass. The potential for code sharing is greater, but the possibility of conflicts between multiple superclasses increases the complexity of such systems. Certain flavors of LISP get a great deal of power by using multiple inheritance.

Automatic storage management, though not necessary, is so useful that it almost qualifies as a fifth major element. Automatic storage management techniques such as reference counting and garbage collection permit programmers to ignore details concerning the release of an object's storage. Application code becomes cleaner, and the overall system becomes more reliable.

Object-oriented programming provides major advantages in the production and maintenance of software: shorter development times, a high degree of code sharing (good factoring), and malleability. These advantages make object-oriented programming an important technology for building complex software systems now and in the future. ■

REFERENCES

1. Ingalls, Daniel H. *The Smalltalk-76 Programming System Design and Implementation*. Conference Record of the Fifth Annual Symposium on Principles of Programming Languages.
2. BYTE, Smalltalk Issue, August 1981.
3. Goldberg, Adele, and Dave Robson. *Smalltalk-80: The Language and Its Implementation*. Reading, MA: Addison-Wesley, 1983.
4. Goldberg, Adele. *Smalltalk-80: The Interactive Programming Environment*. Reading, MA: Addison-Wesley, 1984.
5. Krasner, Glenn. *Smalltalk-80: Bits of History, Words of Advice*. Reading, MA: Addison-Wesley, 1983.
6. Wirth, Niklaus. *Programming in Modula-2*. 3rd corrected edition. New York: Springer-Verlag, 1985.
7. *Reference Manual for the Ada Programming Language*. United States Department of Defense, 1980.
8. Cox, Brad J. "Object-oriented Programming in C." *Unix Review*, October/November, 1983.
9. Cox, Brad J. "Message/Object Programming: An Evolutionary Change in Programming Technology." *IEEE Software*, vol. 1, no. 1, January 1984.

PSEUDOVARIABLES

Syntactically, pseudovariables are treated the same as normal variables. Their semantics, however, are different since they cannot be assigned a new value during any particular invocation of a method.

Two important pseudovariables in Smalltalk are *self* and *super*. Both *self* and *super* refer to the object that received the message currently being processed. For example, if there happen to be 22 different rectangle objects currently existing and one of them is sent the center message, then the system will set both the pseudovariables *self* and *super* to refer to that rectangle. The difference between

these two pseudovariables lies in the way that the message lookup is performed.

When *self* is sent a message, the message lookup algorithm is identical to the way a lookup is performed when the message is sent externally, starting in the object's direct class.

When *super* is sent a message, the lookup is performed starting in the superclass of the class in which the method that is currently executing is found. Note that this is not necessarily the superclass of the object's class. This pseudovariable mechanism gives objects a controlled way of accessing superclass methods.

Where Is Desktop AT Power Ultimately Going?



The Toshiba T3100. Desktop AT Power, Toshiba-Style.



ABLE COMPUTER SALES FOR 1986



First Second Third Fourth
QUARTERS

Disk in Use
Left Right CRT
Caps Num Scroll
Lock Lock Lock

T3100
PERSONAL COMPUTER



Anywhere You Want.



Because now you can have desktop AT computing power *without* a mountain of hardware and cables monopolizing your desk;



And *without* tying your productivity to your office;



In fact, you can have a computer so powerful, it's like being able to take your whole desktop anywhere you want.

Toshiba technology improves on AT functionality: The T3100 gives you the power of an IBM® PC-AT™ in a lean, 15-pound computer that looks superb on your desk, and slips into a drawer when you don't need it. Take it home, take it to a meeting, take it around the world. The T3100 puts serious AT computing power anywhere you want.

Don't let its size fool you.

The T3100 is less than a third the size of the Compaq™ Portable II, yet every bit as powerful. It uses the same 80286 microprocessor as a full-sized IBM PC-AT, and is fully IBM compatible, so you can continue to share data with the other PC's in your office. The T3100's 10MB internal hard disk gives you ample storage for sophisticated applications, and the ability to take high volumes of information anywhere you go. You'll work comfortably with the T3100's full-sized 81-key keyboard. And Toshiba built in a full-sized, advanced gas plasma screen to give you the clarity and brightness of a CRT display — without the bulk.



Out of sight: Try putting one of last generation's desktop AT computers into a drawer!

More memory for more applications.

The T3100 runs the most popular software applications written for the IBM PC/XT™ and IBM PC-AT. Its full 640KB RAM enables you to work with integrated financial and analysis programs, large spreadsheets, lengthy documents, electronic filing and more.

The T3100's built-in 720KB diskette drive lets you take advantage of the new industry standard 3½"



Compact is as compact does: The T3100 is less than a third the size of the Compaq Portable II.

diskettes. Each IBM-compatible pocket-sized disk holds *twice* as much information as a conventional 5¼" diskette! And you can easily transfer data to and from other desktop computers using Toshiba's optional external 5¼" diskette drive.

"Big" system expansion options.

Like any full-function desktop system, the T3100 grows to accommodate your computing needs. In addition to the T3100's many built-in features, Toshiba offers a full line of internal and external expansion options: An internal 300/1200 bps Hayes®-compatible modem; internal 2MB extended memory card*; external expansion chassis with 5 IBM-compatible slots; external 5¼", 360KB diskette drive; and external 15-key numeric keypad. * Add options as you need them, and take them off when you aren't using them. *That's flexibility.*

AT power anywhere you go.

In the office, the T3100 handles sophisticated integrated software, electronic filing, utilities, RAM-resident programs, telecommunications and more — without taking over your whole desktop.

At home, the T3100 gives you the power to do the same number crunching, analyzing and projecting you do at work; no more late nights at the office; no more shuffling diskettes back and forth; and no more waiting to return to the office to access vital data.

In a meeting, the T3100 gets you answers on the spot, for more informed, more productive discussions.

On a business trip, or attending a conference? Stay in touch with

headquarters and tap into on-line information services using the optional internal modem. The T3100's dual-voltage power supply lets you plug in and go to work just about anywhere in the world.

The next generation of computing is here. And it sure would look good on your desk. Or away from it.

Desktop computing will never be quite the same again, thanks to Toshiba's advanced CMOS and proprietary gate array LSI technology.



The T3100 runs the most popular applications software written for the IBM PC/XT and AT.

The T3100 is backed by our reputation for high quality electronics, and by our 110-year commitment to technological excellence.

See where desktop AT power is headed.

The T3100 is *here now!* Call: **1-800-457-7777**, for your nearest Toshiba dealer.

Now!
Includes **SideKick™**
and **SuperKey™**



In Touch with Tomorrow
TOSHIBA

TOSHIBA AMERICA, INC., Information Systems Division

Keyboard: It's a pleasure to work with the efficient layout of the T3100's full-sized 81-key keyboard.

Display: Toshiba's full-sized, high-resolution gas plasma screen displays 80×25 character text and 640×400 bit-mapped graphics in brilliant, easy-to-read amber hues.

Switch-selectable power supply: The T3100's dual-voltage power supply lets you plug in and go to work just about anywhere in the world.

Specifications:

- IBM PC-AT compatible
- 80286 processor, running at 8 MHz or 4 MHz
- 640KB RAM, extendable to 2.6MB
- Built-in 10MB hard disk
- Built-in 720KB 3½" diskette drive
- MS-DOS 2.11 operating system
- High-resolution gas plasma display
- IBM Color Graphics Adapter (CGA) compatible
- 80×25 character display
- 640×400 bit-mapped graphics display
- Full-sized 81-key keyboard
- RGB color monitor port
- Parallel printer port
- RS-232C serial port
- 110/220 VAC switch-selectable power supply
- 12.2" W × 3.1" H × 14.2" D
- All this—and only 15 pounds!

Options:

- Internal 300/1200 bps Hayes-compatible modem
- Internal 2MB extended memory card*
- Expansion chassis with 5 IBM-compatible slots
- 15-key numeric keypad*
- External 5¼", 360KB diskette drive
- Floppy Link to desktop 5¼" diskette drive

TOSHIBA

Toshiba America, Inc.
Information Systems Division
2441 Michelle Drive, Tustin, CA 92680

Footprint: The T3100's small footprint takes up remarkably little desktop space. Its built-in features and compact design free you from last generation's tangle of cables and hardware.

80286: Using the same powerful 80286 microprocessor as the IBM PC-AT, the T3100 easily handles today's most sophisticated applications.

Memory: The T3100 gives you 640KB of user memory, extendable to 2.6MB, plus a built-in 10MB hard disk—abundant storage for all of your large files and lengthy documents. The T3100's built-in 720KB diskette drive lets you take advantage of the new industry standard 3½" diskettes.

Interface ports: The T3100's built-in ports make connection to external peripherals a snap. You can easily attach it to an RGB color monitor, parallel or serial printer or other devices. Or add internal options like Toshiba's 300/1200 bps Hayes-compatible modem or 2MB extended memory card.

* Available Fall, 1985.

Trademarks: PC-AT, PC-XT—International Business Machines Corporation; Company Computer Corporation; MS-DOS—Microsoft Corporation. Registered Trademarks: IBM—International Business Machines Corporation; Hayes—Hayes Microcomputer Products, Inc.

A SMALL TASTE OF SMALLTALK

BY TED KAEHLER AND DAVE PATTERSON

Two classic programming problems illustrate Smalltalk syntax and design philosophy

This article is adapted by kind permission of the publisher from A Taste of Smalltalk by Ted Kaehler and Dave Patterson (New York: W. W. Norton & Co., 1986). All rights reserved. "The Animal Game" section is new material provided by the authors for use in this article.

NEWCOMERS TO OBJECT-ORIENTED languages often have difficulty phrasing their programming problem in terms of objects. They struggle with how to divide a new programming problem into objects. A good starting place is to imagine that every fragment of program and every piece of data are floating together in space. Now imagine pieces of string between code and the data it uses, and between segments of code that are used together or that perform a similar function. Then imagine moving everything around until the total length of string is the shortest. Clustered around each data structure would be the routines that use it, and natural divisions in the code become apparent. Dividing a problem into objects is just a process of putting things where they belong.

Dividing a problem into objects and defining actions that are "natural" for those objects actually simplifies programs. When the actions of an object are divided into the right kinds of "chunks," we can think and write code at a higher level. We know that the procedures we call from the high-level code are correct because they match the way we think about the problem. When that assurance exists, we make fewer mistakes. We have less anxiety about whether the subordinate procedures are doing the right thing.

The overhead of calling a Smalltalk procedure is small for both the system and the programmer. The system has optimized Smalltalk procedure calls because they happen

so frequently, typically 10 to 50 times per procedure. The overhead for a programmer to create a new Smalltalk procedure is small as well. Declarations and preambles are very short in the Smalltalk-80 system, and you can edit, run, and debug without changing environments. In Smalltalk, compiling a method and linking it into the system takes only a few seconds, as opposed to several minutes in a "batch-processed" system, where many modules may have to be recompiled. Writing a new procedure and calling it in the original program is easier in Smalltalk than in Pascal. Thus, Smalltalk encourages programmers to modularize code.

We will now stop philosophizing and start explaining with the aid of some sample programs just how object-oriented programming makes the programmer's job easier. In the next section we will write a program in Smalltalk that looks just like a program in a traditional language. (We will also include a Pascal version of the program so you can see how close it is.) The program is not written in an object-oriented style, but it does serve as a Rosetta stone for learning Smalltalk. Later in the article we will write a program to solve the Animal Game in a truly object-oriented style. Along the way we will provide a step-

(continued)

Ted Kaehler, a senior engineer at Apple Computer, worked on Smalltalk for many years in the Learning Research Group at Xerox PARC. He can be contacted at Apple Computer Inc., 20525 Mariani Ave., MS: 22Y, Cupertino, CA 95014.

Dave Patterson is a professor at the University of California at Berkeley who does research on reduced instruction set computers (RISC) and teaches computer literacy. He can be contacted at 571 Evans Hall, University of California, Berkeley, CA 94720.

by-step description of how to use the Smalltalk user interface.

A TOWERING TUTORIAL

The Tower of Hanoi program represents one of the few examples of agreement in computer science. Practically every programming text introduces recursion using this

program, and our book is no exception (reference 1). The Tower of Hanoi is based on a game (popular in the 1960s) that has its own mythology (also popular in the 1960s):

An ancient myth has it that in some temple in the Far East, time is marked off by monks engaged in the transfer of 64 disks from one of three pins to another. The universe as we know it will end when they are done. The reason we do not have to concern ourselves about the cosmological implications of this is that their progress is kept in check by some clever rules: the monks can only move one disk at a time; the disks all have different diameters; and no disk can ever be placed on top of a smaller one (reference 2).

The rules seem easy enough, but with 64 disks you might get confused and never be sure if you were making forward progress. Luckily, there is a way to simplify things and find an algorithm.

To move n disks from peg A to peg C:

1. Move $n - 1$ disks from A to B.
2. Move 1 disk from A to C. (This is easy.)
3. Move $n - 1$ disks from B to C.

Since we know how to handle the case when n equals one (move the single disk from A to C), we can easily do n equals two. From there we can do the cases of three or more disks. The only problem is keeping track of which step of which solution for which number of disks we are currently working on. This solution is more suited to a computer than to a person, and listing 1 shows a Pascal program to solve the Tower of Hanoi problem.

MESSAGES AND OBJECTS EVERYWHERE

Smalltalk strives to use a small number of powerful concepts unconstrained by conventions or terms from other programming languages. For example, a Smalltalk procedure or subroutine is called a *method*. We will try to justify the Smalltalk names as soon as you learn enough to understand the excuse, but for now we will keep the unconventional names to a minimum in this tutorial. Variable names in Smalltalk are often highly descriptive and thus quite long. Following the Smalltalk tradition, we use capitals as visual separators (moveTower) instead of hyphens. The designers of the Smalltalk language chose a format for procedure names that encourages the programmer to describe each of the arguments. The idea is to provide more than just the order of the arguments to help the programmer remember which one is which. Each part of a procedure name ends with a colon and is followed by the argument it describes. [Editor's note: In an effort to distinguish Smalltalk code from menu items of the Smalltalk pop-up menu, we have used the Triumvirate Light typeface for code words and Triumvirate Oblique type for menu items.]

The four words ending in colons in the first line of listing 2a are the four parts of the name of the method that is being defined. When you want to talk about the method, squeeze all the parts of its name together; in this example, the actual name of the methods we have been working with is moveTower:from:to:using:, a method with four arguments. This method calls three methods (itself twice

(continued)

Listing 1: Tower of Hanoi in Pascal. This program is derived from a program found in Programming in Pascal by Peter Grogono (reference 4).

```

program hanoi(input, output);
  var total : Integer;
  procedure movetower (Height, Frompin,
                      Topin, Usingpin : Integer);

  procedure movedisk ( Frompin,
                      Topin : Integer);
  begin
    writeln( Frompin, '->', Topin)
  end; { movedisk }

  begin { movetower }
    if Height > 0 then
      begin
        movetower(Height-1, Frompin,
                  Usingpin, Topin);
        movedisk( Frompin, Topin);
        movetower(Height-1, Usingpin,
                  Topin, Frompin)
      end
    end; { movetower }

  begin { hanoi }
    read(total);
    movetower(total,1,3,2)
  end. { hanoi }

```

Listing 2a: A recursive Smalltalk program to solve the Tower of Hanoi problem. Note that this method refers to the method moveDisk:to: in listing 2b.

```

moveTower: height from: fromPin to: toPin
           using: usingPin
"Recursive procedure to move the disk at a
height from one pin to another using a
third pin"
(height > 0) ifTrue: [
  self moveTower: (height - 1) from:
    fromPin to: usingPin using: toPin.
  self moveDisk: fromPin to: toPin.
  self moveTower: (height - 1) from:
    usingPin to: toPin using: fromPin]

"This comment gives an example of how to
run this program. Select the following
text and choose 'do it' from the
middle-button menu.

(Object new) moveTower: 3 from: 1 to:
                    3 using: 2 "

```

NORTHEASTERN *Software* TURBO 286™

7 Trap Falls Rd.
Shelton, Connecticut 06484

AT LAST, A FASTER PC AT A BETTER PRICE!



- RUNS ALL MAJOR SOFTWARE WRITTEN FOR THE IBM PC,™ AT,™ AND COMPATIBLES.
- 8 MHZ SYSTEM UNIT [6 MHZ SYSTEM UNIT ALSO AVAILABLE]
- 640 KB MOTHER BOARD INSTALLED AND TESTED.
- 1.2 MB AND 360 KB FLOPPY DISK DRIVE. (PRODUCED BY MAJOR INDUSTRY MANUFACTURERS)

- AT STYLE KEYBOARD.
- 200 WATT POWER SUPPLY.
- 8 EXPANSION SLOTS
- MS DOS 3.1,™ USERS MANUAL, AND 2 YEAR LIMITED WARRANTY INCLUDED.
- TWO SERIALS AND ONE PARALLEL PORT
- CLOCK/CALENDAR WITH BATTERY BACKUP
- COMBINED FLOPPY/HARD DRIVE CONTROLLER CARD

OVER 30% FASTER
THAN THE IBM PC-AT™

\$1945.00

**CALL TOLL FREE
1-800-382-2242
CONNECTICUT ORDERS
CALL 203-929-8522
IN CANADA
1-800-843-0074**

SIMPLY THE BEST

Northeastern Software Turbo 286 is a trademark of Northeastern Software.
IBM PC, AT are trademarks of IBM Corporation.

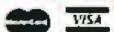

WITH PURCHASE RECEIVE AN ADDITIONAL 2% DISCOUNT ON ANYTHING ELSE WE SELL FOR A FULL YEAR.

An object is a package of data and procedures that belong together.

Specifically, all constants and the contents of all variables are objects.

and moveDisk:to: once). You may find it helpful to mentally translate calls on Smalltalk methods to the familiar format of procedure name followed by arguments, for example, moveTower:from:to:using: (height, fromPin, toPin, usingPin).

The moveTower:from:to:using: method in listing 2a has local names for its arguments: height, fromPin, toPin, usingPin. On the second line, the text between double quotes is a comment. Next is an expression, (height > 0), that evaluates to true or false. The Smalltalk if statement is like Pascal except that the Boolean expression precedes, instead of follows, the if. Next is a block, similar to Pascal blocks, except that Smalltalk surrounds blocks with square brackets instead of begin and end. There are three statements in the block, and they are executed sequentially. In Smalltalk, periods are used to separate statements. Pascal programmers will find this syntax familiar provided they remember to use a period instead of a semicolon. There is a comment at the end of the procedure.

You've probably heard that Smalltalk is an object-oriented system and may be curious to know what an *object* is. An object is a package of data and procedures that belong together. Specifically, all constants and the contents of all variables are objects. An object in Smalltalk is like a record in Pascal but much richer and more versatile. The only things that don't denote objects are the message selectors (operators or procedure names), the comments, and a few punctuation characters.

Most systems get work done in a variety of ways: by calling procedures, applying operators to operands, conditionally executing blocks, and so forth. Following the goal of using a small number of consistent abstractions, Smalltalk has exactly one way of getting work done: by "sending messages" to objects. A *message* is a message selector with its operands. The object that receives a message, the receiver, appears just to the left of the message. In listing

2a, everything that is not an object, a comment, a bracket, or a period is a message selector.

Smalltalk always returns a value as the result of each method, and, as you might expect from an object-oriented language, that result is also an object. For example, in listing 2a, height - 1 returns an integer object and height > 0 returns a Boolean object.

You now know enough that we can explain more Smalltalk lingo. The terms "method" and "message selector" were invented while asking the question, "How do we select the method an object will use to respond to this message?" The answer is, "Use the selector to find the right method to execute."

If you talk to yourself while you read code (don't be bashful, everyone does), then you need to know how to "talk" Smalltalk. The phrase height > 0 does exactly what you think it does, and you can pronounce it just the way you would in other languages ("height is greater than zero"), but it is really shorthand for "the object height receives the message greater-than with the argument zero."

When an object receives a message, it looks up the message name to see if it understands the message. If the message is found, it starts executing the method that tells how to respond to the message.

Just as a Pascal procedure may call other procedures, a method may need to call other methods. The way to start another method is to send a message to an object. Sometimes you want to send a message to the same object that received the current message. How is that object named locally? In other words, when a Smalltalk object talks to itself, what does it call itself? Why, self, naturally. Not surprisingly, messages to self are common. You can see them sprinkled throughout the program in listing 2a. When a piece of code happens to send a message to the same selector as the current method, the program is using recursion.

The method moveDisk:to: in listing 2b includes a couple of new things. The System Transcript is a window on the screen. It behaves like a traditional character-oriented terminal. The object that represents the transcript is held in the global variable, Transcript. The message cr tells the transcript to append a carriage return. The message show: takes a string as an argument and appends it to the transcript. It also redisplay the text in the transcript window, so you can see it.

Each comma in the expression (fromPin printString, ' - > ', toPin printString) is a selector meaning "concatenate two strings." In this case, fromPin printString returns a string, and the comma concatenates the literal string ' - > ' onto the end of it. The result of toPin printString is then concatenated to the end of that. An array also understands the message comma. It returns a new array consisting of itself concatenated with the argument.

Specifying an object, sending it a message, and getting back another object as the result are the only things that ever happen in Smalltalk code. Things that require new kinds of constructs in other languages, such as control

(continued)

Listing 2b: The moveDisk:to: method referred to in listing 2a.

```
moveDisk: fromPin to: toPin
```

```
"Move disk from a pin to another pin.
Print results in the transcript window"
Transcript cr.
Transcript show: (fromPin
  printString, ' -> ', toPin printString).
```

We have 1000's of Software and hardware items in stock. Shipments on almost all items within 24 hours!



Call for programs not listed

Technical & Other Info. (802) 246-2222

TOLL-FREE ORDER LINE 1-800-421-3135

FREE! UP TO \$100 SOFTWARE FREE!
With every purchase over \$100.00 you can select one of the following MS/DOS diskettes at no charge.

1. Blueberry I - 54 basic utility programs includes printer select, graphic generation, etc. **Retail value \$10.**
2. Blueberry II - includes a banner generator, a label maker and a checker game (requires graphics card). **Retail value \$10.**
3. Print Select program - Assembly language program to select different type fonts, etc., or make your printer function as a correctable typewriter - perfect for envelopes, notes, etc. Adaptation modules for popular printers included and capability to adapt any printer. **Retail value \$40.**
4. Deposit Program Compiled DBase to list and total cash, check, bank card for bank deposit and keeps history - Developed for our corporate use - Super Program! (source code available). **Retail value \$40.**

Select an additional diskette for every additional purchase of \$150 or purchase over \$500 and receive all four at no charge.

—DATA BASE MANAGERS—

Clipper	\$334
Clout 2	117
Condor III	310
Fox and Geller Quickcode	138
Fox and Geller Quickreport	138
Knowledgeman II	285
K Paint II	60
K Graph II	135
K Text II	105
K Report II	135
Nutshell Filer	59
PFS: File	78
RBase 5000	319
Think Tank	92
Tim IV	139

—WORD-PROCESSING—

Easy (Micro Pro)	88
Leading Edge w/Merge/Spell	75
Microsoft Word 3.0	Call
Multimate 3.31	Call
Multimate Advantage	Call
Oasis Word Plus	85
Peachtext 5000	145
PFS: Write	78
Random House Spell Checker	36
Samna III 3.0	265
Volkswriter 3	139
Word Perfect 4.1	195
Wordstar	162
Wordstar Propac	233
Wordstar 2000	233
Wordstar 2000+	278

—SPREADSHEETS—

Microsoft Multiplan	108
PFS: Plan	78
Supercalc III 2.1	Call
VP Planner	49

—ACCOUNTING—

BPI Accounts Payable	299
BPI Account Receivable	299
BPI General Accounting	299
BPI Payroll	299
Cyma	Call
Dollars and Sense	95
Tobias Managing Your Money	94

TCS. Big Four equivalent of Peachtree Series 4 - Specially augmented and customized for your IBM PC Terminal and Printer - GL, AR, PA, AP, CP/M-80, CP/M-86 for PC XT, DOS 1.1, 2.0.
Each Module \$65 For All Four \$249

—INTEGRATED—

Enable	Call
Smart Software	Call

—TRANSFER PROGRAMS—

Crosstalk XVI	\$89
Hayes Smartcom II	88
Microsoft Access	149
Move-It	79
Remote	89

—GRAPHICS—

Chartmaster	205
Dr. Halo II	99
Energraphics 2.0	289
Fancy Font	129
Fontrix	99
Freelance	197
Graphwriter/Combo	294
Microsoft Flight Simulator	30
PC Mouse W/DR Halo II	106
Printshop	33
Signmaster	134

INCREDIBLE VALUE!

Nationally advertised boards for IBM PC and most compatibles at giveaway prices. 1 year warranty

Keyboards (similar to 5151)	\$89
Monochrome Board w/Printer Port	\$79
Graphic Board with parallel port (similar to Hercules Graphics)	\$85
Expansion Board 0 to 576K	\$42
Multifunction Board w/game port (similar to AST Six Pack)	\$99
Four Drive Floppy Controller	\$45
Color Card without printer port	\$79
Color Card with printer port	\$89
MULTITECH Turbo IBM Compatible Computer 256K, dual drives, 8MHZ, Ports-parallel,-serial-clock, 5151 type keyboard, graphics board (similar to Hercules), mono monitor, DOS 6 month national (TRW) warranty \$995	

—LANGUAGES—

Lattice C Compiler 3.0	Call
Run C Professional	135
Microsoft C Compiler	219
Microsoft Fortran	195
Microsoft Macro Assembler	84
Microsoft Pascal Compiler	166
Microsoft Quick Basic	55
Multi Halo	140

—UTILITIES—

Carbon Copy	115
Copy II PC	19
Copy II PC Board	79
Copywright	42
Desqview	59
Fastback	85
Microsoft Windows	56
Norton Utilities 3.1	49
PC Tools	19
Prokey 4.0	72
Superkey	39

—PROJECT MANAGEMENT—

Microsoft Project	219
Super Project Plus	Call

HARDWARE

—HARD DRIVES—

Bernoulli 20 MB 1/2 ht.	1879
Seagate 20 MB Internal w/Controller ..	399
Seagate 30 MB w/Controller	479

—MODEMS—

Hayes 1200	Call
Hayes 1200B w/Software	Call
Hayes 2400	599

HARDWARE

U.S. Robotics Courier 2400	375
U.S. Robotics Password 1200	Call

—RAM—

64K 150NS Chips (Japan-Set of 9) ..	\$11.50
256K Ram Chips (Set of 9)	32

—BOARDS—

AST Advantage	329
AST Sixpack (384K)	Call
Hercules Color Card	145
Hercules Graphics Card	299
J RAM III (Tall Tree)	Call
J RAM III AT (Tall Tree)	Call
J Lazer (Tall Tree)	Call
Paradise Five Pak	99
Paradise Modular Graphics Card	249
Quadram Board with Par/Ser and Game Port	199
Quadcolor I	185
Sigma Maximizer Multifunction	149
STB Chauffeur Board	249
STB EGA Plus	Call
STB Mono Board	155
AB Parallel Print Switch w/cables ..	75
Mini Micro Parallel Print Buffer	69
IBM 120 Watt Power Supply	83

—COMPUTERS—

Corona PC	Call
-----------------	------

Sperry PC Mono 256K Dual Drive Serial Port, Clock, MS/DOS 2.11
Call

ITT Computers PC Compatible 256K Dual Drive, Mono, MS/DOS	Call
---	------

ITT XP 80286 IBM/PC Compatible, 512K, 10 MB Winchester, 3 times faster than an XT. 30% faster than an AT

Sharp Portable	Call
----------------------	------

—PRINTERS—

CITIZEN	
MSP-10	285
MSP-15	385
MSP-20	325
Citizen 120D	185
Premiere 35 Daisywheel	469

EPSON - Call on all models

JUKI	
Juki 6100	349
Juki 6300	685

NEC	
8850	1098
P5 Parallel	970
P5 XL	1098
Elf 360	398

OKIDATA - Call on all models

PANASONIC	
1091	235
1092	299
1592	435
KXP3151	399

STAR MICRONICS - Call for prices

TOSHIBA	
P351	969
P341	768

—MONITORS—

AMDEK	Call for price
NEC Multi Sync	544
Taxan 121 Green	Call
Taxan 122 Amber	Call
Princeton Max 12	159

TERMS: Add 3% for C.O.D. orders. Shipping on most software is \$5.00. AZ orders +6% sales tax. Personal check-allow fourteen (14) days to clear. Prices are subject to change. We accept purchase orders from authorized companies. All returns are subject to a restock fee. We do not guarantee compatibility.

No Charge for MasterCard or Visa

TOLL-FREE ORDER LINE 1-800-421-3135
WAREHOUSE DATA PRODUCTS

2701 West Glendale Ave. • Phoenix, AZ 85051

Hours 7 A.M. to 6:30 P.M. M.S.T. - Mon. thru Fri.
Saturday 10:00 A.M. to 3:30 P.M.

structures and arithmetic operators, are simply messages sent to objects in Smalltalk. The result of one message can be used as the object that receives another message or as an argument in another message. For example, the object that is the result of the message `- 1` being sent to `height` is used as an argument in the method `moveTower:from:to:using:.` Except for the assignment operator, all Smalltalk code is a grand concoction of messages sent to objects.

ENTERING THE PROGRAM

The Smalltalk programming environment tries to provide every tool you want for finding, viewing, writing, and running Smalltalk methods. The system can tell that a particular piece of text is a method by the window in which it is typed. Thus, there is no need for special punctuation marking the beginning or end of a Smalltalk method. Every time you deal with a whole method, it is inside a window that expects a method.

With traditional programming systems you create a new program that is loosely linked to other programs via the operating system. In Smalltalk, on the other hand, every program is just a piece of the whole system, and the pieces are linked together. This Zen-like approach to programming means we must find a place for the Tower of Hanoi before we can write the program. Let's create a games section in one of the more generic parts of the system. [Editor's note: The Smalltalk-80 system developed at Xerox PARC used a color-coded three-button mouse with red, yellow, and blue buttons. These buttons are often referred to as left, middle, and right but-

tons, and we will use this terminology. If you are using Smalltalk-80 on a Macintosh, you should refer to the documentation included with that system.]

To place the games category in the Smalltalk hierarchy, we will perform a number of steps using a tool called the system browser (figure 1). We have labeled the parts of the browser with letters to ease references to them.

1. Move the cursor into area A of the system browser and select *Kernel-Objects*. (See figure 2.)
2. Move to area B and select *Object*.
3. In area F, make sure the word *instance* is selected.
4. Now let's add a category in which to put new procedures. Select *add protocol* from the middle-button menu in area C. When you select this item, a little window will appear, asking you to type a name. There will be an old name there in reverse video, so just type the word *games* and press the Return key.

If your menu does not have the item *add protocol* on it, you have a License I system from Apple and must do a little more work. Do not choose any items from the menu (move out of the menu and release the button). Move into area B and choose *protocols* from the middle-button menu. After a moment, a long list will appear in area E. Move the cursor there, and without clicking anywhere, type (*'games'*) and press Return. Be sure the parentheses and single quotes are there. Keep the cursor in area E and choose *accept* from the middle-button menu.

5. The name of your new section, *games*, will appear and

(continued)

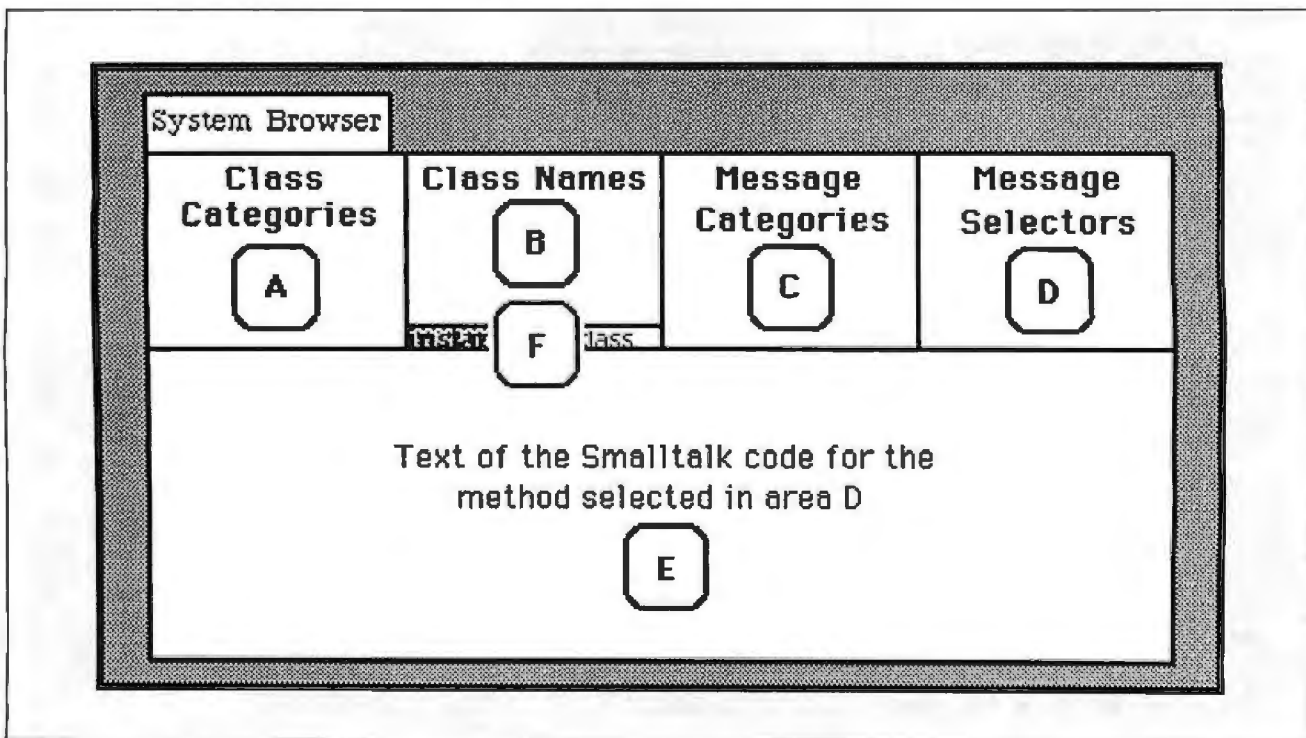
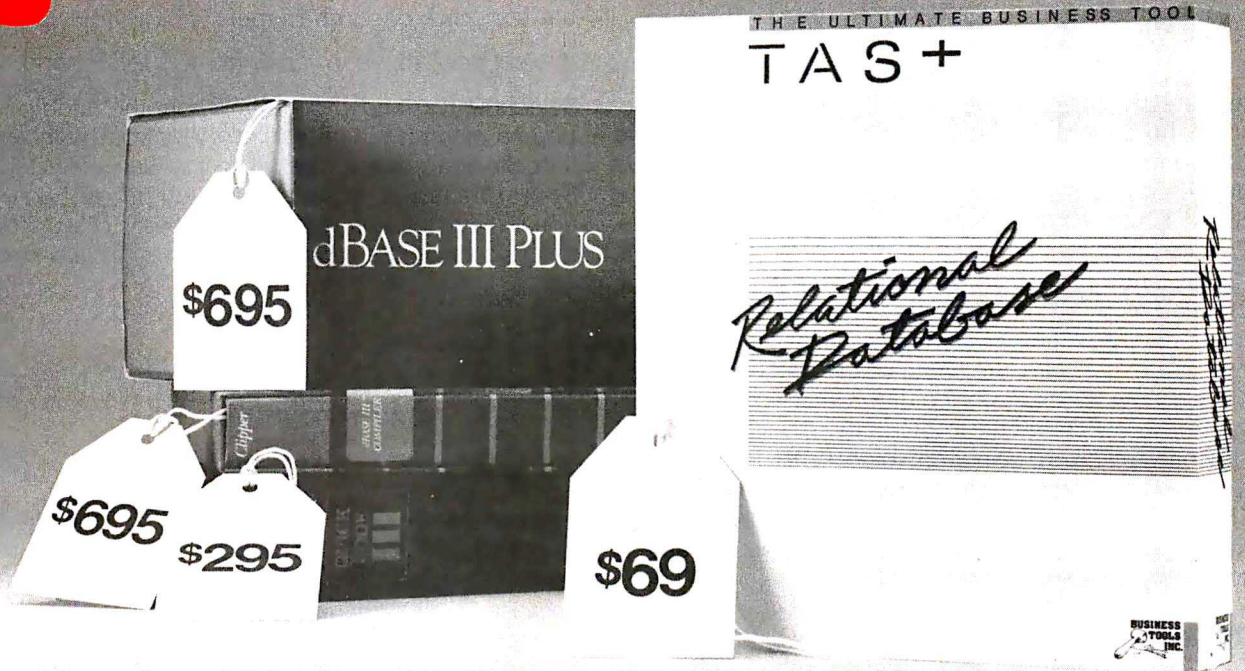

Figure 1: The Smalltalk system browser. The four lists across the top are four levels of detail in the path to a method (a piece of code). The user moves from left to right, choosing an item in each list.

The price of power just went down.



Before you buy DBase III, QuickCode and Clipper, look at TAS-Plus

TAS-Plus just made it faster, easier and cheaper to build database applications. TAS-Plus combines the power of a Relational Database with the ease of a Program Generator. Then TAS-Plus adds a Runtime Compiler to produce lightning-fast finished code. Look at what TAS-Plus gives you:

- Relational Database**
- 4th Generation Language**
- Screen Painter**
- Program Generator**
- Report Writer**
- Source Code Editor**
- Runtime Compiler**

TAS-Plus gives you power where it counts. You can store up to 65,000 records, open up to 16 files at a time and enter up to 10,000 characters per record. TAS-Plus even reads your old DBase files.



The following are registered trademarks of these companies: TAS-Plus, The Accounting Solution, Business Tools, Inc.; DBase III, Ashton-Tate; CP/M, Digital Research; IBM PC/XT/AT, International Business Machines Corp.; QuickCode, Fox & Giller; Clipper, Nantucket Inc.

© Copyright 1986 Business Tools, Inc.

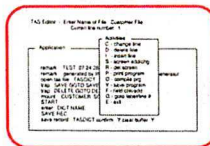

TAS-Plus writes the program for you

With TAS-Plus, you can start building professional database applications on day one. Just "paint" the screen the way you want and TAS-Plus writes the program for you. You can even paint using different colors or graphic characters. And custom reports are just as easy.

TAS-Plus has over 86 commands and 200 options available in its Source Code Editor, so you won't run out of room to grow.

Easy to use features

Add new databases quickly and easily. Add, change or delete records without any programming at all. Browse through your database and see multiple records on the screen at the same time. Restructure capability allows you to change existing databases without loss of any data.

All this for just \$69

TAS-Plus would be respectable at any price, at \$69 it's awesome.

30 day Money Back Deal

TAS-Plus comes with a 30 day money back guarantee (less \$15 handling fee). TAS-Plus is available for the IBM PC/XT/AT and fully compatible computers. Limited versions available for CP/M and non-IBM machines.

Order Today 1-800-648-6258

Call our Toll-Free Hotline. Use your VISA, MasterCard or American Express to order today. For information or Washington residents call 1-206-644-2015.

TAS+™

NOT COPY-PROTECTED

YES! Rush me the following items.

Qty.	Item	Price	Subtotal
_____	TAS+	\$69	_____
Shipping add \$8 USA, \$25 outside USA		Shipping	_____
WA res add \$5.99 Tax		Tax	_____
			Amount Enclosed (US funds only)
Name: _____			
Shipping Address: _____			
City: _____			
State: _____		Zip: _____	
Telephone: _____			
Payment: VISA MC AMX Check			
Credit Card Expiration Date: _____			
Card Number: _____			
Name on Card: _____			

BUSINESS TOOLS INC.
4038-B 128th Ave. S.E., Suite 266
Bellevue, Washington 98006
(206) 644-2015



be selected for you in area C. Move the cursor into area E at the bottom of the browser. The browser should appear as in figure 2.

6. Replace the text in area E with listing 2a.

7. Read over what you have typed. If you have typed it in correctly, select *accept* from the middle-button pop-up menu of area E. This attempts to compile, link, and load what we have just typed. You don't need to select any text because *accept* reads everything in area E.

8. The system will tell you that it doesn't understand `moveDisk:to:` and ask you if you made a typo or are just mentioning a new procedure. Reassure the system by clicking *proceed as is* (or, on a Macintosh, click the name of the method). When the system successfully accepts the new procedure, it will list the name of the procedure in area D and show the name in boldface in area E.

9. Now we will type in `moveDisk:to:.` Go to area D and click once on `moveTower:from:to:using:` to deselect it. Go to area E and replace all the text in area E with listing 2b and choose *accept* from the middle-button menu. The message selector `moveDisk:to:` should appear in area D of the browser.

RUNNING THE PROGRAM

Let's try the Tower of Hanoi using three disks. Move the cursor to the window labeled System Transcript (probably

in the upper left corner of the display) and click the left button. When the window wakes up, point to the end of the text, click once, and type:

(Object new) moveTower: 3 from: 1 to: 3 using: 2

Select the text and choose *doit* from the middle-button pop-up menu (see figure 3). *doit*, as you might expect, tells Smalltalk to execute what you have selected. The System Transcript shows program output, just as a traditional character-oriented terminal does in other programming systems. This sequence of moves should scroll by:

```
1 -> 3
1 -> 2
3 -> 2
1 -> 3
2 -> 1
2 -> 3
1 -> 3
```

Notice that we never declared the type of the arguments to our procedure, `moveTower:from:to:using:.` In this instance, Smalltalk is much more like LISP than Pascal because Smalltalk variables can be any type. As long as they understand the messages they are sent, variables can hold values of a different type than we originally intended. Without making changes to the procedures, we can ac-

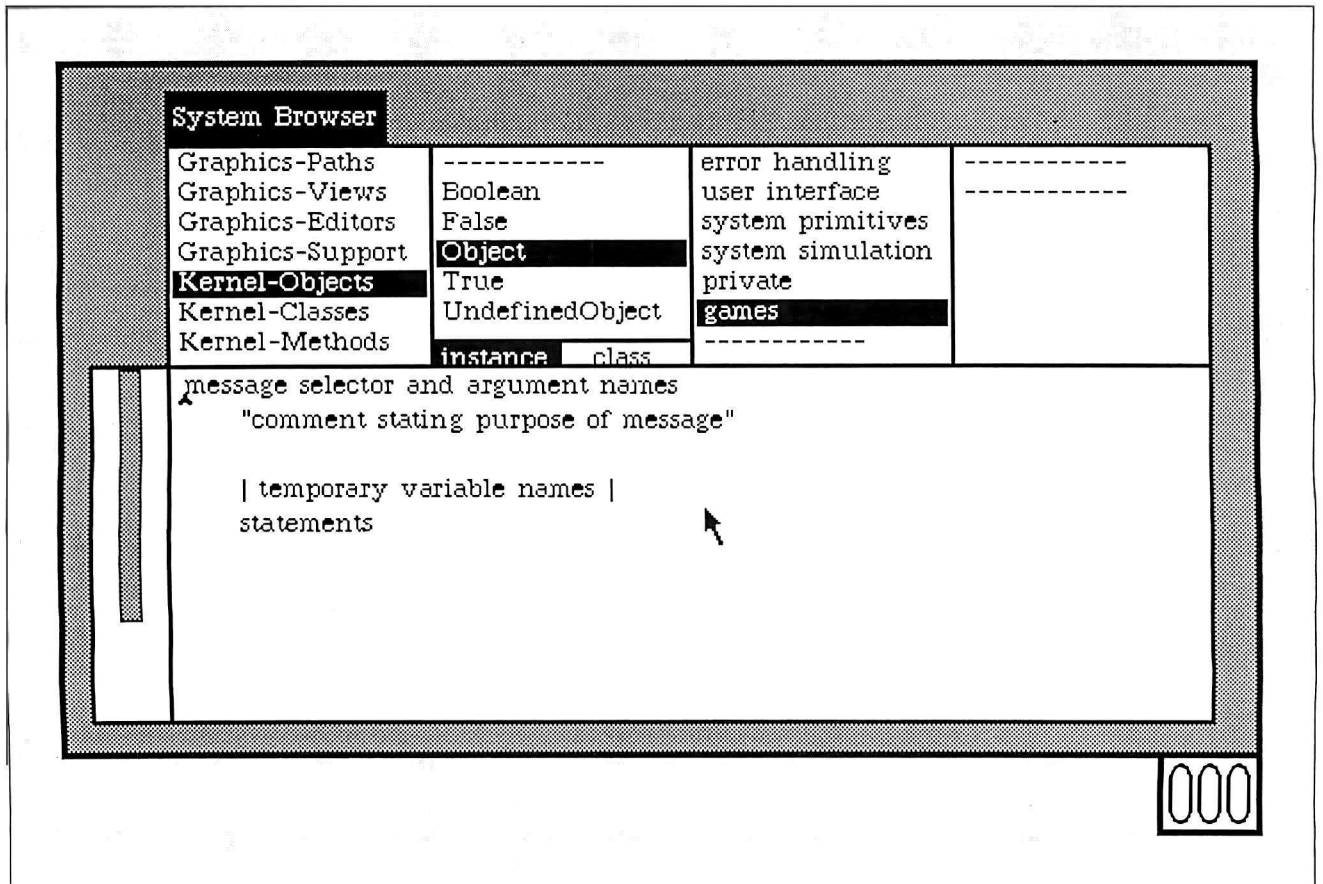

Figure 2: The state of the browser just before adding the methods in listings 2a and 2b.

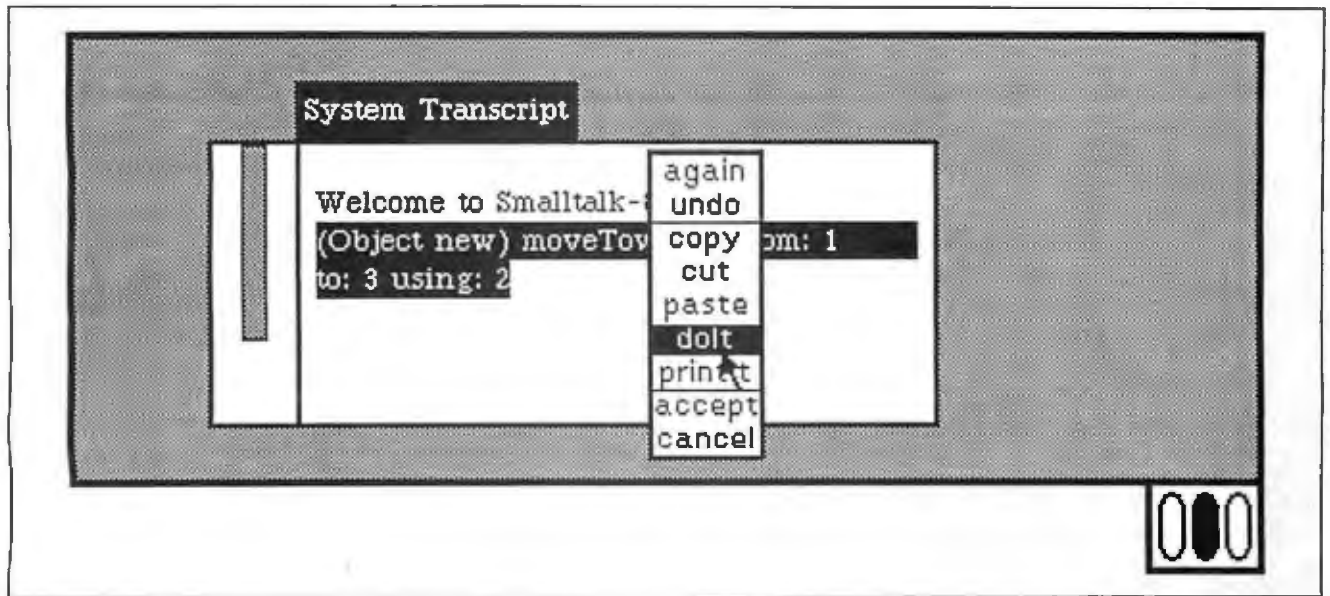

Figure 3: The System Transcript with the text to run the Tower of Hanoi program highlighted. The *doit* command that will execute the highlighted text is about to be chosen.

usually run the program with strings as the names of the poles instead of integers! Furthermore, the height can be a floating-point number. Try the example again with new pole names:

```
(Object new) moveTower: 3.0
from: 'North' to: 'South' using: 'Telephone'
```

When you select this and choose *doit*, the System Transcript will show

```
'North' -> 'South'
'North' -> 'Telephone'
'South' -> 'Telephone'
'North' -> 'South'
'Telephone' -> 'North'
'Telephone' -> 'South'
'North' -> 'South'
```

The recursive solution of the Tower of Hanoi problem presented here is not object-oriented. The program in Smalltalk looks very much like the equivalent program in the other languages. It contains objects, but they are not exhibiting the full power of object-oriented programming. [Author's note: A Taste of Smalltalk contains versions of this program that are object-oriented and that take advantage of Smalltalk graphics to show an animation of disks moving between the poles.]

THE ANIMAL GAME

Let's now consider a new game and write a program that uses objects as they are meant to be used. The Animal Game is used commonly as an example of binary trees (we found it in *Oh! Pascal!* by Doug Cooper and Michael Clancy [reference 3]). The user thinks of an animal, and the program tries to guess what it is.

Does it swim?

```
<click yes>
Does it have gills?
<click no>
Are you thinking of a Dolphin?
<click no>
Gee, I don't know this one.
What animal were you thinking of?
(type it and press return)
Penguin
Please type a question that distinguishes between
a Penguin and a Dolphin
Does it have feathers?
Remind me about a Penguin. Does it have feathers?
<click yes>
Would you like to think of another animal?
<click yes>
Does it swim?
...
```

The program begins by asking the user a series of yes-or-no questions and finally suggests a specific animal. If the program is wrong, it asks the user what animal he or she was actually thinking of and what question would distinguish it from the other animal. By installing this information at the right place in a binary tree, the program builds up a collection of questions and animals to ask about in the next round.

The tree is composed of "question objects" and "animal objects" (see figure 4). Each object has variables it owns, much like the variables in a Pascal record. A question object needs to store the following information:

```
fatherNode  object above this one in the tree (a question,
an animal, or nil)
```

(continued)

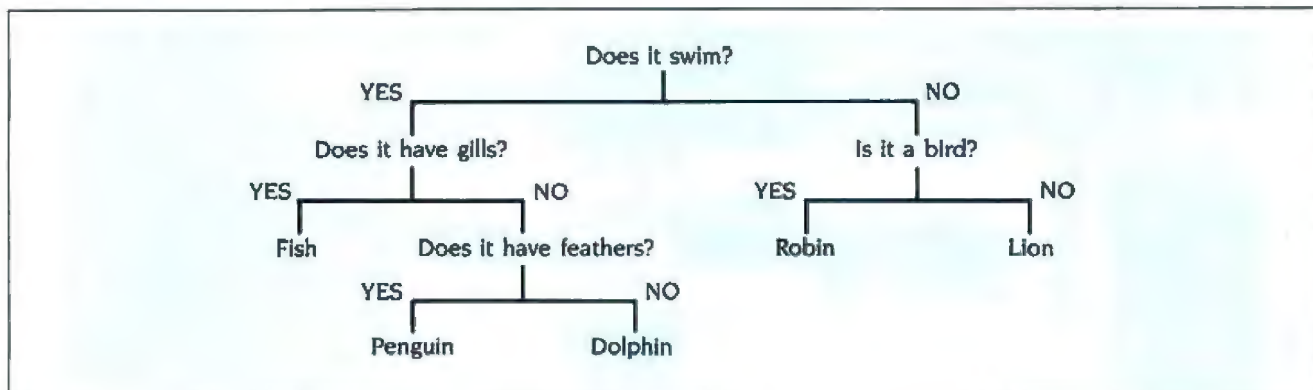

Figure 4: An example of a binary tree that the Animal program might build.

myQuestion text of a question to ask (a string)
 yesBranch object to go to if the user says yes (an object in the tree)
 noBranch object to go to if the user says no (an object in the tree)

And an animal object needs to store:

fatherNode node above this one in the tree (another object or nil)

name animal's name (a string)

Before creating an object, we need to describe it. After we have described a single object, the description can serve as the definition of a whole class of objects. We call such an object description a *class*. A class is like a user-defined data type combined with a module that has a set of procedures as an external interface. Any object created from the description is called an *instance* of the class.

(continued)

Now works with DOS 3 DEBUG! X-VIEW 86™

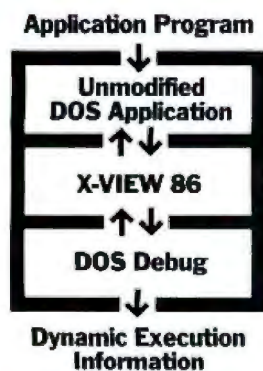

X-VIEW 86 profiles the execution of DOS software, and displays information needed to improve program performance, identify compatibility issues, and pinpoint conversion problems.

Profiles DOS application software and solves problems Debug can't touch.

X-VIEW 86 is a DOS software X-ray machine. X-VIEW 86 monitors internal software operations during execution to help you debug, test, port, or convert programs. X-VIEW 86 adds new features to Debug to profile either your own applications software or top-sellers like 1-2-3®. You get fast, reliable results.

Real solutions to technical challenges.

Save hours of time-consuming, tedious work using data from X-VIEW 86's built-in reports that identify:

- Execution hotspots
- Segment usage
- Memory map references
- Report information is displayed on screen. And new breakpoint commands added to Debug stop a program on:

- I/O port references
- Interrupt calls
- I/O port references
- Memory data references

Hardware and software requirements.

X-VIEW 86 runs on the IBM PC and compatibles with DOS Debug 2.x or 3.x. Even if you use a different debugger, X-VIEW 86 turns Debug into your program profiler. And it's not copy protected.

Priced at an affordable \$59.95.

Get a whole new outlook on your work with X-VIEW 86. We've made it easy. Order today by calling 1-800-221-VIEW (in Texas, or outside the U.S., call 1-214-437-7411). We accept Visa, MC, DC, and AmEx cards. Or order by writing to: McGraw-Hill CCIG Software, 8111 LBJ Freeway, Dallas, Texas 75251. X-VIEW 86 is just \$59.95 plus sales tax and \$3.00 shipping (\$9.00 outside the U.S.). Be sure to include credit card number and expiration date with mail orders. Orders paid by check are subject to delay. To order call

1-800-221-VIEW

McGraw-Hill CCIG Software

8111 LBJ Freeway, Dallas, Texas 75251

X-VIEW 86 is a trademark of McGraw-Hill, Inc.; IBM is a registered trademark of International Business Machines; 1-2-3 is a registered trademark of Lotus Development Corporation.



DR. JACK PURDUM

Get the proven product from the man who wrote the books on "C".

C Programming Guide

After reading the 1st edition, Jerry Pournelle (BYTE Magazine) said: "I recommend this book... Read it before trying to tackle Kernighan and Ritchie." The second edition expands this best seller and walks you through the C language in an easy-to-understand manner. Many of the error messages include references to this book making it a perfect companion to Eco-C88 for those just starting out with C.

\$20

C Self-Study Guide

(Purdum, Que Corp.) Designed for those learning C on their own. The book is filled with questions-answers designed to illustrate many of the tips, traps, and techniques of the C language. Although written to complement the Guide, it may be used with any introductory text on C.

\$17

C Programmer's Library

(Purdum, Leslie, Stegemoller, Que Corp.) This best seller is an intermediate text designed to teach you how to write library functions in a generalized fashion. The book covers many advanced C topics and contains many useful additions to your library including a complete ISAM file handler.

\$22

CED Program Editor

CED now supports on-line function help. If you've forgotten how to use a standard library function, just type in the name of the function and CED gives you a brief summary, including function arguments. CED is a full screen editor with auto-flagging of source code errors, multiple windows, macros, and is fully configurable to suit your needs. You can edit, compile, link, and execute DOS commands from within the editor. Perfect for use with Eco-C88. For IBM PC, AT and look-alikes.

\$29.95

C Source for Standard Library

Contains all of the source code for the library functions that are distributed with Eco-C88, excluding the transcendentals and functions written in assembler.

\$10 (\$20 if not with order)

Developer's Library

Contains all the source code for the standard library, including transcendental and assembler functions. Available with compiler purchase only.

\$25 (\$50 if not with order)

Ecosoft Inc.
6413 N. College Ave.
Indianapolis, IN 46220

Inquiry 101

THE FIRST PROFESSIONAL 'C' COMPILER FOR UNDER \$60.00

Limited Time Offer
FREE
CED TEXT EDITOR WITH "BUILT-IN" FUNCTION HELP.

NOTHING IN THIS PRICE RANGE EVEN COMES CLOSE.

"Ecosoft's Eco-C is going to turn some major heads."

"Eco-C is the first compiler reviewed that has clearly begun implementing the coming ANSI standard. Eco-C supports prototyping."

"Eco-C performed well on all the benchmarks, generating code that was quite comparable to that of compilers 10 times as costly."

from:
Christopher Skelly
Computer Language,
Feb., 1986

"The driver program is another strength: it compiles and links a list of files and provides a simple MAKE capability."

"This compiler does handle syntax errors much better than average—no avalanche of spurious messages here."

from:
William Hunt
PC Tech Journal,
Jan., 1986

"Eco-C88 is a high-quality package... comparable to systems costing much more."

"Eco-C88 is one of the fastest..."

"It is convenient to use, works well, and produces acceptably compact and fast programs."

from:
Dr. David Clark
Byte, Jan., 1986

Minimum System Requirements:

To use Eco-C88 Release 3.0, you must have:

1. An IBM PC, XT, or AT-compatible computer with monitor.
2. 256K or more memory
3. Two 360K disk drives, or a hard disk
4. PC or MSDOS 2.1 or later to include the MSDOS linker.

Eco-C88, mini-make, memfiles and CED are trademarks of Ecosoft Inc
IBM is a trademark of International Business Machines.
UNIX is a trademark of Bell Labs.
MSDOS and MASM are trademarks of Microsoft.

Full-featured C compiler. Supports all C features, data types (except bit fields), and operators.

New Language Enhancements. You also get prototyping, enum and void data types, plus structure passing and assignment.

Tiered Error Checking. All syntax errors are automatically flagged, but you can select the level of "link-like" semantic error checking you want.

Complete Standard Library. Over 200 functions, many of which are System V compatible for greater source code portability.

Screen and Memory Functions. Now you can write programs that use color, cursor addressing, even ones that let you design your own graphics functions. You also get memfiles™ that allow you to access memory outside the normal data segment as a file.

8087 and 80287 Support. If you have one of these math chips, your programs will take immediate advantage of it. If you don't have one, the code automatically switches to software floating point.

Full Screen Editor. The CED editor is a full screen editor with multiple windows, macro commands, on-line function help, plus a full set of editing commands. (Requires a true IBM PC compatible.) You can edit, compile, link, and execute programs from the editor which greatly reduces development time.

Includes a cc and mini-make™. The UNIX-like cc makes compiling programs a snap. You can run cc from within the CED editor.

ASM or OBJ Output. You can select assembler or relocatable output from the compiler. Both are MASM compatible and ready for use with the MSDOS linker to produce EXE files.

	Eco-C88	Lattice	Computer Inn. C86	Microsoft	Mark Williams
sieve	12	11	13	11	12
fib	43	58	46	109	—
deref	14	13	—	10	11
matrix	22	29	27	28	29

Orders only: **1-800-952-0472**

ORDER FORM CLIP & MAIL TO: Ecosoft Inc., 6413 N. College Ave., Indianapolis, IN 46220

- C Compiler \$59.95 _____
- C Programming Guide \$20.00 _____
- C Self-Study Guide \$17.00 _____
- C Programmer's Library \$22.00 _____
- CED Program Editor \$29.95 _____
- C Source for Standard Library \$10.00 (\$20.00 if not with order) _____
- Developer's Library \$25.00 (\$50.00 if not with order) _____

SHIPPING _____ \$4.00

TOTAL (IND. RES. ADD 5% TAX) _____

PAYMENT: VISA MC AE CHECK

CARD # _____ EXPIR. DATE _____

NAME _____

ADDRESS _____

CITY _____ STATE _____

ZIP _____ PHONE _____

ECOSOFT

have already decided what information an individual question should hold (`fatherNode`, `myQuestion`, `yesBranch`, `noBranch`): these variables are called *instance variables*. Each instance has its own private values for its instance variables.

Since both class `Question` and class `Animal` have the variable `fatherNode`, let's separate it out into another description called `TreeNode` (see listing 3). We make the classes `Question` and `Animal` subclasses of `TreeNode` so they can inherit the common instance variable and the methods `fatherNode:` and `playGame` that are common to `Animal` and `Question`. (See class descriptions in listings 4 and 5.)

Let's consider how the program asks the user a question. We send the message `ask` to the top object in the tree. This object might be a question or it might be an animal, and we want different things to happen in each case. Since questions and animals are different kinds of objects, they can respond differently to the message `ask`.

In listing 4 under the message `ask`, we see how a question responds to `ask`. The third line declares a local variable, `answer`. (In Smalltalk you do not need to declare the types of variables.) Names enclosed in vertical bars at the beginning of a method are local to that method. The next statement puts the question on the screen in a confirmation window and stores the user's response in the variable `answer`. The confirm: message returns true for "yes" and false for "no." A left arrow is the assignment operator; you can pronounce it as "gets." In the last two lines of the method, we send the message `ask` to the `yesBranch` object if the answer was true, and we send `ask` to the `noBranch` object if the answer was false. The up arrow at the beginning of the last statement means return an object to the method that sent the message that caused this method to be run. The object is the result of the chosen branch of the conditional. Every Smalltalk method returns a single object as its result. If you don't specify what object to return (by using an up arrow), the object that received this message (which we know as `self`) is returned.

Sending the message `ask` to an animal object causes an entirely different piece of code to run (see the `ask` message in listing 5). We declare `answer` and `newQuestion` as local variables. The next line presents a confirmer window to the user, asking if the user was thinking of this animal and storing the response in the variable `answer`.

If this was not the correct animal guess, we need to build a new object and put it in the tree. We create a new question object (*Question new*), send it the message `askForNewAnimalAndQuestion:` with the current object (`self`) as an argument, and store the result in `newQuestion`. The expression (`fatherNode == nil`) tests if this animal is the top node in the tree (it could be if there is only one object in the tree). If not, `fatherNode` is an object above, and we tell that object to substitute the new question on one of its branches. The top of the tree is stored in a global variable called `AnimalTree`, so the program will remember its knowledge between games. If `self` is the top of the tree, store `newQuestion` into `AnimalTree`. (Normally, you can

Listing 3: The variable `fatherNode` and the methods `fatherNode:` and `playGame` have been factored out of the classes `Animal` and `Question` and put into their own class description, `TreeNode`.

Class Description for `TreeNode`:

```
Object subclass: #TreeNode
  instanceVariableNames: 'fatherNode'
  classVariableNames: ''
  poolDictionaries: ''
  category: 'Kernel-Objects'
```

Methods for class `TreeNode`:

```
fatherNode: aNode
  "remember the parent decision node"
  fatherNode ← aNode

playGame
  "To start new game, select the text
  within the double quotes in the line
  below and choose 'do it' from
  middle-button menu:"
  "(Animal new name: 'Robin') playGame."
  "To restart an old game:"
  "AnimalTree playGame."

| exclamation |
Smalltalk at: #AnimalTree put: self.
[exclamation ←
  (Smalltalk at: #AnimalTree) ask.
nil confirm: exclamation,
'Would you like to
think of another animal?'] whileTrue.
```

Listing 4: The class description and methods for `Question`. This class is a subclass of `TreeNode`.

Class Description for `Question`:

```
TreeNode subclass: #Question
  instanceVariableNames: 'myQuestion
                        yesBranch noBranch'
  classVariableNames: ''
  poolDictionaries: ''
  category: 'Kernel-Objects'
```

Methods for Class `Question`:

```
ask
  "Ask the user a question"
  | answer |
  answer ← nil confirm: myQuestion.
  "Ask a more detailed question"
  † answer ifTrue: [yesBranch ask]
    ifFalse: [noBranch ask].
```

```

askForNewAnimalAndQuestion: oldAnimal
"Ask the user the name of the new animal
and get a distinguishing question."

| newName newAnimal polarity |
newName ← FillInTheBlank request:
  'Gee, I don't know this one.
  What animal were you thinking of?
  (type it and <return>)' .
newAnimal ← Animal new name: newName.
myQuestion ← FillInTheBlank request:
  'Please type a question that distinguishes
  between ', oldAnimal name, ' and ',
  newAnimal name.
polarity ← nil confirm:
  'Remind me about ', newAnimal name, '.
  ', myQuestion.
polarity ifTrue: [yesBranch ← newAnimal.
                 noBranch ← oldAnimal]
               ifFalse: [yesBranch ← oldAnimal.
                        noBranch ← newAnimal].
newAnimal fatherNode: self.

substitute: newQuestion for: oldAnimal
"replace an animal branch with a
decision branch"
(yesBranch == oldAnimal) ifTrue:
  [yesBranch ← newQuestion].
(noBranch == oldAnimal) ifTrue:
  [noBranch ← newQuestion].
newQuestion fatherNode: self.

```

Listing 5: The class description and methods for Animal. This class is a subclass of TreeNode.

Class Description for Animal:

```

TreeNode subclass: #Animal
  instanceVariableNames: 'name '
  classVariableNames: ''
  poolDictionaries: ''
  category: 'Kernel-Objects'

```

Methods for Class Animal:

```

ask
"ask the user if this animal is the one"
| answer newQuestion |
answer ← nil confirm:
  'Are you thinking of ', name, '?'.
answer
ifTrue: [↑ 'Oh, boy! I got it!
']
ifFalse: ["ask what were you thinking of"
  newQuestion ← Question new
  askForNewAnimalAndQuestion: self.
  fatherNode == nil
  ifFalse: [ fatherNode substitute:
            newQuestion for: self ]
  ifTrue: [Smalltalk at: #AnimalTree

```

(continued)

just say `AnimalTree ← newQuestion`, but here we explicitly look it up in Smalltalk, the global dictionary, so you won't have to declare `AnimalTree` before you type this program.) Finally, we set our own `fatherNode` to be the new question object, because we are now below it in the tree.

In the code for `ask` in class `Animal` we create the new instance of class `Question` and send it a message that gathers the data for a new question. Looking at the method `askForNewAnimalAndQuestion:` in class `Question`, the message `request:` to `FillInTheBlank` puts up a window that asks the user for input, using the string we supply as a herald. We store what the user typed in `newName`. We construct the string by using commas to concatenate several strings. The message `name` sent to `oldAnimal` asks the animal object for the string in its `name` field.

The line

```
newAnimal ← Animal new name: newName.
```

creates a new instance of class `Animal` and tells it that its name will be the name we just got from the user (`newName`).

The next line collects a question from the user to distinguish this animal from the wrong guess and stores it directly into the instance variable `question`. We need to know if a positive answer to our new question indicates the new animal or the old one. We ask the user and store the answer in `polarity`. We then test `polarity` and assign the animal objects to the yes and no branches accordingly. Finally, we inform the new animal that its father node is `ourselves`.

We used the messages `name` and `name:` to retrieve and set the name string of an animal. Pairs of messages that have the same name except for a colon are common in Smalltalk. By informal convention, one sets a value and the other retrieves it. In class `Animal` (see listing 5) the `name` method simply returns the contents of the instance variable, `name`. The `name:` method not only sets the value of the instance variable, `name`, but also adds a little class to this program (as if there weren't enough classes already) by automatically putting "a" or "an" in front of the name. "Lion" becomes "a Lion," and "Elephant" becomes "an Elephant." To get the first letter of a string, we treat it as an array and index into it using the message `at:`. Thus, (`newName at: 1`) returns the first character of the string. We want to know if the vowels in the string 'aeiouAEIOU' contain this character. The message `indexOf:` returns the index of the first occurrence of its first argument (a character) in the string. If the index is zero, our character is not a vowel.

When you are exploring the Smalltalk system, you will often be doing what we just did: reading unfamiliar code. Reading code is easy if you can do two things: identify the objects and understand the order in which messages are sent. All words that begin with a letter and don't end with a colon are objects, except those that immediately follow another object. In the expression (`oldAnimal name`), `oldAnimal` is an object and `name` is a message. In a series of words without colons such as (`oldAnimal name`)

(continued)

```

                                put: newQuestion ].
fatherNode ← newQuestion.
↑ ' ' ].

name
"reply with my name"
↑ name

name: newName
"Save the name of this new animal.
Add 'a' or 'an' before the name."
('aeiouAEIOU' indexOf:
 (newName at: 1)) = 0
  ifTrue: [name ← 'a ', newName]
  ifFalse: [name ← 'an ', newName]

```

asUppercase), the first word is an object and the rest are message names. In (height printString) size, the token size is still a message name, since the expression in parentheses evaluates to an object.

The order in which messages are sent in Smalltalk is a little more complicated than identifying which things are objects. As you might expect, parentheses are used to show what to do first. We were amazed to find that parentheses are not required in any of the methods we wrote until name:. In the expression

```
('aeiouAEIOU' indexOf: (newName at: 1)) = 0
```

(newName at: 1) is evaluated first. The message indexOf: uses the result as its argument, and the message = is sent last of all. When you write code you can include as many parentheses as you want, but you may have to read code that has a minimum of parentheses, so it helps to know the order of evaluation.

Smalltalk has just two rules that tell which messages are sent before others. Messages without arguments (name, printString, etc.) are executed first. They take precedence over adjacent messages that are operators (+, -, *, =, >, comma, etc.). Thus, aString size > 0 is the same as (aString size) > 0 and means send the message size to aString first. Operator messages are executed before adjacent messages whose names contain colons. Thus,

```
(yesBranch == oldAnimal) ifTrue:
  [yesBranch ← newQuestion ].
```

does not need parentheses to cause yesBranch and oldAnimal to be compared before the message ifTrue: is sent. Two messages without arguments are evaluated left to right, as are two operators in a row (3 + 4 * 5 evaluates to 35). The Smalltalk books (references 1 and 4) have the complete story. As you may have guessed, all spaces, tabs, and carriage returns in Smalltalk code are meaningless to the system. Packed methods compile just as well as beautiful, poetically indented ones. (You do need a space in oldAnimal name to show that it is not the single long name, oldAnimalname.)

Returning to our program, in the method ask we sent

a message to fatherNode, the object above the current node, so it will use the new Question object next time. In class Question, look at the method substitute:for: (see listing 4). If the animal we are replacing is exactly the same object as the yesBranch (tested by the message ==), replace it with the new question. If the noBranch was the old animal, then it is the one to replace. In any case, set the fatherNode of the new question object to be the current object (self).

The methods substitute:for: and askForNewAnimalAndQuestion: in class Question each tell an object to set its fatherNode. Both Animals and Questions get their fatherNodes set in the same way, so we can put the code in class TreeNode where it will be shared by both kinds of nodes (see listing 3).

We are all done except for launching the game. The top node of the tree is stored in the global variable AnimalTree, and it can be a node of either kind. The comments that compose the first four lines of the method playGame (see listing 3) tell how to start the game, both normally and from scratch.

After exclamation is declared local and the current object is installed as the root of the tree (the same object is already there when this method is called from the expression AnimalTree playGame), the rest of the method is a single statement. The block of code enclosed in brackets is a while loop, and it is executed repeatedly until the last expression in the block returns false. All the work is done by the first statement in the block, which sends the message ask to AnimalTree, which is an animal or a question object.

ENTERING THE PROGRAM

Let's consider how to enter our program into a Smalltalk-80 system. In area B of figure 1, deselect any class that is currently selected. A class-definition template will appear in area E. Modify it to be the definition of class TreeNode and accept it. Our new class, TreeNode, will appear in area B. Deselect it and enter the class descriptions of Animal and Question in the same way. (You can create a second browser on the screen by holding down the left mouse button in the gray area outside all windows.) Now we will enter the methods for these classes.

If you are using an early version of the Level 0 Smalltalk system for the Macintosh 512K, you will have to add the method request: to the system. Do this by entering area A of the browser and selecting the category *Interface-Menus* (it is above *Kernel-Objects*). Select *FillInTheBlank* in area B and *class* in area F. Look in area D to see if the method *request:* is there. If not, enter the method *request:* shown in listing 6 and accept it. When you have finished, be sure you change the selection back to *instance* in area F.

In each of the three classes, create a category for messages, as we did in the Tower of Hanoi example, and enter and accept the methods. Be sure to put the right method in the right class. Note that you make a left arrow by typing an underscore and an up arrow by typing a caret. To run the program, select the appropriate part of the com-

Listing 6: Missing method in the class portion of FillInTheBlank. (Only early versions of Apple's Level 0 system are missing this method.)

```
request: messageString
"Create an instance of FillInTheBlank
whose question is messageString. Display
it centered around the cursor. Return the
string that the user types and accepts."

self
request: messageString
displayAt: Sensor cursorPoint
centered: true
action: [:response | response]
initialAnswer: ''. "<- two single quotes"
↑ response
```

ment in playGame and choose *doit* from the middle-button menu. The system should ask you questions in the form of small windows that appear on the screen. You have now explored a truly object-oriented program.

WHY USE OBJECT-ORIENTED LANGUAGES ANYWAY?

The most important part of object-oriented programming is not any technical advantage it gives but the fact that it crosses a threshold of perception. When we put all the information associated with a question node into an instance of class Question, we didn't just clean up the Animal program. We allowed ourselves to think of that body of information and action as a single unit, namely, a question node. We perceive the world around us as made up of objects, and our brains arrange information into chunks. By using objects in a programming language, we can tap into an existing pattern of thought.

Thinking of an algorithm in terms of objects makes it easier to understand. This ease of understanding often comes not from the details of how a procedure is constructed but from not having to think about the rest of the program. When you are working inside one Smalltalk class, you are largely safe from the side effects and complexities of parts of your program outside that class.

Good design and clean code are not the sole province of Smalltalk. It is possible to write extremely beautiful code in other languages, as well as terrible code in Smalltalk. However, the designers of Smalltalk believe that you already know what makes a good design and clean code. Smalltalk encourages you to follow your best instincts.

REFERENCES

1. Kaehler, Ted, and Dave Patterson. *A Taste of Smalltalk*. New York: W. W. Norton & Co., 1986.
2. Winston, P. H., and B. K. P. Horn. *LISP*. Reading, MA: Addison-Wesley, 1981, page 88.
3. Cooper, Doug, and Michael Clancy. *Oh! Pascal!*. 2nd ed. New York: W. W. Norton, 1985, page 505.
4. Grogono, Peter. *Programming in Pascal*. Reading, MA: Addison-Wesley, 1978, pages 102-103.
5. Goldberg, Adele, and David Robson. *Smalltalk-80: The Language and Its Implementation*. Reading, MA: Addison-Wesley, 1983. ■

PROLOG APPLIED!

The **FIRST** Interactive Prolog for the IBM and Macintosh.

PROLOG/i

A new enhanced Interactive Prolog for MS-DOS. Upwardly compatible with PROLOG V and V-plus. **\$69.95**

PROLOG/m

Prolog for the Macintosh! Edinburgh syntax. Floating point, math functions. **\$99.95**

THREE GREAT APPLICATIONS

READY TO RUN
NO PROGRAMMING
EXPERIENCE NECESSARY.

NFL X-pert \$49.95
Expert system for professional football handicapping.

TOOLBOX \$29.95
Including subroutines that speed and compress list handling, searches, sorts, reversal algorithms.

TOYBOX \$29.95
A collection of games and puzzles that make learning Prolog fun.

MIX AND MATCH FOR ADDED SAVINGS

	PROLOG/i	PROLOG/m	*SAVE*
Interpreter plus...			
Toolbox or Toybox	\$ 79.95	\$109.95	\$20
Toolbox and Toybox	99.95	129.95	30
NFL X-pert	99.95	129.95	20
NFL X-pert and Toolbox and Toybox	119.95	149.95	30
BUY ALL 4 AND SAVE \$50	129.95	159.95	50
Applications Only			
Toolbox and Toybox	\$49.95		
NFL X-pert and Toolbox or Toybox	69.95		
BUY ALL 3 AND SAVE \$20	89.95		

COMPATIBILITY

Applications fully compatible with Prolog compilers and interpreters with Edinburgh syntax.



CHALCEDONY SOFTWARE, INC.

System Requirements
PC-DOS/MS-DOS
Ver. 2.0 or later
256K RAM
512 Macintosh

5580 LA JOLLA BLVD.
SUITE 126 D
LA JOLLA, CA
92037
(619) 483-8513

LAST CHANCE AT THESE PRICES

PHONE ORDERS: 1-800-621-0852 EXT 468

PAYMENT ENCLOSED \$ _____ CA residents add 6% sales tax

CHARGE MY: MasterCard Visa

Card No _____ Exp. Date _____

Signature _____

Mr /Mrs./Ms. _____ (please print full name)

Address _____

City/State/Zip _____

PROLOG/i \$69.95
PROLOG/m \$99.95
If you own PROLOG V or PROLOG V-plus, call for upgrade information

SHIPPING:
\$ 5.00 U.S.
7.50 Canada
10.00 Caribbean,
Hawaii Air
20.00 Overseas Air

COD Orders Not Accepted
15 day check clearance



NOTHING DOWN.

Even the best of personal computers can have a bad day. Blackouts happen. Usually at the worst possible time.

But power interruptions don't need to be business interruptions. And lost power shouldn't result in lost data. Not with the POWERMAKER[®] Micro UPS from Topaz.

Designed specifically for hard disc and critical-use business systems, Powermaker Micro UPS ensures a continuous supply of smooth sine wave power even during

a total blackout.

And there's more. Powermaker Micro UPS also removes spikes and other error-producing transients from incoming power, protecting your PC's sensitive circuitry.

So, if your PC needs a little help once in a while, give it Powermaker Micro UPS protection. For nothing down. Call us today at (619) 279-0831, or contact your local Square D distributor.

TOPAZ[®]

A Subsidiary of Square D Company

OBJECTS, ICONS, AND SOFTWARE-ICS

BY BRAD COX AND BILL HUNT

*Object-oriented programming can make it easier
to create iconic user interfaces*

MAKING COMPUTERS EASIER TO USE has been an enduring dream since the dawn of computing. This is one of the reasons for the current interest in *iconic* or *object-oriented* user interfaces—interfaces that present information as pictures instead of text and numbers. However, iconic programs can be excruciatingly difficult to build. They must not only do all that conventional programs do, but they must also present their workings as pictures instead of the usual words and numbers, and they must determine the user's needs from a graphical input device like a mouse rather than the usual commands from a keyboard. Unless tools can reduce this complexity, iconic user interfaces will remain costly and comparatively rare.

This article will demonstrate why object-oriented programming is becoming so popular, not only for building iconic programs but for programs of any kind. This popularity is the result of two language features beyond those provided by non-object-oriented languages: encapsulation and inheritance. Encapsulation means that code suppliers can build, test, and document solutions to difficult user interface problems and store them in libraries as reusable software components that depend only loosely on the applications that use them. Encapsulation lets consumers assemble generic components directly into their applications, and inheritance lets them define new application-specific components by inheriting most of the work from generic components in the library.

Building programs by reusing generic components will seem strange if you think of programming as the act of assembling the raw statements and expressions of a pro-

gramming language. The integrated circuit seemed just as strange to designers who built circuits from discrete electronic components. What is truly revolutionary about object-oriented programming is that it helps programmers reuse existing code, just as the silicon chip helps circuit builders reuse the work of chip designers. To emphasize this parallel we call reusable classes Software-ICs.

Even though the examples in this article are written in Objective-C, not Smalltalk-80, you will find the graphics primitives chapter in Adele Goldberg and David Robson's book *Smalltalk-80: The Language and Its Implementation* (Addison-Wesley, 1983) helpful in understanding the portable graphics substrate on which this work is based. More information on Objective-C and the Software-IC approach to system building is contained in Lamar Ledbetter and Brad Cox's article "Software-ICs" (June 1985 BYTE) and in Cox's book *Object-oriented Programming: An Evolutionary Approach* (Addison-Wesley, 1986).

WORKBENCH

To determine how much a Software-IC library can help in building iconic applications, we developed the program whose interface is shown in the top window in figure 1.

(continued)

Brad Cox, a founder and chief technical officer of Productivity Products International (27 Glen Rd., Sandy Hook, CT 06482), is the originator of Objective-C and its user interface library.

Bill Hunt currently works on user interfaces and high-speed graphics for Hewlett-Packard (P.O. Box 301, Loveland, CO 80539). He was also part of the team that developed the HP 110.

This program is called Workbench because it lets a programmer describe the files on his workbench and how they should be transformed into other files by tools like compilers and linkers. Workbench shows each file as an icon, dependencies between files as lines, and the programs that transform files as small circles. For example, the file named testOutput depends on two other files, testInput and theProgram. The file named theProgram depends on the three binary files shown as Software-IC icons, and each of these depends on its own source file. By relying on the operating system to maintain time stamps showing when each file was last changed, Workbench could be made to automatically rebuild the target files to bring them up to date when the source files they depend on change.

Since Workbench is currently only a prototype that we built to test the Software-IC library, we have not yet implemented the logic for rebuilding target files when source files change. Except for this unimplemented (but crucial)

feature, Workbench and the UNIX utility make provide radically different user interfaces for the same problem. Figure 2 shows the file a user would have to build to describe the same information described in figure 1 by Workbench.

BUILDING THE COMPONENTS

An iconic user interface is like an animated movie or cartoon. Once a cartoon has been designed through script-writing and storyboarding, an artist builds the components of the animation by painting gels on transparent acetate sheets, turning generic materials from an art supply store into the specialized components needed for the movie on hand. The user interface library is the programmer's art supply store. It provides generic components from which specialized ones are defined by using encapsulation and inheritance the way an artist uses paint, scissors, and glue. This section will show how a programmer builds

(continued)

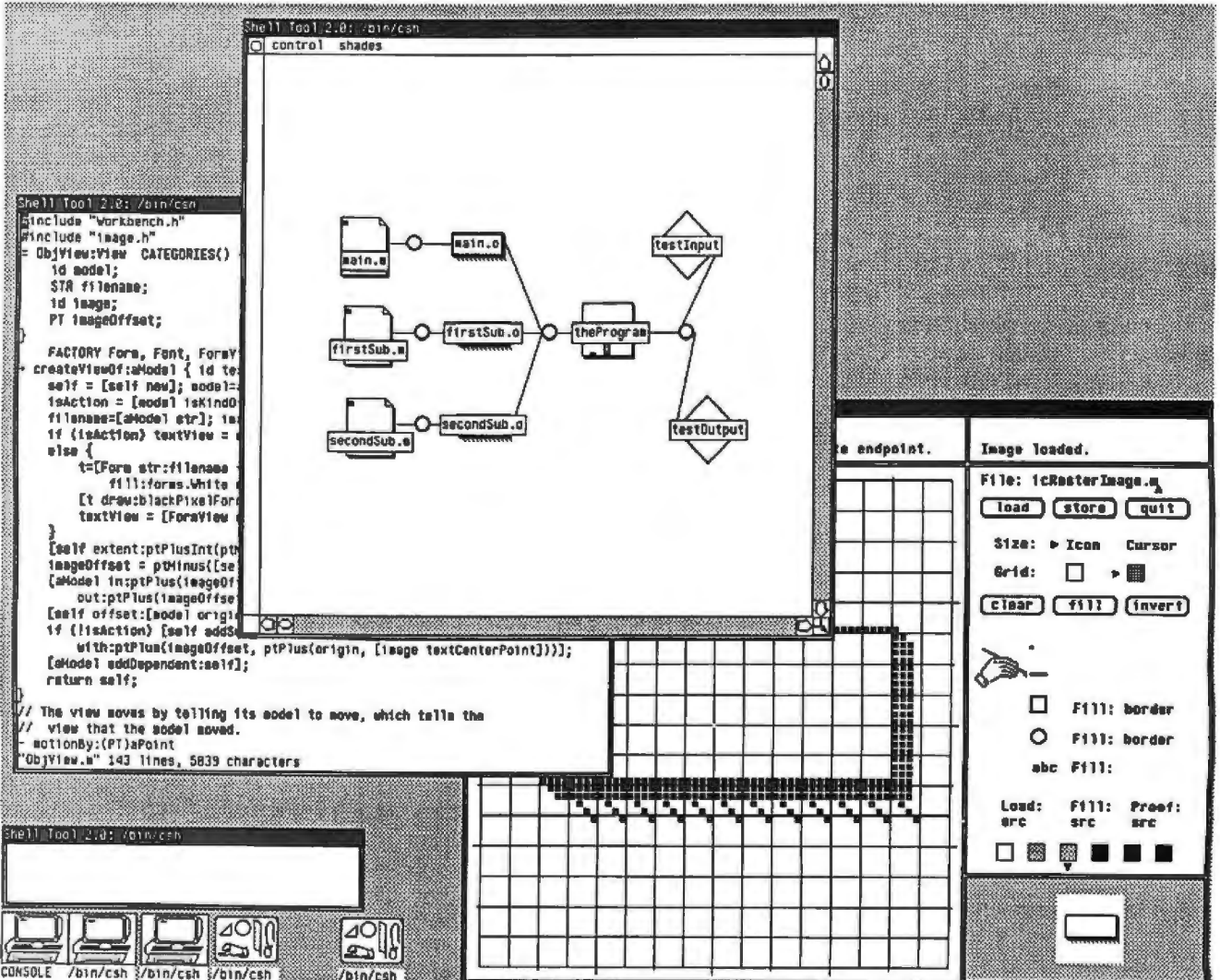

Figure 1: Workbench as it might be seen by a programmer. The topmost window shows the iconic user interface, the window to the left shows a text editor, and the window to the right shows a bit-map editor.

GET 10 DISKS FREE FROM VERBATIM.[®]

OR CASH REFUNDS UP TO \$12 WITH PURCHASE OF VERBATIM DATALIFE™ TEN-PACKS.

1 Buy one ten-pack — get a \$5 rebate!

2 Buy two ten-packs — get a \$12 rebate!

3 Buy three ten-packs — get a ten-pack free!

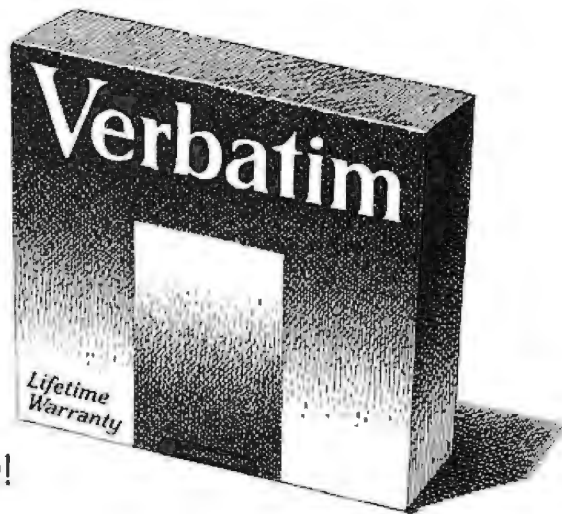

Offer good 7/1/86 through 11/1/86. Limit one choice per name and address. For the name of a dealer near you, call toll-free (800) 538-1793. In California and Canada, call collect (408) 737-7771.

CASH IN ON VERBATIM TODAY!

It's easy. Buy your Verbatim DataLife 10-pack(s), and send us this coupon with your proofs of purchase and receipt(s). Please, only one redemption per name and address.

Please send me the DataLife 10-pack I've indicated below. I have enclosed my fully completed coupon, three (3) UPC symbols and dated cash register receipt(s) with purchase price(s) circled.

Select one only:

5¼"

Single Sided
Double Density

5¼"

Double Sided
Double Density

3½"

Single Sided
Double Density

3½"

Double Sided
Double Density

Please send my \$12 Cash Rebate Check. I have enclosed my fully completed coupon, two (2) UPC symbols, and dated cash register receipt(s) with purchase price(s) circled.

Please send my \$5 Cash Rebate Check. I have enclosed my fully completed coupon, one (1) UPC symbol, and dated cash register receipt with price circled.

Name: _____

Address: _____

City: _____ State: _____ Zip: _____

Send completed coupon and proofs of purchase to: Verbatim 1-2-3- FREE Offer, P.O. Box 8966, Clinton, Iowa 52736. Limit one choice per name and address. Offer void if correct and valid proofs of purchase and complete return name and address are not included. Mechanical reproductions of this coupon or UPC symbols will not be honored. Offer rights not assignable or transferable. Allow eight (8) weeks for delivery. Void where taxed, prohibited or otherwise restricted by law. Requests must be received no later than November 1, 1986.

BYT08

a stockpile of specialized components from generic components in the library. Later we will show how the components are assembled into an application and brought to life in the way that an artist assembles gels into layers and moves them with respect to each other to simulate motion.

The programmer's sheet of acetate is a generic class in the library named `View`. [Editor's note: It is a naming convention to capitalize the first letter of class names and lowercase the first letter of the instances of these classes.] Workbench's user interface in figure 1 was produced by many different instances of many specialized kinds of views, assembled like overlapping layers of acetate. No instances of the generic `View` class appear because instances of this class are transparent. But instances of specialized view classes can be seen because the programmer who defined them added "paint" to make them visible. For example, `BorderedViews` provide two colors of paint, one for a border of adjustable thickness and another for the region inside the border. One of these drew the white square in the upper left corner, two others drew similar squares in two other corners, and a fourth drew the tall vertical rectangle along the left edge. Several other `BorderedView` instances cannot be seen because they are obscured by other views lying on top of them. For example, the views in this figure are arranged on top of a large `BorderedView` that serves as an opaque backing to which all the others are attached.

Having seen how views work visually, let's turn to how they are implemented. The most generic abstraction, the `View` class, was defined by compiling a file that contains the following class definition statement, along with a large number of methods. In this section, no methods will be shown because they would introduce far too much detail for now.

```
= View : Rectangle {
  id clipList; // list of visible regions
  id superView; // or nil
  id subViews; // OrderedCol'n of subViews
  BITS flags; // flag bits
}
```

```
testOutput: testinput theProgram
  theProgram testinput >testOutput
theProgram: main.o firstSub.o secondSub.o
  objc main.o firstSub.o secondSub.o
  -o theProgram

main.o: main.m
  objc -c main.m
firstSub.o: firstSub.m
  objc -c firstSub.m
secondSub.o: secondSub.m
  objc -c secondSub.m
```

Figure 2: The file a user would have to build to convey the information in figure 1 to the UNIX utility make.

This statement defines a new class, `View`, as a subclass of another generic class from the library, `Rectangle`. This declaration is all that is needed to ensure that every view will automatically inherit the ability to behave as a rectangular region. For example, each view instance will inherit two instance variables from `Rectangle`, namely a point (an *x,y* pair) named `extent` that describes the size of the view and a point named `origin` that specifies its position on the screen. Finally, the declaration adds four new variables that will be used to describe how each view is attached to other views. The `superView` variable identifies another view that provides the background against which this view will be displayed. A view's `superview` also establishes its coordinate system, and it clips any graphics drawn by the subview that extend beyond the `superview`'s margins so that they don't appear on the screen. The variable `subViews` identifies those views for which the current view is background. These variables will be inherited by all other views. Thus every view will be linked into an important data structure, the view hierarchy, that describes how the views are stacked into layers.

`BorderedViews` are a specialized kind of view that is not transparent, and their declaration states as much explicitly:

```
= BorderedView:View {
  short borderWidth; // thickness of border
  id borderPattern; // color of border
  id insidePattern; // color of inside
  id outsideRectangle; // computed rectangle
}
```

In other words, a `BorderedView` instance is exactly like a view but has four additional variables to describe how thick its border should be and a pattern (a "color") to display for its border and central region.

This may seem like a lot of trouble just to draw a black line around a white box, but effort spent on generic classes is seldom wasted. `BorderedView` actually turns up repeatedly in this and other iconic applications, both as a component that is reused directly through encapsulation and as a generic class to be specialized through inheritance. We have shown several places where unmodified `BorderedViews` appear, but they are also inherited by specialized subclasses that can modify their appearance in surprising ways. For example, consider `MacScrollBar`, the class whose instances drew the horizontal and vertical scroll bars in the topmost window of figure 1:

```
= MacScrollBar : BorderedView {
  BOOL isVertical; // NO if horizontal
  id scrollMore; // ArrowFixture
  id scrollLess; // ArrowFixture
  id elevator; // ElevatorFixture
}
```

Even though the `MacScrollBar` instances look very different from ordinary `BorderedViews`, they were imple-

(continued)

JOB INVOICE

SOLD TO: MANHATTAN EXPORTS
ATTENTION

DATE: 04/15/88
INVO. NO.: 8270
ISS. JOB NO.: 2188
CODE: AMOUNT:
\$10,287.50

PH SEAS SHIPPING COMPANY
TIBLY SALES REPRESENTATIVE
BY CUSTOMER

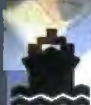

South Seas Shipping Company

November 20, 1988

Ms. Cathy Lyons
Import Officer
Botanical Research Ltd.
55 Wewak Road
Moresby, Papua, New Guinea

Re: Palm Fruit Research

Dear Ms. Lyons:

This letter confirms the agreement we reached at our meeting last week in San Francisco.

Botanical Research, Ltd. will recommend the optimal conditions for shipping palm fruit and palm oil.

Important issues for consideration are: temperature during shipping and length of time between shipping.

Completed by June 1, 1987.

South Seas Shipping Company
Corporate Organizational Chart

PRESIDENT
Trevor Cardinal

INVESTOR'S UPDATE

SHIPPING GOES WILD IN THE PACIFIC

BY ROSEANNE FARFANG
DIRECTOR OF SALES

South Seas is continuing to maintain its growth through the year. South Seas has managed to maintain its growth through the year. South Seas has managed to maintain its growth through the year. South Seas has managed to maintain its growth through the year.

Competitive Factors

One of the primary factors in South Seas success has been the company's ability to identify new market opportunities and then to establish the dominant position in that market. The palm oil trade is a prime example of this successful strategy. Since entering the market in 1977, South Seas has become the key player in the specialty shipping market.

However, LHC Ltd. is expected to become a more aggressive player. The Singapore concern had concentrated its efforts on short-haul container freight in the Indian Ocean. Last year, LHC purchased the ailing Hutton Lines. This move more than doubled LHC's tanker capacity. Several of these mid-sized tankers have been refitted for the palm oil trade and are expected to enter service by mid-1988. So far, the LHC has been successful in winning any of South Seas customers. In the future, increased competition can be expected to depress both prices and margins, but for the short-term, South Seas contracts with most of the palm oil industries largest producers should insulate it.

Joint Ventures Considered

Another growth strategy South Seas is exploring is to establish joint ventures with several of the producers of these commodities. These ventures would be ideal for the Transpac/South Seas operation, in that South Seas has a strong presence in the offer to shipping capabilities. The company is holding preliminary talks with many of the expore firms. Another firm would be to join with a firm during concern.

Outlook for Sales

Spectacular sales for the first quarter will set the pace for what industry analysts expect will be a record year for South Seas. "South Seas will be the industry leader by 1990," says Michael Wong, a vice president at Doonvan, Kroll & Co. "Their growth strategy is sound and their balance sheet gives them the financial muscle to continue to grow even during the current slump in the shipping industry."

SHARE OF PALM OIL TRADE (1985) DOLLAR VOLUME

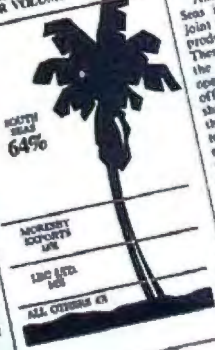

What if...

YOU COULD PRINT EVERYTHING ON THIS DESK FROM A BUSINESS PC?

The world's best-selling desktop laser printer has something in store for just about every business that's ever dealt with the printed word.

Because the Hewlett-Packard LaserJet Printer is the only printer of its kind specifically designed to work with over 300 software programs. And since it hooks up to almost any business PC, it's right for all kinds of users—not just the art department. So you can print everything on this desk—from simple memos to your life's memoirs. And get high-quality, professional-looking output.

Combined with our very fast, very versatile HP Vectra PC (it's IBM PC/AT compatible) and the software of your choice, the HP LaserJet is the cornerstone for a complete desktop publishing solution. One your whole company can easily use.

Of course, the HP LaserJet also works with IBM PC's and compatibles. As well as software like Lotus 1-2-3, WordStar and d:BASE II. And, for around \$3,000, it's the laser printer you can afford.

We can't print all the reasons our HP LaserJet is the printer of choice. But if you stop by an authorized HP dealer or call us at 1 800 367-4772, Dept. 276A for the one nearest you, we'll show you why HP quality printing makes very good business sense indeed.



HP Vectra PC

Print samples produced on a LaserJet Plus with the following software packages: Studio Software, Spellbinder® Desktop Publisher, MicroPro WordStar 2000® Lotus 1-2-3® and FormMaker II™ HP Vectra PC is a trademark of Hewlett-Packard. IBM PC is a registered trademark of International Business Machines Corp. Lotus 1-2-3 is a registered trademark of Lotus Development Corp. WordStar is a registered trademark of MicroPro International. d:BASE II is a registered trademark of Ashton Tite II™ © 1988 Hewlett-Packard Co.



HP LaserJet



HEWLETT
PACKARD

Business Computing Systems

Inquiry 132

PG601178

Specializing from reusable generic code is what makes object-oriented programming so productive.

mented as a specialized `BorderedView` whose `insidePattern` variable is set to a uniform gray tone. Three instance variables are also added to refer to two instances of class `ArrowFixture` and one instance of class `ElevatorFixture`. These too are specialized `BorderedViews` that have overridden the method that draws their central region with one that displays a specific iconic image rather than a plain shade of gray. They also have additional methods that make them interpret cursor events as commands to control scrolling.

This ability to define specialized new facilities from generic facilities in the library is one of the key things that makes object-oriented programming so productive. When the new classes get so specialized that they are specific to the application on hand, they are no longer stored in the generic library. Nonetheless, they are still part of the inheritance hierarchy, and they are built exactly like the generic classes shown so far. For example, the large white region in the center of the Workbench user interface was drawn by an instance of class `WbView` that describes the files on the Workbench, a UNIX directory area.

```
= WbView : BorderedView {
    id model; // the Wb being viewed
}
```

This class defines an instance variable, `model`, that identifies the instance of class `Wb` to be interfaced to the user. Most applications involve several kinds of application-specific views, and these are produced in exactly the same way, by defining specialized subclasses of `View`.

MODELS AND VIEWS

Until now we've described only how the components of this application were defined. Now let's turn to how they work together when the Workbench program first runs in a particular UNIX directory. Like most other programs, Workbench must support two very different kinds of interfaces: one between itself and the file system, and the other between itself and the user. When Workbench starts executing, it must read information from the file system and represent it in some internal form. Then it must create whatever objects it needs for its user interface, draw these objects on the screen, and accept commands from the user that then modify the internal form. Finally, Workbench must save the modified information so that it will be available the next time the program is run in that directory.

This pattern is so typical that special terms are used to distinguish the two interface levels. The word *model* refers to the internal form, that is, whatever structure is used to represent the objects to be saved between sessions. The

term *view* refers to the objects that implement the user interface. Views have been described in the previous section, and we turn now to the models.

The Workbench application uses only four kinds of model objects: `Entity`, `Action`, `Obj`, and `Wb`. Each file in the directory is represented by an instance of class `Entity` that holds the name of a file, its modification time, and two collections that describe those entities that depend on it and those that it depends on. When an entity's modification date is older than the date of a file that it depends on, it must be rebuilt by executing a program specified by the user. Another class, `Action`, holds the command string that describes how this program should be run. The `Entity` and `Action` classes have some features in common (such as where they are on the screen), and this is represented in a common superclass, `Obj`. A final class, `Wb`, represents the contents of the Workbench as a whole as a collection of entity and action instances.

When Workbench runs for the first time in a directory, it builds an instance of class `Entity` for each file and installs it in an empty instance of class `Wb` named `workbenchModel`. Next, the program creates a user interface so that the user can manipulate the models in the following ways: by moving them around on the screen, by describing which entities depend on which others, and by defining actions. (In the Workbench user interface, entities are presented to the user as file icons, actions are the circles, dependencies are the lines connecting the actions and entities.) The effect of this is to interconnect the models, forming a complicated web of linked objects that must somehow be saved at the end of the session so that it can be restored the next time the program runs in that directory. The code needed to do this is highly nontrivial to write, but object-oriented programming makes it seem simple. Since every class is a subclass of the most generic class in the system, `Object`, every object automatically inherits a method that can be used to save it in a file:

```
[workbenchModel storeOn:"workbench.io"];
```

When the application is executed again, it recreates `workbenchModel` by reading the file like this:

```
workbenchModel = [Wb readFrom:"workbench.io"];
if (workbenchModel == nil)
    workbenchModel = [Wb new];
[workbenchModel synchronizeWithDirectory];
```

The first statement requests the factory object for the `Wb` class to recreate `workbenchModel` from the file named `workbench.io`. The attempt will fail if the program has never been run in this directory, in which case the `Wb` factory object is requested to construct a new (empty) instance. In either event, the `synchronizeWithDirectory` message requests `workbenchModel` to examine the directory, adding or removing entities as needed to reflect files that have been created or removed since `workbench.io` was last written. Instance variables in the models are now updated to reflect the time at which each file was last changed.

(continued)

A CROSSTALK[®]

Klone FOR \$49⁹⁵

The Closer You Look, the Better We Look!

FEATURING
Foreground/Background Communications

MIRROR is the mirror image of Crosstalk XVI V3.6, the industry standard in data communications software for small business computers. **MIRROR**'s design closely reflects Crosstalk XVI's menus, commands and features. In fact, if you have used Crosstalk XVI before, you will feel right at home with **MIRROR**. The one thing you will not find reflected in **MIRROR** is Crosstalk XVI's \$195.00 price. Because we control the reflection, **MIRROR** costs only \$49.95.

If you are new to data communications, it makes sense to go with the industry standard in data communications software, but why pay the industry standard price. **MIRROR** lets you have the industry standard at 1/4 the price. If you or your company have already standardized on Crosstalk XVI, then consider **MIRROR** for future purchases and upgrades, you'll realize significant savings, without sacrificing on quality, standardization or features.

MIRROR™
WILBOS

THE RIGHT DATA COMMUNICATIONS
CHOICE FOR ANY USER!



1210 East Park Avenue
 Tallahassee, Florida 32301
 For Information Call:
 1-904-878-8564
 TLX: 6714280 KLOM

\$49.95

Site Licensing Available
 60 Day Money-back Guarantee
 Not Copy Protected

To Order Call Toll-Free



National **1-800-538-8157** Ext. 848
 California **1-800-672-3470** Ext. 848

\$49.95, plus \$5.00 postage/handling
 (\$8.00 for COD orders) ea.

Florida residents must add 5% sales tax
 Overseas orders: Add \$18.00 for shipping.

MIRROR is available for the IBM PC/XT/AT and compatibles and requires MS-DOS 2.0 or higher.

MIRROR, Kloneware and Softklone are trademarks of Softklone Distributing Corporation. Crosstalk XVI and Microstuff are registered trademarks of Microstuff, Inc. WILBOS is a registered trademark of Micro Microcomputer Products, Inc. Wordstar is a registered trademark of Micropro International.

DISTRIBUTED IN CANADA BY:
 Saraguay Software Distributors
 121 Avenue Road, Suite 202
 Toronto, Ontario, M5R 2G3
 Ph: (416) 923-1500

Inquiry 266

For New Users,
MIRROR Provides:

- Menu/Command Driven
- Complete Crosstalk XVI V3.6 Compatibility
- New User Script File (Enables you to sign-on to your favorite online service in minutes)
- Auto-dial/Auto-answer
- Alphabetized Help-Command Summary
- Money Saving Offers From Online Information Services

For Experienced Data Communications
Users, MIRROR Provides:

- Complete Background Operation (concurrent operation/memory resident)
- Programmable Script/Command Language (Crosstalk XVI V3.6 compatible with extensions)
- Extended Error-checking Protocol Support (XMODEM-single, XMODEM-multi-file, Crosstalk, HAYES and KERMIT)
- Integrated Wordstar-like Text Editor
- Multiple Terminal Emulations (VT-100/52, IBM 3101, Televideo 912C/920/925, TI 940, ADDS Viewpoint, ADM-3A)
- Enhanced Individualized Password Protection

Object-oriented programming

allows most of the work

to be developed in advance,

stored in the library,

and reused off-the-shelf

as generic Software-ICs.

Although `workbenchModel` is a complicated web of interconnected entity and action linked by dependency instances, the `storeOn:` method walks this web automatically, converting each object to a symbolic representation from which `readFrom:` can reconstruct the web during the next session. The developer of this application didn't have to design, code, test, document, or maintain this logic. Apart from the pair of triggering statements, this complicated data structure was saved and restored without writing any new code. The supplier of the most generic class in the system, `Object`, undertook this task once and for all, and every other class will inherit this work automatically.

The complete parts inventory for `Workbench` is shown in figure 3. Most of the classes are generic components taken directly from the user interface library. Only those in the bottom section are application-specific, and the total amount of application-specific code is 531 lines—269 lines specific to the internal representation of `Workbench` (`model`) and 262 lines used for the user interface (`view`). This was possible only because object-oriented programming allowed most of the work to be developed in advance, stored in the library, and reused off-the-shelf as generic `Software-ICs`, just as hardware designers use silicon chips to build specialized circuits.

ASSEMBLING THE USER INTERFACE COMPONENTS

We now have model objects to be interfaced to the user and a library full of components for building user interfaces. The next step is to assemble the components to build a user interface for the model objects. First, we must build an opaque sheet of plain white acetate, on which all the others will be arranged, and attach to it another sheet painted with a standard frame of scroll bars:

```
[baseView = [BaseView new]
  addSubview:stdView = [StdSysView new]];
```

The `baseView = [BaseView new]` expression commands `baseView`, the factory object for class `BaseView`, to create a new instance named `baseView`, and `baseView` is immediately requested to add `stdView`, a newly created instance of class `StdSysView`, as its first subview. `BaseView` is a simple subclass of `BorderedView` that provides plain white backing on which any kind of animation can be assembled, and the `StdSysView` class defines a consistent

overall appearance and behavior for all applications by arranging nine subviews in three rows and three columns to cover the available space completely:

```
= StdSysView:View {
    PT topLeftExtent;
    PT botRightExtent;
}
+ new {
    self = [super new];
    topLeftExtent = pt(16,16);
    botRightExtent = pt(16,16);
    // 0 = topLeft 1 = topCenter 2 = topRight
    [self addSubview:[BorderedView new]];
    [self addSubview:[BorderedView new]];
    [self addSubview:[BorderedView new]];
    // 3 = midLeft 4 = midCenter 5 = midRight
    [self addSubview:[BorderedView new]];
    [self addSubview:[BorderedView new]];
    [self addSubview:[MacScrollBar vert]];
    // 6 = botLeft 7 = botCenter 8 = botRight
    [self addSubview:[BorderedView new]];
    [self addSubview:[MacScrollBar horz]];
    [self addSubview:[StretchFixture new]];
    return self;
}
```

This is the first example that shows how methods are defined in Objective-C. The plus sign in the fifth line assigns this method to the factory object for class `StdSysView`, while a minus sign in the same position signifies an instance method. Factory objects already inherit a method named `new` from the `Object` class, but it is being overridden here to create and initialize instances in a class-specific way. For example, the two instance variables (of type `PT`, short for `Point`) are given an initial value, and nine subviews are automatically installed, such as `MacScrollBar` instances in the center position of the bottom row and right column.

Newly created `StdSysView` instances contain only generic subviews initially, but they can be customized to the specific application by requesting them to replace one or more of them with application-specific views like this:

```
[stdView midCenterView:wbView =
  [WbView createViewOf:workbenchModel]];
```

`WbView` is an application-specific subclass of `BorderedView` that implements a user interface for an instance of class `Wb`.

```
= WbView ...
+ createViewOf:aWorkbenchModel {
    id sequence, member;
    self = [super new];
    model = aWorkbenchModel;
    sequence = [[model entities] eachElement];
    while (member = [sequence next])
        [self addSubview:[ObjView
```

(continued)

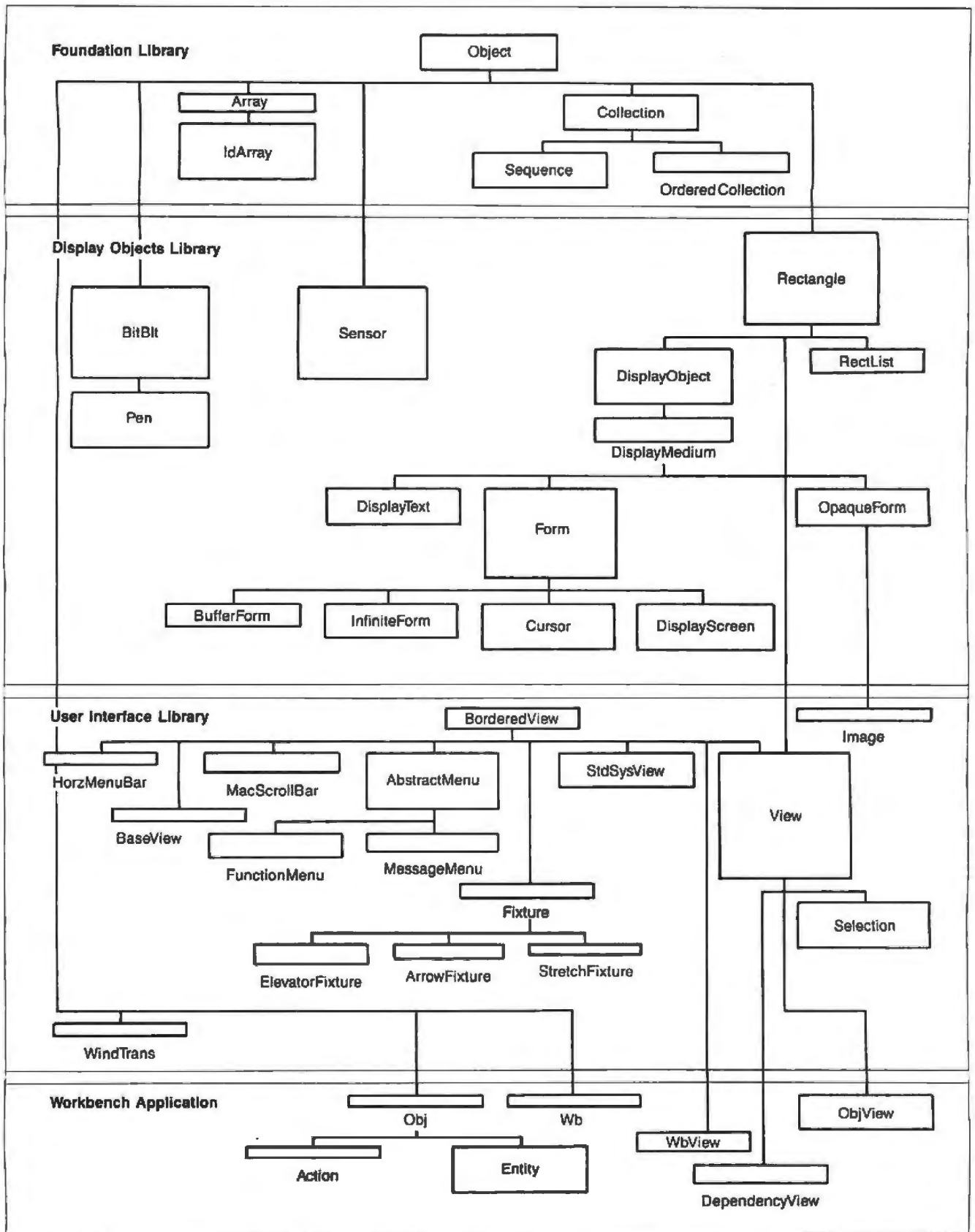

Figure 3: The inheritance hierarchy for the Workbench classes. The source bulk in each class is represented as the height of each box.

```

        createViewOf:member]);
[sequence free];
sequence = [(model actions) eachElement];
while (member = [sequence next])
    [self addSubView:[ObjView
        createViewOf:member]];
[sequence free];
return self;
}

```

Application-specific views are exactly like the generic views discussed earlier, but they nearly always define an instance variable that points to the model that they are responsible for managing, plus factory methods for initializing this variable and installing any additional views that they need to implement the user interface. For example, this `createViewOf:` method loops over each of the entities and actions in the model and creates an instance of class `ObjView` for each one.

POSITIONING, SIZING, AND DISPLAYING

The application has created many different kinds of views and specified which ones lie on top of which others. But no attention has been given to how big each view should be and to where each view should be positioned on the screen. And of course, nothing has been displayed on the terminal. Since the sizing and positioning of each view may change each time the window size is changed, these functions are done separately in the course of responding to a `windowChangedEvent`. The event handler will automatically generate this event as soon as the application passes control to it:

```
[baseView controlStart];
```

One of `BaseView`'s main functions is reading events from the event handler, determining which views lie under the location of the event, and sending those views messages that describe which event has occurred. Since the `windowChangedEvent` affects all views, the `BaseView` handles it specially:

```

= BaseView ...
- (BOOL)windowChangedEvent {
    [self rect:currentDisplay];
    [self display];
    return YES;
}

```

The global variable `currentDisplay` identifies an instance of class `Display` that manages the window in which the application is running; the `rect:` message sets the `BaseView`'s position and size to that of `currentDisplay`. This message is eventually implemented (in class `Rectangle`) via two separate messages, `origin:` and `extent:`, both of which are overridden (in class `View`) to give views the behavior of a sheet of acetate. For example, `View` defines a default implementation for the `origin:` method that automatically repositions a view's subviews when it is repositioned, and a default `extent:` method that changes only the receiver (stretching a background acetate does not

stretch acetates that are attached to it). These defaults are sometimes inappropriate, so views like `StdSysView` override them to meet special needs, for instance, ensuring that subviews completely cover the available space. This triggers a wave of `origin:` and `extent:` messages that propagates through the view hierarchy, assigning a place and a size to every view.

Nothing appears on the screen until the `windowChangedEvent` method in `BaseView` executes `[self display]`, which triggers the following generic display methods into operation:

```

= View ...
- display {
    [currentDisplay lock:self];
    [[self topView] displayExcept:nil];
    [currentDisplay unlock];
    return self;
}
-- displayExcept:aCollection {
    if (aCollection && [aCollection contains:self])
        return self;
    if (TBIT(flags, ISLOCKED))
        [self computeClipList];
    if (lockedRegion == nil
        || [self intersects:lockedRegion]) {
        [self displayView];
        SBIT(flags, ISVISIBLE);
        if (TBIT(flags, ISSELECTED))
            [self emphasizeView];
        if (subViews) [subViews
            eachElementPerform:
                @selector(displayExcept:)
                with:aCollection];
    }
    return self;
}
- displayView
    { return self; }

```

The `lock:` message in the `display` method commands `currentDisplay` to set its clipping region to the margins of the receiver (the `lock:` and `unlock` messages) and commands the topmost view in the hierarchy to display itself and all of its subviews. The `displayExcept:` method is a multipurpose method used not only for redrawing the entire view hierarchy, as here, but also for erasing views and for highlighting views when they are selected, and these extra functions obscure the fact that this method basically sends a `displayView` message to each view in the hierarchy. As an efficiency optimization, it avoids considering views whose graphics would be clipped by the global clipping region, `lockedRegion`. The argument, `aCollection`, is a way of using the `display` methods to erase views, by re-displaying everything but the views that are to be erased.

All graphics are generated by `displayView` messages. A default implementation is defined in the `View` class that displays nothing, another way of saying that the `View` class implements transparent acetate. The views that do draw

(continued)

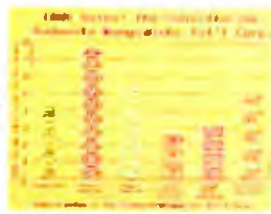

*Until today,
you needed a
Charting program,
a Drawing program,
and a
Presentation program.*



NOW ALL YOU NEED IS

ENERGRAPHICS 2.0



EnerGraphics 2.0 simply outperforms the competition. Whether you're making charts for a presentation, analyzing data, making maps, flow charts or creating almost any type of graphic, you'll find the capability with EnerGraphics 2.0.



EnerGraphics 2.0 is easy to use too, because a mouse has been added. Now with mere pushes of a button, stunning charts and drawings are easily created. Help screens are also available, plus, new documentation with a quick-tip book that makes EnerGraphics 2.0 a breeze to use.

So, if you want this kind of performance and capability which can be used by anyone, the simple choice is EnerGraphics 2.0.

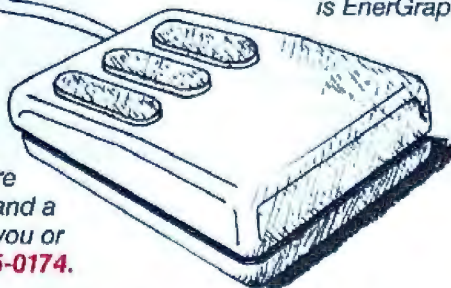
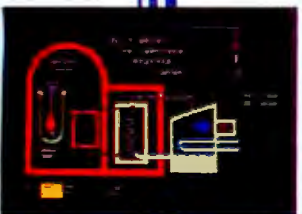
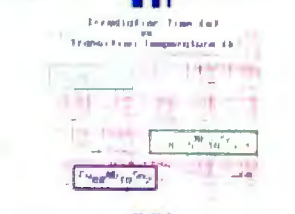

Write for more information and a dealer near you or call 800-325-0174.

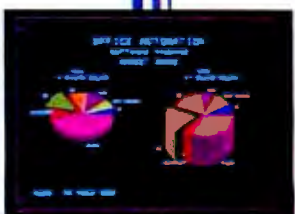

ENERTRONICS

Conceptually, events occur at the tip of the cursor and penetrate through the views at this location.

on the screen simply override this method. like this:

```
- Fixture : BorderedView {
    id form;
}
- displayView {
    [super displayView];
    [form displayOn:display at:origin
     clipBy:clipList rule:rules.Over];
    return self;
}
```

The Fixture class is the one that draws the small iconic fixtures in the scroll bars. Its instance variable, form, identifies the fixture's image, an instance of class Form that was hand-painted with a pixel editor.

EVENT HANDLING

Once the windowChangedEvent has caused each view to draw itself on the screen, control returns to the event handler to await interrupts from the graphics substrate signaling that something has happened; perhaps a key has been struck on the keyboard, one of the mouse buttons was pressed or released, or a time-out has expired. Conceptually, events occur at the tip of the cursor and penetrate through the views at this location like a needle through a stack of acetates. Each possible event is assigned a message, for example, leftButtonDown, keyboardEvent, timeoutEvent, and the View class defines a method for each one so that, by default, all views are transparent to all events.

```
= View ...
- (BOOL)rightButtonDown { return NO; }
- (BOOL)leftButtonDown { return NO; }
- (BOOL)middleButtonDown { return NO; }
- (BOOL)keyboardEvent { return NO; }
- (BOOL>windowChangedEvent { return NO; }
...
```

When a view wants to receive an event, it just overrides the inherited method with one that works as desired and then returns YES to signify that the event has been consumed. For example, StdSysView instances attach a standard system menu to the right mouse button like this:

```
= StdSysView ...
- (BOOL)rightButtonDown {
    static id menu = nil;
    if (menu == nil) { id tmp;
        menu = [MessageMenu str:"System Menu"];
        [menu add:[MessageMenu
            selector:@selector(exit)]];
        [menu add:[MessageMenu
```

```
selector:@selector(refresh)]];
[menu add:[MessageMenu
    selector:@selector(print)]];
[menu add:tmp = [MessageMenu str:"debug"
    selector:@selector(dbgToggle)]];
[tmp add:[MessageMenu str:"on"
    selector:@selector(dbgOn)]];
[tmp add:[MessageMenu str:"off"
    selector:@selector(dbgOff)]];
}
[menu applyTo:self at:event.origin];
return YES;
}
```

Notice that the single abstraction, views as layers of acetate, suffices to organize both directions of information transfer between the program and the user. This is a departure from the Model-View-Controller paradigm of Smalltalk-80 in which events are handled by a separate hierarchy of Controller classes.

INTERACTION

So far, we have shown how a programmer defines the components of an iconic application by defining specialized subclasses of the generic View class. When the application begins executing, instances of these classes are created and linked into a hierarchy that represents how they are arranged with respect to each other. Finally, control is passed to the event handler, at which time a position and a size are assigned to each view and they are displayed for the first time to the user. The initial frame of the animated movie has been projected onto the screen, and a data structure, the view hierarchy, has recorded where the parts of the image appear on the screen.

Very little new code is needed to get an application to this point because most has been provided by generic classes from the library. For example, the user interface for the Workbench application involved only three new classes (WbView, ObjView, and DependencyView) of two methods each, one to create a view of a specified model (createViewOf:) and another to draw a picture of the model on the screen (displayView). Now the harder part by far remains, giving life to the picture by making it respond to commands from the user. This is a huge topic that cannot be treated thoroughly here, other than to demonstrate some of the complexities and show how inheritance and encapsulation can control them by abstracting interaction scenarios into generic classes that can be reused in diverse applications. For example, in the Workbench application, the following scenario is used for selecting one or more objects for subsequent operations:

If the left button is pressed over one or more objects and released immediately, only the topmost object is selected. If it is held while the mouse is dragged, a box should outline a rectangular region. When the button is released, each of the objects inside the box should be selected. Selections are undone by selecting nothing, that is, by clicking the button over the empty background.

(continued)

The subject is the object.

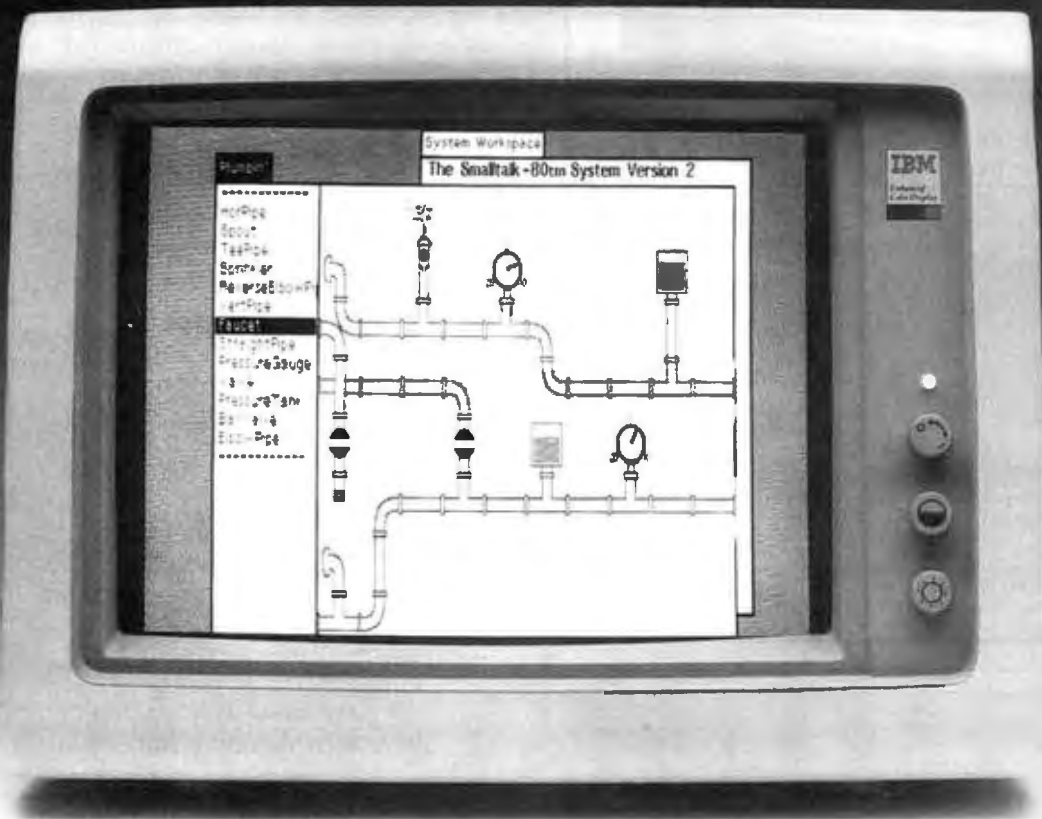

If we were to write a dissertation on the value of Smalltalk-80,[™] the subject would be the object. Because objects are central to Smalltalk's design. With objects, you can build natural and intelligent simulations. From plant management to spreadsheets. From marketing analysis to 3-D modeling.

The subject of Smalltalk would not be complete without mentioning Smalltalk AT from Softsmarts. Smalltalk AT is the full Xerox Smalltalk-80, Version 2 implementation. It's just like the multi-tasking version that runs on those expensive, dedicated computers. With one exception. Smalltalk AT runs on your inexpensive IBM AT personal computer.

So, it's our thesis that you should be using Smalltalk AT from Softsmarts in your next important project. Because not only will Smalltalk AT save you time and save you money, it will give you a more intelligent solution. And of course, that's the object. Smalltalk AT. \$995.



softsmarts, inc.

intelligent software

4 Skyline Road
Woodside, CA 94062
415-327-8100

OEM DESIGN/DEALERS WELCOME!! ALPHA CONCORD
99% Hayes compatible 300/1200 MODEM
 • Auto dial, auto answer (tone or pulse)
 • 8 status indicators & switch selectable
 • Auto speed selection (0-300, 1200 bps)
 • Speaker with volume control
 • Aluminum case, with adaptor **6 MONTH WARRANTY**
BEST ON THE MARKET **ONLY \$129**
FOR DEALERS OR GROUP USER ...\$85 each
 (Minimum purchase over 100 units)



Add 5% Shipping Charge

NEW !! 2400 MODEM
 300/1200
 2400 **MODEM \$229**

Replacement & 99% Compatible
AT COMPATIBLE MOTHERBOARD
\$360
 (Price do not include any INTEL IC)
XT MAINBOARD \$125



AT/XT KIT
AT \$279
XT \$169
 (Price include only case, power supply, & keyboard)



BUILD YOUR PORTABLE XT/AT AT/XT PORTABLE \$119
 (Price is for CASE only.) Add \$27 shipping, full size keyboard, 9" monitor, 130 watt power supply extra.)

CONCORD Technology Ltd.
 47 W. Broadway, Van., B.C. Canada V5Y 1P1
 Ph. (604) 879-3555 or 879-7419

FACTORY PRICES ON AT/XT or lite cases, cards, EGA CARD \$210

ICONS AND SOFTWARE-ICS

Items are automatically highlighted once they are selected, and the highlighting is removed when the selection is undone.

This scenario is implemented by a generic class from the library, Selection. When the left mouse button is pressed over the Workbench, WbView creates an instance of class Selection and passes control to it:

```
= WbView ...
- (BOOL)leftButtonDown {
    [Selection fromUserIn:self];
    return YES;
}
```

The Selection class implements the fromUserIn: method like this:

```
= Selection : View {
    id selectedArea; // Rectangle
    id selectedViews; // OrderedCollection(Views)
}
+ fromUserIn:aView {
    self = [self rect:aView];
    selectedArea = [Rectangle fromUser];
    selectedViews = [OrderedCollection new];
    [aView addSubViewsIn:selectedArea
    to:selectedViews];
    if ([selectedViews isEmpty]) {
        id singleView = [aView
            subViewAt:[selectedArea center]];
        [selectedViews add:singleView];
    }
    if ([selectedViews isEmpty])
        return [self free];
    [self adjustSelectedArea];
    [selectedViews eachElementPerform:
        @selector(emphasize)];
    [aView addSubView:self];
    return self;
}
```

Once a selection has been created, it must override the usual meanings of all mouse events, so it simply behaves like a large transparent sheet of acetate that covers all of its sibling views. Since it covers them, it will receive all events before they do, and it can override the usual event meanings with new ones. For example, whereas the left-ButtonDown event previously created the new selection, the selection immediately assigns it a new meaning:

```
= Selection ...
- (BOOL)leftButtonDown {
    if ([self eventOverASelectedView]) {
        PT old = event.origin;
        [superView erase:selectedViews
            in:selectedArea];
        [selectedViews eachElementPerform:
            @selector(motionStart)];
        while([currentSensor leftButtonDown]) {
            PT delta = ptMinus(event.origin, old);

```

(continued)

It's Time To

NEW SLIM DESIGN and a LIFETIME WARRANTY...
 Two great reasons to make the switch. Only 1/2" high, but still with the same high quality features you have come to expect from DATA SPEC Switch Boxes.

- Reinforced printed circuit boards
- Full shielding



Switch Boxes

- Durable metal construction
- Gold-plated contacts
- All pins switched

And now, backed by a lifetime warranty. Visit your local DATA SPEC dealer and see our full line of slim style data switch boxes and other computer accessories.

DATA SPEC
 A DIVISION OF ALLIANCE RESEARCH CORPORATION
 20120 Plummer Street • P.O. Box 4029 • Chatsworth, CA 91313 • (818) 993-1202
 In Japan: Call Data Spec Japan LTD., Tokyo, Japan, Tel. (03) 774-7741

THE ULTIMATE IN COMPUTER ACCESSORIES

Now it costs even less to look good.

The Cordata Desktop Printshop™ has always been the best value in PC-compatible laser printers.

With speed and flexibility that the others can't match. Type fonts on diskette, not expensive cartridges. Data transfer up to 30 times faster than Hewlett-Packard's LaserJet+. Features implemented in software, for easy update. And Epson™ emulation, so it runs with most MS-DOS programs.

But now the Desktop Printshop is an even better value:

A menu-driven forms design software program for rapid document creation, the industry-acclaimed Wordstar 2000™ word processing program, and 38 fonts on diskette are included with the Desktop Printshop, for the amazingly low price of \$2995.

So don't settle for just any laser printer. Demand the Desktop Printshop.

All it takes is a call to Cordata at: (800) 621-6746 (in CA: (805) 495-5800; in Canada: (604) 984-0641) for the name of your nearest Desktop Printshop dealer.

After all, how can you afford *not* to look your best?

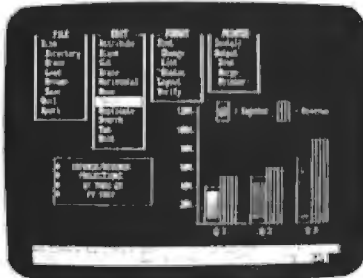

Not to mention
being easier.

The Desktop Printshop.™

CORDATA, 275 E. Hillcrest Drive, Thousand Oaks, CA 91360
TELEX 650-2698270; in Europe: Holland 032-16111

~~\$3395.00~~
\$2995.00



cordata

formerly **corona**
data systems, inc.

USER INTERFACE PERFORMANCE ISSUES

BY JOHN UEBBING AND CHARLES YOUNG

The human visual system has several characteristic limits that should be accounted for in building responsive iconic interfaces. For example, changes occurring in less than 20 milliseconds are perceived as instantaneous. If successive frames of a moving image are redrawn in less than 50 milliseconds, the object is perceived as moving smoothly. If feedback to user-initiated events is produced in less than 300 milliseconds, it is perceived as occurring instantaneously. These speeds represent significant qualitative thresholds past which objects move smoothly without flicker and do not interrupt the user's train of thought.

For example, Hewlett-Packard 9000-310 workstations are based on a 10-MHz Motorola 68010 chip that executes an Objective-C message in about 0.04 milliseconds. If a drawing of an animated mechanical robot consists of 100 lines, and if each line is implemented as an object and manipulated by messages, 4 of the available 20 milliseconds could be wasted just in message-passing overhead.

It would pay to avoid this overhead by implementing only the robot as an object, storing the lines as C data structures to be accessed by a high-performance polyline procedure.

On the other hand, dispatching a mouse event to one of 25 objects would spend only 1.0 of the available 300 milliseconds in messaging. Even a complex series of messages, redrawing 20 objects with 10 messages per object, would consume only 8.0 milliseconds in messaging. The lesson is to use messaging extensively for flexibility in things like menus and mouse event dispatching where messaging time is small relative to response times of the human visual system, and to avoid messaging in critical loops like displaying individual lines and characters. By judiciously combining messaging and high-performance C and assembly code, it is possible to build very flexible and powerful human interfaces with fully adequate speed using today's low-cost hardware. A general rule is to start out by using messaging, time the execution of the critical parts, and then substitute C, assembly code, or even special hardware to bring performance to the needed level.

John Uebbing and Charles Young, who have both worked extensively in electronic displays, are now involved with advanced user interface concepts. They can be contacted at Hewlett-Packard Research Laboratory, 1651 Page Mill Rd., Palo Alto, CA 94304.

```

if (delta != 0) {
    [selectedViews eachElementPerform:
        @selector(motionBy:)
        with:delta];
    [selectedArea moveBy:delta];
    old = event.origin;
}
[selectedViews eachElementPerform:
    @selector(motionEnd)];
return YES; // consume the event
}
[self free];
return NO; // not over selected view
}
    
```

The opening if statement tests whether the event occurred over one of the selected views, and if not, the selection is undone. Otherwise, the event signifies that the selected items should begin tracking the cursor so that the user can drag them to new screen positions.

Dragging is hardly as simple as it may seem, but the complications are handled in generic code that all views inherit from the View class. The objects to be moved must first be erased to produce a clean image of the stationary objects, and this is done by creating a clipping region around the views to be erased and redrawing the rest of the hierarchy inside this region (this is where the generality of the `displayExcept:` method pays off). Finally, movement is simulated by repeatedly drawing each view with exclusive-or raster operations to toggle the pixels beneath them on and off without losing information. This lets them

glide across the screen without damaging their background.

SUMMARY

The design and construction of pleasant user interfaces is a remarkably deep and complicated topic, and this article has only skimmed the surface. The user interface library contains many kinds of components that have not been mentioned like menus, choice boxes, verifiers, text editors, etc., but describing these could easily take as much space as the simpler components that have been presented. We have not discussed several technical challenges in the Workbench application, such as how dependency lines between views are redrawn while views are being moved such that the lines behave like rubber bands. And we have focused only on how to build iconic interfaces and said very little about how to make them genuinely pleasant to use. This is especially important given the proliferation of poorly designed but flashy systems that are seen so often today. For a discussion of performance issues, see the text box "User Interface Performance Issues" above.

Although direct code size comparisons between Workbench and the UNIX utility make should wait until Workbench is as mature and widely used as make is today, we find it highly encouraging that its iconic user interface could be built in only 262 lines of new code. This suggests that object-oriented programming, and its ability to capture large quantities of reusable code in generic Software-IC libraries, may actually reduce development costs to the point that iconic interfaces may become as prevalent as text-oriented interfaces are today. ■

NOBODY DELIVERS LIKE LOGICSOFT.



**FREE OVERNIGHT
DELIVERY**

**LOWEST PRICE
GUARANTEE**

**TOLL-FREE
CUSTOMER SERVICE**

Buy it today, use it tomorrow!

Only Logicsoft ships your order the same day via overnight courier.* Free.

Nobody beats Logicsoft prices.

In fact, if you find a lower price (advertised or a bonafide quote) on any of the hundreds of products we stock, we'll beat it by \$10.† Our Corporate Accounts Program offers attractive volume discounts. Credit cards and PO's accepted.

Outstanding customer service and technical support.

It's only a toll-free phone call away. Another reason why Logicsoft is a major hardware and software supplier to over 50,000 companies, including over 90% of the Fortune 1000.

See inside for the lowest prices on over 800 products for IBM-PC's and compatibles.

*Applies to order totaling over \$100. If under \$100, shipped UPS—FREE (Within Cont. U.S.). Due to weight restrictions, printers and monitors are also shipped UPS—FREE. †This offer does not apply to items under \$100, American Express or Terms orders. In these instances, we will meet any lower price. We reserve the right to request a current written price quote.

LOGICSOFT®

110 Bi-County Boulevard, Farmingdale, NY 11735

To order or receive technical assistance, call our National Hotline:

1-800-645-3491

NY STATE: 1-800-235-6442 (516) 249-8440
Customer Service: 1-800-431-9037 NYS: 516-249-8440
FAX #516-249-5289



No surcharge for MasterCard, VISA, American Express, C.O.D., money order, check or PO's (please call for price verification) • No sales tax on orders shipped outside N.Y. State • Please add 2% for insurance and handling (\$3.00 minimum) (int'l orders add 't) • We do not bill until we ship. All products covered by mfg's warranty. Defective merchandise may be returned for repair or exchange only. We do not guarantee compatibility. Any goods returned for credit are subject to a 15% restocking charge. All prices and policies subject to change without notice.

NOW LEASE OR PURCHASE SYSTEMS FROM LOGICSOFT.

THE ECONOMY AND FLEXIBILITY OF A LOGICLEASE.

High tech without high cost. Outstanding flexibility. Plus substantial tax benefits. Logicsoft's new leasing program gives you them all and much more. Lease the computer system you need now for 36 months (customized lease programs also available) at one of our low, low rates. At the end of the term, you can purchase the system for only 10% of the original purchase price. Or negotiate a lease extension. Give Logicsoft a call. **We'll process your lease application in 24 hours.** And deliver your system within three days. First and last lease payments required in advance. Lease proposals subject to credit approval. Rates based on current cost of funds.

FREE 90-DAY, ON-SITE SERVICE ON ALL SYSTEMS.

Whether you lease or purchase a system from Logicsoft, you get a unique bonus: *a free 90-day, on-site system hardware service contract.* We've contracted with one of the nation's largest and most respected independent computer maintenance firms to provide you free service in most metropolitan areas. If a problem arises, it will be corrected quickly and efficiently. *At your facility. And at no additional cost to you.* There's no inconvenience of transporting your system to and from a service center. Wherever you are. Whatever the problem. Expert assistance is only a phone call away.

LOGICSOFT®

To order or receive technical assistance, call our National Hotline:

1-800-645-3491

NY STATE: 1-800-235-6442 (516) 249-8440
Customer Service: 1-800-431-9037 NYS: 516-249-8440
FAX #516-249-5289

EUROPE: 020-83 48 64
Telex: 10759 Logic NL

Mail orders to:
LOGICSOFT EUROPE BV
pb 9460, 1006 AL Amsterdam, Holland

110 Bi-County Blvd., Dept. 543
Farmingdale, NY 11735
CANADA: 416-283-2354
Domestic/Int'l Telex
286905 SoftUR

Circle #400 on reader service card.



Leading Edge Model D

- 256K Memory • Two 360K Half/Height Floppy Drives • Four Expansion Slots • Keyboard • Text Display Card • High-Resolution Monochrome Monitor • One Parallel And Serial Port • Color option available

• Purchase Price: **\$1,375**

Lease For **\$59** per month

New IBM AT—30 Mb

- 8 MHz • 512K • 30 Mb Hard Drive (Full Height, w/controller) • 1.2 Mb Half/Height Floppy • Eight Expansion Slots • IBM Enhanced PC Keyboard • Serial/Parallel Adapter • Free 90-Day, On-Site Service Contract • Color or Monochrome Monitor Available as Option

• Purchase Price: **\$4,179**

Lease For **\$165** per month

New IBM XT—20 Mb

- 512K • 20 Mb Hard Drive • 360K Floppy Drive Half Height • Eight Expansion Slots • IBM Enhanced PC Keyboard • Asynchronous Communications Adapter • Free 90-Day, On-Site Service Contract • Color or Monochrome Monitor Available as Option

• Purchase Price: **\$2,369**

Lease For **\$99** per month



New Compaq Deskpro 286—30 Mb

- 512K RAM Memory • 80286 Based CPU • One 30Mb Hard Drive (w/controller) • One 1.2 Mb Half/Height Floppy Drive • Eight Expansion Slots • Compaq Keyboard • Graphics Card • One parallel port • Free 90 Day On-Site Service Contract • Color or Monochrome available as option

• Purchase Price: **\$3,859**

Lease For **\$152** per month

New Compaq Deskpro 20Mb

- 640K RAM Memory • One 20Mb Hard Drive (w/Controller) • One 360K Floppy Drive • Eight Expansion Slots • Compaq Keyboard • Graphics Card • One Parallel port • Asynchronous Communications/Clock Board • Free 90-Day, On-Site Service Contract • Color or Monochrome Monitor Available as option

• Purchase Price: **\$2,299**

Lease For **\$99** per month

New Compaq Portable II 20Mb

- 640K RAM Memory • 80286 Based CPU • One 20Mb Half/Height Hard Drive (w/controller) • One 360K one-third Height Floppy Drive • Two Expansion Slots • Compaq II Keyboard • Text/Graphics Display Card • 9" Text/Graphics Monochrome Monitor • One Serial and Parallel Port • Free 90-Day, On-Site Service Contract

• Purchase Price: **\$3,879**

Lease For **\$153** per month

New Compaq Portable 286—20Mb

- 640K RAM Memory • 80286 Based CPU • One 20Mb Hard Drive (w/controller) • One 1.2 Mb Half/Height Floppy Drive • Five Expansion Slots • Compaq Keyboard • Graphics Display Card • 9" Text/Graphics Monochrome Monitor • One Parallel Port • Free 90-Day, On-Site Service

• Purchase Price: **\$3,898**

Lease For **\$154** per month

AT&T 6300 Total Business System

- 640K RAM Memory • One 10 Mb Half/Height Hard Drive (w/Controller) • One 360K Floppy Drive • Seven Expansion Slots • AT&T Keyboard • High-Resolution Graphics Card • High-Resolution Monochrome Graphics Monitor • Serial & Parallel Ports • Toshiba P-351 Printer And Cable • Software Bundle (dBase III Plus, Lotus 1-2-3, Word Perfect, SideKick, G.W. Basic and MS-DOS) • Free 90-Day, On-Site Service Contract

• Purchase Price: **\$4,299**

Lease For **\$169** per month
color optional

100% Burn-In and Testing.

All systems undergo a 48-hour configuration, testing and burn-in period. We configure system boards, set DIP switches, format hard drives, perform memory diagnostics and check system with monitor.

AND A HUGE SELECTION OF PERIPHERALS.

PRINTERS*		12" Amber 300 A 135		Modular Graphics Card 249		MEMORY STORAGE	
CANON		12" Amber 310 A 149		Color/Mono 159		IOMEGA	
Bubble Jet BJ-80 \$459		NEC		QUADRAM		Bernoulli Box (10 + 10) . \$2329	
EPSON		JC—1401P 3A		EGA Plus Graphics 389		Bernoulli Box (20 Mb) . 2299	
LQ 800 579		Multi-sync color		SIGMA		Bernoulli Box (20 + 20) 3279	
LQ 1000 749		w/swivel base 569		EGA Board 375		HARD DISK DRIVES	
RX-100 385		IBM		Color 400 (Princeton) . . . 479		MOUNTAIN COMPUTER	
FX-85 399		Color Monitor 539		STB		Hard Drive Card (20 Mb) . \$975	
FX-286 589		Monochrome Monitor . 225		Chauffeur 255		Hard Drive Card (30 Mb)	
JUKI		Enhanced Color Display 679		Graphics Plus II 229		Low Price Call!	
6100 359		PRINCETONE GRAPHICS		EGA Plus 319		PRIAM CORP	
6300 709		RGB HX-12 419		TECMAR		60 Mb Internal Hard Drive	
NEC		RGB HX-12E 535		Graphics Master 439		1489	
8800 1045		RGB SR-12 569		COMMUNICATIONS		Innerspace ID 40Mb . . . 1299	
Pinwriter P-5 Series		RGB SR-12P 625		BOARDS		PLUS +	
Low Price Call!		Amber Max 12 165		AST		Hard Card 10 Mb 699	
Pinwriter P-6 449		QUADRAM		5251-11 \$645		TALLGRASS TECHNOLOGY	
Pinwriter P-7 635		Amberchrome 12" 145		DCA		Tc 5525i 25 Mb Int 799	
MANNESMAN TALLY		EGA Monitor w/swivel . . 549		IRMA Board 839		SEAGATE	
MT-86 489		TAXAN		MODEMS		10 Mb ½ Ht Int 465	
MT-85 399		121/122 145		AST		20 Mb ½ Ht Int 499	
OKIDATA		620 415		Reach 1200 Half Card . . \$345		20 Mb Full Ht (AT) 599	
182 Plug & Play 224		640 525		EVEREX		30 Mb Full Ht (AT) 789	
192 Plug & Play 349		MULTI-FUNCTION BOARDS		Evercom II 149		40 Mb Full Ht (AT) 899	
193 Plug & Play 545		AST RESEARCH		HAYES		60 Mb Full Ht (AT)	
2410 P Plug & Play . . . 1759		Six Pack Premium \$389		Smartmodem 300 145		Low Price Call!	
PANASONIC		Six Pack Plus (384K) . . . 239		Smartmodem 1200 389		CORE	
KX 1091 255		Rampage w/256K 289		Smartmodem 1200B		20 Mb Int (AT) 1299	
KX 1595 Low Price Call!		Rampage (AT) w/512K . . 459		w/Smartcom II 359		30 Mb Int (AT) 1399	
TOSHIBA		Advantage (128K) 369		Smartmodem 2400 599		40 Mb Int (AT) 1495	
P 321 489		I/O Mini Half Card 119		Smartmodem 2400B		72 Mb Int (AT) 2795	
P 341 795		I/O Plus II 125		w/Smartcom II 559		CARTRIDGE TAPE BACK-UP	
P 351 999		EVEREX		PROMETHEUS		EVEREX	
CITIZEN		Magic Card II w/384K . . . 199		Pro-modem 1200B		Excel Stream 20 Mb Int . \$639	
MSP 10 259		TECMAR		w/software 239		Excel Stream 60 Mb Int . 799	
MSP 15 349		Captain (384K) 219		QUADRAM		Excel Stream 60 Mb Ext 929	
MSP 20 309		QUADRAM		Quadmodem Series		IRWIN	
MSP 25 479		Quadboard (384K) 269		Low Price Call!		Irwin 110 10 Mb Int 499	
Premier 35 479		Silverboard 235		VEN-TEL		20 Mb Int 595	
LASER PRINTERS*		EMS		PC Modem 1200 Half		20 Mb 325 (AT) Ext. D . . 779	
CANON		w/256K 349		Card 365		SYSGEN	
Laser Printer \$1995		Liberty (AT) w/128K . . . 315		1200 Plus 339		Image Tape Backup	
HEWLETT PACKARD		INTEL		PC Modem 2400 Half		10 Mb Int 789	
Laser Printer 2569		Above Board (PC) 275		Card 499		Image Tape Backup	
Laser Printer Plus 3399		Above Board (AT) 435		MOUSE INPUT DEVICES		20 Mb Int 599	
OASYS		Above Board (PS) 64K . . 329		MOUSE SYSTEMS		Image Tape Backup	
Laser Pro Express 1699		Above Board (PS) AT		PC Mouse w/DR Halo 2 . \$135		20 Mb Ext 699	
PLOTTERS*		256K 429		MICROSOFT		TECMAR	
FACIT		8087 Math		Microsoft Mouse (Serial) 135		QIC 60 AT 1250	
4550 (6 Pen Plotter) . . . \$ 395		Co-Processor 129		Microsoft Mouse (Buss) 125		QIC 60 Ext Tape Backup 1599	
HEWLETT PACKARD		80287 Math		SURGE PROTECTORS		CORE	
7475A 1699		Co-Processor 209		KENSINGTON MICROWAVE		60 Mb Ext 1599	
HOUSTON INSTRUMENTS		GRAPHICS BOARDS		Masterpiece \$ 95		FLOPPY DISK DRIVES	
DMP 40 875		AST		Masterpiece Plus 119		Panasonic 360 K ½ Ht. . \$119	
DMP 41 2599		Preview \$249		CURTIS		Tandon TM-100 360 K	
DMP 42 2599		EVEREX		Diamond 39		F/Ht. 125	
DMP 51 3949		Graphics Edge 239		Emerald 45		Tandon TM-100 360 K	
DMP 52 3949		The Edge 239		Ruby 59		½ Ht. 105	
MONITORS*		HERCULES		KEYBOARDS		Toshiba 360 K ½ Ht. . . . 115	
AMDEK		Monochrome Graphics		KEYTRONIC		BACK UP POWER SUPPLIES	
Color 600 \$ 389		Card 299		5151 (Deluxe) 169		DATA SHIELD	
Color 722 509		Color Card 155		5153 (w/touch Pad) 289		200 Wt (PC) \$249	
Color 725 Low Price Call!		PARADISE SYSTEMS		3270 PC 245		300 Wt (XT) 359	
12" Green 300 G 125		Multi-Display Card 189		Keytronic Jr. 5151 169		500 Wt (AT) 569	
						800 Wt (AT) 655	

*Due to weight restrictions, Printers and Monitors are shipped UPS—free. All prices and policies subject to change without notice.

CAN'T FIND IT? ASK FOR OUR SPECIAL ORDER DEPT.

There's a good chance we do carry the product (we're adding new ones every day). Or, we can get it for you from one of our suppliers—still at our low direct-to-you prices.

LOGICSOFT ALSO OFFERS SOFTWARE FOR VIRTUALLY EVERY IBM PC APPLICATION...

WORD PROCESSING	
DISPLAY WRITE III	\$369
Easy Writer II	195
MICROSOFT WORD 3	269
Multimate	239
MULTIMATE	
ADVANTAGE	295
Office Writer	239
Pfs: Write	85
Samna III	279
VOLKSWRITER 3	145
WORD PERFECT	199
Wordstar	169
Wordstar Pro Pak	239
WORDSTAR 2000	249
Wordstar 2000 Plus	295
XY WRITE III	219
WORD PROCESSING ADD-ONS	
Fancy Font	\$145
Punctuation & Style	75
TURBO LIGHTNING	59
Word Finder	59
DATABASE MANAGEMENT	
Cornerstone	\$ 85
dBASE III PLUS	429
Knowledge Man 2	275
Paradox	495
Pfs: File	85
Pfs: Report	79
Powerbase	209
R:BASE 5000	329
Revelation	495

REFLEX	59
Think Tank	109
Q & A	215
DATA BASE MGMT. ADD-ONS	
Clipper (D Base)	\$359
Clout 2 (R:Base)	129
DB III Compiler (Wordtech)	459
Ext. Report Writer (R:Base)	99
Quickcode III (D Base)	149
Quickreport (D Base)	149
SPREADSHEETS/ INTEGRATED	
Ability	\$ 65
Enable	339
FRAMEWORK II	419
Javelin	459
LOTUS 1-2-3	315
Multiplan	119
Supercalc III	195
SYMPHONY	439
SPREADSHEET ADD-ONS	
LOTUS REPORT WRITER	
WRITER	\$109
Cambridge Spreadsheet Analyst	75
Sideways	45
Spreadsheet Auditor	99

Quickcode for 1-2-3	85
GRAPHICS	
CHARTMASTER	\$209
Diagram Master	189
Energraphics (NEW)	295
Gem Draw	159
Graph Writer	219
Harvard Presentation	249
Map Master	229
MICROSOFT CHART	179
Pfs: Graph	85
Sign Master	149
CAD/CAM	
Auto CAD ... Low Price Call!	
Pro Design II	229
PLOTTERS AVAIL.	
See hardware listings	
LANGUAGES	
C COMPILER (MS)	\$239
Cobol Compiler (MS)	429
Fortran Compiler (MS)	219
Lattice C Compiler	259
MACRO ASSEMBLER (MS)	
(MS)	95
Pascal Compiler (MS)	185
Quick Basic (MS)	69
True Basic	119
TURBO PASCAL	45

PROJECT MANAGEMENT	
Harvard Total	\$279
Microsoft Project	229
SUPER PROJECT PLUS	259
Timeline	239
FINANCIAL	
MANAGING YOUR MONEY	
MONEY	\$109
Dollars N' Sense	109
ACCOUNTING	
BPI Entry	from \$319
COMPUTER ASSOCIATES (Formerly IUS)	from 319
SPECIAL!	
<i>Buy Any (3) CA Accounting Modules & get Easy Plus FREE!</i>	
Great Plains	from 449
Open Systems	from 319
State of the Art Mas.	from 579
TCS Client Write Up	895
Real World	from 529
MISC/UTILITIES	
COPY II PC	\$ 35
Crosstalk XVI	99
FAST BACK	99
Microsoft Windows	65
NORTON UTILITIES	55
Prokey 4.0	79
Remote	99
Resident	75
SIDEKICK	49
Superkey	45

OVER 200 OTHER SOFTWARE TITLES IN STOCK AT LOW DISCOUNT PRICES.

#1 Rated productivity software.



dBase III Plus \$429

Add-Ons for dBase III Plus

Clipper

dBase III compiler. **\$359**

Quickcode III

Quickcode III reduces programming time by over 70%. **\$149**

Quickreport

The most powerful report writer for dBase III. **\$149**

dWINDOW III

Generate windows; any number, size, character, and color. **\$75**



LOTUS 1-2-3 \$315

Add-Ons for LOTUS 1-2-3

Sideways

Sideways lets you create extra wide printouts of reports without staples, glue or tape. **\$45**

Spreadsheet Auditor

The most powerful error trapping program available. (Includes side print utility.) **\$109**

LOTUS 1-2-3 Report Writer

Now you can format your own reports, forms and mailings from 1-2-3 files. **\$109**



Word Perfect \$199

Add-Ons for Word Perfect

Turbo Lighting

Random House Thesaurus & Spell-checker. **\$59**

Punctuation & Style

Helps improve the quality of your writing. **\$75**

Fancy Font

Lets you use multiple fonts to enhance the appearance of your letters & reports. **\$145**

INTRODUCING LOGICWARE. FULLY COMPATIBLE COMPUTER PRODUCTS.

**5-Year Unconditional Warranty • Made in U.S.A.
Immediate Replacement or Repair Policy • Low Power Consumption**

Now Logicsoft gives you a logical choice.

We're manufacturing a complete line of computer products called LogicWare. They're fully compatible with major manufacturers.

The boards pictured here are part of a vast array of ultra-reliable computer products.

We save you money—not by using inexpensive labor or parts—but through state-of-the-art technology, which reduces part requirements and increases reliability. Each product has a 5-year unconditional warranty plus our immediate replace or repair policy.

LogicWare. It's the logical way to get high quality without paying high prices.



AST Compatible AT Multifunction Board w/128K—\$219

- Expandable to 2 Megabytes on Board • Install Either 64K or 256K Chips to Customize the Memory to your Existing Memory Configuration • Software RAM Disk • Printer Spooler/Buffer • One Parallel Port • Two Serial Ports • Game Port

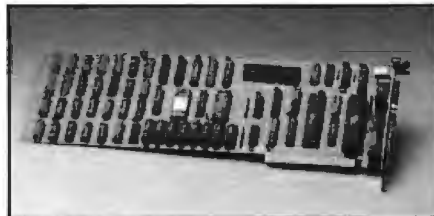

Hercules Compatible Monochrome Graphics Board—\$119

- 720 × 348 Pixel Graphics • Parallel Printer Port • Lotus 1-2-3 Compatible • TTL Monochrome Output • ATD Software Supplied For Direct Emulation of Hercules Graphics Card • Low Power Consumption

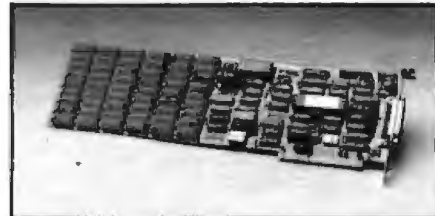

AST Compatible Six Function Card w/384K—\$159

- One Parallel Port • One Serial Port • Clock Calendar • 384K RAM Memory • Low Power Consumption • Software • Printer/Spooler Buffer



AST Compatible 576K RAM Board Half Card with 64K—\$69

- Expandable to 576K • Supports 64K or 256K Memory Chips • Fits in Short Slot • Low Power Consumption • Clock Calendar Option loaded w/384K \$135 loaded w/576K \$149

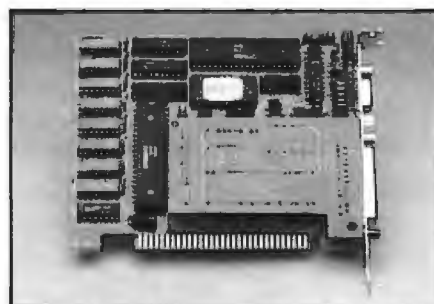

Hercules Compatible Color Graphics Board—\$99

- 320 × 200 Color Pixels • 640 × 200 Monograph Pixels • Parallel Printer Port • Low Power Consumption • Fits in Short Slot • Will Drive a Medium Resolution Color & Composite Monochrome Monitor

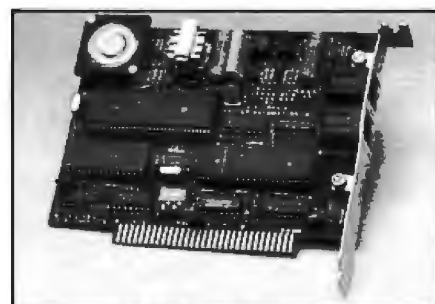

Hayes 1200 B Compatible Half Card Modem w/Software—\$149

- 300/1200 Baud • Bell 103/212A Compatible • Auto Dial/Auto Answer • Pulse or Touch Tone Dialing • Full or Half Duplex Operation • Fits in Short Slot • Low Power Consumption

Hayes 2400B Compatible Half Card Modem w/Software—\$299

LOGICSOFT®

To order or receive technical assistance, call our National Hotline:

1-800-645-3491

NY STATE: 1-800-235-8442 (516) 249-8440
Customer Service: 1-800-431-9037 NYS: 516-249-8440
FAX #516-249-5289

EUROPE: 020-83 48 64
Telex: 10759 Logic NL

Mail orders to:
LOGICSOFT EUROPE BV
pb 9460, 1006 AL Amsterdam, Holland

110 Bi-County Blvd., Dept. 543
Farmingdale, NY 11735
CANADA: 416-283-2354
Domestic/Int'l Telex
286905 SoftUR

No surcharge for MasterCard, VISA, American Express, C.O.D., money order, check or PO's (please call for price verification) • No sales tax on orders shipped outside N.Y. State • Please add 2% for insurance and handling (\$3.00 minimum) (int'l orders add) • We do not bill until we ship. All products covered by mfg's warranty. Defective merchandise may be returned for repair or exchange. We do not guarantee compatibility. Any goods returned for credit are subject to a 15% restocking charge. All prices and policies subject to change without notice.

Circle #400 on reader service card.

OBJECT-ORIENTED LANGUAGES FOR THE MACINTOSH

BY KURT J. SCHMUCKER

An overview of the languages and their capabilities

CURRENTLY, A LARGE NUMBER of object-oriented languages are available, and more are being designed and implemented every year. Some of these languages now on the market or in development are for the Apple Macintosh, an ideal computer for object-oriented languages because of its processing power and the nature of its user interface. In this article I will survey some of the Macintosh object-oriented languages. I will also present a table detailing each language's object-oriented characteristics, such as whether it can access the MacApp class library (see my article "MacApp: An Application Framework" on page 189) or whether it provides for class methods. After describing the languages, I will discuss the mechanics of programming with them on the Mac.

SMALLTALK

The Smalltalk language is the ancestor of all object-oriented languages. It was implemented on the Macintosh by Apple as part of an experiment to demonstrate Smalltalk's portability and debug the Smalltalk specification. Apple currently distributes Smalltalk for the Mac as an unsupported, low-cost product, but a fully supported and greatly enhanced version is expected soon. A fact sheet on Smalltalk and the other languages I describe in this article is presented in table 1.

Smalltalk has a message-sending syntax that often seems unusual to the novice object-oriented programmer, but it quickly becomes the natural way of doing things. Smalltalk syntax and the syntaxes of all the languages I discuss herein are shown in table 2.

New classes and methods are defined by editing standard templates in an interactive source-code browser. The class library for the Macintosh version of Smalltalk contains over 300 classes with special classes for accessing the Macintosh file system, the Macintosh Toolbox (including the QuickDraw routines), and the AppleTalk network added by Apple. Since Smalltalk has been described in previous BYTE articles and elsewhere, I will not elaborate on its language features.

OBJECT PASCAL

Object Pascal is Apple's second object-oriented extension of Pascal. (The first, Clascal, was only for the Lisa Office System and thus is no longer supported by Apple.) The syntax for Object Pascal was jointly designed by Apple's Clascal team and Niklaus Wirth, the designer of Pascal, who was invited to Apple's Cupertino headquarters specifically for this project. In addition to implementing Object Pascal on the Mac, Apple has put the Object Pascal specification in the public domain and encouraged others to implement compilers and interpreters for it. Several such developments are under way.

Object Pascal implements classes as an extension of

(continued)

Kurt J. Schmucker, director of educational services for Productivity Products International (Severna Park Mall, H & R Block Office, 575 Richie Highway, Severna Park, MD 21146), teaches seminars on object-oriented programming. Kurt has written three books on computer science, including the forthcoming *Object-oriented Programming for the Macintosh* (Hayden, 1986).

MAC LANGUAGES

Pascal's RECORD structure. In Pascal, records have only data as their component fields, but in Object Pascal, object types (as classes are called in Object Pascal) have data fields (instance variables) and method fields. Messages are sent using the same syntactic construct used in ordinary

Pascal for field qualification—the period.

Thus, in Object Pascal, accessing an instance variable and accessing a method (that is, sending a message) are accomplished with the same syntax.

New classes are defined using one new compiler key-

Table 1: Summary of object-oriented languages.

		Smalltalk-80	Object Pascal	Neon	ExperCommonLISP	Objective-C	Object Assembler	Object Logo
General	Developer	Apple Computer	Apple Computer	Kriya Systems	Exper-Telligence	Productivity Products	Apple Computer	Coral Software
	Base language	None	Pascal	FORTH	LISP	C	68000 assembler	Logo & CommonLisp
	Current version	0.2	1.0	1.5	2.0	3.1	1.0	1.0
	Toolbox access	Yes, but difficult	Yes	Yes	Yes	Yes	Yes	Yes
	Supports 128K ROM	No	Yes	Yes	Yes	Yes	Yes	Yes
Object-oriented Information	Instance variables and instance methods	Yes	Yes	Yes	Yes	Yes	Yes	Yes
	Class variables	Yes	No	No	Yes	Yes, but cannot be inherited	No	Yes
	Class methods	Yes	No	No	Yes	Yes	No	Yes
	Multiple inheritance	No	No	No	No	No	No	Yes
	Unique instance methods	No	No	No	No	No	No	Yes
	Number of classes in class library	Approx. 300	Approx. 30	Approx. 40	Approx. 45 in ExperCaste	Approx. 25	Approx. 30	Approx. 30
	MacApp access	Yes	Yes	Planned	Planned	Planned	Yes	Planned
Summary	Greatest strength	compatible with other Smalltalks	simplicity of design	speed	object-oriented features; library size	portability to other machines	speed	uniform treatment of objects
	Greatest weakness	speed	limited object-oriented concepts (no class methods)	"unusual" syntax of FORTH	LISP still an "unusual" language	not a native compiler	limited object-oriented concepts (no class methods)	longer learning time for experienced object-oriented programmers
	Other	requires 1000K of RAM for serious work	supported by Apple Computer	numerous user groups, bimonthly newsletter	(note: not shipping at press time)	—	(note: not shipping at press time)	(note: not shipping at press time)

word, OBJECT. The basic schema is

```
TYPE
  ClassName = OBJECT (SuperclassName)
  < instance variable declarations >
  < method header definitions >
END;
```

where < > denote optional portions of this schema. Methods are defined as ordinary Pascal procedures or functions that have been qualified with the name of the class:

```
PROCEDURE ClassName.ProcedureName(argumentList);
BEGIN
.
.
.
END;
```

Object Pascal is a "bare bones" object-oriented language. It makes no provision for class methods, class variables, multiple inheritance, or metaclasses. These concepts were specifically excluded in an attempt to streamline the learning curve encountered by most novice object-oriented programmers.

The Object Pascal class library is MacApp.

NEON

The language Neon is, depending on your programming-language point of view, either an object-oriented extension to the FORTH language or an incisive and efficient implementation of Smalltalk as a threaded interpreted language. Regardless of which view you take, Neon is a remarkably concise language that nicely bridges the gap between the object-oriented languages (à la Smalltalk) and the threaded languages (à la FORTH). Neon was developed by Kriya Systems expressly for the Mac and was first shipped in 1984.

The basic Neon syntax shows its strong FORTH heritage: From the point of view of most of the other languages discussed in this article, Neon's syntax is backward. (To be fair, many programmers consider the Smalltalk syntax, which has the object precede the message, to be backward compared to the procedure call used in most languages, so perhaps Neon, with the message preceding the object, is one of the few object-oriented languages to get it right!)

New classes and methods are defined using special Neon compiler words that delimit class definitions (:CLASS and ;CLASS) and method definitions (:M and ;M). The basic schemas are

```
:CLASS ClassName <Super SuperClassName < n Indexed>
  <instance variable names >
  < method definitions >
;CLASS
and
:M Selector: < { named arguments \ local variables — results } >
  < method body >
;M
```

where < > denote optional portions of these schemas. One of the most useful features of Neon is the provi-

sion for both named arguments and local variables in methods. Named arguments let you associate a name with the arguments placed on the stack prior to the invocation of the method and then simply refer to these arguments by name when you need them in the body of the method. Local variables let you declare and use temporary variables in the method body. Both features simplify the use of Neon compared to the complex stack manipulations often required in FORTH.

Neon allows you to choose between the efficiency of static binding and the flexibility of dynamic binding (called *early binding* and *late binding* in the Neon manual) on a message-by-message basis. Early binding will resolve at compile time a message sent to a given object into an invocation of a particular method in a particular class; late binding will leave this resolution until run time. The compile-time determination is made based on the declared classes for the reference variables. (Thus, Neon is like Object Pascal, which allows a reference variable to be declared of a certain class, and unlike Smalltalk, in which all object references are equal.) The Neon line `Get: myInt` will send the `Get: message` to the object referred to by `myInt`, with the resolution of that message determined at compile time by the declared class of `myInt`. The line `Get: [myInt]` will send the `Get: message` to the object referred to by `myInt`, with the resolution of that message determined at run time by the run-time class of `myInt`. Late binding can be used with any construct that generates an object reference, such as `Get: [i at: myArray]` to send the message `Get: to the object referred to by the ith element of the array object myArray`, with the resolution of that message determined at run time by the run-time class of the object stored at that element in the array.

The basic approach of the current Neon class library—unlike that of MacApp, which provides a completely functional application framework—is to "lift" the Toolbox data types to the level of classes. Accordingly, Neon has classes like `Point`, `Window`, `Dialog`, and `Event`, which provide a more functional set of building blocks than do the basic Toolbox data types and procedures for the Pascal or C

(continued)

Table 2: A comparison of the syntax of each language. The message, `msg`, with argument, `arg`, is sent to the object referenced by `obj`.

Syntax	Language
<code>obj msg: arg.</code>	Smalltalk
<code>obj.msg(arg);</code>	Object Pascal
<code>arg msg: obj</code>	Neon
<code>(obj 'msg <arg >)</code>	ExperCommonLISP
<code>[obj msg: arg];</code>	Objective-C
<code>MOVE.W arg(A6)-(SP)</code>	Object Assembler
<code>MOVE.L obj(A6)-(SP)</code>	
<code>MethCall msg</code>	
<code>tell :obj [msg "arg]</code>	Object Logo

- ☑ COMPATIBILITY
- ☑ AFFORDABILITY
- ☑ RELIABILITY
- ☑ EXPANDABILITY

IBM XT/AT COMPATIBLE COMPUTERS BY
☑ AFTON COMPUTER INC.

QUANTUM 286 TURBO

**Made
In The
USA**



- IBM AT COMPATIBLE
- PHOENIX BIOS
- 8-10 MHZ SWITCHABLE CLOCK SPEED
- 512K UP TO 1 MB RAM ON BOARD
- 2 SERIAL PORTS 1 PARALLEL PORT ON BOARD
- 20 MB HARD DISK
- 1.2 MB FLOPPY
- 8 EXPANSION SLOTS
- AT KEYBOARD
- 200 WATT POWER SUPPLY
- ONE YEAR WARRANTY

All For Only \$1995⁰⁰

QUANTUM XT TURBO (Made in the USA)

- PHOENIX BIOS
- 4.77-8MHZ SWITCHABLE CLOCK SPEED
- 640K ON BOARD
- SERIAL, PARALLEL AND CLOCK
- AT STYLE KEYBOARD
- 360K FLOPPY
- 135 WATT POWER SUPPLY
- ONE YEAR WARRANTY

All For Only \$745⁰⁰

Quantum XT 4.77 MHz... Call For Pricing

AFTON COMPUTER INC.
(714) 863-6951

24825 Calle El Toro Grande
 El Toro, California 92630
 Customer Service (714) 553-1701
 Telex 756731

Prices and Configurations Subject To Change.

programmer, but not quite the type of building blocks that the MacApp classes provide for the Object Pascal programmer.

EXPERCOMMONLISP

The language ExperCommonLISP is one of the most comprehensive object-oriented languages for the Macintosh in that it implements all of the features of object-oriented languages (except unique instance methods), provides a set of classes that mirror the Toolbox data types, and, with the next release, will provide MacApp access. ExperCommonLISP was developed by Experelligence expressly for the Mac. It was derived from the ExperLISP product available for the Mac since early 1985.

ExperCommonLISP syntax shows its strong LISP heritage: Message sending, setting object reference variables, accessing instance variables, and other object-oriented programming language features are accomplished with list functions.

(setq Triangle (send Object 'subclass)) defines a new subclass of Object, named Triangle, by sending the message subclass to the Object class. (setq tri1 (send Triangle 'New)) instantiates a new instance of the Triangle class and stores a reference to this new instance in the variable tri1. (send tri1 'height) sends the message height to the object referenced by tri1.

Actually, the definition of a new class in ExperCommonLISP can be much more detailed than this simple example shows. The full class-definition schema includes provisions for instance and class variables and instance and class methods.

Note: LISP users will observe that this schema uses terms like arg__lists rather than the traditional lambda-list style common to LISP. The lists are written here in a nonrigorous, informal notation. This is to make this explanation of ExperCommonLISP more understandable to those who do not have a reading knowledge of LISP.

```
(setq NewClass(CLASS (superclass, superclass,...superclass,)
  (IVS (iv_)(iv_)...(iv_))
  (Methods (method_(arg__list)(body))
           (method_(arg__list)(body))
           .
           .
           (method_(arg__list)(body)))
  (CVS (iv_)(iv_)...(iv_))
  (Metamethods(method_(arg__list)(body))
              (method_(arg__list)(body))
              .
              .
              (method_(arg__list)(body))))
```

where

- IVS is a keyword for the instance-variable-definition clause. Each portion of that clause names an instance variable and provides its initial value and attributes.
- Methods is a keyword for the method-definition clause. Each portion of that clause defines a message, its argument list, and the method that will be invoked when that

(continued)

With all these SoftLogic Solutions, you could run out of problems.

Now there's a whole family of low-cost, easy to use Softlogic software for the IBM PC, XT, AT, and compatibles. They'll save you time, aggravation, and lots of money. Got a problem? Check out these Softlogic Solutions.



Software Carousel™—The easy way to move from one program to another.

What a hassle. Saving, exiting, loading, retrieving—just to move from one application to another. With Software Carousel, you can keep up to ten programs loaded and ready to run. Best of all, you can use all your memory in each and every one. Supports AboveBoard™ and RAMpage™, too.

Disk Optimizer™—Speeds up your disk by cleaning up your files.

You may not notice, but your hard drive is getting slower. Because your files keep getting fragmented and scattered on your disk. Reading, writing, everything takes longer, because your disk is working harder. Disk Optimizer puts back the speed by putting your files back in one piece—where they belong.



Cubit™—Packs more of your data onto less disk space.

Filling up your hard disk again? Don't run out and get a bigger drive. Get Cubit, and get up to twice the storage capacity from the drive you already have. Cubit compresses and decompresses word processor, spreadsheet, database, all kinds of files—quickly, safely, invisibly.

DoubleDOS™—The multitasking software that takes less of everything.

You can spend more money, load more memory, and read more manuals with systems like TopView™ or Windows™. Or you can get DoubleDOS, the amazingly simple concurrent software environment that lets you and your computer each work on different tasks at once. Nothing could be easier. And nothing costs you less.

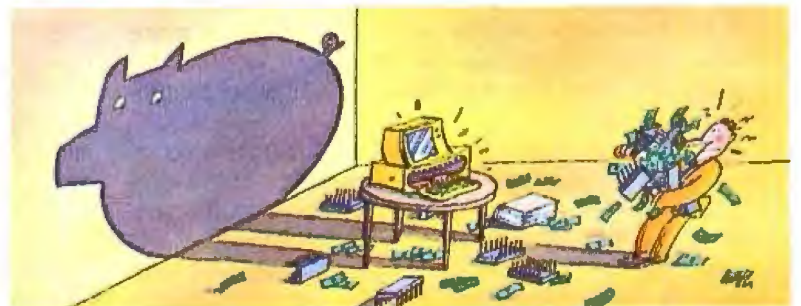

Put your problems behind you. Order these SoftLogic Solutions today.

\$49⁹⁵*
Each

*Plus \$5.00 shipping & handling.

So why put up with problems? Especially when you can get dependable SoftLogic Solutions for just \$49.95* each. Ask for SoftLogic products at your computer dealer. Or order directly from SoftLogic Solutions by calling 800-272-9900 (603-627-9900 in New Hampshire).

Order today:
800-272-9900

SoftLogic Solutions, Inc.
530 Chestnut Street
Manchester, NH 03101
800-272-9900 (603-627-9900 in NH)

SOFTLOGIC
SOLUTIONS

*Perhaps the greatest
strength of Objective-C is
that it is available on a
large number of machines.*

message is received by an instance of this class.

- **CVS** is a keyword for the class-variable-definition clause. Like the instance-variable-definition clause, each portion of the CVS clause names an class variable and provides its initial value and attributes.
- **Metamethods** is a keyword for the class-method-definition clause. Each portion of that clause defines a class message, its argument list, and the class method that will be invoked when that message is received by the class object.

Even this detailed schema does not present a full picture of the facilities in ExperCommonLISP. As one example of a capability in ExperCommonLISP that is not exhibited by this schema and is not present in any of the other object-oriented languages discussed in this article, consider the more detailed format of the following instance-variable-definition clause: (IVS (instance-variable₁-definition) (instance-variable₂-definition)...(instance-variable_n-definition)) where an instance-variable definition has the form (< instance-variable-name> < default-value-form >< set >< get >).

The keywords `get` and `set` specify whether the instance variable can be accessed from outside the object. If the keyword `get` is used, the variable can be read from outside; if the keyword `set` is used, the variable can be written. Thus, the degree of encapsulation can be set on a class-by-class basis, and within a class on an instance-variable-by-instance-variable basis. This is a much more flexible middle ground between the unrestricted access provided by Object Pascal and the total lack of access provided by Smalltalk.

The ExperCommonLISP class library includes a set of classes that "lift up" the Toolbox data types to the level of objects as well as the MacApp classes. As with Smalltalk, Neon, and Object Logo, this MacApp access is achieved by a reimplementing of the MacApp class functionality by `Expertelligence`.

OBJECTIVE-C

Objective-C brings the basic notions of object-oriented programming to the C language in a manner that is machine-independent. This is accomplished by a compiler that accepts Objective-C source code and outputs an equivalent C source code. The resulting C source code can then be compiled for execution on the target machine. This has resulted in a language that can (and does) exist on both the IBM PC and the VAX-11/780 and on many machines in between. Objective-C was developed by

Productivity Products International (PPI) and first shipped in 1983.

The Objective-C language is a strict superset of the C language. The object-oriented extensions are achieved by adding a new expression type to the C language, the message expression. Syntactically, this message expression is delimited by brackets (see table 2). The message expression brackets can be distinguished from the standard-array subscripting brackets used in ordinary C by context. The internal message syntax is similar to that of Smalltalk; it even follows Smalltalk's syntax for keyword messages. This new expression type exists on an equal level with all C expressions. The result is that an Objective-C statement message expression can be used anywhere that an expression can be used in C. A sample statement that shows the resulting flexibility is: [Point x: foo() + 7 y: [box top]]. In this statement, the keyword message `x:y` is being sent to the Point class. The first argument (of the `x:` portion) is the result of a function call and an addition (`foo() + 7`). The second argument (of the `y:` portion) is the result of sending the message `top` to the object referred to by `box`.

New classes are defined in a special class-description file of the following form:

```
= ClassName: SuperClassName (PhylaList) { Instance Variable Declarations }
+ ClassMethodName {Method Implementation}
- InstanceMethodName {Method Implementation}
=;
```

Only one class may be defined in any such file, although the number of class-method definitions and instance-method definitions may vary.

One object-oriented programming concept that is unique to Objective-C is *phyla*. Phyla in Objective-C are groups of classes, just as phyla in biology are higher-order organizations than the biological notion of a class. When you indicate that a new class belongs to a particular phylum, you are stating that this class will often be used together with the other classes in that phylum. When the Objective-C source code is compiled, this information is used to generate a more efficient method table structure.

The Objective-C class library consists of some 25 classes that implement collection classes, basic geometric notions, and standard data structures—all in a machine-independent way. The fact that the Objective-C language is available on a large number of machines and that its class library is machine-independent is perhaps its greatest strength. Productivity Products International coined the term "software-IC" to describe such a machine-independent class, although the term is now used to describe any well-designed class. (The concept of a software-IC has been described in "Software-ICs" by Lamar Ledbetter and Brad Cox, June 1985 BYTE.)

OBJECT ASSEMBLER

Object Assembler is a set of macros for the Motorola 68000 assembly language that provides easy access to the MacApp class library and to class-definition facilities. It is built on top of the macro assembly language provided

(continued)



USE THE BRAINS YOUR IBM WASN'T BORN WITH.

Right at your fingertips in CompuServe's IBM® Forums.

In the **IBM New Users Forum** you'll swap ideas with other new PC users, learn to use Forum features, and pose even basic questions to PC experts.

Our **IBM Junior Forum** gives PCjr® users a reliable source for tips on software, hardware, telecommunications, games and other interests.

In the **IBM Software Forum** you'll trade tips with other IBM PC and AT users on utility software, word processing, DOS and other operating systems.

Visit the **IBM Communications Forum** for advice on the features and compatibility of communications software and hardware, PC Bulletin Boards, micro-mainframe interfaces and more.

The **IBM Hardware Forum** addresses hardware topics of all types, plus product updates and announcements.

Easy access to free software.

- Download first-rate, non-commercial, user-supported software and utility programs.
- Take advantage of CompuServe's inexpensive weeknight and weekend rates (when Forums are most active, and standard online charges are just 10¢ a minute).
- Go online in most major metropolitan areas with a local phone call.
- And receive a **\$25.00 Introductory Usage Credit** with purchase of your CompuServe Subscription Kit.

Information you simply can't find anywhere else.

Use the **Forum Message Board** to send and receive electronic messages, and pose specific questions to other IBM and compatible owners.

Join ongoing, real-time discussions in a **Forum Conference**.

Search our unparalleled **Forum Data Libraries** for free software, user tips, transcripts of online conferences and more.

Enjoy other useful services like:

- **Popular Computer Magazines**—electronic

editions, for your reading pleasure. Including *Dr. Dobbs' Journal* and *Computer Language*.

- **Other CompuServe Forums**—supporting LOTUS® products like *Symphony™* and *1-2-3™*, Borland International®, Ashton-Tate®, Digital Research®, MicroPro®, Microsoft® and other software. Also Pascal, Basic, C, Fort, Assembly and other programming languages.

All you need is your IBM or IBM-compatible computer and a modem ... or almost any other computer.

To buy your Subscription Kit, see your nearest computer dealer. Suggested retail price is \$39.95. To receive our free brochure, or to order direct, call 800-848-8199 (in Ohio, call 614-457-0802). If you're already a CompuServe subscriber, type GO IBMNET (the IBM Users Network) at any ! prompt to see what you've been missing.

CompuServe®

Information Services, P.O. Box 20212
5000 Arlington Centre Blvd., Columbus, Ohio 43220

800-848-8199

In Ohio, Call 614-457-0802

An H&R Block Company

Inquiry 65

by the Macintosh Programmer's Workshop assembler. Object Assembler was developed by Apple expressly for the Macintosh and it will be officially shipped late in 1986.

The Object Assembler macros let you define new classes, define method bodies, instantiate objects, easily reference instance variables by name, and invoke methods, including inherited ones. A few examples will demonstrate the use of these Object Assembler macros. The basic schema for defining a new class in Object Assembler, for example, is

```
MACRO
ObjectDef &TypeName,&Heritage,&FieldList,&MethodList
```

and an example of the use of this macro is:

```
ObjectDef Shape,Object, //
((boundRect,8), //
(borderThickness,2), //
(color,2)), //
((Draw), //
(MoveBy), //
(Stretch)) //
ObjectDef Arc,Shape, //
((startAngle,2), //
(arcAngle,2)), //
((Draw,OVERRIDE), //
(GetArea), //
(SetArcAngle)) //
```

(The backslash is required by the assembler when continuing a statement from one line to the next.)

Let me demonstrate defining a method and referencing an instance variable by name with some examples.

Defining a method:

Schema

```
MACRO
&ProcName ProcMethOf &TypeName
MACRO
EndMethod
```

Example

```
Draw ProcMethOf Arc
< code >
EndMethod
```

Accessing an instance variable:

Schema

```
MACRO
ObjectWith &TypeName
MACRO
EndObjectWith
```

Example:

```
ObjectWith Arc
MOVE.L startAngle(A1), -(SP)
PEA boundRect(A1)
EndObjectWith
```

In this example of accessing an instance variable, A1 must already be loaded with an arc object reference. The ObjectWith macro simply qualifies startAngle and boundRect for you. Note that the ProcMethOf (and the corresponding FuncMethOf) macros automatically invoke the

ObjectWith macro with the given class, making references to the instance variables of that class easy.

In terms of its object-oriented semantics, Object Assembler is just like Object Pascal. MacApp access is provided, as is access to any class implemented in Object Pascal. It also is possible to subclass Object Assembler classes in Object Pascal. No easy access is possible to classes implemented in other languages.

OBJECT LOGO

Object Logo is the most unusual object-oriented language for the Macintosh because it is implemented as a classless language—an object-oriented language in which there is no firm distinction between an instance object and a factory object (a class) that makes those instances. Object Logo was developed by Coral Software Corporation expressly for the Mac, and it is scheduled to be shipped in the summer of 1986.

In designing a language that has no distinction between classes and instances, Coral Software's programmers left out a concept that is commonly used in the implementation of object-oriented languages. Classes, after all, are really an implementation convenience—a way of economizing on the amounts of memory required to write object-oriented programs. From Coral's point of view, the conceptual issues in using an object-oriented language are more important than implementation efficiency concerns. By removing the class "artifact," Coral has designed a language in which all objects are treated uniformly, which it believes is easier to learn than traditional object-oriented languages.

There are a number of technical consequences of this philosophical decision to remove distinctions between classes and objects. In Object Logo, objects can be given instance variables and methods "on the fly" during an interactive session. You could, for example, create an object, give it two instance variables, then define a couple of methods, use those methods, clone the object (i.e. copy all relevant object information), *add some instance variables, remove some methods*, and then clone the object. In terms of the vocabulary I have developed up to this point, you have created an instance (from no template), redefined the structure of an instance while it existed, added new methods while it existed, and then used it as a factory to produce a new instance just like itself—all notions that don't make sense with the traditional object-oriented vocabulary. The problem isn't with the vocabulary. The problem is that many of the notions of object-oriented programming that we have spent so long acquiring just don't apply to Object Logo as well as they do to other languages. Consequently, Object Logo is somewhat harder to learn than the other object-oriented languages described in this article, if you are already familiar with other object-oriented languages. Object Logo requires that you unlearn some concepts about object-oriented programming and learn some new ones that don't fit in with your conceptual model of how objects, classes, messages, and methods interrelate. For example, Object Logo is the only language described in this article that provides for unique

instance methods—methods not associated with a data structure shared among objects with a similar format, but rather methods directly “attached” to objects. In Object Logo, such a concept is natural; in the other languages discussed here, it is most unusual.

Because conceptual simplicity was one of the major goals in the design of Object Logo, Object Logo adds only a few new primitives to the Logo language.

KINDOF anObject creates a new object which inherits from anObject. TALKTO anObject makes anObject the “current object.” (At any time during the execution of an Object Logo interactive session, there is exactly one current object. All references to variables and procedures are resolved in the context of this current object.) HAVE word thing adds the instance variable word to the current object. The initial value of word, in the context of the current object, is thing. HOWTO procedureName adds the method procedureName to the current object. USUAL invokes the inherited method. (This is essentially equivalent to the Object Pascal INHERITED and to sending messages to super in Smalltalk.) And TELL anObject InstructionList executes a list of instructions in the context of anObject without making anObject.

Object Logo is one of the few languages in this article that implements multiple inheritance. In Object Logo, a subclass can invoke all methods for a message common to its immediate ancestors. This style differs considerably from that of Smalltalk. (For legal reasons, the version of Smalltalk for the Mac does not have multiple inheritance. This is the only major technical difference with other Smalltalk implementations.)

At the time of this writing, no comprehensive listing of the Object Logo class library was available. However, the plans for Object Logo class library include a complete reimplementation of the MacApp classes using their Logo primitives for accessing the Toolbox. Like Neon and ExperCommonLISP, this reimplementation will produce a semantically similar set of classes so that the MacApp programmer could move from Object Pascal or Neon to Object Logo with very little additional training about the MacApp class library.

PROGRAMMING WITH A MAC OBJECT-ORIENTED LANGUAGE

Object-oriented languages for the Macintosh can be divided into two sets—those that have interactive interpreters and those that don't. The languages with interactive interpreters—Smalltalk, Neon, ExperCommonLISP, and Object Logo—have self-contained development environments consisting of a text editor, an interpreter, a compiler (sometimes), and other application building tools. These development environments are generally in accordance with the Macintosh User Interface Standard. New classes are developed interactively with reasonably functional debugging facilities. When debugged, the new classes are loaded into a working image that then can be saved in a snapshot. Many such snapshots can be saved on disk, each representing a different development effort, a different project, and so on. Classes are used as incre-

mental building blocks: As soon as a new class is defined, it is available for use. The results of developments in different images can be combined in a single image, usually by recompiling the source code versions of the new classes and methods. None of these languages can use procedures written in standard languages like Pascal or C, or classes written in other object-oriented languages, with the exception of ExperCommonLISP, which can access Pascal and C procedures.

In the languages that do not currently have interactive interpreters on the Macintosh—Object Pascal, Object Assembler, and Objective-C—classes are developed first (using a standard text editor) and compiled with the appropriate compilers. Then a main program using these classes is written, compiled, and linked with the classes. All of these languages can access procedures and functions written in either Pascal, C, or assembly language.

Most of these languages, whether compiled or interpreted, contain all the facilities to construct a stand-alone Macintosh application. For example, they have special routines to construct menus and to link the choice of a particular menu item with the execution of a certain method. Each of these object-oriented languages has its particular strengths and weaknesses as an implementation language depending on your application and background. ■

Expansion Chassis / Sub-System

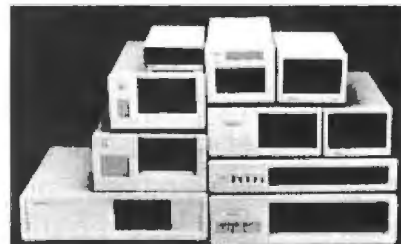

Specification

Model No.	No. of Slot	Space for 1/2 Height Drive	Power Supply (Watts)	Dimension D x W x H (cm)	Price
M-1*	0	1	50	30 x 15 x 6.5	\$149
M-2	3	3	100	42 x 25 x 16	\$299
M-3	5	3	100	39 x 30 x 15	\$239
M-4	12	2	100	40 x 39 x 14	\$299
M-5	0	2	45	39 x 18 x 15	\$149
M-6	0	1	50	26.5 x 18 x 13.5	\$169
M-7	5	2	100	38.5 x 30 x 13.5	\$299
M-8	0	2	45	39.5 x 18 x 13.5	\$149
M-9	0	2	60	38.5 x 49 x 9	\$249
M-10	8	4	135	43 x 49 x 14	\$259

*Extra space for a stand alone controller

EXT and RCV Adapters (Interface Computers & Chassis) ... \$159

ORDER TOLL FREE: (800) 826-0267

In California Call (415) 651-3355

DEALER INQUIRIES INVITED

SOURCE ELECTRONICS CORP.

45277 Fremont Blvd., Unit 6

Fremont, CA 94538

Telex: 279366

Fax: (415) 791-0935

OFFICE AUTOMATION

Tech PC, we're out to capture your micro-computer business. No one matches our diverse line of high performance products, or our comprehensive system of support, warranty, and third party maintenance service options. Tech PC is a large Southern California computer design and manufacturing firm with computer research and design specialists, production engineers, technical assistance staff, qualified sales personnel, and a strong management and investment team to provide you with state of the art products, state of the art reliability, and state of the art economy.

PORTABLES

Tech PC Portable Computers come in four different base models to match your computing needs. Our entry level **Tech PC/XT** portable computer is designed to provide a non-obstructive profile, and has a capacity to hold two thirty megabyte hard disks, a high resolution monochrome monitor with a Hercules compatible graphics card to drive it with 800 by 400 lines resolution, and never before heard of 6 expansion slots in a portable computer. If 4.77 MHz of Intel 8088 power isn't fast enough, try our **Turbo 4.77 to 8 MHz 8088-2** or optional **NEC V-2** microprocessor based portable machine. Designed to increase speed up to 170 percent of a standard PC/XT, the **Tech PC/AT** and **Tech Turbo PC/AT** portable units are state of the art in portable performance. The 80286 microprocessor based units can be fitted with up to 240 megabytes of high speed voice coil hard disk technology, and with the Turbo AT's 10 MHz math co-processor socket and 10 MHz

80286 microprocessor the unit can manipulate large spreadsheets with unparalleled performance.

DESKTOPS

Tech PC Desktop Computers are designed for survival. The **XT's** leave your desktop looking comfortably empty with their slim non-obtrusive profile; The **AT's** give you a powerful presence with a clean lined sturdy chassis. Combined with a 14 inch, 800 by 400 line amber monochrome monitor or a 14 inch, 1280 by 800 black and white monochrome monitor you've got **State of the Art** staring straight back at you. If 8 MHz 80286 power isn't fast enough for you... try the **Tech Turbo PC/AT** with its 10MHz 80286 and 10 MHz 80287 math co-processor socket. The **Tech Turbo PC/AT** gives you the **strongest, most powerful 80286** performance available from anyone, anywhere... available with up to 16 megabytes of memory and hard disks up to 1 gigabyte with our new optical storage disk, the **Tech Personal**

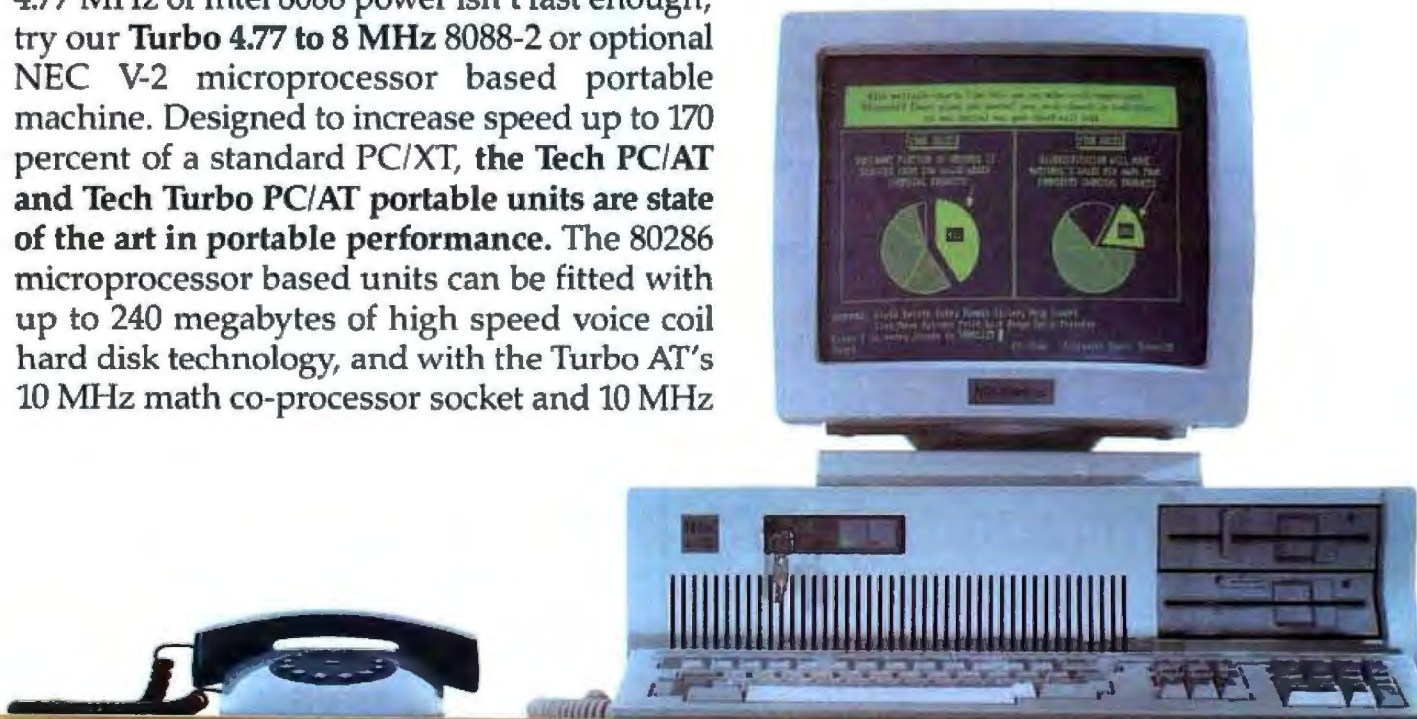

Computer Desktops represent the cutting edge of desktop microcomputer technology.

Tech Personal Computers, Inc. is a full service manufacturer of Micro Computer Products and offers a complete line of Desktop, Portables and Multi-User Computer Systems as well as an accessory line of over one hundred enhancement products. **Tech Personal Computers, Inc.** are all backed by a full one year warranty with additional maintenance coverage and extended maintenance contracts available through Momentum Service Corp. For more information concerning hundreds of MSC Service Centers throughout the United States, contact **Tech Personal Computers, Inc.** at (714) 754-1170.



OFFICE ON LOCATION

DESKTOPS

- TECH PC/XT DESKTOP\$ 529
- Options:*
- Tech PC/XT with 20MB Hard Disk\$ 979
- Tech PC/XT with 20MB Hard Disk, Monochrome Monitor, Hercules® Compatible Mono/Graphics Card\$1179
- TECH TURBO PC/XT DESKTOP\$ 629
- Options:*
- Tech Turbo PC/XT Desktop with 20MB Hard Disk\$1079
- Tech Turbo PC/XT 20MB Hard Disk, Monochrome Monitor, Hercules® Compatible Mono/Graphics Card\$1279
- TECH PC/AT DESKTOP\$1399
- Options:*
- Tech PC/AT with 20MB Hard Disk\$1799
- Tech PC/AT with 20MB Hard Disk, Monochrome Monitor, Hercules® Compatible Mono/Graphics Card\$1999
- TECH TURBO PC/AT DESKTOP\$1599
- Options:*
- Tech Turbo PC/AT Desktop with 20MB Hard Disk\$1999
- Tech Turbo PC/AT with 20MB Hard Disk, Monochrome Monitor, Hercules® Compatible Mono/Graphics Card ..\$2199

PORTABLES

- TECH PC/XT PORTABLE\$ 899
- Options:*
- Tech Turbo PC/XT Portable with 20 MB Hard Disk ...\$1349
- Tech Turbo PC/XT Portable with 1200 Baud Internal Hayes Compatible Modem and 20 MB Hard Disk\$1549

- TECH TURBO PC/XT PORTABLE\$ 999
- Options:*
- Tech Turbo PC/XT Portable with 20 MB Hard Disk ...\$1449
- Tech Turbo PC/XT Portable with 1200 Baud Internal Hayes Compatible Modem and 20 MB Hard Disk\$1649
- TECH PC/AT PORTABLE\$1799
- Options:*
- Tech PC/XT Portable with 20 MB Hard Disk\$2199
- Tech PC/XT Portable with 1200 Baud Internal Hayes Compatible Modem and 20 MB Hard Disk\$2399
- TECH TURBO PC/AT PORTABLE\$1999
- Options:*
- Tech PC/XT Portable with 20 MB Hard Disk\$2399
- Tech PC/XT Portable with 1200 Baud Internal Hayes Compatible Modem and 20 MB Hard Disk\$2599

All TECH PC PORTABLES available with tape backups, hard disks up to 1 gigabyte, networking systems, and hundreds of other hardware and software accessories.

TECH PC

714/754-1170

2131 South Hathaway, Santa Ana, California 92705
 Telex 272006 Answer Back - TECH FAX: 71415568325

Microprocessor Development Dreams Come True!

On-Line Help menus,
Command Glossary,
and Word List.

Windows can be used
to view source files,
previous traces,
and more.

Symbol translation
or source code
line display.

Screen displays scroll off
into history buffer –
can be viewed later.

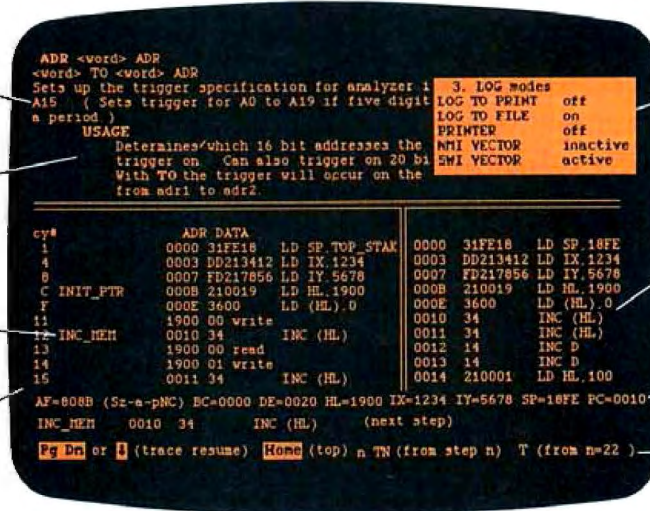

Pop-up Mode
Selection panel
called by soft key.

Disassembly of code
in memory can be
compared with trace in
adjacent window.

Symbolic debug
register display.

Context sensitive
prompt line.

NEW UniLab II™: FOUR INSTRUMENTS IN ONE!

Here are all the development tools you ever dreamed of integrated into one PC-controlled system:

- An Advanced 48-Channel Bus State Analyzer
- An 8/16-Bit Universal Emulator
- A Built-In EPROM Programmer
- An Input Stimulus Generator

The synergy of these instruments that were designed together to work together saves you time and money. All UniLab II commands and menus are seamlessly integrated into a single, super-efficient working environment.

An Integrated Software Environment, too!

Imagine being able to split your screen and look at real-time program traces and the source code that produced them at the same time! Then go to the On-Line Help or pop-up Mode Panels instantly.

If you see something on a trace that doesn't look like last time, you can hold it in one window while you scroll back through your previous displays.

If you set a breakpoint and single-step you can then go back to using the analyzer without missing a beat. You can even execute a DOS batch file from UniLab to edit, assemble, and link, then automatically load the new program and symbol table. UniLab uses the full power of the PC.

Find bugs fast with Hardware-assisted Debugging

The traditional way to look for bugs is to single-step through suspect parts of the code until you catch it in the act. This requires a lot of guessing and wasted time.

With UniLab's built-in analyzer you eliminate the guesswork. Just describe the bug symptom as a trigger, and let the UniLab hardware search

for it as your program runs in real time. UniLab will show you a trace of the program steps leading up to the symptom, almost like magic.

A friendly user interface

UniLab lets you use commands or menus – or a mixture of both. An on-line manual, soft-key help screens, a glossary of commands and their parameters, with full-screen writeups are also at the ready.

Reconfigure for any 8 or 16-bit processor in seconds

Thanks to our unique approach to emulation, changes between processor types require only cable and diskette changes. At last count, we specifically support over 120 micro-processors.

Bonus! The built-in EPROM Programmer and Stimulus Generator are simply icing on the cake.

Affordable capability

How much does all this superior capability cost? A lot less than our less able competitors, and probably a lot less than you expect. Our products are sold with a Money Back Guarantee, and our crack team of Applications Engineers is standing by if you need help. Get the full story on the amazing UniLab II and how it can liberate your development projects, today.

ACTION COUPON

Send me info on UniLab II and your No-Risk 10-Day Evaluation!

Name: _____ Title: _____

Company: _____

Address: _____

City: _____

State/ZIP: _____

Tel.: _____ Ext. _____

UniLab II™

Universal Development Laboratory



Orion Instruments, Inc.

ORION

702 Marshall Street
Redwood City, California 94063

CALL TOLL FREE: 1-800-245-8500

In California (415) 361-8883

MACAPP: AN APPLICATION FRAMEWORK

BY KURT J. SCHMUCKER

*This application can significantly reduce
Macintosh program development time*

ONE FASCINATING and potentially far-reaching use of object-oriented programming is in the design of an application framework for a personal computer or workstation. Several examples of such frameworks exist, such as the Lisa Toolkit, discussed in "Software Frameworks" by Gregg Williams (December 1984 BYTE), and more are being designed all the time. This article examines one specific application framework for the Macintosh, MacApp—The Expandable Macintosh Application from Apple.

The average end user does not generally use or even know about application frameworks. They are tools for developers who design the software for end users. In theory, an application framework can be developed for any personal computer. However, they are especially useful on those with a well-defined user-interface specification.

WHAT IS MACAPP?

The MacApp framework is basically a complete, self-contained application that implements most of the Macintosh user-interface standard. It has

menus that pull down and windows that scroll and can be moved about the screen, it works correctly with desk accessories and with Switcher, and it prints on the Imagewriter and the LaserWriter. The only things missing from a complete application are the contents of the windows and the items on the menus. An application framework is only the shell of a real application—a shell that you can easily customize into a true application. This customization process differentiates an application framework from a set of merely useful subroutines.

For example, let's examine the way in which an application framework supports undoing commands. MacApp knows that after you choose a menu command, the Undo command should reverse the effect of the command. But a general application framework can't know how to undo, or do, all the commands. These operations are accomplished with the dynamic binding present in an object-oriented language. The application framework "knows" about command objects and it knows that when a command is to be performed or undone,

it should send the message *Dolt* or *Undolt* to the current command object. The application framework defines the basic skeleton of the application, but it leaves the specifics—for example, the actual details of undoing the Double Space command—to the command object. To build a specific application from this framework, you need to design only the objects that perform these specific actions and then install them into the framework.

The framework knows in general what a Macintosh application is supposed to do. It knows how to make the menus work, how to give up control when a desk accessory is activated, how to scroll windows, and so on—all the things that are common to

(continued)

Kurt J. Schmucker, director of educational services for Productivity Products International (Severna Park Mall, H & R Block Office, 575 Richie Highway, Severna Park, MD 21146), teaches seminars on object-oriented programming. Kurt has written three books on computer science, including the forthcoming *Object-oriented Programming for the Macintosh* (Hayden, 1986).

Macintosh applications. The framework knows that the most recent command should be undone when you choose the Undo menu item and that the current selection should be highlighted when you activate a window. However, it doesn't know how to reverse the actions of particular commands or how to highlight the current selection. The *objects* you install in your customization of the application framework determine these actions. For example, to undo the last command, the application framework sends the message `UndoIt` to the current command object. The dynamic binding of this `UndoIt` message to a method at run time invokes the routine you have designed to handle undoing this particular command. The application framework proceeds without knowing what that command, or that selection, really is.

The application framework is more than just a skeleton with a fixed number of pluggable slots for commands and selection. Using the techniques of object-oriented programming, you can override every major decision (and many minor ones). Any application on this framework can take control at any decision point in the program by overriding the preprogrammed method to perform a user-written application-specific method.

To give it this flexibility, the application framework is set up as a group of classes, or class library, that you can use and specialize while developing a new application. If you want your application to behave in some unique, specific way, you can add some new objects into the framework to provide this behavior. If you don't want anything unusual, the applica-

tion framework will handle the application correctly as is.

THE BASIC STRUCTURE OF MACAPP

The class library that is MacApp contains more than 30 different classes and over 450 methods. (Figure 1 shows the inheritance structure of these classes.) However, if you understand the operation of just three of these classes—`TApplication`, `TDocument`, and `TView`—and seven of their methods, you will be able to build your own application on top of the MacApp framework. The class `TApplication` takes care of things that are the responsibility of the application as a whole. This includes launching the application, setting up the menu bar, deciding which documents to display in the "Open Which Document?"

(continued)

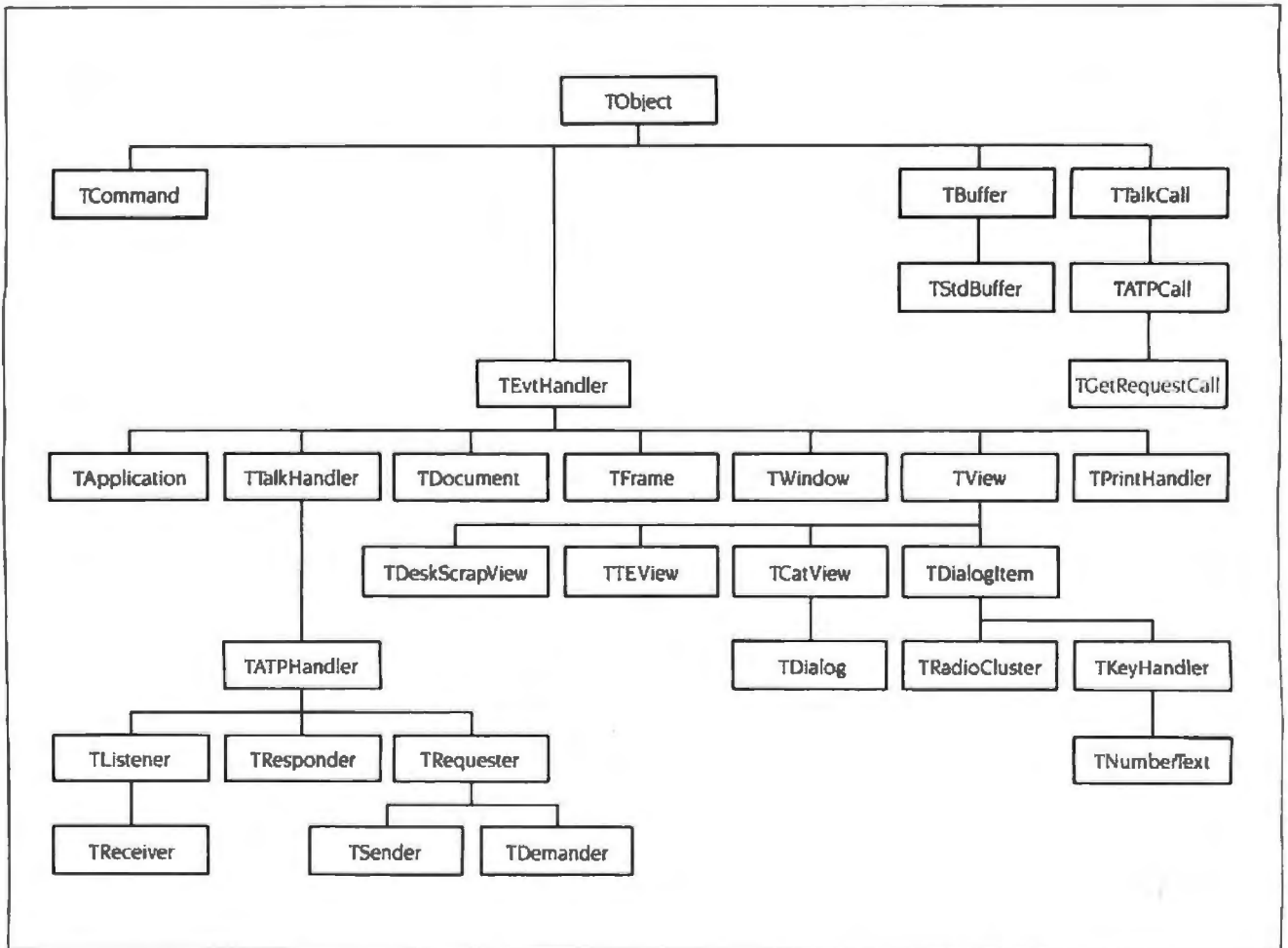

Figure 1: The inheritance tree of the MacApp classes.

AVOCET INTRODUCES MACRO ASSEMBLERS.



Put your design ideas into more chips.

New AVMAC™ Macro cross-assemblers, combined with our simulators, emulators and EPROM programmers, turn your PC or VAX into a complete development system.

AVMAC is fast. Its transparent buffering scheme provides the speed of memory-based assembly without restricting file size. And, AVMAC has one of the most comprehensive macro facilities available.

AVMAC is loaded with features that make your development job easier. You get source code flexibility; AVMAC supports over 1000 relocatable segments. AVLINK™ linker and AVLIB™ librarian support modular programming with full control over segment combination and placement. AVREF™ generates cross-references by line and procedure. And, AVMAC gives you informative, plain English error messages.

AVMAC offers superior compatibility with manufacturers' assembly languages. And it's designed to work hand-in-hand with AVSIM™, Avocet's software simulator/debugger.

Every company talks about service. But at Avocet we're committed to satisfying customer requests for in-stock items in 2-3 working days. And that's a fact!

For easy access, call our 800 number for ordering, product information and technical assistance. We're also interested in your ideas on how we can better serve your needs.

AVMAC Macro Cross-assemblers
MSDOS™, PCDOS™\$349
VAX™/UNIX™\$995

Target Microprocessor Families Supported:

6804	6502/65C02	Z8
6805	6800/01, 6301	Z80
6809	NEC 7500	68H11
1802/1805	8085	HD64180
8048/8041	COP400	68020
8051	F8/3870	68000/68010
NEW!	TMS32010	TMS32020

In addition to AVMAC, Avocet provides everything you need to develop micro-processor software.

AVSIM full-screen Simulator/Debuggers make software simulation practical. Test your code in a crashproof, interactive environment, without additional hardware. Price \$299.

TRICE™ self-powered In-circuit Emulators recognize 34 different commands;

set break points, single-step, trace and more. Priced from \$498.

AVPROM™ Programmers work with any PC. Program over 37 different devices, including EPROMs through 27512, CMOS and E²PROMS, and MPU/EPROM combos, using fast, "adaptive" algorithms. From \$429. Gang programmers from \$979.

To find out more about Avocet software development tools, call us toll-free:

1-800-448-8500

(In the U.S. except Alaska.)

VISA and Mastercard accepted. Most popular disk formats now available—please specify. Software shipment by second-day air within the continental U.S. included. Special handling and other shipping additional; call for exact quotes. OEM INQUIRIES INVITED. Avocet Systems Inc., P.O. Box 490-B16, Rockport, Maine 04856, (207) 236-9055. Telex: 467210 AVOCET CI.

AVOCET 
SYSTEMS INC.®

™ signifies manufacturer's trademark

dialog box, and so on. You design your own special subclass of TApplication, overriding whatever methods you choose in order to specialize any of these behaviors. One behavior you must always override is the type of document that holds your application's data (the method DoMakeDocument).

The class TDocument processes commands like Save and Close, which are specific to each of the documents that are open at any one

instant. (MacApp applications can usually deal with multiple documents being open at once.) Two behaviors that you must override in your subclasses of TDocument are the types of windows that display the data stored in the document (the method DoMakeWindows) and the contents of the windows (the method DoMakeViews). (The DoMake-something MacApp methods are the ones you must override.)

The class TView takes care of every-

thing inside your windows—drawing the images, highlighting the selection, handling mouse interaction with those images, and other things. TView knows when a portion of the window needs to be redrawn and when the selection should be highlighted. It doesn't know exactly how to do these things. It relies on you to override the methods that supply these behaviors in your subclasses of TView. These methods are Draw, HighlightSelection, and DoMouseDownCommand.

DEVELOPING AN APPLICATION

To develop a MacApp application, you must design your own subclasses of TApplication, TDocument, and TView. It is traditional in MacApp programming to name these new subclasses so that you can easily determine their respective superclasses. Therefore, I have used the names TSmallApplication (a subclass of TApplication), TSmallDocument (a subclass of TDocument), and TSmallView (a subclass of TView). The application is called SmallApplication, and its entire source code requires only 87 lines of Object Pascal. (For a discussion of Object Pascal and other object-oriented languages, see my article "Object-oriented Languages for the Macintosh" on page 177.) Two printouts of screen shots from SmallApplication are shown in figures 2 and 3. [Editor's note: The entire source listing for SmallApplication is available in a variety of formats. See page 405 for details.] Let's look at two representative methods from this application—the DoMakeViews method of the class TSmallDocument and the Draw method of TSmallView.

DoMakeViews is one of the methods MacApp needs to access one of the classes designed specifically for SmallApplication. I call this kind of method a MacApp hook method. Listing 1 contains the full text of SmallApplication's DoMakeViews method. This method generates, initializes, and installs one instance of TSmallView. MacApp sends the message DoMakeViews precisely so it can obtain one of these and use it to draw inside the window. If this method seems rather short, that is a common characteristic of object-oriented programs, especially those

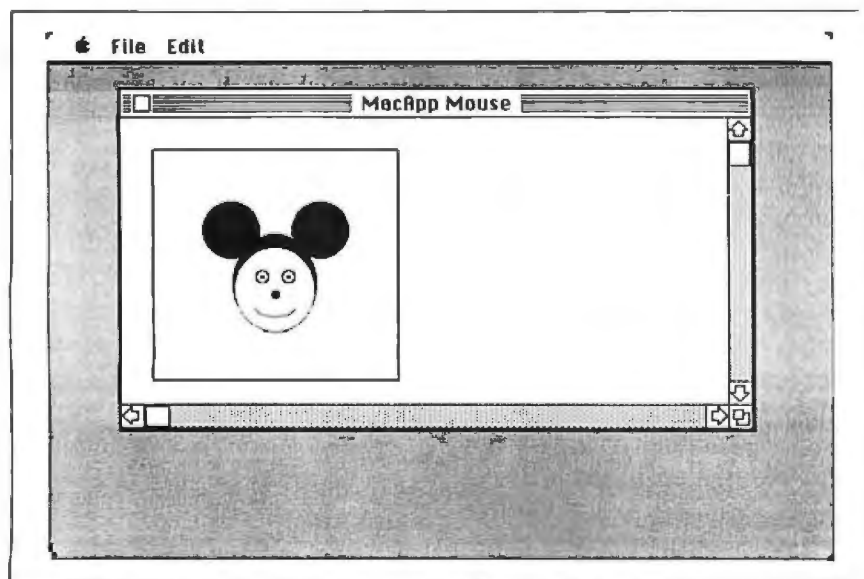

Figure 2: SmallApplication—the smallest MacApp application.

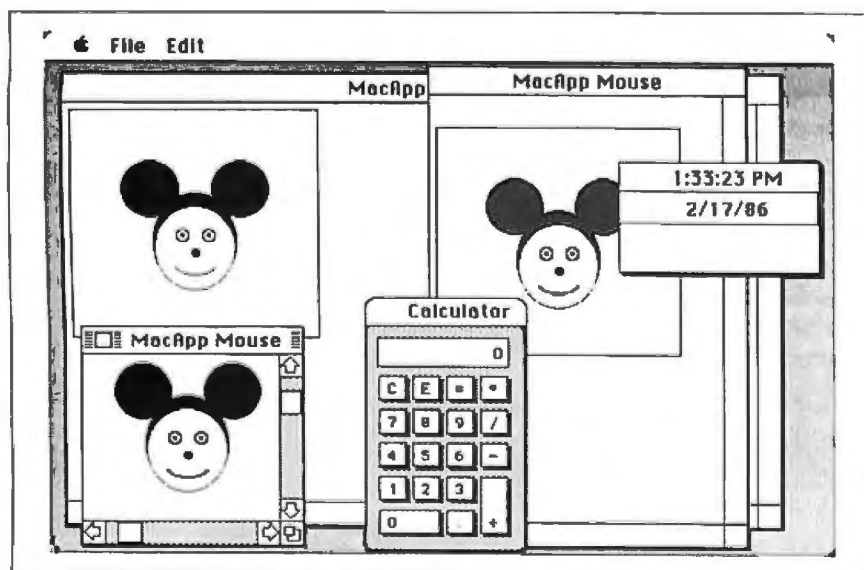

Figure 3: MacApp applications typically work with multiple documents and always work correctly with desk accessories, even multiple ones.

Listing 1: *The full text of DoMakeViews.*

```

PROCEDURE TSmallDocument.DoMakeViews(forPrinting: BOOLEAN); OVERRIDE;
VAR smallView: TSmallView;
BEGIN
  NEW(smallView);           { Create a new instance of TSmallView }
  smallView.ISmallView(SELF); { Send new view object its init message }
  SELF.fSmallView := smallView; { Install this view object in document }
END;
```

Listing 2: *A procedure that overrides TSmallView's Draw method to draw a picture of a mouse.*

```

PROCEDURE TSmallView.Draw(area: Rect); OVERRIDE;

  FUNCTION MakeRect(top, left, bottom, right: INTEGER): Rect;
  VAR r: Rect;
  BEGIN
    SetRect(r, left, top, right, bottom);
    MakeRect := r;
  END;

BEGIN
  PenNormal;
  PaintOval(MakeRect(74, 72, 139, 127));      { Outline of the mouse head }
  EraseOval(MakeRect(84, 74, 138, 125));     { Outline of the mouse face }
  FrameOval(MakeRect(109, 84, 129, 115));     { Mouse mouth (part 1 of 2) }
  EraseRect(MakeRect(109, 84, 123, 115));     { Mouse mouth (part 2 of 2) }
  FrameOval(MakeRect(98, 87, 107, 96));       { Left eye }
  FrameOval(MakeRect(98, 104, 107, 113));     { Right eye }
  PaintOval(MakeRect(101, 90, 104, 93));      { Left pupil }
  PaintOval(MakeRect(101, 107, 104, 110));    { Right pupil }
  PaintOval(MakeRect(111, 97, 117, 103));     { Nose }
  PaintOval(MakeRect(53, 52, 91, 90));        { Left ear }
  PaintOval(MakeRect(53, 110, 91, 148));      { Right ear }

  FrameRect(MakeRect(20, 20, 170, 180));      { A bounding rectangle }

END;
```

designed to be overridden for many different purposes. Instead of hard coding many decisions, the designer of a class will make each such decision a method. You can change such a decision by creating subclasses and overriding the appropriate method.

The Draw method of the TSmallView class is a method for which MacApp cannot possibly provide a generic version. You can't draw anything in a window that would be useful to all Macintosh applications. In such cases, MacApp provides a stub method that does nothing, a null method. You don't have to override a null method like you do a hook method, but if you don't override this one, part of your application may appear to do nothing. The code in listing 2 overrides TSmallView's Draw method to draw a picture of a mouse.

If you continue this process for five

other methods, you will have developed SmallApplication, an application that draws a picture of a mouse. SmallApplication is a stand-alone Mac application that works correctly on 128K-byte and 512K-byte Macs, the new Mac Plus, and the Mac XL. It works with Switcher and with any number of desk accessories, prints on the Imagewriter and the LaserWriter, supports multiple documents, and allows you to resize and move windows and use menus. As trivial as the application itself may seem, it does illustrate the flexibility of the MacApp framework.

THE BENEFITS AND COSTS OF USING MACAPP

Early studies indicate that MacApp can reduce application development time by a factor of four or five. MacApp also decreases the amount of source code you need, again by a

factor of four or five. It maintains consistency with respect to the Macintosh user-interface standard and provides error handling and an interactive debugging facility, which are useful during development. It provides a conceptual framework that lets you concentrate on your application rather than on Macintosh internals.

Some feel that these gains are at the expense of performance in the finished application and of a large amount of additional memory. In fact, many MacApp programs actually run faster than their non-MacApp versions, despite the run-time overhead of messaging. MacApp applications are usually somewhat larger than their non-MacApp versions—about 10K to 15K bytes. But for most end-user applications, this is not a large penalty when weighed against the decrease in development time. ■

\$345 (0K)

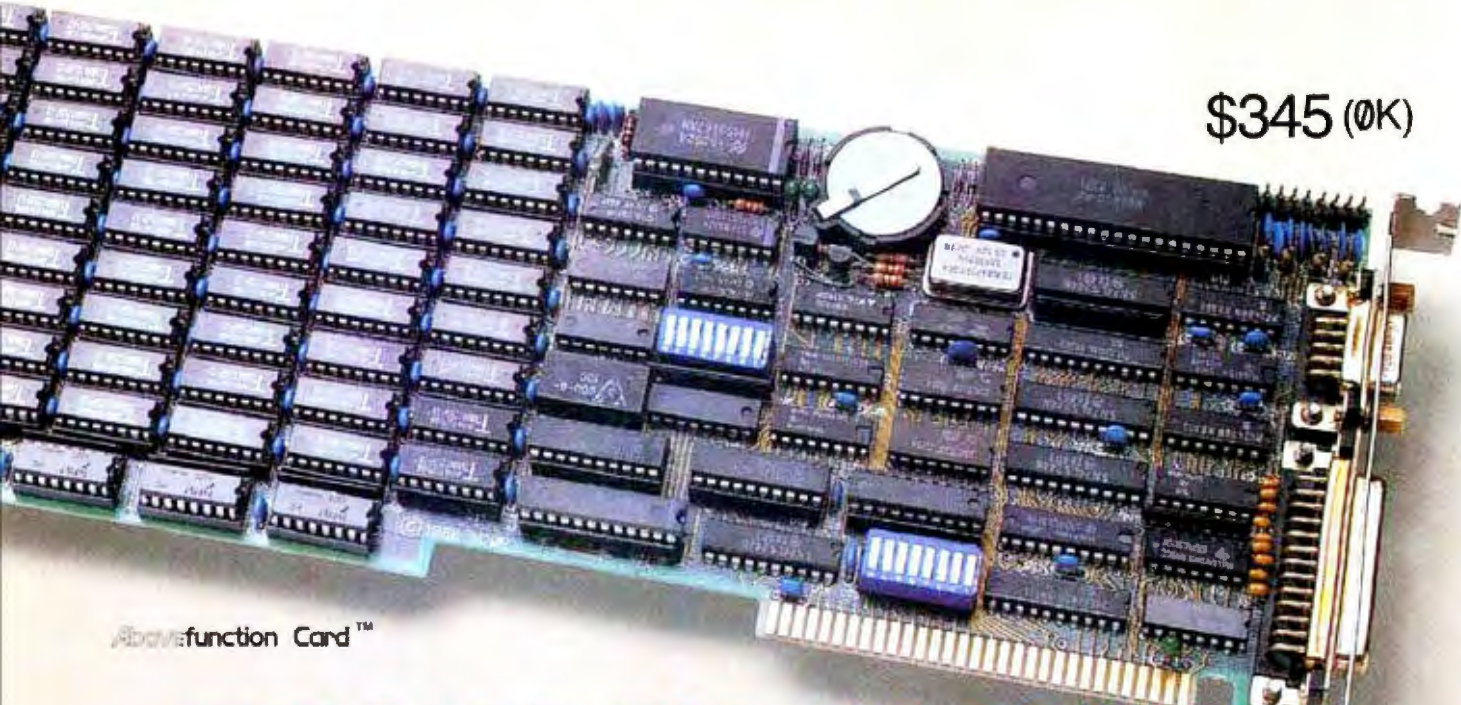

Abovefunction Card™

THE CARD FOR ALL REASONS

Reason 1: More Memory

When you need more memory, the Abovefunction Card* from American Computer & Peripheral, Inc. delivers a full 2 Megabytes of RAM to your American, IBM* personal computers and compatibles.

The American Abovefunction Card can fill conventional memory to 640K with the remaining as expanded memory or install up to four Abovefunction Cards to provide the maximum 8 Megabytes of expanded memory for your PC system.

Reason 2: More Functions

In addition to expanded memory, the American Abovefunction Card includes commonly used features, such as a serial, parallel and game port and real-time clock/calendar, all on one board.

The American Abovefunction Card has Cache Memory, an enhanced disk buffer software that is transparent to the user and gives up to four times faster hard disk access. RAM disk and print buffer capabilities are also contained on the EMM (Expanded Memory Manager)/Utility Diskette.

Reason 3: Maximized Slot Usage

Plan for the future with the American Abovefunction Card. One card provides your memory and multi-function needs in one I/O expansion slot. This frees valuable slot space for other enhancements.

Reason 4: Compatibility

The American Abovefunction Card is based on Lotus*/Intel*/Microsoft* specifications and is compatible with Intel's Above* Board.

Reason 5: Price

And, one of the best reasons of all, the American value: \$725.00 (includes 2 Megabytes RAM) and \$345.00 (0K)

AUTHORIZED DISTRIBUTOR AND SERVICE CENTERS:

California Micro, Inc.
Los Angeles, CA (800) 792-6500

Imagine Computers
Goleta, CA (800) 344-2964

PC Land, Inc.
Tustin, CA (714) 730-6723

Computer Professionals
Lakewood, CO (303) 232-4009

Computer Peripheral Warehouse, Inc.
Deerfield Beach, FL (305) 481-2170

5K Computers
Orlando, FL (800) 624-3250

The Super Source
Norcross, GA (800) 241-8579

Mid America
Carmel, IN (317) 846-3101

CPU Distribution, Inc.
Burnsville, MN (612) 894-9310

Asibem, Inc.
Bluespring, MO (816) 229-2442

Computer Wholesalers
Lincoln, NE (402) 466-1962

Micro Configuration East, Inc.
Brooklyn, NY (718) 941-2512

Microtel
Oklahoma City, OK (405) 787-4354

Omega Data
Hillsboro, OR (503) 640-3995

Power House Sales
Sioux Falls, SD (605) 335-7181

American Computer Distributing
Chattanooga, TN (615) 870-1073

Columbia Data Systems, Inc.
Columbia, TN (615) 381-4650

Omega Data
Kirkland, WA (206) 823-9769

Inter-Micro Distributor, Inc.
Alberta, Canada (403) 438-3997

Paris Sud Electronique Composant
Paris, France (1) 69.20.66.99

MAJOR DEALERS:

Computerland of Whittier
Whittier, CA (213) 945-8321

Etek-tek, Inc.
Chicago, IL (312) 677-7660

Inacomp Computer Center
Columbus, OH (614) 431-2230

Inacomp Computer Center
Saginaw, MI (517) 790-1360

American
COMPUTER & PERIPHERAL, INC.

Corporate Office: 2720 Croddy Way, Santa Ana, CA 92704 USA • Tel: (714) 545-2004 • Fax: (714) 545-2146

Northeastern Office: 826 Busch Court, Columbus, OH 43229 USA • Tel: (614) 846-5433 • Fax: (614) 846-7656

*Abovefunction, IBM, Lotus, Intel Above and Microsoft are trademarks of American Computer & Peripheral, International Business Machines, Lotus Development, Intel and Microsoft Corporations, respectively.

Inquiry 18 for End-Users. Inquiry 19 for DEALERS ONLY.

PROGRAMMING EXPERIENCES

BY LARRY TESLER

Programmers using object-oriented languages say the benefits make the learning worthwhile

WHAT IS IT LIKE to write a program in an object-oriented language? I posed that question to several people who program in Objective-C, C++, Object Pascal, and Smalltalk, hoping to gain insight into how different programmers think about object-oriented design. Their experiences had more in common than you might expect.

I asked each person to describe his project and discuss how object-oriented programming affected its progress. Their recollections tended to support oft-heard claims that object-oriented languages can be a boon to large programming projects. The software development benefits stem from three properties of object-oriented programs: object-based modular structure, data abstraction, and the ability to share code through inheritance.

The term *modularity* refers to the factoring of a large program into units that can be modified independently. In an object-oriented system, every module is an object, that is, a data structure that contains the procedures that operate upon it. Object-oriented design is the process of identifying objects that constitute a useful model

of the problem at hand. In the early stages of designing a program, the need to partition the problem into objects stimulates the designers to identify its principal constituents and to specify their behavior and interaction.

Data abstraction is the process of hiding a data structure behind a set of procedures through which access to the data is forced. In this way, the "concrete" representation chosen by the programmer is replaced by an "abstract" catalog of available operations. The advantage of data abstraction is that at any time the programmer can change representations without having to change other programs that relate to the operations. Data abstraction is a natural concomitant of object-oriented programming because each object contains not only its data structure but also the procedures that operate upon it. These procedures, often called methods, are usually the only aspects of the object accessible to other objects.

All object-oriented languages can share code through *inheritance*; that is, object-oriented languages provide the ability to define one type of object as a variation of an existing type. The

new object type is called a *subclass* of the old, and the old type a *superclass* of the new type. Objects in the subclass inherit all the properties of the superclass, including the implementations of methods. The subclass can define additional methods and redefine old methods by providing so-called *overrides*. By using inheritance during the development of an object-oriented program, code can be shared among similar objects. Later, certain kinds of enhancements can be made simply by creating new object types as variations of existing ones.

A WINDOWING SYSTEM

The first person I interviewed was Gary Walker, Manager of Primary Interaction Development in the Distributed Systems Group at Burroughs Corporation in Boulder, Colorado. He and his group of nine programmers were assigned the task of implement-

(continued)

Larry Tesler, currently Manager of Advanced Development at Apple Computer, previously managed the development of Lisa applications, the Lisa Toolkit, and MacApp. He can be contacted at Apple Computer, 20525 Mariani Ave., Dept. 5770, Cupertino, CA 95014.

Teach your old word processor the newest tricks

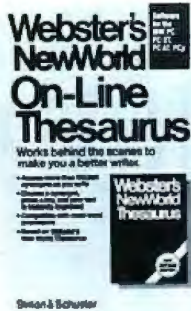

"Truly amazing... outclasses every other program of its type." —John C. Dvorak, *S.F. Examiner*

Feature for feature, *Webster's New World® On-Line Thesaurus* leaves the competition at a loss for words. With 20,000 root words, 120,000 synonyms, 500,000 replacement alternatives, and much more (see our comparison chart below)—*Webster's New World® On-Line Thesaurus* guarantees that you'll never be without the right word again. For the IBM PC, XT, AT and PCjr. \$69.95



The phenomenal software that catches complicated yet common misspellings—like "lenomenal." Just type in a word the way you think it sounds, like "potenshal," and the Spelling Checker automatically corrects it for you. Think of the potential that gives you! No wonder *PC Magazine* hails it as **"the knock-down, drag-out, clear-cut winner!"** (*Editor's Choice 1985*) For the IBM PC, XT, AT, PCjr and Apple II+, IIe, and IIc. \$59.95

LOOK HOW WE COMPARE:

WEBSTER'S NEW WORLD® ON-LINE THESAURUS			
	Webster's New World	Turbo Lightning	Random House Reference Set
Root word entries	20,000	5,000	5,000
Root words + derivatives	64,000	5,000	5,000
Number of synonyms	120,000	50,000	50,000
Replacement alternatives	500,000	50,000	50,000
Word-processors supported	33	11	14
Resident RAM required	44K	64K min.	24K min.
Disk space required (full dictionary)	360K	160K	208K
Find synonyms for synonyms repeatedly	y	n	n
Undo synonym replacement	y	n	n
Backtrack through selections	y	n	n
Note pad	y	n	n
Multiple on-screen synonym pages	y	n	n
Edit synonym before insertion	y	n	n
WEBSTER'S NEW WORLD® SPELLING CHECKER			
	Webster's New World IBM, Apple	Turbo Lightning IBM	Random House Reference Set IBM
Number of words	114,000	83,000	50,000 or 80,000
Help windows	y	y	n
Browseable dictionary	y	n	y
Catches:			
Phonetic misspellings			
You type:	PHENOMENAL	FELLOWMEN	FEMININE

SIMON & SCHUSTER COMPUTER SOFTWARE

Now at your local retailer, or call toll-free today:

1-800-624-0023 (National) 1-800-624-0024 (In N.J.)

WEBSTER'S NEW WORLD®
When Every Word Counts™

ing a general windowing environment, featuring menus, check boxes, buttons, and the other trappings of a see-and-point user interface. After conducting a comparative study of the available object-oriented languages, his group chose C++, an object-oriented extension of C inspired by Simula-67 and developed by Bjarne Stroustrup at Bell Laboratories in Murray Hill, New Jersey. Only object-oriented languages were considered for the project. "In a windowing system," Walker explained, "you want to instantiate objects for windows, each with its own private data. By defining separate types of windows as different classes, they can inherit common characteristics and still possess their own special properties."

Walker found data abstraction to be the most significant advantage of using C++. Smalltalk and some other object-oriented languages force data abstraction upon the programmer by hiding the internal structure of one object from other objects. For example, to move a chess piece, a Smalltalk program must invoke a method such as `move_to`, passing the destination square as a parameter. It cannot use an assignment statement to modify the data structure describing the chess piece's position. The advantage of the restriction is that both the representation of chess pieces and the implementation of `move_to` can be changed without having to alter the code in other objects that access them.

Unlike Smalltalk, Object Pascal and C++ allow objects to access part or all of the internal data of other objects. However, many textbooks warn against direct data access except when performance considerations are paramount. Walker's group found through experience with C++ that interobject direct data access is usually a detriment to modularity. "If you want to get at somebody else's variables," he said, "you should go through access functions [methods]."

Another property of object-oriented programs that benefited the windowing system project is modular structure. It gave the designers the ability to create what Walker calls "isolated

(continued)

Actually, we give you two things free.
Our source code. And your freedom.

Just buy part or all of our excellent integrated
business accounting system, the SBT Database
Accounting Library.

We'll give you our source code absolutely free.

Which, in turn, gives you the freedom to
customize our software to fit your business needs.

Say, for instance, you want to change the
way a management report is formatted. Our free
source code enables you to change it.

What's more, the change will be quick and
simple because our software is written in easy-to-
use dBASE.

In fact, the entire SBT Database Accounting
Library runs with dBASE III or dBASE II,* so you
get the power and flexibility of those best-selling
programs. Plus the freedom to use any computer
that runs dBASE.

The SBT Database Accounting Library.
Great software and freedom. All in the same box.

Call today for our demo disk and brochure.
(415) 331-9900.

THE SBT DATABASE ACCOUNTING LIBRARY.

dProfessional	Time & Billing	\$395
dOrder	Sales Order processing	\$195
dInvoice	Billing/Inventory Control	\$195
dStatement	Accounts Receivable	\$ 95
dPurchase	Purchase Order	\$195
dPayable	Accounts Payable	\$295
dPayroll	Payroll/Labor	\$395
dLedger	General Ledger/Finance	\$395
dAssets	Asset/Depreciation	\$295
dProject	Project/Job Accounting	\$395
dBackup	Menu/Backup	\$ 65



Three Harbor Drive
Sausalito, CA 94965
(415) 331-9900

Call today for the name of the SBT consultant
in your area.

Free source code in every box.



Back, by popular demand.

Just a few years ago, illegal hunting and encroaching civilization had all but destroyed the alligator population in the south. They were added to the official list of endangered species in the United States.

Now alligators have made a comeback.

Conservationists intent on preserving this legendary reptile helped the alligator get back on its feet. Once again some southern swamps and marshes are teeming with alligators.

With wise conservation policies, other endangered species have also made comebacks... the cougar, gray whale, Pacific walrus, wood duck, to name a few.

If you want to help save our endangered species, join the National Wildlife Federation, Department 106, 1412 16th Street, NW, Washington, DC 20036.



worlds of data and functions."

Walker also suggested a more pragmatic advantage of modularity based on objects: cutting down on the number of global variables in the program. The advantage of avoiding global variables in an interactive system is that multiple instances of each object can easily be created. It would be quite difficult to support multiple windows if the data describing a window resided in global variables. According to Walker, if you follow the advice of many software engineering books and avoid global variables, you usually end up passing too many parameters to functions. With C++, Walker explained, data can be "private" to an object, and all functions of that object can access its data without passing parameters.

Having heard Walker mention inheritance as a key factor in his choice of the object-oriented paradigm, I asked him for an example of its use in the windowing system. He cited the class `Menu`, a data abstraction with several subclasses, including `VerticalMenu`, `RadioButtons`, and `CheckBoxes`. The system displays each type of menu a different way, and the user interacts with each a bit differently. But all serve the same basic purpose: They give the user choices, and they report the user's choice to the object in the application program.

Some methods of `Menu` are inherited by the subclasses without modification, while others are overridden by special implementations in each subclass. An example of an inherited method is `selectionTitle`, which returns the string containing the user's menu choice. The implementation of `selectionTitle` is shared by `Menu` and all its subclasses. An example of an overridden method is `prompt`, a function whose arguments are the text strings that represent the choices available in the menu. For example, `my__menu.prompt("sherbert", "cheese cake", "torte")` specifies the choices in a dessert menu. Each subclass of `Menu` implements its own version of `prompt`. The version in the class `VerticalMenu` displays a list of the strings in a style similar to Macintosh pull-down menus, while the version in the class `CheckBoxes` displays the strings

side by side with a check box beside each one, similar to Macintosh dialogs.

The variable `my__menu` is declared to be of the type `Menu`, but at different times during execution its value may refer to objects of different subclasses of `Menu`. Whenever the `my__menu.prompt` is executed, it will invoke the version of `prompt` associated with the class of the object that is currently referred to by `my__menu`. This is one of several cases where Walker's group found a use for the so-called polymorphic property of objects. Polymorphism refers to the ability of one procedure call to invoke different procedures at run time depending on the type of one of its parameters. In object-oriented languages, polymorphism is achieved by letting different classes implement methods that have the same name and formal parameters but different implementations.

The ability of subclasses to inherit from superclasses can also simplify the maintenance of large object-oriented programs. The Burroughs team found that by making a change to the superclass, in effect they changed all the subclasses at once, and if they made changes to one of the subclasses to get distinctions they wanted, the code in the superclass and the other subclasses remained safe.

Walker's group was not alone in that finding. I heard similar claims from Seth Snyder and Dale Peterson of Recording Studio Equipment Company based in Miami, Florida, who used an object-oriented language to implement an integrated application that controls a spectrum analyzer while managing time billing for a recording studio. According to Snyder and Peterson, when new features had to be added to their program, they were able to add them reliably, without any risk of affecting the performance of features they had implemented earlier.

A SHIPBOARD NAVIGATION SYSTEM

Carl Nelson, a computer consultant in Seattle, Washington, was approached

(continued)

Aztec C ... The Best C

Frees the genius in you

You've got a great idea . . .

. . . you're ready to write your programs.

You don't want to be sidetracked by all the paperwork. With Manx Aztec C and the ingenious **make** function, your creative processes won't get bogged down in program administration and housekeeping. Manx Aztec C has the most sophisticated, hardworking program administrator available to you. Once you've described your project, adding new features or enhancements is simple. You never have to concern yourself with the repetitive, tedious task of rebuilding your systems.

The development process moves quickly. Compiles, assemblies, link edits . . . all finish in record time.

Manx Aztec C is the fastest, most efficient C development system in the industry. Benchmarks show it . . . reviews commend it . . . users praise it.

You're ready to test the program. You're ahead of schedule. The Manx Aztec C Source Level Debugger shows you the exact C language statement giving you a problem. You fix the problem quickly . . . you're still ahead of schedule.

You've got some time for fine tuning. The Manx Aztec C Profiler examines your program, tells you where the slow spots are and validates your test procedure. A few changes and it's exactly what you wanted.

You've made it!

Aztec C is available for MS-DOS/PC DOS. Call for details on Macintosh, Amiga, Apple II, CP/M-80, CP/M-86, TRS-80, ROM and others.

To order, or, for information

Call Today

1-800-221-0440

In NJ or outside the USA call
(201) 542-2121

30-day satisfaction guarantee. Special Discounts are available to professors, students, independent developers, and on a "trade-in" basis. Site licenses.

MANX

Manx Software Systems
One Industrial Way
Eatontown, NJ 07724

MS is a registered TM of Microsoft, Inc. CP/M TM DRI, HALO TM Media Cybernetics, PANEL TM Roundhill Computer Systems, Ltd., PHACT TM PHACT Assoc., PRE-C, Plink-86 TM Phoenix, db Vista TM Raina Corp., C-terp, PC-lint, TM Gimpel Software, C-tree TM Faircom, Inc., Windows for C TM Creative Solutions, Apple II, Macintosh TM Apple, Inc., TRS-80 TM Radio Shack, Amiga TM Commodore Int'l

" . . . a superb linker, a profiler, an assembler, and a set of development utilities are only the beginning of this package . . . performed admirably on the benchmarks, with short compile times and the best link times in this review . . . includes the most professional make utility . . . documentation is clear and complete. There is no doubt that this is a valuable and powerful programming environment." **Computer Languages Feb. '86**

" . . . execution times are very good, close to the best on most tests . . ." **PC Tech Journal Jan. '86**

" Easily one of the fastest compilers overall . . . library provides a lot of flexibility . . . generates small .EXE files." **Dr. Dobbs Journal Aug. '85**

C'Prime (Compiler, Assembler, Linker)	\$ 99.
Aztec C 86-d Developer's System	\$299.
Aztec C 86-c Commercial System	\$499.
PC ROM (8086, 68000, 8080, or 6502)	\$750.

Third Party Software for Aztec C: HALO, PHACT, C-tree, PRE-C, Windows for C, PC-lint, PANEL, Greenleaf, db Vista, C-terp, Plink-86, FirsTime, C Util Lib, and others.



3.5" DISK DRIVE

FOR YOUR PC
OR COMPATIBLE

Supports the new
IBM PC Convertible

NEW PRODUCTS MANZANA's line of 3.5 inch External Diskette Drives now includes new low-cost models which derive power from the host computer. These carefully designed peripherals run on IBM PC, XT, AT and many compatibles including AT&T 6300, Compaq, Tandy 1000. *Prices from \$355.*

All Manzana systems come with our sophisticated but easy-to-use software package... allowing you to read & write to many 3.5" formats including:

IBM Convertible, Toshiba T1100, HP110 & 150, Atari 520 ST, DG/One, GRiDCase, Kaypro 2000, Tandy 600.

Compatible with all DOS 2.0 and above.



MANZANA... the Industry
Pioneer in 3.5" Peripherals

Call or write for more information.

In Canada, please contact Quay Computer Corp. at
(416) 629-1570



MANZANA™
MicroSystems, Inc.

P.O. Box 2117
Goleta, CA 93118
(805) 968-1387

by a group of investors for his assistance in building a computer-assisted navigation system. The envisioned system, to be installed on boats in coastal waters, would consist of a Macintosh connected to a Ioran. A Ioran collects data on a ship's position from a radio receiver tuned to three or more land-based transmitters. Using a combination of triangulation and dead reckoning, it displays the ship's position and bearing on a simple (one- to three-line) display. The captain can key in the latitude and longitude of points along the desired course, and thereafter the Ioran will display the current heading and the distance to the next point in the course. If connected to an autopilot, the Ioran can command it to steer the vessel along the planned route.

The clients told Nelson that even though the Ioran and autopilot are mainstays of navigation for many boat owners, the equipment can be tedious and time-consuming to use. The digital information on the display does not relate to a position on a navigational chart at first glance. A "what you see is where you are" system—one that displays the chart on the screen with the present course lines superimposed on the image—was needed. Such a system would allow a navigator to plan a course on the chart with a mouse and then would transmit the coordinates electronically to the Ioran. The system would save time, increase accuracy, and avoid problems that arise when incorrect coordinates are entered.

The entrepreneurs used a Thunder-scan digitizer to transfer images of nautical charts into MacPaint files, and they wrote a utility program to convert those files to a format usable by the application. One of the investors already had a Macintosh connected to the Ioran on his boat and recorded the telemetry of one day's voyage on a floppy disk. That disk enabled Nelson to test his program in the comfort of his office. For testing, Nelson used two computers. The main computer displayed the chart and allowed the course to be specified with a mouse. The other Macintosh served as a Ioran simulator, playing back the recorded telemetry through one of its

serial ports to the main computer.

All that was left was to program the application and the simulator. Because he had only four months from project start to public demonstration, Nelson needed a software development environment that enabled rapid prototype development and implementation. He chose MacApp, an object-oriented software framework for the Macintosh (see "MacApp: An Application Framework" on page 189), and Object Pascal, the only language available then (mid-1985) that could be used with MacApp.

To understand MacApp, you must be familiar with certain standard concepts underlying Macintosh applications, including the concepts of document, view, window, and command. A document in the Macintosh corresponds roughly to a file in a traditional computer. The programmer must design a file format for storing it on disk and a data structure for storing it in memory. The programmer must also provide one or more ways to represent the document visually on the display and on the printed page.

Each different visual representation is called a view. For example, an array of floating-point numbers can be viewed as a tabular column of text containing digits and decimal points, or as a pie chart with shaded wedges of varying size. The size of a view often exceeds the size of the screen, but you can see portions of it through a window that you can scroll and resize. Using the mouse and the keyboard, you can issue commands that change the document. The changes are reflected in all views of that document that are presently displayed.

MacApp defines the abstract classes Document, View, Window, and Command, corresponding to the above concepts. A class includes a set of methods that define what the class can do. For example, a document can open and save, a view can draw and print, a window can resize and move, and a command can do and undo. To use MacApp, you must structure the application in a modular fashion in terms of these objects. Once that is done, the application can inherit an extensive library of user-interface and

(continued)



THE GREAT ESCAPE!

FROM IVORY TOWERS AND
COLD COMPUTER ROOMS TO
THE WARMTH OF YOUR OFFICE.

Artificial intelligence for business
has arrived in a revolutionary new
product . . . Guru.

At last, artificial intelligence designed especially for business! Guru brings together expert system capabilities of artificial intelligence, the productivity of familiar business computing tools and the ease of communicating with your computer using menus, commands or plain English. All available in a single, integrated program.

Guru works like human experts, considering uncertainties, reasoning through forward and backward chaining, asking for more information when needed, and explaining its recommendations.

Guru's expert system works hand-in-hand with all the familiar business computing tools like spreadsheets, statistical analysis, business graphics and a programming language, always available for both expert consultation and your everyday business computing needs.

Best of all, you won't need to learn LISP or PROLOG or buy fancy computers . . . Guru runs on your PC and communicates in plain English! Guru is artificial intelligence that means business.

For more information, call or write Micro Data Base Systems, Inc./Marketing & Sales, P.O. Box 248, Lafayette, IN, 47902, 317/463-2581, Telex 209147 ISE UR.

GURU™

ARTIFICIAL INTELLIGENCE THAT MEANS BUSINESS.

Inquiry 187

mdb is a registered trademark and Guru is a trademark of Micro Data Base Systems, Inc., P.O. Box 248, Lafayette, IN, 47902



error-handling facilities.

According to Nelson, the framework provided by MacApp gave him a structure to plug things into. As he studied the navigation problem, he asked himself, "What do I have in this application that maps onto objects supplied by MacApp?" After identifying all the concepts that mapped easily into MacApp objects, he found that the whole user interface was accounted for. The only code that remained to be designed was that which manipulated internal data structures unrelated to the user interface.

In the navigation application, the most important subclass of the class View was easy to identify: a digitized chart with latitude and longitude lines. The window in which that view was displayed was a little harder to design, because it had to provide nonstandard controls for scrolling around a spherical world. The command objects were easily determined by enumerating the commands available in the user interface, such as place marker and show navigation info. The choice of document objects was not so clear-cut.

A document in MacApp is an object that manages the principal data structures of an application both in RAM and in file storage. In Nelson's application, several different files are employed, including the digitized

nautical chart image with added annotations, and a trip file, which consists mainly of the trail of coordinates recorded during a specific voyage. Nelson had to decide whether the document object of his application should be of the class NauticalChart or of the class Trip, or whether his application should support both kinds of documents. He based his decision on an analysis of the operations associated with each type of object. For example, he wanted the client to be able to save the history of a trip in a file and then reopen that file by clicking an icon in the Macintosh Finder. But he also wanted the client to be able to open a chart file to review the annotations that had been made on the chart. He concluded that both the trip and the chart are appropriate document objects, and his application defines both as subclasses of Document.

The chart file consisted of a digitized image plus markers indicating significant locations such as reefs and buoys. Once the program was running, Nelson and his client realized that not all markers should be associated with the chart file. It made sense for a marker labeled "lighthouse" to be stored with the chart, but a marker labeled "caught 30 lb salmon" really belonged with the trip. Nelson decided to divide all markers

into two subclasses of the object class Marker, namely, TripMarker and ChartMarker. He analyzed what the two kinds of markers had in common—for example, the display algorithm and the routines to edit an annotation—and implemented that common behavior in the superclass Marker, from which the subclasses could inherit it. He also determined what differentiated them—for example, the shape of the displayed icon and the file used for storage—and implemented that special behavior as overrides in the subclasses. Nelson called the differentiation process "pushing down the details" from superclass to subclass (see figure 1).

A CAD SYSTEM

At Artecon Inc. in Carlsbad, California, a group of 20 programmers led by Dana Kammersgard used an object-oriented language on Sun-2 and Sun-3 workstations in the development of ArteMate, an integrated CAD and office automation system. To make the system as portable as possible, Kammersgard's graphics group coded their routines according to an industry standard called GKS (Graphical Kernel System). GKS provides a way to construct images by transforming and combining primitive forms such as lines, polygons, curves, and ellipsoids. The standard specifies a device-independent set of procedure calls, leaving to each implementation the task of interpreting those calls in a manner appropriate to the available output devices.

According to Kammersgard, his team wanted the CAD portion of ArteMate to display two-dimensional and three-dimensional graphics on a wide variety of plotters and screens. To obtain that flexibility, an object-oriented approach seemed best. The language they chose for their implementation was Objective-C, developed by Productivity Products International of Sandy Hook, Connecticut, and available on a variety of computers and operating systems.

The first question Kammersgard's group addressed was how to organize the code for a number of graphics devices, including the CalComp 1043

(continued)

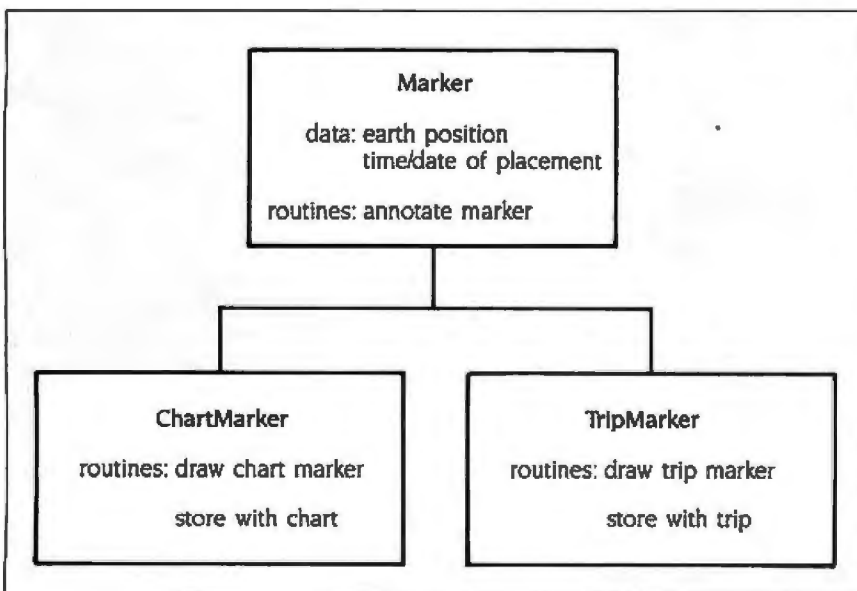
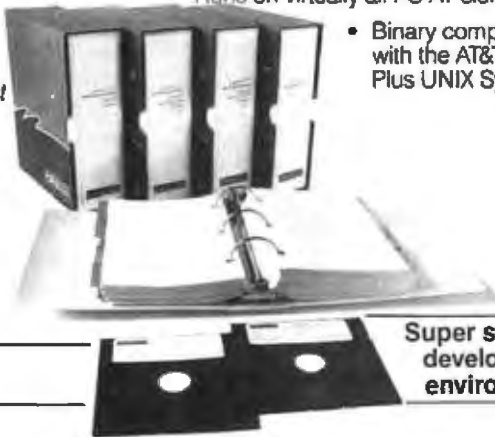

Figure 1: An example of class hierarchy.

If you think you can't afford a UNIX[®] system, we've got a \$160 surprise.

Turn your PC into a multi-user system.

Convert your IBM PC-AT (or compatible) into a multi-user/tasking UNIX work station—at *absolutely the best price anywhere, any time*. Based on the AT&T-certified UNIX System V/286, the MICROPORT SYSTEM V/AT is designed for use in virtually any computer environment, from office automation to software development.



Over 200 utilities come standard.

Grep, awk, sort, split, cut, paste, vi and ed (and many more) now let you search and modify files, make use of electronic mail, emulate terminals, calculate electronically, convert data and publish.

SYSTEM V/AT is more than a look-alike. It was derived from AT&T's own UNIX System V release 2 iAPX286. It thereby contains standard System V features the competitors don't support, such as the powerful symbolic debugger, sdb, the shell-layering job-control facility and the F77 Fortran compiler, as well as programming tools such as ctrace, cflow, and bs. Also standard is File System Hardening which greatly reduces data loss in a power failure.

Want some more features?

- Console driver providing ANSI terminal interface for monochrome, CGA, Hercules and EGA cards.
- Multiple Virtual consoles allow up to four virtual windows of operation.
- Record and File Locking
- Supports the 286's 16 megabyte virtual address space and fully utilizes its other advance features.
- Supports all standard IBM drive types and most non-standard hard-disk drives.
- Requires only one hard-disk partition, and allows DOS to reside on the same hard disk.
- Provides utilities to transfer files to-and-from DOS file systems.

- Dynamic disk buffer allocation provides RAM disk performance for systems with large memory configuration.
- Runs on virtually all PC-AT clones.
- Binary compatible with the AT&T 6300 Plus UNIX System.

Super software-development environment

We've provided everything: Make, yacc, lex, sccs, cflow, ctrace plus every standard System V software-development tool. The F77 Fortran compiler. And the AT&T Portable C compiler for the 286. Both C and Fortran compilers generate 287 instructions directly—for systems not containing 287 math coprocessors, a kernel-resident IEEE-compatible 287 emulator is provided. The large-model code produced by the compiler is among the densest and fastest currently available.

So, how do we do it?

MICROPORT offers SYSTEM V/AT at a fraction of the price of the competitors simply because we build on the generic System V/286 product from AT&T. This entire utility package from the certified release has been copied directly to SYSTEM V/AT—without so much as a recompile. Not only does this mean that MICROPORT can offer SYSTEM V/AT at a remarkable low price, it also *guarantees a level of quality* present in few (if any) other UNIX-system implementations. (And, since our staff was part of the group that implemented the standard System V/286 port for Intel, MICROPORT can offer comprehensive support for the system, as well.)

And a dollar change

The price is even better than you thought. Order right away and we'll return one silver dollar just as rapidly, with your product shipment. (If you'd like a little more time we'll apply that dollar to the cost of a brochure—which we'll send right away too.)

90 DAY MONEY BACK GUARANTEE

And a dollar change.



To order: Complete the information below. Your attractively-packaged and fully-documented order will be shipped within two weeks.

MICROPORT SYSTEMS, INC.
4200 Scotts Valley Drive
Scotts Valley, CA 95066
408/438-UNIX or 800/PC2-UNIX (outside CA)

SYSTEM V/AT

- RUNTIME SYSTEM** Includes the SYSTEM V/AT operation system and over 200 utilities for two users.
QUANT _____ **\$160.00**
- SOFTWARE DEVELOPMENT SYSTEM** The complete Software Generation System for 286 development.
QUANT _____ **\$169.00**
- TEXT PREPARATION SYSTEM** Includes nroff, troff, spell and other programs.
QUANT _____ **\$169.00**
- THE COMPLETE SYSTEM** Contains all three packages indicated above.
QUANT _____ **\$439.00**
- OPTIONAL** three to eight-user upgrade
QUANT _____ **\$99.00**

Subtotal _____

(CA residents add 6.5% tax per copy) _____

Shipping and handling charges (In the USA \$14.00, in Canada, \$18.00 and in Europe, \$11.00) _____

TOTAL DUE: _____

NAME _____

TELEPHONE _____

ADDRESS _____

CITY _____

STATE _____ ZIP _____

COUNTRY _____

VISA MASTERCARD BANK DRAFT CHECK

CARD NUMBER _____ EXP DATE _____

Send a brochure only and keep me on your mailing list, please.



M I C R O P O R T

CopyWrite

BACKS UP IBM PC SOFTWARE

Hundreds of the most popular copy-protected programs are copied readily. CopyWrite needs no complicated parameters. It needs an IBM Personal Computer, or an XT or an AT, 128k bytes of memory, and one diskette drive. CopyWrite will run faster with more memory or another drive.

CopyWrite is revised monthly to keep up with the latest in copy-protection. You may get a new edition at any time for a \$15 trade in fee.

CopyWrite makes back up copies to protect you against accidental loss of your software. It is not for producing copies for sale or trade, or for any other use that deprives the author of payment for his work.

To order CopyWrite, send a check for \$50 U.S., or call us with your credit card. We will ship the software within a day.



Quaid Software Limited

45 Charles Street East
Third Floor
Toronto, Ontario M4Y 1S2
(416) 961-8243

Ask about ZeroDisk to run copy-protected software from a hard disk without floppies.

and I044 and the HP 758X models, in such a way that it could perform both input and output to a number of black-and-white and color display systems, including the Sun Color Graphics Processor and the IBM 5080. The programmers decided that each type of device should be represented by a different type of object. Accordingly, they defined Objective-C classes such as SunGP and CalComp1044.

At different times during program execution, a program variable can contain pointers to different device classes. For example, if `dev` refers to an instance of the class SunGP, the statement `dev poly_line: coordList` invokes a device-specific method in class SunGP to display a polygon on the Sun screen. If `dev` is later assigned a reference to a CalComp 1044, the statement `dev poly_line: coordList` invokes a device-specific drawing method in the class CalComp1044 to drive the pen plotter along a polygonal path. To support a new device, the programming team can simply define a new class without modifying existing code.

Kammersgard says that where they could take advantage of special hardware features, they implemented a device-specific method in the class. For example, the method `poly_line` normally has to apply transformations to the coordinates supplied in its parameter list to account for the visual perspective of the viewer. To calculate these transformations involves matrix multiplications, which are time-consuming operations in a conventional computer. Because the Sun Graphics Processor implements a three-dimensional transformation pipeline in hardware, the class SunGP overrides the standard implementation of `poly_line`, substituting a version that is shorter and faster than transformations performed wholly in software.

Like biologists who classify life forms into species, group similar species into a genus, group related genera into a class, and so on, object-oriented programmers design hierarchies of classes according to the similarities and differences they perceive between objects. In the

Artecon system, specific output devices are the species of the graphics kingdom, and company product lines are the genera. Since different devices from the same manufacturer often have similar interface specifications, Kammersgard's team defined the class CalCompPlotter as a superclass of both CalComp1043 and CalComp1044. They moved methods common to both models up to the superclass and left model-specific methods in the subclasses. In a similar fashion they added generic classes like HPPlotter, SunDisplay, and IBM50SeriesDisplay to the class hierarchy. By sharing as much code as possible between device classes, they were able to reduce program size and development time considerably.

The hierarchy of device classes continues for two more levels. At the level above product lines, all kinds of plotters are grouped into one class, and all kinds of interactive displays into another; display classes implement methods for user input, while plotter classes do not. At the highest level is the class GKSWorkstation, which is the ancestor of all other device classes. At that level, device-independent operations are implemented—for example, the GKS primitives that change display attributes in data structures in memory without communicating to the devices.

In any graphics application, another obvious application of objects is to represent the graphical components of the drawing. For example, all ellipsoids ought to be instances of the class Ellipsoid, and all cylinders ought to be instances of the class Cylinder. In the Artecon system, all geometric modeling classes are grouped together under a superclass called GeometricObject. Geometric objects respond to messages such as `draw`, `rotate`, and `store`.

But a CAD system must do more than a simple drawing program. It must allow the user to indicate relationships among design components. Kammersgard's group found themselves adding "links" to geometric objects and to other objects within the system, such as instances of the class ViewPort. After a while, they realized

(continued)



IT'S WHAT TDK MAKES FOR COMPUTERS THAT MAKES THEIR DISKS THE BEST.

The initial step from computer technology to computer disks was a natural for TDK, because they're more than manufacturers, they're creative innovators. TDK has used its expertise as one of the world's major producers of electronic component parts (including the most sophisticated heads for disk drives) to design floppy disks that deliver error free performance.

Absolute quality has always been a major source of pride for TDK. Their position as the world's largest manufacturer of magnetic media has been earned by an unparalleled level of technical superiority that spans over 50 years.

Millions of people around the world rely on TDK for the ultimate in audio and video recording performance. Now they can rely on TDK for the same consistently high performance in floppy disks. After all, PCs have feelings too. They deserve the TDK advantage other sophisticated electronic equipment has always enjoyed.

Let your PC know you care, choose from TDK's family of 5.25-inch standard, 5.25-inch High Density and 3.5-inch No-Risk™ Disks. Because it just doesn't pay to cut corners when it comes to floppy disks.

 **TDK**[®]
THE NO-RISK™ DISK.

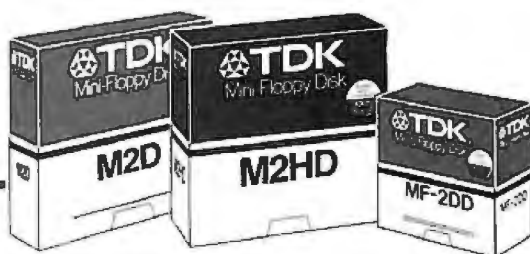

Northeastern Region: 516-625-0100; Southern Region: 404-948-1346; Midwestern Region: 312-676-5356; Western Region: 714-863-1844

© 1986 TDK Electronics Corp.

MathCAD

The Engineer's Scratch Pad

FOURIER.MCD

FOURIER RECONSTRUCTION: SQUARE WAVE

N := 40 j := 0 .. N ... 40 points

S := 1 - 2 · δ(j - 20) ... step function

Reconstruct function, using first two terms of Fourier series i := 1,3 .. 3

$$R_j := \frac{4}{\pi} \sum_i \frac{1}{i} \sin \left[i \cdot 2 \cdot \pi \cdot \frac{j}{N} \right]$$



A powerful computation and documentation tool for your IBM-PC.

With MathCAD you simply and interactively create, edit and display formulas on the screen the way you are used to writing them. Equations are instantly computed and the results displayed on the screen as a single number or a plot. Text may be added to the screen and everything may be printed out as an integrated document. MathCAD has built-in hyperbolic and circular functions, performs all calculations with real and complex numbers, performs iterative calculations, handles all units, performs error checking and dimensional analysis and much more . . .

The price of MathCAD—\$189.
In Massachusetts add 5% sales tax.

To order send check, p.o., call us with your MasterCard number or call us for the nearest dealer.

1.800.MathCAD or 617.577.1017

Math Soft

Σ ∙ \ = × ∫ ∫ ∫

One Kendall Square
Cambridge, Massachusetts 02139

PROGRAMMING EXPERIENCES

that the various implementations of links could be combined by embodying Geometric_Object and ViewPort in a new superclass called AssociativityObject. An associativity object contains a set of links and supports operations such as add_link, remove_link, and modify_link. A member of any subclass, say, Cylinder, inherits the ability to contain links as well as the routines for manipulating them. Adding the class AssociativityObject required a modest restructuring of existing code. According to Kammergard, it is common to restructure the class hierarchy to take advantage of newly discovered opportunities for sharing code through inheritance.

A KNOWLEDGE-BASED APPLICATION

Bill Hutchison, a behavioral psychologist living in Silver Spring, Maryland, is implementing a knowledge-based system on the IBM PC. The system organizes information in a way that allows a seemingly rational response to stimuli. After considering a number of development systems, Hutchison decided upon Methods, a Smalltalk dialect developed by Digital Inc. of Los Angeles, California. I spoke to Hutchison after he had been using Methods for four months. "I like the way I can think about the problem," he said. "I map out the general problem in my head and can almost extract the objects from how I write it down in English. I make an object for each physical thing, process, or activity that I am dealing with."

I asked him if Smalltalk was difficult to learn. Hutchison, who has programmed extensively in assembly language, COBOL, BASIC, PILOT, and PLANIT, said he found Smalltalk "the most natural way" to program. He admits, however, that most of his learning time went to mastering Smalltalk's extensive class library. Large libraries are typical in object-oriented systems because they are extremely easy to build and maintain using subclassing and inheritance. The library that comes with Methods includes classes that are similar in purpose to those of MacApp. That allowed him to implement the user interface of his ap-

plication easily and give it fancier features than he had first thought possible.

Hutchison said he structured the application's objects in a modular way. Knowledge is stored in association networks that relate situations, conclusions, and responses. He first developed a basic Network class able to represent simple domains, and he said that doing so was not as difficult as he had expected. Later, when he decided to tackle more difficult problems, complex networks became subclasses of the basic version. The first subclass he defined was InteractionNetwork, which adds the ability for parts of networks to interact with each other. That class was itself subclassed to define MultiResponseInteractionNetwork, which permits the system to respond along multiple dimensions.

At each stage he had to restructure existing definitions a little to allow the new class to inherit as much as possible from the old classes. The modular structure of the application made it easier to change one part without affecting others. "Sometimes," Hutchison said, "a radical change that I was dreading took me only an hour or less to accomplish." But Hutchison added that to make the program that modular, he had to develop the discipline to confine knowledge of an object's internal structure to its own class—only after having done that could he make changes to an object's structure without affecting others.

OBJECT-ORIENTED FUTURE

Certainly, object-oriented programming offers a great deal to software developers who want to manage large software projects or create prototypes quickly. Now that several suitable languages are widely available, many programmers will likely invest the time necessary to acquire the skill of using them. The interviews I conducted encouraged me to believe that these languages can be applied effectively in diverse situations by people of varied technical backgrounds. Even though the learning curve is high, most programmers can easily exploit the full potential of object modularity, data abstraction, and inheritance offered by object-oriented languages. ■

DON'T LOOK FOR PRODUCTIVITY IN A PRODUCT.

The purchase of a data base system should be the beginning of a relationship.

That relationship should include planned product upgrades, experienced technical support, vertical application templates, informational seminars, training programs, user groups, newsletters, special marketing programs... and much, much more.

Demand a Relationship

At Software Solutions, the relationship begins as soon as you contact us. We'll help you find answers to your questions about DataEase™—or about any information management issue.

The product evaluator at

Manufacturer's Hanover Trust summed up the experience of tens of thousands of users by calling DataEase "the most impressive productivity tool I have seen."

When you talk to us, ask for our sample diskette. See for yourself why *Data Based Advisor* points to DataEase as "the easiest to understand and use full-featured data base program," calling it "a program which could easily set the industry standard."

Discover us. Find out how important the company behind the product can be.

Send information and a free DATAEASE BYT/86 sample diskette for my PC (check one):

IBM WANG DEC TI

Include materials relating to:

Corporate Client Retailer
 MIS/DP/IC Professional VAD
 Other

Name: _____

Title: _____ Phone: _____

Company: _____

Street: _____

City: _____ State: _____ Zip: _____

Mail to:
Software Solutions, Inc. Telex: 703972
12 Cambridge Drive 800-243-5123
Trumbull, CT 06611



Software Solutions. Get into a relationship that works for you.

Canada
Computerlinks, Toronto, Ontario; (416) 231-1270

United Kingdom
Sapphire Systems, Essex; 01-554-0582

West Germany, Austria
M&T Software Verlag, Munich, 089-4613-0

Scandinavia
West Soft A/S, Alesund, Norway; (47) 71-46166

Switzerland, France
Softsource, S.A. 1209 Geneva, Switzerland; 965152&985-153



AT performance at an XT price. Introducing the TeleCAT-286. \$2995. Complete.

With TeleVideo, you always settle for more.

Up till now, with a mid-range budget, you had to settle for mid-range performance. And a mid-range set of features.

But not anymore. Because now, there's the new TeleCAT-286™, from TeleVideo. An IBM AT-compatible machine that lets you settle for an entirely new concept in medium-priced PCs: more.

More Performance.

The TeleCAT-286 retails for \$2995, roughly the same as a comparably-equipped IBM XT. But the similarity ends there. Instead of starting you off with a stripped-down box, we've loaded up the TeleCAT-286 with 512K RAM. A 20MB hard disk. A 1.2MB floppy. And everything else you need. Like an Intel 80286 CPU that runs at either

28% Smaller Footprint:

What you do with the extra desk space is up to you, but as you can see here, the TeleCAT-286 gives you a lot more of it than the IBM AT.



6 or 8 MHz clock speed. There's even a high-resolution monitor for text and graphics.

To make even better use of internal space, we socketed the TeleCAT-286 for one MB of RAM, and also included serial and parallel ports on the motherboard. As a result, we can still

give you three extra expansion slots.

More Productivity.

Using our experience in building terminals and systems for 750,000 users worldwide, we've designed a machine that's the last word in ergonomics. With

LEDs On Locking Keys:

For maximum visibility, we put our LEDs right on top of the three critical locking keys, so they won't get covered up by overlays.



sculptured keycaps on a high-quality keyboard. LEDs on the three critical locking keys. And a footprint that's 28% smaller than the IBM AT's. So you get more of your desk back, too.

Find Out Even More: 1 (800) TELECAT.

There's a whole lot more we could tell you about the TeleCAT-286. But it's an even better idea to get your hands on it. So call us at 1 (800) TELECAT, Dept. 209, and we'll tell you the nearest place you can try one.

The TeleCAT-286. Our 20MB version is \$2995; 30MB, \$3495. For high performance at a low price, don't settle for less.

 **TeleVideo®**
Settle for more.

TeleVideo Systems, Inc. 1170 Morse Avenue
Sunnyvale, California 94088-3568 • (408) 745-7760

©1986 TeleVideo Systems, Inc. IBM is a registered trademark of International Business Machines, Inc.
Screen graphics by Chartmaster ©Decision Resources, Inc.

Your System/Controller should fit you like a good suit.



LET MICROMINT CUSTOM FIT YOU

Whether it's suits or system controllers, you can't buy off the rack when you need a custom fit.

That's why Micromint individualizes its system controllers to meet your particular needs and budget. What's most important to you? Software compatibility? Speed? Everything on one board? Economical computing power?

#1: "I want software compatibility."

Solution:

THE SB180 COMPUTER/CONTROLLER

The SB180, only 4" by 7½", offers a Z80 compatible CPU running at 6MHz, 256K bytes of RAM, up to 32K bytes of ROM, two serial ports, a parallel port, Z80/6800 I/O expansion bus, and an industry standard 765A-compatible disk controller for up to four disk drives — any combinations of 3½", 5¼" or 8" drives. The SB180 is based on the Hitachi HD64180 CPU, a microcoded CMOS chip which provides high performance, reduced system cost, and low power operation while maintaining complete compatibility with the large base of standard CP/M software.

SB180-1 w/8K ROM monitor . . . \$369.00
 SB180-1-10 w/8K ROM monitor,
 BIOS source and
 Z-system \$418.00

#2: "I need speed."

Solution:

THE Z8 FORTH SYSTEM/CONTROLLER

The Z8 FORTH System/Controller is only 4" by 4½" and includes a custom masked Z8 version of the FORTH

language with a full screen editor, cassette I/O driver primitives, EPROM programmer primitives, and other utility words. It also contains up to 4K bytes of RAM or EPROM, an RS-232 serial port with selectable baud rates, and two parallel ports. Additional Z8 peripheral boards include memory expansion, a smart terminal board, serial and parallel I/O, real time clock an A/D converter, and an EPROM programmer. It's perfect for data reduction and high speed control applications.

BCC21 w/utilities . . . \$225.00

#3: "Let me have an entire development system on one board."

Solution:

THE BCC52 SYSTEM/CONTROLLER

The BCC52 is a new stand alone single board microcomputer which is bus compatible with the Micromint BCC11 /BCC21 Z8 System/Controllers and expansion boards. The BCC52 features the Intel 8052AH-BASIC microprocessor which includes a ROM resident 8K byte floating point BASIC inter-

preter with extensions for process control work. It contains sockets for up to 48K bytes of RAM/EPROM, an "intelligent" 2764/128 EPROM programmer, 3 parallel ports, a serial terminal port, and a serial printer port.

BCC52 . . . \$239.00

#4: "Give me lots of economical computing power."

Solution:

THE BCC11 BASIC SYSTEM/CONTROLLER

The Z8 BASIC System/Controller is nearly identical to the FORTH System/Controller but contains a tiny BASIC interpreter, up to 6K bytes of RAM and EPROM, an RS-232 serial port with switch selectable baud rates, and two parallel ports. Add a power supply and terminal to start programming in BASIC or machine language. Programs can be transferred to 2732 EPROMS with the optional EPROM programmer for auto-start applications. It can also use any of the expansion boards mentioned under the Z8 FORTH System/Controller.

BCC11 . . . \$149.00

Additional information on peripheral boards and OEM pricing is available.



For a System Controller suited to your needs, give us a call.

Order Toll Free
1-800-635-3355
 In Connecticut call: 1-871-6170

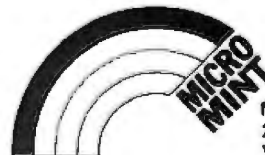

MICROMINT, INC.
 25 Terrace Drive
 Vernon, CT 06066

DESIGNING AN EFFICIENT LANGUAGE

BY CHARLES B. DUFF

A language designer discusses the inefficiencies of Smalltalk and suggests ways to improve upon them

ALTHOUGH SMALLTALK is the mother of modern object-oriented languages, and is certainly the best-known, its use in the microcomputer world has been limited, primarily because of its size, relative inefficiency, and fairly long learning curve for new programmers. These problems are partially the result of a philosophy that emphasizes theoretical consistency and universal application of a few principles. By modifying this design philosophy somewhat, it is possible to develop a new language that combines the benefits of an object-oriented language and the efficiency of a popular production language such as C or Pascal.

Over the past two years, my company, The Whitewater Group, has been at work on a new language called Actor, which is targeted for artificial intelligence work on microcomputers. Our goal was to make use of the consistent object-oriented philosophy of Smalltalk but to incorporate some architectural changes that might enhance efficiency, ease of use, and accessibility for the average programmer. In this article I will discuss some

of the design details of Smalltalk and point out how we attempted to improve upon them.

The issues under discussion include garbage collection, late versus early binding, and models for the interpreter. I'll also look at the relative advantages of a token-threaded interpreter over Smalltalk's byte-code interpreter in creating a language that supports early binding and other optimizations.

GARBAGE COLLECTION

Smalltalk, like other sophisticated languages such as LISP and Prolog, includes a garbage-collection facility that automatically reclaims data structures that have been created by the programmer but are no longer needed. This is a tremendous advantage in a large, complex application because you never have to worry about memory management (unless, of course, memory becomes exhausted in spite of garbage collection).

The Smalltalk-80 specification includes a reference-counting garbage collector but does not mandate this approach. A reference-counting sys-

tem keeps track of the number of pointers to each object in the system. When the pointer count drops to 0, the object is deleted.

Unoptimized reference-counting collectors can consume up to 70 percent of total execution time because of the constant maintenance of reference counts. The University of California at Berkeley has published a number of clever optimizations that minimize the reference-counting overhead in Smalltalk. Nevertheless, reference counting has a serious chronic effect on the efficiency of the language. Anyone who attempts to create a more efficient object-oriented language would do well to consider alternate architectures for garbage collection.

THE BAKER COLLECTOR

Henry Baker at MIT developed a method of garbage collection for LISP

(continued)

Charles B. Duff (The Whitewater Group, 906 University Place, Evanston, IL 60201) is a systems programmer whose last product was the language Neon for the Macintosh. His new language, Actor, should be available for the IBM PC in October.

that involves splitting memory into two spaces. As an application executes, objects that are known to be "alive" (i.e., accessible to the program) are copied from one space to a new one. Eventually all active objects are copied to the new space. The copying process is then reversed, copying back into the original space and writing over the "dead" objects.

The principal advantage of this approach is that the collection process can be performed incrementally as the program executes, allowing even real-time applications to make use of garbage collection. Also, compaction occurs naturally as a result of the copying. The efficiency of Baker's method, however, is dependent on how many objects remain alive as opposed to how many die. Highly volatile objects such as contexts (see below) may well come and go before they are copied, thereby requiring no maintenance overhead. The difficulty comes in when a large number of objects with long lifetimes are created,

resulting in much copying activity. Each application has a unique profile with respect to object lifetimes.

The best solution for this problem seems to be a variation of Baker's approach suggested by Henry Lieberman and Carl Hewitt of MIT and first applied to Smalltalk by a team at DEC. In this approach, objects that have been around for a long time are migrated to an area that is rarely checked for dead objects, thus minimizing useless copying of permanent objects and directing the energies of the collector where it can be most effective. In our design of Actor's garbage collector, we employed an approach similar to this.

CONTEXTS

Any stack-based language must have a run-time facility to create activation records for each procedure that is executed (see figure 1). This is an area at the top of the stack that contains current values of variables and parameters to be used by the procedure. As

long as a simple stack allocation discipline is used, these structures do not require any sophisticated memory management; they come and go with procedure calls and returns.

In Smalltalk, the activation record is called a context and is actually an object (see figure 2). Every time a method begins execution, a new context object must be created. The context actually combines a traditional activation record with a local work stack for use during the method's execution. Space for the stack is allocated from the context's indexed instance variables. Thus, each invocation of a method has its own private stack.

Even after a method finishes executing, its context can persist and be sent messages as a full-fledged object. A debugger can exploit this fact to reconstruct the state of a method that had a problem. On the downside, however, objects are much more expensive to allocate than stack space. Since a context is created with each method activation, it is no surprise that the Smalltalk garbage collector spends much of its time managing context objects alone. One study indicated that method contexts are responsible for 97 out of every 100 words of object space allocated.

Since the performance consequences of straying from a stack-based allocation discipline seemed too severe in relation to the benefits, we decided not to implement method contexts as objects in Actor. We did, however, implement block contexts as objects, because these contexts are used less frequently and do not conform to stack-based allocation strategies. These contexts are created only when a block is passed to another method, or function, for repetitive execution. (In this article, we will use the terms method and function interchangeably.)

As a consequence of our decision, however, the process of constructing a debugger is less elegant, requiring us to make use of assembly language primitives to access the stack. Alternatively, we could use Actor to construct an emulator that would treat contexts as objects for the sake of

(continued)

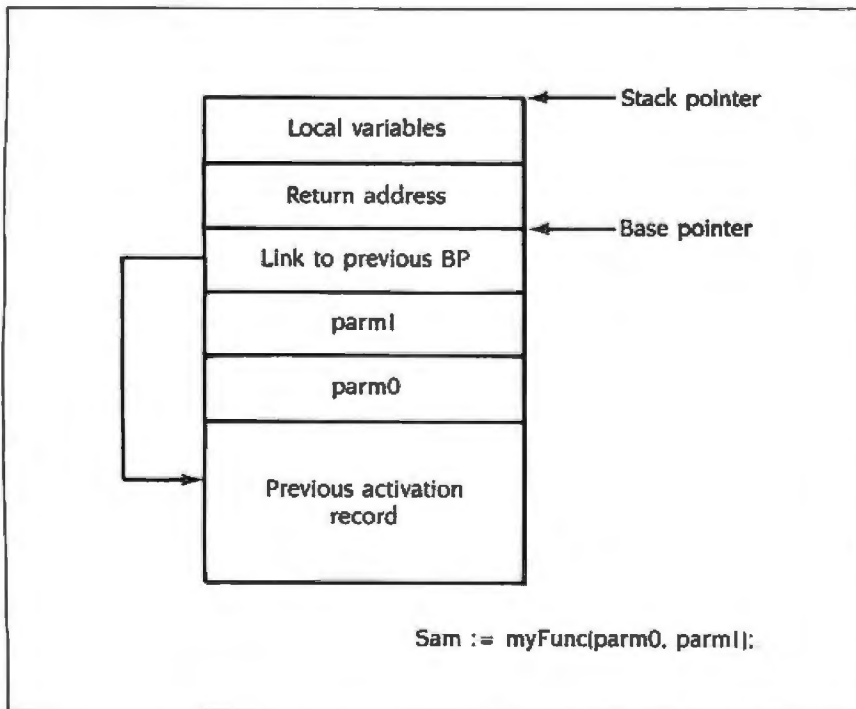

Figure 1: A typical activation record in a compiled language. When a function (myFunc) is executed, the parameters passed to it by the calling routine are placed on the stack, along with the return address. The function then allocates space for its local variables. The base pointer serves as a fixed location from which to index both the passed parameters and the local variables. Below is the activation record for the function that called myFunc.

XEROX

It's not surprising that the company which invented Daisywheel printing should be the one to take it to a breakthrough level of performance.

Introducing the Xerox 635 Diablo Daisywheel Printer, the next generation of printers.



It's fast—up to 55 cps. It's quiet—perfect for a busy office.

And because it's a Xerox printer, the 635 just won't quit.

It's also extremely easy to use. With automatic sheet loading, a simple control panel, and snap-in

interface cartridges give instant compatibility to most microcomputer systems, including Xerox, IBM and Apple.

The Xerox 635 has a choice of 225 drop-in printwheels including Memorywriter and IBM typestyles and fonts. So you can make almost all your documents look uniform.

And only Xerox offers you such a complete line of peripherals. Like a bi-directional tractor, single-bin sheet feeder, dual-bin sheet feeder or dual-bin sheet feeder with an envelope bin.

Call 1-800-TEAM-XRX, ext. 122, or send the coupon below.

Because you gain a lot by setting higher standards.

Xerox Corporation, P.O. Box 24, Rochester, NY 14692
I'm interested in learning more about the Xerox 635 Diablo Daisywheel Printer.

Please have a dealer or sales representative contact me.
 Please send me more information.

NAME _____ TITLE _____

COMPANY _____

ADDRESS _____ CITY _____

STATE _____ ZIP _____ PHONE _____

Or, if you can't wait, call
1-800-TEAM-XRX, ext. 122

11-NMI-R12-6979, ext. 1221

122

192 8/1/86

The people who set the industry standard just raised it.



XEROX®, DIABLO® and the  are trademarks of XEROX CORPORATION.
IBM® is a registered trademark of the International Business Machines Corporation. APPLE® is a registered trademark of the Apple Corporation.

FOR MORE INFORMATION ON XEROX DIABLO PRINTERS,
CIRCLE CODE 321 ON THE READER SERVICE CARD.

debugging. We have yet to find that step necessary, however.

EARLY AND LATE BINDING

When you call a function in a typical high-level language such as C, the compiler and linker actually generate a subroutine call to a physical address. This is very efficient, but you must be careful to associate functions with the appropriate data structures. For example, if you were to pass an array to a function that was designed to work on strings, trouble would surely result. The problem would most likely be caught at compile time by the type-checking facility of the compiler. Of course, in an untyped language such as FORTH, the problem wouldn't be caught at all until the program started behaving strangely.

Smalltalk relieves the programmer of this burden by automatically calling the appropriate method for a given data structure. The programmer uses generic names for operations, and Smalltalk uses the class of the

receiving object to look up the method having the correct name. Since the lookup occurs at run time, however, it carries a rather severe efficiency penalty with respect to the previous technique.

We decided to implement a facility that combines the merits of each approach. We designed our compiler to automatically associate, or bind, a generic operation name with a physical function in the manner of Smalltalk. But, unlike Smalltalk, the programmer can choose on a case-by-case basis whether this occurs at run time (late binding) or at compile time (early binding).

ADVANTAGES OF LATE BINDING

Late binding has some notable advantages. Since all references are symbolic, a method can be recompiled without having to recompile all of its callers. More important, the same symbolic name can be used for a similar operation in several different types of objects. This is possible in

Smalltalk because each object's class has, as one of its private variables, a dictionary associating names with methods. When a message is sent, the interpreter determines the class of the receiver and finds this dictionary, which it then uses to look up the method for the symbol sent.

The fact that a single message can invoke any of several methods is known as polymorphic behavior and is probably the most powerful feature of object-oriented programming. It allows code to be written that is insensitive to the type of object receiving the message. Of course, if the object doesn't happen to have a method for the name sent, an error will occur at run time. This can be disturbing to a programmer who is accustomed to such problems being resolved at compile time. But for certain types of problems, late binding greatly simplifies the code. A lot of control structure, such as if and case statements, simply vanishes, because the logic is incorporated into the distinction between classes.

Unfortunately, late binding is not very efficient. Even the best algorithms for searching the dictionary are several times slower than simply executing the method without a search. Much research, however, has been done in Smalltalk with respect to method caching, which greatly speeds message-sends. Caching uses a hash table to store the most recently used methods, avoiding the more time-consuming dictionary lookup. Caching and other optimizations have greatly improved late-binding performance, but the performance penalty remains severe.

EARLY BINDING

A sensible compromise can be made with respect to late binding. It is possible to forego the consistency of uniform polymorphic behavior in return for a good deal more efficiency. In a previous language I wrote for the Macintosh called Neon, which had object-oriented facilities and a FORTH-like syntax, I allowed the programmer to select early or late binding in each message. This has proven to be a workable and efficient solu-

(continued)

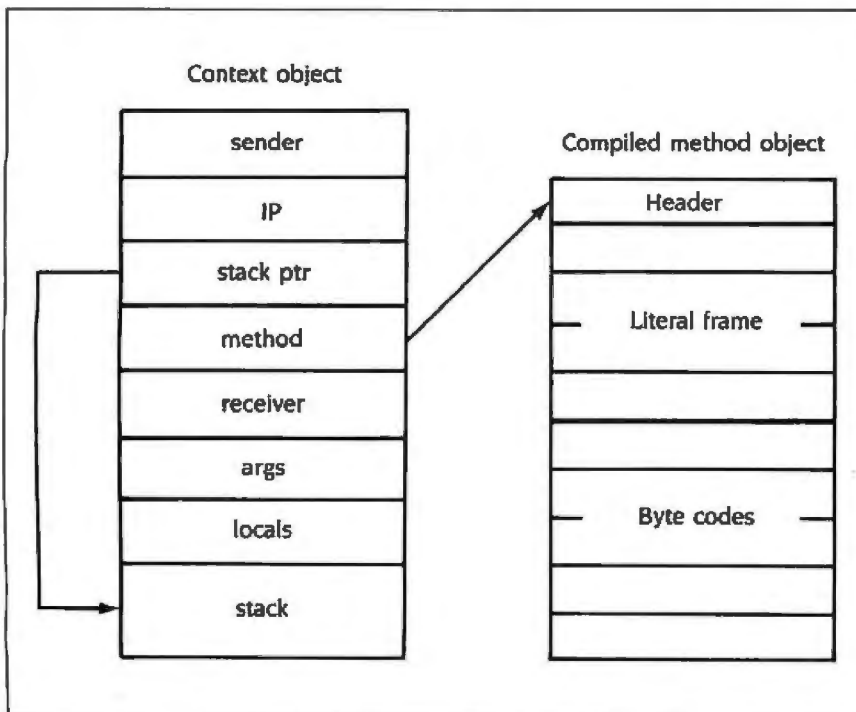

Figure 2: An activation record in Smalltalk. Instead of allocating activation records on a single continuous stack, in Smalltalk each method activation causes the creation of a method context, which is actually an object. Each method activation has its own private stack, which includes space for the instance variables designated by the Context class of objects. This arrangement, with its consequent garbage collection, is much less efficient than simple stack allocation.

Your first color monitor should be good enough to be your last.

NEC introduces the only color monitor you need. Superb resolution plus MultiSync for across-the-board compatibility with all three PC graphics boards made by IBM® for business graphics, CAD/CAM, computer art, and text.

Now there's one high resolution color monitor that does things your way. The MultiSync™ monitor from NEC. It gives you the best color resolution available at the price.



- Compatibility with the IBM Professional Graphics Adapter, the IBM Enhanced Graphics Adapter, and the IBM Color Graphics Adapter.

Compatibility with the IBM® Enhanced Graphics Adapter Board



- MultiSync, the NEC feature that automatically adjusts to color adapter board scanning frequencies from 15.75 KHz to 35 KHz—suggesting the possibility that the MultiSync monitor might be compatible with *all* color graphics boards that are fully compatible with the IBM PC, PC/XT, and PC/AT, now and in the future.
- Full implementation of high resolution graphics software for business and other applications, now and in the future.
- And color capability limited only by the board being used.

See Things Our Way
Until now, you had to choose different color monitors for

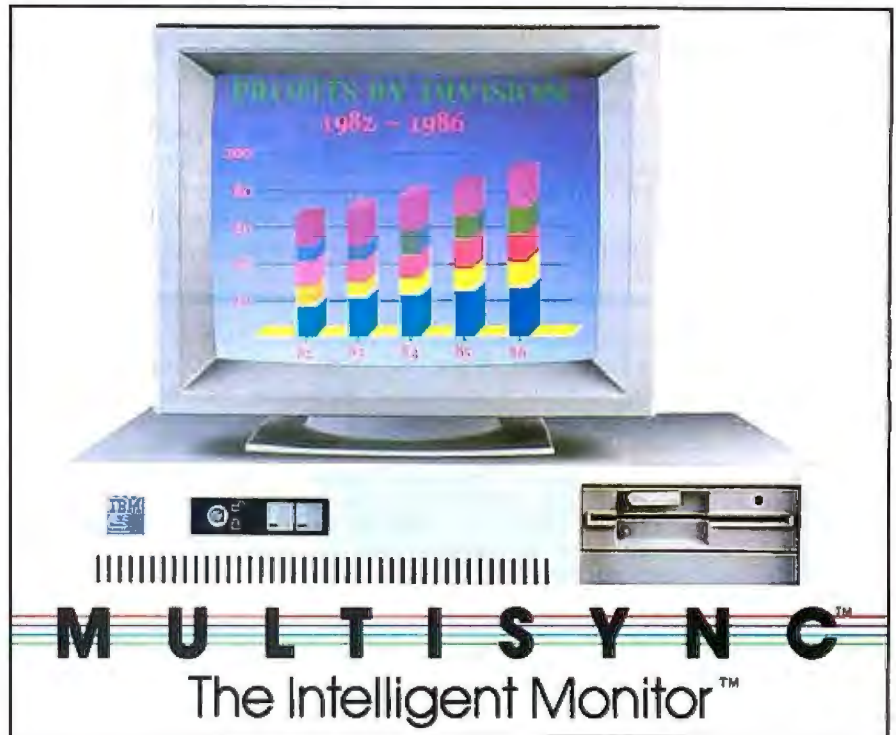

compatibility with all three PC color graphics boards made by IBM. With so many board and monitor configurations, folks didn't know which way to look.

The new MultiSync color monitor gives you unique compatibility. As well as TTL and analog color. With 7 switchable text colors. And resolution up to maximum 800 horizontal dots and maximum 560 vertical lines, on a large, 13" diagonal viewing area.

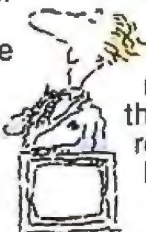

All that, priced at just \$799. All from NEC, a name respected around the world for advanced, reliable products backed by nationwide service.

Compatibility with the IBM® Professional Graphics Adapter Board



It's the one color monitor that does everything your way.

Compatibility with the IBM® Color Graphics Adapter Board

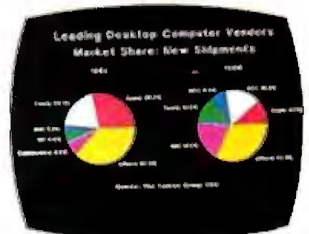

But why talk more about it? Visit your nearest dealer and see a graphic demonstration of the new NEC MultiSync monitor's capabilities. Then draw your own conclusions.

For information dial
1-800-447-4700

NEC HOME ELECTRONICS (U.S.A.) Inc.
Personal Computer Division
1401 Estes Avenue
Elk Grove Village, IL 60007



tion. Neon makes no attempt, however, to ensure that the class of the receiver is appropriate at run time for the method being called. In general, the philosophy in Neon was to provide minimal protection at run time, which allows maximum efficiency. Most FORTH systems have taken this approach, but it is an unsuitable environment for complex AI work.

Even in Smalltalk, polymorphism is really used in only about 15 percent

of the code. The rest of the system makes implicit assumptions about an object's class and could just as well be early-bound. Other researchers have speculated on various ways in which this fact could be exploited for more efficiency.

Our goal was to provide selective early binding with protection against class mismatches at run time. For instance, if at compile time we bound a call to a method in class Rectangle,

and, at run time, an Array was actually the receiver, serious consequences could result. Either every method has to check that its arguments are of the proper class at run time, or the compiler has to ensure integrity at compile time. Run-time checking is a burden that would eat up much of the efficiency gained in early binding. And since compilation can usually be done in relatively small chunks in an object-oriented system, compilation efficiency isn't of much concern.

We decided to develop a scheme whereby the programmer can, at compile time, selectively bind "types" (classes) to variables and to the values returned by functions. This scheme is similar to type declaration in Pascal and allows the compiler to ensure the integrity of an early-bound method call at run time. We also decided to equip the compiler with a sort of miniature expert system that allows it to selectively early-bind method calls. In cases where the early binding criteria fail, it defaults to late binding.

For example, in listing 1 we have a number of list-handling method definitions, as they might be written in Actor for a class called ListCell. (Note, however, that the actual function names are different in Actor; I have used the equivalent LISP function names here to make the code more familiar to LISP programmers.)

We specified all Actor function (method) definitions to consist of the word `Def` followed by the name of the new function, followed by a list of formal parameters enclosed in parentheses. The first parameter is always `self`, because that is where the receiver appears in the method call.

The body of the function is delimited by curly braces (which are optional in the case of a single statement). A caret causes the function to return the value of the next statement.

You will notice that in the list of arguments for the `append` function, the formal parameters, `self` and `arg`, are followed by `:ListCell`. As in Pascal, this assigns a type to the formal parameters. In Actor, types are actually classes, so the definition says that at run time the formal parameter must be of class ListCell.

(continued)

Listing 1: Examples of function definitions as they might be written in Actor, illustrating how early binding may be specified. In the function `append`, the variables `self` and `arg`, along with the result of the function, have been "typed" as instances of class ListCell.

```
/* this version of append assigns types (classes) to its
arguments. carVal and cdrVal are the two private
variables in class ListCell. Typing permits the compiler
to generate much more efficient code for messages
involving typed parameters. */
```

```
Def append(self:ListCell, arg>ListCell):ListCell
{ ^cons(carVal, append(cdrVal, arg))
}
```

```
/* cons is an example of ACTOR's optimization of private
variable references. The form cell.cdrVal is a very
efficient way of referring to the cdrVal private variable
in the local variable, cell. If the programmer were to
assign a type to cell, an even more efficient machine
language primitive would be compiled. */
```

```
Def cons(self, arg | cell)
{ cell := new(ListCell);
  cell.cdrVal := arg;
  cell.carVal := self;
  ^cell
}
```

```
/* The do function performs a post-order traversal of a
list by executing a passed-in block at each leaf (non-
list) node. */
```

```
Def do(self, aBlock)
{ if isAtom(carVal)
  then eval(aBlock, carVal);
  else do(carVal, aBlock);
  endif;
  if cdrVal
  then do(cdrVal, aBlock);
  endif
}
```

Listing 2: Another definition for `append`. In this case neither the parameters nor the return value of the function are typed, and as a result, all messages will be late-bound.

```
Def append(self, arg)
{ ^cons(carVal, append(cdrVal, arg))
}
```

jc lips

The Word is Out...

It's going to break your heart if you already own a PC.

JC LIPS provides a new experience in personal computing. Our third generation personal computer brings you technological advancement and features which have not been possible in the past. It runs all popular IBM PC software 2 to 4 times faster than other compatibles. It will impress you with unsurpassed performance and cool reliability. Best of all, it is available to you at an affordable price.

JC LIPS features the advanced-technology CMOS NEC V40 processor running at 8 MHz with an equivalent throughput of at least 9.5 MHz. The systemboard has 256K of RAM, expandable to 640K, a built-in floppy disk controller, a socket for a high speed floating point processor, and 8 I/O expansion slots. Also included as standard on systems are 360K floppy disk(s), a serial interface, a parallel printer interface, a battery backed-up clock, a keyboard, and a 135 Watt power supply, capable of handling all of this plus any accessories you may add later.

JC LIPS' display system includes a quality 14" high resolution monochrome monitor, with a dark

background non-glare screen and a tilt and swivel base for easy viewing. The multi-function display card provides an IBM PC compatible interface for a monochrome display with Hercules compatible graphics or a RGB color graphics display.

JC LIPS is also available with high speed 20 MB hard disk with 2K cache buffer memory controller, Enhanced Color Graphics display adapter, high resolution RGB color monitor, local area networking controller, and more. These options can be added at any time, and with the features we supply as standard, it will be a difficult system to outgrow.

NOW *the word is out.* Another superb product is available from the high-performance, multi-user systems company, JC Information Systems.



JC INFORMATION SYSTEMS

161 Whitney Place
Fremont, CA 94539
(415) 659-8440 TWX 910-381-7041

We designed the compiler to enforce this by requiring that any early-bound call to `append` (i.e., a message to a typed variable) must pass a `ListCell` as its argument. If `append` is invoked as the result of a late-bound message, a type-checking routine will ensure the class integrity of its parameters. This check is performed only if a function with typed parameters is invoked in a late-bound message-send.

We can control the early binding of messages to self by typing the self formal parameter. It is usually desirable to leave self untyped, however, to allow redefinition of a function in a subclass. If typed, the message to self will be bound at compile time.

Listing 2 shows an alternative version of `append` whose parameters are untyped and that does not use early binding.

USING EARLY BINDING

We designed the typing facility to be most effective when used during program optimization. During initial development, the programmer can leave all variables and functions unbound. This makes the code easier to change

and debug and minimizes dependencies between the various parts of the application. After the code is debugged and has become fairly stable, the programmer can then isolate areas that are heavily executed and begin optimizing them. Variables and functions can be bound in the time-critical methods, allowing the compiler to generate more efficient early-bound references. To attempt even better performance, high-level functions might be converted to primitive functions, until performance is acceptable. The latter step is not possible in standard Smalltalk-80, which allows the user to write only high-level methods.

INTERPRETER MODELS

Smalltalk works by compiling the source code for methods into an intermediate language. This language consists of a set of basic operations, such as fetching and storing variables, fetching literal objects, sending messages, and manipulating the stack. Theoretically, users could write in this language, but then they would be working directly with the stack in the manner of FORTH and would be with-

out the protection and sophisticated features provided by the compiler.

The job of the interpreter is to scan the intermediate code and execute machine code to make the language perform. This situation is entirely analogous to a microprocessor scanning machine instructions and executing microcode. In fact, the interpreter has a register, called the interpretive pointer (IP), that is the equivalent of the instruction pointer register in a microprocessor.

THE BYTE CODE INTERPRETER

Smalltalk's intermediate language consists of byte codes—that is, a series of bytes, each of which encodes an elementary operation in the Smalltalk "virtual machine." A compiled method consists of two data areas. First there is the "literal frame," an area in which the method stores any objects that are referred to as literals in the method. (Literals are objects created without a name, such as "A string", 12000, or #aSymbol.) This is followed by the byte code area, in which the compiler places the compiled code for the method. Several byte codes are dedicated to accessing the objects in the literal frame.

Let's examine what a small piece of compiled Smalltalk code would look like. Suppose that, in the middle of a method, the compiler sees the phrase

```
myFile := File new name: "users.txt"
```

In this phrase, `myFile` is the name of the zeroth local variable allocated by this method in its private stack. What gets compiled is a series of 5 byte codes and 3 words of literal data, for a total of 11 bytes, excluding the header (figure 3).

The first byte code fetches the contents of literal location 2 (the string "users.txt") and places it on the stack. This will later serve as the parameter for the `name:` method. The next method fetches the contents of an Association object that identifies the class `File` in the main dictionary, Smalltalk. This is the receiver for the new method, sent by the next byte code (several byte codes are dedicated to sending common messages like `new` or `at:`).

(continued)

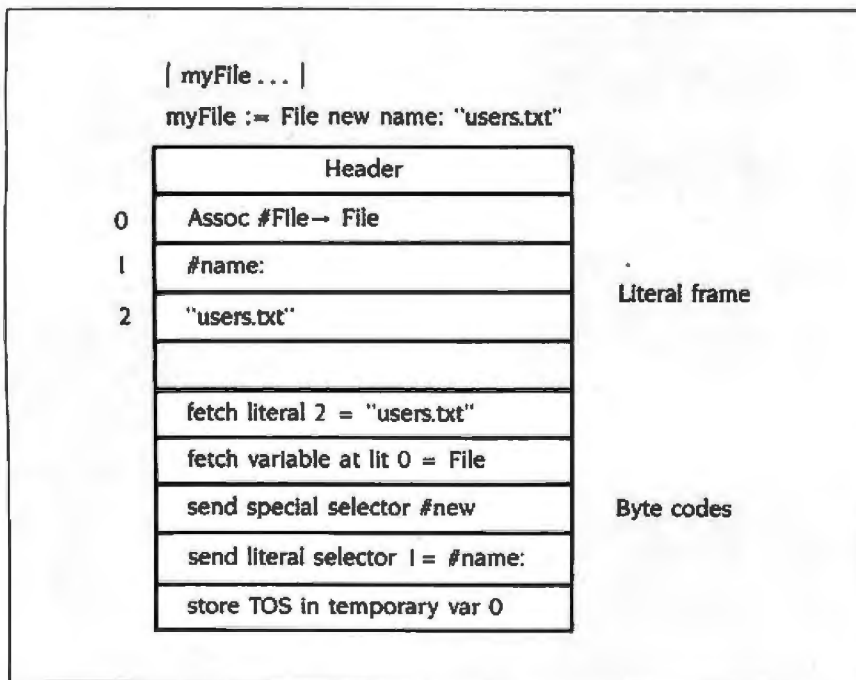

Figure 3: A sample of compiled code in Smalltalk. The compiled method consists of two data areas: the literal frame (for literal data) and a series of byte codes (1-byte instructions).

My marketing class meets when I want it to!



The Electronic University Network

For some time I've known I needed a course that would fine tune my strategic marketing skills, but with a demanding job, a family, it's not easy to do. Then I was told I missed a promotion because I needed an MBA. Still, going back to school at my age seemed nearly impossible. With my work schedule, the kids, there just isn't enough time to go to campus.

Now I go to class when it's convenient for me.

By connecting my home computer to the Electronic University Network, I can choose from 150 courses from colleges and universities all across the country, and even earn an undergraduate degree, or an MBA. **I make college fit my schedule.**

The network has put personalized instruction at my fingertips by bringing the university to me, in my home or office, at my own pace, anytime. And I'm able to work one-on-one with expert instructors from excellent schools. In effect, I have my own marketing mentor.

What's more, since the credit I have earned comes from fully-accredited colleges and universities, my company is covering 100% of the costs through its Tuition Reimbursement program.

Studying via the network is typically less expensive than equivalent on-campus courses—and no computer knowledge is needed to participate.

For details on course costs, participating schools, full degree programs, and an Electronic University Network 1986-1987 Catalog, call toll free:

800-22LEARN

California residents call:

800-44LEARN

If you're involved in employee education—ask about our corporate programs. We're currently working with corporations of all sizes across the nation to make affordable, convenient coursework available to valuable employees.

505 Beach Street
San Francisco, California 94133

COPY II PC™ OPTION BOARD



AN ALMOST FOOLPROOF WAY TO MAKE ARCHIVAL BACKUPS OF PROTECTED SOFTWARE!

The Copy II PC Option Board is an add-in board that will give your PC the same disk duplication technology used by most disk duplication firms (who put the copy protection on software in the first place).

DUPLICATES NEARLY ALL PROTECTED DISKETTES.

The Option Board can easily backup almost all protected diskettes for the IBM PC (except those "protected" by physical disk damage), including ones software-only backup programs can't touch. It even includes a track editor that will allow the more technically inclined to look at protection schemes and edit any data on a diskette.

The Option Board uses a full size slot in an IBM PC, XT or AT (with at least 1 360KB floppy disk drive), Heath/Zenith 150, 151, 158, Compaq Deskpro. Extra \$15 cable required for Compaq Portable, HP Vectra and Tandy 1000. Tandy 1000 requires 256K of memory.

Call 503/244-5782, M-F, 8-5:30 (West Coast time) with your   in hand.

Or send a check for \$95.00 U.S. plus \$3 s/h, \$15 overseas. Please specify your computer brand when ordering so we can send you the correct cable.

\$95.00

Central Point Software, Inc.
9700 S.W. Capitol Hwy., #100
Portland, OR 97219

*Central Point
Software*
INCORPORATED

Backup utilities also available for the Macintosh, Apple II, Commodore 64/128 and Atari ST.

EFFICIENT LANGUAGE

The next byte code sends the #name: selector that is stored in the literal frame at location 1. This is how any send not involving the "special" (frequently used) selectors is compiled. Finally, the result of the name: message is stored in myFile, which is temporary variable 0.

Several things are noteworthy about this arrangement. First, the literal frame is required, because only byte codes can be executed by the interpreter. Anything not a byte code (e.g., the string "users.txt") has to be stored in the literal frame and fetched by one of the access byte codes, which introduces a certain amount of overhead. Second, because the byte codes are only 1 byte in length, only 256 operations are available to the interpreter. Third, because the size of the literal frame can vary for each method, the interpreter has to calculate the address of the start of the byte code area whenever a method is executed.

THREADED INTERPRETERS

In our design of Actor, a principal goal was an efficient implementation of early binding. This led us away from the byte code interpreter to a threaded model. Early-bound function calls and literal references can be more efficiently implemented with a threaded interpreter.

There are several varieties of threaded interpreter. All models share the "threaded" aspect, which connotes building a procedure by stringing together a list of virtual or physical addresses of other procedures. At execution time, the interpreter scans through the list, picking up each thread in turn and executing it.

In a threaded environment, every object in the system, whether code or data, is assigned a "thread value." Generally, the result of executing a data object is simply the placement of its address on the stack. This works very well in an object-oriented system—a literal object simply stacks its address, which can be used as a parameter in a message.

In Smalltalk, the set of byte codes is closed and cannot be extended. In a threaded system, however, every code routine, whether primitive or

(continued)

FREE!

EXCLUSIVE TIME- AND MONEY-SAVING FEATURES:

- A complete, 96-page catalog for more than 2000 products—many available only from Inmac.
- Easy-to-use: clear, comprehensive descriptions; four-color photos of products in use; invaluable helpful hints.
- Convenient comparative shopping guides—by price, feature and quantity.
- Special sections on new products, CAD/CAM printer and plotter supplies, and the industry's most complete cable guide.
- Same-day shipping, 45-day trial, minimum 1-year guarantee, 10-year history of satisfied customers!

**CALL TOLL-FREE
1-800-547-5444
TODAY!**

Or complete and return the coupon below.

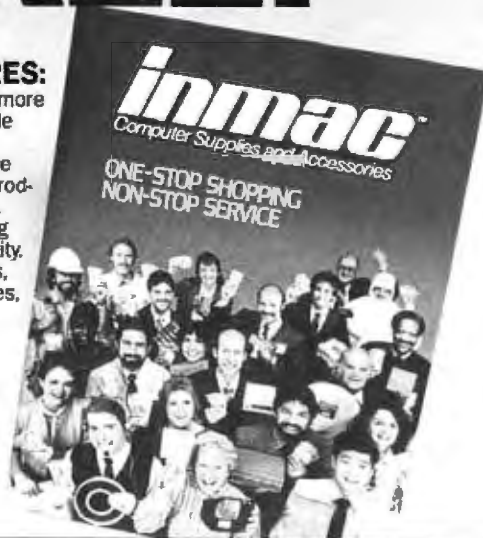

Simply mail your completed coupon to:

inmac™

Catalog Department
2465 Augustine Drive
Santa Clara, CA 95054

Or call
1-800-547-5444

Name _____

Company _____

Address _____

City _____ State _____ Zip _____

Phone (_____) _____ - _____

5029

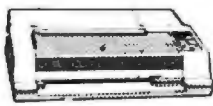

SAVE ON THESE IN STOCK PRINTERS



NX-10....CALL

STAR MICRONICS

NX-10 (NEW)	CALL
NB-15 (NEW)	CALL
SB-15 (NEW)	CALL
SG-15	367
SD-10	319
SD-15	438
SR-10	469
SR-15	578
SB-10	589
Powertype	297

EPSON

LX80	209
FX85	369
DX10	207
Hi80	355
HS80	298
FX285	529
LQ800	529
LQ1000	659

TOSHIBA

P1340	469
P351+	1149
P341P	969
P341S	999
351 Sheet Feeder	529

SEIKOSHA

SP-1000 VC (C-64)	185
SP-1000 A Centronics	197
SP-1000 I IBM	197
SP-1000 AS RS-232	197
SP-1000 AP Apple IIc	197
BP-5200 I	649
SP-1000 ribbon	8 50
BP-5200 ribbon	12 50
BP-5420	999

BROTHER

HR-15XL-P	359
HR-15XL-S	359

DIABLO

D25	549
D80 1 F	2395
P 32 CO 1	699
P-38	1749
C-150	999
635	1029

C. ITOH

1550 SP+	Call
D1040	Call
Prowriter Jr	Call
Prowriter 8510 SP+	Call

1080\$199

PANASONIC

1080	199
1091	226
1092	325
3131	257
3151	399
1592	439
1595	NEW

JUKI

Juki 6100	339
RS232 Serial Board	55
6100 Tractor	119
6100 Sheet Feeder	209
Juki 6300	757

OKIDATA

Okimate 10	179
182	214
192	343
193	563

LEGEND

1080	Call
1380	258
1385	289
808	148

SILVER REED

EXP 420 P	209
EXP 600 P	489
EXP 800 P	649

CITIZEN

MSP-10	268
MSP-15	377
MSP-20	355
MSP-25	528
120-D	195
Premier 35	469

MONITORS

TEKNIKA

MJ-10	175
MJ-22	250
MS-305 RGB	NEW

AMDEK

300 Green	118
300 Amber	128

SAKATA

SG 1000 12" Green	99
SA 1000 12" Amber	109
SG 1500 12" Green TTL	119
SA 1500 12" Amber TTL	129
STS1 Tilt stand	29

THOMSON

CM36512V1	299
CM36632	159

ZENITH

ZVM 1220	95
ZVM 1230	95
ZVM 1240	149

PRINCETON GRAPHICS

MAX-12 Amber	175
HX-12 RGB	458
SR-12 RGB	575

COMMODORE

1802 Color	CALL
1802 Color	CALL

DISKETTES

MAXELL

5 1/4" SSDD	11 99
5 1/4" DSDD	15 99

VERBATIM

5 1/4" SSDD	9 99
5 1/4" DSDD	13 99

SUNKYOUNG

SKC 5 1/4" SSDD	11 99
SKC 5 1/4" DSDD	13 99

DISK NOTCHERS...\$7.95!!

BONUS

5 1/4" SSDD	6 99
5 1/4" DSDD	8 99

MISCELLANEOUS

DUST COVERS

PC-AT 2 pc	10 99
PC-XT 2 pc	10 99

QUADRAM

Gold quadboard	399
Silver quadboard	229
Quadboard	189

JOYSTICK

Tac 10 (Ap/Pc).....22.95

STB

EGA Plus	329
----------	-----

AST

Six Pack Plus	209
---------------	-----

MODEMS

US ROBOTICS

Password 1200M	189
Password 1200F	229
Password 300M	139
Password 300F	139
Courier 2400	395

HAYES

Smartmodem 300	133
Smartmodem 1200	377
Smartmodem 1200B	347
Smartmodem 2400	598

ANCHOR

Volksmodem	55
Volksmodem 12	179

COMPUSERVE...18.95

DRIVES

TYMAC

MDD-640 3 1/2"	
Apple Drive 640K	289

TANDON

320K 5 1/4" Drive	115
-------------------	-----

INDUS

GT Atari	Call
----------	------

COMTEL

Enhancer 2000 (C-64)	155
----------------------	-----

IBM-PC COMPATIBLE

SUBLOGIC (IBM)

Jet Simulator	34 95
Scenery Disks EA	14 95
Set 1-6	69 95

SSI (IBM)

Battle for Normandy	24 95
Knights of Desert	24 95
Tigers in Snow	24 95
Computer Baseball	24 95
Cartels & Cutthroats	24 95
OP Market Garden	29 95
50 Mission Crush	24 95

BRODERBUND (IBM)

Bank St. Writer	48 95
The Print Shop	34 95
Graphics Library 1	22 95
Ancient Art of War	27 95
Champ Lode Runner	22 95
Karateka	22 95

ACTIVISION (IBM)

Borrowed Time	24 75
Mindshadows	24 75
Music Studio	29 95
Alter Ego	29 95

SYNAPSE (IBM)

Symstock	64 95
Essent	28 95
Wizard of Wall St	28 95
Brimstone	28 95



TO ORDER



Inquiry 173

or send order to
Lyc0 Computer
P.O. Box 5088
Jersey Shore, PA
17740

CALL TOLL FREE 1-800-233-8760
In PA 717-494-1030
Customer Service 717-494-1670

RISK FREE POLICY

In-stock items shipped within 24 hours of order. No deposit on C.O.D. orders. Free shipping on prepaid cash orders within the continental U.S. Volume discounts available. PA residents add sales tax. APO, FPO, and International orders add \$5.00 plus 3% for priority mail service. Advertised prices show 4% discount for cash, add 4% for MasterCard and Visa. Personal checks require 4 weeks' clearance before shipping. Ask about UPS Blue and Red label shipping. All merchandise carried under manufacturer's warranty. Free catalog with order. All items subject to change without notice.

TOLL FREE 1-800-233-8760

LYCO COMPUTER MARKETING & CONSULTANTS

high-level, is assigned a thread value. Any high-level routine or primitive can be called (early-bound) by compiling its thread value in-line. There is a certain elegance in referring to system primitives and user routines through the same mechanism.

Another benefit that threading provides is the ability to add primitives to the system easily. In Smalltalk, a special mechanism is used for dis-

patching primitives, and there is no provision for users to add their own. But in FORTH users can recode certain time-critical words in machine code. Because this can be done so easily, it is an effective and powerful technique for improving performance.

TOKEN THREADING

Using physical addresses as thread values is difficult, however, in a

garbage-collected system. We need to be able to move objects around very easily without having to update a lot of references to the obsolete addresses. This is the rationale for the object table in Smalltalk. An object is referred to via its object pointer (OP), which is an index into the object table. That location contains the physical address of the object and is the only place that requires updating if the object is moved.

This architecture is very reminiscent of what is called a token-threaded system in the world of threaded languages. A token table fills the same role as the object table in Smalltalk. However, in Smalltalk the object table is discrete from the byte code interpreter. For instance, you could not compile an object pointer in-line in a Smalltalk method and expect the code to execute properly. Object pointers are passive, serving only as a means of finding an object's data address. Tokens, on the other hand, are associated with executable machine code, regardless of whether they point to data or a routine.

In our design of Actor, we integrated the concepts of object table and token table, along with the byte code and primitive dispatch tables from Smalltalk (see figure 4). Every type of object, primitive, or high-level routine has an entry in the object table and is active in the sense that its object pointer can be executed. Each object also belongs to a family that describes its behavior when interpreted. The family code is embedded within the object table entry and is used to dispatch a machine language routine in the interpreter.

This architecture makes it very easy to accomplish early binding. To bind a function call at compile time, its object pointer is simply compiled in-line. A function is then an object whose family behavior is to execute itself. When the interpreter hits the function OP, it executes code that causes the old IP to be stacked and the IP is set to the beginning of the function's data area, which may contain a series of threads to other functions and objects. By contrast, a late-bound send is compiled as the OP of a machine

EditCheck syntax checks C source programs from within its multi-window editor.

EditCheck is a new kind of programmer's tool that provides an integrated C language source code programming platform. It improves your productivity, and reduces your frustration caused by making multiple cycles between a program editor and a compiler to manually locate and eliminate syntax, semantic, and other errors in your programs.

You can think of EditCheck as a powerful editing and program checking facility that works as a front-end companion to your C compiler.

EditCheck consists of an extensive C language source program checker, a window-oriented full screen editor, a file access facility, and a context sensitive on-line help facility, all united in a consistent, integrated environment platform that extensively uses a fast windowing system.

All EditCheck commands can be executed through single keystrokes, or thru a fast pop-up menu system, or by a combination of keystrokes and menu choices. All keystroke commands can be user reassigned to any keyboard key.

INTERACTIVE INTRA & INTER-MODULE CHECKING

The heart of EditCheck's contribution is a powerful C language program checker which provides strong type checking from within the editing environment. The "lint like" checker does a thorough evaluation of your source code and detects common errors and questionable practices, including many that most C compilers will overlook. The checker is based on "K & R" C specs plus Unix extensions and "lint" functions.

The checker runs interactively on part or all of a source program file, or group of program files. It opens a context window on the file where an error is detected and highlights the token which was being parsed when the error was detected. It also opens a message window with a descriptive error message, and presents a menu of options which you can take to correct the error.

The checker allows you to provide a program module list for complete checking or checking of unchecked modules. You can also check the modules in this list in batch mode if you desire.

Everest Solutions Inc.
3350 Scott Blvd., Bldg. 58
Santa Clara, CA 95054
(408) 986-8977

Inquiry 107

The source program checking capabilities in EditCheck will substantially increase your speed in achieving error-free C programs.

WINDOW-ORIENTED FULL SCREEN EDITOR

EditCheck's editor allows you to edit text in the current window and to copy or move text within or between windows. The editor supports both horizontal and vertical scrolling, and allows you to use marks and zones, move the cursor to specified objects, search and replace (case sensitive or insensitive), change case of the text, control input mode, etc.

The editor uses a file paging scheme which allows you to edit and check modules larger than your available RAM memory. Any ASCII file may be read by the editor. Files may be inserted or appended to the current window file.

The editor is both key-command driven and menu driven, or mixed usage. Key-commands are fully user reassignable.

WINDOWS, FILES AND MORE

The EditCheck environment is window oriented. You may have as many windows open at the same time as you wish. Windows may overlap or be tiled, at your option. You may switch back and forth between windows, and move or copy information between them.

The windows which you open may display different files or multiple different areas of the same file. You control the location and size of all user windows, and can save the contents of a window, hide it, bury it, close it, or show it.

Windows are also extensively used by the EditCheck system to build commands, display help, show a module list, display messages, show program context while checking, etc.

Access to some of the DOS file-oriented commands is also provided from within EditCheck.

A group of environment commands are available to change the coloring of windows (with a color graphics adaptor and display), set the way you are notified of errors, and redefine the meaning of keys on the keyboard.

CONTEXT SENSITIVE HELP

Help is available to you in several ways. You may use a function key to get context sensitive help particular to where you are in the system. You may select the help index, and choose a topic of interest. You may also ask the help subsystem to search for a particular word of interest within the entire system. Display of current key bindings is also available.

SYSTEM REQUIREMENTS

EditCheck requires an IBM PC/XT/AT or compatible, with 384K RAM, 2 flexible 5.25 inch disk drives or one flexible and one hard disk, DOS 2.0 or later.

HOW TO GET EDITCHECK

You can order today by mailing the coupon, or by phoning our toll free number. Send your check with the coupon, or we can ship COD (US only) or on your purchase order. No Credit Cards at this time. Outside USA please pay in US funds.

EditCheck

Everest Solutions, Inc.
3350 Scott Boulevard, Bldg. 58
Santa Clara, CA 95054

To Order Call:
1-800-621-0854 Ext. 923

or Send Coupon:

Please rush me EditCheck with 30 day money back guarantee, and without copy-protection.

Price \$90.00 plus applicable charges:
(Please check items below)

___ CA. resid. add. Sls. Tax: \$6.30
___ Ground ship add: \$3.00
___ USA Air Ship add: \$5.00
___ Outside USA Air Ship add: \$9.00
___ COD or Purch. Ord. add: \$5.00

Amount Enclosed: _____
or: COD requested (USA only) _____
or P.O. # _____

Co. Name _____

Name _____

Street _____

City _____

State _____ Zip _____

Day Phone _____

(continued)

WHERE

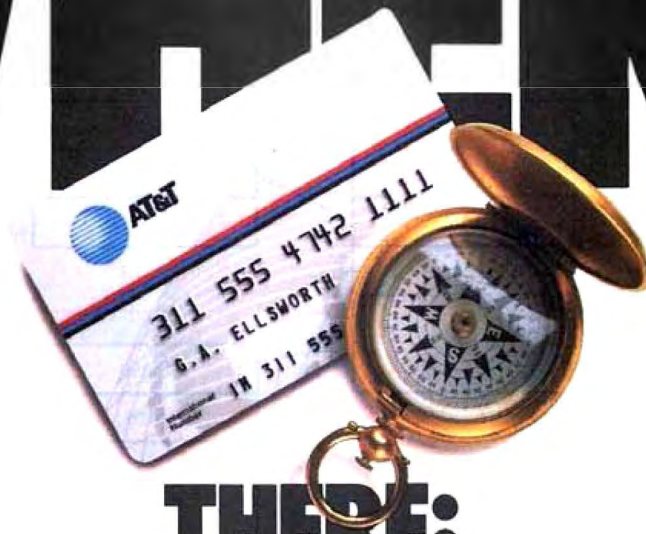

THERE:

From the United States you can call just about anywhere in the world through the vast, reliable AT&T Long Distance Network.

So, whether you're doing business near the corn fields of Kansas or the rocky coast of Maine, the AT&T Long Distance Network is virtually as close as the nearest phone.

And, you can always count on the nationwide AT&T Long Distance Network's quality service. Providing you with full service AT&T long distance operators ready to help place calls or give credit for misdialed long distance numbers.

And, whether you're traveling around the country or to many foreign locations, it's reassuring to know you have the AT&T Card.

Use the AT&T Card to plug into the AT&T Long Distance Network. To order your AT&T Card today, simply dial

1 800 CALL ATT, Ext. 229.



AT&T

The right choice.

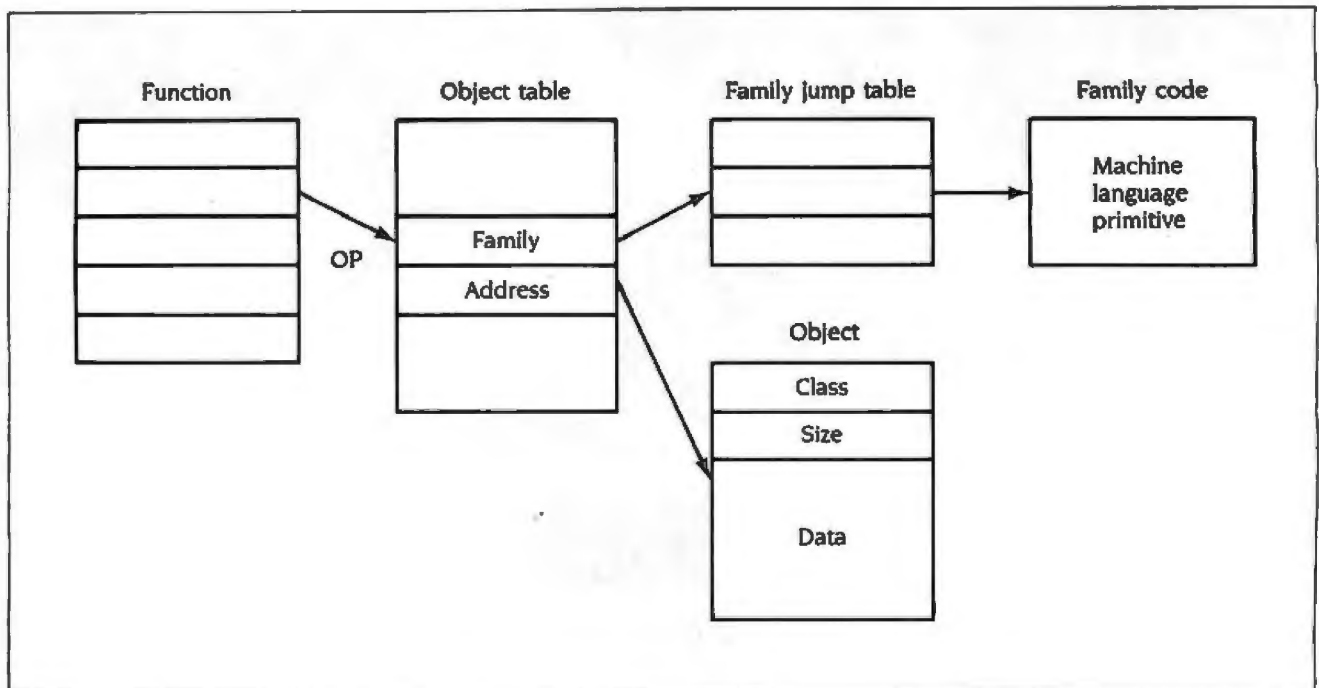

Figure 4: An example of token threading as implemented by Actor. Here a function consists of a list of object pointers (OPs), which are offsets into the object table. The interpreter scans through the OPs and executes the code relating to the "family" for each OP. If the OP is in the Primitive family, its respective data consists of machine code, which is executed directly. If the OP is in the Function family, the current instruction pointer is placed on a stack and the interpreter begins executing the OPs within that function. For most objects, the family code simply places the OP on the stack so it can be passed as a parameter or used as a receiver of a message.

language primitive followed by the OP of a symbol.

Because of this difference in design, a piece of compiled code in Actor would look much different from an equivalent piece of Smalltalk code. The Actor code would lack the literal frame. This means that all functions have their code starting at the same offset. It also simplifies the construction of the interpreter and the compiler.

If early binding is used, the compiled Actor code fragment should actually be shorter than the equivalent Smalltalk code, even though each "operation" code is 2 bytes long instead of 1! The threaded model also allows more extensive optimization on the part of the compiler and allows for easy extension should the current set of primitives prove incomplete.

SYNTAX

Another aspect of efficiency relates not to the performance of a particular application, but to the time required to train a programmer how to write

that application. Smalltalk's syntax can be initially confusing to the casual reader. It is sometimes difficult to sort out the relationships between identifiers in a moderately complex phrase, since the infix notation fails to make the precedence explicit.

In our design of Actor, we decided to use a conventional, Pascal-like syntax as a means of reducing the learning load on new programmers. There is enough to absorb in learning the object-oriented paradigm itself, along with the hundreds of classes and their methods, without having to learn a completely new syntax.

CONCLUSION

There are several areas in which the basically successful model of object-oriented programming developed in Smalltalk could be made more suitable for personal computing environments. In our design of a new language called Actor, we have implemented some of these.

Our goal was to design a threaded interpreter with an intelligent com-

piler that could support user primitives and optimize message passing by using early binding. We also designed an incremental garbage collector with sensitivity to object lifetimes that eliminates the long pauses and general inefficiency of other garbage-collection techniques. Finally, a syntactical model that is closer to Pascal reduces the learning load for new programmers.

There seems to be a critical mass of interest developing in object-oriented programming. It is my belief that more efficient and accessible implementations of object-oriented languages will promote their much wider use in solving sophisticated personal computing problems.

Editor's note: Actor is scheduled to be available from the Whitewater Group (906 University Place, Evanston, IL 60201) for the IBM PC, XT, and AT in October. It will include the Microsoft Windows environment and provide interactive access to Windows system routines. It will also include a set of classes designed to support list processing and predicate logic for AI applications. ■



BYTE

Mindware.

Subscribe to BYTE, the small systems journal. Every month we'll send you a volume jam-packed with information on hardware, software, applications and product reviews. Read your first issue. If it isn't everything you expected, write "cancel" on our invoice. The trial issue is yours to keep.

United States

1 yr. \$21 (12 issues)

Canada or Mexico

1 yr. \$23 US (12 issues)

- Europe, 1 yr. air deliv. \$69 US
(Please remit in US funds drawn on a US bank.)
- Worldwide 1 yr., surface deliv. \$37 US
(Air delivery available upon request)
- VISA MasterCard Bill me (US only)

4686

Please Print

Name _____

Address _____

City _____

State/Province/Country _____

Code _____

Card # _____

Expires _____

Signature _____

Allow 6-8 weeks for processing





NO POSTAGE
NECESSARY
IF MAILED
IN THE
UNITED STATES

BUSINESS REPLY MAIL

FIRST CLASS PERMIT NO. 39 MARTINSVILLE, NJ

POSTAGE WILL PAID BY ADDRESSEE

BYTE

Subscription Dept.
P.O. Box 597
Martinsville, NJ 08836

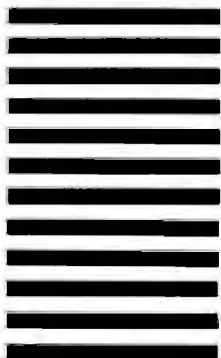

Read what the experts say about the PC's Limited AT.

"I have no qualms recommending this system to experienced users who need the added speed."

—Sol Libes,
Micro/Systems Journal,
January/February 1986

30 DAY
Money-Back
Guarantee



"The PC's Limited AT" proved to be the functional equivalent to the IBM® product, only faster. Priced at roughly one-third less, it rates as one of the best bargains available."

—Winn L. Rosch,
PC Magazine,
February 25, 1986

"If price is your primary consideration, skip both AT&T® and TI® and choose this issue's best buy, the PC's Limited AT™. Check its benchmark results—you won't be sacrificing performance to save money."

—*PC Magazine*,
Editor's Choice,
February 25, 1986

**And if that's not enough to convince you,
now we've got a 30-day money-back guarantee.**



- One Year Limited Warranty
- 80286-based System Unit (Runs at 6MHZ. 8MHZ option included at no extra charge.)
- 1024K on Mother Board
- 1.2 Meg Floppy Drive
 - Combined Floppy/Hard Drive Controller Card
 - AT Keyboard
- 192W Power Supply
 - 2 Serials and 1 Parallel Port
- Clock/Calendar with Battery Backup
- Operations Manual

\$1495

I'm Michael Dell, President of PC's Limited. And I want you to know about your latest industry-leading step. We're so sure that you'll like everything about our PC's Limited AT that we're willing to offer you a 30-day money back guarantee on it. This machine, with 1024K on the Mother Board and an 8MHZ option included at no extra cost, has been a standout since we introduced it. So give us a chance to show you what it can do for your operation. With a deal like this, there's no way you can lose. (And see the opposite side of this page for information about our Turbo PC™, plus details on our guarantee.)

Michael Dell

When a PC's Limited Turbo PC is on your desk, you'll think it's a headliner too.

"... a good machine. And a heck of a buy... a fine box. One I'd happily choose over Big Blue's original... no status... beyond the status that attaches to getting twice as much for your money."

—Jim Seymour,
PC Week,
August 13, 1985

"It almost sounds unbelievable."

—*MIS Week,*
August 21, 1985

"We tested a wide variety of software on the machine and everything ran well... The bottom line for anyone considering buying one of these computers would seem to be this: PC's Limited sells quality systems for extraordinarily low prices."

—*PC Week,*
October 29, 1985

TOTAL SATISFACTION GUARANTEE WARRANTY

For Warranty Service: One year Limited Warranty on PC's Limited products. Contact Technical Support for a Return Authorization Number (RMA). Returns must be accompanied by your RMA, the invoice, and a brief explanation. During the Warranty Period, PC's Limited will repair or replace items at our option.

30-DAY TOTAL SATISFACTION GUARANTEE

Items now bought from PC's Limited may be returned within 30 days from the date it was shipped for a full refund of your purchase price. Returned items must be unused, not modified or damaged, with all warranty cards, manuals, and packaging intact. Returned items must be shipped prepaid and insured, and must bear a PC's Limited Credit Return Authorization (CRA) on the shipping label. All PC's Limited's Customer Support Department for CRA. No credits issued after 30 days from date of shipment.

CONSUMER TIP

When shopping for PC products, ask our competitors about their refund policies.

- 16-bit 8088-2 System Unit (runs at 4.77 or 6.66MHZ)
- 640K on Mother Board
- 360K Floppy Drive
- AT Keyboard
- 130W Power Supply
- Operations Manual
- One Year Limited Warranty

\$795



Our Turbo PC™ has sold in large quantities since the first week we introduced it. Of course, that's not surprising, since we were the first company to break the \$800 barrier with a machine that outruns the "Big" name by a 40% speed factor. Now, we're going to extend the margin even further by offering a 30-day money back guarantee. If that sounds good, it'll look even better when one of our Turbo PC's is on your desk. So call us today. We're guaranteeing you'll like what you get.

Order guarantee may be limited. PC's Limited and equipment certified as to compliance with FCC Class B standards. All prices are subject to change without notice.



PC'S LIMITED™

SALES CALLS OUTSIDE TEXAS, 1-800-426-5150

SALES CALLS INSIDE TEXAS, 1-800-252-8336

1611 Headway Circle, Building 3, Austin, Texas 78754

Sales Calls from anywhere in the country, (512) 339-6962

Technical Support Calls, (512) 339-6963 Customer Service Calls, (512) 339-6964

*Limited Warranty

Telex No 9103808386 PC LTD FAX (512) 339-6721



Call for latest prices.

FREE SHIPPING

in the Continental United States via UPS Ground.

NO SURCHARGE FOR



OR



Floppy Disk Drive

Also available for AT™ in Gray Color.

MITSUBISHI ELECTRONICS
Half-Height, DS/DD **\$95**

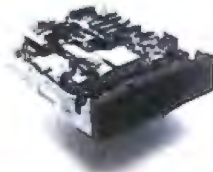

PC's Limited AT Multifunction Card

- Expandable To 3 Meg (1.5 on Board/1.5 on Piggy Back Board)
- Supports 64 or 256K Rams
- Parallel Port
- Serial Port (2nd Serial Optional)



\$199 w/OK Piggy Back Board \$59 w/OK

PC's Limited Mini I/O

- Serial Port
- Parallel Port
- Clock
- Software
- Fits In Short Slot

\$99

300/1200 Baud Hayes Compatible Modem Fits in Short Slot



\$159

64K RAM \$10 per set
Set of 9 chips, 200 or 150 Nanoseconds

256K RAM \$29 Set of 9 chips
150 Nanoseconds

UNIVERSAL GRAPHICS CARD II

\$199

- Fully compatible with IBM CGA, Plantronics COLORPLUS IBM Monochrome, and Hercules compatible graphics modes
- Includes Parallel Port and fits in a "short" slot



Seagate 20 30 and 40 MEG High Speed 40 MS Access Time Hard Drives for AT™

Uses Linear Voice Coil Actuator.

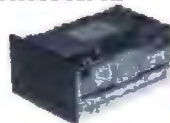

Heads park automatically at power down.

20 MEG \$579
30 MEG \$699
40 MEG \$819

Includes Seagate Full Bright Hard Disk, Cable, and Mounting Bath. Runs from Hard Disk. One Year Warranty.

PC's Limited PC-576 RAM Board

- Expandable to 576K
- Supports 64K or 256K RAMS
- Fits In Short Slot

\$69 w/OK



PC'S LIMITED Six Function Card

- Upgradable to 384K
- Clock/Calendar
- Includes Software
- Parallel Port
- Serial Port
- Game Port



Two Year Warranty

w/OK \$99 w/384K \$129

SOLVE YOUR POWER PROBLEM.

XT™ POWER 130W \$99



Directly replaces power supply in PC.™ Fully XT™ compatible. One Year Warranty

PC'S LIMITED MONO-1 MONITOR \$169
PC'S LIMITED RGB-1 MONITOR \$459



- 11-inch screen
- Amber
- Compatible with monochrome or color graphics cards



- 130M dot pitch
- RGB input
- 11-inch screen
- 600x360 resolution
- 16 colors

Wangtek 60 MEG Tape Backup System

- Backs up 4 Megs per minute
- Runs under MS-DOS or PC-DOS, Novell, Xenix
- Pulse Software Included

\$795

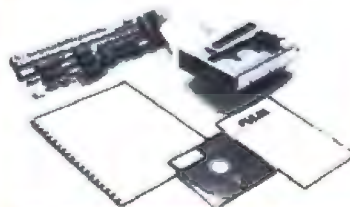

Tandon HD - Western Digital Controller 20 MEG Hard Disk System for PC

Internal \$409



Includes Tandon Hard Disk, Western Digital Controller, Cables, Manual, Software, and Mounting Hardware. Runs From Hard Disk. One Year Warranty

Buy a second 20 MEG Hard Drive to your system with the PC's Limited Hard Disk Kit—Two 20 MEG Hard Drives disassembled together, plus a controller card—\$895.

Our Hard Disk Systems are compatible with the latest versions of the following Computer: IBM PC, IBM XT, AT&T 6300, Compaq Deskpro, Tandy 1000, Tandy 1200 PC, Limited Turbo PC, Leading Edge PC (both Models), Sperry PC, Wyse PC, Televideo PC, Faraday Mother Boards, Contax PC, Eagle PC, ITT PL, and most other compatibles.

PLEASE SPECIFY YOUR COMPUTER TYPE WHEN ORDERING.

WARRANTY

One Year Warranty for the PC's Limited Hardware on PC's Limited products. Computer Technical Support for a System Authorization Number (SANA). Reviews must be accompanied by your RMA, the license, and a brief explanation. During the Warranty Period, PC's Limited will repair or replace items at our option.

30-DAY TOTAL SATISFACTION GUARANTEE

Any item bought from PC's Limited may be returned within 30 days from the date it was shipped for a full refund of your purchase price. Returned items must be in original, unmodified or damaged, with all necessary cards, manuals, and packaging intact. Returned items must be shipped prepaid and insured, and must bear a PC's Limited Credit Return Authorization (CRA) on the shipping label. Call PC's Limited's Customer Support Department for CRA. No refunds issued after 30 days from date of shipment.

CONSUMER TIP

When shopping for PC products, ask your computer store about their refund policies.

☐ Ad Number 408/86

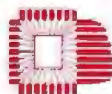

PC'S LIMITED

SALES CALLS OUTSIDE TEXAS, 1-800-426-5150
SALES CALLS INSIDE TEXAS, 1-800-252-8336

1611 Headway Circle, Building 3, Austin, Texas 78754

Sales Calls from anywhere in the country, (512) 339-6962

Technical Support Calls, (512) 339-6963 Customer Service Calls, (512) 339-6964

Telex No 9103808386 PC LTD FAX (512) 339-6721

*Limited Warranty

Panasonic, T&E, Mitsubishi, Intel, IBM, Hercules, Plantronics, Seagate, Western Digital, AT&T, Compaq, Tandy, Leading Edge, Sperry, Wyse, Televideo, Faraday, Contax, Eagle, and ITT are registered trademarks of their respective companies. IBM PC, IBM XT, IBM AT, are trademarks of IBM Corporation. Leading Edge PC, Sperry PC, Wyse PC, Compaq Deskpro, Televideo PC, Contax PC, Eagle PC, AT&T 6300, Tandy 1000 and Tandy 1200 are trademarks of their respective companies.

Some quantities may be limited. PC's Limited sells equipment certified to be compliant with FCC Class B standards. All prices are subject to change without notice.

MICRO CAP and MICRO LOGIC put your engineers on line... not in line.



MY OWN WORKSTATION



How many long unproductive hours have you spent "in line" for your simulation? Well, no more. MICROCAP and MICROLOGIC can put you on line by turning your PC into a productive and cost-effective engineering workstation.

Both of these sophisticated engineering tools provide you with quick and efficient solutions to your simulation problems. And here's how.

MICROCAP: Your Analog Solution

MICROCAP is an interactive analog circuit drawing and simulation system. It allows you to sketch a circuit diagram right on the CRT screen, then run an AC, DC, or Transient analysis. While providing you with libraries for defined models of bipolar and MOS devices, Opamps, transformers, diodes, and much more, MICROCAP also includes features not even found in SPICE.

MICROCAP II lets you be even more productive. As an advanced version, it employs sparse matrix techniques for faster simulation speed and larger net-

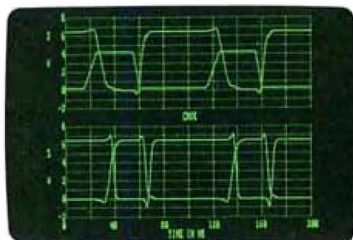

"Typical MICROCAP Transient Analysis"

works. In addition, you get even more advanced device models, worst case capabilities, temperature stepping, Fourier analysis, and macro capability.

MICROLOGIC: Your Digital Solution

MICROLOGIC provides you with a similar interactive drawing and analysis environment for digital work. Using standard PC hardware, you can create logic diagrams of up to 9 pages with each containing up to 200 gates. The system automatically creates the netlist required for a timing simulation and will handle networks of up to 1800 gates. It provides you with libraries for 36 user-defined basic gate types, 36 data channels of 256 bits each, 10 user-defined clock waveforms, and up to 50 macros in each network. MICROLOGIC produces high-resolution timing diagrams showing selected waveforms and associated delays, glitches, and spikes—just like the real thing.

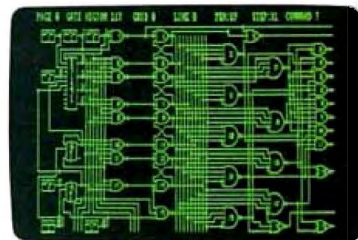

"Typical MICROLOGIC Diagram"

Reviewers Love These Solutions

Regarding MICROCAP... "A highly recommended analog design program" (PC Tech Journal 3/84). "A valuable tool for circuit designers" (Personal Software Magazine 11/83).

Regarding MICROLOGIC... "An efficient design system that does what it is supposed to do at a reasonable price" (Byte 4/84).

MICROCAP and MICROLOGIC are available for the Apple II (64k), IBM PC (128k), and HP-150 computers and priced at \$475 and \$450 respectively. Demo versions are available for \$75.

MICROCAP II is available for the Macintosh, IBM PC (256k), and HP-150 systems and is priced at \$895. Demo versions are available for \$100.

Demo prices are credited to the purchase price of the actual system.

Now, to get on line, call or write today!

Spectrum Software

1021 S. Wolfe Road, Dept. B
Sunnyvale, CA 94087
(408) 738-4387

Inquiry 278

OBJECTORIENTED FORTH

BY DICK POUNTAIN

*A new mechanism for designing
and writing FORTH programs*

THE FORTH EXTENSIONS I describe in this article introduce object-oriented features that greatly simplify the design and coding of many data-intensive programs. When compiled into a FORTH-83 standard system, these extensions add a new mechanism for defining abstract data types, which are well suited to the description of real-world objects.

For programmers already familiar with FORTH, the new mechanism enables you to write object-oriented programs similar in some ways to Smalltalk-80 programs, although it does not include the full power of Smalltalk. In fact, the mechanism is closer to the "package" mechanism used in Ada, but since it's written in FORTH, it's fully interactive.

ABSTRACT DATA TYPES

An abstract data type describes a class of program objects in two ways. First, it describes the representation of such objects, that is, the shape and size of memory that they're made of. Pascal records and C structures are examples of such descriptions from other languages. Second, an abstract data type describes the operations that can be used to access objects. These operations are hidden from the rest of the program—an object can be accessed only by these operations and by no others. This provides great security; it is not possible to corrupt complicated data structures by using the wrong methods to access them.

But before anyone starts to panic that I'm about to launch into a computer science lecture, let's look at an example of an abstract data type definition.

A good example to start with is the complex number, and for the sake of simplicity, I'll restrict it to an integer

complex number. A complex number is represented by two components, its real part and its imaginary part. Thus, its representation will consist of two integer variables called REAL and IMAG.

I could define any number of operations on complex numbers, but for now I'll define just the equivalent of FORTH's @ (fetch) and ! (store) operations and call them COM@ and COM!. The definition looks like this:

```
TYPE> COMPLEX
2 VAR REAL
2 VAR IMAG
OPS>
:COM@ REAL @ IMAG @ ; ( --- n n )
:COM! IMAG ! REAL ! ; ( n n --- )
ENDTYPE> COMPLEX
```

The definition of COMPLEX is in two parts, separated by the word OPS>. Between TYPE> and OPS> is the description of the representation, namely two variables, each 2 bytes in size (2 VAR), called REAL and IMAG. Between OPS> and ENDTYPE> are the operations permitted on the type, in the form of two normal FORTH colon definitions that use the variables REAL and IMAG. Such operations can freely use any words from the normal FORTH vocabularies but cannot "see" the operations inside another type.

TYPE>, VAR, OPS>, and ENDTYPE> are some of the new words defined in the source code that accompanies

(continued)

Dick Pountain is a technical author and software consultant living in London, England. He can be contacted c/o BYTE, One Phoenix Mill Lane, Peterborough, NH 03458.

this article, which needs to be compiled before you can define any types. [Editor's note: The source code for the program examples, TYPES.DOC (an ASCII file), is available in a variety of formats. See page 405 for details. The source code compiles to less than 1500 bytes, so it can be used on quite small FORTH systems.]

When a type definition such as COMPLEX is compiled in a FORTH system, inspection of the dictionary will reveal only the single word COMPLEX. All the internal detail—REAL, IMAG, COM@, and COM!—is hidden from view and from use. If you try to enter the word REAL, for example, FORTH will tell you that it's undefined.

Your system will warn you that COMPLEX has been redefined when you compile this definition. This makes the syntax prettier, and it also places a copy of the type name inside the operations vocabulary, which can be used by various debugging tools.

To use this type definition you have to create an instance of the type, which you do by using the word COMPLEX. If you say

```
COMPLEX FRED
```

a new complex variable called FRED will be created in the dictionary. This variable responds to the messages COM@ and COM!. Note that the message-passing syntax is reverse Polish, so if you say

```
23 45 FRED COM!
```

the numbers 23 and 45 will be stored in FRED as its real and imaginary parts. Saying

```
FRED COM@
```

results in 23 and 45 being placed on the stack. In other words, FRED behaves like a FORTH variable, but one with an internal structure. What's more, you can access this internal structure only by the operations COM@ and COM!. If you say FRED @ or FRED + or follow FRED by anything other than COM! or COM@, then an "undefined operation" error message will be issued.

You can create any number of named complex variables, just as you can create any number of ordinary FORTH variables. The complex variables all have the same internal structure (i.e., two 16-bit integers), and all respond only to COM! and COM@.

It is often convenient when using structured variables like this to initialize them to default values. Otherwise, you might waste a lot of code initializing them—don't forget that they could be much bigger and more complicated than COMPLEX. (Note that the ordinary FORTH word VARIABLE allows initialization in FIG-FORTH but not in FORTH-79 or -83.) For this reason I've included the special operation INIT. If this operation is added to a type definition, it will be executed automatically when a new instance is created. So if you say

```
TYPE> COMPLEX
2 VAR REAL
2 VAR IMAG
OPS>
: COM@ REAL @ IMAG @ ; --- n n )
```

```
: COM! IMAG ! REAL ! ; ( n n --- )
: INIT 0 IMAG ! 0 REAL ! ;
ENDTYPE> COMPLEX
```

then FRED or any other instance will be created with zero values for its two parts, rather than random values. You can place INIT anywhere between OPS> and ENDTYPE>.

Another useful and powerful facility would be the ability to create arrays of structured data objects of type COMPLEX, and the word ARRAY-OF allows just this. The statement

```
20 ARRAY-OF COMPLEX JIM
```

creates an array of 20 objects of type COMPLEX. You can access the individual objects by prefixing the name JIM with an index (starting with 0). Thus 0 JIM is the first object in the array, while 19 JIM is the last object. The objects otherwise behave just like simple objects of type COMPLEX, so

```
23 45 5 JIM COM!
```

stores 23 and 45 in the sixth element of the array. Of course, we could also say

```
FRED COM@ 5 JIM COM!
```

When compiling references to an array, you can indicate that the index is a constant known at compile time as follows:

```
: TEST VAL[ 3 ] JIM COM@ ;
```

This permits compilation of the actual address of the element and gives better performance than

```
: TEST 3 JIM COM@ ;
```

although both lead to the same result.

A word of warning: The system as given here has no array-bounds checking, so you could say 30 JIM and blow the system away. This was done deliberately for efficiency and to keep the code simple. In true FORTH style, you have a choice. Either you can do array-bounds checking at the application level, or you can add a bounds check to the word INDEX+ in screen 10 of the source code.

COMPOUNDING TYPES

The mechanism already looks useful, since it provides a secure way to handle complicated data structures in FORTH. But we've only begun to see its potential. It's also possible to use a previously defined abstract data type as an instance variable in a new type. *Instance variable* is just another name for a variable, like REAL and IMAG, that is used to describe the representation of an object. Every instance of the type gets its own private set of instance variables, which are copies of those in the type definition. The instance variables, however, are anonymous, the names being kept in the type definition.

Suppose, for example, you're writing an application that calls for pairs of associated complex numbers to be used

(continued)



The one videodisc player that won't box you in.

The Sony LDP-2000. The one and only videodisc player with the total flexibility you've been looking for. All other videodisc players limit your ability to expand. What you see is what you get. But the Sony LDP-2000 is amazingly expandable.

The LDP-2000 is the foundation of the Sony Intelligent Video™ System. It enables you to choose from five configurations to fit your application. And when your needs change, simply add the boards you need internally. The footprint always stays the same.

The LDP-2000 will work with *any* computer. It has two external interfaces: an RS-232C and an optional IEEE-488 parallel interface for high-speed digital data transmission. It can also control up to 14 players through one communication bus.

You can take the LDP-2000 anywhere with confidence because of its Automatic Optical Block

Lock—turn off the power and the optical block locks, eliminating potential damage in shipment.

Then there's the Still Frame Audio capability for over 15 hours of compressed digital audio per videodisc side. The LDP-2000 also decodes up to 221 megabytes of digital data from the videodisc, making it a data disk and videodisc in one.

And the LDP-2000's access speed is really impressive: under 1.5 seconds from frame 1 to frame 54,000.

Of course, the LDP-2000 is an integral part of the Sony View System, the only totally integrated intelligent video system.

But if all you need now is a videodisc player, remember Sony's is the only one that won't box you in.

For more information or to arrange a demonstration, write to: Sony Information Center, Dept. A, P.O. Box 6185, Union, N.J. 07083.

SONY
VIDEO COMMUNICATIONS

QUEUE SIMULATION: A SAMPLE OBJECT-ORIENTED PROGRAM

This sample program is a simple discrete simulation of customers queuing in a bank. Customers arrive singly at random intervals and go to a random cashier's window, where they queue if necessary until served. Each customer takes a finite but variable time to be served, which is random but constrained within limits. By playing with the average time between arrivals and the average time to be served, you can investigate the queueing patterns. (I assume a pseudorandom number generator called RANDOM is available, which takes a number from the stack and returns a random number between [and including] zero and that number.)

The program uses two type declarations: type CUSTOMER, which records the attributes and the behavior of customers, and type CASHQ, which is a queue of customers. The bank is represented by an array of CASHQs, with an element for each cashier.

The attributes recorded for customers are the duration of their intended transaction with the cashier, their time of arrival in the bank, and a status flag that determines whether or not they have been served. The behavior of customers is to enter the bank and join a queue, carry out a transaction with the cashier when they reach the head of the queue, and reply to the query "Are you finished?" Here's the declaration for type CUSTOMER:

```
10 CONSTANT TDELAY -- upper limit for transaction time
TYPE> CUSTOMER
2 VAR TRANSACT.TIME -- duration of desired transaction
2 VAR ENTRY.TIME -- time bank entered
2 VAR DONE -- flag for completion of transaction
```

OPS>

```

-- introduce a new customer
: JOIN CLOCK @ ENTRY.TIME ! -- record entry time
      TDELAY RANDOM 5 + -- a number between
                        5 and TDELAY +5
      TRANSACT.TIME ! -- initialize duration
      FALSE DONE ! ; -- not served yet

-- carry out one time slice of a transaction
: TRANSACT -1 TRANSACT.TIME +! -- decrement by
                                one time unit
```

```

TRANSACT.TIME @
IF FALSE DONE ! -- still being served
ELSE TRUE DONE ! -- finished
ENDIF ;
```

```
-- test for completion of transaction
: DONE? DONE @ ;
```

ENDTYPE> CUSTOMER

The type CASHQ describes a circular queue created according to standard textbook principles. A queue data structure is a collection of items to which new items can be added (called *enqueueing*) and from which old items can be removed (called *dequeueing*). Unlike the case with a stack, however, the first item into a queue is also the first to be removed. Like a stack, a queue requires a pointer to the head of the queue (the place from where an item can be removed), but unlike a stack, a queue also requires a pointer to its tail, where new items are added. In fact, the program records the length of the queue rather than a tail pointer; the tail can then be found by adding the length to the head pointer. Circularity is achieved simply by performing all such arithmetic on the pointers, modulo (size of the array).

CASHQ has an enqueue operation that merely performs JOIN on the first free customer in the queue. In other words, we do not actually create any new instances of CUSTOMER but simply reuse the queue elements as if they were new objects. Similarly, the dequeue operation merely moves the head pointer and does not return any object (our customers vanish into thin air after they've been served!). Here's the declaration of CASHQ:

TYPE> CASHQ

```
2 VAR HEAD
2 VAR LEN
20 CONSTANT MAXQ
MAXQ ARRAY-OF CUSTOMER QBODY
```

OPS>

```

: FULL? LEN @ MAXQ = ; -- is queue full?
: EMPTY? LEN @ 0 = ; -- is queue empty?
: DQ EMPTY? NOT IF HEAD @ 1 +
```

a lot. You can define a type COMPAIR as follows:

```

TYPE> COMPAIR
COMPLEX A
COMPLEX B
OPS>
: COMP@ A COM@ B COM@ ; (--- n n n n)
etc. . . .
```

I've defined only one possible operation, COMP@, which puts both the complex parts of a COMPAIR on the stack.

This demonstrates that the instance variables A and B are used in the operations exactly like objects of type COMPLEX (i.e., FRED) and "understand" only the operations COM@ and COM! defined for COMPLEX.

You can also use ARRAY-OF inside a type definition, with the one proviso that the size of the array be fixed at the time the definition is compiled; that is, it must be a constant value. For example:

TYPE> COMSTACK

```

MAXQ MOD HEAD !      -- bump head
  -1 LEN +!          -- decr. length
  ENDIF ;
: NQ  FULL? NOT IF HEAD @ LEN @
  + MAXQ MOD          -- get tail
  QBODY JOIN          -- add customer
  1 LEN +!            -- bump length
  ENDIF ;
: SERVE HEAD @ DUP QBODY TRANSCAT
  -- serve head of
  -- queue
  QBODY DONE? IF SELF DQ
  ENDIF ;            -- vanish if done!
: SHOWQ EMPTY? NOT   -- display queue
  IF LEN @ 0 DO ." #" LOOP
  ENDIF ;
: INIT  0 HEAD ! 0 LEN ! ;      -- initialize the
  -- queue pointers

```

ENDTYPE > CASHQ

Note that the INIT clause is actually superfluous because ARRAY-OF automatically initializes its elements to zeros. However, INIT can be used to write a word for wiping the array clean during a program run.

With these two types we can now produce the main program loop. The "bank" is an array of CASHQs. Concurrency is simulated by incrementing the variable CLOCK at the beginning of the loop, so that each pass through the loop represents one time slice. A NEXT.CUSTOMER variable is initialized with a random number, representing the delay before a new customer enters the bank. A test is made each time slice to see if a new customer is required. Next, an inner loop services the customers at the heads of all the queues, using up one time slice of their transaction time, and prints a character-graphic display of the bank.

```

-- working variables.
VARIABLE CLOCK  VARIABLE NEXT.CUSTOMER
VARIABLE LAST.CUSTOMER
-- maximum delay before new customer enters

```

```

2 VAR STACKPTR
100 ARRAY-OF COMPLEX STACKBODY
OPS >
: INIT  0 STACKPTR ! ;
: PUSH  STACKPTR @  STACKBODY COM!
  ( n n --- )
  1 STACKPTR +! ;
: POP   -1 STACKPTR +!  ( --- n n )
  STACKPTR @  STACKBODY COM@ ;
: EMPTY? STACKPTR @ 0 = ;  ( --- flag)

```

```

5 CONSTANT CDELAY
-- is a new customer due?      ( --- flag )
: TIME.FOR.NEXT?  CLOCK @ LAST.CUSTOMER @
  - NEXT.CUSTOMER @ > ;
-- set up the "bank"
10 CONSTANT BSIZE
BSIZE ARRAY-OF CASHQ CASHIER
-- main loop
: QSIM  0 CLOCK !      -- initializations
  0 LAST.CUSTOMER !
  CDELAY RANDOM  NEXT.CUSTOMER !
  BEGIN
  1 CLOCK +!          -- advance one tick
  TIME.FOR.NEXT?
  IF BSIZE RANDOM CASHIER NQ
  -- new customer at random
  CLOCK @ LAST.CUSTOMER !
  -- record time of entry
  CDELAY RANDOM NEXT.CUSTOMER !
  -- time till next
  ENDIF
  BSIZE 0 DO | CASHIER SERVE
  -- serve head customers
  | . | CASHIER SHOWQ
  -- display queues
  LOOP
  ?TERMINAL UNTIL ;

```

For portability, the display part of the program is left very crude. It merely produces a scrolling list of the queues, displayed by character graphics. If you have a cursor-addressable terminal and a FORTH that supports it, you can modify the final DO. . . LOOP to get an animated display of the queues. Simply reset the cursor to the top of the screen and blank the previous display.

Obviously, this simulation could be made much more sophisticated. It's easy to write a word FIND.SHORTEST to make a new customer go to the shortest queue. The time of entry could be used to "interview" customers as they are served and find out how long they had to wait. It's only when you come to make such modifications that the power of object orientation will be revealed to you.

```

: FULL?  STACKPTR @ 99 = ;      ( --- flag)
ENDTYPE > COMSTACK

```

Here I've defined a type of stack that operates with complex numbers. You can create new complex stacks at will, as in COMSTACK CSTACK1.

For a more substantial example of the capabilities of the system, see the sample program in the text box "Queue Simulation: A Sample Objected-oriented Pro-

(continued)

Computers For The Blind

Talking computers give blind and visually impaired people access to electronic information. The question is how and how much?

The answers can be found in "The Second Beginner's Guide to Personal Computers for the Blind and Visually Impaired" published by the National Braille Press. This comprehensive book contains a Buyer's Guide to talking microcomputers and large print display processors. More importantly it includes reviews, written by blind users, of software that works with speech.

Send orders to:

National Braille Press Inc.,
88 St. Stephen Street, Boston, MA 02115
(617) 266-6160

NBP is a nonprofit braille printing and publishing house.

gram" on page 230. The program is a discrete simulation of queuing in a bank and will give you a clear sense of the programming style that results from using objects.

USING THE SOURCE CODE

The file TYPES.DOC contains screens 1 through 13 of the source code in ASCII form. To compile them into many FORTH systems, the carriage return/linefeeds will have to be stripped out. The code is written in Laboratory Microsystems' PC/FORTH and is 83-standard except for the word LIT in screen 8, (INITIALIZE), which creates a string literal. Most good FORTHS have such a word, although it may be called ". If you do not have such a word, omit INITIALIZE.

The procedure for converting the code to 79-standard is straightforward. Replace all occurrences of the header field words (NAME>. >BODY, etc.) with their 79-standard equivalents (NFA, PFA, etc.), and replace '>BODY by [COMPILE] '. There's a problem, however, with the word FIND, which behaves differently in FORTH-79. INITIALIZE cannot be made automatic in 79-standard since FIND cannot take a string argument from the stack, and the message INIT will have to be issued explicitly to newly created objects.

LIMITATIONS

I developed this system by simplifying a previous system, which was a direct emulation of the class mechanism of Smalltalk-80 in FORTH. While working on that system I discovered that by using existing FORTH infrastructures (in particular, the vocabulary mechanism), I could make a smaller and faster implementation with a more recognizably FORTH-like syntax.

As always, there is a price to pay, and with this system one price is that its inheritance mechanism is much less general and powerful than that in Smalltalk. In particular, inheritance is restricted to operations and does not apply to representation.

You can use the extra word INCLUDE> to make a type inherit all the operations of a previously defined type. However, if you also want the type to inherit all the instance variables of the previous type, you'll have to declare them all again inside the new type, in the same positions and order and with the same names. For example, you could define a type EXTRACOMPLEX

```
TYPE> EXTRACOMPLEX
2 VAR REAL
2 VAR IMAG
2 VAR WEIRD
OPS> INCLUDE> COMPLEX
: W! WEIRD ! ;
: W@ WEIRD @ ;
ENDTYPE> EXTRACOMPLEX
```

and have it inherit all the operations of COMPLEX, while adding two new ones of its own.

Another limitation is the absence of an equivalent to Smalltalk's indexed variables. In Smalltalk such variables can be assigned a size at instance creation time, which

BYTE back issues for sale

	1985	1986
Jan	\$4.25	\$4.25
Feb	\$4.25	\$4.25
March	\$4.25	\$4.25
April	\$4.25	\$4.25
May	\$4.25	
June	\$4.25	\$4.25
July		\$4.25
Aug	\$4.25	
Sept	\$4.25	
Oct	\$4.25	
Nov	\$4.25	
Dec	\$4.25	

SPECIAL ISSUES and INDEX

BYTE '83-'84 INDEX \$1.75

1984 Special Guide to IBM PCs
(Vol. 9, No. 9) \$4.75

1985 INSIDE THE IBM PCs
(Vol. 10, No. 11) \$4.75

Circle and send requests
with payments to:

BYTE Back Issues
P.O. Box 328
Hancock, NH 03449

Check enclosed
Payments from foreign countries must be made in US funds payable at a US bank.

VISA MasterCard

Card # _____

Exp. _____

Signature _____

The above prices include postage in the US. Please add \$.50 per copy for Canada and Mexico; and \$2.00 per copy to foreign countries (surface delivery). Please allow 4 weeks for domestic delivery and 12 weeks for foreign delivery.

Name _____

Address _____

City _____ State _____ Zip _____

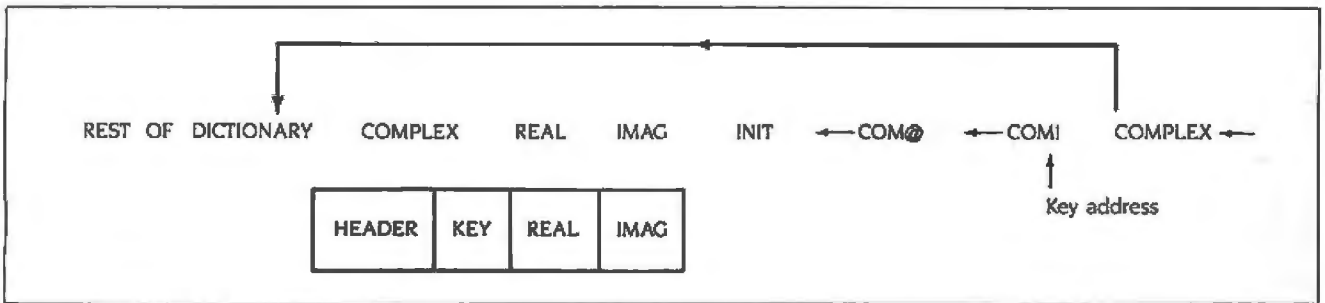

Figure 1: The key to a type's sealed vocabulary is stored in the first two bytes in each of the type's instances (top). An instance such as FRED has an internal structure like that shown at bottom.

allows different-size objects to be created from the same definition. An obvious application is type STRING, whose instances could be of different sizes. In my system, however, all types are of fixed size.

Another drawback, which sorrows me, is that you cannot pass types as parameters to other types, a capability that would be equivalent to Ada's concept of a generic package. For example, you could define a type GENSTACK that included the archetypical behavior of all stacks and then use it to create specific types of stacks, such as a stack of COMPLEX, by passing the item type at instance creation time.

Both these latter facilities can be added, but the extra complexity they introduced was too great a price to pay for my purposes here.

HOW DOES IT WORK?

Briefly, TYPE> and ENDTYPE> manipulate the dictionary structure (by redirecting link field pointers) to conceal all the code between them from normal dictionary searches. The operations of a type then occupy, in effect, a sealed vocabulary that cannot be accessed by ordinary FORTH words. The key to this sealed vocabulary is the link field address of its last member, and this key is stored in all a type's instances, in their first two bytes (see figure 1).

When a message is sent to an object, the object uses its key to unlock the operations vocabulary and look up the compilation address of the required operation. If the object/message pair is found inside a colon definition, as in

```
: TEST   FRED COM@ ;
```

then this lookup occurs at compile time, and the actual address of the operation is compiled, which makes for much greater efficiency than if it were left until run time. This is known as *early binding*.

The performance cost of using types is hard to quantify, since they alter programming style to the point where it's difficult to write an equivalent plain FORTH program for comparison. Comparing trivial examples overestimates the overhead of types, which tends to be fixed and thus diminishes in importance as types and operations become more complex.

In storage terms, the overhead is 2 bytes per object, which is used to store the key. In a simple type like COMPLEX this amounts to a 50 percent overhead, but for

COMSTACK it is negligible. Compound types store a single key, not a key for each typed field. Similarly, an ARRAY-OF has only one key, not one for each element (since they are all of the same type).

In execution terms, the overhead is due largely to the pushing and popping of a third stack called OSTACK, which holds the address of the current object. Each use of an instance variable also incurs an overhead, since an addition has to be performed at run time to calculate the variable's absolute address from its relative offset. Both of these problems can be improved by machine coding.

There is also a modest increase in code size due to the OSTACK pushing and popping code that's compiled for every object/message pair. This overhead increases as objects become more compound.

WHAT IS IT GOOD FOR?

As with most programming methodologies, there's a temptation to push object orientation as a universal panacea. In the case of these FORTH extensions I will not go so far.

The use of abstract data types in FORTH certainly simplifies many kinds of programming, and I find the design process comes very naturally. For example, you look at an object in the real world that you wish to model. Which of its attributes (e.g., size, weight) are you interested in? They become the instance variables. Which of its behaviors (e.g., departure, arrival) are you interested in? They become the operations.

Fields that could clearly benefit, apart from discrete simulation, are graphics (using types for graphics objects), AI systems (using types for frames), and even commercial applications where types provide a more powerful abstraction than do records. Types are also invaluable for certain kinds of system work, for the extra protection they bestow is very welcome when you're handling potentially explosive data structures such as lists and heaps.

Given that types do impose a performance cost, it isn't worthwhile to use them for very simple objects. I would not, for example, define a type INTEGER, for which FORTH already has a good representation. But it takes a little practice to learn how to combine plain with object-oriented FORTH into an efficient hybrid programming style.

Editor's note: For a fuller version of this code and a detailed description of how it works, see Dick Pountain's book Object-Oriented FORTH, soon to published by Academic Press. ■

This Is One Time
IBM's Size Is Not
An Advantage.

TOSHIBA

T1100PLUS



When it comes to a portable computer, smaller is better.

That's one reason the new dual disk drive Toshiba T1100 PLUS has it all over the IBM PC Convertible!

But our new portable PC is not only smaller than the IBM. It's also lighter. And more powerful.

How much smaller? A full 20%. And theirs weighs 12.2 pounds. Ours is under 10 pounds.

And with the IBM portable computer, if you want serial and parallel ports or a CRT port, you have to add add-ons. Which makes it even bigger and heavier. And more expensive.

With the T1100 PLUS, the serial, the parallel and the CRT ports are standard built-in features. Simple mathematics tells you which portable is more portable. And more affordable.

WE TAKE THE PORTABLE PC TO A HIGHER POWER.

Before we go any further, we have to tell you there is one thing about the T1100 PLUS that's bigger than the IBM portable. Its maximum memory capacity. Ours is 640K of RAM. Theirs is only 512K of RAM.

Now we can tell you that the T1100 PLUS is faster than the IBM. Our 80C86 microprocessor lets you zip through work at up to twice the speed.

ANOTHER CLEAR ADVANTAGE.

The Toshiba T1100 PLUS uses a high-contrast, high-resolution LCD display screen. It shows 25 lines by 80 characters of text with 640 x 200 resolution, tilts to any convenient viewing angle and folds flat when you use a CRT monitor.

The IBM portable also uses an LCD display screen. But it doesn't have

as much contrast. It doesn't tilt to as many convenient angles. And you have to pull it off to hook up another monitor.

ONE MORE THING THAT MAKES US EXCEPTIONAL.

Of course, the Toshiba T1100 PLUS is fully IBM-compatible. So you can run popular software like Lotus 1-2-3², WordStar³ and dBASE III⁴.

And, as we mentioned, it has two built-in 720K 3.5" disk drives. It also has an optional 1200-baud Hayes⁵-compatible internal modem and runs on built-in rechargeable batteries. Just like the IBM portable.

But should either stop running, only Toshiba guarantees you overnight delivery of a replacement while your T1100 PLUS is being fixed. It's all part of our "Exceptional Care" program.

To find out more about the T1100 PLUS, call 1-800-457-7777 for the name of the Toshiba dealer near you. And see why being small is going to make us one of the biggest names in PCs.

In Touch with Tomorrow

TOSHIBA

Toshiba America, Inc., Information Systems Division

Inquiry 302



1. IBM and IBM PC Convertible are registered trademarks of International Business Machines Corporation. 2. Lotus 1-2-3 is a registered trademark of Lotus Development Corporation. 3. WordStar is a registered trademark of Micropro. 4. dBASE III is a registered trademark of Ashton-Tate. 5. Hayes is a registered trademark of Hayes Corporation.

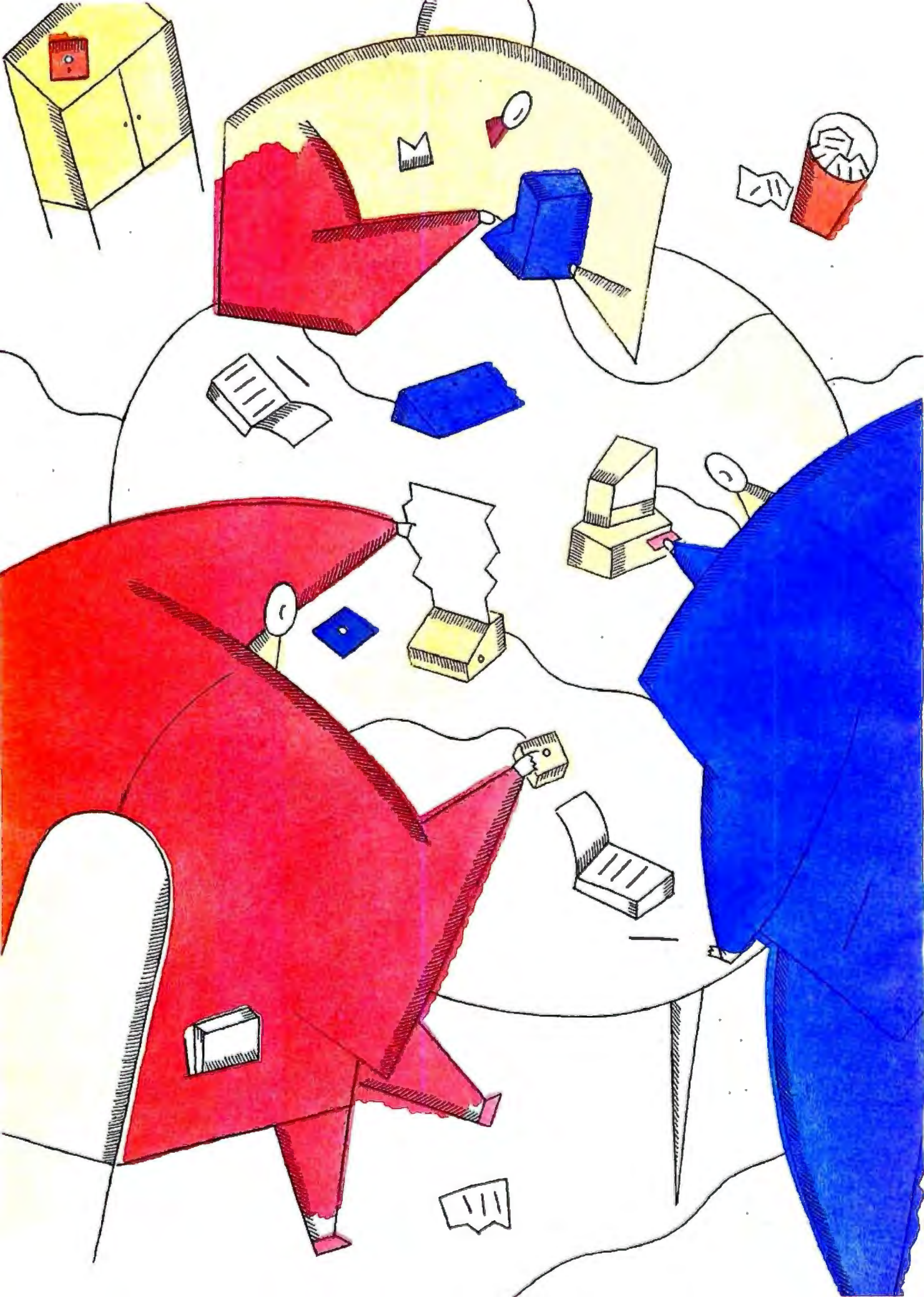

Reviews

REVIEWER'S NOTEBOOK <i>by Ion Edwards</i>	239
THE NCR PC6 <i>by Arthur Little</i>	241
THE SPERRY PC/IT <i>by Frederick D. Davis</i>	247
DESNET C DEVELOPMENT PACKAGE FOR THE MACINTOSH <i>by Jonathan Robie</i>	253
TOPSI 2.0 <i>by Leonard Moskowitz</i>	261
LET'S C AND CSD <i>by William G. Wong</i>	267
NEWWORD 3 <i>by John Heilborn and Nanci Reel</i>	273
REFLEX <i>by Rusel DeMaria</i>	277
GURU <i>by Ernest R. Tello</i>	281
THE DATRAN MODEM ACCELERATOR <i>by Barry Nance</i>	289
REVIEW FEEDBACK	295

The NCR PC6 is an IBM PC compatible with two clock speeds, 4.77 MHz and 8 MHz, a preconfigured hard disk and tape backup system, and a programmable user interface. The machine offers a good price and, especially at the higher clock speed, competitive performance. Arthur Little notes that the machine's most serious drawback is its mediocre documentation.

According to Frederick Davis, the Sperry PC/IT boasts a reasonable price and a significant increase in performance over the IBM PC AT. The computer has three clock speeds: 6 MHz with one wait state, 8 MHz with one wait state, and 7.16 MHz with no wait states. The benchmark results suggest that at the 7.16-MHz clock speed, the Sperry operates approximately 50 percent faster than the IBM PC AT. The computer has a true hardware reset button and nine expansion slots, seven with AT-style 16-bit data lines.

The DeSmet C Development Package for the Macintosh produces faster and more compact code than most Macintosh C compilers. Jonathan Robie reports that it also compiles faster, has a good programming environment, and gives good support for the ROM Toolbox. The author has noted important bugs and shortcomings, and he has compared the benchmark results to five other C compilers for the Macintosh.

TOPSI 2.0 is an implementation of the OPS5 production system language for MS-DOS. It includes all the core functions, and Leonard Moskowitz explains that you will be able to work around incompatibilities with standard OPS5. You can use it as a serious programming tool and as a learning aid for expert systems and artificial intelligence techniques.

Let's C is a \$75 package that includes a screen editor, a full C compiler, an 8086/88 assembler, and a linker. For \$75 more there is csd, a powerful C symbolic debugger. William G. Wong found the package to be of high quality with a good environment for learning C, yet with all the tools you will need to create applications. The main drawbacks include the lack of 8087 and IEEE floating-point support.

We take a look at three software packages this month.

NewWord 3 is affordable, versatile, and much faster and more full-featured than previous versions. John Heilborn and Nanci Reel note that the word processor now includes an in-text math calculator, enhanced menus, a spelling checker, a macro facility, and provision for computer-aided indexes and tables of contents.

Borland's Reflex permits effective control over five different "views" of your data. Rusel DeMaria found that this analytical database offers several unique features for interpreting your data.

And there is Guru, a very powerful integrated software package that offers an exceptional number of features.

Finally, we examine the Datran Modem Accelerator. With this add-on board plus software, you can shorten the time required to transmit text. The product can also conserve disk space by storing files in compressed form.

**NETWORK
VERSION
AVAILABLE**

INTRODUCING OPEN ACCESS® II™

**THE FULLY INTEGRATED BUSINESS SYSTEM
WITH THE WORLD AT YOUR FINGERTIPS**

Open Access II is a new, super-program which can perform virtually every managerial and business task you'll ever need with performance and ease-of-use unheard of in the industry.

Open Access II combines an extremely powerful relational database and superior spreadsheet with data communications, word processing, 3-dimensional graphics, and time management. Information is conveniently changed from module to module.

Open Access II's data communications provides you with the capabilities to handle any of your micro computer communications needs. All of Open Access II's modules work together and data is easily communicated to the rest of the world.

**Open Access II
Comparison Chart**

	Database	Form Query	Report Generator	Query Processor	Relational Database	Graphics	3-D Graphics	Spreadsheet	Goal Seeking	Word Processor	Communications	Time Management	Price
Open Access II	✓	✓	✓	✓	✓	✓	✓	✓	✓	✓	✓	✓	595⁰⁰
Lotus 1-2-3	✓					✓	✓						495 ⁰⁰
Symphony	✓	✓	✓			✓		✓	✓	✓			695 ⁰⁰
Framework	✓		✓	✓		✓		✓	✓	✓			695 ⁰⁰
Enable	✓		✓			✓	✓	✓	✓	✓			695 ⁰⁰
Smart	✓	✓	✓			✓	✓	✓	✓	✓	✓		895 ⁰⁰

Open Access II's Database features an effective and flexible report generator and user definable screens. "Programmer," our new Database language, features simple interacting English-like commands to produce your customized applications.

Open Access II's Spreadsheet offers a unique combination of business problem solving capabilities; including goal-seeking, and an advanced table look-up command. Professional business presentations are easily produced by the enhanced graphic capabilities.

Open Access II's improved Word Processor can merge data from Spreadsheet or Database easily to produce reports, mail merge and graphic presentations.

**BEST OF ALL,
THE PRICE**

\$595.

Open Access II's super program is also available in the network version. Ask for details. Call (619) 450-1526 in California, or (800) 521-3511 if outside California for your nearest authorized dealer or distributor and expand your business base with Open Access II, the fully integrated business system.

SPI

SOFTWARE PRODUCTS INTERNATIONAL

10240 Sorrento Valley Road
San Diego, California 92121

(619) 450-1526

For Your Authorized Dealer
or Distributor Outside California

(800) 521-3511

Inquiry 271 for End-Users
Inquiry 272 for DEALERS ONLY

Open Access is a registered trademark of Software Products International, Inc.
Lotus 1-2-3 and Symphony are registered trademarks of Lotus Development Corp.
Framework is a registered trademark of Ashton-Tate.
Enable is a trademark of The Software Group.
Smart is a trademark of Innovative Software, Inc.



R·E·V·I·E·W·E·R'S N·O·T·E·B·O·O·K

This month we begin with a correction. In the July review "BYSO LISP and Waltz LISP" by William Wong, we incorrectly listed the price of BYSO LISP as \$69.95. The correct price is \$150. Our apologies to the Levien Instrument Company. Now let's take a look at some interesting and relatively inexpensive utilities and applications software we've received.

The Norton Commander (\$75 from Peter Norton Computing, 2210 Wilshire Blvd., Santa Monica, CA 90403, (213) 453-2361) provides a very quick alternative to entering DOS commands on the IBM PC and compatibles. Using a simple intuitive approach, you can quickly view, copy, move, and delete files. Among its many uses, the product is a boon for cleaning up directories. You can delete selected files, directly edit a directory structure, or move files among subdirectories. The program is fully compatible with all memory-resident software because it is an application that you can load whenever you need it.

Point Five, priced at \$195 by Pacific Crest Software (887 Northwest Grant Ave., Corvallis, OR 97330, (503) 754-1067), is an analysis and modeling system for the IBM PC and compatibles. At the heart of the application is a programmable calculator with 150 built-in mathematical, financial, and statistical functions. Using these functions, you can build complex models and programs. You can, for example, define and manipulate tables of data very quickly and then display data with a variety of bar graph functions.

Bridge Software (P.O. Box 118, New Town Branch, Boston, MA 02258, (617) 527-1585) offers Datasurf, a \$125 surface sketching utility that generates three-dimensional graphic images. For the IBM PC and compatibles, Datasurf can read files created by word proces-

sors, spreadsheets, and languages. You can adjust the viewpoint and scale, rotate images, hide or restore lines, crosshatch surfaces, add and label axes, and print high-resolution (960- by 1056-pixel) images on most dot-matrix printers.

Mace + Utilities (\$69.95 from Paul Mace Software, 206 Alicia Ave., Ashland, OR 97520, (800) 523-0258) prevents data loss on hard disks by moving data to safe areas before the sectors go bad. With this utility you can clean up directories, "undelete" files, compress and sort directories, and recover from an accidental formatting of your hard disk.

Tornado Notes (Micro Logic Corporation, P.O. Box 174, Hackensack, NJ 07602, (201) 342-6518) is a \$49.95 RAM-resident productivity tool for the IBM PC and compatibles that lets you enter, edit, combine, and access notes. With this tool you can browse through text documents or search for notes by specifying key words or phrases. An import command allows you to import ASCII files into Tornado Notes; you can therefore use the utility to search for data within text files that may be structured in widely different ways.

Also for the IBM PC, for only \$19.95, is PopDrop (InfoStructures Inc., P.O. Box 32617, Tucson, AZ 85751, (602) 299-5962), which lets you load and remove RAM-resident software and work with up to 1.5 megabytes of RAM. With this utility, you can avoid incompatibilities among your other utilities and create a series of useful environments without having to reboot your IBM PC.

We have also received some applications and utilities for the Atari 1040ST. Tom Hudson's work is always impressive, and his \$49.95 CAD-3D (Antic Software, 524 Second St., San Francisco, CA 94107, (415) 957-0886)

is no exception. With this program, you can design three-dimensional solid or wire-frame objects and specify multiple views and light sources. The package includes an animator. You can save your creations in either DEGAS or NEOchrome formats.

A whole range of other 1040ST utilities deserve mention here also. Solid Applications Inc. (1333 Moon Dr., Yardley, PA 19067, (215) 736-2449) has STKey, a memory-resident facility that provides user-programmable function keys, and Diskmenu, a file archive and backup utility. DOS Shell from MichTron (576 South Telegraph Rd., Pontiac, MI 48053, (313) 334-5700) provides a command-line interface that emulates MS-DOS. The MichTron Utilities allow you to change file contents, attributes, or names to restore deleted files and to recover data from damaged disks.

Finally, Hippopotamus Software (985 University Ave., Suite 12, Los Gatos, CA 95030, (408) 395-3190) supplies Hippo Disk Utilities, a collection of routines that you can use to recover lost data; to copy, move, or selectively delete files; and to edit RAM and disk storage directly.

Macintosh owners should note that there are three new BASIC compilers for the Macintosh. ZBasic and True BASIC now have Macintosh versions (see the reviews in the May 1985 and May 1986 issues of BYTE). In addition, PCMacBasic from Pterodactyl Software (P.O. Box 538, 200 Bolinas Rd., #27, Fairfax, CA 94930, (415) 485-0714) includes dynamic and pageable program arrays, and use of resource files to create icons, dialog boxes, and much more. We are planning a comparative review for an upcoming issue.

—Jon Edwards

Senior Technical Editor, Reviews

Powerful MS-DOSTM Software.

For the IBM®-PC, XT, AT & others with generic MS-DOS/PC-DOS 2.0 or higher.

Not copy
protected!

Only **\$39⁹⁵** Each!

UTAH COBOLTM

Whether student, teacher or professional programmer, this is the one you've heard so much about.

- It's easy to use. Compiles 5000 statements on a 128K machine.
- 170 clear error messages, i.e. DATA-NAME IS MISSING OR MISPELLED.
- Distribute your object code programs royalty free.
- Small object code programs conserve disk space.
- Fast compile times to increase programmer productivity. Over 25 times faster than one compiler costing \$995!
- You get a diskette and 213-page manual with lots of examples and 16 complete COBOL source code programs. **\$39.95.**

Also available: COBOL Application Packages, Book 1 **\$9.95.**

UTAH PASCALTM

- 14-digit precision, BCD math, no round-off errors with decimal arithmetic for business and floating point + 63 - 64 for scientific.
- A very nice TRACE style debugging.
- Arrays up to 8 dimensions and 64K strings.
- External procedures and functions with dynamic auto-loading.
- One-step compile, no assembly or link required.
- You get a 132-page manual and diskette. **\$39.95**

UTAH PILOTTM

- Perfect for industrial training, office training, drill and testing, virtually all programmed instruction, word puzzle games, and data entry facilitated by prompts.
- John Starkweather, Ph.D., the inventor of the PILOT language, has added a built-in full-screen text editor, and much more.
- Meets all PILOT-73 standards for full compatibility with older versions.
- You get a diskette, 125-page manual and ten useful sample programs. **\$39.95.**

Also still available for 8-bit machines with CPM[®] is our world famous Nevada Software Series used by 50,000 customers in 40 countries. These include Nevada COBOL, Nevada FORTRAN, Nevada PASCAL, Nevada PILOT, Nevada BASIC and Nevada EDIT. **\$39.95** each.

Satisfaction guaranteed. If for any reason you're not completely satisfied, just return the package within 15 days in good condition, and we'll refund your money.

IBM is a registered trademark of International Business Machines Corp. CPM is a registered trademark of Digital Research. MS is a trademark of Microsoft Corp. © 1985 Ellis Computing, Inc.

UTAH FORTRANTM

- FORTRAN IV based upon ANSI-66 standards.
- Very fast compile times and easy to use.
- IF . . THEN . . ELSE constructs.
- Chaining with blank and named common.
- Copy statement.
- ENCODE and DECODE.
- Free-format input and output.
- A very nice TRACE style debugging.
- 150 English language error messages.
- You get a diskette, and 223-page manual. **\$39.95**

UTAH EDITTM

- A character-oriented full-screen video display text editor designed specifically to create COBOL, FORTRAN and PASCAL programs.
- Only requires 15K disk space so it can fit on the same disk as your compilers.
- Completely customizable tab stops, default file type, keyboard control key layout and CRT by menu selection.
- Diskette comes with easy to read 58-page manual. **\$39.95.**

UTAH BASICTM

- This interpreter has a built-in full-screen editor.
- Single- and Multi-line user definable functions.
- BCD Math- no round-off errors.
- Full Matrix operations.
- You get 220-page manual and diskette. **\$39.95.**

Handling/Shipping: No shipping charge within US. Overseas add \$10 for first package, \$5 each additional. Checks must be in US Dollars, drawn on a US bank.

Utah Software requires 128K RAM and PC-DOS or MS-DOS 2.0 or higher.

HOW TO ORDER. Send check or money order to Ellis Computing, Inc. with VISA or MASTERCARD order by phone. Sorry no COD's.



Ellis Computing, Inc.
5655 Riggins Court, Suite 10
Reno, Nevada 89502
Phone (702) 827-3030

SINCE 1977  

ELLIS COMPUTINGTM



THE NCR PC6

BY ARTHUR LITTLE

A dual-speed IBM PC compatible of robust design with two clock rates

The NCR PC6 is an IBM PC compatible that, like the IBM PC, is an 8088-based system. Unlike the IBM PC, the PC6 has two clock rates, standard and high speed. The PC6 comes in three versions—one with two floppy disk drives (Model 1012), one with a floppy disk drive and a 20-megabyte hard disk drive (Model 1014), and a similar one that includes a 10-megabyte tape backup unit (Model 1015). Prices range from \$2390 to \$3690. I reviewed a Model 1015.

HARDWARE

The PC6 Model 1015 is no lightweight: The system unit tips the scales at a hefty 37 pounds, the monochrome monitor weighs 32 pounds, and the keyboard weighs 4½ pounds. Much of that weight is from the metal used in its construction. It is a solid unit.

Generally, the PC6 shows extraordinary attention to detail, from the XP (Extra Performance) switch and the speaker volume control on the front panel to the knurled plastic tips on the monitor cable screws. You'll never need a screwdriver to attach or detach the monitor cables.

Unfortunately, not all of the engineering is of the same caliber. The cabinet is attached to the chassis with three spring-loaded, quarter-turn screws. After I disengaged these screws, the cabinet would not slide forward for removal. I finally detached the cabinet by prying the case open with a screwdriver.

DISPLAY

The PC6 has four optional displays: a standard monochrome display with

25 columns of 80 characters for \$195; a high-resolution (640 by 400 pixels) monochrome graphics display with an adapter for \$849; a color graphics display for \$659; and a high-resolution, 16-color graphics display plus adapter for \$1260.

I reviewed a PC6 equipped with the high-resolution monochrome graphics display. The brightness and contrast controls are located at the top of the unit. Once you have them set to the desired level, you can push them in so that they are flush with the monitor's housing. The display's characters are sharp and readable but seemed a little too thin.

KEYBOARD

NCR chose to emulate most of the features of the IBM PC keyboard, with

a few welcome additions. Between the QWERTY layout and the numeric keypad, there is a two-part cursor-key cluster. The top part is made up of separate keys for Del, End, PgUp, PgDn, and another Ctrl key. The bottom part has four cursor keys and a Home key. There are two other refinements over the IBM layout: The numeric keypad has its own Enter key and both the Num Lock and Caps Lock keys have LED indicators.

INTERNALS

The NCR PC6 uses an 8088-2 microprocessor that runs at two clock rates: 4.77 MHz, for complete IBM PC compatibility, or 8 MHz, NCR's XP (Extra Performance) mode. The motherboard has a socket for an 8087 math coprocessor. If you choose to add an 8087, be certain

that it is rated at the 8-MHz clock rate. One feature that the PC6 lacks is a hardware reset switch.

The Model 1015 system comes standard with 512K bytes of RAM, as does the Model 1014 (although for some reason, my review machine had only 256K bytes of RAM, like the Model 1012). The PC6 can accommodate a maximum of 640K bytes of RAM. It also has 16K bytes of EPROM, which contains the BIOS and an empty socket for an additional 16K bytes of ROM.

The power supply for the NCR PC6

(continued)

Arthur Little (4 Seaway Rd., Squantum, MA 02171) is a former technical editor for BYTE and a freelance writer. He has been manager of documentation for two software publishers.



NCR PC6

Company

NCR Corporation
 Personal Computer Products
 1150 Anderson Dr.
 Liberty, SC 29657
 (803) 843-1751

Size

19.5 by 15 by 5.5 inches; Model 1015 system unit: 37 pounds, monitor: 32 pounds, keyboard: 4½ pounds

Components

Processor: 8088-2 (4.778 MHz)
Memory: 256K RAM (Model 1012); 512K RAM (Models 1014 and 1015); 16K ROM (all models)

Mass storage: Two 360K-byte, 5¼-inch, half-height floppy disk drives (Model 1012); one floppy disk drive and one 20-megabyte half-height hard disk drive (Model 1014); or one floppy disk drive, 20-megabyte hard disk drive, and a 10-megabyte half-height cartridge tape backup (Model 1015)

Display: Monochrome with 25 rows of 80 characters, high-resolution monochrome (640 by 400 pixels), color, or high-resolution color; all optional

Keyboard: 95 keys, including 10 function keys; numeric and cursor keypads

Power source: 120 volts AC, 200 watts

Expansion: Eight PC-compatible slots

Interfaces: One RS-232C serial port; one Centronics-compatible parallel printer port

Software

NCR-DOS version 2.11.30, NCR User Interface, GW-BASIC, NCR Tutor, NCR Pal, Help program, User Diagnostics, tape backup and restore software

Documentation

PC6 Owner's Manual, 144 pages
 NCR-DOS manual, 376 pages
 GW-BASIC Manual, 424 pages

Price

Model 1012: \$2390
 Model 1014: \$2990
 Model 1015: \$3690

SYSTEM FEATURES

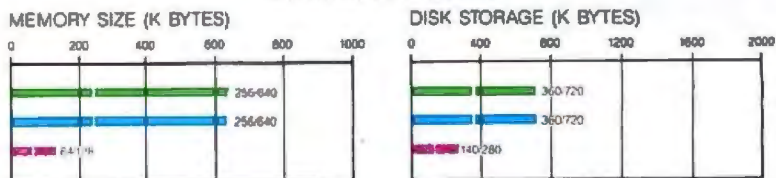

DISK ACCESS IN BASIC (IN SECONDS)

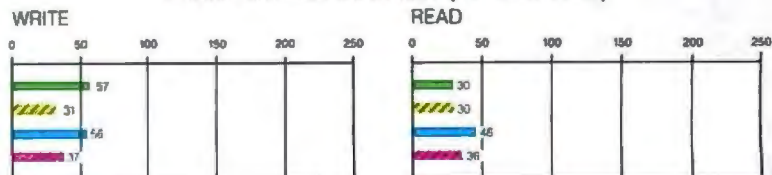

BASIC PERFORMANCE (IN SECONDS)

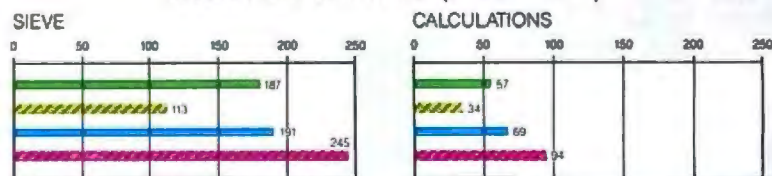

SYSTEM UTILITIES (IN SECONDS)

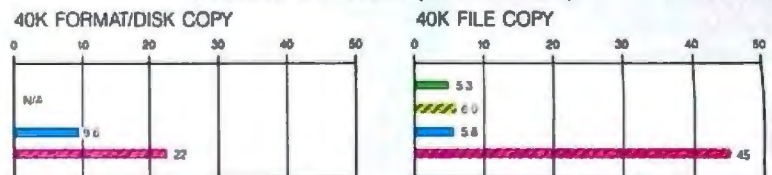

SPREADSHEET (IN SECONDS)

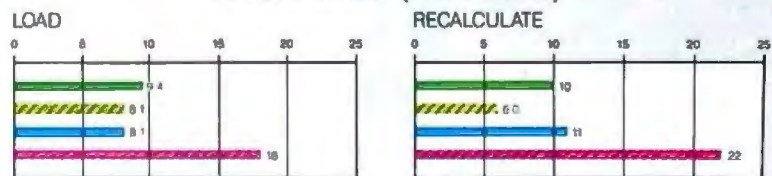

Legend: NCR PC6 (green), NCR PC6 (XP MODE) (hatched), IBM PC (blue), APPLE IIE (red)

The Memory Size graph shows the standard and optional memory available for the computers under comparison. The Disk Storage graph shows the highest capacity for a single floppy disk drive and the maximum standard capacity for each system. The graphs for Disk Access in BASIC show how long it takes to write and then read a 64K-byte sequential text file to a blank floppy disk. (For the program listings, see BYTE's *Inside the IBM PCs*, Fall 1985, page 195.) The Sieve graph shows how long it takes to run one iteration of the Sieve of Eratosthenes prime-number benchmark. The Calculations graph shows how long it takes to do 10,000 multiplication and 10,000

division operations using single-precision numbers. The System Utilities graphs show how long it takes to copy a 40K-byte file using the system utilities. The Spreadsheet graphs show how long it takes to load and recalculate a 25- by 25-cell spreadsheet in which each cell equals 1.001 times the cell to its left. The spreadsheet used was Microsoft's Multiplan.

Note that the NCR PC6 Model 1015 tested had one floppy disk drive and one hard disk drive, so the standard Format/Disk copy benchmark was not applicable. Also note that the PC6 was tested in standard (4.77 MHz) mode.

is rated at 200 watts. The motherboard has eight IBM PC-compatible expansion slots. In my review unit, two of these slots were in use, one for the display card and one for the hard disk controller. Note that the floppy disk controller is located on the motherboard and does not require an expansion slot.

The PC6 comes with two interfaces: an RS-232C serial port and a Centronics-type parallel printer port that uses the IBM-standard DB-25 connector.

MASS STORAGE

The PC6 Model 1015 comes with three mass storage devices: one 360K-byte floppy disk drive, an internal 20-megabyte hard disk drive, and a tape backup system for the hard disk drive.

The PC6 is very much an OEM unit; NCR purchased all three mass storage devices from outside vendors. The floppy disk drive is a 360K-byte half-height unit manufactured by Teac. The hard disk is a 20-megabyte half-height unit from NEC. Both drives worked flawlessly during the course of their operation.

The 10-megabyte cartridge tape backup system is from Irwin Magnetic Systems. This built-in unit does not need an expansion slot for its controller, as it uses one of the floppy disk controller ports. The system uses the Irwin TC200 high-density data cartridge. These eight-track cartridges must be formatted prior to use, a process that takes over 16 minutes.

The tape system's software lets you back up files either as a disk image or as a group of files (by date and time or by directory). This backup is called a "saveset," and the entire saveset must be written to disk during a restore. Actual backup of 1 megabyte of data, in the form of a 180-file subdirectory, took 10 minutes and 31 seconds.

SOFTWARE

NCR-DOS is NCR's version of MS-DOS. The version used for this review was NCR-DOS version 2.11.30, which has the commands and features of MS-DOS version 2.11.

In addition to the standard MS-DOS

command-driven interface, the NCR system comes with the NCR User Interface, which is a menu-driven shell to the MS-DOS operating system. This shell presents the user with the main menu, which leads to several submenus. These submenus let you do a number of things, such as define and use menus for applications programs; choose DOS commands; set the level of assistance you desire (novice, medium, or experienced); define up to 37 different key combinations using the Function, Shift, Alt, and Ctrl keys with macros of up to 127 characters; set the current time and date; turn the time and date display on or off; and change your default drive.

If you have problems with conflicts between the NCR User Interface and your applications programs, function key F1 displays a single page of "hints and kinks." A DOS command Help facility is also readily available, which covers 59 DOS commands.

The package also includes GW-BASIC, Microsoft's interpreted BASIC, which is directly comparable to IBM's Advanced BASIC. NCR supplies GW-BASIC version 2.02.30.

Finally, the system comes with software for the tape backup subsystem, which lets you format cartridge tapes, do file-oriented backup, do disk image backup and restore, and test the drive.

Although NCR is not bundling any specific business software with the PC6, they have included a fair amount of "get acquainted" programs designed for the end user. NCR Pal, for example, is a mini-tutorial and introduction to the operation of the PC6 computer. This program covers the keyboard functions and briefly describes NCR Tutor, the Help package, and the NCR User Interface. It also describes types of applications programs (spreadsheets, word processing, and BASIC) in detail. The last section of the Pal main menu is an overview of the computer hardware.

NCR Tutor comes on an auto-boot disk and provides an on-line explanation of much of the information contained in the NCR-DOS manual but with more examples. The concepts it covers include introduction to DOS, disks/directories/files, disk/file-related

The PC6's floppy

disk controller

does not require

an expansion slot.

commands, system environment-related commands, special keys, EDLIN, batch commands, and redirection/filters/pipes. The Tutor has many hands-on examples that require your input to continue the tutorial. The material builds on previously learned information until it reaches some fairly sophisticated levels. It is well done.

A User Diagnostics software package includes the Microsoft system diagnostics familiar to IBM PC users. However, all of the tests are presented via a Diagnostic Shell menu, which is more informative and simpler to use than its IBM counterpart. The package includes tests for both the XP mode and the tape backup subsystem.

DOCUMENTATION

Overall, the NCR documentation is a sincere but flawed effort consisting of three manuals: The *Owner's Manual*, the GW-BASIC manual, and the NCR-DOS manual. The two reference manuals from Microsoft (GW-BASIC and NCR-DOS) present the material in much the same way as the equivalent IBM manuals—if you liked those, you'll like these.

The *Owner's Manual* is the weakest of the three. The first chapter, "Historical Data," is bogged down with leaden prose such as "... Data are processed in the CPU. It contains all the arithmetic and logical circuitry in the computer, and often has a component called the Arithmetic and Logic Unit (ALU)."

Chapters 2, 3, and 4 are a little better, but the manual presumes too much technical expertise on the part of the user. Perhaps the documentation writers should have modeled their approach after that used in the Pal and Tutor software. The two high points of this manual are an 18-page

(continued)

OUR PLUG-IN CARD GIVES YOU PLUG-IN CONTROL.

PC \leftrightarrow 488 allows your IBM PC/XT/AT or compatible to control IEEE-488 instruments.

With **PC \leftrightarrow 488**, you can:

- Plug-in to BASIC, C, FORTRAN, or Turbo Pascal™
- Emulate hp controllers,
- Use Tek Standard Codes and Formats,
- Run IBM's IEEE-488 software, and much more.

Just \$395 for the complete hardware and software interface.



Capital Equipment Corporation
10 Evergreen Avenue
Burlington, MA 01803
Call today (617) 273-1818



Turbo Pascal is a trademark of Borland International.

REVIEW: THE NCR PC6

glossary and an index.

The supplemental installation and operation instructions for the graphic controller and the monitor manage to be terse and cryptic in English, German, French, Italian, and Spanish.

BENCHMARKS

According to the BYTE benchmarks, the PC6 in its standard (4.77 MHz) mode is slightly, but consistently, faster than the IBM PC. When I ran the benchmarks in the XP mode (8 MHz, about 68 percent faster than the PC6's standard clock speed), the system performance increased noticeably.

Typically, the XP mode represented about a 40 percent improvement in performance (i.e., the XP times were only 60 percent of the standard mode times) on the in-memory benchmarks (BASIC Performance and Spreadsheet Recalculate). The differences between the standard and XP modes in the disk-related benchmarks ranged from the sublime (46 percent performance increase for the Disk Write test) to the ridiculous (12 percent performance decrease for the File Copy test). See the benchmark graphs for precise times and comparisons.

CONCLUSION

The NCR PC6 is a high-end machine designed for business applications that require performance, reliability, and IBM PC compatibility. Its 20-megabyte hard disk and 10-megabyte tape backup make it a system that is ideally suited for business and professional users.

The PC6's major assets are its dual-speed, IBM PC-compatible system of robust design; its preconfigured fixed disk and tape backup system; and its programmable User Interface, which simplifies interaction with DOS commands.

The PC6's greatest liability is its mediocre documentation. A previous problem, high cost, has already been solved: NCR recently announced significantly lower prices for all three models, which are reflected in this review. Although not the most inexpensive IBM PC compatible around, the PC6 is at least competitive now, especially among the major vendors of compatibles. ■

SUNDAY 10-5 **PROMPT DELIVERY**

IBM PC 160k 2 Floppies	\$1849.00	LAP TOP COMP. Kaypro NEC 8401 Toshiba T-1100 Toshiba 2100	\$1379.99 \$699.99 \$1349.99 Call	Brother HR15-XL Brother HR-35 Brother M-1509 Brother Tmewriter 5 w/purchase of TF-50 Canon LP6-200S Citizen MSP-10 Citizen MSP-20 Citizen MSP-25 Epson FX-85 HP Laserjet Plus IBM Pro Printer II IBM Quietwriter II NEC P-6 NEC P-6 NEC 8850 Okidata 193 Okidata 292 Okidata 293 Okidata 2410 Star SG-10C Toshiba 321 Toshiba 351 w/purch. of Tractor Feed	*249.99 Call 189.99 329.99 Call 1849.99 229.99 329.99 Call 344.99 2879.99 362.99 1029.99 449.99 1019.99 448.95 469.95 Call 619.95 214.99 399.95 639.99 899.95			
IBM PC 256k 10 Meg. Dr.	\$1299.00	COMMODORE Comm 128 1902-A Amiga w.col. Mon.	210.00 289.99 1049.99 Call	MONITORS NEC Multi-Sync PGS HX 12 PGS MAX 12 Taxan 630 Taxan 640 IBM Col. Mon. PGS HX-12E Comex Col. w. Aud	514.99 399.99 149.99 409.99 469.99 469.99 139.99 69.99 124.00 119.00 199.99	BROTHER SPECIALS Brother TF-50 Brother TF-100 Brother CF-300	119.00 199.99	
IBM XT-288 Dual Flopp.	\$1799.99	AT&T 6300 640k 10 Meg. Drive 1 Flop. w/Mon.	Call	AT&T 6300 Plus 640k 30 Meg. Dr.	Call	\$1399.99	SPERRY PC - HT SPERRY PC - IT 44 Meg.	\$2649.99

GUARANTEED LOWEST PRICES
COMPUTER: 1-800-874-1235
VIDEO: 1-800-223-6779
S'nW ELECTRONICS & APPLIANCES
633 Bedford Ave. Bklyn, NY 11211

TOLL FREE OUT OF N.Y. IN N.Y. CALL (718) 237-2828

HOURS: Mon-Thurs. 9-6
Fri. 9-7, Sat. 10-5, Sun. Closed

C.O.D. Accepted
Credit Card Accounts subject to time of order.
Add charge along with order.
Price subject to change without notice.
Not responsible for typographical errors.

PRINTER SHARING AND PRINT BUFFERING ALL IN ONE VERSATILE UNIT

Print Master from BayTech is an intelligent printer controller that connects between your computers and printers. It allows you to share one printer automatically, contend for multiple printers automatically, or switch between several printers by sending a simple code. Plus, Print Master's built-in buffer spools data until your printer can receive it.

A VERY FLEXIBLE PRINTER SHARER

You configure Print Master's ports for any combination of printers and computers by answering questions from the easy-to-follow menus. For example, with the ten-port Print Master, nine computers can share one printer, eight computers can share two printers, seven computers can share three printers, and so on, to one computer which can share nine printers. You can also menu-select these features: the baud rate, word size, stop bits, parity, and XON/OFF handshaking; the disconnect time-out; and form feeds. Ports may be configured individually to translate for printers and computers using different configurations. All changes you make are saved in non-volatile memory.



PRINT MASTER'S BUFFER KEEPS YOU WORKING

Since Print Master can accept data faster than your printer, you can dump a print job into Print Master's 512K buffer and then go on to another project. All connected users can send data to this common pool buffer, and they can be doing it at the same time, even if no printer is available. Data is stored in the buffer until it can be sent on a first-in-first-out basis to

the selected printer. If you need more memory, Print Master is optionally available with one megabyte buffer.

CONTROL PRINT OUTPUT FROM YOUR COMPUTER

If several users are sharing one printer, printer sharing is completely automatic. There are no codes to send. You simply perform your normal print operation. If you are sharing several identical printers, connection is also

automatic. Again, you perform your normal print operation and are connected to the next available printer on a first-come-first-serve basis. Print Master will send data to all printers simultaneously to keep your printers running at full capacity.

If you are sharing several different printers, such as a letter printer, a laser-jet and a plotter, you do your normal print routine but insert a short printer select code (which you can define yourself) as the first characters of your data. The data is then routed to the selected printer. It's that easy.

CHOOSE SERIAL OR PARALLEL MODELS

706A (6 parallel ports), \$795.
706C (6 serial ports), \$795.
706D (4 parallel/2 serial), \$795.
708D (6 parallel/2 serial), \$895.
708C (8 serial ports), \$895.
710C (10 serial ports), \$995.
Additional 500K buffer, \$249.

Want more details? Call or write BayTech at P.O. Box 387, Bay Saint Louis, MS 39520. Telex 910-333-1618. Phone 601-467-8231 or

800-523-2702

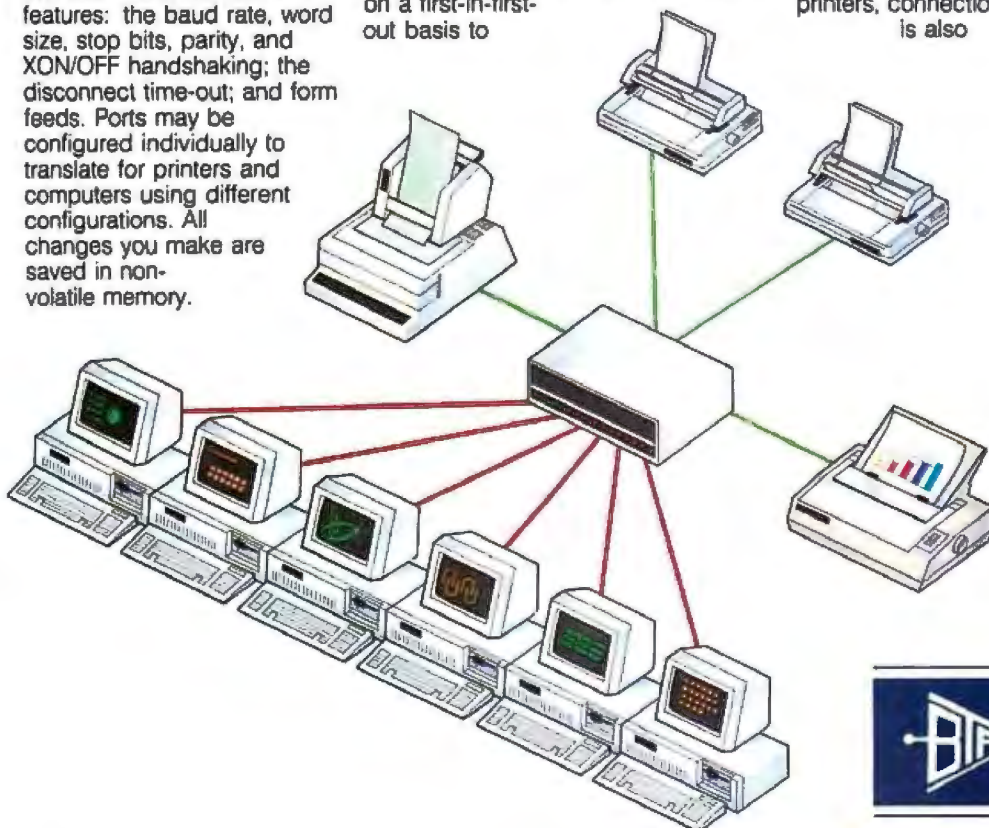

INTRODUCING FUJITSU'S DX FAMILY OF PRINTERS

TAKING PC PRODUCTIVITY TO NEW HEIGHTS

Choose the 80-column DX2100, or the 136-column DX2200. For sheer print volume, these Fujitsu printers can't be topped. At 110 lines per minute, their throughput is almost double that of most major competitors.

The built-in bi-directional tractor speeds paper handling too. Just flick a switch to go from continuous forms to single-sheet feeding, without removing cumbersome optional tractors or tractor paper.

The well-designed operator panel gives you fast, convenient control of all printer functions, and enables you to identify error conditions quickly.

DX printers won't distract you from your work either—thanks to their quiet operation at less than 55 dBA.

And in addition to fast spread sheets, Fujitsu's DX printers produce near-letter-quality print and excellent graphics. They'll grow with your needs, too. Upgrading to color, or changing your system interface, is as easy as plugging in a new module.

You can put these fine printers to work for a lot less than you might expect. And it costs next to nothing to keep them working. They come with a superb reliability rating of 6000 hours MTBF, and a full one-year warranty.

For more information about the new Fujitsu DX family of printers, call Fujitsu America, Peripheral Products Division, at (800) 626-4686. Get the personal printers that really produce.

WE'RE DEVELOPING TECHNOLOGY FOR YOU.



FUJITSU AMERICA

Inquiry 121





THE SPERRY PC/IT

BY FREDERICK D. DAVIS

The Sperry PC/IT is a reasonably priced IBM PC AT compatible designed for multiuser environments. Like Sperry's previous desktop computer, this new machine is manufactured by Mitsubishi in Japan and offers a significant increase in performance over the machine it emulates. The system also supports more serial ports and has a larger hard disk.

Externally, the IT has one major feature that distinguishes it from the IBM PC AT—a genuine recessed hardware reset button. This reset button works even when the Ctrl-Alt-Del reset interrupt is wiped out.

Inside, there are other differences. The IT's 80286 microprocessor can process data at three different rates. By setting two DIP switches on the main board, you can set the clock speed to either 6 MHz with one wait state, 8 MHz with one wait state, or 7.16 MHz with no wait states (see table 1).

The 7.16-MHz rate is the fastest of the three. Sperry claims that the IT runs 45 percent faster than the IBM PC AT. In the spreadsheet test, however, the Sperry was actually more than twice as fast. The IT also features a socket for an 80287 floating-point processor.

The system has a built-in clock with a rechargeable battery system that keeps the clock powered for about 30 days, even if the system is unplugged from the power outlet. The battery also maintains some CMOS memory that contains system configuration data such as quantity and type of disk drives and memory. [Editor's note: Unlike the PC AT, a small array of DIP switches sets

A fast, reasonably priced IBM PC AT compatible designed for multiuser applications



some of the configuration information.

Sperry has provided a total of nine expansion slots, seven of which have AT-style 16-bit data lines, while two have IBM PC-style 8-bit connectors. All board slots are full-length. A double-width slot is taken up by an interface board with two serial ports and one parallel port. The serial ports have male DB-9 connectors, and the parallel port has a female DB-25. After a monitor controller and a hard disk controller are added, six slots are available. [Editor's note: Sperry reports that some early purchasers had complained that they could not install an internal modem because they could not disable one of the serial ports. The company now says that this problem has been fixed.]

The IT has one full-height and three half-height slots for mass storage

devices. Each drive is designed to slide into its slot on plastic rails mounted on the sides. Installation is quick and easy. There is a 195-watt power supply that should be ample for most needs.

An exhaust fan in the cabinet pulls air into the front of the chassis and through the power supply before exiting. The only problem with this arrangement is that there is no easy way for the air supply to be filtered. All of the dust and other particles in the air get sucked into your computer and deposited on its innards. This is not a desirable situation. The only way to filter the air supply for this machine is to completely enclose at least the front of the chassis with some sort of filtration device.

DISK DRIVES

The hard disk is a fast (30-millisecond average seek time) 44.6-megabyte formatted MiniScribe. You can select 15 different hard disk types from the configuration program. The documentation does not describe these, but it does suggest that other hard disks may be added to the machine in the future.

The IT comes in two standard disk configurations: the basic configuration, which features a single high-density 1200K-byte floppy disk drive, and the enhanced system, which has the single high-density drive together with a 44.6-megabyte hard disk. You can have up to two floppy disks in the IT. They may be any mixture of 360K-

(continued)

Frederick D. Davis (P.O. Box 427, Riverton, UT 84065) is an independent software consultant.

and 1200K-byte floppy disks. The floppy drive controller is built into the main board.

In addition to the disk drives, Sperry offers a 60-megabyte half-height ¼-inch tape drive. The tape drive controller occupies one board slot.

You can also have two hard disks of mixed types in the IT. Each hard disk can occupy either the full-height device slot or two half-height device slots. The tape drive and the floppy drives each occupy one half-height device slot. If the designers had thought things through a little more, they could have included another half-height device slot so that you could have one tape, one floppy disk, and two hard disk drives.

After I finished reviewing the machine, I was told by a Sperry distributor that the new ITs were being shipped with new ROM chips. These

chips reportedly speed up disk access by about 5 percent, although I was not able to confirm this.

MEMORY

The main board has room for 1 megabyte of memory. All versions of the IT are shipped with 512K bytes of memory and sockets for another 512K. You can set the second bank of 512K bytes to be used as an additional bank of 128K bytes for a total of 640K bytes available to DOS, or as 512K bytes of extended memory for use as a RAM disk or other 80286 applications. You can install two more boards of 2 megabytes each for a total of 5 megabytes of main memory.

KEYBOARDS

Three Key Tronic-style keyboards are available from Sperry for the IT: a standard IBM PC-style keyboard, an

IBM PC AT-style keyboard (called the PC/IT), and the "Professional" keyboard (also called the "PC Enhanced"). I worked only with the PC/IT keyboard (see photo 1). The main distinction of the Professional keyboard was that it had separate cursor and numeric keypads, and the function keys were across the top instead of clustered on the left.

The PC/IT keyboard has the same key placement as the original IBM PC AT keyboard, including the strange placement of the left single quote (') key at the left end of the number row, and the Escape key over the numeric keypad. The Return key is very large, as are both Shift keys. I found the keyboard to be quite comfortable to use, except for the awkward placement of the Escape key.

MONITORS

Sperry offers three monitors—monochrome, medium-resolution RGB, and high-resolution RGB. Corresponding monitor adapter boards are also available. These monitors correspond to the IBM PC monochrome, color graphics, and enhanced graphics monitors.

I worked only with the monochrome monitor. It is functionally identical to the IBM monochrome monitor, except that it has a very effective antiglare coating. Also, the phosphors are yellow-green with a moderate consistency. When scrolling, the smearing is not nearly as bad as a lot of the IBM PC-style monitors that I have seen.

Like most IBM PC clones, the display, although readable, is not really crisp. The characters in reverse-video mode are so hard to read that this mode isn't really usable. To me it looks like excessive diffusion causes the bright areas to bleed into the dark areas. When, however, I replaced the Sperry monochrome controller card with an Everex Edge card, the diffusion problem disappeared.

One other available card designed specifically for the Sperry IT is a serial port card with four asynchronous ports for terminals or modems. Two of these cards may be installed for use with the XENIX System V operating system, allowing up to eight

(continued)

Table 1: The effect of clock speed and wait states on processor performance for the Sperry PC/IT. Shown are the times, in seconds, required to finish two BASIC benchmarks—the Sieve of Eratosthenes and Floating-Point Calculations. Note that the 7.16-MHz clock speed without wait states is significantly faster than the speeds that involve wait states.

Clock speed (MHz)	Wait states	Sieve of Eratosthenes	Floating-point calculations
6	1	67.4	22.0
7.16	0	44.4	14.4
8	1	49.6	16.0



Photo 1: The PC/IT keyboard for the Sperry PC/IT. Two other keyboards are also available for this system.

Sperry PC/IT

Company

Sperry Corporation
P.O. Box 500
Blue Bell, PA 19424
(800) 547-8362

Size

System unit: 22¾ by 17 by 6¾ inches
Monitor: 12 by 11¾ by 11 inches
PC/IT keyboard: 17¾ by 7½ by 1½ inches

Components

Processor: 80286, 16-/16-bit processor; variable clock speed (6, 7.16, or 8 MHz); optional 80287

Memory: 512K bytes or 1 megabyte on main board; 5 megabytes maximum

Mass storage: 1200K-byte 5¼-inch floppy disk drive; 44.6-megabyte hard disk (30-millisecond average seek time)

Display: Choice of IBM PC-style monochrome, medium-resolution RGB, or high-resolution RGB

Keyboard: Choice of IBM PC style, PC/IT (IBM PC AT style), or Professional

Expansion: Additional 1200K-byte (\$650) or 360K-byte (\$425) floppy disk drive; additional 44.6-megabyte hard disk drive (\$1725); 60-megabyte tape drive (\$1995); up to eight more serial ports (for XENIX V)

Interfaces: Two serial ports and one parallel port standard

Software

MS-DOS 3.1, Sperry BASIC 3.0

Documentation

BASIC user's guide (469 pages), MS-DOS user's guide (475 pages), system installation guide (186 pages)

Price

Basic system with one 360K-byte floppy disk drive, one 1200K-byte floppy disk drive, one 44-megabyte hard disk drive, monochrome monitor and adapter, color adapter, two serial ports, one parallel port, and system software: \$6044

SYSTEM FEATURES

MEMORY SIZE (K BYTES)

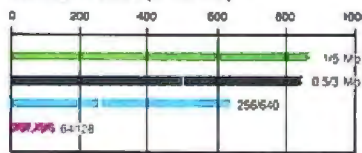

DISK STORAGE (K BYTES)

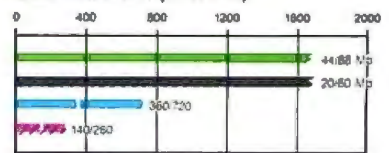

DISK ACCESS IN BASIC (IN SECONDS)

WRITE

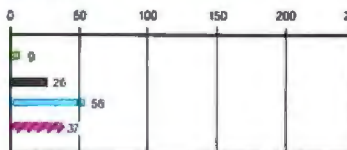

READ



BASIC PERFORMANCE (IN SECONDS)

SIEVE

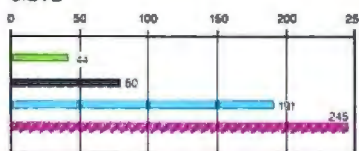

CALCULATIONS

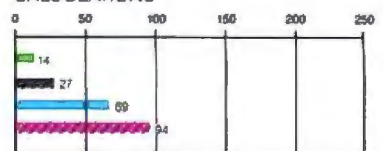

SYSTEM UTILITIES (IN SECONDS)

40K FORMAT/DISK COPY

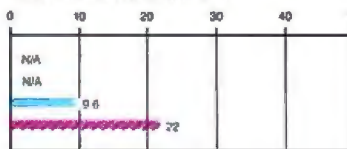

40K FILE COPY

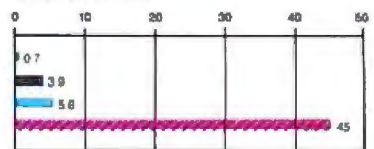

SPREADSHEET (IN SECONDS)

LOAD

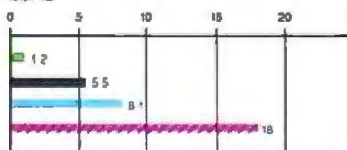

RECALCULATE

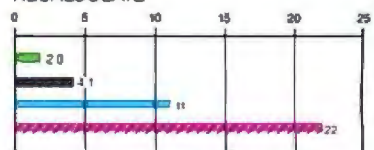

■ SPERRY PC/IT ■ IBM PC AT ■ IBM PC ■ APPLE IIe

The Memory Size graph shows the standard and optional memory available for the computers under comparison. The Disk Storage graph for the IBM PC AT and the Sperry PC/IT shows the standard hard-disk capacity and the highest disk capacity offered by the manufacturer. For the IBM PC and the Apple IIe, the Disk Storage graph shows floppy disk capacities. The graphs for Disk Access in BASIC show how long it takes to write and then read a 64K-byte sequential file to a disk. In the Disk Access tests, a hard disk was used for the Sperry PC/IT and the IBM PC AT; a floppy disk drive was used for the IBM PC and the Apple IIe. (For the program listings, see *BYTE's Inside the IBM PCs*, Fall 1985, page 195.) The Sieve graph shows how long it takes to run one iteration of the Sieve of Eratosthenes prime-number benchmark. The Calculations graph shows how long

it takes to do 10,000 multiplication and 10,000 division operations using single-precision numbers. The File Copy portion of the System Utilities graphs shows how long it takes to copy a 40K-byte file from one part of the hard disk to another, or from one floppy disk to another (for the IBM PC and the Apple IIe). No Disk Copy tests are done on hard disk systems. The Spreadsheet graphs show how long it takes to load and recalculate a 25- by 25-cell spreadsheet where each cell equals 1.001 times the cell to its left. The spreadsheet used was Microsoft's Multiplan. Tests for the Sperry were done with Sperry DOS 3.1 at 7.16 MHz, and tests for the PC AT were done with PC-DOS 3.0 at 6 MHz. The IBM PC used BASICA running under PC-DOS 2.0. The Apple IIe used ProDOS for all tests except the Spreadsheet tests, which were done with Apple DOS 3.3.

additional terminals to be attached to the system.

OPERATING SYSTEMS

MS-DOS version 3.1 comes with the IT. Included is the XDISK program for formatting a second logical DOS partition, allowing full use of the 44-megabyte drive. It has no surprises. Also included is Sperry BASIC 3.0. It appears to be a fairly standard version of Microsoft BASIC 3.0. All of the BYTE benchmarks ran without modification.

Sperry has also chosen to release XENIX System V for this computer. I have not yet used XENIX on this system but look forward to doing so.

Concurrent PC-DOS 4.1 from Digital Research runs quite nicely on the IT, and the machine is fast enough to support several processes running at the same time. Concurrent's major limitations on the IT at this time are its 640K-byte memory limit, the fact that you can put only two additional terminals on the IT, a 40-megabyte hard disk capacity limit, and an inability to access the tape drive. In addition, the IT will not boot Concurrent PC-DOS from the hard disk, while the IBM PC AT will.

SPERRY SERVICE

The Sperry hardware comes with a one-year warranty for carry-in or ship-in service. You can get on-site service for a small additional fee. After one year, service contracts are available for on- or off-site service. Sperry provides a toll-free technical support number. The people with whom I spoke seemed knowledgeable and willing to dispense information.

One slight problem with Sperry's service policy concerns non-Sperry parts. According to a warning in the manual, all non-Sperry parts in computers sent in for service "will be deemed by Sperry to have been discarded by the customer." This implied confiscation policy for non-Sperry parts is not realistic in a market where hundreds of makers and marketers of the same or similar hardware exist. Perhaps it needs only to be reworded to come across with a more benign intent. [Editor's note: A spokesperson for Sperry stated that despite the warning in the

manual, non-Sperry parts will not be confiscated from machines being serviced.]

DOCUMENTATION

Three manuals are included with the system—BASIC, MS-DOS, and the system installation guide. All manuals are bound in an IBM PC-style slipcased three-ring binder.

The system installation guide was a pleasant surprise. It features step-by-step instructions for setting up the system and installing options. The major omission in this manual was the pin-out diagram of the 9-pin serial ports. A toll-free call to Sperry technical support quickly supplied this information.

COMPATIBILITY

All of the IBM PC software that I tried with the system seemed to work, but I did notice a curious incompatibility with non-Sperry floppy disk drives.

When I installed a non-Sperry Mitsubishi 501 floppy disk drive, the system worked perfectly under Concurrent PC-DOS. Under MS-DOS, however, both the Sperry and the non-Sperry drives became inaccessible and remained so until I rebooted and reconfigured the system. The Sperry version of MS-DOS seems to check if a non-Sperry disk drive is present, and if so, it apparently erases the floppy disk drive configuration information stored in CMOS memory.

From Sperry distributors, I learned that you have to block the disk change signal (lead 34) on the card edge connector of all non-Sperry drives. I did so with a small piece of tape, and my Mitsubishi drive worked perfectly. Unfortunately, the disk change signal is used occasionally by the Concurrent PC-DOS operating system. I find it most curious that Sperry's version of MS-DOS seems to go to such lengths to discourage the use of non-Sperry disk drives.

I experienced a couple of minor problems with the high-density floppy disk drive. Most of the time it was able to read a 360K-byte formatted disk. However, several 360K-byte disks formatted on an Eagle and written by a CompuPro could not be read on the high-density drive under either operating system, although they were

readable with the 360K-byte drive on the Sperry IT. I also experienced several disk read/write errors on brand new high-density floppy disks that had formatted without error on two different ITs.

COMMENTS

Even at the system's fastest speed (7.16 MHz with no wait states), I found the keyboard auto-repeat to be too slow. (Fortunately, as with the IBM PC AT, there are short public domain programs to speed this up.)

As a whole, the benchmarks were fast. From BYTE's benchmarks and some benchmarks of my own, I found that both system- and disk-intensive tasks run significantly (460 percent) faster compared to a standard IBM PC XT-type machine.

Some factors of perceived speed don't show up in BYTE's benchmarks, however. For example, when I use WordStar on most systems, I find the wait for the overlays to be annoying. On the IT's hard disk, there was no perceptible delay. Another factor is how fast the screens come up. The IT has the fastest screens I have ever seen, even with screens completely full of text.

One minor annoyance concerns the system enclosure. It sometimes tends to resonate noisily with the hard disk drive. I had to use a small amount of padding to tighten up the fit.

CONCLUSIONS

I enjoyed working with the Sperry IT. Its drawbacks are primarily those shared by most IBM PC compatibles. Its benefits, however, far outweigh its weaknesses. It is a very fast computer for one person to use, and if half a dozen average processes were running on it concurrently, each task would have at least the performance level present on the IBM PC.

In the past, users had to buy the more expensive high-performance micros to adequately run multiuser programs for the MP/M-86 and Concurrent DOS environments. In many cases, the Sperry IT with Concurrent PC-DOS can now fill the bill. It's nice to find a machine designed with the multiuser environment in mind at a reasonable price. ■

EVERYTHING SYMPHONY WAS SUPPOSED TO BE.

**AVAILABLE NOW
ONLY \$84.95
WITH A 60-DAY
MONEY BACK
GUARANTEE**

In One Totally Integrated Package:

- Word Processing With Spell Checker
- Communications
- Spreadsheet
- Database
- Graphs

- Extremely easy to learn and use
- Data is interchangeable with all modules and other products
- Windows allow quick movement between tasks
- Four background, one foreground mode. Can print on two printers or plotters and two communication devices (modem and main-frame direct connection) all at the same time.
- Artificial Intelligence features reduce the number of keystrokes required to perform tasks
- Upgradable software and data to UNIX and XENIX

- **Package contains:** one plastic box, one illustrated reference manual, one program disk, one sample diskette, keycaps and user support plan
- **System Requirements:** IBM PC or compatibles, 512K, two 360K diskette drives, color or mono display
- Twenty-four hour Hotline Support (optional)



Multiple windows allow quick movement between tasks.

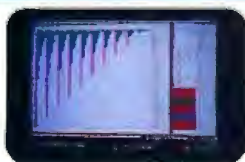

Colorful graphic representations

What the experts say:

"I can safely say that I have yet to come across a package which demonstrates such functionality combined with such an innovative approach to the man-machine interface. ABLE are to be congratulated on producing a product which achieves a very high standard of excellence."

—Michael D. Bowe, DATA GENERAL

"The best multi-purpose product I have evaluated. Multi-tasking works great, able to print, make an on-line connection and edit a document at the same time."

—Robert Lawrence, ITT INFORMATION SYSTEMS

A B L E

International

ABLE Int'l is a longtime, innovative supplier of software for micro and minicomputers.

301 North Main Street
Fueblo, Colorado 81003 USA
Telephone 303-844-9600, Telex 650-2154286

ABLE *One*

To order, call 1-800-826-1907.
In Colorado call 1-800-626-4784.
Order 24 hrs. a day

60-Day Money Back Guarantee*

These prices include shipping to all U.S. cities. All foreign orders add \$10 per product ordered.

Not copy-protected \$84.95
(CO res. add \$5.52 tax per copy)

Quantity: _____ at \$84.95

Amount: CO res. 6 1/2% tax

Payment: VISA MC BankDraft
Check AmEx Diner's

Credit Card Exp. Date: _____

Card #: _____

Name: _____

Shipping address: _____

City: _____

State: _____

Zip: _____

Telephone: _____

CO's and Purchase Orders WILL NOT be accepted by ABLE. Colorado residents add 6 1/2% sales tax. Outside USA add \$10 and make payment by bank draft, payable in US dollars drawn on a US Bank.

*If you find that this product does not perform in accordance with our claims and representations, within 60 days of purchase call our Customer Service Dept. and we will gladly arrange for a refund.

We Dared To Go Beyond RAM.

FEATURES

THE CACHE BOARD

Intelligent host adapter interface for hard disk drive.

COMPATIBILITY

Apple II+, IIe and IIc enhanced systems. Most SCSI hard disk drives.

KEY FEATURES

Cache Memory-replaces mechanical disk access with electronic data transfer.

Z-80 processor-Maintains 256K of "most frequently accessed data" in real cache memory. Automatic save function minimizes data loss.

DMA-Transfers data faster than RAM. Cuts booting time in half.

SUPER CHARGE YOUR SIDER

Specific testing with Sider hard drive resulted in not only substantially faster data accessing but also improved performance of the drive itself.

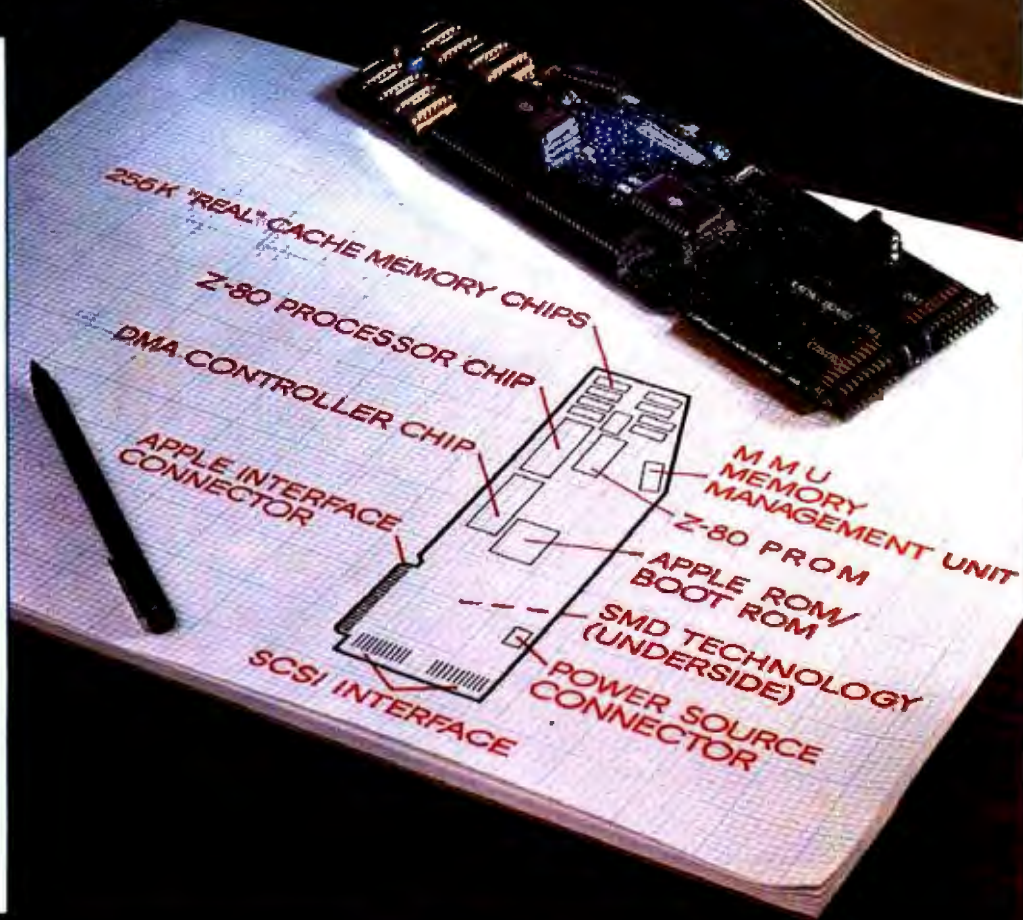

ATTENTION APPLE II USERS:

The Kache Board is an *intelligent* host adapter interface for hard disk drives.

KACHE BOARD DEVELOPMENT

It took over two years of research and development, and long hours of testing to make this product a reality. Ohio Kache Systems dared to go beyond RAM to bring hard disk users a new standard in performance — The Kache Board.

SUPERIOR TO RAM

It's superior to RAM disk, thanks to the use of Cache Memory, Direct Memory Access (DMA), and an on-board microprocessor. When you combine these features with the performance of hard disk drives, you're looking at an *overall 25%-30% decrease in access time and the virtual memory environment of a minicomputer such as the VAX.*

KACHE BOARD PERFORMANCE



- Kache Board Performance
- RAM Performance
- Apple Performance with Hard Disk Drive
- Apple Performance

CONTINUOUSLY INCREASING PERFORMANCE

As more data files reside in Cache, the performance of the Kache Board continues to improve beyond that of RAM disk. An increasing number of disk access requests are replaced by electronic data transfer from "real" cache memory (see graph above).

AVAILABLE SOON

Available soon: Kache Boards for IBM and IBM compatible systems.

DIRECT FROM DEVELOPER

The Kache Board is available exclusively from Ohio Kache Systems on a direct mail basis only. For more information on the Kache Board write for our free brochure. Or call us toll free at:

1-800-338-0050

We think you'll be as excited about this new product as we are!



Ohio Kache Systems Corp.

4166 Little York Road

Dayton, Ohio 45414-2566

513-890-3913

© Ohio Kache Systems is a developer of computer enhancement products.

O.K.S., Kache Board and the O.K.S. logo are trademarks of Ohio Kache Systems, Inc.

Apple is a registered trademark of Apple Computers, Inc.

IBM is a registered trademark of International Business Machines, Inc.

Sider is a trademark of First Class Peripherals, Inc.

VAX is a trademark of Digital Equipment Corp.



DESMET C DEVELOPMENT PACKAGE FOR THE MACINTOSH

BY JONATHAN ROBIE

The DeSmet C Development Package for the Macintosh, a compiler that costs only \$150, produces faster and more compact code than most C compilers for the Macintosh. It also compiles faster, has a good programming environment, and gives good support for the ROM Toolbox. Although this compiler by C Ware Corporation has many strengths, it also has a few significant flaws, which I will examine.

USING DESMET C

DeSmet C operates with a UNIX-like shell that makes program development on the Macintosh similar to working in UNIX or on an IBM PC. There are no windows, no desk accessories, and no icons. The mouse is not even active. The shell is not flashy or fancy, but it is fast and responsive and eliminates the long waits that you would normally expect from the Macintosh. The text editor is similar to UNIX's vi and nearly identical to DeSmet's editor for the IBM PC.

The DeSmet C compiler also comes with a RAM disk. This RAM disk works only on a Macintosh with at least 512K bytes of RAM. It is installed by typing the command ramdisk in the shell or by clicking the RAM disk icon from the Finder. This opens a window that allows you to specify the disk drive number, unit number, and capacity. A set of files can automatically be loaded into the RAM disk at boot-up, and the RAM disk can be selected as the boot disk. This eliminates most of the disk swapping that is so common on the Macintosh and makes it feasible to use the compiler with only one disk drive if you have

A fast, low-cost C compiler with several strengths and a few significant flaws

at least 512K bytes of RAM. Since the disk drives and the Finder are both very slow, you will find that the combination of the DeSmet shell and the RAM disk speeds up work on the Macintosh immensely.

BENCHMARKS

I used the same benchmarks that were used by Tim Field in "Five C Compilers for the Macintosh" (November 1985 BYTE). These benchmarks are described and justified in that article. Table 1 gives the benchmark results and code sizes found by Tim Field, along with those for the DeSmet C compiler. [Editor's note: *New benchmark sizes and times are also provided for Consulair's Mac C, version 4.0.*]

When no register variables are used, DeSmet C is the fastest (or one of the fastest) in the benchmarks that measure loop overhead (FRAME), efficiency of pointers (POINTER), function calls with passed parameters (QSORT), and integer arithmetic (INTMATH). DeSmet C was also the fastest for the SIEVE benchmark, which primarily tests array and integer math operations. Aztec C was slightly faster for the FIB and INTERFACE benchmarks, which measure function calls and the speed of calls to Macintosh ROM. For the benchmark that tests floating-point arithmetic (FLOAT), the Aztec C and Mac C compilers were significantly faster than DeSmet C, which came in third place. DeSmet C

produced the smallest programs in every case except the QSORT benchmark. In this case, the program is significantly larger than that produced by Megamax C, but it is still smaller than the programs produced by the other compilers.

I used two additional benchmarks to test the speed of file I/O and to further explore performance on floating-point operations. Since I did not have the other compilers, I ran these benchmarks only on DeSmet C and Aztec C. The FILEIO benchmark tests the speed of file I/O by creating a 65,000-byte file and performing various reading and writing operations at random locations in the file. There was not much difference between the two compilers for this benchmark. The Savage benchmark (Dr. Dobb's Journal, September 1983, page 120) tests both speed and accuracy of transcendental floating-point functions. DeSmet C was significantly faster than Aztec C for this test, but it performed with slightly less accuracy. The correct output should be 250.00, and neither compiler was off by more than one part in 10 million. [Editor's note: *Mac C was quicker and more accurate than either of the other compilers. See table 1.*]

Overall, the DeSmet C compiler is clearly one of the fastest, and it generally has the most compact code. DeSmet C does not have register variables, however, and the Megamax C

(continued)

Jonathan Robie (P.O. Box 26121, Lansing, MI 48909) is finishing his master's degree in computer science and beginning doctoral work in cognitive psychology at Michigan State University.

and Aztec C compilers generally outperform DeSmet C when register variables are used (the register keyword is accepted, but a technician at C Ware informed me that it has no effect on register allocation). I wonder how fast these programs would run if DeSmet C supported register variables.

Compiling and linking are painfully slow with most Macintosh C com-

compilers, but Tim Field found that these operations were much faster with Aztec C. I compared DeSmet C to Aztec C by compiling the SIEVE program with each. I used the RAM disk that comes with each compiler to hold the compiler, assembler, linker, and libraries, and all temporary files were processed on the RAM disk. The object file was written to the internal drive. Compile time was 11.79 sec-

onds for the DeSmet C compiler and 12.56 seconds for Aztec C. Link time was 15.18 seconds for DeSmet C and 17.47 seconds for Aztec C. The total time required to compile and link was 30.03 seconds for Aztec C and 26.97 for DeSmet C, which means that DeSmet C is roughly 10 percent faster for this program.

FEATURES

The ROM Toolbox interface is well designed and makes calls to the Toolbox quite simple. Since C and Pascal have slightly different data structures and pass their parameters differently, you normally have to use different arguments when calling Toolbox routines from C. Since the documentation for the Toolbox is written with Pascal examples, this can be rather inconvenient. In DeSmet C, all conversions are done automatically before the ROM routine is accessed. Because the Toolbox calls are the same as in Pascal, you can use the formats found in *Inside Macintosh* without changing them. These routines are stored in a file called *maclib.s*, which you must link with your object code to produce a stand-alone application.

The compiler accepts variable names composed of up to 31 letters, making it easy to write readable code. It also allows in-line assembly code. This lets you rewrite time-critical sections of code in assembly language, perhaps retaining the original C source as comments.

DeSmet C uses a small memory model that limits you to 32K bytes of static data. Up to 32K bytes of additional data may be allocated by each called procedure. If you need larger blocks of data, you must allocate them on the heap. Each code segment is also limited to 32K bytes, but you can have up to 32 code segments in your program by using a flag at link time. Segments can be unloaded at run time with a function called *unloadseg()*. This can be very helpful for writing code to run on the 128K Macintosh.

BUGS AND SHORTCOMINGS

The main problem with the DeSmet C compiler is its failure to support

(continued)

Table 1: The results of the benchmark tests and the sizes of the execution files produced.

	Execution Times (in seconds)					
	DeSmet C	Aztec C*	Megamax C*	Mac C	Softworks C*	Hippo-C*
FRAME						
Normal	0.10	0.10	0.10	0.13	0.13	0.25
Register	n.a.	0.05	0.05	n.a.	0.08	n.a.
POINTER						
Normal	20.40	25.50	30.02	31.71	24.33	33.23
Register	n.a.	13.15	18.93	n.a.	11.15	n.a.
INTMATH						
Normal	4.66	5.03	5.05	15.06	30.05	15.93
Register	n.a.	2.70	2.78	n.a.	26.73	n.a.
SIEVE						
Normal	6.08	6.20	6.20	7.80	8.83	12.65
Register	n.a.	3.88	4.17	n.a.	4.73	n.a.
QSORT						
Normal	11.46	68.43	93.38	13.28	157.08	test failed
Register	n.a.	50.87	70.80	n.a.	93.72	n.a.
FLOAT						
Normal	330.55	268.22	334.32	268.90	332.77	n.a.
FIB						
Normal	24.78	24.72	25.97	32.68	28.60	47.22
INTERFACE						
Normal	58.50	56.22	72.00	71.41	59.18	78.47

File Sizes
(in bytes for "normal" [non-register] runs)

FRAME	5792	8537	6544	12,800	32,000	20,992
POINTER	5860	8571	6586	12,800	32,000	21,044
INTMATH	6312	9109	7128	13,312	32,512	21,948
SIEVE	5866	16,897	6768	12,800	40,448	21,318
QSORT	10,356	13,113	7226	13,312	36,608	test failed
FLOAT	6208	9205	7256	13,312	32,256	n.a.
FIB	6016	8751	6810	12,800	32,256	21,304
INTERFACE	5976	8697	6700	12,800	32,256	21,230

Additional Benchmarks
(execution times in minutes:seconds)

	DeSmet C	Aztec C	Mac C
FILEIO	7:46	7:53	9:29
SAVAGE			
Speed	4:04	5:53	3:41
Result	249.999949691499	249.99999968363	250.000000000000

*These times are from Tim Field's November 1985 BYTE article.



**With the IBM System/36 PC,
you can run your business
from here.**



This surprisingly small IBM System/36 PC has the power to keep any size business moving. At a surprisingly small price.

Connect the System/36 PC to your IBM Personal Computer, and you have the power to build your fortune without spending one.

And you also have a system that's part of the System/36 — IBM's most popular multi-user computer family. Which gives any business access to the broad range of System/36 software as well as PC software.

The basic System/36 PC, a processor and a personal computer, easily operates as a standalone system in a small business. Or ties a department in a larger organization together by connecting a combination of IBM PCs, System/36 terminals or compatible printers. So you can share information and resources.

And yet, with all that power, the System/36 PC processor is so small, it fits under your desk, on top, or next to it. Wherever you put it, you can run a successful business from the best position.

For a free brochure on the IBM System/36 PC, or for information on product availability from participating Authorized IBM PC Dealers, Value Added Dealers or IBM Product Centers, call 1 800 IBM-2468, ext. 104/LD. Or call your marketing representative. And be sure to ask about IBM Credit Corporation financing.

IBM

DeSmet C Development Package for the Macintosh

Company

C Ware Corporation
P.O. Box C
Sunnyvale, CA 94087
(408) 720-9696

Necessary Hardware

Apple Macintosh with 512K and two disk drives recommended; can be used with a 128K Macintosh or with a single disk drive

Price

\$150; not copy-protected

logical devices or I/O redirection. Logical devices are reserved file-names that actually refer to devices. This allows you, for example, to access the printer as though it were an output file. Because this compiler does not support logical devices, there is no straightforward way to send output directly to the printer. There is a program called PR included with the package, which prints a text file so you can spool output to a file on disk and then chain to PR to print the file. You could also write your own printer output routines from the PR source code, which is included. A second, minor shortcoming of DeSmet C is that macro substitution does not occur within quoted strings.

I found three bugs in the libraries—two in the Macintosh library and one in a math routine. I was surprised to find that OpenPicture returned an integer rather than a pointer, an error flagged by the compiler. I found that this function was correctly declared in

Quickdraw.h, but this declaration and 16 others were removed using #if 0/#endif statements. A call to C Ware tech support revealed that a prerelease version of the compiler did not have an intelligent linker, and these definitions were removed to keep program size down. You can correct this problem by deleting the #if 0/#endif lines from Quickdraw.h. The second bug is more obscure: When I ran the INTERFACE benchmark under the shell, the system crashed. The same program ran flawlessly under the Finder. I was unable to find the source of this bug. The third bug is in the pow() routine. There is a global variable called errno, which is used to flag errors in math routines. When an overflow occurs in pow(), this variable is not flagged. Dividing by zero also fails to set this flag.

THE SHELL

The shell is a command interpreter that is similar to both the UNIX shell



A Personal Language

When it comes to problem solving, the APL*PLUS System is the undisputed leader.

That's because the APL*PLUS System works with you. It goes far beyond what application software like Lotus® or dBASE® could possibly ever offer. And, it won't tie you down with the details of standard programming languages.

The APL*PLUS System is a personal language, with productivity features that help you concentrate on getting answers,

rather than struggle with intricate calculations and modeling.

With it you can manipulate tables of numbers as easily as single numbers and get quick results from your computer using short, simple statements.

When you've reached the limits of other packages, move up to the APL*PLUS System. It's a powerful and flexible tool that grows with you as your needs become more sophisticated. With over 200 built-in

applications—like graphics, report formatting and communications—you have all the tools at your fingertips to quickly and easily solve those seemingly impossible problems.

Best of all, the APL*PLUS System interfaces well with software packages you're already using—like databases, spreadsheets, and graphics packages. The APL*PLUS System also makes it easy to link those packages that aren't

and the shell provided with the Aztec C compiler. Using the shell is much like using the operating systems on most computers—if you type the name of a program, then the program runs; if you type a command, then the command is carried out. If you are familiar with UNIX or MS-DOS, you will probably learn the shell's commands without much effort. However, you will most likely be annoyed by the fact that the shell, like the compiler, does not support logical device names or I/O redirection. PR is used to print files. Files are typed to the screen using the command more, which operates like the more command in UNIX: the first screen of the file is displayed, and the file scrolls up one line every time you hit the Return key. I find this less convenient than the more command in MS-DOS. The shell does not support subdirectories.

The DeSmet shell completely replaces the Finder and speeds up file access considerably. The Finder was

not designed to make programming efficient, but to make the Macintosh easier to use. Since the shell is fast, flexible, and designed for programming, it is a much more suitable development environment than the Finder.

A series of shell commands can be put in a file (called a "script") and executed by typing the name of the file (like a .BAT file in MS-DOS). If a script is named .profile, then it will be executed whenever the shell is first booted. Scripts can take up to nine parameters, and the script can be aborted if errors occur on any command. The mod operator determines when a file was last modified and allows the programmer to write a make script, which will compile only those source files that have been modified since the last compilation.

The DeSmet shell also allows command logging, a feature found in many UNIX shells, but not in the Aztec shell. When you are logging

commands, they are saved in a log file. To execute one of these commands again, you merely type enough characters to distinguish it from all the other commands. This is extremely convenient. When a C program is compiled or linked, several files may be specified, and several flags may be set. Since the development cycle typically involves compiling the same files repeatedly with the same files and flags, command logging greatly reduces the amount of typing needed. For instance, if you link a file using the command `b68 foo.o 1:local.o 2:maclib.s`, then you can repeat that command by simply typing the command `!b6`.

The Macintosh desk accessories are not available from the shell, and I wish some of them were there. When I program, I like to keep notes and error logs, and I find the Notepad and Scrapbook useful. I also miss the Alarm Clock. These capabilities have

(continued)

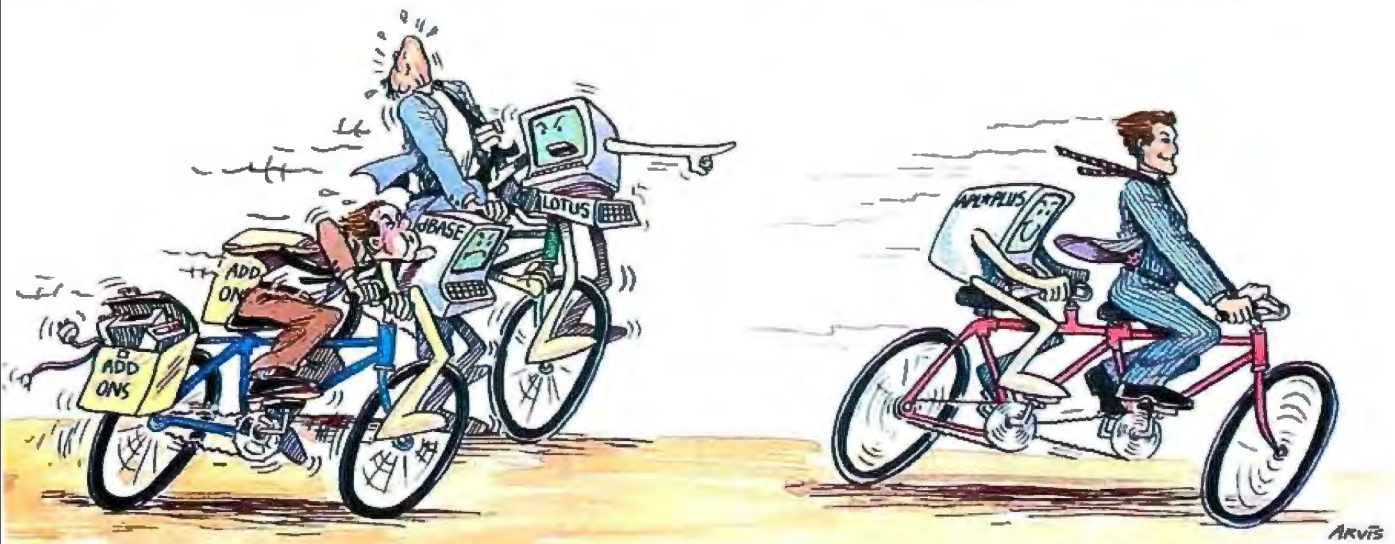

The APL★PLUS® System and You.

currently talking with each other.

With all this problem-solving power, it's no wonder STSC's APL★PLUS System is the personal choice of so many business professionals—financial planners, business analysts, actuaries, scientists, mathematicians, engineers, statisticians, and consultants. Especially since the APL★PLUS System is available on a full range of computers from desktops to mainframes.

Put the power, speed, and flexibility of the APL★PLUS System to work for you. See your local dealer today to get your APL★PLUS System. If they don't have it, refer them to STSC or call STSC toll-free, (800) 592-0050. In Maryland or Canada, (301) 984-5123.

Available nationally through Softsel, Micro Central, and distributors worldwide. Dealer inquiries welcome.

Problem-Solving at the Speed of Thought

STSC STSC, Inc.
2115 East Jefferson St.
Rockville, MD 20852

APL★PLUS is a service mark and trademark of STSC, Inc. PLUS★WARE is a trademark of STSC, Inc. Lotus and dBASE are registered trademarks of Lotus Development Corporation and Ashton-Tate, respectively.

A PLUS★WARE™ PRODUCT

© 1986 STSC, Inc.

\$99**HARD DISK
CONTROLLER****New Shugart Model 1610
5 1/4" Hard Disk Controllers****EMULATES**

- XEBEC S1410 (1610-3) **Full**
- DTC 510 (1610-1) **90 day**
- SCSI (1610-4) **Guarantee**

WORKS WITH

- Micromint COM 180, SB180
- Wavemat Bullet
- AMPRO All Boards **Manual**
- Macintosh **and**
- Apple IIe **Schematic**
- ACS 1000 **Only \$8**
- ISI 5160

COMPUTER SURPLUS STORE

226 Phelan Avenue
San Jose, CA 95112
408-280-1740

Inquiry 70

NEW**SIBEC II**

- 8052AH BASIC V1.1 CPU
- iSBX* expansion connectors
- Prototyping area
- Five 8 bit input/output ports
- PROM programmer
- Expansion connectors

CALL TODAY 603/469-3232**\$295****Binary Technology, Inc.**

MAIN ST. • P.O. BOX 87 • MERRIMAN, NH 03276
(603)469-3232

*iSBX is a trademark of the Intel Corporation

Inquiry 39

Maxell Floppy Disks

**The Mini-Disks
with maximum quality.**



Dealer inquiries
Invited. C.O.D.'s
accepted. Call
FREE (800) 235-4137.



PACIFIC EXCHANGES
100 Foothill Blvd. San Luis
San Luis Obispo, CA 93401
In Cal call (800) 592-5935 or
(805)543-1037

Inquiry 216

REVIEW: DESMET C

made programs like SideKick very popular, and they could easily have been included. Version 1.06F of the Aztec C compiler lets you add desk accessories to the shell by using a resource mover, but it is almost impossible to put all of the necessary files on the default drive and still have room on the disk for the Notepad and Scrapbook. I don't miss the Macintosh Calculator much; simple computations can be done from the shell using the eval statement. This statement, when followed by an arithmetic expression, gives the result in decimal, hexadecimal, and character formats. This is much more useful than the Calculator for programming. The eval statement does not support floating-point operations, however.

THE EDITOR

DeSmet C's editor, See, is a modal editor that is similar to the vi editor found on UNIX systems. The commands of See are much easier to remember than those of vi, however, because of well-chosen names. To make it even easier, a list of the commands is always displayed on the top line of the screen while you are in the text editor.

The Macintosh implementation of See is extremely similar to the IBM PC version (both of which were written by Michael Ouye). It uses the mouse for cursor positioning but also recognizes WordStar-like key combinations for moving the cursor (command-E moves the cursor up, command-X moves it down, etc.). I found See to be simple, graceful, fast, and powerful.

DOCUMENTATION

The manual for the DeSmet C compiler is brief, clear, and extremely helpful. It comes in one IBM-style notebook binder. There is no index, but the table of contents is very detailed and the documentation is well organized, so I was usually able to find specific sections of the manual quickly. An index would have made the documentation easier to use.

The manual describes important technical details that are often left unexplained in other manuals. For instance, the rules for extern declarations are described clearly and

thoroughly, and the memory-model and calling conventions are carefully explained. All error messages are listed in an appendix at the end of the manual, with separate sections of messages for shell, editor, compiler, assembler, binder (linker), library, and CLIST. I like this arrangement; with all the error messages listed near the end of the manual, it is always easy to find them.

The "Macintosh interface" section of the manual is particularly valuable. Each part describes one portion of the Macintosh interface (e.g., QuickDraw, the Event Manager, and the Resource Manager) and contains a "getting started" section that tells the basics of how to use it and gives the code for a simple example. If you are new to programming the Macintosh, you will find these "getting started" sections a good way to learn. Nowhere in *Inside Macintosh* do you find such clear explanations. As I flipped through this section of the manual, I had vivid memories of the large amounts of time I had to spend learning how to program my Macintosh. This documentation probably would have saved me a great deal of time. C Ware claims that over 450 functions are supported by DeSmet C, but only a portion of these are documented in the manual. The manual suggests that you refer to *Inside Macintosh* for documentation on the remaining functions.

CONCLUSIONS

The DeSmet C Development Package for the Macintosh is a useful product with some major flaws and omissions. If future versions correct these problems, this could become the best C compiler available for the Macintosh. The UNIX-like shell is very responsive, the editor is powerful and easy to use, and the compiler produces code that is fast and compact. The Toolbox library makes access to the Macintosh ROM routines straightforward. The manual is clear and readable. In addition to these other features, it is the most inexpensive C compiler available for the Macintosh. Unfortunately, logical devices and I/O redirection have not been implemented, and there is no straightforward support for the printer. ■

STATGRAPHICS®

Now!
Faster, More Procedures,
Improved Data Management!

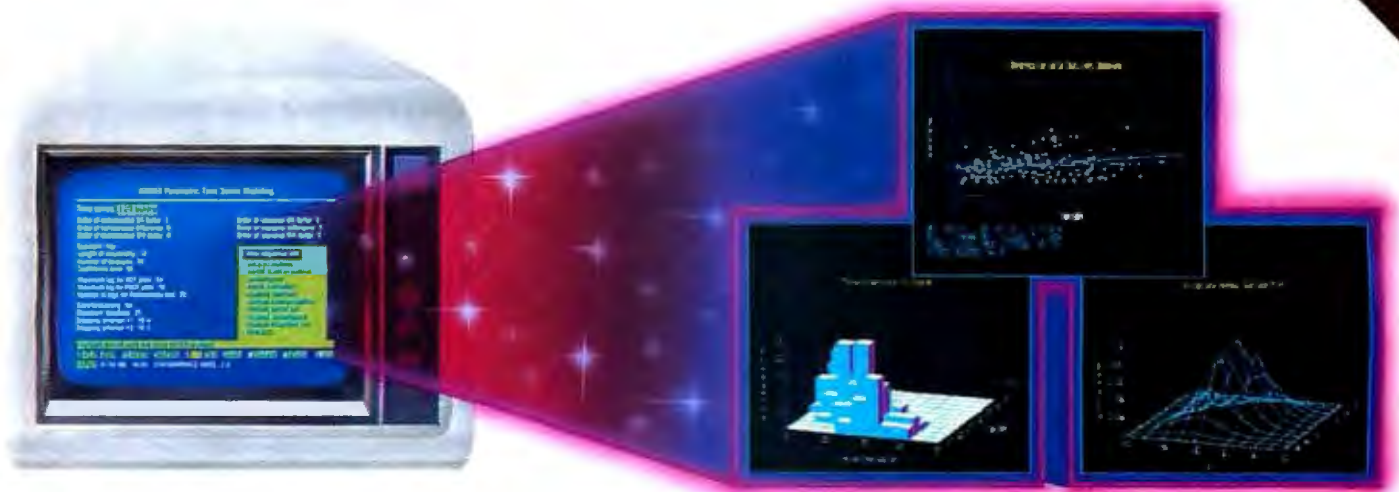

Powerful Statistics, Sophisticated Graphics In One Complete Software System

STATGRAPHICS from STSC is simply the most complete and powerful statistical software available for your PC. STATGRAPHICS integrates powerful statistics with high-resolution color graphics—in one single software system—to give you an extraordinarily powerful analytical environment.

"[STATGRAPHICS] is unusually complete as software systems go in terms of statistical capabilities."
(PC Week)

With more than 250 statistical and mathematical procedures, STATGRAPHICS offers you the power and precision of mainframe software—right on your PC. All the tools you need for comprehensive statistical analysis: ANOVA, complete regression analysis, experimental design, quality control procedures, multivariate techniques, nonparametric methods, and extensive forecasting and time series analysis, including Box-Jenkins.

"I've found STATGRAPHICS to be one of the most complete and easy-to-use statistics programs that I have come across."

(Whole Earth Software Catalog)

All this statistical power is even more valuable with STATGRAPHICS' unique interactive environment. STATGRAPHICS is completely menu-driven so you can get into your statistical analysis work quickly and be productive right from the start. You can easily go back and forth between your numerical and graphical analysis—change variables as many times as you want—and see the effect immediately.

You can also enter and access data easily. STATGRAPHICS has a full-screen data editor and interfaces with standard ASCII files, Lotus® 1-2-3® and Symphony® worksheets, and dBASE® files.

"Verdict: [STATGRAPHICS is] a model PC software system which will set standards for PC statistical software."

(PC User Magazine)

STATGRAPHICS offers you a wide variety of graphics capabilities to help you visually analyze your data—more options and more sophistication than any other PC statistical software. Included are histograms, two- and three-dimensional line and surface plots, scatter plots, time sequence plots, quality control charts, as well as bar and pie charts. STATGRAPHICS supports a wide range of graphics boards, printers, and plotters.

For the most complete, advanced statistical graphics software system available, order STATGRAPHICS today. To order, contact your local dealer. If they don't have it, tell them to call STSC toll-free.

(800) 592-0050

In Maryland or Canada call [301] 984-5123.

STATGRAPHICS—the best overall choice!

	Integrated Statistical Graphics	Direct Lotus & dBASE Interfaces	Menu-Driven	Minimum Hardware Required	Helpline Support	U.S. Suggested Retail Price
STATGRAPHICS	✓	✓	✓	Dual Floppy Disk	✓	\$795*
SPSS/PC+™	NO	NO	NO	10 Meg Hard Disk	✓	\$1385
SAS/PC	NO	NO	✓	20 Meg Hard Disk	✓	\$2700+ Annual Maintenance Fee

Data compiled as of April 1988

STSC

Inquiry 284

Available nationally through Softset and distributors worldwide. Dealer inquiries welcome.

*International prices slightly higher. STATGRAPHICS, SAS, and dBASE are registered trademarks of Statistical Graphics Corporation, SAS Institute Inc., and Ashton-Tate, respectively. Lotus, 1-2-3, and Symphony are registered trademarks of Lotus Development Corp. PLUS*WARE and SPSS/PC+ are trademarks of STSC, Inc. and SPSS Inc., respectively.

A PLUS*WARE™ PRODUCT

CompuPro Solves the Network Puzzle

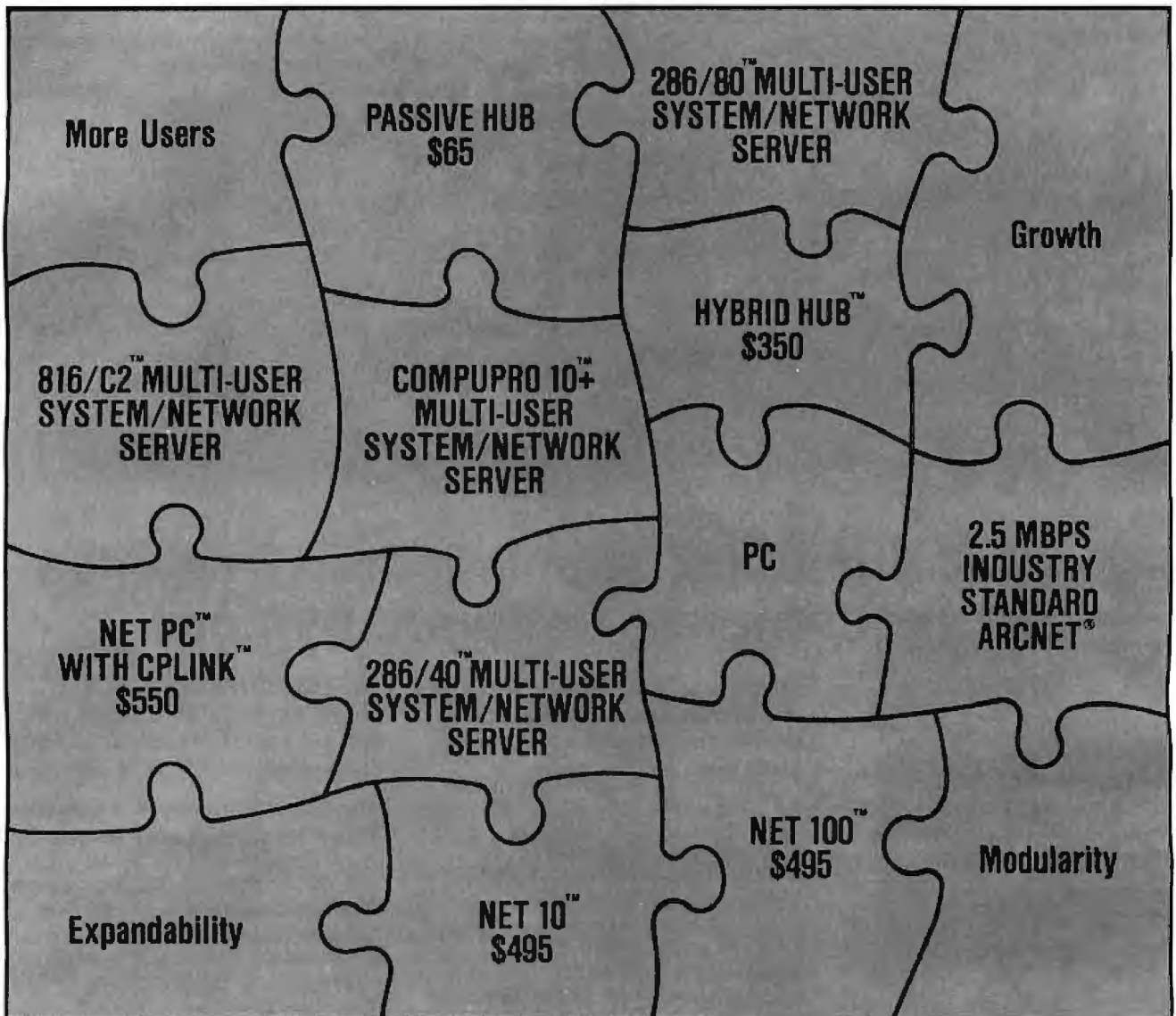

Don't be puzzled by networking. CompuPro puts all the pieces together — our high performance multi-user systems simultaneously double as network servers for IBM® PCs. Move up to a true multi-user system and save your investment in existing PCs. To find out how CompuPro can solve your networking puzzle, call today for the name of your nearest dealer.

CompuPro™

Viasyn Corporation
26538 Danti Court, Hayward, CA 94545-3999 (415) 786-0909

Suggested list prices, subject to change without notice.

Trademarks: CompuPro 286/80 286/40 10 Plus 816/C2 NET 100 NET 10 NET PC HYBRID HUB Viasyn Corporation IBM International Business Machines Corporation ARCNET Datapoint Corporation CPLINK ComputerNet A/S



TOPSI 2.0

BY LEONARD MOSKOWITZ

TOPSI 2.0, from Dynamic Master Systems (DMS), is an MS-DOS version of the OPS5 production system language. OPS5 is often used to write rule-based expert systems. Until recently, OPS5 was available only on large, expensive computers. However, TOPSI is written in Turbo Pascal for the IBM PC and compatibles and is a faithful implementation of OPS5, but with some critical differences.

USING TOPSI

When booting TOPSI, your system-configuration file, CONFIG.SYS, must contain the line `device = ANSI.SYS` to make your IBM PC act like an ANSI terminal. DMS doesn't tell you this in the documentation, however. After I added this line to my configuration file and booted, TOPSI came up clean. DMS does supply a terminal installation program that lets you define a new terminal if yours is not standard ANSI.

When you enter the command TOPSI, you get a right-arrow prompt meaning that you are at the top, or command, level. You can enter productions directly at the top level, which lets you edit your production systems from within the interpreter—a very useful capability. The alternative is to exit to an editor, modify the system, and then reenter OPS5.

At the top-level prompt, TOPSI expects a command in the form of a list, that is, enclosed in parentheses. TOPSI accepts a free-form entry format, so if you type an open parenthesis and press Return, it knows that the command hasn't been properly terminated. However, if you type an unrecognizable command, TOPSI accepts it, ignores it, and gives no error indication. TOPSI will give short, informative error messages, however, if

An implementation of OPS5 written in Turbo Pascal for MS-DOS computers

you enter a known command with incorrect syntax.

You can load a production system directly from the MS-DOS command line. If you enter TOPSI *filename* (where *filename* is the name of a TOPSI production system file), TOPSI loads and runs the desired file, bypassing the top level. Since the productions are evaluated as they are read in, any comments in the source file are ignored.

TOPSI can also save a production system to a file. You can save just the productions, the productions and the contents of the working memory, or a memory image of both (which speeds up the loading process).

Typing (help) at the top level accesses TOPSI's Help file. The entire file is displayed screen by screen, and you can stop the display when you find the information you need. Although you can't ask for help on a particular topic, it's still a helpful feature.

TOPSI doesn't expand horizontal tabs when entering productions from the top level. This makes formatting the productions a little tedious. Normally, however, you would write the productions using a text editor and then load them into TOPSI via the (load) command, bypassing this difficulty. TOPSI formats your productions when you view them via the (pm) command.

BENCHMARKS

OPS5 is not a normal procedural language; therefore, the standard benchmarks don't apply, because it's un-

likely that you would ever use OPS5 for numerical computation and because OPS5 programs are not expected to run in any particular order. A better procedure might be to measure TOPSI's performance under conditions

known to stress it. I regularly use OPS5 on a Symbolics 3670 LISP workstation, and OPS5 for VAX version 1.0 on a VAX-11/785. Since these are strong OPS5 implementations, I have used them as comparisons for TOPSI. A good measure of OPS5's execution speed is the average number of productions it fires, or allows to act, per second.

One of OPS5's best features is its efficient pattern matcher, called the Rete algorithm. Because of it, OPS5's execution speed is relatively insensitive to the number of productions in a system. However, TOPSI doesn't use the Rete algorithm. DMS thought that the IBM PC didn't support enough memory to implement a full Rete network and so traded speed (which the Rete network would have provided) and memory to get a workable version of OPS5 on the IBM PC.

The first benchmark I ran (see figure 1) tested execution speed for a one-production system that matches one working-memory element and modifies it. Since both working memory and production memory remain small (one element each), there is only one instantiation—a production matched with a working-memory element that

(continued)

Leonard Moskowitz (0-75 Morlot Ave., Fair Lawn, NJ 07410) heads a research and development group that applies artificial intelligence technology to the problems of maintenance and diagnostics at Allied Corporation's Bendix Test Systems Division. He is currently working toward a Ph.D. in computer science at Rutgers.

TOPSI 2.0**Type**

Programming language

Company

Dynamic Master Systems Inc.
P.O. Box 566456
Atlanta, GA 30356
(404) 565-0771

Format

5¼-inch MS-DOS floppy disk

Computer

MS-DOS or compatible (128K bytes of
RAM minimum); CP/M-80; UNIX/C

Necessary Software

MS-DOS; source code and Turbo Pascal
required to implement external
procedures

Languages

Executable code; source code available
in Turbo Pascal

Documentation

72-page user's manual; 48-page *Technical
Reference Manual* included with purchase
of source code

Price

\$175; source code version is \$400
complete

Audience

Those with an interest in artificial
intelligence application programming

Comments

Three sample programs, a short tutorial,
and a debug example are included; a
Lattice C version for MS-DOS is also
available

satisfies it—in the conflict set. Since there are only constants in the production and working memory, this could be considered a "best-case" test.

The second benchmark (see figure 2) was also a one-production system. It, too, matched a single working-memory element, but instead of modifying the element, it made a new one. As long as the number of productions stays low (benchmark 2 has only one), and you use only constants in the productions and working memory, this should also be a best-case test. It checks how fast the conflict set is built and resolved.

These two benchmarks provide a measure of efficiency for two of OPS5's fundamental operations—manipulating the working memory and building or resolving the conflict set. For versions that implement the Rete algorithm, both benchmarks should execute at speeds much higher than a typical expert system. All the versions had the trace mechanisms shut down (watch was set to zero and no breakpoints were active). The number of rule firings was controlled by the (run *x*) command, where *x* was the desired number of iterations.

I ran the TOPSI benchmark tests on two IBM PCs running PC-DOS 2.1. One had a full complement of memory (640K bytes). The other had only 192K bytes of memory. The results were identical. TOPSI uses the additional memory only to accommodate more productions. DMS estimates that a 256K-byte IBM PC can support

close to 1000 productions. The VAX tests were run using OPS5 for VAX version 1.0 with a single user on an 11/785 in a 2000-block working set. The Symbolics tests were run on a Symbolics 3670 with 4 megabytes of memory. I used the OPS5 supplied with Verac Inc.'s OPS5e package running under version 5.2 of the Symbolics LISP system. OPS5 was run directly from a LISP Listener, avoiding the OPS5e user-interface enhancements. The garbage collector was disabled.

The results of the benchmarks are shown in table 1. Since the first benchmark is essentially a best-case test, the execution speeds are very high—much higher than you would normally see. TOPSI ran approximately 40 to 50 firings per second. The VAX ran between 300 and 400 firings per second, and the Symbolics ran approximately 400 to 500 firings per second.

In the second benchmark, the speed ratio maintained its roughly two- or three-to-one comparison between the Symbolics and the VAX, but TOPSI's performance dropped off dramatically. TOPSI started well, running about 5 firings per second for the first 50 working elements. After I added 100 elements to working memory, however, TOPSI was down to about 3 firings per second. By 200 elements, it was down to little more than 1 firing per second, and by 400, TOPSI took roughly 3 seconds for every 2 firings. Each time I doubled the number of working-memory elements, the execution time went up by a factor of four.

Since TOPSI does not use the Rete algorithm, the second benchmark is close to a "worst-case" example. TOPSI builds the conflict set dynamically, and in this benchmark every working-memory element is in the conflict set. This means that TOPSI would do only about 1 firing every 2 seconds when under a heavy load. I've tried some medium-size production systems of about 100 productions each, and this seems to be correct.

EXTENSIONS

By far, TOPSI's most useful extension to OPS5 is that the compute action,

Enter this production into production memory:

```
(p one-wme
  (yes) ;match a "yes" in working memory
  -- >
  (modify 1 yes)) ;modify it to "yes"
```

From the top level, enter these commands:

```
(make yes)
(run x)
```

where "x" is the number of firings you desire.

Figure 1: Benchmark 1: production and top-level commands. This benchmark tests execution speed for a one-production system that matches and modifies one working-memory element.

normally available only on the right-hand side, can be used within a left-hand-side condition element. This extends the range of elements that you can match against.

Another new feature is the (find *variable term*) clause. It returns a variable bound to the position within a working-memory element where a particular term is found. You can then test this variable with the logical operators.

The top-level (print *argument*) lets you copy program output that goes to the console screen to a printer or other logical device. This is useful during program debugging and for documentation purposes.

DMS provides some debugging commands that let you examine locations in memory and display certain key addresses within the TOPSI system.

NONSTANDARD FEATURES

TOPSI has one major difference from OPS5 that you must take into consideration if you plan to port programs between dissimilar machines. In OPS5, the two conflict-resolution strategies keep a history of each rule that has been fired and the working-memory elements that satisfied it (an instantiation). The history ensures that no instantiation fires more than once. OPS5 keeps a history that goes back to the first firing. TOPSI, on the other hand, keeps a history that is only one firing deep. Therefore, you must explicitly account for the removal of instantiations from the conflict set if you don't want them to fire unexpectedly. This incompatibility means that you can move TOPSI production systems to OPS5 and they will run as is; however, you can't port OPS5 to TOPSI as easily.

Second, TOPSI doesn't like nil as a class name or as an atomic working-memory element. If you use nil this way, you will confuse the conflict resolver, and the production that matches the nil will stay in the conflict set forever. In general, you shouldn't use keywords as production or variable names. The rest of TOPSI's differences from standard OPS5 syntax are minor. For comparison, on the VAX, medium-size production systems run between 5

and 12 firings per second.

TOPSI lets you delete single elements from working memory via the (remove *argument*) command, where *argument* is the time tag of the element. There is no way to delete multiple working-memory elements from the top level, although you may delete multiple elements from the right-hand side of productions. TOPSI does not have the equivalent of the OPS5 (remove -) command, which removes all elements from working memory.

TOPSI also lacks two functions that standard OPS5 requires: (rjust), which right-justifies output, and (literal), which lets you assign a particular index to an attribute. TOPSI does have a command called (literal), but that's TOPSI's version of the (literalize) com-

You can move TOPSI production systems to OPS5 and they will run as is, but you can't port OPS5 to TOPSI as easily.

mand. (TOPSI lets you rename keywords, so this is not really an incompatibility.)

TOPSI's interface to external func-
(continued)

Table 1: The benchmark results. Both benchmarks are best-case tests for implementations using the Rete algorithm. Benchmark 2 turns out to be nearly a worst-case test for TOPSI. (The - symbol means "too small to measure.")

Benchmark 1 (in seconds)

Number of firings	TOPSI (IBM PC)	OPS5 for VAX version 1.0 (VAX-11/785)	OPS5 (Symbolics 3670)
1000	21	3	2 to 3
10000	208	29	20

Benchmark 2 (in seconds)

50	9	-	-
100	36	-	-
200	146	-	-
400	581	1	<1
1000	not measured	4	1 to 2
2000	not measured	11	3
4000	not measured	38	6

Enter this production into production memory:

```
(p many-wme
  (yes) ;match a "yes" in working memory
  -- >
  (make yes)) ;make a new wme
```

From the top level, enter these commands:

```
(make yes)
(run x)
```

where "x" is the number of firings you desire.

Figure 2: Benchmark 2: production and top-level commands. This benchmark tests execution speed for a one-production system that matches one working-memory element and then makes a new one.

*If you plan to use
external procedures,
familiarity with
Turbo Pascal would
be a definite plus.*

tions and procedures is generally nonstandard. The (call) function passes arguments directly, while standard OPS5 does not. The \$ functions, which OPS5 provides to interface with external functions and procedures, are included when you buy TOPSI source code.

The file-access functions are also nonstandard. The TOPSI (openfile) action opens files for both input and output. The OPS5 version of these commands requires that you specify the allowable file operations.

In TOPSI, you must use the (default) action to map a file to an input or output action. OPS5 allows its file input and output functions—(accept), (acceptline), and (write)—either to access the default file (set via the (default) command) or to directly specify a file. TOPSI uses the default file for input and output. This means that you must reassign input and output via a (default) command if you want to switch files.

DOCUMENTATION AND SUPPORT

The TOPSI package includes the executable code on a floppy disk and in the user's manual. The manual includes a review of OPS5 fundamentals, a short step-by-step tutorial to get you started, a concise description of all the commands, and an example of the development and debugging of a short TOPSI program. All the basic functions of the tutorial worked well; it is a good learning aid. The manual is complete and well written in a pleasant conversational style, but it's no substitute for a textbook. If you haven't used OPS5 before, I recommend *Programming Expert Systems in OPS5* by Lee Brownston et al. (Addison-Wesley, 1985).

Since TOPSI is written in Turbo Pascal, you'll need to buy the TOPSI source code if you want to reference external functions or procedures from within your TOPSI programs. Turbo Pascal doesn't compile to linkable modules but instead compiles directly to executable code. Therefore, you must have all source code available at compilation time.

The TOPSI source code package includes a copy of DMS's *Technical Reference Manual* and a second disk containing the source code and some interface procedures. The *Technical Reference Manual* explains in detail how to modify TOPSI's source code to add user-defined subroutines and functions. It also describes the major program modules and data structures and has listings of the interface and floating-point math functions that DMS provides. Like the user's guide, it is well written, but a bit more technical. If you plan to use external procedures, some familiarity with Turbo Pascal would be a definite plus.

DMS is a two-person operation, consisting of David M. Smith and his wife, Julie. Their responses to my questions and problems were quick and courteous. If you should find a problem with TOPSI, DMS will provide the first update free of charge if you are a registered user. Subsequent updates will be provided at a nominal fee. For \$10, DMS also offers a TOPSI user library.

CONCLUSIONS

TOPSI is a real implementation of OPS5 for microcomputers. All the core functions are there. Its incompatibilities with standard OPS5, once known, can be dealt with. While it is slow compared to the versions of OPS5 that run on more powerful computers, it should be adequate for many applications. Interfacing TOPSI to external procedures requires that you buy source code. The interfacing is not simple and requires familiarity with Turbo Pascal.

TOPSI is very reasonably priced. It can be used both as a serious programming tool and as a learning aid to introduce programmers to expert systems and artificial intelligence techniques. ■

Advanced Authorized Dealers (Eastern U.S.)

Aardwolf Microsystems
217 East 85th, Suite 102
New York, NY 10028
212/538-7840

Advanced Information Systems, Inc.
1336 Edna S.E.
Grand Rapids, MI 49507
616/243-1312

Archive Systems, Inc.
1876 N.W. 2nd Ave.
Boca Raton, FL 33431
305/393-4602

Corporate Micros, Inc.
333 West 52nd St., Suite 1204
New York, NY 10019
212/315-2853

Creat Systems, Inc.
2101 Magnolia Ave., Suite 208
Birmingham, AL 35205
205/328-4882

Fast Forward, Inc.
129 Adams Street
Louisville, KY 40206
502/589-0301

ICS Software
P.O.C. 359015
Brooklyn, NY 11235
718/743-4050

INACOMP Computer Centers
700 Remington Road
Schaumburg, IL 60195
312/519-1900

Micro City Computers
110 West 31st Street
New York, NY 10001
212/563-6110

Mitech Corporation
#1 Perimeter Park South, Suite 335-S
Birmingham, AL 35243
205/967-0605

Modular Management Systems, Inc.
451 Bloomfield Ave.
Caldwell, NJ 07006
201/228-3838

National AI Lab, Inc.
1800 Century Blvd., Suite 770
Atlanta, GA 30345
404/633-3900

Network Data Systems, Inc.
3419 Pierson Place
Flushing, MI 48433
313/732-6340

**PRISM Computer & Consulting
Services, Inc.**
2100 Riverchase Center, Suite 420
Birmingham, AL 35244
205/988-5111

Don Silvitz & Associates
435 Dayton Street
Cincinnati, OH 45214
513/421-1105

Southeastern Systems, Inc.
619 East Price Ave., Suite #12
Gastonia, NC 28054
704/866-8048

TRIMARC Systems, Inc.
11716 Parklawn Drive
Rockville, MD 20852
301/231-4991

Open Computer Systems
4701 N.W. 72nd Avenue
Miami, FL 33166
305/594-2960



**THE
SOFTWARE
LINK, INC.**

**SATELLITE
MODULES
NOW \$99**

The Most Powerful LAN Fits on a Disk.

Network Power. You knew that someday there would be a powerful LAN that didn't need old-technology network boards. It would be fast, easy to install, and run 99% of PC-DOS software. It would be expandable, provide remote access, password-protection, and enable you to use inexpensive terminals as workstations in a PC-DOS environment.

Dream no more, because the power is here.

Its name is LANLink™

A Software-Driven LAN Powerful Enough To Use RS-232 Ports for Network Communications. In development for over three years, LANLink™ represents the next generation of local area networks. All of the logic which has traditionally resided on network boards is on LANLink's Satellite and Server Diskettes.

No additional hardware is required. Inexpensive serial ports replace "Kilobuck" Network Interface Boards making installation costs one-third that of a board-driven network.

How To Configure a Smart Network...With Dumb Terminals, But Without Dedicated Servers. Boasting a wide variety of configurations, LANLink™ is most often set up as a "Star" having up to eight satellites connected to a central, nondedicated server. Larger networks can have multiple servers, supporting a total of 73 or more network users.

R-LAN™ (Remote-LAN) gives users the ability to interact with a LANLink™ network in real time via modem. Plus, if **MultiLink Advanced™** is run on a Satellite, inexpensive dumb terminals can be used to access network disks, files, and programs.

99% of PC-DOS Applications Run In a Totally-Transparent Network Environment. If you know DOS, you already know how to use LANLink™ COPY transfers files among users, and a 2-drive PC Satellite boots 1-2-3 from the Server's hard disk with the entry c:\lotus. Each satellite's access can be limited to specific disks, printers, and sub-directories. A wide variety of software including Lotus 1-2-3, dBASE III, and WordStar 2000 is fully compatible. LANLink™ has a collision-free data transfer rate which exceeds 115,000 BPS.

Power Up Your PCs Today. For complete details and the authorized dealer nearest you, call The Software Link TODAY. The LANLink™ Starter Kit is \$495 and includes modules for both a Server and a Satellite. For a limited time, 50 feet of shielded RS-232 cable will be included free of charge. Additional Satellite Modules are only \$195, each.

LANLink™ is immediately available and comes with a money-back guarantee. VISA, MC, AMEX accepted.

Inquiry 270

LANLink™



THE SOFTWARE LINK, INC.

Developers of LANLink™ and MultiLink Advanced™

8601 Dunwoody Place, Suite 632, Atlanta, GA 30338 Telex 4996147 SWLINK

CALL: 404/998-0700

Dealer Inquiries Invited

THE SOFTWARE LINK, INC./CANADA 400 Esna Park Drive, Suite 19
Toronto (Markham), Ont./L3R 3K2 CALL: 416/477-5480

LANLink™ MultiLink Advanced™ & R-LAN™ are trademarks of
The Software Link, Inc.

IBM, PC, & PC-DOS are trademarks of IBM Corp. WordStar 2000,
dBASE III, and Lotus 1-2-3 are trademarks of MicroPro, Ashton-
Tate, and Lotus Development Corp., respectively.

ORDER LINE 800-354-7330

**LOWEST PRICES
NO SURCHARGE
ON BANK CARDS
SILICON SPECIALTIES**

ZENITH COMPUTERS
Always the lowest prices.
Call us for a quote.

HARDWARE

PRINTERS

Anadex All Models	Save
Brother All Models	Save
Canon Laser Printer	\$2099
Citizen MSP-10	\$255
MSP-10	\$349
MSP-15	\$319
MSP-25	\$485
Premier 35	\$409
Datsouth All Printer Models	Save
Diablo D-25	\$489
D35	\$1035
Other Printer Models	Save

Toshiba 321	\$449
F351 Parallel & Serial	\$969
TOSHIBA	
321 Parallel	Save
321 Serial	Save
341 Parallel	\$829
341 Serial & Parallel	\$879
351 Serial & Parallel	\$985

EPSON	
All Printer Models	Save
6100	\$349
6300	\$669
NEC	
5510, 5550, 3515, 3530	\$729
8810, 8850, 8850	\$1039
P3, P6, P7	Save
EP 360	\$379
EP 370	\$379

DISKETTES	
Maxell MD-2 (Qty 100)	\$125
Sony MD/2 (Qty 100)	\$119

MONITORS	
Amdex All Monitors	Save
NEC All Monitors	Save
Princeton Graphics	Save
Zenith All Models	Save

VIDEO TERMINALS	
Quint CMT Green 101	\$299
QVT Amber 101	\$314
Wyse 30	\$299
50	\$419
75	\$559
Wyse 85	\$439
Wyse 350	\$859
Zenith Z-72	\$455
Z-79A	\$559
Z-49	Save

OKIDATA	
All Printer Models	Save
Panasonic 1080	\$219
1091	\$235
1092	\$309
1592	\$429
KXP3151	\$399

STAR MICRONICS	
All Printer Models	Save

TRAINING	
Flight Simulator	\$28
Typing Instructor	\$28
Typing Tutor III	\$28

INTEGRATIVE SOFTWARE	
Enable 1.1	\$319
Framework II	Save
Smart Software System	\$379
Symphony	Save

GRAPHICS	
Chartmaster	\$205
Diagram Master	\$185
Energraphics 2.0	\$269
In-A-Vision	\$249
Microsoft Burs Mouse w/PC Paintbrush 3.0	\$106
Microsoft Chart	\$164
Microsoft Serial Mouse	\$119
Newsroom	\$32
PC Mouse w/Paint Plus	\$119
PFS Graph	\$76
Printmaster	\$30
Click Art Personal Publisher	\$69
Signmaster	\$132
Turbo Graphics Tool Box	\$30

COMMUNICATIONS

CompuServe Starter Kit	Best Price
Crosslink XVI	\$92
MS Access 1.01	Call
Business	\$92
Smartcom II	\$83
UTILITIES	
Copy II PC	\$19
1 Dip	\$47
Fastbook	\$67
Norton Utilities 3.1	\$48
Sidestart	\$30
Sidestart (Unprotected)	\$47
Sidestart - Superkey (Bundle)	\$85
Sideways 3.1	\$34
Superkey	\$39
Traveling Sidestart	\$39
Turbo Protlog	\$59

PROJECT MANAGEMENT	
Harvard Total Project Manager	\$262
Microsoft Project	\$219
Super Project Plus	Save
Timeline 2.0	\$209

UTILITIES	
Copy II Mac	\$19
Magic Works	\$45
Pro Print w/cable	\$56
Sidestart w/Phone Link	\$56
Smooth Talker	\$49

SPREADSHEETS	
Chart	\$69
Click On	\$44
Multiplex	\$108

TRAINING	
MasterType	\$28
Mind Prober	\$26
Typing Intrigue	\$25
Typing Tutor III	\$33

COMMUNICATIONS	
Smartcom II	\$83

DATA BASE MANAGERS	
Business File Vision	\$199
File Maker	\$96
I Know It's Here Somewhere	\$33
Microsoft File	\$108
Overview 2.0	\$144
Think Tank 512	\$96

LANGUAGES	
Basic 2.0	\$84
Centaur C w/F.P. (New Ver.)	\$235
Microsoft Fortran	\$165
Microsoft Logo	\$69

MONEY MANAGEMENT	
Dollars & Sense	\$78
Dollars & Sense Forecast Module	\$38
Mac Home Accountant	\$50

UTILITIES/COMMUNICATIONS	
Copy II Plus	\$19
Pro Robot	\$35
Sideways	\$30
Turbo Pascal (Rep. c/f/m)	\$35
Crosslink	\$94

TRAINING	
HT Sim II	\$32
Typing Tutor II	\$29

DATA BASE MANAGEMENT	
PFS: File	\$68
PFS: Report	\$68
Appworks	Call

WORD PROCESSORS	
Bank Street Writer	\$39
Bank Street Speller	\$39
PFS: Write	\$68
Think Tank	\$75
Word Perfect	\$79
Wordstar Professional (Rep. c/f/m)	\$259

SPREADSHEETS	
Supercalc 3A	\$98
PFS: Plan	\$68
Multiplex	\$35

SOFTWARE

IBM PC AND 100% Compatibles

WORD PROCESSORS	
Leading Edge Word Processor	\$48
Leading Edge W/P w/Spell & Mail	\$72
Lightening	\$55
Microsoft Word 3.0	Call
Multimate Advantage	Save
PFS: Write w/Spell Checker	\$76
Wordstar Pro Pack	\$233
Word Perfect (Ver. 4.1) \$196	

Wordstar 2000 Plus 2.0 \$278

LANGUAGES	
C Compiler (Microsoft)	\$219
Fortran Compiler (Microsoft)	\$195
Lattice C Compiler	\$242
Macro Assembler (Microsoft)	\$84
Pascal Compiler (Microsoft)	\$166
Quick Basic 2	\$55
Run C Interpreter	\$82
Turbo Pascal 3.0	\$38
Turbo Database Tool Box	\$30

MACINTOSH

ACCOUNTING	
Polantis G/L	\$74
Polantis A/P	\$74
Polantis A/R	\$74
Proactive G/L	\$84
Proactive A/R	\$84
Proactive A/P	\$84
BPI G/A	\$209

ACCESSORIES	
Mac Tape Carrying Case	\$56
MacVision	\$166
MousePad (by Novatek)	\$7
Printer Ribbon	\$6
The Easy	\$12
Pocket Pack	\$9

DISKETTES	
SONY Disks (10 Pack) D.S.	\$18
SONY Disks (10 Pack) D.S.	\$27

GRAPHICS	
Clip Art #1	\$16
Clip Art #2	\$21
Newsroom	\$32
PFS: Graph	\$68
Puzzlebox	\$29
Printshop Companion	\$23

MONEY MANAGEMENT	
Dollars & Sense	\$68
Managing your money	Save

DISK DRIVES

Alpha Omega Turbo 10	\$379
Turbo 20	\$439
Turbo 30	\$569
Imagex Benchmark Boxes for IBM	Save
Benchmark Boxes for Macintosh	Save
Paradise Modem Hard Disk	Save
Sengale 20 meg w/Western I/O	\$409
BOARDS	
AST Advantage	\$209
Rompage PC	\$239
Six Pack Plus	\$159
Heracles Color Card	\$149
Graphic Card	\$305
Intel	
Above Boards	Save
Maynard Hardcard	\$549
Paradise Modular Graphic 06-1	\$239
Five Pak	\$175
Quadram	
Gold & Silver Boards	Save
Quadlink	\$329
Quad EGA+	\$365
Tec Mar Graphics Master	\$269
Caplan Mac Memory	\$169

PLOTTERS

Epson Hi-80	Save
KEYBOARDS	
Keytronics 5151	\$159

SPREADSHEETS

Lotus 1-2-3	Save
Multiplex	\$108
Spreadsheet Auditor 2.0	\$82
VP Planner	\$49
Supercalc 4 \$196	

MONEY MANAGEMENT

Dollars & Sense w/Forecast	\$94
Tabcon Managing Your Money	Save

DATA BASE MANAGEMENT

Clipper	\$339
dBase III Plus	Save
Extended Report Writer	\$74
KnowledgeMan II	\$279
Nutshell 2.0	\$59
PFS: File	\$76
PFS: Report	\$67
Quickcode	\$138
QuickReport	\$138
Relax	Save
Think Tank	\$91
R:Base 5000 \$319	

WORD PROCESSORS

Hyden Speller	\$45
Microsoft Word	\$108
MacSpell Plus	\$53
Mac Lightening	\$49

INTEGRATED SOFTWARE

Helix 2.0	\$212
Microsoft Excel	\$219

GRAPHICS

Accessory Pack I	\$22
Click Art	\$28
Mac Pic II 1 & 2	\$28
Mac The Knife II	\$28
Ready Set Go 2.1	\$96
Video Works	\$55



SILICON SPECIALTIES
2034 WEST SOUTHERN
MESA, ARIZONA 85202
602-969-0909

Product shipped in factory cartons with manufacturer's warranty. Please add \$10.00 per order for UPS shipping. Prices & availability subject to change without notice. Send cashier's check or money order ... all other checks will delay shipping two weeks.

Inquiry 261 for MS DOS Products. Inquiry 262 for all others.

Many other titles available.

Circle 538



LET'S C AND CSD

BY WILLIAM G. WONG

Let's C is a \$75 package of development programs from the Mark Williams Company that includes a screen editor, a full-blown C compiler, an 8086/88 assembler, and a linker. A powerful C symbolic debugger, *csd*, is available for an additional \$75. This is quite a collection for such a low price.

DOCUMENTATION

Let's C comes with two manuals: one covering the compiler and all the associated utilities, and the other dedicated to the text editor, MicroEMACS. Both are well organized with a good table of contents and index. Examples are quite sparse, however, especially in the description of the support library functions. The compiler manual is written with typical UNIX-style terseness.

The MicroEMACS manual layout is totally different. It is designed as a tutorial rather than a reference manual. Examples are plentiful, and sections are grouped by function. Unfortunately, there is no associated reference section except for an alphabetical listing of functions at the end; a simple functional list would have sufficed. Overall, the documentation is good, and most information is easily accessible. Sometimes, however, it takes a bit of digging through the manuals to answer a question or to see if an option exists.

MICROEMACS

You could use another line- or screen-oriented text editor in place of MicroEMACS, but since MicroEMACS is such a nice program you will probably decide that you want to use it. Because MicroEMACS is a memory-based editor, there is a limit to the file size it can handle. Fortunately, C's modularity keeps this from be-

An inexpensive C development package and a symbolic debugger

coming much of a problem.

MicroEMACS is written in C and the source code for it is provided in the Let's C package, which makes it possible to modify and enhance the editor. The source code contains useful comments.

MicroEMACS supports windowed screen operation and multiple files. Windows provide views of different portions of the same file or views of different files altogether. Text can be moved between files. Command repetition and limited macro capabilities are supported. The limited number of functions makes it relatively easy to memorize most of the commands. (MicroEMACS's ancestor, EMACS, cannot make the same claim; it has significantly more options and operating modes.)

You enter commands with Control or Escape sequences. Multikey sequences are preceded by the Escape key or a Control-X (in the EMACS tradition). Commands tend to be mnemonic: Control-F moves forward one character, and Control-B moves backward one character.

MicroEMACS does have some quirks, but fortunately they can be fixed by using the ANSI.SYS driver file. This file is supplied with many MS-DOS systems and is usually included with PC-DOS. The source code for MicroEMACS comes in very handy, since you may have to make minor modifications if it does not work properly with your system.

I found that reading MicroEMACS source code uncovers some features

of the editor that are not described in the manual. For example, I discovered that I could use the Escape sequence in place of Control-@ (which made my keyboard generate something else) to set the "mark," which is a point to start a block operation like copy or delete.

While recompiling the editor, I was disconcerted to find that certain functions used in the editor do not follow strict C procedures. Although the compiler flagged the offending functions, the resulting code still worked. (The reason for this is that the compiler generates only 16-bit pointers due to the small memory model.) Don't try to use another compiler or memory model without checking all flagged errors, or the program may not run at all.

Rebuilding the editor on a hard disk takes less than half an hour if you start from scratch. It is possible to rebuild it on a floppy disk system, but it is much more time-consuming.

LET'S C COMPILER

The Let's C compiler is very complete; it includes standard C function libraries as well as a math library with floating-point support for trigonometric functions. It is a four-pass compiler (including the preprocessor) and you can automatically invoke the linker.

The most striking feature is the large number of options supported by the compiler and various utilities. The compiler itself has over 30 command-line options, including various ways to customize the compiler and redirect-

(continued)

William G. Wong (Logic Fusion Inc., 1333 Moon Dr., Yardley, PA 19067) is president of Logic Fusion Inc. and a developer of systems and applications software.

Let's C and csd

Type

C development package and symbolic debugger

Company

Mark Williams Company
1430 West Wrightwood Ave.
Chicago, IL 60614
(800) 692-1700

Necessary Hardware

MS-DOS- or PC-DOS-based system
One floppy disk
256K bytes of RAM

Copy-protected

No

Price

\$75 each

able I/O, which is also available to application programs created with Let's C. For example, you can use DOS commands to put control text into the DOS environment. You can also set which drive will be used for work files or #include files so that this information does not have to be repeated on the command line.

The command-line options are very powerful and are designed to make creation of multiple modules easy. For example, cc -o all *.c compiles all the C source code in the current directory (all files with a .C extension) and links them into the file ALL.EXE, including the standard C library. You can use multiple source files and wild cards to generate complex systems.

In addition to supporting the language as defined by Kernighan and Ritchie, the Let's C compiler also supports a number of extensions, including enumerated data types. Floating-point numbers may be single or double precision, but since floating-point numbers are stored in the DEC/VAX format, Let's C provides no 8087 support. (The more expensive version of the Let's C compiler allows you to select the IEEE format for storing floating-point numbers.)

Let's C also supports structure as-

ignment, parameters, and return values. This feature can be turned off using the appropriate compiler option.

Dedicated registers are available for one or two variables by using the C "register" specification. These register variables can hold 8- or 16-bit integers and pointers. Let's C uses the SI and DI registers to manipulate register variables. It may be appropriate to use the register specification often, as the compiler always saves and restores the SI and DI registers even if no register variables are specified. The overhead is four instructions and four bytes of code per function. A more sophisticated compiler would save and restore these registers only if they were used.

The library of C functions is very complete with support of stream files (files using the fopen() function) and system-level files (files using the open() function). Standard DOS functions such as file rename and execution of another DOS program are supported, but these are nonstandard and usually nonportable functions. There are a few missing items from the Let's C libraries, the major one being the lack of access to the DOS routines for setting and reading the current time and date. Functions for accessing these routines are described in the manual but are not in the library, and the appropriate #include files are missing.

Let's C supports direct access to I/O ports, 8086 interrupts, and memory via peek and poke functions. Options in the peek and poke functions allow you to access the full 8086 address space. This provides a way to address memory beyond the 64K-byte limit set on small memory model programs (without having to purchase the more expensive version of the compiler), but it is not as efficient as access via the large memory model. This also makes Let's C appropriate for generating memory-resident programs.

The linker supports only the Mark Williams Company's object code and library formats. This restricts your ability to use object modules generated by another assembler or C compiler, but since Let's C comes with

its own assembler, this may not be a problem for many users.

UTILITIES

The utilities that come with Let's C can be divided into two sets: compiler support utilities and general utilities for text-file manipulation. Each is described individually in the documentation. The compiler support utilities include

- as the assembler
- cpp the C preprocessor
- lb a library utility program
- ld the linker
- nm prints an object module's symbol table
- size prints sizes of program segments
- strip removes the symbol table from an object module

The general support utilities include

- cmp compares two files, character by character, for equality
- egrep searches a file for a specific pattern (string)
- pr paginates and prints files
- tail prints a selected number of bytes at the end of a file
- wc counts the occurrences of specific words in a file

The Let's C assembler supports the 8086 instruction set, while the more advanced version adds 8087 support. Macros are not supported by the assembler, but since the C preprocessor, cpp, can be used independently of the compiler, you can simulate a macro assembler by using C-style macros in your source code and executing cpp to expand the macros prior to assembly. Batch files make this a snap. Simulating a macro assembler also allows you to use a single macro syntax with both the compiler and the assembler.

The library utility can create and update library files that are compatible with the linker. Although the Let's C compiler can generate only small memory model programs, the linker and the assembler can also handle larger programs. Consequently, you can create assembler support modules that allow Let's C programs

(continued)

HELLO, **AT&T'S SMALL BUSINESS CONNECTION?**
 LISTEN, MY SMALL BUSINESS **LIVES** AND **DIES** BY THE
TELEPHONE.... AND WITH THESE **☆◎!!*?** "BARGAIN"
 PHONES I BOUGHT, IT'S MOSTLY DYING.... **SURE**, I'D
 LIKE RELIABLE **AT&T** PHONES, BUT WON'T THAT TAKE
 A **BIG BITE** OUT OF MY **BOTTOM LINE?** YOU'RE
KIDDING! I CAN AFFORD THE **MERLIN** SYSTEM
 WITH **AT&T'S PUSH-BUTTON SAVINGS PLAN?**
THAT'S GREA-...HEY, CAN YOU SPEAK UP? THIS
 SO-CALLED "TELEPHONE" IS REALLY GOING
 TO THE DOGS.....!



The AT&T MERLIN® System, America's favorite small business phone, can cost you less than you think.



■ If your business has been bitten by bad phones, you're probably ready for the MERLIN Communications System. It offers all of today's standard features—speed dialing, conference calling, an intercom. Plus it lets you add extra features (or extra telephones) as your business needs change. Which means the MERLIN System is totally adaptable. And it's also totally affordable, thanks to AT&T's Push-Button Savings Plan. Call AT&T's Small Business Connection (1 800 247-7000) for more information about financing the MERLIN System. Perhaps the ultimate telephone for today's dog-eat-dog world. ■

1 800 247-7000 / AT&T's Small Business Connection
 This toll-free number connects you to the office in your area.



AT&T
 The right choice.

Inquiry 28



"16 Data Acquisition boards. Not bad."

Fred Molinari, President

Data Translation stretches itself to new limits for users of the IBM PC.

No one extends himself for a customer like Fred Molinari. Data Translation offers you the broadest line of Data Acquisition boards for the IBM PC in the business—and we've just added four more.

Now you can get low-cost single function boards, medium-performance multi-function boards, and high-performance boards with A/D throughput all the way to 130 KHz. All supported by subroutine

libraries and application software.

Not to mention advanced capabilities like continuous "no-gap" data collection, random channel/gain sequencing, five-level bus interrupt, and a programmable pacer clock.

See the chart for details and remember: Fred Molinari will go to any lengths to provide the boards you need.

Call (617) 481-3700

Data Acquisition Products for the IBM PC	Model	Price (U.S. \$)	A/D			D/A			Clock	Terminal Panel
			Channels	Resolution (Bits)	Speed (kHz)	Channels	Resolution (Bits)	DIO (Lines)		
General Purpose	DT2601	985-2070	4-16	12-16	13-27	2	12	16	Yes	DT707
	DT2606	295	to 80	12	20	to 24	12	to 72	Yes	DT757
	DT2608	495	16	10	3.3	2	8	16	Yes	DT707
Low Cost	DT2614	299	16	12	25	-	-	-	Yes	DT757
	DT2615	399	-	-	-	8	12	-	-	DT757
	DT2617	199	-	-	-	-	-	32	-	DT758
High Speed	DT2821	1195-2495	4-16	12-16	50-130	2	12	16	Yes	DT707



See our new 646 pg. catalog/handbook or see us in Gold Book 1986. Or call for your personal copy today.

PCLAB and ATLAB driver software and DT/Notebook, DT/ILS PC, Asyst, Snapshot, and Labtech Chrom application software.

DATA TRANSLATION

World Headquarters: Data Translation, Inc., 100 Locke Dr., Marlboro, MA 01752 (617) 481-3700 Tlx 951 646

European Headquarters: Data Translation, Ltd., 13 The Business Centre, Moly Millars Lane, Wokingham Berks, RG112QZ, England Tlx: 851849862 (#D)

In Canada: (416) 625-1907.

IBM PC is a registered trademark of IBM. Data Translation is a registered trademark of Data Translation, Inc.

to access memory areas beyond the 64K-byte small memory model limit.

The linker generates executable .EXE files using object modules from the compiler or the assembler. The linker supports a large number of options for segment placement, size, and program construction. Overlays are not supported. The linker does allow for command files, which makes the process of invoking the linker much easier, but there are no command-file parameters like those provided by the DOS batch facility. Hence, a link command file is required for each program being linked.

The list of symbols contained in an object module is obtained using the nm utility. You can generate modules without symbols, or you can remove an object module's symbol table using the strip utility.

CSD

The csd symbolic debugging tool is customized for the IBM PC. It provides multiple windows for viewing source code, debugging history, interactive evaluation, and program output. You can set breakpoints and perform single-stepping at the C statement level instead of at the machine instruction level. You can also examine or modify variables during the debugging process, referencing them by name rather than by address. Even strings and floating-point values are accessible in their "human-readable" form instead of as clumps of hexadecimal digits.

To set a breakpoint (referred to as a "tracepoint" in the manual), you simply move the cursor using the arrow keys and select the line of C code using the F3 function key.

You can also move up and down the stack, discovering which function called which other function. When you are at a particular "level" (or stack frame), csd displays the source code for that particular function and you can examine and change variables and breakpoints unique to the function.

Interaction is very quick, with most operations requiring only one or two keystrokes. The evaluation window allows you to enter and execute most C expressions, including calling user-

and library-defined functions. It does not allow evaluation of expressions with C keywords (except sizeof), braces (compound statements), labels, or semicolons (multiple statements). Nor will it evaluate expressions containing such control constructs as case, for, if, and break.

The evaluation window also performs another useful function. Each statement left in the evaluation win-

dow is executed when a traced C statement is evaluated. This allows complex debugging information to be presented. However, leaving improper statements in the window can be a problem. For example, leaving an assignment statement to a loop's control variable in the window while tracing the loop can cause the loop to repeat indefinitely. Accidental setup

(continued)



**VTERM/220
Quality makes
all other DEC
terminal
emulators
obsolete**

Over 35,000 demanding professionals, like Teradyne's Gregg Prescott, have recognized VTERM's superior quality.

Now this same VTERM quality is available in Coefficient's powerful new emulator, VTERM/220.

Features include:

- Plug compatible VT220 emulation with 132-column support and optional Tektronix™ 4010/4014 graphics.
- Extensive file transfer system offering KERMIT, XMODEM and our VTRANS protocol with VMS™, RSX II M/M+, RSTS/E™ and UNIX™ software.
- Host data capture on PC with conversion to Lotus® 1-2-3®, Symphony® and dBase®
- "Hot Key" toggle between host session and PC DOS.

Call us today at 212-777-6707 ext. 181.



Coefficient

The Leader in DEC Emulation Software

Coefficient Systems Corporation
611 Broadway, New York, N.Y. 10012

Trademarks DEC VMS, RSTS/E, RSX II M/M+, Digital Equipment Corp, Tektronix, Tektronix, Inc, Lotus, 1-2-3, Symphony, Lotus Development Corp, dBase, Ashton-Tate, UNIX AT&T Bell Laboratories

*The symbolic debugger
is a definite aid to
learning C and an
indispensable tool for
program development.*

of such a situation can require some debugging of the debugger state, but it might be useful if the best way to test the loop is to keep it going until a problem is solved.

With a few exceptions, *csd* is close to the ideal debugging environment. Dealing with a program at the source level is a definite plus, and being able to display and alter the status of the program alleviates the need to put explicit debugging code into the program. However, *csd* does have some drawbacks, especially for more sophisticated users. For example, *csd* only works with programs compiled by the Mark Williams C compiler, or with programs that use the small memory model (the only kind available in the Let's C package). In addition, *csd* works only with PC-DOS or MS-DOS on strict IBM PC compatibles, and keyboard compatibility is especially important.

Although working at the source level is very useful, it is occasionally desirable to see things at the machine-code level. This is especially

true when the program interacts with the operating system or hardware. You can access memory locations and hardware ports using *csd*, but the process is often tedious. (You can, however, write C functions to make this easier.) Dumping areas such as the stack or data structures is often useful when debugging.

Note that *csd* keeps most information resident in memory, which speeds up overall operation. An exception is the Help text for the program. This may be a limitation for large programs on small systems, but I did not encounter any such problems while using the system.

SYSTEM PERFORMANCE

As expected, the benchmarks show Let's C to be faster than interpretive BASIC in all categories, with integer- and character-based operations showing the largest speed differential and disk operations showing the smallest (see table 1).

Compile and link times compare favorably with other C compilers, and the size of the executable files is typically smaller. Of course, one big reason for their small size is the fact that only small memory model programs can be generated with Let's C.

The Sieve benchmark was done using various data types and specifications for the flag array used by the algorithm. This results in a significant difference in the execution time, but it is negligible in terms of program size. [Editor's note: The source code for the benchmark programs used is available for

downloading from BYTEnet Listings at (617) 861-9764. All the programs have been combined into a single file, LETS.SRC.]

Note that the default stack size, 2K bytes, was altered for the Sieve test when the flag array was local to the function, since automatic structures are allocated from the stack. Placement of the flag array at the end of the variable definitions makes a difference, since the size of the offsets changes for the other variables if they occur after the array.

SUMMARY

Let's C is an inexpensive, high-quality programming package. It comes with all the tools you will need to create applications; there is no need to purchase an editor or other development software. Let's C also provides a good environment for learning the C programming language.

The drawbacks include the lack of 8087 and IEEE floating-point support, which would have provided a better interface to data files generated by other programs. The lack of overlay support can also restrict applications, but the ability to execute other DOS programs from a C program alleviates some problems. Probably the biggest flaw of Let's C is the lack of time and date support.

The symbolic debugger, *csd*, is a definite aid to learning C and an indispensable tool for program development. It would be nice to be able to run *csd* on non-IBM PC compatibles, however. Also, low-level access similar to other debugging programs would help. The use of function keys and windows greatly enhances the development process.

The growth path to the more advanced Mark Williams C compiler is a real plus, because it allows generation of large applications. This upward compatibility means that programs developed with Let's C can grow. It also adds an extra degree of transportability, as Mark Williams C compilers are available for processors such as the 68000 and the Z8000.

In general, Let's C and *csd* are appropriate for developing small memory model programs or for learning C. For the price, they are hard to beat. ■

Table 1: Benchmark results. The benchmark programs were run on a dual-floppy IBM PC XT with 640K bytes of RAM. Times are in seconds.

Program	Compile and Link (hard disk/floppy disk)	Execution	Size (bytes)
SIEVE.C	50/95		7336
LOCAL int	—	7.3	
LOCAL char	—	6.2	
GLOBAL int	—	6.7	
GLOBAL char	—	5.1	
CALC.C	51/110	20	10860
Write Test	45/94	31	7336
Read Test	45/94	30	7288



NEWWORD 3

BY JOHN HEILBORN AND NANCI REEL

When we reviewed NewWord 1.43 (February 1985 BYTE), we found it to be an affordable and versatile word-processing program. Compatible with WordStar, the earlier version of NewWord operated very much like WordStar while eliminating many of its drawbacks and adding a number of useful features, including an "unerase" buffer and several column-mode functions.

A quick look at NewStar Software's latest version of NewWord, called NewWord 3, shows that it retains all of its predecessor's strengths. In addition, it has an in-text math calculator, enhanced customization menus, both an integrated and a stand-alone spelling checker, programmable key macros, and computer-aided index and table of contents generation. It is accompanied by a hefty but well-organized and clearly written manual.

INSTALLATION

NewWord 3 comes with two installation programs, NWINSTAL and NWCHANGE. NWINSTAL is a simple program that allows you to select a minimum of features, such as your printer type, video-display type, and whether you want to have on-screen underlining or not. For more in-depth customization, you'll need to use NWCHANGE, which gives you access to some of the more advanced customizing features of NewWord 3 under a menu called Patches.

KEYBOARD MACROS

The shorthand (keyboard macros) function allows you to create and save custom character strings. These are then invoked with a two-character string, consisting of the Escape key and one other key. NewWord 3 comes with six preprogrammed shorthand

An impressive word processor that is notably faster than any of its previous versions

macros: display/change a macro definition, display shorthand help menu, display result of last math calculation, display result of last math calculation formatted in dollars and cents, display last mathematical equation, and display today's date (from system clock).

In addition to the preprogrammed macros, NewWord can store 36 custom macros. These are initially limited to a total of 512K bytes (435K bytes without the preprogrammed macros). If you need more space, you can modify the size of the macro buffer with NWCHANGE.

ON-SCREEN CALCULATOR

NewWord features an on-screen calculator, which is called the Math Menu. The Math Menu allows you to perform arithmetic, logarithmic, and trigonometric calculations. For users who already have a memory-resident calculator, this may not seem like a very important feature. However, NewWord 3 lets you "drop" the equation and its result into your text with only a couple of keystrokes. Additionally, NewWord can total rows, columns, or arrays of numbers that have been entered into documents, in much the same way that you would mark and move a block of text.

SPELLING CHECKERS

NewWord 3 has two ways to check spelling: a built-in spelling checker and an external spell-checking utility called The Word Plus. Both spelling checkers use the same dictionaries

and can therefore be expected to find the same types of errors, but for longer documents The Word Plus is faster.

NewWord 3's built-in spelling checker goes through your document and presents

you with any misspelled or unfamiliar words, along with enough of the surrounding text to place the words in context. It also makes suggestions about possible replacement words. A real timesaving feature included in the spelling checker is its auto-alignment feature. Instead of requiring you to go back through the document after checking for spelling errors to ensure that paragraphs remain formatted properly, text is automatically realigned after each replacement. If you don't like this feature, you can easily turn it off. The built-in spelling checker can also be used to check the spelling of a single word.

The on-line spelling checker can look up a word that is not in a document. In this case, you can manually type either all or part of a word. If you enter only part of a word, you may use wild-card characters within the word. Once a match has been found in one of the dictionaries, you can enter the match into the document at the cursor.

NewWord 3 uses three dictionaries—the Quick Dictionary, the Main Dictionary, and the Update Dictionary. The Quick Dictionary contains a list of the most commonly used words. This dictionary is loaded into memory when the program starts, and NewWord looks here first to find a word.

(continued)

John Heilborn (P.O. Box 20102, Castro Valley, CA 94546) is president of ThinkWords Inc., and Nanci Reel (P.O. Box 06281, Portland, OR 97206) is the author of a book about Multiplan for the Macintosh.

NewWord 3

Type
Word processor

Company
NewStar Software Inc.
3351 Vincent Rd.
Pleasant Hill, CA 94523
(415) 932-2278

Format
5¼-inch floppy disk

Computer
IBM PC and compatibles; 128K bytes of RAM; DOS 2.0 or higher

Documentation
User's guide, 780 pages

Price
\$359

If it finds a match, it does not check the longer Main Dictionary, which contains about 45,000 words. If your computer has enough memory and you use the spelling checker on a regular basis, you can load the Main Dictionary into RAM. The program will start up a bit more slowly, but checking spelling during the rest of your work session will be considerably faster, since accessing RAM is less time-consuming than accessing a disk.

NewWord's Update Dictionary stores words that you add to the dictionary yourself. They aren't added

directly to the Main Dictionary, since this dictionary is compressed to get as many words as possible into the smallest amount of disk space.

INDEXING

NewWord 3's Index routine has three ways of constructing an index: it can index all words in a document, all words in a document except those words on an exclusion list, or just the words and phrases that you specify.

The exclusion-list method uses a standard list that is included with NewWord, which eliminates common words such as articles, pronouns, prepositions, conjunctions, and so on. You can also build your own custom exclusion list if you want to exclude additional words.

TABLE OF CONTENTS

With its computer-aided table of contents generation, NewWord can build a table of contents for a document. To use this feature, you go through the document and insert special dot commands in the appropriate places within the text. For example, the command `.tc Introduction #` will replace the # with the correct page number in the table of contents after the page number is found in the document. You can also create sub-entries to be indented under a major heading, such as the title of a chapter:

```
.tc Introduction . . . . . #
.tc About This Book . . . . #
```

The `.tc` dot commands can also in-

clude print control commands. It is also possible to build several tables of contents for one document. If, for example, your document consists of several chapters of a book, you can create a table of contents for the entire book and separate figure and illustration tables all at once.

NEW EDITING COMMANDS

In addition to the global commands covered thus far, NewWord 3 has a number of new editing commands that aid in the process of entering text. Some are WordStar commands that NewWord 1.43 lacked, such as setting and finding block markers and continuous downward and upward scrolling. Other commands add features that WordStar doesn't offer, such as running DOS commands while editing a document, converting all characters in a block to uppercase or lowercase, calculating the number of characters that precede the cursor in a document, and previewing the document as it will print.

MERGE PRINTING

The merge-printing functions included in NewWord 3 may be its most powerful new features. These functions allow you to manipulate text automatically using conditional commands, variables, and numeric controls. To give you an idea of what could be done, let's examine a situation in which you have created a number of individual statements for each sale made to several different customers. By using the appropriate merge-printing commands, you could combine all of the individual statements and produce a single billing statement for each customer. NewWord would create the forms, fill in the names and addresses, and total all of the figures, including taxes and service charges, automatically.

SUMMARY

NewWord 3 is noticeably faster than any of its previous versions, which were all quite fast (see table 1). With its speed, its ability to be customized, and its variety of new editing features, NewWord 3 is a very impressive word processor that is definitely worth consideration. ■

Table 1: The results of performing various functions using a 4000-word text file. Document Load shows the time required to load the file from disk to memory. Document Save shows how long it takes to save the file to disk. Search shows the time it takes to find the last word in the file, starting at the beginning. Scroll shows how long it takes to scroll through the file manually. Note that Document Save takes 14 seconds with the cursor at the top of the document, but only 3 seconds with the cursor at the bottom of the document.

Comparison of benchmark results on the IBM PC (in seconds)

Test	NewWord 3	NewWord 1.43	WordStar 3.3
Document Load	3.4	19.8	9.9
Document Save			
cursor at top of document	14.0	23.2	24.9
cursor at bottom of document	3.4	n.a.	n.a.
Search	9.3	10.8	10.5
Scroll	48.0	81.5	41.2

WITH HOMEBASE IN HAND... YOU'VE GOT A LOT MORE ON THE BALL!

**HOMEBASE
VERSION 2.0...
AT ONLY 80K, IT'S
A WHOLE NEW
BALLGAME!**

This is HomeBase... the one with background electronic mail. The one described by PC Magazine as "... one of those rare software offerings you have to see to believe... One way to look at it is to say that Borland's product (SideKick) is a first generation organizer, while HomeBase is a second or third generation."

We built HomeBase for a wide variety of users. HomeBase's template maker and database system allow VAR's, for example, to custom tailor versions of HomeBase, literally, in minutes. Include tables, specialized databases, or whatever else you need, almost instantly.

Single users have an extraordinary variety of RAM RESIDENT tools at their disposal. The multi-person appointment calendar system makes it perfect for office-wide scheduling. And DOS Services is a lifeline to the novice and a real work-saver for the power user.

HomeBase even auto-answers your modem and receives files in the background while you're working in another program.

Yet, with all these features, HomeBase is incredibly easy to use. Unless you want to customize your copy, you'll probably have little need for the manual. Installation is virtually automatic, and operation remarkably intuitive.

Mobile HomeBase?

By the way, we don't force you to buy another piece of software just to print out your calendar for your appointment book. HomeBase's Report Generator will sort, compose and print information from your HomeBase databases and calendars to clip into your daytimer for those times when you're on the road. In addition, it can print out mailing labels, continuous form Rolodex™ cards... it can even do mail merge.

PC Magazine chose HomeBase as Top Software Product of the Year. We think you will, too!

Safe!!!

HomeBase Version 2.0 is compatible with most popular software, including Lotus, DBase III+, Wordstar 2000 and peripherals such as the Hercules monographic card and EGA. Inquiry 46

PC MAGAZINE—
Top Software
Product
of the Year!

\$69⁹⁵

Not Copy Protected

**Order Your Copy
of HomeBase Today!**

Satisfaction Guaranteed...
or mail it back for a full refund.

Available at better dealers... worldwide.



A LOT MORE THAN WITH SIDEKICK, THAT'S FOR SURE!

THE GREAT REBATE... \$20 REBATE FOR SIDEKICK USERS.

(Just mention the great
rebate when you phone,
or check the appropriate
box on the coupon)

HOMEBASE

Notepad
Autodialer (voice & data)
Appointment Calendars
Calculator
ASCII Table
Phone Directory
Multiple Cut & Paste
Appointment Alarms
Template Maker
Screen Saver
DOS Services
Type-ahead keyboard buffer
Free-form Databases
Structured Databases
Onscreen clock
Programmable Hotkeys
Phone Message Pad
Time and Expense Diary
To-do List
Background Electronic Mail
Resident Terminal
Mailing Label Printer
Report Generator
Area Code Directory

\$69.95

SIDEKICK

Notepad
Autodialer (voice only)
Calendar
Calculator
ASCII Table
Phone Directory
Cut and Paste

\$84.95

ORDER YOUR COPY OF HOMEBASE TODAY!

Toll Free Numbers Also Offer Technical Support 7 Days a Week

**Call Toll Free
800-523-0764**

**in California
800-323-5335**

Please enclose cheque or money order or...

Visa MasterCard American Express

Card # _____

Exp. date _____

Homebase \$69.95* per copy (Not copy-protected)

The Great Rebate - \$69.95 + shipping with your order.
(\$20 rebate mailed to you when you send in your license agreement)

Please add \$5 shipping and handling CA residents add 6½% sales tax.

30 day money-back guarantee.

Amount enclosed \$ _____

For the IBM PC, XT, AT and compatibles.

Name _____

Address _____

City _____

State _____

Zip _____

Phone: (Home) _____

Phone: (Office) _____

Ext. _____

Dealer, distributor and corporate quantity discounts phone: 408-559-4886

*Orders outside the U.S., please add \$20 shipping and handling. (U.S. funds, please)



Western Computer 286 Turbo™

Standard Features

- IBM PC/AT Compatible with 512K RAM
- Up to 1 Megabyte of system memory on the main board
- Switch selectable 8 or 10 MHz operation with one wait state on memory access (80286-10)
- One parallel port/one serial port and Clock/Calendar on main board
- Optional Serial Port on board
- Mass storage options from 20 to 140 Megabyte Hard Disk Drives and 20 to 60 Megabyte tape backup systems
- EGA video options available for CAD/CAM, word processing, etc. . . .
- One year factory warranty

Western Computer has high quality computers at very competitive quantity pricing.

Western Computer XT Turbo™

Standard Features

- IBM PC/XT compatible with 640K RAM on main board
- 4.77 or 8 MHz operation (CPU board made in U.S.A.)
- Two 360K Floppy Disk Drives
- Hercules compatible monochrome graphics controller (720 x 350) or IBM compatible color graphics adapter (320 x 200 - four colors or 640 x 200 - two colors) and parallel printer port
- Monochrome monitor (Composite or TTL input)
- IBM PC/AT style keyboard
- Various hard disk drive and tape backup options available
- One Year Factory Warranty



Western Computer
17781 MITCHELL STREET
IRVINE, CA 92714 U.S.A.
PHONE (714) 553-1611
Customer Service Only
(714) 553-1705

TELEX 756 731 - Answer Back
WESTERN COMP
FAX (714) 553-1705

Western Computer

"For High Technology and Performance"

IBM*, IBM PC*, IBM AT* are trademarks of International Business Machines Corporation.

European Head Office
BELECTRONIC SA,
RUE CENTRALE 43
CH-1880-BEX, SWITZERLAND
PHONE (025) 631250
TELEX 456 168
Answer Back BELE CH.



REFLEX

BY RUSEL DEMARIA

An analytical database that has many unique features for interpreting data

Reflex, from Borland International, is a database that gives you five different "views" of your information—Form View, List View, Graph View, Crosstab View, and Report View. To let you control these views, Reflex employs elements of both the Lotus 1-2-3 and the Apple Macintosh user interfaces. It lets you use the slash (/) key to open the top line of a menu, and then it opens Mac-like windows from the top line choices. Reflex can be controlled by either the keyboard or a mouse, and the commands are consistent throughout the program.

FORM VIEW

The Form View, the most standard aspect of Reflex, is where you begin. To define a field, you simply type its name on the Form design screen. After you exit the design phase, the first data entered into that field automatically defines the data type, or "field"—Text, Numeric, or Date. You can move fields within a form at any time, and you can add or delete fields, or even change the field type.

Reflex has a total of six different fields: the three noted above (Text, Numeric, and Date) and the Repeating Text, Integer, and Calculated fields. The Repeating Text field is much like a normal Text field, except that it conserves memory by saving each repeating value only once. By redefining one field in a test database to Repeating Text, I was able to save 31K bytes of memory in a file.

The Integer field is a memory-saving device. You can define any whole number that falls between -32,766 and 32,767 as an Integer field instead of a Numeric field. By doing this, I was able to save 6K bytes of memory in my test database.

The Calculated field lets you enter

formulas that manipulate data in other fields. When Reflex comes across a Calculated field, it goes to the fields designated by the formula, retrieves the data necessary to perform the calculation, and enters the result in the Calculated field.

Reflex offers several data input shortcuts. By far the most useful is the context-sensitive Choices key (the F10 key). You can use it whenever you need to select a field name (even while defining a formula), a filename from the disk, or one of the summary and analytical formula options. After pressing F10, you select your choice by highlighting it with the cursor keys or with the mouse, or by typing the first letter of its name.

Reflex also lets you perform sophisticated "what if" analysis. The Vary tool lets you create a set of records by varying the values in a field. For instance, if you wanted to test a product's pricing, you could create a series of records that varied the price from \$50 to \$100 in \$5 increments. You can also use Vary for break-even analysis. If you vary a text field using a list of choices, the program will create a record for each choice. You can vary a single record or all the records in the current filter. You can even use Vary when you first set up a database, for instance, to create a record for each month of the year or for each division of a company.

LIST VIEW

The List View is a tabular listing of your records, with a column for each

field and a row for each record. In the List View, you can set column widths, move or delete entire rows or columns, and add or modify records.

Like the other Reflex views, the List View lets you sort your records to any level and change the sort precedence at any time. You can also filter a database using AND, OR, NOT, or any standard mathematical operator, such as <, >, or >=.

GRAPH VIEW

Reflex offers the standard graph types (bar, pie, line, and scatter graphs) and makes them incredibly easy to create. The graphs can have both titles and legends, and the program generates legends automatically. The Summary and For Each options add exceptional power to the Graph View. Summary options include Sum, Count, Minimum, Maximum, Average, Standard Deviation, and Variance. You can change your graph to show one of these calculations with the touch of a key.

Because Reflex can split the screen into two or three windows, the Graph View can share a screen with the Form View or the List View. The live connection between the windows is remarkable. For instance, if you change data in one window, it immediately changes in the other windows, including the Graph View. In addition, if you move along the points of a graph, the records associated with those points appear in the Form View and are highlighted in the List View. Thus, if you see an especially low or high spot on a graph, it is easy to move the cursor to that spot and

(continued)

Rusel DeMaria (443 Lilikoi Rd., Haiku, HI 96708) is a freelance writer and a computer consultant.

Reflex

Type

Analytical database

Company

Borland International Inc.
4585 Scotts Valley Dr.
Scotts Valley, CA 95066
(408) 438-8400

Format

Three 5¼-inch disks; not copy-protected

Computer

IBM PC with at least 384K bytes of memory; high-resolution graphics, EGA, or Hercules-type screen; two floppy disk drives or one floppy disk drive and one hard disk drive

Documentation

One manual plus on-disk README file for updates

Price

\$99

Comments

Can hold up to 32,500 records in memory. New version supports up to 250 fields per record (254 characters per field).

simultaneously view the record that caused it.

The For Each option brings information into sharp focus. Suppose you have invoices for five salespeople, and there are ten products in your product line. You could easily graph each salesperson's total sales using the Sum option. Using For Each, you could show separate information for each product or for each month. If a graph is much larger than the screen or the current window, it will scroll.

CROSSTAB VIEW

The Crosstab View is, in some ways, the heart of the Reflex system. It lets you create an overall view of your data the same way that a graph does, but in a numeric rather than a graphical summary. Reflex will calculate totals, averages, counts, variances, standard deviations, minimums, or maximums on whatever portion of the data you choose. It then displays the results in a chart that you can use to find any hidden relationships and significant figures.

In the earlier example, we looked at a graphical representation of each salesperson's total sales for each product. The Crosstab View can show us the same data in figures. To set up this example, you would summarize total sales for each salesperson and for each product. The result would be a grid with the salespeople's names on one axis and the product names on the other. At a glance, you would see total and individual sales statistics by salesperson and by product.

REPORT VIEW

The Report View is a separate program that performs several functions. You can convert Lotus 1-2-3, Symphony, dBASE II or III, DIF, PFS, or ASCII text files to Reflex's format. You can convert entire files or parts of files, or take a random sampling from any of these files. You can merge two separate Reflex databases into one, provided that both files contain the same field definitions. You can print graphs previously saved on the main Reflex program. You can also design sophisticated reports of all kinds, from mailing labels to complex data analyses containing up to five break conditions.

One drawback to the Report View is that you can't run it from within Reflex; you must exit to DOS and run the Report View separately. Nevertheless, it is a useful utility that is worth the extra effort.

Designing reports is easy and powerful. It uses the same commands and menus used in other parts of Reflex. The design form is very flexible and versatile. You can sort your file within the Report View and use up to five sorted fields as special break fields. You can move entire fields, define variable widths, and set summaries and percentages. You can also define new calculated fields and use logical operators such as IF...THEN, CASE, and CHOOSE. In addition, you can format and align data easily by copying, inserting, and deleting separate entries or entire lines.

OTHER FEATURES

The Preview feature lets you view your report on screen at any time. Because some reports might contain extensive

and complex break conditions and summarizations, the Preview feature is a valuable one. A very helpful feature of the Report View lets you display actual data from the file in place of the filenames. You can actually scroll through your data this way, looking at what will appear in the report.

You can also design reports and print them out to a file. Reflex offers several different delimiters that allow you to export files back to other programs, such as Lotus 1-2-3 or Symphony. Unfortunately, Reflex lacks the ability to export directly to these files, so you will have to retranslate the files from within the target application.

The most recent version of Reflex requires a high-resolution graphics, EGA, or Hercules-type monochrome screen. With the EGA screen, you get roughly twice as many usable lines per screen. For example, with the List View I got 26 lines of data, as opposed to 13 lines with a standard color card. Reflex does not support color. [Editor's note: You can add color to the program by using a public domain program called GCOLOR.COM, which is available in a variety of formats. See page 405 for details.]

Reflex keeps its working file in memory. By merging files, you can create a larger file than the available memory can hold. You can work on parts of files by using the Partial Retrieve feature and by specifying a range, conditional formula, or random sample. Reflex also supports expanded-memory cards that use the Lotus/Intel/Microsoft standard. When you check the status of the program, in addition to total versus available conventional memory and number of records in the database and in the current filter, you will get a total versus available memory reading for any acceptable expanded memory.

SUMMARY

Reflex has a few weaknesses—its inability to export directly back to other programs, its lack of a direct link to the Report View, and its lack of macros. However, Reflex is loaded with unique features that you can use to cut, slice, and dissect data to bring out the hidden meanings within it. ■

The big news in Toshiba 3-in-One technology is small.



Toshiba's 3-in-One™ printer technology gives you speed, letter-quality type and high-resolution graphics. All in one highly reliable machine. Which may be why more people choose Toshiba 24-pin printers than any other.

And now you can get this proven technology in a new compact-size printer, the P321. At a compact price.

The P321 uses the same Toshiba-developed 24-pin print head that has set the standard for the industry. It produces letter-quality documents at 72 CPS, draft quality at 216 CPS and accurate, dot-addressable graphics. And our print head lasts four times longer in the process.

Qume Sprint 11 emulation and a wide selection

of plug-in type fonts are standard features on the P321. And you can get IBM Graphics Printer emulation and downloadable type fonts on diskette as options.

All these features and options in such a compact size and price and IBM-compatibility make the P321 a perfect choice to use with your PC.

If you need to do full-size spreadsheets, the Toshiba P341 is the way to go. It has the same capabilities and features as the P321 but adds a wide carriage which easily accommodates spreadsheets. You can also add a bidirectional tractor feed or electronic integrated sheet feeder.

For the name of the authorized Toshiba dealer near you, call 1-800-457-7777.

In Touch with Tomorrow

TOSHIBA

TOSHIBA AMERICA, INC. Information Systems Division



PERFORMANCE TO GO

Introducing the VISO— a powerful and very convenient personal computer you can take handily from one city to the next on business, or from the study to the patio on a beautiful sunny day.

The VISO was designed as a powerful 512K (expandable to 640K) RAM IBM-PC compatible computer that fits smoothly into the way you live your life.

To begin with, it weighs eleven pounds, and has a footprint a little bigger than the "in" box on your desk. The VISO is a computer you don't have to buy a new desk for.

It also takes a standard full-sized 5-1/4" disk, which gives you access to virtually any software on the market. If the computer at work is an IBM PC or compatible, you'll find this feature frees you to take your work disks home with you rather than work late at the office.

Plus the VISO offers an optional 80 x 25 LCD display, and carries a full range of I/O ports to accommodate a monochrome or color monitor, printer, modem, or any other peripheral you may wish to include in your system.

If you need a complete and powerful PC that doesn't chain you to one desk, your Mitac dealer can offer you freedom: the VISO personal computer.



FEATURES

- FULLY IBM-PC COMPATIBLE
- TAKES A 5-1/4" DISK
- 512/640KB RAM
- COMPLETE ARRAY OF I/O PORTS
- EXPANDABLE
- WEIGHS 11 POUNDS

Model MPC160V

- COLOR GRAPHICS AND LCD DISPLAY INTERFACE
- EXTERNAL 5-1/4" OR 3-1/2" FLOPPY DISK INTERFACE
- FCC CLASS "B" CERTIFIED
- PHOENIX BIOS
- MS-DOS 3.2

OPTIONS:

- MTR-9A/9G 9" AMBER/GREEN MONITOR
- LCD-640V DETACHABLE LCD DISPLAY
- AD-455 ADD-ON FLOPPY DRIVE
- AD-310 EXPANSION BOX
- HANDSOME CARRYING BAG.



mitac

When reliability is a decisive factor

MITAC INC. 585 MING SHENG E. RD. TAIPEI, TAIWAN TELEX: 11942 TAIAUTO FAX: 886-2-501-4265 TEL: (02) 5018231
 AMERICAN MITAC 3385 VISO CT. SANTA CLARA, CA. 95054 TEL: (408) 988-0258; 1-(800) 321-8344



GURU

BY ERNEST R. TELLO

Guru, from Micro Data Base Systems (MDBS), is an integrated software package that includes a spreadsheet, a database, and other business applications, as well as an expert system and a natural-language interface. The expert system offers both a forward and a backward chainer, reasoning with uncertainty, full interaction with the spreadsheet and database, and the ability to execute any command or program. There is also an SQL-like query language (like the one included with KnowledgeMan, another product from MDBS), as well as graphics, communications, and a text processor. Written partly in C and partly in assembly language, Guru runs exceptionally fast for a system that does so much.

PROGRAMMING LANGUAGE

In many respects, the procedural programming language in the Guru environment surpasses those available in dBASE III, Symphony, and Framework. The Guru language has a full range of control and conditional keywords for programming conditional branches and iterative loops, and it supports arrays in two dimensions. There is a macro command that allows you to extend the language interactively to add new commands to the system, as with LISP and FORTH. Guru also has a release command that allows you to free memory by selectively "undefining" macros.

The macro command is greatly limited in comparison to those of FORTH and LISP, since it is unable to write macros that take arguments. It can only be used to write subroutines that operate on named variables, and values have to be assigned to the variables before calling the macro command. In spite of this limitation, how-

A complete, integrated software package that includes an expert-system shell

ever, the macros are very useful and powerful.

The root command in Guru is a surprisingly powerful equation solver. It assigns the root of a given equation in one variable as a value to whatever variable name you specify, with a tolerance range for possible root values. Tolerance ranges are essential for equations that have more than one root. If several roots exist within the specified range, root only supplies one of them. The tighter the range specified, the less work root has to do, and the less time it takes. A particularly good use of this function is solving problems where there is a formula for finding the coefficients of a more complex set of equations, such as in the quadratic formula, or in the characteristic equation for third-order differential equations. Generally, root is capable of handling N -degree polynomials in a single variable, as well as equations involving trigonometric functions.

The perform . . . return combination lets you execute any Guru program in the current directory as a subroutine and then return to the program or macro that called it to continue processing instructions. Programmers will find Guru's ability to declare local variables, macros, forms, and arrays an attractive feature. The run command lets you run external programs in the current directory.

However, the programming environment in this (first) release of Guru is not completely robust and forgiving. If you make a programming error or

forget to initialize a variable that you call, Guru may crash or become unusable and need rebooting. Because the macros, which are dedicated to certain variable names, cannot take arguments, user-defined macro functions are

typically special-purpose routines. However, there are ways of overcoming this limitation. For example, a dedicated array can be set up as a vector that holds values of named variables, much as a stack would. Various functions could then be devised for loading and unloading the array with the desired values.

RULESETS

There are two ways to prepare a knowledge base in Guru. You can use the powerful full-screen text processor, or, until you become familiar with the rulebase syntax, you can use the window-oriented Ruleset Manager.

A ruleset in the expert-system facility consists of various sections or clauses. All rulesets must have an initialization section, a name section, a goal section, a rule section with at least one rule clause, a variables section, and a completion section. In the initialization section, the knowledge base may set the values of any variables it chooses and specify other variables to be input by requesting them from the user. Typically, the environment variables are set, and the variables to be used by the expert system are set to "unknown." Also, any statements in the Guru programming language may be made in this section

(continued)

Ernest R. Tello (1518 West Cliff Dr., Santa Cruz, CA 95060) is director of research and development at Integral Systems. He has written a forthcoming book entitled Artificial Intelligence for the IBM PC/AT.

Guru

Type

Integrated software package

Company

Micro Data Base Systems Inc.
P.O. Box 248
Lafayette, IN 47902
(317) 463-2581

Format

5¼-inch floppy disks

Computer

IBM PC, XT, or AT with a hard disk and 512K bytes of RAM (640K bytes maximum); also available for VAX-11/780

Price

\$2995; run-time package: \$300 for master and each additional package

to be executed by the expert system on start-up.

The goal section contains the declaration of the name of the goal variable, which marks the conclusion of reasoning when it is assigned a value. The completion section contains the directives that are carried out when the evaluation of the goal is completed. Usually this completion section will contain conditionals and cases, which produce different results depending on the state of the variables when the system's goal has been reached. In this way, many types of results are possible for the outcome of an expert system besides bare textual advice.

RULES

Both the premises and conclusions of rules can interact with the spreadsheet using various built-in functions. For example, the premises can look up values in a spreadsheet model and perform various operations on them

for the test, including math, logical, and fuzzy operators. Even text-string functions and wild-card and character class matches can be used in rule premises.

One of the most powerful aspects of the Guru expert system is the availability of the Guru programming language for use in the conclusions of rules. Almost any operation that the integrated environment can do may occur as the result of the firing of a rule. This includes inserting new records in a database, assigning new definitions to spreadsheet cells, and the recalculation of a spreadsheet. It also includes generating graphics displays, communicating with remote computers, executing entire Guru programs, and calling up and searching other rulebases.

The Guru inference engine can be controlled, and various defaults can be modified. The rule language lets you assign cost and priority values to







(continued)

BEST PRICE FOR DEALER PLEASE CALL 408-746-3972
408-746-3973

Compatible System

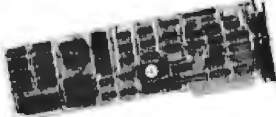

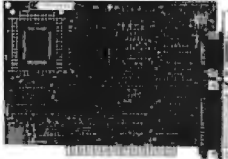
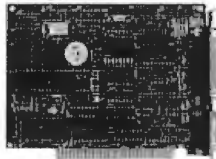
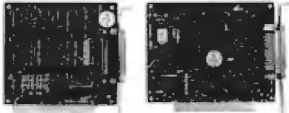
**DUAL FREQ
MONITOR
FOR TTL &
COMPOSITE**

<p>Monochrome/Graphics/ Printer Card</p> 	<p>DISIC I/O</p> 	<p>Enhanced Graphics Adapter</p> 	<p>Color Card</p> 
<p>Mono/Color Card</p> 	<p>Mini I/O</p> 	<p>Printer Card/RS232 Card</p> 	<p>Turbo Board (4 layers) & 640K M.B.</p> 

JOINTEK CO.

3080 Lawrence Expwy, Santa Clara, CA 95051

We Offer Power Supply and Case, Keyboard Too!

IBM, IBM, PC, PC/XT & PC/AT Are Registered Trademark.



50

7

What if...

YOU COULD SAVE A BIG FIFTY DOLLARS ON THE NEW QUIETJET PLUS PRINTER?

If your old printer is beginning to sound like an industrial chain saw, you should give a listen to the new QuietJet Plus printer from Hewlett-Packard. It gives you quiet operation and superb printing quality at a very affordable price. And for a limited time, you can get a \$50 rebate on any QuietJet Plus you buy.

Just visit your HP dealer for a QuietJet Plus demonstration. You'll see its near letter perfect printing quality. And how its wide carriage lets you print a wide range of documents, from short memos to long spreadsheets. You'll hear—or *almost* hear—how incredibly quiet it is. So quiet that you can carry on a normal telephone conversation without being disturbed.

The QuietJet Plus represents the kind of business computing innovations you've come to expect from the company that never stops asking, "What if...?"

So if your printer is breaking the sound barrier, just call 1 800 367-4772, Dept. 276B for the Hewlett-Packard dealer nearest you.



 **HEWLETT
PACKARD**
Business Computing Systems

rules. Rule priorities may be set with integers from 1 to 100. The priority of a rule is used to modify the order in which rules are chosen for testing, according to the assignment of the `esord` environment variable, which is described below. The range of values for the cost of a rule are similar, but opposite in effect to that of the priority value.

The `ready` option lets you specify a Guru command to be executed as soon as a particular rule has been selected for evaluation, but before any of its conditions have been tested. This is useful for customizing the environment to test specific rules. One interesting application for this would be the recording of statistical information each time certain rules come up for evaluation.

The `needs` clause applies when a rule's premise contains a macro or a reference to the element of an array. It is a streamlining feature, making all the information necessary for such rule evaluation immediately available to the inference engine. If this clause is omitted, Guru will still be able to process the rules, but often far more slowly.

The `changes` clause is similar, but it applies to the conclusions, or actions, of rules. It provides a list of all the variables that will be changed either directly or indirectly when the rule fires. This is particularly useful for backward-chaining consultations, where the system will chain backward from a goal to those rules that can establish the conditions needed for that goal. As with the `needs` clause, Guru can function without a `changes` declaration, but it considerably speeds up the search.

ENVIRONMENTAL VARIABLES

One way of controlling the operation of the inference engine is to set the value of various environment variables. These are the most important variables in the Guru environment.

The `esord` variable has six possible values to which it can be set. Assignment is done, as with any other variable, with the `let` command. If the command `let esord = "C"` is used in a program or a knowledge base, then Guru will pursue a least-cost strategy,

meaning that all the rules with the lowest cost value will be processed first. If the "F" option is chosen, the rules will be processed in the order in which they appear in the knowledge base. With the "H" option, the highest possible action certainty for the present goal must be achieved. The "P" option specifies that the highest-priority rules will be considered first. If the "U" option is chosen, the rules that have the fewest unknown variables are tested first.

The `atryp` variable also has a number of options. Setting its value to "S" imposes a strict strategy for evaluating any premise whose value is unknown. This means that its evaluation will be abandoned if any variable's value cannot be determined. If the "P" option is chosen, Guru will try to determine the values for all unknown variables and attempt to evaluate the expression. The "E" option causes Guru to continue to evaluate conditions after each variable becomes known, and it will stop only when the entire premise becomes known.

THE CONSULT COMMAND

Another important way of controlling the operating of the inference engine is by the various options of the `consult` command. The `consult . . . to test . . .` option activates forward chaining, a reasoning strategy driven by the facts that are already known to test as many rules as possible to prove additional facts. The `consult . . . to execute . . .` option lets you supply Guru with the name of a rulebase and a particular agenda of rules to test. This command could be used as part of a loop to periodically test the conditions of rules to see if they are ready to fire.

UNCERTAINTY

As with many expert-system shells, Guru can associate numbers with each expression that records the degree to which such an expression is known by the system. These indexes are called certainty factors. When conclusions are drawn from premises that have certainty factors associated with them, a formula must be used to compute the certainty factors of conclusions. Guru offers an en-

tire catalog of possible options for computing these certainty factors.

Guru also has an interesting implementation of fuzzy sets, which it calls set variables. Set variables may have several values, each with its own certainty factor. This is helpful for problems with no definitive answer, but it is useful to choose the best from some strong candidates. Set variables help to solve the problem of rules that contradict one another, or rules whose values need to change. For example, if two or more rules that fire indicate conflicting values for a given variable, a set variable can record both results, though possibly with different certainty factors.

Set variables may have up to 255 values. The notation for representing the set of values for a given variable is a bracketed list with the elements separated by commas. The set may also mix values of different data types.

EXPLANATIONS

You can generate explanations of how the Guru expert system arrived at its results or why it is asking a question in various ways. If a consultation has already concluded, you use the `how` and `why` commands. If the consultation is still under way and you want to know why a particular question is being asked, the `Control-Y` key combination will generate the result. The explanation facility allows inference tracing so that entire sequences of rule chains may be reviewed. This is a valuable and useful feature.

DATABASE MANAGEMENT AND STATISTICS

One feature that distinguishes Guru's integrated business software from programs like *Symphony* and *Framework* is its powerful relational random access data-file system. Index files can be created for these databases to allow fast random access and retrieval of records. The `select` command can automatically generate an output table based on query conditions supplied either by the user or by rules in an expert system, and it can do so for several data-file tables simultaneously. The `stat` command can be used to compute various statistics from the

values in records, such as sum, minimum, maximum, average, and standard deviation. As with the select command, statistical functions can be done with several files simultaneously.

By using the redefine, browse, change, mark, and compress commands, you can design knowledge bases to alter the contents of databases, depending on which rules fire. Some interesting and complex systems can be built using this capability.

SPREADSHEETS

Guru's full-featured spreadsheet has all the features of a current generation spreadsheet, and more. Two of its special features are the ability to look up cell values from other parts of the Guru environment and the ability to enter them in spreadsheet cells.

In a few ways, the Guru spreadsheet has advanced the state of the art beyond Lotus 1-2-3 and Symphony. For example, when copying complex cell formulas over a range of cells, a prompt will appear, asking if you want the formula adjusted for each of the terms of the formula. Thus, you can devise a complex formula composed of both absolute references and relative references.

The real power of the Guru spreadsheet is that the whole command language with macros is at your disposal for defining the value of cells. This means that you can save an enormous amount of typing by using macros and editing existing programs for the cell formula you need.

Another useful feature of the Guru spreadsheet is its ability to determine the value of a spreadsheet cell by consulting a ruleset. In other words, when the worksheet is recalculated, knowledge bases can be executed. On the basis of such consultations, the value of the spreadsheet cells will be determined and the values placed in the cells.

CUSTOM REPORTING

Custom reports are generated in Guru with predesigned templates, which can be created interactively and stored on disk. When designing a template, you simply position the cursor where you want text to appear and type. Any

"special effects" desired, such as highlighting, blinking, or color attributes, may then be specified.

In addition, header and footer patterns may be designed as part of the template. There are three basic header and footer configurations: report, page, and group setups. The report configuration is a formatted template that shows how information is to be presented. The page configuration, which is for printed reports, specifies how each page will be laid out and what headers and footers will be used. The group configuration presents the information in separate groupings, such as by department or by company.

COMMUNICATIONS

The communications facility in Guru allows the exchange of information between computers through a direct serial connection or via modem. A variety of communication modes are possible, including terminal emulation mode, automatic dialing, log-in, and log-out. Raw communications processing can be done on a character, line, or block basis.

Guru lets you embed commands that trigger data retrieval at transmission time. With information that will change over time, the communication routines can be written so that the most up-to-date information will be retrieved automatically and included in the message at sending time.

BUSINESS GRAPHICS

Guru can graph data using bar graphs, exploded pie charts, area graphs, line plots, and scatter graphs. It also has free-form graphics, so maps and other illustrations can be presented on graphics screens or combined with text. Using the free-form graphics facility, a single command will send Guru to retrieve data stored in array blocks and then produce a drawing to represent the data.

Mirror images can be plotted simply by resetting the range command from high to low, or vice versa. Since these arrays can be created and modified by the firing of rules in a knowledge base, the form of a free-form picture may be determined by an expert-system consultation. This

Custom reports

*are generated with
predesigned templates.*

could produce both a report and an illustration.

A graph can be based not only on the data stored in database files and spreadsheets but also on query specifications, statistics, and information stored by the Guru command language in variables and arrays. It is possible to display more than one such graph simultaneously, with the display characteristics of each controlled separately. Different regions of a graphics screen may also be cleared separately and new graphs can be drawn on them. This makes possible the comparison of charts for different sets of data values.

CONCLUSIONS

Even if it did not have a built-in expert-system shell, Guru would still be an extremely powerful integrated software system. Yet, in spite of all its power, Guru does have limitations. One is memory—with only half a megabyte, or even 640K bytes, there are real limits on what you can do. Another drawback is Guru's knowledge representation. Because the effect of rule firing in Guru is to set the value or values of a variable, more complex representation schemes, such as the familiar Object-Attribute-Value scheme, are not directly supported.

Since the expert-system facility in Guru is capable of calling on any function or command in the system or activating separate procedural programs, there is really nothing in the entire integrated software system that cannot be accessed from an expert-system application. This total integration of programming language, rule-based reasoning, and integrated business software facilities lets the user develop hybrid systems in which either the expert system or procedural programming has the upper hand. Guru's concept of total integration is not only very useful, it is very powerful. ■

BYTE Invites You to Join **BIX**

BYTE is the world's leading high-tech microcomputer magazine. Its readers collectively possess more information about personal computers and related topics than any other group in the world. BIX is BYTE's brand-new electronic information exchange, a computer conferencing system that puts you in touch with BYTE readers and other computer enthusiasts on a daily basis.

YOU AND BIX

BIX goes far beyond electronic bulletin boards to give you all the advanced features of true computer conferencing. It's the first major system dedicated to microcomputer information. Check these features:

- You can join ongoing discussions about your favorite computers, programming languages, operating systems, and applications programs, exchange information, ask questions, and offer opinions.
- You can read what others have already entered, add your own thoughts, and download information.
- You can participate when it's convenient for you, from home or office or while you're traveling.
- You also get electronic mail with BIX, putting you in direct, private contact with BYTE editors and BIX users everywhere.

CUSTOMIZE BIX TO MEET YOUR NEEDS

As a BIX user, you select only the conferences and topics that are of real interest to you. You may join a new conference or leave an old one anytime you want. Each time you log on to BIX, you're immediately notified of any electronic mail messages waiting for you, and you see which of the conferences you've joined have had new activity since the last time you logged on. BIX keeps track of your interests.

With BIX, you're an active participant in a giant microcomputer information exchange.

WHAT BIX COSTS...HOW YOU PAY

REGISTRATION FEE:\$25

BIX HOURLY USAGE FEES (All times are local):
Off Peak (6 p.m.-7 a.m. plus weekends
and holidays)\$9
Peak (7 a.m.-6 p.m. weekdays).....\$12

TELECOMMUNICATIONS CHARGES:

BIX is available via Tymnet from anywhere in the United States.

TYMNET (Continental U.S.):

Off Peak\$2/hr. Peak\$6/hr.

PAYMENT:

BIX and Tymnet charges are billed through either VISA or MasterCard. No cash, checks, or money orders.

START USING BIX NOW!

With our easy on-line registration, you can start using BIX in the next few minutes. No lengthy waiting for your registration to be processed by mail. (Step-by-step instructions on how to log on to BIX follow. Reading this material before you log on will speed you through the registration process.)

LOG-ON INSTRUCTIONS AND REGISTRATION INFORMATION

BEFORE YOU CALL BIX:

Having your credit card handy (VISA/MasterCard) before you log on will speed you through BIX registration. *You will not be billed for the time you spend on line registering for BIX. If at any time during the on-line process you decide not to register for BIX, just hang up.*

HOW TO LOG ON TO BIX:

Step 1: Set your computer's telecommunications program for full duplex using 8-bit words, no parity.

and 1 stop bit, or 7-bit words, even parity, and 1 stop bit. You may call at either 300 or 1200 baud.

Step 2: To reach BIX via Tymnet.*

* BIX is accessible from anywhere in the country through local Tymnet numbers. If you don't know the Tymnet numbers for your area, contact the BIX Customer Service Line (see below). At other times, numbers can be obtained by calling Tymnet at 800-336-0149.

- Call your local Tymnet number and log on.
- Depending on your baud rate, Tymnet will respond with "garble" or request a terminal identifier. Enter the letter "a". (Ignore quotation marks in this and succeeding entries.)
- Tymnet will ask you to log on. Enter "byteneti" and a carriage return (CR).
- Tymnet will ask you for a password. Enter "mgh" and (CR). You will then be at the door to the BIX computer.

Step 3: (If there is no prompt requesting a login at this point, hit a (CR) which should produce it.) When you see a phrase ending in "login:", enter "bix". (Echoing of this response is normal.)

You should now see the BIX logo scroll onto the screen and a prompt asking you to enter your name. Since this will be your first time on the system, enter "new" and a carriage return. This will

take you to a special section where you enter the information we need to register you as a BIX user. Follow the on-line prompts and supply the information requested. BIX lets you re-enter data if you make a mistake.

When you've completed your registration, BIX will automatically take you to a special "Learn" conference where you'll get a quick tutorial on how to use the system. (Typing "help" or "?" at any prompt while you are on BIX will give you an immediate review of available commands.)

ACCESSING BIX FROM FOREIGN COUNTRIES

To reach BIX from other countries, you need an account with your local Postal Telephone & Telegraph (PTT) company. From your PTT, enter 310600157878. Then follow instructions starting at Step 3. A list of PTT addresses and contacts for most foreign countries is available by calling or writing BIX.

CUSTOMER SERVICE

If you follow these instructions but still are unable to log on to BIX, call the BIX Customer Service Line for assistance at 800-227-2983, 8:30 a.m.-11 p.m. eastern time weekdays. In New Hampshire and outside the U.S., call (603) 924-7681.



We'll Send You a BIX User's Manual and Subscriber Agreement As Soon As We've Processed Your Registration

**BYTE INFORMATION EXCHANGE
ONE PHOENIX MILL LANE
PETERBOROUGH, NH 03458
(603) 924-9281**



The ITT XTRA XP desktop personal computer

**"ALL MY POSSESSIONS
FOR A MOMENT OF TIME"**
Elizabeth I

You can't buy time.

Long before Queen Elizabeth I, man began his quest to hoard that most precious and elusive of commodities. Time.

He can only make better use of the few hours he already has. Hence, the development of today's business computer.

The ITT XTRA™ XP. Our crowning achievement.

By matching memory to the muscle of the Intel 80286 microprocessor, we're able to achieve "no wait states."

Processing never pauses for slower memory.

Making the ITT XTRA XP thirty percent faster than the IBM AT. And fully XT-compatible.

Giving you speed and flexibility.

Because, being a corporation of many businesses, we're in a unique position to better understand what you need to grow.

Today, as well as tomorrow.

	ITT XTRA XP	COMPAQ 286	IBM PC/AT
Lotus 1-2-3	11sec	13sec	15sec
dBase	36sec	52sec	56sec
FormSort	52sec	1min 5sec	1min 10sec

All comparisons are for purposes of illustration only. User's application performance is dependent on application.

A moment's investment today can pay off royally tomorrow.

Call (800) 321-7661. In California, (800) 368-7300.

And call quickly. Every moment wasted is a potentially profitable moment you'll never possess again.



BECAUSE TIME IS THE ULTIMATE BOTTOM LINE.

© 1986, ITT Information Systems. IBM, PC/AT and PC/XT are registered trademarks of International Business Machines. Intel 80286 is a registered trademark of Intel Corporation. Compaq 286 is a registered trademark of Compaq Computer Corporation. Lotus and 1-2-3 are registered trademarks of Lotus Development Corporation. dBase is a registered trademark of Ashton-Tate.



THE DATRAN MODEM ACCELERATOR

BY BARRY NANCE

The Datran Modem Accelerator is an add-on board plus software that shortens the time required to transmit prestored textual material over telephone lines. The Modem Accelerator's printed circuit board fits into a full-length slot of an IBM PC, XT, AT, or compatible. You need two Modem Accelerator boards for normal use—one at either end of the telecommunications link. The accompanying software includes a spelling checker. In addition to lessening telecommunications time, the Modem Accelerator conserves disk space by storing files in compressed form.

HOW IT WORKS

Version 1.1 of the Modem Accelerator board, which is reviewed here, contains a 28,000-word dictionary in ROM and produces compressed files by substituting a "token" for each word or phrase in the source file that it finds in the dictionary. (Datran calls this concept the "Symbolic Tokenizer.") The board transfers words that it doesn't find in the dictionary into the compressed file untouched. Datran claims that files compressed with this product are about one-third the size of the original file and that the time and cost of on-line telecommunications are reduced accordingly.

Datran has designed the board with customization in mind; it plans to release legal and medical dictionaries on ROM chips in 1986 and is considering foreign-language dictionaries.

*A special-purpose
time, space, and money saver
for transmitting text files*

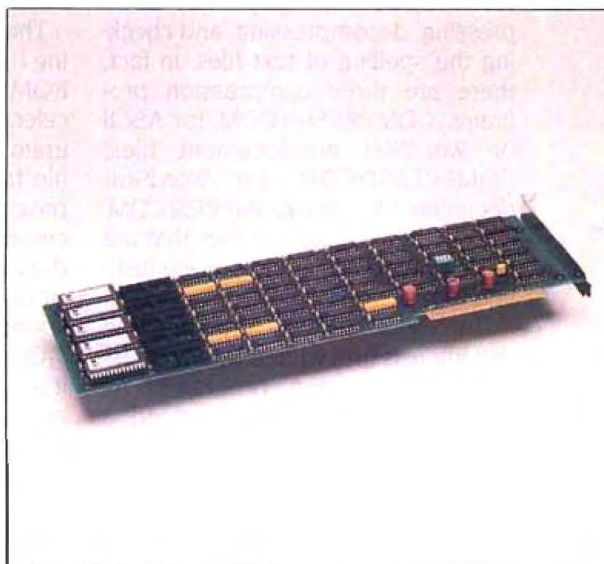

It also makes special ROM dictionaries for corporations that use specialized nomenclature or that have special security requirements. The board that was delivered to BYTE for review had five ROM chips installed and five empty sockets for future additions.

INSTALLATION OF THE BOARD

I easily installed the Modem Accelerator hardware as the fourth board in my IBM PC. Since I have the standard 63.5-watt power supply (which feeds a graphics adapter, a 384K-byte multi-function board, a combination hard/floppy disk controller, a 20-megabyte hard disk drive, and a floppy disk

drive), I wondered if adding the fourth board would cause power problems. However, the PC powered up cleanly after installation and has shown no sign of hardware trouble since.

When you're not compressing, decompressing, or checking the spelling of files, the Modem Accelerator is completely transparent to the operation of your PC. I ran the IBM Advanced Diagnostics program after installing the board (a good practice after installing any hardware in your PC) and found no diagnostic errors. The list of installed devices shown by the Diagnostics program did not include the Datran board.

The Modem Accelerator has switches that you can set to address the board at different I/O addresses and to accommodate faster microprocessors, such as the AT's 80286. My installation did not require changes in the switch settings. Datran says it doesn't know of any other board whose presence would require the I/O port addresses to be different, but it provides the switches just in case. Datran also says that if error messages appear or if the board seems to malfunction, you should reset the switches (and run an installation program to notify the software of the change) to determine if the prob-

(continued)

Barry Nance (17 Pease St., Wilbraham, MA 01095) is president and chief programmer for Business Software Services. He moderates several conferences on BIX.

**Datran Modem Accelerator,
version 1.1**

Type

Text-file compression/decompression for telecommunications purposes

Company

Datran Inc.
10519 Lauriston Ave.
Los Angeles, CA 90064
(213) 474-3684

Hardware Needed

IBM PC, XT, AT, or compatible with at least 128K bytes of RAM, serial port, and modem

Software Needed

Text editor or word processor that places the Control-Z EOF marker at the end of its files

Dimensions

Full-length board for IBM PC, XT, or AT (4.2 inches high and 13.2 inches long)

Software

File-compression programs, decompression program, line editor for spelling dictionary, spelling checker (one 5¼-inch double-sided 360K-byte disk)

Documentation

17 photocopied, stapled pages with table of contents and appendix showing error-message definitions; 3-page short manual for "impatient experienced users"

Price

\$495 each; normally purchased in pairs

lem is caused by duplicate I/O port usage.

SOFTWARE INSTALLATION

Instead of putting both the dictionary and the compression software in ROM, Datran chose to distribute the software on disk. Thus, the "data" (a table of words and their tokens) is in ROM chips, while the software is in the form of an easily upgradable disk. The first program disk I received from Datran contained a "hard error," and I could not execute or copy the compress programs. I was able to copy the replacement disk's files to my hard disk drive with no problem—the disk is not copy-protected.

The Modem Accelerator's disk contains separate programs for compressing, decompressing, and checking the spelling of text files. In fact, there are three compression programs: COMPRESSN.COM, for ASCII or WordStar nondocument files; COMPRESSD.COM, for WordStar document files; and COMPRESJ.COM, for WordStar document files that are to be printed using microspace justification.

The DECOMP.COM program can decompress files written by any of the three compression programs. As noted above, though, you need a Modem Accelerator board and software at both ends of a telecommunications link.

The other files supplied on the disk consist of the spelling checker, the special installation program (for any boards whose I/O port addresses conflict with the Modem Accelerator board), some data files, and a program that you can use to create your own dictionary of words (up to 500). This personal dictionary works with the spelling checker but does not take part in the compression/decompression process.

**TESTING THE COMPRESS/
DECOMPRESS FEATURE**

The main feature of the Modem Accelerator is its ability to shrink a text file to a very small size and expand the shrunken file back to its original state. You can send a shrunken disk file across a telecommunications link

in much less time than the full-size version of that same file, saving time and phone charges. Balanced against the phone bill is the cost of the time it takes to perform the compression and decompression.

Shrunken disk files take up less space on the disk, and you can use the Modem Accelerator board and software to produce shrunken disk files merely to conserve disk space. However, if you're using a hard disk drive to hold shrunken files, you should note that the smallest unit of allocation on a hard disk, the cluster, is usually 4K or 8K bytes. Thus, files that are fairly small to begin with are not good candidates for shrinkage, since they will always take up a minimum of 4K to 8K bytes of disk space.

The three programs for compressing files work in conjunction with the ROM dictionary on the Modem Accelerator board. The decompress program can operate on a compressed file from any of the three compress programs. The Datran board only processes text files; program files and data files are not supported (logical, since they would contain no correspondence with the ROM dictionary).

Compressing a file prior to sending it across a telecommunications link is simple: You give, for example, the command COMPRESN <filename.ext>. The software does not support path names. The result of the compression is a new file named <filename.CMP>, which you can send across the phone lines as a binary-type file.

Once the file is received at the other end of the link, the command DECOMP <filename> will produce a file named <filename.RSN> that is an expanded image of the original file. As you can see, it's important to distinguish filenames by using the first eight characters of the name, since the software uses the last three characters to indicate the compression status (and spell-checked status) of a file.

For both the compress and decompress operations, you can use a /D option that deletes the original file after compression or decompression—an

(continued)

The Full-Service Source For Programming Software

At Lifeboat, we're committed to more than selling you the best software. We provide tech support for every program we sell. Our expert staff is ready to take your calls on our Tech Support Hotline and help you quickly solve any technical problems you may encounter. Call Lifeboat for the complete solution to your programming needs.

LANGUAGES

Lattice C 3.0 The best selling C compiler has been upgraded to give you more functions and features. Lattice C 3.0 contains 200 new library functions, better code generation, support for new data types (void, enum, unsigned char, unsigned long), support for the 80186/80286 instruction set and the ability to generate in-line 8087/80287 instructions. Lattice C is the C compiler for professional developers.

RUN/C—The C Interpreter Learn C the natural way with RUN/C. The user interface is similar to BASIC with easy, familiar commands. The new 2.0 version of RUN/C comes with a full-screen editor and other enhancements.

RUN/C Professional New RUN/C Professional "... is the overall best choice of a C interpreter." *PC Tech Journal* (5/86). All RUN/C's capabilities plus powerful features for program development. Load your favorite object libraries with RUN/C Professional. Contains a full-screen editor and source code debugging facilities.

Pro Pascal A truly standard Pascal. Produces fast, tight code with plenty of compile time options.

BetterBASIC New Version Now you can program in BASIC and use the full memory of your PC, create structured programs using functions and procedures, make your own library modules and more. Now compatible with Microsoft BASIC.

LANGUAGE UTILITIES

Plink86 Plus An overlay linkage editor for linking 8086/8088 object modules. Contains new features for memory caching, library allocation, file merging and overlay reloading.

Pfix86 Plus A symbolic and source level advanced debugger for programming professionals.

Periscope I & II The symbolic debugger that can debug anywhere within a program at anytime with a simple press of a button. Periscope's breakout button will interrupt infinite loops, gain freedom from a locked up keyboard or help you find out where that slow running program is spending all its time. Periscope I additionally features a protected memory board which shields the debugger from runaway programs.

BASTOC

A BASIC to C translator for the BASIC programmer who wants to upgrade to C.

EDITORS

Brief This programmer's editor has several outstanding features. Brief's macro language compiler allows the programmer to create new commands and assign them to any key. Brief's unique "undo" facility will even let you recover from accidentally entered commands. Create as many windows as will fit on a screen, containing the same or different portions of one or several files. Compile programs without ever having to leave Brief.

FirstTime Speed-up program development with an easy-to-use C and Pascal syntax checking editor. Detects syntax errors, undefined variables and mismatched type assignments. Use function key menus to generate statements or enter your code directly. On-line help available.

VEDIT Plus A full-screen text editor for program development and word processing. It contains powerful features including use of macros, on-line help facility, paragraph formatting, and file comparison.

EMACS Customizable editor including windowing, multi-tasking and special modes for C and Pascal.

FUNCTIONS

The Greenleaf Comm Library

A library of over 120 communication routines. Contains functions to create interrupt driven routines or perform direct I/O to multiple Comm Ports. Its strengths are in asynchronous communications, interrupt mode, modem control, XMODEM, XON/XOFF and flow control.

PforCe New A library of 400 plus functions for interrupt driven communications, background tasks, string/table parsing, data base manipulation, DOS and BIOS functions and more. Superbly written and documented software with complete source code included.

The Greenleaf Functions A mature library of over 200 functions. Version 3.0 offers all new indexed documentation, with an abundance of examples. Source code included.

Essential C Utility Library Over 300 functions, with special attention given to screen handling, windows and business graphics. Source code is included.

BASIC.C Speed-up development time with this BASIC to C library, which acts as a bridge to C providing many of the capabilities of the BASIC language.

GRAPHICS, WINDOWING and SCREEN DESIGN

GSS*CGI GRAPHICS New The GSS Computer Graphics Interface is designed for creating high performance graphics-based applications. GSS*CGI speeds up application development and provides compatibility with a wide range of peripherals. It's the only CGI implementation that provides true device-independence for both raster and vector graphics. Products in the GSS GRAPHICS line include: the GSS*CGI Graphics Development Toolkit, the GSS Kernel System; the GSS Plotting System; and the GSS*CGI Metafile Interpreter.

Essential Graphics New A brand new graphics library for C programmers with the emphasis placed on ease-of-use and portability. No royalties.

WINDOWS FOR DATA New Provides C programmers with complete control over screen display and data entry, within an easy-to-use windowing system. Features include one-step data entry, multiple data types, Lotus-style menu design, full-featured field editing, pop-up entry windows, and much more.

Panel A powerful tool for interactive screen design.

For more information on these and other products in our complete line call:

1-800-847-7078

NY: 914-332-1875

Special Introductory Offer! For a limited time only you can get the new Software Programming Tools Guide from Lifeboat **FREE** by returning this coupon. To receive your copy of this regular \$9.95 value, you must supply all of the information below. Sophisticated programmers won't want to be without this complete guide to product features and selection.

Name _____ Title _____
Company _____ Business phone _____
Address _____ Zip _____

The Full-Service Source for Programming Software

LIFEBOAT

The names of products listed are generally the trademarks of the sources of the products

©1986 Lifeboat Associates
Inquiry 162

INTERNATIONAL SALES OFFICES

Australia:
Fagan Microprocessor Associates
Phone: (61) 3699-9899
Canada: Scantel Systems
Phone: (416) 449-9252
England: Grey Matter, Ltd.
Phone: (44) 394-53499
Italy: Lifeboat Associates, S.p.A.
Phone: (02) 656-841
Japan: Lifeboat Japan
Phone: (03) 293-4711
Spain: Micromat, S.A.
Phone: (34) 1-457-5056
The Netherlands:
GIGA Computer Products
Phone: (31) 10-771846
West Germany:
MEMA Computer GmbH
Phone: (49) (69) 34 72 26
Omnia:
Phone: (49) (076) 23 61820

Lifeboat
55 South Broadway
Tarrytown, NY 10591

option that you should use with care.

To test the shrink and expand programs, I used BIX (BYTE Information Exchange) as a "holding tank" for the compressed material. In other words, since I had only one Modem Accelerator board, I compressed each file, sent it to BIX, downloaded it back to my PC, and decompressed the downloaded file. I recorded the time required to transmit and receive each file and compared the result with the original file to ensure that no damage had been done to the text. (This article was one of the files that I sent and received. Other files included a 2-page report and a 45-page manual.)

Table 1 shows the results of the tests. Note that when I didn't use an error-checking protocol (such as XMODEM), the transfers took less time, but line noise caused the file to be unusable on every other transmission. With longer files, the probability of damage from line noise increases even more. I highly recommend that you use an error-checking protocol for telecommunications involving compressed files.

Also note that the material traveled

through a packet-switched network (Tymnet) in all cases. This somewhat increased the transmission time over that required for direct PC-to-PC connections, but the effect was the same for all files and it did not affect the relationship between original file and compressed file timings.

For benchmark comparisons, I used two software-only (no hardware involved) compression programs that have been in use for some time—ARC.EXE and SQ.COM. ARC.EXE is a shareware program from System Enhancement Associates. I used version 4.31 for the benchmark. SQ.COM, another shareware program, was written by Richard Greenlaw and Vernon Bueg. I used version 1.28.

Table 2 compares the Modem Accelerator's compression of files with compressions performed by these other methods. Note that the Modem Accelerator produced the smallest files. In contrast, SQ.COM took a little less time to perform its compression but produced files that were significantly larger than those of the Modem Accelerator. The ARC.EXE program compressed files better than

SQ.COM but took much longer to do it. The Modem Accelerator was both quick and effective.

The time required to perform text compression is almost as important as the size of the resulting file. In an environment of compressing, sending, receiving, and decompressing 20 to 50 files per day, the operator time adds up and must be considered in the overall cost savings.

In an environment of sending and receiving many files per day, the Modem Accelerator's speed should keep operating costs down and its degree of compression should reduce long-distance charges accordingly.

SPELLING CHECKER

The Modem Accelerator's spelling checker can check the spelling of words in a file automatically, going through an entire file without stopping, or on a word-by-word basis. If you choose the Automatic Sequencing option, the spelling checker inserts a special character (!) before each word that it cannot find in the ROM dictionary. If you don't choose Auto-

(continued)

Table 1: A comparison of three text files of various sizes, the time the Modem Accelerator took to compress them, their size after compression, and the length of time required to transmit the files, using straight ASCII and XMODEM transfers. Note that although the ASCII transfer (without error-checking protocol) was faster, it failed to transfer the file accurately in two out of three tests. Transmit times are based on 1200 bps (bits per second) transfer through Tymnet. File sizes are in bytes; times are in seconds.

Original Size	Compressed Size	Compression Time	ASCII Transmit (original)	ASCII Transmit (compressed)	XMODEM Transmit (original)	XMODEM Transmit (compressed)
5553	2176	6	48	23	105	40
19825	7680	16	169	74	372	144
51154	21952	35	439	203	960	411

Table 2: A comparison of the three test files as compressed and transmitted by the Datran Modem Accelerator and by two software-based data compression programs, ARC.EXE and SQ.COM. Transmit times are based on 1200-bps transfer through Tymnet using the XMODEM protocol. File sizes are in bytes; times are in seconds.

Original Size	Compress Time			Compressed Size			Transmit Time		
	Datran	ARC	SQ	Datran	ARC	SQ	Datran	ARC	SQ
5553	6	16	4	2176	3181	3305	40	58	61
51154	35	117	30	21952	25480	30477	411	477	571
19825	16	51	14	7680	10301	12288	144	193	230

NOW YOU CAN COMMUNICATE BETWEEN COMPUTERS...

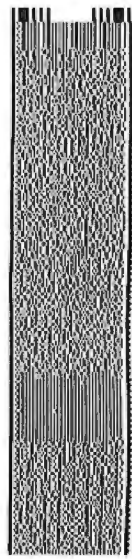

Softstrip

RED2BLUE.COM
Conversion Program

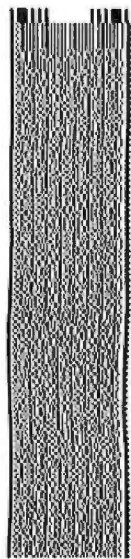

Softstrip

READTHIS.TXT
INSTRUCTIONS

WITH SOFTSTRIP® DATA STRIPS

How can you read a MacWrite file into WordStar?

- Create a file with MacWrite and save it as "text only."
- Print your file as data strips using Macintosh STRIPPER™.
- Read the strips into your IBM PC with the Softstrip reader.
- Run RED2BLUE (strip above) to convert the Macintosh file to IBM format.
- Open the file with WordStar, or most other popular PC word processor programs.

The program above is just one from a series of Application Notes Cauzin has developed. Other handy how-to manuals describing the procedures for exchanging computer data between different computers, using Softstrip data strips, are listed at the bottom of this ad and are available FREE of charge from Cauzin Systems, Inc.*

- ✓ IBM WordStar to/from APPLE Apple Writer
- ✓ IBM MultiMate to/from MACINTOSH MacWrite
- ✓ IBM MultiMate to/from APPLE Apple Writer
- ✓ IBM dBASE to/from APPLE AppleWorks
- ✓ IBM dBASE to/from MACINTOSH MS Works
- ✓ IBM dBASE to/from MACINTOSH Omnix 3
- ✓ IBM Turbo Pascal to/from MACINTOSH Pascal
- ✓ IBM BASIC to/from APPLE Applesoft
- ✓ IBM BASIC to/from MACINTOSH BASIC
- ✓ IBM Lotus 1-2-3 to/from APPLE AppleWorks
- ✓ IBM Lotus 1-2-3 to/from MACINTOSH Excel
- ✓ IBM Lotus 1-2-3 to/from MACINTOSH Jazz
- ✓ IBM Framework to MACINTOSH PageMaker
- ✓ IBM Lotus 1-2-3 to MACINTOSH PageMaker
- ✓ IBM WordStar to MACINTOSH PageMaker

SOFTSTRIP GAINS CRITICAL ACCLAIM!

"Softstrip® is a technology with as much potential for changing our society as the Xerox copier of the floppy disk."

Adam B. Green

INFOWORLD

"Data Based Advisor believes that the Softstrip® System is an important breakthrough for substantially changing storage technology and adding a new dimension to software publishing."

David M. Kalman

Editor in Chief, Data Based Advisor

"The Softstrip® System... the best reason yet to stop fighting paper and number it among effective means of data communications."

Jeff Duntemann

PC Tech Journal

IBM is a registered trademark of International Business Machines Corporation. Softstrip is a registered trademark and STRIPPER is a trademark of Cauzin Systems, Inc. Macintosh is a trademark of McIntosh Laboratories, and is licensed to Apple Computer, Inc. Apple is a registered trademark and Apple Writer, AppleWorks, Applesoft and MacWrite are trademarks of Apple Computer Inc. MultiMate is a trademark of MultiMate International. Lotus and 1-2-3 are registered trademarks and Jazz is a trademark of Lotus Development Corp. Excel is a product and MS Works is a trademark of Microsoft Corporation. Omnix 3 is a trademark of Blythe Software. dBASE and Framework are registered trademarks of Ashton-Tate. WordStar is a registered trademark of MicroPro International Corporation. PageMaker is a registered trademark of Aldus Corporation. Turbo Pascal is a registered trademark of Borland International.

Just let us know which Application Notes you are interested in before September 15, 1986. There is a limit of 5 Application Notes that you can request at any given time. Please include \$1 to cover postage and handling.

You can buy the Softstrip System for only \$199.95 at better computer stores. For the one nearest you, or to order direct, (if there is no dealer in your area) call: 1-800-533-7323 in Connecticut 203-573-0150.

Cauzin Systems, Inc.
835 South Main Street, Waterbury, CT 06706

Does YOUR disk Look Like
THIS?

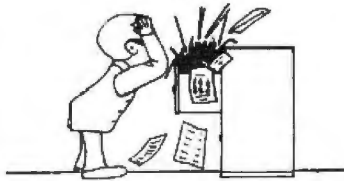

Let

H.D. Tuneup
cleanup your act!

H.D. Tuneup tunes your disk file system, making it better than new. File loads speed along like new. Directory searches are faster than new.

H.D. Tuneup reallocates all of your files to be contiguous. Each file is placed in its proper location, adjacent to its neighbors in the directory.

Disk operations run faster when your files have been Tuned.

H.D. Tuneup relocates your sub-directories into one area of your disk, as close to the root as possible. All deleted entries are actually removed.

Your drive head moves less from directory to directory than when your disk was new. TREE/F will fly when listing all of your files.

H.D. Tuneup requires IBM PC/XT/AT compatibility, 196k, and DOS 2.x/3.x. Fixed disks up to 32mb may be tuned, along with any 5.25" diskette.

NOT COPY PROTECTED!

ONLY \$39.95 plus \$3.00 S/H

SofCap Inc.
P.O. Box 131
Cedar Knolls, N.J. 07927

Visa (201) 386-5876 M/C

N.J. residents add 6% sales tax.

**For the best performance
from your disk
TUNE IT UP!!**

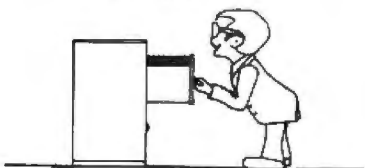

Visa, Master Card, Checks, Money Orders, or COD only.

REVIEW: DATRAN MODEM ACCELERATOR

The spelling checker is not the reason to buy a Modem Accelerator.

matic Sequencing, the program stops at each unrecognized word and lets you mark the word with the | character, ignore the word, save the word in the separate (disk-based) dictionary, or stop the program.

Since the ROM dictionary contains only 28,000 words (and only 500 additional words in the separate disk dictionary), the spelling checker will mark as errors a lot of words that are correctly spelled. The exact number, of course, depends on how closely your writing vocabulary matches that of the dictionary. In tests, I found that the program flagged roughly five percent of the words that were correctly spelled. This is a small portion of a file, but remember that the Automatic Sequencing mode inserts a | character in front of each "error," and you have to remove the | after confirming that the word is indeed spelled correctly.

Also, the spelling checker does not let you correct spelling errors on the spot. You must first exit from the spelling checker, use your word processor or editor to search for the | characters, and then correct the spelling of the flagged words. For this reason, if I were going to use the spelling checker on a regular basis, I would not choose the Automatic Sequencing mode but instead review the words as they pop up as "errors" on the screen.

Some word-processing programs for the IBM PC put an end-of-file (EOF) marker character (Control-Z) at the end of each text file; some don't. The Modem Accelerator software absolutely requires that the marker be present. I tried to check the spelling of a file I created with PC-Write, which doesn't add Control-Z to the end of a file. The spelling checker went into a loop and reprocessed the file over and over—I had to reboot to recover from the error the first time. I tried it again and had to use an NMI push button to reset the computer.

Ctrl-Alt-Del had no effect; the keyboard was locked up.

Datran mentions in its documentation that it is presently adding the capability to handle files from additional word-processing programs. If the documentation that came with your editor/word processor doesn't specify whether it uses the Control-Z convention, you should check with Datran to determine its compatibility with the Modem Accelerator.

CONCLUSION

The Modem Accelerator is a special-purpose tool, suited to certain environments. It works on prestored files—you can't use it in the midst of an interactive telecommunications link to compress keyboard input as it flows across the link. The Modem Accelerator does not work on program or data files, only text files. The text files it compresses must have the Control-Z EOF marker. Compressing a file takes time, as does decompressing the file at the receiving end. Since the resulting compressed file is an encoded version of the original, it may contain "characters" that could be interpreted as telecommunications control characters in some links. Finally, you'll have to establish procedures and conventions for using the boards at either end of the link to conserve connect time and to avoid human errors in the handling of the files.

The Modem Accelerator could be effectively used by corporations that are now sending medium to large files of text across long-distance phone lines. In this environment, the shrink/expand capability could be a time and money saver.

The spelling checker is not the reason for buying a Modem Accelerator board. There are software products that perform this function much better and that contain many more words (the one I regularly use, IBM's Word Proof, version 1.0, has a dictionary of 125,000 words). Keeping in mind that the spelling checker is a by-product of the ROM dictionary, you can use this feature instead of other software on an occasional basis—perhaps as a quick check of a text file that you're about to send over the phone lines. ■

GE'S 3-8100 PRINTER

The otherwise informative and useful review of General Electric's 3-8100 printer by Robert D. Swearingin (May) neglects to mention a factor of importance to potential consumers: cost and availability of essential supplies. Although 100,000 characters must seem like an inexhaustible amount of printing, calculations reveal otherwise. If a page contains 52 lines of 65 characters each, the 100,000 characters turns out to be approximately 30 pages. If double-spaced documents and programs are figured at half this number of pages, it means your ribbon costs, at six dollars each, will run 10 to 20 cents a page! This factor must be taken into account for anyone in the market for low-cost printing.

JOHN DEHAVEN
Ratchaburi, Thailand

ZBASIC

Several difficulties in using ZBasic are not emphasized in the review by TJ Byers (May). My ZBasic experience is with the version for the IBM PC and compatibles on a Panasonic Sr. Partner.

I prefer my high-precision answers to be correct, not crunched, so ZBasic's 6 to 54 internal binary-coded decimal double-precision accuracy appeals to me. There are some calculations that failed at double-precision 54 but worked very well at double-precision 52. Unfortunately, this achievement is marred by the absence of run-time arithmetic error messages.

Subtle and hard-to-find bugs can be introduced into ZBasic programs by their precision rules for complex arithmetic expressions, with mixed precision of the variables. The GW-BASIC and BASICA rules are simple and unambiguous: The expression has the precision of its highest-precision variable.

ZBasic references RESTORE for DATA statements by item number starting at 0 rather than by line number. The input formats for time and date hexadecimals use comma delimiters, and TIMER is not supported.

The requirement that all keywords be in uppercase and that no variable name contain an uppercase keyword is a burden when converting programs to ZBasic.

Variable names are case-sensitive, so Temp, temp, and TEMP are three different variables. Because of this, I found I had to alternate between GW-BASIC and ZBasic. I also had to remember that ZBasic changed the meaning of / and \ divides. The backslash must be used to force floating-point divide.

It took some effort for me to find the equivalence between the usual GW-BASIC screens 0, 1, and 2 and the 16 ZBasic modes. Some modes give surreal displays, and only modes 5 and 7 give correct graphics. Mode 5 is somewhat like screen 1, and mode 7 is somewhat like screen 2.

In brief, ZBasic has many pitfalls for the unwary. Programs must be well debugged before conversion to ZBasic. There are no run-time arithmetic messages, nor is breakpoint debugging possible.

GEORGE WM THOMSON
Detroit, MI

PANASONIC EXEC. PARTNER

I would like to provide additional information on the Panasonic Exec. Partner (reviewed by Rich Malloy in the April issue).

Panasonic has an excellent technical manual for the Exec. Partner. It costs \$5 (plus \$2.25 tax and shipping), and is available from MSC Service Literature, P.O. Box 848, Arlington Heights, IL 60005.

The warning sticker about the disk drive should not have been a disappointment for Mr. Malloy. If you burrow through the manuals for most computers, they have a similar warning. Panasonic seems to have been a little more forthright about the real problem of random flux changes in the heads during initial start-up of the floppy disk drives. It is true that data disks should not be left in place with the heads clamped down; you get media and head degradation as a result. I have Teac drives in my IBM PC, and they raise and lower the heads between uses, which is the way disk drives should work.

The expansion chassis that is available from Panasonic is very easy to attach. By using this box, you can add another monitor and a graphics card. The MODE command allows you to change how the screen (gas-plasma or external) behaves. I think that the proper use of MODE

would probably answer many of your concerns about the gas-plasma screen. I have had both the gas-plasma screen and an external monitor working at once.

FRANCIS P. BOWLES
Woods Hole, MA

VME/10

I read the review of the Motorola VME/10 by Robert E. Robinson III (February). I have been using this machine for two years with the VERSAdos operating system. I would like to express my views on the VME/10, VERSAdos, and Motorola.

First of all, there is considerable doubt in my mind that the 384K bytes of memory is ported on the VMEbus.

Second, the capability for graphics exists, but there is no support software.

Third, between two VME/10s (one of which I've used for two years and the other for over a year), I have had problems with the reset switch, power switch, power supply, disk controller, and keyboard.

Fourth, Dr. Robinson has been luckier in dealing with Motorola than I have. Last October I asked if there was any simpler way of doing backups rather than doing transfers to floppy disks. Can backup be done onto half-inch tape using the 9-track tape controller (MVME435A)? There are no facilities under VERSAdos. There aren't any controllers for quarter-inch streaming tape. A month later, Motorola announced such a controller (MVME350). Subsequent calls to Motorola have produced many promises of data sheets for this device. I finally received a data sheet after three months but no information on what VERSAdos support it has.

Finally, although I disagree with Dr. Robinson's conclusions on the design, construction, and reliability of the VME/10, I am not entirely negative. My next project may be done with Motorola equipment using VERSAdos.

J. L. PAUL
Dorval, Quebec, Canada ■

REVIEW FEEDBACK is a column of readers' letters. We welcome responses that support or challenge BYTE reviews. Send letters to Review Feedback, BYTE, One Phoenix Mill Lane, Peterborough, NH 03458. Name and address must be on all letters.

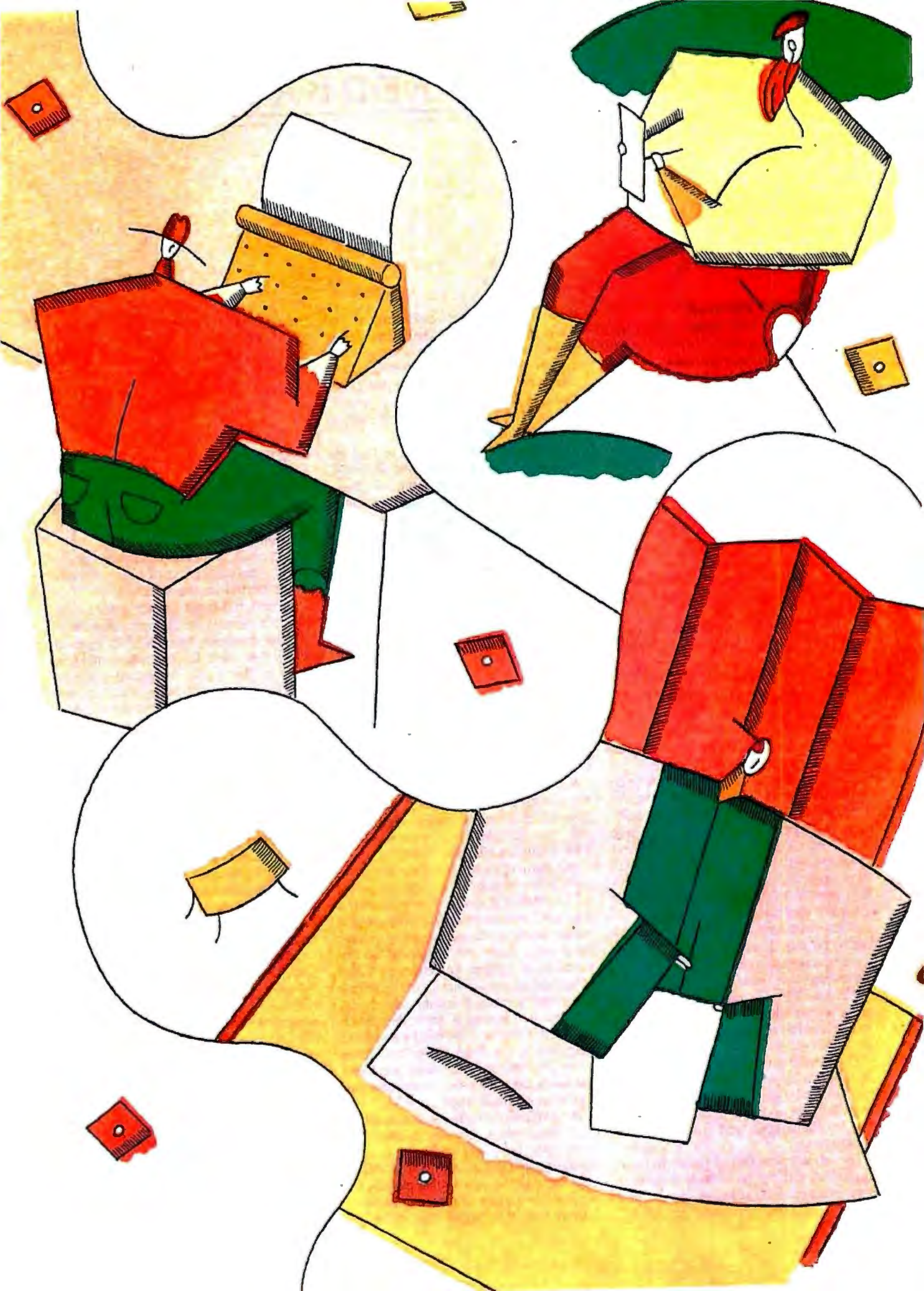

Kernel

**COMPUTING AT CHAOS MANOR:
OFF WE GO**
by Jerry Pournelle 299

APPLICATIONS ONLY: MORE WORDS
by Ezra Shapiro 319

**ACCORDING TO WEBSTER:
GOING TO THE FAIRE**
by Bruce Webster 323

**BYTE JAPAN:
FUJITSU PROCESSOR UPGRADE**
by William M. Raibe 329

**MATHEMATICAL RECREATIONS:
NUMBER GAMES**
by Robert T. Kurosaka 333

JERRY HAS BEEN DOING a great deal of traveling lately. This month he visited the United States Air Force Academy and the West Coast Computer Faire. He then had upcoming trips to Austin, Berkeley, and Atlanta. Although the travel began to grind him down, much of it was fun, and he learned a lot. Jerry is impressed with the use of computers at the Air Force Academy, especially in the area of computer-aided design. He is also pleased to report that the Faire is still his favorite computer show.

Ezra Shapiro thought he had seen the last of word processors for MS-DOS machines. No such luck. He does believe that he is near the bottom of the pile, though. The ones this month are called Mindreader (Ezra is impressed by its oddness), PC-Write 2.6, and Word 3.0.

Bruce Webster also visited the West Coast Computer Faire. While *he* believes that it has become more an exercise in nostalgia than a vital happening, he still sees value in such shows. They provide small, innovative companies direct exposure to users and to the press. Bruce did see some interesting products and plans to keep coming back to the Faire. While he was in the Bay Area, Bruce also visited Atari and Commodore.

UNIX-based systems have been scarce at the personal computer level in Japan. Recently, however, Fujitsu announced an upgrade that could make these systems more common. Bill Raibe looks at the upgraded FM-16 β . Changing his course, Bill then considers the lack of hardware and software to do Japanese-language word processing on an IBM PC.

This month's Mathematical Recreations column finds Bob Kurosaka looking at some number-sequence games: sum of cubes, factorial sums, palindromic sums, and delete and add. Computers make the job of exploring these games much easier than doing it manually. Thus, Bob provides BASIC programs to check them out.

Sharp-eyed Kernel readers will notice there is no BYTE U.K. this month. Dick Pountain was kept busy doing an article for the Theme section. BYTE U.K. will return in September with an Occam technique that boosts performance in parallel-computing systems.

CONNECT



IBM DISPLAYWRITER to IBM 5520 to IBM OS/6 to IBM S/36 to IBM 8100 to IBM PROFS to WANG OIS to WANG VS to CPT to LANIER to NBI to MICOM to DEC WPS to XEROX to LINOLEX to COMPUGRAPHIC to QUADDEX to NCR to DEC VAX to CP/M to DATA GENERAL to UNIVAC to BURROUGHS to HONEYWELL to IBM PC/36

FLAGSTAFF ENGINEERING can connect your incompatible computer systems using diskette, tape, communications, or printed media. We have developed many low cost systems to help you transfer files and documents between different computer systems. Our "FILE", "WORD", and "TYPESETTING CONNECTION" products can read and write most of your 8", 5¼", and 3½" diskette formats. The "PROTOCOL CONNECTION" can provide RS232 communications between your different computers. The "TAPE CONNECTION" system is a 9-track tape drive that can read and write your files on 800, 1600, or 6250 BPI magnetic tape. Since 1982, we have installed thousands of conversion systems at customer locations around the world. Call us today for help in connecting your systems.



**Flagstaff
Engineering**

1120 W. Kaibab
Flagstaff, AZ 86001
Telephone 602-779-3341
Telex 705609 FLAGEN



OFF WE GO

BY JERRY POURNELLE

Jerry hits the road in many directions and learns a great deal

I think they're trying to kill me. When this month is over, I will have spent more time on the road than I did at home. All this travel is necessary, and some of it was fun, but it can sure grind you down. Fortunately I learned a lot, so there's much to report.

COMPUTERS FOR CADETS

One place I went was the United States Air Force Academy in Colorado Springs, where I was the guest of the department of civil engineering. I hadn't thought of it, but of course the U.S. Air Force is the largest owner of pavement in the world and operates one of the world's largest construction enterprises. Besides flying airplanes, the Air Force has to design, build, and operate bases for them, which often means they must set up small, self-contained cities and provide every service from grocery stores to mortuaries.

This fall USAFA is trying an experiment: every cadet will be required to buy a Zenith 248 IBM PC AT compatible. Cadets will be given an allowance for this, and the machines will be theirs when they graduate. Meanwhile, the Academy is stringing coax cable through the dormitories: the intent is to link up all those machines into a central conferencing network. As I write this, they have chosen neither the conferencing software nor the large machines to handle the networking. I've been encouraging them to license CoSy from the University of Guelph. CoSy is the system used by BIX. USAFA and BIX have much the same requirements: electronic mail, conferencing, ability to handle 500 to 1000 simultaneous users (BIX isn't that big yet, but I expect it to be in a year or so). I have no hesitation in recommending CoSy for any reason-

able-size conferencing activity, and, after all, it was developed for academic use.

The Academy is an academic institution, but it's still owned by the U.S. government, meaning that nothing is very simple, and that particularly applies to computers. Example: if Academy professors see a piece of commercial software they think would be useful, they can't just go buy it by name, since that would be a sole-source procurement, and the government really frowns on noncompetitive purchases. You wouldn't *believe* the paperwork they have to go through just to get a compiler, or a math program, or a graphics package. Generally, one of the professors will just buy it out of his own pocket; but clearly there's a limit to how much can be acquired that way.

They do have one thing going for them. Like all the service academies, the Air Force Academy operates on an honor system, and a number of big software publishers have given site licenses to the institution: the cadets can use the software as long as they're at the Academy but can't take copies with them on graduation, and of course they don't let any copies leave the Academy grounds. It all makes sense to me. The practice doesn't cost publishers much, and it can't hurt future sales to have the U.S. Air Force officer corps familiar with a product—especially since in many cases the Zenith 248 the officer owns on graduation will be the most powerful computer at his new post. Of

course, all those computers will need software...

AUTOCAD

One outfit that has donated its software to USAFA is Autodesk, who has not only given the Academy permission to use its CAD software packages but even sent some experts out to get it all properly installed on the Academy's dozen AT&T 6300s last fall. No one at the Academy had ever used a CAD system, but they decided to use it in their design course: meaning that students and professors had to learn together.

It was a raging success. The course not only covered more ground than ever before, but the cadets were able to produce really professional-quality work—and to show not only the professors, but also the AutoCAD designers, some new uses for the program. I'm clearly no expert in either civil engineering or CAD programs, but I heard nothing but glowing praise for AutoCAD.

AutoCAD has a number of nifty features. For example, you can create a shape—say a bathtub—and store it. If you change the scale of drawing, the size of that shape will change when you call it up. To install a bathtub of that style, you retrieve it from memory, drag it about the plan with the mouse, rotate it until it's oriented the way you like, and there it is.

You can also make arrays of shapes, which gave one of the cadets an idea. He drew a parked fighter plane, moved another next to it, set that up as an array, and presto! he had a template for drawing in off-runway park-

(continued)

Jerry Pournelle holds a doctorate in psychology and is a science fiction writer who also earns a comfortable living writing about computers present and future.

The West Coast Computer Faire is still my favorite computer show.

ing areas for F-15 fighters. Others added to the file so that most aircraft shapes are now in the civil engineering department's library.

This year AutoCAD could be used on only a dozen machines. Next year the cadets will be able to work on problems on their own machines. Printing their work will still be a bottleneck—the Academy has only three plotters that they can use—but even so they expect to be able to enrich their design course even more. Incidentally, if anyone out there has a couple of spare plotters they'd like to rent out for a dollar a year, you might write Colonel Swint at the Department of Civil Engineering, USAFA, Colorado Springs, CO 80840.

There's another fallout to this: the Academy is slowly accumulating computerized plans in AutoCAD format for a number of major U.S. Air Force bases, which means the cadets can have experience designing base changes, repairs after combat, and the like, working on real installations. This will cut down their postacademic training period when they leave the Academy and go out to do useful work. It probably won't hurt AutoCAD's sales, either. . .

COLLEGES AND COMPUTERS

The service academies are leading the way, but I suspect that by 1995—probably well before that—just about every college and university will require all students to own a personal computer. The advantages are just too great. Examinations can be turned in on disk rather than paper: not a big advantage in some academic disciplines, but in engineering design and other graphics-intensive course areas the savings in instructor time will be startling.

On the other hand, there may be some glitches. I'm writing this in April.

USAFA expects to have its networking system in place by August. I don't think that will be easy—yet many of the academic departments are planning courses in ways that depend not only on the cadets having computers but on their being networked. I wish them well at it, but I'd sure hate to decide on a computer, buy it, decide on software, buy that, and get it all working to link 4000 PCompatibles in four months' time.

I'm sure USAFA will survive any early setbacks. Meanwhile, the engineering professors have developed some really spiffy instructional software for PCompatibles. One demonstrates pendular motion with springs of various resiliency stressed under different conditions. Another does Hardy cross-analyses. They have drainage models, soil-stress models, and a raft of other stuff to use in engineering classes. It's all in the public domain, too. They don't have a budget for publishing or providing copies to everyone who asks, but they are very interested in suggested improvements. I'm sure that anyone who wants to make a significant software swap will get sympathetic attention.

THE ELEVENTH FAIRE

Another place I went was the West Coast Computer Faire, and I'm pleased to report that the Faire is still my favorite computer show.

It didn't have to be. Early this year the Faire was bought by The Interface Group, the outfit that brings you COMDEX and many other computer shows; and while they do those shows very well indeed, the Interface people are after all involved in a commercial enterprise: while the Faire is something very special.

I needn't have worried. Sheldon Adelson, who is president of Interface, said not once but several times that he considers the Faire "the spawning grounds of the computer industry," and "you have to give something back." He even said it again when he came down to introduce me at the talk I gave. Incidentally, he introduced me as "the consummate hacker," which is flattering but alas not really true, and as "the voice of the computer users," which comes pretty

close to what I attempt to be.

I don't suppose for a moment that start-up companies won't still have Faire troubles, but most will be due to a problem Shelly can't solve. It's expensive to put on shows in San Francisco, and made more so by the strict union contracts the city has signed. Lest someone think I'm automatically antiunion, my wife's father was a coal miner, and company cops once dynamited his house for trying to organize a union; but I do not think he would have approved of a situation in which a small entrepreneur is not allowed to move his own goods and is charged \$450 to have someone do it in five minutes with a forklift. I sometimes wonder if San Francisco really wants conventions and shows.

The Interface Group says they want suggestions from everyone who loves the Faire. Clearly they can't do everything we'd like, and they certainly don't intend to lose money; but they have promised to be cooperative. They certainly paid enough attention to me.

I do believe that Shelly Adelson will try to keep the Faire what it has always been: a place for users, developers, hackers, writers, and enthusiasts to get together. The heart of the Faire has always been the tiny little booths along the walls. Adelson deserves a lot of credit for recognizing that and keeping their costs as low as he can.

I went to this year's Faire with the nagging thought that it might be my last. It won't be.

BACCHANALIA . . .

There's one major change in the Faire. For the past several years, there have been wild parties: one year *InfoWorld* held a press reception in the Coit Tower, and another year they rented the rotunda of San Francisco's City Hall. Microsoft used to throw humorous parties.

During the salad days everyone threw parties; I can recall one Osborne affair at which Lee Felsenstein solemnly informed me that Osborne would set new standards of adequacy in party giving. I wasn't quite sure how to take that. For a few years, though, every night during the

(continued)

THE PROGRAMMER'S SHOP

helps save time, money and cut frustrations. Compare, evaluate, and find products.

RECENT DISCOVERY

APT - Active Prolog Tutor. - Guides you in building applications interactively. Arity, Borland, Prolog-86 compatible. PC \$ 65

AI-Expert System Dev't

Arity System - incorporate w/C. PC \$295
 Expertech - Improved, samples PC \$399
 EXSYS - Improved. Debug, file & external program access. PC \$339
 Insight 2 - dB2, language MS \$879
 Others: APES (\$359), Advisor (\$949), ES Construction (\$100), ESP (\$845), Expert Choice (\$449)

AI-Lisp

BYSO - Common, MacLISP compatible 250+ functions, fast. PC \$150
 GC LISP Interpreter - "Common", rich, Interactive tutorial Call
 Microsoft MuLisp 85 \$199
 PC Scheme LISP - by TI. SCHEME has simple, "orthogonal" syntax. PC \$ 95
 TLC LISP - classes, compiler. MS \$225
 TransLISP - Good for learning MS \$ 75
 WALTZ LISP - "FRANZ LISP" - like, big nums, debug. CPM-80 MS \$149
 Others: IQ LISP (\$155), UNX LISP (\$59), IQC LISP (\$269)

AI-Prolog

ARITY Standard - full, 4 Meg Interpreter - debug. C, ASM PC \$ 350
 COMPILER/Interpreter-EXE PC \$ 795
 With Exp Sys, Screen - KIT PC \$1250
 MacProlog MAC \$ 295
 MicroProlog - enhanced MS \$ 229
 Prof. MicroProlog - full memory MS \$ 359
 Prolog-86 - Learn Fast MS \$ 95
 Prolog-86 Plus - Develop MS \$ 250
 TURBO PROLOG by Borland PC \$ 79
 Others: Prolog-1 (\$365), Prolog-2 (\$1795)

Editors for Programming

BRIEF Programmer's Editor - undo, windows, reconfigure PC Call
 C Screen Editor - w/source 80/86 \$ 75
 EMACS by UniPress - powerful, multifile, MLISP. Source: \$949 \$299
 Epsilon - like EMACS PC \$169
 Kedit - like XEDIT PC \$109
 Lattice Screen Editor-multiwindow multi-tasking Amiga \$100 MS \$109
 PMATE - power, multitask 80/86 \$149
 XTC - multitasking PC \$ 85

FEATURES

Attek ADA Compiler - DoD standard minus multitasking Includes trace, breakpoints, code disassembly, more. Produces virtual stack file or native code PC \$895

Allice v1.3 - Learn Pascal. Interpreter, extensive help, debugger, editor, 8087 support, graphics and windowing functions. Turbo Pascal compatible PC \$ 85

National Accounts Center

Special service is provided by a separate team for organizations with over 500 employees. Purchasing agents, evaluators, managers, and programmers all appreciate the extra information, attention to shipping and invoicing, and help finding and evaluating products. Call 800-446-1185.

Our Services:

- Programmer's Referral List
- Compare Products
- Help Find a Publisher
- Evaluation Literature FREE
- BBS - 7 PM to 7 AM 617-826-4886
- Dealers Inquire
- Newsletter
- Rush Order
- Over 700 products
- National Accounts Center

C Support-Systems

Basic-C Library by C Source MS \$139
 C Sharp - well supported, Source, realtime, tasks PC \$600
 C ToolSet - DIFF, xref, source MS \$ 95
 Lattice Text Utilities PC \$ 99
 The HAMMER by OES Systems PC \$179
 PC LINT - checker. Amiga \$89, MS \$119
 SECURITY LIB - add encrypt to MSC, C86 programs. Source \$250 PC \$125

Fortran & Supporting

Forlib+ by Alpha - graph, comm. \$ 59
 MACFortran by Microsoft - full '77 \$229
 MS Fortran - well liked, solid \$219
 No Limit - Fortran Scientific \$129
 PolyFortran - xref, pp, screen \$149
 Prospero - '66, reentrant \$349
 RM Fortran - enhanced "IBM Ftn" \$395
 Scientific Subroutines - Matrix \$149
 Strings and Things - registers, shell \$ 59

MultiLanguage Support

BTRIEVE ISAM MS \$199
 BTRIEVE/N - multiuser MS \$469
 CODESIFTER - Execution PRO-FILER. Spot bottlenecks. MS \$109
 Dan Bricklin's Demo Program PC \$ 75
 HALO Graphics - 115+ device interfaces, rich, printer. Specify language interface PC \$229
 PANEL - data validation, no royalties Xenix \$539. MS \$239
 Pfinish Performance Analyzer MS \$249
 PLINK-86 - a program-independent overlay linker to 32 levels. MS \$249
 PLINK-86 PLUS - incremental MS \$369
 PolyLibrarian MS \$ 85
 PVCS Version Control MS \$359
 Screen Sculptor - slick, thorough PC \$ 99
 ZAP Communications - VT 100, TEK 4010 emulation, file xref. PC \$ 85
 ZView - screen generator MS \$219

Atari ST & Amiga

We carry full lines of Manx, Lattice, Metacomco and Prospero.

Call for a catalog, literature and solid value

800-421-8006

THE PROGRAMMER'S SHOP™
 128-B Rockland Street, Hanover, MA 02339
 Mass: 800-442-8070 or 617-826-7531 6/86

RECENT DISCOVERY

Smalltalk-80 - "Official" Xerox licensed version. Compatible with Smalltalk-80 v2 running on other systems. Compiler, complete graphics interface, debugger, windows, text and graphics editor, source. Protected mode, RAM access. Requires PC AT PC \$995

C Language-Compilers

AZTEC C86 - Commercial PC \$399
 AZTEC C65 - Personal Apple II \$199
 C86 by CI - 8087, reliable MS \$299
 Lattice C - from Lattice MS \$339
 Lattice C - from Lifeboat MS \$289
 Mark Williams - w/debugger MS \$399
 Microsoft C 3.0 MS \$259
 Q/C 88 by Code Works - Compiler source, decent code, native MS \$125
 Wizard C - full, fast. MS \$389

C Language-Interpreters

C-terp by Gimpel - full K & R. .OBJ and ASM, large progs. MS \$249
 INSTANT C - Source debug. MS \$389
 Edit to Run-3 seconds MS \$109
 Introducing C - learn C fast, self paced tutorial PC \$109
 Run/C Professional - Run/C plus create add-in libraries. load/unload them. MS \$189
 Run/C Lite - improved MS \$109

C Libraries-General

Blaise C Tools 1 (\$109), C Tools 2 \$ 89
 C Essentials by Essential PC \$ 85
 C Food by Lattice-ask for source MS \$109
 C Utilities by Essential - Comprehensive screen graphics, strings. Source. PC \$139
 C Worthy Library - source MS \$295
 Entelekon C Function Library PC \$119
 Greenleaf Functions - portable. ASM \$139
 PforCe by Phoenix - objects PC \$299

C Libraries-Files

FILES: C Index by Trio - full B + Tree, vary length field, multi compiler /File is object only MS \$ 89
 /Plus is full source MS \$349
 CBTREE - multiuser record locking, sequential, source, no royalties MS \$ 99
 CTree by Faircom - no royalties MS \$339
 dbVISTA - full indexing, plus optional record types, pointers, Network. Object only - MS C, LAT, C86 \$179
 Source - Single user MS \$429
 Source - Multiuser MS \$829
 dBASE Tools for C PC \$ 79
 dbc Isam by Lattice MS \$199

FEATURE

Microsoft Windows Software Development Kit - Run graphics. Eliminates need for hardware - specific support. Includes MS Windows user version PC \$399

Note: All prices subject to change without notice. Mention this ad. Some prices are specials. Ask about COD and POs. All formats available. UPS surface shipping add \$3.00

DRIVE INN

Enclosures
& power
supplies for
**FLOPPY,
WINCHESTER,
TAPE DRIVES,
SINGLE
BOARD
COMPUTERS
&
\$-100
SYSTEMS.**

8 inch
5 inch
3 inch

**CUSTOMIZING
AVAILABLE**

Call or write
for free
catalogs
and
application
assistance

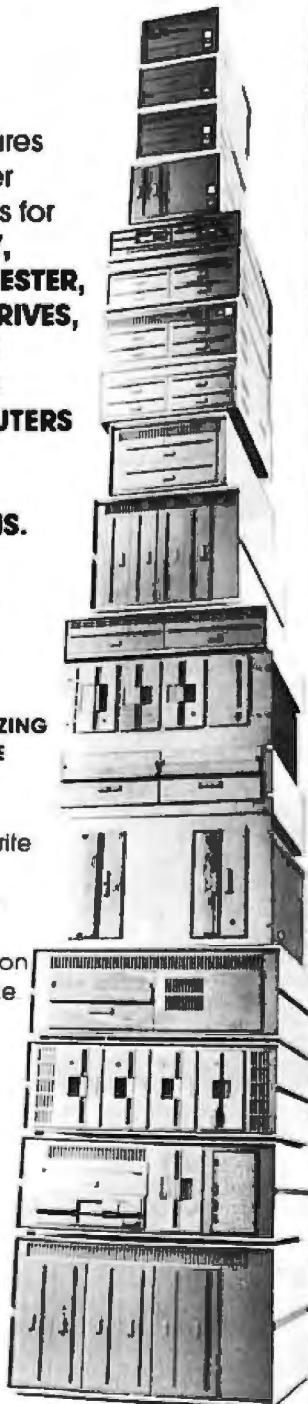

INTEGRAND

RESEARCH CORPORATION
8620 Roosevelt Ave. • Visalia, CA 93291
209/651-4203

TELEX 5106012830 (INTEGRAND UD)
EZLINK 62926572

We accept BankAmericard/VISA
and MasterCard

CHAOS MANOR

Much of the excitement at this year's Faire was centered around the Atari ST machines.

Faire there was at least one big blast.

This year there were almost none. The Interface Group held a traditional reception for press and exhibitors; nothing wrong with it, but it was a pretty tame affair. Of course, *anything* would seem a tame affair after Philippe Kahn's First (and, alas, apparently Last) Annual Bacchanalia last year. Indeed, I'm told, the reason no one, including Borland, threw any kind of big party this year was that no one could think of a way to top last year's toga party. After you've seen Philippe Kahn playing a saxophone while dressed as the Emperor Nero, what's left?

ATARI AGAIN

Much of the excitement at this year's Faire was centered around the Atari ST machines. Neither Atari nor Commodore actually had a booth at the Faire, but both were well represented by users groups. In addition, Atari president Sam Tramiel showed up with his software VP brother Leonard to hold a combination users group meeting and press conference.

According to the Tramiels, Atari is in excellent shape. Sales of 8-bit machines haven't grown, but they're holding steady, and that provides plenty of cash flow for development while the new Atari ST machine sales build up. They also insist that the ST machines are selling well. I believe that, although I think some of the early sales reports were exaggerated. Incidentally, they report that in Europe about half the STs sold are monochrome; in the U.S. only 20 percent are monochrome alone; there are also "substantial" sales of both, but no numbers were mentioned.

A number of users were concerned

about math chips for the Atari ST. "We'll put in math chips when Motorola has a math chip," Leonard Tramiel said. "We won't do a kludge." They may have to reconsider that decision if they want serious penetration of the business market.

Throughout the press conference the Tramiel brothers seemed thoroughly confident. They admit that Atari had far worse financial problems than they knew before they took over the company from Warner. "It took some pretty ruthless actions," Sam Tramiel said. That's an understatement: at Spring COMDEX 1985, Atari had so few employees that even top executives were answering their own telephones. It's still a no-frills company.

As I write this, there still isn't enough software for the Atari, but there's a lot; and perhaps more important, the tools to generate software are showing up. New compilers, debuggers, documents and tip sheets, and especially new users groups make the Atari ST series the machines to watch.

HACKING YOUR ST

A lot of Atari 520 ST owners are improving the machines on their own. The original 520 didn't have the operating system in ROM; this added appreciably to boot-up time. While Atari dealers would install the ROMs for a reasonable price, I didn't have a local dealer since my 520 came directly from Atari. Friends sent me a ROM set, and following instructions given on BIX I sat down one night to do it myself.

It took about 10 minutes, and everything worked fine. A very few programs want the old operating system that boots off disk; thoughtfully, Atari has set things up so you can do that.

I also have instructions for increasing the 520's memory to a full megabyte; the same directions are available on BIX. This is a modification that Atari won't support, and since it involves soldering chips there is significant risk of doing permanent damage to your machine; but provided that you're careful it's not difficult, the parts are cheap, it adds nothing to the complexity of using the machine, and

(continued)

Family Affair



Choose from a family of 4 modems -- the 1200 baud modems at \$139 & \$149, and the 2400 baud modems at \$299 -- that offer unbelievably great performances and make you wonder why everyone else charges so much!

1200 Baud Modems

Internal Modem: Two Jacks, Line Input and Phone Jack, RS-232 Port COM1 or COM2, Speaker with Volume Control
External Modem: 8 Status Indicator Lamps, Snap Off Front Switch Panel, Speaker with Volume Control
 Both Units Bell 103/212A 300/1200 Baud, Fully Hayes "AT" Command Set Compatible, Modular Phone Cord, PC-TALK III Software

2400 Baud Modems

Internal Modem: Modular Phone Cable, Mounting Bracket, COM1 or COM2 Asynchronous Communications
External Modem: AC Power Adapter, Stand Alone Enclosure, Status Indicator LEDs, Asynchronous Communications
 Both Units Hayes Compatible Command Set, CCITT V.22/V.22 bis and Bell 212A Compatible, 110/300/600/1200/2400 bps Operation, Automatic Adaptive Equalization, IBM PC Hardware Compatible, Two RJ-11C Jacks (Alternate Voice/Data Communication)

Pedigree

You can be sure that the Qubie' family of modems are of good stock. Our latest editions, the 2400I Internal Modem Card and 2400E External Modem are proof positive what good breeding can accomplish. These state-of-the-art modems are CCITT V.22/V.22 bis, Bell 212A Compatible, and 2400/1200/600/300/110 bps.

Our modems are fully compatible with all Hayes software commands. Software packages such as Crosstalk, Smartcom II, and Sidekick will work flawlessly. Both the 2400I and 2400E are equipped with Automatic Adaptive Equalization which automatically adjusts to the telephone line and increases performance and decreases the error rate.

The 2400I Internal Modem Card fits into any expansion slot, as it is a compact half-card modem. It's designed specifically to operate in the IBM Personal Computer PC/XT/AT family and compatible computers. The rear panel has two RJ-11C modular telephone jacks for the telephone line and the telephone set. The modem can be set for COM1 or COM2. The 2400I modem allows asynchronous communications with remote computers and other data terminal equipment over standard voice grade telephone lines. The 2400E External Modem offers the user asynchronous or synchronous communications. The 2400E is en-

No Risk Guarantee

If you are not completely satisfied with your purchase, you may return it within 30 days of purchase for a complete refund, including the cost to send it back. If you can get any dealer or competitor to give you the same **No Risk Guarantee**, buy both and return the one you don't like.



For fastest delivery, send cashier's check, money order, or order by MasterCard/Visa. Personal Checks allow 18 days to clear. Company purchase orders accepted, call for prior authorization. California residents add 6% sales tax.

closed in a slimline plastic enclosure. The front panel displays the eight modem status indicator lights. It works on any computer or terminal with an RS-232C serial port.

Siblings

Not to be forgotten are our 300/1200 baud modems. The Internal Modem Card is designed for the PC, PC/XT and most compatibles; it occupies one full length slot and the internal speaker lets you know the call progress. An RS-232 serial port is standard, COM1 or COM2; you can use the port for other peripherals when the modem is not being used. Our External stand alone modem can be used with any computer or terminal which utilizes an RS-232C serial port. It also comes with 8 status indicator lamps and a snap off front panel that allows for quick setting of the switches for all types of communication packages. At \$139 and \$149, these are the best price/performance modems for most communications.

What's in A (Sw)Name?

Everything, if it's a Qubie' supported product. We at Qubie' stand behind what we sell. Our 30-Day "No Risk Guarantee", our one year warranty and 48 hour turnaround on warranty repairs are proof that our products are of the highest quality.

QUBIE'

Department B
 507 Calle San Pablo
 Camarillo, California 93010

Inside California
 805-987-9741

Outside California
 800-821-4479

London (01) 223-4569
 Paris (01) 321-5316

Sydney (02) 579-3322
 Canada (403) 434-9444

Hours: M - F 8 am - 5 pm PTZ Sat 8 am - 12 am PTZ Inquiry 248

having a 700K-byte RAM disk sure cuts down on compile times. Anyone interested in hacking an ST should get into the Atari ST (atari.st) conference on BIX. However, fair warning, if you muck up your machine, don't blame me.

MACCARTRIDGE

Probably the most interesting thing demonstrated at the Faire was Mac-

Cartridge from David Small and Joel Rosenblum of Data Pacific (P.O. Box 10805, Marina Del Rey, CA 90295). This is a device that turns an Atari ST into a fast Macintosh.

Actually none of that's exactly true: that is, they had the MacCartridge, but they didn't exactly demonstrate it because they didn't have a booth, and even if they had they were afraid of Apple's lawyers; and an Atari ST with

MacCartridge won't run all the software you can run on a Mac.

It runs an awful lot of it, including Microsoft's Excel. (As a bonus, Excel runs 20 percent faster, too.) One secret of MacCartridge's success is that it has sockets on board for Apple's (older 64K-byte) Macintosh ROMs. Small and Rosenblum bought their ROM set from Apple; but they can't sell MacCartridge unless Apple will either sell them the ROMs at a reasonable cost or license them to reproduce them. As I write this, Apple hasn't made up its mind what to do about this.

If that weren't enough for Apple to worry about, the MacCartridge will work just fine with RAM chips in those slots, provided that you upload the Apple operating system from disk. While I was at the Faire, at least three people offered me not only disk copies of the ROMs but commented source code to the Macintosh OS, so it's pretty safe to assume that it's widespread among the hacker community. It's also safe to assume that while MacCartridge is a neat hack, Rosenblum and Small aren't the only ones who can think up a way to make the Atari run Macintosh programs right out of the box. Macintosh software developers aren't likely to be unhappy selling to this new market, either.

I don't know what's going to happen, but I think I'm in no danger predicting that by the time you read this there will be a number of ways of making an Atari pretend to be a Macintosh. The Atari may never run some Macintosh software without modification—stuff like Wizardry with really serious copy protection, for example—but much of that will eventually be ported over to the Atari anyway; and meanwhile here's yet another way to expand the Atari ST's software base.

MACNOSY

MacNosy is a serious Macintosh disassembler from Steve Jasik. I first saw it last year at the MacFaire. It has since been improved, and I've yet to meet anyone who didn't think it was worth the money.

One letter from a satisfied MacNosy

NEW!
For Your IBM PC or Compatible
RightWriter® Version 2.0

THE Intelligent Grammar and Style Checker

RightWriter is a new tool to help you produce lean, powerful BUSINESS WRITING. RightWriter uses advanced artificial intelligence technology to flag errors in GRAMMAR, STYLE, USAGE, and PUNCTUATION. RightWriter is the first office automation package aimed at producing better writing, not more writing.

- **Messages are Inserted** directly into text to point out possible errors and problem areas.
- **Easy to Use** — only one command to learn, your word processor does the rest.
- **Works with Leading Word Processors** — including WordStar®, Volkswriter®, PFS:write®, MultiMate®, and others.
- **Readability Index** — measures the reading grade level of the document using the D.O.D. standard Flesch-Kincaid formula.
- **Uncommon Word List** — lists misspelled, slang, and uncommon words.
- **Recommends** — never decides. RightWriter is a writing aid. The final decision is always left to you.

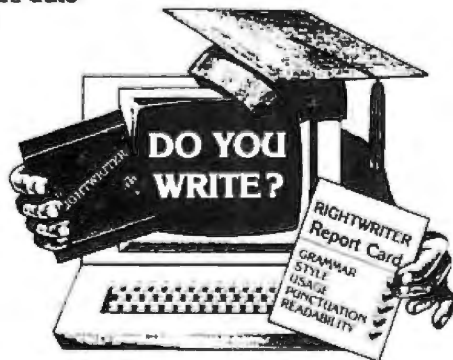

"...RightWriter is an idea whose time is long overdue."
Phil Wiswell — PC Magazine

"RightWriter is an excellent, low-cost, eye-opening software package..."
Inside Word Management

"The documentation is among the best I have seen."
Jim Pile, Soft Sector

Price \$95.00

Available from your local dealer or:
DECISIONWARE, INC./RightSoft Division
2033 Wood St., Suite 218
Sarasota, FL 33577
Phone Orders Call: (813) 952-9211
Add \$4 for shipping and handling.
VISA & MASTERCARD accepted
30 Day Money Back Guarantee

RightWriter is a trademark of DecisionWare, Inc., WordStar is a trademark of MicroPro International Corporation, MultiMate is a trademark of MultiMate International, PFS:write is a trademark of Software Publishing Corporation, Volkswriter is a trademark of Liletree Software, Inc.

user says that it lets you find out what the Macintosh ROM routines really do, as opposed to the hints given in *Inside Macintosh*. That appears to be true; I guess you aren't supposed to wonder why Apple charges a lot of money for a book of hints. After all, Infocom sells hints for its adventure games.

Do understand, a disassembler is a hacker's tool. If 68000 assembly language means nothing to you, MacNosy won't be worth anything at all; but if you're out to hack your Mac, you need MacNosy bad.

AT LIGHTSPEED

I have a problem with language reviews. Readers tell me they appreciate being told about new developments in languages, so I try to say something about them; but it's very difficult (read "impossible") for me really to work with every new compiler long enough to determine its strengths and weaknesses. Of course, in a show report that doesn't matter a lot anyway, since show reports are impressions, not full reviews.

With that said, I can talk about Lightspeed C. This thing compiles code at a demonic rate. It comes with a whole bunch of routines to interface it with the Macintosh, as well as a 68000 assembly language debugger. You can use Lightspeed on a single-drive 512K-byte Mac, but you're much better off with two drives.

The Lightspeed documents are very clear and well written, provided, of course, that you are familiar with the C programming language; Lightspeed doesn't pretend to give you a language introduction manual. There's ample instruction on interfacing with Macintosh ROM routines, including QuickDraw, and an excellent index.

I am extremely unlikely to do any C programming for the Macintosh, but if I decided to try, I'm pretty sure I'd start with the Lightspeed C compiler. C hackers I respect tell me there are some bugs in the present version of Lightspeed C, but Think Technologies has a good list of them and is working hard to correct them; by the time this is in print, most should be fixed.

(continued)

The Only EGA



A fully compatible 256k EGA card with a parallel port for only \$259. If you buy any display card: Color, Monochrome, Hercules, or EGA, without reading this ad, you're probably throwing away a lot of money.

BT/EGA Enhanced Graphics Adapter: 256k of memory, and parallel printer port. Works with all standard IBM displays, and compatible displays.
\$150 Monochrome Display: Both text and 640x350 bit mapped graphics.

\$153 Color Display: 640x200 and 320x200.
\$154 Enhanced Display: Color 640x350 16 simultaneous colors from a palette of 64.

A Clear Upgrade Path

This really is the only display board you may ever need. Regardless of what monitor you buy today, this card is a clear upgrade path for the future, and the best choice today, even if you are only going to use a Monochrome Display. This means one board today does monochrome 640x350 bit mapped graphics and text, and provides a clear upgrade path to 640x350 Enhanced Color Display with no change of display board. It also runs with the 640x200, 320x200 Color Display.

Killer Features

All boards come with a full 256k of memory, and a parallel printer port. That means no extras for later, and 16 simultaneous colors displayed from a palette of 64 colors, and crisp clear text on both Mono-

chrome and Enhanced Color Displays - features or options that are not available on other EGA boards. Since all your current software will run, you're set for today, and prepared for the standard of the future.

The Display Deal

Of course many of you will want to take advantage of the EGA card right away, so we are offering a special deal when you buy the board together with a Basic Time HR 31-350 monitor - you get both for just \$749, or the card only for \$259. This means that you can equip all your PC's now and in the future with displays and EGA cards and get the Qubie "No Risk Guarantee", our one year warranty, and 48 hour turnaround on warranty repairs. The price is the whole price, there are no extras for freight, insurance, or credit cards.

No Risk Guarantee

If you are not completely satisfied with your purchase, you may return it within 30 days of purchase for a complete refund, including the cost to send it back. If you can get any dealer or competitor to give you the same **No Risk Guarantee**, buy both and return the one you don't like.



For fastest delivery, send cashier's check, money order, or order by MasterCard/Visa. Personal Checks allow 18 days to clear. Company purchase orders accepted, call for prior authorization. California residents add 6% sales tax.

QUBIE'

Department B
 507 Calle San Pablo
 Camarillo, California 93010

Inside California
805-987-9741

Outside California
800-821-4479

London (01) 223-4569 Sydney (02) 579-3322
 Paris (01) 321-5316 Canada (403) 434-9444

Hours: M-F 9am - 5pm PTZ
 Sat 9am - 12pm PTZ

UNLOCK™ Removes Copy Protection

RUNS YOUR SOFTWARE ON ANY HARD DISK

Guaranteed to work only with programs below:

UNlock ALBUM "A"

\$49.95 (Plus \$4 ship/handling
Foreign orders \$10)

- LOTUS 1-2-3™ (1.A, 1.A', 2.0)
- dBASE III™ (1.0, 1.1, 1.2 & PLUS)
- FRAMEWORK™ (1.0, 1.1, II)
- SYSTAT™ (1.3 & 2.0)
- SPOTLIGHT™ (1.0 & 1.1)
- GRAPHWRITER™ (4.3 & 4.31)
- REALIA COBOL™ (1.2, 2.0)

UNlock ALBUM "B"

\$49.95 (Plus \$4 ship/handling
Foreign orders \$10)

- SYMPHONY™ (1.1)
- CLIPPER™ (Winter '84, Summer '85)
- ELECTRIC DESK™ (1.04)
- DOUBLEDOS™
- MANAGING YOUR MONEY™ (1.5 & 1.51)
- smARTWORK™ (1.0 REV 8 thru 10)
- DATA BASE MANAGER II™ (2.0, 2.02)

UNlock ALBUM "C"

\$49.95 (Plus \$4 ship/handling
Foreign orders \$10)

- MICROSOFT WORD™ (1.5, 2.0, 2.01)
- MULTILINK ADVANCE™ (3.02 & 3.03)
- IBM WRITING ASSISTANT™ (1.01)
- LOTUS 1-2-3 REPORT WRITER™ (1.0)
- PARADOX™ (1.0)
- PFS ACCESS™ (1984 Edition)
- THINKTANK™ (2.0)

"Best of UNlock" ALBUM "D"

\$74.95 (Plus \$4 ship/handling
Foreign orders \$10)

- MICROSOFT WORD™ (1.5, 2.0, 2.01)
- dBase III™ (1.0, 1.1, 1.2 & PLUS)
- LOTUS 1-2-3™ (1.A & 1.A', 2.0)
- SYMPHONY™ (1.1)
- FRAMEWORK™ (1.0, 1.1, II)
- CLIPPER™ (Winter '84, Summer '85)
- MULTILINK ADVANCE™ (3.02 & 3.03)

- Produce non-protected DOS copies from popular software programs
- For IBM® PC, XT, AT, compatibles

TranSec UNlock is a unique software copying disk that removes copy protection, providing standard non-protected DOS copies. UNlock runs on IBM® PC, XT, AT, and compatibles with at least 256K (or more required for some programs), DOS 2.1 or higher.

BACKUP COPIES. UNlock safely and easily makes backup copies.

RUN ON HARD DISK. Programs load faster, use less disk space and work with any hard disk, including Bernoulli Boxes. No longer do you need the original in drive "A".

RUN ON RAM DISK. UNlock is the only software that can run copy protected software on a RAM disk or micro-floppy.

EASY TO USE. 1) Type UNlock. 2) Select program destination. 3) Insert program disk.

SAFE ORIGINAL. UNlock does not alter your original distribution disk. UNlock works by creating a copy of your distribution disk on a hard or floppy disk. It then removes copy protection from the copy!

Choice of the Critics!

BYTE "UNlock 4.7 defeats the latest Prolok and SuperLock type of copy protection scheme. It's menu-driven and works fine on the programs it's supposed to work on: Lotus 1-2-3, dBase III, Framework, Symphony, Paradox, and several others."

Jerry Pournelle, BYTE, Feb. '86

PERSONAL COMPUTING "UNlock has two particularly endearing characteristics: it works, and works simply. I was able to quickly produce unprotected copies of Lotus 1-2-3 release 2, Symphony 1.1, Microsoft Word 2.0, dBase III 1.1, and Framework II. These copies performed flawlessly, as did copies of these copies."

Christopher O'Malley, PERSONAL COMPUTING, April '86

NEW! SPECIAL OFFER
"Best of UNLOCK™"

ORDER BY TELEPHONE TODAY!
1-305-474-7548



TRANSEC UNLOCK™

TranSec Systems, Inc., 1802-200 North University Drive, Plantation, FL 33322

Trademarks are the sole property of their respective owners. • UNlock is For Use Only to Improve the Useability of Legally Acquired and Operated Software.

CHAOS MANOR

I tried to persuade Think Technologies to port the system over to the Atari ST. I think I heard them say they were working on it. It should be worth watching for.

A NEW MAGAZINE

The last couple of years haven't been particularly good ones for computer magazines. Several major ones folded up, and others began to look pretty sick. However, hope springs eternal, and new ones do appear.

Tony Bove and Cheryl Rhodes have been in the micro revolution for a long time. Their strong point has been clear writing, generally but not invariably for beginners; they have the ability to make complex notions understandable. Their *Users Guide* magazine was about the best CP/M publication around, and one of their books was in the "Pournelle Users Guide" series by Baen Books. In 1985 they founded a new magazine, *Desktop Publishing*. It was, of course, rather specialized, so much so that I didn't even hear about it until they were doing the third issue. Just about then they were acquired by CW Communications, the outfit that publishes the *PC World* series. The name will be changed to *Publish!*

Tony and Cheryl were excited about all this when I saw them at the Faire. I hope it works out well for them. I found their three issues of *Desktop Publishing* quite well done, and I'd have been happy to subscribe. I'm not likely to go into the publishing business for myself, but I make my living as a writer: it's important to keep track of all new developments in publishing, and the trend to more and more author control, right up to finished typesetting, is getting stronger all the time. I suppose now I'll still subscribe, but I can't say I find the name change as thrilling as Cheryl and Tony seem to think it is.

Publish! is likely to remain pretty specialized, but the niche it fits in may be expanding more rapidly than most people think. As the niche expands, they'll get competition. As it is, though, they're moving into an area that has largely been left to the Seybold family, and the Seybold

(continued)



HOT

S·U·M·M·E·R

SAVINGS ON 1200 BAUD MODEMS

**INTERNAL
MODEM**

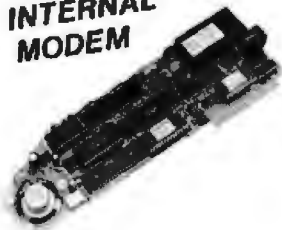

**AppleMate
1200 \$149**

- Apple™ II+, IIe internal
- Hayes™ command compatible
- 1200/300/110 bps
- Auto dial, Auto answer
- Built-in speaker
- Super serial card equivalent
- Built-in terminal software

1 per customer

Now you can save big by purchasing a modem for your personal computer DIRECT.

Sunnyvale Communications Company has acquired a wide range of products that will enable your computer to communicate with the outside world. These products are of outstanding quality and value.

Check these features:



**MacModem
1200LC \$199**

- Mac™ compatible standalone
- Hayes command compatible
- 1200/300/110 bps
- Auto dial, Auto answer
- Built-in speaker
- Mac modem cable included

**LIMITED
QUANTITIES!**

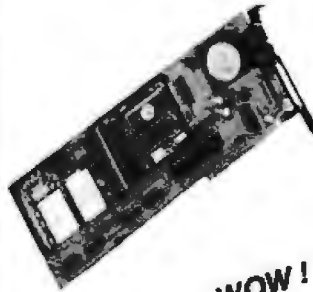

WOW!

1200 TPC \$109

- Hayes™ command compatible
- 1200/300/110 bps
- Auto dial, Auto answer
- IBM™ internal
- Built-in speaker

**1 month special
1 per customer**

1200 LC \$169

- Hayes™ command compatible
- 1200/300/110 bps
- Auto dial, Auto answer
- Built-in speaker
- RS-232 to any computer



SC

**Sunnyvale
Communications
Company**

1398 Borregas Avenue
Sunnyvale, CA 94088-3565
408/752-5095

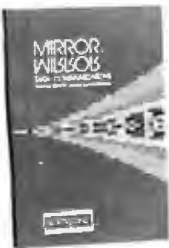

MIRROR™ \$49⁹⁵

- Crosstalk™-like software
- Multi-tasking
- Menu-screen command structure

CROSSTALK XVI™

1 per customer \$39⁹⁵

Hayes is a registered trademark of Hayes Microcomputer Products, Inc. IBM is a registered trademark of International Business Machines Corp. Apple and Mac are registered trademarks of Apple Computer, Inc. Crosstalk is a trademark of Microstuf, Inc. MIRROR is a trademark of Softclone Distributing Corp. CROSSTALK is a trademark of Microstuf, Inc.

Pricing while quantity lasts
800

835-9009 in CA
558-5741 outside CA

ORDER FORM

SC

**Sunnyvale
Communications
Company**

NAME _____

ADDRESS _____

DAY PHONE _____

CHECK ENCLOSED

VISA

MASTERCARD

California residents add sales tax, all USA orders add \$4 per modem for shipping and handling (Canadian orders add \$10 per modem—international orders extra) No C.O.D.s or purchase orders accepted

SIGNATURE _____

ACCT NO _____

TPC LC _____

MAC-LC _____

Applicable MIRROR _____

EXP DATE _____

Subtotal \$ _____

Subtotal \$ _____

Subtotal \$ _____

Handling \$ _____

TOTAL \$ _____



IDETIX™

DIGITAL CAMERA MOS Imaging System

SYSTEM INCLUDES:

MOS sensor based, IBM PC compatible camera with C-Mount lens. High speed controller board. Demonstration software and subroutine library.

Adjustable frame size and resolution to 1024 x 512 pixels using the MOS digital image sensors, IS32A and IS256 OpticRAM™.

Rugged and reliable camera head for industrial environments. The high speed differential driver/receiver camera head measures 4.3"L x 1.5"H x 3"W.

MACHINE VISION APPLICATIONS INCLUDE:

- FACTORY INSPECTION
- ROBOTICS
- REPROGRAPHICS

- PROCESS CONTROL
- MANUFACTURING AUTOMATION
- SIGNATURE VERIFICATION

UNDER \$500 IN OEM QUANTITIES.

Micron Technology, Inc., a world leader in semiconductor development and manufacturing, presents the IDETIX™ Imaging System, a low cost alternative for machine vision applications.

For more information contact:

MICRON
TECHNOLOGY, INC.

Systems Group
2605 E. Columbia Road
Boise, Idaho 83706
(208) 386-3800

"BRIEF is simple to learn and use and extremely sophisticated"

PC Magazine, July 1986

Tailor Program Editing to Your Style

- A high-level, readable Macro Programming Language - allows customization for programming languages . . . Complete, unlimited variables, etc.
- Edit multiple files of unlimited size (2 Meg is OK)
- Multiple Windows on screen with different or same file, fragments, etc.
- A bona-fide UNDO stack (up to 300) of all operations; deletions, reading files, search, translate, more.
- Reconfigurable keyboard
- Full "regular expression search" - wild cards, complex patterns
- Adjustable line length - up to 512.
- Keystroke macros - for common typing sequences
- Suspend BRIEF to execute, exit to DOS - run another program (like a compiler, dir, XREF, DIFF, or DEBUG) then resume BRIEF session
- Compiler-specific support like auto indent, syntax check, compile within BRIEF

Only \$195
Call 800-821-2492

Solution Systems™

335-B Washington St.
Norwell, MA 02061
817-659-1571

Recent Survey Data

- 88% of survey respondents were more productive with BRIEF than other editors.
- 50% were more productive with BRIEF than their previous editor in 5 hours or less.
- 72% were performing all operations in 2 hours.

For PC, AT, compatibles or Tandy 2000.

Full Refund
if not satisfied
in 30 days.

reports aren't competition for *Publish!* because Seybold publications are expensive and don't take advertising.

Incidentally, the Seybold reports are almost indispensable for those serious about keeping up with the absolutely latest developments in the fields of publishing and serious use of microcomputers.

DESKTOPS

"Desktop" publishing isn't an unforeseen phenomenon. A number of writers, including me, predicted that small computers would have an impact on the publishing industry; that impact is just beginning. The effect isn't as great as some predicted because printing is really the smallest part of publishing. The real job publishers do is marketing and distribution. After all, if you had enough money, you always could get a rather handsome book printed by one of the vanity presses—the official name is "author-subsidized publishing"—but because the bookstores know all about those, the typical self-published book is lucky to sell a hundred copies, including to the author's relatives. There are exceptions, but in general, getting your book competently printed isn't the real barrier to effective publication and it never has been.

On the other hand, every author has horror stories. Ogden Nash did a wonderful poem about an author "who took a gun and shot that printer who printed 'not' instead of 'now'." and in the poem the judge lets him off on the grounds of justifiable homicide. During the height of the Napoleonic wars, an authors' convention in England toasted Napoleon who was "if you will, the enemy of all mankind, but who once shot a publisher." The enmity between authors and publishers has quite a lot to do with murdering one's text: editors who substitute their phrasing for yours (that doesn't happen to me often); lousy proofreading; and suchlike.

Small computers, and programs like the excellent Print Shop series and accessories by Brøderbund for the IBM PC, are making it possible for authors to have real control over what their text looks like when it gets into print.

Of course, that means that if it's really fouled up there's no publisher to blame. . .

MIDI

MIDI (musical instrument digital interface) is a standard; it's a bit like ASCII, only it's a way to represent music rather than text in a computer. It's also a hardware standard that specifies a 5-pin DIN connector—sort of as if the ASCII standard also mandated using RS-232C ports.

MIDI is going to change the world. I saw only a little of this at the Faire, and I don't expect to see much at COMDEX Atlanta next week; but MIDI and small computers are bringing about a revolution in music.

For instance: whole movie scores, with what sounds like a full orchestra, are being written and performed by a single composer equipped with a keyboard and a computer. People who have never practiced, can't play an instrument, and don't know how to

read or write music are now recording and performing. Most are hobbyists, but some are doing well commercially. New ideas abound. New products are announced weekly. There's a ferment in the music scene that reminds me of the early enthusiasm among computer hobbyists.

Interestingly enough, most of this is happening unbeknownst to computer people. There is some overlap. The man who brought all this to my attention is Bill Burns, a computer hobbyist I met at the Hacker Convention in the fall of 1984 and again at the Faire this year. Bill was an early member of the Homebrew Computer Club.

He tells me that if you've got an IBM PC or a Macintosh, you can get into the computer music revolution with a pretty small investment. His recommendation is for a PC-compatible; the Roland DG MPU-401 MIDI adapter, which is a PC card and a small box; one of the MIDI-compatible Casio music synthesizers; and a program

called Personal Composer. With those items, you can write symphonies even if you've never played a note in your life.

It works this way. You get an idea for a tune and get it into the machine, if necessary by playing it in one finger at a time on the keyboard. You can then edit the result: change notes; change their duration; change the "attack" or compression; add notes; put in new simultaneous sounds; blend in new instrument voices like horns; and keep fooling around with that until you have what you think sounds right. After that you can do another melody, or an expansion of the old one, and blend it into the original. The result will likely be bloody awful, but it might not be, and anyway you can edit that, too.

When it's all done, Personal Composer will print out what you've written, in standard musical notation, on an Epson MX-80 printer. It's slow,

(continued)

FORTRAN PROGRAMMERS

Looking for the right PC FORTRAN language system? If you're serious about your FORTRAN programming then you should be using F77L - LAHEY FORTRAN.

"Lahey's F77L FORTRAN is the compiler of choice. It's definitely a 'Programmers FORTRAN,' with features to aid both the casual and the professional programmer. . . F77L compiled the five files in a total of 12 minutes, which was 4 times as fast as MS FORTRAN and an astounding 6 times as fast as Pro FORTRAN." - PC Magazine

Compare the features and performance of other PC FORTRANs with F77L and you will find that F77L is clearly the superior product.

- Full Fortran 77 Standard (F77L is not a subset)
- Popular Extensions for easy porting of mini and mainframe applications
- COMPLEX * 16, LOGICAL * 1 and INTEGER * 2
- Recursion - allocates local variables on the stack
- IEEE - Standard Floating Point
- Long variable names - 31 characters
- IMPLICIT NONE
- Fast Compile - Increases productivity
- Source On Line Debugger (Advanced features without recompiling)
- Arrays and Commons greater than 64K
- Clear and Precise English Diagnostics
- Compatibility with Popular 3rd Party Software (i.e. Lattice C)
- Easy to use manual
- Technical Support from LCS

F77L - THE PROGRAMMER'S FORTRAN

\$477.00 U.S.

System Requirements: MS-DOS or PC-DOS, 256K, math coprocessor (8087/80287)

FOR MORE INFORMATION: (702) 831-2500



Lahey Computer Systems, Inc.
P.O. Box 6091
Incline Village, NV 89450
U.S.A.

International Dealers:
England: Grey Matter Ltd., Tel. (0364) 53499
Denmark: Ravenholm Computing, Tel. (02) 887249
Australia: Computer Transitions, Tel. (03) 537-2786
Japan: Microsoftware, Inc., Tel. (03) 813-8222

SERVING THE FORTRAN COMMUNITY SINCE 1967

MS-DOS & MS FORTRAN are trademarks of Microsoft Corporation Pro FORTRAN refers to Professional FORTRAN a trademark of International Business Machines



Editor's Choice
- PC Magazine

since it does it a dot at a time, but it does the job.

So far the musical revolution has been dominated by musicians who have discovered computers and are teaching themselves how to use them. A good part of the ferment centers about *Keyboard* magazine, which used to be a publication for performers but has become something like the BYTE of the computer music hobbyist. *Key-*

board is filled with advertisements for electronics, computer stuff, and programs: you can buy a thousand musical voices for a few dollars. Join users groups. Things like that.

When the old master computer hackers discover this new scene—and some are beginning to—the cross-fertilization ought to be something wonderful to see. Oops. To hear, I can hardly wait to try it. I've some notions

for variations on a theme by Mozart. . .

GENERIC CADD

Computers change everything. Architects are among the last resisters to CAD, which is a pity; but that won't last. One reason it won't is because so many of their customers will have a CAD system.

AutoCAD holds a commanding lock on the top end of professional CAD systems for microcomputers; but it's pretty expensive for those who just want to learn what CAD is all about and maybe want to design a new room, or a toolshed, or just see how they might rearrange their furniture. For people like that, comes now Generic CADD by Generic Software. This is a PC-compatible program that does quite a lot and sells for less than a hundred bucks.

It doesn't pretend to do everything. In particular, Generic CADD doesn't handle overlays as well as AutoCAD; but it does do layers and overlays.

I saw the program demonstrated at the Faire, and I've had a copy to play with for a couple of weeks. It runs just fine on Big Kat, the Kaypro 286i PC AT work-alike with Logitech's Logi-mouse, and while you had better be determined to learn it—there are some puzzling concepts to get used to—I haven't had much problem. I'm putting the new office additions into it. It's as easy a way to learn to use a CAD system as any.

I wish I'd done that before we did the office. Not that I'm not pleased with my office and library; but here and there, changes of a few inches would have made some odd-size cabinets and desks fit better, and I'd have discovered that if I'd done a CAD model before construction began.

Next time I'll have all that. Meanwhile: if you're serious about design work, you probably need AutoCAD; but if you're just interested in CAD and want to know more, you might find Generic CADD more than good enough.

MACINTAX

In the cold light of the next morning this *may* not be the all-time best ever

(continued)

INTRODUCING

SafetyNet™

From The Creators of *PathFinder™*

Revolutionary New File Recovery System
For the IBM PC and Compatibles

49⁹⁵ plus \$5 shipping
and handling

Accidental File erasure is no trivial matter! There are two kinds of users - those who have accidentally erased an important file, and those who will!

SafetyNet™ is a file recovery program designed to recover those files or sub directories of files which have been accidentally erased. Unlike programs such as Norton's UnErase, *SafetyNet™* is a preventive measure rather than an attempt to cure the problem after-the-fact. What if you accidentally reformat your Hard Disk? *SafetyNet™* will restore it with only 5 keystrokes!

Recent surveys have revealed that, on the average, 3.6 persons have access to each computer used in corporate America. It might be four or five days before the victim discovers that their files are no longer available. When several people use a computer, or a single user operates more than two hours per day, there are two chances that a utility such as Norton's Unerase will recover the missing file(s) - slim and none! It is highly likely that the file's space will have been overwritten in the interim (an impossibility with *SafetyNet™*).

It is our belief that when one has accidentally erased a file their anxiety is high - and that's not the time to learn a new technology. With some utility's multi-layered menus, and the admonition that their system doesn't always work, anxiety becomes near panic and increases chances for additional operator error causing loss of the vital information forever!

SafetyNet™ requires the user to do three things: 1) Type "SN" at the > prompt, 2) Mark the files presented on the screen, 3) Press the Enter Key. That's it! No need to know about sectors, clusters, bits or bytes. No requirement to replace the first letter of each previously erased file - a simple, foolproof manner to end the panic which comes when files are accidentally erased.

SafetyNet™ works first time, every time. Regardless of the time span between the actual erasure and discovery, there is no danger that the allocated file space will be overwritten, thus rendering the recovery doubtful or impossible. *SafetyNet™* - a Space-Age utility with a no nonsense user interface.

To order, call toll free (800) 628-2828 ext. 555 or contact:



WESTLAKE DATA CORPORATION

P.O. Box 1711

(512) 474-4666

Austin, Texas 78767

DON'T BOOT UP WITHOUT US!



640 x 350 16 COLOR



EGA PAINT



GEM



FLIGHT SIMULATOR



PAINT BRUSH



Auto CAD

NO MORE Low-End Graphics Adapters.

Why Settle for Less?

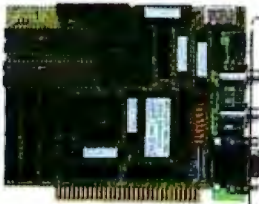

IBM sets the standards for Monochrome, Color/Graphics and the Enhanced Graphics Adapter. Hercules sets the Monochrome

Graphics standard. And the MegaGraph-Plus simply redefines the standard for what the Graphics Adapter is supposed to be: Monochrome text, Hercules graphics, color graphics, enhanced graphics. And most importantly . . . No software driver patches required.

Fully Compatible

You can run almost all software from your early investment. Including Flight Simulator, Pin Ball, Jet and Lotus 1-2-3 Version 1A.

And it will still run all the business software packages written for IBM Enhanced Graphics Adapter (EGA). Examples include Auto CAD, IBM Drawing Assistant, Gem Draw, Microsoft Window, Word & Chart, Lotus 1-2-3 and Symphony, Dr. Halo, PC Paint Brush, EGA-Paint and many, many more.

ATTronics is dedicated to the technical excellence of computing devices. To find out more about ATTronics and our super-high performance ATI-1000 & ATI 2000 AT system compatible boards call or write:

Features

	ATTronics MegaGraph +	Quadram EGA +	IBM EGA	STB EGA +
--	--------------------------	------------------	------------	--------------

	ATTronics MegaGraph +	Quadram EGA +	IBM EGA	STB EGA +
Half size, fits in any slot of PC/XT/AT	✓	✓		
EGA compatible	✓	✓	✓	✓
CGA compatible	✓	(1)	(2)	(2)
MDA compatible	✓	✓	✓	✓
Chip count	24	29	86	40
Hercules compatible 720 x 348 graphics	✓	✓		
No Software Patches required	✓		✓	✓
Boot from:				
- Flight Simulator	✓			
- Pin Ball	✓			
- Jet	✓			
Runs Lotus 1-2-3 version 1A:				
- Hercules mode	✓	(1)		
- Color mode	✓	(1)		
Two Video Jacks	✓	✓	✓	
Display Memory	256K	256K	64K	256K
Light Pen connector	✓	✓	✓	✓

(1) Needs software driver patches

(2) Compatible only to the BIOS level, but not the hardware level. Will not be compatible with most games software



ATTronics International Inc.
491 Valley Way
Milpitas, CA 95035
(408) 943-6629 TLX: 510-600-6093

Mega Graph PLUS

Inquiry 31

IBM, Hercules, Flight Simulator, Pin Ball, Jet, Lotus 1-2-3 Version 1A, Auto CAD, Gem Draw, Window, Word & Chart, Symphony, Dr. Halo, PC Paint Brush, EGA Paint, Quadram and STB EGA+ are all registered trademarks of their respective companies.

Subscription Problems?



We want to help!

If you have a problem with your BYTE subscription, write us with the details. We'll do our best to set it right. But we must have the name, address, and zip of the subscription (new and old address, if it's a change of address). If the problem involves a payment, be sure to include copies of the credit card statement, or front and back of cancelled checks. Include a "business hours" phone number if possible. We'll respond A.S.A.P.

BYTE

Subscriber Service
P.O. Box 328
Hancock, NH 03449



most wonderful program I've used, but it's a candidate: and about 10 p.m. on April 15 I was absolutely certain of it. People, Softview's MacInTax is wonderful. This is a program worth buying a Macintosh for.

As you probably suspect, MacInTax does your income taxes on a Macintosh computer. It does them painlessly. With a certain grace and style, even. Nothing is going to make doing taxes fun, but by gum if anything ever would, this program will do it.

Now, of course, this isn't an accounting program. You have to have all the information demanded ready at hand. For me that's no problem. My life is pretty complicated, and most of it is deductible—provided, of course, that I can prove it. Naturally one of the first things I did when I got a microcomputer was to write an accounting system that would handle all my sources of income and the myriad deductible ways I spend it. Later I added a check-writing system, so that each month I enter my bills and credit-card purchases, poke a couple of buttons, and watch the checks roll out. All those entries are then stored until tax time. Even so, my family has always said they'd rather visit the Inferno than be around me during tax time.

Not any more.

MacInTax is like—well, it's like having a personal tax preparer who *listens*. With MacInTax you never enter information more than once. You never do any calculations at all. Once MacInTax knows enough, it fills in everything it can, and if you change something, it recalculates.

Technically, MacInTax is a series of linked, formatted spreadsheets; but that's a bit like saying that one of Monsieur Andre Lion's medallions of beef with wild forest mushrooms is partly oxidized muscle tissue covered with fungus. What happens with MacInTax is that you start with the basic 1040 form on screen. You go through, adding information where possible. When you can't go any further, pull down new schedules. Schedule B for interest. Schedule E for rents and royalty income. The husband and wife form. Each time you enter something on one of those forms, everything affected changes.

Want to experiment with income averaging? Save your previous work and try it; see what it does for you. Ever get everything all done and suddenly remember another deduction? Sure you have. With MacInTax it's simple. Just go in and add it.

When you're all finished, MacInTax checks things. Does the law require that you explicitly enter -0- somewhere? MacInTax will tell you. Have you made a mistake somewhere else? In general, MacInTax won't let you do that, but if you did, it may find that, too. Eventually, when all is ready, send it to the printer. Laser printer or Imagewriter: MacInTax will generate completely filled-in forms, ready for signing.

As a bonus, it will do your state tax if you live in California, and Softview will be adding other states for next year.

If you do your own taxes or if you're *thinking* of doing your own taxes, get this program, even if you have to borrow a Macintosh to run it on. It's that good.

Boy, is it ever recommended.

TEKMAR GRAPHICS LIBRARY

This is a preliminary report: preliminary because just at the moment the Tekmar Graphics Library is tied to the Tecmar Graphics Master Board for the IBM PC. The Advanced Systems Consultants people are rewriting their science/engineering curve-fitting and plotting programs to work on a standard EGA, and they tell me they'll have all that done about the time you read this.

What they have now is pretty slick. For less than \$200 you get eight disks, a thick and well-written manual, source code to much of what's supplied, subroutines to let you build your own stuff or modify theirs, and as good a scientific plotting/curve-generation program as I've ever seen. The output of the program is totally under user control, and it can be as flashy as you like: multiple colors, labels, windows with detail inserted in dead parts of the graphs; you name it, and you can do it.

The documents are *complete*. They tend to be hacker-oriented, but gen-

(continued)

The BIGGEST reason to buy the FASTCOMM™ 2496 is that it adds Top Speed for Bottom Dollar.

past... Here are 8 more.

The FASTCOMM 2496 is designed for PC to PC, mini and mainframe users who need all popular baud rates—9600—as well as 2400, 1200 and 300. You can do more than ever before with your modem and you can do it now!

#1 ... more modem for your money.

The FASTCOMM 2496 includes 300-2400 baud for interactive work and play. When it comes to high-speed downloading—switch to 9600 baud with a simple AT command. You can transfer full diskettes of data in less than 10 minutes! Say goodbye to excessive long distance charges!

#2 ... with error-free reliability.

What's more, at high data rates, the modem's built-in error detection-correction protocol ensures error-free transmission when phone lines get too "noisy." Constantly monitoring the line, FASTCOMM 2496 quickly bounces you back to top speed when the lines clear. Your data remains intact and error-free! You get optimum performance without the worry!

#3 ... you can choose the flexibility of an internal modem.

The FASTCOMM 2496B may be the version for you! Ideal for PC applications, this half card inserts into any full or short expansion slot in your IBM PC, XT, AT or compatible, leaving you more room for other expansion uses.

#4 ... or choose the portability of an external modem.

Our external version—the compact FASTCOMM 2496—is a superb choice for PC terminal to mainframe applications. Its LED status indicators and speaker control make for easy monitoring during operation.

#5 ... or choose only the speed you need, now.

Start with either our FASTCOMM 9600 or 2400, at even lower prices. Later, snap in additional speeds by purchasing our FASTSNAP boards, available for both the external or half card modem.

#6 ... customize your modem to suit your needs.

With FASTCOMM's non-volatile memory, make changes that stay. Set defaults today, even on your remote modem using the ATY Command; and you'll have them tomorrow! And whenever you autodial, FASTCOMM automatically sets the speed of the receiving modem to match your baud rate!

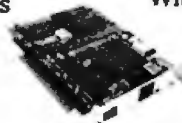

The FASTCOMM 2496B Half Card.

#7 ... supported by popular communications software.

The FASTCOMM 2496 runs with virtually any asynchronous communications software that can support 9600 baud, including *Crosstalk XVI*, *Carbon Copy*, *Respond*, *Relay Gold*, *Q Modem*, *Blast* and *SimPC 3278*.

#8 ... and you get top to bottom service.

Call our toll-free number and your modem will be on its way within 24 hours! If you're not totally convinced the FASTCOMM 2496 sets a new high in speed, flexibility, and savings, return it within 30 days for a full refund.

COMPARE THE ADVANTAGES FOR YOURSELF

Manufacturer	300, 1200, 2400	9600	2496
FASTCOMM	\$619	\$899	\$999
HAYES	\$795	NA	NA
NOVATION	\$795	NA	NA
RACAL VADIC	\$695	NA	NA
VENTEL	\$695	NA	NA

And there's more—dial up our FASTCOMM Bulletin Board for user tips, or our customer service representatives for support. And, if you should ever need it, the FASTCOMM comes with a two-year warranty.

Call 800-521-2496, ext. 12 (in Virginia (703) 620-3900) today!

Fastcomm Data Corp. is an Electronic Vaults, Inc. company.

All product names are trademarks of their manufacturers.



A MEGABYTE FOR DOS!

MicroWay is the world's leading retailer of 8087s and high performance PC upgrades. We stock a complete selection of 8087s that run from 5 to 12 MHz. All of our coprocessors are shipped with a diagnostic disk and the best warranty in the business - one year! We also offer daughterboards for socketless computers (NEC PC) and 287Turbo which increases the clock speed of the 80287 from 4 to 10 MHz. Our NUMBER SMASHER/ECM™ runs at 12 MHz with a megabyte of RAM and achieves a throughput of .1 megaflops with 87BASIC/INLINE, Intel For-

tran, or Microsoft Fortran. Software reviewers consistently cite MicroWay software and 8087 expertise as the best in the industry! Our customers frequently write to thank us for recommending the correct software and hardware to meet their specific needs. They also thank us for our same-day shipping! In addition to our own products which support the 8087 and 80287, we stock the largest supply of specialized software available. For more information call us at

617-746-7341

NUMBER SMASHER/ECM™ THE FASTEST ACCELERATOR CARD AVAILABLE

gives you 12 MHz speed in two modes: 704K or one megabyte of "Extended Conventional Memory." MEGASWITCH MMU and MegaDOS software make it possible to run DOS applications with up to 1015K using PC compilers, AutoCAD and Lotus 1-2-3. Does not require EMS software. Totally compatible. Priced from \$599 with 512K to \$1199 for complete package. Optional 8087-12 ... \$295

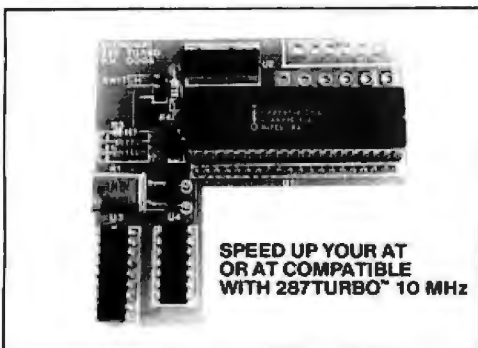

**SPEED UP YOUR AT
OR AT COMPATIBLE
WITH 287TURBO™ 10 MHz**

MicroWay® 8087 Support

For the IBM PC, PC XT, PC AT and Compatibles.

A2D-160™ MicroWay's Data Acquisition Board performs 160,000 12 bit Analog to Digital conversions per second! Includes software drivers. The fastest 12 bit A to D board available. For the IBM PC XT and compatibles. **\$1295**

87SFL™ MicroWay's Scientific Function Library contains 170 scientific and engineering functions. Callable from most 8087 compatible compilers ... First Language \$250; Additional \$100.

MATRIXPAK™ manages a **MEGABYTE!** Written in assembly language, our runtime package accurately manipulates large matrices at very fast speeds. Includes matrix inversion and the solution of simultaneous linear equations. Callable from RM or MS Fortran, MS Assembler, or 87BASIC/INLINE. each **\$99**

87FFT™ Written in assembly language, performs Forward and Inverse FFTs on real and complex arrays which occupy up to 512 Kbytes of RAM. Also does convolutions, auto correlations, hamming, complex vector multiplication, and complex to radial conversions. Callable from most 8087 compatible compilers. **\$200**

87FFT-2™ performs two-dimensional FFTs. Ideal for image processing. Requires 87FFT **\$100**

FASTBREAK™ employs the 8087 to increase the speed of Lotus 1-2-3™ Version 1A or 1A* by up to 36:1 **\$79**

87Verify™ For users who have to be absolutely sure of their results! This background task periodically performs an 8087 accuracy and stress test. **\$49**

Microsoft Fortran V 3.31	\$209
IBM Professional Fortran	\$585
Ryan-McFarland Fortran V 2.0	\$399
NAG Fortran Library	\$300
Grafmatic for Fortran or Pascal	\$125
MultiHalo Graphics (1 language)	\$189
LABTECH NOTEBOOK	\$745
UnkelScope	\$549
INTEL ABOVE BOARD	CALL
JRAM, AST, MAYNARD	CALL

MegaPage™ The only Intel-Lotus EMS board which comes with two megabytes of cool-running, low power drain CMOS RAM installed. Includes RAM disk, print spooler, disk cache, and EMS drivers. For the IBM PC, XT & compatibles. **\$549**

MegaPage AT/ECC™ EMS card for the PC AT and compatibles includes Error Correction Circuitry. With ECC, 11 RAM chips cover 256K so the user never encounters RAM errors. With 1 megabyte CMOS **\$799**; with 3 megabytes CMOS **\$1295**. Optional serial/parallel daughterboard. **\$95**.

DFixer™ Our disk utility which thoroughly checks PC or AT hard disks for bad sectors and updates the MS DOS file allocation table accordingly. Solves the AT hard disk problem! ... **\$149**

DOptimizer™ Optimizes the way your hard disk or floppy stores its files. Speeds up accesses by recombining fragmented files. **\$49**

DCache™ Our disk caching software speeds up your I/O by storing repetitively used tracks in memory. The amount of memory used can be selected in 64 Kbyte banks. **\$49**

87MACRO/DEBUG™ Contains all the pieces needed for writing 8087/80287 assembly code & MicroWay's 87DEBUG debugger. **\$199**

OBJ-ASM™ A multipass object module translator and disassembler. Produces assembly language listings which include public symbols, external symbols and labels commented with cross references. Ideal for patching object modules for which source is not available. **\$200**

87BASIC™ includes patches to the IBM BASIC or MS Quick BASIC Compiler for USER TRANSPARENT 8087 support. Provides super fast performance for all numeric operations including trigonometrics, transcendental, addition, subtraction, multiplication, and division. each **\$150**

87BASIC/INLINE™ converts the output of the IBM BASIC Compiler into optimized 8087 inline code which executes up to seven times faster than 87BASIC. Supports separately compiled inline subroutines which are located in their own segments and can contain up to 64 Kbytes of code. This allows programs greater than 128K! Requires the IBM BASIC Compiler Version 1 and a Macro Assembler. Includes 87BASIC ... **\$200**

MICROWAY UDI runs RTOS or RMX compilers under DOS. **\$300**

8087 UPGRADES

All MicroWay 8087s include a one year warranty, complete MicroWay Test Program and accurate installation instructions.

8087 5 MHz..... \$109
For the IBM PC, XT and compatibles.

8087-2 8 MHz..... \$149
For Wang, AT&T, DeskPro, NEC, Leading Edge.

80287-3 5 MHz..... \$179
For the IBM PC AT and 286 compatibles.

80287-6 6 MHz..... \$229
For 8 MHz AT compatibles.

80287-8 8 MHz..... \$295
For the 8 MHz 80286 accelerator cards.

NEC V20, V30..... \$16, \$30

64K RAM Set 150ns..... \$10

256K RAM Set 150ns..... \$29

256K RAM Set 120ns..... \$39

128K RAM Set PC AT..... \$49

287Turbo™ 10 MHz If you own an AT, Deskpro 286 or AT compatible, this is the card you need to get reasonable numeric performance. It plugs into your 80287 socket and includes a specially driven 10 MHz 80287. The card comes in three configurations. The IBM AT version includes a hardware RESET button. **\$450**

287Turbo 8 MHz..... \$369

87/88Turbo™ is a stubby card which includes a clock calendar and a speed controller which changes the speed of your motherboard from 4.77 to 7.4 MHz. Its use requires your PC to have a socketed 8284. Typical speed increase is 1.6 to 2.0. The card overcomes slow hardware by slowing up only when such devices are accessed and running at full speed otherwise. **\$149**
Optional 8087-2 **\$149**

286TurboCache™ This new MicroWay accelerator uses 8K of cache memory and 80286/80287 processors to provide an average speed increase of 3:1 for most programs. Call for specifications and benchmarks. **\$595**

Call for our complete catalog of software which supports the 8087.
In London, please phone 223-7762

MicroWay P.O. Box 79
Kingston, Mass.
02364 USA
(617) 746-7341

ITEMS DISCUSSED

AUTOCAD \$2500 Autodesk Inc. 150 Shoreline Highway, #B Mill Valley, CA 94941 (415) 331-0356	MACINTAX \$75 Softview 315 Arneill Rd., Suite 215 Camarillo, CA 93010 (805) 388-2626	PRINT SHOP Apple II family \$49.95 Commodore 64 and Atari 400/800 \$44.95 IBM PC and compatibles .. \$59.95 Bröderbund Software 17 Paul Dr. San Rafael, CA 94903-2101 (415) 479-1170
FIRST TIME Microsoft or Lattice C \$295 Turbo Pascal \$74.95 Microsoft Pascal \$245 dBASE III \$125 Spruce Technology 189 East Bergen Place Red Bank, NJ 07701 (201) 741-8188	MACNOSY \$85 Jasik Designs 343 Trenton Way Menlo Park, CA 94025 (415) 322-1386	ROLAND MPU-401 \$200 Roland DG 7200 Dominion Circle Los Angeles, CA 90040 (213) 685-5141
GENERIC CADD \$99.95 Generic Software 13250 Northeast 40th St. Bellevue, WA 98005 (206) 885-5307	PC-WRITE disk only \$10 complete registration \$75 Quicksoft 219 First North, #224 Seattle, WA 98109 (206) 282-0452	STAR RAIDERS II ST version... Price not announced Atari Corporation P.O. Box 61657 Sunnyvale, CA 94089 (408) 745-2000
LIGHTSPEED C \$175 Think Technologies 420 Bedford St., Suite 350 Lexington, MA 02173 (617) 863-5595	PERSONAL COMPOSER \$495 Personal Composer P.O. Box 648 Honolulu, HI 96726 (808) 328-9518	TEKMAR GRAPHICS LIBRARY \$195 Advanced Systems Consultants 21115 Devonshire St., Suite 329 Chatsworth, CA 91311 (818) 407-1059

erally any engineer or scientist who understands his own data would be able to use this program, given a bit of patience and determination. If you've got curves to fit and plots to make and access to a machine with a Tecmar Graphics Master Board, this is probably the program for you. If you've got everything but the hardware, it might be worth finding out how far they've got in the rewrite. There are easier programs to use, but I haven't seen any that beat this for value.

WINDING DOWN

As usual, there's a huge pot full of stuff I can't get at. As part of this mad month, I was up to Bellingham, Washington, a town that Larry and I pretty well flattened in our novel *Footfall*. Bob Wallace, who invented shareware with his PC-Write, came up: he's entirely redone the manual, as well as added new features. PC-Write is one heck of a value for the money.

Spruce Technology has renamed their intelligent programming editor

that understands quite a lot about the C language. They call it First Time, and anyone who hacks Microsoft or Lattice C on PC-compatibles would be well advised to look it over. A number of programmers I respect swear it saves them quite a lot of time and frustration. First Time has syntax checking, "place holder" markers, ways to edit include files, and a whole bunch of other conveniences, as well as more standard program editor features like search and replace. It isn't copy-protected. Good value. There are Pascal versions as well.

The book of the month is *Price Theory: An Intermediate Text* by David Friedman (South-Western Publishing Company of Cincinnati, OH, 1986). I wouldn't normally read an economics textbook for fun, but this isn't a normal economics text. I've known David for some years, and I wouldn't expect anything he wrote to be normal. This book tries to explain darned near everything people do in economic terms, and whether or not it succeeds, it sure ain't dull. I wish they'd used it

as a text when I studied the subject.

The game of the month is Star Raiders II for the Atari ST, which is like the old 8-bit Star Raiders had died and gone to heaven. The action is fast, the graphics are gorgeous, and I've spent entirely too much time with it.

Tomorrow morning I'm off to Austin, Texas, for a meeting with the chancellor; from there to Berkeley, California, for the science fiction Nebula Awards banquet; and from there direct to Atlanta for COMDEX. My new office is finally finished and it's wonderful. Now I have to figure out a way to be in it for a while. Every now and then someone asks me why I do all this. Sometimes I wonder too, but not for long. The truth is, I love it.

Jerry Pournelle welcomes readers' comments and opinions. Send a self-addressed, stamped envelope to Jerry Pournelle, c/o BYTE Publications, One Phoenix Mill Lane, Peterborough, NH 03458. Please put your address on the letter as well as on the envelope. Due to the high volume of letters, Jerry cannot guarantee a personal reply. ■

COMPUTER MAIL ORDER

THE CMO ADVANTAGE

TO ORDER
CALL TOLL FREE
1-800-233-8950
 DEPARTMENT A108
 TELEX 5106017898
 OR MAIL YOUR ORDER TO:
COMPUTER MAIL ORDER
 Department A108
 477 E. Third Street
 Williamsport, PA 17701



POLICY Inquiry 68
 Add 3% (Minimum \$7.00) shipping and handling. Larger shipments may require additional charges. Personal and company checks require 3 weeks to clear. For faster delivery use your credit card or send cashier's check or bank money order. Pennsylvania residents add 6% sales tax. All prices are subject to change and all items are subject to availability. Defective software will be replaced with the same item only. Hardware will be repaired or replaced at our discretion within the terms and limits of the manufacturer's warranty. We cannot guarantee compatibility. All sales are final and returned shipments are subject to a restocking fee.

EDUCATIONAL INSTITUTIONS
CALL TOLL FREE
1-800-221-4283
CUSTOMER SERVICE
& TECHNICAL SUPPORT
 1-717-327-1450

CANADIAN ORDERS

1-800-268-3974
 Ontario/Quebec

1-416-828-0866
 In Toronto

1-800-268-4559
 Other Provinces

TELEX: 06-218960

2505 Dunwin Drive,
 Mississauga, Ontario
 Canada L5L1T1

All prices shown are for U.S.A. orders. Call the Canadian Office for Canadian prices

THE CMO ADVANTAGE

- ✓ Next day shipping on all in-stock items.
- ✓ Free easy access order inquiry.
- ✓ Orders from outside Pennsylvania save state sales tax.
- ✓ Free technical support from our factory trained technicians.
- ✓ There is no limit and no deposit on C.O.D. orders.
- ✓ There is no extra charge for using your Visa or MasterCard and your card is not charged until we ship.
- ✓ No waiting period for cashier's checks.
- ✓ We accept purchase orders from qualified corporations. Subject to approval.
- ✓ Educational discounts available to qualified institutions. (See the toll free educational phone number above.)
- ✓ FREE CATALOG MEMBERSHIP

HOME COMPUTERS

ATARI

65XE (64K).....	\$89.99
130XE (128K).....	\$139.00
520ST (512K).....	\$369.00

520ST Monochrome System

- 520ST with modulator
- disk drive
- mouse
- logo
- Basic
- 1st Word
- monochrome monitor

LOW, LOW SYSTEM PRICE
\$64900

520ST Color System

- 520ST with modulator
- disk drive
- mouse
- logo
- Basic
- 1st Word
- color monitor

LOW, LOW SYSTEM PRICE
\$76900

800XL 64K.....	\$69.99
1010 Recorder.....	\$49.99
1050 Disk Drive.....	\$148.00
1020 Printer.....	\$29.99
1027 Letter Quality Printer.....	\$129.00
1030 Direct Connect Modem.....	\$59.99
Comrex 220 Atari.....	\$89.99

APPLE

APPLE IIe.....	CALL
APPLE IIc.....	CALL
IIc LCD Display.....	\$329.00

COMMODORE

Amiga Package

- 512K
- 2 - 3 1/2" DS Disk Drives
- Amiga RGB Monitor. **\$1679.00**

C64 Package

- C64
- C1541
- Taxan 220..... **\$499.00**

C128 Package

- C128
- C1571
- NAP8562 Monitor..... **\$779.00**

C128 Computer.....**\$269.00**

C1571 (Disk Drive for C128).....**\$249.00**

C1902 (RGB 13" Monitor for C128).....**CALL**

C1676 (Modem for C128)**\$179.00**

C1530 Datasette.....**\$39.99**

C1660 Auto Modem.....**\$59.99**

Comrex 220 (C64 Interface).....**\$89.99**

Xelec SuperGraphix 8K.....**\$69.99**

Micro R&D 128/64 Interface.....**\$59.99**

C128 Universal Monitor Cable.....**\$19.99**

PORTABLE COMPUTERS

NEC

PC-8401 LB.....	\$699.00
PC-8201 Portable Computer.....	\$339.00
PC-8231 Disk Drive.....	\$599.00
PC-8221A Thermal Printers.....	\$149.00
PC-8281A Data Recorder.....	\$99.99
PC-8201-06 8K RAM.....	\$59.99

SHARP

PC-1350.....	\$149.00
PC-1261.....	\$149.00
PC-1500A.....	\$169.00
PC-1250A.....	\$69.99
CE-125 Printer/Cassette.....	\$129.00
CE-150 Color Printer Cassette.....	\$149.00
CE-161 16K RAM.....	\$129.00
PC-7000 PC Compatible.....	CALL



41CV.....	\$139.00
41CX.....	\$199.00
HP 11C.....	\$49.99
HP 12C.....	\$75.99
HP 15C.....	\$75.99
HP 16C.....	\$89.99
HP1L Module.....	\$99.99
HP1L Cassette or Printer.....	\$359.99
Card Reader.....	\$143.99
Extended Function Module.....	\$63.99
Time Module.....	\$63.99

We stock the full line of HP calculator products

MODEMS

ANCHOR

Volksmodem.....	\$59.99
Volksmodem 300/1200.....	\$139.00
Signalman Express.....	\$209.00
Lightning 2400 Baud.....	\$329.00
Express (PC Halfcard).....	\$149.00
6480 (64/128) 300/1200 Baud.....	\$139.00
520 1200 BPS (Atari ST).....	\$149.00
Lightening Half Card (PC).....	\$349.00
Omega 80 (Amiga).....	\$139.00

AST

Reach 1200 Baud Half Card.....	\$399.00
--------------------------------	----------

DIGITAL DEVICES

AT300 - 300 Baud (Atari).....	\$99.99
-------------------------------	---------

EVEREX

1200 Baud Internal (IBM/PC).....	\$179.00
----------------------------------	----------



Smartmodem 300.....	\$139.00
Smartmodem 1200.....	\$389.00
Smartmodem 1200B.....	\$359.00
Smartmodem 2400.....	\$599.00
Micromodem IIe.....	\$149.00
Smart Com II.....	\$89.99
Chronograph.....	\$199.00
Transit 1000.....	\$309.00



Smart Cat Plus.....	\$299.00
J-Cat.....	\$99.99
Novation 2400.....	\$499.00
Apple Cat II.....	\$219.00
212 Apple Cat II.....	\$379.00
Apple Cat 212 Upgrade.....	\$229.00



Quadmodem II.....	\$339.00
300/1200.....	\$499.00
300/1200/2400.....	\$499.00



MPP-1064 AD/AA (C-64).....	\$69.99
----------------------------	---------

ACCESSORIES

AMARAY

80 Column Printer Stand.....	\$14.99
------------------------------	---------

CURTIS

Side Mount SS-1.....	\$19.99
Side Mount AT SS-2.....	\$34.99
Universal Stand SS-3.....	\$19.99
Diamond SP-1.....	\$29.99
Emerald SP-2.....	\$39.99
Sapphire SPF-1.....	\$49.99
Ruby SPF-2.....	\$59.99
Universal Printer Stand.....	\$14.99
Static Mat.....	\$29.99

DATA SHIELD

300 Watt Backup.....	\$379.00
500 Watt Backup.....	\$589.00
Turbo 350 Watt Backup.....	\$449.00
P125 Power Director.....	\$99.99
P150 Power Director w/Modem.....	\$119.00

KENSINGTON

Master Piece.....	\$99.99
Master Piece +.....	\$119.00

KEYTRONICS

KB5150/KB5151/KB5151 Jr.....	CALL
KB5152B/KB5153/KB5149 Jr.....	CALL

MEMORY CHIPS

4164 RAM Chips.....	(ea.) \$1.99
128 RAM Chips.....	(ea.) \$12.99
256 RAM Chips.....	(ea.) \$10.99



Palette.....	\$1399.00
Power Processor.....	\$229.00
Illuminated Slide Mounter.....	\$39.99
Polarcolor 2 Pack film.....	\$18.99

DISKETTES

GENERIC

DS/DD w/Flip'n'File 10.....	\$11.99
-----------------------------	---------

IBM

5 1/4" DS/DD floppy disks (Box of 10).....	\$26.99
---	---------

maxell

3 1/2" SS/DD (10).....	\$18.99
3 1/2" 5 pack SS/DD/Case.....	\$9.99
3 1/2" DS/DD (10).....	\$28.99
5 1/4" MD-1 SS/SD (10).....	\$11.99
5 1/4" MD-2 DS/DD (10).....	\$16.99
5 1/4" MD-2-HD for AT (10).....	\$29.99

SONY

MD1-5 1/4" SS/SD (10).....	\$9.99
MD2-5 1/4" DS/DD (10).....	\$13.99
MD2HD-5 1/4" High Density (10).....	\$28.99
MFD1-3 1/2" SS/DD (10).....	\$18.99
MFD2-3 1/2" DS/DD (10).....	\$29.99



5 1/4" SS/DD.....	\$12.99
5 1/4" DS/DD.....	\$24.99
Disk Analyzer.....	\$24.99

DISK HOLDERS

AMARAY

50 Disk Tub 5 1/4".....	\$9.99
30 Disk Tub 3 1/2".....	\$9.99
100 Disk Tub 5 1/4" w/lock.....	\$18.99

INNOVATIVE CONCEPTS

Flip'n File 10.....	\$2.49
Flip'n File 50.....	\$14.99
Flip'n File 50 w/lock.....	\$19.99
Flip'n File Data Case.....	\$9.99

DRIVES

OMEGA

A110H Single 10.....	CALL
A210H 10 + 10.....	CALL
A120H Single 20.....	CALL
A220H 20 + 20.....	CALL
Save on 10 & 20 Carts.....	CALL

TALLGRASS

25, 35, 50, 80 meg (PC).....	from \$1299.00
------------------------------	----------------

IRWIN

Tape Backup.....	CALL
------------------	------

EVEREX

60 Meg Internal Backup System.....	\$799.00
------------------------------------	----------

20 Meg Streamer.....	\$699.00
----------------------	----------

CORE

AT20-AT72MB.....	CALL
------------------	------

MOUNTAIN

Hard Drives.....	CALL
------------------	------

Hard Card 20 or 30.....	CALL
-------------------------	------

Tape Back-Up.....	CALL
-------------------	------

PRAM

40, 60 MB Inner Space.....	CALL
----------------------------	------

Shared Data.....	CALL
------------------	------

Shared Space.....	CALL
-------------------	------

FLACORE

1500 Expansion Chassis.....	\$379.00
-----------------------------	----------

1500 Chassis w/DMA.....	\$428.00
-------------------------	----------

2101 256K Memory.....	\$179.00
-----------------------	----------

2103 512K Memory.....	\$199.00
-----------------------	----------

CHS

10 Meg with controller.....	\$399.00
-----------------------------	----------

20 Meg with controller.....	\$499.00
-----------------------------	----------

Rambo-AT.....	\$229.00
---------------	----------

ALLIED TECHNOLOGY

Apple II, II+, IIe 1/2 height.....	\$109.00
------------------------------------	----------

INDUS

Atari GT.....	\$199.00
---------------	----------

C-64 1/28 GT.....	\$199.00
-------------------	----------

MSD

SD1 C-64 Single.....	\$219.00
----------------------	----------

SD2 C-64 Dual.....	\$469.00
--------------------	----------

TANDON

320K 5 1/4" (PC).....	\$119.00
-----------------------	----------

TEAC

320K 5 1/4".....	\$119.00
------------------	----------

SOFTWARE FOR IBM

PRINTERS

MULTIFUNCTION CARDS

IBM Inquiry 68

ANSA SOFTWARE

Paradox	\$499.00
ASHTON-TATE	
Framework II	CALL
dBase III Plus	CALL

BATTERIES INCLUDED

Isgur Portfolio	\$159.00
BORLAND	
Lightening	\$59.99
Sidekick (unprotected)	\$57.99
Reflex	\$59.99
Travelling Sidekick	\$44.99
Turbo Prolog	\$64.99

CENTRAL POINT

Copy II PC-Backup	\$29.99
PC Option Board	\$84.99

DECISION RESOURCES

Chartmaster	\$229.00
Sigmaster	\$159.00
Diagram Master	\$209.00
Map Master	\$259.00

FIFTH GENERATION

Fast Back	\$99.99
-----------	---------

FUNK SOFTWARE

Sideways	\$44.99
----------	---------

HARVARD SOFTWARE INC.

Total Project Manager	\$269.00
Presentation Graphics	\$239.00

LIFETREE

Volkswriter III	\$149.00
-----------------	----------

LIVING VIDEOTEXT

Think Tank	\$109.00
Ready	\$64.99

LOTUS

Symphony	CALL
1-2-3 Version 2	CALL

MECA SOFTWARE

Managing Your Money 2.0	\$99.99
Manage Your Market	\$89.99

MICROPRO

Easy	\$84.99
WordStar 2000	\$239.00
WordStar 2000+	\$289.00
WordStar Pro. w/GL Demo	\$189.00

MICRORIM SOFTWARE

R Base 4000	\$249.00
R Base 5000	\$359.00
Clout 2.0	\$129.00

MICROSOFT

Flight Simulator	\$34.99
MultiPlan	\$129.00
Word 3.0	\$279.00
Mouse	\$139.00

MICROSTUF

Crosstalk XVI	\$89.99
Crosstalk Mark IV	\$149.00
Remote	\$89.99

MULTIMATE

Multi Mate Word Proc	\$219.00
Advantage	\$269.00
On File	\$89.99
Just Write	\$89.99

NOUNEMON

Intuit	\$89.99
--------	---------

NORTON

Norton Utilities 3.1	\$57.99
----------------------	---------

ONE STEP

Golf's Best	\$34.99
-------------	---------

PFS: IBM

Proof	\$59.99
File/Graph	(ea.) \$84.99
Report	\$74.99
Write/Proof Combo	\$84.99

PROFESSIONAL SOFTWARE

Write-N-Spell	\$89.99
---------------	---------

THE SOFTWARE GROUP

Enable	\$349.00
--------	----------

SATELLITE SYSTEMS

Word Perfect 4.1	\$219.00
------------------	----------

SORCIMIIUS

Accounting	
API/AR/GL/INV/OE	(ea.) \$299.00
SuperCalc III	\$199.00
EasyWriter II System	\$239.00
Super Project	\$199.00

SUBLOGIC

Jet	\$37.99
-----	---------

Canon

A40, A50, A55	CALL
LBP-8A1 Laser	CALL

CITIZEN

MSP-10 (80 col.)	\$279.00
MSP-15 (132 col.)	\$389.00
MSP-20 (80 col.)	\$349.00
MSP-25 (132 col.)	\$509.00

C.I.TOH

Prowriter 1550P	\$299.00
Starwriter 10-30	\$299.00
3500 Tri Printer	\$1499.00

corona

Lazer LP-300	\$2799.00
--------------	-----------

DIABLO

D25 Daisywheel	\$549.00
635 Daisywheel	\$1099.00
D80IF Daisywheel	CALL
2000	\$689.00

daisywriter

2000	\$689.00
------	----------

EPSON

Homewriter 10, LX-80	CALL
FX-85, FX-286, RX-100	CALL
DX-10, DX-20, DX-35	CALL
SO-2000, Hi-80, HS-80, AP-80	CALL
LO-800, LO-1000	CALL

JUKI

6000 Letter Quality	CALL
6100 Letter Quality	CALL
6200 Letter Quality	CALL
6300 Letter Quality	CALL
6500 Letter Quality	CALL
6510 Dot Matrix Color	CALL

LEGEND

808 Dot Matrix 100 cps	\$179.00
1080 Dot Matrix 100 cps	\$259.00
1380 Dot Matrix 130 cps	\$289.00
1385 Dot Matrix 165 cps	\$339.00

NEC

3000 Series	\$779.00
8000 Series	\$1099.00
ELF 360	\$399.00
P560, P660, P760	CALL

OKIDATA

182, 183, 192, 193, 2410, B4	CALL
Okimate 10 (Specify C64/Atari)	\$189.00
Okimate 20(IBM), 282, 283	CALL
Okidata 93	\$299.00

Panasonic

KX1080	NEW
KX1091	\$259.00
KX1092	\$389.00
KX1592	\$469.00
KX1595	\$659.00

QUADRAM

Quadjet	\$399.00
Quad Laser	CALL

SILVER-REED

500 Letter Quality	\$189.00
550 Letter Quality	\$299.00
800 Letter Quality	\$699.00

star

SG-10C (C64 Interface)	CALL
SB/SD/NX/SR Series	CALL
Powertype Letter Quality	CALL

Texas Instruments

Ti850	\$529.00
Ti855	\$639.00
Ti865	\$799.00

TOSHIBA

P321 (80 column)	\$499.00
P341 (132 column)	\$799.00
P351 (132 column)	\$1049.00

RamVantage	AST	\$349.00
Rampage-PC		\$379.00
Rampage-AT	CALL	
Six Pack Plus		\$229.00
I/O Plus II		\$139.00
Advantage-AT		\$389.00
Preview Mono		\$299.00
PC Net Cards		\$379.00
5251/11 On-line		\$689.00
5251/12 Remote		\$579.00
5251/11 Plus		\$719.00

IRMA 3270	dca	\$879.00
IRMA Print		\$999.00
IRMA Smart Alec		\$779.00

Edge Card	EVEREX	\$259.00
Graphics Edge		\$219.00
Magic Card II		\$159.00
Magic Card I		\$99.99
EGA Video		\$299.00

Graphics	HERCULES	\$299.00
Color		\$159.00

IDEA 5251	IDE Associates	\$549.00
-----------	----------------	----------

PCNC8087 5MHz	INTEL	
PCNC8087-2 8 MHz		
PCNC80287 8 MHz AT	CALL	
PCNC80287 8 MHz AT	FOR	
1010 PC-Above Board	YOUR	
1110 PS-Above Board	PC	
2010 AT-Above Board		

The Chairman	MYLEX	\$439.00
--------------	-------	----------

Color/Mono Card	PARADISE	\$149.00
Multi Display Card		\$199.00
High Res Mono		\$169.00
EGA Video Card		\$379.00

Bob Board	PERSYST	\$359.00
-----------	---------	----------

Quadport-AT	QUADRAM	\$119.00
Liberty-AT (128K)		\$349.00
The Gold Quadboard		\$449.00
The Silver Quadboard		\$239.00
Expanded Quadboard		\$179.00
Liberty		\$309.00
QuadSprint		\$499.00
QuadLink		\$399.00
QuadColor		\$199.00
Quadboard-AT		\$399.00
8600 E.G.A. card		\$399.00

EGA Plus	STB	\$379.00
----------	-----	----------

Captain - 64	TECMAR	\$199.00
Graphics Master		\$489.00

EGA	VIDEO-7	\$399.00
-----	---------	----------

INTERFACES

Multi I/O (Apple II)	AST	\$149.00
----------------------	-----	----------

DIGITAL DEVICES

Ape Face (Atari)		\$49.99
U-Print A (Atari)		\$54.99
U-A16/Buller (Atari)		\$74.99
U-Call Interface (Atari)		\$39.99
U-Print C (C64)		\$49.99
P-16 Print Buffer		\$74.99
U-Print 16 apple IIc		\$89.99

MICRO R & D

Apple IIc Parallel		\$49.99
Kaypro 2000 Parallel		\$49.99
C64/128		\$59.99

Orange Mikro

Grappler CO (C64)		\$89.99
Grappler Plus (Ile, IIc)		\$89.99
Grappler C (Ile)		\$89.99
Grappler 16K (Ile, II+)		\$139.00

Graphicard	PRACTICAL PERIPHERALS	\$69.99
Serial Card		\$99.99
Microbuffer II+ 84K		\$169.00

Microfazer	QUADRAM	from \$139.00
Etazer (Epson)		from \$79.99

IBM PC SYSTEMS

Configured to your specifications.
Call for Best Price!

IBM-PC, IBM-XT, IBM-AT

Safari (7300)	CALL
8300	CALL

corona

PPC400 Dual Portable	\$1289.00
PPCXT 10 meg Portable	\$1989.00
PC40022 Dual Desktop	\$1389.00

PC400-HD2 10 meg	\$1989.00
------------------	-----------

ITT

ITT X-TRA	
256K, 2 Drive System	CALL
256K, 10 meg Hard Drive System	CALL
XP5, 20 meg	CALL

KAYPRO

KP-2000 Portable	CALL
Kaypro PC	CALL

PC100

IBM CLONE

640K MB-256 installed, 150 Watt Power Supply, XT Keyboard, 360K Floppy, 20 Meg Hard Drive	\$999.00
---	----------

SPERRY

Sperry-AT	as low as \$1749.00
Sperry-IT	as low as \$2699.00
Call for Specific Configuration!	
All Models	CALL

ZILITH

PC-138 Series, PC-148 Series, PC-158 Series, PC-160 Series, PC-171 Series, AT-200 Series	CALL
--	------

MONITORS

AMDEK

Video 300A Amber	\$129.00
Video 310A Amber TTL	\$159.00
410 TTL Amber or Green	CALL
Color 600 Hi-Res. RGB	\$399.00
Color 722 Dual Mode	\$529.00
Color 725	CALL
Color 730	CALL

MAGNAVOX

515 RGB/Composite	\$289.00
613 TTL Green	\$99.99
623 TTL Amber	\$99.99

NEC

JB1270G/1275A	(ea.) \$99.99
JB1280G TTL Green	\$129.00
JB1285A TTL Amber	\$129.00
JC1401 Multi Sync RGB	CALL

PRINCETON

MAX-12 Amber	\$179.00
HX-9 9" RGB	\$469.00
HX-9E Enhanced	\$519.00
HX-12 12" RGB	\$469.00
HX-12E Enhanced	\$559.00
SR-12 Hi-Res	\$599.00
SR-12P Professional	\$699.00

QUADRAM

8400 Quadchrome I	\$499.00
8420 Amberchrome	\$179.00
8500 Quad Screen	\$1449.00

TAXAN

A COMPUTER PROGRAM THAT SPEAKS YOUR LANGUAGE



The Computer Chronicles, a half-hour weekly television series brings you news and information from Silicon Valley and around the world. Correspondent Stewart Cheifet and Gary Kildall, creator of CP/M cover today's headlines and the stories behind them. Find out what is, what was and what will be, with the only computer program you're ever going to need. **The Computer Chronicles**, every week on a public television station near you. (Check local listings for time and channel.)

Produced by KCSM, San Mateo, CA and WITF, Harrisburg, PA with funding from AFIPS and McGraw-Hill's **BYTE** magazine.





MORE WORDS

BY EZRA SHAPIRO

Enough already. I'm getting sick of word processors for MS-DOS machines. You'd think the flood of these products would die down, but no, here are three more of the beasts. At least I've just about made it to the bottom of the pile, and I'll be able to avoid them for a month. Maybe two months. Maybe . . . no, I'll just have to see what wanders in. But next month, I promise, I'll have something different. Maybe graphics. Anything but another word processor.

STRANGE BREW

Mindreader (Businesssoft, \$189) has got to be the oddest product I've used in a long, long time. Before I go any further, I ought to state flatly that Mindreader is a failure as a full-featured word processor, which is what it's supposed to be. If you're only going to be writing small documents—memos and short form letters and the like—you probably could live with the program, but if you have a big writing project, Mindreader just won't cut it. The basic word-processing engine it employs is underpowered, clumsy, and poorly organized.

However, parts of the program are absolutely brilliant, and I'd pay far more money than Mindreader's price for a word processor that had them. Mindreader is a peculiar mixture of the astonishing and the irritating. So I wind up straddling the fence on this one; I simultaneously hate it and love it. My long-term hope is that Mindreader will be improved in future versions, or that other software publishers adopt its innovations in their products. And there are lots of innovations at which to marvel.

The program is certainly fun to use. It loads with graphics and sound ef-

Word processors: Mindreader, PC-Write 2.6, and Word 3.0

fects reminiscent of an action-oriented video game. Although you can shut off the beeps and trills and scales the program makes, they add an air of humor to what everyone else takes as deadly serious business. The configuration routines are also designed to be entertaining; rather than selecting from a standard palette, you get to choose from a list of color combinations with names like "Sahara" (white letters on a black screen) and "Hawaii" (yellow on blue). Mindreader even contains an anagram game that you can play when you want to take a break. I like all this stuff; why should business software always be tedious?

But Mindreader's greatest strengths lie in the area of what could best be called auxiliary text-handling features, by which I mean features peripheral to the actual entering and editing of copy. Tops on my list is Mindreader's glossary, in which you can store as many as 260 boilerplate text items. Each item can be inserted anywhere in your document with three keystrokes, or you can enter keyword labels and locate the right boilerplate by performing a keyword search. An entry can contain up to 700 characters, including carriage returns and prompts for user input, so you can create phrases, paragraphs, signature blocks, even data-entry forms.

Next is what Mindreader calls Word-Complete, and it's what gives the program its name. Here's how it works: Type a couple of characters. If the characters match anything in Mindreader's extensive dictionary, the pro-

gram pops up a window that offers you the five most likely choices for completing the word. You can type a semicolon for the most common choice, or a number from 2 to 5 for the others. This sounds like it would be more

trouble than it's worth, but in practice it's a major boon for slow typists, resulting in massive reduction in keystrokes and a commensurate increase in effective typing speed. If you set the program to its "AI Learn" mode, it will monitor your choices, remember what you're most likely to type, and upgrade that item to the number one spot. You can also force the program to offer specific options: I configured the program to make the phrase "Ezra Shapiro" the primary completion every time I typed an E. Faster typists can either turn this feature off or set it to standby mode for use when needed.

Mindreader also gives you keyboard macros, as-you-type spelling checking (although it doesn't suggest alternatives), a built-in calendar and appointment book, a pop-up calculator, both vertical and horizontal computation in text, and a name/address database that makes for easy merging into form letters. A status command displays file space used; counts of words, lines, characters, and keystrokes; a keystroke reduction factor; and typing speed. And there's TurboCursor—after passing seven characters at normal speed, the cursor accelerates to double time.

So what's wrong? Plenty. Mindreader can only handle files up to 44K bytes. Block moves and copies can only be of single lines or groups of

(continued)

Ezra Shapiro is a consulting editor for BYTE. He can be reached by writing to Applications Only, P.O. Box 170040, San Francisco, CA 94117-0040.

*I can sum up what
makes me like
Quicksoft's PC-Write in
one word: attitude.*

lines—no phrases or sentences that start or end in the middle of a line. Block deletes aren't allowed. There is no true insert mode; pressing the Ins key splits the line, you enter your additional copy, then press Ins again to close things up. There's no command to move the cursor to either edge of the screen. You have no way to re-assign function keys or eliminate the function-key map that fills both the top and bottom margins of the display. Page numbers can't be used in headers: they appear centered at the bottom of the page or not at all. No footers. You have only two printer choices, laser or standard. Both the game and the name/address index can be accessed only from the main menu, but exiting from either drops you out to the DOS prompt.

Also, Mindreader is so insistent on being helpful that it adds the appropriate spacing after every punctuation mark. I couldn't figure out a way to defeat this; as a result, I wound up with two spaces after every comma (one from the program and one that I typed instinctively), three or four spaces at the end of every sentence, and so on. For a real laugh, try typing DOS filenames with their embedded periods and watch what happens.

My conclusion is that anyone out there who's trying to write the Great American Word Processor should buy a copy of Mindreader and study it very carefully. Hunt-and-peck typists with light word-processing needs will enjoy the nifty features without noticing the problems. But anybody who wants heavy-duty capabilities should look elsewhere.

A final note from the Harsh-Realities-of-Life Department: Version 1.0 of Mindreader came to me in a dark blue box with a funky drawing of a wizard and the slogan "writes like a

charm." The manual was written with a light touch and stressed the friendlier aspects of the program; the software wasn't copy-protected. I based this column's evaluation on version 2.09, which arrived in a gray box with the slogan "Artificial Intelligence for Business Writing." The documentation had a much more sober tone, and—you guessed it—the product was copy-protected. Make of this what you will.

SHAREWARE CLASSIC

I can sum up what makes me like PC-Write (Quicksoft, \$75) in one word: *attitude*. The program is one of the earliest shareware products for the PC-and-compatibles world, and shareware it is, perhaps more truly than other programs lumped into the category.

You can obtain a free copy of the program—a complete, legal, working copy—from a users group, a friend, or an electronic bulletin board. If you'd like a copy of the disk, Quicksoft will mail you one for a mere \$10. You're encouraged to use it and to give copies to anyone else. When you decide you like the program (or when you can't live with the guilt), send Quicksoft \$75. In return, you get a disk with an individual registration number, a bound manual, a tutorial, a summary pamphlet, a quick-reference card, a one-year subscription to Quicksoft's quarterly newsletter, two postcards to mail in when you want either a new version of the software or complete source code (Microsoft Pascal and assembler), and a year's worth of telephone support. If that isn't enough, any time someone else registers a copy of PC-Write and submits your number, Quicksoft will send you \$25. (If you give three people copies of your PC-Write disk, and they all decide to register, you've made back your entire investment.) Whew! This is the best deal in software.

The attitude goes further, too. The newsletter publishes known bugs and fixes when possible. (Remember when Ashton-Tate did that with dBASE II and built its customer base into a loyal family?) And the PC-Write manual notes that even though the program comes with definition files for something like 200 printers, if

you've got an obscure printer not covered, just send the company a copy of the printer manual and Quicksoft will write a custom configuration file for you. You know any other company that does that?

I believe in Quicksoft and what the company is doing. The product has been improving steadily, and the recent jump from version 2.55 to 2.6 is another significant step to make a good program better. However, as big a fan as I am, I do have some warnings to issue.

PC-Write is not for the fainthearted or the easily confused. It's powerful but idiosyncratic; it has grown slicker over the years, but the program is still the child of its author, Bob Wallace, and his mind doesn't work the way mine does. I've faulted other products for many of PC-Write's qualities, but somehow this program hangs together better than the rest.

It's a throwback in that it's a two-part word processor: editor and text formatter. The editor is fast and versatile and ranks with the best. The formatter is controlled by dot commands entered in text (a style I detest), but they do offer pinpoint precision.

What I dislike most about the editor is the way it uses nearly every available key combination, to the point where I get thoroughly lost. The Ins key, for example, inserts a space; to toggle insert mode you have to press the Scroll Lock key. The numeric keypad plus-sign key repeats a search, so you can't use it to enter the character. As a safety net, PC-Write accepts many of WordStar's commands, but they use up still more keyboard possibilities.

On the other hand, what I like about the program is its marvelous reconfigurability. You can reassign keys to functions or functions to keys (effectively the same thing) and set up format defaults best suited to your tastes. You can even use the reassignment system to hold macros and boilerplates, if you can find a trigger key that isn't already assigned. Figuring out how to do all this requires a bunch of head-scratching and manual-riffling, but it's worth the torture. Only drawback is that your reconfigured

APPLICATIONS ONLY

ITEMS DISCUSSED

MINDREADER	\$189
(MS-DOS)	
Businesssoft Inc.	
703 Giddings Ave., M-4	
Annapolis, MD 21401	
(301) 263-1962	
PC-WRITE	\$75
(MS-DOS)	
Quicksoft	
219 First N. #224	
Seattle, WA 98109	
(206) 282-0452	
WORD 3.0	\$450
(MS-DOS)	
Microsoft Corp.	
16011 NE 36th Way	
Redmond, WA 98073	
(206) 882-8080	

command set will be out of whack with PC-Write's prompts. If you're that concerned, you *could* always get the source and recompile it, right?

New features with this version include automatic reformatting, embedded ruler lines, up to eight header/footer lines, orphan control, directory editing, footnotes broken over page breaks, automatic numbering of footnotes and headings, enhanced dot commands, support for more printers, and proportional spacing.

The new documentation, bound in a hard cover that makes it look like a high school literature textbook, is light-years ahead of what it once was, but it's still oddly structured and repetitive. Everything you want to know is there, but it's tough to find. However, the program itself is now actually informative. The four cramped help screens of earlier versions have given way to 40 well-designed screens, and the enigmatic command prompts have actually turned into decent menus.

On the whole, I like the program, and I'm continually amazed to discover the neat features that Wallace has tucked away in the cracks. It's a good package even if it represents a journey of exploration.

Oh yes, be sure to phone Quicksoft

(continued)

TEACHING
LEARNING

PROLOG
ARTIFICIAL
INTELLIGENCE

EXPERT
SYSTEMS

LPA micro PROLOG and LPA mac PROLOG

now being used by major corporations, universities and middle schools as a teaching and learning tool and for building intelligent Expert Systems. PROLOG was chosen by the Japanese as the core language for their Fifth Generation Project for building "thinking machines".

NEW LOW PRICES

	COMPILER FOR THE MACINTOSH	\$295 REDUCED
	FOR MICRO COMPUTERS MS DOS AND OTHERS	\$99 & up
	FOR BUILDING INTELLIGENT EXPERT SYSTEMS	\$149 & up
	PROFESSIONAL FULL MEMORY MS DOS	\$395

LPA PROLOG RUNS ON THE APPLE II, COMMODORE 64, IBM PC AND COMPATIBLES, AND UNDER THE UNIX & VMS SYSTEMS.

Call or write for our complete catalog of Artificial Intelligence products.

NORTH AMERICA
Programming Logic Systems Inc
31 Crescent Drive
Milford, CT 06460, U.S.A
Tel: (203) 877-7988

ELSEWHERE
Logic Programming Associates, Ltd., Dept. BY/3
Studio 4, The Royal Victoria Patriotic Building
Trinity Road, London SW18 3SX, England
Tel: 01-874-0350



Visit Us At AAAI-86 Philadelphia, PA August 12-14, Booth 423



Need Research That Utilizes
Computer-Assisted
Telephone Data Gathering?

Want to gather information rapidly using state-of-the-art computer-assisted telephone interviewing? Need fast access to tabulated results? Require integrated graphics with sophisticated analysis? Are you seeking real-time information?

Call **RESEARCHNET** at
McGraw-Hill Research

ResearchNet is the leading edge approach to research that integrates study design, computer-assisted telephone interviewing, on-line tabulation, and report analysis capabilities as well as real-time data gathering. ResearchNet links together McGraw-Hill Research project teams, interviewers' terminals, respondent input, and *you*—to produce timely, accurate and meaningful study results.

For a quote or proposal call Sheryl R. Fox (609) 426-5946 (Information Data Gathering) or Joseph T. Collins (212) 512-3264 (Full-Service Research) or write David P. Forsyth at McGraw-Hill Research, 1221 Avenue of the Americas, NY, NY 10020



If it's a marketing research problem, we probably pioneered the solution.

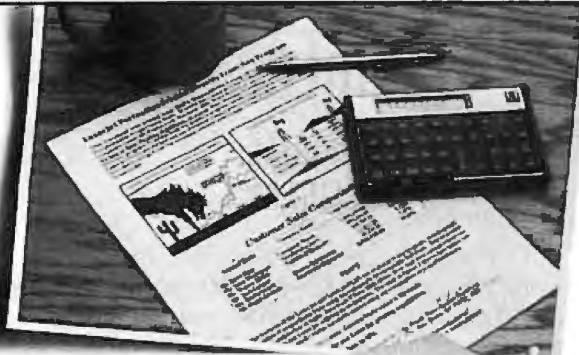

Desktop Publishing.

\$149⁰⁰

Hewlett-Packard's LaserJet created desktop publishing. *Ram-Resident PrintMerge* brings it to life. It does true proportional spacing and justification. With *any* font



combination. You can merge text with screen or output graphics

from other programs. Draw lines or boxes. Align proportional tab columns. *Only* PrintMerge offers these unique capabilities. You print directly from virtually *any* program including: dBase, DisplayWrite3, Lotus 1-2-3,

Multimate, WordStar. You've already spent 90% of what's needed for a powerful personal publishing system with your *current* software and LaserJet. Just a bit more for *Ram-Resident PrintMerge* will bring it to life.

Call 800/338-5943 (In CA 800/231-3531)

Toll-Free for *Ram-Resident PrintMerge* Ordering Information for IBM PC/ATs and 100% compatibles. 30-day no-risk money back guarantee.

POLARIS
SOFTWARE

310 Via Vera Cruz, Ste. 205
San Marcos, CA 92069 619/471-0922

APPLICATIONS ONLY

before ordering anything. The company was talking about price changes on July 1, but when I wrote this it hadn't yet made any final decisions.

WORD, BRIEFLY

More good news and bad news. The good news is that Word 3.0 (Microsoft, \$450) is faster and sports a number of spiffy new features. The bad news is that it's still Microsoft Word.

Microsoft seems determined to make a run on the desktop publishing market, and to that end Word supports nearly every printer ever manufactured, particularly ones that include the word "laser" in their names. My hunch is that this release is a first step in that direction, and that Microsoft will continue to enhance the product to make it a winner in this arena. So I think it's a good bandwagon to ride on.

The hot feature is moderately powerful outlining capability. New commands allow you to expand and collapse blocks of text in outline form. The program is primarily a word processor, not an outliner, and I'm still not comfortable working with it. I'm accustomed to using Ready! to maintain small outlines that I pop into my documents. Word gives you the ability to really develop a text document as easily movable chunks. Barring the sudden appearance of a cheap monitor that can display several pages of text in sharp resolution, this may be the only method of zooming between structure and detail that we'll have for a while. I have to admit I'm tempted to spend a lot of time with this one.

So I'm giving the product an early plus rating, even though I loathe the Microsoft interface (the one with the useless box around the screen and the menu along the bottom). But it works great with a mouse, and overall it's a solid package. The documentation is thick and thorough, and not badly written. The disk tutorials are excellent.

Is this a recommendation? I'm not sure. I think I'll have to run the product head-to-head against PC-Outline, MaxThink, and whatever Living Videotext is cooking up and get back to this later. ■

a message to our subscribers

From time to time we make the BYTE subscriber list available to other companies who wish to send our subscribers material about their products. We take great care to screen these companies, choosing only those who are reputable, and whose products, services, or information we feel would be of interest to you. Direct mail is an efficient medium for presenting the latest personal computer goods and services to our subscribers.

Many BYTE subscribers appreciate this controlled use of our mailing list, and look forward to finding information of interest to them in the mail. Used are our subscribers' names and addresses only (no other information we may have is ever given).

While we believe the distribution of this information is of benefit to our subscribers, we firmly respect the wishes of any subscriber who does not want to receive such promotional literature. Should you wish to restrict the use of your name, simply send your request to the following address.

BYTE Magazine
Attn: Circulation Department
One Phoenix Mill Lane
Peterborough NH 03458





GOING TO THE FAIRE

BY BRUCE WEBSTER

Bruce also debates product values with Commodore and Atari execs

It's late April as I write this, and a few weeks have passed since my trip to the 11th Annual West Coast Computer Faire. The Faire used to be an important trade show where new products made their debut and rival companies covertly (or overtly) scouted each other out. I attended my first Faire some years back as a representative of a software firm introducing a major revision of an existing product. I can still remember the worry about what our competitors might be bringing out and our delight in discovering that we had jumped ahead of all of them. Since all the major companies in that market segment were there, it was good news indeed.

Now the Faire has become more an exercise in nostalgia than a vital happening. As a computer industry event, it no longer matters. Press announcements, market research, and COMDEX have supplanted the Faire and reduced it to a local end-user computer show. In fact, plans are underway to hold Faires in different parts of the country.

At this point, you can insert standard sermon B-5 about How The Industry Has Matured. Sadly, all the clichés in the sermon are true: Things *have* changed irrevocably, and it ain't ever going to be as fun (or easy or cheap) as it once was to get in there and slug it out with everyone else. I don't see much evidence, though, that this maturity has improved the industry. A lot of turkeys still hit the shelves, only now many are kept alive longer than they deserve to be, thanks to fancy dressings and constant infusions of advertising money. Meanwhile, a lot of valuable, innovative products never get onto the shelves because the firms pushing them don't have the bucks to compete with the big boys.

Lest I sound too gloomy, let me hasten to add that I sense a shift of direction in the pendulum's swing. Many consumers have learned that slick packaging and gorgeous ads don't necessarily indicate a product's true worth, nor does a photocopied manual in a plastic bag mean a program is buggy or inadequate. Thanks to Turbo Pascal and similar products, buyers have learned that price and value are not necessarily related; an inexpensive product may be quite good and an expensive product quite bad. Indeed, a growing number of users are starting to suspect an inverse relationship between price and value.

A brief aside. The legend of Turbo Pascal has by now reached mythic proportions in the industry, as evidenced by the number of firms that, in marketing meetings, make

plans to become "the next Borland." As with any legend, a few ironies stand out. First, Borland didn't achieve its success by imitating another firm: instead, the company found an empty niche and gambled that it could succeed by filling that slot. Second, Borland itself is in danger of being overwhelmed by its own success and becoming (if it hasn't already) just another one of the big boys, instead of the renegade innovator that it portrays itself to be. The company seems to be falling prey to some of the common sins of the industry: not offering enough technical support, introducing too many products (some of dubious value), preannouncing new software (a practice Borland used to shun), and even advertising vaporware (will Turbo Pascal for the Amiga ever be released?). On the other hand, given Borland's track record and market position, the company can probably do what it wants to—for now, at least.

Getting back to the original topic, there is still a lot of value in shows like the West Coast Faire, the Mac Exposition, and so on, because they provide small, innovative companies direct exposure to users and to the press. Of course, they also provide exposure for small, dull companies, for large, dull companies, and other distractions, so that users and the press have to try and sort one from another. But that's part of the fun. (The question asked most often at the Faire was, "What did you see that was interesting?")

In summary, I wish the Faire a long life. I, for one, plan to keep coming back.

FAIRE HIGHLIGHTS

What did I see that was interesting? Well, the most significant product was Lightspeed C from Think Technologies, the same folks who developed MacPascal and Instant Pascal for Apple.

Lightspeed C is an integrated C development environment for the Mac that looks as though it could really speed up program development. Not only does the compiler scream along, but the linker is also amazingly quick and intelligent, allowing quick turnaround time for program changes. It appears to be a full-featured C, with complete Macintosh Toolbox and operating system support. And

(continued)

Bruce Webster, a consulting editor for BYTE, can be reached c/o BYTE, P.O. Box 1910, Orem, UT 84057, or on BIX as bwebster.

COMPETITIVE EDGE

631 S. MAIN ST. • PLYMOUTH, MI 48170 • (313) 451-0685

FEATURING S-100 COMPONENTS FROM:

COMPUPRO®

CLOSEOUT ON CDOS 3.1 \$195
DISK 1 A¹⁵ \$446 MORIVE-H® \$371

LOMAS

Thunder +512K \$895 1024K \$999
Mega S Ram 256K \$412 10MHZ 286 \$821

TELETEK

SYSTEMASTER® II 8MHZ 128K \$795
SPC-1 6MHZ 128K \$350 HDC \$375

86/72 MB H.D. SUB-SYS W/DISK 3 FOR COMPUPRO \$2395
20MB H.D. SUB-SYS FOR TELETEK \$950 FOR LOMAS \$1050

ALSO FEATURING OUR AT COMPATIBLE:

VELOCITY 286



10 MHZ OPERATION
1024K ON MOTHERBOARD
30 MB FAST HARD DISK
ENHANCED GRAPHICS
ADAPTER STANDARD
1.2MB FLOPPY DOS 3.2
ONLY \$3295

10MHZ - 8 USER XENIX®
BASIC SYSTEM \$4395
8 SERIAL, 1024K, 30 MB

10 MHZ 16 USER XENIX
SYSTEM \$8195, 86/72 MB
H.D., 60 MB TAPE 4096K,
18 SERIAL PORTS

10 MHZ 16 USER XENIX
SYSTEM \$9995 190/112 MB
H.D., 60 MB TAPE 4096K,
18 SERIAL PORTS

VELOCITY 286 312 MB H.D FILE SERVER \$9895
(2) 156 MB FORMATTED HARD DISK DRIVES EGA, 1024K, PAR.,
SERIAL, CLOCK DOS 3.2

PRICES SUBJECT TO CHANGE

CompuPro, Ram 22, Move-H are either trademarks or registered trademarks of Viesyn Corporation. Systemaster is a registered trademark of Teletek Enterprises. PC AT is a trademark of International Business Machines. Xenix is a registered trademark of Microsoft. UNIPATH is a trademark of Pathway Design, Inc. SDO is a trademark of THE SANTA CRUZ OPERATIONS. Autopack is a trademark of Autodesk, Inc.

it's cheap: \$175, compared to \$250 to \$500 for most other Macintosh C compilers.

Lightspeed C was developed primarily by Michael Kahl, with help from Jon Hueras. Andrew Singer, president of Think Technologies, was involved in the product's conception and design. I just received a review copy; look for a more detailed report in the next month or two.

The most interesting product, and one which you've undoubtedly heard about, was MacCartridge from Data Pacific. This is a ROM cartridge for the Atari ST that contains—surprise!—the old 64K-byte Apple Macintosh ROMs. When used with a host program, it converts your ST into a quasi-Macintosh. There remain the small problem of disk formats (though Data Pacific offers Mac software transferred to ST disks) and the large problem of Apple legal action, which may well have killed the product by now.

David Small, who was exhibiting MacCartridge in one of the Atari users-group booths, said he was visited by a contingent from Apple, led by Guy Kawasaki (noted software evangelist) and "a lot of guys in T-shirts who talked like attorneys." Small evidently persuaded them that he had done nothing actionable and even tried to convince them that such a product would ultimately help Apple, though I suspect it would help Macintosh software developers far more than it would Apple. And since said product would also help Atari an awful lot, I see little chance of Apple giving its blessing to MacCartridge and a good chance of the company actively opposing it. Small says he has no funds to fight a legal battle and so would have to fold at the sign of any threat from Apple. It was a great hack, though...

One product that I walked by two or three times before noticing was Morgan Computing Company's Advanced Trace86, an upgrade of the firm's Trace86 debugging utility for IBM PCs and clones. Trace86 is already a good alternative to the MS-DOS Debug program, but the advanced version provides several enhancements and improvements. According to the flier, it has an assembly language interpreter that does incremental assembly of instructions as you type them in. It also allows you to create assembly language programs and save them as .COM files. The program runs on IBM PCs with at least 128K bytes of RAM. Since 8086 assembly language programming is not one of my strong points, I'm very interested in using this to help me make the plunge. Look for a follow-up here once I get a review copy.

There weren't too many finished (shippable) Amiga programs showing at the Faire, but I did see a beta-test version of Mimetics Corporation's Sound Scape, a program that turns your Amiga into a synthesizer and MIDI (musical instrument digital interface) sequencer. Adding a MIDI adapter to the serial port allows you to receive MIDI commands from other devices, or you can use the Amiga's keyboard as, er, a keyboard. Watching the demo, I got the feeling that I could really compose some interesting (and maybe even enjoyable) music with it, prompting BYTE's Ezra Shapiro to comment on the "triumph of technology over talent." A finished version of Sound Scape should

NOVAS BEYOND IBM COMPATIBILITY MORE POWER PLUS RELIABILITY

NOVAS TURBO 286 MOTHERBOARD

- Fewer ICs For Greater Reliability—Only 36 Compared to IBM's 131
- Dual Speeds—6 & 8 MHz—Keyboard or Jumper Selectable (10 MHz opt.)
- 4 Serial and 1 Parallel Ports On Board Option
- Expandable to 1 Megabyte RAM
- Complete with Setup Program
- Fully Compatible BIOS
- Socket for 80287
- 0, 1 Wait State. Jumper Selectable. Hardware reset port.

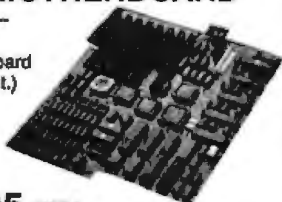

\$495 OEM

ALL AT ACCESSORIES AVAILABLE—CALL!

NOVAS 1000 EGA BOARD

- Supports EGA, CGA, MDA
- 640 x 350 Pixels EGA
- 640 x 200 Pixels Color
- 320 x 200 Pixels Color
- 720 x 350 Pixels Monochrome
- Parallel Port on Board
- 256K RAM on Board



\$225

NOVAS TURBO 286 AT COMPATIBLE SYSTEM . . . \$1445.00

Include: 640K, 6/8 MHz Turbo Speed (10 MHz opt.), 1 S/1 P, 1.2 Meg. Dr.

COMPLETE NOVAS PC TURBO SYSTEMS AND COMPONENTS IN ANY CONFIGURATION—CALL FOR CURRENT PRICES

OUR QUALITY AND PRICES CANNOT BE BEAT!
CALL US FOR COMPLETE SATISFACTION

COMPUTRADE COMPANY

780 Trimble Road, Suite 605 Tel: (408) 435-2662
San Jose, CA 95131 Fax: (408) 435-5458

* IBM & AT are trademarks of International Business Machines Corp.

ACCORDING TO WEBSTER

show up here in a month or two; again, look for a more detailed report then.

One Amiga product that is being shipped is a version of Aztec C from Manx Software. You may recall from my May column that I ended up switching from Lattice C to a beta-test copy of Aztec C for most of my Amiga benchmarks, with a significant improvement in times. Not only that, but Aztec C has its own linker that works a lot faster than the standard Alink program that Lattice C uses. I'll be curious to see if this "finished" (is any compiler ever finished?) version is any better. Jim Goodnow, who worked heavily on the Amiga version, gave me some additional good news: Manx is porting Aztec C to the ST.

MEANWHILE, DOWN AT THE RANCH

My trip to San Francisco included visits to Atari and Commodore. At Atari, Neil Harris and Leonard Tramiel spent a fair amount of time with me, doing their best to answer some of my criticisms of the ST and to explain strong points I might have overlooked. In some respects, they were preaching to the converted—I think the 1040ST is a great machine and that Atari will probably sell as many as they can produce—but I appreciated their comments nevertheless.

Tramiel argued that GEM Desktop, the user interface on the ST, is just as powerful and easy to use as the Macintosh Finder. He made the valid point that "different" doesn't necessarily mean "better" or "worse" and that many users are so accustomed to the Macintosh Finder that they perceive GEM Desktop's differences as deficiencies. He also pointed out some of GEM Desktop's advantages, such as the ability to open a disk's window multiple times so that you can view different portions of a directory simultaneously.

Still, I think GEM Desktop is rigid and demanding compared to Finder. All windows have to be organized the same (names versus icons, as well as method of sorting). You can't rearrange icons within a window. Viewing by icons forces you either to open the window the full width of the screen or to do a lot of horizontal scrolling, since the icons are not adjusted to fit within the current window size. And those infernal drop-down menus are always getting in the way, requiring a lot of extra button pushing compared to Apple's patented pull-down menus. The irony is that GEM's developers at Digital Research designed the drop-down menu to avoid patent infringement and wound up having legal problems with Apple anyway.

Tramiel is right about one thing: I have been spoiled by the Macintosh, and I tend to resent GEM making decisions for me that I would rather make myself.

Tramiel and I agreed on another point, namely, the ease of low-level access within the ST. He showed me an animated three-dimensional Bessel wave function running through a 20-step cycle at an amazing rate of several cycles per second. The method was simple: All 20 steps were individual screen images that had been predrawn (at about 3 minutes each) and saved on disk. The demo program then loaded the 20 pictures into RAM, eating up 640K

(continued)

Little Board™/186... \$495
High Performance, Low Cost PC-DOS Engine

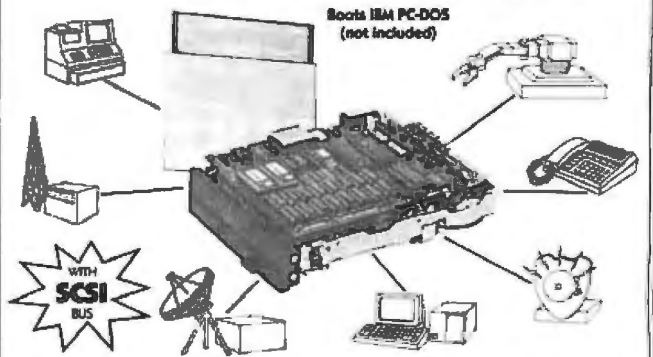

- Three times the COMPUTING POWER of a PC
- Data and File Compatible with IBM PC, runs "MS-DOS generic" programs
- 8 MHz 80186 CPU, DMA, Counter/Timers, 512K RAM, zero wait states, 16-128K EPROM
- Mini/Micro Floppy Controller (1-4 Drives, Single/Double Density, 1-2 sided, 40/80 track)
- 2 RS232C Serial Ports (50-38, 400 baud), 1 Centronics Printer Port
- Only 5.75 x 7.75 inches, mounts directly to a 5-1/4" disk drive
- Power Requirement: +5VDC at 1.05A; +12VDC at .05A; On board -12V converter
- SC51/PLUS™ multi-master I/O expansion bus
- Software Included:
 - PC-DOS compatible ROM-BIOS boots DOS 2.x and 3.x
 - Hard Disk support
- NEW OPTIONS AVAILABLE
- EXPANSION/186 with:
 - 512K additional RAM
 - 2 Sync/Async RS232C/422 serial ports
 - Battery backed Real Time Clock
 - 8087 Math Co-Processor
 - Buffered I/O Bus
 - SC51/TOP for STD BUS
 - PROTO/186: prototyping adapter
 - CONCURRENT DOS: Multitasking/Multi-user (2/4) Operating System

AMPRO
 COMPUTERS INCORPORATED
 67 East Evelyn Ave. • Mountain View, CA 94041 • (415) 968-0930 • TELEX 4940302

DeSmet C

now with 32-Bit Pointer Option

C88.....still \$109

The editors' choice for fast compilation and execution. The price/performance winner in all major C benchmarks since 1983. Includes Compiler, Assembler, Binder, Librarian, Execution Profiler and Full Screen Editor. Supports both disk and memory resident Overlays. Contains both 8087 and Software floating point support. Full STDIO library.

Large Case Option.....\$50

Makes a great C Compiler even better. Adds 32-Bit Pointers to C88 so you can utilize all of your PC. Groups scalar and static data for fast access. Supports the D88 debugger.

D88.....\$50

Gain most of the benefits of an interpreter while losing none of the run-time speed of the C88 compiler. Display C source and variable contents during execution. Set breakpoints by function name or line number. Examine and set variables by name using C expressions.

order direct from:

C Ware Corporation

505 W. Olive, Suite 767, Sunnyvale, CA 94086 U.S.A.
 (408) 720-9696 — Telex: 358185
 We accept VISA, MasterCard & American Express



So you can't get Toshiba Printer Accessories, Bunkie?

Any time (24 hours) grab your VISA or MasterCard
JUST CALL **800/854-0561** EXT 837
IN CALIFORNIA CALL 800/432-7257 EXT 837

Type Font Cartridges for

Toshiba P351, P341 and P321 Printers

T/FC 011 \$69	T/FC 015 \$69
Bold Letter	ORATOR 1
T/FC 012 \$69	ORATOR 2
Elite Gothic	T/FC 016 \$69
T/FC 013 \$69	Outline Script
Greek / Math / Apl	T/FC 017 \$69
	Home & Studio

Ribbon for 3-in-One Printers

T/R 001 \$12: Ribbon fits Toshiba dot matrix printers.

Start-Up Kit

T/SK \$99: Accessory sample kit contains Type Font Cartridge (Bold Face, Letter Gothic), Type Font Disk (Extended Word Processing), Printer Ribbon, Data Disk, Enhancement Catalog, Type Font Catalog and much, much more

P351 Dual Emulation Kit

T/DE 351 \$99: Upgrade your early model P351 to add IBM Graphics Printer emulation. Complete instructions included

User's & Technical Reference Manuals

Complete line of manuals to support Toshiba Printers: P1340, P351, P341, P321. Write for complete catalog

A minimum shipping and handling charge of \$4.75 will be added to each order. 6% sales tax will be added to California orders.

Type Font Disks (Downloadable)

G/FD 051 \$50:	Designed especially for scientific applications; 4 fonts.
G/FD 053 \$30:	Maxiset (overized characters for headlines); 1 font
T/FD 016 \$69:	Extended word processing package. Ideal for desktop publishing; 5 fonts.
T/FD 011 \$49:	Standard word processing packaging; 3 fonts
T/FD 014 \$49:	Presentation size type fonts, 2 Orators & 1 Outline
T/FD 015 \$49:	Correspondence quality type fonts; 1 Roman, 1 Script & 1 Italic
T/FD 013 \$69:	Math and Scientific fonts; 2 Math; 1 Application & 1 Scientific
T/FD 021 \$49:	Quality Pack; 1 Regular and 1 Bold Italic & 1 Gothic
F/FD 001 \$95:	2 Micro (10 & 20 cps), Copper, Reg. Italic, Bold Italic, Zap & Science.
F/FD 002 \$95:	Demio Gothic, Gothic (15 cps), Boss, Serif Italic, Gothic Italic, Fathead, Greek.
F/FD 004 \$95:	Roman, Elite Italic, OCR A & B, Pres. Pica, Greek, Micro (15 cps)

PRINTER
ACCESSORIES

WRITE FOR A COMPLETE CATALOG

DIRECT INC. / P.O. BOX 19608-347, IRVINE, CA 92713

bytes (this was on a 1040ST). The program created an animation effect simply by changing the screen pointer successively to each of the 20 images. This simple technique would be impossible on the Macintosh and would be limited by the 512K bytes of "chip RAM" on the Amiga 1000.

The ST makes it easy to get down and mess with the "guts" of the machine; with the Macintosh and the Amiga, both the hardware and the system software tend to get in the way. I think that's very much the reason why ST software has come onto the market so quickly, while Amiga software has lagged behind.

The mood at Atari was upbeat and aggressive. The 1040ST and the new 520ST started shipping in March, relieving a lot of dealers who went through a lean period with few machines to sell. Atari even released an explanation for the delay in shipping: A plane loaded with 1040s was on its way to the U.S., stopped in the Philippines for refueling, then was unable to take off again for a few weeks due to the political upheavals caused by the then-pending presidential election. There *are* signs that the initial 1040STs were shipped in a hurry. For example, the initial models that dealers received did not have the promised RF modulator, though there was space for the circuitry on the motherboard and even a cutout on the internal shielding for the RF wiring to pass through. The customers don't really seem to care, though; reports are that the 1040ST is selling just fine.

GOOD SIGNS FROM COMMODORE

At Commodore, as well as at the local ComputerLand-Amiga show in San Jose, indications are that the company is finally getting its act together with regard to the Amiga machine.

First, Commodore planned a large exhibit at COMDEX/Spring. Commodore's absence at COMDEX/Fall and the Winter CES hurt them with developers and dealers.

Second, Commodore has a "limited time" offer of an Amiga 1000 plus an RGB monitor for just \$1295; in effect, the monitor is free. That significantly shrinks the price gap between the Amiga 1000 and the ST models, a gap that had grown with the introduction of the 1040 and the unbundling of the 520.

Management changes are also encouraging. These include shifts in location (back to the West Coast) and changes in the people who handle third-party developers. Ever since Commodore moved third-party relations last year to West Chester, Pennsylvania, developers have been complaining about lack of cooperation from the company. Prior to that move, Caryn Mical (née Havis) had been doing an outstanding job in the West Coast office.

Finally, Commodore's new magazine ad campaign (touting the special bundled deal) appears to be better conceived and executed than previous efforts. It relies on understatement and simplicity rather than hoopla or bizarre imagery and makes the Amiga look like a business machine—something Commodore very much wants.

Even with all that, I still get a sense of carefully guarded frustration from some of the current employees at Com-

8086
8088

AMX

Now
68000

8080
Z80
6809

Real-Time Multitasking Executive

- No royalties
- Source code included
- Fault free operation
- Ideal for process control
- Timing control provided
- Low interrupt overhead
- Inter-task messages

Options:

- Resource Manager
- Buffer Manager
- Integer Math Library

■ Language Interfaces :

C	Pascal
PL/M	Fortran

■ DOS File Access :

CP/M-80	
IBM PC DOS	

AMX for 8080	\$ 800 US
8086	950
6809	950
68000	1600
Manual (specify processor)	75

AMX is TM of KADAK Products Ltd
CP/M-80 is TM of Digital Research Corp
IBM, PC DOS are TM of IBM Corp

KADAK Products Ltd.

(604) 734-2796
Telex: 04-55670

206-1847 W. Broadway, Vancouver, B.C., Canada V6J 1Y5

ACCORDING TO WEBSTER

modore (and not-so-guarded frustration from those who have left). The frustration is not so much over current policies and directions; there is universal agreement that Commodore has finally committed itself to the Amiga and is heading in the right direction. The frustration is more in terms of lost time and opportunity.

MACINTOSH SHUFFLE

Hmm. Let me check my calendar here. Yes, it's time to pull out my gun and take some shots at Apple, rehashing old criticisms and relishing my being able to say "I told you so."

In April, Apple announced and released yet another Macintosh, the Mac 512K Enhanced. This represents the fourth (or, if you really want to get picky, the fifth) version of the Mac to appear in a little more than two years since the Mac was first announced. There was the original 128K Mac; purists may contend there were two versions here, the "original" original and the one with the same motherboard as the 512K Mac. Then came the 512K Mac, followed by the Mac Plus. Now we have the 512K Mac Enhanced, a machine with the new 128K-byte ROMs, an 800K-byte disk drive, and the same list price (\$1999) as the old 512K Mac, which has been dropped (the second

(continued)

ITEMS DISCUSSED

ADVANCED TRACE86 \$175
Morgan Computing Company
P.O. Box 112730
Carrollton, TX 75001
(214) 245-4763

AZTEC C (Amiga version)
developer's system \$299
commercial system \$499
Manx Software Systems
One Industrial Way
Eatontown, NJ 07724
(800) 221-0440

LIGHTSPEED C \$175
Think Technologies Inc.
420 Bedford St., Suite 350
Lexington, MA 02173
(617) 863-5595

MACCARTRIDGE Price not set
Data Pacific Inc.
P.O. Box 10805
Marina Del Rey, CA 90295
(213) 821-2623

SOUND SCAPE PRO MIDI STUDIO \$149
Mimetics Corporation
P.O. Box 60238
Palo Alto, CA 94306
(408) 741-0117

IBM PC AT performance! PCjr price!

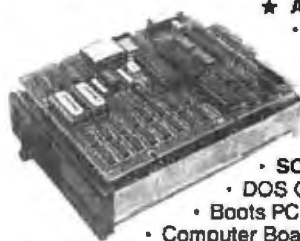

- ★ **AMPRO Little Board/186**
 - 8Mhz 16 Bit 80186 CPU
 - 512K RAM—No Wait-States
 - 2 Serial Ports 50-38.4K Baud
 - Parallel Printer Port
 - 4 Drive Mini/Micro-Floppy Controller
 - SCSI Bus Hard Disk Interface
 - DOS Compatible ROM-BIOS
 - Boots PC DOS 2.x, 3.x
- Computer Board Assembled and Tested with Tech Manual and DOS utilities...**\$489**
- ★ **DRI Concurrent DOS 4.1 Multi-User O/S**...**\$395**
- ★ **Expansion Board for 512K (1Mb total) 8087-1 Socket, Real-Time Clock, 8530 SCC 2 Channel RS232/422, Buffered Expansion Bus and more...**from **\$149**
- ★ **AMPRO Little Board (Z80) Same as 80186 board but Z80A CPU, 64K RAM, 16K EPROM, CP/M 2.2 & ZCPR3 and manuals...****\$239 (\$279 w/SCSI)**
- Enclosures w/Power Supply...from **\$99**
- Mini/Micro Floppy Drives...call for current price
- **XEBEC or SEAGATE SCSI Drives—Low power 1/2 Ht Drive w/built-in Controller 10/20Mb...****\$449/\$599**
- Terminals: **WYSE, QUME, KIMTRON**...from **\$395**
- Power supplies, cables, connectors in stock

Complete technical support. Complete systems available. Write or call for more information. Most orders shipped same day.

VISA, MasterCard, Money Order, C.O.D. Checks allow two weeks. Purchase orders and bids welcome. Prices F.O.B. Prairie View, IL.

IBM PC AT, PCjr, PC DOS are trademarks of International Business Machines Corporation. Concurrent DOS is a trademark of Digital Research, Inc. Xebec Owl is a trademark of Xebec, Inc.

DISKS PLUS INC. 15945 West Pope Blvd.
Prairie View, IL 60069
(312) 537-7888

HARMONY COMPUTERS

2357 CONEY ISLAND AVE., (Bet. Aves. T & U) BKLYN, NY 11223
800-VIDEO84 or 800-441-1144 or 718-627-1000

	Commodore 128	PANASONIC 1091			
	\$232.95	\$221.95			
	STAR NX-10	IBM (268)			
	\$219.00	\$1449.00			
"PRINTER SPECIALS"					
Brother HR 15XL	275	NEC P7	559	Star SD 10	264
Brother HR35 (Compatible C4)	399	Datatac 192	319	Star SD 15	386
Cadent MSP 10	239	Datatac 193	454	Star SR 10	418
Epson LX80	219	Datatac 292	456	Star SR 15	539
Epson LQ800	479	Datatac 293	603	SR 19 SR 15 Shorthand	99
Epson LQ 1000	644	Panasonic KXP 1091	272	Star SB 10	189
Epson FX 35	349	Panasonic KXP 1092	299	Star Reed Exp 550	258
Epson 286	479	Panasonic KXP 3131	234	Star Reed Exp 500	158
IBM Proprinter	359	Panasonic KXP 3151	364	Star Reed Exp 800	619
Juki 8100	329	Panasonic KXP 1090	187	Starhite 1340	369
NEC 3250	699	Panasonic KXP 1592	409	Starhite 241	609
NEC 8850	1026	Star Gemini 10K	149	Starhite 251	945
NEC P5	428	Star NX-10	219	Starhite 321	434
		Star SG 15	331		

OPEN SUNDAY

IBM	ATARI	MONITORS
AT Unenhanced	130 XE	Amdek 300 Green
AT Enhanced IBM	65 XE	Amdek 300 Amber
AT Enhanced IBM 30 Meg	1027 Puritan	310 Amber
IBM Monitor	1050 Drive	Color 600
IBM PC No drives	Alan Wang +	Color 722
PC XT 256	Compaq Printer	Princeton MX12
PC XT Clone	520 ST Color System	Princeton MX12E
IBM Pro Printer	ST 520 Keyboard	Princeton Max 12
AST Pro Pack 384K	ST 520 Drive	Princeton Max 12E
Hercules Color	ST 520 B&W Monitor	SR12
Hercules Monochrome	ST 520 Color Monitor	SCAN Doubler
Color Card		Tuzan 220
Multifunction Card		NEC MultiSync
IBM FH	Hayes 1200	COMPAQ
IBM 1.2M	Hayes 1200B w/Smartcom	Portable 256K 7-360K
Terminal Graphics Master	Hayes 300	Compaq Drive
IBM 1.2M	Hayes 2400	Portable 256K 1-360K
AT/XT Chip	Hayes 2400B w/Smartcom	1-2048 Hard
Evesex Graphics v.3pp	Micromodem 2E	Desqtop 540K 1-360K
Evesex Edge	Prometheus 1200	1-2048 Hard
Evesex Graphics Plus	Prometheus 1220B	COMMODORE
Joytech for IBM		Commodore 128
SEAGATE	2E Enhanced w/128K	1571 Drive
Hard Drives	& Apple Drive	Commodore 64
10 Meg w/ controller	Drive	1541 Disk Drive
10 Meg w/ controller		1802 Monitor
30 Meg AT		1802 Monitor
40 Meg AT		4.5SP 400K Printer
20 Meg w/o controller		Compaq Printer

800-441-1144

Some items may be sold or checked out separately. For your protection we check for stolen credit cards.
No C. visit welcome. Personal checks cause 2 wks delay. Shipping & handling charge extra.
Price and availability subject to change without notice.

A Sensible Approach to Digital Typesetting

Why buy an entirely new system, when you can use your PC, any word processor, BYSO™ LaserPRINT, and an HP LaserJet? This delivers the highest quality typography with complete capabilities (including spreadsheets and forms).

BYSO LaserPRINT's strong feature is a library of 110 typefaces, each of which can be set in a variety of sizes. It works automatically, or you can use 80 professional formatting commands to take control.

We also offer BYSO PRINT for most dot matrix printers.

BYSO LaserPRINT or BYSO PRINT, each license \$500, including 8 typefaces. Add \$5 shipping. For sale in the U.S. and Canada only.

Order from
Levlen Instrument Co.
 Sitlington Hill
 Box 31
 McDowell, VA 24458
 Tel (703) 396-3345
 This ad set with
 BYSO PRINT and a
 TOSHIBA P351

*Demo disk
 and
 evaluation
 kit, \$5*

ACCORDING TO WEBSTER

*Apple is apparently
 listening to what users want
 and doing its best to undo
 some of the unfortunate decisions
 made a few years back.*

the old 512K Mac, which has been dropped (the second version of the Macintosh to die within the past two years).

Please don't get me wrong. I am not criticizing Apple for replacing the old 512K-byte Mac with the new one. On the contrary, I think it's a necessary move to make the new ROMs and disk drives the standard. And Apple is wisely providing upgrade paths from the old 512K-byte Mac to the new one and from the old and new 512K-byte Macs to the Mac Plus.

What makes me want to laugh (and sometimes cry) is the memory of the statements that came out of Apple a few years back, defending the machine's closed, limited architecture. The major claim was that programmers would not have to worry (as they supposedly do with, say, the IBM PC) about how much memory or what peripherals or ports the machine had. Instead, developers would always be assured of a fixed configuration.

Now, developers not only have to worry about four different models, they also have to deal with in-between versions caused by partial upgrades: two different keyboards, two different ROM sets (64K and 128K bytes), two different disk capacities (400K and 800K bytes), an optional SCSI port, whether or not HFS (hierarchical file system) is being used, if the +5-volt pin is available on the serial ports (it isn't on any Mac that's been upgraded to the new round serial connectors), and, of course, the amount of RAM available. This gives the Macintosh many of the disadvantages of an open architecture (with which Apple II and IBM PC developers seem to have somehow coped) and none of the advantages.

Again, I'm not really taking shots at the current Apple management, which now seems committed to open-architecture machines. The company is apparently listening to what the users want and doing its best to undo some of the unfortunate decisions made a few years back. I just hope Apple and other firms learn from those mistakes.

IN THE QUEUE

Lots of stuff is lined up for next month. Look for reports on Turbo Prolog from Borland, Lightspeed C, Multi-Forth for the Amiga, and the Supra 20-megabyte hard disk for the Atari ST. Until then, see you on the bit stream.

Thanks to James, Mike, and Mike at Lloyd's Computers for hardware repairs above and beyond the call of duty; to Neil Harris at Atari for his time and patience; and to Lynne Judd for tackling the stables of Augeas (or at least the modern equivalent). ■

Special Purchase
LAP COMPUTER
FULL FACTORY WARRANTY

BUILT IN 300 BAUD MODEM
 Built in speed dial, similar to Lotus Terminal Emulator to Communicate with Personal Computers

IT'S A HANDS FREE PHONE
 Comes with Rechargeable Batteries and Charger. Options Available Serial or Parallel Port Workstation Printer

workSlate
 BY COMBIVISION TECHNOLOGIES

THE MOST PORTABLE TERMINAL

OUR BEST PRICE EVER **\$295.00** ORIGINALLY \$1795.00

INCLUDES FREE SOFTWARE WORTH \$68.00
Intelligence and Consultant Services Software

OTHER SOFTWARE PROCESSES - WITH PURCHASE ONLY

Case Management	\$19.00	Inventory Analysis	\$19.00
Financial Statements	\$19.00	Customer Data	\$19.00
Inventory Management	\$19.00	Inventory Control	\$19.00
Shipping Management	\$19.00	Order Analysis	\$19.00
Time Reporting	\$19.00	Workflow Analysis	\$19.00

15 Day Money Back Guarantee

CEC
 1208 S. Arroyo Blvd. #3
 San Mateo, CA 94402
 800/228-3411

(This state of the art computer comes with two instructional cassettes that take you through the learning process. They contain human voice that tells you which keys to press as you are learning to manipulate information on the screen. This computer also has built-in hardware that lets you look at its services the Dow Jones News retrieval. The Source, MCI Mail, and many other services including thousands of electronic business cards. Dimensions: 8 1/2" x 11 1/2" x 1 1/2" (depth). LCD 48 characters per line, 16 lines. Keyboard, 80 keys. Typewriter-style keyboard and calculator pad. Power, NiCad rechargeable battery. AC adapter/recharger or AA alkaline batteries. Software that includes business management, financial analysis, check calculator and communications store up to 10 worksheets or 45 minutes of audio information.)

FUJITSU PROCESSOR UPGRADE

BY WILLIAM M. RAIKE

UNIX now runs on the Fujitsu with an 80286 chip on board

The majority of personal computers sold in Japan are not designed to be IBM PC-compatible. That holds true for all of the computers in NEC's PC9800 series, as well as for the Fujitsu FM-16 β . Fortunately, however, a considerable amount of U.S.-made software will run on these machines because they run under either MS-DOS or CP/M-86. Both operating systems are enhanced to support the extensive Japanese-language features built into these powerful computers. UNIX-based systems, though, have been scarce at the personal computer level; one exception has been the NEC PC98XA, for which a kanji (Japanese-language) version of Microsoft's XENIX operating system has been available for nearly a year. But recently Fujitsu announced an upgrade of its personal computer series that could make UNIX-based systems less scarce here in Japan.

FUJITSU'S 80286 BOARD

A major factor in my decision to buy the Fujitsu FM-16 β last year was Fujitsu's announcement that an 80286 processor board would be available for the computer shortly. I had welcomed it as an opportunity to use the XENIX operating system. A prototype of the board was in operation at the same computer show where NEC introduced its top-of-the-line 80286-based PC98XA last spring; both ran Microsoft/ASCII's version of XENIX that supports the Japanese language. At long last, Fujitsu has released the new processor board, although its \$500 list price doesn't exactly spur me to rush out and buy one. And the price of Fujitsu's version of XENIX, to be sold separately, hasn't been announced yet but may well be more than \$1000. Having just switched from

CP/M-86 to MS-DOS (see the May BYTE Japan), I'll wait before trying another operating system.

AN UPGRADE OF THE FM-16 β

Fujitsu's introduction of its 80286 processor board is actually a side effect of the company's most recent steps to upgrade the FM-16 β . This computer, based on the 80186 processor, is a powerful machine. I'm very satisfied with the one I bought last year. It can hold up to a full megabyte of RAM and uses an MBL68B09E coprocessor to relieve the main processor of the need to manage the screen and keyboard.

The upgraded Fujitsu FM-16 β comes in four models: the FD I and HD I, and the FD II and HD II. The FD I and HD I are essentially the same as the original FM-16 β models; the FD designation indicates two built-in floppy disk drives, while the HD models incorporate a built-in 10-megabyte hard disk drive. The main difference between the FD I and HD I models and the previous ones (FD and HD) is that the new versions come with a full megabyte of memory as standard, in addition to the standard 192K bytes of graphics video RAM; the older models came equipped with only 512K bytes.

The Japanese-language features of all the models are identical and extensive: They incorporate both the JIS (Japanese Industrial Standard) No. 1 and No. 2 kanji character sets in ROM, with a total of over 6000 characters, in addition to the normal alphanu-

meric character sets and the Japanese katakana phonetic alphabet. (The combination of alphanumeric characters and katakana is often abbreviated in Japanese brochures as the "ANK character set.") They can run

either the CP/M-86 or MS-DOS (version 2.11 or 3.1) operating systems.

The core of the upgrade revolves around the central processor. The new FD II and HD II models incorporate an 80286 processor in place of the 80186 in the FD I and HD I. The 80286, the same processor used in IBM's top-of-the-line PC AT, runs at 8 MHz, the same clock speed as the 80186 in the FD I and HD I models, but it is a substantially more powerful chip. Among other things, its 24-bit addressing capability allows the processor to directly address 16 megabytes of memory. Contrast that with the 8088/8086/80186 chips used in most personal computers these days that can address a maximum of only 1 megabyte. The UNIX operating system and its variants generally perform best in an environment in which substantial amounts of fast disk storage (i.e., hard disk capacity) are available. UNIX can take especially effective advantage of large amounts of semiconductor memory (i.e., RAM disk), which is rapidly becoming inexpensive due to recent advances in large-scale integrated circuit memory technology.

Although the new Fujitsu models are not compatible with IBM's PC AT

(continued)

William M. Raiké, who has a Ph.D. in applied mathematics from Northwestern University, went to Japan in 1980 looking for 64K-bit RAMs. He has been there ever since as a technical translator and a software developer. He can be contacted c/o BYTE, One Phoenix Mill Lane, Peterborough, NH 03458.

computer or its various clones, they can run under MS-DOS and XENIX. The amount of Japanese-language software you can buy is considerable, although it isn't much compared to the volume of software Americans can access if they own a PC AT or clone. Of course, Fujitsu FM-16 β computers have no problems running U.S.-made generic MS-DOS software. And the price of this amount of computing

power is low: At current yen/dollar exchange rates, the FM-16 β HD II model with an 80286 processor, 1 megabyte of RAM, one 1.2-megabyte floppy disk drive, and one 10-megabyte hard disk drive sells for only about \$3765. The dual floppy disk version costs only \$2180. And for the FD I and HD I models the price reductions mean that the second 1/2-megabyte of memory is essentially free compared

to the price of the older models. The dual floppy disk version sells for about \$1895, while the hard disk model goes for about \$3475. These prices are list prices—you can usually find discounts of around 20 percent in Tokyo's electronics district in Akihabara.

A FREQUENT QUESTION

The most frequent question I get from BYTE readers is, What software and/or hardware is available that will allow Japanese-language word processing on an IBM PC or PC clone? Unfortunately, my answer is always brief: To my knowledge, there is no such software and/or board available. The IBM "standard" is no standard at all in Japan, since Japanese personal computer hardware has generally been considerably more powerful and cost-effective than the IBM PC, PC XT, PC AT, or their many work-alikes. Japanese computers incorporate extensive Japanese-language features such as kanji-character ROM and operating system support for the Japanese language, together with some quite powerful graphics features.

Many letter writers asking that question are students and faculty members from American universities. Taking all things into consideration, it seems there would be a significant potential market for equipment (like a kanji ROM board in conjunction with something like the Hercules graphics board on the IBM PC and compatibles) that could work with at least one existing Japanese-language word-processing program for IBM PC owners. As far as I know, no one has approached this market, despite the thousands of boards you can buy for the IBM PC that perform various other specialized functions.

Another important potential market for a combined hardware/software solution to the problem of giving the IBM PC a Japanese-language capability is the growing number of foreign companies that market their products in Japan. For example, one American manufacturer of laboratory instrumentation equipment with a Japanese subsidiary produces a system based on an IBM PC clone. The company installs its proprietary circuit boards,

We Beat The Systems.

Display Telecommunications Corporation was named Best Small Business Exporter in Texas for 1986 because we offer the best IBM® PC clone available. We offer state-of-the-art components and our service reps are always accessible to answer your questions. Beat the systems with DTC.

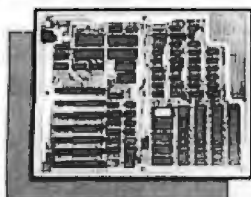

MEGA-BOARD-XT™
The Industry Standard

MEGA-BOARD-AT™
80286 CPU

MEGA-NET™
Token-Passing Ring LAN • IBM NETBIOS Compatible



MULTIPLE INPUT / DUAL OUTPUT SWITCHING BUFFER
4 Computers In—2 Printers Out • Automatically routes Computer to Printer • Internal Buffering 64K or 256K

OEM QUANTITY PRICING AVAILABLE ON REQUEST

XT Bare Board	59.95
XT Assembled 256K	299.95
Mega-Case	69.95
Mega-Kit	775.00
DTC-2 BIOS	29.95
Power Supply	89.95
Switching Buffer	399.00

BIOS licensing.

IBM is a registered trademark of International Business Machines Corporation.



MEGA-KIT™
Motherboard 256K • Case • 130W Power Supply • (2) 1/2 Height Floppy Disk Drives with Controller • Keyboard

BARE-BONES MEGA-KIT™
Same as Mega-Kit but without floppy Disk or Controller

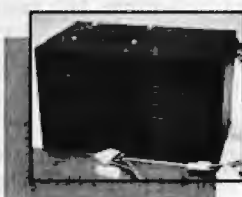

POWER SUPPLY
130 Watt • Rear Power Switch

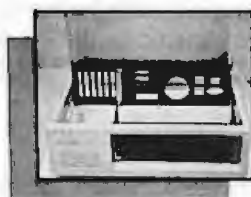

MEGA-CASE™
Flip Top (requires a power supply with a switch in the rear)

Display Telecommunications Corporation

8445 Freeport Parkway • Suite 445 • Irving, TX 75063
1-800-227-8383 • For Technical Calls Only: 1-214-929-1382
TELEX 5106000176 DTC UD

which it then supplies along with its own special-purpose software. Company representatives asked my opinion about their plans to introduce the equipment to the Japanese market, with the idea that the computer could be performing useful tasks (such as word processing or other chores) when it isn't being used for taking laboratory measurements.

Since a computer that has no Japanese-language capabilities (such as the IBM PC) would have minimal usefulness outside the immediate (laboratory instrumentation) application, I felt the company's choices were limited. One might redesign the product around a Japanese personal computer like the NEC PC9801, but the potential market (perhaps one or two hundred systems per year) couldn't possibly justify it. Even for products with larger sales volumes, I can guess that with two separate versions of a product for home and export (i.e., Japanese) markets, the engineering improvements for the export model would take a back seat.

A CHALLENGE

I challenge BYTE readers with entrepreneurial inclinations to approach this problem. It'll take a knowledge of both hardware and software: Designing a kanji ROM board will require familiarity with the IBM PC (or PC XT or PC AT) and demand an awareness of the problems and issues involved in dealing with the Japanese language in computers, especially the state of the art of Japanese word processing. The goal should be to run at least one Japanese word-processing program currently in widespread use on, for example, the NEC PC-9801VM2 computer, substantially as is, on an IBM PC or PC clone that is equipped with a suitable kanji ROM board (and probably a Hercules or equivalent graphics board).

We all hear about the U.S./Japan trade imbalance. Consider that Japanese auto manufacturers can produce right-hand-drive models for their domestic market and left-hand-drive models for export. It would seem that American manufacturing companies make all too few efforts to tailor their

products to the long-term Japanese market. Why not adapt personal computer products to the Japanese market?

The only analogous development I know of for a U.S.-made computer is the DynaMac version of Apple's Macintosh that I wrote about earlier (January BYTE Japan). That machine doesn't really do much to address either of the markets I've mentioned,

since it's not sold in the U.S. and since there are far more third-party hardware/software products available for IBM personal computers than for the Macintosh.

NEXT MONTH

Bill discusses a new trend in Japanese culture that leads him into sharing some interesting highlights of the Microcomputer Show. ■

Scan'n Cut'n Paste PC

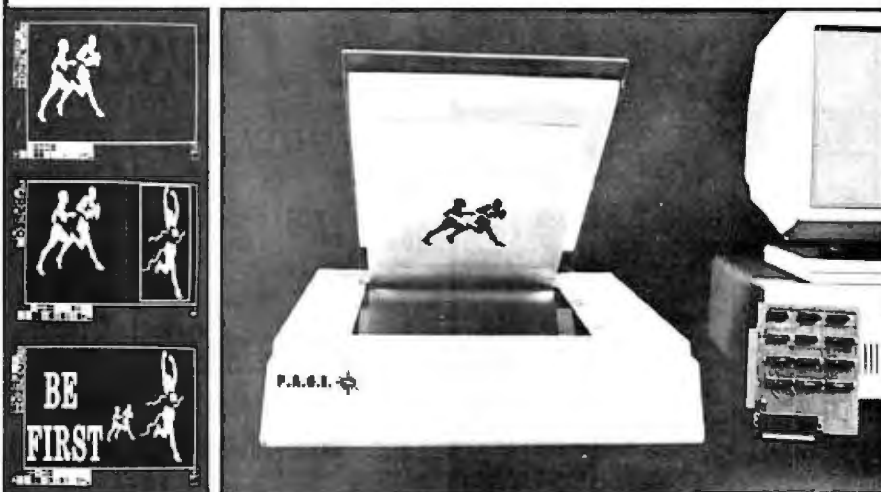

New P.A.G.E. Scanner gives your blind PC the eyes it needs.

Introducing the missing link. The big leap that gives your PC the eyes it needs to capture and enhance existing artwork.

The new P.A.G.E. Scanner takes any photo, flat art, magazine or book and converts them into digitized images. Now you can turn, invert, enlarge, reduce, mirror and even reverse any image, with resolution to 300, 240, 180 or 100 dots per inch, matching laser printer quality.

The possibilities for image manipulation are incredible. There's a zoom feature for fat bit (single pixel) editing, even at a maximum resolution of 90,000 dp sq in.

Hardware Features

- Scans to four resolutions, 100, 180, 240 or 300 dpi.
- Line or halftone.
- Flat bed—easy manipulation of originals.
- Scans books and other dimensional objects.
- 1/2-card interface for IBM PC™, XT™, AT™ and compatibles.
- Compatible with most graphics cards.
- Compatible with most pointing devices.
- Compact and lightweight—15"W x 19"D x 5"H.

- Compatible with most popular dot matrix and laser printers.
- Data file compression saves valuable disk space.
- Runs in virtual page to maximize memory.
- Requires 256K minimum; 640K for high resolution.

Software Features

- Icon driven.
- 20 fonts with text manipulation.
- Grids, filled and unfilled circles, ellipses and boxes, pencil and airbrush, scissors, draw, paint, cut and paste and rubberstamp.
- And even an undo function to instantly correct slip ups.

P.A.G.E. SCANNER

complete with interface, software, cables and user guide.

Just \$2,995⁰⁰

Financing available to qualified buyers. Terms: Major credit cards, checks or money orders. Add sales tax in N.J. Order yours now and give your blind PC the eyes it needs. Call (201) 647-8678 ext. 40. Or send your order to:

P.A.G.E. 
 Printing And Graphic Enhancement
 150 Mt. Bethel Road, Dept. B2
 Warren, NJ 07060

IBM, PC, XT and AT are trademarks of International Business Machines Corporation. Dealer and OEM inquiries invited



NUMBER GAMES

BY ROBERT T. KUROSAKA

Bob teaches some familiar old tricks to a new machine

Here's an old number trick: Start with any four-digit number, say, 3917. Form a new number by arranging its digits in decreasing order, 9731, and another with the digits in increasing order, 1379. Find the difference of these numbers: 8352. Repeat the procedure with 8352: $8532 - 2358 = 6174$. Another repetition produces $7641 - 1467 = 6174$. We see that further repetitions will yield an endless sequence of 6174s.

Questions arise immediately: Will *all* four-digit numbers eventually arrive at this or some other self-replicating value? Which numbers require the most steps before they are repeated? It turns out that *all* four-digit numbers (except multiples of 1111) will reach 6174 in at most seven steps.

Many similar procedures exist for generating repeating sequences, and some of them produce startling results. Computers make the job of exploring them far easier than the manual method.

What's the purpose of this intellectual thumb-twiddling, you ask. Hardly ever a practical one, I admit, but after all, the name of this column is "Mathematical Recreations."

This month I'll look at several number-sequence games, providing BASIC programs that check them out. (Readers are also encouraged to seek ways of improving on my solutions.)

In all cases, the term *number* will mean *positive integer*.

SUM OF CUBES

Start with any number, say, 352. Find the sum of the *cubes* of its digits: $3^3 + 5^3 + 2^3 = 160$. Repeat the procedure with 160: $1^3 + 6^3 + 0^3 = 217$, which in turn gives $2^3 + 1^3 + 7^3 = 352$. We already find ourselves in a loop: (160, 217, 352).

Listing 1 is a program that performs the sum-of-cubes routine on any set of consecutive numbers. For a particular *n*, it prints the consecutive sums of cubes until a loop is found. Readers may wish to modify the program later, perhaps suppressing the actual terms and printing out only the number of steps taken and the type of loop.

It has been proved that all numbers will eventually reach one of several loops. I have seen the proof in a Mathematical Association of America journal, but I cannot find that article, nor do I remember the proof.

The following are a few of the known loops: three-step: (55, 250, 133); two-step: (136, 244) and (919, 1459); one-step: (153), (370), (371), and, of course, (1).

After exploring the sum-of-cubes procedure, readers may wish to investigate other powers or even other number bases.

FACTORIAL SUMS

Start with any number, say, 169. Find the sum of the *factorials* of its digits: $1! + 6! + 9! = 363601$. Repeat the process: $3! + 6! + 3! + 6! + 0! + 1! = 1454$. Then, $1! + 4! + 5! + 4! = 169$, and we have already found a loop: (169, 363601, 1454).

I have examined all numbers less than 1000 and found that nearly all of them enter this particular loop. You will also find some one-step loops, since $1 = 1!$, $2 = 2!$, and $145 = 1! + 4! + 5!$. Some two-step loops are (871, 45361) and (872, 45362).

Listing 2 calculates the sum of factorials for any range of numbers. When numbers are set for 10-digit precision, the program can handle starting values up to 9999999999. But even this giant yields $10 \times 9! = 3628800$. As long as we limit the argument to 10 digits at most, no result will exceed 7 digits. Of course, if double precision is available, the program can be adapted to work with even larger numbers.

PALINDROMIC SUMS

It has been said that the first man introduced himself to the first woman with a palindrome: "Madam, I'm Adam!" Not to be outdone, she replied in kind: "Eve."

Now we'll go searching for sequences that produce numeric palindromes, that is, numbers that read the same forward and backward.

Start with any number, say, 48. Reverse its digits and add the result to the original number: $48 + 84 = 132$. Repeat the procedure: $132 + 231 = 363$, a palindrome.

All numbers may eventually produce palindromes using this reverse-and-add routine—but that remains to be proved. Some numbers are known to require many steps: for example, 89 requires 24 steps.

Charles W. Trigg, presently book review editor for the *Journal of Recreational Mathematics* and a prolific contributor to numerous mathematics publications, found only 249 numbers less than 10,000 that require more than 100 steps to reach a palindrome. Among them is the dreaded 196, which has been taken to *hundreds of*

(continued)

Robert T. Kurosaka teaches mathematics in the Massachusetts State College system. He can be reached clo BYTE, One Phoenix Mill Lane, Peterborough, NH 03458.



MEMORIES

**ADD-IN BOARDS
PIN-FOR-PIN COMPATIBLE
EASY INSTALLATION**

**HP 150
HP 1000
HP 3000
WANG PC**

GFK

Amandestr. 60, 2000 Hamburg 6
West Germany

Phone (40) 4301051 Telex 2162272

Dealers are invited

US Distributor:

HyPoint Technology (216) 526-0323

Inquiry 328

COLOR

VT220 \$150*

*plus your
PC, jr, XT, AT or compatible

ZSTEMpc-VT220 Smart Terminal Emulator
132-col. by windowing - no addit. hardware
Double High Double Wide Characters
Full VT100 line graphics. Smooth scrolling
2-way file transfers incl. XMODEM and KERMIT
Full keyboard solitkeys/MACROS
Data rates to 38.4KB. High Throughput
Colorgraphics, monochrome & EGA support
International Font Support • DOS Access
ISO and attribute mapped color
ZSTEMpc-VT220 \$150. 4010/4014 Option \$99
ZSTEMpc-VT100 — Choice of the U.S. Airforce
30 day money back guarantee. MCVISA

KEA SYSTEMS LTD.

#412 - 2150 W Broadway
Vancouver, B.C. CANADA V6K 4L9
Support (604) 732-7411
TELEX 04-352848 VCR

Order Toll Free (800) 663-8702

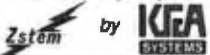

Inquiry 323

OC8000

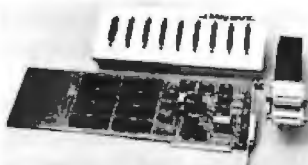

**EXPANDS PC
PERFORMANCE AT A FRACTION
OF NETWORKING COST**

- Adds four to eight serial communication ports to IBM PC, XT, AT or compatibles.
- Standard RS-232 or optional RS-422 ports for increased transmission speed and distance.
- Supported by Xenix, Multi-Link, RTCS, QNX, and other multi-user, multi-tasking operating systems.

STAR GATE TECHNOLOGIES, INC.

Suite 109
33800 Curtis Blvd. • Eastlake, OH 44094
Call: (216) 951-9922

Inquiry 280

NUMBER GAMES

thousands of steps with no palindrome in sight. The same is true for its "cousins," 295 and 394.

Listing 3 investigates palindromic sums for any range of numbers. The lower limit for the sequence is 11, and there is no explicit upper limit. It does not have safeguards against dubious numbers like 196 that produce very

long sequences. Improvements are left to the reader's ingenuity.

DELETE AND ADD

One of my favorites is the delightful little marvel shown in the sample run of listing 4. Begin by listing the whole numbers 1 through n . You then delete

(continued)

Listing 1a: The BASIC program to produce cube sums until a cycle is found.

```

10 REM Sum of Cubes
20 REM by Bob Kurosaka
30 REM -----
40 DIM A(10),B(100) :REM A() holds digits, B() holds sums.
50 CLS
60 PRINT "Program generates sequences of cube sums."
70 PRINT
80 PRINT "Lower limit, upper limit ";
90 INPUT LL, UL
100 LL=ABS(INT(LL))
110 UL=ABS(INT(UL))
120 REM -----
130 FOR N=LL TO UL :REM Sequences for each no. LL to NN
140 SP=0 :REM SP counts the steps before a cycle
150 B(SP)=N :REM Make the first term=N
160 PRINT B(SP): :REM Print the current term
170 M=B(SP) :REM Make a copy of latest term
180 REM -----
190 REM Break up the term into its component digits
200 D=1 :REM D = no. of digits
210 T=INT(M/10) :REM T = no. of "Tens" in M
220 A(D)=M-10*T :REM Store rightmost digit in array A
230 IF T<>0 THEN D=D+1: M=T: GOTO 210
240 REM -----
250 REM Calculate the sum of the cubes of the digits in A()
260 SUM=0
270 FOR I=1 TO D
280 SUM=SUM+A(I)*A(I)*A(I)
290 NEXT I
300 REM See if sum has occurred already.
310 I=0
320 WHILE B(I) <> SUM AND I <= SP
330 I=I+1
340 WEND
350 IF B(I)=SUM AND I <= SP THEN 400
360 SP=SP+1 :REM one more step
370 B(SP)=SUM :REM Store SUM in array B
380 GOTO 160
390 REM -----
400 PRINT SUM; "* loops to step "; I
410 NEXT N
420 END

```

Listing 1b: A sample run.

Program generates sequences of cube sums.

```

Lower limit, upper limit ? 21, 25
21 9 729 1080 513 153 153 * loops to step 5
22 16 217 352 160 217 * loops to step 2
23 35 152 134 92 737 713 371 371 * loops to step 7
24 72 351 153 153 * loops to step 3
25 133 55 250 133 * loops to step 1
Ok

```

NUMBER GAMES

Listing 2a: The BASIC program to produce factorial sums until a cycle is found.

```

10 REM Sum of Factorials
20 REM by Bob Kurosaka
30 REM -----
40 DIM A(10),B(100),F(10)
50 DATA 1,1,2,6,24,120,720,5040,40320,362880
60 FOR J=1 TO 10
70 READ F(J)
80 NEXT J
90 CLS
100 PRINT "Program generates factorial sum sequences."
110 PRINT
120 PRINT "Lower limit, upper limit ";
130 INPUT LL, UL
140 LL=ABS(INT(LL))
150 UL=ABS(INT(UL))
160 REM -----
170 FOR N=LL TO UL :REM Sequences for each no. LL to NN
180 SP=0 :REM SP counts the steps before a cycle
190 B(SP)=N :REM Make the first term=N
200 PRINT B(SP); :REM Print the current term
210 M=B(SP) :REM Make a copy of latest term
220 REM -----
230 REM Break up the term into its component digits
240 D=1 :REM D = no. of digits
250 T=INT(M/10) :REM T = no. of "Tens" in M
260 A(D)=M-10*T :REM Store rightmost digit in array A
270 IF T<>0 THEN D=D+1: M=T: GOTO 250
280 REM -----
290 REM Calculate the sum of the factorials of digits in A()
300 SUM=0
310 FOR I=1 TO D
320 SUM=SUM+F(A(I)+1)
330 NEXT I
340 REM See if sum has occurred already.
350 I=0
360 WHILE B(I)<>SUM AND I<=SP
370 I=I+1
380 WEND
390 IF B(I)=SUM AND I<=SP THEN 440
400 SP=SP+1 :REM one more step
410 B(SP)=SUM :REM Store SUM in array B
420 GOTO 200
430 REM -----
440 PRINT SUM; "* loops to step "; I
450 PRINT
460 NEXT N
470 END
    
```

Listing 2b: A sample run.

Program generates factorial sum sequences.

```

Lower limit, upper limit ? 24, 27
24 26 722 5044 169 363601 1454 169 * loops to step 4

25 122 5 120 4 24 26 722 5044 169 363601 1454
169 * loops to step 9

26 722 5044 169 363601 1454 169 * loops to step 3

27 5042 147 5065 961 363601 1454 169 363601 * loops
to step 5
    
```

Ok

SAVE MONEY EPROM PROGRAMMER

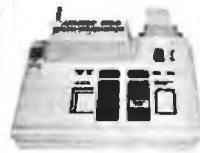

APROTEK 1000
ONLY

\$265.00

COMPLETE WITH
PERSONALITY
MODULE

117 AC POWER-RS-232 CONNECT
-8 BAUD RATES - HANDSHAKE TO HOST
ALLOWS READ, WRITE, VERIFY & COPY

Comes complete with IBM-PC, Apple, or CPM
(Specify Computer) Driver Program on Disc.

Programs the following 5 Volt 24 or 28 pin
devices: 2716 series through 27512, 26xx series,
58764 plus others. Please Specify Personality
Module desired with order. Additional Personality
Modules only \$15.00 ea. Full 1 year warranty.

TO ORDER CALL 1 800 962 5800 OR WRITE

APROTEK

1071 A AVENIDA ACASO

Add

CAMARILLO, CA 93010 \$4.00 Shipping USA

Info (805) 987 2454 VISA or MC Add 3%

We Accept Govt., School & Large Corp. P.O.s

Inquiry 23

9-TRACK MAG. TAPE SUBSYSTEM FOR THE IBM PC/XT/AT



For information interchange, backup and archival storage,
IBCX offers a 9-track, IBM format-compatible 1" magnetic
tape subsystem for the IBM PC.

■ 42 M-Bytes on a single
reel.

■ IBM format 1800 cpl.

■ Software for PC-DOS,
MS-DOS.

Write, phone or FAX
for information

IBCX

IBCX COMPUTER CORP.
20741 Mariposa St.
Chesapeake, CA 91311
(818) 705-8100
FAX 818-883-2071

Inquiry 135

64K ■ 128K ■ 256K

DRAMS

80287-8 ■ 80287-3

8087-3 ■ 8087-2

8087-1

BITTNER

BE
ELECTRONICS

899 SOUTH COAST HIGHWAY
LAGUNA BEACH, CA 92651
(714) 497-6200
CALL NOW FOR FREE CATALOG

Inquiry 40

ROSE DATA SWITCHES
ELECTRONICS



SHARE computers, printers, any parallel or serial device
ELIMINATE cable swapping
INEXPENSIVE way to network
COMPATIBLE with all computers
Businesses, Schools, Homes

WE ALSO OFFER:
Data Buffers, Line Drivers
Modems, Protocol Converters,
Parallel - Serial Converters,
Cables, Computers, Printers,
Disk Drives, and more

AUTOMATIC - CARETAKER is ideal for a business or school to share a printer or modem among many computers. Operation is fully automatic with no software required.
Parallel or Serial 4 channels - \$285 8 channels - \$395

MANUAL - HARD SWITCH is operated with the flip of a switch. 2-2 and 2-4 models allow simultaneous communication.

Serial 1-2 - \$59 1-4 - \$ 89 2-2 - \$109 2-4 - \$169
Parallel 1-2 - \$79 1-4 - \$139 2-2 - \$119 2-4 - \$199
LED and spike protection on serial models add \$20.

CODE ACTIVATED - PORTER connects one computer to multiple peripherals. A software code selects the peripheral.
Parallel or Serial 4 channels - \$295 8 channels - \$395
Buffer option 64K - \$100 256K - \$250

REMOTE - TELEPATH connects multiple computers to multiple peripherals. A selector at each computer or terminal chooses up to 4 peripherals and displays busy status.
4-4 - \$485 4-8 - \$785 selector - \$30

Give a Rose to your computer

ROSE ELECTRONICS (713) 933-7673
P.O. BOX 742571 MC & VISA Accepted
HOUSTON, TX 77274 Dealer inquiries invited
CALL US FOR ALL YOUR INTERFACE NEEDS

Inquiry 254

DATA ACQUISITION TO GO
INTERFACE FOR ANY COMPUTER
FREE IBM SOFTWARE



Connects via RS-232. Fully IBM compatible. Built-in BASIC. Stand alone capability. Expandable. Battery Option. Basic system: 16 ch. 12 bit A/D, 2 ch. D/A, 32 bit Digital I/O. Expansion boards available. Direct Bus units for many computers.

(201) 299-1615
P.O. Box 246, Morris Plains, NJ 07950

ELEXOR

Inquiry 103

Get the whole story on graphics terminal emulation.



To find out more about software that lets your PC emulate **TEKTRONIX™ 4105/6/7/9** and **DEC VT100™** terminals, call or write:

GRAFFPOINT
4340 Stevens Creeks Blvd., Suite 280,
San Jose, CA 95129 (408) 249-7951

Inquiry 125

Listing 3a: The BASIC program to find palindromes by adding a number to its reverse image and repeating the process with the resulting sum.

```

10 REM Palindromic Sums
20 REM by Bob Kurosaka
30 REM -----
40 SP$=" " :REM One space inside quotes
50 D$="0123456789"
60 YES=(1=1)
70 DIM A(100) :REM A() holds the digits.
80 CLS
90 PRINT"Program generates sequences ending in palindromes."
100 PRINT
110 PRINT "Lower limit (>10) and upper limit ";
120 INPUT LL, UL
130 LL=ABS(INT(LL))
140 UL=ABS(INT(UL))
150 IF LL<10 THEN 110
160 FOR N=LL TO UL
170 SP=0 :REM SP counts the steps before a cycle
180 REM -----
190 REM Break up the term into its component digits
200 M=N :REM Make a copy of latest term
210 D=1 :REM D = no. of digits
220 T=INT(M/10) :REM T = no. of "Tens" in M
230 A(D)=M-10*T :REM Store rightmost digit in array A
240 IF T<0 THEN D=D+1: M=T: GOTO 220
250 ODD=ABS((INT(D/2)<>D/2)) :REM Even or odd no. of digits?
260 REM -----
270 REM Print the latest term
280 FOR I=D TO 1 STEP -1
290 PRINT MID$(D$,A(I)+1,1);
300 NEXT I
310 PRINT SP$;
320 REM -----
330 REM Check for palindrome
340 FOR I=1 TO D/2
350 PL=(A(I)-A(D-I+1))
360 IF NOT PL THEN I=D/2 :REM Exit if not a palindrome
370 NEXT I
380 IF PL THEN 580
390 REM -----
400 REM Add each digit to its reverse image counterpart
410 FOR I=1 TO D/2+ODD
420 A(I)=A(I)+A(D-I+1)
430 A(D-I+1)=A(I)
440 NEXT I
450 REM Check for carry
460 FOR I=1 TO D
470 IF A(I)<10 THEN 500
480 A(I)=A(I)-10
490 A(I+1)=A(I+1)+1
500 NEXT I
510 IF A(D+1)=0 THEN 540
520 D=D+1
530 ODD=ABS((INT(D/2)<>D/2))
540 SP=SP+1
550 GOTO 280
560 REM -----
570 REM Indicate that a cycle has been found
580 PRINT "* at step "; SP
590 FOR I=1 TO D
600 A(I)=0
610 NEXT I
620 NEXT N
630 END
    
```

(continued)

SAVE 50% *



- United States One Year \$21 2 Years \$38 3 Years \$55
Canada/Mexico One Year U.S. \$23 2 Years U.S. \$42 3 Years U.S. \$61
Europe \$69 (air delivery). U.S. Funds enclosed
Worldwide \$37 (surface mail). U.S. Funds enclosed

BILL ME If I'm not completely satisfied with my first copy, I'll simply write "cancel" across your invoice, mail it back, and my subscription will be cancelled.

Check Enclosed Bill VISA Bill Mastercard

Please allow 6-8 weeks for processing your subscription.

Name _____ 4286

Address _____

City/State/Zip _____

Card # _____ Expires _____

Signature _____

* off newsstand price of \$42.00



SAVE 50% *

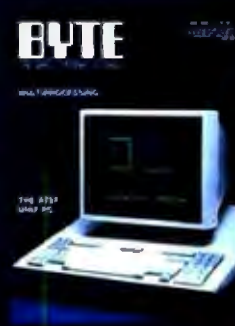

- United States One Year \$21 2 Years \$38 3 Years \$55
Canada/Mexico One Year U.S. \$23 2 Years U.S. \$42 3 Years U.S. \$61
Europe \$69 (air delivery). U.S. Funds enclosed
Worldwide \$37 (surface mail). U.S. Funds enclosed

BILL ME If I'm not completely satisfied with my first copy, I'll simply write "cancel" across your invoice, mail it back, and my subscription will be cancelled.

Check Enclosed Bill VISA Bill Mastercard

Please allow 6-8 weeks for processing your subscription.

Name _____ 4286

Address _____

City/State/Zip _____

Card # _____ Expires _____

Signature _____

* off newsstand price of \$42.00





NO POSTAGE
NECESSARY
IF MAILED
IN THE
UNITED STATES

BUSINESS REPLY MAIL

FIRST CLASS PERMIT NO. 39 MARTINSVILLE, NJ

POSTAGE WILL BE PAID BY ADDRESSEE

BYTE

Subscription Dept.

P.O. Box 597

Martinsville, NJ 08836-9956



NO POSTAGE
NECESSARY
IF MAILED
IN THE
UNITED STATES

BUSINESS REPLY MAIL

FIRST CLASS PERMIT NO. 39 MARTINSVILLE, NJ

POSTAGE WILL BE PAID BY ADDRESSEE

BYTE

Subscription Dept.

P.O. Box 597

Martinsville, NJ 08836-9956

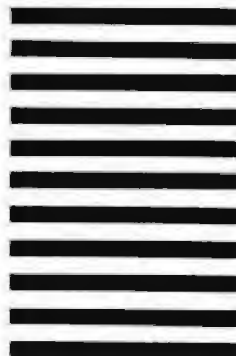

NUMBER GAMES

Listing 3b: A sample run.

Program generates sequences ending in palindromes.

Lower limit (>10) and upper limit ? 75, 80

```
75 132 363 * at step 2
76 143 484 * at step 2
77 * at step 0
78 165 726 1353 4884 * at step 4
79 176 847 1595 7546 14003 44044 * at step 6
80 88 * at step 1
```

Ok

Listing 4a: The BASIC program to perform the delete-and-add routine for any integral power.

```
10 REM Delete and Add
20 REM by Bob Kurosaka
30 REM -----
40 N=50 :REM N=number of integers in starting sequence.
50 DIM SF$(3), A(N) :REM SF$( ) = suffixes, A( ) = sequence.
60 DATA nd, rd, th
70 FOR J=1 TO 3: READ SF$(J): NEXT J
80 REM -----
90 CLS
100 PRINT "Program uses a delete-and-add process"
110 PRINT "to generate I^p for I=1 to ";N; "/ p."
120 PRINT: INPUT "Enter a value for p (power)"; P
130 P=ABS(INT(P))
140 IF P<2 THEN 100
150 REM -----
160 PRINT: PRINT "Starting sequence:"
170 FOR I=1 TO N
180 A(I)=I
190 PRINT I;
200 NEXT I
210 PRINT
220 REM -----
230 FOR R=P TO 2 STEP-1
240 DC=0 :REM Counts the terms deleted.
250 FOR J=R TO N STEP R :REM Delete every Jth term
260 A(J)=0
270 DC=DC+1
280 NEXT J
290 REM -----
300 REM Print deleted array
310 WSF=SGN(R-3)+2 :REM Select suffix
320 PRINT: PRINT "Delete every "; R; SF$(WSF); " term:"
330 FOR I=1 TO N
340 IF A(I)<>0 THEN PRINT A(I); ELSE PRINT "*";
350 NEXT I
360 REM -----
370 REM Compute Partial Sums
380 K=1
390 FOR J=2 TO N-DC :REM There will be N-DC valid numbers.
400 K=K+1 :REM K points to next term to be added.
410 IF A(K)=0 THEN K=K+1 :REM Skip zero (deleted) terms.
420 A(J)=A(J-1)+A(K) :REM Calculate partial sum.
430 NEXT J
440 N=N-DC :REM Revise the number of valid terms in A().
450 REM -----
460 REM Print Partial Sums
470 PRINT: PRINT: PRINT "Partial sums:"
```

(continued)

ROBOTICS — SCIENTIFIC BUS

For IBM PC/XT/AT/compatibles, Apple II...



The Local Applications Bus

- Host Adapter Module: approach to data acquisition and control. A 40 conductor ribbon cable bus is generated by a host adapter card. Up to 8 low cost Modules can be located anywhere on a cable up to 100 ft long. Bus features DMA, interrupts, 16 data bits. Open & non-proprietary. Host adapter card, utility software & manual \$160
- Fast A/D Module: 80K samples/sec, 8 bit, four differential channels, programmable gain & offset, EEPROM. Complete package with Scope program host adapter, Fast A/D Module & cable \$500. FFT available
- 12 Bit A/D Module: four channels, 10K samples/sec, int. amp \$230
- Port/Walky Module: fit standard utility rack, 24 bits I/O, interrupt
- Clock Module: Real time & periods, battery, interrupts, software
- Four Axis Stepper Motor Driver Module: 15V @ 1.5A/phase motor. Full step, half step, brake, free wheel. Software & motor excluded \$32
- Smart Dual Axis Motor Control Module: For DC, brushless or stepper motor drives & encoders. Processors from HP allow changes & monitoring on the fly. Optically isolated. Call for low cost.
- Unique in LAB 60 is an ability to efficiently interface directly to chips, such as co-processors & converters, with the latest hardware & software developed. Call for more info or order our Projectbook.
- LAB 60 Projectbook: 10 hardware and software projects with IBM PC \$25

Computer Continuum

75 Southgate Ave., Suite 6 • Daly City, CA 94015
(415) 755-1278

6809 Single Board Computer

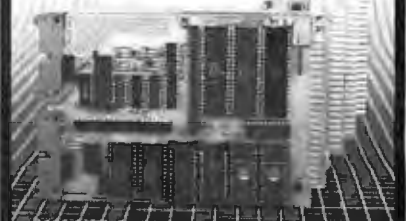

6809 MPU, 2 serial ports, 4 parallel ports,
RAM, EPROM, real-time clock, watchdog
timer, 44-pin 4.5" x 6.5" PCB
EXPANSION MODULES: RAM, EPROM, CMOS
RAM/battery, analog I/O, serial I/O,
parallel I/O, counter/timer, IEEE-488,
EPROM programmer, floppy disks,
cassette, breadboard, keyboard/display.



Wintek Corp
1801 South Street
Lafayette, IN 47904
317-742-8428

Inquiry 318

9-Track Tape Subsystem



Now you can exchange data files between your IBM PC/XT/AT and any mainframe or minicomputer using IBM compatible 1600 BPI 9-Track tape. Unit can also be used for disk backup and archival storage. Transfer rate is one megabyte per minute on PCs and 100% compatibles. Subsystems include 7" or 10 1/2" streaming tape drive, tape coupler card and DOS compatible software. Prices start at \$3,555.

QUALSTAR

9015 Eton Ave., Canoga Park, CA 91304
Telephone: (818) 882-5822

Inquiry 246

```

480 FOR I=1 TO N
490 PRINT A(I);
500 NEXT I
510 PRINT
520 NEXT R
530 END
    
```

Listing 4b: A sample run.

Program uses a delete-and-add process to generate i^p for $i=1$ to $50/p$.

Enter a value for p (power)? 4

Starting sequence:

```

1 2 3 4 5 6 7 8 9 10 11 12 13 14 15 16 17
18 19 20 21 22 23 24 25 26 27 28 29 30 31 32
33 34 35 36 37 38 39 40 41 42 43 44 45 46 47
48 49 50
    
```

Delete every 4th term:

```

1 2 3 * 5 6 7 * 9 10 11 * 13 14 15 * 17 18 19 *
21 22 23 * 25 26 27 * 29 30 31 * 33 34 35 * 37 38
39 * 41 42 43 * 45 46 47 * 49 50
    
```

Partial sums:

```

1 3 6 11 17 24 33 43 54 67 81 96 113 131 150
171 193 216 241 267 294 323 353 384 417 451 486
523 561 600 641 683 726 771 817 864 913 963
    
```

Delete every 3rd term:

```

1 3 * 11 17 * 33 43 * 67 81 * 113 131 * 171 193 * 241
267 * 323 353 * 417 451 * 523 561 * 641 683 * 771 817
* 913 963
    
```

Partial sums:

```

1 4 15 32 65 108 175 256 369 500 671 864 1105
1372 1695 2048 2465 2916 3439 4000 4641 5324 6095
6912 7825 8788
    
```

Delete every 2nd term:

```

1 * 15 * 65 * 175 * 369 * 671 * 1105 * 1695 * 2465 * 3439 *
4641 * 6095 * 7825 *
    
```

Partial sums:

```

1 16 81 256 625 1296 2401 4096 6561 10000 14641
20736 28561
    
```

Ok

The delete-and-add process produces a power sequence.

every fourth term and list the partial sums of the remaining terms (see figure 1 for an explanation). Now delete every third term and again list the partial sums. Then delete every second term and list the partial sums one last time.

We stop at this point (we wouldn't delete every term, would we?) and note the remarkable results: The sequence consists of the fourth powers of the whole numbers.

This procedure generalizes to n th powers (begin by deleting every n th term, and so on). It was discovered by Alfred Moessner in 1951 and proved by Oskar Perron in the same year. A thorough treatment can be found in "On the Moessner Theorem on Integral Powers" by C. T. Long in the *American Mathematical Monthly*, vol. 73 (1966), pages 846-851.

Listing 4 performs the above delete-and-add routine for any integral power. For larger powers, the initial list of whole numbers should be extended in line 40. (Hint: For the n th power, only $1/n$ th of the list will remain to the conclusion.) For very large powers, the use of extended or double precision may be in order.

I hope you find these procedures and their results as enjoyable as I do. I would welcome any references and sources on these or other number sequences. ■

Series with every fourth term deleted

New series composed of partial sums



Figure 1: In the delete-and-add program, partial sums are taken to produce a new sequence of terms. The first term is unchanged. The second term is added to the first term to produce a new second term. That new term is added to the third term to produce a new third term, and so forth.

(continued from page 24)

word silly is not an identifier; it is a *tag* and is conceptually in a disjoint symbol table from identifiers. Were the self-referential item next not included in the structure, the tag could even be omitted. However, if I want to refer to the structure in other files (e.g., in extern declarations), I am forced to write stuff like

```
extern struct silly s3, s4;
```

that is, the tag itself is not a type. It has to be preceded by the word `struct` or `union`. The use of `typedef` offers a neater notation, to wit:

```
typedef struct thing{
    int a;
    char b[6];
    struct thing *nest;
} Silly;
silly s1, s2;
```

That is, Silly becomes an actual type name. It should be mentioned that the C++ language removes much of the need for `typedef` by making the tag itself an actual type.

Now, why is all of this important? In a large program, composed of many inde-

pendently compiled files, the only way to prevent accidental type incompatibilities is to put the global information in header files that get brought into desired source files by use of the `#include` directive. This information consists of constants and macros defined by `#define`, all type declarations, and all external variable declarations. In particular, global structures and unions will need such declarations, and the cleanest and easiest organization is to have separate header files for those declarations that do not reference allocated memory, like `#define` and `typedef`, and for those that do, like extern declarations for variables and functions. It is in the context of such organization that `typedef` makes for easier reading. It goes without saying that the first thing one must do before reading an unfamiliar program is to print out the header files and tack them to the nearest wall.

HERBERT KANNER
Palo Alto, CA

I was interested to learn some of the history of UNIX and C from Mr. Kanner's letter. I have never used C on a minicomputer system running the UNIX operating

system and was not aware that enumeration data types were part of that environment.

Variations in C was written for micro-computer programmers, and all of my C programming experience is on CP/M and MS-DOS micros. The compilers and interpreters I have used on these systems have kept close to the K&R standards of the C language, which do not use the enumeration data type or void declarator. Presumably, this situation will change once the proposed ANSI C standard is finalized.

I agree with Mr. Kanner that judicious use of the #define preprocessor command is a useful programming technique. The one thing that bothered me in Variations in C was the use of #define and typedef to create synonyms for C's reserved storage-class keywords. I want to emphasize that this is personal predilection I have. The technique that Mr. Kanner suggests, tacking up the header files on the nearest wall when you begin working with an unfamiliar program, is a good suggestion that helps to get around the problem of struggling with someone

(continued)

PC Scheme— a simple, modern LISP for under \$100.

Texas Instruments presents PC Scheme, the \$95* solution to your symbolic processing needs.

Whether you're an experienced LISP user, or just beginning to discover the power of symbolic programming languages, PC Scheme is the right product for you. It runs on IBM® Personal Computers, as well as the TI Professional Computer family, including the Business-Pro™ computer.

Powerful features include an optimizing incremental compiler for ease of programming and fast execution; an EMACS-like editor; extensions for debugging, graphics, and windowing; DOS-CALL capability; and a programming system for the development of object-oriented

applications—all designed to work efficiently on personal computers.

To order, or for more information, call toll-free:

1-800-527-3500

*Suggested list price.
Business-Pro is a trademark of Texas Instruments Incorporated.
IBM is a registered trademark of International Business
Machines Corporation.

**TEXAS
INSTRUMENTS**

Creating useful products
and services for you.

©1986 TI 261765-02

else's "intuitive" redefinitions of C's reserved keywords.

—JOHN D. UNGER

MORE ON PAN-REIF ALGORITHM

"The Inversion of Large Matrices" by Thomas E. Phipps Jr. (April) was interesting. Pan and Reif's important contribution is that of providing an initial approximation to the inverse that permits the Newton iteration algorithm to always converge. This can be important for parallel

processing. It is not appropriate, however, to use this algorithm for serial processing.

As a general rule, direct methods are more efficient than iterative methods. For matrix inversion there exist a number of good algorithms (Gauss, Gauss-Jordan, Cholesky) that involve far fewer arithmetic operations (for serial processing) than the Pan-Reif algorithm. To be specific, matrix inversion with Gaussian elimination requires about n^3 multiplications and an equal number of additions. Given that

multiplications are slower than additions, they control the speed of the algorithm. Each iteration of the Pan-Reif algorithm needs two n^3 multiplications. If we iterate ten times (which seems conservative) we do twenty times more work than with Gaussian elimination. And if a microcomputer "poops out" with Gaussian elimination, it will also poop out with other algorithms. The accuracy of the computed inverse depends on the condition number of the matrix. If this number is high, the matrix is ill-conditioned and no method will calculate an accurate inverse. As an example, consider a 20 by 20 Hilbert matrix. These matrices are notoriously ill-conditioned, and both Gaussian elimination and the Pan-Reif algorithm compute garbage when trying to invert them. A good use of the Newton iteration is to improve the accuracy of an inverse matrix calculated by some other algorithm, such as Gaussian elimination. Suppose we are working in single precision, which on our particular computer gives seven decimal digits of precision, and that the condition number of the matrix to be inverted is 10^3 . The elements of the computer inverse will be accurate to about four digits. A few iterations of the Newton method (about three) will produce an inverse to full single-precision accuracy if we express the Newton method in the form:

$$B_n + I = B_n + B_n (I - AB_n)$$

As Forsythe and Moler (*Computer Solution of Linear Algebraic Systems*, Prentice-Hall, 1967, pages 78 and 79) point out, it is crucial to calculate the matrix inner products in AB_n with double precision and to calculate the correction $B_n (I - AB_n)$ separately and then add it to B_n .

Rather than regard the Pan-Reif algorithm as a practical one for matrix inversions on microcomputers, I think its most important use is pedagogical. As author Phipps mentions, it is fun to see the Newton iterates converge. It can also be instructive. Start first with a well-conditioned matrix: A unit matrix with random noise distributed between -0.1 and 0.1 added to the elements will do nicely. The Newton iterates will converge with a very small error term. Then try the algorithm with a 10 by 10 Hilbert matrix. Single precision fizzles completely, whereas double precision converges with an error term of about 10^{-6} (on a VAX-11/780). Now try a 20 by 20 Hilbert matrix. Not even double precision works now. I can think of no more illuminating demonstration of the effect of the condition number of a matrix on the inversion process.

RICHARD BRANHAM
Mendoza, Argentina ■

Finally, a language that spans the generation gap.



The language of solutions

There's only one reason for you to learn a new language—to do your work better and faster. That's exactly what the Arity/Prolog development environment will help you do. Our powerful tools, based on the general purpose programming language Prolog, will speed up your development time significantly and allow you to solve a whole new range of problems.

No translation required

What good is a new language if you have to translate all of your existing programs to use it? With Arity/Prolog, you can start speaking a fifth generation language today without giving up the languages you're comfortable with.

Our development environment for the IBM PC family and all MS-DOS compatibles gives you Arity/Prolog, Arity/Expert System, Arity/SQL, and an interface with C, Pascal, Fortran, and Assembly, so you can build right on to your existing applications. You'll be truly multilingual—what better way to span the generation gap?

It can take you to new places

You'll discover amazing speed, power, and flexibility using the Arity/Prolog programming environment, with its one gigabyte virtual memory, for conventional applications.

And if you're working in new territories, like expert systems, natural language, or sophisticated database management systems, you'll be speaking the native tongue.

Speak it Freely

Our products are not copy protected and we charge no royalties, so you can use them in as many end-user applications as you'd like. Why keep the language of solutions all to yourself?

ARITY CORPORATION
358 Baker Ave., Concord, MA 01742 U.S.A.
617-371-1243

Yes, I'd like to be fluent in the language of solutions. Please:

Send me information on Arity products Add me to your mailing list.

Name _____ Title _____

Company _____

Address _____

City _____ State _____ Zip _____

Telephone _____

0069a

Conducted by Jerry Pournelle

FORTRAN FOR MICROS

Dear Jerry,

In the January "Chaos Manor Mail," page 366, you answered someone's request for information about FORTRAN as follows: "I just don't think there's an easy-to-use implementation of it for micros. Certainly there wasn't back when MacLean and I were first learning about these little machines." Jerry! How quickly you forget! Cromemco, that obscure little company that was one of the founders of the micro-computer industry, has had Z80 FORTRAN and RATFOR for almost eight years and 68000 versions since 1982 or so. All are solid as a neutron star and easy to use (in conjunction with the Screen text editor). The Z80 version runs on Cromemco's personal computer, the C-10, so one doesn't need one of the big S-100 hard disk multi-user metal boxes to use it.

JEFF JOHNSON
Mountain View, CA

Cromemco is an odd company. My original Ezekiel was a Cromemco Z-2, and I was very happy with him. When it came time to replace him, though, Cromemco never answered any letters, and shortly after came out with their own DOS, effectively trying to isolate their users from the rest of the micro mainstream. My friend Gordon Dickson bought a Cromemco about then and had real trouble with software and suchlike.

Given Cromemco's early-on technical excellence, it's too bad they didn't grow into one of the giants. Some of Zeke's boards are still happily running!—Jerry

DESCRIPTIVE FILENAMES

Dear Jerry,

I have an Epson QX-10 for a specific dedicated task. Valdocs 1.19 was not asked for, but it was included in the package. I don't like Valdocs: 90 percent molasses and 10 percent bugs.

Valdocs does have one feature I am lost without: the Index Reference, which is generated by the wordsmith and can contain up to 16 keywords. The word processor automatically generates a filename of eight characters using the date and the sequence number of the document for that day. The wordsmith sees only the

descriptive Index Reference string.

I also have an IBM PC XT on which I do word processing. I selected a word processor that is fast, hard to learn, and stores documents under filenames without reference to a descriptive string. I have to keep a log of what those cryptic filenames represent. I want a word processor for my XT that generates an array index (filename) to which is assigned the string (Index Reference) that I generate using keywords. I want to look at only the string, not the cryptic filename.

Do you know of any IBM-compatible word processors that have this feature?

P. C. KAMRATH
Columbus, NE

Yeah. Valdocs had some wonderful ideas. Pity it didn't come off, and now the whole QX line has been abandoned.

There are some directory shell programs that do sort of what Valdocs did, but they aren't automatic. The worst of it is that I've probably got what you describe somewhere in the labyrinth below Chaos Manor and don't know it. Sigh.—Jerry

WRITE ON

Dear Jerry,

On the strength of Chaos Manor recommendations, I got WRITE several weeks back and am now a believer. WRITE word-processing software makes computing fun—without an extra investment in tutorials or how-to books.

I haven't always been this happy with my Kaypro 2-X. For a year it sat in a corner, displacing dust. The software that came with it had devoured every last ounce of patience.

In effect, WRITE mobilized this \$1800 investment. No exaggeration. For those owning CP/M hardware and not equipped with a hacker's dedication let alone expertise, WRITE is an absolute godsend.

Keep up them superb recommendations!

WINSTON MCLEAN
Bad Vilbel, West Germany

Thanks. Glad I could be of help. Now if I can just get Tony Pietsch to jiggle up a V20/V30 version of WRITE to run on a PCompatible! The trouble is that

WRITE is in 8080 assembly language: to get it running on an AT would take some major work. If I had WRITE for an AT (say the AT&T 6300 Plus), I'd convert like a shot.—Jerry

CHAINING CBASIC

I received a lot of letters about chaining and overlays in CBASIC. Apparently, things depend in part on versions. Sue Rosenberg's letter will explain what you can do now.

It's important, because CBASIC is still one of the best and most easily learned computer languages. Many of my most important programs were written in CBASIC, and even years after writing them I have been able to go back and make crucial modifications, add features, etc. I would be happier if my programs were in Modula-2; but the fact is that CBASIC is more than good enough, and I've never had the time or strong enough inclination to convert.

Sue Rosenberg, for those unfortunate enough not to know her, is a BIX moderator and one of the most careful people I know; when she explores a subject, she really wrings it out. She's also one of five economists who are slowly convincing me that there may be something of a science to that discipline.

Dear Jerry,

The first letter in your May Chaos Manor Mail complains that Compiled CBASIC won't let the user put data in common blocks, chain to a program, and then go back to the original. This is untrue.

You can set up a root module, say ROOTCMD, with a common block that can contain all kinds of data types, including dimensioned variables, strings, and all sorts of overlays, called, for example, OVERLAY1.OVL, OVERLAY2.OVL, . . . OVERLAYN.OVL. To execute the program, you would type ROOT, which can chain to any of the overlays or to itself.

For example, if ROOT and OVERLAY1 were on the logged-in drive, ROOT could chain to OVERLAY1 with CHAIN OVERLAY1, and OVERLAY1 could chain to ROOT with CHAIN ROOT.CMD. Any module can chain to any module, in-

(continued)

cluding itself. The important thing to remember is that if a file extension is not specified in the chain statement, the compiler assumes an extension of OVL. This has tripped me up a few (well, more than a few) times, when I wanted to chain back to the root and forgot to include the extension.

Another important thing to remember is that the common blocks have to be identical in all the chained programs. The easiest way to ensure this is to have the

common statements in a separate .BAS file that you include as the first statement in each module.

It's true that you enter each module at the beginning of the module and not at the point where you left to chain. What you can do to go to a point other than the start is to set up a jump table (ON...GOTO) as the first statement (after any necessary initialization) and use a variable in common to dispatch you to the proper location.

There is yet another solution for the CBASIC user running MS-DOS. Microsoft has a Compiled CBASIC clone, Business BASIC, that is similar, but not identical, to CB80/CB86. In Business BASIC, no module can be more than 64K bytes, but you can compile subroutines separately and link them together, so the overall code size can be greater than 64K bytes. Most commands are similar to Compiled CBASIC commands, although the syntax is sometimes different, and error handling, garbage collection, and chaining are philosophically different. In chaining, Business BASIC keeps files open; CBASIC closes them. CBASIC code is more compact; Business BASIC is generally faster.

It is not a completely painless process to bring CBASIC programs over to Business BASIC. A fair amount of conversion can be handled by a conversion program supplied with Business BASIC.

But I think that Microsoft, like Digital Research, is not putting much effort into maintaining, let alone upgrading, Business BASIC. Alas.

SUE ROSENBERG
McLean, VA

ATRON BUGBUSTERS GREASE BORLAND LIGHTNING

"If I were starting a software company again, from scratch, Atron's AT PROBE™ would be among my very first investments. Without Atron's hardware-assisted, software debugging technology, the flash of Turbo Lightning™ would be a light-year away!"
Philippe Kahn, President, Borland

HOW BORLAND DOES SO MUCH, SO WELL, SO FAST

We asked Borland International president Philippe Kahn to share his secrets for rapidly taking a good idea and turning it into rock-solid reality. How does the Borland team do so much, so well, so fast?

He begins, "...I remember when Atron used the June 24, 1985 *Wall Street Journal* chart of top-selling software in an ad." [Note: At that time, seven of the top ten software packages were created by Atron customers; it's now now nine out of ten.] "Side-Kick was number four, and I let Atron quote me in saying that there wouldn't have been a SideKick without Atron's hardware-assisted debuggers.

"You might say lightning has literally struck again. Turbo Lightning made number four on

SoftSet's Hotlist within weeks of its introduction! And again, I say we couldn't have done it without Atron debugging technology.

"Cleverly written code is, by definition tight, recursive, and terribly complex," he continues. "Without the ability to externally track the execution of this code, competent debugging becomes very nearly impossible."

Concludes Philippe, "And after Turbo Lightning was solid and reliable, Atron tuning software turned our Probes into performance analyzers. How do you think we greased our lightning?"

Philippe, along with a couple million or so of your satisfied customers, we say congratulations on yet another best-selling product. We can't wait to see what awesomely useful technology will come shooting out of Borland International next.

HOW BUGBUSTERS KEEP YOU FROM GETTING SLIMED

The AT PROBE is a circuit board that plugs into your PC/AT. It has an umbilical which plugs into the 80287 socket and monitors all 80286 activity.

Since AT PROBE can trace program execution in real time, and display the last 2048 memory cycles in symbolic or source-code form, you can easily answer the questions: "How did I get here?" and "What are those silly interrupts doing?"

It can solve spooky debugging problems. Like finding where your program overwrites memory or I/O-impossible with software debuggers.

You can even do source-level debugging in your favorite language, like C, Pascal or assembler. And after your application is debugged, the AT PROBE's performance measurement software can isolate performance bottlenecks.

Finally, the AT PROBE has its own 1-MByte of memory. Hidden and write-protected. How else could you develop that really large program, where the symbol table would otherwise take up most of memory.

LOOK AT IT THIS WAY.

History shows that non-Atron customers don't stand a very good chance of making the Top Ten list. Lightning really does have a way of striking twice!

The PC PROBE™ is \$1595 and the AT PROBE is \$2495. So call Atron today. You can be busting some really scary bugs tomorrow. And maybe, just like Borland, you can also bust some records.



THE DEBUGGER COMPANY

20665 Fourth Street • Saratoga, CA 95070 • 408/741-5900

Copyright © 1985 by Atron Corp. PC PROBE™ and AT PROBE™ Atron, SoftSet™ and Turbo Lightning™ Borland International, Inc. Adv. by TRBA, 408/258-2788



puters (P.O. Box 2233, Station A, Champaign, IL 61820-8233); the Minnow Bear CBC Tools for both CP/M-86 and MS-DOS CBASIC are really well done. CBASIC with Minnow Bear Tools is structured, easy to use, and portable. They also have an improved Run Time package that speeds up CBASIC considerably. No code rewrite is required; simply relink using the package.

There is also the CBASIC User Group (P.O. Box 40690, Cincinnati, OH 45240-0690). Between Minnow Bear and the User Group, programmers can get most—alas, not all—of the support Digital Research ought to be giving the language. —Jerry

MICROSOFT WORD, MOUSE

Dear Jerry,

Until about 16 months ago, I knew nothing about computers and had no desire to know any more. Since buying a Zenith Z-150, however, I've gotten quite fascinated with the technology. I've found your columns very interesting and informative and have followed many of your suggestions, with good results. (The Z-150 itself was partly a result of your columns.) I've been delighted with Microsoft Word.

Your extolling of XyWrite—along with a certain slowness in cursor movement in Word—had been prompting me to try the program. I'm currently writing a book based on my public radio series *New England Almanac*, and the writing involves editing about a thousand pages of transcribed interviews. But I'm going to be slow to try XyWrite now that I have discovered the way a mouse interacts with Word. I can't imagine editing being any easier than it is with a mouse—it's just like using a red pencil on paper.

I'm very pleased with Word overall, by the way. In particular, I'm convinced its mnemonic approach to invoking commands makes it one of the easiest programs for novices to learn; I've taught it already to three of them. Word has layers of shortcuts and speedups that you can learn as you get more and more comfortable with the program. Through it all runs a streak of logic that you can easily follow. I guess some people might feel that having three different ways to invoke a command is confusing. . . . I find it to be one of the beauties of Word.

The elegance of Word reaches its high point. I think, in its use of style sheets.

I've been shocked to find out that the Macintosh Word hasn't got them yet. That's like having pancakes without the maple syrup.

Finally, the new Microsoft mouse (5.0) with its higher resolution runs rings around earlier mice I've tried (e.g., Mouse Systems).

TOM LOOKER
Montague Center, MA

Thanks. I have the newest version of Microsoft Word; I'll have to try that. My problem with mice is that my work area isn't really set up properly to use them; I have about decided that I'll have to construct some special-purpose furniture, since mice are becoming more important. They certainly can't be beat for some jobs—provided, of course, that you can find the mouse and a spot bare of papers to use it on.

I'm in the process of changing over systems; it's time to give up my ancient CompuPro Z80 and VDM memory-map video board for something more modern. Problem is what I should get used to, so I'm fooling about with everything. Thanks for the suggestions. —Jerry ■

TWICE THE PERFORMANCE... AT HALF THE COST!

DATA I/O 280™ COMPATIBILITY - UNDER \$1,000.00

GANG AND SET PROGRAMMING FOR LAB & VOLUME PRODUCTION

Model 125-EG Multiprogrammer™



\$995 COMPLETE

ORDER TODAY:

800-523-1565



In Florida - 1-305-994-3520
MASTERCARD OR VISA WELCOME

NOW SETTING HIGHER STANDARDS

- Memory capacity to 1Mbyte, 64 bit wide programming, device type and parameters stored in non-volatile memory
- Supports virtually all MOS/CMOS EPROM/EEPROM Technologies to 512K and new Megabit devices
- 3-Way Device type selection: manually, auto ID or from menu
- 2-Way Command Execution: Functions keys or menu
- 1Mbyte download for set programming of two sets of 8-512K devices simultaneously (each with different data)
- Algorithm updates easily installed by user
- PROMlink™ and PROMsoft™ compatible

25 Key 32 Character LCD Display - Memory Expandable to 1 Megabyte

Compatible with BYTEK IBM-PC Software Utilities

Options: RS232 Interface for PC Operation

Parallel Printer Port - 16 Socket Programming

21 Day No Obligation Trial Period

Data I/O, PROMlink are trademarks of DATA I/O, Inc.
PROMsoft is a trademark of BYTEK Corp.
Made in the U.S.A.



Instrument Systems Division • 1021 South Rogers Circle • Boca Raton, Florida 33431

THE BEST OF BIX is a selection from some of the most interesting messages from BIX, the BYTE Information Exchange. Conferences covered this month are Commodore Amiga, Atari ST, IBM PC (and compatibles), Macintosh, and object-oriented programming languages. These pages represent a small window into the world of BIX.

For information on joining BIX, see page 286.

AMIGA

The Amiga conference remains very active as users and developers explore and share their discoveries. This month's window on the Amiga conference kicks off with a discussion of chain and overlay programming methods. A question of directories follows, with various techniques suggested for letting AmigaDOS know where you are. The major hardware thread concerns interfacing 5¼-inch disk drives to your Amiga, ending with how to get complete expansion bus specs from Commodore. The window closes with two major discussions on how to handle your mouse through Intuition.

"CHAINING" IN C

amiga/softw.devlpmt #1637, from drl [Dave Lundberg]

Could someone steer me in the right direction? I would like to "chain" from one C program to another.

amiga/softw.devlpmt #1638, from cheath [Charlie Heath]
a comment to message 1637

Aztec has a routine that will allow chaining in their library. You can do an AmigaDOS "Execute()" call to run another program, but the calling program remains resident. As an alternative (I assume you have Lattice), you could figure out the correct set of LoadSeg for the new program and UnLoadSeg for the old one, which would allow you to terminate the original program before starting the new.

You might also be able to achieve this with overlays or an Amiga library, both of which would allow you to load new stuff from disk without using more RAM.

amiga/softw.devlpmt #1639, from jdow [Joanne Dow]
a comment to message 1638

Rather than the dumsier approach of chaining, which seems to be a BASIC trick, why not carefully think out an approach using overlays with a modest-size main program which is the top-level menu? That would be an almost perfect use of the overlay structure. It also allows much better control over program flow.

amiga/softw.devlpmt #1663, from drl

Thanks for the input. I have shied away from overlays simply because I have not used them before and don't understand how they work. I may give LoadSeg/UnLoadSeg a try, since this chain is a once-only thing, that is, the first program is a title page which will chain to the main program, never to be returned to.

Is it possible to UnLoadSeg the program running, then LoadSeg the new program? This would be ideal since I would like to keep memory as unfragmented as possible. Any ideas?

amiga/softw.devlpmt #1665, from jdow
a comment to message 1663

Oh boy—that one is tailor-made for overlays! The main point to watch for is that there is no direct communication between the two halves of the overlay program. It all must take place through the main program. The main loads overlay one and calls it. When it returns, the main unloads the first and loads the second overlay, then calls the second in normal fashion. This has many of the benefits of chaining, with the added benefit of tighter control over what runs when. (After all, some yo-yo might try to run the second program without entering the first at all. With CLI it'd probably be quite a likely event once the user figured out the structure.)

amiga/softw.devlpmt #1666, from cheath
a comment to message 1665

Overlays really aren't that hard; you don't change much at the program source level except perhaps for separating things into separate source files. I haven't tried the Amiga overlays, but in general, all you have to do is specify a "tree" structure for the input files. You also need to link in an overlay object file. Has anyone else used the AmigaDOS overlays yet who can shed more light on this?

amiga/softw.devlpmt #1669, from drl
a comment to message 1665

You talked me into it. We'll see what those overlays can really do. Thanks for the help. If I get stuck, I'll let you know.

PROBLEM WITH EXECUTE FILE

amiga/softw.devlpmt #1652, from greggw [Gregg Williams, Senior Technical Editor, BYTE]

I'm writing an execute script that has a compiled file on the RAM disk. I want to copy it to wherever I am (this assumes that the current directory is somewhere on one of the disks). I can't find a way to do this in AmigaDOS. If we were in UNIX, I could say

```
cp ram:<filename> .
```

where "." means "where I am right now." But I can't find any such thing in AmigaDOS.

Am I overlooking something *real* obvious? In any case, any ideas?

amiga/softw.devlpmt #1654, from jdow
a comment to message 1652

Alas, there is no symbol for "where I am now" in AmigaDOS utilities. Some new utilities could be generated, but they'll for sure be much bigger than the old ones.

amiga/softw.devlpmt #1657, from cmcmanis [Chuck McManis]
a comment to message 1654

Certainly there is! Use "" for the current directory. Not intuitive but it does work. Another neat trick is a "visit" command. It works something like this

```
visit :
assign foo: ""
cd newdir
leave :
cd foo:
```

This lets you pop into another directory for a moment, type leave, and be back where you were. Note that "newdir" above should be the first

parameter passed; I don't have my book handy and can't remember the syntax.

amiga/softw.devlpmt #1658, from jim_kent [Jim Kent]
a comment to message 1657

Chuck, I heard about the

copy file ""

trick at the BADGE meeting. Whenever I try it, it just copies it to the parent device of the directory I'm at. If I'm in df1: it works, but if I'm in df1:letters it ends up in df1:. Am I unique?

amiga/softw.devlpmt #1659, from jdow
a comment to message 1658

No, you are not unique. "" is a long form for :, it seems.

amiga/softw.devlpmt #1660, from Inoland [Les Noland]
a comment to message 1652

Can do!

Sorry Chuck, but Jim is right;

copy file ""

just places the file in the root directory, not in the current directory. There is a way that is simple and will work, however. If you model your execute file after the following, you should be in good shape:

```
.k file
.bra {
.ket }
cd >ram:curdir
copy <ram:curdir >nil: from {file} ?
delete ram:curdir
```

Of course, you can change "ram:curdir" to anything you like. And if the name of the file isn't variable, you can dispense with the first three lines and save that ridiculous disk access to :T (unless, of course, you have other parameters to pass).

5¼-INCH DISK DRIVES

amiga/tech.talk #499, from agima [Neil Halistar]

I am connecting a 5¼-inch IBM drive up to the Amiga. I don't have the external 3½-inch drive. Is it OK to use the Amiga's power for the 5¼-inch?

amiga/tech.talk #501, from duck [Dale Luck, Commodore-Amiga]
a comment to message 499

If the power consumption of the 5¼-inch is same or less than the 3½-inch, it should be OK. However, we cannot make any promises that it won't affect other items that you may hook up that also get their power from the Amiga if the disk drive sucks up too much power. Each of the power pins on the external connectors has been spec'd for a maximum current. We have added all those up and spec'd the power supply to be able to supply just enough current.

amiga/tech.talk #502, from jdow
a comment to message 499

No, it is definitely not OK to use the Amiga's power. Also, those 5¼-inch drives will only be accessible from the PC emulator. I seem to remember that was what you wanted, so go for it—with an external power supply.

amiga/tech.talk #503, from neil [Neil Katin, Commodore-Amiga]
a comment to message 499

It is *not* OK to connect a 5¼-inch drive to the Amiga without providing it with extra power; the motor-on surge is more than the Amiga can provide (under worst-case conditions).

amiga/tech.talk #504, from cheath
a comment to message 503

Neil, do you know of anybody manufacturing the 96-track 5¼-inch drives that will hold 880K (that is 96 tracks, right?) of data and thus can be accessed as if they were 3½-inch drives? That would seem to make a lot of sense to me for anybody who needed a 5¼-inch drive for IBM emulation, but who also wanted to make use of the drive under AmigaDOS.

amiga/tech.talk #505, from jdow
a comment to message 504

How much are people willing to spend? The hack can be done. Modern 96-tpi (tracks per inch), 5¼-inch drives do it even better than my hack of an older version Mitsubishi. Newer drives have "door open" switches built in. The only real problem is getting the 23-pin connectors. A dual box shouldn't be very expensive compared to an HD (except on a bux/bit basis). I could probably build a few and get them out my door for under \$450.

amiga/tech.talk #518, from neil
a comment to message 504

There are several disk manufacturers that have 96-tpi, double-sided 5¼-inch drives. Flipping out my handy book of disk drive specs, I find a Tandon TM 65-4, World Storage Tech. (no model #), Tokyo Electric Co. FB-504, Control Data Corp. CDC-445, Mitsubishi M4551. There are many others—check Mini-Micro Systems' annual peripherals report.

There is one catch, however. Our system assumes that the DISKCHANGE signal (pin 2) will go active when a disk is removed. You will probably want to wire up a switch and a flip-flop to emulate this feature.

Happy Hacking.

amiga/tech.talk #519, from jdow
a comment to message 518

The latest revision of the Mitsubishi M4853 drive supports that. Alas, the ones I bought were an earlier revision, so I had to do mucho kludging. There would still be some strapping and such needed, but the green wire count would reduce materially. (What I don't know is whether that drive now uses some LSI part instead of LSI/MSI parts, which allow strapping in the motor latch as easily as the revision I have.)

Care to generate some kind of discussion over in hardware about the expansion bus and how to handle the hardware aspects of it? I have some preliminary documents dated early this year. Is this still proprietary info or can I feed it into the system here as people ask? If it's still proprietary, I'll keep it under my hat, as much as that hurts. That's the basis on which I got it and I don't wish to violate the confidence.

amiga/tech.talk #520, from neil
a comment to message 519

Re: Expansion architecture availability

The expansion architecture is no longer proprietary. However, we would prefer if people got the document directly from Commodore-Amiga; this

(continued)

allows us to know who has it, and who we should mail updates to. Our current policy is to mail a copy to anyone who asks for it. We'll keep this up until the load gets too high; by then it should be stable enough to publish (hope, hope . . .). To get your copy, call Cheryl Gibbons, (408) 395-6616, and ask for an expansion architecture packet.

The expansion stuff is an amazing step forward for personal computers: There are no switches on any of the boards. This is one of the most intimidating things for a novice to do—set all those bit switches. In addition, the software can figure out, at run time, what boards are in the system and will attach the correct driver to each board. To install a new driver into the system is as easy as dragging an icon into the "expansion" directory; nothing else is required.

All this is currently being shipped to version 1.2 alpha-test sites. Beta is coming up, and we hope to send it to a wider audience.

If you have specific hardware questions, mail to me (neil) and I will make sure the right people see the questions.

INTUITION AND THE MOUSE
 amiga/softw.devlpmt #1608, from drl

Has anyone actually used the SetMPort() routine to change the port that Intuition uses to read the mouse? I would like complete control of the mouse, but I don't want the user to have to physically move the mouse to the second game-port connector. I would rather "trick" Intuition into using the second game-port connector, so that I can then access the first connector by opening the game-port device. I know that it is possible to steal the mouse events by inserting an input event handler ahead of Intuition, but I would rather use the game-port device, since it handles a lot of the dirty details for you.

A second problem, also dealing with Intuition, concerns stealing sprite 0 (Intuition's cursor). I would like to use all 8 hardware sprites (greedy me) using the simple sprite routines. A point to note is that I am using Intuition in my program, so "killing" Intuition (if that is even possible) is not an answer. I am using it to "cook" the keyboard input and to give me tick events.

amiga/softw.devlpmt #1615, from cheath
 a comment to message 1608

Good luck on both accounts. As far as I know, while Intuition is active it wants mouse port 0 and sprite 0. You can probably read the mouse

directly (i.e., not through a device driver) without interfering with Intuition, but Intuition would still get the mouse inputs, too, using processing time as well as possibly doing something with the events.

amiga/softw.devlpmt #1617, from drl
 a comment to message 1615

That seems to be a bit of a problem. Even if I were to give in and say OK, I would make the user switch his mouse to the other port and not use sprite 0; the arrow sprite would still be visible. Although thinking about it, I suppose the arrow could be redefined as "transparent."

amiga/softw.devlpmt #1618, from cheath
 a comment to message 1617

You can do a "SetPointer" to a couple words of NULL data to get rid of the pointer.

amiga/softw.devlpmt #1623, from duck
 a comment to message 1608

What's the matter, 6 or 7 sprites not enough? Some of the other programs on the market cheat by just calling FreeSprite(0). Not too friendly for Intuition 'cause it will think it still has a handle on it.

amiga/softw.devlpmt #1636, from drl
 a comment to message 1623

Oh, I guess 6 or 7 sprites is enough. Yes, I did try FreeSprite(0) and Intuition still thinks it has control of it. It keeps changing the position and image back to the arrow. I guess my main concern is getting Intuition to lay off mouse port 1, so I can access it using the game-port device (which processes the mouse input very efficiently). Any ideas on that subject?

IDCMP (INTUITION DIRECT COMMUNICATION MESSAGE PORT) EVENTS

amiga/softw.devlpmt #1599, from skrenek [Steve Krenek]

My program is getting a little bogged down with MOUSEMOVE and MOUSEBUTTON messages and losing a lot of memory (5 to 10 messages at a time at 56 bytes a pop). I wouldn't care so much that

KJ COMPUTERS
 10815 Zelzah Ave.
 Granada Hills,
 CA 91344

WE'VE SLASHED PRICES ON THE AMIGA!

The West Coast's Largest Inventory of Commodore And Amiga Software And Hardware Products

CALL **KJ** (818) 366-5305
 (818) 366-9120

AC/FORTRAN™ **AMIGA**

Mainframe quality, full feature **ANSI FORTRAN 77** compiler includes **Debugger**, Linker, Library Manager, Runtime Library, **IEEE** math, and **C** interface. Supports **Complex numbers**, **Virtual arrays**, **Overlays** and **Dynamic Linking**. Not copy protected. Available now. \$295. Turbo Amiga version also available.

AC/BASIC™ - Coming Soon

From the authors of **Microsoft BASIC** compiler for Macintosh, comes **AC/BASIC** for the Amiga. Companion compiler to the **Amiga BASIC** interpreter. Two more features and includes a **Debugger**, includes **BLOCK IF**, **CASE** statement, and **STATIC** keyword extensions and executes up to **50x** faster. **AC/BASIC** is the new **BASIC** reference for **Macintosh** based personal computers. Not copy protected. \$295.

Telephone orders welcome

abssoft

Scientific Engineering Software
 4268 N. Woodward, Royal Oak, MI 48072 (313) 569-7111
 Amiga trademark of Commodore Amiga
 Microsoft trademark of Microsoft Corp.

BUY UNITED STATES SAVINGS BONDS

the memory doesn't get returned if it used the same 200 to 600 bytes each time. But it seems to lose an additional 200 to 600 bytes each time my program gets behind. My loop is similar to one on pages 8 to 14 of the Intuition manual; I just have a lot to do. Will this memory be returned in a later version, or will I have to periodically close, then reopen my windows to reclaim this memory and keep my program from suffering memory crashes?

amiga/softw.devlpmt #1601, from cheath
a comment to message 1599

Are you replying to all messages that you receive? You shouldn't lose memory if all the messages have been replied to. Perhaps Intuition has to allocate more space for messages and doesn't free up its local pool. You might consider flushing the input when you get behind. Whenever you get a MOUSEMOVE event, set a flag and continue to read messages until you get something other than MOUSEMOVE (including "no more messages"). (Also, make sure to reply to each message after reading.) Then, test for the "mouse moved" flag before processing each event.

amiga/softw.devlpmt #1602, from skrenek
a comment to message 1601

Right. According to the documentation, Intuition does allocate more memory for the messages and doesn't return that memory. RKM (volume 1, pages 3 to 108) seems to imply (and it seems to be true) that the newly allocated memory is not reused if you get caught up, then behind again. Instead, it seems even more is allocated. So each time you get behind, that amount of memory is permanently lost. Well, not permanently. It's returned if you close the window, but that doesn't help if you run out of memory and crash.

As I said, my program is similar to the one in the Intuition manual. The only difference is that instead of setting a flag inside the loop, my program completely ignores MOUSEMOVE messages inside the loop, but responds if the last message as it leaves the loop was a MOUSEMOVE.

```
Wait( . . . );
while(message = GetMsg( . . . );
{
    copy the info
    class = message -> Class;
    Reply(message);
    if(class != MOUSEMOVE) ProcessMessage( . . . );
}
if(class == MOUSEMOVE) ProcessMove( . . . );
goto Wait;
```

amiga/softw.devlpmt #1610, from jbritt [John Bittner]
a comment to message 1599

If your application permits, you could do an Smodify(DCMP) and turn off REPORTMOUSE whilst you do your processing, then do it again when you're ready for more Mouse Info.

amiga/softw.devlpmt #1614, from cheath
a comment to message 1602

Hmm. You shouldn't have any problem with that, I don't think. Are you getting behind because of menu activity? You'll keep getting MOUSEMOVE events while the menu is active, unless you set window -> flags & = REPORTMOUSE; while the menu is on-screen.

ATARI ST

The Atari ST conference remains a great source for technical information on this machine. This month's peek at the conference begins with hopeful questions on Atari ST/IBM Convertible disk compatibility. The next section is a rather long look (with code samples included) at screen handling problems related to menu selector boxes. The peek ends with a quick discovery of (and factory response to) an undocumented control vector and a surprisingly civil discussion of programming editors for the ST.

IBM CONVERTIBLE/ATARI ST DISK COMPATIBILITY
atari.st/main #143, from rhonesty [Robert Honesty]

The company I work for got in one of the new IBM PCs with a 3½-inch disk drive. So, I took a 720K disk from the ST in to try it out. No luck. IBM (predictably) wouldn't read it. I tried alternate plan two. Formatted on the IBM and tried reading on the ST. Success! Now I can skip the plan to get a 5¼-inch drive. I tried out VIP WKS files with 1-2-3. Nirvana! If I get the time I'll try and figure out why IBM has such problems.

atari.st/main #144, from al [Alastair J.W. Mayer, author of BIX's CoSy software]
a comment to message 143

Problems are probably due to some subtlety in the way formatting is done. Anyway, a couple of questions: Assuming the disks are formatted on IBM (so both IBM and ST can read them), can you write a file with the ST that the IBM can read? (I think your message implies this, but not sure.) What other machines using 3½-inch disks is the ST read-and/or write-compatible with? Anybody got firsthand experience?

atari.st/main #145, from timoren [Tim Oren, KnowledgeSet Corp.]
a comment to message 143

The reason for this is that the PC and the ST use different disk controller chips—with the ST using an "older" type. The upshot is exactly the effect you describe: PC-formatted disks read on the ST, but not vice versa. Not being a hardware person, I can't describe the reason in detail.

atari.st/main #146, from jtuermer [Joerg Tuermer]
a comment to message 143

Did you try a disk formatted on the ST, but with the boot sector being an exact copy of the IBM boot sector (this can be made with a disk monitor)? Maybe the IBM is more finicky than the ST as to what it expects to find (like an IBM logo).

atari.st/main #147, from rhonesty
a comment to message 144

Yes, the IBM can read ST files.

atari.st/main #165, from ptoland [Paul Toland]

I've just logged on for the first time in a couple of weeks and have seen the stuff on reading IBM 3½-inch disks. I've tried reading disks from my Data General One on the ST and they read OK as well. Going the other way is a bust, and the info from the DG/One looks as though it's having trouble picking up the first directory block.

(continued)

atari.st/main #171, from dsmall [David Small]
a comment to message 165

I believe you will find that disks formatted on the ST are unreadable with NEC and NEC-like (Intel 8272) floppy controllers, as in IBM anything. However, you can read and write IBM-formatted disks with the ST. This applies to 5¼-inch disks, but I can't think of a reason it would not apply to 3½-inch disks as well.

SELECTOR BOX PROBLEMS

gem/atari #25, from jruley [John Ruley]

TITLE: fsel_input

```
/* this is a code fragment to display a file selector
box */
/* works in Hippo.C—should work in Alcyon or others */
char d_path[256], f_spec[256];
short int ret;
strcpy(d_path, "\\ *.*");
strcpy(f_spec, "_____");
graf_mouse(0,0);
graf_mouse(257,0);
ret = fsel_input(d_path,f_spec,&button);
graf_mouse(256,0);
...
/* ignore all the graf_mouse commands—that's 'cause
I've got the mouse turned off when I start*/
```

Problem—when the selector box goes away, it leaves a big gray blotch in the middle of the screen. So I need something that will save the screen before, and restore it after, the fsel_input call.

gem/atari #32, from alexl. [Alex Leavens]
a comment to message 25

You could do a form_dial on the area to save it. Code fragment is

```
int return;
int (all your system variables)
.
.
return = form_dial(0,0,0,0,Box_x, Box_y, Size_x,
Size_y);
if(return == 0)
. printf("Error in allocation memory for box ");
```

Now do your fsel_input stuff . . .

```
return =
form_dial(3,0,0,0,Box_x,Box_y,Size_x,Size_y);
```

Ta-da! You're done. Box_x and Box_y are the x and y coordinates of the upper left corner of the box. Size_x and Size_y are the size of the space you want to save (should be greater than or equal to the menu that you want to draw).

If you want to get fancy, you can use functions 1 and 2 of the form_dial command to draw a growing and shrinking box, respectively.

gem/atari #35, from alexl.

A form_dial(0, . . .) saves whatever's under the area that you've defined, and a form_dial(3, . . .) restores it (by telling the system to do a re-draw). I admit it ain't real clear in the Abacus books. It ain't real clear in the DRI documentation either . . .

gem/atari #36, from jruley
a comment to message 35

Sorry Alex—I just tried it, and it does not work.

I'm not sure what the form_dial(0 . . .) did, but the form_dial(3 . . .) attempted to restore a GEM desktop—I got the clear top line, and gray in the rest of the screen. Maybe this is happening because I'm not using a window?

This is all sort of beating around the bush anyway—does anybody out there savvy the raster ops for blitting? I think that's more what I need. . . .

gem/atari #37, from alexl.
a comment to message 36

Absolutely. I savvy the blitter ops (having used them plenty myself). What do you want to know? By the way, you say you're not opening a window . . . what exactly do you mean? Are you not using the "open virtual workstation" command (v_opnwrk)? Or something else? Please explain further; maybe I can figure out the problem.

gem/atari #38, from jruley
a comment to message 37

Ummm . . . might be better if I set up a short demo program and put it in listings. I am using the open virtual workstation but am sending text and graphics directly to the screen, without opening a window with the w_whatsoever() commands.

Let me put up some code in listings and we can talk then.

gem/atari #39, from jruley
a comment to message 38

Okay, I've generated a demo which shows the problem—it's in listings as "idiot.c"—compiles under Hippo (with my own XBIOS—if you need it, I will post that too), should compile under Alcyon. It's a GEM application. Operation should be obvious if you read the comments. Run it with all three screen-save routines—none, mine (non-GEM, using physbase()) and a 32K character array), and Alex's (using form_dial, as we've discussed). If you can fix it so that form_dial works, or suggest an alternate routine (blitting?), I'll be VERY grateful!

gem/listings.st #7, from jruley

TITLE: idiot.c

```
/* idiot.c
an example to show my problems with
screen save & restore—J. Ruley */
/* static globals: */
/* set up for GEM operation */
static short int xryr;
static unsigned char *gbuf,scrn[32000],*physbase();
/* set up for GEM operation */
/* set up for GEM operation */
main(){
short int work_in[12],work_out[57],handle;
char d_path[256],f_spec[256];
short int ret,x,y,i;
handle = graf_handle(&x,&x,&x,&x);
for(i=0;i<10;i++)work_in[i] = 1;
work_in[10] = 2;
v_opnwrk(work_in,&handle,work_out);

/* now set up a test screen */

v_cirwk(handle);
ret = vst_effects(handle,12);
vst_height(handle,16,&x,&x,&x,&x);
```

```

ret = vs_point(handle,16,&x,&x,&x,&x);
xr = work_out[0];
yr = work_out[1];
x = xr / 4;
y = yr / 2;
v_gtext(handle,x,y,"Testing . . .");

/* post an alert box to select the type of screen save
*/

ret = form_alert(2,["Screen save
type:|[none|mine|alex's]"]);

/* save the screen */
sav_scrn(ret);

/* get a filename */
strcpy(d_path," \ \ ".");
strcpy(f_spec,"_____");
i = fsel_input(d_path,f_spec,&x);

/* restore the screen in the selected way */
rst_scrn(ret);

/* wait for a keypress */
conin();

/* and quit */
v_cisvbk(handle);
appl_exit();
}

/* subroutines: */

sav_scrn(n)
short int n;
{
short int ret, i;
if(n == 2){
    gbuf = physbase();
    for(i=0;i<32000;i++)scrn[i] = *gbuf++;
}
if(n == 3){
    ret = form_dial(0,0,0,0,0,x,y);
}
}

rst_scrn(n)
short int n;
{
short int ret, i;
if(n == 2){
    gbuf = physbase();
    for(i=0;i<32000;i++)*gbuf++ = scrn[i];
}
if(n == 3){
    ret = form_dial(3,0,0,0,0,x,y);
}
}

```

gem/atari #41, from alexl.

TITLE: Saving/Restoring Screen

I spoke with Leonard Tramiel yesterday, and he suggested the following:

1) If you're using the fsel_input call, pay attention to the GEM message buffer (which will tell you that you need to do a redraw), and then do it.

2) If you don't want to do that, use (as you figured) the bit calls, to blit the screen memory to a safe location, and then blit it back again. See my listing of Crabs.C in the listings section for some code on how to use the bit. If you need more help, drop me a line. I'm going to see if I can't get Atari to let me post the source code to the demo accessory and application that come with the developer's kit.

gem/atari #42, from timoren
a comment to message 32

To be strictly technical, form_dial doesn't actually save the desktop area. Instead it tells the system to redraw it. Subtle distinction but important.

gem/listings.st #8, from alexl.

TITLE: File Selector Listing

This is a listing of a simple program which will open a (non-functional) window, and then a file selector box, which will let you do all sorts of file selector types of things.

SELECT.C

Test program to show how to pull up a file selector dialog, and save the underlying window. Note that although the form_dial successfully redraws the window, that part of the internal structure of the window gets roached by the file selector. This is because the window itself is not being redrawn (which is up to the programmer, and which I've left out, being the lazy sot that I am).

```

#include <osbind.h>
#include <define.h>

#define HIDE_MOUSE graf_mouse(256,&dummys)
#define SHOW_MOUSE graf_mouse(257,&dummys)

int contrl[12], intin[256], ptsin[256], intout[256],
    ptsout[256];
int handle;

int res1[4] =
{
    0, 15, 320, 170
};

int res2[4] =
{
    130, 15, 380, 170
};

int res3[4] =
{
    130, 35, 380, 330
};

main()
{
int t, dummy, mx, my, num_colors;
int charw, charh, boxw, boxh;
int wind_handle;
long boxadd;
int mgbuff[8], pxy[4];
char decimal[4];
char d_path[256], f_spec[256];
int x,y,w,h,xdial,ydial,wdial,hdial;

/* Set the system up to do GEM calls*/

appl_init();

```

(continued)

```

/* Get the handle of the desktop */
handle = graf_handle(&charw,&charh,&boxw,&boxh);
/* Open the workstation */
for (i = 1; i < 10; ++i) intin[i] = 1;
intin[10] = 2;
v_opnvwk(intin, &handle, intout);
pxy[0] = 0; pxy[1] = 0; pxy[2] = intout[0]; pxy[3] = intout[1];
/* Find out what res mode we're in */
num_colors = intout[13];
vs_clip(handle,1,pxy); /*turn on clipping*/

Now open a very simple window, strictly designed to show if we are,
in fact, restoring the desktop after the call to fsel_input...
/* Open a window. Note that even though all
elements of the window are present (slider, kill box,
etc.) None of them work! */
wind_handle = wind_create(0x0FFF,50,50,200,150);
i = wind_open(wind_handle,50,50,200,150);
x = y = w = h = 0; /* size of smallest box, i.e., non-
existent */

Now, get the size of the file selector input box, depending upon the
resolution mode that we're in. Note that these are hand-calculated
values. I looked real close at the screen and tried to figure out how
many pixels the sucker was.
*/
if(num_colors < 3) /* Monochrome
resolution */
{
xdial = res3[0];
ydial = res3[1];
wdial = res3[2];
hdial = res3[3];
}
else
if(num_colors < 5) /* Medium res,
color (4 colors) */
{
xdial = res2[0];
ydial = res2[1];
wdial = res2[2];
hdial = res2[3];
}
else /* Low res, color (16
colors) */
{
xdial = res1[0];
ydial = res1[1];
wdial = res1[2];
hdial = res1[3];
}

/* reserve room on the screen */
form_dial ( 0, x, y, w, h, xdial, ydial, wdial,
hdial );

/* draw a growing box */
form_dial ( 1, x, y, w, h, xdial, ydial, wdial,
hdial );

/* get a file name */
strcpy(d_path, "\ \ *.*");
strcpy(f_spec, "_____");

```

```

i = fsel_input(d_path,f_spec,&x);
/* draw shrinking box */
form_dial ( 2, x, y, w, h, xdial, ydial, wdial,
hdial );
/* free up screen area */
form_dial ( 3, x, y, w, h, xdial, ydial, wdial,
hdial );
/* Wait for a mouse click to end the program ... */
evnt_button(1,1,1,&mx,&my,&dummys,&dummys);
/* Close the window */
wind_close(wind_handle);
/* Close the workstation */
v_clswwk(handle);
/* Release GEM calls */
appl_exit();
}
/*-----Plot(x,y)-----*/
Plot(x,y)
{
int pxy[4];

pxy[0] = x; pxy[1] = y; pxy[2] = x; pxy[3] = y;
v_pline(handle,2, pxy);
}
/*-----End of Plot (x,y)-----*/
/*-----rand()-----*/
/*This function will return an 8-bit random number*/
rand()
{
return(Random() &0x00FF);
}
/* End of
rand */

```

SYSTEM VECTOR EXPLORATIONS

atari.st/tech #172, from hisoft [Dave Howorth]

For trivia freaks, there is a (to my knowledge, undocumented) system vector at \$502 which points to the screen dump routine, called by the BIOS trap and Alt-Help. If you change it, you can do screen dumps on any printer of your choice. The Amiga conference has people from Amiga on it who read messages like the one above and then say, "We'll define it so you can use it," or "Don't use it—it's gonna change." Is there anyone from Atari on this conference with similar knowledge?

atari.st/tech #178, from jtittsler [Jim Tittsler, Atari Corp.]
a comment to message 172

The vector at \$502 (scr_dump) is a safe vector for the ROM TOS only. We will maintain it in future versions of the operating system. There are also individual vectors for printer device output:

prtblk character-output vectors

Prtblk() uses four vectors to output characters to printer devices. The vectors are in protected OS memory. "prv_isto" initially points to the PRN: device output status, and "prv_ist" initially points to the PRN: output driver; "prv_auxo" initially points to the AUX: (RS-232) device output status, and "prv_aux" initially points to the AUX: output driver. Prtblk() uses the PRN: or AUX: vectors based on bit 4 of the printer

configuration word (see the guide). Output of Prtblk() may be redirected by modifying the appropriate vectors.

Prtblk() Output Vectors			
prv_!sto:	1	ds.l	; (506) -> _!stostat()
prv_!st:	1	ds.l	; (50a) -> _!stout()
prv_!auxo:	1	ds.l	; (50e) -> _!auxostat()
prv_!aux:	1	ds.l	; (512) -> _!auxout()

In general, the policy is, if the vector is listed in the "System Variables" section of the guide, their locations and meanings in future revisions of the ST BIOS will not change.

A QUESTION OF EDITORS

atari.st/tech #191, from davjon [David Jones]

TITLE: Program Editors

One thing that occupies my mind over here in the U.K. is, What is the best ST program text editor? I find that most of the editors that I have used on the ST (1st Word, GSTEDIT, Modula-2 Editor, MicroEMACS, Metacomco ED, Hippo-C, et al.) always have some annoying feature, like not auto-indenting, for example. I would be really interested to know what other developers think about the available editors.

atari.st/tech #192, from sprung [Ron Sprunger]
a comment to message 191

I've given up on 1st Word and TDI M2 editors, and use only MicroEMACS, which is adequate, though lacking somewhat. All I want is the Turbo Pascal editor, which I can run completely from the home position on the keyboard, and which I can make behave like the Alpha Micro editor VUE. EMACS is not bad, but it's always in insert mode, uses commands in drastic disagreement with those of VUE or Word-Star, pages backward awkwardly, has no built-in search and replace (macros are neat, but I don't want to use them for every search and replace, and especially not for globals). It also inserts real tabs, which I have to filter out before sending text to the M2 compiler. Still, it is far and away the best available for programming and does not require me to fiddle with a silly mouse, or grope for function keys.

atari.st/tech #194, from sgrimm [Steve Grimm]
a comment to message 192

I always use Regent Word to program, for the simple reason that it is very, very fast. I hate having to wait for EMACS to update the screen when scrolling through a file. Also (and I know this isn't of world-shattering importance), you can select a file to load with one keystroke. The only complaint I have about Regent Word is that it can't load files from subdirectories.

atari.st/tech #195, from mmallett [Mark Mallett]
a comment to message 192

User sprung says: "EMACS is not bad, but it's always in insert mode." Editors being like religions, this is probably one of the major fissures in the faiths of the followers of editors: moded vs. non-moded editors. Many would claim that one of the great points of EMACS is that it is always in the same "mode" (I am one who would claim this.) Having to remember, when using an editor, whether one is in insert or command mode is something that can drive a person like me insane (maybe that is what did it). Sprung also comments, "It also inserts real tabs," which have to be filtered out before being given to a compiler. I would claim that the problem is in the compiler. I would class as unusable an editor that refuses to store tabs as tabs (e.g., the MIX editor).

atari.st/tech #199, from conover [Harry Conover]
a comment to message 192

MicroEMACS isn't bad, but it can't be compared to a real programming editor like vi, which I understand will be soon available for the ST. I still haven't learned how to go directly to line *n* to correct a diagnostic-detected error. Can you tell me how?

atari.st/tech #202, from alexl.
a comment to message 199

Get to the beginning of a file. Type <ctrl> u, then enter the line number for the argument. Then press the down arrow key. Ta-da!

atari.st/tech #203, from sprung
a comment to message 195

You misunderstand me on modes. I mean "insert" as opposed to "overwrite."

I don't care if an editor splits the work between edit and command modes, and I use editors of both persuasions. As for tabs, certainly the M2 compiler is remiss in not ignoring them, but it is not alone in that respect. I personally prefer the tabs and don't mind running everything through detab before compiling.

IBM PC AND COMPATIBLES

The IBM PC conference excerpts concentrate on software this month, with three discussions centering on various aspects of DOS. First, there is a question (and, yes, answers) about format problems with specific hard disk/controller/DOS combinations. Next, BIXen get into a thorough look at *exactly* where in memory DOS begins and ends. Finally, someone asks how to create a file of precise printer output for debugging purposes. Several software solutions are proposed.

DOS 3.1 FORMAT PROBLEMS

ibm.pc/pc.hardware #779, from smack [Steve Mack]

I have a WD (Western Digital) controller and a Rodime 30Mb HD that were formatted with DOS 2.1 until a couple of days ago. I got tired of 8K clusters and wanted to do a low-level format anyway, due to a new bad sector, so I BACKUP'd, formatted, and tried to bring up DOS 3.1. The FDISK went OK, made entire disk my DOS partition, but then "FORMAT C:/s/v" would say "Format complete" but also said "Invalid media or Track 0 bad—disk unusable, format failure."

Several more attempts led me to get a new drive and controller under warranty (Statewide Microelectronics by the way—quick swap; no hassles), but the new set did the *same thing*. Finally, I tried DOS 2.1 again and it runs fine, formatting with no errors. Next, I tried DOS 3.1 with a partition size of 100 cylinders, instead of the 639 on the entire disk, and this worked.

Next I tried "FORMAT C:" with no /s/v, but on the entire disk as DOS partition, and still got the error. Then I ignored the error and did "SYS c:" and copied COMMAND.COM over. Lo and behold, all is fine now! 2K clusters and all! Restored 30 some-odd floppies and all is fine. Does anybody have any idea of what just bit me? Am I hallucinating? Better part of two days makes me want an answer even though it works now.

(continued)

ibm.pc/pc.hardware #780, from sak [Sal Magnone]
a comment to message 779

I get all kinds of fun things with my WD controller. Sometimes it doesn't format in 3.1. Other times (when I had a Victor Speed Pac) it refused to catch. That means the computer does not manage to recognize the fixed disk. The faster you go, the more often it'll refuse to catch. Now I just got a V20 and the drive refuses to catch maybe 1 out of 10 times. I'm not the only one with these problems!

ibm.pc/pc.hardware #783, from conniek [Conrad S. Kageyama]
a comment to message 779

Sigh. You've run into the tried-and-true DMA boundary problem with FORMAT.COM. . . .

First, the cure to get you formatted and running. If you did not do it from a plain vanilla system (no TSRs loaded, no CONFIG.SYS), then try it that way and see what happens. If it still bombs from a plain vanilla system, then change your BUFFERS= to 99 and try it again. This should do it for you. There is most likely absolutely nothing wrong with either your drive or your controller. The problem lies in the fact that one of FORMAT's buffers *cannot* lie across a 64K boundary. By cranking up the buffers (each one takes 512 bytes of RAM), you're simply moving that buffer to another location, hopefully not across a boundary.

Now, once you're all fixed up and running, you can start playing with your normal system to modify it so you won't get that error message. As you add new TSRs to your AUTOEXEC, you will be moving this load limit, and the same buggy could crop up. In my experience, the easiest fix is to alter my BUFFERS= by one buffer at a time for a 512 byte adjustment, or my RAM disk by 1K for a 1K adjustment.

Also, if you get this error message, a sure-fire way to confirm the DMA boundary problem is to load Debug and then look at the registers by doing an R at the — prompt. If the register is in the range of D thru F or 0 thru 3, then you've confirmed the problem.

If it's any consolation, this bug is also evident in DOS 2.1 but was *supposed* to be fixed in 3.x. It is now reputed to be fixed in 3.2, but I haven't had any reports yet.

MS-DOS LOAD ADDRESSES

ms.dos/other #424, from stevebh [Steve Booth]

OK, here is a real problem: I am a software developer, primarily using Lattice C's large model to develop a large application program. One of the real problems with Lattice C in the large model is that it can (by definition) modify any location in memory. Unfortunately, somehow we have managed to write our software so that it clobbers MS-DOS. We have an analyzer that can catch our program doing this, and thereby determine what is going wrong, but we can't seem to find out just where in memory MS-DOS is loaded *exactly*.

I called Microsoft—they told me to call IBM. I called IBM, they told me to call ComputerLand. ComputerLand told me to get Norton's MS-DOS book. I did. It doesn't tell where MS-DOS is loaded, and further it does not tell how to find out. I am at a loss to know where to look next. HELP! I have managed to learn that when MS-DOS is booted, it loads IO.SYS, then MSDOS.SYS, then COMMAND.COM into memory, but how do you find out where? Where are the FATs stored? Where are the BUFFERS stored? Why is none of this in any of the documentation?

ms.dos/other #425, from barryn [Barry Nance]
a comment to message 424

"User memory"—where the very first program (DOS) can be loaded—begins at 00500 (hex) in IBM PCs. 00000-00400 are used for the interrupt vectors and 00400-00500 are used as a BIOS/DOS data area.

The ending address depends on which version of DOS you're using, of course. Does that help?

ms.dos/other #426, from stevebh
a comment to message 425

Not really. I already know where MS-DOS starts, and as you say, on an IBM, it's at 500 hex, but where does it end? Where does it put its FATs? Where do the file buffers start? Where does COMMAND.COM start? Where does it end? What is between my user program and the top of DOS (wherever that is)?

ms.dos/other #427, from dmick [Dan Mick]
a comment to message 426

It is, as Barry says, dependent on the version you're using. The only thing between the top of DOS and you is your environment, which DOS builds at load time. FATs and buffers and COMMAND.COM are all lower than where you load by the environment length. Why in the world would you want to know this for a C program? Are you trying to collect stats about DOS? In my opinion, ya shouldn't be writing lower than your load address *period*, because that's just not the way to play the game. But I'm interested enough to ask, so . . . whatya doin'? (Or maybe the fact that DOS is contiguous is what you wanted?)

ms.dos/other #428, from barryn
a comment to message 426

I just took a look with DEBUG.COM, and I found out the following:

(I have DOS 3.1, with BUFFERS=20, FILES=20, and ANSI.SYS.)

1. The permanent portion of DOS ends at 0BED:05AA on my system.
2. The FATs are apparently brought into memory when necessary, and are not permanently resident.
3. The file buffers are apparently in low memory, just before DOS, in the area 0050:DA00 or thereabouts.
4. COMMAND.COM is loaded into high memory . . . on a 640K machine, it would be at the 617K mark (or so).
5. I don't understand what you mean by "between my program and DOS."

Does that help a little more?

ms.dos/other #429, from dmick
a comment to message 428

Sorry, that's right, COMMAND.COM loads high. I have PC-DOS 2.10 on an XT, BUFFERS=20, ANSI.SYS and got 8C2:0 as the first command load address (where the first resident program was). It appeared that there were fragments of directories (implying buffers) all through this general area of core, seeming to follow no certain pattern, although I'm sure it must. I know that DOS tries to keep FATs and DIR of the current subdirectory in memory to speed access times . . . don't know where, though. That's what the MediaChange function of the block device drivers is all about, though—to check if that stuff needs reloading.

ms.dos/other #430, from rduncan [Ray Duncan]
a comment to message 428

The DOS buffer pool is much higher than that . . . it lies between the DOS kernel (MSDOS.SYS or IBMDOS.COM) and COMMAND.COM. What you may be seeing was a dedicated disk buffer for one of the drivers. COMMAND.COM is divided into 3 parts. The "resident" part sits above DOS and below your program. This part is fairly small and contains the handlers for the critical error, Control-C, and termination interrupts, among other things. The "transient" part sits at the top of memory and can be overlaid by other programs. It is reloaded from the disk when needed using the COMSPEC variable in the environment. It contains the batch file interpreter, intrinsic commands (like COPY, DEL, etc.), and so forth. The "initialization" part sits just above the "resident" part when the system is booting. It is mainly responsible

for interpreting the AUTOEXEC.BAT file, and is then discarded. Like dmick said, as long as you don't write into any memory *below* where your program loads, you aren't going to have problems. Poking into the innards of DOS seems to be the wrong approach . . . figure out what is wrong with the program that is causing the trouble instead.

ms.dos/other #441, from stevebh
a comment to message 427

It's not that I *want* to know it, it's that this damned C program *writes* on top of MS-DOS, and I'm trying to find out where in the program it's doing it. I have a Logic Analyzer that will catch any write to any memory location, but in order for it to be useful, I have to know where MS-DOS is, in order to catch the write.

ms.dos/other #443, from dmick
a comment to message 441

Well, what I'd do is load the C program with Periscope or some other debugger that is resident. What? You don't have PS or Atron? Well . . . they're great for this type problem 'cause you could breakpoint writes to any location lower than your load address. In lieu of that, however, why don't you load Debug or CORELOOK or sumpin' else that allows you to examine memory, then look for where *that* program starts, by looking for its environment/pspseg. Then exit that program and you know where the next one (the C program) will load. The logic analyzer can then be used to see when addresses below that load address are accessed, assuming you can single-step your C code.

PS: With Debug, for example, the address you get after typing DEBUG <ret> is the "new load address" after Debug installs itself. Look below the CS:IP Debug gives you for environment (easily recognized by strings . . . PROMPT, COMSPEC, etc.). The paragraph above the end of the environment (marked by 00 00) is the Memory Control Block for Debug's psp-code segment and is marked by 4D as the byte in offset 0. The *next* paragraph is Debug's psp (goes on for 10 paragraphs or 100 hex bytes), then Debug's code. Your load address will be where Debug is now, after you exit Debug and run your errant program. (Is all this as clear as mud?) Perhaps a diagram. . .

```
xxxx:0000 Environment for Debug
(COMSPEC=c:\comm~Hand.com,00h,etc.)
xxxx:0000 4D . . . mcb for Debug's code and psp
to follow
>xxxx+1:0000 CD 20 . . . psp for Debug (starts with
INT 20H)
xxxx+1:0000 will be your C program's load address.
(There, the horse is dead!) Hope this helps, too.
```

IMAGE FILE SPOOLER

ms.dos/utilities #310, from r1amb [Richard Lamb]

I have a question that I hope some of the assembly language hackers can help me with. I often find, especially when installing word processors, that I need to find out *exactly* what is being output to the printer. I need a disk file that duplicates the bytes sent to the printer. However, many word processors do not have a "print to disk" function, and even those that do frequently don't send the same thing to disk that they do to the printer. Therefore, what I would like to do is create an assembly language program that would stay resident, listen to all output sent to the STDPRN device, and send it to an open disk file. I have a public domain utility called FSPOOL which is supposed to do exactly that, but doesn't work on the Zenith Z-100 I tried it out on. At any rate, here is how I plan to tackle it: Use function 46h of INT 21 to force handle 4 (STDPRN) to duplicate onto an open disk file. Then use 4Bh (EXEC) to load and execute a second copy of COMMAND.COM. Since the new command interpreter would inherit the old environment,

its PRN would be redirected. Using the second copy of COMMAND.COM, I can then load whatever application program I want. Finally, after quitting the application and exiting the second COMMAND.COM, the utility would close the disk spool file and terminate.

Before I start on this, I'd like to find out if there is a better way. Somehow, two copies of COMMAND.COM, one utility, and one application all loaded into memory at once seems a bit inelegant. I am trying to avoid using any IBM-specific interrupts or BIOS services. Seems like the DOS services should be sufficient. Anyone have any suggestions? The completed program will be placed into the public domain.

ms.dos/utilities #311, from barryn
a comment to message 310

I wonder if the WP programs that don't support print-to-disk perhaps bypass DOS and issue INT 17 (Print a Character) BIOS calls directly? Such programs would be difficult to deal with. On the Zenith, is INT 17 a printer BIOS routine?

ms.dos/utilities #312, from dmick
a comment to message 310

My documentation on CDUP is awfully sketchy. It says that if the read/write pointer for the original file is moved, so will be the duplicated file handles pointer. It does *not* say anything about read or written data to either. DUP is more explicit about this, and says essentially that you will have a dual reference to the file, so one would assume CDUP is the same with the "forcing" applied. However, if the application you are using does not use file handles (read WordStar or other ill-behaved DOS 1.x programs, even some released after DOS 2.x but updated by lazy programmers), then you're out of luck here. The other option I would suggest is this:

Enumerate all the standard DOS functions that send stuff to the printer, including 40h (write to handle), and AUX out, and PRN out, and the old (FCB-style) writes; then catch them all with an INT 21h filter, and process them accordingly (write to a file, hopefully without getting into reentrance problems). Of course, this filter would have to be smart enough to figure out that it was indeed PRN (or LPT1: or COM1: or whatever) that was receiving the output/file write for those cases where the function is not specific; and then

Tear your hair out trying to debug all this.

I'd cop out, myself, like FSPOOL does, and intercept the last element in the chain of getting things printed, the BIOS call. That is really the only appropriate place for a robust routine. On IBM clones, the call is INT 17h; on your Z-100, the call is BIOS__PRNFUNC, and its vector is an offset only into segment 40H and is located at 40:48h. See the PUP guide for reference as to what the call does, input/output, etc.

A question: why the second copy of COMMAND.COM? Seems like, if you just wanted to catch the data in another handle, the call to DUP would do it. Or am I missing the boat completely here?

ms.dos/utilities #317, from rduncan
a comment to message 310

Why not just EXEC the application directly after FDUPing the printer handle, rather than doing it via COMMAND.COM? Otherwise, your proposed method looks right to me, if you want to avoid IBM-specific interrupts and BIOS services, etc.

ms.dos/utilities #318, from r1amb
a comment to message 312

Well, you have certainly brought up some valid concerns in your message. Indeed, after studying the manual, I realized that the very

(continued)

programs I'm trying to work on are the ill-behaved ones. (WS is one of the problem children, XyWrite III another. I'm not sure what method Xy uses to print, however.) The reason for the second COMMAND.COM was that I wanted to avoid writing enough code to allow the routine to handle any application, a command-line parser, etc. Pure laziness. My current method for handling this problem is to use Zenith's CONFIGUR program (performs an identical function as IBM's MODE command) to change the output to the AUX: port, then capturing it with a Tandy Model 100. Although I'm limited to about 30K bytes, it's beginning to not seem so inconvenient. As to the use of the DUP function to force redirection of the PRN handle, I'm taking Peter Norton at his word on that. Before he made specific reference to that use of the DUP function, I hadn't a clue as to what to use it for. Does anyone have the source to FSPOOL? Perhaps I can modify it to use the Zenith's BIOS call rather than IBM's INT 17H.

ms.dos/utilities #319, from dmick
a comment to message 318

Well, I don't have the source, but I have unassembled the code with Debug and it's not too bad. If you have ASMGEN and a copy of the .COM file you should be in business. What? You've never heard of ASMGEN? It generates .ASM source from .COM or .EXE files and a file of instructions you create (5a is a data byte, 100 to 200 are 00 reserved for stack, etc., . . . that kind of thing). Great for reverse- (perverse-?) engineering this thing or that, especially if it's small and easily understood. I think it's already on listings; if not, I can post, but you may be able to just use FSPOOL and Debug. Or look at the former and create your own code. It's pretty easy, as I recall.

I have used FSPOOL to debug WS. It's hard to beat seeing just what that ~\$%&(*) is sending to my printer to make it enter compressed mode, do 50 form feeds, and beep at me! Good luck. Hope we've helped out here.

MACINTOSH

The Macintosh conference this month was busy with questions concerning the effects of new Macs, and Mac upgrades, on existing software and future purchase plans. Our excerpts from the conference begin with a spine-chilling tale of hard-disk adventure. Next, a problem with RamStart on the Mac Plus and various solutions are discussed. BIXen mdelugg asks questions about the virtues of upgrading and gets a number of replies from those who have gone before him. Finally, we wrap up with two threads of speculation on new products, the first on possible CD-ROM directions, and the second with directions all its own.

MACINTOSH HARD DISK

macintosh/hardware #106, from microprose [Russell Finn]

TITLE: It Was a Dark but Non-Stormy Night. . .

Now that my hands have stopped shaking, I feel I should share my experience with other Macintosh users. I have had my "dream system" (Mac Plus, HD 20, ImageWriter II, Personal Modem) at home for less than a week; having acquired Red Ryder 8.0, I have begun to download software from various systems. In short, life is good.

Tonight, however, while I was perusing one of my latest acquisitions (the MacinTalk documentation), the lights in my apartment *blinked* once—twice—three times, and I found myself facing a blinking question mark. Almost immediately, the HD 20 started whirring and blinking, so I waited for the desktop to reappear. And waited. And *waited*. And . . . the blinking question mark came back!

I became a little nervous at this. Manually resetting the Mac using

the programmer's switch produced the same results as before. Clearly something was amiss. I popped the System Tools disk into the slot, and in moments the familiar desktop had reappeared. I waited for the "Hard Disk 20" icon to emerge. And waited. And . . .

[Hard Disk icon] This disk is unreadable. (Eject) (Initialize)"

I stared in horror at the dialog box. In just under a week I had accumulated over five megabytes of data; had they all gone to the great bit-bucket in the sky? Was I being punished for not buying IBM? I started to look for some useful utility—FEdit, MacFloofs—but realized that none of the versions I had were HFS-compatible. There seemed no hope . . . unless . . .

I reached behind the HD 20 and threw the power switch; the drive quickly coasted to a stop. Then, breathing a prayer to the Great Spirit Woz, I turned it back on. And waited. And . . .

Window after window appeared on my screen—applications, fonts, VCO face files . . . *they were back!* All five megabytes! Order had triumphed over chaos!

Satisfied, I went to the kitchen for a Diet Coke.

MORAL I: Don't panic!

MORAL II: When you can't afford an uninterruptible power supply, you have to learn to accept some anchovies in the great pizza of life.

MORAL III: Does anyone have a good HFS-compatible backup utility?

macintosh/hardware #107, from cgibson [Chris Gibson]
a comment to message 106

I have found that anytime an abnormal termination occurs while my HD 20 is on-line, when I power up the HD 20 after the termination, the HD will sit there, furiously doing something, sometimes for quite awhile. While I don't know exactly what's going on, I would guess that the hard disk is left in a less than perfect state, and it takes the time to delete internal temp files, or check the directories, or rebuild some index. I make no pretenses on my expertise in this area, but what I can say is this: if your HD freaks, power down, then switch on the HD *only*. As long as it is making noises, and the light is blinking, don't interrupt it. *Wait* until the light glows steady, then power up your Mac. (Whoops, I don't know if this works with the old ROM—I only use my HD 20 with my Mac Plus, not my 512K.) Anyway, microprose is right: DONT PANIC!!

macintosh/hardware #108, from lloeb [Larry Loeb]
a comment to message 106

(Getting up after falling on floor, laughing) Woz (gasp, chortle) rewards the faithful.

macintosh/hardware #109, from lloeb
a comment to message 107

Well, since microprose doesn't have Strike Force Eagle out for the Mac yet, maybe this is the start of a new game: HD CRASH! Survive massive data loss! (Batteries Not Included.)

macintosh/hardware #111, from paul.hoffman [Paul Hoffman]
a comment to message 106

MORAL I is especially true. Here's another that the folks at Apple don't admit to: Hitting the programmer's switch is *not* the internal equivalent of turning the Mac off and on. Somehow, resetting does not clear everything internally. If you get a bomb, reset, and one of your disks seems trashed:

—Take two deep breaths.

—Turn the Mac off for 5 seconds (the vision of black on the screen may be good for the soul).

—Turn it back on.

This has happened to me many times during software development.

RAMSTART/MAC PLUS PROBLEMS

macintosh/mac.plus #58, from dpallen [David P. Allen]

I have been trying to use RamStart with the new ROMs and everything works OK until RamStart tries to massage the system file into the RAM disk. At that point comes the big bomb with ID = -03. Everything else seems to work OK with the RAM disk, and I can move the system file over manually after the RAM disk is created, and it seems to work OK when I change the default manually to the RAM disk Finder and system file.

I tried a patch of RamStart, suggested by a chap over in CompuServe, but it didn't help. Any suggestions?

macintosh/mac.plus #59, from deu [William Deu]
a comment to message 58

Yeah, I think I had the same problem. My guess is it has something to do with the system file's boot blocks. I worked around it this way:

- First, I boot with the system disk, with RamStart in a folder by itself.
 - Second, I then open the folder and launch RamStart.
 - Third, I copy whatever I need to copy into my RAM disk.
 - Fourth, I then stick the system disk in and launch TMON or some other application. Then I quit it and when I'm back to the Finder I don't have anymore problems.
 - Fifth, I'm not sure why this works.
- (PS: I'm using RamStart v1.21 with the patch from CompuServe.)

macintosh/mac.plus #60, from dpallen
a comment to message 59

Here is the solution to the RamStart problem as presented by a chap on CIS. I tried it and it works. It is necessary to do the hard disk patch to get rid of the occasional error message.

Patching of RamStart Versions 1.21 and 1.22 to Operate with Mac 128K ROMs:

The patching can be undertaken with MacTools, FEdit, MacZap, or similar utilities which are capable of searching for text strings and then writing changed ones to disk.

.....

To patch version 1.21:

In sector \$0C, offset \$B4, replace 4EBA 0682
with 4E71 4E71

In sector \$0D, offset \$17A,
replace 6700 0012 006E 8000
with 6000 0012 006E 8000

If you're using a hard disk, you may need to apply the following patch (Gary had to use it for both the Corvus and the Warp Nine):

In sector \$06, offset \$190,
replace 41FA 0388
with 6000 000C

The symptom for this last problem is a message "can't find our drive #."

.....

To patch version 1.22:

In sector \$0C, offset \$36, replace 4EBA 0678
with 4E71 4E71

In sector \$0D, offset \$F8,
replace 6700 0012 006E 8000
with 6000 0012 006E 8000

If you're using a hard disk, you may need to apply the following patch (Gary had to use it for both the Corvus and the Warp Nine):

In sector \$06, offset \$132, replace 41FA 0384
with 6000 000A

The symptom for this last problem is a message "can't find our drive #."

CONSIDERATIONS FOR MAC UPGRADE

macintosh/mac.plus #61, from mdlugg [Michael Delugg]

Question: I've got a 512K with single-sided drives. While I often find myself spending time "re-organizing" my files so as to not run out of disk space, I don't find it too bothersome (yet). I mainly use the Mac to help me run a "small" business (billing, scheduling, etc.), and so far, my third-party memory upgrade (to 512K) seems to be holding its own. The point is: What improvements would I realize from the Mac Plus upgrade (probably the RAM, too) as opposed to any drawbacks? I've seen a lot of messages dealing with power supply problems and incompatible software. Will Copy II Mac back up to the 800K drives? My three most-used applications are OverVUE 2.0, MS-Word, and Red Ryder.

macintosh/mac.plus #62, from pkarnig [Peter Karnig]
a comment to message 61

I use Mac Plus, Word, File, Excel, Red Ryder 8.0. My small business has 512K Macs. I can only say that the Mac Plus is quite a bit faster and utilizes Switcher much, much better. Copy II does not work on 800K disks, but you can use the hard disk copy tool to copy applications to a RAM disk, then copy it to your 800K. This works. I use version 1.21 and have just heard of a new version: 1.22. Hope this helps.

macintosh/mac.plus #64, from ccrawfor [Chris Crawford]
a comment to message 61

My two-penny opinion is this: You should definitely do the \$300 ROM and disk drive upgrade. For that money, you get faster operations and a disk with more capacity. This can be very important in terms of allowing a system disk with all the fonts and desk accessories that you want.

The next upgrade, the new board with the SCSI port and the 1 Mb of RAM, is considerably more expensive and definitely worthwhile if you expect to buy a hard disk soon, as SCSI drives are faster and cheaper than the drives that connect through the old serial ports. If you do not expect to purchase a hard disk, then the only value of the board is for an extra 512K of RAM; I do not think this is a good buy. There are better ways to get more RAM for your Mac.

Finally, the new keyboard is of value to those who do a lot of numeric entry. It does interfere slightly with mouse operation, so I do not want it for my own use.

macintosh/mac.plus #65, from lloeb
a comment to message 64

I tend to agree. If you want more from what you have now, the Plus is a good upgrade. But if you see those 68020 machines over the horizon . . . well, consider if you really need the logic board before [the new machines are introduced].

macintosh/mac.plus #66, from stike [Jim Stikeleather]
a comment to message 64

Chris, I appreciated your two-cent opinion. I have been wrestling with whether to upgrade or not for about a month now. I had pretty much come to the same conclusion as you. The Mac goes in next week. It's always nice to have my decision reinforced.

(continued)

macintosh/mac.plus #71, from cccrawfor

On the question of using an old keyboard on the Mac Plus: I took two Macs, one a standard Fat Mac, the other a standard Mac Plus, and swapped keyboards. Both seemed to work just fine. I did *not* put them through a torture test, just light use.

macintosh/mac.plus #72, from tom__thompson [Tom Thompson, Technical Editor, BYTE]
a comment to message 64

I'll raise ya two, Chris (*clink*). I agree with you on this, and I can offer yet another reason for not going to the new logic board. Unless your dealer has the new cables handy, you're going to have a Plus that you can't hook to your existing printer and modem, thanks to the DIN-8 connector on the serial ports.

If you have a ton of peripherals that use the DB-9 connector or the +5V out of the serial ports, consider things carefully before taking the plunge.

FUTURE PRODUCT SPECULATION

macintosh/news #362, from frankb [Frank Boosman]

TITLE: Another Slimy Rumor

Have you ever wondered what Bill Atkinson has been working on since MacPaint? I have. Oh, sure, he did MacVisio, but that probably took him a month or so. Then there was PaintMover, but that was probably a week job. Rolodex most likely took him all of an hour. So what has he been up to? What fantastic software has he been designing?

Well, we know he's working on an updated version of QuickDraw—one that will allow device-independent graphics, with color, high resolution, and all that. And it would seem to be a safe bet he's working on a color version of MacPaint—unless doing the first one burned him out on painting programs.

So we're back to wondering what he's doing with all this extra time. In the book *Inside MacPaint*, the author asked him just that question. His answer? Well, his answer was that he was working on something neat, but he doesn't like to talk about things before they're finished. He likes to spring them on people.

Last weekend, I watched "Hackers" on PBS. In it, they talked with Bill briefly. He used MacPaint to demonstrate a concept he said he had been thinking about of late (this was about a year ago, mind you). What he demonstrated—again, using MacPaint pictures—was sort of a Filevision-type CD-ROM interface. You know, click on an object and get information. His idea looked pretty nifty, especially considering it was a year ago, when no one really cared about CD-ROM.

So, is that the mysterious program Bill is working on? We do know that Apple is committed to CD-ROM—in a recent CompuServe conference, Jean-Louis Gasse said they would be introducing products "soon." And they wouldn't want to introduce a CD-ROM product without software.

Have I stumbled onto it? Or do you think I'm just barking up the wrong tree?

macintosh/news #366, from frankb

I've never seen PaintMover (could someone upload it?), but from the article I read, it appears to be a utility for working with full-page MacPaint documents. You can enlarge areas to poster-size, smooth them, etc. . . . again, this is definitely secondhand.

macintosh/news #368, from cccrawfor
a comment to message 362

I know the guy at Apple who is responsible for marketing projects involving laser disk and CD-ROM. He is in a research group, not a prod-

uct development group, and I have never gathered the impression that he is close to anything like a product. Then again, it is considered bad form to pry.

macintosh/news #370, from tom__thompson
a comment to message 366

I've got version 0.3. It does handle full-page Paint documents. Essentially you get two windows, one for input (your MacPaint file) and one for output. Then you select the region you want copied to the output window by clicking and dragging over the desired area in the input window. Next, you select "copy," plus any scaling function, and inverse or XOR bit operations, and see the result appear in the output window. Finally, you save the output to a MacPaint file. It is very good for handling stuff that won't fit within the MacPaint window. I had a portion of a chart to copy for a new document, and it covered a full 8- by 11-inch page. I simply selected the region I wanted in PaintMover, copied it over, saved, and made some minor edits to get a new chart. I would have had to perform several major operations to transfer it using MacPaint. It's one of those nifty utilities that you don't need for several months, but when you need it, you need it bad.

macintosh/news #376, from cccrawfor
a comment to message 368

I called my friend at Apple today and he was appropriately evasive about the subject of CD-ROM products—this is in itself an indication that something is cooking after all. He did read me some comments that had already been cleared for a speech he gave at the Microsoft conference; fairly bland stuff, but the implication seems to be that Apple is looking very seriously at CD-ROM. One point that he was explicit on was that Apple is trying hard to get a good standard set up. The immediate fruit of this standards stuff is a set of VTOCs on each CD-ROM for each of the major machines. With 550 Mb, you can afford multiple VTOCs.

Finally, he cautioned against premature expectations for CD-ROM. A lot of people seem to think that this technology is just around the corner, and his opinion (I think it was a personal opinion, not an Apple policy) is that it will take a few years to mature.

Sorry this is all so vague, but he did not want to play Corporate Blabbermouth, and I didn't want to pry.

macintosh/news #384, from kerskine [Keith Erskine]
a comment to message 376

Chris, could you explain VTOCs? I'm not familiar with that abbreviation.

macintosh/news #386, from cccrawfor
a comment to message 384

Oops, sorry; I should have known better, for it is a tad obscure. It means "Volume Table of Contents" and is a table of all files on the disk and their locations (more precisely, the locations of the first part of the file). Floppies use VTOCs, hard disks use VTOCs, and so must CD-ROMs, unless you are setting up a really weird system. The idea Apple is promoting is to rig the CD-ROM with a number of VTOCs, each one designed to be accessible to the operating system of each of the major machines. Instead of coming up with One Universal Standard that everybody can be happy with, the idea is to compromise down to two or three semi-universal standards that everybody can live with. Sounds to me like one of the more pragmatic solutions to the old standards bugaboo.

macintosh/news #387, from mwelch [Mark Welch]
a comment to message 386

Multiple VTOCs make a lot of sense if you have IBM users who want to

access a CD-ROM using DOS filenames, and Mac users of the same disk who want to access it using the desktop. And those who are quite interested are invited to join the cd.rom and storage conferences.

OBJECT-ORIENTED PROGRAMMING LANGUAGES

One of the important facets of BIX is the staging of "special events." This month, the special event on Object-oriented Languages seemed particularly appropriate for inclusion here. The threads cover possible definitions of object-oriented programming languages (OOPs) and a practical application using Smalltalk.

DEFINITIONS OF OBJECT-ORIENTED LANGUAGES

smalltalk/expert.forum #17, from bstroustrup [Bjarne Stroustrup, AT&T Bell Labs]

What is a really good definition of an object-oriented language?

"Really good" may be too much to ask for, since there are several different schools of thought, but here is mine:

A language supports object-oriented programming if it provides an inheritance mechanism. That is, in Simula67 and Smalltalk terminology: subclasses. The language is object-oriented if it enforces the rule that *all* communication between objects must be in the form of calls of methods (sometimes called member functions).

smalltalk/expert.forum #25, from Itesler [Larry Tesler, Apple Computer Inc.]

What is a really good definition of an object-oriented language?

A language in which statements tell objects to perform actions and to transmit results, instead of telling procedures to operate upon data.

In an object-oriented language, a statement is more like a stage directive in a play (Smith: exit stage left) than an imperative command (Kick out Smith!).

smalltalk/expert.forum #39, from cox [Brad Cox, Productivity Products International Inc.]

I agree with Bjarne that a "really good" definition is probably too much to ask for until today's wealth of personal definitions can be sifted for areas of consensus. Assembler, FORTRAN, C, Ada, C++, Objective-C, and Smalltalk are points on a continuum of increasingly object-oriented languages, and it is hard to divide a continuum into crisply separated regions with any "really good" definition.

I propose two definitions in my book, one broad enough to encompass even statically bound languages like Ada, and the other narrower, to include only languages with dynamic binding. By the broad definition, an object-oriented language (1) allows code suppliers to define new types for export to code consumers and (2) allows code consumers to use them as genuinely new types rather than as an unconnected conglomeration of data declarations and functions. Ada's package facility qualifies under this definition since, for example, it is possible to define a new type (e.g., Point) as a collection of data declarations (e.g., a Point is a pair of integers) and operations on that data (e.g., point arithmetic operators), and to export the package

describing the new point type to consumers who may use them as if they were predefined types of the language, without concern for their implementation.

I prefer the narrower definition that results from adding the requirement that (3) the decision as to which piece of code should be executed, given a particular data-name/operator-name pair in the source, must be made as late as possible: at run time, not at compile time. The primary reason is that late binding allows highly reusable code to be produced that adjusts automatically to the environment that its user places it in. Early binding requires that the user *invoke the compiler* and have access to the supplier's source code to adjust the code to his needs, the first of which is not generally possible at run time and the second of which inhibits the development and use of highly reusable code by requiring code suppliers to trust consumers to respect their proprietary interest in source code.

smalltalk/expert.forum #67, from j.jones [Jeremy Jones, Coral Software Corp.]

Creating new types is a fundamental activity in most programming languages including non-OOPs. This does not distinguish them. What distinguishes OOPs is that behaviors are associated with types. This leads to a definition for OOPs: An OOP is a programming language that deals with entities that can have both state and behavior. These entities are often called "objects."

I believe that this definition includes all languages that claim to be object-oriented. But perhaps this definition is not exclusive enough. By this definition, ALGOL68 is object-oriented since procedures can have "owned" variables, variables that are local to a procedure and whose state is maintained even when the procedure is not dynamically active. So perhaps the definition could be extended to: An OOP is a programming language that provides tools for dealing with entities that can have both state and behavior. Some of these tools are "message passing," "inheritance," "classes," "subclasses," "polymorphism," and "encapsulation."

Here is the rationale for these tools:

There needs to be a way to initiate behavior in objects; this is the reason for "message passing."

If you have a language that deals with objects, it is useful to have the capability to create objects that are "just like" other objects, without actually making copies of everything. This is "inheritance."

It is also useful to have a capability that allows many objects to share the same behavior, but have different state. This is the reason for having "classes" and "instances."

Once you have inheritance, it is useful to have the capability to create an object that is "just like" another object "except" for minor differences. This is the origin of "subclasses."

It is useful to have different kinds of objects respond to a request in their own particular ways. This is "polymorphism."

Since objects already have state and behavior, it seems natural that the state of an object can only be changed by its own behavior. This is "encapsulation."

smalltalk/expert.forum #71, from j.jones

a comment to 67

This note describes the way Object LISP and Object Logo deal with the issues brought up in my last note.

Object behavior is initiated by telling an object to evaluate an expression. The functions and values associated with symbols depend on the current object. Herein lies the main difference between Object LISP and other OOPs. Object LISP is a "pure" OOP in the sense that every operation involves an object, but the object is implicitly *self*.

Sharing knowledge is accomplished by supplying a list of objects to inherit from when an object is created. Conceptually, this list of objects is searched, in sequence, on every function call or variable reference

(continued)

until a value is found. Since each parent object also inherits from a list of objects, there may be duplicates in the search path. These duplicates are actually eliminated when the object is created so that the search path is linear. The last of a series of duplicates is retained. The search stops when the global object is reached.

Classes and instances are implemented by using the conventional procedure "exist" to create an instance's state. Any object that has an exist procedure can be considered a class. An instance is created by creating an object that inherits from a class, then calling exist to create the state. This is done in one operation by calling "oneof."

Subclasses with overriding or shadowing of functions is accomplished automatically, since the search for a binding stops when the first one is found, and any object can have a binding for a particular symbol.

Polymorphism is also accomplished automatically since the same symbol can have as many different function bindings as there are objects.

Encapsulation is not accomplished via the object system in Object LISP. A very good encapsulation technology already exists in many LISPs. This is called "packages." Packages allow you to have many different "namespaces" in a system, and to specify which names are accessible outside of a package. This encapsulation technology is used successfully in some very large systems such as Macsyma and the LISP Machine. Our view is that encapsulation is orthogonal to an object system. Objects are mainly an inheritance and dispatching technology. Accomplishing encapsulation with objects is overextending the technology, hence the confusion of whether or not to allow subclasses to access and change a superclass's state.

There is one other OOPL tool that I forgot to mention in my last note; this is "method combination." It is the ability to create a behavior that is a combination of other objects' responses to the same request. This is accomplished in Object LISP by using the "usual" facility. This allows a procedure to call the "usual" procedure at any time during its execution. The "usual" procedure is the one that would have been called if the current definition did not exist. Anytime a procedure is written that is a specialization of an inherited procedure, the "usual" procedure should be called somewhere within the procedure.

Object LISP purposefully does not supply a "super" capability. This is because a procedure should not normally explicitly call any procedure in a parent object except the "usual" one. If an object overrides an inherited definition, that definition should always be used.

What do other people think of this method of categorizing characteristics of OOPLs?

smalltalk/expert.forum #72, from j.anderson [Jim Anderson, Digitalk Inc.]
a comment to 67

That was an excellent summary of the "essence" of object-oriented languages, Jeremy.

In order for an OOPL to be an effective tool for problem-solving on a personal computer there are some additional attributes of an object-oriented programming system which I believe are essential.

Language Issues

Jeremy described the fundamental features: "message passing," "inheritance," "instances," "subclasses," "polymorphism," and "encapsulation." I add two more requirements:

1. Safety

Although a strict interpretation of encapsulation (separation of internals from externals) accomplishes safety, several of the OOPLs claim they feature encapsulation while they allow internals to be changed from the outside (from other objects or objectless code). This is unacceptable in a long-running environment with a valuable population of objects where a prototyping style of development results in making changes and er-

rors at a rapid pace. The only object "deaths" that are acceptable are via suicide or garbicide (garbage collection).

2. Garbage Collection

This is a language feature because I code differently when automatic garbage collection is present. Garbage collection stated in terms of Pascal means I must say "new" but I never have to say "dispose." It is a convenience and eliminates a major type of programming error: disposing too soon. Garbage collection is essential in a long-running environment where diverse activities are performed.

Environment/Implementation Issues

Language issues alone are too abstract. I need support from an environment in order to do practical object-oriented programming.

1. Performance

The environment must be highly responsive for effective program development and application use. It has to be fast enough so that I prefer to be working in it rather than outside of it.

2. Organization of Object Population

I need to be able to systematically locate the classes, methods, and other objects in the environment. I need to be able to quickly browse through them.

3. Exploratory Programming

I need to be able to change (and add new) classes, methods, and other objects quickly in order to do exploratory programming. I don't want lengthy edit/compile/link/test steps. I need a debugger which permits me to see the complete problem state and to resume execution after errors are corrected.

4. Access to Other Languages

I want to be able to call non-OOPLs in order to access existing applications and to utilize the strengths of other languages.

5. Access to Underlying OS

I want to be able to utilize the features of the host operating system in order to access files, keyboard, mouse, display, printers, communications ports, date, and time.

THE METHODS BIX BROWSER

smalltalk/expert.forum #11, from j.anderson

Eva, you asked if there were any useful applications. I'm using one now. I'm accessing BIX using my 4.77-MHz Compaq with a "BIX Browser" window implemented in Smalltalk by George Bosworth. With the Bix Browser, I can review all BIX activity using a mouse, without touching the keyboard.

The BIX Browser window has four panes (views). The three at the top contain lists of BIX groups, conferences, and topics. When I select a group, I get the list of conferences in that group. When I select a conference, I get the list of topics in that conference. When I select a topic, I am automatically "joined" to that topic, whether or not I was previously registered. Then I can go to the large TTY-emulator pane below to browse the messages in the selected topic. There is a special group "joined" which shows all the conferences I have joined.

The TTY-emulator pane is multipurpose. I can read messages via menus. If I type at the end, inputs are sent over the communication line and echoed back. If I type before the end I have the normal Methods text editor. I can evaluate Smalltalk expressions like "50 factorial" (very useful) and get

```
3041409320171337804361260816606476884437764156896051200
0000000000
```

So, here is an application which replaces the somewhat complex text dialogue of BIX with the simpler "point and click" Smalltalk-style interface.

[Editor's Note: The source code for the Methods Bix Browser can be downloaded from the long.messages topic of the Digitalk conference.] ■

THE BUYER'S MART

A Directory of Products and Services

THE BUYER'S MART is a monthly advertising section which enables readers to easily locate suppliers by product category. As a unique feature, each BUYER'S MART ad includes a Reader Service number to assist interested readers in requesting information from participating advertisers.

RATES: 1x—\$475 3x—\$450 6x—\$425 12x—\$375
Prepayment must accompany each insertion. VISA/MC Accepted.

AD FORMAT: Each ad will be designed and typeset by BYTE. Advertisers must

furnish typewritten copy. Ads can include headline (23 characters maximum), descriptive text (250 characters maximum), plus company name, address and telephone number. Do not send logos or camera-ready artwork.

DEADLINE: Ad copy is due 2 months prior to issue date. For example: October issue closes on August 1. Send your copy and payment to THE BUYER'S MART, BYTE magazine, 70 Main Street, Peterborough, NH 03458. For more information call Karen Burgess at BYTE 603-924-3754.

ACCESSORIES

LOWEST PRICES ON DISKETTES

5 1/4" DSDD 28, High Density 1.85
3 1/2" SSDD 1.45, DSDD 1.85

- Lifetime warranty
- 100% error free
- Finest quality
- Includes lycrak sleeves
- Reinforced hub ring
- Labels & write protect tabs

Add 3.00 shipping per 100 Minimum 100 diskettes.
Send check or call. CA residents add 6 1/2% sales tax
Same day shipping

Data Bureau Inc.

1833 Westwood Blvd., Ste. 120, Los Angeles, CA 90024
213-479-0345

Inquiry 679

ACCESSORIES

FREE CATALOG

Thousands of parts and new surplus electronic parts at super low prices. **FAST ORDER PROCESSING AND SHIPPING** (95% of all orders shipped within 48 hours)

CALL OR WRITE FOR A FREE CATALOG

ALL ELECTRONICS CORPORATION

POB 20406, Los Angeles, CA 90006-0406

1-800-826-5432

Inquiry 654

BAR CODE

BAR CODE READERS

Program-transparent, Keyboard-wedge Bar Code Readers for IBM PC, AT and compatibles—\$595. Other wedge readers for IBM 3180, 3178, 3278, 5251, 5291, and RS-232 terminals. Portable Bar Code Readers from \$325. Programmable Hand-Held Portables—\$1200.

Worthington Data Solutions

130 Crespi Court, Santa Cruz, CA 95060
(408) 458-9936

Inquiry 756

DATA SWITCHES

Stop recabling forever, with our Serial or Parallel AB or X Data Switches. Two printers can share one computer or two computers can share one printer or plotter, or modem, or monitor, or etc. Prices start as low as \$42.00. Send for our catalog or see our ads in Jan./Mar./May issues. To increase your systems productivity today, call **602-623-5716**

Via West, Inc.

534 N. Stone Ave., Tucson, AZ 85705

Inquiry 752

...SOFTWARE PUBLISHING...

GDS offers a wide variety of services that will help get your software to the market. Address your needs with GDS

- IBM style (cloth/vinyl) 3-ring binders/slips
- Labels, sleeves, disk pages, bulk diskettes
- Disk duplication with 100% verification
- Shrink wrapping and product assembly
- Check turnaround

A well packaged product can make the difference in making a sale. Call us now! VISA/MC

GLENCO DEVELOPMENT SYSTEMS(312) 392-2492
3920 Pidge Ave., Arlington Hts., IL 60004

Inquiry 700

BOOKS/DISKS/VIDEOS

NOW THERE ARE TWO BOOKS!!

Programmers' Handbook of

Computer Printer Commands

Vol. I — pns as new as '84 — \$37.95

Vol. II — pns as new as '85 — \$26.95

Self — I & II — \$58.95

*50+ Manua of DWP/DMP/Color *450 pgs./Table Form
MC/VISA/CX/PO + \$2 COD + \$2.50 SH

ORDERS CALL: 1-800-628-2828 ext. #534 OR WRITE:
CARDINAL POINT INCORPORATED
P.O. Box 596, Ellettsville, IN 47429
(812) 876-7811 (M-F 9-5)

Inquiry 669

Self-Inking Printer Ribbon

For users of Okidata and other open spool ribbon printers. Controlled Printout Devices are a new kind of printing ribbon that re-ink themselves, and will last 15 times longer than the ribbon you are now using. For further information please call or write.

CONTROLLED PRINTOUT DEVICES, INC.

POB 869, Baldwin Rd., Arden, NC 28704

(704) 684-9044

Inquiry 678

FREE CATALOG

Outstanding prices on computer accessories for your computer and workstation. Our catalog features a wide selection of quality products to meet all your accessory needs. Call or write today to receive your free catalog.

LINTEK COMPUTER ACCESSORIES

POB 8056, Grand Rapids, MI 49508

(616) 241-4040

Inquiry 713

BUSINESS OPPORTUNITIES

VIDEO STORES

We need ambitious dealers in all U.S. states and Canada to market a powerful system to computerize video tape rental stores.

WINCHESTER DATA PRODUCTS INC.

3301-Executive Drive., #204, Raleigh, N.C. 27609

(919) 872-0995

Inquiry 755

SOFTWARE PACKAGING, DISKS

Cloth binders & slips like IBM's. Vinyl binders, boxes, and folders—many sizes. Disk pages, envelopes, & labels. Low city, imprinting. Bulk & branded disks. Much More! Low prices. Fast service. Call or write for FREE CATALOG

Anthropomorphic Systems Limited

376-B East St. Charles Road
Lombard, IL 60148

1-800-DEAL-NOW (312) 629-5160

Inquiry 657

39 ms "AT" H-Drives from \$199

20 & 30 mb w/rails/cables/software -

Factory sealed cartons.

Smith Corona Printers\$69

Toshiba 1/2 h.t. floppies\$79

PC SYSTEMS

305-843-8447

Inquiry 733

STUCK AT HOME?

Use your PC/XT/AT to earn money at home keypunching data from forms and printing reports using our software. No experience req'd but must be able to type well. Send personal data, hardware config., printer model and location (ex: 15 ml. NNW of center city Boston) to:

CAC

2348 Eden Lane, Bethlehem, PA 18018

Inquiry 667

BAR CODE

PRINT BAR CODES ON PC

Print Bar Codes and Large Text Labels on PC with Epson/Okidata/IBM Printers - Code 39, I 2of5, UPC, MSI, DOD-LOGMARS, AIAG. Text up to 1" tall. Labels and Catalogs from files. Assembly subrtns for BASIC, Turbo Pascal, Pascal, MS-C. Latrice C. dBASE III +

Worthington Data Solutions

130 Crespi Court, Santa Cruz, CA 95060

(408) 458-9938

Inquiry 756

COMMUNICATIONS

VT102/52 TEK4014 VT220

Our terminal emulators turn your PC/AT/jr into a full featured terminal. Features include: local printing, ASCII & KERMIT file transfer, softkeys, DOS key, ANSI COLOR, 4014 graphics support. Guaranteed compatibility. Call today for free info packet.

General Micro Systems

P.O. Box 5330, Hopkins, MN 55343-1553

(612) 944-0593

Inquiry 898

COMPUTER PROTECTION

- UPS • LINE CONDITIONERS • ISOLATORS
- MODEM PROTECTORS
- AC POWER INTERRUPTERS

— HUNDREDS OF HINTS & PRODUCTS —

FREE CATALOG 1-800-225-4876

ELECTRONIC SPECIALISTS, INC.

171 So. Main St., POB 389, Natick, Mass 01760

1-800-225-4876

Inquiry 683

THE BUYER'S MART

DATA/DISK CONVERSION

DISK AND TAPE CONVERSIONS

High quality conversion services for Dedicated Word Processors, Mini and Microcomputers. Over 600 3 1/2", 5 1/4", and 8" formats. Also 800-1600BPI tape. Included: Wang, NBI, CPT, DEC, Vydec, Lanier, OS/8, Xerox, IBM Sys/34/36/38/5520, Mac, Victor, TRS, Apple, NSTAR, IBM PC/AT, HP, and most of the other microcomputers. We can convert directly into word processing software such as: DW3, WP, MSAWRD, WS, Samna, MM, PFS, and many others.

DATA FORMATS, INC. (408) 972-1830

Inquiry 682.

DATA/DISK CONVERSION

Disk/Disk • Tape/Disk

Over 600 formats! 3 1/2, 5 1/4, or 8 inch disks; 9 track mag tape, 10 MB Remoull cartridge. Data base and word processor translation specialists.

Computer Conversions, Inc.

9580 Black Mountain Rd., Ste J
San Diego, CA 92126
(619) 693-1697

Inquiry 675.

GRAPHICS HARDWARE

HOUSTON INSTRUMENTS PLOTTERS

DMP 40M1&2 (1 Pen, A-B-C-D-size) \$966/\$2577
DMP-51/52MP (C, D-size 174-Pen) \$3661/\$5031

DIGITIZERS

Summagraphics MM1201 complete \$434
OTCO MD7-1212 complete \$602
Hitachi HDG-1111B Tiger II w/stylus \$735
Houston T3-1011 w/power & stylus \$670
Orchid TurboEGA & NEC Multisync \$1220
Arist 1 & Mitsubishi 19" monitor \$3113

Large corp. & institutional PO's accepted O.A.C.
ARDEN SYSTEMS, INC. (213) 479-6707 ext.20
12335 Santa Monica Bl. #240, Los Angeles, CA 90025

HARDWARE

\$79 MONO/GRAPHIC/PRINTER BOARD

* Hercules compatible * 720 x 348 pixel
* Lotus 1-2-3 compatible * 80 x 25 text
* Printer, Monitor port * 1 year warranty
* Light pen port * In stock delivery
1 - \$99 2-9 \$89 10 - \$79

SUGAR INTERNATIONAL

12015 NE 8th Ste. 3, Bellevue, WA 98005
(206) 462-9283, Mo-Sa, 9-6

Inquiry 759.

CONVERSION SERVICES

Convert any 9 track magnetic tape to or from over 500 formats including 3 1/2", 5 1/4", 8" disk formats & word processors. Disk to disk conversions also available. Call for more info. (312) 459-8010

Pivar Computing Services, Inc.

165 Arlington Hgts. Rd., Dept. #B
★ ★ Buffalo Grove, IL 60089 ★ ★

Inquiry 735.

INCOMPATIBLE WORD PROCESSORS?

We convert to and from: XEROX, DEC, IBM, LANIER, WANG, CPT, NBI, MICOM, CT, CPM'S, MULTIMATE, WORDSTAR, WORDPERFECT, DW3, SAMNA.

GUARANTEED LOWEST PRICES

Free Test Conversion Available

DATA CONVERSION INC.

6310 Caballero Blvd. • Buena Park, CA 90620

(714) 522-7782 (800) 824-4851 In CA.

Inquiry 680.

DUPLICATING SERVICES

"DUPLICATION SOLUTIONS"

MEGASOFT specializes in all of your Diskette Duplication needs. Our "STATE OF THE ART" equipment produces 0 defects of the end product. We also provide:

- * AUTOCLOADERS
- * BULK DISKS
- * SERIALIZATION
- * TECHNICAL SUPPORT
- * COPY PROTECTION
- * PACKAGE ASSEMBLY and DISTRIBUTIVE SHIPPING.

MegaSoft

P.O. Box 710, Freehold, NJ 07728

1-800-222-0490 201-462-7628 (In NJ)

Inquiry 681.

EPROM/EEPROM PROG. \$250

Programs 2716-27512, 25xx and 68764/66 eproms via RS-232. Also 874x micros and 28xxA & 52Bxx EEPROMs. Automatic baud rate select, built in help menu, no personality modules!

16 BIT I/O MODULE \$75

Low cost control via RS-232 Expands to 512!

INTELLITRONICS

P.O. Box 3283, Tustin, CA 92680
(714) 669-0614

Inquiry 708.

DISKETTE COPYING:

3 day turn around, security, quality, most popular formats.

MAG RABBIT
616-685-6186

Inquiry 715.

WESTERN TRANSDATA, INC.

Why risk duplicating your important programs on your computer, when our equipment is designed solely to duplicate disks & verify their perfection 100%? Over 600 formats: 3 1/2", 5 1/4" & 8". Plus serialization, copy protection, labeling, packaging, shrink-wrapping and fast, personalized service.

WESTERN TRANSDATA, INC.

1701 E. Edinger Ave. A-4
Santa Ana, CA 92705

714/547-3383 (collect)

Inquiry 754.

CHIP CHECKER

- 5474 TTL
- 144000 CMOS
- 5474 CMOS
- 14-24 Pin Chips
- Two 24 Pin ZIF sockets
- 3" and .6" IC widths

Tests/Identifies chips with ANY type of output in seconds. Inexpensive software updates will be offered as new chips become available. For C128 and C64. \$129 plus \$3.50 s+h.

DUNE SYSTEMS

2603 Wills Dr., St. Joseph, MI 49085
(616) 983-2352

Inquiry 687.

CONVERT TAPE TO DISK

We will transfer data from any 1/2" 9-track magnetic tape recorded at 1600 or 3200 bpi to 5 1/4" IBM PC floppies. Diskettes included. Quantity and repeat customer discounts. Fast turnaround. Disk to tape transfers also available.

Competitive Rates!

Micro Data Services

5 Town and Country Village, Suite 774 • San Jose, CA 95128
(408) 980-7203

Inquiry 720.

BLANKET SERVICES

Diskette duplication • Packaging • Stocking/Drop shipping • 48 hour delivery • SUPERLoK copy protection • No mastering fee • No charge for standard labels • Place a blanket order with releases as you need them for any quantity at a fixed price.

Star-Byte, Inc.

2564 Industry Lane, Norristown, PA 19403
215-539-4300 800-243-1515

Inquiry 747.

HEY!! I.O. HERE!!

ANY COMPUTER w/Serial Interface.

8 Analog Inputs, 8 Bits, 4 Gains.
16 TTL I/O lines. Individually programmable as Input or Output with 8 special counter/timer functions.

6X3X6 inches. 200 ma. 9-12 VDC. \$159

Circle svc number or write.

NORTH COAST PERIPHERALS

P.O. Box 199, Vermilion, OH 44089

Inquiry 723.

CONVERT-IT/CBASIC

CONVERTS CPM CBASIC VERSION 1&2 SOURCE PROGRAMS TO MS-DOS MICROSOFT BASIC OR QUICKBASIC. CONVERTS 95%-100% OF YOUR SOURCE, GOTO/SUB, UCASES, CONCHAR%, RANDOM I/O, INCLUDE FILES, SIZE AND MORE IN MINUTES. USER GUIDE HAS TIPS, EXPLAINS OPERATION IN DETAIL.

EVERYDAY SOFTWARE

PO Box 5185, Warren, MI 48090-5185
(313) 977-7013

Inquiry 695.

FIRE PROTECTION

HALON FIRE PROTECTION

Automatic, completely self-contained. No wiring, pipes, gages, tanks, etc. Labeled "clean" by the Air Force, no residue of any kind to damage delicate electronic circuitry. Affordable, SAFE TO USE. Easily installed in minutes. Also hand-held portable units, 12 ounces to 20 pounds.

THE FIRE GUARD CO., INC.

6604 West Skyline Dr., Tulsa, OK 74107
(918) 445-0022

Inquiry 697.

SANYO 550/555 USERS

TURBO BOARD-72 MHZ \$ 85.00
20 MEG EXTERNAL HARD DISK SYSTEM \$749.95
VIDEO BOARD \$125.00
HARD DISK CONTROLLER (ST-508 COMPATIBLE) \$248.95
IBM BOARD ADAPTOR \$ 49.95
768 MEM. CLK. & EXPANSION BD.
(FREE RAMDISK, SPOOLER, & SOFTVIDEO-RUNS
IBM PROGRAMS) \$199.95

TAMPA BAY DIGITAL

1807 Gulf-to-Bay Blvd., Clearwater, FL 33575
813-443-7048

Inquiry 748.

THE BUYER'S MART

HARDWARE

68000 COMPUTERS

Single board computers, 128K to 1M RAM, 4 serial, 2 parallel ports (expandable to 22 ports total), floppy controller for 2 to 4 drives, SASI interface for Winchester addition, timer/clock, real time multi-tasking multi-user operating system, assembler, line editor, 2 screen editors, spreadsheet. From \$995.00

AAA Chicago Computer Center
120 Chestnut Lane - Wheeling, IL 60090
(312) 459-0450

Inquiry 650.

HARDWARE

IBM - TOSHIBA PRINTER INTERFACE

- all extended capabilities of the TOSHIBAS available
- bit mapped graphics supported
- Prints all IBM extended ASCII characters
- screen dumps in text and graphics
- escape sequences supported
- popular software supported directly
- "Sideways" and "Pixel Visuals" support
- dealers welcome \$79.95 (\$2.50 S&H)

Integrated Data Technologies, Inc.
4775 Bunchberry Lane, Colorado Springs, CO 80917
303-597-5547 MC/VISA

Inquiry 708

PUBLIC DOMAIN

\$4.50 IBM PC Software

490 disks: \$4.50 ea. 1-3 WKS, 8 disks \$36.
Arcade games, 4 disks \$18. Directory, 2 disks \$9.
Utilities, 4 disks \$16. "c" routines, 6 disks \$27.
Turbo pascal routines, 8 disks \$36.
Unprotect software, 4 disks \$18.
Catalog \$1.00. Add \$4 S&H. MC/VISA accepted.

The Computer Room
P.O. Box 1598, Dept. 102, Gordonsville, VA 22942
703/832-3341 (M-F 10-5)

Inquiry 677

USED APPLES & IBM'S

Laser 128 (new) — call
PC-XT Clone — \$475.00
Motherboards & accessories — call
We buy, sell, & horse-trade — Apple, IBM, & CBM.

SHREVE SYSTEMS
845 Lark Ave., Shreveport, LA 71105
318-865-6743 4-9 p.m. C.S.T. VISA/MC

Inquiry 761.

POWERLINE GREMLINS?? POWER FAILURES??

The MEIRICK STANDBY POWER SYSTEM is the TOTAL SOLUTION to your powerline problems.
240 watt system — \$365, 400 watt system — \$495
800 watt system — \$795

MEIRICK Inc., POWER SYSTEMS DIV.
Box 298, Frisco, CO 80443 303-668-3251

Inquiry 719.

► SOFTWARE FOR PENNIES ◀

GET BEST AND LATEST PC-DOS, CPM-80 AND CP/M-86 PUBLIC DOMAIN PROGRAMS FOR BUSINESS, PERSONAL, EDUCATION, SOFTWARE DEVELOPMENT, MODEMING, SCIENCE, AND MORE. AT LOW COST OF COPYING 3-1/2, 5-1/4 AND 8" DISK FORMATS ARE SUPPORTED SEND \$5.00 FOR CATALOG.

MULTIPATH, INC.
Box 395, Montville, NJ 07045
(201) 575-5880

Inquiry 725.

TANDY-EPSON Our 10th year of DISCOUNTS COMPUTERS & CELLULAR PHONES

Freight Prepaid. Save Tax
Toll Free 800-231-3680

MARYMAC INDUSTRIES, INC.
22511 Katy Fwy., Katy (Houston), TX 77450
1-713-392-0747 Telex: 774132

Inquiry 716.

1-800-826-0843 THE COMPUTER BARN

Super Low Prices on Micro Computers and Accessories

WYSE 30	\$300	Teleview 905	\$285
WYSE 50	400	Teleview 9220	485
WYSE 75	539	Canon Laser 8A1	2195
WYSE PC	999	Canon AA0	245
WYSE 85	439	Dialup 635	1095
WY-500 (Green Model)	180	WY 350 (Color)	885

K17/PC \$500

CASE/RIXON, ARK PARADYNE, PRENTICE, Modema. Complete line of Canon, Diablo, Datasouth Printers. Many other Products. Call for FREE Brochure

Inquiry 674.

SOFTWARE/ACCOUNTING

MoneyCounts™ Only \$69.95

A COMPLETE MONEY MANAGEMENT SYSTEM. Checking, Savings & Credit Card Mgmt. smart account reconciler with auto error detector, budgeting, financial statements, graphics, high speed financial data base, special reports, pop-up calculator, tutorial, on line help screens, CPA designed. Great for home & business. Free Brochure

IBM & Compatibles with DOS 2.0 or later and 192K
PARSONS TECHNOLOGY
6925 Surrey Dr. NE., Cedar Rapids, IA 52402
(319) 373-0197 CHECK/VISA/MC

Inquiry 782.

Z80™ / CP/M™ CO-PROCESSORS

Plug-in co-processors for PC, PC/AT.
Blue Thunder (5 mhz) \$199.50
Blue Lightnin' (9 mhz) \$595.00
Run CP/M software on PC as if MS-DOS software. Diskette conversion included. Can run Intel ISIS software. We have cards for PDP-11 and VAX too.

DECIMATION
2065 Martin Ave. #110, Santa Clara, CA 95050
(408) 980-1678

Inquiry 685.

HARDWARE ADD-ONS

640K for IBM XT and Portables

Expand your memory board with MAXRAM. Easy plug-in installation, does not violate IBM's warranty, 100% software compatible. MAXRAM-R includes two banks of 256K chips.

MAXRAM \$49.00
MAXRAM-R \$129.00

Shipping included, dealer pricing available.
Call (315) 478-0722 to order.

LOGICAL SYSTEMS CORPORATION
6184 Teal Sta., Syracuse, NY 13217

Inquiry 714

CALL 1-(800)-824-7888 op. 138

TIME & BILLING \$99 JOB COST OPTION \$50
Try It, You'll Like It With Our 30 Day Money-Back Trial
Great for contractors, accountants, architects, engineers, attorneys—anyone who needs to bill for service work and expenses. Very flexible and very easy to learn to use. Prints your statements, many reports. Job cost option includes job estimating, job summary, job detail, and more! For IBM PC and compatibles. Order with VISA, MC, COD or send for free comprehensive brochure.

Accounting Systems (919) 467-3428
1148-5 Executive Circle, Cary, NC 27511

Inquiry 651

MEGABYTES OF MEMORY

Lowest Prices Guaranteed in US. Dealer Inv. Invited
Fully Populated 2MB Memory Boards

TALLTREE SYSTEMS — JRAM BOARDS

JRAM 2	\$339	OPEN 7	
JRAM 3 Aboveboard	409	DAYS A WEEK	
JRAM AT	309	M-F 9-8	
JRAM AT Aboveboard	439	S-S 9-6	
JDISKETTE	135	VISA, MC, AE, CHOICE	
JLASER I	275		
JMODULES	CALL		

703-370-7173

Information and Technology Services, Inc.

Inquiry 705

RS-232 RS-422

- Four Port RS-232 w/software \$349.00
- RS-422/485 Serial \$149.00
- RS-232/422 with 24 Parallel I/O \$199.00
- RS-422 Synchronous \$299.00

Call About Custom Designed Boards

Sealevel Systems Inc.
P.O. Box 1808
Easley, South Carolina 29641
(803) 855-1581

Inquiry 853.

CUSTOM PAYROLL

All systems have multiple pay categories, calculation of all taxes, user defined deductions, 401(k) handling, many reports, paychecks, W-2 forms, and much more. Custom features are available. Prices start at \$695 for system, manual and PC Basic source code.

Datasmith, Inc.
Box 8036, Shawnee Mission, KS 66208
(913) 381-9118

Inquiry 683.

PROGRAM GENERATORS

WINDOW.LIB \$99.

An easy to use complete windowing system for programmers and whang !!

- BASIC IBM M-S, CB86
- C LATTICE, M-S
- COBOL M-S RMF
- PASCAL M-S TURBO
- FORTRAN M-S RMF

Window editor included. Create callable pop-up menus, help screens. The line selector features auto reverse highlighting and cursor control. No royalties. Ask about our BIOS/DOS LIB/VISA/MC

GLENCO ENGINEERING (312) 392-2492
3920 Ridge Ave., Arlington Hs., IL 60004

Inquiry 701.

EPSON QX-16 — A complete computer system
512K - 2 Drives - Monitor - Keyboard - PP - SP 1500 of
FREE software - Vadocs2 - CPM - MS - DOS

List \$2700 Your Cost \$895

OKIDATA-93

160 cps - Wide Carriage with NLQ

List \$900 Your Cost \$379

Electrified Discounters (203) 937-0106
996 Orange Ave., P.O. Box 151, West Haven, CT 06515

Inquiry 891

FINANCE MANAGER II - General Ledger

A small business/personal finance package for IBM PC. Menu driven, easy setup, complete reports, budget, graphs, double entry, simple inputs, d/m/d files. Tracks income, expenses, assets, liabilities, net worth. Evaluation copy with manual on disk for only \$10. Registered copy with printed manual \$65. Visa/MC/Amex

Hooper International
Dept. B. P.O. Box 6009, Vancouver, WA 98668-6009
(206) 256-6361

Inquiry 703

THE BUYER'S MART

SOFTWARE/ACCOUNTING

► FINANCIAL CALCULATOR ◀

Memory resident calculator performs compound interest, NPV, IRR, bonds, depreciation. Prints financial schedules. Allows importing/exporting of data. Includes all HP-12C functions plus more. Introductory price \$49.95 plus \$3 s/h; after 9/1/86, \$69.95.

K SOFTWARE HOUSE, INC.

Rt. 2, Box 83B1 Unionville, TN 37180
(615) 294-5090

Inquiry 712.

SOFTWARE/BUSINESS

"THE CLERK" RETAIL POINT OF SALE

New software gives your small-medium business the same advantages the "Big Guys" have. Automatic sales slip, invoices, inventory control, discounts, taxes, reports, and much more! Indispensable management tool! Demo disk \$4.95 (refundable) Regular \$349.95 — Just \$179.95.

1-800-346-3026 ext.958

WDR SALES CO.

9604 BELMONT, KANSAS CITY, MO. 64134
Dealer inquiries welcome.

Inquiry 733.

SOFTWARE/BUSINESS

PC-Write™ Shareware

Fast, powerful word processor/text editor for IBM PC. New Version 2.6 with auto reformat, optional menus, on-screen help, laser printer support, new expanded manual. Mailmerge, split screen, ASCII files, macros. All software, tutorial/guide on diskette, \$10. OK to copy. Register for full manual, support \$75. 90-day money-back guarantee.

Quickssoft (206) 282-0452 Visa/MC
219 First N. #224J, Seattle, WA 98109

Inquiry 739.

ACCESS: Report Writer

Powerful, Easy to Use, Fast. For RM/COBOL Applications. Supports query, sort, reports, computed columns, control breaks, totals & sub-totals, headings, mailing labels & catalogs. Bridges data to 1-2-3, Multiplan & WP.

MSDOS - \$149; XENIX - \$249

DCM DATA PRODUCTS

1710 Two Tandy Center, Fort Worth, TX 76102
817/870-2202

Inquiry 742.

Info-Lion™ Relational DBMS

Outstanding data entry & validation. Powerful query. Password security. Easy to use, online help. Much more! For MS/PC-DOS systems. Only \$159.95 VISA/MC

Remember, go with the lion...
because it's a jungle out there!

Morgan Software Inc.

414 Valley Ave., Wilmerding, PA 15148
(412) 824-0458

Inquiry 725.

LP88-LINEAR PROGRAMMING

A powerful menu-driven system for solving linear programs w/ up to 510 constraints & 2510 variables. Features include interactive & batch operation, spreadsheet style input & editing, storage of problems & bases, Simplex Algorithm restart, report generator, sensitivity analysis. Req. IBM PC. 192K \$99 w/8067 support, user's guide. VISA/MC

EASTERN SOFTWARE PRODUCTS INC.

P.O. Box 15328, Alexandria, VA 22309
(703) 549-5469

Inquiry 688.

SOFTWARE/BUSINESS

The Andsor Collection™

Unique concept: creates complete, self-contained, window-based data management environment, in one DOS file. Simplifies everything. Combine functions to create your own solutions in any application: calculations, database management, modeling, text processing, charts, data analysis, statistics, reports, labels, forms, presentations, mail-merge, etc. Simple enough for a PCjr, sophisticated enough for a PC AT.

SEE ALSO THE AD BELOW

Inquiry 718.

BILINGUAL WORD PROCESSOR

DuangJan, a special word processor for English and; European, Greek, Lao, Portuguese, Russian, Spanish, Thai, Vietnamese, your own language, or more. For IBM PC/XT/AT/C clones with graphics & IBM/Epson/Citich printer. \$59 + \$4 S&H in US&Can (+ 10 others)

MEGACHOMP COMPANY

3524 Cottman Ave., Philadelphia, PA 19149, USA
(215) 331-2748/8138

Inquiry 718.

SOFTWARE/CHURCH

ROMAR CHURCH SYSTEMS™

Membership-61 fields plus alternate address; labels, letters, reports any field(s). Offering 256 funds; optional pledge; statements; post to 255 x/year. Finance-G/L with budget; up to 500 sub-totals & 89 depts. month & YTD reports anytime for any month. Size 2000 people/flop-py. 25000/10 meg. Ad too short! Write!

Romar Church Systems, Attn: MBM

P.O. Box 4211, Elkhart, IN 46514
(219) 262-2188

Inquiry 740.

The Andsor Collection™

From simple calculations, files, inquiries, to complex models, data structures, reports. Superb 400 page hard-cover manual, with many examples. US \$95 + \$5 s/h. 60-day money-back guarantee. Visa/MC/AmEx/Chk/MO/CO. Call or write now to order. IBM PC/XT/AT/PCjr, 128K+, one drive or hard disk, monochrome and/or color, DOS 2.0+. Not copy-protected.

ANSOR RESEARCH INC.

181 University Avenue., Suite 1202,
Toronto, Ontario, Canada M5H 3M7
(416) 364-8423

Inquiry 656.

PC-File III™ Version 4

Search, sort, browse, global changes, macros, mailing labels, format reports with selection & calculations, sub-totals, totals, averages, encryption. Exchange data with 1-2-3, WORD, WordStar. Over 190,000 users. \$59.95 + \$5 s/h. For IBM PC

ButtonWare, Inc.

P.O. Box 5786, Bellevue, WA 98006
1-800-J-BUTTON

Inquiry 683.

Church Package

Parishioner Time, Talent and Treasure System program is written in modifiable dBASE source code.

- Contributions • Disbursements • Ledger
- Names with mailing labels
- Personal information database.

Requires dBASE II or III. PC-DOS/CPM-80 \$200.

Feller Associates

550 CR PPA, Route 3, Ishpeming, MI 49849
(906) 486-6024

Inquiry 696.

DATA ENTRY SYSTEM

Heads-down data entry with two-pass verification for the PC/XT/AT & compatibles. Loaded with features like: Auto dup & skip, verify bypass, range checks, & table lookups. Fully menu driven only \$395. Call for free 30 day trial period.

COMPUTER KEYS

21929 Makah Rd., Woodway, WA 98020
(206) 778-8443

Inquiry 678.

PC-File/R™

All the power of PC-File III plus: Relational link to other databases, integrated letter writing & mail-merge, context sensitive pop-up help windows. New binary search retrieves data hundreds of times faster. \$149.95 + \$5 s/h

ButtonWare, Inc.

P.O. Box 5786, Bellevue, WA 98006
1-800-J-BUTTON

Inquiry 684.

SOFTWARE/GENERAL

AI for the IBM PC

TOPSI is a full version of OP55 which runs under MS-DOS, Unix or CP/M. A fast, efficient expert system development tool.

Prototyping: \$125
Production: \$250
Professional: \$375
C version, add \$20. Shipping, add \$5

DYNAMIC MASTER SYSTEMS

POB 566456, Atlanta, GA 30356
(404) 565-0771

Inquiry 688.

GREAT SOFTWARE, CHEAP!

Absolutely Smashing User Supported Software \$4.95 per disk. PC-Outline, PC-Write, DOSmatic, Commercial Unprotect, File Express, Cheap Assembler, PC-Disk, utilities galore, many more. Money-back guarantee. IBM PC, PC Jr, or compatibles. FREE CATALOG.

PLUS SOFTWARE

33495 Del Obispo, Suite 180 M,
Dana Point, CA 92629

Inquiry 753.

OFFICE AUTOMATION SOFTWARE

Order Entry, Inventory \$49.95 each. Independent or interactive. Fast, accurate. Database sizes: 150 to 1000. Monitor up to 15 w/hes. Other configs avail. Order acknowledgment forms, inventory listings, & reorder level listings printed. Min. req: IBM PC or compatible, 1 DSDD 360K drive, 128K RAM memory, DOS 2.10 or later. MC/VISA, free shipping.

FutureSoft (216) 753-1336

P.O. Box 23005, Cuyahoga Falls, OH 44223-1100

Inquiry 761.

SIDEWINDER

Print letters, spreadsheets, etc. sideways on Epson compatible or Printronix dot matrix printers. Font editor modifies default fonts, creates new ones. Configurable for various paper widths, printer codes. For IBM PC. Manual incl. \$39.95.

ELECTRONICS INC.

Paine Field Bldg. 335, Everett, WA 98204

(206) 355-1855

Inquiry 692.

THE BUYER'S MART

SOFTWARE/GRAPHICS

GRAPHICS PRINTER SUPPORT

AT LAST! Use the *PrtSc* key to make quality scaled B&W or color reproductions of your display on any dot matrix, inkjet, or laser printer. GRAFPLUS supports all versions of PC or MS-DOS with IBM, Teemar, and Hercules graphics boards. \$59.95.

Jewell Technologies, Inc.

4302 SW Alaska St., Suite 207, Seattle, WA 98116

(206) 837-1081

Inquiry 711

SOFTWARE/GRAPHICS

FORTRAN PROGRAMMER?

Now you can call 2-D and 3-D graphics routines within your FORTRAN program.

GRAFATIC: 75 callable routines for screen output. \$135.

PLOTMATIC: Pen plotter driver. \$135.

For the IBM PC, XT, AT and compatibles. We support a variety of compilers, graphics boards and plotters.

MICROCOMPATIBLES

301 Prelude Drive, Dept. B

Silver Spring, MD 20901

(301) 593-0683

Inquiry 722

SOFTWARE/LANGUAGES

MATRIX 100

Perform multiple regression, solve simultaneous equations, invert matrices, etc. in BASIC or Fortran. Very sound numerically. Very powerful and very easy to use. — *DR/MS Today* 2/85: "Stanford Business Software deserves congratulations" — *PC Mag*, 5/14/85. Price \$80. 8087 support \$125; compiler support \$250. Fortran library \$175 (\$4 s&h).

STANFORD BUSINESS SOFTWARE, INC.

2672 Bayshore Parkway, Ste. 304

Mountain View, CA 94043

To Order Call (415) 424-9499

Inquiry 745

SOFTWARE/LANGUAGES

RUN FAST, LOOK BEAUTIFUL

If this is what people expect from your BASIC programs, then you need YES MASTER: a DOS-resident development aid that includes a screen painter, an ISAM file manager, a window manager, a printer generator and more. All in one package \$245. No royalty.

SOFTWAY, INC.

500 Sutter St., Suite 222 BC

San Francisco, CA 94102

(415) 397-4666

Inquiry 744

PLOTTER SOFTWARE

Save time and money by creating your own presentation quality text slides. THE DGI SIGNMAKER is an easy to use menu driven program for your IBM or APPLE computer and most plotters (Epson, HP, HP-GL, IBM and others) for only \$75.

DECISION GRAPHICS, INC.

P.O. Box 2776-B, Littleton, Colorado 80161

Phone (303) 796-0341

Inquiry 684

C PROGRAMMERS

CCmem and CCfile are tools that can be used as front-ends to the standard memory and file primitives to perform usage and profiling statistics. Add your own features in one hour. Easily turned on and off. Super for debugging! Source is \$50 each.

— **COMEAU COMPUTING** —

91-34 120th Street, Richmond Hill, NY 11418

(718) 849-2355 — 24 hr. HOTLINE

Inquiry 671

TI PRO + TURBO + GRAPHICS

UNLEASH YOUR TI PRO WITH: TURBO 2.0 or 3.0 + TIGrafix. GRAPHICS, TURTLEGRAPHICS, MUSIC, SCREEN & CURSOR CONTROLS & more routines than IBM TURBO. Use BASIC PICS w/o reprog. Convert IBM code to TI PRO. Source & doc included. TIGrafix \$99.95, + TURBO \$149.95, + TURBO 8087 \$179.95. SWITCH TO TURBO NOW!!!

ProWare, Inc. (503) 233-4465

1023 SE 36th Ave., Portland, OR 97214

VISA/MC/CHECK 7AM-7PM MON-FRI

Inquiry 737

BE A SCREEN STAR!

In BASIC, PASCAL, DBASE, C, COBOL, FORTRAN, ASSEMBLER design data entry screens in minutes. All popular features + 99 windows, save, restore, merge, redefine keys, pull down menus, ASCII table. No royalty. HIGH SCREEN is \$129. DEMO \$15. S&H \$5. CA add 6.5%.

SOFTWAY, Inc., PC/SOFT Product Line

500 Sutter St., Suite 222, San Francisco, CA 94102

(415) 397-4666

Inquiry 758

EXPERT SYSTEMS!

You can develop expert systems with KNOWOL, the Knowledge Oriented Language from IMCO. Includes a tutorial, unlimited development capability, and a smart rules editor. Not copy protected. An incredible introductory offer at \$39.95 plus \$2 s&h (\$4/COD).

Intelligent Machine Company

3813 N. 14th St., Arlington, VA 22201

(703) 528-9136

Inquiry 707

SCIENTIFIC PLOTTING

Are conventional graphics packages not meeting your requirements for engineering/scientific plotting with your HP plotter? **GRAFIT 3.4** is the answer—all the features you want, and more. Only \$90 + \$5 s&h. Send for details.

JAYAR Systems

P.O. Box 2885, Station "A"

Sudbury, Ontario, Canada P3A 5J3

(705) 522-2230

Inquiry 710

Minnesota SNOBOL4 Language

Powerful string & data handling facilities. Interpreter compatible with mainframe SNOBOL4. 32K strings, 32 bit integers, 8087 for float & large memory model. Sample pgms include ELIZA. For > 128K IBM PC & DOS or equivalent. Define "green" book by Gniswold et al available.

Guide + 5 1/4" SSD diskette \$44.95

Guide + diskette + "green" book \$59.95

"Green" book only \$26.95

Postpaid in USA. In NY add tax. VISA/MC (914) 271-5855

BERSTIS INTERNATIONAL

POB 441, Millwood, NY 10546

Inquiry 660

SOFTWARE/SCIENTIFIC

MATRIX CALCULATOR v. 1.20

80+ Matrix Opns, Sys of Eq'ns, Multi-Lin Regr, Statistics, LP: Simplex, Param, Sensitivity, Dif Eqns and Numer. Integr. Super Matrix Make-Edit-Print. Pascal Code + 3 utilities at \$120 (all 4 disks).

SOFTTECH INC.

18505 W. 8 Mile, Detroit, MI 48219

1-313-544-8544

Inquiry 743

TRICLOPS INVASION

Animated 3D space game with fractal Earth, jets, tanks, cities, walking robots, and geodesic satellites. Runs on IBM AT's, using standard color graphics card. Includes demos. *PLUS* 1000 lines 8086 polyfill source.

\$15.00 postpaid

GEODESIC PUBLICATIONS

P.O. Box 7, Willow Creek, CA 95573

(916) 629-2514

Inquiry 699

FORTRAN UTILITIES

CROSS-REFERENCE UTILITY: Mainframe grade symbol x-ref listing for variables, subprogram calls and labels. Variable map shows type, length, alloc, scope, usage tag, etc. All FORTRAN 77 compilers \$49.95 + \$2.50 S&H.

UTILITY LIBRARY: Assembly language routines for screen, cursor, keyboard, time, sound, etc. MS/IBM and IBM Pro/PM.

FORTRAN compilers \$39.95 + \$2.50 S&H.

IBM PC with DOS 2.0 + VISA/MC/MO/Check (2 wk)

PJN INTERNATIONAL

P.O. Box 201363, Austin, TX 78720

(512) 837-2888

Inquiry 736

Affordable Engineering Software

CALL OR WRITE FOR FREE CATALOG
Circuit Analysis • Root Locus • Thermal Analysis • Plotter Drivers • Graphics • Signal Processing • Filter Design • Report Prefreader • Transfer Function Analysis.

BV Engineering

2200 Business Way Suite 207, Riverside, CA 92501

(714) 781-0252

VISA/MC

Inquiry 686

PC-KEY-DRAW TRY IT \$15 VER. 3.1

Comprehensive, high-power graphics editor, CAD, paint, slide show program. Over 150 standard functions plus macros, 64 pages/layers, zoom printer, 64 patterns, novice/expert modes. \$15 includes manual, software, quick ref. card. Register \$100 for support, updates complete printed manuals. Shareware. IBM PC and compatibles.

OEDWARE

P.O. Box 595, Columbia, MD 21045-0595

(301) 997-9333

Inquiry 730

SCREEN PROGRAM GENERATOR

SPG creates BASIC program code quickly and easily. Design your screen directly and SPG will generate the BASIC program code to handle the display and input of data. Controls use of color, editing, graphics, cursor movement and function keys. Generated code easy to modify. Merge IBM PC & compatibles 128K.

\$75 + \$3.00 S&H (CA + tax)

Trebeard Software

5901 Warner Avenue, Suite 428

Huntington Beach, CA 92649

(714) 840-6939

Inquiry 750

ORDINARY/PARTIAL DIFFERENTIAL EQN SOLVER

FOR THE IBM PC & COMPATIBLES

MICROCOMPATIBLES

301 Prelude Dr., Silver Spring, MD 20901

(301) 593-0683

Inquiry 723

THE BUYER'S MART

SOFTWARE/SCIENTIFIC

ENGINEERING SOFTWARE WRITTEN BY ENGINEERS FOR ENGINEERS

Highest power per dollar. Highest power per K of memory. Satisfaction guaranteed.

Electronic Circuit Analysis \$450.
EC-ACE \$95.

TATUM LABS

33 Main St., Newtown, CT 06470
(203) 426-2184

Inquiry 749

CROSS ASSEMBLERS for VAX VMS and PC/MS DOS New Low Prices

Relocatable Macro Cross Assemblers, Linkers, Libraries Targeted to almost all Microprocessors

ENERTEC, INC.

BOX 1312, Lansdale, PA 19446
215-362-0968 MC/VISA

Inquiry 694

DIGITAL SIGNAL ANALYSIS

Fourier Perspective II w/graphics. FFT/IFT, convolution, deconvolution, Hanning, Power Spectrum, Cross Correlation, 25 more. Graphics 2D and 3D 8087 recommended, not required. Easy to use menus. FP II \$395 or FP I (FFT w/graphics only) \$149. Runs on PC, PC-XT, PC-AT.

Alligator Transforms Scientific Software
P.O. Box 11386, Costa Mesa, CA 92627
(714) 662-0660

Inquiry 655

POP-UP HP-41 EMULATOR

Graphically presents HP-41 keypad and unique view of stack and registers. Binary, Octal, Decimal, Hexadecimal display and input. 12 digit precision. 500 accessible registers. For IBM PC/XT/AT and close compatibles. Standard version \$69.95; 8087 version \$79.95 (\$4 shipping and handling, plus sales tax in Calif.)

ECLIPSE LOGIC INC.

P.O. Box 2003, Huntington Park, CA 90255-1303
(213) 569-8020

Inquiry 690

System Simulations

Micro-CSMP simulates Control & Servo Systems of Robotics of High Order Filters of Chemical Processes of Stress & Strain. Graphical results in minutes, typically requiring 10-20 lines of input. Full IBM 3/360 CSMP compatibility. LSAP analyzes linear systems producing Bode, Nyquist, and Transient Response plots, and Root-Locus diagrams. Micro-CSMP is \$800, LSAP is \$450 for PC-DOS or MS-DOS systems.

Call (714) 581-7854

California Scientific Software
25642 Hazelnut, El Toro, CA 92630

Inquiry 668

CHARACTER CUSTOMIZATION

CHARGENI 2.1 lets you modify the character set on the EGA. Useful for scientific/engineering symbols on your word processor, special symbols in your programs, and more. Requires DOS 2.x or 3.x. Enhanced Graphics Adapter. \$35 + \$2 s/h (MN add 6%)

DK Micro Consultants

P.O. Box 6714, Minneapolis, MN 55406
(612) 722-0931

Inquiry 698

SOFTWARE/SCIENTIFIC

FORTRAN SOURCE CODE PROFESSIONAL SIGNAL PROCESSING & MATRIX ANALYSIS UTILITIES

35 PROGRAMS WITH TUTORIAL & EXAMPLES
FFT, AR Modeling, Digital Filters, Matrix: SVD, Conjugate Gradient, Pseudo-Inverse, Root Finder, Cubic Spline Interp, Graphics, Random Numbers, More. Disk/Hard-copy. Documented, 130 pages. Bibliography. Send for info Pkg. \$99.

CLAREN SOFTWARE

P.O. Box 5333 - MESA, AZ 85201
(602) 820-3877

Inquiry 670

SOFTWARE/SORT

OPT-TECH SORT/MERGE

Extremely fast Sort/Merge/Select utility. Run as an MS-DOS command or CALL as a subroutine. Supports most languages and filetypes including Btrieve and dBASE. Unlimited file sizes, multiple keys and much more! \$149.

(702) 588-3737

Opt-Tech Data Processing

P.O. Box 678 - Zephyr Cove, NV 89448

Inquiry 732

ON WORD

- Accurate Optical Scanning (direct to word processors)
- Precise Data Conversions (including format codes)
- Great Tune-Around/Best Prices (48 or 24 hour, even same day)
- Custom Conversions (yes, we support — you!)
- Call Us Today, Call Us Now

ON WORD DEVELOPMENT

2434 Main St. Suite #201, Santa Monica, CA 90405
(213) 399-7733

Inquiry 731

SOFTWARE/SYSTEMS

CPM-80 LIVES on your PC

CP/Mulator puts a 4mhz 8 bit CPM emulator in your IBM-PC for \$99. (\$3 s+h).

- A great 8 bit development system
- Saves expensive CPM-80 applications
- Increases PC speed 10% for 8088 programs
- Priced less than most software only products
- Uses no valuable board slots

Source Information

P.O. Box 2974, Warminster, PA 18974
VISA Phone (215) 441-8178 MC

Inquiry 745

SOFTWARE/TOOLS

PC-Type™

Fast, compact, capable & easy! Help panels, hands-on tutorial, macros, multiple-line headings & footings, DOS path support, print spooling, block operations, etc. ASCII files. Install program allows customization. \$59.95 + \$5 s/h. For 128K IBM PC.

ButtonWare, Inc.

P.O. Box 5786, Bellevue, WA 98006
1-800-J-BUTTON

Inquiry 665

THE PL/M CONNECTION

- Develop PC software with your PL/M compiler.
- Complete Interface to PC-DOS and PC-BIOS
- Fast Graphics Routines example programs.
- All source files are included.
- 200 page Technical Reference Manual
- \$295.00 No Royalties.

CompuFirm Corporation

7841 Balboa Ave. #108, San Diego, CA 92111
(619) 671-0228

Inquiry 673

SOFTWARE/TOOLS

Programmers:

We guarantee our products to be solid, bugfree
• CorrectForth - Very professional, 83 standard
• Correct_Datamizer - 50.1 data compression guaranteed.
\$80.75 per program MC/VISA/AMEX/MO/Check (SD sales tax 4%) Specify computer.

Correct Software, Inc.

RR1 Box 140, Black Hawk, SD 57718
(605) 787-5904

Inquiry 760

CROSS ASSEMBLERS

Develop microprocessor programs on your IBM PC or MS-DOS computer.

- Macros • Conditional Assembly • Editor •

Complete support for most 8 bit microprocessors
Linker and EPROM Programmer Driver

MicroComputer Tools Co.

1255C Kenwal Rd., Concord, CA 94521
(415) 826-4200

Inquiry 724

METRICS FOR MANAGEMENT

ANALYZE reads your code & produces metrics on VOLUME, COMPLEXITY, PRODUCTIVITY & more! Management, QA/QC & Engineers gain valuable insight to scheduling, problem areas, testing, maintenance & compliance to standards. For IBM PC, Analyze FORTRAN & "C" \$495.00 + S/H. Add Adaptor only \$200.00 more! MC/VISA

AUTOMETRIC INC.

891 Elkridge Landing Rd., Suite 350, Linthicum, MD 21090
(301) 859-4111

Inquiry 658

FORTRAN Addenda

Graphics, color text, keyboard control, and much more for PC/XT/AT FORTRAN Programs. Includes gels/puts, tiling, fills, pull-down windows, and USER I/O EDITING! MDA thru EGA modes. 170 pg. manual & annotated samples. Sold as 2 libraries: each \$95; combined \$165.

IMPULSE Engineering

P.O. Box 3540
San Francisco, CA 94119-3540
(415)-788-4611

Inquiry 764

STATISTICS

SL-MICRO

Tabulate survey results or analyze experimental data using SL-MICRO. It has Frequencies with statistics, Crosstabs, Anova, Multiple Regression & Correlation. Data Editor & Data Transformations.

Only \$250 for PC-DOS, MS-DOS or CP/M

QSC

Box 778, East Lansing, MI 48823
(517) 841-4428

Inquiry 652

RATS! Version 2.0

RATS, the best selling Econometric software package, now includes daily and weekly data, a new easier to use 500 page manual, and many advanced features. Use RATS for time-series and cross-section regression, including OLS, ARIMA, VAR, logit, and probit. IBM PC or compatible. \$200. MC/VISA. Call for brochure.

VAR Econometrics, Inc.

P.O. Box 19334, Minneapolis, MN 55419-0334
(612) 822-9690

Inquiry 751

THE BUYER'S MART

STATISTICS

The Statistician

Includes: Multiple Regression (Stepwise, ridge, all subsets, backward elimination)

• Time series analysis • descriptive statistics • transformations • survey research • nonparametrics • X-Y plots • ANOVA • random samples • data base • data editor • search & sort • hypothesis tests

For IBM, MS-DOS, XENIX, CPM, TRS-DOS.

QUANT SYSTEMS

Box 628, Charleston, SC 29402
803-571-2825

Please call
TOLL FREE
1-800-334-0854
(Ext. 814)

Inquiry 738.

TYPESETTING

DESKTOP PUBLISHING

Laser Printer composition software to drive Cordata L300 with 76 PS fnts \$495. With add 14 PS Lndscp fnts \$695. For Canon LBP-8 A2, NCR, or HP LaserJet+ with 41 PS Pnt or Lndscp fnts \$695. H & J, merge graphics, mix face & pt. size anywhere on any line, mult tab & col justification. Boxes & Rules.

Micro Print-X, Inc.

P.O. Box 581, Ballinger, TX 78821
(915) 365-2343

Inquiry 721.

UTILITIES

SOURCE CODE LIBRARIAN & REVISION CONTROL SYSTEM

TLIB™ keeps ALL versions of your program in ONE compact library file, even with hundreds of revisions

• 5 times faster than SCCS • LAN compatible

• Free public domain MAKE (with source) by L. Dyer MS/PC-DOS 2.x & 3.x. \$99.95 + \$3 S&H. VISA/MC

BURTON SYSTEMS SOFTWARE

POB 4156, Cary, NC 27511
(919) 469-3068

Inquiry 862.

STATISTICS CATALOGI

If you need statistics for IBM PC or Apple II, call us and let our technical advisors help you find the statistics programs you need.

Write or call now to get a FREE catalog of statistics and quality control software.

HUMAN SYSTEMS DYNAMICS

9010 Reseda Blvd., Ste. 222
Northridge, CA 91324

(800) 451-3030 (818) 993-8536 (CA)

Inquiry 704.

UTILITIES

PADLOCK/PADLOCK II DISKS

PADLOCK furnishes the user with a method for providing protection against unauthorized duplication from DOS commands \$99. PADLOCK II disks come preformatted with finger-print and serialization. PADLOCK II disks offer superior protection. Ask about our HARD DISK protection with uninstall capability. MCVISA

GLESCO ENGINEERING

3920 Ridge Ave., Arlington Hts., IL 60004
(312) 392-2492

Inquiry 702.

MEDIA MASTER PLUS

READ, WRITE, and FORMAT over 60 CP/M disks and run most CP/M-80 programs on your IBM PC! Two program package includes ZPEM, a CP/M-80 emulator program that transforms your IBM PC into a 1-2 MHZ CP/M 2.2 computer \$59.95 + \$3.00 S/H (CA 6%)

INTERSECTING CONCEPTS, Inc.

4573 Heathergreen Ct., Ste 10
Moorpark, CA 93021
(805) 529-5073

Inquiry 708.

NUMBER CRUNCHER STAT SYS

Menu-driven. Multiple & stepwise regression, ANOVA, time series, discriminant, cluster, and factor analysis, principal components, scatter plots, histograms, Hests, contingency tables, non-parametrics. Import export data. Spreadsheet, sort, join, merge. \$79. IBM PC/Macintosh. Quantity discount.

NCSS-B

885 East 400 North, Kaysville, UT 84037
801-546-0445

Inquiry 727.

TheEMCEE DOS IT ALL—EVEN WINDOWS

Now your PC's can be powerful, efficient & friendly. With TheEMCEE, your application manager, create unlimited custom menus for single keystroke access. Protect your data from being viewed, changed or deleted. Monitor & report system usage with SYSTEM LOG. Now with DOS WINDOWS. Virtually non-resident. Powerful control & protection for managers, friendly interface for users. \$49.95. VISA/MC

COMMAND SOFTWARE SYSTEMS, INC.

1-800-423-9147 or 213-457-1789

Inquiry 872.

CONCURRENT DOS BACKUP

BackPack™ runs like BACKUP/RESTORE and supports DOS and CP/M media as well as users. Backs up and restores up to 1000K/min on an AT and 360K/min on an XT. Supports release 4.1. Also available on CP/M-80 and CP/M plus. \$150.

Bright Light, Inc.

520 Fellowship Rd. #C301, Mt. Laurel, NJ 08054
(609) 778-0772

Inquiry 681.

STATISTIX™

\$75 - Satisfaction guaranteed

A comprehensive, powerful, yet easy-to-use statistical analysis system for IBM PC/XT/AT's, Apple II's, and MS DOS machines. Clear 200p manual. Write for information.

NH ANALYTICAL SOFTWARE

801 West Iowa Ave., St. Paul, MN 55117
(612) 488-4436

Inquiry 728.

ZERODISK

ZeroDisk runs dozens of copyprotected business packages from your hard disk without floppies. Call for the latest list of software it handles. Needs IBM AT, XT, PC, or compatible, DOS 2.0 or higher. ZeroDisk is revised monthly and is not copy protected. \$75 US. Check or Credit Cards accepted.

QUAID SOFTWARE LIMITED

45 Charles St. E. 3rd Fl.
Toronto, Ontario, Canada M4Y 1S2
(416) 961-8243

Inquiry 767.

PAL FOR SIDEKICK!

Personal Appointment Locator automatically shows coming appointments, searches your file, maintains to-do list, examines multiple files. Resident alarm tool! Only \$45. Cheap at twice the price!

PAL SOFTWARE

Ste. 12B 110 Green St., New York, NY 10012
212-925-1843

Inquiry 767.

TEXT SCANNING

ELIMINATE KEYBOARDING
CONVERT TYPESET AND
TYPEWRITTEN COPY
TO DISK OR TAPE
CALL

**MEDIA CONVERSION
CORPORATION**
312-346-0102

Inquiry 717.

GENSCREEN

For Microsoft Cobol/IBM Cobol
Generates Cobol Source Code For Your Screen
Section and Data Divisions Fast!!!

GenScreen is a powerful new programmers productivity tool which utilizes a screen image text file produced from your own editor. This in turn is run through our interactive utility to produce 100% syntax free Cobol source code. GenScreen will produce "genrec" or custom data names for your code automatically. GenScreen is available for only \$89.99 from...

Personal Computer Development Corp.

POB 8556, Warwick, RI 02888-8556
(401) 333-8704

Inquiry 734.

* DEC RAINBOW USERS !! *

B.E.V. SOFTWARE ANNOUNCES DR. DISK - The latest in DEC RAINBOW utilities!

- View or modify any sector on the diskette
- Restore deleted files
- Alter file attributes (HIDDEN, SYSTEM, etc.)
- Learn RAINBOW MS-DOS disk organization
- Determine the extent of crashed disks

This tool has long been used by software developers in the field and is finally being offered to the public at a fraction of its commercial cost. Send \$29.95 to:

Bill Norton - B.E.V. SOFTWARE
P.O. Box 139, Schenectady, NY 12301

Inquiry 669.

Advertise your computer products for as little as \$375 in
THE BUYER'S MART.

For more information call Karen Burgess at BYTE
603-924-3754.

10th ANNIVERSARY SALE

8MHz TURBO SUN-ST COMPUTER

\$530

(ASSEMBLED & TESTED)

Dealer & Computer Groups
Call for Special Price



- 4 LAYER MOTHER BOARD
 - 8 MHz CPU (Keyboard Switchable to 4.77 MHz)
 - 256K RAM (Expandable to 640K)
 - 360 KB DISK DRIVE
 - AT STYLE KEYBOARD
 - COMPUTER CABINET w/SPEAKER
 - 1 YEAR LIMITED WARRANTY
 - FCC APPROVED
- Call for other configurations

SUN-ST UPGRADE ITEMS

- RAM UPGRADE TO 640K \$60
- 2ND DISK DRIVE (360 KB) \$109
- MONO G CARD w/PP (Hercules Compatible). \$99
- COLOR GRAPHIC CARD \$85
- ENHANCED GRAPHIC CARD w/256K \$290 (IBM EGA Compatible)
- 12" TTL GREEN MONITOR - \$115 or AMBER - \$135
- COLOR MONITOR (640x240) \$365
- MULTI-I/O PLUS CARD (Serial, Parallel, Game Port, Clock, Calendar, Ram Disk, Spool) \$95
- 8087-2 \$159

SUN-286 (IBM-AT Compatible) COMPUTER SYSTEM

\$1,529

- 6 MHz & 8 MHz DUAL SPEED MOTHERBOARD
 - 640K RAM ■ 8 EXPANSION SLOTS
 - 1.2 MB FLOPPY DISK DRIVE & CONTROLLER
 - 200W POWER SUPPLY ■ AT STYLE KEYBOARD
- OPTIONS:
- 20 MB (40 ms) . . . \$590 ■ 30 MB HDD (40 ms) . . . \$690
 - MULTI FUNCTION CARD (Serial, Parallel, RAM Expandable to 3 MB, OK) \$225
 - I/O CARD (Serial, Parallel Port) \$ 69



SUNTRONICS CO., INC.
12603 Crinshaw Blvd., Hawthorne, CA 90250

1-800-421-5775
(orders only)
213-644-1140

STORE HOURS
MON - FRI 9:00am - 6:00pm
SATURDAY 10:00am - 3:00pm
Dealer & OEM Inquiries Invited

TERMS: VISA, MasterCard (in Southern Cal), Cash or Certified Check (VISA or MC Ref. Requests Subject to Suntronics P.O. approval). Shipping & P.C. \$4.00/line 1.40 plus \$4.00 for each additional CA resident add CA Sales Tax \$10.00/Mo. Credit WARRANTY: 30 Days Without Labor Parts Replacement Only. IBM is a registered trademark of International Business Machines.

TURBO SPEED XT

FULLY COMPATIBLE AND 40% FASTER THAN IBM PC/XT

By Using State Of The Art *NEC V-20 Processor



\$595⁰⁰



- * Fully IBM PC/XT Compatible
- * 640k On Board Memories
- * 8 IBM PC/XT I/O Slots
- * Standard 4.77 Mhz Clock Speed
- * Slide in FCC Type Case
- * 150 Watt Power Supply
- * AT Style Full Function Keyboard
- * 2 Half Height Disk Drives
- * Floppy Disk Controller

OPTIONAL ADD ONS:

- A. For 5151 Keyboard Add \$40⁰⁰
- B. RGB Color Monitor + Color Graphic Card Add \$410⁰⁰
- C. 22 MGB Internal Hard Disk With Controller Add \$460⁰⁰
- D. TTL Monochrome Monitor + Monochrome Graphic Card With Parallel Printer Port Add \$229⁰⁰
- E. 300/1200 Baud Auto Dial/Auto Answer Modem Card Add \$145⁰⁰

*V20 by NEC is the superset of 8088 and pin to pin compatible with 8088, increases speed of PC from 40% to 80% (rated 1.8 according to Norton Utility 3.0's system information while IBM PC and PC/XT are rated 1.0 as standard) without changing the clock speed of the system, run all IBM PC compatible software with no problem.

SHIPPING CHARGES: 5% for C.O.D., 2% for prepaid orders inside Continental U.S. No Personal Checks Accepted.

OTHER SYSTEM CONFIGURATIONS AVAILABLE: PLEASE CALL FOR DETAILS

* IBM is registered trade mark of IBM Corp.

PINE COMPUTER INC. • (818) 575-1882

9690 TFL STAR AVENUE • SUITE 204 • EL MONTE, CA 91731 • STORE HOURS: Mon. - Sat. 9 AM - 6 PM

U.L. Rated • High Reliability • Full Technical Support

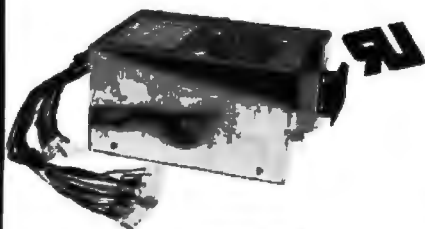

140W (Typ.) 150W(Max.)
 PC/XT \$129.00

- U.L. recognized, yellow card available File # E-101115(S)
- Meet FCC class B, European safety spec.
- 115/230V AC convertible
- Low noise DC fan
- OVP, OCP, short circuit protection
- IBM® standard pin out or Faraday type pin out selectable
- 100% 24 hrs. burn-in 100% pre-shipment test.
- One full year warranty

Your PC represents a substantial investment. It does not make sense to risk costly down time due to bargain power supply, when for a few dollars more you can have the confidence of FORTRON QUALITY.



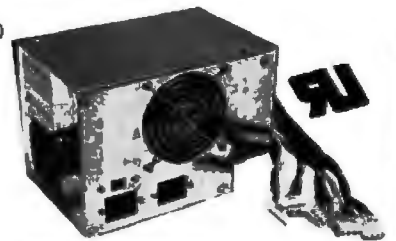



IBM is a registered trademark of International Business Machines.



FC 5192 200W (max)
 PC/AT \$189.00

PROFITABLE DISCOUNT PRICES FOR SYSTEM INTEGRATORS & DEALERS - PLEASE CALL

FC 520 Color Graphic / Mono / Printer  • TTL / components level outputs • 300 x 300 (total) 840 x 300 (RAM) • Centronics Printer Port \$99.00	FC 550 (CT-6040) Monochrome / Graphic / Printer  • 80 x 25 text mode • 720 x 348 graphic mode • Ram Latch (-3-3) auto read, etc • IBM® compatible \$109.00	FC 730 (CT-6050C) 384K Multifunctions  • Memory expansion to 384K • Clock / controller • Serial, parallel ports • Game port (PK) \$119.00	FC 740 Multi-I/O w/ Floppy Controller  • 1 EA-RS232C port (2nd optional) • 1 Centronics port, game port • Clock / controller • Control 2 floppy drives • FC 770 w/ a Floppy Controller \$99.00	FC 1730 Multifunction Card for PC AT  • 1 EIA-RS232 port (2nd optional) • 128K to 1.5 MB memory • Expandable to 3 MB (optional) by program back board • Game port \$189.00	FC 1930 RS232 / Printer Port for PC AT  • 1 EIA RS232 port (2nd optional) • Centronics parallel port \$99.00
FC 940 RS232 / Real Time Clock  • RS232C port • To 65536 baud • Battery back-up \$69.00 (stock only) \$49.00	Hard Disk Controller  Hard Disk Controller for XT • DTC 5158 IC \$149.00 • HD WX-2 (Western Digital) \$149.00 • Cable 5 9.90 F.D. & H.O. Controller for AT • DTC 5258 \$249.00 • Western Digital WX-2 \$269.00 • Cable Set \$19.00	FC 230 Floppy Disk Controller  • Drives up to four 5 1/4" floppy drives • IBM compatible • With cables \$59.00	XT CPU Board  FC 150 (4.77 MHz) \$149.00 FC 180 (8.00 MHz) \$199.00 • Expandable to 640K on-board memory • Optional 8087 co-processor • Optional IBM® comp. BIOS	Modems \$149.00  INTERNAL Hayes Compatible 1200 Baud \$149.00 2400 Baud \$425.00	SPECIAL • FC 830 512K memory exp. card .. \$69.00 • FC 830S 576K memory exp. card \$69.00 • FC 930 serial/parallel adaptor for XT \$49.00 • FC 530 monochrome controller w/printer port \$79.00

Enhanced Graphic Adaptor IBM® Compatible  w/o printer port • For PC / XT / AT and compatibles • 256K on board memory • Full 18 colors in 640 x 360 on IBM® enhanced color display • Support 640 x 350 IBM® compatible enhance color and monochrome monitors • Parallel port - Light pen interface \$239.00	EGS Monitor \$459.00  w/ printer port	FORTRON 200 U.P.S. for PC  • 115V / 230V AC input convertible • Input current 2.5 amp • 200VA continuous • 1/2 cycle (typical) transfer time • Holding time from 30 minutes (200VA) up to 60 minutes (80VA) • 6.12" x 7.7" x 12.48" \$259.00	FC 447 PC/AT Keyboard  • IBM AT compatible keyboard • Ejector return key • Light on num. lock key \$109.00	FC 427 (5150 Type) \$79.00  FC 437 (5151 Type)  • For PC XT • Large return key • Light on num. lock keys \$99.00
---	---	--	--	--

CABINETS & EXPANSION CHASSIS

FC 630 A-2 XT CHASSIS  • For PC XT compatible only option • 256K on board memory • Full 18 colors in 640 x 360 on IBM® enhanced color display • Complete mounting hardware \$79.00	FC 620 AT CHASSIS  • For PC AT compatible • LED lamps, key, key lock, speaker and mounting hardware included \$139.00	FC 610 Drives Chassis  • 18" x 9" x 9" • Capable of holding 2 half-height drives • Comes w/ power supply, fan • LED power indicator \$149.00	FC 640 / 5 Slots PC Expansion Chassis \$239.00  • W / 5 slot mother board • 100V power supply, fan • Capable of holding 3 half-height drives • Dia 5 1/4" x 12" x 6 1/2" • Option of system interface edgecar \$149.00	FC 650 / 6 Slots PC Expansion Chassis \$249.00  • PC XT Mother slot • W / 6 slot mother board • 100V power supply • 4 half-height drives • System interface adaptor \$149.00	FCC 680 / 12 Slots PC Expansion Chassis \$299.00  • Dia. 15 1/2" x 15 1/2" x 6 1/2" • W / 12 slot mother board power supply, fan • Capable of holding 3 half-height drives • System interface adaptor .. \$149.00
---	---	--	--	---	--

MONITORS \$89.00 • Monochrome Tejung LM 1282 A / G \$109.00 800mg \$99.00 • Color Hi-Res (640 x 200) Tejung CM-1260 \$249.00 • Enhanced Graphic (640 x 350) Tejung CM-1260 \$499.00 Princeton GE-126 \$259.00 Mitsubishi EGA \$359.00 Quinix PV-22 \$459.00	DISK DRIVES • Floppy Teac 555V \$109.00 1.2 MB 525PV \$149.00 • Hard w/ controller & cables 10 MB \$379.00 20 MB ST-4025 \$399.00 30 MB ST-4030 (40 MB) drive only \$579.00 30 MB ST-4030 (40 MB) drive only \$499.00 • 31 MB CM-6640 (40 MB) drive only \$499.00	Tape Back-Up (w / controller, cable & tape)  INTERNAL Sysgen 20 MB \$575.00 Sysgen 60 MB \$745.00 EXTERNAL Sysgen 20 MB \$749.00 Sysgen 60 MB \$955.00	Printers \$89.00  • Tejung DP-130 \$79.00 • 130 C.P.S. • 80 columns • 8 x 8 dot matrix font • Parallel standard interface TT2-60 \$ 99.00 • 80 C.P.S. • 80 columns • Parallel standard interface • Thermal printer	RAM CHIPS • 64K RAM \$7.00 / 8 pin • 128K \$9.00 / 8 pin • 256K \$14.00 / 8 pin (for PC AT) Terms: • Min. shipping & handling \$6.00 • CA res. add 6.5% tax • Restocking charge 15% • No rtn goods w/o a RMA no • Prices subject to change w/o notice
--	---	--	--	---

Compu\$ave

Call Toll Free: 1-800-624-8949

A DIVISION OF ADLANKO CORPORATION

MONITORS

Amdek 310A . . . 143	Amdek 722 . . . 499
NEC Multisynch . 539	PGS HX12E . . . 499
Samsung TTL . . . 89	PGS MAX12 . . . 158
Samsung 1251 . . . 72	Taxan 630 . . . 429
Tatung 1360 . . . 399	Taxan 640 . . . 495
Tatung 1370 . . . 449	Wyse 620 . . . 385
Thorn 36382SI . . 375	Wyse 700 . . . 1145
Zenith 1360 . . . 515	Zenith 1230 . . . 92
Roland/12"/RGB/640x240/.37 . . . 289	
Sakata/13"/Comp & RGB 640x200 . . 359	
Thomson/14"/Color Comp/Apple . . 139	
Hitachi/Mitsubishi/Nanao CALL	

MODEMS

Anchor Volksmodem 12 178
Anchor Lightning 2400/Software . . . 308
Hayes Smartmodem 1200 368
Incomm 2400/Upgradeable 4800 + . . 359
Novation 2400 Professional 509
Practical 1200 Half-Card/Software . . 145
Prometheus Promodem 1200G 195
Prometheus 300/Ap IIC/Software . . . 79
Racal-Vadic 1200V 219
Racal-Vadic 2400 PC/Software 399
US Robotics Courier 2400 378
Zoom IIE Internal/Software/Apple . . . 92
AST/Codex/Rixon/UDS/Ven-Tel CALL

COMPUTERS

Cordata 400XT Port/20M Drive . . . 1499
Cordata PC400/2 Drives/Monitor . . . 1125
Sharp PC7000 Portable/2 Drives . . . 1235
Sperry IT/11M/40M Hard Drive 2899
Televideo AT/1 2M/20M/Monitor . . . 2349
Toshiba T1100 Portable/1 Drive 1385
Wyse PC1100/256K/1 Drive 945
Altos/NEC/Olivetti/Zenith CALL

CTC SYSTEMS XT \$558

640K / 4.77 MHz / 1 Floppy Drive / 135 W Power Supply / XT-Style Keyboard / User Documentation / 6 Months Warranty

CTC SYSTEMS AT \$1783

1M / 8MHz / 1.2M Floppy Drive / 200 Watt Power Supply / Keyboard / Clock/Calendar / 1 Parallel & 2 Serial Ports / Documentation / FCC & UL Approved / 6 Month War.

TERMINALS

IBM 3161-11 . . . 489	Altos III . . . 575
Kimtron KT7 . . . 435	Altos IV . . . 359
Qume QVT-101G . 293	Ampex 210 . . . 365
Televideo 905 . . . 289	Wyse 30 . . . 289
Televideo 955 . . . 445	Wyse 50 . . . 415
Televideo 9220 . . 459	Wyse 60 . . . 475
Visual 65 399	Wyse 85 . . . 438
Adds/CIE/Liberty/Link/Zenith CALL	

PRINTERS/PLOTTERS

Citizen 120D . . . 179	Canon A40 . . . 235
Citizen MSP10 . . 279	Canon Lazer . 1935
Cordata Lazer . . . 2175	NEC P5 865
Epson FX286 . . . 539	NEC P5XL . . 1099
Epson JX80/NLQ 349	NEC P6 439
Okidata 2410 . . . 1799	Okidata 182 . . 209
Panasonic 1091 . . 228	Okidata 292 . . 616
Panasonic 1092 . . 299	Ricoh 52LQ . . . 795
Panasonic 1592 . . 419	Star NB15 . . . 979
Toshiba 351 Col . . 1199	Star NX10 . . . 245
Toshiba 321 495	Tally MT86 . . . 426
Anadex/Data Prod/Diablo/Juki CALL	
Fujitsu/Genicom/Televideo/TI CALL	
Buffers/Cables/Sheet Feeders CALL	
Stands/Switch Boxes/Tractors CALL	
Houston/Ioluna/Roland Plotters SAVE	
Houston/Kurta/Summa Digitizers SAVE	

DISK DRIVES

Gamma Drives/Apple II, II+, IIE . . . 119
IOMEGA Dual 10M Bernoulli Box . . . 1945
IOMEGA Dual 20M Bernoulli Box . . . 2445
Priam ID40/XT-AT Hard Drive 1129
Seagate 20M Hard Drive Kit 405
Talgrass 25M Drive/60M Backup 2199

OTHER FLOPPY AND HARD DRIVES

Alloy • Archive • CDC • Corvus • Haba • Irwin • Maxtor • Maynard • Mitsubishi • Panasonic • Sanyo • Shugart • Tandon • Teac • Tecmar • Tulin • Western Digital

BOARDS

AST Rampage/PC-XT 245
AST Six Pack Plus/64K 155
ATI Graphics Solution 199
Color Card Clone 85
Hercules Color Card (With Rebate) . . . 93
Orange Grappler + (Apple) 69
Orchid Tiny Turbo 286 445
Orchid Conquest/OK 255
PC 576K RAM Board (OK) 59
PC Monochrome Graphics Card 89
PC Serial/Clock Card 85
STB Super Res 400 Card 285
Sigma 400 High Res Card 439
Tecmar EGA Card 439
Tecmar Jr. Captain 189
Intel/Paradise/Persyst/Quadram CALL
Prac. Peripherals/Thesys/Vutek CALL

ALL TYPES OF BUSINESS, CAD AND RECREATIONAL SOFTWARE VERY LOW PRICES. CALL

WE ALSO CARRY

Kensington Masterpiece Plus 122
Mouse Systems PC-Mouse 115
FTI-85 Surge Protector (#1 Rated) . . . 52
Cables/Chips/Disks/Graphics Tablets
Joysticks/Keyboards/ Power Supplies
Labels/Mice/Stands/Surge Protectors
LOW PRICES CALL

**HOURS: MON - FRI 7AM - 6PM/SAT 9AM - 2PM
IN ARIZONA CALL (602) 437-4855**

CompuSave: 4207 S. 37th St., Phoenix, AZ 85040/For Customer Service Call (602) 437-4856/Prices Reflect Cash Discounts And Are Subject To Change Without Notice/Minimum Shipping Charge \$4 Purchase Orders & Major Credit Cards Welcome

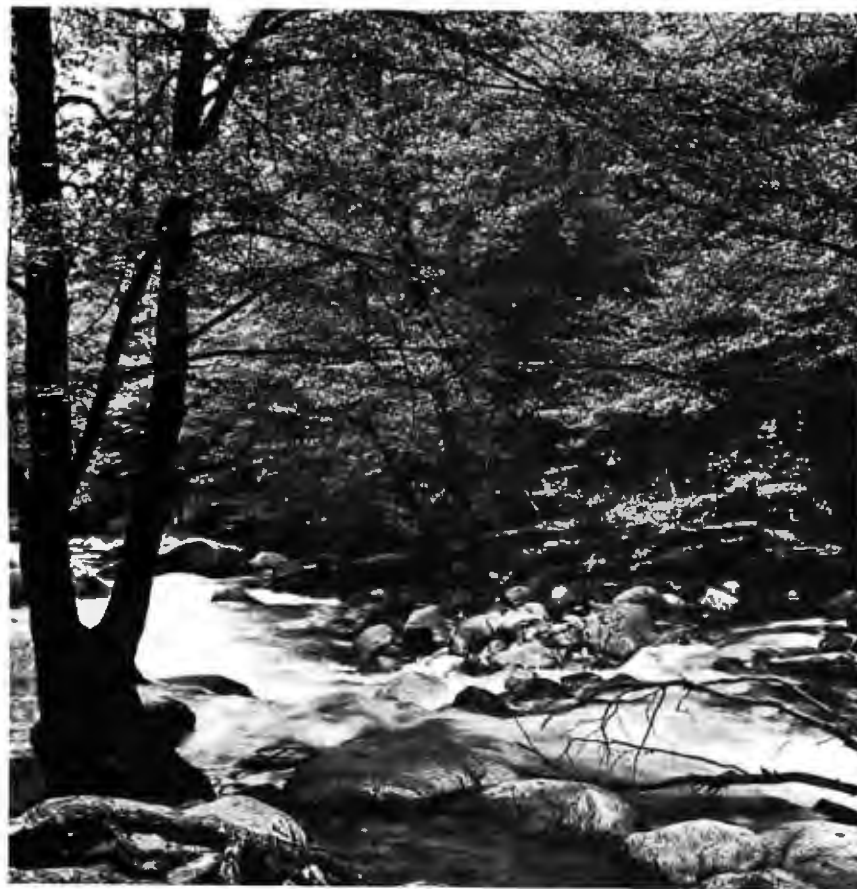

Bruce Barnbaum

To Explore, Enjoy, and Protect

You and I share a great love of this earth.

The ocean's pounding surf, Spring covering the earth with that season's newness, a bird's song reaching out. . . and we are moved.

We enjoy the earth's beauty, its grandeur. The endless sweep of colors, and sounds, and everywhere, the excitement of life.

And we of the Sierra Club join together to protect the earth.

We invite you to join with us. To explore, to enjoy. To protect this wondrous earth. For all of us. . . forever.

For membership information, write Sierra Club, 530 Bush Street, San Francisco, CA 94108, (415) 981-8634.



Sierra Club

21 MEGABYTE HARD DISK ON A PLUG-IN CARD

\$479⁰⁰ MEGACARD!



© 1986, LOGIC ARRAY

MEGACARD! 21 megabyte hard disk drive on a plug-in board that instantly converts any PC or compatible to an XT.

And **MEGACARD!** enables PC and XT users with a hard drive to run two drives on a single slot. You get an extra expansion slot!

MEGACARD! combines the NEC "zero defect" program with state-of-the-art technology. This "drive-on-a-card" installs in seconds. Just plug in and power up!

MEGACARD! delivers:

- NEC technology
- "Zero defect" reliability
- Fast, easy plug-in installation
- Two year parts and labor guarantee.

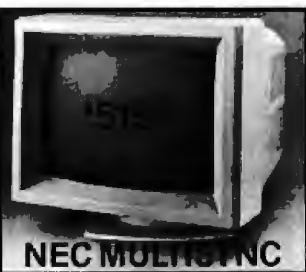

NEC MULTISYNC

NEC MONITORS

JC1401P3A	MULTISYNC	515.00
JC1216DFA	RGB	269.00
JB1280DA	TTL GREEN	105.00
JB1285DA	TTL AMBER	105.00

From the legal beagles.
Prices and availability subject to change without notice. Prior authorization required on all returns. All returns subject to restocking charge. All normal manufacturers' warranties apply. NEC, MultiSync, EGA Paint are registered trademarks of their respective companies.

CHIPS

64K DRAMS, SET OF 9	9.00
256K DRAMS, SET OF 9	27.00
128K PIGGYBACK, SET OF 18	72.00
C8087	125.00
C8087-2	179.00
C80287-3	225.00
V20 8MH	10.95

EGA

ATI MEGA GRAPH PLUS	295.00
MYLEX EGA BOARD	249.00
RIX EGA PAINT SOFTWARE	52.00



EGA PAINT

PORTABLE COMPUTERS

NEC PC8201A	360.00
(See listing of 8201A programs)	
NEC PC8401ALS	599.00

PC8201A ADD-ON PRODUCTS

PC8206A 32K RAM CARTRIDGE	360.00
PC8221A THERMAL PRINTER	125.00
PC8231A FLOPPY DISK DRIVE	560.00
PC8241A CRT ADAPTER	149.00

PC8281A PORTABLE CASSETTE RECORDER	85.00
------------------------------------	-------

PC8201A-06 8K RAM CHIP	52.00
------------------------	-------

PC8201A-90 NI-CAD BATTERY	16.00
---------------------------	-------

PC8271A-01 AC ADAPTER	16.00
-----------------------	-------

CASSETTE PROGRAMS FOR 8201A

PERSONAL PLAN	36.00
GENERAL STATISTICS	36.00
BUSINESS GRAPHICS	36.00
FINANCIAL ANALYSIS	36.00
TAX PLANNING	36.00
APPLICATION KIT	85.00
REAL ESTATE ANALYSIS	36.00
PERSONAL FILER	36.00
TIME ACCOUNTING	36.00

MODEMS

INTERNAL 1200 BAUD	230.00
EXTERNAL 1200 BAUD	230.00
SECURITY 1200 BAUD	310.00
INTERNAL 2400 BAUD	375.00
EXTERNAL 2400 BAUD	395.00

NEC DISK DRIVE KITS

All drives include controller and cables.

5¼" 20MB D5126	389.00
5¼" 40MB D5146	649.00
(40MB includes Disk Manager)	
3½" 20MB D3126	389.00



NEC DRIVE KITS

IT'S EASY TO ORDER

• We ship immediately when you pay by Visa, Master Card, Cashier's Check or Money Order. Allow 3 weeks for personal or company check.

• No Surcharge on Visa or Master Card.

• Minimum \$5 shipping and handling up to 3 lbs. in Continental U.S. only. On other orders, call for information.

• All orders insured.

• No Sales tax on orders outside California (California residents add 6% sales tax.)

When you want the best peripherals money can buy with expert technical support you'll just have to settle for paying less. That's logic. From Logic Array.

LOGIC ARRAY
P.O. BOX 3799
Costa Mesa, CA 92628-37099

CALL NOW AND WE CAN SHIP TODAY!

FOR EXPERT TECHNICAL SUPPORT

800-22-LOGIC

800-843-0426 (in Calif.)

HOURS: Mon.-Fri. 7a.m.-5p.m. PDT

Inquiry 165 for End-Users. Inquiry 166 for DEALERS ONLY.

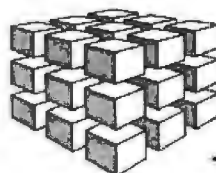

Logic Array

BYTE CONNECTION INC. (714) 778-6496

BOTTOM LINE PRICE BUSTERS! - "Who you gonna call?"

PERSONAL COMPUTERS

IBM * IV, (IBM AT Compatible), with 8 MHz, 640 K, 1.2 MB Floppy, 20 MB HD, Graphics Card, Monitor & Keyboard \$2275

IBM PC, with 256K K.B., Two 360 Floppies \$1295
 IBM PC XT, with 256K, 360 Floppy, 20 MB HD, K.B., Graphics Card, Monitor \$2350
 IBM PC XT, with 640K, IBM 360 Floppy, IBM 20 MB HD, New Keyboard, Graphics Card, Monitor ... \$2559 IBM PC AT #339, 512K, 1.2 Floppy, IBM 30MB HD ... \$4525
 IBM PC AT, with 512K, K.B., 20 MB HD \$3550
 IBM PC Convertible 80 C 88 Processor, with 512K, Two 720KB Floppies \$CALL
 IBM Proprinter \$ 475 IBM Quietwriter \$1200
 IBM EGA, with 256K Memory ... \$ 775 IBM EG Monitor \$ 695

COMPAQ PORTABLE II with 512K, 80286 Processor, Two 360 Floppies \$2875
 COMPAQ DESK PRO, with 640K, Two 360 Floppies, Graphics Card & Monitor ... \$1895
 COMPAQ DESK PRO & PORTABLE 286, with 640K, 1.2 Floppy, 20 MB HD, Monitor \$3895 For 86 MB, instead of 20 MB, add \$ 995

AT & T 6300 PC, with 256K, K.B., Two 360 Floppies, AT & T Graphics Card & Monitor..... \$1795
 AT & T 6300 Plus, with 512 K, 1.2 Floppy, K.B., Graphics Card & Monitor \$3495

SPERRY PC-IT, with 640K, 1.2 MB Floppy, 40 MB HD, K.B. \$3095

PLOTTERS & DIGITIZERS

CALCOMP 1042 - While Supplies Last \$8395 1043 \$7359
 1044 ... \$11,195 GOULD 6320 11 x 17 ... \$1550 IO LINE 3700 ... \$3895
 HI DMP 56 \$4596 DMP 40 \$ 920 DMP 51/52 \$4145
 HP 7475 \$1659 HP 7580 \$8415
 NICOLET ZETA 824 \$8995 ZETA 836CS \$13,295
 GTCO 3648L \$3095 1117A \$1195 2436TL \$5995
 KURTA 12 x 12 \$ 595 12 x 17 \$ 695
 SUMMAGRAPHS 11 x 11 \$ 495 18 x 12 \$ 750
 HITACHI 36 x 48 ... \$4195 TIGER 11 x 11 ... \$ 675 15 x 15 ... \$1295

GRAPHIC CONTROLLERS & MONITORS

HITACHI HM 3719 & BNW 15 \$3290
 MICROVITEC 905CNO GRAPHPORT D \$2795
 TAXAN 640 & COLOR 400L \$1099
 PERSYST BOB 16 & NEC 1401 \$1150
 GALAXY 800 & MITSUBISHI 6469 \$2995
 VERTICOM CD-1 & VERTICOM M-16 \$2395
 BNW ADAPTER \$1950 ARTIST-IT \$2295
 Conographics 400 & Mitsubishi 3479 LP \$2295
 Mitsubishi 1341 & Sigma 400 \$1195

SOFTWARE

Accounting Package \$ 495 AUTOCAD \$1950
 T & W VERSACAD \$2395 CADVANCE \$1950
 ARMOR SYSTEM'S Excalibur & Plus Series CALL
 COMPUTER ASSOCIATE (IUS) A/R, A/P, G/L EACH \$ 350
 UNIVAIR'S Dental Management & Medical Management-9000 CALL
 CYMA Medical, Chiropractic, Orthodontic, Dental Package \$1625
 Physician Micro Systems Package \$1850
 Hotel Information Systems Package \$2450
 MICROCRAFT, BALCONE, UNIVAIR CALL
 IBM Doctor Officer ManagerII \$2950

PRINTERS

CITOH LQ24 \$ 875 F10-40 \$ 875
 F10-55 \$ 995 C-10 \$ 475
 CITIZEN MSP 15 \$ 415 MSP 25 \$ 525
 CITIZEN PREMIER 35 \$ 515
 CORONA LAZER \$2350
 DIABLO 835 \$1250 INKJET \$ 895
 DIABLO 34LQ \$1095
 DIABLO LAZER/COPIER 4045 \$4259
 EPSON FX85 \$ 379 EPSON 286 \$ 550
 HEWLETT-PACKARD LASER JET \$2195 HP Plus \$2995
 HEWLETT-PACKARD 500 Plus \$4150
 NEC P560 \$ 995 P760 \$ 650
 FUJITSU MAX 24 \$1175 MAX 24 COLOR \$1275
 FUJITSU DL 2400 \$ 959 DM 2400 \$ 859 2200 CALL
 TOSHIBA P321 \$ 550
 OKIDATA 912 ... \$ 369 193 ... \$ 479 OKIDATA 293 ... \$ 665
 TOSHIBA P351 \$1095 P341 \$ 750

HARD DRIVES & BACK UP SYSTEMS

SEAGATE 20 MB \$ 450 SEAGATE 1038 \$ 695
 SEAGATE 4051 \$ 850 HARD CARD 20 MB \$ 650
 MAXTOR/MICROPOLIS 85MB \$1550
 MAXTOR 105/140 MB \$1850/\$2195
 TEAC 20 MB Tape B/U \$ 595
 ARCHIVE 60 MB Tape B/U \$ 850

CALL FOR WHAT IS NOT LISTED, WE GUARANTEE THAT YOUR CALL WILL NOT BE A WASTE.

No charges for testing and configuring equipment. Prices and availability subject to change without notice.

(714) 778-6496

167 West Cerritos Ave., Anaheim, CA 92805

How a software engineer got to captain the lunar landing module.

The Computer Museum is everything you'd expect, and a lot of things you wouldn't.

Of course, the museum contains a collection of the most significant accomplishments in the history of information processing. But it's not just a great place to see things, it's also a great place to do things.

There are over twenty interactive exhibits at The Computer Museum. You can design a car, create your own fractal landscape, or even captain the lunar landing



module on the Apollo flight simulator.

So, the next time you're in Boston, stop by The Computer Museum. You'll discover it's more than a lot of machines, it's also a lot of fun.

For more information, or to become a Museum Member, write The Computer Museum, or call (617) 423-6758.

The Computer Museum

B O S T O N
There's something in it for everyone.

300 Congress Street, Boston, MA 02210

Computer Parts Mart

San Jose, CA 95112
634 North 8th St. (408) 993-9011

STEPPER ENSEMBLE

100 Step High Precision Motor

By Applied Motion. Stepper driver with bipolar windings, 26 ohms/5mH 1/4" x 2.1" ground shaft with helical follower groove @ 0.182" pitch. This is an extremely high accuracy assembly good to better than 50 microns absolute. Ball bearings, 5.5gm/cm inertia, 10 oz. in. holding torque @ 400 ma. New, never used. Driver I.C.s: 3717 for P.W.M. Microstepping allow efficient use of any supply voltage up to 40v D.C. Motor and Two I.C.s including data sheets



\$14.95

STD-BUS



64K RAM Card expandable to 256K	\$ 99
256K Card	\$248
Voltax Card	\$148
SASI Interface Card	\$100
4-SID Card	\$165
4-PID Card	\$129
2-SID & 2-PID Card	\$125
230 CPU Card	\$ 79
6800 Proc. Card	\$300

Complete STD Systems available - up to 10 disks, 10 MB Disk, etc.

Inquiry 69

IF YOU USE A COMPUTER YOU CAN USE

UNIT CONVERSIONS™

NOW ONLY \$49.95

IBM PC/XT/AT and Apple IIe/IIc/II - Compatible
Virtually ALL the conversions you will ever need!
UNIVERSAL UNCHANGING PRECISE

Feet to metres, kilowatts to horsepower, light years to angstroms and 3,561 MORE!

TO ORDER: see your local software dealer or call toll free 24 hours a day 1-800-356-5324 (ext 1328)
WI or outside USA: 608-257-6648
VISA, MasterCard, or C.O.D. Welcome
ALL ORDERS SHIPPED WITHIN 48 HRS. OF RECEIPT
SHIPPING PAID BY ICI FOR USA ORDERS
Outside USA: add \$10.00 shipping and handling, pay in U.S. dollars (No C.O.D.)

ICI INTERNATIONAL COMPUTING, INC.
1501 Monroe, Madison, WI 53711 USA
The Quiet Star in Software

Inquiry 140



! not only a printer buffer !

THIS IS THE MOST SOPHISTICATED
PRINTER BUFFER - MULTIPLEXOR - SWITCH

WITH TWO SEPARATE INPUTS (SERIAL AND PARALLEL) AND TWO SEPARATE OUTPUTS (SERIAL AND PARALLEL) CAN BE USED LIKE STANDARD BUFFER WITH ANY INPUT TO ANY OUTPUT BUT ALSO YOU CAN CONNECT 2 COMPUTERS TO 1 PRINTER OR 1 COMPUTER TO 1 PRINTER, OR 2 COMPUTERS AND 2 PRINTERS AND MORE - 1 COMPUTER TO 3 PRINTERS OR 1 COMPUTER TO 1 PRINTER
HIGH CAPACITY - 64 KB TO 160 KB AND - 230 KB TO 1 MB (MODELS A AND B) PAUSE, COPY AND RESET FUNCTIONS SERIAL PORTS WITH 2 OR 8 BITS WORD LENGTH, 1 OR 2 STOP BIT, PARITY, XON/XOFF, DTR, RTS

DCB-A-64K \$ 260 (*) DCB-B-260K \$ 290 (*)

(*) Power supply and parallel cables are included

ALSO, WE HAVE THE MOST COMPLETE DATA CONVERTER UNIT CONVERTS SERIAL TO CIRCULARS PARALLEL OR VICE VERSA, JUST BY MOVING JUMPERS BAUD RATE AND PROTOCOL FULLY PROGRAMMABLE FROM 00 TO 19900 BAUDS INCLUDES DTR, RTS, XON/XOFF, PARITY, etc

DCU \$ 40 (**)

(**) Power supply and cables NOT included



serial \leftrightarrow parallel
bi-directional converter



INTECRA, Inc. - Dept. 222
1009 TERMINAL BLVD
MOUNTAIN VIEW, CA 94033
(415) 967-0218 TLX 745543

Inquiry 140

PROF JONES
1840 W. STATE ST.
BOISE, IDAHO 83702
ORDER LINE (208) 342-9839

PROFESSIONAL HANDICAPPING SYSTEMS

PROFESSIONAL SERIES™ (Throughput/Bytehour/Format) - The of the Professional Series™ represents the most advanced handicapping software available

Analysis Module™ - Complete dot analysis highlights the basic Professional Series™ module. Full 50 instructions. \$149.95

Factor Variable/Multiple Regression Module™ - Factor Value weighting highlights the addition module™. \$149.95

Data Base Manager Module™ - Automatic storage of text 11 cases highlights the update (379.95) with Factor Value Module™. \$149.95

GOLD EDITION™ (Throughput/Bytehour/Format) - The classic Gold Edition™ from Prof. Jones offers flexibility, results, and ease of use

Gold Edition™ \$159.95

Enhanced Gold Edition™ \$199.95

Limited Gold Edition™ \$299.95

Ultim Edition™ \$399.95

Professional Price Realized™ 599.95 with optional audio ratings \$149.95 Professional Series™ \$199.95

Expanded Library/Data Analysis - Library 3-4 digit \$79.95. Solo max of 99 digit \$99.95. Enhanced Library/Data \$129.95

Handicapper's Bulletin Board and VHS Training Tapes now available

Terms: Free shipping all software. Add \$4.00 C.O.D. \$500 UPS Bill \$300 Out of country. ID residents add 5% (13 weeks personal checks) Cash price only add 2% VISA MC AMEX. Prices subject to change

FREE CATALOG

Inquiry 237

CHANGING SYSTEMS? What Happens to Your Data? Does JUST Media Conversion Solve Incompatibilities?

WHAT IF . . .

everything is changing. Including your software, hardware, operating systems and media? What happens to your spreadsheet data and formulas, database structures and/or word processing documents and codes?

What do you do, and what is the cost?

We Make Incompatible Data Compatible!

The source can be mainframes, minis, micros, dedicated word processors or typesetters. ADAPSO member.

CompuData Translators, Inc. 213-462-6222
6565 Sunset BL, #301 Hollywood, CA 90028

Inquiry 63



Sure it's insured?

SAFWARE® Insurance provides full replacement of hardware, media and purchased software. As little as \$39/yr. covers:
• Fire • Theft • Power Surges
• Earthquake • Water Damage • Auto Accident

For information or immediate coverage call:
1-800-848-3469

In Ohio call 1-614-262-0559



SAFWARE, The Insurance Agency, Inc.

Inquiry 258

Printer (Data) switch \$45.00 Distributors, Dealers welcome

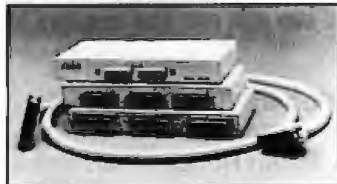

- Metal case, fully shielded
- Push button switch
- 2 layer PC board
- 1 year warranty
- Dimensions: 1" x 4 1/4" x 8 1/4"
- All pin switched
- Color: beige

Switch box DS 28/Cantronic	RS-232 Miniature	\$7
7 way switch (push button)	Printer Change Mode Pin	\$10
2 way cross factory	Real Moment	\$10
4 way switch (push)	Jumpers for Surge-protector	\$10
	Mini-socket Mini-socket box	\$15

Cable: Moscad shielded UL cable \$12 and up Break-out box \$30

30 Day Money Back Guarantee

Terms: Shipping & handling \$3.00 C.O.D. add \$1.00 California residents add sales tax

JACO ENTERPRISES
1478 POPPY WAY, CUPERTINO, CA 95014
(408) 396-0675

Inquiry 143

68020



High Performance Implementation
12.5 Mhz or 16.67 Mhz
I/O Expansion Port
68881 Co-Processor
2 Meg RAM - 256K EPROM
4 Serial Ports - 1 Parallel Port
Battery Backed Up Clock
720K Floppy Drive
40 Meg Hard Disk - Unix-Like OS's
58000 Version Also Available

Frank Hogg Laboratory - 770 James Street
Syracuse New York 13203 - TELEX 646740

315/474-7856

Inquiry 120

DOUBLE THE OPTION CAPACITY OF YOUR IBM PERSONAL COMPUTER

PC-XTRA

- DIRECT EXTENSION OF IBM PC BUS
- NO SOFTWARE CHANGES
- NO HARDWARE MODIFICATION
- STYLING CONSISTENT WITH IBM

Add all those special options that you've been wanting without worrying about filling your plug-in and back panel space



DEALER INQUIRIES INVITED

\$549.00* F.O.B. SANTA ANA

CALIFORNIA RESIDENTS ADD 9% SALES TAX

P C HORIZONS, INC.

1701 E. Edinger, Ste. A6, Santa Ana, CA 92705
(714) 953-5396

Inquiry 215

CLASSIC BYTE T-SHIRTS!

#T1 -
COMPUTER
ENGINEERING



#T2 - SOFTWARE PIRACY



Software Piracy

#T3 -
INSIDE IBM



#T4 -
FUTURE PAST



#T5 -
BREAKTHROUGH



Five classic Byte covers – and boy, do they look great on this $\frac{3}{4}$ sleeve "baseball shirt"! The vivid royal blue sleeves and neckline really complement the full-color design. And don't mistake this for a rubbery patch that cracks and peels off after a few washings. This is true four-color process: the permanent inks are silk-screened into the fabric, resulting in a beautiful, full-color image that lasts!

You'll also appreciate the shirt itself: a real

heavyweight made of 50% cotton, 50% polyester. You'll enjoy cotton comfort in a tough, sporty shirt that keeps its crisp, fresh look through many washings – with almost no shrinking! The price for each Classic Byte T-Shirt is only \$12.50 (\$11.50 each for 3 or more). Be sure to include shirt size: C-(child 10-12), S-(34-36), M-(38-40), L-(42-44), XL-(46-48). Most orders shipped within a week.

Please send me the following shirt(s) at \$12.50 each, or \$11.50 each for 3 or more. I have included \$2 for shipping and handling (\$5 overseas).

QTY.	#	TITLE	SIZE	AMOUNT
				\$
				\$
				\$
				\$
				\$
				\$
Shipping & Handling (see above)				\$
TOTAL				\$

Send free brochure.

I have enclosed check or money order.

VISA MasterCard Am. Express

Card #: _____

Exp. Date: _____

Ship my shirt(s) to:

Name: _____

(Business): _____

Address: _____

City: _____

State: _____ Zip: _____

Mail this coupon to:

Robert Tinney Graphics
1864 North Pamela Dr.
Baton Rouge, Louisiana
70815

For VISA, MasterCard or
American Express orders,
or for more information

Call 1-504-272-7266

Incredible SwyftWare!™

It is not possible in an ad to really explain this Apple II (e or c) product which outperforms all other software in speed and simplicity. It does no-frills word processing, information retrieval, telecommunications and many other tasks. Reviewers call it "bulletproof and frustration free" and "blindingly fast."

It appeals to beginners and experts. Jef Raskin,

who invented the Macintosh and who later created SwyftWare, has written up the hows and whys of this product. Please write for a copy. No charge. Or order SwyftWare and see for yourself. At \$89.95 and with a 30-day refund policy, there's no risk.

US 800/982-5600 CA 800/562-7400

Information Appliance

1014 Hamilton Ct., Menlo Park, CA 94025

Quelo® 68000 Software Development Tools

Quelo Assembler Packages are Motorola compatible. Each package includes a macro assembler, linker/locator, object librarian, utilities for producing ROMable code, extensive indexed typeset manuals and produces S-records, Intel hex, extended TEK hex, UNIX COFF and symbol cross references. Portable source written in "C" is available. It has been ported to a variety of mainframes and minis including VAX.

68020 Assembler Package

For CP/M-88, -88K and MS/PC-DOS \$ 750

68000/68010 Assembler Package

For CP/M-80, -88, -88K and MS/PC-DOS \$ 595

68000 "C" Cross Compiler

For MS/PC-DOS by Lattice, Inc.

With Quelo 68000/68010 Assembler Package \$1095
With Quelo 68020 Assembler Package \$1250

Call Patrick Adams today:

Quelo, Inc.
2464 33rd W. Suite #173
Seattle, WA USA 98199
Phone 206/285-2528
Telex 910-333-8171

COO, Visa, MasterCard

Trademark: CP/M, Digital Research, MS, Microsoft Corporation, Quelo, Quelo, Inc.

Inquiry 250

NEW!



SafeSkin™ KEYBOARD PROTECTOR

Remains in place during keyboard use. Prevents damage from liquid spills, dust, ashes, etc. Fits like a second skin, excellent feel. Available for: IBM-PC, AT, Apple (all), Compaq, Model 100, NEC 8201, C64, Zenith 150, DEC, Kaypro, KB5151, AT&T 6300, WYSE 50 and many others. Send \$29.95, check, M.O., Visa & MC include exp. date. Specify computer type. Dealer inquiries invited. Free brochure avail.

Merritt Computer Products, Inc.
2925 LBJ Fwy. #180 / Dallas, Texas 75234
(214) 339-0753

Inquiry 185

The Bullet-286 XT



Better than the AT

FASTER—8 MHz, 80286 processor (10 MHz optional), no wait states, scores a 9.2 in Norton's Sys Info 3.0 (10 MHz scores an 11.4)

MORE COMPATIBLE—100% BIOS and bus compatible with the IBM PC XT, completely network and multiuser compatible including Xenix, Thoroughbred, concurrent DOS and more

HIGHER CAPACITY—20 to 70 MB hard disk drives, including new FRLL format drives

LESS MONEY—System prices start at under \$1700 without monitor

Merchand International

1240 N. Van Buren, Unit 108, Anaheim CA 92807

(714) 630-3382

FCC approved

Inquiry 178

NEW — FOR TURBO PASCAL™ ZIPCALC

INSTANT TEXT DISPLAY - the Pascal "write" procedure takes several seconds to fill the screen with text. ZIPCALC does it in less than 1/10 sec. Instant windowing capability is also included.

ULTRA FAST NUMBER DISPLAY - ZIPCALC removes the real number time barrier with a 32-bit Long Integer data type that converts to a string 7 times faster.

HIGH SPEED COMPUTATION - the Long Integer is ideal for many financial and other applications with its dramatic increase in computation speed. ZIPCALC provides a full set of procedures for Long Integer arithmetic, shifts, compares, conversions to other data types, and full string conversions. ZIPCALC has the power of a 32-bit processor in Pascal callable form.

EASY TO LEARN - EASY TO USE - ZIPCALC consists of 35 highly optimized routines, most assembler coded, a tutorial User's Guide, programmed demos, and many examples. IBM PC & TRUE COMPATIBLES \$45 includes N.Y. sales tax & shipping

DYNAMUS 1045-B Gravel Road
Webster, N.Y. 14580
MICRO DATA SYSTEMS, INC. (716) 671-5886

Turbo Pascal is a trademark of Borland Int. Inc.

Inquiry 327

ORDER TOLL FREE 24 HOURS EVERY DAY 800-662-2686

HARDWARE COMPUTERS

IBM COMPATIBLES 640K Ram, Keyboard, 1 yr. wr. w/1 Floppy ... 599 Plus 20MB Hard Disk ... 1079

PANASONIC BUSINESS PARTNER..... CALL
EXECUTIVE PARTNER..... CALL

ATARI ST COMPUTERS / ITT COMPUTERS CALL
MODEMS, BOARDS, DRIVES

Everom 1200 Internal	175	SuPakPlus 384K	218
Hoyes Modems	CALL	Intel Above Board	288
Rocal Vadic 1200	238	Above Board PS	308
Practical Modem 1200	135	Above Board AT	419
Genoa Spectrum	279	J-Ram 2/3	136/179
QuadEGA+	389	J-Ram 3AT	239
Sigma Color 350	389	J-Loser	199
Sigma Color 400	489	Tecmar Captain 384K	199
Mono Graphics Card	99	6 Function Card 384K	169
Video 7 Vega	398	20MB Hard Disk Kit	429
AST Rampage	245	File Card 20MB	658
Rampage AT	448	Imagica 210H	1995
AST Advantage	358	DataShield XT300	389

PRINTERS, PLOTTERS & MONITORS

EPSON All Models	CALL	Amdex 310A	149
Canon Laser Printer	2099	Amdex 600/722	419/519
Citizen 120D	199	NEC 1280 TTL Mono	119
Citizen Premier 35	509	NEC 1401 Multi-Sync	559
Panasonic 1091	249	Sony KV13111 RGB/TV	469
1092/1592	319/448	Taxon 620	399
Roland DXY-101 Plotter	509	Taxon 630/640	455/519
Houston Inst DMP-29	1850	Thompson 38432	319

SOFTWARE

—ACCOUNTING—		—DATABASE—	
BPI Accounting/Mod	from 319	dBase III Plus	418
BPI Entrepria/Mod	429	Multibase	79
Peachtree/Module	269	Paradox	448
Back To Basics Acctg	209	Reflex	89
Open Systems/Module	359	Revelation	548
Paragon	559	PPS File & Report	149
SBT All Modules	CALL	Q & A	206

SPREADSHEETS & INTEGRATED SOFTWARE

Lotus/Symphony	CALL	Ability	63
Framework II	389	Multiphan 2.0	119
Supercalc 3	209	Mosaic Twin	89

WORD PROCESSING

Volkwriter 3	155	PPS Write & Proof	82
Microsoft Word 3	289	Multibase	219
Word Perfect 4.1	219	Multibase Advantage	309

GRAPHICS

Charmaster	219	Generic Oad	77
Click Art Pers. Pub.	109	In A Vision	259
Energraphics 2.0	309	Microsoft Chart 2	179
Freelance	209	ProDesign II	179
Harvard Press Graphics	229	Dr Halo II w/Mouse	119

UTILITIES & LANGUAGES

Turbo Lightning	57	Sideways	37
Microsoft C Compiler	239	Traveling Steadfast	39
Microsoft Fortran	206	Windows	59
Macro Assembler	90	Pop-Up Desktop	55
Quick Basic	63	Deskview	59
Fontix	92	Prokey	77
Fastback	89	Alrus	31

Call Toll Free 24 hrs Every Day
800-662-2686 orders only
for Ca. Orders, Tech Support, Price Quotes, Info
415-668-9350 9-5 pacific time, m-f
Call or Write for Free Catalog

PAYMENT: (No Fee For Credit Cards) Visa, MasterCard, Cashier's Checks, Personal Checks with 2 week hold, Qualified P.O.'s. California residents add sales tax.
SHIPPING: UPS ground-2% per order, \$5 min. FREE for SW orders over \$1000. UPS Blue-3% per order, \$7 min. FREE for SW orders over \$1500. Printers, Monitors, Disk Drives, Computers - Call for charges.

All Products New with full warranties.
Price & availability subject to change without notice.

THE BEST PRICES



THE BEST SERVICE

THE BAY EXPRESS COMPANY

584 CASTRO ST., SUITE 487 SAN FRANCISCO, CA 94114
a division of MCS3 Inc. Computer & Software specialists since 1981

AUGUST 1986 • BYTE 373

PORTABLE ADDITIONS

PORTABLE DISK DRIVE \$229

3 1/2", batt. oper., TS-DOS, 100K storage

24K RAM CHIP for Tandy 200 \$89

8K RAM CHIP for Model-100 \$29
and NEC 8201. . . 3 for \$79, 6 for \$149

SIDESTAR for NEC Starlet \$399

128K Ram Disk Cartridge

SIDECAR for NEC PC-8201A \$259

4 banks of 32K in one cartridge

CALL TOLL FREE 1-800-732-5012

Call: 805-987-4788

Canada: 604-856-8858, Australia: 02-419-8899

PURPLE COMPUTING VISA/MC & AMER. EXP.
420 Constitution Ave., Camarillo, CA 93010

Inquiry 240

DON'T MAKE A \$300 MISTAKE!

WHEN YOU CAN
BUY IBM COMPATIBLE
SOFTWARE FOR
ONLY \$6 A DISK
OVER 500 DISKS FULL
OF PUBLIC DOMAIN AND
USER SUPPORTED PROGRAMS

LONE STAR SOFTWARE

Recently a Customer Wrote . . .

"... I'm SICK! Friday afternoon I bought a \$300.00 data base manager from my local computer dealer. When I got home I found out my neighbor bought the same kind of program from you last week for six dollars. What's worse, I like your program better! Please send me your disk directory and the following disks . . ."

What can we say? Isn't it really about time you discovered that spending big bucks for all of those "glamorous-name" software products doesn't necessarily guarantee you anything but a thin pocketbook and a fancy copy protection scheme?

No . . . Computerland won't tell you about us or our great software. But why make a \$300.00 mistake? Many of our \$6.00 packages will actually do everything better and faster than the great "Starword-dplus-4.5.6", and you can keep the difference.

Here is just a sample of our library by category.

WORD PROCESSORS

PC-Write 2.6 (#78) A full featured word processor that is faster than Wordstar.
DICTIONARY (#378) Dictionary type spelling checker.
IV-ED (#415) Word processor - editor.
LETTERWRITER (#415) controls letter processing.
PC TYPE (#455) Jim Button's contribution to a full fledged word processor.

SCREEN EDITORS

FOIL EDIT (#347) Full screen editor. Top to bottom and left to right.

TEXT PROCESSING TOOLS

FOGFINN (#378) reverses writing complexity using the "Fog Index".
WORDSTAR AIDS (#379) collection of the most useful utilities for the Wordstar user.
PC OUTLINE (#414) Create and collapse and outline. Great for plans, essays, etc.

DATABASE PROGRAMS

PC FILE III (#5) most popular database program from Jim Button.
U-MIND (#133) Fast hashing makes this a dandy database. (Intelligent database)
NEWBASE (#233) Menu driven database for the beginner.
PC-DBMS (#383) A relational database management system that provides on-line help and screen editing functions.
ELSIE EXPERT SYSTEM (#398) Artificial intelligence shell to build a custom knowledge-base.

PDS*BASE (#396) Complete hierarchical data base system master/detail or mother/daughter type.
CREATOR (#339) create, report, and sort makes this a super database management system.

DATABASES

BOBCAT (#247) Small business database. Excellent!
MFIND (#311) Database of over 2000 movies that can be searched in any category, or you can add your own.

SPREADSHEETS

PC-CALC (#199) Fabulous 123 work-a-like from the author of PC-File.
PC-PAD (#406) Spreadsheet and address book program written in basic.

SPREADSHEET TEMPLATES

LOTUS 1-2-3 PLATES AND MACROS (#140, 141, 165, 257, 289, 301-304, 406, 414) Why spend hours of writing your macros when these are ready made? Modify them yourself.
SYMPHONY WORKSHEETS (#305, 306)

FINANCIAL PROGRAMS

PC-CHECK MANAGER (#275) Keeps multiple checkbooks in balance.
TAX FILE DBS (#295) Tax record keeping system that saves you money on April 15.
SAGE TRADER (#242) Analyzes commodity trades. Don't "short" this one!
PORTSWORTH PACKAGE (#101) Evaluates your ever changing stock portfolios.
FINANCE (#164, 227) Determine present and compound values, interest rates, etc.
HOME FINANCE (#406) Lotus 1-2-3 Macros for real life applications.
PC-GENERAL LEDGER 1.2 (#237) An exceptional accounting system. Used by some CPAs.
TIME AND MONEY (#251) Financial record keeping and analyst system.
LOAN AMORTIZATION (#399) For output to screen or printer. Lots of on-line help.
BASIC CHECKBOOK (#271) Keep track of checkbook and personal finances.
ACCU-TAX 1985 (#479) You can't buy a better "commercial" program.
MR. BILL (#468, 470) Prepare invoices, client report, audit trail, etc.
ANALYTIC CALC (#430-432) 3 disk set. Complete spreadsheet, database, graphics, word processor - fassst!

COMMUNICATIONS

QMODEM (#310) The best and fastest com-

munications programs you can buy at any price, bar none!

PC-TALK (#16) The classic "Freeware" communication program.
PC-VT (#286) VT-100 Emulation.
SYSCOMM (#338) Menu driven system allowing unattended file transfer.
RBBS 12.2 (#212) Become a SYSOP and start a bulletin board.
FIDO NET (#333) Bulletin Board System. Perhaps the easiest to run.

MATH AND STATISTICS

EPISTAT 3.1 (#88) Statistical analysis of small to medium-sized data samples.

LANGUAGES

CHASM 2.13 (#10) Cheap assembler with tutorial.
XLISP 1.4 (#148) Lisp language interpreter.
MVP-FORTH (#31, 32) Two disk set of Mountain Valley Press Forth.
3 FORTHS (#352) To modify or expand your own forth language. MVPFORTH, FORTH-H and SEATTLE Computer's Forth.
PROLOG & UNIFORTH (#417) Complete with editor and documentation.
SNOCREST BASIC (#409, 410) two disk set. Real basic interpreter with manual. Can be used with a multi-user system.
ESIE (#398) Build and generate an expert system in a flash.
PASCAL COMPILER (#424) Written in Turbo Pascal.
P-BASIC (#381) BASICA work-a-like for clones, etc.

UTILITIES

DISKCAT 4.0 (#106) Catalog all your disk files in a hurry.
GINACO (#86) 54 polished routines written in basic for any beginner or experts. We love it!
ULTRA-UTILITIES 4.0 (#133, 245) Recover lost files, modify sectors, etc. Like Nortons.
SYSTEMU (#250) Build a menu driven menu system. Excellent for hard disks.
LOAD-US (#284) Allows Lotus and Symphony to be used on a hard disk.
PC-DESKMATES (#405) Better than Sidekick and all of the rest of the memory resident desktop utilities.
ALIGN 1.6 (#217) Disk alignment tool.
TOP UTILITIES (#273) All of the most requested utilities on one disk.
NUNZAP (#204) Removes line numbers from BASIC programs.
HARD DISK UTILITIES (#478) A collection of the best in the library.
UNPROTECT (#414) Various routines to disconnect protection schemes.

PATCHES (#378) make back up copies of some of the most popular commercial programs with this collection.

PRINTER UTILITIES

SP 3.4 (#186, 275) Printer buffer that partitions your data so you can use your computer and print at the same time.
SIDEWAYS (#265, 411) Prints text sideways on an Epson printer.
SETPRTR (#79) Sets up Epson printer from a menu.
SLIDE (#244) produce medium resolution slides and overhead transparencies.
PRINTER UTILITIES (#411) Sorgeboard of utilities and tools.
EPSON PRINTER UTILITIES (#326) Pool, set up routines all designed for Epson codes.
BANNER (#386) make long banners with large letters. Includes MS-FORTRAN source codes.

EDUCATION

EQUATOR (#249) A teaching tool for math, science and finance.
PC-TUTORIAL (#403) A first course in computer usage covering various aspects of MS-DOS. Good!
PC-PROFESSOR (#105) Learn Basic the easy way. One of the best tutorials on BASIC.
PC-DOS HELP (#254) type "help" for the DOS command you forgot.
FLASH CARDS (#367-370) 4-disk set. Vocabulary builder, spelling teacher.
TOUCH-TYPE (#320) Advanced type tutor.

GAMES

TOP GAMES (#274) The most requested arcade type games.
ARCADE GAMES (#293) Another goodie bag of top Arcade games.
TRIVIA GAMES (#327-329) Lots of files and documentation for hours of fun. Will not work on PC JR.
PC JR GAMES (#354) Games that will work only on PC JR. Combat, dungeons and dragons, Global Thermonuclear War.
MISC. GAMES (#390) Good selection of educational, adventure, and arcade games.
SIG FOUR GAMES (#272) Texas most popular. STARGATE, ZAXXON, AIRTRAX, and DND

MUSIC

PC-MUSICIAN (#127) Compose music on your PC, save and play again.
PIANO MAN (#279) Play your PC keyboard like a piano.

APPLICATIONS

GENEALOGY ON DISPLAY 3.0 (#90)
GENEALOGY - FT 1.25 (#240) from Pine Cone software.
LABELMAKER (#146) Our favorite label file and maker. Menu driven.
PC-FLY "Fileplan" 2.1 (#261) Pilots prepare and file your flight plans.
RECIPES 83 (#281) Recipe index for use with PC File III (#5)
FAMILY HISTORY (#361) Family history, ancestor and descendant charts. Sample programs.
FORM LETTERS (#388) LOTS of samples of the most commonly used business letters. Modify!
HAM RADIO (#436, 437) Electronic goodies, design antennas, great circle, etc.

GRAPHICS

PC-KEY DRAW (#344-345) A small CAD system. Lots of demonstration files.
PC-PICTURE GRAPHICS (#136) Drawing package allows you to zoom, color, and store pictures.
PC-GRAPH (#418) Allows you to create graphics from PC-File report files.
ORIGAMI (#408) Japanese art of paper folding. Graphics required.
DRAFTSMAN (#400) Easy to use presentation quality. Mouse or keys.

ORDER FORM

LONE STAR SOFTWARE, INC.
2100 Hwy. 360, Suite 1204
Grand Prairie, Texas 75050
214/647-1010

CIRCLE DISK NUMBER DESIRED:

1	2	3	4	5	6	7	8	9	10	11	12	13	14	15	16	17	18	19	20
21	22	23	24	25	26	27	28	29	30	31	32	33	34	35	36	37	38	39	40
41	42	43	44	45	46	47	48	49	50	51	52	53	54	55	56	57	58	59	60
61	62	63	64	65	66	67	68	69	70	71	72	73	74	75	76	77	78	79	80
81	82	83	84	85	86	87	88	89	90	91	92	93	94	95	96	97	98	99	100
101	102	103	104	105	106	107	108	109	110	111	112	113	114	115	116	117	118	119	120
121	122	123	124	125	126	127	128	129	130	131	132	133	134	135	136	137	138	139	140
141	142	143	144	145	146	147	148	149	150	151	152	153	154	155	156	157	158	159	160
161	162	163	164	165	166	167	168	169	170	171	172	173	174	175	176	177	178	179	180
181	182	183	184	185	186	187	188	189	190	191	192	193	194	195	196	197	198	199	200
201	202	203	204	205	206	207	208	209	210	211	212	213	214	215	216	217	218	219	220
221	222	223	224	225	226	227	228	229	230	231	232	233	234	235	236	237	238	239	240
241	242	243	244	245	246	247	248	249	250	251	252	253	254	255	256	257	258	259	260
261	262	263	264	265	266	267	268	269	270	271	272	273	274	275	276	277	278	279	280
281	282	283	284	285	286	287	288	289	290	291	292	293	294	295	296	297	298	299	300
301	302	303	304	305	306	307	308	309	310	311	312	313	314	315	316	317	318	319	320
321	322	323	324	325	326	327	328	329	330	331	332	333	334	335	336	337	338	339	340
341	342	343	344	345	346	347	348	349	350	351	352	353	354	355	356	357	358	359	360
361	362	363	364	365	366	367	368	369	370	371	372	373	374	375	376	377	378	379	380
381	382	383	384	385	386	387	388	389	390	391	392	393	394	395	396	397	398	399	400
401	402	403	404	405	406	407	408	409	410	411	412	413	414	415	416	417	418	419	420
421	422	423	424	425	426	427	428	429	430	431	432	433	434	435	436	437	438	439	440
441	442	443	444	445	446	447	448	449	450	451	452	453	454	455	456	457	458	459	460
461	462	463	464	465	466	467	468	469	470	471	472	473	474	475	476	477	478	479	480
481	482	483	484	485	486	487	488	489	490	491	492	493	494	495	496	497	498	499	500

SHIP TO: _____

TOTAL \$ _____ x \$6 = _____

DISK DIRECTORY (Explanation of all files & programs) x \$6 = _____

OTHER _____ " _____

SUBTOTAL _____

TEXAS RESIDENTS ADD 6% TAX _____

SHIPPING & HANDLING _____

(1 at \$1.00 and .50 for each additional disk) TOTAL _____

MASTERCARD VISA

CARD NO. _____

EXPIRATION DATE _____

SIGNATURE _____

PLEASE ENCLOSE CHECK WITH ORDER

© 1986 Lone Star Software, Inc

TIME SAVING — MONEY SAVING PRINTER BUFFER



SPOOL-Z-Q PLUS

SPOOL-Z-Q PLUS is a parallel printer buffer which works with any parallel printer and frees up your computer for production use while printing. Very high capacity (128K to 512K) and full line space and half character compression means that SPOOL-Z-Q Plus is ready to take on the really big jobs. A special Pause-on-Frontend feature allows printing single sheets from the buffer. SPOOL-Z-Q Plus also has Copy, Clear and Soft Line functions built in. Supplied complete with 1.5 A/C in-line power supply, the SPOOL-Z-Q Plus buffer is easy to install and use. All models are user expandable to 512K at any time by just plugging in standard 256K RAM chips. SPOOL-Z-Q Plus is the professional's choice for user features and price.

(Without Cable) 128K-8279 256K-8309 512K-8349
(Including Cable) 128K-8309 256K-8339 512K-8379
SPOOL-Z-Q BLUE PLUG IN PRINTER BUFFER FOR THE IBM PC and compatible computers is a GENUINE HARDWARE PRINTER BUFFER, NOT A SPOOLER. Parallel only and Serial/Parallel models available. Works with any software and does not use any of the computer's memory. Runs from 250k to 512k. An available SPOOL-Z-Q Blue replaces the parallel printer card in the PC (may be LPT1, 2 or 3). Many more advanced features. Call or write for full details. Price starts at \$199 (Parallel only) and \$199 (Serial capable).

Available from dealers or direct from us. We accept M.C., VISA, AMEX or COD orders. No charge for shipping or EDD 15 day trial period (non-refundable return policy on all products). CA residents — 6% tax.

DEALER INQUIRIES INVITED.

O.E.M.s — We can modify our buffers to meet your special requirements.

1601 Fulton Ave., Suite 10A
Sacramento, CA 95825
(916) 483-8709

Inquiry 153

FREE CATALOG



Outstanding prices on computer accessories for your computer and workstation. Our catalog features a wide selection of quality products to meet all your accessory needs. Call or write today to receive your free catalog.

LINTEK COMPUTER ACCESSORIES
POB 8056, Grand Rapids, MI 49518
(616) 241-4040

Inquiry 163

Protect Your Private Parts.

Whether you're a software developer or an end user, whether you work alone on a PC or you're part of a 24-person project team, keeping new software or sensitive data from prying eyes is serious business.

Short of complicated, wizard-like protection schemes, or James Bond, you haven't had too many realistic alternatives. Until now.

Because Rainbow Technologies has developed simple, easy-to-use systems called Sentinels that say no to prying eyes. No matter how hard they look.

The key to Sentinel is just

that—a smart piece of plastic smaller than a best-selling cassette that plugs into the parallel port of your IBM PC/XT/AT or compatible.

There are two ways to go. The Software Sentinel™, that prevents anyone from using your licensed software program unless you give them a key. And the Data Sentinel™, Rainbow Technologies' newest prying eye-stopper, that automatically protects sensitive personal or project data as you enter it.

The Sentinel Security Systems from Rainbow Technologies. The only hard part is the key.

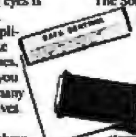

17971 Skyway Circle, Suite E, Irvine, CA 92714
Phone (714) 264-0228 Telex: 386078

Inquiry 253

PC/XT USERS!

- COGTREE Utilities by
Cogitate \$129.95
- LYNC by Norton-Lamber \$199.95
- DATAFLEX by Data Access...Varies
- RMICOBOL by Ryant
McFarlandVaries
- Universe by Omnitrend \$ 98.50
- Blue MacI by Cogitate \$599.00
- CadPower+ by Trilex \$995.00
- Softext Teaching Aids \$ 95.00
- PrintSet by Cogitate \$ 79.95
- CogITAPE by Cogitate CALL!!
- Anti-Static ProductsVaries
- Uninterruptible Power
BackupsVaries
- TeleVideo SoftwareCALL!!



"A Higher Form of Software"
24000 Telegraph Road
Southfield, MI 48034
(313) 352-2345/Telex 386581

VISA/MASTERCARD ACCEPTED
Dealer Inquiries Welcomed

Inquiry 60

ATTENTION BERNOULLI BOOSTERS Go Either Way!

BOOT
from the Bernoulli Box!
from the AT Hard Disk!

FORMAT WITH DOS
PARTITION WITH FDISK
NO SLOWING
We've been shipping Bernoulli Boots
that work for over a year —
still working?

Golden Bow Systems

\$95-\$110

Just \$5 for shipping!
Inquiries
California residents add
9% sales tax



P.O. Box 3020
San Diego, CA 92102
(619) 298-9349

Inquiry 123

DATAFLEX™

- Multi-user Database!
 - Powerful!
 - Multiple Operating System Compatibility!
 - Attractive Dealer Pricing!
 - Full Dealer Support!
- Dataflex is a trademark of Data Access
Dealer Inquiries Invited



24000 Telegraph Road
Southfield, Michigan 48034 USA
(313) 352-2345

Inquiry 61

PC-SIG Library

Keeps on growing...

New disks recently added to our library of user-supported and public domain software for the PC:

- #471 **Present VS.1** Make your own slide shows for business or home using your color monitor
- #477 **Name Gram/Break Down/Phone Word** Do anagrams, find what words your phone number makes
- #480 **PC-Outline** Outline and organize information, much like ThinkTank.
- #481 **Still River Shell** Makes DOS easy to use
- #483 **Mail Master** Keeps track of multiple lists, sorts and prints by city, state, zip and name.
- #485 **Icon Maker and FX-Matrix** Makes graphics characters like the MAC for your screen and you can paint them on your EPSON printer.
- #487 **Reflex Point** An action game modeled after the ROBOTECH cartoon series.
- #492 **Nutrient** Tracks your diet and its calorie/nutrient value
- #494, 495, 496 **The World Digitized** Find over 100,000 different locations in the world and display them on screen.
- #498 **DOS-a-Matic** Load different programs and manipulate them with single keystrokes.
- #499 **PROCOMM** Communications with XMODEM, KERMIT, ASCII protocols, supports IBM-3101, DEC VTS2/1000, ADM-3 and ANSI.
- #501 & 502 **Saleseye** Tracks prospects, leads and memos and prints letters with that information.
- #503 **Reliance Mailing List** Keeps track of multiple lists, sorts and prints by specific group—good for custom mailing.
- #506 **Bibliography of Business Ethics and Moral Values** The regularly updated master bibliography for those doing papers and research involving business ethics.
- #507 **PC-Sprint** Software and instruction on how to cheaply speed up your system 2-3 times.
- #508 & 509 **Statistics Tools** Factor experiments, "FORGET-IT" plots, simultaneous confidence intervals, randomization tests, expected mean squares
- #510 **Visible PASCAL Compiler** Learn to program PASCAL and watch the internal functions of PASCAL as it runs.
- #511 **Turbo Sprites and Animation** Create, maintain and animate your own images in TURBO PASCAL.

RECENT DISK UPDATES

- # 5 **PC-File** Ver. 4
- # 78 **PC-Write** Ver 2.6/1
- #124 **Extended Batch** Ver 2.04a
- #199 **PC-Calc** Ver 3
- #212, 334 **RBDS-PC** (2 disks) Ver. 3.7
- #388 **100 Letters** Ver. 1.1
- #393 **Checkbook** Ver. 2
- #395 **Home Inventory** Ver. 2
- #397 **Checkbook Program** Ver. 3.31
- #402 **IBM 370 Cross Assembler** Ver. 1.1
- #403 **Computer Tutor** Ver. 4.2
- #417 **ADA Prolog** Ver 1.90
- #449 **Gags** Vars 1.06
- #468 **CPA Ledger** Ver. 1.1
- 350-page directory (disks 1-300) \$8.95
- Printed Supplement (disks 301-454) \$3.95
- 1 yr PC-SIG Membership (\$35 foreign) \$20
Includes printed directory, supplement, bimonthly magazine

SPECIAL

Any 5 Disks plus 1-Year Membership \$39

Disks are \$5 each. Add \$4 postage and handling (\$10 foreign)—CA residents add state sales tax.

Total Enclosed \$_____ by Check VISA MC

Card No. _____

Exp. date _____ Phone _____

Name _____

Address _____

City _____ State _____ Zip _____

To order, call: **800-245-8717**
In CA: **800-222-2996**
For technical questions or local orders: **(408) 730-8291**
1030-D East Duane Avenue
Sunnyvale, CA 94086 **213**



Inquiry 253

...the leader in magnetic media development.
Lifetime Warranty

SS-DD	Factory Sealed Box of Ten QTY 58X 5.25" 48 TPI	DS-DD	
77¢		\$1.03	
\$1.17	5.25" 48TPI w/Flip 'n' File/15	\$1.47	
\$1.45	3.50" 135 TPI	\$1.97	
\$1.73	3.50" 135T Ptw-Flip 'n' File	\$2.25	
	DS-HD 96 TPI for the "AT"	\$2.20	
	DS-HD 96 TPI w Flip 'n' File 15	\$2.50	
	8.00" SS-DD W/WP	\$1.50	
\$1.84	8.00" W/WP	\$2.05	
	3M Head Cleaning Kit	\$6.95	

Call for our super low prices on 3M bulk diskettes & other 3M computer accessories

BASF "No gimmicks of Bulk diskettes in a plastic case We only sell BASF factory sealed "BOXED PRODUCT"

SS-DD	Factory Sealed in boxes of 10's w/everything included	DS-DD	
75¢	5.25" 48 TPI	85¢	
\$1.43	3.50" 135 TPI	\$1.89	
	DS-HD/96 TPI for the "AT"	\$1.99	

Supper Sale on Nashua

Nashua Boxed

10 Nashua professional-quality, branded Diskettes to a box with protective sleeves, user ID labels, write-protect tabs and reinforced hub rings. Factory sealed

Lifetime Warranty Price per box of 10
5.25" DS-DD (10 boxes per case. Sold only in case lot) (offer good while supply lasts) **\$6.79**

No Logo **BULK** Diskettes Made by the leading USA magnetic media manufacturer Same name brand quality w/o box **PACK DISKETTES LIFETIME WARRANTY**

With Hub Rings or Envelopes Write-Protect Tabs
User ID Labels in Factory Sealed Packs
70% or higher clipping level - 100% certified

SS-DD	QTY 100	DS-D	QTY 1000
100	50	100	50
.53	.48	5.25"/48 TPI	.62
1.39	1.35	3.50m/135 TPI	1.56
1.33	1.63		1.58
5.25" DS-HD 96 TPI for the "AT"	1.60	1.55	1.45

COLOR DISKETTES USA made Premium Quality at Affordable Prices! **WHY PAY MORE?**

With Hub Rings or Tyvek sleeves Write-Protect Tabs
User ID Labels in Factory Sealed Packs
70% or higher clipping level - 100% certified
Available in rainbow colors and many other assortable colors

65¢	SS-DD	QTY 100	DS-DD	79¢
		5.25" 48 TPI		

5.25" DS-HD 1.6mb for the "AT" **\$1.79**

RIBBONS STORAGE

Epson MX 70/80	\$2.95	Amaray Media Mate	\$8.99
Epson MX 100	\$3.99	Disk Minder II-75	\$6.49
Okidata 80/82/83/92/93*1.28	\$3.99	Micro Disk Minders-36	\$6.49
Apple Image Writer	\$3.99	Plastic Library Case	\$1.99

TERMS: No surcharge on VISA or MasterCard American Express also accepted COD orders only add \$3.00 Prepaid orders deduct 2% cash discount POs accepted from corporations rated 3B2 or better, government and schools on net 30 basis. FPO, APO, APO, AK, HI, PR & CN add 5%. No sales tax outside Utah! Minimum order: \$30.00

SHIPPING: Add \$4.00 for 100 diskettes or first 6 pounds
*WE BEAT ANY PRICE! (APPLES TO APPLES)

Toll-Free Order Line: **1-800-523-9681** Inquiries & Info Line: **1-801-942-2273**

DISKOCOTECH

DISKCO TECHNOLOGIES, INC.
2234 East 1000 South, Salt Lake City, Utah 84112
Hours: 7 AM-6 PM (Mtn. Time)

"CPYAT2PC"

IS LIKE HAVING A
FREE
360K FLOPPY DRIVE

Allows copying of IBM AT file for use on IBM PC's & compatibles with no modification of existing hardware or software. A 360K floppy drive is not required. CPYAT2PC may reside on your IBM PC/AT hard disk and copies 1 file or entire subdirectories in 1 step. Also runs on other AT compatibles such as COMPAQ 286, ZENITH Z-200, and KAYPRO 2861. Dealer inquiries welcome. **ONLY \$79 + shipping.**

MICROBRIDGE COMPUTERS
Sky Way Building, Suite 125
655 Sky Way, San Carlos, CA 94070
(415) 593-8777 • (415) 595-2150
CHECK, COD WELCOME (Prepayment Required)

Inquiry 192

PC Compatible CASH DRAWERS

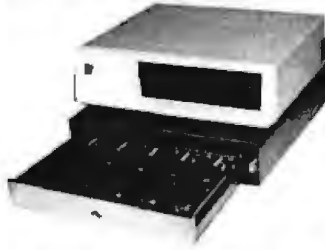

M-S CASH DRAWER
10711 Flower St., Stanton, CA 90680
(800) 544-1749
In California call:
(714) 821-1133

Inquiry 174

72 Digital I/O



PXB-721
Parallel Expansion Board

- For IBM-PC & Compatibles
- 72 Digital I/O Lines
- Simple Programming
- Uses One Expansion Slot
- Fast Delivery

\$195

QUA TECH, INC.
478 E. Exchange St. Akron OH 44304
(216) 434-3154 TLX: 5101012728

Inquiry 241

MODULAR DATA ACQUISITION



- For IBM & Compatibles
- Flexible and Inexpensive
- Money Back Guarantee
- Free Technical Support

Fast Delivery
QUA TECH, INC.
478 E. Exchange St. Akron OH 44304
(216) 434-3154 TLX: 5101012728

Inquiry 242

SPEED IBM-PC/XT TO 700%

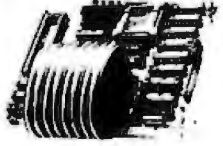

- Uses 80286 Processor
- Installs in Minutes
- Fits Short Slot
- Optional 80287 Processor

\$399

Computer-Age, Inc.
55 Fishry Street
Hartford, CT 06120
203-724-5100

Inquiry 67

ATTENTION MEGABYTES

Beat The 33 Mbyte Limit!

Feature for **BIG** disks files
User-Transparent
Security Features Included.

Golden Bow Systems

880 - 5120 Add \$3 for shipping handling California residents add 9% sales tax
619/288-9349 P.O. Box 3028 San Diego, CA 92103

Inquiry 124

NEW DEALER SPECIAL

XT—COMPUTER	QTY	2
640K MOTHER BOARD W/OK	89	
256K RAM	27	
135 WATT POWER SUPPLY	53	
FLOPPY DISK CONTROLLER	27	
FLIP TOP BOX	38	
XT/AT KEYBOARD	58	
MONO/GRAPHICS/PRN (HERC)	54	
TTL MONITOR W/SWIVL	96	
(1) 360K FLOPPY	82	
PARTS	\$535	
ASSEMBLY & TEST	64	
	\$599	

20 MEG HARD DISK W/CONTROLLER 425

AT COMPUTER QTY 2

80286 MOTHER BOARD	595
W 512K RAM	
200 W POWER SUPPLY	98
AT BOX W/KEY LOCK	79
SERIAL & PARALLEL CARD	65
AD KEYBOARD	59
1.2 M FLOPPY	129
FDD & HDD CONTROLLER CARD	225
PARTS	\$1,290
ASSEMBLY & TEST	150
	\$1,400

30 MEG 40 NSEC HARD DRIVE	615
EGA CARD	295
EGA MONITOR	449

XT PORTABLE \$985

- 640K MOTHER BOARD
- 640K RAM
- MULTI I/O CARD
- CLOCK, CALENDAR, SERIAL, PARALLEL
- TWO 360K FLOPPY DRIVES
- MONO/GRAPHICS/PRN (HERC)
- DETACHED KEYBOARD
- 135 W POWER SUPPLY
- PORTABLE CASE
- 9" MONITOR, GREEN or AMBER

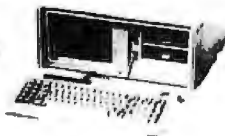

ADD ON BOARDS — PARTIAL LIST

XT-640K TURBO 4.77/8 MHZ W/OK	99
LOCAL AREA NET CARD W/SOFTWARE	249
384K MULTI-FUNCTION (AST & COMP) OK	69
MODEM CARD 300/1200 (HAYES COMP)	149
DISK I/O 2FD CTRL, PRN, SER, CLOCK, CAL, GAME	70
AB SWITCH BOX W/64K BUFFER (1:2 or 2:1)	94
AB SWITCH BOX (1:2 or 2:1)	29
COLOR/GRAPHICS/PRINTER CARD RGB	58

ACS IMPORTERS
5311 DERRY AVE, UNIT A
AGOURA HILLS, CA 91301
HOURS 9 AM - 6 PM PST
(818) 889-1092
TELEX: 299353 POST UR

LOW COST UNIVERSAL PROGRAMMER KITS



- NO PERSONALITY MODULES REQUIRED
- ON LINE HELP AND MENU SELECTION
- ON BOARD 110/220V POWER SUPPLY
- FAST PROGRAMMING MODE AT 6V VCC
- BUILT IN MONITOR FOR I/O DEBUG
- CAD PCB SILKSCREEN & SCHEMATIC
- SOFTWARE DRIVERS FOR MOST PCs
- SUPPORTS ALL 5V EPROMS, EEPROMS AND INTEL MICROCOMPUTERS

KITS FROM \$125 ASSEMBLED \$295
DRIVERS \$35 SHIPPING \$4
VISA & MASTER CARD ACCEPTED

B&C MICROSYSTEMS

6322 MOJAVE DR. SAN JOSE CA 95120
PHONE (408)997-7685 TELEX 4995363

UNIVERSAL EPROM PROGRAMMER



- NO PERSONALITY MODULES REQUIRED
- ON LINE HELP AND MENU SELECTION
- ON BOARD 110/220V POWER SUPPLY
- FAST PROGRAMMING MODE AT 6V VCC
- BUILT IN EPROM ERASER V/TIMER
- GANG PORT FOR FUTURE EXPANSION
- SOFTWARE DRIVERS FOR MOST PCs
- SUPPORTS ALL 5V EPROMS, EEPROMS AND INTEL MICROCOMPUTERS

1409C-33 \$545 1409C-34 \$695
DRIVERS \$35 SHIPPING \$6
VISA & MASTER CARD ACCEPTED

B&C MICROSYSTEMS

6322 MOJAVE DR. SAN JOSE CA 95120
PHONE (408)997-7685 TELEX 4995363

Truly Low Cost PC Imaging!



—IMAGE ACE II— Video Capture System

- Digitize video from cameras, tuners, and VCRs directly to your IBM PC display
- 320 x 200 x 4 levels
- 1.3 sec. full screen capture
- Complete with hardware card, software, cable, and manual

Lodge Electronics

P.O. Box 338 • Streamwood, IL 60103
(312) 837-6553

Inquiry 164

MYSTIC PASCAL Fastest Compiler on Earth NOW ONLY \$16!!

- 640K code, data and stack
- incremental compiler runs in background while you are editing
- produces linkable OBJ files
- color graphics with pan & zoom
- 8087 & software math
- true multi-tasking for up to 100 Pascal procedures
- full screen editor
- complete Help windows
- We are open 8-5 Mtn. time, Mon-Sat

disk with condensed manual to print out \$16—
printed manual \$16—both \$32—for IBM PC 320K
Visa/MC/COD—add \$2 shipping, COD \$5,
overseas \$10

Mystic Canyon Software
P.O.B. 1010
Pecos, NM 87552 505/757-6344

Inquiry 198

RS-232 to RS-422A CONVERTER

For Under \$50!



- Allows your RS-232 Equipment to communicate with devices using RS-422A
 - Two converters can extend RS-232 signals up to 4,000 ft.
 - Bi-directional, uses 12 volts
- ORDER NOW! Model 422CON \$49.95
Optional power supply \$14.95. Cash orders shipped postpaid. IL Res. add 6% sales tax. Visa and MasterCard accepted. Satisfaction Guaranteed. FREE fully illustrated newly revised catalog of interface & testing equipment. Phone: 815-434-0848

B&B electronics
MANUFACTURING COMPANY
1500B BOYCE, OTTAWA, IL 61350

Inquiry 393

Hard Disk and Tape Subsystems

SEAGATE 20MB HARD DRIVES

with Western Digital controller
\$399 (qty 6+)
\$419 (qty 1)

Now you can't afford not to have the storage power of a 20 megabyte Seagate Hard Drive. Call 1-800-528-3138 Now! We will not be undersold!

MORE HARD DRIVES, ETC.

Quantum Q-540 40MB 1 Year Warranty \$1095
Micropolix 1325 85MB 25ms Access \$1439
Wangtek PC-38 60MB Int Tape Complete \$889
Tecmar QIC-80 Ext Tape w/Host \$1449
Western Digital Controller \$99
Alloy PC-8TRACK 1/2" Tape Cartridge CALL

PC-INSIDER/OUTSIDER, AT-INSIDER, Hard Disk Series for IBM. Boots from Hard Disk, Formatted w/ Ctrl. & Cble., Hardware & P/S or PC Style Cabinet **CALL NOW!**
TECMAR QIC-80 External Tape \$1359
TECMAR 40410 - 11 Slots 33 + 5Mb Removeable .. 1995
SMS OMT1 6510 - 7 Controller 109
DRIVE SUBSYSTEMS FOR COMPUPRO
with Disk 3, CABINET, FAN, P/S, CABLES, etc.
-20Mb Seagate / Teac 895
-40Mb Quantum Q-540 1695
-72Mb MC1325.....\$2095 / XT-1085..... \$2359
10MB TAPE Int. (Requires CDS 4.1) 429
10MB TAPE Ext. (Requires Concurrent DOS) 519
ALLOY IDXC8-1007 17.7Mb Ext. Tape (CPM-80/86)1559

ATTENTION! 250 CPU OWNERS!
HARD DISK SUBSYSTEMS WITH 20MB ENTRY LEVEL... STARTING AT \$795

S-100 Boards & Accessories

If you bought before calling S-100 you paid too much! We stock COMPUPRO, DUAL, EARTH COMPUTERS, ICM, KONAN, MULLEN, PICKLES & TROUT, INDUSTRIAL COMPUTER DESIGNS, TARBELL, VECTOR...

Just a few of THIS MONTH'S SPECIALS!

RAM 16 64K Static \$95
COMPUPRO RAM 22 256K Static 446
COMPUPRO CPU 286...\$429 SPUZ 256 3249
COMPUPRO Disk-1A.....\$372 Disk-3 \$447
DUAL AIM-12 A/D Input 12 Bit/32 Channel 629
INTERCONTINENTAL MICROSYSTEMS Master & Slave Boards 8 & 16 bit. IN STOCK **CALL NOW**
MACROTECH MI-286 80286/280 Dual Proc 675
MACROTECH MSR-II 1MB DRAM / 2Mb..... 625/1059
MACROTECH ST-II 1Mb..... 2249

Floppy Disk Drives

MITSUBISHI 2894 8".....\$475 2896 1/2 hi 8" \$435
MITSUBISHI MF501 48TPI / MF504 95/149
TEAC FD55GFV / IBM-AT 96TPI 125
TEAC FD55FV 96TPI...\$115 FD55BV 48 TPI 95

Modems

PROMETHEUS PROMODEM 1200/2400-Hayes Compatible with Power Supply and Software. \$275/\$385
PROMETHEUS 1200G without Options 189
PROMETHEUS 300C - Apple IIc Piggy Back 129
MULTITECH MT224EH MNP Error Correction..... 529
MULTITECH MT224ER Rack Mount with E.D.C..... 495

CTS 224ADH Hayes 2400 Compatible \$339
CTS 212AHC Hayes Compatible 159

Hobby Corner

ACCESSMATRIX (ACTRIX) 2 Pipe, Amb, Modem Int. Portable w/ a Lot of Software \$485
ADAPTEC 29724 97-506 PC Hard Disk Ctrl. 165
FUJITSU 29029 8" 29.4Mb H.D. (RA 2000) 795
INTEGRAND 2210F 4 Slots Dual 5 1/4 Drives 169
PARA DYNAMICS 8300-G3 3 1/2" 3.5" Flpy & H.D. 189
5TB SUPER RIO 256k, S.P.G. Ctl 199
SYGEN S7-505 CTRL to 140Mb 149
TECMAR WAVE 64k-256K Card 189
TECMAR BOSUN 95
U.S.R. AUTO DIAL 212A Hayes Control 229
U.S.R. PC MODEM 256K, Parrel, Ctl, Telespc 169
U.S.R. PC CARD MODEM W/ Telespc 145
XEBEC XE1210M 97-506 PC Hard Disk Ctrl. 165

Monitors and Terminals

NEC MULTISYNC \$555
PRINCETON GRAPHICS ALL MODELS CALL
TATUNG GM-1350 640x200 RGB, 13", G/A switch. \$395
TATUNG MM-1222 HiRes 12" TTL (IBM) 109
TATUNG GM-1390 EGA 640x350 RES. 499
LIBERTY Freedom Terminals CALL
LINK 125 Emulates WY-50 and others. HiRes 14" Grm/Amb 8 Scroll Rates, IBM Selectric K.B. 1 YR Warr..... 399
LINK PC-TERM Emulates WY-50, TVI 925 & Mora, 132 Col, IBM-AT KB, Ideal for Multi-user PC-Slave BDS. 440

Printers and Buffers

BROTHER M-1509 180/45cps, Parallel & Serial Ports, 13" w/ Tractor, EPSON FX286 Compatible CALL
BROTHER HR-35 36cps Daisy, Wide Carriage... \$729
BROTHER HR-15XL 17cps Daisy, S or P..... 359
CALL 1-800-528-3138 Today for the BEST PRICE on EPSON - OKIDATA - CITIZEN
HANZON Buffer 64K-256K S-S, S-P, P-P Ports ... 265
XEROX D25 Diablo 497
DIABLO 635 1049
DIABLO D80-IF 2159
DIABLO 34LQ 989
4045 LASER With Copier..... 4995

BROTHER 1509

~~\$895~~ CALL



180 CPS Draft - 45 CPS NLO - Push Tractor
Auto Feed - S & P Ports - Wide Carriage
Epson Compatible - More!

BROTHER TWINWRITER

~~\$995~~ CALL

Finally, Daisywheel Letter Quality
and Dot Matrix Graphics in one Printer!
Call 1-800-528-3138 Today and find out more
about the amazing Brother TwinWriter.

Video / Graphics / CAD

TATUNG SUPER EGA PACKAGE!
13" True Color 640x480 (480x320) w/ Dual SPC
RAM & EGA Hardware. Complete card w/ 2MB... \$795

ACS GRAPHAX 20/20 32 Colors, 2Kx2K RES .. CALL

HOUSTON INSTRUMENT PLOTTERS
CALL NOW - WE WILL NOT BE UNDERSOLD!

PC Boards, etc.

We carry the best selection of Multifunction & Memory Cards for IBM-PC, XT, AT, portables and compatibles!

AST PRODUCTS CALL
INTEL Above Board PCMB 1010 - 64K to 512K - Allows Lotus, Symphony, others to run above 640K..... \$255
INTEL Above Board-AT 128K to 4Mb 399
STB RIO GRANDE 128K to 5Mb for PC/AT 259
TECMAR GLOBE OUTII Save \$\$\$! 1-800-528-3138 CALL
TECMAR IEEE 488 \$235
ALLOY PC-SLAVE/16 1Mb 8MHz..... \$679
ALLOY PC-PLUS Package! PC-SLAVE/16, 1Mb, 8MHz, Link PC-TERM Terminal, 20' Cable 1099
RTNX MSDOS 2.1 / ATNX MSDOS 3.1 109/189

INDUSTRIAL COMPUTER DESIGNS

1016-PC 96TTL I/O Lines \$446
A/D 64-PC 64 Input...\$446 D/A 64-PC 64 Output.. \$527

Software

We sel. all well known brands. ORDER CORRECTLY!
SOFTWARE IS NOT RETURNABLE!
NEW STAR NEWWORD 2 w/ MergePrint, WordPlus spell check, WordStar Compatible 8 bit...\$99 16 bit 129
NEW STAR NEWWORD 3 for PC's. Spell checker, Indexing, Content Tables, Macro's, Shorthand keyboard, Run other programs while in NewWord 209
BD SOFTWARE C Compiler 8" SSSO 8 bit 95

Computer Systems

MULTIUSER / NETWORK SYSTEMS
INTEGRATED & SUPPORTED BY S100
SDD XENIX - AT'S, ALFOS
68000 UNIX - S100 & VME
NOVELL - Complete HW & SW. Lisa
ALLOY PC-SLAVE Networks
TurboDOS - PC/DOS Network
MS-DOS on S-100
Concurrent DOS on S-100, PC's

CompuPro™

816/C2 w/80286, 512K RAM, SPUZ-256, 40MB HD, 10MB Tape, 5" 96TPI flpy, CDS 816/286, NewWord & SuperCalc2..... CALL

IBM-PC COMPATIBLES

We carry a wide range of Desktop, Laptop & Portables designed to run the software that fuels today's business.
CORONA PC-400 512K, Monitor \$1149
SHARP PC-7000 8086 LAPTOP \$1299
COMPAQ XEROX 6064 AT&T 6300 Compatible From \$1689
IBM-PC/XT/AT CALL
ZENITH 148, 158, 171, 200AT CALL
SPERRY IT, HT, USER NET CALL
ACS ET-286 1Mb, 3S & 2P, CLK, 8 Slots, 8/10/12.5MHz, 20Mb & 1.2Mb Disks, MSDOS 3.2 Complete \$2595
ACS-1000 SYSTEM 8/4/7MHz, 2 FLPY DRVS, 1Mb RAM, 20Mb H.D. DRV., COLOR/MONO CTRL, MSDOS 3.2, SASI, 2S/P PORTS, CLK/CAL \$1650

EPSON EQUITY II

The IBM-PC compatible NEC V30 gives you 8088 CPU power at speeds of 4.77 & 7.16MHz. It has 640K RAM, versatile mono graphics, color, clk/csl, 3 ports, two 5.25" drives, an AT type keyboard & 1 yr warranty. You can see it makes sense to start building some EQUITY into your business.

The Epson EQUITY II... CALL

cordata
formerly **corona**
data systems, inc.

ATD/ATP

- 80286 CPU @ 8MHz
- 1.2 MB Floppy Drive
- HiRes Graphics (840x400)
- Serial/Parallel Ports
- 130 Watt P/S • 640K RAM

ROM BIOS Compatible to the IBM-AT. The CORDATA ATD/ATP runs virtually all software designed for today's business environment.



Desktop Publishing



LP-300 DESKTOP PRINTSHOP

Create professional looking newsletters, ad copy, documents, etc. with LASER accuracy.

- 8 pages/min
- Autofeed
- 300x300 dots
- 38 fonts
- Cable & Toner included

THE cordata CAD SYSTEM

- CORDATA ATO
- FASTDRAFT PGA CARD
- NEC MULTISYNC 640x480
- HOUSTON INSTRUMENT DIGITIZER
- HOUSTON INSTRUMENT PLOTTER
- AUTOCAD SOFTWARE

NOW \$6899

P.C. Computer Brokers Inc.

The Place To Buy Your Epson Printers



EPSON FX-286
 List \$749⁰⁰ **\$495⁰⁰**

Epson Printers List SALE
 Homewriter Printer *249⁰⁰ ... * 199⁰⁰
 AP-80 Printer *379⁰⁰ ... **CALL**
 LX-90 Printer *329⁰⁰ ... * 229⁰⁰
 SQ-2000 Ink Jet Printer *2295⁰⁰ ... *1579⁰⁰



FX-85
 list \$499⁰⁰ **\$349⁰⁰**
 Call Toll FREE 1-800-245-4122
Seagate 20 Meg Hard Drive With Controller \$459⁰⁰

Epson Printers List SALE
 Spectrum LX-80 \$ 299⁰⁰ ... * 219⁰⁰
 HS-80 Ink Jet Printer \$ 449⁰⁰ ... * 339⁰⁰
 Comrex High Speed CR-420 Printer \$2195⁰⁰ ... *1449⁰⁰
 HI-80 Four Pen Plotter \$ 599⁰⁰ ... **CALL**

Call P.C. Computer Today For Low Prices on Many Other Computer Products—Call 1-800-245-4122

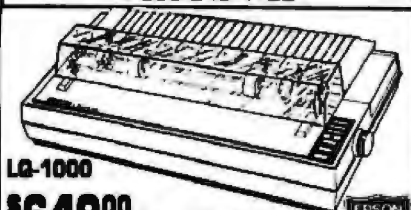

LQ-1000
\$649⁰⁰ list \$1085⁰⁰

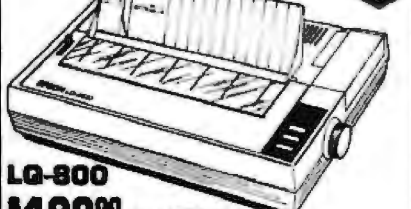

LQ-800
\$499⁰⁰ list \$799⁰⁰

Prices Subject to Change Without Notice
 Add 2.9% For Use of Visa, M/C & Choice.

These Prices Are Good For Mail Order Dept. Only

P.C. Computer Brokers Inc.
3879 East 120th Ave.
Thornton, CO 80233
(303)450-6727

Call Toll FREE **1-800-245-4122**

DATA ACQUISITION AND CONTROL

DATATAKER: \$1897 COMPLETE



46 Analog/8 Digital Inputs
 Matches Common Transducers & Sensors
 Built-in Software/RS-232 Communications
 Portable
 Dedicated or Stand Alone

What makes it a best buy?
 Call or write today:



2151 Park Boulevard/P.O. Box 60490, Palo Alto, CA 94306
 Telephone: (415) 326-2151

Inquiry 322

TERMINAL EMULATION

Softerm PC emulates over 30 popular terminals including the:
 • DEC VT102, VT220
 • Data General D200, D410
 • IBM 3101-20 (block mode)
 • Hewlett-Packard 2622A
 • Honeywell VIP7801, VIP7803

Guaranteed Compatibility
 Call for free product brief!
\$195 MC-VISA-COD
 For the IBM PC/XT/AT, DG, NEC, Wang, TI, Gridcase, Tandy, Zenith



7899 Lexington Dr., Ste 210
 Colorado Springs, CO 80918
 1-800-225-8590/(303) 593-9540

Inquiry 268

DYNAMIC RAMS

41256	100ns	\$4.85
41256	120ns	\$2.95
✓41256	150ns	\$2.70
4164	120ns	\$1.40
✓4164	150ns	\$1.10
4464	150ns	\$3.95

PROCESSORS		E. PROMS	
8087-2	5MHz \$189.00	27C256	250ns \$7.80
8087-3	5MHz \$119.00	27256	250ns \$5.50
80287-3	5MHz \$179.00	27128	250ns \$3.95
80287-4	5MHz \$ CALL	27C64	200ns \$4.50
V-20	5MHz \$ 127.75	2764	250ns \$3.35
V-30	5MHz \$ 140.00	2732A	250ns \$4.25
STATIC RAMS		8000's	
6264LP-15	150ns \$2.95	(Parts in stock)	

I.C. EXPRESS

15356 Valley Blvd., City of Industry, CA 91746
 Phone: 818-368-2686 (Mon-Fri • 8-5)
ORDER TOLL FREE (800) 892-8889 • (800) 882-8181
 Outside California Inside California
CALL FOR CURRENT PRICES & VOLUME DISCOUNTS
 Price Shown for Cash + MasterCard/VISA add 3% more
 Prices are subject to change. Minimum order \$10.00
 California residents must add 6.5% sales tax
 Shipping & Handling UPS Ground \$3.00, UPS Air \$7.00 (under 1 lb)
 ALL MERCHANDISE IS 100% GUARANTEED

Inquiry 136

RS-422

Communications Board

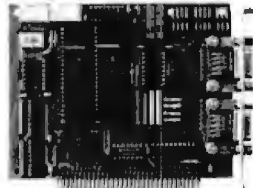

- For IBM-PC/AT/XT and compatibles
- Dual RS-422/RS-485 interface
- Differential drivers to 4000 ft.

Fast Delivery



478 E. Exchange St. Akron OH 44304
 (216) 434-3154 TLX: 5101012726

Inquiry 243

BULK DISKETTES

MAXELL

5 1/4 SS/DD 64^c

Other name brand Diskettes as low as **49^c**

Prices based on quantities of 500 includes white Tyvek sleeves
 Visa, MasterCard or C.O.D. Accepted
Call 800-222-0490
 (In N.J. 201-462-7628)

Full service duplication facility



P.O. Box 710
 Freehold, N.J. 07728

Inquiry 183

RS-232

Communications Board

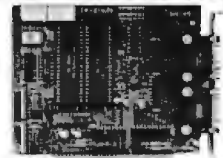

- For IBM-PC/XT/AT & comp.
- Dual RS-232C interface
- Optional software supports COM1, COM2, COM3, COM4
- Jumper selectable interrupts

Fast Delivery



478 E. Exchange St. Akron OH 44304
 (216) 434-3154 TLX: 5101012726

Inquiry 244

TIMELINE INC.

CALL US FOR ALL YOUR NEEDS!

We have 10 Million I.C.'s in stock!

Minimum I.C. Order: \$200.00

Continental U.S.A

Inside California

L.A. & Technical Info

**OEM
INQUIRIES
WELCOME**

(800) 872-8878 (800) 223-9977 (800) 217-8912

Multitech MIC-500/504 CP/M SYSTEM

JUST ADD A TERMINAL!
\$199.00

INCLUDES: 2 48 or 96 tpi drives Your choice
Z80A Microprocessor
Ports: Centronics parallel, Two serial

Comes with all software & manuals:
Magic Worksheet, Word Right, Analyst, OSORT,
NAD (Name and Address System)



100 Systems available

MOTOROLA 7" DIAGONAL SCREEN HIGH RESOLUTION GREEN SCREEN MONITOR

22 MHZ
TYPICAL
BANDWIDTH



\$29.95

MODEL MD1700

- Flat Faceplate
- 800 lines at Center 650 lines at corners
- Operates from 12VDC at 1 Amp.
- Vertical input is 47 to 63 Hz.
- Horizontal input: 15.7 Khz (18.7 Khz optional)
- Video input signal: Positive white, input termination 470 ohms ± 5%, 2.5V to 5.0V P-P
- Weight: 6lbs.

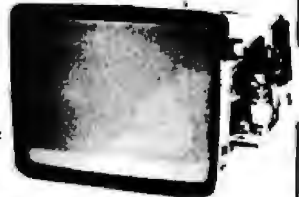

For split video (TTL Input) operation. Not composite video.

MODEL NO. CT-AA1403

13" COMPOSITE COLOR

RCA JACKS
FOR VIDEO INPUT
AND AUDIO INPUT

Apple, Atari, and Commodore compatible.

RESOLUTION: 260H by 300V
GREEN/COLOR SELECTOR

\$129.95



ASTECC 65 WATT SWITCHING POWER SUPPLY

Dual input voltage 115/230 VAC - Overvoltage protection - Short circuit protection - Dual isolated +12V - Built-in EMI filter - Very compact size - UL/CSA/VDE approved - 100% thermal cycle & burn-in - High efficiency - Vacuum impregnated transformers - Convection cooling - Open PCB "L" bracket or boxed construction.

Dimensions:
8.0" - Length
4.4" - Width
2.4" - Height

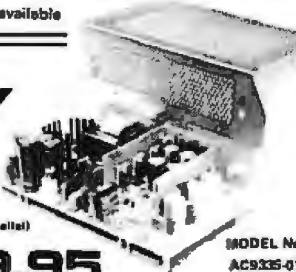

MODEL No. AC9335-01

OUTPUTS: +5V DC @ 5.0A +8V DC @ 5.0A (with two +12V outputs in parallel)
Condition No.1 +12V DC @ 1.5A +12V DC (with two +12V outputs in parallel)
+12V DC @ 2.1A @ 3.5A (8.0A surge)
-12V DC @ 0.25A -12V DC @ 0.25A

\$39.95

MICROSCIENCE Model No. HH-612 HARD DISK DRIVE

With Controller Card & Cables
10Mb 1/2 Height
Drive alone: \$199.00 **\$299.00**



286 SPEED PAK FOR IBM PC & XT UP TO 7 TIMES PC SPEED

CLASSIC TECHNOLOGY CORPORATION

- Increases speed of PC/XT to make it 30% faster than an AT
- 20-30% faster than boards that use cache
- Compatible with IBM Enhanced Graphics Adapter and the Lotus/Intel above board
- Can run programs designed for the AT's and also PC/XT's
- No software patches needed
- Includes native mode
- Made in U.S.A.

\$770.00 3 Year Warranty

HIGH SPEED MONOCHROME GRAPHICS & MEMORY EXPANSION ADAPTER FOR IBM AT

FULLY COMPATIBLE WITH THE HERCULES GRAPHICS AND THE IBM MONOCHROME ADAPTER.

-Lotus Compatible
-Graphics mode: 720x348
-Parallel Printer Interface
-Comes with 128 or 384K
-3 YEAR WARRANTY

\$279.00

PLUS-- 3 TIMES FASTER SCREEN UPDATING
-16 BIT OPERATION
-UP TO 384K MEMORY EXPANSION TO BRING AN AT
UP TO 640K MEMORY (NO EXTRA SLOT NEEDED)

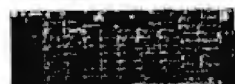

MULTIFUNCTION ADAPTER

- Clock Calendar - 384K RAM Included - Serial Port - Parallel Port - Game Port - High Speed Electronic Disk - Software Included - Printer Cable Included - Made in the U.S.A.

\$179.00



3 YEAR WARRANTY PLUS-- FASTER PRINTER SPOOLER WITH MORE OPTIONS -ALARM CLOCK & OTHER CLOCK FEATURES!

MONOCHROME GRAPHICS ADAPTER

FULLY COMPATIBLE WITH THE HERCULES GRAPHICS AND THE IBM MONOCHROME ADAPTER.

- Lotus Compatible
-Graphics Mode: 720x348
-Parallel Printer Interface
-Made in the U.S.A.

\$139.00

3 YEAR WARRANTY PLUS-- TURN ON/OFF OF PARALLEL PORT -IDEAL FOR USE IN PC/XT!



Switchable Power Supply

110/220V 141 Watt +5V @ 3.0A
+9V @ 3.0A
+12 @ 0.1A
-12V @ 0.2A
+12V @ 3.0A

\$49.95

Weight: 7lbs.

HIGH CAPACITY DRIVE

AMLYN 1860A 5 1/4" DS/High Density
3.2 mByte Uniformated
2.3 Formatted
Takes 8" controller to operate

\$139.00

Wt: 4lbs.



Standard Data - Local Area
NETWORK BOARD
With Software **\$150.00**

Tandon 848-2

IBM COMPATIBLE
DOUBLE SIDED/DOUBLE DENSITY
1/2 HEIGHT - 8" DRIVE
2 mByte Uniformated
1.2 Formatted
Wt: 7lbs. **\$199.95**

Tandon TM55-4 Disk Drive
1/2 Ht. - 80Track - DS/DD **\$69.00**



EPSON QX-10 MOTHERBOARD WITH VIDEO CARD & YOUR CHOICE OF ASCII KEYBOARD (ENCLOSED) OR HASCII (BARE)

\$169.95

ONLY 250 SYSTEMS AVAILABLE!
Will work with any IBM compatible disk drive - CPU
POT/804C-1 (280A compatible) 4 MB/4 Memory RAM
256K on board Video RAM 128K on CRT board C-MOS
RAM 2K EPROM-2/4/8K for I/O Clock C-MOS real-time
clock interface Serial and Parallel DMA 7 channels
Interrupt level 15. Counter/timer 6 channels Card slots
3. Compatible with any TTL monitor Weight 10 lbs with
enclosed keyboard, 8 lbs with bare keyboard

NASHUA DISKETTES 5 1/4" SOFT SECTOR

15/100 with high single density write
protect tabs and labels

\$8.00 BOX OF 10

.70c 5 BOXES OF 10
.62c 10 BOXES OF 10

Nashua Diskettes were
judged to have the highest
polish & recorded
amplitude of any diskette
tested. According to
"Comparing Floppy
Disks" Byte 9/84.

SERIAL PRINTER /MODEM CABLE

(Male to Female)
1/2
\$7.95 OFF!

FOR USE IN SERIAL
APPLICATIONS
Such as Serial Printers
and Modems.

RICOH PRINTER RP 1200N

-25 CPS

Centronics
Interface
Delay Wheel

\$400.00

4164-15
.89¢

100 pc. min. qty.

10" Length
Full double wiring of Nylon
tape
Tinned copper leads
24 AWG wire
Mated DS 25 pin male &
female connectors
All solder removed pins are
plated
Pins 1 & 6 & 30 Wired
Color Page

KEPCO/TDK SWITCHING POWER SUPPLY

\$39.95

ONLY 250 AVAILABLE!
Model EPX 100T-3 100W +5V
@ 8A +5V @ 1.5A +12V @
2.0A +12V @ 2.0A input Volt-
age 100 to 130VAC or 200 to 260VAC 47-440 HZ Single
phase + Brownout Voltage 50VAC @ 180VAC + Fused Input
Output protected against short circuit Dem 9x4 1/2 x 4 1/2 x 7 1/2
x 3 1/2 Weight 3 lbs. Spec included

SIEMENS 8" DISK DRIVE

\$44.95

Model 801R equivalent
Single Sided Single/Double Density
Full Height Drive 48 lbs Documentation
included! Speedy 110 or 220
Volt Model! These drives are new
and sold AS IS Weight 14 lbs



DISK DRIVE CABINET

\$12.95

Full Height Disk Drive Case for
Apple & 8 1/2 inch height drives Can
be modified for other uses Dem
9 1/2 x 6 1/2 x 3 1/2 Weight 3 lbs



"Soy in the Sky" Fairchild CCD122 1,728 ELEMENT

Linear Image Sensor
\$29.95

The Designed for page scanning applications
including facsimile, Optical Character
recognition and other imaging applications
which require high resolution and high
sensitivity.

GUME Sprint 9/35 KSR

TERMINAL/
PRINTER
-35 CPS
Serial Interface
51lbs. **\$299.00**



1490 W. ARTESIA BLVD., GARDENA, CA. 90247

Continental U.S.A

Inside California

L.A. Area & Technical Info

(800) 872-8878 (800) 223-9977 (213) 217-8912



Inquiry 298



Minimum Order: \$25.00. Shipping & handling charges
via UPS Ground: \$.50c/lb. UPS Air: \$1.00/lb. Minimum
Charge: \$4.00. We accept cashiers checks, MC or VISA.
No personal check COD's. Items reflect 5% cash or check
discount. California residents add 6 1/2% sales tax. We are
not responsible for typographical errors. All merchandise
subject to prior sale. Phone orders welcome.
Foreign Orders require special handling

**The greatest value ever
Special Offer on
BASF Qualimetric
diskettes!**

**Buy 10, get 12
and a**

FREE storage case!

This is an *exclusive offer* from DISK WORLD!...your chance to buy 5.25" BASF Qualimetric diskettes at our low prices and ...get 12 instead of 10 and ...get a **FREE plastic storage case** (a good one, not a cheapie)!

.79 ea. < SSDD DSDD > .90 ea

Qty 50 Qty 50
Quantities are limited, so act now! BASF special promotion diskettes are in plastic boxes of 12 with Tyvec sleeves.

LIFETIME WARRANTY!
Regular BASF Price List:

	Qty. 20-40	Qty. 50+	Qty. (BULK) 150+
5.25 Diskettes			
SSDD (P N3406)	81	79	72
DSDD (P N3407)	92	90	83
SSDD96 (P N3404)	92	90	N A
DSDD96 (P N3405)	1.03	1.01	N A
DSDDHD (P N3403)	2.07	2.04	N A

* Bulk is (P N3408) ** Bulk is (P N3409)
Regular (non-bulk) product is packed 10 to a box with Tyvec sleeves, user-ID labels and write-protect tabs BULK product is in cartons of 150 diskettes with Tyvec sleeves.

	Qty. 20-40	Qty. 50+	Qty. (BULK) 200+
3.50 Diskettes:			
SSDD (P/N3402)	1.53	1.48	1.52
DSDD (P/N3412)	2.06	2.01	2.05

BASF 3.5" diskettes, except for bulk, are packed in boxes of 10 and include user-ID labels. BASF bulk product is in boxes of 100 and includes user-ID labels.

PRINTER RIBBONS!

Brand new ribbons to factory specs!	
EPSON MX-70/80(P N2500)	\$ 2.70ea
EPSON MX-100(P N2501)	\$ 4.08ea
Okidata Micro83(P N2505)	\$ 1.37ea
Okidata Micro84(P N2502)	\$ 2.98ea

Add 25c per ribbon for shipping!

STORAGE CASES!

DISKMINDER III(P N2850) Holds 75 5.25" diskettes with dividers. \$ 9.69ea + \$ 2.00 Shpg
DISK MINDER 36(P N2950) Holds 36 3.50" diskettes with dividers. \$ 6.49ea + \$ 2.00 Shpg.
DISK CADDIES(P N2200) Beige. Holds 10 diskettes. \$ 1.65 ea. + 20 Shpg.

HOW TO ORDER:

ORDERS ONLY:

1-800-621-6827

(In Illinois: 1-312-256-7140)

INQUIRIES:

1-312-256-7140

FOR FASTEST SERVICE, USE NO-COST MCI MAIL. Our address is DISKORDER. It's a FREE MCI MAIL letter. No charge to you. (Situation permitting, we'll ship these orders in 24 hours or less.)

SHIPPING: 5.25" & 3.50" DISKETTES-Add \$ 3.00 per each 100 or fewer diskettes. OTHER ITEMS: Add shipping charges as shown in addition to other shipping charges. **PAYMENT:** VISA, MASTERCARD and Prepaid orders accepted **COD ORDERS:** Add \$ 5.00 special handling charge APO, FPO, AK, HI & PR **ORDERS:** Include shipping charges as shown and additional 5% of total order amount to cover PAL and insurance. We ship only to United States addresses, except as shown above. **TAXES:** Illinois residents add 7% sales tax.

MINIMUM ORDER: \$ 35.00

DISK WORLD!, Inc.

629 Green Bay Rd. • Wilmette IL 60091

DISK WORLD!, Inc.

**NO SHIPPING CHARGES
ORDER TOLL-FREE 800-824-3432**
In California Call (916) 241-0033

DRIVES

1/2 HI IBM™ Compatible	85.99
Tandon 100-2	98.99
Tandon 100-4 (96 tpi)	129.99

ADD ONS

Multi-Function w/OK	119.99
Monochrome Graphics w/Printer Port	98.99
Color Graphics	99.99
64K D-Rams	9/10.99
640K Motherboard w/bios (OK)	189.99
Printer Card by IBM	48.99

SYSTEMS

PC/XT Compatible 499.99

- 640K on Motherboard
- 1-1/2 HT. Floppy
- Mono Card w/Printer Port
- Flip Top Case
- 135 Watt Power Supply
- 5150 Type Keyboard

We carry a complete line of electronic components. Call or write for our free catalog!



NICORN ELECTRONICS
10010 Canoga Ave. Unit B-8 Chatsworth, CA 91311

Minimum order \$10.00 - No shipping charges on paper orders - COD add \$3.00 - UPS Blue add \$3.00 - Call responses add 5% to cover Postage. Checks held for clearance VISA - Int.

Inquiry 303

**8051
PASCAL
CROSS
COMPILER**

For MS-DOS Computers

SCIENTIFIC ENGINEERING LABORATORIES
104 Charles Street, Suite 143
Boston, MA 02114 Tel 617 262 3903

Inquiry 260

**UNBRANDED
DISKETTES**

100% ERROR FREE,
LIFETIME WARRANTY

With Hub Rings, Write Protect Tabs,
Tyvec Envelopes, User ID Labels -
In Factory/Sealed Poly Packs

(YOU GET EVERYTHING BUT THE BOX)
PRICES ARE PER DISK

5 1/4"			3 1/2"	
SSDD	DSDD	DSHDB6TP1	SS	DS
.47	.52	1.89	1.39	1.65

SPECIAL OFFER! DATA CASE FOR 5 1/4" Diskettes HOLDS 50!
JUST \$5.00 (With Order of 100 Diskettes)

Minimum order: \$25.00 Shipping and Handling: \$4.00 per 100 diskettes. Continental U.S.A. APO/FPO, add \$8.00 per 100 diskettes. Foreign order, please call. Reduced shipping charge for larger quantities. C.O.D. add \$4.00. Cash or certified check. MI residents add 4% sales tax. Prices subject to change without notice. HOURS: 8:30 AM-6:00 PM Eastern Time

Precision Data Products
P.O. Box 8367, Grand Rapids, MI 49518
(616) 452-3457 • Michigan 1-800-632-2468
Outside Michigan 1-800-238-0028

Inquiry 233

**SEAMLESS
File Transfer**

Softerm PC provides a transparent Micro-to Mainframe link using *Virtual disk drive specifiers* accessible from any DOS application program. Memory resident.

Transfers files in background using customizable communications scripts. Includes 32 exact terminal emulations.

For IBM PC/XT/AT, DG, NEC, HP, Wang, TI, Gridcase, Tandy, Zenith
\$195 - Visa, MC, COD
Call 800-225-8590 orders/info.

SOFTRONICS

7899 Lexington Dr., Ste 210
Colorado Springs, CO 80918
(303) 593-9540 Telex #450236

Inquiry 335

Heritage Systems Corp.

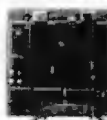

HSC-9100
80 By 24 Or 25 Line
Alpha-numeric
Video Terminal Card

ANSI X3.64/Other Terminal Emulations
50 To 38.4K Baud Serial Port
RS-232 Or TTL/CMOS Versions
IBM PC Compatible Keyboard Input
EEPROM Based On Screened Configuration
Composite or Separate Video
100 By 100mm Card 5V Only @ 200mA
\$138 TTL/CMOS \$148 RS-232

PO Box 10588,
Greensboro, NC 27404-0588
(919) 274-4818

Inquiry 131

**NEW
EPROM
PROGRAMMER**

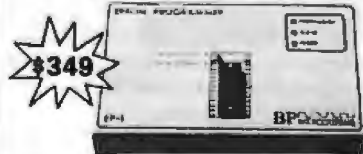

The EP-1 is a great value, here's why:

- IBM PC Software included or RS-232 to any computer
- ASCII Command driven operation. All intelligence in unit
- Reads, Programs, Copies over 150 types from 2716 to 27512
- Optional Intel microcontroller programming head
- Menu-driven Dip Selector; No Personality Modules
- Fast, Slow, Quick-Pulse Programming Algorithms
- Intel (8080 & 8085), Motorola, Tekbit, Sengate Hex File
- Split File By Base Address and Odd/Even (16 bit systems)
- Gold Tantalum ZIF IC Socket • Generate & Set Checksums
- Over-Current Protection • 8 Baud Rates 300 to 38,400
- Full One Year Warranty • 5, 12.5, 21, 25V
- UV Erasers from \$34.95 Programming

BP Microsystems

5325 Glenmont, Suite E, Houston, TX 77081
(800) 225-8102 (713) 867-1836

Inquiry 44

An end to diskette lies!

Super Star™ Diskettes are of equal or higher quality than 3M, Maxell, TDK and many other "famous" brand names. They simply cost about half as much!

Super Star™ diskettes are manufactured to equal or exceed the same specifications as 3M, Maxell, TDK and many other "famous" brand name products.

They are designed for 60% or higher clipping levels, not the 40% used in IBM and ANSI standards. Each is guaranteed for ten million read/write passes. Every Super Star™ diskette is 100% verified and carries a LIFETIME WARRANTY!

Yet Super Star™ diskettes cost only about half as much...

How can we deliver Super Star™ diskettes of such high quality at such a low price?

Simple...we don't make fools out of our customers.

We bargain hard with the same people who turn out many of the "famous name" brands. Their manufacturing capacity far exceeds their capability to sell everything they make. So, as large scale purchasers, we are able to obtain significantly lower prices than others for high-quality diskettes.

For example, we pay one of the big name manufacturers 98¢ for their "famous name" diskette in a pretty box. In an unequalled display of favoritism, that same manufacturer sells the same diskette in the same fancy box to a major corporation for 42¢ each. Finally, a software duplicator can buy the same diskette *without* the box for 37¢!

A 265% price difference: for what?

In the example above, that's a difference of 265% in price for the very same diskette!

So you see, paying for a "famous name" on a diskette doesn't guaranty you that you're getting any more for the money.

You may be paying for some big corporation's fleet of aircraft and their executive retreats in Minnesota and Canada, but you are not paying for any more quality.

You're simply getting rooked out of money you could have in your own pocket.

There are four kinds of diskettes:

And Super Star™ is right up there with the best.

As you leaf through the pages of this magazine, you will see diskettes advertised at prices as low as 33¢. Every one, of course, claims to be the "best".

It's simply not true.

Here are the only kinds of diskettes you can buy:

High-Clip Product: this is what you get when you buy Super Star™, 3M™, Maxell™, TDK™ or any number of other famous and not so famous name diskettes. They have clipping rates of 60% or more, are certified for ten million read/write passes or more and are simply the best diskettes available. You can expect perhaps 1 out of 100,000 to fail...and that will usually be the result of dirty or misaligned drives.

ANSI Spec Product: These are "okay" diskettes. They have a clipping level of 40%. Usually they are the fall-out from a manufacturer's "high-clip" product line. You can expect about 1 out of 20 to fail in normal use.

(But that failure rate has more to do with the disk drive rather than the diskette.) The price difference between an ANSI-spec disk and a High-Clip product is only a few cents. But the failure rate of ANSI product is 50,000 times higher!

Duplicator Product: This is a catch-all category. Some of it may be High-Clip Product, some ANSI spec, some cosmetically blemished, some garbage. Usually anyone who buys product in this class justifiably anticipates that 20 out of every 100 diskettes will not format properly.

Floor Sweepings: This is just plain "garbage". For example, the 5.25" SSSD diskettes that you see advertised for 39¢ are exactly that: garbage. No decent manufacturer has sold any 5.25" SSSD diskettes in several years. SSSD is the absolute bottom of the line in terms of quality. Most of the discount diskettes you see advertised are "floor sweepings"...bought up by brokers and passed on to the unsuspecting public by unscrupulous merchants who are simply out to make a fast buck.

When every bit counts, you can count on Super Star™!

Well, I wish we had more space, but we don't.

So, here's the message in a nutshell:

1. Super Star™ diskettes are high-clip product, 100% certified, tested to 60% or higher clip levels and not less than ten million read/write passes.

2. Super Star™ diskettes carry a LIFETIME WARRANTY.

3. Super Star™ diskettes equal or exceed the published specifications of such "famous" brand names as 3M, Maxell, TDK, etc.

4. Super Star™ diskettes give you this quality at about half the price of the big names!

Save your money: buy Super Star™ diskettes!
That's the message:
Super Star™ diskettes mean the highest quality at about half the price!

SUPER STAR SPECIAL!
Your choice of storage for \$ 4.95!

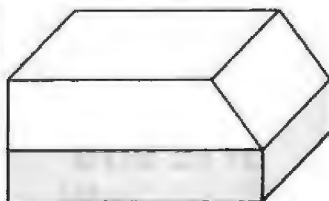

Buy 50 Super Star™ diskettes of either size and you can get a nice plastic storage case for only \$ 4.95 (shipping included!).

These are durable plastic cases with dividers.

The 5.25" unit holds 50 diskettes and the 3.50" unit holds 40 diskettes.
5.25" Storage Unit (P/N3100) \$ 4.95ea.
3.50" Storage Unit (P/N3102) \$ 4.95ea.

Super Star™ 5.25"

SSDD (P/N3800)	.55ea.
DSDD (P/N3801)	.62ea.
SSDD96 (P/N3802)	.78ea.
DSDD96 (P/N3803)	.82ea.
DSDDHD (P/N3804)	\$ 1.61ea.

ORDER IN MULTIPLES OF 50 ONLY!

All Super Star 5.25" Diskettes are poly-bagged in lots of 25 with Tyvec sleeves, write-protect tabs and user ID labels.

QUANTITY DISCOUNTS: 350-500 diskettes, deduct 3%. 550-700 diskettes, deduct 6%. 750-1,000 diskettes, deduct 9%. 1,050+ diskettes, deduct 12%.

Super Star™ 3.50"

SSDD (P/N3805)	\$ 1.52ea.
DSDD (P/N3806)	\$ 1.67ea.

ORDER IN MULTIPLES OF 50 ONLY!

Super Star 3.50" diskettes are packaged in boxes of 50 with user ID labels.

QUANTITY DISCOUNTS: 350-500 diskettes, deduct 1.5%. 550-700 diskettes, deduct 3%. 750-1,000 diskettes, deduct 4.5%. 1,050+ diskettes, deduct 6%.

TAKE A CLOSE LOOK AT OUR DISCOUNTS!

Take a real close look at our discounts. They're some of the best around.

HOURS:

**8AM-6PM Central Time
Monday - Friday**

HOW TO ORDER:

**ORDERS ONLY:
1-800-621-6827**

(In Illinois: 1-312-256-7140)

INQUIRIES:

1-312-256-7140

FOR FASTEST SERVICE, USE NO-COST MCI MAIL. Our address is DISKORDER. It's a FREE MCI MAIL letter. No charge to you. (Situation permitting, we'll ship these orders in 24 hours or less.)

SHIPPING: 5.25" & 3.50" DISKETTES-Add \$ 3.00 per each 100 or fewer diskettes. **OTHER ITEMS:** Add shipping charges as shown in addition to other shipping charges. **PAYMENT:** VISA, MASTERCARD and Prepaid orders accepted. **COD ORDERS:** Add \$ 5.00 special handling charge. **APO, FPO, AK, HI & PR ORDERS:** Include shipping charges as shown and additional 5% of total order amount to cover PAL and insurance. We ship only to United States addresses, except as shown above. **TAXES:** Illinois residents add 7% sales tax.

MINIMUM ORDER: \$ 35.00

DISK WORLD!, Inc.

629 Green Bay Road
Wilmette, Illinois 60091

MEMORIES—DRIVES—PRINTERS

- * 64K/128K/256K D-RAMs at LOW PRICES
- * H-P Vectra 128K Upgrade..... \$39.95
- * V20-5 \$14.00 / V20-8 \$16.00
- * V30-8 \$18.00 / 8087 \$115.00
- * 8087-2 \$155.00 / 80287-3 \$160.00
- * **Memory Boards and Modules**
- JRAM-2 Parallel or Serial w/8K \$129.50
- JRAM-3 JRAM-AT Par. or Ser. w/8K \$177.50
- JRAM AT-3 Par. or Ser. w/8K \$229.50
- Ser/Par or Ser/Ser Clock module \$132.00
- Ser/Par or Ser/Ser module \$85.00
- Clock/Calendar module \$55.00
- JDISKETTE module \$135.00
- JLASEP-1 \$185.00
- Canon Printerswitch + cables \$80.00
- Corona cable \$35.00
- IBM Multi-Function Board w/384K \$115.00
- * **TEAC FD55-BV DS/DD Disk Drive** \$95.00
w/ one year factory warranty
- * **BROTHER Printers & Accessories**
- M-1509 Dot Matrix Printer \$395.00
- HR-15XL Daisy Wheel Printer \$375.00
- Twewriter-5 Dot Matrix/Printer \$885.00
- Printer Accessories 25% off L1BT

* WARRANTY: All I.C.s guaranteed for 180 days. * OEM and DEALER discounts available. * Prepaid orders - No shipping charges. * Maryland residents must add sales tax.

Advanced Technology Products, Corp.
P.O. Box 2205 / 11141 Georgia Ave., Silver Spring, MD 20902
Phone: 301-933-3523

Inquiry 9

PC EXPANSIONS

- AST SixpackPlus (384 K) \$219
- Advantage (128 K) \$369
- Advantage (1.5 M) \$529
- Advantage (3 M) \$809
- Rampage (2 M) \$499
- RampageAT (2 M) \$659
- INTEL AboveAT (2 M) \$549
- Quadboard (384 K) \$249
- Gold Quadboard (384K) \$429
- LibertyAT (2 M) \$call
- QuadportAT \$135
- Teemar Maestro (2.5 M) \$629
- HERCULES graphics board \$299
- Color Card \$159
- HAYES Smartmodem 1200B \$349
- Smartmodem 1200 \$389
- Maynard Disk Controller \$100
- Sandster Series \$call
- MaynStream Tape backup from \$979
- WDFile Card (10 M) \$769
- Tandon Diskard (20 M) \$789
- Set of 9 chips (84 K) \$10
- Set of 9 chips (256 K) \$27
- 8067-3 \$119
- Qume 142A: \$99 Teac \$109
- Teac FD55BV (for AT) \$109
- CDC 9409: \$119 Tandon \$109
- Verbatim (Box of 10) \$19
- Maxell (Box of 10 for AT) \$39

VLM Computer Electronics
10 Park Place • Morristown, NJ 07960
(201) 267-3268 • Visa, MC, Check or COD

1	Exxon
2	General Motors
3	Mobil
4	Ford Motor
5	IBM
6	Texaco
7	E.I. du Pont
8	Standard Oil (Ind.)
9	Standard Oil of Cal.
10	General Electric
11	Gulf Oil
12	Atlantic Richfield
13	Shell Oil
14	Occidental Petroleum
15	U.S. Steel
16	Phillips Petroleum
17	Sun

27 million Americans can't read. And guess who pays the price.

Every year, functional illiteracy costs American business billions. But your company can fight back...by joining your local community's fight against illiteracy. Call the Coalition for Literacy at toll-free **1-800-228-8813** and find out how.

You may find it's the greatest cost-saving measure your company has ever taken.

A literate America is a good investment.



American Semiconductor
Computers, Components, Hardware and Software

THE BARE XT TURBO SYSTEM
\$399

*Looks, feels, and acts like an IBM, AND it's 100% compatible.

8087 \$119.00
80287 175.00
64K 99

V-20 \$14.00
FLOPPY 75.00

XT & AT ADD ON CARDS
For AT, XT, Compaq, & Corona:

20MB \$325
30MB Hi-Speed RLL KIT \$499

TO ORDER TOLL FREE CALL
1-800-237-5758, EXT. 812

Inside Florida 813-961-9444
Technical Line 1-813-961-5384
Prices subject to change. Add 3.3% for VISA/MC purchases.
16520 N. Florida Ave., Lutz, Florida 33549

Inquiry 20

Nashua Diskettes

5 1/4" DS/DD with hub ring and sleeve. factory warranted, packaged in 50's Shipping Extra Quantity 50, 85c each

SUMMER SPECIAL!!

Order 100 or more disks before Sept. 30, 1986 and WE'LL PAY THE SHIPPING. Just mention this ad when you place your order and receive FREE SHIPPING.

75¢ each (on 100)

(Offer not valid in conjunction with any other offer)

We sell 3 1/2" & 5 1/4" disks—all types, major brands. Call toll free:

1-800-321-4668
in Colorado, 303-234-0871

VISA, MASTERCARD, OR COD ACCEPTED

ALF 1315-F Nelson St. Denver, CO 80215

Inquiry 13

I.C. MEMORY HOT LINE
LEADER IN WHOLESALE PRICING
(MAJOR AMERICAN/JAPANESE)

DRAM CHIPS

- ✓ 4164 150 NSEC **\$1.15**
- ✓ 4164 120 NSEC **\$1.25**
- 4464 150 NSEC **\$5.15**
- ✓ 41256 150 NSEC **\$2.40**
- 41256 120 NSEC **\$3.20**

■ PROCESSORS

- 8087-2 8MHz \$180.00
- 8087-3 8MHz \$120.00
- 80287-3 8MHz \$180.00
- 80287-8 8MHz CALL
- Many 8000 series in stock

■ EPROMS

- 27C256 250ns \$8.00
- 27256 250ns \$7.00
- 27128 250ns \$3.95
- 2764 250ns \$3.25
- 2732A 250ns \$4.00

Also we carry 7400, 74S, 74LS, 74ALS, 74HC, 74HCT, ECL in stock. Also diskettes, floppies, drives, monitors, add on for P.C., XT, AT, peripherals, PC ST, AT

Seagate ST 4051 Drives	\$825.00	IBM PC AT Computer	\$899.00
Seagate ST 251 Drives	\$800.00	IBM PC AT Compatible Motherboard	\$599.00
Tandon 755 Drives	Low Price	Floppy Disk Controller	\$89.00
Teac 558V for PC Drives	\$109.00	Color Card	\$99.00
96TPI for PC AT Drives	Low Price	Mono Card	\$79.00
		Modems	Call

PLEASE CALL FOR VOLUME DISCOUNT
Technical and Volume Discount Call 818-378-1440
ORDER TOLL FREE—COD, Cash or Cashier's Check Only
1-800-423-5624/California resident 1-800-352-5689
(Min. order \$350.00)

Inquiry 336

Advertise your computer products through **BYTE BITS** (2" x 3" ads)

For more information call Dan Harper at **603-924-6830**

BYTE
70 Main St.
Peterborough, NH 03458

Inquiry 337

MSO
MICRO
SUPPLY
ORGANIZATION INC.

the giveaway.

MSO, the leader in cost effective computer systems, is offering the Sanyo MBC 1200 at a giveaway price!

The MBC 1200 Accounting Software -G/L, A/R, A/P, Inventory and Payroll modules retail for \$398 per module. Now from MSO you pay only \$99 per module or all five for \$299! Second disk drive with fan-option available. COMPAT disk utility available.

SPECIFICATIONS:

- Two Z-80A (main and subsidiary) CPUs with no-wait mode for fast execution, substantial memory capacity (RAM 64KB, ROM 4KB).
- High-resolution full graphic function with 640 x 400 dot matrix display.
- Choice of 33 or 40 line text mode.
- CP/M operating system complete with interpreter, editor and all utilities.
- Easy-to-use Sanyo graphic BASIC.
- One (MBC 1200) or two (MBC 1250) internal double-sided, double-density, double-track, 5¼" slim-type 640KB formatted mini floppy disk drives.
- Special design featuring detachable ergonomic keyboard with coiled cable.
- Interfaces for Centronics printer and one RS-232C port provided.

20 meg internal hard drive sub-system for Sanyo MBC 1100, 1160 & 1200

\$599 (with purchase)

Printer specials with purchase

805/393-2247

All systems carry full 90 day warranty.

CASH PRICE ONLY

Check in advance. Add 3% for VISA/MC Shipping & handling charges will be added to each order.

For our catalog with complete details and prices, send \$2 to:

Micro Supply Organization, Inc.
4909 Stockdale Hwy. #180
Bakersfield, CA 93309



15% Restocking on Returned Orders

SANYO
MBC 1200

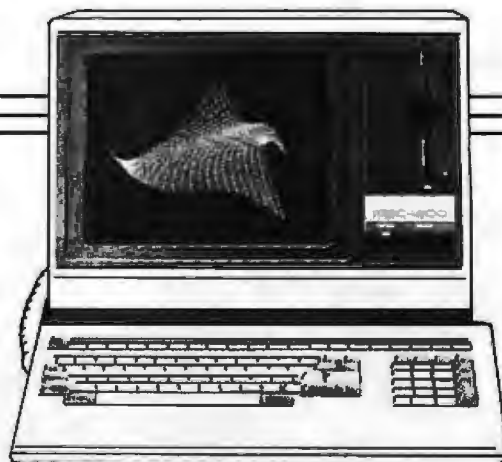

FREE SOFTWARE

- Wordstar • Spellstar
- Calcstar • Mailmerge
- Infostar • Basic

\$399



“The Boys Club helped me run my life.”

—Pres., O.J. Simpson Enterprises

O.J. Simpson

“When I was growing up, I was the quickest kid on the block. But the streets were catching up with me. I’m sure glad there was a Boys Club around to help keep me a step ahead.

“You know, a Boys Club shows kids there are lots of ways to reach goals, besides scoring touchdowns. It gives them every chance to be leaders. And encourages something every bit as important as good leadership—good citizenship.

“They sure pointed me in the right direction, and I’ve been running my life ever since—running through

lines, running through airports. Now I’m even running my own business!

“It’s no wonder so many Boys Club kids grow into productive, civic-minded adults, like teachers, politicians, business executives and professional athletes. Which gives more than 1,200,000 young people, at 1,100 Boys Club facilities across the country, something to look forward to.

“Hey, I’m not saying a Boys Club can turn every kid into a star. But a Boys Club sure can teach ’em how to reach for one.”



The Club that beats the streets.

ATTAK-286™

HIGH SPEED 12 MHZ OPERATION Software Selectable for 6,8,10, and 12 MHZ!

- FULL IBM PC-AT* COMPATIBILITY!
- FOUR MEGA-BYTE RAM CAPACITY ON MOTHERBOARD!
USING 1 MEGA-BIT DRAMS.

QUANTITY DISCOUNTS AVAILABLE FOR QUALIFIED DEALER, OEM, UNIVERSITY AND CORPORATE ACCOUNTS.

NEW!

HIGH SPEED INDUSTRIAL GRADE COMPUTER FOR:

- Scientific
- Engineering
- Industrial
- Medical
- University/Education
- Artificial Intelligence
- Etc., Etc., Etc.

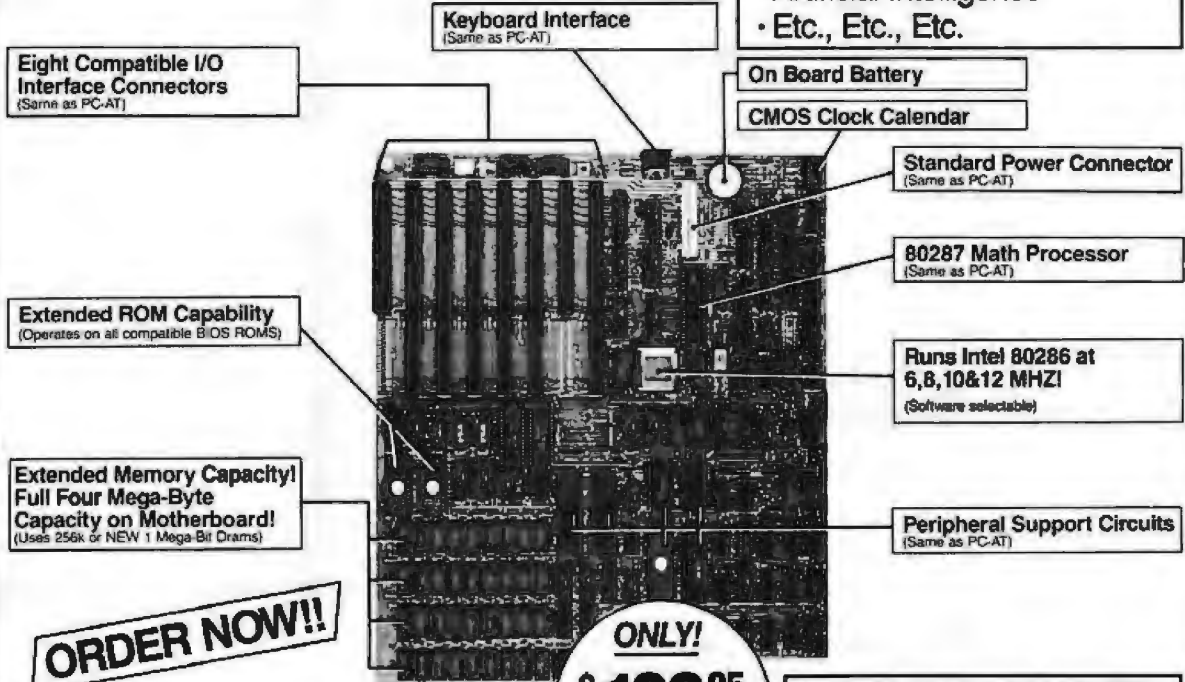

ORDER NOW!!

ONLY!
\$199⁹⁵
EVALUATION BOARD KIT

- ATTAK-286™ FULLY ASSEMBLED (LESS ICS)\$499.95
- AT CASE 100% COMPATIBLE.....\$129.95
- AT POWER SUPPLY 192W.....\$129.95
- ATTAK-286™ TECHNICAL REFERENCE MANUAL ... \$ 29.95
- TURBO-SCOPE™ A/D BOARD\$ 99.95

Board Size: Standard IBM-AT*
Dimensions: 12 inch x 13.8 inch
with 6 mounting holes to fit all AT compatible cases.

100% SATISFACTION GUARANTEED.
10 DAY MONEY BACK GUARANTEE IF NOT COMPLETELY SATISFIED!



ATTAK-286™ evaluation board kit highest quality multi-layer PC board with full assembly instructions and parts lists!

AiT CORPORATION
ADVANCED INTELLIGENCE TECHNOLOGY

4100 Spring Valley Road
Suite 400
Dallas, Texas 75244
(214) 490-0344

TERMS: We accept cash, checks, money orders and credit cards. Prices and availability subject to change without notice. Shipping and handling charges via UPS ground 50c/lb UPS air \$1.00/lb. Minimum charge \$3.00.

*IBM and IBM PC-AT are trademarks of International Business Machines

CORPORATE BUYERS CALL
GILLES, LOUANE, MANDI, MIKE or DAVE

TOLL FREE
800-854-8230
CA Residents 714-558-8813

OUR POLICY
•Surcharge for VISA or Mastercard. Inquiry 8
•Volume purchasing agreements available.
•Orders subject to availability. •Supply limited on certain items.
•Pricing subject to change without notice.
•ACP Retail Store pricing may vary. Not responsible for typos.

IBM Compatible ADVANCED PC/XT



Don't miss out on this unbeatable system manufactured by Toshiba for ACP. ACP has sold over 3,000 ADVANCED XT's to satisfied customers including "true blue" users like Rockwell, Hughes, and Kodak. Not only is the price affordable but the features and compatibility are unbeatable. For more details call one of our expert consultants. Don't hesitate this will be a sellout!

COMPLETE SYSTEMS FROM \$895⁰⁰

Call for complete Monochrome or Color RGB system prices with 10 or 20 Mb hard disk drives or the NEW 20Mb Drivcard.

20 Mb Upgrade \$449 **20 Mb Drivcard \$699**
Package (1 Yr War) Plug-in 1 Yr War)

SEAGATE FOR AT
(Linear Voice Coil Activator)
20 Mb for AT.....\$675.00
30Mb for AT.....\$695.00
40Mb for AT.....\$815.00
(Inc. Cable & Mounting Rails)

PC UPGRADE SPECIAL

\$14⁹⁵ SET OF (9) 64K RAMS
\$36⁹⁵ SET OF (9) 256K RAMS
\$7.95 4128 PIGGYBACK RAM
\$139.00 8087 Coprocessor
\$169.00 8087-2 Coprocessor

1200 Baud Hayes™ Comp. Modem
Short Card by U.S. Robotics with Telpac I Software.
List \$499 ACP... **\$149.95**
Buy (6)..... **\$139.95**

AST	Sixpak Plus w/O.....	\$175.00
	Advantage 128K, AT.....	\$99.00
	ALPS.....	\$95.00
	AST 5251-11.....	\$75.00
	AST 3780.....	\$75.00
	RAMpage up to 2 Mb.....	Call
DCA	Irma.....	\$785.00
	Irmaline.....	\$95.00
DIABLO/XEROX	620 Serial LOP..... was 1495 now \$349.00	
	620 API LOP.....	\$99.00
	620 D36 (36cps).....	\$48.00
	Tractor..... was 395 now \$99.00	
	F-21 Sheet Feeder..... was 896 now \$49.99	
	Cable for 620 (to IBM).....	\$9.00
	Diablo P-11 100cps.....	\$29.95
	Diablo S-11 100cps Serial.....	\$29.95
	Diablo P-31 Wide.....	\$29.95
	Diablo S-31 Wide.....	\$29.95
	Other Diablo Dot Matrix's available.....	Call
EPSON	FX85 160cps NLD.....	\$375.00
	FX286.....	\$59.00
EVEREX	Graphics Edge or Edge.....	\$259.00
HAYES	Smartmodem 1200.....	\$385.00
	Smartmodem 1200B.....	\$48.00
	Smartmodem 2400 (Int).....	\$75.00
	Smartcom II 2.1 Software.....	\$8.00
	Hayes Comp. 1200 (Int) w/SW.....	\$69.95
	Hayes Comp. 1200 (Ext).....	\$69.95
HERCULES	Color Card.....	\$185.00
	Graphics Card w/Software.....	\$25.00
INTEL	Above Board PC or AT.....	Lowest Price
IRWIN	310A 10 Mb Tape (Ext).....	\$849.00
	1100 10 Mb (Int).....	\$495.00
KEYTRONICS	5151 Deluxe Keyboard.....	\$169.95
	5153 w/Touchpad.....	\$295.00
	PC Jr. Numeric Keypad.....	\$6.95
MICROSOFT	Mouse.....	\$139.00
	Mouse (Serial).....	\$55.00
MOUNTAIN COMPUTER	20Mb Drivcard.....	\$999.95
MOUSE SYSTEMS	PC Mouse w/Paintbrush.....	\$139.00
	ACP Mouse w/Keyboard.....	\$49.00

★ NEW ★ Advanced ATI INTRODUCTORY PRICE

- 80286 CPU-8MHz
- 1.2 Mb Floppy Disk Drive
- Hard Disk Controller w/Floppy
- AT Style Keyboard
- 192W Pwr Sup. • 8 Expan. Slots
- MS-DOS 3.1, BIOS

\$1495.00

ADVANCED AT CARDS

ADV-320	Hard Disk Controller with Floppy for AT.....	\$220.00
ADV-6020AN	Color/Graphics/Printer.....	\$9.95
ADV-8050	2Mb Multifunction with RS-232, Game & Cable.....	\$69.95
ADV-8080	3Mb Memory Expansion.....	\$29.95
ADV-8120	Printer/RS-232 and RS-232 (Opt.).....	\$9.95

ADVANCED PC/XT CARDS

ADV-6040	Monochrome/Graphics/Printer.....	\$99.95
ADV-6040-3	As Above for 132 Col.....	\$39.95
ADV-6050A	Monochrome/Printer Adapter.....	\$9.95
ADV-6050C	384K Multifunction Card RS-232, Printer, Game, Clock 1/2 Card.....	\$119.95
ADV-7060	Floppy Controller, 2 Floppies.....	\$20.00
ADV-EGA	EGA Short Card.....	\$29.95
ADV-6120E	Printer, RS-232 x 2.....	\$79.95
ADV-6250A	Multifunction, RS-232, Printer, Game, 1/2 Card.....	\$6.95
6260A	Multifunction, Floppy Cont., RS-232, Printer, Game, 1/2 Card.....	\$149.95
ADV-6260	640K Memory Card, OK.....	\$6.95
ADV-6090	Mono/Color/Graphics, Printer 80/132 Columns.....	\$179.95

ORCHID	PC Turbo 186 w/256K.....	\$585.00
PARADISE	Color/Monocard.....	\$185.00
	Modular Graphics Card.....	\$274.00
PERSYST	Mono Board w/Parallel Color Board.....	\$159.00
	Time Spectrum.....	Sale Call
PRINCETON GRAPHICS	HX-12 RGB (640x240).....	\$445.00
	MAX-12E Amber TTL.....	\$75.00
	SR-12.....	\$75.00
	HX-12E (800x350).....	\$45.00
PROMETHEUS	ProModem 1200 w/Write (Int).....	\$336.00
	ProModem 1200B (Hayes Comp.).....	\$299.00
	Alpha/Num or Options Proc.....	\$79.95
QUADRAM	Expanded Quadboard (OK).....	\$185.00
	Gold Quadboard (OK).....	\$85.00
	Silver Quadboard (OK).....	\$215.00
	Quadlink.....	\$99.00
SIGMA	Color 400 Card.....	\$485.00
SHARP	12" Med-res RGB Monitor.....	\$299.95
	Color Plotter w/Software.....	\$199.00
STAR MICRONICS	Gemini 10K..... reduced \$179.00	
	Gemini 15K..... sale \$29.00	
	HX-10..... NEW! \$35.00	
TAXAN	415 (640x260) RGB..... was 699 now \$279.95	
	Mod. 640 (Ultra Hi-res).....	\$95.00
TEMPLATES	Lotus, dBase III, etc.....	Lowest Price
TITAN	Accelerator PC w/256K.....	sale Call
TOSHIBA	P321 "3 in 1" LQ Printer..... sale \$599.00	
	P341 24 Pin 136 Col.....	\$69.00
	P351 24 Pin w/Serial & Parallel.....	\$1099.00
	T-1100 MS-DOS Lap Top.....	Call
WESTERN DIGITAL	Cobra Hard Disk Controller.....	\$179.95
ZENITH	ZVM-1220/30 12" Grn/Amb TTL.....	\$189.00
	ZVM-1240 & ZVM-135 RGB.....	Call

SYSGEN 20/20

- 20Mb Hard Disk
- 20Mb Tape Back-up
- New/Factory Box
- PC/XT/AT Comp.
- External Complete
- Reg. Retail \$3300

ACP Only **\$999**

Grid Compass MS-DOS Lap Computer Demo Sale Call for Details. 100's in Stock as Low as \$849⁰⁰

EGA SPECIAL
New Advanced EGA Card for High-res IBM Graphics.
SPECIAL PRICE! Only **\$288⁹⁵**

UNBELIEVABLE!

Micropo INFOSTAR SYSTEM! Includes

Datastar, Reportstar (PC DOS).....	\$99.95
IBM brand Pascal Compiler.....	\$9.95
IBM Pascal Reference.....	\$49.95
IBM DOS 2.0.....	\$24.95
Visicalc IV IBM.....	\$9.95
Compaq MS DOS/BASIC ver.2.....	\$49.95

Advanced Computer

California Digital

17700 Figueroa Street • Carson, California 90248

IBM Compatible Computer



\$495

Eclipse
DATA PRODUCTS

- 256K Expandable to 640K on Motherboard
- Double Sided Double Density Disk Drive
- IBM Type Keyboard (with LED indicators)
- Floppy Controller Card
- Eight Expansion Slots
- 135 Watt Power Supply

The Eclipse 16 is an outstanding value in IBM Compatible Computers. After careful research and evaluation we found it to be the most reliable unit.

Our computer includes some of the newest features available, such as the 4.7MHz, multi-layer motherboard with 256K of RAM upgradable on board to 640K. A generous eight expansion slots and 135 Watt power supply give you ample room and power for add-on boards. The enclosure has an easy-access flip top lid making upgrades a breeze. And our floppy controller supports up to four drives, so as many as three additional drives can be used. Finally, each computer is configured and fully tested before sending it to you.

Satisfaction Guaranteed! We're really excited about this new unit, and so sure you will be too... that you may return the Eclipse 16 for a full credit towards an IBM PC if you are not completely satisfied.

OPTIONS

20MB Hard Drive w/Controller.....\$495	RGB Color Monitor.....199
Additional Drive-Installed.....99	TTL Monochrome Monitor.....139
Irwin 10 Meg. Tape Back up.....489	Microsoft Mouse.....139
Upgrade from 256K to 640K RAM.....79	Upgrade from Floppy Controller to Disk I/O
8087 Math Co Processor.....119	2 drive controller, clock/cal., software
Color Graphics Card.....79	parallel, serial, and game ports.....79
Monochrome Graphics Card.....99	1200 Baud Internal Modem w/Software 179

21 Megabyte Gold Card

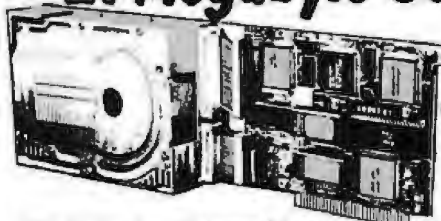

\$559

The fastest, lowest powered, longest warranted, most durable, highest capacity, most reliable, lowest priced HARD-DISK-ON-A CARD available in the world today.

- 63ns Access Time • Fastest Available • Automatic Head Unloading • Protects Heads and Media • 2K Sector Buffer • Increases System Throughput • High Reliability: 26,000 hr. MTBF • No one else even close • 15.5 Watt Power Consumption • Lowest Available • 2 Year Warranty • Longest Available

WERE \$695... GET 'EM WHILE THEY LAST FOR JUST \$559

NOW YOUR COMPUTER CAN READ!!

Omni-Reader... the first optical character reader designed and priced for the small computer

\$179

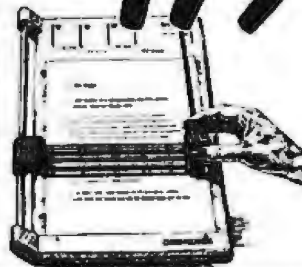

COPY:

- Manuscripts • Contracts • Articles
- Forms • Invoices

APPLICATIONS:

- Mailing Lists • Editing • Data Base Management
- Transferring information between incompatible systems

Uses a standard RS-232 serial port hookup to interface easily with your computer.

1200 BAUD MODEMS



AVATEX 1200

\$99

This 300/1200 baud modem matches the design specs of the Bell 212A, feature by feature, bringing you reliability, impeccable transmission and easy operation. Hayes Compatible, except for "S" register. Communication software included.

The AVATEX 1200, at \$99, is a steal!

SMARTTEAM 1200



\$189

The Team 212A offers all the features of the Hayes Smart Modem 1200 for a fraction of the price. Now is your opportunity to purchase a 1200 baud modem at the price of a 300 baud modem.

SIGNALMAN 300 BAUD MARK VI



\$49

The Anchor Automation Mark VI is a 300 baud direct connect modem that plugs into any slot of your IBM/PC. This modem supports auto answer and auto dial capabilities. Other features include telephone number storage, send / receive text files, single key-stroke dialing along with many other functions provided on disk. The Mark VI was originally priced at over \$300.

ECLIPSE 2400 BAUD MODEM



\$359

- Hayes & Bell 212A/103 Compatible
- CCITT V.22, V.22 bis

The ECLIPSE 2400 modem is a microprocessor-based full or half-duplex modem incorporating the latest in high speed data communications capabilities. It also accommodates computers and terminals equipped with an RS-232 port allowing communication with other computers or timesharing systems either locally or remotely. Compatibility, Versatility and Performance are yours in a configuration designed to provide years of reliable operation.

MODEMS

Eclipse 1200 100% Hayes, with status lamps	EDP-1200	179.00
Eclipse 1200B Internal with software	EDP-1200B	179.00
Eclipse 2400 External, Hayes Compatible	EDP-2400	359.00
AvateX 1200 baud external, Hayes	AVA-1200	99.00
Hayes Smartmodem 2400 baud modem	HYS-2400	599.00
Team 1200 Hayes Compatible, 300/1200 baud	TEAM-1200	189.00
UltraLink 1200 data and voice on same line	UTL-1200A	99.00
CTS 212AH 1200 baud, auto dial	CTS-212AH	179.00
Terminal software for CTS 212AH	CTS-212SFT	35.00
Prometheus 1200 super features	PRM-P1200	289.00
Prometheus 1200B internal PC	PRM-P1200B	279.00
Signalman Mark VI, 300 baud internal PC	SGL-MK6	49.00
Hayes Smart Modem 1200 baud, auto dial	HYS-212AD	369.00
Hayes 1200B for use with the IBM/PC, 1200 baud	HYS-1200B	269.00
Hayes Smartmodem, 300 baud only, auto dial	HYS-103AD	199.00
Hayes Chronograph, time & date	HYS-CHR232	199.00

Seagate

20 MEGABYTE WINCHESTER HARD DISK DRIVE

\$299

Quantity Two

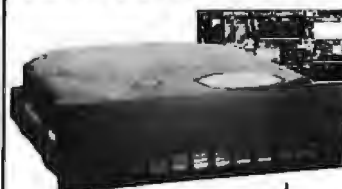

Five Inch Winchester Disk Drives
each two+

SEAGATE 225 20 Meg. 1/2 Hl. 329	299
SEAGATE 4028 26 M. 35mS. 759	729
SEAGATE 4051 51 M. 35mS. 995	950
FUJITSU 2242 65 M. 35mS. 1599	1529
FUJITSU 2243 86 M. 35mS. 2095	2019
RODIME RO-202E 27 Meg. 650	829
RODIME RO-203E 40 Meg. 995	959
RODIME RO-204E 53 Meg. 995	859
CONTROL DATA 94155-80 M. 1629	1779
MAXTOR XT1140 140 Meg. 2995	2929
HONEYWELL 85M. 27 mS. 1795	1695
TOSHIBA MK5670 M. 30mS. 1789	1729
TANDON 582 10 Meg. 419	379

- Winchester Controllers for IBM/PC
- XEBEC 1220 with floppy controller 229
- NATIONAL COMPUTER 5004 139
- DTC 61508X 139
- OMTI 5510 half card 139
- ADAPTEC 20-10A software install 189
- WESTERN DIGITAL WD/1002 139
- SCSI/SASI Winchester Controllers
- XEBEC 1418A 514" foot print 219
- OMTI 20L 119
- Winchester Accessories
- Installation Kit with manual 10
- Winchester enclosure and supply 139
- Dual 28/34 cable set 25
- Switching power supply 49

TOLL FREE ORDER LINE
(800) 421-5041

TECHNICAL & CALIFORNIA
(213) 217-0500

California Digital

17700 Figueroa Street • Carson, California 90248

Letter Quality Printer F-10 DAISY WHEEL

\$429



The F-10 Daisy Wheel printer is the perfect reasonably priced 40 character per second word processing printer. This printer is "extremely" similar to C. Itoh's F-10-40 Starwriter printer, however we have been advised by legal counsel for the C. Itoh Company that we should refrain from referring to the F-10 printer as a Starwriter.

This printer auto installs with Wordstar and Perfect Writer, features extensive built-in word processing functions that allow easy adaptability and reduced software complexity. Industry standard Centronics interface provides instant compatibility with all computers equipped with a parallel printer port. The F-10 accepts paper up to 15 inches in width.

These printers were originally priced to sell at over \$1400. Through a special arrangement California Digital has purchased these units from a major computer manufacturer. We have a limited number of these popular printers left... while they last we're offering a special Accessory Pak, including six Diablo daisy wheels and two ribbon cartridges, with every F-10 printer already priced at a fraction of their original cost.

Options available: sheetfeeder, tractor feed, buffered memory and an assortment of printer cables for a variety of computers.

FREE

Accessory Pak
Includes 6 Daisy Wheels
& 2 ribbon cartridges
With F-10 Purchase



SONY 53W Floppy Disk Drive

3 1/2" New IBM portable compatible

\$139



5 1/4" DISK DRIVE SALE \$89

Quantity Two

Your Choice 48 or 96 TPI drive.
QUME MODEL 142 • 48 TPI
MITSUBISHI 4853 • 96 TPI



MASS STORAGE ALTERNATIVE

TAKE IT WITH YOU!

Bernoulli Box

was \$3540 now only

\$1595

The Bernoulli Box, by Iomega, features 10 & 20 megabyte removable cartridges, and delivers reliability, expandability, transportability, security and speed in one versatile subsystem. It lets you transfer megabytes of information safely and swiftly for primary or backup storage. Or combine several software programs onto a single cartridge for easy switching from one to another.

Reliable, the Box has incredible resistance to shock and vibration completely eliminating the possibility of head crash!

Expandable... grow at your own pace by adding inexpensive cartridges.

When security is essential, don't lock up your system... just lock up the cartridges.

The Bernoulli Box delivers performance that often exceeds the very best hard disk drives. Hard disk speeds and floppy convenience. The Bernoulli Box. At this price, don't be caught wishing you'd had one after a loss of irreplaceable data.

Data Transfer Rate: 1.13 Mbytes/second

Start/Stop Time: 57 seconds

Average Access Time (milliseconds): A210N-32ms

A220N-36 ms

LIST OUR PRICE

10+10 MEG.	A2210H	5480	1999
20+20 MEG.	A220H	4540	2099
Bootable Controller	PC2B	265	189
10 MEG. Cartridge		79	49
20 MEG. Cartridge		99	65

TEKTRONIX MOUSE



\$79

- 200 dots-per-inch resolution
- Programmable baud rate
- Multiple protocols
- Programmable buttons
- Serial interfaces
- Runs on any surface
- Free of pads or grids
- Microsoft™ compatible driver

Moving your cursor has never been so easy! This mouse combines the best features of optical and mechanical technology into one high performance mouse. The Tektronix mouse was private labeled by LogiTech for Tektronix. The 200 dots-per-inch resolution requires less desk space and gives you precision control. This mouse is fast and precise in the most demanding environments. And it has a programmable baud rate so you can use it with almost any of your favorite software.

PLOTTER



\$179

The Comshare Comshare is the ideal solution to make short work of translating financial and numeric data into a graphic presentation. Many ready-to-run programs such as Lotus 1-2-3, Visio and Apple Business Graphics already support this plotter.

The Comshare 1 features programmable driver sizes up to 8 1/2 by 100 inches, 60 inch per second plot speed and 9,600 step size EASY to implement Centronics interface allows the Comshare 1 immediate use with the greater part of major personal computers.

The Comshare 1 is manufactured by Comshare by the Enter Computer Corporation. The plotter is marketed by Heath Kit and also sold under Enter's own "Sweet P" label. This is your opportunity to purchase a plotter which was originally priced at \$795 for only \$219.

Also available is a support package which includes demonstration software, interface cable, a multiplier pen assembly and a variety of paper and transparency materials.

Quick-Link 300



\$59

The Quick-Link 300 gives you an instant link to any dial up data base. Such as Dow Jones, Western Union or the Source. The Quick-Link has four user programmable log-on keys, allowing the operator, with only one key stroke, to dial the data base, log-in and give the password. All this information is permanently stored in non-volatile RAM.

Features include video output to television or monitor, auto-log, auto-log, full sized keyboard, 300 baud modem and 1200 baud auxiliary printer port. All this is available for only \$59.

CP/M 2.2 Operating System

\$14.95

Complete with manual by Digital Research

Originally \$185.00
Now only \$14.95

(10+ = 9.95 -- 100+ Call)



TEAC FD55BV half height	109	99	89
TEAC FD55FV 96 TPI, half ht.	119	109	105
TEAC FD55GF for IBM AT	169	159	155
PANASONIC 455 Half Height	109	99	89
PANASONIC 465 1/2 Ht. 96TPI	119	109	105
TANDON 100-2 full height	129	123	119
MITSUBISHI new 501 half ht.	129	119	109
MITSUBISHI 4853 96/TPI 1/2 Ht.	99	89	89
MITSUBISHI 4854 8" elec.	295	285	275
QUME 142 half height	99	89	89
Switching power supply			49
Installation Kit with manual			10
Dual enclosure for 5 1/4" drives			59
34 pin edge connectors			5
Scotch head cleaning kit			19
Flip & File Storage tubs			15



QUME \$119

Eight Inch Single Sided Drives

QUME 841 single side	129	119	call
SHUGART 801R	359	359	354
SIEMENS FDD 100-8	119	115	109

Eight Inch Double Sided Drives

QUME 842 "QUME TRACK 8"	189	179	call
SHUGART SA851R	495	485	475
OLIVETTI double sided	189	179	159
REMEX RFD-4000	179	169	159
MITSUBISHI M2896-63 1/2 Ht.	459	449	409
Dual 8" enclosure with power and fan			259
Switching power supply			89
Installation kit with manual			10

MEMORY

4164 DYNAMIC MEMORY 150ns
Quantity 100
\$.99

DYNAMIC MEMORY	1-100	100+	1000+
4164 150ns, 128 refresh	1.39	1.19	.99
41256 150ns, 256K	4.99	3.99	3.29

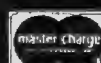

Shipping: First five pounds \$3.00, each additional pound \$.50.
Foreign orders: 10% shipping, excess will be refunded.
California residents add 6 1/2% sales tax. • COD's discouraged.
Open accounts extended to state supported educational institutions and companies with a strong "Dun & Bradstreet" rating.

ameco ELECTRONICS

Mail-Order Electronics 415-592-8097

7400

Part No.	Price	Part No.	Price
SN7400N	19	SN7485N	55
SN7402N	19	SN7486N	35
SN7404N	25	SN7488N	1.95
SN7405N	29	SN7490N	39
SN7408N	29	SN7493N	35
SN7407N	29	SN74121N	29
SN7403N	25	SN74123N	49
SN7410N	19	SN74125N	45
SN7414N	45	SN74126N	49
SN7416N	35	SN74143N	3.95
SN7417N	35	SN74150N	1.29
SN7420N	19	SN74154N	1.25
SN7430N	19	SN74155N	1.39
SN7432N	29	SN74173N	75
SN7436N	29	SN74174N	59
SN7442N	45	SN74175N	59
SN7445N	69	SN74176N	89
SN7446N	79	SN74189N	1.95
SN7447N	79	SN74193N	1.95
SN7448N	39	SN74193N	69
SN7472N	39	SN74198N	1.35
SN7473N	35	SN74221N	89
SN7474N	35	SN74273N	1.95
SN7475N	39	SN74365N	59
SN7476N	35	SN74376N	59

74LS

74LS00	19	74LS185	79
74LS02	19	74LS189	89
74LS04	25	74LS173	49
74LS05	25	74LS174	39
74LS06	99	74LS175	39
74LS07	99	74LS188	3.95
74LS08	19	74LS191	89
74LS14	19	74LS193	89
74LS10	39	74LS221	59
74LS12	26	74LS240	89
74LS30	19	74LS243	69
74LS32	26	74LS244	69
74LS42	39	74LS245	79
74LS47	29	74LS254	1.19
74LS73	35	74LS273	79
74LS74	25	74LS279	39
74LS75	29	74LS322	2.95
74LS76	29	74LS365	39
74LS85	49	74LS389	39
74LS86	25	74LS387	39
74LS90	39	74LS366	39
74LS93	39	74LS373	79
74LS123	49	74LS374	79
74LS125	39	74LS393	79
74LS138	39	74LS990	5.95
74LS139	39	74LS254	1.05
74LS154	1.49	74LS229	2.49
74LS157	35	74LS640	99
74LS158	35	74LS645	99
74LS163	49	74LS670	99
74LS164	49	74LS577	1.95

74S/PROMS*

74S00	29	74S188	1.75
74S04	35	74S189	1.95
74S05	39	74S240	1.49
74S10	29	74S244	1.49
74S32	35	74S254	1.49
74S74	49	74S257	1.69
74S85	1.49	74S287	1.69
74S86	35	74S288	1.69
74S124	2.75	74S373	1.69
74S174	79	74S472	3.49
74S175	79		

74ALS

74ALS00	35	74ALS138	89
74ALS02	35	74ALS174	89
74ALS04	39	74ALS175	89
74ALS08	35	74ALS240	1.79
74ALS10	35	74ALS244	1.79
74ALS27	49	74ALS373	1.95
74ALS30	35	74ALS374	1.95
74ALS32	39	74ALS573	1.95
74ALS74	55		

74F

74F00	50	74F139	1.29
74F04	65	74F157	1.29
74F08	59	74F183	4.95
74F10	59	74F240	2.49
74F32	69	74F253	1.79
74F74	69	74F373	2.95
74F96	89	74F374	2.95
74F138	1.19		

CD-CMOS

CD4001	19	CD4081	25
CD4001	19	CD4082	25
CD4013	19	CD4053	39
CD4018	29	CD4054	1.49
CD4017	49	CD40103	2.95
CD4018	89	CD4503	49
CD4020	69	CD4510	59
CD4024	49	CD4511	59
CD4027	29	CD4512	1.29
CD4030	39	CD4518	79
CD4040	65	CD4520	79
CD4049	29	CD4522	79
CD4050	29	CD4538	59
CD4051	65	CD4541	69
CD4052	65	CD4543	69
CD4053	65	CD4553	4.95
CD4059	3.49	CD4555	89
CD4060	89	CD4566	1.95
CD4066	29	CD4893	1.19
CD4069	25	CD4894	59
CD4070	29	CD4826	75
CD4071	25	MC14411	9.95
CD4072	25	MC14490P	4.49
CD4076	89	MC14572	89

COMMODORE CHIPS

For VIC-20, C-64 and C-128 Personal Computers

Part No.	Price	Part No.	Price	Part No.	Price
*8502 MPU w/Clock	2.75	*8526CIA	14.95	*8572	19.95
*8507	8.95	*8529SFI	7.95	*8581SID	19.95
*8508 w/RAM & I/O	14.95	*8551ACIA	3.95	*8582IOPLA	18.95
*8510CPU	9.95	*8590VIC-I	14.95	*8701 Clock Chip	9.95
*8526PT	9.95	*8591VIC-II	19.95	*8721FLA	14.95
*Specs. Available @ \$1.50 each		*8569	19.95	NOTE: 8261D0 = 417 (C-64)	

NEC V20 & V30 CHIPS

Replace the 8086 or 8088 in Your IBM-PC and Increase Its Speed by up to 40%!

Part No.	Price
UPD70108D-5 (5MHz) V20 Chip	\$11.95
UPD70108B-8 (8MHz) V20 Chip	\$18.95
UPD70116D-8 (8MHz) V30 Chip	\$15.95

MICROPROCESSOR COMPONENTS

MICROPROCESSOR CHIPS	8500/8800/88000 Cont.	8080 SERIES Cont.	
Part No.	Price	Part No.	Price
D765AC	4.95	8237-5	6.95
CDP1020CE	6.95	8243	2.49
2661-3	6.95	8250A	6.95
286, 286A, 286C, SERIES			
Z80	1.79	8251A	7.15
Z80-CTC	1.79	8251-5	2.25
Z80-DART	4.99	8254-2	1.95
Z80-FD	1.79	8255A-5	2.49
Z80A	1.85	8257-5	2.49
Z80A-CTC	1.89	8259-5	2.49
Z80A-DART	1.95	8272	4.95
Z80A-FD	1.95	8273	2.95
Z80A-SIO/CT	5.25	8741	6.95
Z80B	3.95	8746	7.95
Z80B-CTC	3.95	8749	6.95
Z80B-FD	4.95	8755	14.95
8500/8800/88000 SER.			
6502	2.75	8080 SERIES Cont.	
65C02	10.95	ADOC0804	3.49
65C02-1	2.95	ADOC0808	8.95
6522	4.95	ADOC0903	3.95
6532	6.49	ADOC0816	14.95
6551	3.95	ADOC0817	8.95
6500	4.95	ADOC0808	1.95
6502	4.95	DAC1006	7.95
6610	1.95	AY-3-1015D	4.95
6621	1.95	AY-5-1013A	3.95
6640	8.75		
8080 SERIES			
80C1	6.95		
80C91BH	19.95		
80C35	3.95		
8073N	29.95		
8090A	3.95		
8085A	2.75		
8096	3.95		
8096-2	10.95		
8087 (8MHz)	12.95		
8087-2 (8MHz)	19.95		
8098	3.95		
8098-2	9.95		
8116	9.95		
8135	2.75		
8150	3.95		
8156	2.75		
8202	9.95		
8203	24.95		
8212	1.95		
8224	2.25		
8226	3.49		

Part No.	Function	Dynamic RAMS	Price
4116N-15	16,384 x 1	(150ns)	.89
4128 (Piggyback)	131,072 x 1	(200ns)	5.95
4164N-150	69,536 x 1	(150ns)	1.25
4164N-200	65,536 x 1	(200ns)	1.15
TMS4416-12	16,384 x 4	(120ns)	4.95
MM5280	4096 x 1	(200ns) 2107	1.95
6118	16,384 x 1	(120ns)	.69
41296-150	262,144 x 1	(150ns)	2.95
50484-15	65,536 x 4	(150ns) (4464) (41484)	5.49
STATIC RAMS			
TN4M2018-12	2048 x 8	(120ns)	1.69
2102	1024 x 1	(350ns)	.89
2102-2L	1024 x 1	(250ns) LP (91L02)	1.49
2114N	1024 x 4	(450ns)	.99
2114N-L	1024 x 4	(450ns) LP	1.09
2114N-2L	1024 x 4	(200ns) CMOS	1.59
2114N-2L	1024 x 4	(200ns) (CMOS)	1.49
2149	1024 x 4	(45ns)	4.95
5101	256 x 4	(450ns) CMOS	3.95
HM8116P-3	2048 x 8	(150ns) CMOS	1.49
HM8116LP-3	2048 x 8	(150ns) LP CMOS	1.49
HM8264P-12	8192 x 8	(120ns) CMOS	4.09
HM8264LP-12	8192 x 8	(120ns) LP CMOS	4.29
HM8264P-15	8192 x 8	(150ns) CMOS	3.75
HM8264LP-15	8192 x 8	(150ns) LP CMOS	3.89
6514	1024 x 4	(350ns) CMOS (UPD444C)	4.49

Part No.	Price	Part No.	Price
7102A	256 x 8	1702A	256 x 8
71052516	2048 x 8	71052516	2048 x 8
TMS2332	4096 x 8	TMS2332	4096 x 8
TMS2564	8192 x 8	TMS2564	8192 x 8
2708	1024 x 8	2708	1024 x 8
TMS2716	2048 x 8	TMS2716	2048 x 8
2716	2048 x 8	2716	2048 x 8
27C16	2048 x 8	27C16	2048 x 8
2732	4096 x 8	2732	4096 x 8
2732A-20	4096 x 8	2732A-20	4096 x 8
2732A-25	4096 x 8	2732A-25	4096 x 8
2732A-45	4096 x 8	2732A-45	4096 x 8
27C32	4096 x 8	27C32	4096 x 8
2758	1024 x 8	2758	1024 x 8
2764-20	8192 x 8	2764-20	8192 x 8
2764-25	8192 x 8	2764-25	8192 x 8
2764-45	8192 x 8	2764-45	8192 x 8
27D54	8192 x 8	27D54	8192 x 8
27128-25	16,384 x 8	27128-25	16,384 x 8
27128A-25	16,384 x 8	27128A-25	16,384 x 8
27256-25	32,768 x 8	27256-25	32,768 x 8
27C256-25	32,768 x 8	27C256-25	32,768 x 8
27512-25	65,536 x 8	27512-25	65,536 x 8
68764	8192 x 8	68764	8192 x 8
68976	8192 x 8	68976	8192 x 8
74S387	256 x 4	74S387	256 x 4
74S471	256 x 8	74S471	256 x 8
82S123	32 x 8	82S123	32 x 8

Part No.	Price	Part No.	Price
8 pin LP	13	12	11
14 pin LP	15	13	11
16 pin LP	17	15	13
24 pin LP	31	30	29
28 pin LP	37	35	33
40 pin LP	49	46	43
WIRE WRAP SOCKETS (GOLD) LEVEL NS			
8 pin WW	55	49	45
14 pin WW	69	63	59
16 pin WW	75	69	65
24 pin WW	119	109	99
28 pin WW	139	129	119
40 pin WW	179	159	159

SOLDERED STANDARD (GOLD & TIN) AND HEATER PLUG SOCKETS ALSO AVAILABLE

SATELLITE TV DESCRIBER

The MM5321 is a TV camera sync generator designed to supply the basic sync functions for either color or monochrome 525 line/60Hz interlaced and camera video recorder applications. **COLOR BURST GATE & SYNC ALLOW STABLE COLOR OPERATION**

MM5321... \$9.95

DIGITALK™

DT1050 - Applications: Teaching aids, appliances, clocks, automotive, telecommunications, language translators, etc. The DT1050 is a standard DIGITALK kit encoded with 137 separate and useful words, 2 tones, and 5 different sound durations. The words and tones have been assigned discrete addresses, making it possible to output single words or words concatenated into phrases or even sentences. The voice™ output of the DT1050 is a highly intelligible male voice. The DT1050 consists of a Speech Processor Chip, MM54104 (48-pin) and two (2) Speech ROMs MM5216438R1 and MM5216439R2 (24-pin) along with a Master Word list and a recommended schematic diagram on the application sheet.

DT1050... \$24.95

MM54104... \$ 9.95

DT1057 - Expands the DT1050 vocabulary from 137 words to over 250 words. Includes two (2) ROMs and specs.

DT1057... \$11.95

Worldwide • Since 1974

• QUALITY COMPONENTS • COMPETITIVE PRICING • PROMPT DELIVERY

Mail Order Electronics • Worldwide
Jameco
ELECTRONICS

COMMODORE™ COMPATIBLE ACCESSORIES

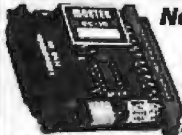

Now Compatible With C-128!
RS232 Adapter for VIC-20, C-64 and C-128

The JE232CM allows connection of standard serial RS232 printers, modems, etc. to your VIC-20, C-64 (excluding the SX-64 Portable), and C-128. A 4-pole switch allows the inversion of the 4 control lines. Complete installation and operation instructions included.

• Plugs into User Port • Provides Standard RS232 signal levels
• Uses 6 signals (Transmit, Receive, Clear to Send, Request to Send, Data Terminal Ready, Data Set Ready)

JE232CM..... \$39.95

Voice Synthesizer VIC-20 & C-64
Plug-in - Talking in Minutes!

JE520CM..... \$99.95

300 Baud Auto Modem

Mitey-Mo (For C-64)..... \$54.95

Parallel Printer Interface

2K Buffer, Expandable to 10K!

MW350 (For VIC-20, C-64 & C-128)..... \$54.95

TRS-80™ COMPATIBLE ACCESSORIES

E-X-P-A-N-D TRS-80 MEMORY

All kits come complete with documentation

TRS-80 MODEL I, II

TRS-16K3 200ns (Model III)..... \$5.95

TRS-16K4 250ns (Model I)..... \$5.49

TRS-80 COLOR AND COLOR II

TRS-64K2..... \$11.95

New models only -

TRS-CoCo-Incl. 2-50484's (41484's)..... \$13.49

TRS-80 MODEL 4, 4P

TRS-64K2..... \$11.95

Expands Model 4 from 16K-64K or Model 4P from 64K-128K

TRS-64K2PAL..... \$29.95

Expands Model 4 from 64K to 128K

TRS-80 Model 100 • NEC • Olivetti

M100K..... \$24.95 ea. or 3 for \$59.95

TRS-80 Model 100 Expansion

NEC8KR..... \$24.95 ea. or 3 for \$59.95

NEC Model PC-8201A Expansion

OM108K..... \$24.95 ea. or 3 for \$59.95

Olivetti Model M10 Expansion

TANDY 200

M200R..... \$74.95 ea. or 2 for \$129.95

Tandy Model 200 Expansion

UV-EPROM ERASER



Erases all EPROMs. Erases up to 8 chips within 21 minutes (1 chip in 15 minutes). Maintains constant exposure distance of 1". Special conductive foam liner eliminates static build-up. Built-in safety lock to prevent UV exposure. Compact - 9.00" L x 3.70" W x 2.60" H. Complete with holding tray for 8 chips.

DE-4 UV-EPROM Eraser..... \$74.95

UVS-11EL Replacement Bulb..... \$17.95

DATA BOOKS

30003 National Linear Data Book (83)..... \$14.95

30009 Intersil Data Book (85)..... \$ 9.95

30013 Zilog Data Book (85)..... \$14.95

30032 National Linear Supplement (84)..... \$ 6.95

210830 Intel Memory Handbook (86)..... \$17.95

230843 Intel Microsystem Hndbk. Set (86)..... \$24.95

MUFFIN/SPRITE-STYLE FANS



MUF80 (8PM15-2462)..... \$9.95

Howard Industries (4.68" sq, 80 cfm)

SUC27..... \$9.95

EG&G Rotron (3.125" square, 20 cfm)

NEW!



13" Color Composite Monitor
for VIC-20 and C-64

Also compatible with other computers with composite output (i.e. Apple II, II+, IIe*)

Ideal for color graphics and games
• Resolution: 260H x 300V • Recommended Display Character Number: 960 Characters (40 Characters x 24 Rows on 5x7 Dot Matrix)
• CRT: 13" diagonal • Size: 14.8" W x 13.5" H x 15.5" D • Weight: 25.3 lbs

2 for

CMON..... \$129.95 each or \$219.95

RCA-3-DIN (Universal Computer to Monitor Cables for Atari, Commodore & TI).... \$3.49

NEW PRODUCTS!

ZUCKERBOARD Expansion Memory Half Card and Clock/Calendar for the Tandy 1000



The Zuckerboard Expansion Memory Board allows you to expand the memory of your Tandy 1000 (128K Model) as much as 640K! 256K DRAM chips increase your computer's memory by either 256K or 512K, bringing your total system memory up to either 384K or 640K. The memory board also includes a DMA controller chip. Optional clock/calendar plugs directly onto the memory board. Manual included.

TAN-Clock Clock/Calendar Option (only)..... \$ 39.95

TAN-EM256K Includes 256K RAM..... \$ 99.95

TAN-EM512K Includes 512K RAM..... \$139.95



1MBYTE RAM CARD
for Apple II, II+ and IIe*

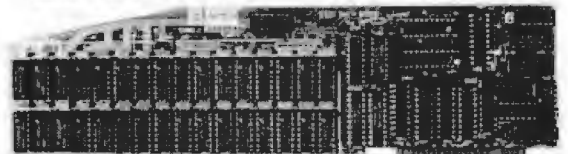

Introducing a third generation memory card that gives you both great expandability and great versatility at an extraordinary price. Versatility to users means that BIG BOARD is compatible with software written for the Syntex SSD (Flashcard) as well as for Jameco's JE888 128K RAM Card. Big Board makes available 426K of worksheet space, using the program THE Spreadsheet Version 2.0. It is compatible with PLUSWORKS XM for running Appleworks on the Apple II. Versatility also means that BIG BOARD comes complete with RAMDISK software for DOS 3.3, ProDOS, Pascal 1.2, and CP/M for Microsoft's Softcard. A separate driver is available for the AppliCard (StarCard).

BIG BOARD-256K 256K RAM..... \$199.95

BIG BOARD-512K 512K RAM..... \$249.95

BIG BOARD-1M 1Meg RAM..... \$299.95

1 Yr. Warranty!

eytes

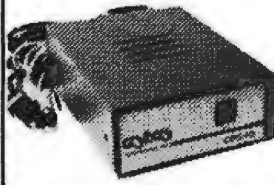

External Power Supply for the Commodore 64

• Input: 117VAC @ 60Hz • Output: 5VDC @ 3 Amps, 10VAC @ 250mA • Short circuit protected and current limited • Transient spike suppression on 2 auxiliary 110VAC sockets
• Switch on front serves as power switch for the computer and other peripherals
• RFI/EMI filtered • Adjustable linear regulator • Has less than 50mV ripple rms at full load • 5 Amp primary fuse • Two conductor with ground line • Color: brown • Size: 7 1/2" D x 5 1/2" W x 2 1/2" H • Weight: 5 lbs.

CPS-10..... \$39.95

IBM™ COMPATIBLE ACCESSORIES

83-KEY KEYBOARD



• Identical layout as original IBM PC Keyboard • Highly desirable case with palm rest • Complete with cable and data • JUST PLUG IN!

KB83..... **SALE**..... \$29.95

Build an IBM PC/XT™ Compatible!

IBM-64K(2) 64K RAM Chips (18)..... \$ 24.98

KB-83 83-Key Keyboard..... \$ 29.95

IBM-FCC Floppy Controller Card..... \$ 49.95

IBM-Case Case..... \$ 49.95

IBM-MCC Monochrome Card..... \$ 89.95

IBM-PS Power Supply..... \$ 89.95

FD55B Disk Drive..... \$119.95

IBM-MON Monochrome Monitor..... \$109.95

IBM-MB Motherboard..... \$169.95

Regular List \$734.58

IBM™-Special (Incl. 9 items above) .. \$649.95

Additional Add-Ons Available!

IBM-KB 83-Key Keyboard..... \$ 79.95

IBM-ENH Enhanced Keyboard..... \$ 99.95

IBM-ICB Integrated Color Board..... \$109.95

IBM-EGA Enh. Graphics 256K RAM..... \$349.95

IBM-20MBK 20MB Hard Disk Drive..... \$499.95

IBM is a registered trademark of IBM Computers

NEW! Universal 64K/256K NEW! Printer Buffer

JOHNATHAN FREEMAN DESIGNS



The UBUFFER Universal Printer Buffer is a hi-speed data buffer that accepts data at a high rate, and then outputs this data to your printer. You save valuable computer time. The UBUFFER can be connected to practically any computer or printer. There are four possible combinations: 1) Serial to Serial, 2) Serial to Parallel, 3) Parallel to Parallel, 4) Parallel to Serial. Manual included. Size: 9-1/2" L x 4-1/2" W x 1-1/2" H.

UBUFFER-64K... \$199.95

UBUFFER-256K... \$229.95

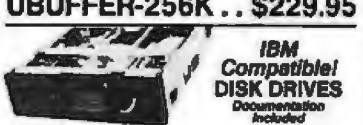

FD55B Teac 5 1/4" DS II-Height..... \$119.95

SA455 Shugart 5 1/4" DS II-Height..... \$119.95

TM100-2 Tandon 5 1/4" DS Full-Height..... \$109.95

JMR 5 1/4" DISK DRIVE ENCLOSURES

Complete with power supply switch, power cord, fuseholder and connectors.

DDE-1FH Houses 1 Full-Height 5 1/4" Floppy Drive..... \$69.95

DDE-2NH Houses 2 Half-Height 5 1/4" Floppy Drives - Vertical..... \$79.95

HDDE-1FH Houses 1 Hard Disk Drive..... \$199.95

\$20 Minimum Order - U.S. Funds Only
Shipping: Add 5% plus \$1.50 Insurance

California Residents: Add 6% or 6 1/2% Sales Tax

Spec. Sheets - 30¢ each
Prices Subject to Change

Send stamped, self-addressed envelope to receive a Quarterly Sales Flyer - FREE!

8/86



Send \$1.00 Postage for a FREE 1986 JAMECO CATALOG

©1986 Jameco Electronics

1355 SHOREWAY ROAD, BELMONT, CA 94002 • PHONE ORDERS WELCOME 415-592-8097 Telex: 176043

1200 BAUD MODEM

These truly Hayes compatible, intelligent 1200 baud modems have features found on the expensive name brand modems. Choose either the internal Jade 1200 baud Smart-Card, including

software for your IBM PC compatible; or our best selling Jade 1200 baud external modem for any computer with a serial RS-232C port. We guarantee you will be satisfied.

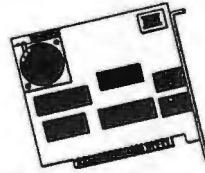

\$149

INTERNAL OR EXTERNAL

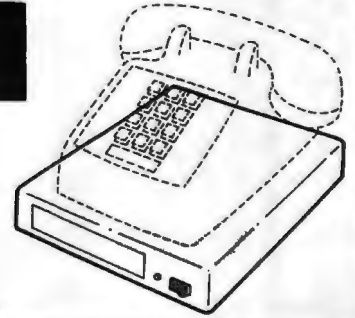

JADE XPC or XPC-AT

- 640K of RAM
- 4.77 MHz 8088
- 7 MHz turbo mode
- 135 watt power supply
- 360K disk drive
- Floppy disk controller
- 5151-style keyboard
- 8 expansion slots
- PC-style case
- 90 day warranty



\$788

- 1 MB of RAM
- 6 MHz 80286
- 8 MHz turbo mode
- 200 watt power supply
- 1.2 MB disk drive
- Floppy/hard disk controller
- AT-style keyboard
- 8 expansion slots
- AT-style case
- 90 day warranty

\$1988

HIGH RESOLUTION COLOR MONITOR

Manufactured by Hitachi

- IBM PC color graphics compatible
- High resolution 640 x 240
- Excellent dot pitch .38 mm
- 16 true colors, 2000 characters
- Accepts standard RGB input signals
- Non-glare picture tube
- New designer sculpted case

\$289

List Price \$699
Free PC RGB cable included

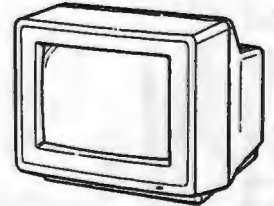

OPTION #1
Two disk drives
Mono graphics card
Parallel printer port
Amdek 310A monitor

XPC XPC-AT
\$1188 \$2488

OPTION #2
20 MB hard disk
Mono graphics card
Parallel printer port
PGS MAX-12E monitor

XPC XPC-AT
\$1588 \$2888

OPTION #3
20 MB hard disk
Color graphics card
Parallel printer port
Hitachi high res color monitor

XPC XPC-AT
\$1788 \$3088

MANNESMANN TALLY PIXY 3 3-PEN PLOTTER

\$198 LIST PRICE \$799
YOU SAVE OVER \$600!
Limited Quantity

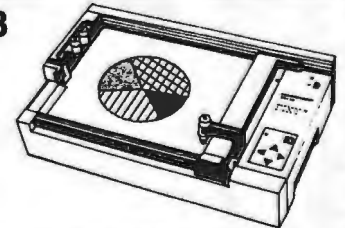

We're probably making a mistake selling this high speed plotter for only \$198. They are easily worth at least \$500 more. Compare the features to plotters costing \$2000 or more.

- High speed 8 IPS plotting
- 3-pen auto select
- 8 colors available
- Serial interface
- Full graphics + built-in fonts
- 8 1/2 x 11 paper or transparencies

	LIST	JADE
8 extra water base pens	\$30	\$16 ⁹⁵
4 extra oil base pens	\$30	\$16 ⁹⁵
100 sheets 8 1/2 x 11 paper	\$9	\$4 ⁹⁵
50 sheets 8 1/2 x 11 transparencies	\$9	\$4 ⁹⁵
Plotter software for IBM PC	\$195	\$59 ⁹⁵

KAYPRO 2000

IBM Compatible
Lap Computer

\$1188

- 768K of RAM
- 720K disk drive
- Includes FREE software

We have a limited quantity of these specially priced lap computers and Kaypro 2000 accessories at 30% off. All with a 10-day money-back guarantee—Call for details.



HARD DISK SYSTEM

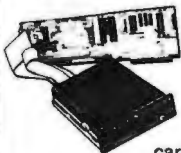

FOR YOUR IBM PC
\$399⁹⁵

Complete with controller card, data cable, and mounting hardware, totally PC/XT compatible.

10 MB Internal Kit	\$990	\$399.95
20 MB Internal 1/2 High	\$1550	\$445.95
10 MB Hard Disk Card	\$699	\$399.95
20 MB Hard Disk Card	\$899	\$588.95

POWER/SURGE PROTECTION

6 Button, Under-Monitor, Swivel Power/Surge Control Center

\$799⁹⁵

List Price \$129



6 Socket, UL Listed, U.S. Made Power/Surge Strip

\$189⁹⁵

List Price \$49

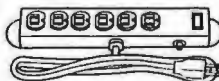

Why pay \$1149 for a C. Itoh STARWRITER F-10

when our 40 cps letter quality daisywheel from the same manufacturer is only as low as

\$399⁹⁵ Each for 5 or more

Each—\$499 | 2 to 5—\$429

*StarWriter is a Trademark of C. Itoh Digital Products, Inc.

Limited Quantity

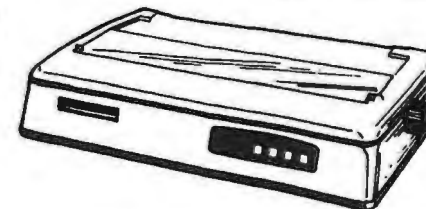

	LIST	JADE
Bi-directional deluxe tractor	\$249	\$149 ⁹⁵
Automatic cut sheet feeder	\$449	\$199 ⁹⁵

360K DISK DRIVE

IBM PC, XT or compatible

\$69⁹⁵



TANDON 100-2, DS, DD	\$299	\$119.95
TEAC 55B, DS, DD	\$249	\$119.95

FREE Software W/MOUSE

	LIST	JADE
Microsoft Mouse w/Paintbrush	\$199	\$139.95
PC Mouse w/PC Paint Plus	\$195	\$139.95

High Speed APU Chips

8087-3	\$149.95	80287	\$249.95
8087-2	\$199.95	NEC V-20	\$24.95

AST Boards On Sale!

	LIST	JADE
AST Six Pak Plus 64K	\$395	\$229.95
AST Six Pak Plus 384K	\$945	\$279.95
AST Rampage 256K	\$495	\$379.95
AST Rampage 2 MB	\$1995	\$679.95
AST Advantage-AT 128K	\$595	\$399.95
AST Advantage-AT 3 MB	\$4145	\$999.95

ISO-BAR

These industrial quality ISO-BAR's contain surge suppression circuitry and built-in noise filters plus a 15 amp circuit breaker.

	LIST	JADE
6 Socket, 1 Filter ISO-BAR	\$69	\$44.95
4 Socket, 2 Filter ISO-BAR	\$89	\$59.95
8 Socket, 4 Filter ISO-BAR	\$99	\$69.95
200 Watt Standby Power Supply	\$359	\$269.95
425 Watt Standby Power Supply	\$539	\$449.95

MICROFAZER Buffers

Expandable to 64K (Parallel model to 512K)

8K Parallel in/Parallel out	\$189	\$139.95
64K Parallel in/Parallel out	\$225	\$164.95
128K Parallel in/Parallel out	\$445	\$269.95
512K Parallel in/Parallel out	\$879	\$499.95

Your choice: serial in/serial out; parallel in/serial out; serial in/parallel out.

8K	\$199	\$169.95	64K	\$260	\$199.95
----	-------	----------	-----	-------	----------

TALLTREE

JRAM-2		JRAM 3-AT	
0K	\$169 ⁹⁵	0K	\$259 ⁹⁵
2 MB	\$599 ⁹⁵	2 MB	\$699 ⁹⁵
		Add-on Modules	
JRAM-3		S/P/C	\$159 ⁹⁵
0K	\$199 ⁹⁵	S/S/C	\$159 ⁹⁵
2 MB	\$629 ⁹⁵		

Printers

EPSON FX-85	OKIDATA
EPSON FX-286	TOSHIBA
EPSON LQ-800	CITIZEN
EPSON LQ-1000	C. ITOH
EPSON LX-80	DIABLO

PRICED TOO LOW TO PUBLISH!
Call us for our best price.

New HAYES 2400B Internal

	LIST	JADE
New 2400B Card w/Smartcom	\$799	\$579.95
HAYES Smartmodem 2400	\$899	\$629.95
HAYES Smartmodem 1200	\$699	\$389.95
HAYES 1200B w/o Smartcom II	\$539	\$339.95
HAYES 1200B for IBM PC	\$599	\$359.95

Multifunction Card

Up to 384K, parallel printer port, RS-232 serial port, game port, clock/calendar, RAM disk/printer buffer software package.

	LIST	JADE
0K JADE 7 Pak Plus	\$299	\$119.95
384K JADE 7 Pak Plus	\$649	\$199.95

135/150 Watt Power Supply

135 Watt Power Supply	\$199	\$89.95
150 Watt Power Supply	\$249	\$99.95

Apple Accessories

	LIST	JADE
IIC 1/2 High Disk Drive	\$279	\$119.95
IIE 1/2 High Disk Drive	\$239	\$119.95
IIE, II+ Disk Drive Full Ht.	\$249	\$139.95
IIE 64K, 80 Column Card	\$159	\$49.95
Grappler Printer Card	\$175	\$89.95
II+ 16K RAM Card	\$99	\$39.95
II+, IIE Printer Card & Cable	\$109	\$49.95
II+, IIE Cooling Fan	\$99	\$59.95

INTEL Above Board

64K PC expands to 2MB	\$299.95
2MB PC Above Board	\$599.95
128K AT expands to 4MB	\$449.95
4 MB AT Above Board	\$1299.95

IBM Video Boards

	LIST	JADE
Hercules Color Graphics	\$245	\$189.95
JADE Color Graphics	\$199	\$99.95
Hercules Monochrome Graphics	\$499	\$339.95
JADE Monochrome Graphics	\$299	\$119.95
JADE EGA+ Card	\$495	\$389.95

JADE COMPUTER

4901 W. Rosecrans Ave. Box 5046
Hawthorne, CA 90251-5046

We accept cash, checks, credit cards or purchase orders from qualified firms and institutions. Minimum prepaid order \$15.00. California residents add 6 1/2% tax. Prices & availability subject to change without notice. Shipping & handling charges via UPS Ground 50¢/lb. UPS Air \$1.00/lb. Minimum charge \$3.00.

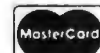

PLACE
ORDERS
TOLL
FREE!

Continental U.S.A.
(800)421-5500
Inside California
(800)262-1710
Los Angeles Area
(213)973-7707



COMPUTERBANC

IBM COMPATIBLE HARDWARE

DRIVES

20 MB Seagate drive\$439
 30 MB drive for AT\$629
 360 K Floppy for AT\$110
 Teac 55B\$109

Multifunction card 384K, S.P. CLK\$139
 AT Multifunction card OK-3MB\$169
 MONOCROME graphics card\$99
 Color Graphics card\$89
 ComBo CARD ser. par. clock\$69
 EXPANSION CHASIS 7 slots\$569

TAPE DRIVES

10 MB Irwin\$379
 20 MB Irwin\$429
 Everex Stream 20\$569
 Everex Stream 60\$899

SYSTEMS

COMPAQ 286, 20MB
 Portable, 512K, DOS
\$3999

COMPAQ Deskpro 20MB
 Seagate, 640K, Monitor, DDS
\$2399

SPERRY II 44MB
LEADING EDGE

**CALL
 CALL**

IBM AT COMPATIBLE
 8MHZ, 512K, 20meg
 Monitor, graphics, ser, par
\$2399

IBM XT COMPATIBLE
 256K, 20 meg, Monitor
 graphics, ser, par
\$1195

IBM AT 30MB\$3900
 Seagate 512K, DOS, Monitor

IBM XT 20MB\$2495
 Seagate, 256K, DOS, Monitor

EQUITYCALL
ITT XTRACALL

IBM SOFTWARE

LOTUS 123CALL
 SymphonyCALL
 ENABLE399.00
 V P Planner59.00
 ASHTON TATE FrameworkCALL
 dBASE II279.00
 dBASE III PlusCALL
 POWERBASECALL
 CLIPPER dBASE III Compiler355.00
 LATTICE C COMPILER249.00
 MULTIMATE225.00
 MULTIMATE ADVANTAGE289.00
 SORCIM SUPERCALC III199.00
 MICROSOFT Multiplan119.00
 WordCALL
 Windows65.00
 Project239.00
 FOX & GELLER Quickcode149.00
 BORELAND TURBO PASCAL39.00
 REFLEX89.00
 LIGHTENING39.00
 SUPERKEY49.00
 SIDEKICK (unprotected)49.00
 ASCII PRO Comm Software69.00
 GROSSTALK XVI99.00
 MIRROR Comm Software49.00
 PEACHTREE Back to Basics199.00
 BPI GENERAL ACCOUNTING299.00
 OPEN SYSTEMSCALL
 REALWORLDCALL
 ONE-WHITE PLUS149.00
 IN-HOUSE ACCOUNTANT89.00
 ACCOUNTING PARTNER199.00
 MONOGRAM DOLLARS & SENSE89.00
 TOBIAS MANAGING YOUR MONEY99.00
 SATELLITE WORD PERFECT225.00
 MICROPRO WordStar PRO249.00

WordStar 2000 PLUS285.00
 SAMNA WORD III279.00
 RBASE 5000359.00
 PRINTMASTER35.00
 BREAKTHROUGH TIMELINE255.00
 DECISION RESOURCES CHRISTMAS219.00
 ENERGRAPHICS w/plotter opt207.00
 FUNK SIDEWAYS36.00
 LIFETREE VOLKSWRITER DELUXE149.00
 HARVARD TTL PROJECT MNGR285.00
 THINKTANK110.00

IBM HARDWARE

AST 6 Pack Plus w/384k229.00
 Advantage W/128k399.00
 STB Rio Plus 384K 5 function215.00
 RIO Grande 3 function for AT289.00
 Companion PC 0 2 MB LIMS189.00
 Chauflour monographics229.00
 EGA - Plus Color Board325.00
 JRAM 3179.00
 JRAM AT3225.00
 HERCULES Mono Graphics
 Color CardCALL
 ORCHID Tiny TurboCALL
 QUADRAM Quadboard D-K
 EGA +195.00
 QuadPort for AT ser & par379.00
 PARADISE Modular Graphics Card
 130 WAT Power Supply125.00
 TALLORASS W/Tape
 Graphics Edge CardCALL
 1.2MB FLOPPY for AT239.00
 HOUSE SYSTEMS Mouse189.00
 MICROSOFT Mouse w/stlwr119.00
 KOALA RAT137.00

MODEMS

ANCHOR Express 300/1200199.00
 Volksmodem 1200 (5 yr wrmy)118.00
 EXPRESS 1300/1200149.00
 Lightning 2400 BaudCALL
 HAYES 1200369.00
 1200B349.00
 2400CALL
 PROMETHEUS 1200259.00
 Promodem 1200B219.00
 Promodem 1700A249.00
 Promodem 300 IIC115.00
 Promodem 2400CALL

**SUMMER
 SPECIALS**

MONITORS

AMDEK 300A139.00
 310A Hi-Res Amber149.00
 Color 722 RGB 720 X 350CALL
 PRINCETON GRAPHICS HX-12399.00
 HX-12E RGB 720X350CALL
 SR-12CALL
 SR-12149.00
 MAX-12CALL
 TAXAM: ALL MODELS
 PANASONICCALL
 DF-H103 10" High Res RGB399.00
 IBM COMPATIBLE Monochrome99.00
 Color RGB Monitor (640X200)349.00

PRINTERS

PANASONIC (2 yr warranty)
 KX-P1080199.00
 KX-P1091229.00
 KX-P1092315.00
 KX-P1592419.00
 KX-P1595 240 CPSCALL
 KX-P3131 12cps Daisey249.00
 KX-P3151 22 cps Daisey385.00

Citizen MSP-10299.00
 MSP-15405.00
 MSP-25CALL
 STAR MICRONICSCALL
 EPSON LK-80CALL
 FX-286for
 LQ-800Best
 LQ-1000Prices
 LQ-1000379.00
 BROTHER-1509829.00
 Twinwriter 5CALL
 OKIDATA - All ModelsCALL
 TOSHIBA All ModelsCALL
 CANNON Laser PrinterCALL
 HEWLETT PACKARD PRINTERSCALL
 HOUSTON INSTRUMENTS Plotters
 DigitizersCALL

APPLE PRODUCTS

APPLE Compatible Drive IIe99.00
 IIC compatible drive99.00
 MAC Compatible 3 1/2 drive229.00
 MICROSOFT Softcard II259.00
 ASCII XPRESS (Communications)69.00
 APPLEWORKS215.00
 SPELLWORKS49.00
 PRINT SHOP35.00
 Mach III Joystick39.00
 SYSTEM SAVER Fan69.00
 VIDEO 7 IIC EnhancerCALL
 VIDEX Ultratrim165.00
 APRICORN (Lifetime Warranty)
 Super Serial Imager75.00
 Graphics Interlace65.00
 80 Column/64K75.00
 EXTEND IT 64K55.00
 KOALA Speedkey99.00

Call for catalog. Thousands of products available. Volume discounts.



COMPUTERBANC

16783 Beach Blvd., Huntington Beach, CA 92647
 TELEX #550757 ANSWER BACK—COMPUTER UD



For Customer Service Call 714-847-BANC



Orders Only

800/332-BANC

OUTSIDE CALIFORNIA

714/841-6160

Cash prices indicated. All products are in factory sealed packages. We guarantee all items for 30 days. Within this period, defective merchandise returns must be accompanied by RMA number. All other returns will be subject to a 10% restocking fee. For prepaid orders, there will be a 3% shipping charge; 5% for UPS Blue Label; \$5.00 minimum; all orders outside U.S.A. at 15% shipping. California residents add 6% sales tax. Prices subject to change without notice.
 ©Copyright 1985 COMPUTERBANC. All Rights Reserved.

LOOK what's Inside!

5 Complete Systems

Pricing!

XAT TURBO



The **XAT** is our most versatile and powerful system. Using Intel's 80286 processor, the system runs at 6 and 8 MHz with a true 16-bit data bus. Comes standard with a 3 meg Add-On board, 2 parallel & one serial port, monitor, keyboard, DOS 3.1, two 1/2 height DS DD 1.2 meg floppies.

XPC TURBO



The standard system is as compatible with IBM as it can be. Featuring a 4 layer mother board, 8 slot expansion up to 840K memory on the motherboard, and the 6.67 MHz **TURBO** mode. Also included: DOS 3.1, keyboard, 135 watt power supply, TTL 720 & 348 resolution video card, green or amber monitor, serial & parallel ports, Real Time Clock, and software.

XTC TURBO



The perfect choice for the system integrator. The IBM compatibility, but not in the standard PC case. The 3 meg floppies, 8 slot and 840K memory, 2 height, 1/2 height, and 1/2 height floppy or hard disk, and 1/2 height 135 watt power supply. Also included: DOS 3.1, File Server, and a multi-user configuration.

XT Jr.



The **XT Jr.** is only junior in size! With up to 640K memory on the motherboard and four expansion slots, the stand-alone system is also great for workstations in a networking environment. It can be upgraded to the **TURBO** two speed motherboard and you can also add up to 2 serial & 2 parallel ports or any IBM compatible expansion card. A perfect word processing data entry system.

XPC Compact



This is truly the affordable portable and we'll build it to your specifications. Need a 20 meg hard disk and 20 meg tape with 640K memory in your portable? No problem! The **XPC Compact** comes standard with a 9 amber TTL monitor, 135 watt P S, 256K memory, two 360K drives, Real Time Clock, Calendar, a battery Back-up, serial and parallel ports, and our **TURBO** Motherboard.

Amsterdam ■ 020-45-26-50

24 Add-On Cards

Germany ■

2 MB Expansion Board

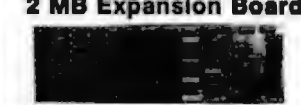

This board embodies the new approach suggested by INTEL and Logic 1-2-3. Also may be used on our **XT-SBC TURBO** board for memory based at 0K.

Hard Disk Controller



The Western Digital controller handles 1 or 2 drives, 5 to 140 megabytes with minimum software configuration. Features DOS 2.1 & 3.1 compatibility and 67 50K interface.

384K Multi-Function



A Multi-Function board featuring Parallel Port, Serial Port, Game Port, Real Time Clock, Calendar with Battery Back-up, Expand to 384K, all Cables, PrintSpooler and RAM Disk Software and Manuals.

4 Meg Token Ring



Control your workstation to an existing 4 Megabyte IBM token ring system or build up your own IEEE 802.5 standard system. The lowest possible cost for 100% security standard compatibility.

AT H.D. & Floppy



This new Western Digital control board with 3 1/2 speed VLSI technology will give you a dual monitor and 50% faster than the existing control board in the AT class. Both 360K and 1.2 meg floppy disk drives.

Mono & Color Graphics



Supports two levels of graphics and text in composite monochrome or RGB color. Low resolution 320 x 200 pixel, high resolution 640 x 200 pixel.

7 PAK Multi-Function



Features Floppy Controller, Parallel Port, Serial Port, Clock Calendar with Battery Back-up, RAMDisk, PrintSpooler, all Cables & manuals.

PROM Laser



High speed algorithms will burn 2716, 2732, 2732A, 2764 (in 52 sec), 27128, 27288 EPROMS under software control right in your PC. Zero Force Insertion Sockets, Software, and Manual.

England ■

35 Components

Bombay ■ 357172

Motherboards
XAT TURBO XT-SBC



- RTC Calendar
- 6 & 8 MHz clock
- 8 slot expansion
- Intel 80286
- 4 77 & 6 MHz clock
- Serial & Parallel
- 4 layer PCB design
- RTC Calendar

XPC TURBO XPC-XT



- 4 77 & 6.67 MHz
- 4 layer PCB design
- 8 slot expansion
- up to 640K Memory
- 8086 processor
- Standard 4 77 MHz
- up to 640K memory
- 8 slot expansion
- Standard 8086 CPU
- 8086 processor

Power Supplys
XT 135 watt XT 150 watt



- 135w switched
- Whisper Fan
- 8 AC switch
- 5V-15A - 5V 5A
- 12V-4.2A - 12V 5A
- 200 watt XTC 135
- Whisper fan
- W Output 50 Watt
- 4 DC connectors
- 5V-15A - 5V 5A
- 12V 5A - 12V 5A



- 135 Watt power
- 8 AC switch
- 4 DC power conn
- 5V 20A - 5V 5A
- 12V 7.7A - 12V 5A
- Rear Mount
- Rear On Off switch
- extra AC outlet
- 5V-15A - 5V 5A
- 12V 5A - 12V 5A

Cabinets

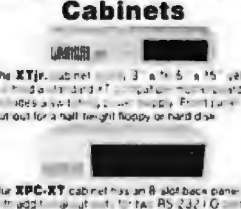

The **XT Jr.** cabinet has a 3 x 4 x 6 x 15" size. It has a 1/2 height and 1/2 height floppy or hard disk. Includes a 135 watt power supply. Front panel cut out for a half height floppy or hard disk.



Our **XPC-XT** cabinet has an 8 slot back panel with a 1/2 height cut out for the RS 232 C ports. Features mounting holes for a half height computer terminal.

The right choice for all external add on cabinet. Add on a floppy tape back-up or up to 33 meg of hard disk half height. Switching power supply is included.

Keyboards

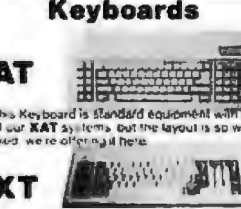

AT
 This Keyboard is standard equipment with 33 of our **XAT** systems. But the layout is so well liked, we're offering it here.

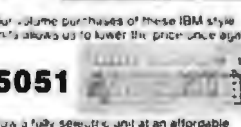

XT
 Our volume purchases of these IBM style units allow us to lower the price on our agent.

5051
 Now a fully electric unit at an affordable price. Features a 10 key numeric pad & a separate cursor pad.

Drives



Archive
Irwin
Maxtor
Memtek
Miniscribe
Panasonic
Seagate
TEAC
Tulin

3 Sub-Systems



This full height cabinet will hold a Tape Back-up with full or 1/2 height Hard Disk inside for two Hard Disks.

A perfect cabinet for Tape or Hard Disk - a nice addition to your PC.

Choose from single 1/2 height, dual 1/2 height or 1/2 height with full height base. All Sub-systems include controllers, cables, software and manuals.

3 Networks

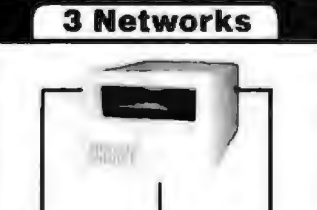

One way to stay ahead of the competition is by using a Multi-User Network System. Get yours from **Micro Products International**. Choose between RS 232 C, **XDR-NET**, **SDLC** or Token Ring. Data transfer rate up to 4 megabyte/second can be obtained.

Cassette Training



What's the Cassette Training concept? Using interactive Audio Training to combine the advantage of your own and self training.

The Method: You record your voice & listening explaining the program. You then record back on a high speed keyboard. The program will play back your voice. Software intervals the time between your voice & the student keyboard input which is monitored for accuracy by the **MITS CODED**.

Int/Ext Modems



- FCC approved for direct RUM connection
- Phone Cable & Power Supply
- Finally a price breakthrough on a Hayes compatible external 300-1200 baud modem. Includes driver software.
- Runs the popular Hayes communications software
- Also runs XCOM software
- Also runs Hayes communications software
- Runs the popular Hayes communications software
- We included everything you would want in a modem card. It's FCC registered for direct connection to your modular phone line with the cord included.

DiskMASTER[®]

The Ultimate Diskette Value ...

Discover The Difference ...

2 FOR 1 LIFETIME WARRANTY

- Performance exceeds ANSI specifications by 62.5%
- Each diskette 100% tested and certified error free
- 65% clipping level • Over 10 million passes per track
- Reinforced Hubs • Tyvek® (not paper) sleeves
- W/P tabs and ID labels

SS-DD **.54** 5 1/4 48 TPI **.59** DS-DD

Simply top Brand-Name Quality, made in the U.S.A. to our specifications by a leading manufacturer. Factory polybagged in lots of 25. Quantity discounts available.

CenTech[®]

America's Premium Quality Color Diskettes

TIMELESS WARRANTY

- Performance exceeds A.N.S.I. specifications by 88%
- Each disk 100% tested and certified
- 14 COLORS for data organization
- Pkgs. of 10, tyvek sleeves, w/p tabs, and ID labels

SS-DD QTY. 10 BOXES OR 100 DISKETTES DS-DD

.74 5 1/4" Color, BOXED, 48 TPI **.98**

1.39 3.5" Color, BOXED **1.99**

.64 5 1/4" Color, BULK, 48 TPI **.88**

1.30 3.5" Color, BULK **1.92**

High Density, Color, 1.6mb, IBM AT Compatible **2.05**

Includes Tyvek sleeves, w/p tabs, ID labels
Call for excellent prices on other CenTech products

America's No. 1 Name-Brand Diskettes

LIFETIME WARRANTY

- High quality and consistently reliable
- More rigid jackets than ever before

SS-DD QTY. 5 BOXES DS-DD

.74 5.25, 48 TPI **.99**

1.35 3.5, 135 TPI **1.95**

DS-HD 96 TPI, IBM AT Compatible **2.09**

Call for best 3M prices on head cleaning and data cartridges.

Nashua[™]

Affordable Quality Incredible Value Best Prices Ever!

LIFETIME WARRANTY

- Factory Fresh in BOXES of 10 with sleeves, w/p tab, ID labels

SS-DD QTY. 10 BOXES DS-DD

.63 5.25, 48 TPI, box of 10 **.69**

1.59 3.5, 135 TPI **2.19**

High Density, IBM PC-AT Compatible **2.09**

BULK SPECIAL OF THE MONTH

Made in U.S.A.

LIFETIME WARRANTY

- Exceeds ANSI specifications
- Includes Tyvek sleeves and w/p tab

MULTIPLES OF 100

5 1/4 DS-DD 38¢

ORDERING INFORMATION

TERMS: Free use of VISA, Mastercard, and American Express. P.O. orders accepted from recognized corporations rated 3A2 or better, government and schools on 2% net 30. PAYMENT: Add \$3.00 per 100 diskettes or fraction thereof, add \$3.00 for head cleaning kit or dozen ribbons, add \$3.00 for COO orders.

PRICE PROMISE: We will better any lower delivered price on the same products and quantities advertised nationally.

Toll Free Order Line: **1-800-233-2477** Information Line: **1-801-561-0092**

199 Cottage Avenue
Salt Lake City, Utah 84070
Hours: 9am to 5pm
(min. time)

Computer Affairs, inc.

Serial Parallel

NEW!

Convert What You Have To What You Want!

- RS232C Serial
- 8 Speed Rates
- Latched Outputs
- Controlling Parallel
- Handshake Signals
- Compact 3 1/2" x 4 1/2" x 1 1/2"

No longer will your peripheral choices be limited by the type of port you have available! Our new High Performance 700 Series Converters provide the missing link. Based on the latest in CMOS technology, these units feature full baud rate selection to 19.2K, with handshake signals to maximize transfer efficiency. Detailed documentation allows simplified installation. Order the Model 770 (SerPar) or Model 775 (ParSer) Today!

Buffer Products Company Inc. **only \$89.95**

ligertronics
2794-C Johnson Dr.
Post Office Box 377
Vankus, California 92083

CALL (805) 658-7468 or 658-7467
For FAST Delivery

Inquiry 297

NEC PRINTERS

(1 Year Factory Warranty)

Pinwriter P5.....\$ 930

Pinwriter P5XL.....\$1075

Pinwriter P6.....\$ 450

Pinwriter P7.....\$ 615

Elf 350/360.....\$ 380

3510/15/30/50.....\$ 715

8810/15/30/50.....\$1040

Optional Forms Handling Devices.....CALL

QUALITY PRINTERS
8415 Cement City Road
Brooklyn, Michigan 49230
Phone: 517-592-3749

Inquiry 245

TURBO PC/XT

COMP. SYSTEM: 640K ONE DRIVE MONOGRAPHIC CARD W/P.P., AT STYLE KEYBOARD, HI-RES. MONITOR W/SWIVEL BASE & 6 MONTHS WARRANTY

\$679 ONLY

TO ORDER CALL **800-227-2400 EXT. 998**

BAY AREA BUS SYSTEMS
1740 MARKET ST.
S.F. CA. 94102
(415) 431 - 2808
15 YEARS IN BUSINESS

TURBOLINK +

Now Add TURBO Prolog to your Pascal Code!

"TURBO Pascal hackers will like this program."
Jerry Pournelle
Byte Magazine

- Add 512K of TURBO Pascal* to your code
- Call up to 8 memory resident TURBO Pascal modules from programs written in:
 - BASIC, BASICA, Compiled BASIC
 - MS Pascal, C, MS FORTRAN
 - Standard, 8087 and BCD TURBO Pascal
 - TURBO Pascal
- Add TURBO Pascal's 8087, BCD and graphic capabilities to other languages
- Automatically generate TURBO Pascal compatible inline machine code.
- Use all TURBO Pascal variants in a single program
- Add AI capability to your Pascal programs
- For IBM PC and compatible

\$69.95 Foreign orders add \$10.00

S&H included
VISA/MC: 1-800-835-2246 x123
KANSAS CALL: 1-800-362-2421 x123
Inquiries and Technical Information (303) 971-0729

PATHFINDER SOFTWARE, INC.
P.O. Box 43, Littleton, CO 80160

*TURBO Pascal and TURBO Prolog are trademarks of Borland International

Inquiry 217

GAT-288 COMPLETE SYSTEM—\$2195.00

Includes one megabyte memory on board, 6 or 8 MHz, zero wait state, Phoenix BIOS; Disk drive controller with 2 floppy disk drives (1.2 M.B. and 360 K) and one 20 M.B. hard disk; monochrome monitor with adapter, serial/parallel ports; 200 W. power supply, keyboard, case. IBM PC/AT compatible. Certified to comply with FCC class B standards.

PC/XT/AT COMPATIBLE PARTS

Seagate 30 M.B., High Speed Hard Disk **\$645.00**
20 M.B. Hard Disk Kit (drive, controller, cables) **\$400.00**
135 W. Power Supply **\$ 65.00**
I/O Card for XT or AT **\$ 75.00**
LOGIMOUSE **\$ 85.00**
8087-3 Co-Processor **\$120.00**
80287-3 Co-Processor **\$215.00**
SEIKOSHA SP1000 (80 column) Printer w/Cable **\$195.00**

LUCKY COMPUTERS

(214) 890-8110
1701 Greenville, Suite 602, Richardson, TX 75081

IBM PC/XT/AT are Registered Trademarks of International Business Machines Corp.

Inquiry 172

ICs PROMPT DELIVERY!!!

SAME DAY SHIPPING (USUALLY)
QUANTITY ONE PRICES SHOWN FOR JUNE 30, 1988

OUTSIDE OKLAHOMA: NO SALES TAX

DYNAMIC RAM		
1M	100Kx1	100 ns \$70.00
256K	64Kx4	150 ns 4.00
256K	256Kx1	100 ns 5.50
256K	256Kx1	120 ns 3.40
256K	256Kx1	150 ns 2.85
128K	128Kx1	150 ns 4.25
64K	64Kx1	150 ns 1.35
EPROM		
27512	64Kx8	250 ns \$23.00
27C256	32Kx8	250 ns 6.95
27256	32Kx8	250 ns 5.20
27128	16Kx8	250 ns 3.65
27C84	8Kx8	200 ns 4.75
2784	8Kx8	250 ns 3.40
STATIC RAM		
43256L-12	32Kx8	120 ns \$35.00
6264LP-15	8Kx8	150 ns 2.99

640 Kbyte MOTHERBOARD KITS Zenith 150, \$78.00 (IBM PC XT, Compaq Portable & Plus, Ipa, Vectra)

V20 V30 8 MHz \$14.00
60287-8 8 MHz \$365.00
8087-2 \$175.00
8087-3 \$175.00

OPEN 6 DAYS: MasterCard VISA or UPS CASH COD

SUNDAY & HOLIDAYS: SHIPMENT OR DELIVERY, VIA U.S. EXPRESS MAIL, SAT DELIVERY INCLUDED ON FEDEX ORDERS RECEIVED BY: 11:59 AM EST on Fri. Pkgs. \$13.25

Factory New, Prime Parts **UPC**
MICROPROCESSOR UNLIMITED, INC.
24 000 S. Peoria Ave., BEGGIS, OK 74421
(918) 267-4961, 62, 63, 64

Prices list for current prices because prices are subject to change. Shipping & insurance extra. Cash discount prices shown. Orders received by 4 PM CST can usually be delivered to you by the next morning, via Federal Express, Standard Air or 24HR or Priority One or 11:59 AM.

THE LATEST IN PC ENHANCEMENT PRODUCTS

ENHANCED GRAPHICS ADAPTOR

100% IBM COMPATIBLE—PASSES IBM EGA DIAGNOSTICS

- * COMPATIBLE WITH IBM EGA, COLOR GRAPHICS ADAPTOR AND MONOCHROME ADAPTOR
- * DISPLAYS 16 COLORS OUT OF 64 COLORS
- * COMES WITH 256K OF VIDEO RAM
- * DUAL SCANNING FREQUENCIES WORKS WITH STANDARD OR EGA TYPE RGB MONITORS
- * LIGHT PEN INTERFACE

**NOW ONLY
\$259.95**

EGA MONITOR

FULL ONE YEAR WARRANTY

- * EGA AND CGA COMPATIBLE
- * SCANNING FREQUENCIES: 15.75 KHz / 21.85 KHz
- * 14" BLACK MATRIX, NON-GLARE SCREEN
- * RESOLUTION: 640 x 200 / 640 x 350
- * .31 DOT, 25MHz
- * 16 COLORS OUT OF 64
- * TEXT SWITCH-GREEN/AMBER

\$499.95



20 MB HARD DISK SYSTEM

INCLUDES HARD DISK CONTROLLER, CABLES AND INSTRUCTIONS. ALL DRIVES ARE PRE-TESTED AND COME WITH A 1 YEAR WARRANTY.

\$389.95

AT MULTIFUNCTION CARD \$199.95

ADDS UP TO 3 MEGABYTES OF USER EXPANDABLE MEMORY

- * SHIPPED WITH ZERO K RAM, USER EXPANDABLE TO 1.5 MEGABYTES RAM ON BOARD, UP TO 3 MEGABYTES WITH OPTIONAL PIGGYBACK CARD
- * USES 64K OR 256K DYNAMIC RAMS
- * PARALLEL PORT & GAME PORT
- * SERIAL PORT
- * OPTIONAL SECOND SERIAL PORT

PIGGYBACK MEMORY CARD (NO MEMORY INSTALLED) \$49.95

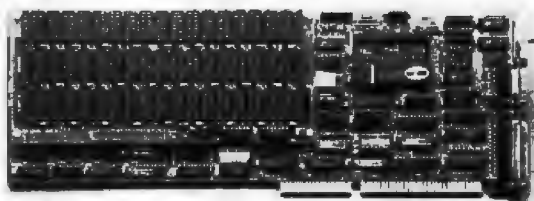

EXPANDED MEMORY CARD \$199.95

UP TO 2 MEGABYTES OF LOTUS/INTEL COMPATIBLE MEMORY

- * CONFORMS TO LOTUS/INTEL EXPANDED MEMORY SPECIFICATIONS (EMS)
- * SHIPPED WITH ZERO K RAM, USER EXPANDABLE TO 2 MEGABYTES
- * USES 64K OR 256K DYNAMIC RAMS
- * USE AS EXPANDED (EMS) OR CONVENTIONAL MEMORY, RAMDISK OR SPOOLER
- * SOFTWARE INCLUDES EMS DEVICE DRIVERS, PRINT SPOOLER AND RAMDISK

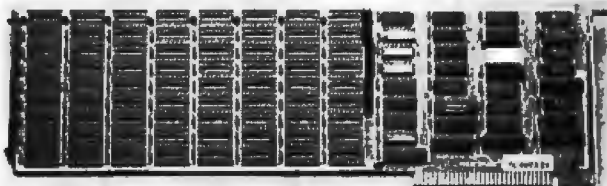

EPROM PROGRAMMER \$129.95

FOR IBM PC/XT/AT AND COMPATIBLES

- * PROGRAMS 27xxx SERIES EPROMS UP TO 27512
- * MENU DRIVEN SOFTWARE PROVIDED ON DISKETTE
- * AUTOMATICALLY SETS PROGRAMMING VOLTAGE
- * LOADS AND SAVES EPROM BUFFER TO DISK
- * READ, WRITE, COPY, VERIFY OR CHECK BLANK
- * DEBUG STYLE EDITOR FOR EASY MODIFICATION OF PROGRAM
- * SPLITS OR COMBINES EPROMS OF DIFFERING SIZES
- * INTERNAL CARD WITH EXTERNAL CABLE FOR A ZIF SOCKET

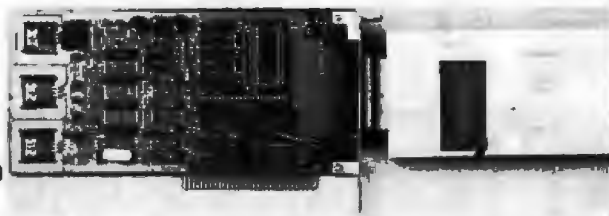

JDR Microdevices 1224 S. Bascom Avenue, San Jose, CA 95128
Toll Free 800-538-5000 • (408) 995-5430 • FAX (408) 275-8415 • Telex 171-110

© COPYRIGHT 1986 JDR MICRODEVICES

THE JDR MICRODEVICES LOGO IS A REGISTERED TRADEMARK OF JDR MICRODEVICES. JDR INSTRUMENTS AND JDR MICRODEVICES ARE TRADEMARKS OF JDR MICRODEVICES.

IBM IS A TRADEMARK OF INTERNATIONAL BUSINESS MACHINES.

20MB HARD DISK SYSTEM ONLY \$389.95!

STATIC RAMS

2101	286x4	(450ns)	1.95
5101	258x4	(450ns)(CMOS)	3.95
2102L-4	1024x1	(450ns)(LP)	.99
2112	286x4	(450ns)	2.99
2114	1024x4	(450ns)	.99
2114L-4	1024x4	(450ns)(LP)	1.09
2114L-2	1024x4	(200ns)(LP)	1.49
2114L-15	1024x4	(150ns)(LP)	1.99
TMS4044-4	4096x1	(450ns)	1.95
TMM2016-150	2048x2	(150ns)	1.49
TMM2016-100	2048x2	(100ns)	1.95
HMS116-4	2048x8	(200ns)(CMOS)	1.89
HMS116-3	2048x8	(150ns)(CMOS)	1.95
HMS116LP-4	2048x8	(200ns)(CMOS)(LP)	1.95
HMS116LP-3	2048x8	(150ns)(CMOS)(LP)	2.06
HMS116LP-2	2048x8	(120ns)(CMOS)(LP)	2.96
HMS264P-15	8192x1	(150ns)(CMOS)	3.99
HMS264LP-15	8192x8	(150ns)(CMOS)(LP)	3.49
HMS264LP-12	8192x8	(120ns)(CMOS)(LP)	4.95

LP=Low power

DYNAMIC RAMS

4116-250	16384x1	(250ns)	.89
4116-200	16384x1	(200ns)	.89
4116-150	16384x1	(150ns)	.89
4116-120	16384x1	(120ns)	1.49
MK4332	32768x1	(200ns)	6.95
4164-200	65536x1	(200ns)(5v)	1.19
4164-150	65536x1	(150ns)(5v)	1.28
4164-120	65536x1	(120ns)(5v)	1.96
NCM68665	65536x1	(200ns)(CMOS)	1.95
TMS4164	65536x1	(150ns)(5v)	1.95
4164-REFRESH	65536x1	(150ns)(5v)(REFRESH)	2.95
TMS4416	16384x4	(150ns)(5v)	4.95
41129-150	131072x1	(150ns)(5v)	6.95
TMS4464-15	65536x4	(150ns)(5v)	6.95
41256-200	262144x1	(200ns)(5v)	2.96
41256-150	262144x1	(150ns)(5v)	2.96

5v=Single 5 Volt Supply REFRESH=Pin 1 Refresh

★★★★HIGH-TECH★★★★

NEC V20 UPD70108 \$11.95

REPLACES 8088 TO SPEED UP IBM PC 10-40%

- * HIGH-SPEED ADDRESS CALCULATION IN HARDWARE
- * PIN COMPATIBLE WITH 8088
- * SUPERSET OF 8088 INSTRUCTION SET
- * LOW POWER CMOS

8MHz V20 UPD70108-8 \$13.95
8MHz V30 UPD70116-8 \$19.95

★★★★SPOTLIGHT★★★★

EPROMS

2708	1024x8	(450ns)	4.95
2716	2048x8	(450ns)(5V)	3.49
2716-1	2048x8	(350ns)(5V)	3.95
TMS2532	4096x8	(450ns)(5V)	5.95
2732	4096x8	(450ns)(5V)	3.95
2732A	4096x8	(250ns)(5V)(21V PGM)	3.95
27C64	4096x8	(200ns)(5V)(21V PGM)	4.25
2784	8192x8	(250ns)(5V)(CMOS)	5.95
2784-250	8192x8	(450ns)(5V)	3.49
2764-200	8192x8	(250ns)(5V)	3.95
2764-200	8192x8	(200ns)(5V)	4.25
MCM68768	8192x8	(350ns)(5V)(24 PIN)	17.95
27128	16384x8	(250ns)(5V)	4.25
27C256	32768x8	(250ns)(5V)(CMOS)	10.95
27256	32768x8	(250ns)(5V)	7.49

5V=Single 5 Volt Supply 21V PGM=Program at 21 Volts

SPECTRONICS CORPORATION EPROM ERASERS



Model	Timer	Capacity Chrp	Intensity (uW/cm²)	Unit Price
PE-14	NO	9	8,000	\$83.00
PE-14T	YES	9	8,000	\$119.00
PE-24T	YES	12	9,500	\$175.00

ORDER TOLL FREE 800-538-5000



8000

8035	1.49
8039	1.95
8080	2.95
8085	2.49
8087-2	169.95
8087	129.00
8088	6.95
8088-2	9.95
8155	2.49
8155-2	3.95
8748	7.95
8755	14.95
80286	129.95
80287	189.95

8200

8203	24.95
8205	3.29
8212	1.49
8216	1.49
8224	2.25
8237	4.95
8237-5	5.49
8250	6.95
8251	1.69
8251A	1.89
8253	1.89
8253-5	1.95
8255	1.69
8255-5	1.89
8259	1.95
8259-5	2.29
8272	4.95
8279	2.49
8279-5	2.95
8282	3.95
8284	2.95
8286	3.95
8288	4.95

Z-80

Z80-CPU 25 MHz	1.69
4.0 MHz	
Z80A-CPU	1.79
Z80A-CTC	1.89
Z80A-DART	5.96
Z80A-DMA	5.96
Z80A-PIO	1.89
Z80A-SIO/0	5.96
Z80A-SIO/1	5.96
Z80A-SIO/2	5.95

8.0 MHz

Z80B-CPU	3.75
Z80B-CTC	4.25
Z80B-PIO	4.25
Z80B-DART	14.95
Z80B-SIO/0	12.95
Z80B-SIO/2	12.95
Z80B7 Z80G	19.95

6500

6502	2.65
65C02(CMOS)	12.95
6507	8.95
6520	1.95
6522	4.95
6528	26.95
6532	6.95
6545	6.95
6551	5.95
6561	19.95
6581	34.95

2.0 MHz

6502A	2.95
6520A	6.95
6532A	11.95
6545A	7.95
6551A	6.95

3.0 MHz

6502B	6.95
-------	------

6800

6800	1.95
6802	4.95
6803	9.95
6809	5.95
6809E	5.95
6822	4.95
6810	1.95
6820	2.95
6821	1.95
6840	6.95
6843	19.95
6844	12.95
6845	4.95
6847	11.95
6880	1.95
6883	22.95

2.0 MHz

68800	4.95
68802	5.95
68809E	6.95
68809	6.95
68821	3.95
68845	6.95
68850	2.95
68854	7.95

CLOCK CIRCUITS

MM5369	1.95
MM5369-EST	1.95
MM58167	12.95
MM58174	11.95
MSM5832	2.95

CRT CONTROLLERS

6845	4.95
88B45	8.95
6847	11.95
HD46805SP	6.95
MC1372	2.95
8275	26.95
7220	18.95
CRT5027	12.95
CRT5037	9.95
TMS9918A	18.95

DISK CONTROLLERS

1771	4.95
1791	9.95
1793	9.95
1795	12.95
1797	12.95
1799	15.95
2793	19.95
2797	29.95
6843	19.95
8272	4.95
UPD705	4.95
M8876	12.95
M8877	12.95
1691	6.95
2143	6.95

BIT RATE GENERATORS

MC16411	9.95
881941	5.95
4707	5.95
MM6116	8.95
COM5307	4.95

UARTS

AY3-1013	3.95
AY3-1015	4.95
TR1602	3.95
2651	4.95
IWB402	6.95
IWB403	9.95
INS8250	6.95

SOUND CHIPS

76477	5.95
76489	8.95
SSI-263	39.95
AY3-8910	12.95
AY3-8912	12.95
SP1000	39.00

CRYSTALS

32.768 KHz	.95
1.8432	2.95
1.8432	2.95
2.097162	1.95
2.4576	1.95
3.2768	1.95
3.2768	1.95
4.0	1.95
4.0	1.95
5.0888	1.95
6.0	1.95
6.144	1.95
6.5536	1.95
8.0	1.95
10.0	1.95
10.738635	1.95
12.0	1.95
14.31818	1.95
16.0	1.95
16.0	1.95
17.430	1.95
18.0	1.95
18.432	1.95
20.0	4.95
22.1184	1.95
24.0	1.95
32.0	1.95

CRYSTAL OSCILLATORS

1.0MHz	5.95
1.8432	5.95
2.0	5.95
2.4576	5.95
2.5	4.95
4.0	4.95
5.0888	4.95
6.0	4.95
6.144	4.95
8.0	4.95
10.0	4.95
12.0	4.95
12.480	4.95
16.0	4.95
18.0	4.95
18.432	4.95
20.0	4.95
24.0	4.95

MISC.

TMS99531	9.95
TMS99532	19.95
ULN2003	.79
3242	7.95
3241	4.95
MC2470	1.95
MC2480	6.95
MC2487	2.95
11C90	19.95
2613-001 UP	6.95
AVS-2376	11.95
AVS-3600 PRC	11.95

74LS00

74LS00	.16
74LS01	.18
74LS02	.17
74LS03	.18
74LS04	.16
74LS05	.18
74LS08	.18
74LS09	.18
74LS10	.16
74LS11	.22
74LS12	.22
74LS13	.26
74LS14	.39
74LS15	.26
74LS20	.17
74LS21	.22
74LS22	.22
74LS23	.23
74LS28	.26
74LS30	.17
74LS32	.18
74LS33	.28
74LS37	.26
74LS38	.26
74LS42	.39
74LS47	.78
74LS48	.85
74LS51	.17
74LS52	.79
74LS54	.24
74LS57	.29
74LS70	.28
74LS73	.49
74LS75	.49
74LS86	.22
74LS90	.39
74LS92	4.95
74LS93	.39
74LS95	.49
74LS107	.34
74LS109	.36
74LS112	.29
74LS122	.46
74LS124	.75
74LS125	.39
74LS126	.38
74LS132	.39
74LS133	.49
74LS136	.39
74LS138	.39
74LS139	.39
74LS145	.89
74LS147	.89
74LS148	.89
74LS151	.39
74LS153	.39
74LS154	1.49
74LS155	.69
74LS157	1.49
74LS158	.29
74LS160	.29
74LS161	.39
74LS162	.49
74LS163	.39
74LS164	.49

HIGH SPEED CMOS

A new family of high speed CMOS logic featuring the speed of low power Schottky, the typical gate propagation delay, combined with the advantages of CMOS: very low power consumption, superior noise immunity, and improved output drive

74HC00

74HC00	.59	74HC148	1.19
74HC02	.59	74HC151	.89
74HC04	.59	74HC154	2.49
74HC08	.59	74HC157	.69
74HC10	.59	74HC168	.95
74HC14	.79	74HC163	1.15
74HC20	.59	74HC175	.99
74HC27	.59	74HC240	1.89
74HC30	.59	74HC244	1.89
74HC32	.59	74HC257	1.89
74HC81	.79	74HC257	.85
74HC74	.79	74HC259	1.39
74HC85	1.39	74HC273	1.89
74HC86	.89	74HC289	4.99
74HC93	1.19	74HC289	.99
74			

20MB HARD DISK SYSTEM ONLY \$38995!

CMOS

4001	.19	14419	4.96
4011	.19	14433	14.96
4012	.25	4853	.49
4013	.35	4811	.89
4016	.29	4816	.79
4018	.29	4818	.85
4017	.48	4822	.79
4018	.48	4828	.79
4020	.59	4827	1.95
4021	.69	4826	.79
4024	.48	4829	2.95
4025	.25	4832	1.95
4027	.35	4838	.95
4028	.65	4841	1.29
4038	.69	4853	6.79
4040	.69	4858	.75
4041	.75	4702	12.95
4042	.59	74C00	.29
4043	.89	74C14	.59
4044	.89	74C23	1.95
4045	1.89	74C23	1.95
4046	.69	74C85	1.99
4047	.69	74C98	.99
4049	.29	74C150	5.79
4050	.29	74C151	2.25
4051	.49	74C161	.99
4052	.49	74C163	.99
4053	.69	74C164	1.39
4056	2.19	74C192	1.49
4060	.69	74C221	1.49
4066	.29	74C221	2.49
4069	.19	74C240	1.89
4070	.59	74C244	1.89
4077	.29	74C374	1.99
4081	.22	74C908	10.95
4085	.79	74C911	8.95
4096	.89	74C917	12.99
4093	.49	74C923	4.95
4094	2.49	74C923	4.95
14411	8.95	74C926	7.95
14412	8.95	80C37	.95

7400/9000

7400	.19	74147	2.49
7402	.19	74148	1.20
7404	.19	74150	1.38
7406	.22	74151	.95
7407	.24	74154	.95
7408	.24	74154	1.48
7410	.19	74158	.75
7411	.25	74157	.55
7414	.49	74159	1.85
7416	.25	74181	.69
7417	.28	74163	.69
7420	.19	74184	.85
7423	.29	74185	.85
7430	.19	74188	1.00
7432	.29	74178	.85
7438	.29	74177	.75
7442	.49	74178	1.15
7445	.89	74181	2.25
7447	.89	74182	.75
7470	.35	74184	2.00
7473	.34	74191	1.15
7474	.33	74182	.85
7475	.45	74194	.85
7476	.35	74196	.79
7483	.50	74197	.75
7485	.59	74199	1.35
7486	.35	74221	1.35
7489	2.18	74246	1.35
7490	.39	74247	1.25
7491	.50	74248	1.85
7493	.35	74249	1.95
7495	.58	74251	.75
7497	2.75	74265	1.35
74100	2.29	74273	1.99
74121	.29	74278	3.11
74123	.49	74367	.85
74125	.45	74368	.85
74141	.65	9349	3.99
74143	.85	9602	1.50
74144	2.89	9437	2.95
74145	.60	96502	1.95

74500

74500	.29	745163	1.29
74502	.29	745166	3.95
74503	.29	745174	.79
74504	.29	745175	.79
74505	.29	745186	.95
74506	.35	745189	1.99
74508	.29	745195	1.49
74515	.48	745195	2.48
74530	.29	745197	2.95
74532	.35	745226	3.99
74537	.89	745240	1.49
74538	.89	745241	1.49
74574	.49	745244	1.49
74585	.95	745257	.79
74586	.95	745258	.79
745112	.99	745258	.95
745124	2.75	745280	1.95
745138	.79	745287	1.69
745140	.59	745288	1.89
745151	.79	745299	2.89
745153	.79	745373	1.95
745187	.79	745374	1.69
745188	.99	745471	4.95
745161	1.29	745571	2.95

VOLTAGE REGULATORS

TO-220 CASE			
7905T	.49	7905T	.59
7906T	.49	7906T	.59
7912T	.49	7912T	.69
7915T	.49	7915T	.59
TO-3 CASE			
7905K	1.39	7905K	1.69
7912K	1.39	7912K	1.49
TO-93 CASE			
79L06	.49	79L06	.69
79L12	.49	79L12	1.49
OTHER VOLTAGE REGS			
LM323K	5V 3A	TO-3	4.79
LM328K	A0 5A	TO-3	3.95
79H05K	5V 5A	TO-3	7.95
79H12K	12V 5A	TO-3	6.95
79P05K	5V 10A	TO-3	14.95

LINEAR

TL066	.99	LM733	.99
TL071	.69	LM741	.29
TL072	1.09	LM747	.69
TL074	1.95	LM748	.59
TL081	.59	MC1330	1.89
TL082	.99	MC1350	1.19
TL084	1.49	MC1372	6.95
LM301	.34	LM1414	1.59
LM309K	1.75	LM1458	.49
LM311	.59	LM1488	.49
LM311H	.89	LM1489	.49
LM317K	3.49	LM1496	.85
LM317T	.95	LM1812	8.25
LM318	1.49	LM1889	1.96
LM319	1.25	ULN2003	.79
LM320	9997900	KR2208	3.96
LM322	1.95	KR2211	2.95
LM323K	4.79	KR2240	1.95
LM324	.49	MPO2607	1.95
LM331	3.95	LM2517	1.95
LM334	1.19	CA3046	.89
LM335	1.79	CA3081	.99
LM336	1.75	CA3082	.99
LM337K	3.95	CA3086	.80
LM338K	6.95	CA3089	1.95
LM339	.69	CA3120E	.89
LM340	9997800	CA3148	1.29
LM350T	4.80	CA3160	1.19
LF353	.59	MC3470	1.95
LF356	.99	MC3480	8.95
LF357	.99	MC3497	2.95
LM358	.59	LM3900	.49
LM380	.89	LM3909	.99
LM383	1.95	LM3911	2.95
LM386	.99	LM3914	2.99
LM393	.45	MC4024	3.49
LM394H	5.95	MC4044	3.99
TL494	4.20	RC4138	1.25
TL497	3.25	RC4558	.69
NE555	.29	LM13600	1.49
NE556	.49	75107	1.49
NE558	1.29	75110	1.85
NE564	1.95	75150	1.95
LM565	.95	75154	1.95
LM566	1.45	75188	1.25
LM567	.79	75189	1.25
NE570	2.95	75451	.39
NE590	2.50	75452	.39
NE592	.98	75453	.39
LM710	.75	75477	1.29
LM723	.49	75492	.79
H-TO-5 CAN. K-TO-3. T-TO-220			

DATA ACO INTERFACE

ADC0800	15.55	DT26	1.29
ADC0804	3.49	DT28	1.29
ADC0809	4.48	DT95	.89
ADC0816	14.95	DT96	.89
ADC0817	9.95	DT97	.59
ADC0831	9.95	DT98	.89
DAC0800	4.49	DM8131	2.96
DAC0806	1.95	DP8304	2.25
DAC0808	2.95	D8833	2.25
DAC1020	8.25	D8835	1.99
DAC1022	5.95	D8836	.99
ICM7207A	5.95		
ICM7208	15.95		

IC SOCKETS

8 PIN ST	1.99	100-
14 PIN ST	.11	10
16 PIN ST	.11	.09
18 PIN ST	.12	.10
20 PIN ST	.15	.13
22 PIN ST	.18	.15
24 PIN ST	.20	.16
28 PIN ST	.25	.18
40 PIN ST	.30	.22
64 PIN ST	1.95	1.49
ST-SOLDERTAIL		
8 PIN WW	.59	.69
14 PIN WW	.69	.52
16 PIN WW	.69	.58
18 PIN WW	.99	.90
20 PIN WW	1.09	.98
22 PIN WW	1.29	1.28
24 PIN WW	1.49	1.35
28 PIN WW	1.69	1.49
40 PIN WW	1.99	1.80
WW-WIREWRAP		
16 PIN ZIF	4.95	CALL
24 PIN ZIF	5.95	CALL
28 PIN ZIF	6.95	CALL
40 PIN ZIF	9.95	CALL
ZIF-TEXTOL		
(ZERO INSERTION FORCE)		

EDGECARD CONNECTORS

100 PIN ST	S-100	.128	3.95
100 PIN WW	S-100	.125	4.95
62 PIN ST	IBM PC	.100	1.95
60 PIN ST	APPLE	.100	2.95
44 PIN ST	STD	.158	1.95
44 PIN WW	STD	.158	4.95

36 PIN CENTRONICS

MALE		FEMALE	
IDCN36	RIBBON CABLE	6.95	
CEN36	SOLDER CUP	4.95	
FEMALE		RT ANGLE PC MOUNT	
IDCN36/F	RIBBON CABLE	7.95	
CEN36PC	RT ANGLE PC MOUNT	4.95	

INTERSIL

ICL7105	9.95
ICL7107	12.95
ICL7660	2.95
ICL8038	7.95
ICM7207A	5.95
ICM7208	15.95

DIP CONNECTORS

DESCRIPTION	ORDER BY	CONTACTS								
		8	14	16	18	20	22	24	28	40
HIGH RELIABILITY TOOLED ST IC SOCKETS	AUGATxxST	.62	.79	.89	1.09	1.29	1.39	1.49	1.69	2.49
HIGH RELIABILITY TOOLED WW IC SOCKETS	AUGATxxWW	1.30	1.80	2.10	2.40	2.50	2.90	3.15	3.70	5.40
COMPONENT CARRIERS (DIP HEADERS)	ICCxx	.49	.59	.69	.99	.99	.99	.99	1.08	1.49
RIBBON CABLE DIP PLUGS (IDC)	IDPxx	---	.95	.95	---	---	---	1.75	---	2.95

FOR ORDERING INSTRUCTIONS SEE D-SUBMINIATURE BELOW

D-SUBMINIATURE

DESCRIPTION	ORDER BY	CONTACTS					
		9	15	19	25	37	50
SOLDER CUP	MALE DBxxP	.82	.90	1.25	1.25	1.60	3.48
	FEMALE DBxxS	.95	1.15	1.50	1.50	2.35	4.32
RIGHT ANGLE PC SOLDER	MALE DBxxPR	1.20	1.48	---	1.95	2.65	---
	FEMALE DBxxSR	1.25	1.95	---	2.00	2.79	---
WIRE WRAP	MALE DBxxPWW	1.69	2.56	---	3.89	5.60	---
	FEMALE DBxxSww	2.76	4.27	---	6.84	9.95	---
IDC RIBBON CABLE	MALE IDBxxP	2.70	2.95	---	3.99	5.70	---
	FEMALE IDBxxS	2.92	3.20	---	4.33	6.78	---
HOODS	METAL MHODxxK	1.25	1.25	1.30	1.30	---	---
	GREY HOODxxz	.65	.65	---	.65	.75	.96

ORDERING INSTRUCTIONS: INSERT THE NUMBER OF CONTACTS IN THE POSITION MARKED "x" OF THE "ORDER BY" PART NUMBER LISTED

EXAMPLE: A 15 PIN RIGHT ANGLE MALE PC SOLDER WOULD BE DB15PR

MOUNTING HARDWARE \$1.00

IDC CONNECTORS

DESCRIPTION	ORDER BY	CONTACTS					
		10	20	26	34	40	50
SOLDER HEADER	IDHxxS	.82	1.29	1.68	2.20	2.58	3.24
RIGHT ANGLE SOLDER HEADER	IDHxxSR	.85	1.35	1.78	2.31	2.72	3.39
WW HEADER	IDHxxW	1.86	2.98	3.84	4.50	5.28	6.63
RIGHT ANGLE WW HEADER	IDHxxWR	2.05	3.28	4.22	4.45	4.80	7.30
RIBBON HEADER SOCKET	IDSxx	.79	.99	1.39	1.59	1.99	2.25
RIBBON HEADER	IDMxx	---	5.50	6.25	7.00	7.50	8.50
RIBBON EDGE CARD	IDExx	1.75	2.25	2.65	2.75	3.80	3.95

FOR ORDERING INSTRUCTIONS SEE D-SUBMINIATURE ABOVE

HARD TO FIND "SNAPABLE" HEADERS

CAN BE SNAPPED APART TO MAKE ANY SIZE HEADER, ALL WITH .1" CENTERS

1x40	STRAIGHT LEAD	.99
1x40	RIGHT ANGLE	1.49
2x40	STRAIGHT LEAD	2.49
2x40	RIGHT ANGLE	2.99

20MB HARD DISK SYSTEM ONLY \$389⁹⁵!

BARGAIN HUNTERS CORNER ATTENTION PC USERS!

10 MB HARD DISK SYSTEM \$349

- * SHOCK MOUNTED FOR 80 Gs—IDEAL FOR PORTABLES!
- * MMI MODEL MM212 1 1/2" HEIGHT, 75ms ACCESS
- * INCLUDES CONTROLLER CABLES & INSTRUCTIONS FOR IBM

WIRELESS KEYBOARD \$129

- * MADE BY CHERRY FOR IBM PC & PCjr
- * OPERATES UP TO 40 FEET FROM COMPUTER
- * INFRARED RECEIVER FOR PC-XT INCLUDED

HURRY—QUANTITIES ARE LIMITED!
SPECIALS END 8/31/86

PAGE WIRE WRAP WIRE PRECUT ASSORTMENT IN ASSORTED COLORS \$27.50

100ea: 5.5", 6.0", 6.5", 7.0"
250ea: 2.5", 4.5", 5.0"
500ea: 3.0", 3.5", 4.0"

SPOOLS

100 feet \$4.30 250 feet \$7.25
500 feet \$13.25 1000 feet \$21.95

Please specify color:
Blue, Black, Yellow or Red

EMI FILTER

\$4.95

- * MANUFACTURED BY CORCOM
- * LOW COST
- * FITS LC-HP BELOW
- * 6 AMP 120/240 VOLT



6 FOOT LINE CORDS

LC-2 2 CONDUCTOR .39
LC-3 3 CONDUCTOR .99
LC-HP 3 CONDUCTOR W/STD FEMALE SOCKET 1.49

MUFFIN FANS

3.15" SQ. ROTRON 14.95
3.63" SQ. ETRI 14.95
3.15" SQ. MASUSHITA 16.95

WIRE WRAP PROTOTYPE CARDS FR-4 EPOXY GLASS LAMINATE WITH GOLD-PLATED EDGE-CARD FINGERS



IBM-PR2

IBM

BOTH CARDS HAVE SILK SCREENED LEGENDS AND INCLUDES MOUNTING BRACKET

IBM-PR1 WITH +5V AND GROUND PLANE . . . \$27.95
IBM-PR2 AS ABOVE WITH DECODING LAYOUT \$29.95

S-100

P100-1 BARE - NO FOIL PADS . . . \$15.15
P100-2 HORIZONTAL BUS . . . \$21.90
P100-3 VERTICAL BUS . . . \$21.80
P100-4 SINGLE FOIL PADS PER HOLE . . . \$22.75

APPLE

P500-1 BARE - NO FOIL PADS . . . \$15.15
P500-2 HORIZONTAL BUS . . . \$22.75
P500-4 SINGLE FOIL PADS PER HOLE . . . \$21.80
7060-45 FOR APPLE IIe AUX SLOT . . . \$30.00

SOCKET-WRAP I.D.™

- * SLIPS OVER WIRE WRAP PINS
- * IDENTIFIES PIN NUMBERS ON WRAP SIDE OF BOARD
- * CAN WRITE ON PLASTIC, SUCH AS IC #

PINS	PART#	PCK. OF	PRICE
8	IDWRAP 08	10	1.95
14	IDWRAP 14	10	1.95
16	IDWRAP 16	10	1.95
18	IDWRAP 18	5	1.95
20	IDWRAP 20	5	1.95
22	IDWRAP 22	5	1.95
24	IDWRAP 24	5	1.95
28	IDWRAP 28	5	1.95
40	IDWRAP 40	5	1.95

PLEASE ORDER BY NUMBER OF PACKAGES (PCK. OF)

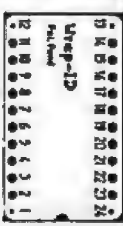

10 WRAP 24

FRAME STYLE TRANSFORMERS

12.6V AC CT 2 AMP 5.95
12.6V AC CT 4 AMP 7.95
12.6V AC CT 8 AMP 10.95
25.2V AC CT 2 AMP 7.95

25 PIN D-SUB BENDER CHANGERS \$7.95



SWITCHING POWER SUPPLIES

PS-IBM \$89.95

- * FOR IBM PC-XT COMPATIBLE
- * 135 WATTS
- * +5V @ 15A, +12V @ 4.2A
- * -5V @ .5A, -12V @ .5A
- * ONE YEAR WARRANTY



PS-IBM-150 \$79.95

- * FOR IBM PC-XT COMPATIBLE
- * 180 WATTS
- * +12V @ 5.2A, +5V @ 16A
- * -12V @ .5A, -5V @ .5A
- * ONE YEAR WARRANTY



PS-130 \$99.95

- * 130 WATTS
- * SWITCH ON REAR
- * FOR USE IN OTHER IBM TYPE MACHINES
- * 90 DAY WARRANTY



PS-A \$49.95

- * USE TO POWER APPLE TYPE SYSTEMS, 75.5 WATTS
- * +5V @ 7A, +12V @ 3A
- * -5V @ .5A, -12V @ .5A
- * APPLE POWER CONNECTOR



PS-SPL200 \$49.95

- * +5V @ 2A, +12V @ 3.5A
- * -5V @ 1A, -12V @ 1A
- * UL APPROVED
- * ALUMINUM ENCLOSURE



CAPACITORS

TANTALUM

1.0µf	15V .35	47µf	35V .45
6.3	15V .70	1.0	35V .65
10	15V .80	2.2	35V .65
22	15V 1.35	4.7	35V .85
.22	35V .40	10	35V 1.00

DISC

10µf	50V .05	680	50V .05
22	50V .05 <td>.001µf</td> <td>50V .05</td>	.001µf	50V .05
33	50V .05 <td>.0022</td> <td>50V .05</td>	.0022	50V .05
47	50V .05 <td>.01</td> <td>50V .07</td>	.01	50V .07
68	50V .05 <td>.02</td> <td>50V .07</td>	.02	50V .07
100	50V .05 <td>.05</td> <td>50V .07</td>	.05	50V .07
220	50V .05 <td>.1</td> <td>12V .10</td>	.1	12V .10
560	50V .05 <td>.1</td> <td>50V .12</td>	.1	50V .12

MONOLITHIC

.01µf	50V .14	.1µf	50V .18
.047µf	50V .15	.47µf	50V .25

ELECTROLYTIC

1µf	25V .14	1µf	50V .14
2.2	35V .15 <td>10</td> <td>50V .18</td>	10	50V .18
4.7	50V .15 <td>22</td> <td>10V .14</td>	22	10V .14
10	50V .15 <td>47</td> <td>50V .20</td>	47	50V .20
47	35V .18	100	35V .25
100	16V .18	220	25V .30
220	35V .20	470	50V .50
470	25V .30	1000	18V .80
2200	16V .70	2200	18V .70
4700	25V 1.48	4700	16V 1.25

DATARASE EPROM ERASER \$34.95

- * ERASES 2 IN 10 MINUTES
- * COMPACT-NO DRAWER
- * THIN METAL SHUTTER PREVENTS UV LIGHT FROM ESCAPING



1/4 WATT RESISTORS

5% CARBON FILM ALL STANDARD VALUES FROM 1 OHM TO 10 MEG. OHM

10 PCS same value .05 100 PCS same value .02
50 PCS same value .025 1000 PCS same value .015

RESISTOR NETWORKS

SIP	10 PIN	9 RESISTOR	.69
SIP	8 PIN	7 RESISTOR	.69
DIP	16 PIN	8 RESISTOR	1.09
DIP	16 PIN	15 RESISTOR	1.09
DIP	14 PIN	7 RESISTOR	.99
DIP	14 PIN	13 RESISTOR	.99

SPECIALS ON BYPASS CAPACITORS

.01 µf CERAMIC DISC 100/\$5.00
.01 µf MONOLITHIC 100/\$10.00
.1 µf CERAMIC DISC 100/\$6.50
.1 µf MONOLITHIC 100/\$12.50

WISH SOLDERLESS BREADBOARDS

PART NUMBER	DIMENSIONS	DISTRIBUTION STRIP(S)	TIE POINTS	TERMINAL STRIP(S)	TIE POINTS	BINDING POSTS	PRICE
WBU-D	.38 x 6.50"	1	100	---	---	---	2.95
WBU-T	1.38 x 6.50"	---	---	1	630	---	6.95
WBU-204-3	3.94 x 8.45"	1	100	2	1260	2	17.95
WBU-204	5.13 x 8.45"	4	400	2	1260	3	24.95
WBU-206	6.88 x 9.06"	5	500	3	1890	4	29.95
WBU-208	8.25 x 9.45"	7	700	4	2520	4	39.95



WBU-208

LITHIUM BATTERY AS USED IN CLOCK CIRCUITS

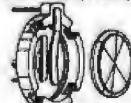

3 VOLT BATTERY \$3.95
BATTERY HOLDER \$1.49

NEW EDITION! 1986 IC MASTER THE INDUSTRY STANDARD

\$129.95

VISIT OUR RETAIL STORE LOCATED AT 1256 SOUTH BASCOM AVENUE IN SAN JOSE

JDR Microdevices

1224 S. Bascom Avenue, San Jose, CA 95128
Toll Free 800-538-5000 • (408) 995-5430
FAX (408) 275-8415 • Telex 171-110

HOURS: M-W-F, 9-6 TU-TH, 9-9 SAT, 9-5
PLEASE USE YOUR CUSTOMER NUMBER WHEN ORDERING

TERMS: Minimum order \$10.00 For shipping and handling include \$2.50 for UPS Ground and \$3.50 for UPS Air. Orders over 1 lb. and foreign orders may require additional shipping charges - please contact our sales department for the amount. CA residents must include applicable sales tax. All merchandise is warranted for 90 days unless otherwise stated. Prices are subject to change without notice. We are not responsible for typographical errors. We reserve the right to limit quantities and to substitute manufacturer. All merchandise subject to prior sale.

© COPYRIGHT 1986 JDR MICRODEVICES
THE JDR MICRODEVICES LOGO IS A REGISTERED TRADEMARK OF JDR MICRODEVICES. JDR INSTRUMENTS AND JDR MICRODEVICES ARE TRADEMARKS OF JDR MICRODEVICES
IBM IS A TRADEMARK OF INTERNATIONAL BUSINESS MACHINES. APPLE IS A TRADEMARK OF APPLE COMPUTER.

20MB HARD DISK SYSTEM ONLY \$389.95!

DISK DRIVES FOR APPLE COMPUTERS

AP-150
\$99.95



- 1/2 HT, DIRECT DRIVE
- 100% APPLE COMPATIBLE
- SIX MONTH WARRANTY

BAL-500
\$129.95



- TEAC MECHANISM-DIRECT DRIVE
- 100% APPLE COMPATIBLE
- FULL ONE YEAR WARRANTY

AP-135
\$129.95



- FULL HT SHUGART MECHANISM
- DIRECT REPLACEMENT FOR APPLE DISK II
- SIX MONTH WARRANTY

DOUBLE SIDED!

MAC535
\$249.95

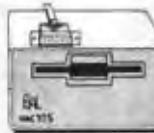

- 3.5" ADD-ON DISK DRIVE
- 100% MACINTOSH COMPATIBLE
- DOUBLE SIDED 800K BYTE STORAGE
- HIGH RELIABILITY DRIVE HAS AUTO-EJECT MECHANISM
- FULL ONE YEAR WARRANTY

AD-3C
\$139.95

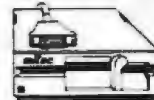

- 100% APPLE IIc COMPATIBLE. READY TO PLUG IN, W/ SHIELDED CABLE & HOLDERS 19 PIN CONNECTOR
- FAST, RELIABLE SLIMLINE DIRECT DRIVE
- SIX MONTH WARRANTY

DISK DRIVE ACCESSORIES

- FDD CONTROLLER CARD \$49.95
- IIc ADAPTOR CABLE \$19.95
- ADAPTS STANDARD APPLE DRIVES FOR USE WITH APPLE IIc

KB-1000

\$79.95

CASE WITH KEYBOARD FOR APPLE TYPE MOTHERBOARD

- USER DEFINED FUNCTION KEYS
- NUMERIC KEYPAD WITH CURSOR CONTROL
- CAPS LOCK • AUTO-REPEAT



KEYBOARD-AP

\$49.95

- REPLACEMENT FOR APPLE II KEYBOARD
- CAPS LOCK KEY, AUTO-REPEAT
- ONE KEY ENTRY OF BASIC OR CP/M COMMANDS



EXTENDER CARDS

IBM-PC	\$45.00
IBM-AT	\$68.00
APPLE II	\$45.00
APPLE IIc	\$45.00
MULTIBUS	\$86.00

APPLE COMPATIBLE INTERFACE CARDS

EPROM PROGRAMMER \$59.95

MODEL NP525

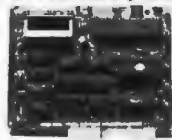

- DUPLICATE OR BURN ANY STANDARD 27x1 SERIES EPROM
- EASY TO USE MENU-DRIVEN SOFTWARE IS INCLUDED
- MENU SELECTION FOR 2716, 2732, 2732A, 2764 AND 27128
- HIGH SPEED WRITE ALGORITHM
- LED INDICATORS FOR ACTIVITY
- NO EXTERNAL POWER SUPPLY NEEDED
- ONE YEAR WARRANTY

16K RAMCARD

\$39.95



- FULL TWO YEAR WARRANTY
- EXPAND YOUR 48K APPLE TO 64K
- USE IN PLACE OF APPLE LANGUAGE CARD
- BARE PC CARD W/ INSTRUCTIONS \$8.95

IC TEST CARD

\$99.95



- QUICKLY TESTS MANY COMMON ICs
- DISPLAYS PASS OR FAIL
- ONE YEAR WARRANTY
- TESTS: 4000 SERIES CMOS, 74HC SERIES CMOS, 7400, 74LS, 74L, 74H & 74S

300B MODEM \$49.95

FOR APPLE OR IBM

INCLUDES ASCII PRO-EZ SOFTWARE

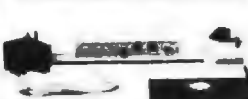

JOYSTICK CR-401

\$7.95

- FCC APPROVED
- BELL SYSTEMS 103 COMPATIBLE
- INCLUDES AC ADAPTOR
- AUTO-DIAL
- DIRECT CONNECT
- CABLE FOR APPLE IIc \$14.95

DISKFILE

HOLDS 70 5 1/4" DISKETTES



\$895

3.5" DISKFILE HOLDS 40 \$895

POWER STRIP

- UL APPROVED
- 15A CIRCUIT BREAKER

\$12.95



3-WAY SWITCH BOXES

- SERIAL OR PARALLEL
- CONNECTS 3 PRINTERS TO ONE COMPUTER OR VICE VERSA
- ALL LINES SWITCHES
- HIGH QUALITY ROTARY SWITCH MOUNTED ON PCB
- GOLD CONTACTS
- STURDY METAL ENCLOSURE



SWITCH-3P CENTRONICS PARALLEL \$89.95

SWITCH-3S RS232 SERIAL \$99.95

PRINTER BUFFERS

- FREES COMPUTER FOR OTHER TASKS WHILE PRINTING LONG DOCUMENTS
- STAND-ALONE DESIGN; WORKS WITH ANY COMPUTER OR PRINTER
- ALL MODELS FEATURE PRINT PAUSE, MEMORY CHECK, GRAPHICS CAPABILITY

SP120P PARALLEL \$139.95

- 64K UPGRADABLE TO 256K
- LED INDICATOR SHOWS VOLUME OF DATA IN BUFFER

SP120S RS232 SERIAL \$159.95

- 64K UPGRADABLE TO 256K
- 4 SELECTABLE BAUD RATES, FROM 600B-19,200B

SP110P PARALLEL \$249.95

- 64K UPGRADABLE TO 512K
- SPOOLS OUTPUT OF UP TO 3 COMPUTERS
- LED BARGRAPH DISPLAYS AMOUNT OF DATA IN BUFFER
- RESET FUNCTION CLEARS DATA IN BUFFER
- REPEAT FUNCTION CAN PRODUCE MULTIPLE COPIES OF A DOCUMENT



SP120

SP110

NASHUA DISKETTES DEALS

5 1/4" SOFT SECTOR DS/DD WITH HUB RINGS

\$9.90 **69¢ea** **59¢ea**

BOX OF 10 BULK QTY 50 BULK QTY 250

- NASHUA DISKETTES WERE JUDGED TO HAVE THE HIGHEST POLISH AND RECORDED AMPLITUDE OF ANY DISKETTES TESTED ACCORDING TO "COMPARING FLOPPY DISKS", BYTE 9/84

DISKETTES

NASHUA 5 1/4"

N-MD2D	DS DO SOFT	\$9.90
N-MD2F	DS QUAD SOFT	\$34.95
N-MD2H	DS HD FOR AT	\$49.95

NASHUA 8"

N-FD1	SS/DO SOFT	\$27.95
N-FD2D	DS/DO SOFT	\$34.95

NASHUA 3.5"

N-3.5SS 3.5" SS/DO FOR MAC \$32.95

VERBATIM 5 1/4"

V-MD1D	SS/DO SOFT	\$23.95
V-MD2D	DS/DO SOFT	\$29.95
V-MD110D	SS/DO 10 SECTOR HARD	\$23.95

TEST EQUIPMENT FROM JDR INSTRUMENTS

DIGITAL MULTIMETER PEN DPM-1000
AUTO RANGING, POLARITY AND DECIMAL!

\$54.95

- LARGE 3.5 DIGIT DISPLAY
- DATA HOLD SWITCH
- FREES READING
- FAST, AUDIBLE CONTINUITY TEST
- LOW BATTERY INDICATOR
- OVERLOAD PROTECTION



20MHZ DUAL TRACE OSCILLOSCOPE

MODEL 2000

\$389.00

35MHZ DUAL TRACE OSCILLOSCOPE

MODEL 3500

\$549.00

FOR MORE INFORMATION ON THE OSCILLOSCOPES, CALL US FOR FREE PRODUCT BRIEFS.

Sakata 120 CPS DOT MATRIX PRINTER

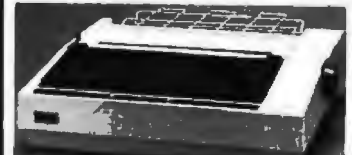

MODEL 8P-1200

\$169.95

- EPSON/IBM COMPATIBLE
- 9-WIRE PRINTHEAD
- 120 CPS-BIDIRECTIONAL, 80 COL.
- FRICTION AND TRACTOR FEED
- PROPORTIONAL SPACING
- CENTRONICS PARALLEL INTERFACE
- 8 CHARACTER SETS AND GRAPHICS

6 FOOT IBM PRINTER CABLE \$2.95

REPLACEMENT RIBBON CARTRIDGE \$11.95

5 1/4" FLOPPY DISK DRIVES

TEAC FD-55B 1/2 HT DS/DD (FOR IBM)	\$109.95
TEAC FD-55F 1/2 HT DS/QUAD (FOR IBM)	\$124.95
TEAC FD-55G 1/2 HT DS/HD (FOR IBM AT)	\$154.95
TANDON TM100-2 DS/DD (FOR IBM)	\$119.00
TANDON TM50-2 1/2 HT DS/DD (FOR IBM)	\$79.95
MPI-552 DS/DD (FOR IBM)	\$79.95
QUME QT-142 1/2 HT DS/DD (FOR IBM)	\$79.95

8" FLOPPY DISK DRIVES

FD 100-B SS/DD (SA/801 EQLM)	\$119.00
FD 200-B DS/DD (SA/851R EQLM)	\$159.00

DISK DRIVE ACCESSORIES

TEAC SPECIFICATION MANUAL	\$5.00
TEAC MAINTENANCE MANUAL	\$24.95
1/2 HT MOUNTING HARDWARE	\$2.95
MOUNTING RAILS FOR IBM AT	\$4.95
"Y" POWER CABLE FOR 5 1/4" FDDs	\$2.95
5 1/4" FDD POWER CONNECTORS	\$1.19

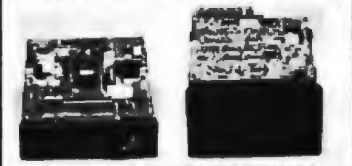

TEAC FD-55

TANDON TM100-2

DISK DRIVE ENCLOSURES

CAB-APPLE \$24.95
APPLE TYPE CABINET W/ OUT POWER SUPPLY

CAB-1FHS \$89.95
FULL HT 5 1/4" BEIGE CABINET W/ POWER SUPPLY

CAB-2SVS \$49.95
DUAL SLIMLINE 5 1/4" CABINET W/ POWER SUPPLY

CAB-2SVH \$299.95
VERTICAL DUAL SLIMLINE 8" CABINET W/ POWER SUPPLY

CAB-2FHS \$219.95
HORIZONTAL DUAL FULL HT 8" CABINET W/ POWER SUPPLY

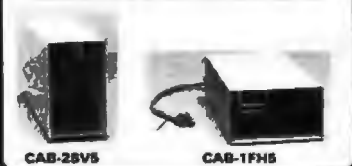

CAB-2SVS

CAB-1FHS

20 MEGA BYTE HARD DISK SYSTEM ONLY \$389.95!

SEAGATE ST-225 20 MB HARD DISK SYSTEM

INCLUDES HARD DISK CONTROLLER, CABLES AND INSTRUCTIONS. ALL DRIVES ARE PRE-TESTED AND COME WITH A ONE YEAR WARRANTY.

\$389.95

XT COMPATIBLE MOTHERBOARD

\$129.95

- 4.77 MHz 8088 CPU, OPTIONAL 8087 CO-PROCESSOR
- 6 EXPANSION SLOTS
- 0K RAM INSTALLED, EXPANDABLE TO 640K ON-BOARD MEMORY
- ALL ICs SOCKETED-HIGHEST QUALITY PC BOARD
- ACCEPTS 2784 OR 27128 ROMS

PRO-BIOS \$19.95

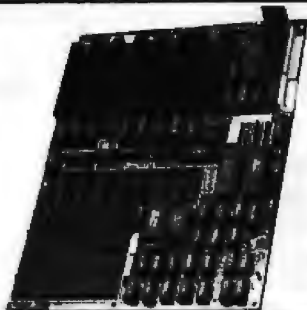

IBM COMPATIBLE INTERFACE CARDS

ALL WITH A ONE YEAR WARRANTY

MULTI I/O FLOPPY CARD

\$89.95

PERFECT FOR THE 640K MOTHERBOARD

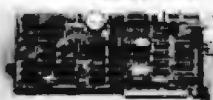

- 2 DRIVE FLOPPY DISK CONTROLLER
- 1 RS232 SERIAL PORT; OPTIONAL 2nd SERIAL PORT
- PARALLEL PRINTER PORT
- GAME PORT
- CLOCK/CALENDAR
- SOFTWARE: CLOCK UTILITIES, RAMDISK, SPOILER
- OPTIONAL SERIAL PORT \$15.00

MULTIFUNCTION CARD

\$84.95

ALL THE FEATURES OF AST'S 6 PACK PLUS AT HALF THE PRICE



- CLOCK/CALENDAR
- 0-384K RAM
- SERIAL PORT
- PARALLEL PORT
- GAME PORT
- SOFTWARE INCLUDED
- PRINTER CABLE \$9.95
- 84K RAM UPGRADE \$11.81

COLOR GRAPHICS ADAPTOR

\$89.95

FULLY COMPATIBLE WITH IBM COLOR CARD



- 4 VIDEO INTERFACES: RGB, COMPOSITE COLOR, HI-RES COMPOSITE MONOCHROME, CONNECTOR FOR RF MODULATOR
- COLOR GRAPHICS MODE: 320 x 200
- MONO GRAPHICS MODE: 640 x 200
- LIGHT PEN INTERFACE

MONOCHROME GRAPHICS CARD

\$89.95

FULLY COMPATIBLE WITH IBM MONOCHROME ADAPTOR & HERCULES GRAPHICS

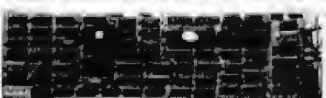

- LOTUS COMPATIBLE
- TEXT MODE: 80 x 25
- GRAPHICS MODE: 720 x 348
- PARALLEL PRINTER INTERFACE
- OPTIONAL SERIAL PORT \$19.95

MONOCHROME ADAPTOR

\$49.95

ANOTHER FANTASTIC VALUE FROM JDR!

- IBM COMPATIBLE TTL OUTPUT
- 720 x 350 PIXEL DISPLAY
- PLEASE NOTE: THIS CARD WILL NOT RUN LOTUS GRAPHICS AND DOES NOT INCLUDE A PARALLEL PORT

FLOPPY DISK DRIVE ADAPTOR

\$34.95



- INTERFACES UP TO 4 STANDARD FDDs TO IBM PC OR COMPATIBLES
- INCLUDES CABLE FOR TWO INTERNAL DRIVES
- STANDARD DB37 FOR EXTERNAL DRIVES
- RUNS QUAD DENSITY DRIVES WHEN USED WITH JFORMAT

1200 BAUD MODEMS

HAYES COMPATIBLE, AUTO-DIAL, AUTO-ANSWER, AUTO RE-DIAL ON BUSY, POWER-UP SELF TEST, FULL ONE YEAR WARRANTY

MODEL 1200B*

- INTERNAL DESIGN
- 10 INCH CARD
- SERIAL PORT INCLUDED

\$169.95

*FOR IBM, INCLUDES PC TALK III COMMUNICATIONS SOFTWARE

MODEL 1200H*

- INTERNAL DESIGN
- HALF LENGTH (5") CARD
- INCLUDES SPEAKER

\$149.95

SMARTTEAM

- EXTERNAL DESIGN
- WITH POWER SUPPLY
- LED STATUS INDICATORS

\$189.95

CRT MONITORS FOR ALL APPLICATIONS



LUXOR HI-RES RGB MONITOR

MODEL 190-9528

- DIGITAL RGB-IBM COMPATIBLE
- 14" SCREEN
- 16 TRUE COLORS
- 25 MHz BANDWIDTH
- RESOLUTION > 640 x 262
- 31mm DOT PITCH
- CABLE FOR IBM PC INCLUDED

\$299.95



SAKATA COMPOSITE COLOR

MODEL SC-100

- TOP RATED FOR APPLE
- 13" COMPOSITE VIDEO
- RESOLUTION: 280H x 300V
- INTERNAL AUDIO AMP
- ONE YEAR WARRANTY

\$169.95



CENTER SYSTEMS MONOCHROME

MODEL KLM-1211

- IBM COMPATIBLE TTL INPUT
- 12" NON-GLARE SCREEN
- P39 GREEN PHOSPHORUS
- VERY HIGH RESOLUTION: 25 MHz BANDWIDTH: 1100 LINES (CENTER)
- EMER VERSION \$109.95

\$99.95

BUILD YOUR OWN 256K XT COMPATIBLE SYSTEM

XT MOTHERBOARD	\$129.95
PRO-BIOS	\$19.95
256K RAM	\$28.55
130 WATT POWER SUPPLY	\$89.95
FLIP-TOP CASE	\$39.95
DKM-2000 KEYBOARD	\$59.95
1/2 HEIGHT QUME DRIVE	\$79.95
FLOPPY DISK CONTROLLER	\$34.95
MONOCHROME ADAPTOR	\$49.95
MONOCHROME MONITOR	\$99.95
TOTAL:	\$611.10

MONITOR STAND



TILTS AND SWIVELS

ONLY \$12.95

IBM PRINTER CABLE



- DB25 TO CENTRONICS
- SHIELDED CABLE \$9.95

IBM STYLE COMPUTER CASE

AN ATTRACTIVE STEEL CASE WITH A HINGED LID FITS THE POPULAR PC/XT COMPATIBLE MOTHERBOARDS

- SWITCH CUT-OUT ON SIDE FOR PC/XT STYLE POWER SUPPLY
- CUT-OUT FOR 3 EXPANSION SLOTS
- ALL HARDWARE INCLUDED

\$39.95

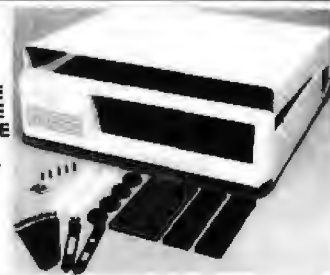

IBM COMPATIBLE KEYBOARDS

DKM-2000 \$59.95

IBM-5151 \$79.95



- "5150" STYLE KEYBOARD
- FULLY IBM COMPATIBLE
- LED STATUS INDICATORS FOR CAPS & NUMBER LOCK
- 83 KEY - SAME LAYOUT AS IBM PC/XT KEYBOARD



- REPLACEMENT FOR KEYTRONICS KB-5151™
- SEPARATE CURSOR & NUMERIC KEYPAD
- CAPS LOCK & NUMBER LOCK INDICATORS
- IMPROVED KEYBOARD LAYOUT

POWER SUPPLY



NOW ONLY \$69.95

- FOR IBM PC-XT COMPATIBLE
- 135 WATTS
- +5V @ 15A, +12V @ 4.2A
- -5V @ .5A, -12V @ .5A

150 WATT MODEL \$79.95

DISK DRIVES TANDON TM50-2

\$79.95

- 1/2 HT DS/DD
- IBM COMPATIBLE
- EXTREMELY QUIET!

TEAC FD-55B	DS/DD	\$109.95
TEAC FD-55F	DS/QUAD	\$124.95
TEAC FD-55B	DS/HD	\$154.95
QUME QY-142	DS/DD	\$79.95
MONITOR HARDWARE		\$2.95
AT/RAILS		\$4.95

JDR Microdevices

1224 S. Bascom Avenue, San Jose, CA 95128
Toll Free 800-538-5000 • (408) 995-5430 • FAX (408) 275-8415 • Telex 171-110

D·I·S·K·S A·N·D D·O·W·N·L·O·A·D·S

ORDERING DISKS OF BYTE LISTINGS

Listings that accompany BYTE articles are available in a variety of disk formats and on Cauzin Softstrip. Each disk package (which sometimes consists of more than one disk) contains an entire month's listings. If you want to order a disk package from a previous month, please call (603) 924-9281 to find out how many disks it includes. To order listings (for noncommercial use only), fill out this form and send a check or money order in the correct amount to:

BYTE Listings
One Phoenix Mill Lane
Peterborough, NH 03458

All prices include postage. Program listings can also be downloaded via BYTEnet Listings at (617) 861-9764.

BYTE issue: _____

COMMON 5¼-INCH FORMATS

All cost \$5 per disk in North America, \$6 in Europe and South America, \$7 in Asia, Africa, and Australia.

- Apple II 5¼-inch DOS 3.3
- Apple II 5¼-inch ProDOS
- Hewlett-Packard 125
- IBM PC
- Kaypro 2 CP/M
- Texas Instruments Professional
- TRS-80 Model III
- TRS-80 Model 4
- Zenith Z-100

COMMON 3½-INCH FORMATS

All cost \$6 per disk in North America, \$7 in Europe and South America, \$8 in Asia, Africa, and Australia.

- Apple Macintosh
- Atari 520ST
- Commodore Amiga
- Data General/One
- Hewlett-Packard 150

CP/M STANDARD 8-INCH FORMAT

\$6 per disk in North America, \$7 in Europe and South America, \$8 in Asia, Africa, and Australia.

- Single-sided single-density
- Double-sided double-density

OTHER FORMATS

Due to the diversity of requests and the custom work involved, there will be some delay in fulfilling these requests. All cost \$6 per disk in North America, \$7 in Europe and South America, \$8 in Asia, Africa, and Australia.

Size 8-inch 5¼-inch 3½-inch
Machine _____

CAUZIN SOFTSTRIP

\$2 per month in North America, \$3 per month in Europe and South America, \$3.50 per month in Asia, Africa, and Australia.

SEND TO:

Name _____

Street _____

City _____ State or Province _____

Postal Code _____ Country _____

Check or money order enclosed for \$ _____

BULLETIN BOARDS IN CANADA

Listed below are some computer bulletin boards that carry program listings from BYTE. Programs are for noncommercial use in connection with BYTE articles only. Some BBSs may charge an annual maintenance fee, and you must pay your own telephone charges.

Western Canadian Distribution Center (3420 48th St., Edmonton, Alberta T6L 3R5) will be supplying listings to its member bulletin board systems.

Edmonton, Alberta, (403) 454-6093

Meadowlark, Alberta, (403) 435-6579

Montreal, Quebec, PComm Systems, (514) 989-9450

Prince George, British Columbia, (604) 562-9519

Regina, Saskatchewan, (306) 586-5585

Toronto, Ontario, Epson Club of Toronto (EPCOT), (416) 635-9600

Winnipeg, Manitoba, (204) 452-5529

In addition, arrangements for BYTEnet Listings have been made with one or more system operators in the following nations: Australia, Austria, Brazil, Denmark, France, Hong Kong, Indonesia, Italy, Japan, Malaysia, The Netherlands, Nigeria, Norway, Saudi Arabia, Singapore, Sweden, Switzerland, United Kingdom, and West Germany. Contact us at (603) 924-9281 for an up-to-date list. ■

B.O.M.B

BYTE'S ONGOING MONITOR BOX

ARTICLE#	PAGE	ARTICLE	AUTHOR(S)	ARTICLE#	PAGE	ARTICLE	AUTHOR(S)
1	9	Microbytes	staff	15	195	Programming Experiences	Tesler
2	29	What's New	staff	16	211	Designing an Efficient Language	Duff
3	50	Ask BYTE/Circuit Cellar Feedback	Ciarcia	17	227	Object-oriented FORTH	Pountain
4	63	Book Reviews	Vose, Kendall, Czarnik	18	241	The NCR PC6	Little
5	85	Similarity Mapping	Spencer	19	247	The Sperry PC/IT	Davis
6	97	Ciarcia's Circuit Cellar: Parallel Interfacing: A Tutorial Discussion, Part 2: Applications	Ciarcia	20	253	DeSmet C Development Package for the Macintosh	Robie
7	108	The Definicon 68020 Coprocessor, Part 2: Software Support	Marshall, Jones, Kluger	21	261	TOPSI 2.0	Moskowitz
8	115	Mathematics of Programming	Hoare	22	267	Let's C and csd	Wong
9	131	Programming Insight: Polar Normal Distribution	Latour	23	273	NewWord 3	Heilborn, Reel
10	139	Elements of Object-oriented Programming	Pascoe	24	277	Reflex	DeMaria
11	145	A Small Taste of Smalltalk	Kaehler, Patterson	25	281	Guru	Tello
12	161	Objects, Icons, and Software-ICs	Cox, Hunt	26	289	The Datran Modem Accelerator	Nance
13	177	Object-oriented Languages for the Macintosh	Schmucker	27	299	Computing at Chaos Manor: Off We Go	Pournelle
14	189	MacApp: An Application Framework	Schmucker	28	319	Applications Only: More Words	Shapiro
				29	323	According to Webster: Going to the Faire	Webster
				30	329	BYTE Japan: Fujitsu Processor Upgrade	Raiko
				31	333	Mathematical Recreations: Number Games	Kurosaka
				32	344	Best of BIX	BIXen

BOMB Results

MASSIVE APPEAL

The winner of \$100 for gaining the most votes in the May BYTE is Leonard Laub for his theme article covering "The Evolution of Mass Storage." In second is "Easy C," featuring tips for good code by Pete Orlin and John Heath, who will be splitting \$50. Best of BIX, by the BIXen (regular

participants on BIX), wins first in the in-house lineup, followed by Computing at Chaos Manor and According to Webster.

Leonard Laub also wins the \$50 award for quality with "The Evolution of Mass Storage." Congratulations.

BYTE ADVERTISING SALES STAFF:

Dennis J. Riley, Advertising Sales Manager, One Phoenix Mill Lane, Peterborough, NH 03458, tel. (603) 924-9281

NEW ENGLAND
ME, NH, VT, MA, RI,
EASTERN CANADA
Paul McPherson Jr. (617) 262-1160
McGraw-Hill Publications
575 Boylston Street
Boston, MA 02116

ATLANTIC
NY, NJ, CT, NJ (NORTH)
Leah G. Rabinowitz (212) 512-2096
McGraw-Hill Publications
1221 Avenue of the Americas—
39th Floor
New York, NY 10020

Dick McGurk (203) 968-7111
McGraw-Hill Publications
Building A—3rd Floor
777 Long Ridge Road
Stamford, CT 06902

EAST
PA (EAST), NJ (SOUTH),
MD, VA, W.VA, DE, D.C.
Daniel Ferro (215) 496-3833
McGraw-Hill Publications
Three Parkway
Philadelphia, PA 19102

SOUTHEAST
NC, SC, GA, FL, AL, TN
Maggie M. Dorvee (404) 252-0626
McGraw-Hill Publications
4170 Ashford-Dunwoody Road—
Suite 420
Atlanta, GA 30319

MIDWEST
IL, MO, KS, IA, ND, SD, MN, WI, NB, IN
Bob Denmead (312) 751-3740
McGraw-Hill Publications
Blair Building
645 North Michigan Ave.
Chicago, IL 60611

GREAT LAKES, OHIO REGION
MI, OH, PA (ALLEGHENY), KY,
ONTARIO, CANADA
Renee Navarro (313) 352-9760
McGraw-Hill Publications
4000 Town Center—Suite 770
Southfield, MI 48075

SOUTHWEST, ROCKY MOUNTAIN
UT, CO, WY, OK, TX, AR, MS, LA
Kevin Harold (214) 458-2400
McGraw-Hill Publications
Prestonwood Tower—Suite 907
5151 Beltline
Dallas, TX 75240

SOUTH PACIFIC
SOUTHERN CA, AZ, NM, LAS VEGAS
Jack Anderson (714) 557-6292
McGraw-Hill Publications
3001 Red Hill Ave.
Building #1—Suite 222
Costa Mesa, CA 92626

Karen Niles (213) 480-9243, 487-1160
McGraw-Hill Publications
3333 Wilshire Boulevard #407
Los Angeles, CA 90010

NORTH PACIFIC
HI, WA, OR, ID, MT, NORTHERN CA,
NV (except LAS VEGAS), W. CANADA
Mike Kisseberth (415) 362-4600
McGraw-Hill Publications
425 Battery Street
San Francisco, CA 94111

Bill McAfee (415) 349-4100
McGraw-Hill Publications
951 Mariner's Island Blvd.—3rd Floor
San Mateo, CA 94404

**WEST COAST SURPLUS
AND RETAIL ACCOUNTS**
Tom Harvey (805) 964-8577
3463 State Street—Suite 256
Santa Barbara, CA 93105

The Buyer's Mart
Karen Burgess (603) 924-3754
BYTE Publications
70 Main Street
Peterborough, NH 03458

BYTE BITS (2x3)
Dan Harper (603) 924-6830
BYTE Publications
70 Main Street
Peterborough, NH 03458

Post Card Mailings
National
Bradley Browne (603) 924-6166
BYTE Publications
70 Main Street
Peterborough, NH 03458

International Advertising Sales Staff:

Mr. Hans Csokor
Publimedia
Reisnerstrasse 61
A-1037 Vienna, Austria
222 75 76 84

Mrs. Gurit Gepner
McGraw-Hill Publishing Co.
PO Box 2156
Bat Yam, 59121 Israel
3 866 561 321 39

Mr. Fritz Krusebecker
McGraw-Hill Publishing Co.
Liebigstrasse 19
D-6000 Frankfurt/Main 1
West Germany
69 72 01 81

Mrs. Maria Sarmiento
Pedro Teixeira 8, Off. 320
Iberia Mart I
Madrid 4, Spain
1 45 52 891

Mr. Andrew Karnig
Andrew Karnig & Associates
Flombodavagen
S-131 31 Nacka, Sweden
8-44 0005

Mr. Alain Faure
McGraw-Hill Publishing Co.
128 Faubourg Saint Honoré
75008 Paris
France
(1) 47-20-33-42

Mr. Arthur Scheffer
McGraw-Hill Publishing Co.
34 Dover St.
London W1X 3RA
England 01 493 1451

Manuela Capuano
McGraw-Hill Publishing Co.
Via Flavio Baracchini 1
20123 Milan, Italy
02 86 90 617

Seavex Ltd.
400 Orchard Road, #10-01
Singapore 0923
Republic of Singapore
Tel. 734-9790
Telex: RS35339 SEAVEX

Seavex Ltd.
503 Wilson House
19-27 Wyndham St.
Central, Hong Kong
Tel: 5-260149
Telex: 60904 SEVEX HX

Hiro Morita
McGraw-Hill Publishing Co.
Overseas Corp.
Room 1528
Kasumigaseki Bldg.
3-2-3 Kasumigaseki,
Chiyoda-Ku
Tokyo 100, Japan
3 581 9811

Mr. Ernest McCrary
Empresa Internacional de
Comunicacoes Ltda.
Rua da Consolacao, 222
Conjunto 103
01302 Sao Paulo, S.P., Brasil
Tel. (11) 259-3811
Telex: (1100) 32122 EMBN

R·E·A·D·E·R S·E·R·V·I·C·E

Inquiry No.	Page No.	Inquiry No.	Page No.	Inquiry No.	Page No.	Inquiry No.	Page No.
326 A.W. ABLE.....	251	* COMPUTER CHRONICLES.....	318	125 GRAFPOINT.....	336	179 MARK WILLIAMS CO.....	57
2 ABSOFT.....	346	* COMPUTER CONTINUUM.....	337	* HARMONY COMPUTERS.....	327	180 MARK WILLIAMS CO.....	59
331 ACS IMPORTERS.....	378	68 COMPUTER MAIL ORDER.....	316, 317	128 HAYES MICROCOMP PROD.....	31	329 MATHSOFT.....	206
3 ADDISON-WESLEY COMPSCNCE.....	52	* COMPUTER MUSEUM.....	370	130 HERCULES COMPUTER TECH.....	79	* MAXELL DATA PRODUCTS.....	7
4 ADDISON-WESLEY EDMEDIA.....	124	69 COMPUTER PARTS MART.....	371	131 HERITAGE SYSTEMS CORP.....	382	* MCGRAWHILL RESEARCH.....	321
5 ADV DIGITAL CORP.....	28	70 COMPUTER SURPLUS STORE.....	258	132 HEWLETT-PACKARD.....	165	182 MCGRAWHILL SOFTWARE.....	154
6 ADV DIGITAL CORP.....	28	71 COMPUTER WAREHOUSE.....	66	133 HEWLETT-PACKARD.....	283	183 MEGASOFT.....	360
7 ADV INTELLIGENCE TECHN.....	387	72 COMPUTER WAREHOUSE.....	66	46 HOMEBASE.....	275	184 MEGATEL COMPUTER TECH.....	76
8 ADVANCED COMP. PROD.....	388, 389	73 COMPUTERBANC.....	396	135 IBEX COMP CORP.....	335	185 MERRITT COMP. PRODUCTS.....	373
9 ADVANCED TECHNOLOGY PROD.....	384	74 COMPUTERS INTERNATIONAL.....	140	* IBMSMALL SYSTEMS DIV.....	255	186 METACOMCO.....	48
10 AFTON COMPUTER.....	180	75 COMPUTRADE.....	324	136 IC EXPRESS.....	380	187 MICRO DATA BASE SYS.....	201
11 AFTON COMPUTER.....	180	76 CONCORD TECHNOLOGY CO.....	174	396 IC MEMORY.....	384	333 MICRO INTERFACES CORP.....	69
13 ALF PRODUCTS, INC.....	384	77 CONROY-LAPOINTE.....	60, 61	* INFORMATION APPLIANCE.....	373	334 MICRO INTERFACES CORP.....	69
* ALPS AMERICA.....	48 A-L	78 CONROY-LAPOINTE.....	60, 61	137 INMAC.....	220	189 MICRO MART, INC.....	72, 73
15 AMDEK CORP.....	126, 127	79 CONROY-LAPOINTE.....	60, 61	* INTECTRA INC.....	371	190 MICRO PRODUCTS INT'L.....	397
* AMERICAN AIRLINES.....	33	80 CORDATA.....	173	138 INTEGRAND RESEARCH CORP.....	302	191 MICRO SUPPLY ORGANIZATION.....	385
18 AMERICAN COMP& PERIPH.....	194	83 CUESTA SYSTEMS.....	56	139 INTEL CORPORATION.....	106, 107	192 MICROBIDGE COMPUTERS.....	376
19 AMERICAN COMP& PERIPH.....	194	85 DATA SPEC.....	174	140 INTERNATIONAL COMPUTING.....	371	193 MICROGRAFX.....	17
20 AMERICAN SEMICONDUCTOR.....	384	86 DATA SPEC.....	174	141 ITT INFORMATION SYSTEMS.....	288	* MICROMINT INC.....	210
21 AMERICAN SMALL BUSN COMP.....	62	87 DATA TRANSLATION INC.....	270	142 ITT INFORMATION SYSTEMS.....	288	195 MICRON TECHNOLOGY.....	308
22 AMPRO COMPUTERS INC.....	325	88 DECISIONWARE INC.....	304	143 IACO ENTERPRISES.....	371	196 MICROPROCESSORS UNLTD.....	398
23 APROTEK.....	335	89 DECISIONWARE INC.....	304	144 IADE COMP/PROD.....	394, 395	332 MICROPORT SYSTEMS, INC.....	203
24 ARITY CORPORATION.....	340	90 DICONIX.....	134, 135	145 IAMECO ELECTRONICS.....	392, 393	* MICROSOFT CORP.....	51
* AST RESEARCH INC.....	19	34 DIGIT, INC.....	22	146 IC INFORMATION SYSTEMS.....	217	* MICROSOFT CORP.....	128, 129
* AT&T COMMUNICATIONS.....	223	91 DIGITALK INC.....	45	147 IC INFORMATION SYSTEMS.....	217	198 MICROTECH.....	378
28 AT&T INFORMATION SYS.....	269	92 DISKOTECH.....	376	148 IDR INSTRUMENTS.....	125	199 MICROWAY.....	96
29 AT&T PHOTO & IMAGING CTR.....	12, 13	93 DISKETTE CONNECTION.....	332	149 IDR MICRODEVICES.....	399	200 MICROWAY.....	314
30 ATRON CORP.....	342	66 DISKMASTER.....	398	150 IDR MICRODEVICES.....	400, 401	201 MITAC.....	280
31 ATRONICS INT'L, INC.....	311	94 DISKS PLUS.....	327	151 IDR MICRODEVICES.....	402, 403	12 MIX SOFTWARE.....	21
32 AVOCET SYSTEMS INC.....	191	95 DISKWORLD INC.....	382	152 IDR MICRODEVICES.....	404	202 MULTITECH ELECTRONICS INC.....	130
33 B&B ELECTRONICS.....	378	96 DISKWORLD INC.....	383	153 IVB ELECTRONICS.....	375	203 MYSTIC CANYON SOFTWARE.....	378
* B&C MICROSYSTEMS.....	378	97 DISPLAY TELECOMMUNICNS.....	330	154 KADAK PRODUCTS LTD.....	326	204 NANTUCKET.....	37
* B&C MICROSYSTEMS.....	378	98 DOKAY COMP. PROD. INC.....	377	52 KALGAN SOFTWARE INC.....	77	205 NANTUCKET.....	37
35 BARRINGTON SYSTEMS.....	25	99 DRESSELHAUS COMP/PROD.....	105	53 KALGAN SOFTWARE INC.....	77	206 NATIONAL INSTRUMENTS.....	18
36 BAY AREA BUSINESS SYSTEMS.....	398	327 DYNAMUS MICRO-DATA SYS.....	373	323 KEA SYSTEMS.....	334	207 NEC HOME ELECTR.USA.....	215
37 BAY EXPRESS COMPANY, THE.....	373	126 EAST DIGITAL.....	282	155 KIMTRON CORP.....	41	208 NEC INFORMATION SYS.....	CM
38 BAY TECHNICAL ASSOC.....	245	101 ECOSOFT.....	155	156 KIMTRON CORP.....	41	209 NORTHEASTERN SOFTWARE CO.....	147
39 BINARY TECHNOLOGY, INC.....	258	325 ELECTRONIC UNIVERSITY NETWORK.....	219	157 KI COMPUTERS.....	346	210 OHIO CACHE SYSCORP.....	252
40 BITTNER ELECTRONICS.....	335	103 ELEKOR INC.....	336	158 LAHEY COMPUTER SYSTEMS.....	309	211 ORCHID TECHNOLOGY.....	23
450 BIX.....	286, 287	104 ELLIS COMPUTING INC.....	240	159 LATTICE, INC.....	114	212 ORCHID TECHNOLOGY.....	23
42 BORLAND INT'L.....	CM, 1	105 ENERTRONICS RESEARCH.....	171	160 LEADING EDGE PROD.....	55	213 ORION INSTRUMENTS.....	188
43 BORLAND INT'L.....	CM, 1	107 EVEREST SOLUTIONS INC.....	222	161 LEVIEN INSTRUMENT CO.....	328	214 PC COMPUTER BROKERS INC.....	380
44 BP MICROSYSTEMS.....	382	108 EVEREX SYSTEMS.....	35	162 LIFEBOAT ASSOC.....	291	215 PC HORIZONS INC.....	371
45 BROWN BAG SOFTWARE.....	133	109 EVEREX SYSTEMS.....	35	163 LINTER COMP ACCESSORIES.....	375	216 PACIFIC EXCHANGES.....	258
47 BUSINESS TOOLS INC.....	151	* FASTCOMM DATA CORP.....	313	164 LODGE ELECTRONICS.....	378	217 PATHFINDER SOFTWARE INC.....	398
* BUYER'S MART SECTION.....	359-363	110 FELLOWES MANUFACTURING CO.....	89	165 LOGIC ARRAY.....	369	219 PC MART.....	53
* BYTE BACK ISSUES.....	232	111 FLAGSTAFF ENGINEERING.....	298	166 LOGIC ARRAY.....	369	220 PC NETWORK.....	80, 80 A-B, 81
337 BYTE BITS MESSAGE.....	384	112 FLAGSTAFF ENGINEERING.....	298	167 LOGICAL DEVICES.....	112, 113	221 PC SIG.....	375
* BYTE SUB MESSAGE.....	322	113 FORMAT SOFTWARE.....	90	168 LOGICAL DEVICES.....	112, 113	* PC'S LIMITED.....	224 A-B
* BYTE SUB SERVICE.....	312	114 FORMAT SOFTWARE.....	90	400 LOGICSOFT.....	176 A-F	224 PC'S LIMITED.....	225
49 BYTE CONNECTION, THE.....	370	115 FORTRON CORPORATION.....	64	* LOGITECH INC.....	119	225 PECAN SOFTWARE SYS, INC.....	16
51 BYTEK COMP SYS CORP.....	343	116 FORTRON CORPORATION.....	64	170 LOGITECH INC.....	121	226 PERMA POWER ELECTRONICS.....	124
* C WARE/DESMET C.....	325	117 FORTRON CORPORATION.....	367	171 LOGITECH INC.....	123	227 PERMA POWER ELECTRONICS.....	124
* CALIFORNIA DIGITAL.....	390, 391	118 FORTRON CORPORATION.....	367	* LONE STAR SOFTWARE INC.....	374	228 PERSOFT INC.....	8
54 CAPITAL EQUIPMENT CORP.....	244	119 FOX SOFTWARE INC.....	20	172 LYCO COMPUTERS.....	398	229 PERSONAL TEX, INC.....	68
55 CAUZIN SYSTEMS.....	293	120 FRANK HOGG LABORATORY.....	371	173 LYCO COMPUTER.....	221	230 PINE COMPUTER INC.....	366
82 CEC.....	328	121 FUJITSU AMERICA.....	246	174 M-S CORPORATION.....	376	231 POLARIS SOFTWARE.....	322
56 CENTRAL POINT SOFTWARE.....	220	328 GFK.....	334	175 MANX SOFTWARE SYS.....	71	232 POLARIS SOFTWARE.....	322
57 CHALCEDONY SOFTWARE.....	159	122 GOLD HILL COMPUTERS.....	138	176 MANX SOFTWARE SYS.....	199	233 PRECISION DATA PRODUCTS.....	382
58 CHALCEDONY SOFTWARE.....	159	123 GOLDEN BOW SYSTEMS.....	375	177 MANZANA MICROSYS, INC.....	200	234 PRINTER ACCESSORIES DIRECT.....	326
59 COEFFICIENT SYS. CORP.....	271	124 GOLDEN BOW SYSTEMS.....	376	178 MARCHAND INTERNATIONAL.....	373	235 PRINTING & GRAPHIC ENHANC.....	331
60 COGITATE.....	375					236 PRODUCTIVITY PRODINT INC.....	26, 27
61 COGITATE.....	375					237 PROFESSOR JONES, INC.....	371
* COMPAQ COMPUTER CORP.....	84					238 PROGRAMMER'S SHOP.....	301
62 COMPETITIVE EDGE.....	324					330 PROGRAMMING LOGIC SYS, INC.....	321
63 COMPUTADA TRANSLATORS INC.....	371					239 PROSOFT.....	43
* COMPUPRO.....	260					240 PURPLE COMPUTING.....	373
64 COMPUSAVE.....	368					241 OJA TECH, INC.....	376
65 COMPUSERVE.....	183					242 OJA TECH, INC.....	376
67 COMPUTER-AGE, INC.....	376					243 OJA TECH, INC.....	380

 TO GET FURTHER information on the products advertised in BYTE, either pick up your touch-tone telephone and use TIPS (if you are a subscriber), or fill out the reader service card. Either way full instructions are provided following this reader service index which is provided as an additional service by the publisher, who assumes no liability for errors or omissions. *Correspond directly with company.

BYTE READER SERVICE



Fill out this coupon carefully. PLEASE PRINT. Requests cannot be honored unless the zip code is included. This card is valid for 6 months from cover date.

Name _____ AUGUST 1986
4188

(Title) _____ (Company) _____

Address _____ Telephone _____

City _____ State _____ Zip _____

I purchased this copy by Subscription Newsstand, computer store, or bookstore

1 23 45 67 89	111 133 155 177 199	221 243 265 287 309	331 353 375 397 419	441 463 485 507 529	551 573 595 617 639	661 683 705 727 749	771 793
2 24 46 68 90	112 134 156 178 200	222 244 266 288 310	332 354 376 398 420	442 464 486 508 530	552 574 596 618 640	662 684 706 728 750	772 794
3 25 47 69 91	113 135 157 179 201	223 245 267 289 311	333 355 377 399 421	443 465 487 509 531	553 575 597 619 641	663 685 707 729 751	773 795
4 26 48 70 92	114 136 158 180 202	224 246 268 290 312	334 356 378 400 422	444 466 488 510 532	554 576 598 620 642	664 686 708 730 752	774 796
5 27 49 71 93	115 137 159 181 203	225 247 269 291 313	335 357 379 401 423	445 467 489 511 533	555 577 599 621 643	665 687 709 731 753	775 797
6 28 50 72 94	116 138 160 182 204	226 248 270 292 314	336 358 380 402 424	446 468 490 512 534	556 578 600 622 644	666 688 710 732 754	776 798
7 29 51 73 95	117 139 161 183 205	227 249 271 293 315	337 359 381 403 425	447 469 491 513 535	557 579 601 623 645	667 689 711 733 755	777 799
8 30 52 74 96	118 140 162 184 206	228 250 272 294 316	338 360 382 404 426	448 470 492 514 536	558 580 602 624 646	668 690 712 734 756	778 800
9 31 53 75 97	119 141 163 185 207	229 251 273 295 317	339 361 383 405 427	449 471 493 515 537	559 581 603 625 647	669 691 713 735 757	779 801
10 32 54 76 98	120 142 164 186 208	230 252 274 296 318	340 362 384 406 428	450 472 494 516 538	560 582 604 626 648	670 692 714 736 758	780 802
11 33 55 77 99	121 143 165 187 209	231 253 275 297 319	341 363 385 407 429	451 473 495 517 539	561 583 605 627 649	671 693 715 737 759	781 803
12 34 56 78 100	122 144 166 188 210	232 254 276 298 320	342 364 386 408 430	452 474 496 518 540	562 584 606 628 650	672 694 716 738 760	782 804
13 35 57 79 101	123 145 167 189 211	233 255 277 299 321	343 365 387 409 431	453 475 497 519 541	563 585 607 629 651	673 695 717 739 761	783 805
14 36 58 80 102	124 146 168 190 212	234 256 278 300 322	344 366 388 410 432	454 476 498 520 542	564 586 608 630 652	674 696 718 740 762	784 806
15 37 59 81 103	125 147 169 191 213	235 257 279 301 323	345 367 389 411 433	455 477 499 521 543	565 587 609 631 653	675 697 719 741 763	785 807
16 38 60 82 104	126 148 170 192 214	236 258 280 302 324	346 368 390 412 434	456 478 500 522 544	566 588 610 632 654	676 698 720 742 764	786 808
17 39 61 83 105	127 149 171 193 215	237 259 281 303 325	347 369 391 413 435	457 479 501 523 545	567 589 611 633 655	677 699 721 743 765	787 809
18 40 62 84 106	128 150 172 194 216	238 260 282 304 326	348 370 392 414 436	458 480 502 524 546	568 590 612 634 656	678 700 722 744 766	788 810
19 41 63 85 107	129 151 173 195 217	239 261 283 305 327	349 371 393 415 437	459 481 503 525 547	569 591 613 635 657	679 701 723 745 767	789 811
20 42 64 86 108	130 152 174 196 218	240 262 284 306 328	350 372 394 416 438	460 482 504 526 548	570 592 614 636 658	680 702 724 746 768	790 812
21 43 65 87 109	131 153 175 197 219	241 263 285 307 329	351 373 395 417 439	461 483 505 527 549	571 593 615 637 659	681 703 725 747 769	791 813
22 44 66 88 110	132 154 176 198 220	242 264 286 308 330	352 374 396 418 440	462 484 506 528 550	572 594 616 638 660	682 704 726 748 770	792 814

BYTE's BOMB is your direct line to the editor's desk. Each month the two top-rated authors receive bonuses based on your evaluation. First look at the list of this month's articles and corresponding article numbers (located on the page preceding the Reader Service list), then rate each article you've read as Excellent, Good, Fair, or Poor, based on your overall impression of the article, by circling the appropriate number in each column below. Your feedback helps us produce the best possible magazine each month.

Article No.	1	2	3	4	5	6	7	8	9	10	11	12	13	14	15	16	17	18	19	20	21	22	23	24	25
Excellent	1	5	9	13	17	21	25	29	33	37	41	45	49	53	57	61	65	69	73	77	81	85	89	93	97
Good	2	6	10	14	18	22	26	30	34	38	42	46	50	54	58	62	66	70	74	78	82	86	90	94	98
Fair	3	7	11	15	19	23	27	31	35	39	43	47	51	55	59	63	67	71	75	79	83	87	91	95	99
Poor	4	8	12	16	20	24	28	32	36	40	44	48	52	56	60	64	68	72	76	80	84	88	92	96	100

Article No.	26	27	28	29	30	31	32	33	34	35	36	37	38	39	40	41	42	43	44	45	46	47	48	49	50
Excellent	101	105	109	113	117	121	125	129	133	137	141	145	149	153	157	161	165	169	173	177	181	185	189	193	197
Good	102	106	110	114	118	122	126	130	134	138	142	146	150	154	158	162	166	170	174	178	182	186	190	194	198
Fair	103	107	111	115	119	123	127	131	135	139	143	147	151	155	159	163	167	171	175	179	183	187	191	195	199
Poor	104	108	112	116	120	124	128	132	136	140	144	148	152	156	160	164	168	172	176	180	184	188	192	196	200

BYTE READER SERVICE



Fill out this coupon carefully. PLEASE PRINT. Requests cannot be honored unless the zip code is included. This card is valid for 6 months from cover date.

Name _____ AUGUST 1986
4188

(Title) _____ (Company) _____

Address _____ Telephone _____

City _____ State _____ Zip _____

I purchased this copy by Subscription Newsstand, computer store, or bookstore

1 23 45 67 89	111 133 155 177 199	221 243 265 287 309	331 353 375 397 419	441 463 485 507 529	551 573 595 617 639	661 683 705 727 749	771 793
2 24 46 68 90	112 134 156 178 200	222 244 266 288 310	332 354 376 398 420	442 464 486 508 530	552 574 596 618 640	662 684 706 728 750	772 794
3 25 47 69 91	113 135 157 179 201	223 245 267 289 311	333 355 377 399 421	443 465 487 509 531	553 575 597 619 641	663 685 707 729 751	773 795
4 26 48 70 92	114 136 158 180 202	224 246 268 290 312	334 356 378 400 422	444 466 488 510 532	554 576 598 620 642	664 686 708 730 752	774 796
5 27 49 71 93	115 137 159 181 203	225 247 269 291 313	335 357 379 401 423	445 467 489 511 533	555 577 599 621 643	665 687 709 731 753	775 797
6 28 50 72 94	116 138 160 182 204	226 248 270 292 314	336 358 380 402 424	446 468 490 512 534	556 578 600 622 644	666 688 710 732 754	776 798
7 29 51 73 95	117 139 161 183 205	227 249 271 293 315	337 359 381 403 425	447 469 491 513 535	557 579 601 623 645	667 689 711 733 755	777 799
8 30 52 74 96	118 140 162 184 206	228 250 272 294 316	338 360 382 404 426	448 470 492 514 536	558 580 602 624 646	668 690 712 734 756	778 800
9 31 53 75 97	119 141 163 185 207	229 251 273 295 317	339 361 383 405 427	449 471 493 515 537	559 581 603 625 647	669 691 713 735 757	779 801
10 32 54 76 98	120 142 164 186 208	230 252 274 296 318	340 362 384 406 428	450 472 494 516 538	560 582 604 626 648	670 692 714 736 758	780 802
11 33 55 77 99	121 143 165 187 209	231 253 275 297 319	341 363 385 407 429	451 473 495 517 539	561 583 605 627 649	671 693 715 737 759	781 803
12 34 56 78 100	122 144 166 188 210	232 254 276 298 320	342 364 386 408 430	452 474 496 518 540	562 584 606 628 650	672 694 716 738 760	782 804
13 35 57 79 101	123 145 167 189 211	233 255 277 299 321	343 365 387 409 431	453 475 497 519 541	563 585 607 629 651	673 695 717 739 761	783 805
14 36 58 80 102	124 146 168 190 212	234 256 278 300 322	344 366 388 410 432	454 476 498 520 542	564 586 608 630 652	674 696 718 740 762	784 806
15 37 59 81 103	125 147 169 191 213	235 257 279 301 323	345 367 389 411 433	455 477 499 521 543	565 587 609 631 653	675 697 719 741 763	785 807
16 38 60 82 104	126 148 170 192 214	236 258 280 302 324	346 368 390 412 434	456 478 500 522 544	566 588 610 632 654	676 698 720 742 764	786 808
17 39 61 83 105	127 149 171 193 215	237 259 281 303 325	347 369 391 413 435	457 479 501 523 545	567 589 611 633 655	677 699 721 743 765	787 809
18 40 62 84 106	128 150 172 194 216	238 260 282 304 326	348 370 392 414 436	458 480 502 524 546	568 590 612 634 656	678 700 722 744 766	788 810
19 41 63 85 107	129 151 173 195 217	239 261 283 305 327	349 371 393 415 437	459 481 503 525 547	569 591 613 635 657	679 701 723 745 767	789 811
20 42 64 86 108	130 152 174 196 218	240 262 284 306 328	350 372 394 416 438	460 482 504 526 548	570 592 614 636 658	680 702 724 746 768	790 812
21 43 65 87 109	131 153 175 197 219	241 263 285 307 329	351 373 395 417 439	461 483 505 527 549	571 593 615 637 659	681 703 725 747 769	791 813
22 44 66 88 110	132 154 176 198 220	242 264 286 308 330	352 374 396 418 440	462 484 506 528 550	572 594 616 638 660	682 704 726 748 770	792 814

To get further information on the products advertised in BYTE, fill out the reader service card with your name and address. Then circle the appropriate numbers for the advertisers you select from the list. Add a first-class stamp to the card, then drop it in the mail. Not only do you gain information, but our advertisers are encouraged to use the marketplace provided by BYTE. This helps us bring you a bigger BYTE. The index is provided as an additional service by the publisher, who assumes no liability for errors or omissions.

PLACE
POSTAGE
HERE

BYTE

READER SERVICE
PO BOX 298
DALTON, MA 01227-0298
USA

PLACE
POSTAGE
HERE

BYTE

READER SERVICE
PO BOX 298
DALTON, MA 01227-0298
USA

BYTE THE MICRO COMPUTER

SUBSCRIPTIONS

4186

For a subscription to BYTE, please complete this card.

Name _____

Address _____

City _____

State _____ Zip _____ Country _____

Card No. _____

Expiration date _____

Four digits above name—Master Charge only _____

Signature _____ Date _____

Please allow eight weeks for processing. Thank you.

-
- 1 year
-
-
- 2 years
-
-
- 3 years

- USA
-
-
- \$21
-
-
- \$38
-
-
- \$55

- Canada
-
- Mexico
-
-
- \$23
-
-
- \$42
-
-
- \$61

-
- \$69. Europe (air delivery) payment enclosed
-
-
- \$37 Worldwide (surface mail) payment enclosed

(Air mail rates available upon request)

Please remit in US funds drawn on a US bank. Thank you.

-
- Check enclosed (Bonus: (North American only) one EXTRA issue—receive 13 issues for the price of 12)



-
- Bill me (North America only)

BYTE THE MICRO COMPUTER

SUBSCRIPTIONS

4186

For a subscription to BYTE, please complete this card.

Name _____

Address _____

City _____

State _____ Zip _____ Country _____

Card No. _____

Expiration date _____

Four digits above name—Master Charge only _____

Signature _____ Date _____

Please allow eight weeks for processing. Thank you.

-
- 1 year
-
-
- 2 years
-
-
- 3 years

- USA
-
-
- \$21
-
-
- \$38
-
-
- \$55

- Canada
-
- Mexico
-
-
- \$23
-
-
- \$42
-
-
- \$61

-
- \$69. Europe (air delivery) payment enclosed
-
-
- \$37 Worldwide (surface mail) payment enclosed

(Air mail rates available upon request)

Please remit in US funds drawn on a US bank. Thank you.

-
- Check enclosed (Bonus: (North American only) one EXTRA issue—receive 13 issues for the price of 12)



-
- Bill me (North America only)

*Note our special offer!
Send cash with your order
and receive 13 issues
for the price of 12 for
each year you subscribe.
(North America only, please.)*

Don't Miss An Issue!

Have BYTE delivered to your door.

Each month BYTE will bring you the latest in microcomputer technology.

DISCOVER and IMPLEMENT new ideas. Don't miss the original information presented in the pages of BYTE.

With BYTE you'll always be among the first to know about the important breakthroughs, worthwhile new equipment, and innovative projects in the world of computing.

CHALLENGE US to deliver the very best idea in microcomputers and advanced technology to you. Return the attached card today!

Subscribe to BYTE—the world's leading computer magazine.



NO POSTAGE
NECESSARY
IF MAILED
IN THE
UNITED STATES

BUSINESS REPLY MAIL
FIRST CLASS PERMIT NO. 39 MARTINSVILLE, NJ

POSTAGE WILL BE PAID BY ADDRESSEE

BYTE SUBSCRIPTIONS
PO Box 597
Martinsville, NJ 08836-9956
USA

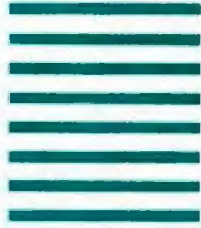

NO POSTAGE
NECESSARY
IF MAILED
IN THE
UNITED STATES

BUSINESS REPLY MAIL
FIRST CLASS PERMIT NO. 39 MARTINSVILLE, NJ

POSTAGE WILL BE PAID BY ADDRESSEE

BYTE SUBSCRIPTIONS
PO Box 597
Martinsville, NJ 08836-9956
USA



TODAY IS THE BLACKEST DAY IN DOT MATRIX PRINTER HISTORY.

It would pay you to mark it on your calendar.

Because today is the day we introduce our new Pinwriter™ P5XL dot matrix printer. The only dot matrix printer available capable of producing the rich, black printing you associate with a letter-quality printer. Because it's the only one designed to use a multi-strike film ribbon — the same ribbon used in typewriters and letter-quality printers.

A LITTLE BLACK MAGIC.

Actual line printed with the
Pinwriter P5XL printer.

Black letter-quality printing is only the beginning. The Pinwriter P5XL printer can also use an optional ribbon to print in seven other colors. And it has the finest graphics resolution of any impact printer you can buy. Plus it's very fast and exceptionally quiet.

It's only natural that

the first dot matrix printer with true letter-quality printing should be an NEC. After all we make Spinwriter® letter-quality printers, the most popular line today, as well as the Pinwriter P5 dot matrix printer, the most advanced 24-pin printer.

The Pinwriter P5XL printer is part of the most extensive line of 24-pin printers available. You'll find a model designed to fit every need and budget. See them at your dealer or call 1-800-343-4418 (in MA 617-264-8635). Or write: NEC Information Systems, Dept. 1610, 1414 Massachusetts Ave., Boxborough, MA 01719.

**NEC PRINTERS. THEY ONLY STOP
WHEN YOU WANT THEM TO.**

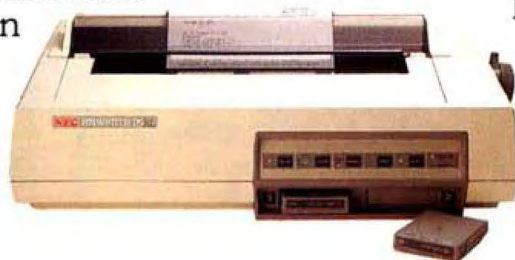

Radio Shack has the best



...of everything

Accessories can make the difference between just a computer system and an *efficient* computer system. That's why Radio Shack offers the finest in accessories and support.

If your computer workspace needs organization, then our beautifully styled, simulated oak finish Computer Workcenter (A, \$99.95) is just what you need. It features a full-width monitor shelf, space for a computer and printer, plus plenty of workspace.

From 3½ to 8", single-or double-sided, 40 to 80-track,

we've got the diskettes (B) you need. Store your diskettes safely in our Disk Storage Box (C, Low as \$12.95)—three sizes to choose from! And to keep your disk drives in top form get our Disk Drive Head Cleaning Kits (D, Low as \$7.95). Choose the right kit for your particular drive.

We have a full selection of fanfold printer paper (E, Low as \$8.95). Choose 9½ x 11" or 147/8 x 11", available in various sizes and quantities.

Finally, our Universal Monitor Pedestal (F, \$16.95) allows

you to tilt or rotate your monitor for maximum viewing ease. The pedestal holds all Tandy monitors, and matches the monitor's color and finish.

Come in and see our complete line of computers and accessories. We offer the systems you need at a price you can afford. Visit a Radio Shack Computer Center today!

Radio Shack®
The Technology Store™

A DIVISION OF TANDY CORPORATION

Prices apply at Radio Shack Computer Centers and participating Radio Shack stores and dealers. Components pictured with accessories not included.

Inquiry 252